



# SILENT AUCTION

Super X - Model 1

**AMOSKEAG**  
AUCTION COMPANY, INC.

AUCTION NO. 105  
MARCH 28 & 29, 2015

# AMOSKEAG MARCH 28 & 29, 2015 - SALE NO. 105 - SILENT

## TERMS AND CONDITIONS OF SALE

### GENERAL STATEMENTS

- The Silent Auction is by absentee bidding only. Absentee bidders must register by filling out and signing an absentee bid sheet.
- The highest bidder acknowledged by the auctioneer shall become the owner upon the fall of the hammer. The auctioneer has sole discretion in the case of a dispute among bidders.
- Amoskeag Auction Company, Inc. has taken great care in the preparation of the descriptions in this catalog. Although we believe everything in the descriptions to be true, we do not guarantee any part of any description. We recommend that the bidders view the items in person and form their own opinions as to condition, originality, origin, etc. Amoskeag Auction Company, Inc. will consider all requests for refunds. If a customer is unhappy with a purchase we will be happy to discuss a remedy with them.
- Amoskeag Auction Company, Inc. reserves the right to reject any bid in order to protect our consignors interests.
- Bidding on any item in the sale indicates the bidder's full acceptance and understanding of all terms and conditions of sale.

### PAYMENT POLICY

- Amoskeag Auction Company, Inc. will accept cash, check, MasterCard, Visa, and American Express as payment for items purchased by those customers who attend the sale. Amoskeag Auction Company, Inc. reserves the right to demand cash or hold merchandise until funds are collected in full. THERE WILL BE A \$35.00 CHARGE FOR ALL RETURNED CHECKS.
- There will be a Buyer's Premium of 17.5% added to all purchases. A discounted Buyer's Premium of 15% will apply to all purchases paid by cash or check.

### GUIDELINES FOR FIREARM PURCHASES

- All Federal, State and Local firearms laws will be observed. FFL holders may take possession of any firearm on day of sale when they present a signed copy of their Federal Firearms License. New Hampshire residents over the age of 21 may take possession of any firearm on day of sale providing the proper paperwork is filled out and the transfer has been approved either through the NH State Police or the FBI NICS System. While most NICS and State approvals are immediate, approvals could take up to 3 days. Most non-residents may take possession of long guns on day of sale after completing the proper forms and successfully completing a NICS check; modern handguns will need to be shipped to an FFL holder in the buyer's home state. Buyer is responsible for any and all shipping charges and all items must be paid for on day of sale. Bidders should be familiar with their local and state laws.

Firearms are marked as follows:

ANTIQUÉ - no paperwork required

C&R - for firearms that fall under the ATF Curio & Relics licensing and if purchased by a person with a "C&R License" no paperwork is required. **NOTE:** Items that meet the age requirements but have been altered from their original configuration may NOT be delivered on a C&R License.

Firearms that are not marked with one of these notations are considered to be "MODERN" and all proper paperwork is required unless you are an FFL Dealer.

## WARNING

Amoskeag Auction Company, Inc. **does not** warranty the safety of any article it sells. Therefore, we recommend that, before you use any firearm, purchased here or anywhere else, you have it examined by a qualified gunsmith to determine whether or not it is safe to use.

250 commercial street - suite 3011 - manchester, new hampshire 03101  
603/627-7383 fax 603/627-7384 www.amoskeagauction.com  
jason & melissa devine - nh license no. 2555

**NOTE: ALL BIDS ARE DUE BY 2:00PM, MARCH 29, 2015. IF YOU ARE BIDDING ON AN EXCESSIVE AMOUNT OF ITEMS WE REQUEST THAT YOU SUBMIT YOUR BID SHEETS BY FRIDAY, MARCH 27, 2015.**

**RESULTS FOR THE SILENT AUCTION WILL BE AVAILABLE APRIL 1, 2015.**

**2000. EXTREMELY RARE U.S. MODEL 1900 AUTO PISTOL HOLSTER FROM ROCK ISLAND ARSENAL**

This is an exceptionally fine example of a U.S.-issue regulation holster for the Colt Model 1900 service pistol, manufactured at Rock Island Arsenal. The leather remains mostly supple showing light crackling over most of the surface of the body with light crackling and flaking on the flex point of the closure flap and the top and rear edges of the suspension billet. The seams and stitching remain tight overall and the "U.S." on the cover flap remains mostly visible, being slightly light along its leading edge. The rear of the suspension billet is marked "Rock Island/Arsenal/EHS". This example is one of the 276 made to be worn "butt-forward", the Ordnance Department steadfastly clinging to the antiquated cavalry "twist draw" adopted when men wore swords on the left side which they would draw with the right hand. While these fine pistols are very rare, intact holsters for them are even more seldom-encountered, total production of only 326 units fabricated. This is a very fine example worthy of display with even the nicest Model 1900 pistol. (37027-9)



(1500/2000)

**2001. EXCELLENT U.S. MODEL 1900 AUTO PISTOL REGULATION HOLSTER AND OFFICERS BELT**

This is an excellent example of a private-purchase flap holster for the Colt Model 1900 pistol. The leather is overall smooth and is a dark brown-russet color; it shows the beginnings of some light crackling and a few minor scuffs and handling marks along the lower edge of the holster, the flex point of the flap and suspension billet at the rear showing the very lightest amount of crackling. The seam stitching is tight and intact around its periphery and the "U.S." embossing on the cover flap is strong. The holster is constructed nearly identically to the U.S. government arsenal-made examples, this example however is un-marked. The holster comes suspended from a regulation U.S. officers belt with a regulation pattern 1851 Eagle belt plate. The plate itself is a Hanover Brass reproduction and rates about excellent with crisp Eagle and wreath, the rear is marked "GW" and "HBF". The belt itself appears to be an original product with overall flaking and crackling but is still mostly supple with tight seam stitching (clearly re-stitched to attach this buckle). A very nice holster overall showing nice age yet still supple. (37027-11)



(1200/1800)

**2002. VERY FINE U.S. MODEL 1900-1902 NON-REGULATION SWIVEL HOLSTER**

This is an excellent example of a high-quality private-purchase swivel holster for the Colt Model 1900-1902 semi-auto pistols. The holster is constructed of brown leather and is overall smooth and supple showing only the very lightest beginning of crackling on the flex point of the cover flap. The seam stitching is intact around the entire periphery and there is a swiveling suspension billet attached with a single copper rivet at the rear of the holster. The flap is secured with simple snap attached to the body and flap of holster, the interior shows the imprint of a Colt Model 1902 pistol. The flap is maker marked in an oval by a maker in San Jose Costa Rica with a horse's head as its trademark; the entire embossing cannot be completely read but appears to be "Talanterian Inglesa/San Jose Costa Rica". Really an excellent example overall and a very nice accompaniment to any comprehensive collection of early Colt automatic pistols. (37027-10)



(400/600)

**2003. NICE BRONZE BRITISH GRENADE MORTAR FROM LAPAN FOUNDRY**

This is a nice little bronze mortar with a 2 1/4" bore about 3 1/2" deep with a 1 3/4" deep charge reservoir; it is lightly oxidized green. The outside diameter at the muzzle ring is about 4" with an overall length of roughly 7 1/2". The center reinforce shows a cast-in-relief cipher of King George "GR" and there is a small priming reservoir at the vent field. The trunnions are about 1 1/4" in diameter and 7/8" long, the left trunnion with LaPan foundry's intertwined "LP". The mortar sits atop a nice hardwood block bed with cast capsquares retained by captive wedges, chained to the body of the bed. There are brass handles on each side for carry. Purportedly originals would throw a 1 pound explosive shell a half-mile. The overall finish is slightly rough as-cast; the bore is a bit rougher. Really an attractive and compact little piece, likely tons of fun. (36985-2)

**2004. BRONZE MUZZLELOADING SALUTE CANNON BARREL**

This is a cast brass or bronze salute cannon, about 1 1/4" bore 14" deep with an oxidized slightly rough bore. The overall length is 16 3/4" and the body is smooth its entire length without reinforces, astragals or fillets. The trunnions are 1 1/4" in diameter by about 1 1/4" in length and the rear shows a cast-in relief eyelet, perhaps the attachment for some manner of elevation device once on a carriage, the rearmost face of this as well shows a drilled and tapped hole, perhaps for some manner of tiller. The body of the cannon shows overall light dings with a couple that are moderate and a few that are heavy, one of the trunnions being slightly bent and showing a small crack. The underside about 4" from the muzzle shows what may be casting flaws in the surface, appearing to be small cracks, lightly crazed. The tube is completely unmarked and is vented, it is likely however this piece should be relegated to display only at this stage. Nonetheless it would make an impressive display piece properly dressed and polished with a nice carriage. Weight is about 30 Lbs. (36579-3)



2005. **CAST IRON SALUTE OR DISPLAY CANNON BARREL** This is a cast iron "howitzer"-looking barrel with 2" bore 18 1/2" deep and as-cast, slightly rough, with sprue at the rear-most section. The muzzle flare is rather generous and there are four round medials adjacent to the trunnions and the breech area is rather bulbous and also rather generous with two medials ahead of the cascabel. Slightly rough as-cast on the exterior, now painted black. The trunnions are about 1 5/8" in diameter and about 2 1/2" in length. The tube is not vented. Weight is about 50 Lbs. (36579-4)
2006. **LARGE CAST IRON MOUNTAIN HOWITZER BARREL** 2" bore about 19" deep, lightly and moderately oxidized. There is a flat muzzle face with a slightly raised medial, the outside diameter at the muzzle nearly 5". The body is mostly straight its full length with a slightly raised section at the trunnions. The overall length from the muzzle face to the very large cascabel is 26 1/4". The trunnions are 3" in diameter by about 2" long. Over all the metal surfaces are slightly rough as-cast with overall pits, it is currently painted a slightly oxidized black. The tube is vented and the weight is about 130 Lbs. (36519-576) [Richard "Stretch" Kennedy Collection] [Extra Shipping Will Apply]
2007. **CAST IRON CANNON BARREL** This is roughly-cast and could almost be considered a scale model of a British three-pounder. There is an about 1 3/4" bore about 33" deep with a rough as-cast bore showing a mould seam down the center of each side. There is a rough-cast muzzle face, slightly flaring muzzle ring, a smooth chase to two medials ahead of the trunnions-they are unturned. There is another medial just ahead of what would be the breech reinforce, but there is no actual "re-enforce" per se as the tube merely tapers front to rear without additional heavier reinforcing steps. There is a breech ring and a somewhat smallish cascabel giving an overall length of about 40". The trunnions are about 1 1/2" in diameter and about 3" long, they appear welded to the tube rather than being cast integrally. The tube is not vented and weight is 125 Lbs. A nice base overall for someone wishing to do their own final finishing for a display gun or the craftsman who wishes to go even further and machine the tube for a high tensile steel liner. (36519-577A) [Richard "Stretch" Kennedy Collection] [Extra Shipping Will Apply]
2008. **CAST IRON CANNON BARREL** This is roughly-cast and could almost be considered a scale model of a British three-pounder. There is an about 1 3/4" bore about 33" deep with a rough as-cast bore showing a mould seam down the center of each side. There is a rough-cast muzzle face, slightly flaring muzzle ring, a smooth chase to two medials ahead of the trunnions-they are unturned. There is another medial just ahead of what would be the breech reinforce, but there is no actual "re-enforce" per se as the tube merely tapers front to rear without additional heavier reinforcing steps. There is a breech ring and a somewhat smallish cascabel giving an overall length of about 40". The trunnions are about 1 1/2" in diameter and about 3" long, they appear welded to the tube rather than being cast integrally. The tube is not vented and weight is 125 Lbs. A nice base overall for someone wishing to do their own final finishing for a display gun or the craftsman who wishes to go even further and machine the tube for a high tensile steel liner. (36519-577B) [Richard "Stretch" Kennedy Collection] [Extra Shipping Will Apply]

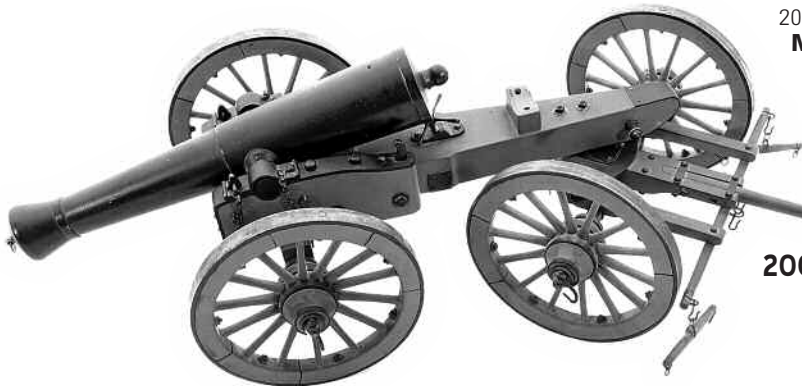

2009. **EXTREMELY NICE SCALE MODEL OF THE U.S. MODEL 1841 6-POUNDER**

This is an extremely nice, read that Museum-grade, scale model of the U.S. model 1841 six-pounder field gun. The steel barrel has an about 5/8" bore 10" deep. The barrel is a nice reproduction of the full-size tube with muzzle face, flare, medial chase and slight reinforce nearer the breech from the trunnions rearward, with breech ring and cascabel. The barrel is

2009

mounted to an extremely nice siege carriage with the appropriate limber included. All the iron hardware is appropriately painted black, the faces of the tires worn to silvery brown gun-metal.

The "wood" pieces painted an olive drab green. The overall condition is quite nice with the tube showing a few small flaked areas, the wood on the wheels has shrunk slightly with age, a number of the felloes showing some prominent gaps due to shrinkage and the hub reinforces now slightly loose. Model is very detailed and working in every respect; a nice brass tompion is included. The cannon was purchased by the consignor from the George Woodbridge estate. George was a military historian and illustrated many books, you would recognize his work from George Neumann's Collector's Illustrated Encyclopedia of the American Revolution and American Military Equipage, 1851-1872 by Frederick P. Todd. He was named a fellow of the Company of Military Historians in 1961 and interestingly enough was also an illustrator for MAD Magazine of all things. Really just an absolutely super scale model. (36985-5) (500/700)

2010. **SCALE MODEL U.S. MODEL 1841 6-POUNDER** This is a very nicely-made model of a U.S. model 1841 six-pounder field gun. The bronze or brass barrel has a 7/8" bore 14 1/4" deep with the tube having an overall length of 16 1/2"; it is not vented. It has a nice turned muzzle face, flaring muzzle, fillet and astragal and smooth chase to the reinforce with a nicely turned breech ring and cascabel. The barrel sits atop a nice No. 1 field carriage. The tube is a deep tarnished ocher patina while the wooden portions of the carriage are an O.D. green with all the iron hardware painted black. One of the side handles on the tailstock is missing as is one of the capsquare wedges. The wheels are designed to rotate, although it would seem they need a little bit of oil, the elevation screw works well. Overall a very nicely made cannon that should have a little bit of work done to it and have some loading tools and perhaps a miniature tar bucket made for it. Overall length is about 33". with a maximum width of about 19". Very top-shelf overall however. (36519-641A) [Richard "Stretch" Kennedy Collection] (700/900)

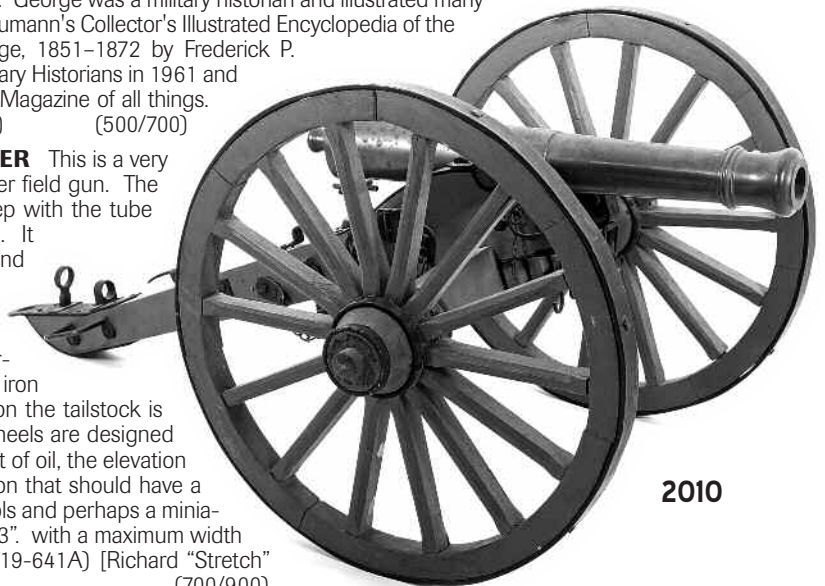

2010

2011. **FINE SCALE MODEL NAVAL 6-POUNDER** This is a nicely-made, what appears to be scale model of a Naval six-pounder, on a Naval or Garrison style carriage. It is just over 3/4" in diameter with a slightly to moderately oxidized bore 18 1/2" deep. The barrel is an overall length of about 23 1/2" with a lipped muzzle face and flared muzzle with two astragals with fillets and rings and ogees at each end of the second reinforce and a long-ish vent field ahead of the breech ring. The muzzle face is marked "Middleton Ironworks/Middleton New Hamp/DLN WT-47 LB N92" and it would appear as though there is a modern steel liner installed in the tube; the gun is vented. The trunnions are about 1 1/4" in diameter and roughly 2" long, the left one is marked "1982". This tube sits atop a nice-quality oak carriage in the Naval or Garrison style. The carriage itself rates very good plus to excellent with nice rounded wheels, without tires. There is an elevation chock in place which rides in a grooved bed affixed to the rear axle stretcher. One of the retaining pins which keeps the wheel on the axle is no longer present and one of the capsquare eyelets is missing, the one which is present is not drilled for a wedge. There is a nicely-made muzzle plug accompanying the gun and the overall length is about 24 1/2" and 11 1/2" wide. Really very nicely made, the black paint showing a number of minor chips flakes and handling marks. While it would appear as though this cannon was designed to be fired, clearly some work will need to be done to affix the capsquares in a more permanent fashion to keep barrel on carriage during firing. Very attractive overall, the weight of the entire unit is 60 pounds. (36519-641C) [Richard "Stretch" Kennedy Collection]



2011

2012. **LARGE SCALE MODEL NAVAL-STYLE SALUTE CANNON** This is a rather large iron-tube cannon with what appears to be a steel liner. The bore is about 2 3/8" in diameter and about 32" deep, lightly oxidized. The tube itself is in 7" diameter and about 43" overall length with a very large cascabel, almost the size of the diameter of the tube itself. This sits atop a Naval or Garrison style carriage of softwood, the barrel retained by two welded steel capsquares bolted to the top flat. There is a bead front sight affixed and a small peep sight rear; the gun is vented. The wheels are 7" in diameter and are wood, capped with sheet iron or tin, the overall length muzzle to end of carriage is about 44". There is no elevation block however one could be fabricated easily. The overall weight seems to be in excess of 230 Lbs. (36239-1) [Extra Shipping Will Apply]
2013. **SPANISH SCALE MODEL NAPOLEON CANNON** serial #11276, .70 Cal, 13 1/4" bore showing only some light oxidation. The steel barrel is about 15 1/4" overall and is mostly a bright pewter in color showing some sparsely scattered very light oxidation staining in a number of spots. The hardwood carriage rates about excellent with nearly all its original varnish intact and only a light handling mark here or there. The balance of all the metal is finished bright and largely unstained. The gun includes the chained wheel stop and both rammer/cleaning brushes are present. The barrel is "Jukar Spain"-marked along with the caliber and serial number. A nice example overall that would be super for Fourth of July or any other occasion worthy of celebration. (36935-48)

2014. **SPANISH SCALE MODEL NAPOLEON CANNON** .72 Cal, 13 1/4" bore showing only some light and some moderate oxidation. The steel barrel is about 15 1/4" overall and is a dull gunmetal gray with light surface oxidation across its top surfaces, a spot or two which is more moderate. The hardwood carriage rates very good with lightly flaking original varnish intact and some minor handling marks here or there. The balance of all the metal is finished bright and now has an overall light coating of oxidation, there are metal ammunition boxes affixed to the axles left and right of the cheeks. The gun includes the chained wheel stop and one rammer/cleaning brush is present. The barrel 15 unmarked but this clearly is one of the offerings from CVA, likely from the 70s. A nice example overall that would likely clean up rather well. (36519-641B) [Richard "Stretch" Kennedy Collection]



2015

2015. **UNMARKED NAVAL STYLE BREECH-LOADING SIGNAL CANNON** 8 Ga., 23" overall length barrel with a 21 1/8" bore showing some moderate oxidation. The barrel is heavy iron and has a nice muzzle flare, tapering its full-length from a heavy outer iron breech section. The rear-most of breech section is about 3" square with a vertically-sliding breech block. There is a spring-loaded striker fitted, there is no trip mechanism in place. The gun is mounted on a conical heavy brass base looking very much like a Naval mount. The brass is a dark tarnished ochre patina and has six drilled holes for attachment lags. The diameter of the base is 7 1/4" with an overall height of 7 3/4". The overall length when assembled with breech is 25 3/4". The cannon weighs 35 Lbs. (36935-49)

2016. **UNMARKED BRASS SALUTE CANNON** This is an all brass-constructed cannon on a field style carriage. The bore is about .36 cal about 7 1/2" deep and is likely vented for likely firecracker fuse, designed as a salute cannon only and not for projectile use. The barrel itself is 9 3/4" with a flared muzzle, trunnion reinforce and somewhat large cascabel at the breech ring. The single trail trace is roughly 12 1/2" overall with an overall length muzzle face to trace ring of 16 1/2". The brass is an overall slightly tarnished gold-enrod patina with a very bright hue. A very attractive looking cannon overall. (36852-4)
2017. **HEAVY IRON DISPLAY CANNON** This is an antique iron salute cannon. It consists of the cannon tube, heavy iron capsquares, split trace and two spoked iron wheels attached to a heavy iron axle. The bore is about 1 5/16" and is heavily eroded and about 18" overall length. The gun is vented and there is a touchhole present as well as the remnants of what may have been some type of a striker mechanism at the rear face of the breech and atop the trunnion reinforce; perhaps there was a nipple attached years ago for musket cap ignition. The barrel no longer pivots nor do the wheels rotate on the axle, but this could likely be rectified by someone with some time and talent to devote to the piece. It is currently painted black and is overall lightly and moderately pitted beneath the enamel. The wheels are 14" in diameter and six-spoked, currently the barrel and trace are held onto the wheels axle by gravity only. It would appear as though there was a stretcher along the rear most portion of the trace at some point, it is no longer present and a hardwood block holds the two-pieces together. The unit is very heavy and weighs about 185 Lbs, the overall length is 32 1/2" and width axle tip to axle tip is about 20 1/2". A number of the spokes show cracks on the wheels but they are stable and do not move. Still a very attractive and large piece for the gun room or den. (37008-2) [Extra Shipping Will Apply]



2018. **SCALE MODEL NAPOLEON CANNON WITH LIMBER**

This is an attractive model cannon made of die cast zinc and wood with molded plastic wheels. Model is a faithful reproduction of a Napoleon six-pounder and is quite detailed. Includes rammer, powder scope, towrope and chains and the capsquares and wedges are removable. The limber is similarly constructed and also very nice, the lid of the ammunition chest is hinged and operates. An attractive die cast zinc and wood set overall for bookshelf or desktop. (34299-83)

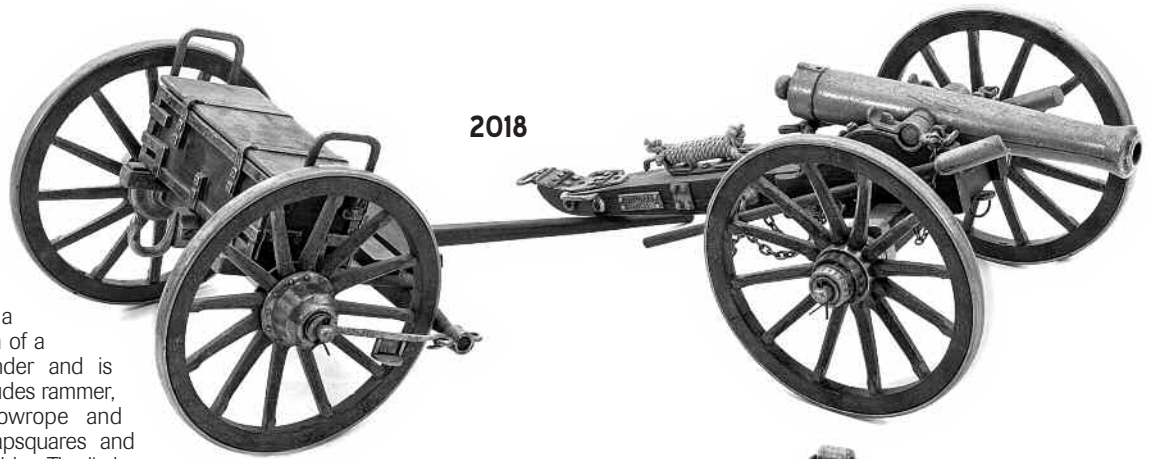

2018

2019. **SCALE MODEL COLT MODEL 1883 GATLING GUN** This is a nicely detailed die cast zinc model of a Colt 1883 Gatling gun on an iron carriage. The model is zinc, wood and with molded plastic wheels. The model is quite detailed and features a movable rear sight, cranking handle which turns and rotates the barrel mechanism and a detachable Accles feed drum. Additionally the gun will operate through its full traverse of elevation and depression. Very good plus to excellent overall. (34299-84)

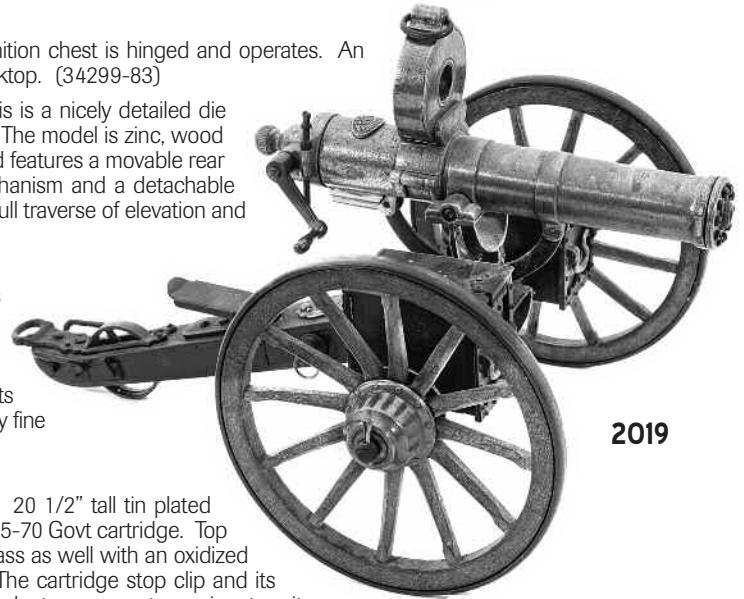

2019

2020. **GATLING MODEL 1877 VERTICAL FEED MAGAZINE** 20 1/2" tall tin plated sheet iron 40 rd. magazine with heavy brass feed throat for the 45-70 Govt cartridge. Top is heavy cast brass, soft-soldered to the body, the follower is brass as well with an ocher-colored thumb piece. The cartridge stop clip and its spring are intact and functional. Magazine has a minor dent or two at its top most section and a minor compression mid-body. Overall very fine with traces of original tin plate, primarily a dull gunmetal gray. (36519-659) [Richard "Stretch" Kennedy Collection]

2021. **GATLING MODEL 1877 VERTICAL FEED MAGAZINE** 20 1/2" tall tin plated sheet iron 40 rd. magazine with heavy brass feed throat for the 45-70 Govt cartridge. Top is heavy cast brass, soft-soldered to the body, the follower is brass as well with an oxidized thumb piece showing some rust and a green oxidized patina. The cartridge stop clip and its spring are intact and functional. Magazine has a couple minor dents, one most prominent on its left side halfway down, easily raised through the magazine follower slot opposite it. Overall fine with scant traces of original tin plate, primarily a dull gunmetal gray. (36519-659A) [Richard "Stretch" Kennedy Collection]



2020

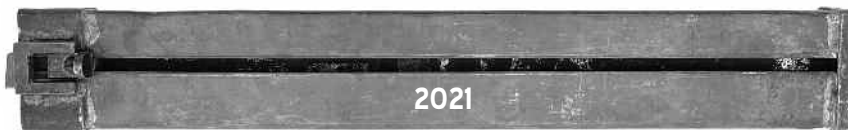

2021



2022



2023

2022. **GATLING MODEL 1871 VERTICAL FEED MAGAZINE** 15" curved magazine, second type with one-piece spring catch stop clip which retained cartridges until inserted into gun. Caliber is .50-70. Top is soldered-on tin-plated sheet iron, as is the body. Body is stiffened by three rolled-in ribs on each side. follower is heavy brass and the thumb tab is a tarnished ocher patina. Overall very fine, primarily a gunmetal gray with remnants of original tin, strongest on its left side. (36519-660) [Richard "Stretch" Kennedy Collection]

2023. **GATLING MODEL 1871 VERTICAL FEED MAGAZINE** A large 19" curved magazine, first type of 1871 with the detachable magazine cover, rather than the spring catch. The caliber is likely .43 Berdan or .43 Spanish, both of which fit the magazine well, the .45-70 being too short and the .50-70 being much too short. In 1868 the Russian's took delivery of .42 Russian (.43 Berdan) chambered Gatlings, in 1873 the Spanish Government in Cuba ordered guns in .43 Spanish (the Gatlings used in the U.S. Ordnance dept. "Fortress Monroe Trials" in 1873 were chambered for the .42 Russian cartridge). The early guns had this style of magazine, it's no stretch to assume they could have been made as early as 1868 and would have certainly still been around in 1873. No follower or magazine cover is present; the chain is still attached however. Overall light oxidation but good plus to very good. (36519-660A) [Richard "Stretch" Kennedy Collection]

2024. **GATLING GUN CAVALRY CART YOKE** The tall thin-armed sculpted style yoke seen typically on light cavalry carts and some tripod mounts. 1" center mounting hole in base with brass-trunnion seats for 1 1/4" dia. trunnions. The left capsquare catch shows an old repair to the ball-shaped knob, both catches are still fully functional. There are no markings discernible at all. Base diameter is 9 5/8", height from base flat to center of trunnions is 8 3/8" with the inside of the harp measuring 8 5/16" capsquare flat to capsquare flat. Overall about fine with about 90% of its original black paint lightly flaking. (36519-578) [Richard "Stretch" Kennedy Collection]

2025. **GATLING GUN STUCK CASE REMOVER** is an iron rod with split for end and round hanger loop handle. The rod measures 38 1/4" overall length and shows remnants of original black enamel but is primarily overall a light oxidized brown which should clean to a nice smooth patina. These are designed for 45-70 caliber barrels and are inserted from the muzzle and designed to remove a stuck or separated case that remains in the chamber. A very neat Gatling gun accessory, very nearly indispensable "back in the day". (1X6519) [Richard "Stretch" Kennedy Collection]

2026. **WINCHESTER MODEL 1885 FOREARM** This custom forearm rates very good plus to excellent as-refinished (or perhaps new-made) with its ebony forend tip intact. The forearm is for an octagon barreled rifle with an about 1" width across the flats. It has a Winchester-style tuning fork palm rest added at a later date, it is numbered "2144" in the interior barrel channel. The tuning fork is blued and rates excellent, its pivoting attaching hardware retains all its original nickel, both parts are likely modern. (37026-10A)

2027. **WINCHESTER MODEL 1885 FOREARM** This custom forearm rates very good plus to excellent as refinished (or perhaps new-made) with its ebony forend tip intact. The forearm will fit an octagon-barreled 1885 Winchester with 1 1/8" width, across the flats. The forearm has a nice color case-hardened palm rest base neatly installed on its belly. A quality-made forearm in a very nice state of condition. (37026-11A)

2028. **BRITISH BROWN BESS SOCKET BAYONET BY KETLAND** This is a nice British Brown Bess bayonet with 16" blade and 20 5/8" overall length. The blade has a flat face and is stamped "WK" at its root, we surmise William Ketland, and what appears to be "Broughton" or "Roughton", the first couple letters are lost due to light pitting. The socket is 4" in length and is a plum brown patina with an L-shaped mortise and reinforcing medial along the rearmost edge. The root of the blade has a number of vise or clamp marks that are very old. As mentioned the blade has a flat face with near full-length back flutes. The blade is an overall dull pewter gunmetal gray with light oxidation staining and near overall pinprick pitting, some spots may be closer to moderate. The blade comes in an antique leather frog with tight seam stitching and a brass rear frog-hook, dual-riveted. There is a tip chape which was painted yellow and the throat itself was painted yellow as well, the body is still overall supple with only light crackling. Really a very nice Brown Bess bayonet overall with some nice markings, further research may prove their true identity. (37082-11A)

2029. **U.S. MODEL 1903 SPRINGFIELD ACTION** A nice 1903 action serial #941520, overall condition is excellent retaining 98% original or arsenal deep black phosphate finish. Appears perhaps arsenal "re-parked" or blued, receiver left side has an index mark so it is likely it was barreled at one time. Bolt has bent handle, swept slightly rearward and is "R" and "3" marked. All milled bottom metal, trigger assembly is an excellent quality commercial, fully adjustable (likely Timney) offering (nice t. pull). The perfect platform for a top notch custom rifle or for a military 1903 re-store. (37023-22) [Mark Benenson Collection]

2030. **REMINGTON HEPBURN FALLING BLOCK ACTION** This is a nice in-the-white Remington Hepburn falling block action. It has been dressed and has pistolgrip-style bottom metal nicely curved. The hammer and trigger show some rough casting marks with a prominent seam on the rear of the trigger. The hammer is powered by a coil mainspring, rather than a flat style. While it does not appear to be an original Remington Hepburn action, it is still quality-made throughout, perhaps one of the many kits that are available on the market. (37022-167) [Mark Benenson Collection]

2031. **GERMAN MAUSER SMALL RING 98 ACTION** serial #67804 This is an essentially stripped German small ring Mauser action, likely from a Car. 98. The action and the bolt assembly are all in-the-white. The action has been neatly polished and its rear ring nicely machined into a sporting contour. The bolt assembly is polished bright as well and the handle has been very nicely low-forged and swept for scope clearance, the original safety is still intact but low scope safeties are plentiful. The bottom metal is a black enameled hinged-floorplate aluminum offering from Brownell's. The floorplate features a pronghorn antelope and oakleaf and acorn decoration, it rates very good with a couple flakes in the enamel. There is no magazine spring nor follower present, there is no trigger assembly present. The receiver rings have been nicely drilled and tapped for scope bases, there is a front one-piece steel Redfield base in place. The bolt stop/ejector is present, there is only one action screw. (36758-49)

2032. **WINCHESTER PRE '64 MODEL 70 ACTIONS** serial #224918 & 149327. Both receivers are completely stripped, the earlier still retaining the stripper clip cut in the bridge. They are both a dark mottled gray-blue patina, both with four drilled and tapped holes atop the receiver and two for receiver sight on the left side of the ring. There is a stripped aluminum triggerguard included which rates about very good with overall minor dings and scratches and a bolt assembly included numbered 395691, the shroud screw is missing. The handle and shroud are a dark gray-blue with the bolt body showing some light oxidation staining. (37023-21, 23)

2033. **SAVAGE MODEL 99 LEVER ACTION** serial #332003, This action appears complete and seems to function well. It is straight-gripped and retains the lever style safety catch rather than top-tang mounted. The surfaces are an overall dull gray and speckled oxidized brown patina with pewter undertones beneath. Dressing has just started to be done atop the action ring where draw filing marks are present. The bolt body is now a dull pewter with minor oxidation staining. The cartridge counter is brass and there is a top-of-action cocking indicator; the sear screw nut on the right side of the action has been replaced with a brass example. (37023-25)



2034. **WINCHESTER MODEL 1885 HIGH WALL ACTIONS** serial #124371, and NSN. These are both flat thick-sided actions, the serial numbered example showing strong traces of what appears to be original blue with overall flaking to brown also showing some light oxidation and perhaps the oddly scattered pinprick pit; this is more prevalent on the lower curved pistolgrip tang. The lever shows some strong restored blue finish as does the hammer, the breechblock shows some very nice pale original color case-hardening. The action appears mostly complete and mechanically functional, it is missing the extractor, hammer spring and trigger spring as well as one of the filler screws for the upper tang. All of the Winchester factory markings are still visible and the breechblock appears to be rimfire. The action missing the lower tang has been lightly dressed and is now in-the-white, showing evidence of also having some water damage, which has left light water spot oxidation over most of the action. Lever, breechblock and hammer all show later reblued finish. In addition to the lower tang, the extractor is missing, we do not know what other parts may not be present. Breechblock appears to be centerfire. (37023-20,24)
2035. **LOT OF NORWEGIAN KRAG ACTIONS.** These appear to Kongsberg-manufactured actions, one dated 1916 the other 1924, serial numbered 11854 and 26640. 26640 is for salvage of parts as there is a large crack from the magazine box to the receiver ring, this directly behind the ring proper. The complete magazine assembly and bolt assemblies are present as is the complete trigger assembly. There is no bottom metal nor barrel. The other action has a magazine gate (only), no magazine cover and the bolt is only partially present, missing its shroud and attendant parts, the striker and spring are present with a peep sight affixed to the rear of the striker. There is a sear but no trigger. Both actions are deep gray blue with some light oxidation, one bolt knob with fairly prominent oxidation. (37023-19A,B)
2036. **KRAG-JORGENSEN MODEL 1896 BARRELED ACTION AND STOCK** serial #62853, 22 3/8" shortened barrel with a very good plus bore which is mostly bright with sharp rifling showing some scattered light frosting. The barrel is an overall dull gray-blue patina showing scattered light oxidation and some moderate pitting on the underside which would've been beneath the wood line. The action is stripped and is a silvery speckled case-hardened patina with light brown oxidation staining. The muzzle has been fitted with a sporting banded front sight ramp which may be homemade, it supports a Marbles ivory bead, the rear shows a custom-made sight base which has a Marbles semi buckhorn sight affixed. The barreled action sits in a nice American walnut sporter stock from Herter's. The stock is Monte Carlo style with a semi-roller cheekpiece and features checkered panels front and rear and has plastic forend tip, gripcap and buttplate. It rates about very good with overall original Herter's varnish with minor dings and handling marks, the cheekpiece has been dressed down and is without finish. The only other parts included with the gun are a magazine cover plate, a trigger, the magazine cut off, an as-cast sear assembly and a striker assembly with extractor attached (there is no bolt body). Overall a pretty decent start to making an antique Krag sporting rifle. (37022-57) {ANTIQUÉ}
2037. **SAVAGE MODEL 99 LEVER ACTION BARRELED ACTION** serial #500962, 300 Savage, 24" barrel with a bright excellent bore. The barrel retains about 97% original blue while the action retains a similar amount of later rust blue, perhaps done by Griffin & Howe when they attached the side mount G & H base which is present (there is no ring set present). The lever retains excellent original color case-hardening. The gun appears to be complete and functional in every respect however there is no wood present nor are there any sights on the barrel. (37022-131)
2038. **WINCHESTER MODEL 1885 HIGH WALL BARREL AND ACTION** serial #64930, 30 U.S. (30-40 Krag), 30" round No. 3 weight barrel with a poor bore. The metal surfaces of the barrel are an overall dull gray and speckled brown oxidized patina with scattered minor dings, handling marks and some light pitting. The action is in a similar state of condition showing some moderate and heavy oxidation which will result in pitting once removed, this is confined primarily to the sides of the action and could be dressed down and removed without affecting the integrity of the frame. There is a centerfire breechblock included which shows some generous traces of original color case-hardening and the lower tang is fitted with double set triggers; there is an appropriate elongated lever which accommodates those triggers. There are no other parts present. Barrel and frame are not set-up tight and while this barrel is un-serial-numbered, a tag hanging on it indicated it went to this action. (37023-28)
2039. **WINCHESTER MODEL 1885 HIGH WALL BARREL AND ACTION** serial #99090, 30 U.S. (30-40 Krag), 30" No. 3 weight barrel with a fair bore. Barrel and action are primarily a dull gray-blue with scattered oxidation speckling, some light handling marks and a few spots of light pits. There is a Savage-style front sight and a Winchester semi buckhorn rear sight. The frame is primarily a dull pewter gray with brown oxidation staining and scattered light pitting, the tang and lever are similar. The straight grip walnut buttstock rates fair-good showing an old repair to a long crack left and right of tang (top and bottom as well); a cross-bolt repair has been made through the cheeks of the stock, there is now evident synthetic filler in that area. The forend fits the barrel very well and rates good with overall dings and handling marks and worn finish, its ebony tip insert is intact. The gun seems to function well mechanically and while the barrel is not serial numbered, a tag affixed to it numbered it to this receiver. The crescent buttplate does not fit precisely, there is quite a gap at its fit at the heel, showing the beginnings of two very small cracks at its leading front edge. It should be noted that currently barrel and action are disassembled from each other. (37022-50)
2040. **WINCHESTER MODEL 1885 HIGH WALL BARREL AND ACTION** serial #45196, 22 WCF, 26" octagon No. 1 weight barrel with a poor bore. The barrel is an overall oxidized brown patina with areas of light and moderate pitting. There is a simple Lyman front sight in place and a later homemade brass rear. The high wall frame, lower tang and breechblock all show an older nickel plate, the surfaces beneath lightly buffed with an electric buffing wheel. The serial number is extremely faint but close scrutiny has revealed the first and last two numbers, the two center numbers are this writer's opinion. The hammer, trigger and lever are a brown oxidized patina over an older reblue. The buttstock appears to be English walnut and is partially fitted and currently does not seat fully on the action. It is very nice quality, very Griffin & Howe-like. It features a rounded left side shadowline cheekpiece, nice comb flutes and a Niedner buttplate. The wood adjacent to the Niedner buttplate shows some oxidation staining leaching in. What is likely the original forend is in place, it rates fair-good with heavy added varnish and a couple-three minor cracks the ebony forend tip is intact. Barrel and frame are currently separated. An about very good project high wall overall. (37022-105) {ANTIQUÉ}
2041. **SAVAGE MODEL 1899 LEVER ACTION RIFLE** serial #279289, 30-30 Win, 20" takedown barrel (now permanently affixed) with a very good bore which shows frosting its full length. The metal surfaces retain about 90% original blue, the loss due primarily to even fading, most of the surface is now a darker gray-brown patina, with wear to pewter on the sharp edges and contact points. The straight gripped walnut buttstock is uncheckered and it does not fit precisely; it may be from a different rifle and certainly appears as though it will need final fitting. The length of pull to the 3/4" pebbled face pad is 13 3/4". The gun seems to operate well mechanically and has factory open sights with the tang drilled and tapped for an aperture base. There is no forend present. (37022-77) (200/400)





2042. **CUSTOM WINCHESTER MODEL 1885 FALLING BLOCK RIFLE** serial

#94259, (rebored to) 44 Magnum, 22" part octagon part round No. 3 weight barrel with a bright excellent bore. The barrel is an overall plum brown with light dings and handling marks and toning to pewter on the high edges. It shows remnants of a ".357 Magnum" stamping, this lightly dressed and over stamped with "44 (Mag)", according to Mr. Benenson's notes this work was done by Ward Koozer, the underside of the barrel is so-marked. The frame retains about 97% excellent quality rust blue with there still being some color case-hardening in the recesses of the breechblock. The custom lever has been toned to a plum and flaky blue patina with the custom triggerguard retaining all its nice blue. The American walnut buttstock rates excellent as neatly, very carefully refinished and is likely original equipment to the rifle, its toeline shows a walnut plug where a standard Winchester-style sling swivel with base was inletted, the butt has a smooth shotgun style plate. The forend appears to be the rifle's original Winchester forend rating good with overall dings and handling marks and worn varnish, its ebony tip is intact. A separate triggerguard has been fitted to the lower tang and the lever has been very neatly converted to loosely Farquharson or Ruger No. 1-style with a down-swept rear lip, nicely metal checkered with a catch at its leading edge which fits neatly into a recess in the triggerguard. Additionally the arm has Winchester close-coupled double set triggers which work very well. The rifle is sighted with an ivory bead front sight which is adjustable for windage, a standard Lyman folding leaf rear sight and a nice Kings locking staff, tang-mounted aperture sight. The gun seems to function well mechanically however there is no rear screw through the tang sight and therefore the tangs, the front tang screw shows some slot damage, the balance of the screws are unmolested. Really a very nicely-converted rifle showing some real craftsmanship. To this writer the front end should be done i.e. the forearm professionally refinished and the barrel re-blacked. (37022-126) [Mark Benenson Collection] (400/600)

2043. **COLT MODEL 1849 POCKET REVOLVER** serial #157514, .31 cal. percussion, 5" octagon barrel with a dark oxidized bore. The metal surfaces on this five-shot pocket are an overall lightly cleaned gunmetal gray. There are remnants of light oxidation staining and light pinprick pitting near over all; some areas of the frame and recoil shield with common pitting. All of the numbers are matching including the wedge and the cylinder scene is perhaps 40% visible. The backstrap is a dull ocher patina as is the triggerguard, showing some strong trace tarnished silver remnants at its root. The smooth walnut one-piece grip rates about very good showing an older refinish with some added varnish, the leading edges slightly shy of the grip frame, it is numbered to the gun. The gun seems to function well mechanically. Overall a good too perhaps very good example with a very frontier-used appearance. (37005-1) {ANTIQUE} (400/600)



2044. **RARE ROBIN HOOD AMMUNITION COMPANY CORRESPONDENCE**

This is a nice framed piece of correspondence on Robin Hood Ammunition Company letterhead dated October 1911. Nicely framed and matted, the letterhead shows the Robin Hood Smokeless Powder trademark along its left upper edge with the "Robin Hood Ammunition," center and right, listing the principles at the upper right-hand corner. The correspondence is between a Mr. Ellsworth of Ipswich Mass reference shotshell pricing and a descriptive flyer of the products, the company also asking for the name of a local retailer that would perhaps handle their products for them. It is signed by ET Bradley, sales manager; he was also the secretary of the company. The letterhead itself is still vibrant and very clear while the type-written text below has faded somewhat with the years; Mr. Bradley's signature in ink pen is still very crisp. There is a small section of loss at the upper right corner of the correspondence, it is inconsequential. The view measures about 8" by 10 1/2" with the frame itself measuring 12 5/8" by 15 5/8" overall. The Robin Hood Powder Company changed their name to the Robin Hood Ammunition Company in 1906, in 1915 they were acquired by Remington UMC, they would cease all operation in 1919. An extremely rarely-encountered piece of correspondence still in very fine condition. (36679-63) (300/500)



2045. **FINE U.S. CARTRIDGE COMPANY FRAMED SHOT-SHELL DISPLAY**

This is a lovely original glass and tin display from the U.S. Cartridge Company. It consists of black back-painted glass with embossed foil backgrounds showing cartridges and shotshells, the "U.S. Cartridges And/The Black Shells" advertising logo and shot sizes No. 10 through No. 4 as well as six different types of powder utilized by the company: DuPont bulk powder, EC bulk powder, Dead Shot bulk powder, Ballistite dense powder, Infalible dense powder and finally, black powder. The depictions of the shot sizes are all embossed in tin and painted dark gray against a white background, the powder features actual samples of granulated powder adhered to the tin backing. This is framed in what is likely its original dark-stained cherry or maple frame which rates very good. The image itself shows five very small flaked areas on the backside of the glass. Overall this is a really fabulous depiction, very seldom-encountered, still in a very nice state of preservation. (36678-55) (600/800)



cartridges and shotshells, the "U.S. Cartridges And/The Black Shells" advertising logo and shot sizes No. 10 through No. 4 as well as six different types of powder utilized by the company: DuPont bulk powder, EC bulk powder, Dead Shot bulk powder, Ballistite dense powder, Infalible dense powder and finally, black powder. The depictions of the shot sizes are all embossed in tin and painted dark gray against a white background, the powder features actual samples of granulated powder adhered to the tin backing. This is framed in what is likely its original dark-stained cherry or maple frame which rates very good. The image itself shows five very small flaked areas on the backside of the glass. Overall this is a really fabulous depiction, very seldom-encountered, still in a very nice state of preservation. (36678-55) (600/800)



2046. **WINCHESTER REPEATING ARMS COMPANY LITHOGRAPHED SHOT-SHELL BOARD** This is a rather large 1960's-Vintage Winchester 1897 Double "W" Cartridge Board lithograph. These were produced by "e.h.y. enterprises inc." for Winchester on a limited basis and the margin is so-marked in the lower right corner. The lithograph rates about very good with most of the depiction bright, the left upper corner showing some light fading while the whole bottom margin shows some evidence of light water staining, a few spots which may be slightly more moderate. The view measures 33 1/2" x 49 1/2" with the outer frame measuring 37" by 53". Displayed on the lithograph are 161 large rifle cartridges; 39 pistol cartridges; 39 rimfire cartridges; 15 early large caliber bullets; 11 paper shotshells; 9 brass shotshell cases and 9 tins of primers and percussion caps; calibers run the gamut from .22 to .58. A nice representative example for den or gun room without the very costly five-figure price tag associated with actual cartridge boards. (36679-62) [Extra Shipping Will Apply]

2047. **INTERESTING "STEAM-PUNK" DESK OR TABLE LAMP** This is a large "fantasy" desktop or table lamp in a "steam punk" type of motif. It features a central "tank" with an upper collector onto which a large spoked gear is attached. This is then connected to a rear "driving gear" attached to one of the large rear wheels, there are front "steering" wheels with the connecting rods being made out of combination box-open ended wrenches. There is a chromed "smokestack" at the front of the entire contraption. The construction is of welded steel with the bulk of the parts being painted a copper-tone, the driving gear and bicycle chain painted silver. All of the parts are static and immovable. These sit atop a cast-brass grate or stovepipe ring which remains a tarnished goldenrod in color. This assemblage is screwed to a hardwood base which is suspended slightly above the table on four chromed carriage bolts. The lamp staff is painted green and has a small steel ivy leaf and vine motif encircling it, the lampshade is white linen. The overall condition is as-new, the lampshade showing one small stain. An interesting tabletop lamp overall nicely crafted by some home hobbyist, perhaps a machinist perhaps a "steam punk" aficionado. (Proceeds will benefit the Franklin Opera House, Franklin NH) (37086-1) [Extra Shipping Will Apply] (200/300)





2048. **HARRY POPE TANG MOUNTED APERTURE SIGHT** This is a quality all steel aperture sight with mounting screws. The sight itself retains perhaps 85% original blue with flaking or fading to pewter along the sharp edges and contact points, with some very sparsely scattered remnants of extremely light oxidation staining. The staff is spring-loaded and the elevation of the adjustable staff is regulated by two knurled locking wheels, with small drilled holes for spanner or small punch to be inserted to tightly secure the staff from movement (it is included). The aperture block is adjustable for windage and the aperture is included. As mentioned, the small wire nut-tightening "wrench" is in place on the windage block and is included with the sight (these are easily and very often lost). The base of the windage staff is numbered "five" as is the aperture block and the sliding windage piece. The front and rear of the sight base are normally nicely radiused, this base has had a tiny bit of metal ground off front and rear, from being mounted on a various arms over the years (if one wished they could be nicely re-radiused and the base blued, it is unobtrusive and certainly not necessary). The knurled pivot-tightening thumb piece on the base has had two edges neatly flattened, directly opposing one another, so that a shooter may use a spanner to securely tighten the staff in place rather than just thumb pressure. A very nice example overall of a very seldom-encountered Pope sight. (36106-563)



2048

**THE FOLLOWING LOTS OF VINTAGE SCOPES AND SIGHTS  
ARE FROM THE COLLECTION OF MARK BENENSON**

2049. **LEUPOLD SCOPE LOT** This lot consists of a Leupold model M8-4x33mm scope serial #H407249. This fixed, 4X scope measures 11 1/2 inches in length, 1" diameter with a standard duplex reticle. The exterior metal surfaces exhibit a reddish-plum color from age as well as light ring marks. The metal surfaces also exhibit minor handling marks from honest use. The optics remain crisp and clear with the scope in very good to excellent condition overall. (67023-5-1A)
2050. **WEAVER SCOPE LOT** This lot consists of a Weaver K4-1, fixed 4x power scope. The scope measures 11 3/4" in length with a 1" tube and a standard duplex reticle. The exterior metal surfaces retain 98% original blue finish with a silver scuff on the underside of the eyepiece. The tube exhibits minor ring marks with the optics remaining clear and bright. In excellent condition overall. (67023-5--2A)

2051. **SHEPHERD SCOPE LOT** This lot consists of a Shepherd Model 310P22LR, 3-10x40mm adjustable power scope with advertized 1 shot zero capability and patented dual range finding reticle specifically made for 22LR and 22 Hornet ballistics. The scope measures 13 3/4" in length with a 1" tube. The exterior metal surfaces retain 99% original blue finish with one or two very faint marks from handling and storage. The optics are bright and clear with the scope in almost new condition overall, includes original box. (67023-5S)



2052. **REDFIELD SCOPE LOT** This lot consists of a Redfield 3-9x variable power scope serial #C16324. The scope measures 12 1/2" in length with a 1" tube and features a fine crosshair reticle. The exterior metal surfaces retain 98% original blue finish with minor wear from handling and storage. The optics remain clear with the scope in excellent condition overall. (67023-5P)
2053. **LEUPOLD SCOPE LOT** This lot consists of a Leupold Vari-X, 3-9x33mm Compact model scope serial #348130B. The scope measures 11" in length, 1" tube and a duplex reticle. The exterior metal surfaces retain 99% original blue finish with minimal wear from handling and storage as well as faint ring lines. The scope has sharp, clear optics and is in excellent to almost new condition overall. (67023-5N)

2054. **SHEPHERD SCOPE LOT** This lot consists of a Shepherd Model Type IV, 2.5-7.5x32mm adjustable power scope with advertized 1 shot zero capability and patented dual range finding reticle. The scope measures 11 1/2" in length with a 1" tube. The exterior metal surfaces retain 97% original blue finish with minor marks from handling and storage. The adjustment screws and turrets exhibit minor silvering. The optics are bright and clear with the scope in almost new condition overall, includes original box. (67023-5R)



2055. **LEUPOLD SCOPE LOT** This lot consists of a Leupold model M8-4x33mm scope serial #188400F. This fixed 4x scope measures 11 1/2 inches in length, 1" diameter with a standard duplex reticle. The exterior metal surfaces retain 99% original blue finish with minimal wear from handling and storage. The optics remain crisp and clear with the scope in excellent condition to almost new condition overall. (67023-5U)

2056. **VINTAGE SCOPE BOX LOT** This lot consists of a vintage Lyman Challenger 4x power scope box. The exterior lid is navy blue exhibiting white lettering with black detail. The corners feature metal brackets for support. The graphics remain clear with a game mount on the top and game scenes on the sides. There is a minor scuff on the top from the remnants of cellophane tape as well as information on the bottom of the base written in pencil. The box is in excellent condition overall given the age and will make a nice addition to any sportsman's collection. (67023-5U-1)



2056

2057. **WEAVER SCOPE LOT** This lot consists of a Weaver K3-C3 fixed 3x scope with Griffin & Howe double lever side mount without base. The scope measures approximately 10 3/4", 1" tube, a flat top post and crosshair reticle. The exterior metal surfaces retain 98% original blue finish with minor handling wear from limited use. The optics remain clear with the scope in excellent condition overall. (67023-5U)

2058. **LYMAN SCOPE LOT** This lot consists of a Lyman Alaskan model 2 1/2x power scope featuring Pachmayr top mount with split rings. This later model scope features internal adjustments, measures approximately 10 3/4" with a 3/4" tube and fine crosshair reticle. The external metal surfaces retain 97% original blue finish with sporadic oxidation staining. There is silvering on the high edges as well as the eye piece. This scope retains clear optics and is in very good to excellent condition overall. (67023-5AB)



2059. **ZEISS SCOPE LOT** This lot consists of a Zeiss Zielklein model 2 1/2x power scope featuring a flat top post and crosshair reticle. The scope measures 10" with a 22mm tube. The external metal surfaces retain 99% professionally refinished blue color with minor sporadic oxidation staining. There is minor wear on the adjustment knobs showing light brass color. The optics are exceptionally clear with the scope in excellent refinished condition overall. (67023-5H)
2060. **UNERTL SCOPE LOT** This lot consists of a J. Unertl Hawk model 4x power scope with a fine crosshair reticle. The scope measures 11 3/4" with a 1" tube. The tube exhibits a different color blue color suggesting a custom refinish in the distant past. The eye piece and objective housing exhibit minor scuffing and wear, the tube exhibits minor ring wear. The optics are clear with the scope in excellent refinished condition overall. (67023-16A)
2061. **R. NOSKE SCOPE LOT** This lot consists of a Noske Hunter model 2 1/2x scope with Picket post reticle. The scope measures 9 1/4" with a 1" tube. The exterior metal surfaces retain 98% original blue finish with light ring marks as well as sporadic wear from honest use. The eye piece and adjustment knobs exhibit faint silvering on the edges. The optics are slightly cloudy with the scope in very good to near excellent condition overall. (67023-5AA)
2062. **ZEISS SCOPE LOT** This lot consists of a Zeiss Zielklein model 2 1/2x power scope featuring a flat top post and crosshair reticle as well as a Griffin & Howe double lever mount without base. The scope measures 10" with a 22mm tube. The external metal surfaces exhibit sporadic oxidation staining and wear. There is minor wear on the adjustment knobs showing light brass color. The optics remain clear with the scope in very good condition overall. (67023-16)
2063. **ZEISS SCOPE LOT** This lot consists of a Zeiss Zielklein model 2 1/2x power scope featuring a flat top post with horizontal wire reticle. The scope measures 10" with a 22mm tube. The external metal surfaces exhibit minor wear and a few sporadic scuffs. There is minor wear on the adjustment knobs showing light brass color. The optics are clear with the scope in excellent condition overall. (67023-5A)
2064. **LEUPOLD SCOPE LOT** This lot consists of a Leupold Alaskan model 2 1/2x scope with duplex reticle. The scope measures 10 1/4" with a 1" tube. The exterior metal surfaces retain 98% original blue finish with sporadic wear and oxidation staining from honest use. The optics remain clear with the scope in excellent condition overall. (67023-5I)
2065. **LYMAN SCOPE LOT** This lot consists of a Lyman Alaskan model 2 1/2x power scope with crosshair reticle. This later model scope features internal adjustments, measures approximately 11 1/2" with a 3/4" tube. The external metal surfaces retain 98% original blue finish with minor wear. There is faint silvering and wear on the adjustment covers. This scope retains clear optics and is in excellent condition overall. (67023-5G)
2066. **LYMAN SCOPE LOT** This lot consists of a Lyman Alaskan model 2 1/2x power scope with crosshair reticle and a set of half turn lever rings that fit a 5/8" male dove-tail base. This later model scope features internal adjustments, measures approximately 10 3/4" with a 3/4" tube. The external metal surfaces retain 98% original blue finish with minor wear from honest use. There is faint silvering and wear on the adjustment covers. This scope retains clear optics and is in excellent condition overall. (67023-5L)
2067. **KAHLES SCOPE LOT** This lot consists of a Kahles H/26 model 2-6x power scope with sharp picket post reticle. The scope measures approximately 10 3/4" with a 26mm tube. The scope exhibits exposed locking adjustment rings with 1/2" increments. The exterior metal surfaces retain 97% original blue finish with the securing ring on both ends exhibiting exposed brass color. The tube exhibits minor wear. The optics remain clear with the scope in excellent condition overall. (67023-5Q)
2068. **AJACK SCOPE LOT** This lot consists of an Ajack 4x90 power scope with crosshair reticle and Leupold style rings without base. The scope features internal elevation adjustments and measures approximately 11 1/2" with a 26.5mm tube. The exterior metal surfaces retain 98% original blue finish with sporadic wear and oxidation staining. The optics remain clear with the scope in excellent condition overall. (67023-5T)
2069. **WEAVER SCOPE LOT** This lot consists of a Weaver 330 model scope with Weaver 22 Tip-Off base and crosshair reticle. The scope measures approximately 10 1/2" in length and a 3/4" tube. The exterior metal surfaces retain a majority of original blue finish with oxidation staining. The adjustment screws exhibit minor slot damage. The optics remain clear with the scope in very good condition overall. (67023-5E)
2070. **LYMAN SCOPE LOT** This lot consists of a Lyman Alaskan model 2 1/2x power scope with "Lee Dot" reticle. This later model scope features internal adjustments, measures approximately 11 1/4" with a 3/4" tube. The external metal surfaces retain 98% original blue finish with minor wear from minimal use. This scope retains clear optics and is in excellent condition overall. (67023-5F)
2071. **FECKER SCOPE LOT** This lot consists of a Fecker 3/4" target telescopic sight with crosshair reticle. The scope measures approximately 20" with Fecker 1/4 minute click mounts. The external metal surfaces exhibit wear, a few brown patches, as well as some streaking presumably from cold blue application. The metal surfaces also exhibit minor oxidation staining. The optics are relatively clear with light cloudiness. The scope is in very good condition overall. (67023-11D)
2072. **BUSHNELL SCOPE LOT** This lot consists of a Bushnell Scopemaster model 6x fixed power scope with crosshair reticle. This early 1970's scope measures approximately 13 3/4" with 1" tube. The external metal surfaces retain 99% original blue finish with minor wear and faint ring marks. The optics remain clear with the scope in excellent condition overall. (67023-5)
2073. **LYMAN SCOPE LOT** This lot consists of a Lyman 5A model 5x power scope with crosshair reticle. The scope measures approximately 16" with a 3/4" tube and micrometer mount. The external metal surfaces retain 97% original blue finish with wear consistent with age and use as well as silvering on the high edges. The objective housing exhibits mild oxidation browning. The optics are clear with the scope in very good to excellent condition overall. (67023-11)

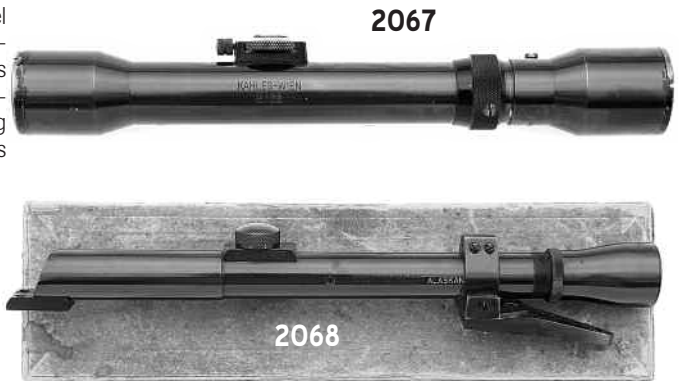

2074. **NOSKE SCOPE LOT** This lot consists of Noske 2 1/2x and 4x fixed power scopes. The 2 1/2 power scope measures approximately 9 1/2" with a crosshair reticle, the 4x scope measures approximately 10 1/4" with a picket post reticle. The 2 1/2x power scope retains 98% original blue finish with minor wear. The 4x scope retains approximately 90% plus original blue finish with moderate wear consistent with age and honest use. There is silvering on the high edges as well as the occasional scuff. The optics on the 2 1/2x scope exhibit a minor blemish on the upper crosshair. The 4x scope retains clear optics with the lot in very good to excellent condition overall. (67023-16E)
2075. **WEAVER SCOPE LOT** This lot consists of two Weaver K3 model 3x scopes. The first scope features a flat top post and crosshair reticle and the other features a crosshair reticle. The scopes measure approximately 10 1/2" in length with 1" tubes. The external metal surfaces retain 98% original blue finish with minor wear from age and use. The optics remain clear with the scopes in excellent condition overall. (67023-16B)
2076. **NOSKE SCOPE LOT** This lot consists of two Noske 4x fixed power scopes. Both scopes measure 10 1/4" in length with 1" tubes. The first scope retains 97% original blue finish with light but noticeable ring wear as well as scuffing. The second scope retains strong portions of original blue finish with upper portions exhibiting wear and browning. The eye piece exhibits heavy wear and scuffing. The first scope features a crosshair reticle while the second exhibits a failed crosshair, needing repair. The lot is in good to very good condition overall. (67023-16F)
2077. **NOSKE SCOPE LOT** This lot consists of two Noske 4x fixed power scopes. Both scopes measure 10 1/4" in length with 1" tubes. The first scope retains 97% original blue finish with light but noticeable ring wear as well as scuffing. The second scope retains 95% original blue finish with stronger wear and scuffing than the first scope in this lot. The adjustment covers on both scopes exhibit minor oxidation. Both scopes exhibit relatively clear optics with crosshair reticles, in very good to excellent condition overall. (67023-16C)
2078. **KARL KAPS SCOPE LOT** This lot consists of a Kaps Ziellux model 2 1/2x scope with European post reticle. The scope measures approximately 10", a 7/8" tube and is equipped with rings for a rimfire rifle. The metal surfaces retain 98% original blue finish with wear consistent with honest use as well as silvering on the high edges. The top adjustment cover exhibits a gouge which should not hinder adjustment. The optics are clear with the scope in excellent condition overall. (67023-16D)
2079. **WEAVER SCOPE LOT** This lot consists of a Weaver K3 model 3x and K4 model 4x scopes both with crosshair reticles. The Weaver K3 measures approximately 10 1/2" in length with a 1" tube and the K4 measures approximately 11 1/4" in length with a 1" tube. The K3 includes Weaver mounts with the external metal surfaces retaining 98% original blue finish. The K4 features external adjustments with the external metal surfaces retaining 98% original blue finish. Both scopes exhibit wear consistent with age and use. The optics remain relatively clear with the scopes in excellent condition overall. (67023-5B)
2080. **WEAVER SCOPE LOT** This lot consists of a Weaver K3 model 3x and K4 model 4x scopes. The Weaver K3 measures approximately 10 1/2" in length with a 1" tube and the K4 measures approximately 11 1/4" in length with a 1" tube. The K3 retains 98% original blue finish with wear, light ring marks and a few light scuffs. The K4 retains 98% original blue finish with the occasional minor scuff. The K3 features a post and crosshair reticle with the post slightly left of center and the K4 features a crosshair reticle. The optics remain relatively clear with the scopes in good to very good condition overall. (67023-5C)
2081. **WEAVER SCOPE LOT** This lot consists of a Weaver K2.5 model 2 1/2x and K4 model 4x scopes. The Weaver K2.5 measures approximately 10 3/4" in length with a 1" tube and the K4 measures approximately 11 1/4" in length with a 1" tube. The K2.5 retains 98% original blue finish with wear and a few light scuffs. The scope exhibits light silvering on the high edges. The K4 retains 98% original blue finish with the occasional minor scuff as well as wear consistent with age. The K2.5 does not appear to have a reticle and the K4 features a crosshair reticle. The optics remain relatively clear with the scopes in good to very good condition overall. (67023-5J)
2082. **SCOPE LOT** This lot consists of a Kollmorgan Bear Cub II model 4x scope and a Weaver K4 model 4x scope both with crosshair reticles. The Kollmorgan measures approximately 11 3/4" in length with a 26mm tube. The external metal surfaces exhibit wear and scuffing consistent with age; the Weaver K4 measures approximately 11 1/4" in length with a 1" tube. The external metal surfaces retain 97% original blue finish with wear and scuffing. The K4 scope includes a set of Weaver rings. The optics are relatively clear with the lot in good to very good condition overall. (67023-5D)
2083. **LEUPOLD SCOPE LOT** This lot consists of a Leupold Alaskan model 4x scope serial #90 with duplex reticle and original box. The scope measures approximately 10" in length, 1" tube with the external metal surfaces retaining 99% original blue finish with negligible wear from handling and storage. The original box exhibits minor wear with a closure panel missing and light foxing at the creases. There is a cellophane tape repair on one end which has yellowed due to age. The optics are crisp and bright with the scope in very good to almost new condition overall. (67023-16G)
2084. **REDFIELD SCOPE LOT** This lot consists of a Redfield IER model 1-4x20mm scope with crosshair reticle. The scope measures approximately 10 1/4" in length with a 1" tube. The external metal surfaces retain 99% original high polished blue/black finish with minimal wear from handling and storage. The optics are exceptionally bright and clear with this scope having multiple applications from scout rifle, AR platform or slug gun. This intermediate eye relief scope is in excellent to almost new condition overall. (67023-5X)
2085. **LYMAN SCOPE LOT** This lot consists of a Lyman Alaskan model 2 1/2x scope with tapered post and crosshair reticle as well as a Stith Savage 99 mount. The scope measures approximately 11 1/4" in length and 3/4" tube. The metal surfaces retain 98% original blue finish with light wear and very faint silvering on the high edges. The scope includes the original brown cardboard box, crisp optics and is in excellent condition overall. (67023-5T)

2086

2086. **UNERTL SCOPE LOT**

This lot consists of what appears



to be a 1.0" Clear Aperture Objective Target Scope serial#2179, 10 x clear and approximately 22" in length with a 3/4" tube. The scope retains 95% plus original blue finish with light travel wear and a few small areas of oxidation staining most notably on the threaded metal end caps. Equipped with a fine crosshair reticle, clear optics as well as 1/4" click adjustable mounts the recoil spring is absent but the locking ring remains. The scope is in very good to excellent condition overall. (67023-11C)

2087. **UNERTL SCOPE LOT** This lot consists of what appears to be a 1 1/4" Varmint Scope serial #48993, 10x, approximately 20" in length with a 7/8" tube. The metal surfaces retain 95% plus original blue finish with normal travel wear, minor scuffs and a few patches of oxidation staining consistent with honest use. The scope is equipped with crosshair reticle and crisp optics as well as standard 1/4" click adjustable target mounts, recoil spring and locking ring. In very good to excellent condition overall. (67023-11A)



2088. **FECKER SCOPE LOT** This lot is what appears to be a Fecker Small Game Scope serial #4262, 4x, approximately 18" in length, 3/4" tube, crosshair and dot reticle with clear optics.



The metal surfaces exhibit 97% original blued finish with light travel wear and the occasional scuff. Equipped with 1/4" click adjustable mounts, recoil spring and locking ring, the scope is excellent condition overall. (67023-11B)

2089. **FECKER SCOPE LOT** This lot is what appears to be a Fecker Small Game Scope serial #4441, 4x, approximately 12" in length, 3/4" tube and crosshair reticle that has lost its sharp edges. The metal surfaces retain 95% plus polished blued finish with scattered handling marks and wear. Equipped with 1/4" click adjustable mounts, the recoil spring and locking ring are absent. The optics are slightly cloudy with the scope in good condition overall. (67023-5W)

2090. **LOT OF SCOPES** Total of three: the first scope is a Kollmorgan Bear Cub 4x Double model scope with crosshair reticle and Stith mounts for a Savage 99 rifle. The scope measures approximately 12" in length and 1" tube. The external metal surfaces retain 98% original blue finish with light wear from honest use. The adjustment caps exhibits silvering on the high edges as well as a few light scuffs. The optics remain clear with the scope in excellent condition overall; the second scope is a Lyman Challenger model 4x power scope with crosshair reticle. The scope measures approximately 11 3/4" with a 26mm tube. The external metal surfaces retain 95% original blue finish with heavy wear most notably on the objective lens housings. There is silvering on the high edges as well as ring marks on the tube. The optics remain clear with the scope in good to very good condition overall; the third scope is a Bushnell Scopechief IV, 4x power scope with Bushnell "Command Post" reticle. The scope measures approximately 11 1/2" in length and a 1" tube. The external metal surfaces retain approximately 97% original blue finish with the occasional light scuff. The turret covers exhibit silvering on the high edges coupled with an impact mark. The optics remain clear with the scope in very good condition overall. (67023-5M)

2091. **STITH SCOPE MOUNT LOT** This lot consists of a Stith "Install-It-Yourself" mounts for Remington models M721 and M722 as well as Winchester models M70 and M54 rifles. This style mount was designed for fixed power scopes which were prevalent in the 1950's. The lot appears complete with the metal surfaces retaining 99% original blue finish with minimal wear from handling and storage. The lot has five individual pieces and an Allen wrench, in excellent condition overall. (67023-2BX)

2092. **LOT OF RIFLE MOUNTS** Total of two complete sets: the first set is a Griffin & Howe double lever mount for a Savage model 99 rifle. The ring size is .875" with the metal surfaces retaining 98% original blue finish with wear from honest use. The mount includes the side mount base; the second mount is a Paul Jaeger single lever mount similar in design to the Griffin & Howe model with the ring size .875". The metal surfaces retain 95% plus original blue finish with wear and silvering on the high edges. The base exhibits minor oxidation staining. The lot includes three replacement screws, Griffin & Howe box and is in very good to excellent condition overall. (67023-2AK)

2093. **LOT OF RIFLE MOUNTS** Total of two complete mounts and two pairs of rings: the first mount is a Paul Jaeger single lever mount with base. The 1" rings and other metal surfaces retain 97% original blue finish with normal wear from honest use. The base exhibits mild oxidation staining which can easily be removed with Break-Free and fine steel wool. There is also silvering on the high edges as well as contact points; the second mount is by Pachmayr with 1" rings. The external metal surfaces retain 95% plus original blue finish with normal wear and silvering on the high edges and screw holes; the first set of rings are by Griffin & Howe measuring .875". The rings retain 99% original blue finish with minimal wear; the second set of rings resembles Griffin & Howe in the split ring configuration. The metal surfaces retain 98% original blue finish with minimal wear. The lot is in very good to excellent condition overall. (67023-2AQ)

2094. **LYMAN SIGHT LOT** This lot consists of what appears to be a Lyman No.103 Windgauge tang sight for a Savage 99 model rifle. The patent markings are not visible and the screw-in eye disc is absent. The base exhibits the "Lyman" "Middlefield, Conn. USA" on the top and Base Code "SA" on the underside. The metal surfaces retain 98% original blue finish with minor oxidation staining. This sight does not include mounting screws and is in excellent condition overall. (67023-2U)

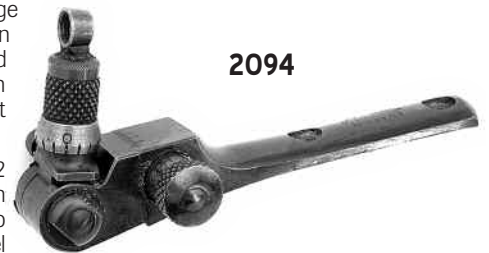

2095. **REDFIELD SIGHT LOT** This lot consists of what is believed to be a Redfield model 102 receiver sight. The application code is absent as is the eyepiece. The metal surfaces retain a majority of original blue finish coupled with a dark brown patina. The metal surfaces also exhibit scattered, light oxidation staining. The sight is believed to be for a Savage 99 model rifle, does not include mounting screws and is in very good to excellent condition overall. (67023-2R)

2096. **LYMAN SIGHT LOT** This lot is a Lyman No.56S model receiver sight for a Savage 99 model rifle. The sight is complete with eye disc. The metal surfaces retain a majority of original blue finish combined with light oxidation staining and minor pitting. The sight does not include mounting screws, in good to very good condition overall. (67023-2AM)

2097. **LOT OF TANG SIGHTS** This lot consists of two sights: the first is an unknown model Lyman tang sight with the application code of R12 on the underside of the base originally for Remington Models 12 and 121 repeating rifles. The base has been ground down and is modified to fit an unknown model of firearm. The Lyman markings usually seen on the top of the base are absent as is the eye disc and mounting screws. The metal surfaces retain portions of original blue finish combined with heavy oxidation staining and pitting. The knurled stem exhibits light silvering with the patent date barely visible; the second sight is believed to be a Lyman No.2 Combination Tang Sight for a Savage Model 99, the Lyman markings and application code are not present, nor is the eye disc and mounting screws. Both sights are functional with the lot in good to very good condition overall. (67023-2A2)



2098. **LYMAN LOT** This lot is a Lyman No.48 Receiver Sight- 2nd Variation with short slide for 100 yards or less. The application code "W" for Winchester model 73 rifle is located on the base interior. The metal surfaces with the exception of the slide retain 98% original blue finish with a few minor areas of oxidation freckling. There is no eye disc or mounting screws present, in excellent condition overall. (67023-2V)
2099. **LYMAN LOT** This lot is a Lyman 1A Combination rear "Cocking Piece" sight for a Krag rifle. The original blue finish on the metal surfaces exhibit a blue/brown patina with silvering on the high edges as well as minor oxidation freckling. This unique sight was discontinued by Lyman in 1955 and is in very good to excellent condition overall. (67023-2AP)
2100. **LOT OF GUN PARTS** This lot is a tin measuring approximately 6"x8", weighing approximately 5-7 lbs of various firearm, scope and sight parts. Includes but not limited to: Winchester 1885: lower tang, (4) triggers, (3) sears, (4) firing pins, (8) forend attaching dovetail blocks, (3) links, (3) hammer spring mounting block, (8) extractors and numerous wood and machine screws and small parts. The lot is a virtual grab bag of assorted springs, sights, triggers, sears from American and European firearm manufacturers perfect for the gunsmith or home do-it yourselfer. In very good condition overall. (67023-13A)
2101. **LOT OF SCOPE RINGS** This lot consists of two sets of Sako scope rings for a 1" scope, fitting the wedge-shaped male dovetails atop Sako receivers. The metal surfaces retain 99% original blue/black finish with negligible wear. The rings are in excellent to almost new condition overall. (67023-2DH)
2102. **LYMAN LOT** This lot consists of a Lyman No.103 Windgauge tang sight for a Savage model 99 rifle. The Lyman stamping is present on the top of the base and the application code of SA on the underside. The metal surfaces retain 97% original blue finish with mild silvering on the knurled stem and mild scattered oxidation freckling. The eye disc and mounting screws are absent with the sight in excellent condition overall. (67023-2)
2103. **PARKER-HALE LOT** This lot is a Parker-Hale tang sight believed to be for a Savage 99 rifle. The model number is unknown but the metal surfaces retain 98% original blue finish with light sporadic oxidation staining. The sight does not include mounting screws and is in excellent condition overall. (67023-2X)
2104. **WESTERN SIGHT LOT** This lot consists of a Western Krag aperture rear sight. The metal surfaces retain 98% original blue finish with scattered oxidation staining and silvering on the high edges. The lot includes the original cardboard box and instructions. Does not include mounting screws with the lot in excellent condition overall. (67023-2AT)
2105. **LYMAN LOT** This lot consists of a Lyman front ramp sight for a Krag rifle. The lot includes the original box, instructions and a No.26 ivory bead front sight. The metal surfaces retain 99% original blue finish with minor scattered oxidation staining. The mount does not include the mounting screw and is in excellent condition overall. (67023-2AF)
2106. **REDFIELD LOT** This lot consists of a Redfield Model RE-K receiver sight for a Krag rifle. The sight is complete with box and instructions but does not include mounting screws. The metal surfaces retain 99% original blue finish with the sight in excellent to almost new condition overall. (67023-2AL)
2107. **ALLEN-JAC LOT** This lot consists of a Allen-Jac Tele-Sight scope mount for a Savage 99 rifle or a Remington 760 rifle. The lot appears complete with box, instructions and three mounting screws. The metal surfaces retain 99% original blue finish with minor wear from handling and storage. In excellent to almost new condition overall. (67023-2AI)
2108. **MARBLES LOT** This lot consists of a Marbles KR receiver sight for a Krag rifle. The sight includes the original box but not mounting screws. The metal surfaces retain 98% original blue finish with minor wear and light silvering on the high edges. In very good to excellent condition overall. (67023-2AN)
2109. **SCOPE MOUNT LOT** Total of two: the first is a Redfield Junior scope mount for an unknown model rifle with rings for a 3/4" diameter scope. The mount includes the original box, instructions and three mounting screws. The metal surfaces retain 98% original blue finish with minor scattered oxidation staining; the second mount is an Armscor mount for an unknown model rifle with rings for a 3/4" diameter scope. The metal surfaces retain 97% original blue finish with light scattered oxidation staining. Both mounts in the lot are in very good to excellent condition overall. (67023-2BW)
2110. **PACIFIC SIGHT LOT** This lot consists of a Pacific rear sight for a Krag rifle. The lot includes the original box but the mounting screws and eye disc are absent. The metal surfaces retain 97% original blue finish with light wear, minor slot damage on the adjustment screws and silvering on the high edges. In very good to excellent condition overall. (67023-2AH)
2111. **LYMAN LOT** This lot consists of a Lyman receiver sight and front sight assembly with brass bead sight for a Krag rifle. The items in this lot are individually boxed in the original cardboard containers. The mounting screws and eye disc are absent. The metal surfaces retain 99% original blue finish with minimal wear from handling and storage, in excellent to almost new condition overall. (67023-2AB)
2112. **LYMAN LOT** This lot consists of a Lyman No.2A Tang Sight for a Savage 99 rifle. The sight includes the eye disc but the mounting screws are absent. The metal surfaces retain 97% original blue finish with minor scattered oxidation staining. In very good to excellent condition overall. (67023-2D)
2113. **REDFIELD LOT** This lot consists of a Redfield No.40-D, band type, ramp front sight with brass bead blade and hood for a Springfield rifle with a 24" barrel measuring .635" inside diameter. The lot includes the original cardboard box with red lid. The metal surfaces retain 99% original blue finish with minimal wear from handling and storage, in excellent condition overall. (67023-2G)
2114. **KRAG LOT** Two items: this lot consists of a Marbles KR receiver sight for a Krag rifle. The sight includes the original box with mounting screws. The metal surfaces retain 99% original blue finish with minimal wear. In excellent condition overall; also included is a peep sight by an unknown maker for a Krag rifle. The metal surfaces retain a majority of original blue finish with silvering from use. The peep sight is in a small, unmarked box, in good condition overall. (67023-2AR)
2115. **WILLIAMS SIGHT LOT** This lot consists of a Williams receiver mount for a Krag rifle. The sight is complete with eye disc and mounting screws. The metal surfaces retain 99% original blue finish with negligible wear, in excellent to almost new condition overall. (67023-2T)
2116. **PARKER-HALE LOT** This lot is a Parker-Hale tang sight believed to be for a Savage 99 rifle. The model number is unknown but the metal surfaces retain 98% original blue finish with light sporadic oxidation staining as well as minor silvering on the high edges. The underside has been ground in the distant past with light surface pitting visible. The sight does not include mounting screws and is in very good condition overall. (67023-2P)

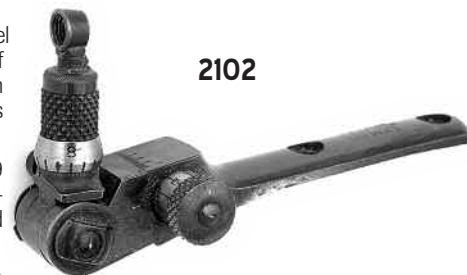

2117. **MARBLES LOT** This lot consists of a Marbles Flexible Joint rear sight believed to be for a Savage 99 rifle. The "Hunter" style eye disc exhibits a small gouge, the mounting screws are absent. The metal surfaces retain 95% original blue finish with light, sporadic pitting and scattered oxidation staining most notably on the underside of the base. In good to very good condition overall. (67023-2I)
2118. **LYMAN SIGHT LOT** This lot consists of a Lyman receiver mount aperture sight for a Krag rifle. The mount includes the original box and instructions. The mounting screws and eye disc are absent. The metal surfaces retain 99% original blue finish with minimal wear from handling and storage, in excellent condition overall. (67023-2H)
2119. **GRIFFIN AND HOWE LOT** This lot consists of two Griffin and Howe Mounts with bases for unknown model of rifles: the first is a Micrometer Mount with rings for a 1" scope tube; the second is a double lever mount with base. The rings are absent. The metal surfaces on both items retain 98% original blue finish with minor wear from honest use. Both mounts are in excellent condition overall. (67023-2AS)
2120. **DAN WESSON ARMS MODEL 15V DOUBLE ACTION REVOLVER** serial #91723, 357 Magnum, 2 1/2" vent rib barrel with an excellent bore. Overall, about 99% original blue finish remains with a few light handling blemishes and a turn ring on the cylinder. The factory grips have been sanded, slightly reshaped and painted black for an overall rating of about very good to excellent in their current state. The revolver is equipped with fully adjustable white outline rear sight and red ramp front sight. (86520-1319) [Richard "Stretch" Kennedy Collection] (200/400)
2121. **CHARTER ARMS BULLDOG MODEL REVOLVER** serial #830359, 44 Special, 3" barrel with an excellent bore. The stainless steel surfaces are in near excellent condition with some light handling marks for an overall rating of about 98%. The checkered rubber factory grips with silver Charter Arms medallions are in excellent condition. This revolver features fixed sights and a bobbed hammer that is serrated on the top allowing enough purchase to cock it single action. (86520-1431) [Richard "Stretch" Kennedy Collection] (300/500)
2122. **LOT OF WINCHESTER MAGAZINES** This lot consist of three Winchester Model 52 "magazines". The first "magazine" is a single shot adaptor with light wear and an oxidation blemish. The second magazine is a ten round magazine with light wear and the word "Tiny" scratched on the side. The last magazine is a five round magazine with light wear and "Tiny" scratched on the side. (84509-5A)
2123. **LOT OF WINCHESTER MAGAZINES** This lot consist of four Winchester Model 52 "magazines". The first "magazine" is a single shot adaptor with moderate wear and the word "Tiny" scratched on the side. The second magazine is a five round magazine with light wear, a missing spring and the word "Tiny" scratched on the side. The third magazine is a five round magazine with light to moderate wear. The last magazine is a five round magazine with moderate wear. (84509-5B)
2124. **LOT OF SHOOTING ACCESSORIES** This lot consist of 29 items. Included are: (1) Badger shooting box measuring 27 3/4" x 8 1/4" x 7 3/4" with leatherette covering, brass reinforced corners and brass hardware. The box has a removable four compartment top shelf and large open bottom space. There is some light wear on the exterior except the center latch is broken off but is provided, and the interior covering is starting to peel on the rear and bubble on the top for an overall rating of very good to excellent. The box contains (1) 48" leather sling with two keepers exhibiting light crazing, (1) 46" leather sling with an Al Freeland metal keeper and exhibiting light to moderate wear, (1) 10X brand leather shooting glove with light to moderate wear, (1) 1 7/8" x 3 3/8" x 7" wood box cut to hold a 50 round box of 22 LR ammunition and holes for 50 individual rounds of ammunition that is in very good condition, (1) 1 5/8" x 3 1/2" x 7 5/8" wood box cut to hold a 50 round box of 22 LR ammunition and holes for 50 individual rounds of ammunition that is in very good condition but has a broken hasp, (3) binder clips, (6) pencils, (1) grease pencil, (1) ruler, (4) used NRA score books, (1) 22 caliber scoring plug with case, (1) Model 52 trigger shoe, (1) each front sight base, rear sight base and (2) mounting screws. (84509-5)
2125. **COLT 1911 BARREL LOT** This lot consist of a single Colt Model 1911 barrel with a sideways P / H proof / acceptance marks on the chamber area. This 5" barrel has a lightly frosted bore and was made by Colt. They were used in their Model 1911 in the serial number range of 85,000 to 400,000 (depending on the information source). The barrel is heat treat marked with a 5 in front of the lugs and a sideways R on the right lug. The barrel has scattered light oxidation and pits and has been lightly buffed with about 25% original finish remaining. (86441-2)
2126. **SMITH & WESSON MODEL 41 BARREL LOT** This lot consist of a single modified factory barrel for the Model 41. The 5 1/2" heavy barrel has an excellent bore and retains about 60% original blue finish with some high edge wear, and some poorly re-blued oxidation blemishes on both sides of the barrel. The top of the barrel has been machined on both sides of the rib for a length of 4 5/8" with a four vents cut into it. The micro adjustable factory rear sight is present but the factory Patridge front sight has been modified with a slight undercut. It is unknown who did the modification but they are similar to those performed by Bob Loveless and others. (86520-324A)
2127. **SMITH & WESSON MODEL 422 TARGET SEMI-AUTO PISTOL** serial #TFR7445, 22 LR, 6" barrel with light traces of oxidation present in the bore. This pistol retains about 96% original blue and anodized finishes with some light high edge wear, a few light oxidation blemishes and the slide is drifting to plum. The checkered walnut factory stocks with silver medallions are in good to very good condition with moderate scratches, dents, dings and flaking finish. The pistol is equipped with a black blade micrometer adjustable rear sight and Baughman ramp style front sight. The pistol includes a factory box that is correctly end labeled and numbered to the gun and contains a single magazine, factory sight adjustment tool, manual and paperwork. (86520-286) [Richard "Stretch" Kennedy Collection] (100/200)
2128. **COLT CONVERTIBLE FRONTIER SCOUT SINGLE ACTION REVOLVER** serial #27461K, 22 LR / 22 WMRF, 4 5/8" barrel with an excellent bore. This 1966-made revolver retains about 96% original nickel finish on the metal surfaces with some worn finish at the muzzle, scattered light scratches, and the finish is starting to cloud in areas and turn ring on the 22 LR cylinder. The 22 WMRF cylinder has a faint turn ring and some light scratches. The smooth hardwood grips rate about good with moderate dents, dings and scratches as well as some flaking finish. The revolver is provided with red velvet-lined wood presentation case that remains in excellent condition on the interior. The exterior is in good condition with numerous scattered light to moderate scratches, dings, scuffs and dents. (86520-2599) [Richard "Stretch" Kennedy Collection] (300/500)
2129. **BRAZILIAN CONTRACT SMITH & WESSON MODEL 1917 REVOLVER** serial #194998, 45 ACP / AR, 5 1/2" barrel with an excellent bore. This importer-marked revolver has been completely refinished with a Parkerized finish over glass beaded metal surfaces, exhibiting some light handling wear for an overall rating of about 98%; some pitting is still visible under the new finish. The hammer was also Parkerized but is exhibiting operation marks and the trigger has been ground and polished smooth with a bright face and Parkerized sides that are flaking from use. The original grips have been replaced with a set of rubber Pachmayr "Gripper" stocks. All appropriate parts are correctly numbered to the gun. The S&W logo is still legible on the frame but the Brazilian crest on the sideplate is all but gone except for the 1937 date at the bottom. (86520-1174) [Richard "Stretch" Kennedy Collection] (200/400)

2130. **SMITH & WESSON SIGMA MODEL SW9V SEMI-AUTO PISTOL** serial #PAN2096, 9mm, 4" barrel with an excellent bore. The stainless steel and polymer surfaces are in very good to excellent condition with some scattered light scratches and handling marks on the slide and frame for an overall rating of about 97%. The pistol features drift adjustable three dot sights and light gray colored frame. The pistol includes a single magazine. (86520-1298) [Richard "Stretch" Kennedy Collection] (200/400)
2131. **THOMPSON CENTER ARMS CONTENDER PISTOL** serial #66851, 22 LR, 10" octagon barrel with an excellent bore. This single shot pistol retains about 99% original blue finish with a few light handling marks. The checkered walnut thumbrest stocks and forearm are in near excellent condition with a few scratches present, mostly on the forend. The pistol is equipped with fully adjustable black blade rear factory sight and factory Patridge front sight. It also features the early style hammer with screw type selector and no safety. (86520-1424) [Richard "Stretch" Kennedy Collection] (300/500)
2132. **SMITH & WESSON 38 DOUBLE ACTION TOP BREAK REVOLVER** serial #420124, 38 S&W, 3 1/4" barrel with a lightly frosted bore. This 4th model revolver retains about 30% original blue finish with the remainder a mix of gunmetal gray and brown interspersed with oxidation blemishes, pits and handling marks. Most of the finish remains at the rear of the barrel and the triggerguard. The diamond checkered hard rubber grips are in very good to excellent condition with only light wear. The grips and all appropriate parts are correctly numbered to the gun. There is some play between the barrel and frame and the bolt is in need of attention. (86520-1407) {C&R} [Richard "Stretch" Kennedy Collection] (200/400)
2133. **COLT OFFICIAL POLICE REVOLVER** serial #856844, 38 Special, 4" barrel with an excellent bore. This 1957-made gun retains about 85% original blue finish with moderate silvering at the muzzle, high edge wear, turn ring on the cylinder and scattered light handling marks. The gun has been fitted with mottled brown "Coltwood" checkered plastic grips that are period correct but not for this year of manufacture. The grips are in good condition with a visible crack on the butt of the right panel and a poor fit were it meets the frame at the top. Lock up and timing are still excellent and this should make a great shooter or starter gun for the aspiring Colt collector. (86520-1175) {C&R} [Richard "Stretch" Kennedy Collection] (300/500)
2134. **SMITH & WESSON 32 DOUBLE ACTION TOP BREAK REVOLVER** serial #149711, 32 S&W, 3" barrel with a lightly frosted bore. Overall this 4th model revolver retains about 75% original nickel and blue finish with scattered light freckling and interspersed shallow pits on the frame. The cylinder is mostly a mottled mix of oxidation blemishes and gunmetal gray with a few scattered traces of nickel finish in protected areas. The hammer and trigger retain moderate to strong case-hardened colors with operation marks. The diamond checkered hard rubber grips are in good to very good condition with moderate handling wear. The grips and all appropriate parts are correctly numbered to the gun. Frame to barrel fit remains tight and the gun still times and locks up correctly. (86520-1167) {ANTIQUÉ} [Richard "Stretch" Kennedy Collection] (250/350)
2135. **MAUSER WTP MODEL 1 VEST POCKET SEMI-AUTO PISTOL** serial #12646, 25 ACP, 2 1/2" barrel with an excellent bore. This pistol retains about 75% original blue finish with most of the loss on the slide. The metal surfaces exhibit scattered oxidation blemishes, pits, thinning finish and high edge wear. The one-piece wrap-around checkered hard rubber grip with Mauser logo is in very good to excellent condition with light handling wear. The pistol includes a single magazine. (86520-1565) {C&R} [Richard "Stretch" Kennedy Collection] (300/400)
2136. **INTRATEC TEC-22T SCORPION SEMI-AUTO PISTOL** serial #087097, 22 LR, 4" barrel with an excellent bore and threaded muzzle protected by a screw-on cap. The metal surfaces retain 97% original blue, the polymer frame is in very good to excellent condition with scattered light handling and operation wear. The rear sight is adjustable for elevation and the front for windage. Included with this pistol are a factory black plastic hardcase containing a single factory magazine, paperwork and a manual. This pistol is designed to use Ruger 10/22 magazines. (86520-516) [Richard "Stretch" Kennedy Collection] (300/400)
2137. **NORTH AMERICAN ARMS MINI REVOLVER** serial #G20423, 22 LR, 1 1/8" barrel with an excellent bore. The stainless steel surfaces of this micro single action are in excellent condition with a few light scratches and handling marks retaining 99% factory satin and brushed polish. The smooth rosewood grips are in like new condition. The gun includes a factory box correctly end labeled and numbered to the gun and contains a locking zippered sheepskin lined factory soft case with two keys, a factory inside the waist band suede holster with belt clip, factory belt buckle designed to hold the pistol, manual and paperwork. This gun is virtually as new in the box. (86520-1461) [Richard "Stretch" Kennedy Collection] (150/250)
2138. **SMITH & WESSON MODEL SW40F SEMI-AUTO PISTOL** serial #PAA1528, 40 S&W, 4 1/2" barrel with an excellent bore. The metal surfaces retain 99% original blue with the frame in near excellent condition with a few faint handling marks. The pistol includes a factory hard case that is correctly end labeled and numbered to the gun containing a pair of magazines. (86520-1581) [Richard "Stretch" Kennedy Collection] (300/400)
2139. **SMITH & WESSON MODEL 22A-1 SPORT SERIES SEMI-AUTO PISTOL** serial #UDA3324, 22 LR, 5 1/2" heavy barrel with top mounted rail. The steel and aluminum surfaces retain 99% original blue and anodized finishes. The black synthetic factory grips are in like new condition. The pistol has a Patridge front sight, black blade adjustable rear sight and optics rail. The pistol includes a factory box that is correctly end labeled and numbered to the gun and contains (3) magazines, (2) spare recoil spacers and paperwork. (86520-330) [Richard "Stretch" Kennedy Collection] (150/250)
2140. **UNMARKED SPANISH PHILADELPHIA DERRINGER SINGLE SHOT PISTOL** serial #175393, .45 cal. percussion, 2 7/8" barrel with an oxidized bore. The barrel and hammer retain about 75% black finish with some silvering around the muzzle and nipple areas plus flaking finish on the hammer. The lock retains its case-hardened colors and brass colored forward section under the drum. There is also scattered light oxidation blemishes and handling marks present. The brass triggerguard has mellowed to a straw color with the one-piece smooth varnished hardwood stock generally in near excellent condition. Unfortunately someone has tried their hand at checkering starting a project on the left side of the stock opposite the lock but did not complete it nor did they finish the raw wood in the checkered areas. (86520-2529) {ANTIQUÉ} [Richard "Stretch" Kennedy Collection] (15/35)
2141. **HIGH STANDARD MODEL R-108 SENTINEL "SNUB" REVOLVER** serial #1798515, 22 LR, 2 3/8" barrel with an excellent bore. The revolver retains about 98% original nickel finish, however it is starting to cloud on and around the grip frame, as well as a few marks from handling. The checkered factory white plastic grips are in near excellent condition with minor soiling present. This nine shot revolver has a drift adjustable rear sight. (86520-2946) [Richard "Stretch" Kennedy Collection] (200/300)
2142. **REMINGTON MODEL 1863 POCKET PERCUSSION REVOLVER BY PIETTA** serial #H004747, .31 cal., 3 1/2" barrel with an excellent bore. This revolver retains about 96% original blue finish with the only real loss to the right barrel flat that has flaked to a brown hue. The hammer and trigger retain strong case-hardened colors. The smooth hardwood grips remain in very good to excellent condition with a few light dents. The gun does appear unfired. (86520-973) {ANTIQUÉ} [Richard "Stretch" Kennedy Collection] (100/200)



2143. **SMITH & WESSON MODEL 61-2 ESCORT SEMI-AUTO PISTOL** serial #B32835, 22 LR, 2 1/8" barrel with an excellent bore. This small pocket automatic retains about 98% blue and anodized finishes with a few selected areas of high edge wear. The mottled brown checkered plastic factory grips rate near excellent with a few light scratches and handling marks present. The pistol includes a single nickel plated magazine. (86520-3036) [Richard "Stretch" Kennedy Collection] (200/300)
2144. **SMITH & WESSON MODEL 61-1 ESCORT SEMI-AUTO PISTOL** serial #B10519, 22 LR, 2 1/8" barrel with an excellent bore. This small pocket automatic retains about 98% nickel plated finish with scattered light dents and scratches. The white checkered plastic factory grips rate near excellent with light soiling plus a few light scratches and handling marks present. No magazine is included and the gun is missing its indicator pin and plunger and perhaps other parts as it will not fire in its current condition. (86520-2513) [Richard "Stretch" Kennedy Collection] (50/100)
2145. **KEL-TEC MODEL P3AT SEMI-AUTO PISTOL** serial #JLH85, 380 ACP, 2 3/4" barrel with scattered but limited surface pits. The metal parts retain 98% original blue and polymer surfaces of the frame are in near excellent condition with very light handling wear. The pistol is equipped with a pocket clip and "Arma+Laser" laser sighting unit that does not work. The unit may just need batteries but there is an errant spring protruding down in front of the Laser lens. The pistol includes a single magazine. (86520-333) [Richard "Stretch" Kennedy Collection] (175/275)
2146. **RUSSIAN MODEL 1895 NAGANT REVOLVER BY IZHEVSK ARSENAL** serial #VB331, 7.62x38mmR Nagant, 4 1/2" barrel with an excellent bore. This 1943-made revolver has been arsenal refinished at some time and retains 99% re-applied finish. The checkered hardwood grips are in excellent condition. The serial numbers on the frame, triggerguard and cylinder match. Included are a holster, cleaning rod and lanyard. (86520-119) {C&R} [Richard "Stretch" Kennedy Collection] (125/225)
2147. **REMINGTON MODEL 1858 TARGET PERCUSSION REVOLVER BY PIETTA** serial #R278001, .44 cal., 8" barrel with an excellent bore. This replica revolver retains about 99% original blue finish with a light turn ring on the cylinder. The brass triggerguard remains in excellent condition. Strong case-hardened colors remain on the trigger and hammer. The smooth factory hardwood grips are in excellent condition. This gun is equipped with Patridge front sight and fully adjustable black blade front sight. (86520-3187) {ANTIQUÉ} [Richard "Stretch" Kennedy Collection] (125/225)
2148. **GREAT WESTERN ARMS DERINGER DOUBLE BARREL PISTOL** serial #690, 38 S&W, 2 7/8" double barrels with excellent bores. This early pistol retains about 50% original finish with the barrels now a predominate gunmetal gray as well as some thinning finish on the backstrap along with scattered light scratches and oxidation blemishes. The remaining finish on the frame is now a plum color. The checkered black plastic grips are in good condition with light to moderate finish with scratches and dings. The left and right panels have different size checkering and patterns. The barrel-to-frame fit is slightly loose. (86520-956) {C&R} [Richard "Stretch" Kennedy Collection] (300/500)
2149. **COLT AGENT MODEL REVOLVER** serial #270727LW, 38 Special, 2" barrel with an excellent bore. This 1968 made revolver retains about 95% original blue and anodized finishes with a turn ring on the cylinder, silvering on the topstrap and scattered high edge wear. The checkered walnut grips with silver Colt medallions rate about good with moderate to heavy diamond point wear, scattered scratches and dents. The gun still times and locks up tight. (86520-963) [Richard "Stretch" Kennedy Collection] (300/400)
2150. **MIXED SHOOTERS LOT** This lot consist of two items. The first is an Aimpoint Mark III Electronic dot sight with intergral dovetail mounts and rubber end caps. The sight has clear optics and is in need of batteries. Overall the unit rates about very good with light handling wear. The second item is (50) rounds of Fioocchi 7.65 Parabellum (30 Luger) ammunition in excellent condition. This ammunition loaded with 93gr. FMJ bullets. (86520-294A & 6520-2597A)
2151. **COLT POLICE POSITIVE CUTAWAY DOUBLE ACTION REVOLVER** serial #5377, 38 New Police / S&W, 4" barrel with a near excellent bore exhibiting a small surface pit near the forcing cone. This 1906-made revolver retains about 70% original blue finish that is thinning on the grip frame, cylinder and barrel from handling and use. The correct checkered hard rubber grips are hand numbered to the gun and remain in very good to excellent condition with some scattered light dents. This early Colt has the correct "-38" after the Police Positive markings on the left side of the barrel but there are no markings present on the side plate due to the cuts. The cuts are present on both sides of the frame to expose the trigger mechanism and appear to have been professionally done. An ampersand is stamped under the crane on the frame indicating a return to the factory for some type of service. Interestingly this little revolver remains capable of being fired and still times and locks up as well as the day it left the factory. This would be an interesting addition to a Colt collection. (86520-1220) [Richard "Stretch" Kennedy Collection] (300/500)
2152. **GLOCK MODEL 17 SEMI-AUTO PISTOL** serial #AH861US, 9mm, 4 1/2" barrel with an excellent bore. Overall the pistol retains about 97% original Tenifer finish on the slide with some light high edge and holster wear. The polymer frame exhibits light handling and holster wear rating about excellent. This gun is equipped with white dot front sight and windage adjustable white outline rear sight. Included with gun is a factory "Tupperware" box that is correctly end labeled to the gun but not correctly numbered. The box contains a pair of magazines, manual and a bore brush. (86520-2418) [Richard "Stretch" Kennedy Collection] (300/500)
2153. **KEL-TEC MODEL P3AT SEMI-AUTO PISTOL** serial #H2C24, 380 ACP, 2 3/4" barrel with excellent bore. The surfaces of the polymer frame are excellent and black finished steel slide retains about 99% original blue. The little pocket pistol includes a factory cardboard box correctly end labeled and numbered to the gun, two magazines and factory nylon carry pouch. This gun appears to have seen little if any use. (86520-2913) [Richard "Stretch" Kennedy Collection] (200/300)
2154. **KEL-TEC MODEL P40 SEMI-AUTO PISTOL** serial #62049, 40 S&W, 3 1/4" barrel with excellent bore. The surfaces of the polymer frame rate excellent and blue finished steel slide retains about 98% overall blue with some light scattered high edge wear. The pistol features three dot sights and is equipped with a factory pocket clip. This pistol includes a factory hard case correctly labeled and numbered to the gun, a single magazine, Allen wrench with original factory pins removed to install pocket clip and a manual. (86520-443) [Richard "Stretch" Kennedy Collection] (175/275)
2155. **TAURUS MODEL PT-22 SEMI-AUTO PISTOL** serial #AOA45791, 22 LR, 2 3/4" barrel with an excellent bore. This pistol retains about 98% original black factory finish on the steel and aluminum parts with scattered light high edge wear and some light handling marks. The checkered hardwood grips with medallions are in near excellent condition with a few scant handling marks. This double-action-only pistol includes a factory hard case correctly end labeled and numbered to the gun, a pair of magazines and a manual. (86520-2616) [Richard "Stretch" Kennedy Collection] (150/250)

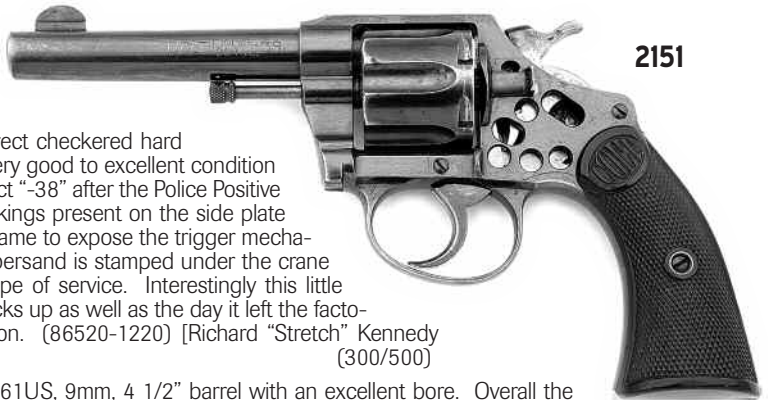

2156. **COLT COBRA DOUBLE ACTION REVOLVER** serial #26025LW, 38 Special, 4" barrel with an excellent bore. This 1953-made gun retains about 55% original blue and anodized finishes with most of the loss on the frame. The grip frame, topstrap, bottom of the frame and front of the frame has worn to silver. The finish on the cylinder and barrel has thinned considerably with minor freckling present on the trigger. The checkered factory "Coltwood" grips are in good condition with light to moderate handling marks and a small section of checkering worn smooth on the left panel. The grips have warped over time with a small gap present at the top of each panel. The butt of the revolver is stamped "Q.P.D. 53". (86520-1218) {C&R} [Richard "Stretch" Kennedy Collection] (150/250)
2157. **NAVY ARMS MODEL 1851 NAVY PERCUSSION REVOLVER BY UBERTI** serial #4212, .36 cal., 7 1/2" barrel with an excellent bore. This revolver retains about 99% original blue finish but the chemically color case-hardened frame and loading lever exhibit areas of silvering on the side of the frame and loading lever. Overall, the gun rates about 95% with most of the loss to the frame along with scattered light handling marks. The brass grip frame and backstrap have mellowed to a straw color with scattered light scratches. The smooth hardwood grips are in very good condition with some minor flaking of the finish and handling marks but the frame is proud of the grips along the frontstrap. (86520-1480) {ANTIQUÉ} [Richard "Stretch" Kennedy Collection] (75/175)
2158. **THOMPSON CENTER ARMS CONTENDER SINGLE SHOT PISTOL** serial #19529, 30-30 WCF, 10" octagon barrel with an excellent bore. The pistol retains about 99% original blue finish with a few light scratches and handling marks. The checkered thumb rest walnut pistolgrip and forend are in good to very good condition with scattered light dents, dings and scratches. This pistol has fully adjustable iron sights, early style selector switch that utilizes a screw driver to change between rimfire and centerfire, and the name plate on the base of the pistolgrip has been hand stamped "Pope". (86520-1443) [Richard "Stretch" Kennedy Collection] (300/500)
2159. **THOMPSON CENTER ARMS CONTENDER SINGLE SHOT PISTOL** serial #105590, 7mm T/CU, 10" bull barrel with an excellent bore. This pistol retains about 97% original blue finish with a few light handling and operation marks plus some light scratches. The pistol has been retrofitted with checkered rubber Pachmayr Contender grips that remain in near excellent condition with light handling blemishes. This pistol is equipped with fully adjustable iron sights, mid-design hammer selector switch that utilizes a screw driver to change between rimfire and centerfire along with a cross bolt safety. (86520-1309) [Richard "Stretch" Kennedy Collection] (200/400)
2160. **RUGER NEW MODEL SUPER BLACKHAWK REVOLVER** serial #83-90530, 44 Magnum, 10 1/2" barrel with an excellent bore. This revolver retains about 97% original blue finish with light wear at the muzzle, scattered light scratches, a turn ring on the cylinder and an oxidation blemish near the muzzle. There is some light staining and minor oxidation blemishes on the side of the hammer. A set of checkered rubber Pachmayr Presentation grips have been installed and remain in very good condition with light handling wear. The gun has a black ramp front sight and white outline adjustable rear sight. Unfortunately the ejector rod housing is missing and the mounting stud is absent from the barrel. Both should be an easy fix. (86520-1479) [Richard "Stretch" Kennedy Collection] (300/500)
2161. **COLT MODEL 1908 VEST POCKET HAMMERLESS MODEL SEMI-AUTO PISTOL** serial #272544, 25 ACP, 2" barrel with a lightly frosted bore. This 1920 made pistol retains about 80% original blue finish with numerous scattered light scratches, light oxidation blemishes, random pitting, and thinning finish. Some of the pits and oxidation blemishes have been lightly cleaned. The case-hardened colors on the trigger remain strong but are weak on the thumb safety and grip safety. The back of the grip safety has drifted to a brown hue from handling. The checkered walnut factory stocks with silver Colt medallions remain in very good condition with light flattening of the diamond points and few dents and scratches. The grip screw is a replacement and protrudes on the opposite side. The pistol has correct matching serial number on the slide and includes a single Colt marked magazine that has been cleaned and polished. (86520-3993) {C&R} [Richard "Stretch" Kennedy Collection] (150/250)
2162. **COLT MODEL 1903 POCKET HAMMERLESS SEMI-AUTO PISTOL** serial #330712, 32 ACP, 3 3/4" barrel with a very lightly frosted bore. This 1920 made, type III pistol retains about 50% original blue. The lower portions of the frame retain the strongest colors especially in the protected areas with the frontstrap now a brown hue. The remainder of the metal surfaces are a mottled mix of predominately brown with blues and grays seen. There is strong evidence that the upper surfaces of the frame and the slide were cleaned to minimize oxidation blemishes and pitting. The checkered hard rubber grips are period correct and remain in very good condition with scattered light scratches and handling wear. The pistol includes a single magazine. (86520-1207) {C&R} [Richard "Stretch" Kennedy Collection] (200/300)
2163. **SMITH & WESSON MODEL NO. 1 THIRD ISSUE TIP-UP REVOLVER** serial #99656, 22 Short, 3 3/16" barrel with moderately pitted bore. This revolver retains about 96% re-applied nickel finish with most of the loss due to scattered oxidation blemishes, especially on the cylinder. The metal surfaces have been engraved in a floral pattern that covers about 75% of the revolver. The gun now wears a set of antique ivory stocks that are hand numbered to the gun. Overall, the stocks are in very good to excellent condition with light handling marks and pleasing mix of cream background with coffee colored swirls and highlighted grain. The barrel, frame and cylinder have correctly matching assembly numbers but the barrel-to-frame fit has loosened slightly. (86520-1445) {ANTIQUÉ} [Richard "Stretch" Kennedy Collection] (200/400)
2164. **STEVENS DIAMOND NO. 43 SECOND ISSUE SINGLE SHOT TARGET PISTOL** serial #32285, 22 LR, 6" barrel with a lightly frosted bore. The pistol retains about 60% original blue and nickel finishes with most of the loss on the barrel. It has flaked to a mottled mix of gray, browns and oxidation blemishes. The receiver has a few minor oxidation blemishes and a few spots of bubbling finish. The smooth walnut factory stocks are in good condition with flaking finish, scratches, nicks and dents; the grips are correctly numbered to the gun. The elevation adjustable rear sight blade appears to have been lightly filed probably to help regulate point of impact. (86520-2441) {ANTIQUÉ} [Richard "Stretch" Kennedy Collection] (150/250)
2165. **HARRINGTON & RICHARDSON MODEL 199 SPORTSMAN SINGLE ACTION TOP BREAK REVOLVER** serial #S18844, 22 LR, 6" barrel with bright bore with a bulge about 2" from the forcing cone. This second model, 1950's era pistol retains about 90% plus finish with the greatest loss on the front strap, muzzle and some light repair work to the front sight. The rear sight blade and front sight suffered light damage from a drop with the front blade having been lightly repaired by light filing to the sides. The finish on the barrel is starting to thin but remains strong and several dings are still present on the muzzle and top of the front sight blade. The one-piece checkered factory walnut stocks are in very good condition with light dents and scratches. The revolver has timing issues and is in need of professional services. (86520-1236) {C&R} [Richard "Stretch" Kennedy Collection] (75/150)
2166. **GERMAN MODEL P.27 SEMI-AUTO PISTOL BY CZ** serial #413335, 32 ACP, 3 7/8" barrel with an excellent bore. This "fnh" marked pistol retains about 85% original Parkerized finish with the front strap having worn to silver, even high edge wear is present and scattered oxidation blemishes and pitting observed. The one-piece checkered plastic factory grip with CZ logo is in very good condition with scattered light handling wear. The pistol is Waffenamt marked eagle / WaA76 and proofed with military eagle mark. A pair of magazines is included as is a holster. One magazine has clean metal surfaces but a bent lip on the floorplate and the second has scattered light oxidation and pitting. The holster is marked "EZGJ 1944" but the acceptance stamp is not discernable. The holster has light handling wear and some light scuffs. (86520-4107) {C&R} [Richard "Stretch" Kennedy Collection] (200/300)

2167. **WALTHER P-38 SEMI-AUTO PISTOL** serial #138818, 9mm, 5" barrel with an excellent bore. This August 1961-dated police trade-in retains about 97% original blue and anodized finishes with some light high edge wear and scattered scratches. The black checkered factory grips are in good to very good condition with light to moderate wear of the diamond points as well as light scratches, scuffs and dings. This importer-marked pistol has matching numbers on the slide, barrel and locking block. The pistol includes a black leather full flap holster in very good condition with light scuffs and scratches. Also included are a pair of magazines that are dated 8/61 and 9/73 respectively. (86520-4093) {C&R} [Richard "Stretch" Kennedy Collection] (300/500)
2168. **HENRY U.S. SURVIVAL MODEL SEMI-AUTO RIFLE** serial #US03529, 22 LR, 16 1/4" barrel with an excellent bore. The silver anodized and black surfaces retain about 96% original finishes with scattered light scuffing and wear on the barrel. The silver colored plastic stock of this "AR-7" is in near excellent condition with a few light scuffs and scratches. The rifle includes a pair of blue steel magazines. (86520-133) [Richard "Stretch" Kennedy Collection] (100/200)
2169. **CZECHOSLOVAKIAN MODEL 52 SEMI-AUTO PISTOL BY CZ** serial #E17189, 7.62x25 Tokarev, 4 3/4" barrel with and excellent bore. This importer-marked pistol retains about 97% re-applied arsenal type Parkerized finish with some light high edge wear and scattered handling marks. The serial number on the slide and barrel matches the frame, the acceptance marks and date (1953) remain crisp and the accuracy punch marks (4) are still visible on the slide. The synthetic grips are in good to very good condition with scattered scratches, dents and dings. This pistol includes a pair of magazines, cleaning rod and full flap military holster that remains in very good condition. (86520-3022) {C&R} [Richard "Stretch" Kennedy Collection] (100/200)
2170. **ALLEN & WHELOCK SIDEHAMMER REVOLVER** serial #404, 22 Rimfire, 2 3/8" octagon barrel with a light to moderately oxidized and pitted bore. The metal surfaces are devoid of finish and have been cleaned leaving them gunmetal gray with scattered light oxidation blemishes and shallow pitting. The cleaning has resulted in fine scratch-lines plus washed-out barrel markings and cylinder scenes. The smooth rosewood grips are in very good to excellent condition with light handling wear. The barrel, grips, cylinder and frame all have correctly matching serial numbers. This gun features a raised boss on the topstrap that has the sight cut into it and it appears the cylinder pin may be a replacement. This little revolver still times and locks up correctly. (86786-1) {ANTIQUÉ} (150/250)
2171. **COLT POLICE POSITIVE REVOLVER** serial #102780, 32 Colt Police Positive, 2" barrel with a near excellent bore with some very light oxidation present. This 1912-made gun retains about 65% original blue finish with high edge wear present, thinning finish on the sides of the frame, grip frame has flaked to a brown color along with limited flaking to the muzzle, cylinder release and topstrap. The checkered hard rubber factory grips are in near excellent condition with a few light handling marks and are correctly scratch-numbered to the gun. The gun still times and locks up as well as it did when it left the factory 103 years ago and should make a good shooter. (86520-4472) {C&R} [Richard "Stretch" Kennedy Collection] (200/300)
2172. **COLT NEW POLICE MODEL REVOLVER** serial #1206, 32 New Police, 4" barrel with a lightly pitted and oxidized bore. This 1896-made revolver retains about 75% original blue finish with the grip frame having worn to a predominate gray with intermixed blue colors. There is also high edge wear present and the cylinder is a mix of blues and browns with light oxidation blemishes mix in. The Nitre blue on the trigger and hammer has thinned from use but remains strong in the protected areas. The checkered hard rubber factory grips are scratch-numbered to the gun and remain in near excellent condition. The backstrap is marked "New York City" and is one of 4,500 ordered by then Police Commissioner Theodore Roosevelt to re-arm the New York City PD. This particular gun has inventory number "740" stamped on the butt. This is fine gun still times and locks up as well as the day NYPD received it. This would be a great find for the collector of police-marked guns. (86857-18) {ANTIQUÉ} (200/300)
2173. **MAUSER MODEL 1896 BOLO "BROOMHANDLE" SEMI-AUTO PISTOL** serial #532748, .30 Mauser, 4" barrel with a washed out and oxidized bore. The pistol is now a mix of gunmetal gray and brown on the frame with a predominately brown hue on the barrel and extension. The smooth rosewood grips are in good condition with a mix of dents, dings, gouges and scratches. The grips screw is frozen and will require some Kroil to free it. The magazine spring is broken near the follower as is the lanyard ring on the bottom of the grip. The barrel and extension are not numbered to the gun (547640) nor is the bolt locking block (1700), bolt (713) and hammer (635). Included with the pistol is a near excellent condition Bucheimer Model KDX leather holster. (86824-3) {C&R} (300/500)
2174. **MAUSER MODEL 1896 COMMERCIAL CONE HAMMER "BROOMHANDLE" SEMI-AUTO PISTOL** serial #4715, .30 Mauser, 5 1/2" barrel with crisp rifling and slight traces of frosting in the bore. The pistol retains perhaps 15% original blue finish which is present only in the protected areas with the remainder a brown hue with some gunmetal gray mixed in. The grip frame appears to have been lightly draw-filed under the grips. There is some light spot welds on the left frame at the top of the grip frame, on the triggerguard and on left side of the frame in the shallow milling, to fill in pits. The metal surfaces exhibit signs of light to moderate scattered pitting and oxidation blemishing, plus there is a light dent in the left side of the magazine well. The 23-groove walnut grips are correctly numbered to the gun. The panels are in fair condition with light to moderate handling marks but the left panel is cracked along its length and only visible on the backside. All appropriate parts are correctly numbered to the gun. (84722-4) {C&R} (400/600)
2175. **REMINGTON NEW MODEL ARMY REVOLVER BY EUROARMS** serial #034121, 44 cal. percussion, 8" barrel with an excellent bore. Overall the revolver retains about 96% original blue finish with scattered light oxidation blemishes and a few light scratches. The brass triggerguard frame remains in excellent condition but has mellowed to golden color and the frame has drifted to a plum color. The case-hardened colors remain strong on the hammer and trigger. No grips are provided with the gun. Add a set of grips and this gun should make a good shooter. (86873-10) {ANTIQUÉ} (75/150)
2176. **WEBLEY & SON MARK III TOP BREAK POCKET REVOLVER** serial #25079, 38 S&W, 3" barrel with a few isolated areas of pitting and crisp rifling. Overall the revolver retains about 90% plus of the re-applied black paint with flaking present on the barrel, cylinder, and high edge wear. There is also some light oxidation blemishes on the front of the triggerguard and the hinge area. The oversized diamond-checkered factory hard rubber grips are in near excellent condition with light handling wear. The revolver times correctly and locks up tight but the ejector works intermittently and is in need of attention. Barrel-to-frame fit is "tight as a drum". (86873-5) {C&R} (200/400)
2177. **IVER JOHNSON MODEL P0380 PONY SEMI-AUTO PISTOL** serial #J002713, 380ACP, 3 1/8" barrel with an excellent bore. Overall about 90% plus original blue finish remains with most of the loss on the grip frame from handling along with scattered light scratches and limited edge wear. The checkered factory walnut stocks remain in excellent condition. The pistol includes an original factory box that is correctly end labeled to the gun containing a single magazine and a manual. (87013-5) (300/500)
2178. **STAR STARLET MODEL CU SEMI-AUTO PISTOL** serial #825470, 25 ACP, 2 3/8" barrel with an excellent bore. This little pocket pistol retains about 96% original blue and anodized finishes with most of the loss due to high edge wear and scattered light scratches. The brown checkered plastic factory grips with embossed Star logo are in very good to excellent condition with light scratches present. This little pistol should be of great interest to the 1911 aficionado due to its similar appearance and operating procedure. The pistol includes a single magazine. (87013-17) {C&R} (150/250)



2179. **SPANISH MODEL 1921 SEMI-AUTO PISTOL BY STAR** serial 6993, 9mm Bergmann-Bayard, 5" barrel with an excellent bore. This pistol has scattered light surface pits and oxidation blemishes present on the metal surfaces. The front strap is thinning to gray from handling but the greatest loss is the completely silver grip safety along with some light high edge and operation wear on the metal surfaces for an overall rating of about 80%. The double diamond checkered walnut stocks are in very good condition with some light flattening of the diamond points. This is most prevalent on the lower left panel around the lanyard loop. The pistol has the "Guardia Civil" crest on the slide and all appropriate parts have correct matching assembly numbers. The magazine's serial number does not match the gun (#21382) and the frame is marked "Made in Spain". The slide has "38" stamped next to the 9mm on the slide. This model was only made for one year before the military dropped the grip safety and adopted the Model 1922. (87013-15) {C&R} (350/550)
2180. **SPANISH MODEL 1922 SEMI-AUTO PISTOL BY STAR** serial #24787, 9mm Bergmann-Bayard, 5" barrel with traces of frosting. Overall, this non-importer marked pistol retains about 94% finish with high edge wear present, scattered light oxidation blemishes and surface pitting seen. The checkered plastic factory grips with embossed Star logo are in good condition with light scratches, dents and wear to the diamond points. This pistol is marked with the "Guardia Civil" crest, has the lanyard loop and includes a single magazine. (87013-16) {C&R} (300/500)
2181. **VILAR MODEL 1914 "RUBY" SEMI-AUTO PISTOL BY UNKNOWN MAKER** serial #35928, 32 ACP, 3 1/4" barrel with a lightly frosted bore. This pistol retains about 80% plus original blue finish with the grip frame flaking to a mix of blue and brown in addition to scattered oxidation blemishes on the other surfaces. There is also very light high edge wear and some scattered high edge wear. The pistols hard rubber grips are in good condition with generally very light wear but the left panel is cracked by the lower screw. This pistol is marked "Made in Spain" on the butt and possesses no French acceptance or makers marks. The pistol includes a single unmarked magazine. (87013-13) {C&R} (150/250)
2182. **STAR MODEL 1914 SEMI-AUTO PISTOL** serial #58303, 32 ACP, 5 7/16" barrel with light traces of frosting. This transitional pistol retains about 75% original blue finish with most of the loss on the grip frame and slide as well as high edge wear, scattered light oxidation blemishes and light pitting showing. The checkered walnut stocks are in good to very good condition with diamond point wear, dents and dings present. This pistol is marked with a Madrid distributor address line on the right side of the slide and the left side has English text indicating this may have been for export. The pistol has a lanyard loop on the butt and includes a single unmarked magazine. This pistol appears to have some Model 1919 features such as the small magazine release and screw hammer pivot. An included letter sent to the author of Star Firearms (Dr. Leonard Antaris) by the previous owner discusses some of these discrepancies and he concurs the pistol is probably transitional. All in all an interesting piece for the Star aficionado. (87013-14) {C&R} (200/400)
2183. **COLT POLICE POSITIVE REVOLVER** serial #109598, 32 Colt New Police, 2 1/2" barrel with a lightly oxidized and pitted bore. This 1922-made revolver retains about 70% original blue finish. The grip frame has flaked to predominately gunmetal gray and there is scattered light oxidation marks and pitting that has been lightly cleaned on the metal surfaces. Also present is a turn ring on the cylinder, thinning finish on the right side of the frame that is now a mix of brown and blue plus some high edge wear. Genuine unmarked mother-of-pearl grips in excellent condition have been fitted to the little gun. A factory letter dated August 11, 2014 indicates this gun was shipped on November 3, 1922 with unknown stocks and blue finish on the metal. The gun was shipped to Weed & Company of Buffalo N.Y. along with another gun. Timing and lock up remain excellent. (87013-9) {C&R} (225/325)
2184. **STAR MODEL SI SEMI-AUTO PISTOL CONSECUTIVELY NUMBERED** serial #973329, 32 ACP, 4" barrel with an excellent bore. This pistol retains about 99% original blue finish. The checkered thumbrest brown plastic factory stocks with embossed Star logo are in like-new condition. The case-hardened colors on the hammer and straw finish on the extractor remain robust. This model is a smaller version of the Star 45 caliber, 1911 style pistol. It includes a factory cardboard box correctly end labeled and numbered to the gun, manual, paperwork and a single magazine. This pistol has seen little if any use and would make a fine shooter or great addition to a collection especially if paired with the consecutively numbered gun that follows. (87013-7) (250/350)
2185. **STAR MODEL SI SEMI-AUTO PISTOL CONSECUTIVELY NUMBERED** serial #973330, 32 ACP, 4" barrel with an excellent bore. This pistol retains about 99% original blue finish. The checkered thumbrest brown plastic factory stocks with embossed Star logo are in like-new condition. The case-hardened colors on the hammer and straw finish on the extractor remain robust. Included are factory cardboard box correctly end labeled and numbered to the gun, manual, paperwork and a single magazine. This pistol has seen little if any use and would make a fine shooter or great addition to a collection especially if paired with the previous consecutively numbered gun. (87013-8) (250/350)
2186. **NAZI COMMERCIAL FABRIQUE NATIONAL MODEL 1922 SEMI-AUTO PISTOL** serial #90110a, 32 ACP, 4 3/8" barrel with an excellent bore. This pistol retains about 80% plus original blue finish with most of the loss due to thinning finish on the grip frame, silvering at the muzzle and high edge wear. There are a few scattered light oxidation blemishes and scattered light handling marks. The checkered hard rubber grips with FN logo are in good condition with light scattered scratches, dents and wear to the diamond points. This is one of approximately 2000 Model 1922 routed through German Proof houses during the war for commercial sale to qualified buyers. German eagle / N proofs are present on the slide, frame and barrel and appropriate parts have matching serial numbers. A Theuermann patent military style flap holster is included. It has been modified by removing the two external drop straps and has been professionally replaced with a single belt loop in the rear. Although partially obscured the correct "Nur für lange Browning Pistole Ka. 7.65" is still printed inside the flap. Also printed on the flaps interior is "uffz. Polish". All other markings on the holster are no longer present. Unfortunately someone carved "Menifee" in roughly 1/2" letters on the exterior of the flap. Remaining stitching is intact and the finish is partially worn. The pistol includes a pair of correctly marked magazines. (86914-4) {C&R} (250/350)
2187. **DISPLAY CASE LOT** This lot consist of a single wood display case that measures 15 7/16" x 8" x 3 1/16" tall. The glass framed cover is printed in the lower right corner of the glass "FBI National Academy 1935 - 1985" in an outer ring, "Golden Anniversary - National Academy Association" in an inner ring along with an eagle and shield in the center. The interior is cut for a Ruger Single Six and lined in red crushed velvet. The wood is near excellent condition with a few light scratches and handling marks. No key was provided for the brass locking clasp. (86520-4292A)
2188. **COLT POLICE POSITIVE REVOLVER** serial #411737, 38 Special, 4" barrel with an excellent bore. This 1943-made revolver retains about 80% original blue finish with moderate high edge wear, lightly thinning backstrap, side-plate flaking to brown, lean finish on the cylinder and scattered light scratches. The checkered walnut factory stocks with silver Colt medallions are in poor to good condition with worn diamond points, a poor repair to the toe of the left panel, scattered scratches and dents. There are two drilled and tapped holes on the butt and timing and lock up remain excellent. If you are looking for a shooter this is the perfect gun. (87058-3) {C&R} (300/400)

2189. **COLT OPEN TOP POCKET MODEL REVOLVER** serial #66603, 22 Rimfire, 2 3/8" barrel with a near excellent bore that exhibits a pit about mid center. The brass frame is devoid of any remaining finish and the nickel plating on the cylinder and barrel remain strong with about 90% present. The cylinder has the most loss with scattered worn finish and handling marks for an overall rating of about 40%. The smooth walnut grips are in very good condition with light to moderate handling wear. The grips are correctly numbered to the gun as is the frame. There is evidence the frame is cracking in the area of the loading trough so gun should not be fired. (87014-6) (ANTIQUE) (200/400)
2190. **COLT OFFICIAL POLICE REVOLVER WITH N.Y.S.C.D. MARKINGS** serial #909342, 38 Special, 6" barrel with an excellent bore. This 1966-made revolver retains about 80% plus original blue finish with silvering from holster wear on the barrel and cylinder in addition to the backstrap flaking to gunmetal gray. The checkered walnut factory grips with silver Colt medallions are hand numbered to the gun and remain in very good condition with scattered light scratches, dents and wear. The butt of the gun is stamped "N.Y.S.C.D." (New York State Conservation Department) and should make a nice companion piece to the New Service run in the live auction with similar markings. (87052-3) (300/500)
2191. **REMINGTON DOUBLE DERINGER PISTOL** serial #167, 41 Rimfire Short, 3" barrels with lightly frosted bores. Overall, this Model 4 revolver retains about 99% re-applied nickel and blue finishes. The pistol has a few shallow pits visible under the new finishes. The checkered hard rubber grips are in good to very good condition with light wear to the checkering on the high center. The barrel-to-frame fit is slightly loose and there is evidence the left barrel hinge has started to fail and gun should not be fired. (86940-291) {C&R} (200/400)
2192. **REMINGTON DOUBLE DERINGER PISTOL** serial #96, 41 Rimfire Short, 3" barrels with heavily oxidized and pitted bores. Overall, this Model 4 revolver retains about 80% original nickel with scattered areas of flaking present on the metal surfaces. The checkered hard rubber grips are in good condition with moderate wear to the checkering on the high center as well as scratches and dents. The barrel-to-frame fit is slightly loose and there is evidence the left barrel hinge has started to fail and gun should not be fired. (86940-290) {C&R} (250/450)
2193. **CUSTOM RUGER OLD MODEL SINGLE SIX REVOLVER** serial #132936, 22 LR, 5 1/2" barrel with an excellent bore. This 1959 revolver retains about 97% original blue and anodized finishes with light silvering of the loading gate, muzzle and left recoil shield. A faint turn ring is present on the cylinder along with some scattered light scratches on the metal surfaces. The checkered hard rubber factory grips with black Ruger Phoenix are a pleasing brown and rate near excellent overall. This revolver has a fully adjustable Micro rear sight set in the rear dovetail and Patridge Micro front sight on a ramp pinned over the original sight. The front sight has been under-cut horizontally from the rear a little over 3/4 of the way through, ending with a drilled stress-relief hole. This was probably done to get more height out of the front sight to lower point of impact. The transfer bar safety update has not been performed to the revolver. (87022-153) {C&R} [Mark Benenson Collection] (300/500)
2194. **WALTHER PP SEMI-AUTO PISTOL** serial #371680, 32 ACP, 3 7/8" barrel with an excellent bore. This 1967 proof-dated pistol retains about 95% original blue finish with thinning finish on the grip frame turning to mottled mix of brown and purple. There are a few scattered flecks of silvering on the slide along with some oxidation blemishes and light scratches. The checkered factory plastic grips with Walther banner rate about good with the front edge of the left panel exhibiting a groove, probably to repair a chip, however the panel remains intact. A pair of Walther magazines are included with one equipped with an extended floorplate and the other a standard floorplate. Also included are a leatherette covered factory hard case with crushed velvet lining on the base and satin on the lid. (87076-D29734) (300/500)
2195. **GERMAN P.08 HOLSTER AND ACCESSORY LOT** This lot consist of a three items. The first is a Frost & Jahnel, 1940-dated leather holster with eagle / WaA182 Waffenamts mark. The holster is in good to very good condition overall with the stitching starting to separate on the flap but the remainder still intact. The leather surfaces have random light scars and scuffs. Also included is a Luger tool with eagle / 655 stamped on it. Lastly, an aluminum based magazine with serial #6359y and Waffenamts mark eagle / 655 is included. The blue finished tube shows light wear and rates very good to excellent overall. (87024-17A)
2196. **SMITH WESSON MODEL 1903 32 HAND EJECTOR REVOLVER** serial #25458, 32 S&W Long, 4 1/4" pinned barrel with a frosted bore. This 1st change model retains about 70% original nickel finish with scattered oxidation blemishes on the metal surfaces, light surface dents on the frame, scattered scratches and flaking nickel. The hammer and trigger are mostly brown with the only case-hardened colors seen in the protected crook of the hammer. The diamond-checkered hard rubber grips are correctly numbered to the gun and remain in fair condition. The left panel is fairly clean with light wear and several small gouges on the heel and toe of the butt. The right panel has a repair to the toe and light to moderate wear. The gun still times and locks up correctly and all appropriate parts have correct matching numbers. (87035-30) {C&R} (350/550)
2197. **BRITISH LEND LEASE VICTORY MODEL K-200 REVOLVER BY SMITH & WESSON** serial #V245913, 38/200 (38 S&W), 5" pinned barrel with an excellent bore. This 1942-era gun has the original sandblasted blue finish and currently retains about 75% with the grip frame having flaked to a plum brown patina along with moderate high edge wear and thinning to blue gray finish on the cylinder and portions of the frame. The trigger and hammer are gunmetal gray with light oxidation blemishes. Two sets of grips are provided, the first set are correctly numbered to the gun but the right panel has a crack running the full length of the back, they both exhibit moderate handling wear. The second set are original factory stocks numbered to another gun with light handling wear rating about very good. This revolver has the correct ordnance bomb and inspector marks on the butt, U.S. property markings on the topstrap and proper British proofs. (87021-1) {C&R} (300/500)
2198. **SMITH & WESSON MODEL 1 1/2 SINGLE ACTION TOPBREAK REVOLVER** serial #14566, 32 S&W (short), 3" barrel with an oxidized and pitted bore. This revolver has lost some finish over the years but remains a solid example of the 1 1/2 topbreak fitted a wonderful set of antique ivory grips. This later production revolver retains about 90% plus original nickel finish with scattered light oxidation blemishes and freckling on the metal surfaces. The cylinder has multiple turn rings from use and improper removal / installation. The smooth ivory grips are hand numbered to the gun with no other markings. They have mellowed to a pleasing straw (right panel) and cream (left) color. The left panel has a several small checks. (87063-2) {ANTIQUE} (300/500)
2199. **LOT OF COLLECTIBLE AMMUNITION** This lot consist of a single round of 45-85 W.C.F. ammunition in plastic foam lined clear plastic container with broken latch. The round is headstamped "W.R.A. Co. 45-85 W.C.F." and loaded with a lead round nose flat point bullet. The side of the case is marked 45/85 WCF in marker. The case is lightly tarnished with a small dent and handling marks. The bullets ogive and meplat have light dents and dings. (87063-29)

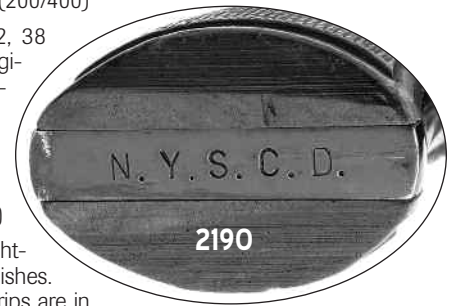

2200. **SMITH & WESSON MODEL 1 1/2 SINGLE ACTION TIPUP REVOLVER** serial #120687, 32 RF, 2 1/2" barrel with a frosted bore. This tip-up has several mechanical issues but has the slightly more desirable 2 1/2" barrel. This second issue tipup retains about 75% original factory nickel finish with scattered freckling and oxidation blemishes which are most prevalent on the frame and cylinder. The right side of the hammer has bold case-hardened colors while the left side has flaked to brown. The smooth rosewood grips are correctly numbered to the gun and are in good to very good condition with scattered light dents, scratches and some flaking finish. The barrel release latch is frozen and the barrel cannot be opened. It also appears the hand (pawl) is also in need of professional services. (87063-18) {ANTIQUÉ} (350/550)
2201. **BERETTA MODEL 1934 SEMI-AUTO PISTOL** serial #912390, 380 ACP, 3 3/8" barrel with an excellent bore. This is a nice condition Model 1934 with light wear. The pistol is dated 1941 on the slide with XIX for the nineteenth year of fascism. It retains about 90% original polished blue finish with high edge wear, thinning grip frame and random handling marks. The pebble texture factory synthetic grips are in very good condition with some slight scuff to the left panel. A single magazine is provided with the pistol. (87017-8) {C&R} (250/450)
2202. **A.M.T. LONGSLIDE HARBALLER SEMI-AUTO PISTOL** serial #A16179, 45 ACP, 7" barrel with an excellent bore. This El Monte California made pistol has light scattered scratches, dents and dings for an overall rating of about 96%. The Pachmayr wrap-around rubber grips are in very good condition with some light handling marks. This pistol is equipped with Millett white outline adjustable rear sight and white lined ramp front sight. A single Colt marked magazine is included. (86956-1) (300/500)
2203. **BERETTA MODEL 9000S SEMI-AUTO PISTOL** serial #SN005001, 40 S&W, 3 1/2" barrel with an excellent bore. This compact polymer frame pistol has ergonomic features designed by the renowned firm of Giugiaro Design. The black finished metal and black polymer surfaces are in excellent condition retains about 99% original blue. The pistol features three dot sights, ambidextrous thumb safeties that allow cocked and locked carry or it can be carried hammer down for a double action first shot. A single magazine is included. This is a fine candidate for concealed carry or home defense. (86973-1) (300/500)
2204. **COLLECTIBLE MILITARY HOLSTER** This lot consists of a single holster with one magazine. The holster is a German P.38 holster constructed of black-colored stamped calfskin. The remnants of the "P 38" stamp on the rear of the holster are still visible as are the faint remains of a Waffenamt mark. The holster is in very good to excellent condition with light wear to the flap, edges of the magazine pouch and toe area. The stitching remains intact with slight fraying on the interior of the holster where the triggerguard rubs. A single "P.38v" marked magazine is included and rates very good to excellent overall. (87014-4)
2205. **GLOCK MODEL 23 SEMI-AUTO PISTOL** serial #BUY097US, 40 S&W, 4" barrel with an excellent bore. This compact pistol was a police trade that was factory rebuilt. The Tenifer finished metal parts retain about 98% original finish and the polymer frame rates very good to excellent condition with scattered light handling wear. The pistol features the standard white outline drift adjustable rear sight and white dot front sight. The pistol includes a factory "Tupperware" box that is correctly end-labeled and numbered to the gun and reflects the factory rebuild. Also included is a pair of magazines, bore brush and magazine loader. (87075-S18408) (350/550)
2206. **SMITH & WESSON MODEL M&P 40C COMPACT SEMI-AUTO PISTOL** serial #HRL9701, 40 S&W, 3 9/16" barrel with an excellent bore. This is a fine condition pistol that looks like it has seen little if any use. The metal retains 99% original blue and polymer surfaces rate excellent. The pistol has a magazine safety, three dot sights and accessory rail. The pistol includes a factory hardcase that is correctly end labeled and numbered to the gun, a pair of magazines, two spare interchangeable backstraps of different size, cable lock with two keys, fired case, manual and paperwork. If you need a good concealed carry pistol or home defense gun, look no further. (87075-S18318) (350/550)
2207. **COLT MODEL 1903 POCKET HAMMERLESS SEMI-AUTO PISTOL** serial #437911, 32 ACP, 3 3/4" barrel with a frosted bore. This is a well-used 1903 that has been well cared for over the years. This early 1924-made pistol retains about 80% original blue finish with the majority of the loss on the grip frame which has worn to a mottled mix of gunmetal gray and brown. The metal surfaces have scattered light scratches, dings, pitting and oxidation blemishes. The checkered hard rubber grips are correct for an early 1924 Model 1903 and remain in near excellent condition with some light handling marks. This pistol has the earlier U-notch rear sight and the slide is numbered to the frame. A single magazine is included as well as a nylon Crossman holster with spare magazine pouch in the front. (86983-28) {C&R} (200/300)
2208. **COLT MODEL 1894 DOUBLE ACTION REVOLVER** serial #11598, 38 Long Colt, 6" barrel with near excellent bore with a few light oxidation blemishes. This 1894-made revolver retains about 45% original blue finish with most of the worn surfaces flaking to a mix of brown and gunmetal gray colors; light scratches and oxidation blemishes are also present. The checkered hard rubber factory grips are correctly assembly-numbered to the gun and remain in near excellent condition. They have the Rampant Colt in a circle with "1892" below them. All appropriate parts are correctly assembly-numbered to the frame and Rinaldo A. Carr's inspection mark appears on the face of the cylinder but not the frame. A Rampant Colt in a circle appears on the left rear of the frame. No military markings appear on the butt. (87024-2) {ANTIQUÉ} (200/400)
2209. **COLT OFFICERS MODEL TARGET REVOLVER** serial #520586, 38 Special, 7 1/2" barrel with an excellent bore and the last patent date of July 4, 1905 on the top. This 1948-made revolver retains about 55% original blue finish with the grip frame and barrel exhibiting the most loss. They are mix of gunmetal gray and brown with interspersed oxidation blemishes, scratches, dents and dings. This revolver has checkered hard rubber factory grips with stylized C in the center and Colt in an oval at the top. They are in good to very good condition with random scratches and dents plus worn diamond points on the right panel. The gun still times and locks up correctly and should make a great shooter or project gun. (87022-152) {C&R} [Mark Benenson Collection] (300/500)
2210. **SMITH & WESSON 32 DOUBLE ACTION TOP-BREAK REVOLVER** serial #232681, 32 S&W (short), 3" bore with scattered oxidation blemishes. This fourth change revolver has been nicely re-nickelled with about 97% remaining. The finish has lightly flaked at the muzzle, on the end of the cylinder and the usual turn ring is visible on the cylinder. The diamond-checkered hard rubber grips are not correctly numbered to the gun but remain in near excellent condition with light handling marks. All appropriate parts are correctly numbered to the gun. This little gun still times and locks up correctly and there is slight play between the frame and the barrel. (86932-3) {C&R} (150/250)
2211. **SMITH & WESSON 38 DOUBLE ACTION TOP BREAK REVOLVER** serial #435941, 38 S&W, 5" barrel with an oxidized and pitted bore. This fourth model revolver has a factory refurbish mark present on the butt. It retains about 40% factory re-applied finish with the heaviest loss on the grip frame and frame which has flaked to brown. The left side of the barrel has also flaked to a brown hue. The hammer has some minor case-hardened colors still present. The remainder of the surfaces on the hammer and trigger are now a mix of gunmetal gray and brown. A set of un-numbered genuine mother-of-pearl grips with gold S&W medallions are fitted to the gun. Overall they are in good condition with smooth surfaces but a chip missing on both panels near the frame. The ejector is somewhat sluggish but should be an easy repair. (86965-43) {C&R} (150/250)



2212. **MARLIN XX STANDARD MODEL 1873 TIP-UP REVOLVER** serial #5921, 22 RF, 3" round ribbed barrel with a lightly oxidized and pitted bore. This pistol retains about 10% original finishes with some blue finish present in the groove under the rib and a few traces of silver plating on the frame behind the recoil shield. The barrel is predominately gunmetal gray with interspersed oxidation blemishes. The brass frame is now an even straw patina with light handling marks. The hammer and trigger are mostly gunmetal gray with traces of case-hardened colors. The smooth rosewood grips are numbered to the gun and exhibit flaking finish and handling marks for an overall rating of about very good. The barrel and cylinder are numbered to the frame. The cylinder pin, timing and lockup are in need of professional attention. (86895-12) {ANTIQUE} (150/250)
2213. **LEE ARMS RED JACKET NO. 3 REVOLVER** serial #58455, 32 RF, 2 3/4" barrel with lightly oxidized grooves. This revolver retains about 99% original nickel finish with some light handling marks. The hammer and trigger have flaked to gunmetal gray with light silvering from wear and handling. The smooth rosewood factory grips are numbered to the gun and remain in fair condition. The surfaces have light handling wear but the back of the right side has a check running the length of the panel. This little gun still times and locks up correctly. (86778-10) {ANTIQUE} (75/150)
2214. **COLT OFFICERS MODEL MATCH REVOLVER** serial #79943, 22 LR, 6" barrel with a lightly frosted bore. The finish on this fifth issue revolver can best be described as a pitted re-blue. All the exterior metal surfaces are evenly covered in moderate pitting that has re-applied blue finish. There is some light scattered surface oxidation present for an overall rating of about 85%. The checkered factory walnut target stocks with gold Colt medallions are in very good to excellent condition with light handling marks. The adjustable Colt Micro sights still function plus timing and lockup remains excellent. (87022-154) (200/400)
2215. **IVER JOHNSON MODEL 55S-A CADET REVOLVER** serial #G15799, 38 S&W, 2 1/2" barrel with an excellent bore. The condition of this revolver and accessories is sure to excite the Iver Johnson collector. This fluted cylinder recessed chamber revolver retains about 99% original blue finish with robust case-hardened colors present on the trigger and hammer. The mottled brown Tenite factory grips are in like-new condition. Included is an original hinged factory box that is correctly end labeled and numbered to the gun, a manual and paperwork. The box is in near excellent condition and the paperwork exhibits light handling. This gun appears to have seen little if any use. (86940-259) (175/275)
2216. **IVER JOHNSON TARGET MODEL 55A SPORTSMAN REVOLVER** serial #H42357, 22 LR, 6" barrel with an excellent bore. This is a fine condition revolver for the shooter or collector. This fluted cylinder recessed chamber revolver has the flash control front rim and retains about 97% original blue finish with light silvering to the cylinder and a few oxidation blemishes. The trigger and hammer retain robust case-hardened colors with scattered freckling. The mottled brown checkered Tenite factory thumbrest target grips are in near excellent condition with a few light handling blemishes. Included is an original hinged factory box that is correctly end labeled and numbered to the gun. The box is in very good condition and the gun appears to have seen minimal use. (86940-261) (150/250)
2217. **IVER JOHNSON TRAILSMAN MODEL 66 TOP BREAK REVOLVER** serial #K3773, 22 LR, 6" barrel with an excellent bore. This fluted cylinder recessed chamber revolver has the flash control front rim and retains about 85% original blue finish. The front strap and muzzle areas have worn to gunmetal gray along with scattered high edge wear and oxidation blemishes. The trigger and hammer retain robust case-hardened colors. The mottled brown checkered Tenite factory thumbrest target grips are in near excellent condition with a few light handling blemishes. The revolver features a windage adjustable rear sight and elevation adjustable rear sight with manual extraction / ejection. Included is an original two-piece factory box that is correctly labeled on the interior to the gun. The box is in good to very good condition with some edge wear and damage on the cover. (86940-258) (100/200)
2218. **IVER JOHNSON MODEL 22 SUPERSHOT SEALED EIGHT TOP-BREAK REVOLVER** serial #L10086, 22 LR, 6" barrel with an excellent bore. This first model Supershot retains about 85% original blue finish with front strap, hump and right side of the frame worn to a brown hue. The muzzle is worn to silver with some light high edge wear. The trigger and hammer retain vigorous case-hardened colors. The lightly checkered oversized factory walnut stocks are in very good condition with some lightly worn finish and handling marks. The revolver features a fully adjustable front sight and Patridge front sight. Included with the gun is a factory hinged box that is not correctly end labeled or numbered to the gun and a manual (both for third model - model 844). The side of the barrel is marked "22 Supershot Sealed Eight". Barrel to frame fit remains tight with correct timing and cylinder lockup. (86940-257) {C&R} (200/300)
2219. **IVER JOHNSON MODEL 56A STARTER REVOLVER** serial #S27811, 22 RF blank, 2 3/4" solid barrel. Overall, this eight shot revolver retains about 90% plus original blue finish with scattered freckling on the frame and to a lesser extent on the cylinder. The oxidation has started to lightly surface pit in select areas. The mottled brown Tenite grips are in excellent condition. The trigger and hammer retain spirited case-hardened colors with light operation marks. The revolver includes a hinged factory box that is correctly end labeled and numbered to the gun. The box shows light storage wear and staining. Just what you need for your next track meet, training your bird dog or celebrating the fourth of July. (BATFE considers these a modern handgun) (86940-270) (50/100)
2220. **IVER JOHNSON MODEL 56A STARTER REVOLVER** serial #S5462, 32 S&W blank, 2 3/4" solid barrel. Overall, this five shot revolver retains about 90% plus original blue finish with high edge wear, scattered scratches. The mottled brown Tenite grips are in very good condition with light scratches and scuffs. The trigger and hammer retain strong case-hardened colors with light operation marks. The revolver includes a hinged factory box that is correctly end labeled and numbered to the gun. The box is in near excellent condition with light storage wear. This is great gun for dog training or field and track meets. (BATFE considers these a modern handgun) (86940-278) (50/100)
2221. **IVER JOHNSON MODEL 56 STARTER REVOLVER**, 22 RF blank, 2 3/4" solid barrel. Overall, this eight shot revolver retains about 95% plus original blue finish with some light but limited high edge wear and pitting on the frame and window around the barrel. The mottled brown Tenite grips are in very good to excellent condition with light handling wear. The trigger and hammer retain vigorous case-hardened colors. The revolver includes a hinged factory box that is correctly end labeled and numbered to the gun and shows faint storage blemishes. The deflector rod for the wads exhibits light silvering from use and cleaning and lacks the hinged loading gate of the later model 56A. (BATFE considers these a modern handgun) (86940-272) (25/75)
2222. **IVER JOHNSON SAFETY HAMMER DOUBLE ACTION TOP-BREAK REVOLVER** serial #K48014, 32 S&W, 3" barrel with a frosted bore. This second model revolver retains about 90% plus original nickel finish with the finish on the cylinder, barrel and muzzle having flaked to brown from oxidation. The hammer and trigger retain strong to fading case-hardened colors with light wear and freckling present. The blue finished triggerguard is thinning to a mottled mix of brown and blue. The provided box bears no information if the genuine mother-of-pearl grips are factory but they remain in excellent condition with the frame metal proud along the frontstrap on both panels. An un-numbered hinged purple factory box that is correctly end labeled to the gun is included and warns against the use of smokeless powder in the firearm. The gun still times and locks up correctly. (86940-247) (150/250)

2223. **IVER JOHNSON TARGET MODEL 57 REVOLVER** serial #J19042, 22 LR, 4 1/2" barrel with an excellent bore. This fluted cylinder recessed chamber revolver has the flash control front rim and retains about 65% original blue finish. The front strap and most of the barrel has worn to gunmetal gray with scattered light scratches, wear marks and oxidation blemishes. The trigger and hammer retain robust case-hardened colors with the face of the hammer wearing to silver. The mottled brown checkered Tenite factory thumbrest target grips are in very good condition with light scratches, dents and dings. The revolver has windage adjustable rear sight and elevation adjustable front sight. Included is an original green leatherette covered hinged factory box that is not labeled but remains in very good to excellent condition with light wear. (86940-275) {C&R} (50/100)
2224. **LOT OF AMMUNITION** Six boxes total, some partial: (1) Remington Kleanbore Express green and red box containing 18 rds. of 257 Roberts, 117 gr., SP Core-Lokt; (1) Western Super-X blue and yellow box containing 17 rds. of 257 Roberts, 87 gr., SP Lubaloy; (1) Winchester red and yellow box containing 9 rds. of 257 Roberts, 100 gr. Silvertip; (1) Winchester Super Speed blue, yellow and red box containing 20 rds. of 7 mm Mauser, 175 gr. SP; (1) Winchester Super Speed red and yellow box containing 16 rds. of 222 Rem., 50 gr. SP; (1) Hansen Posi-Feed silver box containing 20 rds. of 222 Rem., 55 gr. PFSP. Also included is plastic bag containing 200 rds. of assorted handgun and rifle cartridges in various configurations both military and commercial and a plastic bag containing 136 fired brass cases both primed and unprimed of different calibers and makes, both handgun and rifle. Ammunition rates about very good overall with tarnish and oxidation on many of the cases and the boxes showing scuffing, in-markings and missing endflaps. (56161-19)
2225. **LOT OF AIR GUN AMMUNITION AND ACCESSORIES** Fives items total: (1) Daisy 1886-1986 Centennial wooden crate containing 21 tubes of Zinc plated steel BB's. The tubes are 350 ct. tubes and all appear to be full; (1) partial 250 ct. tube of Crossman 22 cal. lead pellets; (2) Crossman packages containing seven 12-gram small neck CO2 cylinders; (1) Beeman Magnum Jet 5 ct. package of 12-gram CO2 small neck cylinders. All are in fine condition overall. (56161-20)
2226. **LOT OF SHARPENING STONES** Four total: (1) 8" Russell's soft Washita/Arkansas oilstones in a hardwood base with lightly stained instruction sheet; (1) 3 3/4" white Russell's soft Washita / Arkansas oilstone with instruction sheet and factory plastic bag; (1) 3" Norton brown and gray India and Crystolon sharpening stone in original two-piece factory box; (1) 4" narrow Norton gray fine Crystolon sharpening stone in two-piece factory box. Stones are in very good condition showing light stains and wear from years of use. (56161-21)
2227. **LOT OF BLACK POWDER SHOOTING ACCESSORIES** Five items total: (1) Dixon & Son Colt style 6" copper bodied flask with single sided "stand of flags" martial motif and common brass top and fixed position charger having some light oxidation staining and handling marks; (1) unmarked brass dual cavity .36 cal. round ball and conical bullet mould with light oxidation and tarnish staining; (1) cardboard box containing about approximately 90 .36 cal. lead round balls; (1) bright steel fixed and (1) blued steel hinged combination nipple wrench and turn-screw. (56121-9)
2228. **LOT OF HANDGUN GRIPS** Nine grips total: (1) set of Franzite checkered faux ivory grips and (1) set of aftermarket checkered walnut grips for a P-08 luger pistol; (1) set of aftermarket checkered thumb rest grips for a unknown rimfire pistol with mounting screw; (1) set of checkered walnut two-hole pistolgrips with medallion cutouts; (1) set of Star checkered thumb rest black plastic pistolgrips; (1) set of unmarked checkered black plastic thumb rest grips; (1) set of Franzite two-piece faux ivory small frame revolver grips with mounting screw and a small crack at the top of the mounting on the right panel; (1) one-piece walnut grips with added grooved grain highlights and varnish for a small frame single action revolver; (1) one-piece smooth walnut grips with added varnish for a large frame single action revolver; (1) unmarked cream colored faux ivory plastic base for a luger magazine. In very good plus condition overall, some showing light wear and handling marks and missing hardware unless otherwise noted. (56121-14B)
2229. **LOT OF MAGAZINES** Four total: (1) 15 rd. M1 carbine magazine retaining most of its original blue finish with light scuffs and scratches and is marked "IU" on the rear spine; (1) unknown 13 rd. 380 ACP magazine retaining about 98% original blue marked "9 mm C (.380)" on the black plastic base; (2) unknown bright finish 25 ACP magazines marked ".25 CAL. AUTO" on the crimped floorplate. (56121-16A)
2230. **REDFIELD FLIP UP PEEP SCOPE RINGS** This lot contains an older set of Redfield No. 70-A, 1" two-piece rings and bases equipped with a flip-up aperture mounted to the back of the rear base for a Winchester Model 70 rifle. The mounts are in excellent condition retaining nearly all of their original blue finish with only some very minor handling marks from prior use, mounting hardware is included. (56161-14C)
2231. **PARKER EDWARDS AMERICAN BLADE COLLECTORS ANNIVERSARY COMMEMORATIVE SURVIVAL KNIFE** This massive knife measures 15" overall with a 10" Damascus steel blade equipped with a sawtooth top edge and matching double guard. The blade remains unsharpened and is numbered "401" next to makers mark on the obverse blade and etched "5 Year Anniversary / American Blade Collectors / 1981-1986 1 of 1200". The knurled black anodized hollow handle with removable pommel is equipped with a black face compass in interior of handle. Knife includes an unmarked dyed black leather sheath with hone in pocket. (56020-K169)
2232. **CASE XX FIXED BLADE KNIFE** This knife measures 9 3/4" overall with a 5 1/8" stainless steel clip point blade equipped with a 1 1/8" sharpened false edge. Although not marked, the knife very closely resembles a model 200. The blade remains bright and unsharpened and is marked "CASE XX / Stainless / U.S.A." on the obverse ricasso. The black composite finger grip handle is separated between an aluminum pommel and guard, separated by brown and aluminum spacers. The handle shows a couple light marks and is scratch engraved with previous owners initials in the reverse side of the handle. Knife includes an excellent condition black leather sheath with a lace stitched seam. (56161-18Y)
2233. **RANDALL MODEL 26 PATHFINDER FIXED BLADE KNIFE** This is an early style Pathfinder measuring 8 1/4" overall with a 4" tool steel blade. The blade remains bright and unsharpened and the single brass hilt has a goldenrod patina with spots of tarnish and staining from sheath storage. The stag handle has darkened nicely with age, is equipped with a brass lined lanyard hole and is separated by a thin red, white and blue spacer collar. Knife includes a Sullivan model E leather covered sheath. (56020-R212) (400/600)
2234. **RANDALL A.G. RUSSELL DEALER SPECIAL FIXED BLADE KNIFE** This smaller-version dealer special knife measures 8 3/8" overall with a 4" tool steel modified drop point blade equipped with thumb serrations. The blade remains unsharpened and bright except for a few scattered specks of light freckling along the top edge and along the tip of the obverse side of the blade; the top edge of the blade is numbered 198. The brass single hilt is a pleasing goldenrod. The stag handle rates excellent and is equipped with a white face compass in the butt and a brass and black spacer collar. Knife includes a Sullivan's model A leather sheath with hone in pocket, Randall Made marked snaps and A.G. Russell Special / Randall Made logos on back of sheath. (56020-R319) (400/600)
2235. **RANDALL NORDIC DEALER SPECIAL DROP POINT FIXED BLADE KNIFE** This dealer special knife measures 7 3/8" overall with a 3 1/4" tool steel drop point blade equipped with thumb serrations. The blade remains unsharpened and bright except for a small speck of freckling along the bevel on the obverse side. The nickel silver single hilt remains bright except for two spots of staining from sheath storage and the genuine stag handle rates excellent and is separated by a red, white and blue spacer collar. There is no sheath included. (56020-R350) (400/600)

2236. **RANDALL MODEL 26 PATHFINDER FIXED BLADE KNIFE** This knife measures 8 1/8" overall with a 4" stainless steel blade equipped with thumb serrations. The blade remains bright and unsharpened with seldom seen "FL." makers mark. The nickel silver single hilt remains bright overall with some light staining along the edges from sheath storage. The genuine stag handle rates excellent and is separated by a thin red, white and black spacer collar. Knife includes a Sullivan's model D leather cover sheath. (56020-R225) (400/600)
2237. **RANDALL A.G. RUSSELL DEALER SPECIAL FIXED BLADE KNIFE** This smaller-version dealer special knife measures 8 3/8" overall with a 4" tool steel modified drop point blade equipped with thumb serrations. The blade remains unsharpened and bright except for some scattered specks of fine staining on the reverse side of the blade; the top edge is numbered 198. The brass single hilt and exposed nut buttcap are toning to goldenrod with scattered spots of modest oxidation and staining. The stacked leather washer handle rates excellent and is centered between black and brass spacers with matching oxidation staining. Knife includes a Sullivan's model A leather sheath with hone in pocket, Randall Made marked snaps and A.G. Russell Special / Randall Made logos on back of sheath. (56020-R221)
2238. **RANDALL MODEL 8 TROUT AND BIRD KNIFE** This knife measures 8 1/4" overall with a 4" tool steel blade. The blade is slowly toning to gun metal with specks of light staining and scuffs and scratches from sharpening over the years. The single brass hilt has a tarnished ocher patina. The slightly curved stag handle has darkened nicely with age, has ingrained dirt staining on the butt and is separated by a red, white and black spacer color. Knife includes a Sullivan's model B leather sheath with Randall Made marked snaps. A nice little Randall that has seen years of honest light use, still in very good condition overall. (56020-R214) (300/500)
2239. **ALLEN AND WHELOCK 22 SIDEHAMMER REVOLVER** serial #538, 22 RF, 2 3/8" octagon barrel with a good bore having pinprick pitting and good rifling the entire length. The nickel plated metal surfaces have almost all but faded to gun metal with scattered pinprick pitting, spots of oxidation and handling marks. The walnut grips rate good with light handling marks under an added varnish and are numbered to the gun. The action is still mechanically functional. (56251-5) {ANTIQUE} (150/250)
2240. **SCHULER REFORM "SEMI-AUTO" PISTOL** serial #793, 25 ACP, 3" four barrel block with very good bores having some spots of light frosting and a pit here and there. The metal surfaces bear an overall dull brown with generous traces of original blue in protected areas along with scattered pitting and oxidation. The checkered hard rubber grips rate poor with softened points, moderate chipping along the top of the left panel and a cracked right panel. The barrels and action still functions mechanically. An unique pre-WWI "semi-auto" vertically-acting pistol. (56535-13) {C&R} (175/275)
2241. **FRENCH ST. ETIENNE FOLDING TRIGGER DOUBLE ACTION REVOLVER** serial #H2054, 8 mm French, 2" round barrel with a very good bore having some faint pitting and frosting towards the muzzle. The metal surfaces retain about 40% original blue toning to brown with light handling marks and scattered pinprick pitting and oxidation staining. The walnut grips with checkered backstraps rate very good with light dents and handling marks. All visible numbers are matching including the grips. The action remains strong and mechanically functional, the cylinder pin and retention spring are a bit loose with light handling marks on the pin. (56564-2) {C&R} (300/500)
2242. **GAULOIS NO. 1 PALM PISTOL BY MANUFACTURE FRANCAISE ST. ETIENNE** serial #11689, 8mm extra short, 2 1/8" barrel with a good bore having modest pitting with faint traces of rifling visible. The metal surfaces are an overall dull brown with traces of original blue still present. The grooved walnut rear pad on the squeeze-firing mechanism shows a small crack along the bottom and remnants of dried glue along the entire edge. The pad is loose fitting and is no longer mounted to the pistol. An about very good example French palm pistol. (56535-11) {C&R} (200/400)
2243. **COLT MODEL 1861 NAVY PERCUSSION REVOLVER** serial #152507, 36 cal., 1 3/4" shortened barrel with a dark oxidized bore. The metal surfaces bear a pewter and brown patina with scattered pitting, oxidation staining and handling marks and the brass backstrap and triggerguard has a tarnished ocher patina with light handling marks. The loading lever and hinge were removed when the barrel was shortened and a dovetail notch front sight has been installed at the muzzle. The walnut grip rates good overall with numerous scuffs, handling marks and dried faded finish. The triggerguard is bent and does not seat properly against the frame; the cylinder no longer advances. An overall good example of a modified Colt "Belly Gun". (56363-47) {ANTIQUE} (200/400)
2244. **HARRINGTON & RICHARDSON TRAPPER DOUBLE ACTION REVOLVER** serial #158978, 22 RF, 6" octagon barrel with a fine bore. The metal surfaces retain about 80% original blue toning to brown with scattered pinprick pitting and oxidation staining. The checkered oversized walnut grips rate very good with light dents and handling marks and are numbered to another revolver. The revolver is equipped with a brass half moon front sight blade. The cylinder pin is slightly bent with light oxidation, the cylinder and action remain mechanically functional. (56855-41) {C&R} (150/250)
2245. **STEVENS NEW MODEL POCKET RIFLE NO. 40** serial #23118, 22 LR, 15" part round part octagon barrel with a good bore showing modest pinprick pitting with light rifling the entire length. The barrel bears a brown and gray patina with some scattered spots of fine oxidation and pinprick pitting. the frame retains about 60% original flaking nickel, the exposed metal an overall pewter with fine oxidation staining and handling marks. The smooth walnut grips rate very good plus with light handling marks. The barrel is numbered to the frame, no shoulder present. (56781-1) {C&R} (200/400)
2246. **UNMARKED SPUR TRIGGER DERINGER** serial #148, 32 RF, 2 3/4" part round part octagon barrel with a pitted oxidized bore. The barrel retains about 80% original nickel flaking to gun metal with spots of light pitting and surface oxidation. The frame is dull gun metal with scattered pitting and handling marks with generous amounts of original nickel on the gripstraps. The brown resin birdshead grips rate good overall showing lightly worn edges and handling marks with numerous pin size holes in the right panel. The grips do not seat properly and could be a later replacement. The action a bit loose but functional. (56416-20) {ANTIQUE} (150/250)
2247. **SWISS MODEL 1882 DOUBLE ACTION REVOLVER** serial #S3341, 7.5mm Swiss, 4 1/4" octagon barrel with a good bore having moderate pitting the entire length. The metal surfaces retain about 20% original blue toning to brown with moderate pinprick pitting and oxidation. The checkered black plastic grips rate near very good with light flattening to some of the points. The cylinder pin has been replaced with a brass rod and the action does not function and is need of mechanical attention. All visible numbers are matching and the lanyard ring is present and intact. (56265-6) (300/500)
2248. **BROWN MANUFACTURING SOUTHERNER DERINGER** serial #5892, 41 RF, 2 1/2" octagon barrel with a good bore having light frosting and pitting the entire length. The barrel shows areas of gun metal under a covering of modest surface rust partially obscuring the address on the barrel. The brass frame has a nice ochre patina with a few light handling marks and spots of tarnish. The walnut grips show modest wear with "L L" incise-carved in the left panel which is numbered to the gun. The barrel, extractor and frame are numbered alike. Lock-up remains pretty tight, the barrel screw shows light slot wear. (56535-23) {ANTIQUE} (300/500)



2249. **AMERICAN ARMS CO. COMBINATION DOUBLE BARREL DERINGER** serial #3988, 22 RF/32RF, 3" superposed barrels with oxidized bores. The barrels are an overall brown patina with scattered fine oxidation staining and a few specks of pinprick pitting. The brass frame has a darkened ochre patina with scattered light handling marks and pinprick pitting. The square butt rosewood grips rate good to very good having warped slightly with light handling marks and a thin crack in the top of the right panel from the frame to the grip screw which is also numbered to the gun. Barrel lockup is a bit loose. (56535-19) {ANTIQUE} (200/400)
2250. **HOOD FIREARMS ROB ROY SPUR TRIGGER REVOLVER** serial #125, 22 Short, 2 1/4" octagon barrel with a good bore showing moderate pitting. The loose scroll-engraved metal surfaces bear a gray brown patina with scattered pinprick pitting, fine oxidation staining and a few spots of surface rust under the grip panels. The polished bone grips rate fine with a few minor handling marks, the left pane is pencil-numbered to the gun and the right to another revolver along with other undecipherable markings. The action does not function properly. (56363-43) {ANTIQUE} (25/75)
2251. **UNMARKED REPRODUCTION ROGERS & SPENCER ARMY PERCUSSION REVOLVER** serial #7, .44 cal., 7 1/2" octagon barrel with a bright fine bore. The metal surfaces retain about 80% original blue toning to brown with areas of gray wear on the rear left of the frame, bottom of the loading lever along with silvering along the edges and spots of surface rust on the frame in front of the cylinder. The hammer and loading lever wedge retain generous amounts of fading case colors. The walnut grips rate very good with light dents and handling marks. A good to very good reproduction Rogers & Spencer for re-enacting or shooting. (56258-59) {ANTIQUE} (200/400)
2252. **UNMARKED SINGLE SHOT DERINGER** serial #259, 22 RF, 2 1/2" round two-step barrel with a very good smooth bore having some fine pitting and frosting. The metal surfaces on this Keno-style deringer retain about 85% original blue toning to brown with light silvering along the muzzle and edges. The birdshead walnut grips rate very good with light handling marks. (56799-6) {ANTIQUE} (200/400)
2253. **ENGRAVED AMERICAN TOOL COMPANY POCKET REVOLVER** serial #10059, 22 RF, 3" octagon barrel with an about very good bore having good rifling with light pitting and oxidation the entire length. The iron metal surfaces are an overall smooth brown patina with fine oxidation staining and light handling marks. The frame has a dull ochre patina with faint traces of original silver plate in protected areas. The frame and barrel flats have lightly softened scroll engraving with punch-dot shadowing. The smooth bone grips rate about very good are un-numbered and slightly undersized, the grip screw is worn and does not fit properly leaving the grips a bit loose. The frame, barrel and cylinder are numbered alike. The hammer and trigger remain strong, the cylinder spins freely and is in need of mechanical attention. (56229-629) {ANTIQUE} [Elliott Riggs Collection] (300/500)



2254. **CASED SHIV DISPLAY PURPORTEDLY FROM HUNTSVILLE PRISON** This lot is an attractive display of handmade shivs (prison knives) ranging in size from 4 5/8" to 11 5/8". All six have ground steel blades and five have complete or partial wood handles; the two longest were made from a ground common file and a section of rebar. The shivs are in very good condition overall with modest pitting and oxidation to the metal and modest wear to the handles. The shivs are mounted with glue and wire in a 16" x 22" glass covered mahogany stained wood frame case with a tan fabric lined interior and a brass plaque that reads "Huntsville State Prison / Huntsville, Texas / First Half 20th Century". The case is suitable for hanging and is in excellent condition, two of the shivs have become partially separated from their mounts but the case can be easily opened and re-mounted. The shivs were purportedly confiscated from prisoners at Huntsville, although confirmation cannot be determined. Huntsville housed some notable prisoners two of the most well-known are Duane "Dog" Chapman and John Wesley Hardin. A neat set of shivs which would make a great wall display for home or office. (56879-28) (200/400)

2255. **UNKNOWN FOLDING LOCKBACK KNIFE** This older lockback knife measures 12" overall with a 5 1/2" clip point carbon steel blade. The blade remains unsharpened and the bright finish is toning to dull gray with scattered oxidation staining; the ricassos both have identifying makers marks. The mottled brown celluloid grips rate about very good with a few tiny chips and cracks and are fastened by three small steel pins. The panels are centered between a rectangular and semi-circular steel bolster that is gunmetal in color with scattered light oxidation. The knife is equipped with a lanyard ring and a fading steel blade release lever matching the finish of the bolsters. (56879-20) (100/200)

2256. **ANTIQUE G. WOODHEAD SHEFFIELD BOWIE KNIFE** This knife measures 10 1/2" overall with a 6" full tang spear point blade. The blade has faded to pewter with scattered pinprick pitting, oxidation staining and numerous scuffs from being moderately sharpened. The obverse ricasso is marked "G. WOODHEAD / 36 HOWARD STREET / SHEFFIELD" The German silver double guard has a fading tarnished patina. The genuine stag handles have a nice dark brown color and are fastened with four small pins. The obverse panel is decorated with a German silver crest-shaped shield. Knife is carried in a gold accented black leather scabbard with German silver tip and throat. The leather shows modest scuffing, stains and fading gold paint while the metal ends show light tarnish staining, dents and a small hole in the collar. A zippered soft padded case is included. (56879-11)



2256

(300/500)



2257

2257. **JAPANESE KATANA** 27 1/4" blade to the plain brass sleeve, 39 1/4" overall length. The blade shows a very pronounced temper line and remains unsharpened and bright overall with some light staining and scuffing towards the front of the blade. The brass sleeve is a lightly tarnished goldenrod and the filed tang remains bright and is signed. The bright yellow faux bamboo painted handle and scabbard are equipped with brass ends and rate near excellent overall with a few light chips in the enamel; the spring on the brass lady bug knob does not lock the scabbard in the handle and the bamboo peg bushings are no longer present. An overall very good example, signed, modern Japanese Katana. (56879-17)

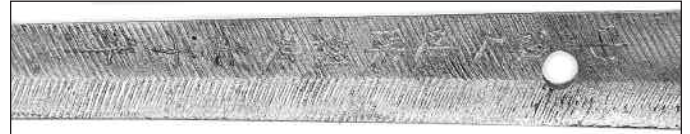

(200/400)



2258

2258. **JAPANESE KATANA** 27" damascus blade to the plain brass sleeve, 39 5/8" overall length. The blade has no temper line and remains unsharpened with a pleasing wavy damascus pattern having sparse spots of light staining and is signed along the rear top edge on both sides of the blade, the tang is unsigned and shows modest red oxidation. The brass sleeve is fading to a tarnished goldenrod with light impact marks and is stamped "97" on the obverse side. The semi-oblong cast brass tsuba is primarily a tarnished ochre with the thin metal spacers having an antiqued copper finish. The segmented grooved wood handle retains about 98% gloss black painted finish and the wood peg is present. The segmented grooved thin bamboo scabbard is equipped with a tarnished embossed brass collar and rates good overall with matching black paint and modest cracks and holes along the seams. (56879-18)

(200/400)

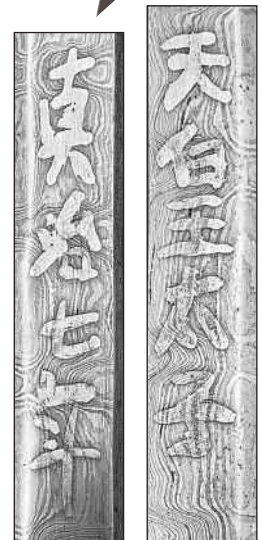

2259. **JAPANESE KATANA** 27 3/4" slightly curved blade to the plain brass sleeve, 39 1/4" overall length. The blade has no visible temper line and is toning to a soft gray with scattered light staining and is decorated with loose flowing scroll and Japanese symbols; the tang is unsigned. The pierced brass tsuba, embossed collar and endcap have a nice tarnished patina and the black enamel painted wood handle is decorated with a faded gold colored dragon and eagle. A non-original bamboo peg is present but does not fit the handle properly. The bamboo scabbard has a matching black enamel finish and embossed brass collar with light gold painted eagle, dragon and mum. The wood shows light dents and handling marks along with a nicely done painted tape repair along the top edge. (56879-19)

(200/400)



2259



2260. **SCARCE BOY'S MINIATURE MODEL 1860 STAFF & FIELD SWORD** Plain 21 1/2" blade, 26" overall length. The blade remains unsharpened and the bright finish is lightly toning to gun metal with some scattered sparse oxidation. The cast brass hilt is primarily a lightly softened goldenrod with embossed federal eagle on shell with no counterguard; stippled handle with embossed eagle on pommel with acanthus floral designs on butt and knuckle bow. The nickel plated steel scabbard has faded to gun metal with scattered fine pinprick pitting and is equipped with three brass ring mounts and drag. The brass has a nice goldenrod patina and is decorated with acanthus flower motifs on the mounts and a stand of arms and star on a stippled background on the drag. (56964-13) (200/400)



2261. **PATRIARCHS MILITANT FRATERNAL SWORD** Independent Order of Odd Fellows (IOOF) 26" blade, 32 1/8" overall length. The blade remains bright overall with some scattered light scuffs and patches of light oxidation staining. The blade is etched "Made by The / M.C. Lilley Co. / Columbus, Oh." on the obverse blade at the hilt along with "Bernard F. Miller" centered between a lamb and lion and flowing tendrils. The reverse side of the blade has matching etched tendrils, crossed shepherds crook and sword with three chained links, shields and entwined "PM". The cast brass hilt is a nice goldenrod with a double quillon guard, pierced crossguard with crown and crossed sword and crook emblem and a crown-topped globe pommel. The leather wrapped handle remains intact and is wrapped with braided brass wire. The nickel plated tubular steel scabbard shows some light staining with patches of modest oxidation between the center mount and drag. The decorative brass mounts remain bright and are numbered "68" which is also marked on the scabbard body at the throat. Included with the hanger is a lightly wrinkled black leather belt with brass Patriarchs Militant plate and hangers. The leather is slightly dried but intact and the brass has a lightly tarnished goldenrod patina. An identical sword is pictured on page 88 of The American Fraternal Sword. A complete sword and belt rig in overall very good condition. (56856-12) (200/400)



2262. **KNIGHT OF TEMPLAR ILLUSTRIOUS ORDER OF THE RED CROSS FRATERNAL SWORD** This is a highly embellished sword with a 30" blade, 37" overall length. The blade remains bright overall with light faking towards the tip and is decorated with lightly thinning gold washed etched panels on both sides. The obverse panel has name in Gothic letters, "George Dander Linder" centered between Maltese Crosses, armored knights and flowing tendrils. The reverse side of the blade has matching tendrils, mounted knights, crosses and is marked "The Lilley / Ames Co. / Columbus" at the hilt. The ornate hilt has a nickel plated guard with a red cross inside of a crown with a blue band on one side and a Maltese cross on the other side, antique ivory handle has a scrimmed cross and the knight's head pommel has no evidence of chain mounting. The tubular steel scabbard retains all its bright nickel plating with etched mounted knight, flowing tendrils and crosses and is equipped with highly decorative mounts with red crosses, stands of arms and matching tendrils. An excellent highly embellished Templar dress sword. (56964-56) (200/400)



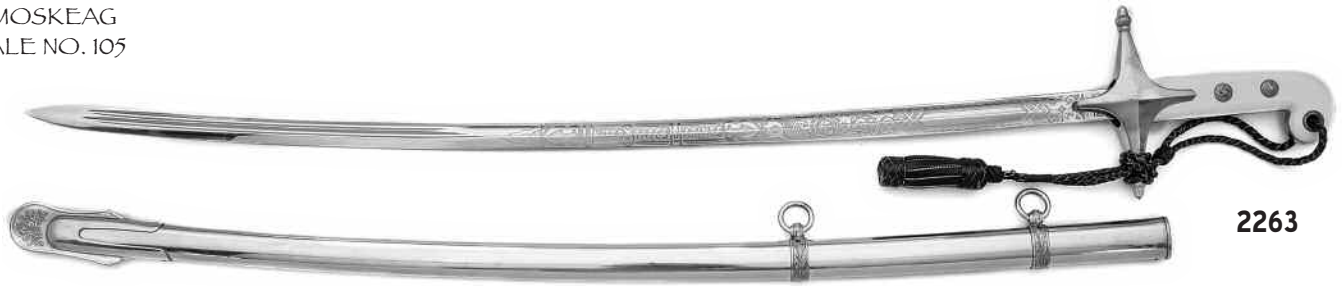

2263

2263. **U.S.M.C. OFFICERS MAMELUKE CEREMONIAL SWORD BY N.S. MEYER** U.S.M.C. app. serial #322, 30" double fuller blade, 35 1/2" overall length. The stainless steel blade retains all its original hand polished finish and its etched "UNITED STATES MARINES", U.S. and Marine flags and flowing tendrils. The obverse side of the blade has an etched un-engraved name riband with a serrated framed border and is marked "TRADE / DefendeR / MARK / N. S. MEYER" towards the hilt while the reverse side has "Star of David" proved mark at the hilt. The hilt is composed of a faux ivory grip accented with a cast brass guard with acorn finials, "star nut" grip pins, gripstrap and lanyard hole. The brass surfaces retain about 85% original gold wash with the exposed brass a bright goldenrod. Attached to the hilt is a braided black leather officer's knot. The included tubular steel scabbard retains 98% original polished nickel with a couple light nicks and scuffs and is equipped with a polished brass collar, dual hangers and drag with acanthus floral decorations. A minty Marine mameluke perfect for wall display or parade. (56964-57) (200/400)

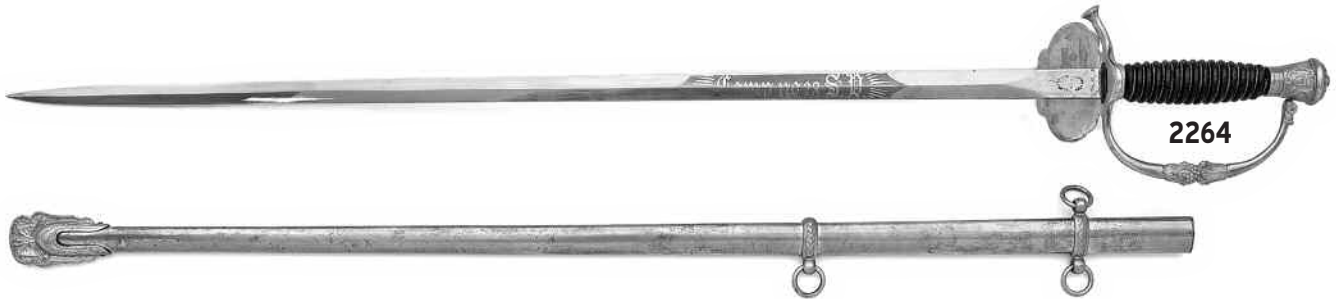

2264

2264. **U.S. SONS OF VETERANS SOCIETY SWORD BY SCHNITZLER WITH RETAILERS MARKINGS** This 1860 Staff & Field pattern sword has a 28" straight double edged blade, 33 1/2" overall length. The sword remains mostly bright with a few light scuffs primarily at the tip and perhaps a small nick or two along the edges. The reverse side of the blade is etched "Camp no. 28 S.D." with "SCHNITZLER / A&A/ SOLINGEN" makers mark on the ricasso while the obverse side is etched "S.V." between flowing tendrils and stand of flags and arms next to "R.M.J. REED / PHILA. / PA." retailers markings. The sword features veterans holding shield amongst panoplies of flags on the counter-guard with floral decorations on the knuckle bow and pommel also showing a federal eagle. The brass surfaces retain much original gilt with exposed brass having a nice goldenrod patina. The leather wrapped handle is fully intact as is the braided wire wrap. The included tubular steel scabbard retains about 90% original nickel with scattered fine pitting and oxidation and is equipped with a brass collar, triple ring mounts and a drag having a lightly mellowed goldenrod patina. A nice retailer marked sword. (56964-54) (200/400)



2265

2265. **U.S. MODEL 1902 OFFICERS SWORD BY PETTIBONE WITH 3RD INFANTRY INSCRIPTION** Pettibone 27" blade with three-quarter length unstopped fullers, 32" overall length. The blade is toning to gray retaining about 80% flaking original nickel with a few light nicks and scratches. The obverse blade is etched in gothic script "Old Guard- Georgia." while the ricasso is maker marked "THE / PETTIBONE / BROS. M.F.G. CO. / Cinti, O.". The brass hilt rates very good and is primarily a pleasing goldenrod with a few light dings and is numbered "66" on the reverse collar. The bone fingergroove grip rates fine with light handling and drying marks. The tubular steel scabbard and drag retain about 95-97% original nickel fading primarily on the drag along with some scattered light dents and impact marks. The brass collar and mounts have an overall ochre patina with generous amount of plating on the ring bands. (56964-55) (200/400)

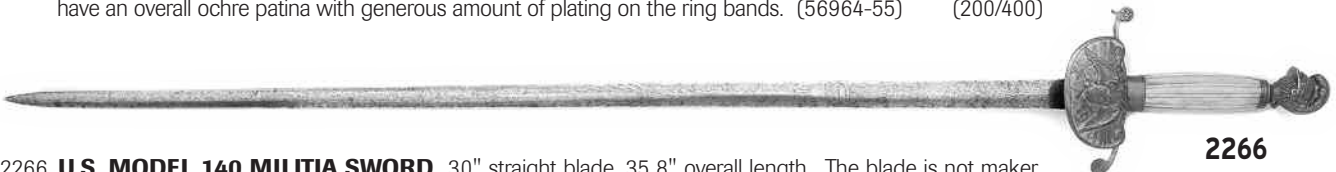

2266

2266. **U.S. MODEL 140 MILITIA SWORD** 30" straight blade, 35 8" overall length. The blade is not maker marked is primarily a dull pewter with scattered pinprick pitting and oxidation etched with floral scrolls and stands of arms, etching has softened lightly over time. The brass hilt has primarily a soft ochre patina with generous traces of original gilt. The hilt has a double guard with circular quillions, a federal eagle and sunburst on the clamshell counter-guard and a slightly loosened knights head pommel. The fluted antique ivory handle rates excellent having a wonderful cream color. There is no scabbard present. (56964-11) (150/250)



2267. **U.S. MODEL 1850 FOOT OFFICERS SWORD** 30 5/8" wide and narrow fuller blade, 36 1/4" overall length. The sword is not maker marked and the tip is well rounded. The blade is etched with floral scroll, "U.S.", stand of arms and flags. The blade bears an even gray patina with scattered pitting and oxidation with patches of moderate pitting and oxidation about 10" from the hilt and more prominent on the reverse side. The pierced brass hilt has a pleasing ochre patina with scattered light impact marks and the leather wrapped grip remains intact as does the braided wire wrap. There is no scabbard present. (56964-12) (200/400)



2268. **UNMARKED FOOT OFFICERS SWORD** 31 1/2" straight double edged blade, 36 3/4" overall, unmarked, and closely resembling an 1840 style foot officers sword. The blade retains about 98% dull nickel with scattered oxidation staining. The brass hilt has a cast imitation wire wrapped grip with plain fixed counterguards, knuckle bow with bulbous shaped finial and an urn shaped pommel with threaded button cap. The leather covered steel scabbard rates excellent with leather intact and is equipped with a brass tip and throat with long pointed frog stud. (56864-9) (200/400)



2269. **BRITISH PATTERN 1897 OFFICERS SWORD BY HENRY WILKINSON** serial #40038, 32 3/4" deep central fuller blade, 38 3/8" overall length. The blade retains about 95% flaking frosted nickel toning to dull gray with scattered fine oxidation staining. The blade is etched with flowing scroll, crowns and shields. The obverse side of the blade is etched "E.T.H." in the fuller and " BY WARRANT" in riband above "PATENET SOLID HILT / HENRY / WILKINSON / PALL MALL / LONDON" while the reverse ricasso has "Star of David" proof. The three-quarter basket guard is decorated with pierced scroll and royal cypher and retains about 95-97% original nickel with pinprick flaking and oxidation staining. The pommel and checkered backstrap remain bright and the checkered black aluminum handle has a couple thin cracks at the mounting pin on the reverse side and is wrapped in thin copper wire. There is no scabbard present. A nice overall very good example 1904-manufactured Wilkinson British Officers sword. (57062-4) (400/600)
2270. **U.S. MODEL 1860 LIGHT CAVALRY SABER** 34 1/2" blade with wide and narrow fullers 40 1/2" overall length. The blade is primarily a dull pewter with scattered light oxidation staining and light scuffing along the edges from being sharpened sometime during the period of use; inspector markings all but faded on the reverse ricasso. The iron hilt retains about 80% original plate with some sparse light impact marks and exposed metal primarily a dull brown patina. The wood handle retains about 65% leather covering, the braided brass wire wrapping is loose but intact. The steel scabbard has a few light dings and dents and retains about 75% flaking nickel toning to brown and gray with scattered pinprick pitting. (56874-5) (200/400)
2271. **AUTO ORDNANCE THOMPSON 22 CAL CONVERSION UNIT** This West Hurley unit is for a model A1-5 Thompson and consists of a factory cardboard box, 22 cal. barrel insert with a bright fine bore, two-part bolt assembly with dual recoil springs and a single magazine. The firing pin, magazine well adaptor and instruction sheet are missing. (77073-12)
2272. **FEDERAL LABORATORIES "TEAR GAS BILLIE" BATON** 9 1/8" overall length with a small 32 cal. removable leather wrapped brass tear gas compartment and brass handle equipped with a sliding cover to prevent accidental discharge. The leather rates excellent with a few minor blemishes and the handle retains about 95% chromium finish with light staining, the leather carry strap has lightly scuffed edges but remains supple and intact. (57006-13)
2273. **BROWNING HIGH POWER BARRELED ACTION** serial #2L17233, 270 Win., 22" barrel with a bright excellent bore. The metal surfaces retain 98% original blue; bolt assembly remains bright with light staining on the handle. The barrel, receiver and bolt are numbered alike. Barrel is equipped with open sights and two-piece Weaver style bases have been installed on the receiver. (56758-56)
2274. **HARRINGTON & RICHARDSON BARRELED ACTION** serial #53780, 30-06, 22" barrel with a bright excellent bore. The metal surfaces retain 98% original blue, the bolt body and extractor remain bright. Equipped with an FN action, the barrel is equipped with a sporting front sight without insert and a Williams adjustable open rear sight. (56758-57)
2275. **REMINGTON MODEL 722 BARRELED ACTION** serial #307023, 222 Rem, 26" barrel with a bright excellent bore. The metal surfaces retain 99% original blue. The barrel is equipped with original open sights, the bolt is electric pencil-numbered to the receiver along the bottom of the body. (56758-55)
2276. **MARLIN MODEL 783 BARRELED ACTION** serial #25645435, 22 WMRF, 22" barrel with a bright excellent bore. The metal surfaces retain 98% original blue with a few light marks from storage. The barrel is equipped with standard open sights, the trigger and other small assembly parts are not included. (56758-54)
2277. **SMITH & WESSON 32 SAFETY HAMMERLESS REVOLVER** serial #250628, 32 S&W, 3" barrel with a very good bore having a few patches of light pitting. The metal surfaces on this third model retain about 80% original blue toning to brown with scattered patches of moderate oxidation. The checkered walnut grips rate good with dents and flattened points; the grip screw has modest slot wear and cannot be removed. The cylinder is numbered to the frame. (57014-10) {C&R} (350/550)

2278. **IVER JOHNSON SAFETY TOP BREAK DOUBLE ACTION REVOLVER** serial #S10556, 32 S&W, 3" barrel with a very good bore having a few specks of light pitting closest to the muzzle. The metal surfaces retain about 95% flaking original nickel with loss along the cylinder, rear barrel flat and muzzle. The checkered owls head hard rubber grips rate very good with a small chip at the heel of the left panel. The revolver is in need of mechanical attention as the trigger does not function properly. (56983-30) {C&R} (100/200)
2279. **BELGIAN CENTER HAMMER PERCUSSION PISTOL** .41 cal., 3" octagon barrel with an oxidized bore. The metal surfaces are primarily a brown and gray patina with scattered spots of fine oxidation staining, frame shows light floral engraving. The smooth walnut bag shaped grips rate very good with much original varnish, a small crack at the rear tang and light handling marks. (56928-7) (175/275)
2280. **UNMARKED CENTER HAMMER PERCUSSION PISTOL** .36 cal., 2 1/2" octagon barrel with an oxidized bore. The metal surfaces are primarily dull gray with brown highlights and scattered fine oxidation staining and sparse light pitting here and there, the hammer is a slightly darker pewter gray. The flared wrist, smooth walnut bag shaped grip rates very good plus retaining much original varnish with a few light blemishes. The half-cock safety no longer functions properly. (56624-37) {ANTIQUÉ} (200/400)
2281. **UNMARKED BRASS BARREL CENTER HAMMER PERCUSSION PISTOL** .41 cal., 3" octagon barrel with cannon-belled muzzle and an oxidized bore. The brass metal surfaces are primarily a tarnished ochre patina with patches of fine oxidation staining and a few scattered light impact marks. The steel hammer, trigger and triggerguard have a dark brown patina with light oxidation and pinprick pitting. The smooth walnut bag shaped grip rates very good with a couple light handling marks and a lightly crack at knot along the rear right edge of the grip. The hammer remains strong and the action crisp. (56629-4) {ANTIQUÉ} (275/375)
2282. **BELGIAN FOLDING TRIGGER PINFIRE DOUBLE ACTION REVOLVER** 32 Pinfire, 3 3/8" octagon barrel with an oxidized bore. The metal surfaces are primarily gun metal gray with scattered patches of moderate oxidation; the frame, cylinder and rear barrel flats have loose foliate scroll engraving. The checkered black plastic grips rate fair with light wear and ingrained dirt staining. (56873-19) {ANTIQUÉ} (150/250)
2283. **BELGIAN FOLDING TRIGGER DOUBLE ACTION REVOLVER** 7 mm Pinfire, 3 1/4" round barrel with a lightly oxidized bore. The metal surfaces are an even balance of gray and brown with scattered oxidation staining. The smooth rosewood grips rate good overall with faint traces of original varnish and lightly worn edges and handling marks. The action no longer functions and is in need of mechanical attention. (56754-9) {ANTIQUÉ} (50/100)
2284. **HARRINGTON & RICHARDSON CZAR SPUR TRIGGER REVOLVER** serial #6080, 22 Short, 3 1/2" tapered octagon barrel with an oxidized bore. The metal surfaces are decorated with loose simple foliate scroll; the frame and barrel retain about 80% flaking frosted nickel with fine oxidation staining, the remaining metal surfaces a darker pewter with scattered pitting and oxidation staining. The checkered brown hard rubber dogs head grips rate very good with a small chip in the upper left corner of the right panel. The action is in need of mechanical attention as the cylinder does not advance properly all the time. (56855-40) {ANTIQUÉ} (100/200)
2285. **FLINTLOCK POCKET PISTOL BY ATVILE** .45 cal., 3 1/4" octagon barrel with an oxidized bore. The metal surfaces have an overall covering of light surface rust with the sideplate primarily a dull smoky gray; the lockplate is marked with fading "R. ATVILE". The walnut stock rates very good with lightly rounded edges and light handling marks. Included is an ebony ramrod with a cracked end. The cock spring is loose prohibiting the action from functioning properly. (56535-15) {ANTIQUÉ} (100/200)
2286. **EK MODEL 5 BOWIE KNIFE** This second generation bowie measures 12 3/4" overall with a 6 3/4" extended full tang stainless steel blade equipped with a fully sharpened top edge. The blade remains bright and unsharpened with etched short double banner makers mark at the hilt on the obverse side of the blade. The brass crossguard remains bright and the grooved laminate hardwood grips rate excellent and are fastened by three machined brass X-nut screws. There is no sheath present. (57059-8)
2287. **EK MODEL 3 FIGHTING KNIFE** This special order second generation fighting knife measures 12 1/2" overall with a 6 5/8" extended full tang stainless steel blade equipped with a 3 7/8" sharpened top edge. The blade remains bright and unsharpened with etched short double banner makers mark and Richmond markings at the hilt on the obverse side of the blade. The brass crossguard remains bright and the grooved walnut grips rate excellent and are secured by three poured lead rivets. Knife includes a maker marked tan leather sheath with dual handle straps and wrapped para-cord. (57059-12)
2288. **EK MODEL 4 FIGHTING KNIFE** This second generation knife measures 12 1/2" overall with a 6 1/2" extended tang double edge stainless steel blade. The blade remains bright and unsharpened with etched short double banner makers mark and Richmond markings at the hilt on the obverse side of the blade. The brass crossguard remains bright and the grooved black micarta grips rate excellent and are fastened by three machined brass X-nut screws. There is no sheath present. (57059-2)
2289. **EK MODEL 3 FIGHTING KNIFE** This second generation knife measures 12 1/2" overall with a 6 1/2" extended tang stainless steel blade equipped with a 3 3/4" sharpened top edge. The blade remains bright and unsharpened with etched short double banner makers mark and Richmond markings at the hilt on the obverse side of the blade. The brass crossguard remains bright and the grooved black micarta grips rate excellent and are fastened by three machined brass X-nut screws. There is no sheath present. (57059-4)
2290. **EK MODEL 5 BOWIE KNIFE** This second generation bowie measures 12 3/4" overall with a 6 3/4" extended full tang stainless steel blade equipped with a fully sharpened top edge. The blade remains bright and unsharpened with etched short double banner makers mark at the hilt on the obverse side of the blade. The brass crossguard remains bright and the grooved black micarta grips rate excellent and are fastened by three machined brass X-nut screws. Knife includes a factory O.D. nylon sheath with wrapped para-cord. (57059-6)
2291. **EK MODEL 3 FIGHTING KNIFE** This special order second generation fighting knife measures 12 3/8" overall with a 6 3/8" extended full tang stainless steel blade equipped with a 3 5/8" sharpened top edge. The blade remains bright and unsharpened with etched short double banner makers mark and Richmond markings at the hilt on both sides of the blade. The brass crossguard remains bright and the grooved black micarta grips rate excellent and are secured by three poured lead rivets. Knife includes a maker-marked black leather sheath with single handle strap. (57059-10)
2292. **FROST CUTLERY TROPHY-STAG FIXED BLADE KNIFE** This larger model Trophy-Stag knife measures 11 1/8" overall with a 6 1/8" clip point damascus blade. The blade is Trophy-Stag marked on the obverse ricasso and remains unsharpened, retaining about 98% of its wavy damascus pattern with some patches of surface rust along the tip and top edge of the blade. The brass single guard and pommel are primarily a mellowed goldenrod with spots of oxidation on the guard. The curved genuine stag handle rates excellent and is centered between brass, red and black spacers. Knife includes a heavy-duty brown leather sheath with handle strap. (57077-1B)



2293. **FROST CUTLERY TROPHY-STAG BOWIE** This Bowie measures 12 7/8" overall with a 8 1/4" full tang bowie style blade equipped with a 3 3/4" unsharpened false edge. The blade is Trophy-Stag marked on the obverse ricasso and retains nearly all its damascus pattern with some scattered specks of sparse oxidation staining and a decorative file work top edge. The genuine stag handles rate excellent fastened by two large brass pins and centered between a bright brass oval double guard and rear bolster with decorative file work along the edges and an engraved large cross in both sides of the rear bolster. Knife includes a heavy duty brown leather sheath with a handle strap having an embossed Great Seal of Oklahoma snap. (57077-1C)
2294. **FROST CUTLERY TROPHY-STAG BOWIE** This Bowie measures 12 7/8" overall with a 8 1/4" full tang bowie style blade equipped with a 3 3/4" unsharpened false edge. The blade is Trophy-Stag marked on the obverse ricasso and retains nearly all its damascus pattern with some scattered specks of sparse oxidation staining and a decorative file work top edge. The genuine stag handles rate excellent fastened by two large brass pins and centered between a bright brass single guard and lanyard hole equipped rear bolster with decorative file work along the edges. Knife includes a heavy duty brown leather sheath with a handle strap having an embossed Great Seal of Oklahoma snap. (57077-1A)
2295. **FROST CUTLERY BEAR & BULL FOLDING KNIFE** This large Congress-pattern knife measures 8" and is equipped with four bright unsharpened stainless steel blades. The swirled brown and orange celluloid scales are fastened by six small nickel silver pins and rate very good with inlaid Bear & Bull shield on one side and a thin crack between an upper and lower pin on the other side and are centered between two large nickel silver bolsters. (57077-2B)
2296. **FROST CUTLERY LIMITED EDITION FOLDING KNIFE** This two blade Trapper-pattern measures 8" overall and is equipped with two bright unsharpened stainless steel blades. The main blade is etched "First Production Run / 1 of 500" next to the Bear & Bull logo. The swirled brown celluloid scales are fastened by six small bright nickel silver pins with inlaid antique rifle shield and are centered between two large nickel silver bolsters. (57077-2A)
2297. **MATADOR ORIGINAL BOWIE** This Solingen Bowie measures 13" overall with a 8" full tang stainless steel blade equipped with a 3 5/8" sharpened false edge. The blade still remains bright with scattered light scuffs from being lightly sharpened and is marked "Original Bowie Knife" on the obverse side of the blade which is also Matador Solingen marked on the ricasso. The stag handle grips have darkened nicely with age and are fastened by three small brass pins and are from the Battle of Crete separated by a thin brass double guard which has loosened slightly. Knife includes a handmade stitched leather sheath with a tooled face and laced seams. (57056-9)
2298. **IVORY HANDLE KNIFE WITH INSCRIPTION** This is a rather neat little paring or small game knife measuring 6" overall with a 3" full tang, thin tool steel blade. The blade is primarily a dull gray with a slightly bent tip and a dull brass collar. The obverse side of the blade is fully engraved with a greek inscription which roughly translates to "Crete, how are you? You proudly show your mountains. / Beasts attacked and fought you but you struck them down. / Heraklion 1963" in regards to "Operation Mercury" in which Greek and Allied troops fought the Germans on the island in 1941. The antique ivory handle is fastened by two small iron pins and rates fair with a modest chip missing in the flared V-shaped end of the obverse grip. (57056-10)
2299. **GIL HIBBEN HUNTER FIXED BLADE KNIFE** This knife measures 8 3/4" overall with 4 1/4" full tang stainless steel skinning style blade. The blade remains unsharpened and bright retaining all its bright polish with facsimile signature and makers mark logo on the obverse side of the blade. The tang is nicely decorated with filework along the spine and butt which is also present along the liners. The single nickel silver guard remains bright and the curved finger grip pau ferro grips rate excellent, are fastened by two large and one small nickel silver pins and is equipped with a lined lanyard hole. Knife includes a high-quality hand tooled open throat leather sheath. (57069-1)
2300. **GERMAN SPRING OPENING FOLDING KNIFE** This knife measures 4 5/8" with a 3 1/4" drop point partially serrated stainless steel blade. The blade remains bright and unsharpened. The aluminum handle with stippled rubber panel inserts rates fine retaining 98% frosted nickel with a small spot of flaking on the side with the inserts. Knife includes a black nylon belt pouch. As with all switchblades and spring-opening knives, this knife can be sold to New Hampshire residents only. (57069-2)

2301. **COLLECTION OF CONTEMPORARY BUCK FOLDING KNIVES**

This lot contains 18 folding knives manufactured by Buck from 1972-1991 ranging in size from 2 5/8" to 5 1/4" and consists of single and multi-blade patterns with wood, plastic and Delrin handles and various marked shields. The included models are as follows: 312X, 305, 701, 303, 319, (2) 501, (2) 319, 313, 110, 112, 703, 309+, 321, 301X, 426 and 317. The knives are all in excellent condition with the brass primarily bright and unsharpened. The knives are housed in a 1970's-era hinged hardwood countertop display case with glass cover and a removable red baize fitted interior; some of the compartments are for models not included, the present model in its spot may be just slightly ill-fitting. The display is in excellent overall condition with a few light handling marks. A great looking and plentiful display for even the most discriminating Buck collector. (57034-78)



2302. **WALTHER GSP GRIP LOT** This lot consists of a wrap-around anatomical left hand Walther GSP hardwood grip with thumb and palm rest that is in excellent condition. They have heavily stippled gripping surfaces and Walther logos on the smooth backside of the grip. (1X86771-20C)
2303. **KNIFE LOT** This lot consists of a Benchmade Osborne Design 940 made with 154 CM steel and is in excellent condition overall with a bit of silvering on the belt clip. The reverse tanto tip blade measures 3 1/4" with an overall length of 8" and is equipped with an ambidextrous thumb opening stud and "AXIS" safety lock. This is a very good example of a Benchmade knife and is made in the U.S.A. (1X156417-2H)
2304. **COLLECTIBLE KNIFE LOT** This lot consists of a folding revolver knife commemorating John Henry "Doc" Holliday. The knife is shaped like a revolver with a 3" blade protruding where the barrel would be and features "Doc" Holliday's picture on the faux ivory grips. Included is a wooden display box with a black leather sheath, playing cards key chain and a bio of Doc Holliday on the inside of the box. (1X156417-2AG)
2305. **STEVENS NO. 41 TIP-UP SINGLE SHOT PISTOL** serial #75211, 22 Short, 3 1/2" barrel with a good bore showing roughness throughout. The metal surfaces of the barrel retain 70% original blue with the loss due to an area of cleaned surface oxidation on the underside of the barrel, now showing as bare gray metal toning to brown patina. Light silvering is present on the muzzle and edges of the barrel flats, with thinning blue around the slanted script barrel address. The frame retains 95% original nickel finish, now showing an aged surface with high edges just starting to wear to brown patina. Minor slot damage is visible on the hammer screw and barrel pivot screw. The smooth walnut grips are pencil-numbered to the gun and remain in near excellent condition with numerous shallow impressions and marks of use scattered across the surface, most noticeably what appears as a light vise impression on the left panel. The pistol wears a nickel silver blade front sight with a simple raised groove in the recoil shield acting as rear sight. A pleasing example of the fifth model No. 41 Tip-Up. (1X146937-1) {C&R} (250/350)
2306. **BOOK LOT** The Broomhandle Pistol: 1896-1936, by Wayne R. Erickson and Charles E. Pate, c. 1985 Wayne R. Erickson and Charles E. Pate. 298 pages hardcover with embossed and raised lettered title over nicely textured brown surface, mild corner wear and a splitting spine but otherwise excellent. (1X75659-6)
2307. **BOOK LOT** The Bowie Knife: Unsheathing an American Legend, by Norm Flayderman; c. 2004 Norman Flayderman. 512 pages thoroughly illustrated and excellent condition hardcover with jacket. (1X75659-6A)
2308. **BOOK LOT** The Winchester Book, by George Madis, c. 1985 George Madis. 654 pages hardcover. This Silver Anniversary Edition is 1 of 1000 and features a blue pebble grain cover with silver embossed lettering, illustrated frontispiece and title page signed by the author. (1X75659-6B)
2309. **BOOK LOT** Marlin Firearms: A History of the Guns and the Company that Made Them, by Lt. Col. William S. Brophy, USAR, Ret.; c. 1989 Lt. Col. William S. Brophy, U.S.A.R., Ret. 696 pages excellent condition hardcover with jacket. (1X75659-6C)
2310. **BOOK LOT** The Winchester Model 94: The First 100 Years, by Robert C. Renneberg; c. 1991 Robert C. Renneberg. 208 pages excellent condition hardcover with light edge wear. (1X75659-6D)
2311. **LOT OF BOOKS** Includes an illustrated three volume hardcover set titled The American Gun, copyright 1960 and 1961, published by Herb Glass and Larry Sheerin. The set is in excellent condition featuring wonderful illustrations. (1X106622-6)
2312. **LOT OF SHOTGUN SHELLS** This lot consists of two boxes of shotgun shells. First is a full box of Winchester 12 ga., #5 shot, 2 3/4" plastic shells in excellent condition. Second is a partial box containing 23 mixed shells from various manufacturers and in a variety of lengths of paper and plastic shells, in 10, 12, 16, and 20 ga. All appear in very good condition. (1X125407-6)
2313. **LOT OF WESTERN SUPER-X EIGHT BORE PAPER HULLS** This lot contains six once-fired No. 8 industrial, reduced-velocity paper shotshells. The shells rate near excellent with light ingrained dirt on the salmon colored hulls and lightly mellowed high brass bases. (1X55497-8A)
2314. **LOT OF CCI AMMUNITION** Includes four full 50 round boxes of Speer Gold Dot .357 Sig, 125 gr., GDHP nickel plated cartridges in excellent condition. (1X106519-5)
2315. **BRICK OF CCI RIFFIRE AMMUNITION** Includes an older black and white box with red print containing 500 rounds of Blazer 22 LR 40 gr., solid tip ammunition in excellent condition overall. (2X106161-30I)
2316. **BRICK OF CCI RIFFIRE AMMUNITION** Includes an older black and white box with red print containing 500 rounds of Blazer 22 LR 40 gr., solid tip ammunition in excellent condition overall. (2X106161-30H)
2317. **BRICK OF CCI RIFFIRE AMMUNITION** Includes an older black and white box with red print containing 500 rounds of Blazer 22 LR 40 gr., solid tip ammunition in excellent condition overall. (2X106161-30C)
2318. **BRICK OF CCI RIFFIRE AMMUNITION** Includes an older black and white box with red print containing 500 rounds of Blazer 22 LR 40 gr., solid tip ammunition in excellent condition overall. (2X106161-30E)
2319. **BRICK OF CCI RIFFIRE AMMUNITION** Includes an older black and white box with red print containing 500 rounds of Blazer 22 LR 40 gr., solid tip ammunition in excellent condition overall. (2X106161-30G)
2320. **BRICK OF CCI RIFFIRE AMMUNITION** Includes an older black and white box with red print containing 500 rounds of Blazer 22 LR 40 gr., solid tip ammunition in excellent condition overall. (2X106161-30D)
2321. **BRICK OF CCI RIFFIRE AMMUNITION** Includes an older black and white box with red print containing 500 rounds of Blazer 22 LR 40 gr., solid tip ammunition in excellent condition overall. (2X106161-30F)
2322. **SHOOTERS LOT** Includes a single 30-round unmarked Mini-14 magazine. The magazine retains near 90% blued finish with several small scratches and spots of oxidation staining. There is silvering along a few of the high edges but the magazine overall rates excellent. Also included is one Gun Hugger double layer pistol case. The case measures 16" X 12" X 6" with sliding closures that have provisions for a small diameter lock. The brown plastic case is in very good to near excellent condition (2X106000-2,3)
2323. **COLT MODEL 1862 POCKET NAVY PERCUSSION REVOLVER** serial #54307, .36 cal., 5 1/2" octagon barrel with an excellent bore. The metal surfaces of this genuine 2nd generation "F"-series Colt revolver retain about 99% blue finish and silver plating. There is a light turn ring on the cylinder and a few scattered light handling blemishes on the other surfaces. The silver plated grip frame is in excellent condition with some light tarnishing. The case-hardened receiver, loading lever and hammer retain vigorous colors for an overall rating of about 99%. The smooth one-piece walnut grips are in excellent condition. The grips and all other appropriate parts are correctly numbered to the gun. This revolver includes a factory box that is correctly end labeled and numbered to the gun and contains a manual, hang tag and paperwork. (1X86520-3406) {ANTIQUE} [Richard "Stretch" Kennedy Collection] (400/600)

2324



2325. **SMITH & WESSON MODEL 1896 HAND EJECTOR FIRST MODEL REVOLVER**

serial #4622, 32 S&W, 3 1/4" pinned barrel with a lightly oxidized and pitted bore. This pre-I frame revolver retains about 85% original nickel finish, the majority of the loss attributed to flaking, worn and oxidized finish on the right and left side of the frame. Light scratches, bubbling, flaking and oxidized finish are also present on the remaining metal surfaces. The hammer and trigger retain strong case-hardened colors despite its years of use with some light silvering present on the edges and on the trigger face. The diamond checkered black hard rubber grips with S&W logo remain in very good condition with light wear to the diamond points and light handling marks. The right panel has worn nearly smooth on the lower back portion from handling. The right grip panel's escutcheon rotates freely and the grips could not be removed to verify any numbering but the cylinder, barrel and frame are correctly numbered. A very good condition but incorrect (wrong model) one-piece hinged factory box is included. (1X86520-2057) {C&R} [Richard "Stretch" Kennedy Collection] (350/550)

2324. **MERRIMACK ARMS & MANUFACTURING SOUTHERNER DERINGER** serial #759, 41 RF, 2 1/2" octagon barrel with a good bore having modest pinprick pitting and oxidation but good rifling still present. The metal surfaces are a dull gray with scattered pinprick pitting, the frame a slightly darker smoky gray. The walnut grips rate about very good with a few light blemishes under a light varnish and are un-numbered. The barrel still locks up pretty good, the extractor is no longer present. An about very good Merrimack Arms Southerner. (1X56229-457) {ANTIQUE} [Elliott Riggs Collection] (350/550)



2325

2326. **SMITH & WESSON MODEL 1903 HAND EJECTOR DOUBLE ACTION REVOLVER** serial #54151, 32 S&W, 4 1/4" pinned barrel with a lightly frosted, moderately bright very good bore. The metal surfaces retain 95% original nickel finish with a few spots of light flaking, a couple of spots of light oxidation and pitting, some bubbling primarily on the frame and gripstrap, and a light turn ring on the cylinder. The trigger and hammer show strong case-hardened colors with a little fading towards gray on the trigger with some light freckling. The S&W monogrammed hard rubber grips are numbered to the gun and rate excellent with a small scuff and a couple of light tiny scratches. The frame, barrel and cylinder are numbered alike. The action does not function properly and is in need of mechanical attention. (2X126916-4) {C&R} (200/400)



2327

2327. **U.S. 1861 PERCUSSION RIFLE MUSKET BY ARMI SPORT** serial #S183, .58 Cal, 39"

barrel with an excellent, likely unfired bore with a few small specks of surface oxidation from storage. The metal surfaces remain in-the-white and rate near excellent overall with a few areas of light staining and a some light handling marks throughout. The near full-length walnut stock rates excellent and has a few small dings and some very light flaking. Rifle is fully functional and historically accurate in detail. A steel tulip head ramrod is included. A wonderfully built modern recreation of a classic U.S. military arm that was widely used by Union troops during the Civil War. An excellent example overall perfect for the re-enactor or would make a great addition to a Civil War military display. (1X46520-2812) {ANTIQUE} [Richard "Stretch" Kennedy Collection] (350/550)

2328. **AIR RIFLE LOT** Includes a Crosman 1077 Repeater; Co2 powered .177 cal., repeater with bright excellent bore. The metal surfaces show light oxidation staining mostly near the muzzle and the one-piece checkered plastic stock rates very good overall. Included with the rifle are the original box and owner's manual (no magazine included). (1X105458-17)
2329. **LOT OF AMMUNITION** Includes three boxes of 44 Rem. Mag. There are two 20 round boxes (one partial containing 12 casings and six cartridges and one full) of Remington High Velocity 240 gr., SP cartridges in very good to excellent condition. Also included is a full 20 round box of Remington High Velocity 180 gr., HP cartridges in excellent condition. (1X106182-1A)
2330. **AMMUNITION LOT** This lot consist of four boxes of fifteen rounds each of IK (Igmad Zavod of Konjic, Yougoslavia) M2 ball ammunition (30-06) for a total of 60 rounds. Three of the four boxes remain unopened and the cartridges in the open box are in excellent condition. Also included is an elastic cartridge sleeve with 6 rounds of Remington 221 Fireball ammunition. (1X84287-29BB)
2331. **J. MANTON & CO. BELGIAN DOUBLE HAMMERSGUN** serial #B7, 30" damascus barrels choked modified and cylinder with bright excellent bores. The contrasting brown and pewter damascus twist pattern barrels rate very good with some oxidation staining present as well as some light scratches. The receiver has some spots of case-hardened color still remaining, mostly on the sideplates and breech edges with other spots showing dark oxidation stains. The checkered pistolgrip walnut stock and forend rate good to very good with some scattered dings and dents as well as a 2" fine crack on the left side of the pistolgrip and a 5" crack along the left side of the forend. The length of pull to the metal buttplate is 14 1/4" with drops of 1 5/8" and 3". (1X156625-44) {C&R} (100/200)
2332. **JAPANESE TYPE 38 ARISAKA BOLT ACTION TRAINING RIFLE** serial #49, 6.5 Blank, 31 1/2" smoothbore barrel with a very good lightly pitted bore. The metal surfaces retain little original blue and are a mottled brown throughout that is mixing with areas of light surface oxidation and light pitting. The hardwood stocks rate good to about very good and have added finish, a chip at the toe and a few substantial cracks running through the wrist area on either side. There is no cleaning rod present and parts are missing from the bolt release mechanism. An about very good example overall. (2X46629-3) {C&R} (25/75)





2333. **PATRIARCHS MILITANT FRATERNAL SWORD** Independent Order of Odd Fellows (IOOF) 28 1/8" blade, 34" overall. The blade remains bright overall with some scattered light scuffs, scratches and specks of fine oxidation pitting. The blade is etched "The/Henderson/Ames Co./Kalamazoo/Mich." on the reverse blade at the hilt along with decorative flowing tendrils, crossed shepherds crook & sword and shields. The obverse side of the blade has matching etched tendrils, animals and "Thurston G. Kenyon" in center shaded riband. The brass crossguard and globe-shaped pommel with button cap has a nice mellowed goldenrod patina. The crossguard features reversed quillons and a center shield showing a crown with crossed shepherds crook and sword. The leather wrapped handle remains intact with some minor light flaking and the brass wire wrap remains intact and tight. The tubular steel scabbard remains bright overall with scattered light pinprick pitting, oxidation staining and is decorated with stamped brass mounts. A nice overall very good condition fraternal sword. (1X5344-6) (350/550)

2334. **JOSEPH ALLEN & SONS NON-XXL BOWIE KNIFE**

This Bowie measures 8 3/4" overall with a 4 7/8" clip style Bowie blade. The blade remains mostly bright with some spots of fine oxidation staining, some light scratches and very fine markings from being professionally sharpened. The reverse side of the blade is unmarked while the obverse side of the blade is marked with a lightly fading "NON-XLL" trademark along the top edge and "JOSEPH / ALLEN & SONS / SHEFFIELD / ENGLAND" on the ricasso. The oval German silver guard has a light tarnished patina and the full-length tang has a thin covering of light oxidation staining. The genuine stag handles have darkened nicely with age and are fastened by three small iron pins. Knife includes an open throat belt sheath having light scuffs and stains, there is a small tear at the middle loop band and light verdigris forming on the two large rivets. An overall very good plus condition Non-XLL Bowie overall. (1X56802-7B)



(400/600)

2335. **WHITNEY ARMS PHOENIX BREECH LOADING SHOTGUN** 14 ga., 30" barrel with bright but moderately pitted bore. The barrel displays a mottled pewter patina showing an older cleaning and scattered pinprick pitting. The brass frame and hinged breech block exhibit a dull ochre patina displaying scattered spots of pinprick pitting and staining. The straight stock and tapered forearm rate fair displaying scratches and dings with an old repaired break on the left side wrist, fastened with brass escutcheons on either side and a wood screw, all over a cleaned dark oil finish. There is a brass buttplate present showing a tarnished and pitted surface which is held in place by two replacement screws. The breech block is loose as is the barrel but this shotgun still provides a good example of these early American breech loaders. (1X116264-47) (ANTIQUE) (350/550)

2336. **CZ MODEL 241 SEMI-AUTO SHOTGUN** serial #11445, 16 Ga, 26" ventilated rib barrel with poly choke and a bright excellent bore. The metal surfaces retain 95% original blue finish with the exception of light scattered oxidation, finish loss at the muzzle and light handling marks. The walnut checkered buttstock and forend rate excellent displaying a few light scratches and dings. (1X176520-3597) (C&R) [Richard "Stretch" Kennedy Collection] (150/250)

2337. **WESTERN AUTO REVELATION SLIDE ACTION SHOTGUN**, serial #G569811, 12 Ga, 26" ventilated rib, poly-choked barrel with a bright excellent bore. The metal surfaces retain 98% original blue finish displaying very light surface oxidation and light fading on magazine tube. The bolt has light surface oxidation as well. The walnut checkered pistolgrip stock and forend rate excellent displaying a few light handling marks. This shotgun is in excellent overall condition. (1X176855-3) (50/100)

2338. **SAVAGE MODEL 755 "CUTAWAY" SEMI-AUTO SHOTGUN** 12 ga., 28" round barrel with a bright excellent bore. The metal surfaces retain 98% original blue with loss due to a few light handling marks. The frame has been cut in certain areas to show how the action works; it was likely designed as a promotional firearm for dealers. The walnut checkered pistolgrip stock and fluted forend rate very good to excellent displaying light scratches and dings over a fading finish. (1X176520-4120) [Richard "Stretch" Kennedy Collection] (100/200)

2339. **WINCHESTER MODEL 141 BOLT ACTION RIFLE** 22 S,L,LR, 21" barrel with bright excellent bore. The metal surfaces retain about 80% blue showing a few light scratches along the barrel and specks of fine oxidation staining near overall. The smooth pistolgrip stock rates very good with faint light handling marks near overall. Installed on the rifle is a Bushnell Sportsview 4X scope with duplex reticle with foggy optics. A used but not abused plinker with lots of life left in it. (1X106520-354) [Richard "Stretch" Kennedy Collection] (50/100)

2340. **COLLECTIBLE AMMUNITION BOX** This is an opened two-piece cardboard box containing two rds. of Robin Hood .32 training rds. with wood tips and one rd. of solid head. The box has a red label with a faded top portion that features the Robin Hood logo in the middle and reads "50 .32 Cal. Smokeless Cartridges 50"/Center Fire/Manufactured for/Smith & Wesson/.32 Cal./Revolvers" on the left side of the logo and to the right: "Solid Head/Velocity/Accuracy/And/Cleanliness/Warranted/Made By/Robin Hood Ammunition Co., Swanton Vermont". This top portion reveals a 2" split that runs diagonally across the middle and has separated slightly below the logo and a small portion is missing at the bottom far right where some of the text is difficult to discern due to wear. The label extends to the sides where an illustration of one of the cartridges is featured with "32/S.&W." within it and accompanied by the following: "50-.32 S.&W.-50/Center Fire/Smokeless", with the left side intact and about 30% missing from the right. The solid red bottom label is a separate piece and reveals light wear at the edges, a couple of scuff marks, and a small dark stain from grime. The box itself is solid with light ingrained dirt to the front and rear panels. In addition to the three rds., with the training rds. experiencing verdigris to the cases and the excellent solid head example, is a second correct label retaining a faded top portion that has faded to a dark shade of pink and has a small tear at the bottom. (2X76679-2B)

2341. **VINTAGE UNMARKED POCKET REAMER** (1) unmaker older pocket reamer for burnishing military crimps and rough edges from primer pockets. In fine condition overall with a lightly turned wooden handle and brass ferrule. (4X56106-666) [Warren Greatbatch Collection]
2342. **LOT OF EPHEMERA FROM GUNSMITH GUS LEHNERT** First is an insurance policy from Northwestern Mutual Life for Gustave A. Lehnert dated November 20, 1879. The policy, for \$4735 each year insures the life of the Gustave A. Lehnert, gunsmith, of Louisville Kentucky for \$1000, for a 20 year period. An interesting read, it shows Gustave was born in Prussia in January of 1849, he has never had the smallpox but he has been vaccinated. He had two brothers and three sisters, it would appear both brothers died as infants. He has never used alcoholic beverages or other stimulants nor is he engaged in the sale of such. Additionally there are two receipts for payment of premium on this policy, one dated November 20, 1881 the other dated November 11, 1880. The receipts are from the Northwestern Mutual Life Insurance Company's agents in Louisville Kentucky, Cowen & Robinson. These papers were tucked in a ledger book which shows dates from 1883-1887 and while Lehnert's name does not appear anywhere in the book it is likely his, showing numerous entries for normal everyday household goods but also entries for barreled actions and machine tools, the only real firearms names mentioned are "AG Spalding Brothers" and "Pittsburgh firearms" as well as "E. E. Eaton". The stock of guns pistols and supplies and materials on hand was worth \$8800. Tools, lathes, drills and reamers were worth \$800. The very last page also shows payment to the Hanover Fire Insurance Company of New York for insurance on his tools, this for the year ending 1888. The life insurance policy is very readable and mostly bright with light foxing on one of the pages and a small tear along one of the folds with some mildew and darkening on the areas of the policy that would've been exposed to the air when it was folded. The ledger book shows a separating spine, some mildew, light foxing and an antique stain on the cover which has affected a number of the pages beneath. A neat grouping overall relating to this famous and well-thought-of gunsmith. (3X34217)
2343. **ITALIAN AUTOMATIC SWITCHBLADE KNIFE BY COLTELLERIE PAOLUCCI** This automatic knife measures 4 3/4" with a 3 7/8" single edge stainless steel blade. The blade remains bright and unsharpened and is maker-marked on the obverse side of the blade. The nickel bolster and stainless steel handle remain bright and the faux mother-of-pearl plastic scales rate excellent and are fastened by four small bright brass pins, the obverse handle is equipped with a large push-button blade release and a smaller locking button. An excellent condition switchblade knife. Please note: Switchblades and all automatic knives can be sold to New Hampshire residents only. (2X56816-10B)
2344. **MINIATURE DROP POINT KNIFE BY BEAVER** This neat little creation by Devon Beaver of New River, AZ. measures 4 3/4" overall with a 2" full tang drop point blade. The blade remains unsharpened retaining all of its bright high polish. The single stainless steel bolster remains bright and the "pink ivory" African hardwood scales rate excellent and are fastened by bright mosaic pins. Knife includes a heavy duty tooled border open throat sheath with belt clip. (2X56020-K270)
2345. **BROWN MANUFACTURING COMPANY SOUTHERNER DERINGER** serial #3443, .41 cal. RF, 2 1/2" octagon barrel with a poor bore. The barrel is an oxidized brown patina with some scattered light pitting, the underside bottom flat showing a number of light impact marks. The frame is now a tarnished goldenrod patina with some minor dings and handling marks from the years. Hammer and trigger have toned primarily to a dull gray-brown case-hardened patina. The smooth rosewood grips rate about very good, showing an old light cleaning, they are stamp-numbered to the gun. Barrel-to-frame lockup is still quite good and the gun functions well mechanically. The top barrel flat is strongly "Southerner" marked and the brass half-moon sight is intact. A very good example overall of the brass-frame Brown Manufacturing Southerner. (1X36439-2) {ANTIQUÉ} (300/500)
2346. **RELOADING LOT** First are thirteen 20 rd. boxes of fired casings: (5) Remington 308 Win; (2) Remington 30-06 Springfield; (6) Winchester .30-06. Next are three 50 rd. size Styrofoam trays of fired casings: (1) full and (1) containing 49 cases of mixed head stamp 38 Special; (1) containing 46 cases of Remington 38 S&W. Next is a bag of rifle caliber brass containing approximately 400 cases, examples are 30-30, 30-06, 308 Win. and 223. Next are two full 50 rd. plastic Case Gard boxes with handles of 22-250 unprimed brass with Winchester Super X and Remington head stamps: (1) unused; (1) previously fired. The fired casings in this lot rate very good overall. The next category is a group of target patches consisting of three full 500 pc. rolls and five partials. Lastly are two excellent 20 rd. wood blocks for large caliber. (1X75850-9,14,16)
2347. **LOT OF COLLECTIBLE AMMUNITION** This lot contains an opened buff colored two-piece folded construction box with matching "12-14" dated label containing 19 rounds of Winchester 7 mm Full Patch Cartridges loaded with 175 gr., full patch bullets. Both box and label rate excellent with only some light wear along the edges of label where seal was broken. The ammunition rates fair with cracked case necks, tarnishing and oxidation on the brass cartridges. (1X54495-61E)
2348. **LOT OF SHOTSHELLS** Includes five ten round boxes of Russian made .410 /70 shotshells for use in the Saiga .410 shotgun. The shotshells are in very good condition with some showing trace amounts of white oxidation. (1X106519-15A)
2349. **LOT OF SHOTSHELLS** Includes 15 boxes: first are three, full 15-round boxes of Remington Slugger 12 ga., 1 oz, HPRS. Second are four, full five-round boxes of Federal Classic, 12 ga., 2 3/4" 1 oz, HPRS in excellent condition. Third are five, full five-round boxes of Winchester / Western Super-X 12 ga., 2 3/4", 1 oz, rifled slugs. Fourth is a full, five-round box of Federal Classic 12 ga., 2 3/4" 9 pellet, 00 Buck. The shotshells in this lot rate excellent overall. (1X106519-59K)
2350. **LOT OF WINCHESTER SHOTSHELLS** Includes two full 25-round boxes of Xpert 12 ga., shotshells. First is a box of 2 3/4", 1 1/16 oz, No.4 Hi-Velocity Steel shot in excellent condition. Second is a 2 3/4", 1 oz, No 6 Game / Target Steel Shot all in excellent condition. (1X106519-59J)
2351. **LOT OF AMMUNITION AND FIRED CASES** This lot consists of five containers: (1) full 20 rd. box of Remington High Velocity 220 Swift 50 gr., pointed SP rating excellent with box showing areas of moderate scuffing; (1) full ten rd. box rating excellent and (1) containing two rds. and three fired cases rating very good of RWS 8x57R; (1) bag containing 44 rds. of 30-06 consisting of 35 Winchester dated 1953 and 9 Remington dated 1954 rating very good to excellent; (1) box containing 18 rds. of Winchester Super X .250 Savage fired cases rating excellent. (1X76519-163G)
2352. **LOT OF MIXED CALIBER AMMUNITION** Includes three Speer Gold Dot boxes: (1) partial 20 round box of 50 AE, 300 gr., GDHP cartridges containing 18 nickel plated hollow point cartridges in excellent condition; (1) full 20 round box of .38 Special +P, 125 gr., GDHP nickel plated cartridges in excellent condition; (1) full 50 round box of .380 ACP, 90 gr., GDHP nickel plated cartridges in excellent condition. (1X106519-58E)

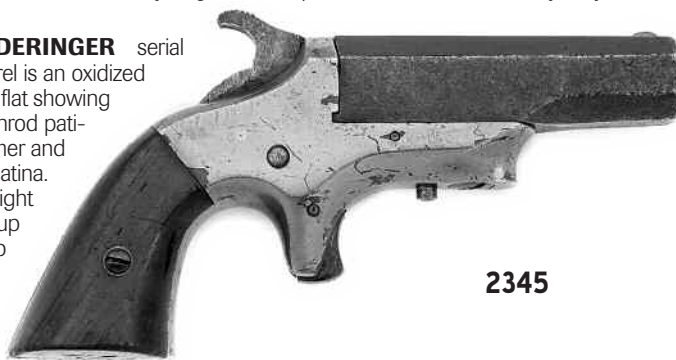

2353. **LOT OF AMMUNITION** This lot consists of five full 20 rd. boxes of American Eagle 7.62x39mm Soviet 124 gr., metal case, in excellent condition. (1X76519-445C)
2354. **LOT OF AMMUNITION** This lot consists of five full 20 rd. boxes of American Eagle 7.62x39mm Soviet 124 gr., metal case, in excellent condition. (1X76519-445D)
2355. **LOT OF AMMUNITION** This lot consists of five full 20 rd. boxes of American Eagle 7.62x39mm Soviet 124 gr., metal case, in excellent condition. (1X76519-445E)
2356. **LOT OF AMMUNITION** This lot consists of five full 20 rd. boxes of American Eagle 7.62x39mm Soviet 124 gr., metal case, in excellent condition. (1X76519-445F)
2357. **LOT OF AMMUNITION** This lot consists of five full 20 rd. boxes of American Eagle 7.62x39mm Soviet 124 gr., metal case, in excellent condition. (1X76519-445I)
2358. **LOT OF AMMUNITION** This lot consists of five full 20 rd. boxes of American Eagle 7.62x39mm Soviet 124 gr., metal case, in excellent condition. (1X76519-445J)
2359. **LOT OF BULLETS** This lot consists of four full 100 rd. boxes of .30 cal., 174 gr. bullets in excellent condition. The plain tan boxes are stamped "1305-00-573 4714/Projectile Caliber/100ea." (76519-452A)
2360. **LOT OF WINCHESTER SHOTSHELLS** Includes four full 25 round boxes of AA Super Sport 28 ga., 2 3/4", 3/4 oz, No. 7 1/2 shotshells in excellent condition. (1X106519-59C)
2361. **LOT OF ESTATE SHOTSHELLS** Includes three full 25 round boxes of 12 ga., 2 3/4", 9 shot, 00 Buck. The boxes and shotshells rate excellent. (1X106519-59F)
2362. **AMMUNITION LOT** This lot consists of a single full box of 20 Hornady Custom 30 T/C, 150 grain SST ammunition (81004). Both the ammunition and box are in excellent condition, the box has some minor flaking on the label. (2X46319-7)
2363. **COLLECTIBLE AMMUNITION LOT** This lot consists of a single, full box of 50 Thompson/Center Contender 357 Hot Shot Capsules. The box is white with red and green labels and rates excellent as do its contents. (2X46464-3)
2364. **LOT OF AMMUNITION** This is a full 50 rd. box of Focchi 9X21 IMI, 123 gr., FMJ in bright excellent condition. (2X76240-24O)
2365. **LOT OF MAGAZINES** Includes three aftermarket Ruger Mini-30 magazines. There are two Eagle 18 round black transparent magazines and one steel unmarked 40 round magazine, all in excellent condition. (106519-488G)
2366. **SCOPE LOT** Includes a Lyman All-American fixed 4x scope with standard crosshair reticle and clear crisp optics. The scope retains about 95% flat black finish showing several light scratches and faint ring marks on the 1" diameter tube. This is a useable scope in very good plus overall condition with lots of life left. (106389-3)
2367. **SMITH & WESSON 32 HAND EJECTOR DOUBLE ACTION REVOLVER** serial #239791, 32 S&W Long, 4 1/4" pinned barrel with a near excellent bore exhibiting a few pits and oxidation blemishes. Overall, this Model 1903 - 5th change revolver retains about 97% of its original factory blue finish with scattered light freckling on the metal surfaces, a turn ring on the cylinder and some light silvering of the high edges. The hammer and trigger have faded to a dull straw / gray color. The factory grips have been replaced with aftermarket "Franzite" grips. They are cream colored with molded-in checkering, and exhibit light staining and handling wear. All appropriate parts have correct matching serial numbers. This five screw revolver still times and locks up properly. (3X86602-54) {C&R} (150/250)
2368. **FOREHAND DOUBLE ACTION REVOLVER** serial #82801, 32 cal, 2 1/2" octagon barrel with a lightly frosted bore showing a couple of light pits. The metal surfaces retain 90% original nickel finish with some scattered spots of bubbling and several spots of light oxidation. The hammer exhibits some strong case colors with a few spots of oxidation. The checkered hard rubber grips are marked F&W; they show some light handling wear and a small scuff on the left side and rate near excellent overall. (1X126916-9) {C&R} (75/150)
2369. **CROSSMAN/WALTHER MODEL CP SPORT AIR PISTOL** serial #JA42546408, .177 cal., single shot CO2 operated air pistol closely resembling the Walther P99 pistol. All polymer construction rates excellent. Included is a working Walther rail mount red laser sight. (1X56901-17540B) {NONGUN}
2370. **J. RODGERS & SON ABERCROMBIE & FITCH HUNTING KNIFE** This fixed blade knife measures 9 1/8" overall with a 5" full tang spear point blade. The blade is in-the-white with marks from being lightly cleaned with evidence of old scattered pinprick pitting. The obverse blade is marked "ABERCROMBIE & FITCH Co. / NEW YORK" next to J. Rodgers & Son Sheffield makers mark. The curved black Delrin handles rate excellent with a few light handling marks and are fastened by three brass pins. The brass bolster and round lanyard hole equipped pommel are fastened by ground brass pins and have a nice mellow ochre patina. There is no sheath present. A neat Sheffield made hunting knife made for the American market. (1X56020-K23)
2371. **YANCEY THREE FINGERS LIGHT SKINNING KNIFE** This handy little knife measures 6" overall with a 2 3/4" stainless steel full tang skinning blade. The blade remains bright and unsharpened with Rocky Mountain makers mark logo on the obverse blade. The curved rosewood handles rate excellent and are fastened by two ground large brass rivets. Knife includes a horizontal leather sheath with a double snap belt loop. (1X56020-K38)
2372. **WALTHER PPK/S CO2 BB PISTOL** serial #3E10613, .175 Caliber BB, 3 1/2" barrel. The air gun retains 98% original finish with the grip frame lightening to a grayish black color from handling. The plastic grips are in excellent condition. This pistol features a reciprocating slide to simulate a real PPK/S during firing. Some of the internal parts are missing prohibiting the gun from functioning properly. (2X85100-4)
2373. **LOT OF REMINGTON ITEMS** This is a lot of two gun care products by the popular manufacturer. First is a full 3 oz. can of gun oil that could be described as a reproduction as this is a modern can that replicates old style Remington design patterns. Excellent condition. The last item is an apparently full can of Powder Solvent with the front rating excellent and the back showing indications of contact with some solvent as about 50% of the graphics are partially or fully obliterated. A nice trio of Remington products. (2X74813-6B)
2374. **SKS MAGAZINE LOT** Included are two black polymer detachable box magazines for an SKS type rifle. They are both 5 round magazines and rate excellent overall. (3X154138-16H)
2375. **MAGAZINE LOT** This lot consists of three magazines. Included are an unmarked blued magazine for a S&W 3914, a Kart Sporting Arms 1911 45 ACP blued steel magazine and a unmarked 30 round M1 Carbine magazine with a bright chrome finish. All are in excellent condition. (2X43615-4AA)



2376. **CETME PARTS LOT** Includes an instructional sheet, one-piece base, sight tool, and bayonet lug for a Cetme rifle from Tapco. Parts are in sealed plastic packages and appear in excellent condition. (2X101683-8A)
2377. **LOT OF COLLECTIBLES** Includes two items; first is a Calvin Cotton Mills Inc. Individual Troop first aid kit in its original packaging. The outer cardboard shell is heavily stained but lettering is still visible and the contents are still sealed. Second item is a Union Metallic Cartridge Co. primer tin containing nine primers. (2X103729-5)
2378. **LOT OF HOLSTERS** This lot consists of a total of three leather holsters. First is an apparently unused and excellent condition light tan holster stamped S-2 dated 1989 and compatible with the CZ 52. Next is a Bucheimer holster measuring 10" in length in excellent condition with minor wear marks to the brown outer shell with light wear to the interior, complete with belt loop and strap. Lastly is a brown Safariland #25 holster suitable for a large frame Smith & Wesson and in nearly identical condition as the Bucheimer. (2X73765-16E13,14,15)
2379. **H&K ACCESSORIES** Includes three items; first is an adjustable 1" leather sling with spring clip. Second are two unmarked aluminum G3 style 30 round magazines. All items are in near excellent condition. (2X104750-1A)
2380. **LOT OF COLLECTIBLE AMMUNITION AND SCOPE ACCESSORIES** Consists of a single box of 22 ammo and some 8mm Mauser. The box of round nose ammo contains 16 unfired cartridges produced by the Union Metallic Cartridge Company. The box rates good plus but exhibits moderate wear, fading, and general deterioration. The 8mm Mauser ammunition consists of 19 loose rounds of ammo. 17 of the unfired cartridges are surplus ammo of Israeli origin. The headstamps for the two remaining rounds denote that they were produced in 1940, with additional research seeming to indicate that these rounds were manufactured in Canada for use with the Inglis 7.92mm Bren guns supplied to the Nationalist Chinese forces during WWII; (12) rds. of the 380 ACP ammo, all of the cartridges were produced by Remington-UMC featuring full metal jacket bullets and have remained unfired. The 380 ACP ammo is stored in a vintage envelope from The Nation Shawmut Bank of Boston. (18) rds. of 45 ACP ammo, 15 of the unfired rounds feature full metal jacket bullets and were produced by the United States Cartridge Company. The remaining three unfired rounds also feature full metal jacket bullets, but were manufactured by the Remington Arms Company; Assortment of rings and bases: Included in the lot are a set of unmarked scope rings, two separate sets of Weaver scope rings mounted on respective bases, Weaver side mount with integral scope rings, an unmarked two-piece scope base mount, scope base mount by Savage Arms, and a portion of a Lyman rear aperture sight apparatus as well as a portion of a scope ring. (1) box of Winchester Super Speed 2 3/4" long range rifled slugs contains its full 5 unfired cartridges. The box rates very good but exhibits some wear as well as missing its right side endflap, the left endflap has separated but is enclosed. (1) Nepalese Kukri knife with a 9" blade. The blade rates very good and features an artistic ethnic pattern design along its right side, but exhibits a dulled edge as well as several light wear and handling marks and an isolated instance of oxidation. The wooden handle rates very good but does exhibit some light wear and handling marks as well as some light fading of its painted finish. The pommel features a lion's head; however, the portion of the face above the nose has broken off. Included with the blade is a black leather sheath and small auxiliary knife with moderate oxidation of its metal. The sheath features a metal tip which remains sharp in its own right. Also included with the lot are a set of transparent lens covers and a tin container with several screws. (3X1347499)
2381. **MAGAZINE AND POUCH LOT** (9) Spanish manufactured 20 round Cetme steel magazines. Each magazine shows light handling marks and are in very good overall condition; (4) green synthetic magazine pouches measuring 6 1/4" x 7 1/4" with each pouch designed to hold (2) 20 round G3 magazines. The exterior exhibits wear consistent with military use, in excellent condition overall. (2X66247-49AW,41A1)
2382. **LOT OF LEATHER GOODS** This lot consists of seven items, Included are: two black leather handcuff cases by Erdman, one black leather pouch for musket priming caps by Lawrence, a two-pocket brown magazine pouch and three Russian, two-cavity pebbled leather ammo pouches. All are in excellent condition, some have some mild mildew which should clean easily with a good leather conditioner. (2X45601-6F)
2383. **LOT OF STOCKS** This lot consists of one buttstock and one forend. The buttstock is for a Model 1920 Columbia Arms (aka Fiala Arms & Equipment Co.) manual repeating arms pistol to convert it into a rifle. The steel buttstock and mounting hardware are present and retain about 60% blue finish with most of the loss due to scattered oxidation blemishes. The smooth walnut buttstock has scattered light scratches, dents, scuffs and dings for an overall rating of very good. The smooth forend has the screw attached and an overall rating of fair. Although the wood has only few handling marks, the front 3" have been cut-off in a non-professional manner. (1X86886-16A)
2384. **RPD ACCESSORIES** Includes an assortment of canvas carry cases and one 100 round drum magazine. There are two drum magazine cases and one rifle case all in excellent condition. Also included is a RPD S.A.W. bag adapter. (2X106593-6A)
2385. **LOT OF DUTY GEAR** Includes two belts and a two way radio. First is a Safariland black leather belt size 44 with the original hang tag. Second is an Uncle Mike's nylon X-large belt. Third is a Standard two-way radio with mic attachment. The radio needs to be charged to determine if it works or not, no charger provided. All items are in very good to excellent condition. (1X104445-14B1A,15RR1)
2386. **SWEDISH MODEL 1896 MAUSER BOLT ACTION RIFLE BY CARL GUSTAFS** serial #502806, 6.5x55, 29" barrel with an excellent bore. The metal surfaces retain about 95% original blue that is lightly flaking to brown and mixing with areas of light surface oxidation, light impact and handling marks. The hardwood stocks rate very good and have several light dings and other handling marks associated with service use. The brass ID disc shows the bore condition as "1", and the stock has a small pin holes where the ballistics plate may have been. There is also some white paint on the comb line. This rifle appears to be complete and matching with the exception of the cleaning rod and the bolt appears to have been renumbered. Oddly there are no visible importer markings. A near excellent example overall that should make a terrific shooter. (1X46895-8) {C&R} (150/250)
2387. **SWEDISH MODEL 1896 MAUSER BOLT ACTION RIFLE BY CARL GUSTAFS** serial #426757, 6.5x55, 29" barrel with an excellent bore. The metal surfaces retain about 95-97% arsenal blue with some light handling marks and wear present along the bearing surfaces. The hardwood stocks rate about very good with added finish over several light dings and divots consistent with service use. The buttstock has a few small cracks, some very light chipping at the toe and a small filler plug along the toeline below the rear swivel. The brass ID disc is marked "1" for bore condition. The receiver is dated "1917" and the numbers appear to be all matching with the exception of the cleaning rod. Rifle appears complete and was imported by Century Arms. A near excellent example overall that should make a terrific shooter. (1X46520-4130) {C&R} [Richard "Stretch" Kennedy Collection] (100/200)
2388. **STOCK LOT** Includes a stripped M1 Garand stock that has been lightly cleaned. The stock shows expected light handling marks and has a 3 1/4" stable with-the-grain crack running to the rear from the middle of the receiver cutout. The front sling swivel is present and there is no other hardware included. (2X106768-3)
2389. **LOT OF SCOPES** Total of two. First is a Tasco 6-24x40 retaining 98% gloss black finish with minor scratches. It features windage and elevation adjustments, crosshair reticle and excellent optics. The other item is a Leapers 3-9x40 with matte black finish showing a few light scratches and featuring windage and elevation adjustment, crosshair reticle and attached rings and mount. The optics are crisp and clear. (1X76519-260H)

2390. **LOT OF PRESENTATION CASES** Includes two wooden cases, first is a Quails Unlimited marked case measuring 14 1/2" X 5 3/4" X 2" with a cloth lined foam interior for a medium framed revolver in good overall condition. Second is a modern oak presentation case, likely for a Rogers and Spencer style percussion revolver with blue felt fitted interior measuring 16" X 8 1/2" X 3" in excellent condition. (2X106257-3A)
2391. **LOT OF PRESENTATION CASES** Includes two custom cigar boxes converted into form fitted pistol display cases. First is a Casa Blanca Cigar Co., box measuring 9 1/4" X 7 1/4" X 2 1/2" with yellow felt interior molded for a Luger style pistol in very good condition. Second is a Casa Blanca Cigar Box measuring 9 1/4" X 7 1/4" X 2" with green felt interior formed for a Radom style pistol in very good condition. There are a couple of grain cracks in the top lid that are stable. (1X106162-55)
2392. **LEATHER PRESENTATION CASE** This is a brown leather illustrated presentation case measuring 9 3/4" X 7 1/4" X 2 1/2" with cavalry soldier on top lid wrapped in gold leaf under a crown. Interior of the case is molded to fit two Smith & Wesson No. 1 revolvers with red and white velour fabric lining. A nice presentation case, sure to add a little flare to one's display. (1X106075-12)
2393. **INTERESTING LOT OF POWDER CANS** Includes three empty large powder cans. First is an 8lb can of Winchester / Western Ball Powder smokeless propellant with wrap around paper label. The can shows scattered spots of light oxidation and staining with a complete paper label that has a few scuff marks and stains but remains complete in very good to near excellent condition. Second is a 10 lb. cardboard tub of Winchester / Western AA Ball Powder smokeless propellant with wrap-around paper label that shows light dirt staining. The tub retains its shipping label and has a few pencil marks on the top, in very good plus condition. Third is a 15 lb. cardboard tub of Hercules Red Dot smokeless shotgun powder with affixed label and painted lid. The tub is in very good condition showing light dirt staining and what appears to be water staining on the lid. An interesting collector's lot sure to spark some explosive conversations. (1X106410-1)
2394. **FRAMED PRINT** Included is a Large poster sized framed print measuring 37 3/4"x27" overall and is titled "Armed Forces Decorations and Awards". Shows illustrations of various U.S. campaign and award medals The print shows light ingrained dirt staining with some spots of water damage but remains in very good to near excellent condition. (1X106321-20)
2395. **UNMARKED PERCUSSION-CONVERTED FOWLER** About 12 bore, 37" barrel with an oxidized bore. The barrel is a dark pewter patina with brown oxidation staining and plum toning. The lockplate is more plum-brown and is doubtless harvested from an older English musket, as-was the barrel. There remains evidence of some light engraving and remnants of a maker's name but it is no longer legible. The hammer is a very plain, unadorned American replacement; the original trigger is lightly sculpted and slightly fancy. There are two ramrod thimbles and tailpipe of brass with a brass triggerguard with pineapple front extension and engraved bow. The American gunsmith-fitted stock is maple and shows some nice grain figure rating very good overall. An antique ramrod is included, it is slightly short; the lock seems to function well. An attractive piece for over the mantle or den wall. (2X36620-1){ANTIQUE} (200/400)
2396. **ENFIELD PATTERN 1853 PERCUSSION MUSKET BY TOWER** .577 cal., 36 1/2" barrel, now smoothbore. The barrel is an overall lightly oxidized brown patina with deep gray and brown undertones, with some pitting in the area around the nipple and breech. There is no front sight in place, a simple bead has been affixed and the rear sight has been removed. Left side of barrel shows appropriate British proofs also with what appears to be a Confederate circled "S/HC" marking, purportedly of the Sinclair Hamilton Company. The lockplate is a dark gray and oxidized brown patina with light borderline engraving and marked "Tower/1862" with royal crown at its rear. The rear barrel band is present with the triggerguard and buttplate being a dull ochre patina. The remnants of the original stock rate about very good with the forestock continuing for about 6 1/2" ahead of the lockplate; from this point forward there is a modern walnut replacement with deep ramrod channel and a rudimentary hammered brass band halfway down its length. There is a very light left-side cartouche and remnants of a maker's name along the toeline which appears to read "Dugard". The lock is mechanically functional there are no sling swivels nor ramrod present. (2X36620-4) {ANTIQUE} (200/400)
2397. **LOT OF ASSORTED SHOOTING RELATED ITEMS** Includes an assortment of patch cutters, pieces from two bullet starters and two powder scoops. Both scoops appear to be home-made one is marked "70" and looks like it was fabricated out of ink pen parts the other is marked simply "8" and is a 32 ACP casing tacked to a 10 penny nail. Items are in good to very good overall condition. (1X102789-245)
2398. **LOT OF LEATHER POUCHES** Two pouches total: unmarked leather shot bag with brass furniture, the spout has some moderate amounts of tarnish and the leather is dried and crazed but is still intact and supple. The stitching has two small sections where it has separated along the top near the spout; unmarked leather powder flask, the flask is in good overall condition and appears to be complete with its only apology being a broken spring on the powder measure. (2X103135-316)
2399. **LOT OF MG 42 BARRELS** This lot consists of two MG 42 spare barrels, 8mm, 20 3/4" barrel, 22 3/8" overall length. The first barrel is numbered 57879 and retains 85% of its original blue with a dark lightly pitted bore. The second barrel is numbered 50946 and retains near 75% of its original blue with a large area of loss just ahead of the number. The bore is dark and pitted near its full length and there is a bulge near halfway down its length. Neither barrel bears any visible Waffenamnt markings. (2X104940-38A)
2400. **LOT OF MG 42 BARRELS** This lot consist of two MG 42 (MG3) spare barrels, 308 Win. (7.62x51 mm NATO), 20 3/4" barrel 22 3/8" overall length. The first barrel is numbered 2428 / C with a bright excellent bore. It is maker coded "avf" on the barrel extension and has some light oxidation staining present near the muzzle. The second barrel is not numbered, with a smoky bore with spotted pitting over its length. It has a "dot" code on the barrel extension which is predominantly grey. (2X104940-38H)
2401. **LOT OF GATLING GUN ACCESSORIES** Three pieces in all. The first is a handmade brass adapter tray for mounting a Bruce feeding assembly or magazine and is fashioned from a mixture of light and heavy gauge sheet brass. The tray has a darkly mottled ochre patina with visible soldered joints and is hand stamped on the back with the name of the builder, "R.L. KLINGER 1961". The tray is well made and fairly well finished. Next is a reproduction bronze patent plate marked, "GATLING'S/BATTERY/GUN...MADE BY COLT'S/PT. FIRE ARMS/MFG CO/HARTFORD, CONN./U.S.A." with the 1862,'65,'71, and '72 patent dates. The bronze has a pleasant dull brown-ochre color and is in excellent overall condition with undrilled screw holes at the sides. The last item is a bronze field carriage swivel bracket which has about 60-70% of an old black painted finish which has flaked to the underlying tarnished ochre metal on the balance. (2X3559-1)
2402. **LOT OF MAGAZINES** This lot consists of (12) HK-91/G3, 7.62x51mm Nato, 20 round magazines. The lot retains a majority of original black paint with general wear and scuffs from handling and storage, in very good to excellent condition overall. (2X66627-11C)
2403. **LOT OF MAGAZINES** This lot consists of (12) HK-91/G3, 7.62x51mm Nato, 20 round magazines. The lot retains a majority of original black paint with general wear and scuffs from handling and storage, in very good to excellent condition overall. (2X66627-11B)
2404. **LOT OF GUN SLEEVES AND VISE** A total of six items to include five assorted padded zipper gun cases and two tie style all in good overall condition. Also included in this lot is a Pachmayr Gun Works Adjustable Lock grip tray in good overall condition. (103026-33)

2405. **IRON PIKEMANS HELMET FROM THE HIGGINS ARMORY MUSEUM**

**COLLECTION** This is a large, one-piece iron helmet that has an overall height of 7" and a conical crown having eight hollow strengthening ridges running down from the top at regular intervals. A series of sixteen dome-shaped studs encircles the bottom of the crown just above the 1 3/4" wide flared brim which rises to two shallow fore and aft peaks. The iron has a muddled gray-brown patina with uniformly oxidized patina on the interior and underside of the brim. There are no provisions for mounting either a liner or chinstrap and the brim has a small punched hole for mounting on a wall. Most likely a Victorian decorative piece, the helmet was part of a group of armor deaccessioned from the famous Higgins Armory Museum Collection and sold by Skinner's in November of 2010. This is a neat helmet that was once part of one of the most respected collections in America. (1X74545-46) (275/375)



2406. **REMINGTON MODEL 11-48 SEMI-AUTO SHOTGUN** serial #5138342, 12 ga., 28" plain barrel choked modified with fouled bore. The metal surfaces retain about 50% blue covered in a layer of surface oxidation. The pistolgrip stock and forend rate fair with a 8" crack in the forearm, dings, scratches, and flaking added varnish. There is a factory gripcap and a grooved Remington buttplate. The buttstock is slightly loose, the forearm does not seat properly against the receiver and the bolt assembly is no longer present. (1X115708-29) (15/30)
2407. **GERMAN MODEL 71/84 MAUSER BOLT ACTION RIFLE BY ERFURT** serial #6932, 11mm Mauser, 31 1/2" barrel with an excellent bore. The metal surfaces have faded to gray with a mottled brown patina that is mixing with light surfaces oxidation, mostly around the buttplate. The walnut stock rates very good and has added finish over light dings and a few small repairs. The original straight bolt has been heated and bent to a downward position. A very good 1887-dated example overall. (46935-12) {ANTIQUE} (400/600)
2408. **JAPANESE ARISAKA TYPE 38 BOLT ACTION RIFLE VIET CONG CONVERSION** serial #25194, 6.5 Arisaka, 19" barrel with an about very good lightly pitted bore. The metal surfaces retain about 80% arsenal blue with light overall fading, pitting and handling wear. The military stock has been shortened and modified and was painted a simple woodland camo pattern. The buttplate has been removed and original sling swivel cutout filled, extra holes were added for newer style swivels, but they are not present. According to the consignor this rifle was a Vietnam-era war trophy and had been modified and used by the Viet Cong. No evidence can be found that Arisakas were used in this fashion on a large scale, and it is likely that smaller factions may have had some of these type arms at their disposal left over from the Second World War (45262-2) (300/500)
2409. **FLAG LOT** This is a 48 star U.S. flag measuring 112"x60" and stamped "U.S. Ensign 7" with white areas of wool fading to yellow and extensive mothing occurring but still structurally sound. A nice find for the navy or military collector. (74749-17A)
2410. **WINCHESTER MODEL 9422 LEVER ACTION RIFLE** serial #F54217, 22 S,L,LR, 20" barrel with a bright excellent bore. The metal surfaces retain 99% original blue with a couple of freckles toward the muzzle and on the receiver, and a spot of oxidation on the front barrel band and again on the magazine tube. The smooth walnut stock and forearm rate excellent showing a couple of superficial scuffs, a few minor dings, and a small check by the heel. This is an excellent gun that appears to have had very minor storage issues, but looks to be unfired. Included is a red, white and blue factory box, hang tag and manual numbered to a different rifle, the left side of the endlabel is missing. (126724-245) (350/550)
2411. **GLOCK MODEL 23 GEN 4 SEMI-AUTO PISTOL** serial #RKZ174, 40 S&W, 4" barrel with an excellent bore. The slide retains about 99% of its Tenifer finish plus the polymer surfaces of the frame remain in excellent condition. The only real loss of finish is slight silvering of the high edges on the rear sight. A set of functioning Glock three dot night sights have been installed and a single thirteen round magazine is included. These are great pistols for sport or defense. (86935-40) (400/600)
2412. **MASTERS OF DEFENSE HARKINS TRITON BK AUTOMATIC KNIFE** This "springer" automatic knife measures 4 3/4" with a 3 1/2" double edge spear point blade with partially serrated edges. The blade remains unsharpened and retains 99% black coated finish. The black anodized aluminum handle with skid-grip panels rate excellent and is equipped with a grooved double action opener and belt clip. Knife is in as-new condition and includes an original factory cardboard box, black nylon sheath and papers. Please note: Switchblades and automatic knives can be sold to New Hampshire residents only. (56935-44)
2413. **MOSSBERG MODEL 590 SLIDE ACTION SHOTGUN** serial #L090030, 12 ga., 20" cylinder bore, ported barrel with a very good lightly oxidized bore. The metal surfaces retain about 90% original parkerized and anodized finish with light handling wear and small scratches and light tool marks throughout. The black synthetic stocks rate excellent. Shotgun is equipped with a set of factory ghost ring sights and includes a canvas GI sling. A very useable shotgun for home defense or for other tactical applications. (46518-34) (200/300)
2414. **LOT OF SHOTSHELL WADS** Includes four 250 count packages of plastic wads. There are two bags of Remington 12 ga., power piston wads and two boxes of Winchester AA 12 ga., wads all in excellent condition, packaging shows minor wear. (106935-43)
2415. **MILITARY LOT** This is a desk nameplate stand for "N.M. Martinsen, Captain U.S.N." The wood stand measures 10"x6"x3 1/2" and rates about near excellent with light handling marks. Captain Martinsen was the 1964 recipient of the Moreell Medal which is presented for outstanding contributions to military engineering. (73658-8)
2416. **MOSSBERG BROWNIE DERRINGER PISTOL** serial #6383, 22 LR, 2 1/2" barrel with four very good bores showing light pitting and moderately strong rifling. The metal surfaces retain 50% original blue with the remainder of the surface fading to a gray and gray-brown patina with a few scattered spots of oxidation and light freckling. The hardwood grips are pencil-numbered to the gun and rate very good with strong grip serrations, a few minor handling marks and an added finish. The barrel, frame and top-break lever are numbered alike. (1X126684-18) {C&R} (200/400)
2417. **REMINGTON MODEL 12C SLIDE ACTION RIFLE** serial #598522, 22 LR, 22" octagon barrel with a bright excellent bore. The metal surfaces have mostly toned to pewter with a few light traces of blue still remaining; there are some patches of light oxidation staining present as well. The plain half pistolgrip buttstock and ribbed forend rate good to near very good overall with some handling marks present and two 2" cracks at the toe of the stock and a 3/4" crack on the rear right side of the forend. This Model 12C is in very good condition overall. (156781-8) {C&R} (400/600)
2418. **KOLB BABY HAMMERLESS DOUBLE ACTION REVOLVER** serial #406, 22 Short, 1 1/4" barrel with a lightly pitted bore. The metal surfaces nickel plate rates very good with scattered light flaking and turn rings on the six shot fluted cylinder showing some mild oxidation on some spot where the nickel has flaked off. The checkered hard rubber grips with "K" logo are scratch-numbered to the gun and are in excellent condition with a few faint handling marks. This revolver requires mechanical attention. (1X126684-15) {C&R} (50/150)



2419. **PICTURE BOX FOR A COLT SINGLE ACTION ARMY FRONTIER REVOLVER** This is a hinged red linen covered cardboard box with red and white picture top label and red and white end label. The top label remains 95-98% intact with some light tears and scuffs along the edges and minor ingrained dirt and age staining. The view shows a picture of a single action revolver next to "7 1/2 inch/Length of Barrel". Below revolver reads "COLT'S/SINGLE ACTION REVOLVER/Colt's Patent Fire Arms Manufacturing Co./HARTFORD CONN." To the left of the revolver is a picture of a Rampant Colt above of a picture of a "Colt's/Magazine Rifle/.44 Cal." cartridge and ".44 Cal. Cartridge". The side label is in equal condition and reads "7 1/2 Colt's Frontier S.A. Pistol .44" in a thin red border. The box is in excellent condition with intact seams and only slightly rounded corners, light scuffing and dirt staining of the red covering. The interior shows a couple light dents and stains and the white bottom label shows light cracks and scuffs and dirt staining. Many years ago spurious examples of these boxes were introduced to the collectors market and it seems likely this is not a factory original but one of those examples. (56265-11)

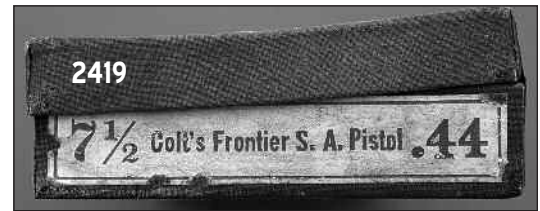

2420. **HOPKINS & ALLEN XL NO 2 SPUR TRIGGER**

**REVOLVER** serial #954, 30 RF, 2 3/8" octagon barrel with good bore showing light pitting and moderately strong rifling. The metal surfaces retain 90% original nickel with areas of flaking to gray and brown patinas with some light pitting. The walnut bird's head grips rate near excellent with a couple of light handling blemishes. This pistol functions mechanically. The cylinder fits a bit loosely in the frame. (1X126684-11) {ANTIQUE} (125/225)



2421. **RARE BEDFORD & WALKER PUSH-PLUNGER AIR PISTOL** .21 cal., 8 1/2" barrel with a very good plus bore. The brass barrel retains about 80% original nickel and is patent date marked at its left rear. The pistol frame retains a similar amount of original heavy nickel with some minor flaking on the right side of the grip, less so on the left, the areas of loss showing a light brown speckled or deep pewter patina. This example features a rear sight at the extreme rear-most portion of the bolt housing, the simple bead front sight is no longer present. There is a small turned cylindrical walnut handle attached to a brass collar which operates the

plunger, cocking the gun. The rear of the gun is fitted for its detachable shoulder stock which is sadly not present. Overall length is just over 14". Overall a very good, likely very late, example of these very scarce air pistols. (36581-1) {NON-GUN} (350/550)

2422. **LOT OF COLLECTIBLE CARDBOARD SHOTSHELLS** This lot consists of four pieces of like new, primed J.P.&S. 4 bore paper body hulls. Each measures 4" long and has is marked "Made In England", the brass bases have light tarnish. (44584-6E3)
2423. **AUSTRIAN PERCUSSION CONVERSION MUSKET** About .74 Caliber, 42" barrel with a heavily oxidized bore. The metal surfaces are overall a mottled brown and gray with areas of light to moderate pitting and oxidation. The wood stock rates fair with several minor cracks (many from drying), repairs, chips and dings. The forend is spliced and pinned at the center barrel band and has a sliver missing from either side, the right being about 4-5" long. The modified flint lock has been fitted with a percussion hammer. The lock and barrel retain only a few small marks, including "PB" on the lock and "0" on the barrel and hammer screw. The other smaller metal parts have various markings as well. A modified iron ramrod with an oversized head is included (the head will not fit in the muzzle however). Though in pretty rough condition the lock seems to function correctly and this would make an interesting relic to hang above the mantle or accent the header above a door or an entryway. (46855-34) {ANTIQUE} (300/500)
2424. **REPRODUCTION U.S. 1861 PERCUSSION RIFLE MUSKET** serial #1040, .58 Caliber, 40" barrel with a near excellent bore that has some very light oxidation present. The metal surfaces are in the white and are still somewhat bright with areas of very light surface oxidation and staining throughout. The walnut, near full-length stock rates very good and has light dings and handling marks overall and some light chipping near the butt. This Japanese made quality replica is appropriately marked and dated "1861". It appears fully functional and includes a correct tulip head ramrod and leather sling. The perfect rifle for an aspiring re-enactor. (46900-33) {ANTIQUE} (400/600)
2425. **GERMAN MODEL K98K MAUSER SHORT RIFLE BY GUSTLOFF-WERKE** serial #77489, 8mm Mauser, 24" barrel with an excellent bore. The metal surfaces retain about 90% original blue which is flaking to brown and mixing with areas of light surface oxidation. The "bcd" coded receiver is simply marked "4" for a date and has a few Waffenamts and eagle proofs present. The laminate hardwood stock rates about very good and has minor dings, divots and other minor handling marks. The numbers are not matching but rifle does appear to be complete and included are a front sight hood, a cleaning rod and a leather sling. A nice example overall that should make a great shooter. (46736-10) {C&R} (300/500)
2426. **U.S. MODEL 1917 RIFLE BY EDDYSTONE** serial #1103563, 30-06, 26" barrel marked "E / (ordnance bomb) / 9-18" with a near excellent bore that is lightly freckled in the grooves. The metal surfaces retain about 95% of an arsenal parkerized finish that covers a few areas of light pitting and other small handling marks. There are a few areas of light surface oxidation and finish loss leaving some exposed gray metal. The dark, oil stained walnut stocks rate about very good. The wood is roughly finished and there are small dings and divots throughout. The handguard has a few minor cracks, one which runs the length of the lower half. The bolt is matching however the magazine follower is missing, a new one should be easy to obtain and install. A very good condition example overall that would likely be a good shooter still. (46869-25) {C&R} (300/500)

2427. **SWISS K31 SCHMIDT-RUBIN SHORT RIFLE** serial #K3111114/889179, 7.5 Swiss, 25 1/2" barrel with an excellent bore. The metal surfaces retain about 99% of the original blue finish. The hardwood stocks rate about very good and have several light dings, minor flaking to the original varnish and some light chipping near the toe. The right finger groove has "GIUBIASCO 1950" marked inside. The numbers appear to be matching, including the detachable box magazine. A muzzle cover and the rear swivel clip are also included. A near excellent example overall that was imported by Century Arms. (46724-276) {C&R} (200/300)
2428. **ORBEA HERMANOS HAND EJECTOR REVOLVER** serial #E3366, 32 S&W, 4 1/8" barrel with a good bore that has areas of oxidation and light pitting present. The metal surfaces retain about 80% original nickel finish that is lightly flaking and revealing areas of brown. The checkered horn grips rate near excellent and have the "OH" factory logo on each. The grips have some interesting character marks and a small crack on the left side. Some of the frame screws have some minor slot damage. This vintage copy of the S&W hand ejector five screw functions correctly and is in very good overall condition. (46886-21) {C&R} (200/300)
2429. **U.S. MODEL 1903 RIFLE BY SPRINGFIELD ARMORY** serial #1249374, 30-06, 24" barrel marked "SA / (ordnance bomb) / 10-22" with a very good bore that is very lightly pitted in the grooves. The metal surfaces retain about 95% of an arsenal quality matte blue finish with light handling wear and some graying along the edges. The walnut stocks rate about very good and show evidence of having been sanded. The stocks have a rough texture and oil finish along with several dings, divots and other handling marks. The buttstock has a few very light firing proofs, but no other markings are present. A good project rifle that would likely make a good shooter as-is. (46917-4) {C&R} (300/500)
2430. **JAPANESE TYPE 38 ARISAKA CARBINE BY KOISHIKAWA** serial #80362, 6.5 Arisaka, 19" barrel with very good lightly oxidized bore. The metal surfaces retain about 80% original blue that is lightly flaking to brown and mixing with areas of light, speckled surface oxidation. The bolt has been disassembled and is not matching, the mum has been ground but the model markings are intact. The hardwood stocks rate about very good and have several dings and other handling marks associated with service use. Included is a Type 30 Arisaka bayonet with scabbard. The bayonet was made by the Jinsen Arsenal and measures 20" long with a 15 1/2" blade. The blade has light overall staining with areas of light pitting and has almost a leopard skin-type appearance. The wood grips rate excellent. The hooked quillon guard and bird's head pommel retain most of their original blue with specks of light oxidation scattered about. The steel scabbard is in similar condition. An about very good example overall. (46916-39) {C&R} (200/300)
2431. **CUSTOM SPRINGFIELD MODEL 1898 KRAG CARBINE** serial #367167, 22" barrel with a near excellent bore that is lightly frosted in the grooves. The original blue is flaking to a pleasing brown with about 90% remaining, the receiver is overall brown as well. The extractor has traces of the original fire blue but is mostly brown as well. The military walnut stock has been modified and features a schnabel tip, checkered and grooved forearm, checkered wrist and has a Jostam solid recoil pad. The wood rates very good and has some small cracks at the tip and some light handling marks and dings throughout. The inspector's cartouche and firing proof are still visible but are very faint. Rifle is equipped with a sporting front sight, the rear sight screw holes have been neatly filled and a Stith mounting system installed on the barrel and left side of the receiver. A very good example overall that will likely make a great shooter. (47022-145) [Mark Benneson Collection] (300/500)
2432. **STEVENS MODEL 311 BOXLOCK DOUBLE SHOTGUN**, 12 ga, 28" matted rib barrels choked full and improved modified with bright excellent bores. The barrels retain 75-80% original blue finish displaying evenly thinning finish loss along with barrels also having scattered oxidation stains. The frame has toned to a smoke gray and has areas of surface oxidation and stains. The smooth walnut pistolgrip buttstock and forend rate excellent displaying a few light handling marks, the forend appears to be replaced as it's a lighter colored wood than the buttstock. The gun features double triggers, an automatic safety, extractors and a checkered buttplate which provides a length of pull of 14 3/4". (177017-11) (200/300)



2433. **JAPANESE TYPE 99 ARISAKA RIFLE BY TOKYO KOGYO** serial #(series 30)84852, 7.7 Arisaka, 26" barrel with an excellent bore. The metal surfaces retain about 95-97% of what appears to be the original arsenal blue finish. The dust cover has some minor flaking and light oxidation staining. The receiver markings are all crisp and the mum is intact and unmolested. The hardwood stocks rate excellent and have a few dings and divots and other minor handling marks from service use. The rifle is equipped with a folding monopod and has the aircraft rear sight wings intact. The numbers are all matching, including the dust cover and a cleaning rod is included. Overall and excellent condition example and though many of these are available few are found complete and in this state condition. (46983-14) {C&R} (400/600)
2434. **JAPANESE TYPE 99 ARISAKA RIFLE BY NAGOYA** serial #(series 4)42441, 7.7 Arisaka, 26" barrel with an excellent bore. The metal surfaces retain about 90% of what appears to be the original arsenal blue finish that is flaking to brown throughout. The receiver markings are crisp and the mum is intact and unmolested, and the parts appears to be all matching. The hardwood stocks rate very good and has some light added finish over a number of small dings, divots and chips along with an assortment of light handling marks from service use. The rifle is equipped with the aircraft rear sight wings and includes a cleaning rod and a later, unmarked dust cover. An excellent example overall with great markings. (47017-14) {C&R} (300/500)
2435. **GERMAN GEW 88 MAUSER RIFLE BY DANZIG** serial #8165a, 8mm Mauser, 29" barrel with a dark, oxidized bore. The barrel has an added black enamel finish with minor flaking, the remainder of the metal surfaces are a mottled gray with light brown staining and other handling marks. The receiver is dated "1895", the numbers appear to be all matching but the bolt is missing its head. The walnut stock rates between good and very good and has several dings and other light handling marks under an added finish. The butt has cracks on either side and there is a semi-circular crack with light chipping at the upper tang. The cleaning rod and forward sling swivel are intact, the sights appear to be correct. An overall good condition example overall. (46842-27) {ANTIQUÉ} (100/200)
2436. **ITALIAN MODEL 1870/87/15 VETTERLI-VITALI RIFLE** serial #KU478, 6.5 Carcano, 33 1/2" barrel with a very good, lightly oxidized bore that appears to have light pitting in the grooves. The metal surfaces retain about 90% of an arsenal blue finish that is flaking to brown and mixing with areas of light surface oxidation. The walnut stock rates about very good and has several light dings and impressions under added finish. There is an arsenal type repair at the toe and several markings still visible on either side. The sights, sling swivels and cleaning rod are intact and rifle is in about very good condition overall. (46877-1) {ANTIQUÉ} (150/250)

2437. **CUSTOM SPRINGFIELD 1892 Krag Carbine** serial #11992, 30-40 krag, 22" barrel with a near excellent bore that is mostly bright but has a few light pits toward the breech. The barrel is an overall mottled brown with light handling marks and some light oxidation present. The "1894" dated receiver has traces of the original oil-quenched case color but is mostly a mottled gray. The barrel band has a black enamel finish. The military walnut stock has been shortened and rates about very good with added finish and has light dings and a few minor cracks. The firing proof is still visible but the inspector's cartouche is very faint and almost not visible. The handguard is no longer present. A sporting ramp front sight has been added at the muzzle but the rifle is equipped with a correct rear sight assembly. A very good condition example overall that should make a pretty good shooter. (46859-1) {ANTIQUE} (300/500)
2438. **CUSTOM SPRINGFIELD 1898 Krag Carbine** serial #399026, 30-40 krag, 24" barrel with an excellent bore. The barrel retains about 85% original blue that is lightly flaking to brown. The receiver is a mottled gray with slight traces of the original oil-quenched case color, the extractor is a rich brown. The military walnut stock has been modified to resemble a carbine stock and has a arsenal type oil finish. The stock has a few light handling marks and the inspector's cartouche and firing proof are faint but still partially visible. The handguard is no longer present. Carbine is equipped with a sporting ramp front sight and has the original 1901 style rear sight. Additionally there is a Lyman 57K adjustable rear sight mounted to the right side of the receiver. A nice looking sporterized 1898 that should make a great shooter. (46903-4) (200/400)
2439. **GERMAN GEW 98 MAUSER RIFLE BY DWM** serial #9006, 8mm Mauser, 29" barrel with an excellent bore. The metal surfaces retain little original blue and are mostly a mottled gray with areas of light pitting and oxidation throughout. The receiver markings are crisp and dated "1916" with a second date of "1920" on the top of the receiver. The walnut buttstock has been modified (possibly the start of a carbine project) and has several dings, divots and other handling marks. The stock is numbered to the receiver and has the "1920" date on the right side of the butt as well. The handguard has a single crack running its entire length. The triggerguard is missing the forward set screw and there is no bolt assembly present. Rifle does have the original front sight and the transitional tangent rear sight. A good project rifle needing completion. (46859-2) (50/75)
2440. **U.S. MODEL 1903 RIFLE BY ROCK ISLAND ARSENAL** serial #423811, 30-06, 24" barrel marked "AV / (ordnance bomb) / 10-18" with a very good bore that is mostly bright but has some light pitting and a slight ring at the muzzle. The metal surfaces retain about 85% of an arsenal parkerized finish that is fading to gray and flaking to brown throughout. The walnut handguard and straight grip buttstock rate near excellent and have light dings and added finish. The correct military sights are intact and rifle is also equipped with a Lyman adjustable rear sight mounted to the right side of the receiver; the stock has been modified for the sight. An overall about very good example. (47030-1) (300/500)
2441. **SAVAGE MODEL 99-E LEVER ACTION RIFLE** serial #270773, 22 H.P., 20" barrel with a very good bore that has a small pitted ring about midway down. The metal surfaces are a mottled gray and brown with areas of light to minor surface oxidation present. The blend of finish and oxidation has almost a tiger-stripe appearance. The lever retains some of its original vibrant case color that is visible in the protected areas, the balance being a mottled gray and mixing with oxidation as well. The walnut stocks rate about very good and have been lightly sanded with a few repairs and cracks in both the straight grip buttstock and the schnabel tipped forearm. The steel buttplate has some minor pitting and is proud of the wood. The original sights are intact and rifle is in about good to very good condition. A 1925 vintage rifle in need of a little TLC. (47022-75) {C&R} [Mark Benenson Collection] (200/400)
2442. **PORTUGUESE MAUSER-KROPATSCHEK MODEL 1886 RIFLE BY STEYR** serial #X608, 8x60R, 32" barrel with a very good, lightly pitted bore that still has strong rifling present. The metal surfaces retain about 85% of the original blue finish that is lightly flaking to brown and mixing with areas of light surface oxidation. The triggerguard and buttplate are a mottled gray with more staining and oxidation present, a few of the screws have minor slot damage. The receiver markings are mostly crisp, the bolt is not numbered to the receiver. The hardwood stocks rate about very good and have dings and handling marks throughout. The roundels are still partially visible on either side of the butt and the handguard appears to be a later replacement. A small oval brass disc with "72" has been installed at the toe. The sights are intact and a cleaning rod is included. A very good example overall that is dated "1886" and does not appear to have any visible importer markings. (46983-21) {ANTIQUE} (300/500)
2443. **CHILEAN MODEL 1895 MAUSER RIFLE BY LOEWE** serial #A5689, 7mm Mauser, 29" barrel with an excellent bore. The metal surfaces retain about 95-97% original blue that is lightly flaking to brown with areas of light edge wear and fine speckled surface oxidation. The bolt remains in the white with some light staining, a bolt release lever has nearly all of its original fire blue. The walnut stocks rate excellent and have several light dings and other light handling marks. The buttstock is numbered to the receiver and has a crisp, double stamped cartouche on the left side of the butt. A small oval brass disc with "22" is installed at the toe. Rifle appears to be complete and all matching and no importer marks are visible. A near excellent example overall. (46983-41) {ANTIQUE} (300/500)
2444. **SWISS MODEL 1869/71 VETTERLI CARBINE BY CORDIER** serial #35633, 41 Swiss RF, 20 1/2" barrel with a very good lightly frosted bore that has a few small pits. The metal surfaces are mostly a mottled gray that is mingling with small amounts of original blue, oxidation and light pitting. The walnut stocks rate very good to near excellent and have a few small dings, the forearm has a small arsenal repair. The barrel appears to have been professionally or even arsenal shortened and though its overall appearance is similar to that of the 1869/71 Vetterli Carbine the barrel is 1 1/2" longer than factory spec and does not have the barrel band or correct rear sight. Sling swivels and a steel cleaning rod are included. A nicely made-up carbine in near excellent overall condition. (46965-25) {ANTIQUE} (400/600)
2445. **SHARPS & HANKINS MODEL 1862 ARMY TYPE CARBINE** serial #6738, 52 RF, 24" barrel with a very good bore that has a few areas of light pitting and oxidation. The metal surfaces are a rich mottled brown with light surface oxidation throughout. The dark stained buttstock rates fair and is cracked through the wrist on both sides. The brass buttplate is intact and has a mild ochre patina. Carbine is equipped with a correct rear sight, the front sight however is no longer present. Carbine is also missing its firing pin assembly but the action still functions correctly. A fair to about good condition example of these rare Army model carbines. (46916-63) {ANTIQUE} (400/600)
2446. **HUSQVARNA MODEL 4100 LIGHTWEIGHT BOLT ACTION RIFLE** serial #225962A, 308 Win, 20 1/2" barrel near excellent bore that is mostly bright and has a few small pits toward the chamber. The metal surfaces retain about 98-99% original blue with areas of light handling wear present. The checkered walnut stock has a few light dings and rates excellent overall. The stock features a schnabel tip and left sided cheek rest and has sling swivel studs. Rifle is equipped with a ramp style front sight, the rear sight has been removed and a slot blank is in its place. A Lyman FN adjustable rear sight has been mounted to the rear of the receiver. An excellent lightweight sporting rifle in excellent overall condition. (47007-18) (350/550)
2447. **J.C. HIGGINS MODEL 50 BOLT ACTION RIFLE** serial #15508, 30-06, 22" barrel with an excellent bore. The metal surfaces retain about 99% original blue with areas of light handling wear and a few specks of light surface oxidation mingling about. The smooth walnut stocks rate near excellent and has a few light dings and a small crack at the upper tang that should be easy to fix. The stock is fitted with a vented recoil pad and has sling swivels. Rifle is equipped with the original sights and is factory tapped for scope mounts. Built on a commercial FN Mauser action this is a near excellent condition sporting rifle ready to be used. (47022-71) [Mark Benenson Collection] (300/500)



2448. **U.S. REMINGTON MODEL 1867 NAVY ROLLING BLOCK CARBINE** serial #20423, 50 CF, 22" barrel with a poor, oxidized and pitted bore. The metal surfaces are overall a rich brown with light pitting throughout. The oil stained walnut stocks rate very good and have light dings. The buttstock has a 3" crack on the left side of the wrist at the upper tang and has a crisp "HBH" in banner inspector's cartouche. The original sights and saddle ring are intact. A fair example overall. (46998-1) {ANTIQUE} (300/500)
2449. **CUSTOM SPRINGFIELD 1898 KRAG RIFLE** serial #215193, 30-40 krag, 24" barrel with an excellent bore. The barrel is flaking to brown with areas of light pitting and surface oxidation present. The receiver retains little of the original oil-quenched case color and is overall a mottled gray and brown as well, the extractor does retain a lot of the original fire blue. The custom walnut stock rates about very good and has a few small cracks at the schnabel forend tip. The stock features a grooved forearm, German style raised side flats and a Swiss style hooked bottom buttplate. Rifle is equipped with a 1903 style custom front sight and has a Lyman adjustable rear sight installed on the left side of the receiver. The original rear sight and handguard have been removed. A unique looking custom Krag rifle that will likely be a great shooter. (47022-111) [Mark Benenson Collection] (300/500)
2450. **SWEDISH MODEL 1896 MAUSER RIFLE BY CARL GUSTAFS** serial #156295, 6.5x55 Swedish, 29" threaded barrel with an excellent bore, the muzzle cap is not present. The metal surfaces retain about 80% original blue that is flaking to brown and mixing with areas of light surface oxidation. The bolt remains mostly bright and has some light staining while the buttplate is more a mottled gray brown with minor oxidation. The hardwood stocks rate very good and have light dings and other minor handling marks throughout. The right side of the butt retains the ID disc which lists the bore condition as a "2". The numbers appear to be all matching and rifle was imported by Century Arms. A near excellent condition example overall that will still make a decent shooter. (47014-27) {C&R} (300/500)
2451. **CUSTOM HUSQVARNA MODEL 1938 MAUSER BOLT RIFLE** serial #650318, 6.5x55 Swedish, 22 1/2" barrel with a near excellent, lightly frosted bore. The metal surfaces retain about 99% of an arsenal type matte blue finish. Rifle is equipped with a modern Monte Carlo walnut unfinished sporting stock that rates excellent. The stock has a squared forend tip and an Uncle Mikes vented recoil pad and has a very small crack at the heel. There are no sights present and mounted to the receiver is an All-Pro 3-9X32 riflescope. The scope features a duplex reticle and has very good optics. The bolt numbers match the receiver and the handle has been modified. A nice sporting rifle that would make a great entry hunting arm and be appropriate for many hunting situations. (47067-15) (150/250)
2452. **SWISS MODEL K-31 SCHMIDT-RUBIN RIFLE** serial #590525, 7.5 Swiss, 25 1/2" barrel with a bright excellent bore. The metal surfaces retain about 97-98% of an arsenal blue finish with light fading at the muzzle and edges of the receiver. The walnut stocks rate near excellent and have light dings and handling wear, the buttstock has a very small crack forming at the heel. A matching numbered magazine and a correct leather sling are included. Rifle was imported by Century Arms and is in near excellent overall condition. (47021-5) {C&R} (250/450)
2453. **SWISS MODEL 1911 SCHMIDT-RUBIN CARBINE** serial #131709, 7.5 Swiss, 23" barrel with an excellent bore. The metal surfaces retain about 85-90% original blue with light handling wear throughout, the buttplate is a mottled gray. The hardwood stocks rate near excellent and have several light dings and other handling marks present. A small brass oval disc is installed at the toe and reads "60". Carbine includes a matching numbered magazine and a brass muzzle cover and appears to be complete. There are no visible importer markings and carbine is in near excellent condition overall. (46983-12) {C&R} (300/500)
2454. **POLISH MODEL 1944 NAGANT CARBINE** serial #KB13747, 7.62x54R, 20 1/2" barrel with an excellent bore. The metal surfaces retain about 99% of an arsenal blue finish, the markings remain crisp and the parts are matching. The receiver bears the "(oval)11" Polish factory code and is dated "1953". The hardwood stocks rate excellent, the buttstock retains the diamond cartouche on the right side of the butt. Carbine is complete and includes the folding bayonet and cleaning rod. There are no visible import markings and carbine is in excellent condition. (47017-27) {C&R} (300/500)
2455. **CZECH CZ MODEL 52 SEMI-AUTO CARBINE** serial #E34160, 7.62x45, 20 1/2" barrel with an excellent bore. The metal surfaces are overall mottled gray with areas of light staining, areas of light pitting and traces of gray parkerized finish still visible. The hardwood stock rates very good and has added finish over light dings and handling marks. The buttstock is numbered to the receiver and there is a small oval brass disc installed at the toe marked "48". A single detachable magazine and a leather sling are included. The folding bayonet is not present but there does not appear to be any import markings. A very good example overall. (46983-16) {C&R} (200/400)
2456. **FRENCH MAS MODEL 1949-56 SEMI-AUTO RIFLE** serial #G69069, 7.5 French, 22 1/2" barrel with an excellent bore. The metal surfaces retain about 95% of an arsenal gray parkerized finish with light handling and edge wear present. The hardwood stocks rate excellent and the butt is equipped with a black rubber factory boot. A leather sling and a single detachable magazine are included. Rifle was imported by Century Arms and is in excellent condition overall. (47017-18) {C&R} (300/500)
2457. **CANADIAN ROSS MK II RIFLE** serial #11567, 303 British, 27" barrel with and excellent bore. The metal surfaces are an overall mottled gray and brown patina with areas of light pitting, oxidation and staining throughout. The walnut stocks show evidence of having been lightly sanded with an added oil finish. The markings are soft but still quite visible there are a few light handling marks present. The right side of the butt has a faint "QUEBEC" roundel and several stacked arsenal markings, some have been struck, and the left side is marked "ACO / 36". The rear portion of the handguard sits loose behind the rear sight. There is a small brass oval disc installed at the toe marked "54". The correct sights and sling swivels are intact. A very good to near excellent example overall. (46983-46) {C&R} (400/600)
2458. **CANADIAN ROSS MK II RIFLE** serial #M240, 303 British, 27" barrel with a dark bore that has strong rifling. The metal surfaces are mostly a rich mottled brown with areas of light surface oxidation. The receiver is mottled gray. The walnut stocks rate very good and have light dings and handling marks throughout. The buttstock has a small chip just forward of the magazine lever and another smaller one on the opposite side. The buttstock also has several arsenal markings on the right side of the butt including a "QUEBEC" roundel. The handguard has a couple small cracks and there is a small oval brass disc marked "46" installed at the toe. The sights and sling swivels are intact, the front sight is missing its hood. The bolt has been disassembled and it is not known if all the parts are included. A very good example overall. (46983-44) {C&R} (200/400)
2459. **COLT NEW LINE ENGRAVED REVOLVER** serial #10185, 22 RF, 2 1/4" barrel with a good, pitted bore. The metal surfaces retain about 60-70% of what appears to be the original nickel finish, most of the loss being along the barrel and sides of the frame in front of the cylinder and cylinder itself. The frame, barrel and cylinder all have some factory-type etched foliate and stippled engraving that appears to be of the factory patterns. The revolver is fitted with a set of antique ivory grips that rate very good, the left grip has a small crack near the top and has some marks on the side. The revolver has been disassembled and it is unknown if all the parts are present or operational. These little revolvers are known to be very collectible and this one may have lots of potential. (46778-1) {ANTIQUE} (400/600)

2460. **REPLICA ARMS WALKER PERCUSSION REVOLVER** serial #1368, .44 Caliber, 9" barrel with a very good lightly frosted bore that has a few areas of light surface oxidation present. The barrel, engraved cylinder and grip frame retain about 85% original blue finish with light handling wear mixing with specks of light surface oxidation. The frame and loading arm retain about 60% gray and vibrant blue case colors and have areas of speckled light oxidation as well. The brass triggerguard is mostly bright with areas of light to mild tarnish. The one-piece walnut grip rates excellent and has a few light dings. This Italian-made reproduction of the classic Colt design appears to function correctly and is in near excellent overall condition. Included is a sturdy hand-crafted leather belt holster. (47014-16) {ANTIQUE} (200/400)
2461. **CUSTOM SPRINGFIELD 1898 KRAG BOLT ACTION RIFLE** serial #391721, 30-40 krag, 22" barrel with a bright, excellent bore. The metal surfaces are a mottled gray and brown overall with areas of light surface oxidation and staining present. There are a few minor handling marks and light impact marks present, the largest being on the outer edge of the front corner of the magazine cover. The modified military walnut stock rates about very good and has light dings and a few small chips and cracks, the inspector's cartouche and firing proof are still visible. There is a small sliver of wood missing at the front of the sideplate and the handguard is not present. A 1903-style front sight with a custom globe sight has been mounted at the muzzle. The original rear sight has been removed and a Redfield adjustable rear sight has been installed on the left side of the receiver. Overall a very good condition military style sporting carbine in very good condition. (47022-124) (200/300)
2462. **CANADIAN ROSS MK III\* RIFLE** serial #415, 303 British, 30" barrel with a very good gray and lightly pitted bore. The metal surfaces are an overall mottled gray with light handling marks and a few areas of light surface oxidation. The walnut stocks rate about very good and have several light dings, divots, cracks and other handling marks associated with service use. The right side of the butt has several arsenal markings including a "QUEBEC" roundel, the left side of the butt has a two Chinese-type characters and "235". There is a small oval brass disc marked "45" installed at the toe. The top of the receiver has additional Chinese-type character markings along with the Canadian and English proofs. Rifle appears to be complete and operational and is not importer marked. A very good condition example overall with some interesting markings. (46983-47) {C&R} (200/400)
2463. **CANADIAN ROSS MK IIIB RIFLE** serial #373, 303 British, 30" barrel with a gray, freckled bore. The metal surfaces retain about 70% of an arsenal type blue finish that is mixing with areas of light surface oxidation and areas of light pitting. The walnut stocks rate about very good, the buttstock is rough finished and has no visible markings, the handguard has arsenal repairs and a crack with chip along the left edge. A small oval brass disc with "39" has been installed at the toe. Rifle is equipped with an Enfield Pattern 14 style front sight and has a triangular shaped flip-up rear target sight. The sights being the only real difference between the standard "Mk III" and "B" series rifles. Made for British military contracts this rifle is in about very good condition overall and is not importer marked. (46983-19) {C&R} (300/500)
2464. **U.S. MODEL 1884 TRAPDOOR RIFLE** with Massachusetts surcharge serial #292720, 45-70, 25" modified barrel with a near excellent bore that has a few light pits and some light oxidation. The metal surfaces are an overall mottled gray with areas of light to minor pitting and oxidation present. The metal markings are faint but the serial number remains strong. The walnut stock rates about very good and has several dings and light divots. The firing proof is still visible and the left side of the butt is marked "4 / MASS / B / 37". The modified stock has a small brass oval disc with "28" is installed at the toe. Rifle still retains its two barrel bands and has correct sights. A very good example overall. (46983-17) {ANTIQUE} (200/400)
2465. **SWISS MODEL 1889 SCHMIDT-RUBIN RIFLE** serial #164070, 7.5 Swiss, 30 1/2" barrel with an excellent bore. The metal surfaces retain about 80% of what appears to be the original finish that is flaking to brown and loss to gray metal. The walnut stocks rate near excellent and have a few light dings and other handling marks. The buttstock has a "1" in (circle) at the heel and crisp markings and has a small brass oval disc marked "4" installed at the toe. A near excellent example overall that does not have any visible import markings. (46983-52) {ANTIQUE} (300/500)
2466. **GERMAN GEW 88 MAUSER RIFLE BY LOEWE** serial #5579d, 8mm Mauser, 29" barrel with an excellent bore. The metal surfaces are a mottled brown with areas of gray and light surface oxidation blending throughout along with a few areas of light pitting. The walnut buttstock rate good and has several handling marks associated with a lifetime of service use. There is light chipping along the edges of the forearm and around the buttplate and a small brass oval disc marked "8" is installed at the toe. The imperial German markings are still partially visible on the right side of the butt, along with a large carved "J". The receiver markings are faint and the numbers are not matching, rifle does not appear to be importer marked. An about good to very good condition example overall. (46983-45) {ANTIQUE} (200/400)
2467. **FRENCH MODEL 1916 BERTHIER-MANNLICHER RIFLE** serial #42794, 8mm Lebel, 31 1/2" barrel with a dark, oxidized bore. The metal surfaces retain about 90% of an arsenal type blue finish with scattered light specks of oxidation present. The hardwood stocks rate very good and have been lightly sanded with finish added. The handguard has a small crack just forward the rear sight and the buttstock has arsenal repairs on the left side of the forearm and at the toe, which has a small oval disc marked "35". There is some minor chipping around the buttplate which is sitting loose and missing the heel screw, there is a crack at the heel as well. The numbers are not matching and no importer markings are visible. An about good to very good example overall. (46983-60) {C&R} (200/300)
2468. **BELGIAN SNIDER ACTION ZULU SHOTGUN** serial #197FF, 12 ga., 32" barrel choked improved cylinder with an about good bore that has minor pitting throughout. The barrel is tapped for a bead sight at the muzzle but one is not present. The metal surfaces are a rich mottled brown with areas of light surface oxidation and light pitting. The hardwood stock rates poor with several cracks and a large portion of wood missing from behind the action. The block does not "lock" into the closed position and much of the firing pin mechanism and the rear action screw are missing. A poor condition example overall. (46859-3) {ANTIQUE} (25/50)
2469. **IVER JOHNSON MODEL 50A SIDEWINDER REVOLVER** serial #E23538, 22 LR, 6" barrel with an excellent bore. The metal surfaces retain about 95% original blue with light handling marks throughout and some areas of minor staining and flaking present. Revolver is equipped with a faux stag one-piece grip that rates excellent. This revolver has been completely disassembled and it is unknown if all of the parts are present or operational. (46779-D29328) (50/75)
2470. **BRIDLE ROSETTE LOT** This lot consists of a brass U.S. Army Cavalry bridle rosette with "US" in center. The 1 3/4" diameter medalion rates about very good and has a few small dents and a darker patina. The rear pins are missing. Likely a post Civil War to pre-1900 era item. (43615-14E)
2471. **CIVIL WAR BELT BUCKLE LOT** This lot consists of a Civil War-era "U.S." belt buckle. This oval-shaped buckle measures about 3 1/4" long by about 2 1/8" tall. The brass has some minor dings and malformed edges but the buckle rates about very good overall. The pins and latch remain intact and the name of a previous owner is neatly stamped twice in the lead core. (43615-14D)

2472. **NH CIVIL WAR BELT BUCKLE** This lot consists of a New Hampshire State Militia brass belt buckle. This oval-shaped buckle measures about 3 1/4" by 2 1/8" and has "NHSM" in center. The brass has a mild ochre patina with some areas of darker tarnish and a few light handling marks on both sides. The pins and latch are intact and there are a few small dings around the outer edge. A very good to near excellent condition example of these very collectible Civil War relics. (43615-14F)



2473. **KNIFE LOT** This lot consists of an antique double edged knife that measures 12 1/2" long with an 8" blade that has some etched designs along the center on one side along with the date "1898". The blade has some minor staining and areas of light oxidation present. The grip features a brass guard and pommel cap and has an antique grooved and wire-wrapped bone handle. The knife is housed in what appears to be the original leather sheath with nickel



silver throat and tip. According to the consignor this knife is of Greek origin, and although the knife does appear to be quite old there are no means of authenticating where it is from. A very nice example overall, that may possibly have an interesting story. (46778-3)

2474. **SCHMIDT & BENDER SCOPE LOT** This lot consists of a Schmidt & Bender Classic series 1.25-4X20 riflescope. This German-made scope features a 30mm matte finish tube and has the A4 style reticle with bright excellent optics. The tube has a few light ring marks from having been previously mounted but remains in excellent condition overall. A top of the line set of quality optics for most hunting applications. (46520-769A)

2475. **LEUPOLD SCOPE LOT** This lot consists of a Leupold M8 4X riflescope. This blue finish scope features a duplex reticle and has excellent optics. There are a few light handling marks but scope is in excellent condition. (46894-2A)

2476. **KAHLES SCOPE LOT** This lot consists of a Kahles ZF69 6x42 riflescope. This is a rare and vintage sniper scope originally used with the Steyr SSG69 PI sniper rifle. Matte finish steel tube diameter is 26mm and scope features a German #1 type reticle. Scope has a few light handling marks but is in excellent condition overall and includes a set of factory lens covers. (46873-39A)

2477. **ZEISS SCOPE LOT** This lot consists of a Zeiss Diavari-C 3-9x36 riflescope. This quality West German made scope features a duplex reticle and has bright excellent optics. The tube has a few light ring marks from having been mounted, but scope is in excellent condition overall. Factory lens cover is included. (46520-2726A)

2478. **ZEISS SCOPE LOT** This lot consists of a Zeiss Diatal-C 4x32 riflescope. The scope features a fine crosshair reticle and has bright excellent optics. Scope includes a set of Weaver extension rings and a set of factory lens covers. Also included is an AA&E Leathercraft brown leather sling. A couple of quality, excellent condition accessories for your deserving sporting rifle. (46815-17A)

2479. **REDFIELD SCOPE LOT** This lot consists of a Redfield Low Profile 3-9X target Accutrac riflescope. The scope has excellent optics and features the Accutrac reticle and a raised elevation adjustment knob. The tube has a few light ring marks but is in excellent condition overall. (46520-2666A)

2480. **REDFIELD SCOPE LOT** This lot consists of a Redfield 3/4" 4X rimfire riflescope. The scope features a crosshair reticle and has excellent optics. The scope has some minor handling wear but is in very good condition overall and includes a set of rings to fit grooved receivers. These vintage scopes are highly sought-after and perfect for a classic 22 sporting rifle. (46520-3447A)

2481. **LEUPOLD SCOPE LOT** This lot consists of Leupold Vari-X 2-7X Rimfire Special riflescope. The gloss blue scope features a duplex reticle and has bright, excellent optics. The tube has a few very light handling marks and the scope is in otherwise excellent condition. The perfect accessory for your classic 22 rimfire sporting rifle. (47022-102A)

2482. **LEUPOLD SCOPE LOT** This lot consists of a Leupold M8 4X riflescope. This matte finished scope features a duplex reticle and has bright, excellent optics. Scope includes a set of Butler Creek flip-up lens covers and a set of 1" engraved rings. A set of bases to fit a Savage 99 rifle are also included and scope is in excellent condition. (47022-26A)

2483. **LEUPOLD SCOPE LOT** This lot consists of a Leupold Vari-XIII 1.5-5X20 riflescope. This gloss finish scope features a crosshair reticle and has bright, excellent optics. The tube has a few light handling marks, but the scope is in excellent condition overall. (47034-43A)

2484. **LEUPOLD SCOPE LOT** This lot consists of Leupold 12X adjustable objective riflescope. This gloss finish scope features a fine duplex reticle and has bright, excellent optics. The body has some light rings marks from having been mounted, but scope remains in excellent overall condition. (47034-47A)

2485. **LEUPOLD SCOPE LOT** This lot consists of a Leupold Vari-XIII 1.5-5x20 riflescope. The matte finish scope features a #4 reticle and has bright, excellent optics. There are a few light handling and ring marks present and the rubber eye rings is loose but is still serviceable. An excellent scope in near excellent condition. (46939-4A)

2486. **LEUPOLD SCOPE LOT** This Lot consists of a Leupold Vari-X 3-9X Compact riflescope. The gloss finish scope features a duplex reticle and has excellent optics. The scope has some minor handling wear and is in near excellent overall condition. (47056-5A)

2487. **LEUPOLD SCOPE LOT** This lot consists of a Leupold Vari-XII 3-9x40 riflescope. This gloss finish scope features a duplex reticle and has bright, excellent optics. The tube has some light ring marks from having been mounted, but the scope is in excellent condition overall. (47056-7A)

2488. **REDFIELD SCOPE LOT** This lot consists of a Denver, Colorado vintage Redfield 2-7X Tracker series riflescope. The gloss finish scope features a crosshair reticle and has excellent optics. The tube has a few light ring marks but the scope is in otherwise excellent condition. (46769-6)

2489. **REDFIELD SCOPE LOT** This lot consists of a Redfield 2-7X Lo-Profile Widefield riflescope. The gloss finish scope features a crosshair wideview reticle and has excellent optics. The scope has some light handling marks but is in near excellent condition overall. (47022-96A)



2490. **BSA SCOPE LOT** This lot consists of a BSA CT4 Contender 4-16x40 TS adjustable objective riflescope. The matte finish scope features a duplex reticle and has excellent optics. The scope includes a 3" sunshade and has a set of see-through rings designed to fit a grooved receiver. An excellent example overall. (46520-520A)
2491. **U.S. BAYONET LOT** This lot consists of A U.S. Model 1905 series bayonet by Rock Island Arsenal with scabbard. The bayonet measures 20 1/2" long and has a 16" lightly sharpened blade dated "1911". The blade remains mostly bright with a few areas of light staining and wear along the edges. The grip steel is a mottled brown with areas of light oxidation, the wood panels rate excellent. The included wood bodied scabbard has a canvas cover with faded leather tip that is heavily flaking and missing a portion. A very good example overall. (46934-27A)
2492. **U.S. BAYONET LOT** This lot consists of a U.S. 1905 series bayonet by Springfield Armory with scabbard. The bayonet measures 20 1/2" long and has a 15 7/8" blade dated "1906". The blade has a mottled gray patina while the grip is brown with areas of minor oxidation. The wood grip panels have added finish but rate near excellent. The included wood bodied scabbard has a tan canvas cover with leather tip that is heavily flaking and is torn at the tip. The canvas seems to have "shrunk" a bit leaving the top 3/4" of the scabbard exposed. A very good example overall. (46934-26A)
2493. **SWISS BAYONET LOT** This lot consists of a Swiss model 1911 Pioneer bayonet with scabbard. The bayonet measures 24" long with an 18 3/4" sawback blade marked "H.S." on the ricasso. The steel has some minor staining and areas of fine surface oxidation. The wood grip panels have some light dings and a small crack on one side. The included blued steel scabbard rates excellent and has some light handling marks. (46924-16)
2494. **SWISS BAYONET LOT** This lot consists of a Swiss model 1911 Pioneer bayonet with scabbard and frog. The bayonet measures 24" long with an 18 3/4" blade marked "WAFFENFABRIK / NEUHAUSEN" on the ricasso. The steel remains bright and the wood grip panels rate excellent and have light added finish. The steel scabbard has an added black enamel finish but both it and the tan leather frog rate excellent. (46910-3)
2495. **FRENCH BAYONET LOT** This lot consists of a French model 1874 Gras bayonet with scabbard. The bayonet was manufactured at the St. Etienne arsenal and measures about 25 1/2" long with a 20 1/2" blade that is dated "1879". The metal surfaces have minor staining and light handling marks. The hooked quillon guard has more brown patina with light oxidation and the brass pommel has mild patina. The wood grip panels rate excellent. The included steel scabbard is mostly a mottled gray with areas of light specks of oxidation. Both the scabbard and guard are numbered the same. An overall excellent example. (46816-9C)
2496. **FRENCH BAYONET LOT** This lot consists of a French model 1874 Gras bayonet with scabbard. The bayonet was manufactured at the St. Etienne arsenal and measures about 25 1/2" long with a 20 1/2" blade that is dated "1879". The blade is mostly bright with a few areas of very light staining. The hooked quillon guard has more brown patina and the brass pommel has light patina. The wood grip panels rate very good and have a few light dings. The included steel scabbard has most of the original blue with a few light specks of oxidation. Both the scabbard and guard are numbered the same. An excellent example overall. (46754-11)
2497. **U.S. NAVY PILOTS KNIFE LOT** This lot consists of a Vietnam War era Jet Pilot's survival knife with sheath made by Camillus. The knife measures 9 1/2" long and has a 5" clip point blade with serrated spine and a lightly sharpened edge. The metal surfaces have a fading parkerized finish mingling with gray steel and specks of light surface oxidation. The serrations have some minor dings and chipped edges. The leather washer grip rates very good and the grip's metal parts have a brown patina. The pommel is marked "CAMILLUS" and dated "2-71". The brown leather sheath rates about very good and has some minor crazing, scuffs and light folds, but the leather remains supple and intact. A stone is included in the front pocket. A very good example of these popular fighting knives. (46782-3)
2498. **U.S. NAVAL BAYONET LOT** This lot consists of a U.S. Model 1870 Navy Rifle bayonet by the Ames Manufacturing Company. The bayonet measures 24 3/4" long and has a 20" dual-edged blade that is lightly sharpened on one side and has a few tiny nicks. The ricasso is marked "AMES MFG CO. / CHICOPEE / MASS." and has "U.S.N. / G.G.S / 1870" on the reverse. The ricasso markings are soft on the edges but still very visible. The blade is bright steel but has a few areas of very light pitting and some light staining mingling with gray patina. The cast brass grip rates very good and has remnants of a reddish brown paint still present and several light handling marks overall. The crossed cannon ordnance wheels are soft but the "GGS." Stamp just above the lug channel is still crisp. No scabbard is present. A very good example of these classic Naval bayonets. (46934-28)
2499. **LOT OF SPORTING KNIVES** This lot consists of two vintage fixed blade sporting knives with sheaths. First is a Schrade-Walden model 147 hunting knife that measures 8 3/4" long with a 4 1/2" blade that has been lightly sharpened and has some light staining. The leather washer grip rates excellent and knife has an aluminum guard and butt. The sheath is black tooled leather with initials carved on the reverse side. Second is a German made hunting knife by Soffe. The knife measures 9" long with a 4 3/4" stainless steel blade that has been lightly sharpened. Knife features a stag grip with aluminum butt and has a nickel silver balled guard. The sheath is tooled brown leather that depicts an Indian Chief's profile. Two very good examples overall. (44543-7A)
2500. **LOT OF SPORTING KNIVES** This lot consists of three fixed blade sporting knives. First is a Case Finn style hunting knife that measures 8" long with a 4" blade that has seen moderate to heavy sharpening. The steel is lightly stained throughout and the leather washer grip is dark and oil soaked. A handmade leather sheath is included. Second is a small decorative Indian Kinjal-style dagger that measures 7" long with a 3 1/2" curved blade. The blade features ethnic star pattern designs and the leather washer grip is infused with white, blue, red and green circular inserts and two white spacers. The cast bronze scabbard features ethnic designs as well. Lastly is a German made knife by Korium that measures 10" long with a 6" blade. The blade has been sharpened and has moderate oxidation toward the tip. Knife features an aluminum "S" swept guard and has a cast grip with the pommel in the shape of an eagle's claw grasping a sphere. The grip and guard are not currently attached and no sheath is included. (44543-7B)
2501. **BLADE LOT** This lot consists two edged items. First is a Japanese Type 30 bayonet by Kokura with scabbard. The bayonet measures 20" long overall and has a 15" blade. The metal surfaces have light pitting and oxidation throughout with areas that have been lightly polished. The straight eagle head pommel has minor impact marks. Bayonet features a hooked quillon guard and has wood grip panels that rate very good and have a few light dings and small cracks. The included steel scabbard rates very good and has an added black enamel finish that is flaking and mixing with areas of light oxidation. Second is a modern machete that measures 23" long and has a 17 1/2" heavily oxidized blade. The blade appears unmarked and machete has a hardwood handle. Included is a canvas sheath. (46825-1A,E)

2502. **LOT OF GERMAN BAYONETS** This lot consists of two German K98 bayonets with scabbards. Each measures 15" long with a 9 3/4" blade. The first is marked "J.Sch." on the ricasso with "6361a" on the reverse and a date of "39" on the spine. The bayonet retains most of its original blue and has a brown bakelite grip that rates excellent. The grip has a few specks of light surface oxidation and a few crisp Waffenamts. The steel scabbard is matching and in similar condition and includes a black leather frog. The second is marked "S/155" on the ricasso, numbered "1352d" on the reverse and is dated "36" on the spine. The metal surfaces are in-the-white with gray patina and areas of light surface oxidation throughout. The wood grips have been sanded and have a few chips, the flash cover is marred along the edges. The included steel scabbard has a heavy enamel finish with some light flaking and some minor dents. (46825-1C,D)
2503. **U.S. SOCKET BAYONET LOT** This lot consists of a U.S. 1873 style socket bayonet. The bayonet measures 20 3/4" long with an 18" triangular blade. The bayonet is unmarked with the exception of a small "H" on the side of the socket just above the mortise. The metal surfaces have an overall dusty gray appearance that is blending with areas of light surface oxidation and staining. No scabbard is included. A good example overall. (46825-1B)
2504. **LOT OF U.S. SOCKET BAYONETS** This lot consists of two Model 1873 U.S. Trapdoor socket bayonets. Each measures about 20 3/4" long with an 18" triangular blade marked "US" on the face, no other markings are present on either. The bayonets retain most of their original blue finish with areas of scattered light surface oxidation present on each. No scabbards are included. Two very good examples overall. (46623-35)
2505. **U.S. TRENCH KNIFE LOT** This lot consists of a U.S. Landers Frary & Clark Model 1917 trench knife. The knife measures 14" long with a 9" triangular blade and cast knuckle guard. The blade has a dark parkerized finish while the guard is a mottled brown and is marked "U.S. / L.F.&C. / 1917". The one-piece finger grooved grip rates excellent. No scabbard is included but knife is in excellent condition overall. (46629-5)
2506. **U.S. SOCKET BAYONET LOT** This lot consists of a U.S. Model 1841 Cadet socket bayonet that measures 17 3/4" long and has a 14 1/2" blade marked "US" on its face, the "U" is only partially visible. The metal has some minor staining and areas of very light surface oxidation and pitting scattered about. A very good example overall. (43615-6R)
2507. **U.S. SOCKET BAYONET LOT** This lot consists of a U.S. 1861 socket bayonet that measures 21" with an 18" blade marked "US / 5 / 35" on the face. The metal is an overall mottled gray-brown patina and there are a few light handling marks and scattered light surface oxidation. A very good example overall. (43615-6H)
2508. **U.S. SOCKET BAYONET LOT** This lot consists of a U.S. 1861 socket bayonet that measures 21" with an 18" blade marked "(dot) / US / S" on the face. The metal is mostly bright steel with some light gray patina and staining present. There are a few light handling marks and nicks along the edges. An excellent example overall. (43615-6Q)
2509. **U.S. SOCKET BAYONET LOT** This lot consists of a U.S. 1873 socket bayonet that measures 21" with an 18" blade marked "US" on the face. The metal retains most of its original blue which is mixing with overall scattered light surface oxidation. A very good example overall. (43615-6O)
2510. **U.S. SOCKET BAYONET LOT** This lot consists of a U.S. 1873 socket bayonet that measures 21" with an 18" blade marked "US" on the face, the "S" is very faint. The metal retains most of the original blue which is flaking to a mottled brown and fading to gray. There are multiple light handling marks and small impact marks present and areas scattered light surface oxidation. A good example overall. (6816-9A)
2511. **U.S. SOCKET BAYONET LOT** This lot consists of a U.S. 1808 socket bayonet that measures 18 1/4" with an 15" blade with top flute marked "US" on the face. The triangular blade has light dings along the edges. The metal is an overall mottled gray-brown patina and there are a few light handling marks and scattered light surface oxidation. An about very good example overall. (43615-6M)
2512. **U.S. SOCKET BAYONET LOT** This lot consists of an early, unmarked socket bayonet that measures 17 3/4" long and has a 14" blade with fullered tip. The metal is a rich brown and mottled gray patina with areas of light surfaces oxidation scattered about. The socket has an "L" shaped mortise that is cut opposite of most examples and it appears that the base once incorporated a bridge which has been removed. The bayonet is fairly rudimentary in design and has several light dings and other handling marks along the edges and sides. Very possibly an early U.S.-made bayonet similar to the pre-1800 U.S. and French designs. (43615-6J)
2513. **SOCKET BAYONET LOT** This lot consists of an unmarked, early style socket bayonet that measures 18 1/2" long with a nearly 15" unfullered blade. Bayonet features a ribbed base with bridge with an "L" mortise and has a mottled brown-gray patina throughout with scattered light pitting and some light surface oxidation. Similar in appearance to American and British examples from the mid-1700's and in about very good condition. (43615-6F)
2514. **PRUSSIAN BAYONET LOT** This lot consists of an unmarked Prussian Model 1809 socket bayonet. The bayonet measures 22 3/4" long with a 19" blade and has moderate to heavy oxidation and pitting throughout. A fair example overall. (43615-6B)
2515. **U.S. SOCKET BAYONET LOT** This lot consists of a U.S. 1873 socket bayonet with scabbard and frog. The bayonet measures 21" long and has an 18" blade marked "US" on its face. The metal surfaces have most of the original blue finish that is flaking to brown and blending with areas of speckled light surface oxidation. The included steel scabbard is an overall mottled gray with traces of brown mingled throughout. The scabbard has the black leather hanger with brass hook that has a round "US" medallion. A near excellent example overall. (46625-50)
2516. **U.S. SOCKET BAYONET LOT** This lot consists of a U.S. 1873 socket bayonet with scabbard and frog. The bayonet measures 21" long and has an 18" blade marked "US / S" on its face. The metal surfaces have most of the original blue finish that is lightly flaking to brown and blending with areas of light surface oxidation. The included steel scabbard is an overall mottled gray with traces of brown mingled throughout. The scabbard has the black leather hanger with leather loop that has a round brass "US" medallion. The leather is crazed and lightly cracking, the arsenal stamping is only partially visible and is not discernable. A very good to near excellent example overall. (46816-9B)
2517. **SHOOTERS LOT** This lot consists of eight shooting related items. First is a Marlin Model 70 22 LR five-round magazine that has light surface oxidation and minor flaking. Second is a Remington ten-round 22 LR magazine for the 511, 513 & 521 series rifles. Third is a set of front and rear adjustable sights for a Remington 700 bolt action rifle. Fourth is an S&K side-mount plate with 1" rings. Fifth is a used set of Hogue rubber grips for a Ruger Black Hawk revolver. Next are two Colt factory screwdriver tools. Seventh is an 1863-style combination tool. Last is a set of RCBS dies for 7x57 Mauser in the original box. All are in excellent condition unless already noted. (46613-4)

2518. **KNIFE LOT** This lot consists of four assorted sporting knives. First is German made fixed blade survival knife. The knife measures 9" long with a 5" clip point blade. Knife features a faux stag grip that has several smaller, more crude, blades and tools and comes in a leather sheath with split seams. Second is a smaller fixed blade German "paring" style knife that measures 5 1/2" long with a 2 1/2" blade marked only "SOLINGEN". The knife features a stag grip with orchid carved into one side and has a leather sheath with silver tip and throat and is marked "Bad Tolz" - a small town in Bavaria. Third is a Browning signature lockback pocket knife Model 722 in its original box. The knife measures 2 3/4" closed and has a 1 3/4" drop point stainless steel blade and black checkered grip. Lastly is a Gerber Magnum Jr Model 400 folding knife also in its original box. The knife measures 3 1/2" closed and has a 2" stainless steel with the "Buckmaster's" logo on one side. The grip is OD green. All are in excellent to as new condition unless otherwise mentioned. (46613-4A)
2519. **ORDNANCE LOT** This lot consists of several assorted military ordnance type items. Included are four 20mm dummy/practice rounds, two smaller 30mm dummy rounds, one 40mm practice grenade, one 40mm artillery shell casing, seven 7.62mm AP dummy rounds and a link of 7.62 NATO (308 Win) with about 75 rounds. All are in very good to excellent condition. (46613-4B)
2520. **JAPANESE BAYONET LOT** This lot consists of a Japanese Type 30 Arisaka bayonet with scabbard by Kokura. The bayonet measures 20" long with a 15 1/2" unsharpened blade. The bayonet features a hooked quillon guard and a straight bird's head grip. The metal surfaces are a rich brown with areas of light surface oxidation and pitting, the wood grip panels have a few light dings. The steel scabbard is in similar condition with a few small dents. An about very good example overall. (46613-4C)
2521. **SWEDISH BAYONET LOT** This lot consists of a Swedish Model 1896 bayonet with scabbard and frog. The bayonet measures 13 1/4" long with an 8 1/4" lightly sharpened blade. The blade is bright steel and the grip has most of the original blue still present, the balance fading to gray. The steel scabbard is in similar condition and is numbered to a different blade. The tan leather frog rates excellent and has light crazing throughout. (46613-4D)
2522. **CUSTOM WOOD RIFLE STOCK** This unmarked, plain pistolgrip walnut stock is in excellent refinished condition overall with a blued triggerguard installed. There is no buttplate present but the length of pull could be estimated at about 13 1/2". The end of the buttstock is varnished with a small run and there is dimple at the heel of the stock. Stock resembles the style used for single shot bolt action rifles, but has been modified and both the forend and butt have been shortened. (46247-15D)
2523. **MODEL LOT** This lot consists of an unmarked die cast metal model of a Browning 50 caliber M2 machine gun on tripod. This quality model measures 14" long, has an adjustable tripod and some moving parts. A well made "Ma Deuce" replica that would be a stellar desk ornament or addition to a military display. (46668-12)
2524. **GERMAN KNIFE LOT** This lot consists of German made Bowie style knife by Linder-Messer. The knife measures 15 1/4" with a 9 3/4" Inox steel blade and features stag grips and a nickel silver guard. The blade is etched "Original Bowie Knife" on the right and "Rehwappen" stag logo on the left. A brown leather sheath is included. An excellent to near new condition example overall. (46668-1)
2525. **MOCCASIN LOT** This lot consists of a pair of buckskin leather moccasins. The moccasins appear to be about a size 8 but are not marked in any way. Each has a decorative multicolored bead pattern comprised of triple stacked triangular pyramid or "tree" designs over the toe areas and a similar single design on the outer ankle area. An included note states that the moccasins were purchased new in the late 1950's in Northwestern Canada, and though the consignor could not recall the name of the tribe they were made by they do appear to be authentic. An excellent example of contemporary native North American Indian footwear. (46668-4)
2526. **SHOOTER'S LOT** This lot consists of three items. First is a full box of 20 Remington Managed Recoil 30-06 125 grain Core-Lokt PSP ammunition in like new condition. Second is a set of Leupold 1" matte finish scope rings, the front ring is an extension. Lastly is a set of S&K 1" gloss finish rings and bases for a Browning A-Bolt rifle. Both sets of rings are in excellent condition. (46668-2A,3)
2527. **COLLECTIBLE LOT** This lot consists of two shooting related items. First is a Winchester Repeating Arms Co. standard smokeless Powder display. This shotshell-shaped display features 12 individual types of powder, visible in a cut-away section with each powder variety separated by a spacer. The top two spacers have become dislodged and the powders mixed. The display is in otherwise good condition. Second is an empty canvas bag marked for Remington #4BK lead shot. This five pound capacity bag is in very good condition and has red Remington factory lettering. Two interesting vintage items from the top two U.S. firearms producers. (46668-4B)
2528. **AUSTRALIAN BAYONET LOT** This lot consists of an Australian Model L1A2 bayonet with scabbard. This all steel bayonet measures 11 3/4" long with a 7 3/4" lightly sharpened blade that has a few light nicks along the edge. The metal surfaces have a lightly mottled brown patina and a few areas of light pitting and light handling marks. The included steel scabbard rates excellent and includes a gray canvas frog. The bayonet is unmarked but is in very good condition overall. (46557-1A)
2529. **AUSTRIAN BAYONET LOT** This lot consists of an Austrian Model 1895 bayonet with scabbard. The bayonet measures 14" long with a 9 1/2" blade marked "CE / WG" on the ricasso. The metal surfaces remain in-the-white with scattered light gray patina, scattered light oxidation and light handling marks. The grip has wood panels that rate excellent, the pommel has a small hole for a loop which is not present. The included steel scabbard has an added blue finish and the frog tab has been brazed on. A very good example overall. (46557-1B)
2530. **BELGIAN BAYONET LOT** This lot consists of a Belgian Model 1949 Short bayonet for the FN rifle. The bayonet measures 14 1/4" long and has a 9" double edged blade. The metal surface have an arsenal type matte black finish that has areas of light wear. The grip is marked on the left side with a series of numbers and a "(crown)JF" logo has several light impact marks. The wood grip panels rate excellent. The included matching numbered steel scabbard is in similar condition and includes a gray canvas frog. An excellent example overall of these export model bayonets. (46557-1C)
2531. **DUTCH BAYONET LOT** This lot consists of a Dutch Model 1895 Infantry bayonet with scabbard. The bayonet measures 19" long with a 14" blade. The metal surfaces have a blue finish with areas of light fading and a few sparse areas of light surface oxidation. The wood grip panels rate excellent. Included is a leather scabbard that has minor crazing and few light cracks and cuts. A very good example overall. (46557-1D)
2532. **SWISS BAYONET LOT** This lot consists of a Swiss Model 1889/11 Schmidt-Rubin bayonet with scabbard. The bayonet measures 16 1/2" long with an 11 3/4" bright steel blade marked "WAFFENBRIK / NEUHAUSEN" on the ricasso. The plated guard and pommel rate excellent and have some very light flaking, the wood grip panels rate excellent. The included steel scabbard is in similar condition and has a small dent and a few minor dings. A very good to near excellent example overall. (46557-1E)
2533. **SPANISH BAYONET LOT** This lot consists of a Spanish CETME bayonet with scabbard. The bayonet measures 13 1/4" with an 8 3/4" blade. The bayonet has light handling wear throughout. The included green composite bodied scabbard rates in similar condition. A very good to near excellent example overall. (46557-1F)



2534. **FAL BAYONET LOT** This lot consists of a Belgian Model 1965 tube style bayonet with scabbard. The bayonet measures 11 1/2" long with a 6 1/2" blade and has a arsenal type black finish with some very light flaking present. The included hard rubber scabbard has some minor handling marks. An excellent example of these FAL accessories. (46557-1G)
2535. **REPLICA BAYONET LOT** This lot consists of an Italian made replica 1862 Zouave bayonet with scabbard and frog by Armi San Marco. The bayonet measures 24 1/2" long overall with a 19 3/4" bright steel blade. The blade has a very slight bend at its base. The cast brass grip rates excellent and is marked "MADE IN ITALY". The included leather scabbard and frog rate excellent. A useful replica in near excellent condition. (46557-1H)
2536. **FRENCH BAYONET LOT** This lot consists of a French Model 1874 Gras bayonet with scabbard. The bayonet measures 25 1/2" long with a 20 1/2" blade. The metal has a light gray patina and the wood grip panels rate very good with light dings and a small chip. The blade is dated "1876" and the included steel scabbard is matching numbered to the hooked guard and is in similar overall condition. A very good example overall. (46557-1I)
2537. **FRENCH BAYONET LOT** This lot consists of a French Model 1886 Lebel bayonet with scabbard. The bayonet measures 25" long with a 20" cruciform blade. The blade has areas of light surface oxidation and staining present, the silver alloy grip has a light tarnish. The steel scabbard has a few small dents and some light oxidation as well. There is also a black leather frog included that has minor crazing and some light cracking. A very good example overall. (46557-1J)
2538. **AUSTRIAN BAYONET LOT** This lot consists of an Austrian Model 1895 bayonet with scabbard. The bayonet measures 14" long with a 9 1/2" blade marked "CE / WG" on the ricasso. The metal surfaces remain in-the-white with scattered light gray patina, scattered light oxidation and light handling and impact marks. The grip has wood panels that rate excellent, the pommel has a small hole for a loop which is not present. The included steel scabbard has a fading blue finish with the balance being a mottled gray. A very good example overall. (46528-2E)
2539. **FRENCH BAYONET LOT** This lot consists of a French Model 1874 Gras bayonet with scabbard. The bayonet measures 25 1/2" long with a 20 1/2" blade. The blade is dated "1879" and has a mottled gray patina. The dark oil-soaked wood grip panels rate very good with light dings and small handling marks, the brass pommel has a dark ochre patina. The remaining metal surfaces including the scabbard have minor to moderate oxidation and pitting. An about good example overall. (46525-2L)
2540. **FRENCH FIGHTING KNIFE LOT** This lot consists of a modified British Model 1913 bayonet made for the French Foreign Legion with scabbard. The knife measures 12" long with a 7 1/4" lightly sharpened blade. The metal surfaces have an arsenal parkerized finish and the grooved wood grips rate excellent. The blade has been shortened from its original length and fashioned to resemble the No.5 series bayonet, the guard has also been modified and is at present oval in shape. The ricasso and reverse markings are still crisp and bear the Remington logo and date of "12 15" along with several British proofs. The green, leather bodied scabbard is in similar condition and has been proportionally modified as well. A tan leather frog has been added. An excellent example overall. (46528-1C)
2541. **LOT OF BRITISH BAYONETS** This lot consists of two British No. 4 series Enfield bayonets with scabbards. First is a No.9 Mk I blade bayonet that measures 10" with an 8" blade. Second is a No.4 Mk II spike bayonet that measures 10" long. Both are in excellent condition and include the correct steel scabbards. (46528-2M,Q)
2542. **LOT OF BRITISH BAYONETS** This lot consists of two British Model 1907 bayonets, one with scabbard. The bayonets each measure 21 1/2" long with a 16 3/4" blade that has a lightly sharpened edge. The first has mottled gray metal surfaces with areas of light oxidation and light pitting. The ricasso markings are soft but most of the proofs are still visible. The wood grip patterns have light dings and a few very small chips but rate very good overall. The included leather bodied scabbard is in similar condition. A very good example overall. The second has more oxidation and light pitting. The grips have a few small cracks, and there are light impact marks as well. The second bayonet does not include a scabbard and is in about good condition. (46528-2A,B)
2543. **U.S. BAYONET LOT** This lot consists of a U.S. Model 1917 bayonet with scabbard by Remington. This "1918" dated bayonet measures 21 1/2" long with a 16 3/4" blade. The ricasso markings are light but still visible and the grooved wood grips rate near excellent with a few light dings. The metal surfaces are a mottled gray with areas of brown blending throughout. The included green leather bodied scabbard rates excellent. (46528-1B)
2544. **BELGIAN BAYONET LOT** This lot consists of a Belgian Model 1924 Short bayonet with scabbard. The bayonet measures 18 1/4" long with a 13 1/2" double edged blade. The edges are blunt and have not been sharpened, but have a few light dings and impact marks. The metal surfaces retain most of a blue finish with areas of light surface oxidation mixing throughout. The wood grip panels rate excellent but the lug retention mechanism is missing. The included steel scabbard has most of a black enamel type finish with areas of light surface oxidation throughout. A faded black leather frog is also included which has minor flaking and is becoming separated along a few of the seams. An about very good example overall. (46528-2R)
2545. **FRENCH BAYONET LOT** This lot consists of a French 1886/91/16/35 Lebel bayonet with scabbard and frog. The bayonet measures 18 1/4" and has a 13 1/2" cruciform blade. The steel metal surfaces are a mottled brown with a few areas of light surface oxidation. The brass grip has some light handling marks and a mild ochre patina. The included steel scabbard is in similar condition with areas of light surface oxidation as well, the black leather frog is heavily crazed and has a shellac-type coating that is cracking. An about very good example overall. (46528-2F)
2546. **FRENCH BAYONET LOT** This lot consists of a French Model 1956 MAS bayonet with scabbard. The bayonet measures 12 3/4" with an 8" blade. The metal surfaces retain most of their arsenal parkerized finish with light silvering along the edges. The composite grip rates excellent. The included steel and brown leather scabbard is in similar condition. The body has light handling marks and the leather is lightly crazed yet very supple. An excellent example overall. (46528-2D)
2547. **BAYONET LOT** This lot consists of a 1924 style bayonet with scabbard that is unmarked with the exception of some Farsi numbers and a (crown) with an "X" in center on the pommel. This long export bayonet measures 21" with a 15 1/2" blade. The metal is mostly bright steel and the wood grip panels rate near excellent with a few light dings. The included steel scabbard is blued and rates excellent as well. An excellent example overall likely Belgian manufacture. (46528-2N)
2548. **ARGENTINE BAYONET LOT** This lot consists of an Argentine Model 1909 bayonet with scabbard by Weyersberg Kirschbaum & Co. The bayonet measures 20 1/2" with a 15 3/4" blade that remains bright with a few light specks of gray visible. The hooked quillon guard and pommel are more a mottled gray-brown with some light handling marks present. The wood grip panels rate near excellent and have a few light dings. The included blued steel scabbard is numbered to the bayonet and is in similar condition with a few areas of light surface oxidation. An excellent example overall. (46528-2C)

2549. **CHILEAN BAYONET LOT** This lot consists of a Chilean Model 1912/35 bayonet with scabbard by Weyersberg Kirschbaum & Co. The bayonet measures 14 3/4" long and has 9 3/4" blade. The metal is an overall darker gray, the oil stained wood grips have light dings and a few small cracks present. The included blued steel scabbard is blending to a mottled gray as well and is not numbered to match. An about very good example overall. (46528-2J)
2550. **U.S. BAYONET LOT** This lot consists of a U.S. M7 bayonet with scabbard by the Ontario Knife Co. The bayonet measures 11 3/4" long with a 6 1/2" blade. The metal surfaces are parkerized and the grip is black checkered composite. The included scabbard is a black M10 hard composite with black nylon upper. An excellent to as-new condition example overall. (46528-1A)
2551. **LOT OF TURKISH BAYONETS** This lot consists of two Turkish Model 1935 bayonets with scabbards. Each measures 14 3/4" long with a 10" blade and are in about very good condition overall. The grip markings are faint but "AS FA" can still be made out on each. The wood grip panels have minor dings and small divots. The included scabbards are different sizes but similar in style and have a few small dings as well. (46528-2I,P)
2552. **GERMAN BAYONET LOT** This Lot consists of a German 1884/98 bayonet with scabbard for the K98 series Mauser rifles by E.F. Horster. The bayonet measures 14 1/2" long with a 9" blade and has an arsenal type blue finish. The markings have been lightly polished but the "43 asw" maker's mark is still visible on the ricasso. The wood grip panels have a few light dings and handling marks as does the flash plate. The included scabbard is in similar condition and is also dated "43" but is by a different maker. A very good example overall. (46528-2G)
2553. **LOT OF BAYONETS** This lot consists of two "spike" bayonets. First is a Russian 1891/30 Mosin-Nagant socket bayonet that measures 19 3/4" long and has a 17" cruciform blade. The markings are soft and the overall condition is fair to good. The second is for the Chinese Type 56 SKS and measures 15" with an 11" cruciform style blade. The mounting screw is included and the bayonet is in excellent condition. (46528-2H,K)
2554. **U.S. BAYONET LOT** This lot consists of a U.S. Model 1873 socket bayonet with scabbard. The bayonet measures 21" with an 18" blade marked "US" on its base. The metal surfaces are mostly a mottled brown with areas of light surface oxidation and staining throughout. The steel-bodied scabbard is mottled brown and has a modern leather frog with brass "US" disc and hook style hanger. An about very good example overall. (46528-3F)
2555. **NEPALESE MUSKET BAYONET LOT** This lot consists of a British type 1839 socket bayonet with Nepalese markings. The bayonet measures 20" long with a 16" triangular blade and has Nepalese marking along the sides of the socket including a depiction of a lion. The bayonet is in very good condition and has a mottled brown patina and some light surface oxidation throughout along with some light handling marks. (46528-3A)
2556. **NEPALESE BAYONET LOT** This lot consists of an 1853 style socket bayonet with Nepalese markings on the face of the blade. The bayonet measures 20 3/4" with a 17 1/2" blade that has three small Nepalese characters on its face. The bayonet is otherwise unmarked and has a rich brown patina that is blending with areas of light surface oxidation. The edges of the blade have light handling marks and a few light nicks. An about very good example overall. (46528-3E)
2557. **ENFIELD BAYONET LOT** This lot consists of an 1853 Enfield socket bayonet with leather scabbard and frog. The bayonet measures 20 3/4" with a 17 1/2" blade and is unmarked. Bayonet has a mottled brown patina that is blending with overall light surface oxidation. The edges of the blade have light handling marks and a few light nicks; the blade has a slight bend near the base. The scabbard and frog have very light crazing but are still quite supple, perhaps newer replacements. A very good example overall. (46528-3G)
2558. **NEPALESE BAYONET LOT** This lot consists of an 1876 Martini-Henry style socket bayonet with Nepalese markings and scabbard. The bayonet measures 25" with a 22" blade and has both British and Nepalese characters near its face. The metal has a mottled gray patina and a few light nicks and other handling marks. The leather bodied scabbard has a brass throat and tip, the stitching is becoming separated. The upper brass portion has several Nepalese markings as well. A very good example overall. (46528-3B)
2559. **BRITISH BAYONET LOT** This lot consists of an 1876 Martini-Henry style socket bayonet with scabbard. The bayonet measures 25" with a 22" blade and has British markings on its face. The socket retains a good amount of blue and there are areas of scattered light surface oxidation throughout. The leather bodied scabbard has a brass throat and tip, the leather is quite faded and the tip is becoming separated. A very good example overall. (46528-3D)
2560. **U.S. BAYONET LOT** This lot consists of a U.S. Model 1821 socket bayonet. The bayonet is in about good condition and measures 20 1/2" with a 17 1/2" triangular shaped blade. The markings along the face are very faint but still partially visible and the metal surfaces are a mottled gray with areas of light pitting and staining present. A reproduction black leather scabbard is included. (46528-3C)
2561. **MACHETE LOT** This lot consists of a Corneta No. 127 machete with scabbard that was manufactured in El Salvador. The machete measures 25 1/2" long and has a 20" lightly sharpened blade. The metal surfaces have overall scattered light surface oxidation but most of the original label remains on the right side of the blade. The grip scales are made from bone and rate excellent. The included tooled leather scabbard rates excellent and has fringe adornments at each end. A very good to near excellent example overall. (46286-8)
2562. **FRENCH BAYONET LOT** This lot consists of a French Model 1886/93 Lebel bayonet with scabbard. The bayonet measures about 25" long with a 20 1/2" cruciform blade. The metal surfaces have light to minor surface oxidation and staining throughout. The silver alloy grip has a moderate tarnish as well. The scabbard has more moderate surface oxidation and staining and the throat is malformed preventing the bayonet from seating properly. An about good example overall. (46998-6)
2563. **U.S. BAYONET LOT** This lot consists of a U.S. Model 1892 Krag rifle bayonet with scabbard. The bayonet measures 16 1/4" long with a 11 1/2" bright steel "1899" dated blade with areas of light staining present. The grip steel is brown with light oxidation over much of the surfaces. The wood grip panels rate excellent. The included steel scabbard is in similar condition to the grip and is brown with light oxidation as well. The scabbard features the metal swivel hook. An about very good condition example overall. (46998-5)
2564. **LOT OF NORMA BRASS** This lot consists of 100 pieces of Norma 7.5x55 Swiss rifle brass. The brass is in excellent to as new condition with 75 being primed. The brass is housed in two green MTM R-50 cases. (45959-1)
2565. **PACHMAYR CONVERSION KIT LOT** This lot consists of a Pachmayr Dominator 308 Win conversion kit for the 1911-series pistols. The kit consists of a 12 1/2" stainless steel barrel assembly with matte black block making the overall length 14". The barrel has a bright, excellent bore and is equipped with adjustable sights. The kit appears to be complete and in its original box and includes the slide adapter, forend, slide top adapter, allen wrenches and has the owner's manual and spec sheet. An excellent condition sporting accessory that should easily install on your 1911 project frame. (45237-4) (250/450)

2566. **OPTICS LOT** This lot consists of a Charles Harvan 15-30X50mm spotting scope. The scope features a gray japanned finish with a few light handling marks on the body and excellent optics. The scope is housed in its original two-piece, blue top box and includes the tripod. An excellent example overall. (45942-6)
2567. **SHOOTERS LOT** This lot consists of a box of assorted hunting and sporting items. Included are ten blaze orange safety vests, including seven that are in their original packaging and are unopened, and three blaze orange hats - one used, size-large insulated hat with ear flaps, and three like-new ball caps. Next is a faded nylon adjustable belt with elastic loops for cartridges and a brown leather cartridge belt that appears to be a size large and has added holes for the buckle. Lastly are five wood shaft practice arrows with field tips and feather fletchings that feature painted bands and are two different lengths. All are in very good to as-new condition. (45942-1,4,5,29)
2568. **LOT OF FOUR BOOKS** This lot consists of four firearms and gunsmithing-related books. First is The Winchester Handbook by George Madis, a 287 page hardcover signed by the author and in excellent condition. Next is Professional Gunsmithing by Walter Howe, a 518 page jacketed hardcover in very good condition, the jacket has some small tears and minor foxing. Third is Rifles: A Modern Encyclopedia by Henry M. Stebbins, a 376 page jacketed hardcover in very good condition, the jacket has some small tears and minor foxing. Lastly is The Complete Encyclopedia Of The World's Firearms by Ian V. Hogg, a 320 page jacketed hardcover in near excellent condition, the jacket has some very small tears. A good assortment of firearms reference books. (45942-7,8,9,10)
2569. **LOT OF COLLECTIBLE AMMUNITION** This lot consists of 39 rounds of vintage Frankfort Arsenal 45-70 ammunition. The ammunition comes in the lower portions of their original boxes which are in poor condition and are torn with only remnants of their original labels. The rounds themselves have light tarnish and oxidation but are in overall very good condition and are housed in a sliding top wood box. (44677-15)
2570. **LOT OF TANNED DEER HIDES** This lot consist of four buckskin deer hides. Each hide has a few small holes and marks from processing, but are otherwise in very good condition. The hides are very supple and would be perfect for a leather garment project. (45942-11)
2571. **GERMAN FLAG LOT** This lot consists of a World War II vintage German flag that measures 98" X 46". The faded red flag has black swastikas on a white circular background stitched on either side and has mounting clips on the upper and lower corners on one side. The opposite side has a few newer repairs and the flag is in about good to very good condition overall. (44747-35)
2572. **REMINGTON STOCK LOT** This lot consists of a black synthetic Remington buttstock for the 12 gauge 870 shotgun. The stock is in excellent condition and features a nickel sling swivel stud and a factory Limb-Saver recoil pad. The mounting hardware is included. (45098-1)
2573. **HOLSTER RIG LOT** This lot consists of a Viking western drop-leg holster rig for a medium to smaller frame single action revolver. This brown leather rig will accommodate a revolver with up to a 5 1/2 - 6" barrel and features belt loops for 22 rimfire. The belt is a size medium and this sturdy leather rig is in excellent condition. (45098-3A)
2574. **LOT OF HOLSTERS** This lot consists of three military style leather flap holsters. First is a brown pebbled leather holster for a Swedish Model 1887 Nagant revolver. The leather is faded and lightly crazed but is in very good overall condition. The flap is marked "ING-4 / KOMP. No 5 / 3 KOMP. No". Second is a black leather holster to fit a percussion revolver. The flap has two closure holes for the closure brass stud to accommodate different revolvers, the belt loop is torn. Third is a modern left hand percussion revolver holster that has tooled crossed sabers on the flap along with some minor cracking. (45098-3B)
2575. **KNIFE LOT** This lot consists of German stag handled hunting knife by Hubertus. The knife measures 10" long with a 4" bright steel blade and has a brass cast elk on the base of the grip. The knife is in excellent condition and includes a leather sheath with brass throat and tip that have oak leaf designs. (45098-7C)
2576. **KNIFE LOT** This lot consists of a fixed blade sporting knife by Beaver U.S.A. The knife measures 11" long and has a 5 1/2" curved blade. The steel has some light oxidation and staining present but does not appear to have been sharpened. The right side of the blade has the Beaver USA logo, the left side is marked "MC CA 017". The grip features a brass guard and a curved "fish tale" style pommel and has a laminate rose-colored wood center with blue and aluminum spacers. The guard has some minor verdigris staining. The original brown leather sheath is included. An excellent example of these custom made knives that resembles the company's Cape Buffalo model knife but has softer edges on the blade with less definition but has a similar swept curve. (45098-7B)
2577. **KNIFE LOT** This lot consists of a vintage Puma White Hunter fixed blade knife with sheath. This 1960's production example measures 10 3/4" long and has a 6" bright steel, partially serrated drop point blade. Made in the 2nd quarter of 1975 as identified by the "51572" code on the guard. The blade is etched near the tip "6377" along with the Puma model information. The grip features a hand crafted and unique set of stag grips which rate excellent as well. The included leather sheath shows some light wear but is in otherwise excellent condition. An excellent example of these classic knives. (45098-7A)
2578. **KNIFE LOT** This lot consists of a Raven fantasy fighting knife by Gil Hibben. This first production run knife measures 12 1/2" long and has a 7" curved stainless steel blade. The blade is etched "Signature Edition / First Production Run / January 1993" and features Gil Hibben's signature on the right side. Also the initials "DKD" are engraved along the flat edge of the blade which is numbered "1147/3000". Knife features a black chrome guard, finger grip and pommel, the grip is wrapped in black leather and a brass wire. The original black leather sheath is included which is hand signed by Gil Hibben on the back and both are housed in the original box. An as-new example of these limited first production run knives. (45098-7D)
2579. **KNIFE LOT** This lot consists of a custom Lahaina Scrimshaw folding National Blade rigging knife. The knife measures 4 1/8" closed and has a 2 1/2" sheep's foot blade marked "The Yachtsman" and a 3" marlin spike. Each of the bone grip panels feature custom scrimshaw nautical scenes, one side featuring a whaling ship with a porpoising sperm whale in the foreground, the other a scene as viewed from a dock with ocean and mountains in the background - likely a view from the Maui shoreline. The scales are signed by the scrimshander, believed to be Alan Jackson who was an artist with Lahaina back in the 1980's. The knife comes in its original box with original care card and info. (45098-7O)
2580. **KNIFE/AXE LOT** This lot consists of a Roberts combination axe and knife. The axe measures 11" long and has a 4" long head with 2 1/2" wide face. The metal is bright steel and there are light handling marks and some small nicks along the edge of the blade. The handle is a contoured black composite in similar condition. Stowed in the handle is an all steel, one-piece 7 1/4" long fixed blade utility knife that has a 2 3/4" blade and also has a few small nicks. The knife is held in place with a locking pin located in the center of the handle. Both edges have been sharpened, but still would make a handy tool for the outdoors. (45098-7P)



2581. **LOT OF CUSTOM KNIVES** This lot consists of three custom fixed blade hunting knives with leather sheaths that appear to be handmade. The first knife measures 10" long with a Randall style 6" blade, stag horn grip and lightly tarnished brass guard. The second also measures 10" long and has a 5" blade marked "S" and "J" on either side of the ricasso. This knife also features a stag grip and has a brass guard with similar tarnish. The third measures 8 1/2" long and has a 4" blade. The knife features horn and bone grip panels that are lightly cracking and a brass pommel. All are in very good condition showing light tool marks and light verdigris. The leather sheaths are handmade and fitted to each knife. (45098-7H)
2582. **LOT OF KNIVES** This lot consists of three fixed blade hunting knives with sheaths. The first is a Muela Commando knife that measures 11" long and has a 6" blade that has been sharpened and has a serrated reversed edge. Knife features a checkered composite grip that has several handling marks with brass pins and a brass guard. Second is a Finnish Mora knife by Marttiini that measures 8" long and has 3 3/4" blade. Lastly is a G96 skinning knife that measures 9 1/2" with a 4 1/2" and has a black composite. Each comes with an appropriate sheath. (45098-7I)
2583. **LOT OF KNIVES** This lot consists of two sporting knives with sheaths. First is a vintage Western L48 series knife that measures 8" long and has a 4 1/4" blade that has been sharpened. The leather washer grip is in about good condition and has some minor wear and damage. The second is a Parker Cutlery folding push knife in near excellent condition. The knife measures 6" long with a 2 3/4" double edged blade that locks at the base of the grip. The blade swivels to the center of the grip changing the configuration from a handy utility knife to a tactical tool. The grip features giraffe bone scales which are expertly scrimshawed with island and nautical scenes. One side of the grip has a few small cracks but is signed by the artist. (45098-7N)
2584. **LOT OF KNIVES** This lot consists of two fixed blade knives. First is a 11" fighting knife with a 6 1/2" blade by Kutmaster. The fullered blade features a tanto-style grip and has a black composite military grip. The metal is a mottled gray with minor tool marks overall. The second is a German made G1 style fighting knife by York Cutlery that measures 9 1/8" long with a 5" blade and a leather washer grip. The grip has a brass guard and aluminum pommel. Both rate very good overall and do not include a sheath. (45098-7G)
2585. **LOT OF KNIVES** This lot consists of five Pakistani-made fixed blade knives. First is a 9" long hunting knife with a 4 3/4" stainless steel blade and multicolored laminate wood grip. Knife features a brass guard and has areas of light surface oxidation. Second is a 9 3/4" long hunting knife with a 5" blade and also has a multicolored laminate wood grip with brass guard and pommel. The next two are nearly identical 9" long double edged boot knives with 5" long stainless steel blades and wood grips with brass guards and pommels. Lastly is a small rendition of boot knife measuring 7 1/2" long and having a 3 1/2" double edged blade. Each knife comes in a leather or faux leather sheath and all are in very good to excellent condition. (45098-7E)
2586. **LOT OF CUSTOM KNIVES** This lot consists of two custom antler-handled fixed blade knives. The first measures 13" long and has a 7" curved carving style blade and brass guard. The second measures 11" long with a narrow 6" fillet style blade. Both are unmarked and the antler handles are slightly curved as well. A single hand-made leather sheath is included, but will only accommodate the larger of the two knives. All are in very good condition. (45098-7M)
2587. **LOT OF KNIVES** This lot consists of two German-made fixed blade sporting knives with leather sheaths. The first is by Edge Mark and measures 10 1/2" long with a 4 3/4" blade, brass guard and deer foot grip. The second is by Edge Brand and measures 7 1/4" long with a 3 1/2" up-curved blade and stag grip with aluminum guard and pommel. Both are in very good to near excellent condition and have the correct leather sheaths. (45098-7L)
2588. **LOT OF KNIVES** This lot consists of three World War II-vintage U.S. fighting knives with sheaths. First is a PAL RH 36 that measures 11" overall and has a 6" lightly sharpened blade and a leather washer grip. Second is a Cattaraugus knife measuring 10 1/2" also with a 6" blade that has been reground and a leather washer grip. Third is a USN knife by Robeson that measures 10" overall and has a 5" blade, leather washer grip and a wood pommel. One of the washers has been replaced with wound chord. All are in about very good condition and the sheaths are appropriate for the knives but may not be the originals. (45098-7F)
2589. **LOT OF KNIVES** This lot consists of five folding pocket knives. First is a larger utility knife by Metco that measures 4 3/4" closed and has eight different blades and jugged bone grips. The metal surfaces are lightly pitted and brass bolster and liners are lightly tarnished. The second is a Camper's Knife by Sabre that measures 3 3/4" closed and has three utility blades. The blades are loose and one end is becoming separated. Next is a two blade folding knife by Camco that measures 3 1/2" closed and has yellow acrylic grips, one scribed "HS". Fourth is also a two blade folding knife that measures about 3 1/2" closed and has jugged bone grips with nickel silver bolsters. Both blades have been sharpened and the smaller blade is broken. The last knife is a Browning three blade knife that measures 3 1/4" closed and has wood grips with nickel silver bolsters. The knives are all in various states of condition ranging from good to excellent and are all still serviceable. (45098-7R)
2590. **LOT OF KNIVES** This lot consists of five assorted folding knives. First is a Great American Bald Eagle Collector Knife by the Franklin Mint. Designed by Ray Beers this collectible measures 5" closed and has a 3 1/4" blade. The grip features a cast bald eagle's head with gold beak and blue stone inlaid in the right bolster. The original zippered case is included. Next is a multi-blade utility knife by Royal which measures 3 1/2" closed with red grips and ten different blades. Third is a Pakistani made folding knife measuring 5" long with a 3 1/2" heavily sharpened blade, wood grip and brass bolsters. The grips have initials carved in them. Fourth is an oversized Pakistani Wilderness II folding knife measuring 6 1/2" long closed with a 5" blade. The ricasso is marked "ROMO / P-11" and knife features wood grips with brass bolsters. Lastly is a small Victorinox three blade gentlemen's pocket knife with red grips marked "HONEYWELL" on one side. The knife measures 2 1/4" closed and includes the tweezers and tooth pick and is housed in a small brown vinyl case. All are in either good or excellent condition. (45098-7Q)
2591. **LOT OF SHARPENING STONES** This lot consists of an assortment of knife sharpening and honing stones and accessories. Included are three Eddie Bauer series stones in a wood box featuring a Hard Arkansas, Soft Arkansas and Washita, one has a chipped corner. Also included are a Buck No.136 Honemaster adapter in its original case, a brown leather stone carrying pouch and a Gerber sharpening steel in its brown leather case. All are in very good condition. (45098-7J)
2592. **SHOOTERS LOT** This lot consists of large grouping of assorted shooting related items. First is a modern Italian-made Batty peace style brass powder flask with minor tarnish and the U.S. standard of arms. Next is an assortment of leather goods including a J.C. Higgins #752 belt mount cartridge box, two brown cartridge belts and a padded sling. Third is a Hoppes bore light and two sets of adult-size ear muffs. Fourth is a small box containing five four-bladed arrow broadheads and a small container of Savora replacement blades. Fifth is a Weaver .22 Tip-Off rifle scope and an assorted grouping of lens covers. The scope features an integral mount for a grooved receiver and a crosshair reticle with very good optics, the lenses have a few light scratches. The lens covers are of various types and sizes and include a set of metal thread-on caps. Sixth is an aluminum handstop with sling swivel. Last is a set of three Mossberg-style 410 gauge choke tubes. Included are a full, modified and cylinder tube as well as a wrench. All are in very good to excellent condition. (45098-2,4,8)

2593. **BADGE LOT** This lot consists of six law enforcement type and western style badges. First is a 2" diameter round Deputy Sheriff badge made by Salt Lake Stamp which has light tarnish. Next is a round U.S. Deputy Marshal, also 2" diameter, that is marked "V.H.B." and "SPB" on the reverse side and is in as-new condition. Third is a 1 5/8" diameter round Sandy City Police badge that is not maker marked and appears to be an older vintage. The next two badges appear to be handmade and are fashioned from silver coin. The first is rudimentarily marked "ARIZONA RANGERS" and was made from a U.S. silver dollar and has no backing. The second is marked "TEXAS FANGERS Co.A" and is more fancily styled. This badge was made from a Mexican coin and is marked "GW 863" on the reverse. Lastly is a U.S. Army Military Police badge in as-new condition and in its original box. (42789-254A)
2594. **LOT OF MILITARY PHOTOGRAPHS** This is a rather interesting lot of military collectibles both from U.S. personnel and possibly those liberated from the enemy. First are two worn photo albums which contain numerous photos of family members, buildings, soldiers, countryside, and other World War II-era news clippings in various stated of condition. Next are a small collection of three brass belt buckles and British hat badge. Included are a U.S. Navy buckle with a small navy blue and gold-stripped belt attached, a British military buckle with the inscription "DIEU ET MON DROIT" surrounding the British lion over crown motif, a vintage rectangular buckle with the initials "A" & "S" and the before mentioned hat badge. The hat badge is in the shape of a flaming ordnance bomb and bears the British Royal crest. A neat collection of assorted militia. (42789-254B)
2595. **LOT OF KNIVES** This lot includes three items. First is a British Commando knife with sheath by J. Nowill & Sons of Sheffield, England. The knife measures 11 1/2" long with a 7 3/4" double edged blade. Both it and the included black leather sheath rate excellent. Next is a 9 1/2" unmarked letter opener with 5" blade, wood handle and brass guard and pommel. Lastly is a petite 9 1/2" letter opener also with a 5" blade that has a embossed leather label on the gipr marked "R.P. WIRTHS" / SPECIAL REPRESENTATIVE / DELHI, N.Y." and "SHEDD-BROWN MFG. CO. / MINNEAPOLIS / FRIENDSHIP BUILDING ADVERTISING / PATENTED UTILITY CALENDARS AND LEATHER GOOD". All are in excellent condition. (42789-254C)
2596. **ANTIQUITIES LOT** This lot consists of seven items in total. First is a small Egyptian faience amulet depicting the Egyptian god Horus. Horus was the falcon headed son of Osiris and Isis and this piece is dated and certified to be from 663-525 B.C. by Barclay Galleries. Next is a medieval era crossbow bolt head circa 1450 A.D. which measures 2 3/4" long. This iron projectile was certified by Faganarms. Next are two Native American flint arrowheads, one 2 1/2" long the other 1 3/4" long. The next two items are uniform pins, one circular button style 1" diameter with black and white "bullseye" center, the other rectangular measuring 1 5/8" by 5/8" and having a Federal eagle in center. Both are unmarked. Lastly is an 8" long cast bronze door knocker made in Belgium. The knocker features renaissance-styled characters with a male fawn's head and cherub children below, the bronze has minor tarnish. (42789-254D)
2597. **AMMUNITION LOT** This lot consists of five boxes of assorted collectible and target ammunition. First is a partial box of Peters 44-40 Winchester 200 grain soft points containing 45 rounds. The blue and yellow box has minor fraying and foxing and is missing one end flap, the ammunition has light oxidation. Next is a partial box of Remington Kleanbore Targetmaster 38 Special 148 grain wad cutter (6138) containing 33 rounds. The green box is missing one end flap and has minor fraying and a few small tears along the edges and corners, the ammunition rates excellent. Third is a blue and white box of Peters 9mm 124 grain metal case ammunition containing 36 rounds. The box has some light foxing and fraying and the ammunition rates excellent. Lastly are two boxes of Winchester USA 9mm 115 grain FMJ, one box is full with 50 rounds the other has 49 rounds. Also included is one 20mm dummy round. (42789-254E)
2598. **COLLECTIBLE AMMUNITION LOT** This lot consists of 20 modern paper cartridges for the .52 caliber Sharps. The cartridges are in very good overall condition and would make a great addition to a Civil War display. (42789-254F)
2599. **LOT OF FLASKS** This lot consists of 13 assorted powder and shot flasks. Included are seven rifle or shotgun brass powder flasks, three smaller brass pistol flasks, two zinc powder flasks and one leather shot pouch. Most have adjustable measures and various foliate and game scenes a few are plain. Many have minor damage and small, older repairs with many of the levers, springs and top caps not being functional. (42789-254G)
2600. **HOLSTER LOT** This lot consists of a Marble's Game Getter leather holster with carry strap. The leather has minor cracking and flaking and one buckle has been torn off but could possibly be repaired. An about good example overall. (45438-2A)
2601. **AMMUNITION LOT** This lot consists of two MTM cases each containing modern ammunition. First is red a R-100 series box containing 58 live rounds of Weatherby 300 Wby Mag ammunition and ten pieces of fired brass. The second is a green H-50 box containing 20 rounds of Remington 300 Win Mag 150 grain Core-Lokt PSP ammunition. All are in excellent condition. (45889-7)
2602. **BORE-SIGHTER LOT** This lot consists of an Allen Supply Co. "The Sweany" Site-A-Line Sportsman's Model bore-sighter. This precision optical sight bore-sighter comes in its original case and includes 16 different sized arbors ranging from .22 up to .45 caliber. An excellent condition example overall. (45889-6)
2603. **S&W BOX LOT** This lot consists of a vintage gold Smith & Wesson K-22 Masterpiece two-piece box. The box features a blue label and lettering and was made for a 6" barrel blued K-22 series revolver. The box is numbered "K134212" on the underside. The box has some very minor fraying and flaking and would make a terrific accessory for your K-22 needing a correct box. (45698-68)
2604. **U.S. NAVY TRAINING LOT** This lot consists of a World War II vintage USN Ship to Ship training aid by Sawyer's of Portland Oregon. The training materials are contained in their original gray two-piece box and include two view-masters with removable eye pieces and assorted training discs. The discs feature four test series (#1-4), two night studies (#1&2), and 21 German and Japanese ship studies (#1-21). All are in excellent condition and would be an interesting and amusing addition to a U.S. Navy collection. (45704-16)
2605. **GERMAN BELT LOT** This lot consists of a World War II-era German military tan canvas belt with buckle. The cast rectangular-shaped buckle has a gray/green enamel finish with some light flaking and wear present. The center features a German Eagle surrounded by the phrase "GOT MIT UNS" (God With Us). A near excellent example overall. (43765-25B11)
2606. **BAVARIAN BELT LOT** This lot consists of a World War I era leather Bavarian Army belt with brass rectangular buckle. The center of the buckle has a circular emblem with a crown in center bordered by "IN TREUE FEST" (In True Faith). The belt has some light crazing yet remains quite supple while the buckle retains a mild ochre patina and has some light handling marks. A near excellent example overall. (43765-25B3)
2607. **MUZZLELOADING LOT** This lot consists of moulds for .36 and .50 caliber muzzleloaders. Included are two sets of Thompson/Center single cavity mould handles and three sets of single cavity moulds. The moulds feature an as-new T/C Seneca .36 Cal round ball mould that is .350" and about 65 grains, two 50 caliber moulds, one round ball and one Maxi ball. All are in excellent or as-new condition. (45877-1A)

2608. **MUZZLELOADING PROJECTILE LOT** This lot consists of assorted lead and copper muzzleloader projectiles in both .36 and .50 caliber. Included are 17 Hornady .350" swaged lead round balls, an open package of Speer .350" lead round balls, a full box of 100 .350" Speer lead round balls, two packages each with 20 rounds of CVA .50 caliber 348 grain copper Power Belts, two bags of loose .490" caliber lead round balls, one box of 100 .490" lead round balls, a full box of 20 unlubricated .50 caliber 370 grain Maxi balls, a box of 50 loose .50 caliber unlubricated Maxi balls, and a full box of 20 Buffalo Bullet Co. .50 caliber 410 grain HP lead bullets. All are in excellent to as new condition. (45877-1B)
2609. **MUZZLELOADING ACCESSORY LOT** This lot consists of an assortment of muzzleloading and blackpowder accessories. Included are: a mixed bag of .50 caliber Butler Creek poly and maxi patches, a brass pistol powder measure, a brass adjustable rifle powder measure with attached pour spout, an unmarked Hawken style breech block nut, a Butler Creek Goex style powder cap/funnel, two packages of 100 Ox-Yoke .50 caliber Wonder Wads, a package of T/C .36 caliber pre-cut patches, two packages of five Blue & Gray muzzleloader Speed Shells, six .50 caliber T/C quick shot tubes, two bullet starters, one three-piece sectional cleaning rod, two flask measure adapters, a Traditions Musket nipple, a small package of .36 caliber cleaning adapters, a small package of .50 caliber cleaning adapters, three inline percussion cap-pers, three nipple wrenches, one tube of Natural Lube 1000, one container of Maxi-Lube, one container of Young Country's Lube 103 and one tube of Lyman Ideal bullet lube. All are in excellent to as-new condition. (45877-1C)
2610. **MUZZLELOADER SIGHT LOT** This lot consists of two rear sights for muzzleloading rifles. First is a brown-finished adjustable rear barrel sight to fit an octagonal barrel. Second is a Vernier Express style adjustable rear tang sight, minus its mounting screws. Both are in excellent condition. (45877-1D)
2611. **.22 CONVERSION LOT** This lot consists of a .22 LR conversion kit for the AR-15. This kit will fit any traditional .223 caliber AR-15 platform upper receivers. This unit is unmarked and does not include a magazine. (46239-3)
2612. **BLACKPOWDER LOT** This lot consists of two items. First is a modern etched powder horn that depicts American Western Cowboy scenes including a mule drawn wagon and farmhand or prospector. The horn is signed with the initials "S.T." with "his horn" etched below. Second is a vintage leather shot pouch with adjustable leather spout. The leather body features game bird scenes and has some minor crazing and cracking throughout. One side is marked "5 lbs". (45630-2,6)
2613. **LOT OF SHOT POUCHES** This lot consists of two vintage leather shot pouches with adjustable measures. The first depicts game scenes on either side and has minor flaking and light crazing overall. The second is plain but has more original finish and is marked "2 1/2 lb" on one side. (44354-14)
2614. **NJ. CARTRIDGE BOX LOT** This lot consists of a vintage Model 1874 McKeever 45-70 cartridge box with NJ National Guard plate. The black leather is still quite supple but has minor crazing and some light cracking throughout. The oval brass plate with "NJ" in center has some mild patina as do the other brass parts including the flap staples and closure tab plate with rivets. The Watervliet Arsenal marking on the reverse is faint but still visible. The canvas loops remain intact and "FJ Roos" is marked in pencil at the base of the interior. A very good example of these seemingly rare Indian War vintage cartridge boxes. (45898-30E)
2615. **CARTRIDGE BOX LOT** This lot consists of a U.S. 1874 McKeever 45-70 cartridge box with stamped "US" marking on the flap. The leather is supple but has some minor flaking along with minor crazing and light cracking to the tab and belt loops. The brass parts have a minor ochre patina and feature a circular riveted plate on the closure tab and staples on the corners of the flap. The Watervliet Arsenal marking is quite visible. The interior canvas loops are intact and there is a "23" marked on the base of the flap along with a number and pencil markings. A very good example of these rare Indian War-vintage cartridge boxes. (45898-30C)
2616. **CARTRIDGE BOX LOT** This lot consists of a Frazier's Patent cartridge box in near excellent condition. The complete leather surface of this piece shows little signs of use, with only light crazing present. The outside face of the box has a small oval brass plate with the initials "NG" for the NY National Guard done in script. The plate has a mild patina and is still anchored by the original wire pin on the inside. The brass finial and riveted catch along with the brass hinges and other parts have similar patina and some normal verdigris build up. The interior is missing the original wooden block drilled for cartridges. The body of the box has two strong stampings, the first is all the patent information and reads "FRAZIER'S PATENT FEBY. 5TH 1872 REISSUED MCH. 5TH 1878 PATENT APRIL 23RD, 1878." The second is the maker's stamp of "McKENNEY & CO. NEW YORK", the right edge is light and almost appears to be double stamped. The leather remains quite supple, the back has two excellent belt loops. This is a first rate example of a Frazier box. (45898-30D)
2617. **CARTRIDGE BOX LOT** This lot consists of a Civil War era Model 1861 flap-style cartridge box. This black leather cartridge box features an original brass oval plate with "US" in center and is in very good condition overall. The leather has some minor crazing and flaking but remains supple. The closure tab has some minor fraying while one the buckle straps has becoming separated. The brass plate and finial have a pleasing ochre patina, the rear rivets are more a bronze color. The original tin inserts are intact. There is no shoulder strap present but the belt loops remain. A great addition for a Civil War uniform display. (45898-30B)





2618. **U.S. LEATHER LOT** This lot consists of a U.S. 1872 model military belt with New Jersey militia buckle. The face of the plate has the "NJ" in the oval in the center of the buckle, the brass has some mild patina. Near the adjuster, the leather has the Rock Island Arsenal maker's mark along with "W.T.G." still visible. The belt has some minor flaking and light crazing throughout but is still quite supple. This is the pattern that was often worn by soldiers during the Indian War time frame on up through the Spanish American War. A near excellent example overall. Also included is a black leather 1861-style sling in similar condition, but has some areas of minor cracking as well. The sling has a hook style clasp and is unmarked. (45898-29)
2619. **VINTAGE POWDER FLASK LOT** This lot consists of an antique engraved powder flask made from a ram's horn. The horn has circular designs and a wood base and top. The top features a brass pour spout and there is an internal iron slide below that is missing the stopper plate. (45898-30A)
2620. **U.S. SOCKET BAYONET LOT** This lot consists of a U.S. 1816 socket bayonet that measures 19 1/4" long with a 16" partially fluted blade marked "US / TA" on the face. The metal has some areas of light pitting and staining with an overall mottled gray patina. The base of the socket is marked "16". A very good example overall. (45898-23F)
2621. **U.S. SOCKET BAYONET LOT** This lot consists of a U.S. Model 1835 socket bayonet that measures 20 1/2" with a 17 1/2" fluted blade marked "US" on the face. The metal has areas of light pitting and staining with a mottled gray appearance overall. This variation features a notched locking ring. A nice example overall. (45898-23E)
2622. **U.S. SOCKET BAYONET LOT** This lot consists of a U.S. Model 1835 socket bayonet that measures 20 1/2" with a 17 1/2" fluted blade marked "US" on the face. The metal has areas of minor pitting and staining with a mottled brown and gray appearance overall. This variation features a notched locking ring. An about very good example overall. (45898-23L)
2623. **U.S. SOCKET BAYONET LOT** This lot consists of an earlier style, non-locking ring U.S. Model 1835 socket bayonet that measures 20 1/2" long and has a 17 1/2" fluted blade marked "US" on its face. The metal has a light gray and speckled brown patina and areas of light pitting and staining scattered about. The base of the socket is marked "\*B" - the first letter is only a partial marking and could be an F or H. A near excellent example overall. (45898-23H)
2624. **U.S. SOCKET BAYONET LOT** This lot consists of a U.S. 1873 socket bayonet that measures 21" with an 18" blade marked "U.S" on the face. The metal retains some of its original blue which is mixing with areas of gray and brown and has overall scattered light surface oxidation. A very good example overall. (45898-23K)
2625. **U.S. SOCKET BAYONET LOT** This lot consists of a U.S. 1873 socket bayonet that measures 21" with an 18" blade marked "U.S" on the face and has a small "R" on the side of the socket. The metal is a mottled gray and brown and has some scattered light pitting and staining. A very good example overall. (45898-23J)
2626. **U.S. SOCKET BAYONET LOT** This lot consists of a U.S. 1862 Hewes & Phillips conversion socket bayonet for the 1816 percussion musket. The bayonet measures 21" long and has an 18" fluted blade faintly marked "U.S." on its face. The metal is mostly bright steel with some light staining and a few small pits. This model does not have a locking ring. An excellent example overall. (45898-23G)
2627. **U.S. SOCKET BAYONET LOT** This lot consists of a U.S. 1816 socket bayonet that measures 18 3/4" long with a 14 1/2" partially fluted blade marked "JN US" on the face. The metal has some areas of light pitting and oxidation with an overall rich brown patina. The cut morse has a narrow channel and appears more rudimentary than other similar examples. A very good example overall. (45898-23I)
2628. **U.S. & N.J. SOCKET BAYONET LOT** This lot consists of a U.S. Model 1873 socket bayonet with scabbard. The bayonet measures 21" long with an 18" blade marked "US" on the face and has two small punch marks, one above and one below the "US" marking. The bayonet retains most of its original blue and is mixing with areas of scattered light oxidation. The steel-bodied scabbard is more a mottled gray and has areas of light pitting. The scabbard has a leather frog with loop hanger and a "NJ" brass disc. The leather has some light crazing, and some light cracking on the backside but remains mostly supple. A near excellent example overall. (45898-23A)
2629. **U.S. SOCKET BAYONET LOT** This lot consists of a U.S. Model 1873 socket bayonet with scabbard. The bayonet measures 21" long with an 18" blade marked "US" on the face and has one small punch mark above the "US" marking. The bayonet retains nearly all of its original blue and is mixing with a few areas of scattered light oxidation. The steel-bodied scabbard has a flaking black enamel finish and has areas of light pitting. The scabbard has a leather frog with loop hanger and a "USN" brass disc. The leather has some light crazing but remains supple, the rear of the loop is marked "D / 23". A near excellent example overall. (45898-23D)
2630. **U.S. SOCKET BAYONET LOT** This lot consists of a U.S. Model 1873 socket bayonet with scabbard. The bayonet measures 21" long with an 18" blade marked "US" on the face and has one small punch mark above the "US" marking. The bayonet retains nearly all of its original blue and is mixing with a few areas of scattered light oxidation. The steel-bodied scabbard has much of its original blue that is fading to gray and has areas light handling wear and a few small dents. The scabbard has a leather frog with loop hanger and a "US" brass disc. The leather has some light crazing but remains supple. A near excellent example overall. (45898-23B)
2631. **U.S. SOCKET BAYONET LOT** This lot consists of a U.S. Model 1873 socket bayonet with scabbard. The bayonet measures 21" long with an 18" blade marked "U.S" on the face. The bayonet retains most of its original blue, the socket is fading to gray and has a few light handling marks. The steel-bodied scabbard has much of the original blue which is fading to gray and has some light handling wear. The scabbard has a leather frog with brass hook hanger and a "US" brass disc. The leather is fading to brown and remains supple. An excellent example overall. (45898-23C)
2632. **LOT OF MUZZLE BLAST PERIODICALS** This lot consists of a red binder filled with a collection of about 25 assorted volumes of the muzzleloading publication Muzzle Blasts. These paperback publications range from December of 1961 - May of 1981. A must-have for the serious blackpowder shooting enthusiast. (41846-16)
2633. **WEAVER SCOPE LOT** This lot consists of a Weaver K4 4X rifle scope. The scope includes a set of Parker-Hale roll-off rings to fit a grooved receiver and features a fine crosshair reticle and has very good optics. A near excellent condition example overall. (47022-142A)
2634. **ROSSI LOT** This lot consists of two factory accessories for a Rossi Model 518 revolver. Included are a blue factory box and a set of checkered wood grips. The grips are in as-new condition and include the grip screw, the box has minor flaking along the edges and corners. (47033-3)

2635. **MADSEN LOT** This lot consists of three Madsen 30 round magazines. The magazines have a flaking green finish exposing the brass underneath. The steel parts have areas of minor oxidation. The magazines are unmarked with the exception of "30" stamped in the spine and are not marked for a specific caliber. The Madsen was offered in a variety of calibers for dozens of countries and these magazines will accommodate the larger 30-06 and 8mm Mauser cartridges. (47073-9A)
2636. **MADSEN LOT** This lot consists of three Madsen 30 round magazines. The magazines have a flaking green finish exposing the brass underneath. The steel parts have areas of minor oxidation. The magazines are unmarked with the exception of "30" stamped in the spine and are not marked for a specific caliber. The Madsen was offered in a variety of calibers for dozens of countries and these magazines will accommodate the larger 30-06 and 8mm Mauser cartridges. (47073-9B)
2637. **MADSEN LOT** This lot consists of four Madsen 30 round magazines. The magazines have a flaking green finish exposing the brass underneath. The steel parts have areas of minor oxidation. The magazines are unmarked with the exception of "30" stamped in the spine and are not marked for a specific caliber. The Madsen was offered in a variety of calibers for dozens of countries and these magazines will accommodate the larger 30-06 and 8mm Mauser cartridges. (47073-9C)
2638. **MADSEN LOT** This lot consists of three Madsen 30 round magazines. The magazines have a flaking green finish exposing the brass underneath. Some of the steel parts have areas of minor oxidation. The magazines are unmarked and are not marked for a specific caliber. The Madsen was offered in a variety of calibers for dozens of countries and these magazines will accommodate the 6.5x55 and similar cartridges. (47073-9D)
2639. **STOCK LOT** This lot consists of a FN BAR D buttstock in about very good condition. The metal surfaces rate excellent and have minor flaking and light handling wear throughout. The wood has several light dings and other handling marks, and has a minor crack on the left side. (46247-16)
2640. **AMMUNITION LOT** This lot consists of an assortment of U.S. 30 Carbine military ball ammunition. Included are two sealed boxes of 50 and two bandoleers with rounds loaded onto stripper clips. The boxes have torn edges and corners and are sealed with tape but appear to be full. One bandoleer is complete with 120 rounds, the other is partial and has about 75 rounds. All appear to be in excellent condition overall. (46757-5)



2641

2641. **REMINGTON NO. 4 ROLLING BLOCK TAKEDOWN RIFLE** serial #331151, 25-10 RF, 22" barrel with a bright excellent bore. The barrel, hammer and breech block retain 95% original blue finish with faint pinprick oxidation evenly dispersed along the barrel and silvering at the muzzle as well as some light handling marks. There is some operational loss on the block and hammer from the years. The frame retains 85% original vibrant case-hardened coloring with the balance toned to pewter. The plain straight grip walnut buttstock and forend rate about excellent with some added finish and light dings and scratches present throughout. A very nice example of a No. 4 takedown rolling block rifle. (156851-24) {C&R} (300/500)

2642. **SCOPE LOT** This lot consists of a Weaver V4.5-W 1.5-4.5x scope with very good squared, Germanic optics. The scope features a post and crosshair reticle and the scope body is in near excellent condition overall with some minor ring marks from previous mounting. The objective lens is 25mm in diameter and does not have a bell and the overall length is 10 1/2". A very good scope overall. (156519-535A)
2643. **SCOPE LOT** This lot consists of a Weatherby Premier 3-9x40mm scope with bright excellent squared optics. The scope features a duplex reticle and the scope body is in excellent condition overall with a total length of 12 1/2". (156520-1792A)
2644. **UNERTL 1 1/2" TARGET SCOPE** serial #41223, 20X, 25 1/2" overall length with a 3/4" tube. The scope retains about 80-85% original blue with some fading and operational wear present as well as some faint oxidation staining. The scope is equipped with a fine crosshair reticle, clear optics, a front target mount (the rear is missing) and a recoil spring with stop. (156519-261P)
2645. **J.W. FECKER 1" TARGET SCOPE** serial #2961, 22 1/4" overall length with a 3/4" tube. The scope retains about 90% original blue finish with some ring wear present and some light scratches. This scope is equipped with a fine crosshair reticle, clear high power optics and front and rear target mounts. (156519-261R)
2646. **GUN CASE LOT** This lot consists of two long gun cases. First is a black plastic Woodstream case with several scratches and handling marks present. The interior is lined with egg crate foam on both sides. There are three latches and two holes for potential locking. Second is an unmarked aluminum hard case with some light scratches and dings present with two locking latches, one of which is still currently locked. Also the handle is no longer present. (156600-10)
2647. **KNIFE LOT** This lot consists of 3 items. First is an Old Timer 3-blade pocket knife in very good overall condition with deep purple Delrin grips toning to white around the edges and light oxidation on the blades. Second is a Frontier Lock-Back stainless folding pocket knife in near excellent condition featuring a drop point blade and black plastic grips which show some wear and have now turned to a mottled gray-black. Third is a 3 knife set of Winchester 2005 Limited Edition folding knives in like new condition overall. Each knife features faux mother-of-pearl grips and come with a Winchester tin with red velour lining. (156600-2A)
2648. **KNIFE LOT** This lot consists of 3 items. First is an Alaskan Ulu knife in excellent condition overall featuring a wooden handle and an image of a wolf on the blade with mountains in the backdrop and "ALASKA" underneath. Second is a Schrade Scrimshaw drop point knife in very good overall condition with brass ends and white faux ivory grips with a sow and cub image on left grip. Last is a G96 Brand Model 960 drop point knife in very good overall condition with some minor tarnishing on the brass ends and light handling marks on the wood grips. (156600-2B)
2649. **NAHC KNIFE LOT** This lot consists of 3 North American Hunting Club knives. First is a Camillus folding knife in excellent condition with NAHC medallion in the wood grip and "North American Hunting Club / Life Member" printed on the blade with original box and paperwork. Second is a Schrade two-blade folding pocket knife in near excellent condition as well with some light tarnishing on the brass ends. The NAHC medallion is embedded in the wood grip and blades are marked "North American Hunting Club" and "Official Member", all within the original NAHC two-piece walnut box with green velour inside lining. Last is a 15th Anniversary NAHC commemorative knife with gut hook and gold NAHC medallion in left side of the burnt orange/white stag handles and brass ends, all of which rate excellent. Included is the original wood box with red velour inside lining and paperwork. (156600-2C)

2650. **KNIFE LOT** This lot consists of 3 fixed-blade knives. First is a Browning Model 512 Bowie knife in excellent condition overall with a 7 1/4" blade and an overall length of 12" with original Browning black nylon sheath. Second is a Buck 119 Hunting knife in excellent condition overall with a 6" blade and an overall length of 10 1/4" with a black leather Buck sheath. Lastly is a Winchester drop point knife in excellent condition with a blade length of 3 1/2" with and overall length of 8". Featured are a rosewood handle and a black nylon Winchester sheath. (156600-2D)
2651. **KNIFE LOT** This lot consists of a Westmark 702 fixed-blade bowie-style knife in near excellent condition overall. The blade is 5" with an overall length of 9 1/2". There is some light tarnishing and faint remnants of verdigris on the brass guard as well as some light scratches and handling marks on the wood grips and aluminum pommel. Included is a Westmark brown leather sheath in very good condition with light verdigris inside the sheath and light scratches and wear in the leather. A nice Westmark 702 knife overall. (156600-2E)
2652. **MOUNTAIN LION SKULL MOUNT** This lot consists of a mountain lion skull that has been mounted to a 7 1/2" x 12 1/2" walnut plaque. The skull has toned to an aged bone yellow with some bleached white areas left and is in excellent condition overall. The skull roughly measures 8 1/4" long and 6 1/4" wide, giving it an overall score of 14 1/2, which would qualify it as a Boone & Crockett mountain lion. A nice piece to add to one's house for decoration or any hunter's game room. (156161-33)
2653. **LOT OF AMMUNITION** Consists of three boxes of 38-40 Winchester. All three boxes are Winchester Western 38-40 Win., 180 gr. soft point lead. One box has 48 full rounds with two empty casings, the second box has 49 full rounds with one empty casing and the last box contains all 50 rounds. (156600-9AA)
2654. **LOT OF AMMUNITION** Consists of three boxes of 9mm Luger. The first two are full 50 round boxes of American Eagle 9mm, 115 grain FMJ; the third box is a full 50 round box of Winchester 9mm, 115 grain FMJ. All three boxes are in excellent condition. (156600-9AB)
2655. **LOT OF AMMUNITION** Consists of three boxes total. First is a full 50 round box of American Eagle 380 ACP, 95 grain FMJ; second is a full 50 round box of Independence 380 ACP, 90 grain FMJ. The last box is a full 50 round box of Winchester Super-X 25 ACP, 50 grain, FMJ. (156600-9AC)
2656. **LOT OF AMMUNITION** Consists of 4 boxes of 30-30 Win. First is a partial 20 round box of Remington Core-Lokt 30-30 Win, 150 grain soft point with 6 full rounds and 14 casings. Second is a full 20 round box of Federal Hi-Power 30-30 Win, 170 grain soft point. The last two boxes are both full 20 round boxes of Winchester Super-X 30-30 Win, 170 grain power-point (soft point). (156600-9AD)
2657. **LOT OF VINTAGE BELT BUCKLES** Consists of 4 metal belt buckles. First is a Zee Series cattle drive gray oval buckle by ADM in excellent condition overall. Second is a Wells Fargo & Co. square brass buckle with stagecoach scene and "\*\*\*SINCE 1852\*\*" underneath in very good condition overall with some very light tarnishing present. Third is a square brass Colt Army Model 44 cal. 1860 buckle with a Colt 1860 Army revolver on the top left corner and a scene of soldiers fighting in the bottom right corner; there is some mild tarnishing present. Lastly is a Raintree buckle of a 3-D whitetail buck with a brown leather background, surrounded by a brass border in excellent overall condition. (156600-2A)
2658. **NORTH AMERICAN HUNTING CLUB BELT BUCKLE LOT** Consists of three NAHC belt buckles. First is an oval brass buckle of an eagle with American flag backdrop surrounded by foliate scroll with "25th Anniversary / 1978-2003" underneath in excellent condition overall. Second is an identical buckle with the exception of the anniversary date being "20th Anniversary / 1978-1998" in very good condition overall with some of the brass toning to a dark gold-brown and some light tarnishing. Lastly is a NAHC Wings of Gold buckle with a silver background with 24 Karat gold plating on the title, borders and image of flying eagle with rifle and bow clutched in its talons. This buckle is in excellent condition and comes with a blue pleather case with blue velour interior. (156600-2B)
2659. **RELOADING KIT LOT** This lot consists of a Lee Loader Complete Reloading Tool kit for reloading 45-70 Gov't. Featured are a flaring crimper, shell head alignment chamber, sizing die, bullet seater assembly, priming tool, primer cleaner, decapper and powder measure. Also included is the original box and paperwork. (156600-2C)
2660. **LOT OF SMITH & WESSON GRIPS** Consists of four pairs of grips, all with Smith & Wesson medallions present. Two of the pairs are K-frame checkered walnut grips and both rate excellent overall with a few light handling marks. The third pair is a set of K frame target Goncalo Alves grips with the wrong sized screw in excellent condition as well. Last is a set of N frame checkered walnut grips in excellent condition with some light handling marks present. (156600-2D)
2661. **ARTILLERY CLINOMETER LOT** Included is a German Simson & Co. Suhl brass artillery clinometer with intact bubble that rates very good overall with some speckled tarnishing on the brass and surface oxidation on the metal tube and adjustment knobs. The mechanism still appropriately functions and locks tightly when desired. A neat collectible item for those with an interest in German militaria. (156600-2E)
2662. **MISCELLANEOUS LOT** Consists of seven items total. The first two are Outers 3-piece cleaning rods in black hard cases, one for a 20 ga. and the other for 22 cal. Both cases include patch holder ends. Third is a silver pocket compass with folding cover that still functions properly. The next two items are a Kreisler butane lighter with the words "Orange-Irish / Bastard" on the front and a Flame X Catalina F.H.S. butane lighter with a 4 point star on the front; the flint no longer makes a spark on either lighter. The last two items are small wooden containers; one is a Winchester 22 LR ammunition box with removable lid and the other box is a half-circular box with hinged lid which is marked "B. Lloyd Barnesville, Ga." in black paint. (156600-2F)
2663. **AMMUNITION LOT** Consists of three items total. First is a full 50 round box of steel cased Russian Klimovsk 22 LR, plated round nose in excellent condition overall. Second is a partial 26 round box of Savage SISK 22 cal., 70 grain soft point reloading bullet heads in excellent condition overall. Third is a full 50 round box of Canadian Industries Limited Canuck 25 Stevens Long, 65 grain lead nose bullets. (156600-2G)
2664. **AMMUNITION LOT** Consists of three items. First is a full 20 round box of Winchester Super-X 222 Rem, 50 grain pointed soft point bullets in excellent overall condition. Second is a full 20 round box of Remington Kleanbore Hi-Speed 222 Rem, 50 grain soft point bullets in very good condition with some wear on all sides and edges of the box. Last is a box of Marlin double edge blades which includes 12 blades with paper wrappings as well as 12 Pal Hollow Ground double edge blades with paper wrappings as well. Some of the blades show light surface oxidation present. (156600-2H)
2665. **AMMUNITION LOT** Consists of three items. First is a full 20 round box of Remington High Velocity 38 Special, 140 grain Multiball load (two 70 grain 000 buckshot rounds) in excellent condition overall. Second is a partial box consisting of 39 rounds of Winchester Super-X 38 Special, 110 grain Silvertip H.P. in very good condition overall with some light verdigris on some of the casings. Last is a partial box consisting of 44 rounds of American Eagle 357 Mag, 158 grain jacketed soft point. (156600-2I)



2666. **HOLSTER LOT** Consists of four holsters. First is an AA & E Leathercraft right handed leather hip holster for a long barreled revolver in excellent condition overall with some light verdigris on the snap and a scene of an eagle flying with a ribbon in its mouth stating "THE RIGHT TO KEEP / AND BEAR ARMS / SECOND AMENDMENT". Second is a Bianchi inside-the-waistband leather holster marked "6X / Beretta M84" in very good condition overall with some light wear. Third is a black leather Smith & Wesson hip holster marked "B21 80" in near excellent condition overall with some light wear marks and a small amount of verdigris on the snap. Last is a Rocky Mountain leather hip holster for single action revolvers marked "4-14 6 1/2" with leg tie and hammer loop in near excellent condition overall with some light wear marks and verdigris on the snaps. (156600-2J)
2667. **COLLECTIBLE AMMUNITION** Lot Consists of two items. First is a single full 20 round box of Oliver F. Winchester 38-55 Win, 255 grain soft point in near excellent condition overall. Second is a full 20 round box of Winchester Legendary Frontiersmen 38-55 Win, 255 grain soft point in near excellent condition as well. (156600-2K)
2668. **LEATHER BELT LOT** Consists of two items. First is a leather holster belt with 20 cartridge loops with remnants of corroded lead within some of the loops and some wear in the leather; the brass buckle has started to lightly tarnish and the only markings on the belt are "4-51 38/357 cal. med". The second belt is an unmarked leather belt which rates very good with some wear and verdigris on the metal with silver studs spaced evenly along the center of the leather with x-style designs throughout. Also featured is a Siskiyou Buckle Co. pewter buckle in excellent condition with a scene of a homestead with a flying duck on the bottom surrounded by maple leaves which are colored in yellow, orange and red. (156600-2L)
2669. **HOLSTER LOT** Consists of two holsters. First is a black leather German P.08 Luger holster by Egleunerg Bautzen in near excellent condition overall with some light wear from the years. This holster is dated 1941 and includes the takedown tool in its respective pouch. Second is a tan leather Walther P38 holster with mag pouch in good condition overall with some mildew staining in the leather from poor storage and verdigris on the metal. There are some words on the inside of the flap at the top right corner in red lettering but are not legible. (156600-2M)
2670. **REMINGTON NO. 6 ROLLING BLOCK RIFLE** serial #S341995, 22 LR, 20" barrel with a bright excellent bore. The barrel retains 75-80% original blue with some sparse scattered thinning and handling marks as well as a dime-sized patch of light pitting on the left side of the barrel just in front of the forend. The frame, block and hammer exhibit bold case-hardened color almost entirely throughout and show some fine scratches. The plain straight grip walnut stock and forend rate near excellent overall displaying a 1 1/4" repaired crack on the right side of the wrist and some lightly added finish, however the wood is still proud of the metal. Featured are the original blade front sight, v-notch rear sight and folding peep sight on the tang. A very nice example of a No. 6 rolling block overall. (156851-21) {C&R} (200/400)



2671. **REMINGTON NO. 4 ROLLING BLOCK TAKEDOWN RIFLE** serial #344647, 25-10 RF, 22" barrel with a bright near excellent bore with exception of a small patch of pinprick pitting about 4-5" from the muzzle. The barrel retains 98% original blue with a few light handling marks present and very light thinning at the muzzle. The case-hardened frame retains about 85-90% vibrant color with the balance toning to pewter. The plain straight grip walnut buttstock and forend rate very good showing some added finish in select areas and thinning in others as well as some dings and dents present; the buttstock is loosely fit to the frame and shows nice fiddleback all the way through. Featured are standard front blade sight with silver bead and rear sporting sight. A truly fine example of a Remington No. 4 rolling block rifle. (156851-18) {C&R} (300/500)

2672. **WINCHESTER MODEL 94 LEVER ACTION CARBINE** serial #3043255, 32 Win, 20" barrel with a bright excellent bore. The metal surfaces retain 95-97% original high polish blue finish with silvering at the muzzle and high edges, faint scratches and some tiny specks of scattered oxidation staining. The lever and hammer show some minor operational loss and the lever has some light surface oxidation specks. The plain straight grip walnut buttstock and forend rate near excellent with some light handling marks present and thinning finish along the toe-line. A very good example overall. (156892-6) (200/400)
2673. **BARREL LOT** Consists of a 20" 12 ga. Ithaca Deerslayer Model 37 rifled shotgun barrel with an excellent bore. The barrel retains 98-99% original blue finish with a few light scratches and very faint surface oxidation at the muzzle; there is a small patch of surface oxidation on the leading edge of the front sight. Featured is a red fiber optic front blade sight and there is currently no rear sight however the dovetailed base is affixed to the barrel. A very nice Model 37 Deerslayer barrel overall. (156758-58A)
2674. **WINCHESTER MODEL 75 TARGET BOLT ACTION RIFLE** serial #80188, 22 LR, 28" barrel with a bright excellent bore. The metal surfaces retain 98% original blue finish with some light surface oxidation present, primarily on the bolt handle. The plain walnut pistolgrip stock with target forend and accessory rail rates excellent overall with some light dings and dents; the checkered steel buttplate shows some moderate surface oxidation. Featured are a Lyman 77 globe sight and a Redfield rear aperture sight. An excellent Model 75 Target bolt action rifle. (156869-12) {C&R} (350/550)
2675. **SAVAGE ANSCHUTZ MODEL 141M BOLT ACTION RIFLE** serial #538971, 22 Mag, 22" barrel with a bright excellent bore. The metal surfaces retain 99% original blue finish with a couple of minor blemishes here or there. The pistolgrip Monte Carlo walnut stock rates near excellent overall, as refinished, with some light dings and handling marks and features skipline checkering on the wrist and forend, flared left side cheekpiece and rosewood forend tip. Included is a single factory magazine. A nice Savage Anschutz Model 141M that would surely perform as well as it looks. (156520-520) [Richard "Stretch" Kennedy Collection] (300/500)
2676. **WINCHESTER MODEL 50 SEMI-AUTO SHOTGUN** serial #153885A, 12 ga, 28" plain barrel choked modified with a bright excellent bore. The metal surfaces retain 99% original blue finish with a few very faint scratches present. The checkered walnut pistolgrip buttstock and forend rate excellent overall with a few minor dings and dents. A like-new Model 50 overall. (156520-1868) {C&R} [Richard "Stretch" Kennedy Collection] (400/600)
2677. **GUN PARTS LOT** This lot consists of several miscellaneous gun parts and accessories all within a clear plastic Flambeau Infinite Divider System box. Items include: several filler screws, plastic triggerlock, 3 pairs pf wooden 1911 grips, Walther P22 parts and grips, six sporting rear sights, a pair of tip-off rings and a pair of 1" rings, multiple front blade sights, set of front/rear sights for a high-wall 45-70, 22 round partial box of Remington Kleanbore 30 Luger, 93 grain, FMJ ammunition, assorted rear aperture sights, slings swivels of various widths and a steel smooth buttplate. (156600-2N)

2678. **LOT OF AMMUNITION** Consists of three boxes. First is a partial 16 round box of Winchester Super-X 303 Savage, 190 grain Silvertip in excellent condition with the four spent casings included. Second is a partial box of 9 rounds of 303 British, marked "RP", contained within an Old Western Scrounger Inc. 303 Savage box. Last is a full 20 round box of 303 British, also marked "RP", within another Old Western Scrounger Inc. 303 Savage box. (156600-13A)
2679. **LOT OF CROSSBOW BOLTS** Consists of a dozen crossbow bolts in like-new condition. Seven of the bolts have tan fiberglass shafts with yellow fletchings and the remaining five have gold aluminum shafts with blue fletchings. All of the bolts have field points and are fitted in a cardboard box. (156600-3C)
2680. **BOAR SHOULDER MOUNT** This lot consists of a shoulder mount of a wild boar in good condition overall. The boar extends 22" from the walnut shield-shaped plaque with dimensions of 16" by 21" at its widest points. The black hair has thinned in some areas and the black paint on the nose and jawline are flaking. This boar is missing the tip of its lower right tusk and the remainder is split down the middle and is removable; the left tusk is 2 1/8" in length. A visible 8" seam is present along the lower left edge of the chest. A good wall hanger for the game room of any hunter with an interest in wild hogs. (156161-22)
2681. **BRITISH SIDE LEVER DOUBLE HAMMERGUN BY J.P. CLABROUGH & BROS** serial #1421, 12 ga, 30" damascus barrels choked modified with bright very good bores with light pitting throughout. The barrels have toned to a pleasing brown patina with damascus patterning present as well as light handling marks and light fading in small spots. The frame, hammers, side lever and triggerguard are nicely engraved with loose foliate scroll and have all toned to mottled pewter with scattered oxidation staining present; the only finish remaining is a strong amount of fire blue on belly of the frame. The pistolgrip walnut buttstock and original splinter forend rate near very good overall with dings and dents from the years. The buttstock is an amateurish replacement and is slightly concave on the left side with some spots beneath the metal. The length of pull from the front trigger to the steel buttplate is 14 1/2" with drops of 1 3/4" and 2 3/4". (156578-25) (100/200)
2682. **BRITISH PERCUSSION DOUBLE SHOTGUN BY W.P. JONES** 12 ga, 30" barrels choked cylinder with good to near very good bores with light oxidation present. The damascus barrels have toned to an even plum brown patina throughout; the words "Fine Twist" are present on the rib. The hammers, locks, tangs and triggerguard have toned to a similar plum brown; the locks display nicely engraved upland fowl on both sides and the triggerguard exhibits the side profile of a bird dog's face, all of which is surrounded by loose foliate scroll. The checkered straight grip walnut buttstock rates good to near very good, as refinished, with several dings and dents present as well as some rust staining behind the fences and around the edge of the steel buttplate. There is a small 1/4" crack at the rear edge of the left lock, both locks show minor chipping around their edges. The length of pull to the buttplate is 14 1/2" with drops of 1 3/4" and 2 1/2". A wooden ramrod is present. A good to near very good example of a W.P. Jones percussion double shotgun that would make for a great wall hanger. (156759-26) {ANTIQUE} (100/200)
2683. **UNMARKED FULL CONTEMPORARY STOCK FLINTLOCK RIFLE** 54 cal, 31" barrel with a very good to near excellent bore with some light surface oxidation at the muzzle. The barrel, lock, hammer, frizzen and spring have all been cleaned and are bright gunmetal gray with some very faint tarnishing beginning to start on the barrel; there is no triggerguard present. The smooth straight grip custom walnut stock rates excellent overall with a semi-elaborate silver toned heart shaped monogram plate atop the wrist with a grotesque face and flourished bottom; the sideplate is a decorative floral design. Also featured is a patchbox along the right side of the buttstock. There is no ramrod present with this rifle. An interesting custom flintlock rifle that, with a few additions, could be a great shooter. (156759-14) {ANTIQUE} (150/250)
2684. **PENNSYLVANIA FULL STOCK SPORTING PERCUSSION RIFLE** 44 cal, 36" octagonal barrel with a fair bore with even surface oxidation. The barrel, lockplate, hammer and upper tang have toned to an even plum brown patina with some faded scroll engraving present on the hammer and lockplate; the lockplate is faintly marked "US / HARRISBURG". The triggerguard is a brass fancy type with finger spurs and has toned to an ochre patina with some light dings present. A brass pendulum style patch box is present on the right side of the buttstock; there are several brass monograms of crescent moons and hearts along the stock as well as a brass buttplate. The plain walnut stock with full length forend rates good overall with the forend being split vertically into two-pieces about halfway down the barrel and has been amateurishly repaired; the leading half of the forend is split horizontally on both sides. Featured is a squared left side cheekpiece. There are several cracks and chips present around the iron and the toe has been repaired. An extended length ramrod is present. Overall a good example of a Pennsylvania percussion rifle that is in need of a new stock but would make for a good wall hanger or decorative piece. (156815-16) {ANTIQUE} (100/200)
2685. **HOPKINS & ALLEN UNDERHAMMER PERCUSSION RIFLE** 45 cal, 32" barrel with a good, partially oxidized bore. The barrel, frame, hammer and triggerguard have toned to mottled pewter brown with patches of oxidation staining present and light scratches. An in-the-white metal collar is surrounding the wrist of the stock and is part of a repair. The plain straight grip walnut buttstock rates about very good with a 1" by 3/4" chip abutting the metal collar and several dings and dents present. Featured are a Lyman globe front sight, empty rear slot and a rear receiver sight. Overall an interestingly modified Hopkins & Allen underhammer rifle. (156688-3) {ANTIQUE} (150/250)
2686. **BRITISH PERCUSSION DOUBLE HAMMERGUN BY W. & C. SCOTT & SONS** 12 ga, 30" matted rib barrels, one choked cylinder and the other unchoked, with good bores showing light oxidation staining. The damascus barrels have toned to an even plum brown patina with no patterning remaining and scattered light pitting; the top of the rib is engraved "LONDON FINE TWIST". The lockplates, hammers, tangs and triggerguard have all toned to a mottled pewter-brown patina with loose foliate scroll engraving present and remnants of light pitting. The checkered straight grip walnut buttstock rates good to near very good overall showing added finish and several dings and dents; a 3/4" crack is emanating from the left side of the tang. The wood shows some moderate rust staining around the triggerguard, upper tang and buttplate; the toeline features a small circular cap box and what is likely the original ramrod is included. An honest W. & C. Scott & Sons double hammer percussion shotgun. (156759-69) {ANTIQUE} (300/500)
2687. **UNMARKED HALF STOCK PERCUSSION SPORTING RIFLE** 52 cal, 39" octagonal barrel with a good bore with light oxidation staining. The barrel, hammer and Joseph Golcher lock have all toned to a gunmetal gray with patches of brown oxidation staining present as well as some light handling marks. The brass triggerguard is a fancy type with finger spur and has toned to a dark ochre patina, as has the brass buttplate and sideplate. The plain walnut buttstock rates very good overall, as refinished, with scattered dings and dents from the years as well as a 5" crack running parallel to the top right edge of the forend; there are two parallelogram-shaped repairs above the painted brass forend plate on the right side. Featured are dual-acting double set triggers and a wooden ramrod. (156759-70) {ANTIQUE} (200/400)

2688. **UNMARKED HALF STOCK PERCUSSION FOWLER** 14 ga, 42" barrel with a good to near very good, evenly oxidized bore. The barrel, lock and hammer have toned to a mottled pewter-brown patina overall with some light remnants of pitting and several handling marks. The brass triggerguard with finger spur, buttplate and sideplate have all toned to a dark ochre patina with some scattered dings; the buttplate shows some mild verdigris and surface oxidation at the screwheads. The checkered straight grip walnut buttstock rates about very good overall with a couple of small cracks on either side of the buttplate and a 1" crack at the toe as well as some handling marks and repair on the wrist just behind the hammer. A wooden ramrod is included. (156759-63) {ANTIQUÉ} (150/250)
2689. **UNMARKED PERCUSSION HALF STOCK SPORTING RIFLE** 50 cal, 37" part round, part octagon barrel with a good, evenly oxidized bore. The barrel, "W. Parker" lock and hammer have all toned to a plum brown patina throughout with some fading to pewter in a few areas and some light oxidation staining present; the hammer and lock show nice simple floral engraving. The brass triggerguard, buttplate and fancy patchbox have all toned to a dark ochre patina. The checkered straight grip walnut stock rates good to near very good and features a flared left-side cheekpiece with shadowline and German silver recumbent stag plate centered on the cheekpiece. There are several dings and handling marks present and the left high edge of the comb, just behind the cheekpiece, shows some black residue. Featured are a globe front sight, adjustable rear sight and a fixed peep sight at the tang; what is likely the original ramrod is present. (156623-29) {ANTIQUÉ} (200/400)
2690. **NEW YORK STATE PERCUSSION HALF STOCK SPORTING RIFLE BY CASWELL** 45 cal, 34" octagonal barrel with a bright very good bore with some light oxidation towards the muzzle. The barrel has toned to a plum brown patina with several areas thinning to pewter; the barrel flat is marked "C. C. Caswell Albany" with loose foliate engraving trailing the words all the way to the two gold barrel bands at the breech end of the barrel and a small amount of engraving at the muzzle end. The lock, marked "S CLARK / EXTRA", and hammer have toned to a similar patina as the barrel with light engraving present as well. The brass triggerguard, buttplate, forend tip and patchbox have all been neatly engraved and have toned to a dark ochre patina. The straight grip checkered walnut buttstock rates good, as refinished, with remnants of a bubbly finish, scattered dings and dents, a crack surrounding the entire wrist and another that wraps around breech-area of the stock; there is some flex in the stock. Featured are a globe front sight, adjustable rear notch sight and a rear aperture sight on the tang. A brass-tipped ramrod is included. A good example overall that, with a new stock, could be a nice presentation piece. (156623-44) {ANTIQUÉ} (150/250)
2691. **SPANGLE HALF STOCK PERCUSSION SPORTING RIFLE** 36 cal, 36" octagonal barrel with a good, evenly oxidized bore. The barrel, lock and hammer have all toned to a dark mottled pewter-brown patina, the barrel flat is hand engraved "SPANGLE", with remnants of pitting throughout. The brass triggerguard with finger spur, patchbox, buttplate, sideplate and star cheekpiece plate have toned to a dark ochre patina. The walnut buttstock with dark fiddleback and scant squared left-side cheekpiece rates good to near very good, as refinished, with several dings and dents as well as a few small repairs at the top of the lock on either side of the hammer and a few light striations of white enamel on left side of the wrist and forend. Featured are an extended wooden ramrod and dual-action double set triggers. A good to near very good Spangle half stock percussion rifle. (156623-43) {ANTIQUÉ} (150/250)
2692. **BRAZILIAN OVER UNDER SHOTGUN BY BOITO** serial #00072, 20 ga, 28" ventilated rib barrels choked improved modified and full with bright excellent bores. The metal surfaces retain 97% original blue finish with some light surface oxidation on the barrels; the lever has toned to a plum color. The high gloss, checkered pistolgrip walnut buttstock and forend rate excellent with some light handling marks present; the black plastic buttplate is slightly larger than the wood. An excellent example overall. (156363-9) (150/250)
2693. **STEVENS MODEL 311A BOXLOCK DOUBLE SHOTGUN** 12 ga, 28" matted rib barrels choked improved modified and full with bright excellent bores. The barrels, lever and triggerguard retain 98-99% original blue with a few light handling marks. The frame and tangs retain 99% original case-hardened color exhibiting bright and vivid color throughout. The plain pistolgrip hardwood buttstock and forend rate very good overall with a 1/2" chip at the bottom of the grip and several dings and dents. The length of pull to the black plastic buttplate is 14" with drops of 1 1/2" and 2 3/4". Overall a near excellent example of a Stevens Model 311A. (156453-22) (150/250)
2694. **AMERICAN GUN CO. KNICKERBOCKER SIDELOCK DOUBLE SHOTGUN** serial #66942, 12 ga, 30" matted rib barrels both choked full with bright excellent bores. The barrels and triggerguard retain 85% original thinning blue with scattered oxidation staining present. The frame, sideplates and lever show vibrant case coloring, retaining about 80%, with the balance toned to bright gunmetal gray with light oxidation staining. The checkered pistolgrip walnut buttstock and checkered splinter forend rate very good overall with some lightly added finish and dings and dents from the years; there is a 1" long section of dark brown enamel on the high left side of the buttstock. The length of pull to the hard rubber buttplate is 14" with drops of 1 3/4" and 2 3/4"; the buttstock may have been shortened at one time. (156496-7) (150/250)
2695. **E. K. TRYON CO. BOXLOCK DOUBLE SHOTGUN** serial #40058, 12 ga, 30" matted rib barrels choked improved modified and full with bright, very good bores with light frosting. The barrels have toned to a dark plum brown patina with scattered oxidation staining, primarily at the breech end of the barrels, and a small dent in the left barrel about 10" from the muzzle. The frame, lever, tangs and triggerguard have all toned to a mottled pewter-brown patina with several handling marks and scratches. The pistolgrip roundknob checkered walnut buttstock and splinter forend rate good to near very good overall with some light dings and dents as well as added finish. The length of pull to the black hard rubber buttplate is 14 1/4" with drops of 1 3/4" and 3 1/2". (156453-17) {C&R} (100/200)
2696. **STOEGER CONDOR SINGLE TRIGGER OVER UNDER SHOTGUN** serial #28521, 12 ga, 26" ventilated rib barrels both choked modified with bright excellent bores. The metal surfaces retain 99% original blue with a light handling mark or two present. The checkered pistolgrip walnut buttstock and checkered forend rate very good overall with several scratches and dings present; the black rubber recoil pad is slightly oversized and is possibly not original. Overall a great shooter or entry level over under. (156357-S17156) (250/350)
2697. **COLT 1862 POLICE CONVERSION CARTRIDGE REVOLVER** serial #556, 38 RF, 4 1/2" barrel with a very good, lightly oxidized bore. The metal surfaces have toned to a mottled pewter-brown patina throughout with remnants of pinprick pitting and traces of bright gunmetal here and there; this conversion features a rebated, half-fluted cylinder. The triggerguard retains 95% reapplied silver-plated finish and the brass backstrap has toned to a pleasing ochre patina. The one-piece walnut grip rates very good with some minor chips at the lower corners and light handling marks from the years. All of the parts are matching with the exception of the loading gate, which is marked "236"; the wedge is un-numbered. The gun times and locks smartly. (156889-143) {ANTIQUÉ} (400/600)
2698. **SCOPE LOT** This lot consists of a Leupold Vari-X III 2.5-8x scope with a 36mm objective lens and bright excellent optics. This scope features a duplex reticle and the body retains 99% matte black finish and is a 1" tube. A very nice Leupold Vari-X III. (157022-49A)
2699. **SCOPE LOT** This lot consists of a Leupold Vari-X III 1.5-5x scope with a 25mm objective lens and bright excellent optics. This scope features a duplex reticle and the body retains 98% matte black finish and is a 1" tube. (157022-41A)
2700. **SCOPE LOT** This lot consists of a Leupold FX-III 6x scope with a 42mm objective lens and bright excellent optics. This scope features a standard duplex reticle and the body retains 99% gloss blue finish and is a 1" tube. (157022-43A)



2701. **STEVENS MODEL 311A BOXLOCK DOUBLE SHOTGUN** 12 ga, 28" barrel choked improved cylinder and full with bright excellent bores; the muzzle of the right barrel is flared. The barrels retain 95% original blue finish with some light thinning and evenly scattered surface oxidation. The frame and tangs retain about 85% case-hardened color with the only loss being on the belly, which has toned to a mottled pewter-brown patina. The refinished checkered pistolgrip walnut buttstock and forend rate very good overall with some light handling marks present; the forend has been sanded and little if any original finish remains. The length of pull to the black plastic buttplate is 14 3/8". (157075-S18246) (150/250)
2702. **SPRINGFIELD MODEL 187S SEMI-AUTO RIFLE BY SAVAGE** serial #A881090, 22 LR, 20" barrel with a bright excellent bore. The metal surfaces retain 95-97% original blue with a fair amount of scattered surface oxidation present. The plain hardwood pistolgrip buttstock rates very good to near excellent with some minor dings and handling marks present. Mounted atop the receiver is a Springfield 4x scope with a broken reticle. (157075-S18036) (100/200)
2703. **MARLIN MODEL 38 SLIDE ACTION RIFLE** serial #8698, 22 LR, 24" octagon barrel with a very good bore. The metal surfaces have toned to a gunmetal gray with patches of dark oxidation staining and pinprick pitting and faint traces of original blue in protected areas. The frame retains no case-hardened color and has toned to a similar patina with a moderate patch of oxidation staining on the top of the frame and rear upper corners. The plain pistolgrip walnut buttstock and ribbed forend rate very good overall, as refinished, with several handling marks and light scratches as well as rust staining at the leading edge of the buttstock. This rifle is missing the bolt and other internal parts. A good parts rifle. (157075-S18405) (75/150)
2704. **HARRINGTON & RICHARDSON TOPPER MODEL 098 SINGLE BARREL SHOTGUN** serial #HM339460, 28 ga, 25 1/2" barrel choked improved modified with a bright excellent bore. The barrel retains 80% original blue with moderate oxidation staining and light pinprick pitting in a few areas as well as some thinning to pewter. The nickel frame rates excellent with a few light blemishes. The black hardwood pistolgrip buttstock and forend rate very good overall with some light dings and handling marks present and a few small scuffs. A nice little single barrel H&R. (157075-S18075) (75/150)
2705. **WINCHESTER MODEL 1911 SEMI-AUTO SHOTGUN** serial #52317, 12 ga, 28" barrel choked full with a very good, lightly oxidized bore. The metal surfaces retain 40-50% original thinning blue with the balance toned to pewter showing lightly scattered oxidation stains. The plain pistolgrip laminated birch buttstock and forend rate very good overall showing lightly added finish and a pair of cracks at the rear of the forend and a single tiny crack at the front left side of the buttstock abutting the metal. The buttstock is fitted with a black rubber ventilated recoil pad. A good example of a "widow maker". (156895-6) (200/300)
2706. **WINCHESTER MODEL 12 SLIDE ACTION SHOTGUN** serial #818171, 12 ga, 30" plain barrel choked full with a bright excellent bore. The metal surfaces retain 98% professionally applied matte blue finish with a few scattered blemishes. The plain pistolgrip walnut buttstock and ribbed forend rate excellent with a few dings and dents here and there. A very nice example overall. (157075-S18076) (200/300)
2707. **GLENFIELD MODEL 30 "GOLDEN 50" LEVER ACTION CARBINE** serial #69 33525, 30-30 Win, 20" barrel with a very good, dark bore. The metal surfaces retain 95% original blue with some partial thinning in a few spots and the lever is toning to a plum brown patina. The checkered pistolgrip walnut buttstock and forend rate very good with some scattered dings and dents; the checkering on the wrist is a roll-stamped scene of a buck surrounded by oak leaves. A Weaver V12 4-12x scope is mounted atop the receiver; the original sights are still present as well. (157075-S18245) (200/300)
2708. **ITHACA MODEL 66 SUPER SINGLE LEVER ACTION SHOTGUN** serial #660223582, 20 ga, 26" barrel choked modified with a bright excellent bore. The barrel retains 95% original blue with scattered oxidation staining, the frame is a matte black finish with some scattered flaking to bright gunmetal gray. The checkered straight grip walnut buttstock and forend rate very good to near excellent with light dings and handling marks present. A very good example of an Ithaca Model 66. (157075-S18247) (100/200)
2709. **BELGIAN FLOBERT ROLLING BLOCK RIFLE** serial #390, 22 RF, 22 1/2" octagon barrel with a near very good, evenly oxidized bore. The metal surfaces have toned to an even plum-brown patina throughout with scattered pinprick pitting; the hammer and upper tang have lightly toned to gunmetal gray from operational wear. The checkered round knob pistolgrip walnut buttstock rates good to near very good overall with some dings and dents from the years as well as scattered mildew from poor storage. The front sight is no longer present and a v-notch rear sight is dovetailed in the barrel. (156855-23) {ANTIQUÉ} (75/150)
2710. **BRITISH PERCUSSION HALFSTOCK FOWLER WITH HUDSON BAY COMPANY MARKING** About 20 bore, 36" part round, part octagon barrel with a turned medial at the point of transition and a very good, lightly oxidized bore. The metal surfaces have been cleaned to bright gunmetal gray throughout with softened edges on the octagonal portion of the barrel and scattered oxidation staining; the left side of the breech is British proofed and the top flat is stamped with a "Seated Wolf, Hudson Bay Company trademark. The lock shows remnants of an engraved game scene towards the rear and center of the lockplate is marked "Partridge". The hammer shows strong blue with light surface oxidation; this fowler is a drum and nipple conversion. The fancy triggerguard has been cleaned as well, displaying a pineapple finial at the front a simple floral motifs on the underside. The straight grip English walnut halfstock rates very good, having been lightly sanded and refinished, with some mild dings and dents from the years, a small crack at the rear of the lockplate and a 1/4" chip between the hammer and upper tang; the metal is proud of the wood at most points of contact. This fowler is devoid of sights and the dovetails have been filled. An age-appropriate wooden ramrod is present and the lock still functions properly. A good percussion fowler that would make a fine decorative piece. (156892-34) {ANTIQUÉ} (100/200)
2711. **REMINGTON NO. 4 ROLLING BLOCK RIFLE** serial #179572, 22 RF, 22 1/2" octagon barrel with a good, moderately oxidized bore. The barrel has toned to plum-brown with even surface oxidation throughout and traces of original blue here and there. The frame shows a similar amount of surface oxidation with light undertones of muted case-hardened color. The straight grip walnut buttstock and forend rate good to near very good, the buttstock in far superior condition to the forend, with scattered dings and dents. There is a chip that runs the length of the upper tang on the left side and the forend has moderate mildew and is most likely from poor storage. With the condition of the forend and buttstock being so different, it is possible that the buttstock could be a replacement. (156794-1) (75/150)
2712. **MAGTECH MODEL 151 SINGLE SHOT SHOTGUN BY CBC** serial #1586740, 12 ga, 28" barrel choked full with a bright excellent bore. The metal surfaces retain 60-70% original thinning blue with the balance toned to a mottled silvery-brown patina. The plain pistolgrip walnut buttstock and forend rate very good overall with some light dings and handling marks as well as a 1 1/2" crack at the tail of the upper tang. This shotgun would make a good entry level break-open. (157075-S18400) (50/100)

2713. **J.C. HIGGINS MODEL 20 SLIDE ACTION SHOTGUN** 12 ga, 26" barrel unchoked with a muzzle brake and a bright excellent bore. The metal surfaces retain about 35% original blue in protected areas with the balance toned to a mottled pewter-brown patina with scattered oxidation staining. The plain pistolgrip walnut buttstock and ribbed forend rate very good, as refinished, with light handling marks and a 1 1/2" crack on the left side of the leading edge of the buttstock. Mounted atop the receiver is a Weaver K15-1 fixed 1.5x scope with a 25mm objective and bright optics, featuring a post and crosshair reticle. (157075-S18248) (100/200)
2714. **BELGIAN "LITTLE ENFIELD" YOUTH FULLSTOCK PERCUSSION MUSKET** .36 cal, 28" barrel with a very good, evenly oxidized bore. The barrel has toned to an even pewter-brown patina with scattered oxidation staining; the breech-end of the barrel is stamped with Belgian proofs and the top of the barrel is marked "BELGIUM THE LITTLE ENFIELD". Golden-colored enamel has been applied to the nipple bolster and the copper lockplate and hammer still show traces of a blue-green finish but has flaked in most areas. The plain straight grip walnut buttstock rates very good overall with some light handling marks and dings from the years as well as a repaired section to the right of the upper tang that has been neatly fixed; the metal is slightly proud of the wood. The hammer does not stay cocked and is in need of professional attention; a likely original ramrod is present. A neat little Belgian "Enfield" musket. (157052-21) {ANTIQUÉ} (150/250)
2715. **SEARS ROEBUCK AND CO. MODEL 200 SLIDE ACTION SHOTGUN** serial #P202192, 12 ga, 20 1/2" shortened deer barrel with Remington rifle sights and a bright excellent bore. The metal surfaces retain 97% original blue finish with some handling marks present and some patches of light oxidation staining. The smooth pistolgrip hardwood buttstock and forend rate near excellent, as refinished, with a few small dings and dents present; the wood has been lightly sanded and the edges of the red rubber buttpad are slightly proud. This Sears Model 200 shotgun was originally manufactured by Winchester and categorized as a Model 1200 and in near excellent condition overall. (156691-35) (100/200)
2716. **MARLIN MODEL 336RC LEVER ACTION CARBINE** serial #J50639, 30-30 Win, 20" barrel with a bright excellent bore. The metal surfaces retain 98-99% original blue with a few scattered specks of surface oxidation. The plain pistolgrip walnut buttstock and forend rate excellent with a few minor handling marks present. This carbine features a brass bead front sight and a v-notch adjustable rear sight. An excellent example overall. (157082-13) {C&R} (350/550)
2717. **IVER JOHNSON MODEL 36 SINGLE BARREL SHOTGUN** serial #51290, 12 ga, 30" round barrel choked improved cylinder with a bright, very good bore with scattered light pitting. The barrel retains nearly all of its browned finish with some faint oxidation staining present. The nickel frame retains about 90% original finish with small patches of brown oxidation staining here and there. The smooth pistolgrip walnut buttstock and forend rate good, as refinished, with a couple of cracks at the upper and lower tang, two rudimentary repairs on the right side of the forend and some dings and dents from the years. (156781-10) {C&R} (100/200)
2718. **ARMS CORPORATION MODEL AK 47/22 SEMI-AUTO RIFLE** serial #AP226528, 22 LR, 18" barrel with a bright excellent bore. The barrel and piston tube retain 98-99% original blue, the receiver and remaining metal retain 98% matte black finish with light flaking at the muzzle. The walnut buttstock, pistolgrip and forend rate very good to near excellent with some minor handling marks. The front sight guard has chipped off on the left side and the front sling swivel has broken off as well. A single magazine is included. A very good example overall. (157075-S18334) (150/250)
2719. **NEW ENGLAND WESTINGHOUSE 1891 MOSIN NAGANT BOLT ACTION RIFLE** serial #42405, 7.62x54R, 32" barrel with a very good, dark bore. The metal surfaces retain 75% arsenal blue with the balance toned to a brown patina with silvering on the edges and oxidation staining. The straight grip military hardwood stock with full-length handguard rate good with several dings and dents, a light chip along the cleaning rod channel and a 3/4" by 1/4" chip along the top of the forend; the cleaning rod is not present and a small brass plate with the number "26" is present on the toeline. Original military sights are present. A good example of a U.S. made Mosin Nagant. (156983-33) {C&R} (200/300)
2720. **FRENCH MODEL 1916 BERTHIER-MANNLICHER BOLT ACTION CARBINE** serial #BD37900, 8mm Lebel, 17 3/4" barrel with a bright excellent bore. The metal surfaces retain 80% thinning arsenal blue finish with some light oxidation staining here and there; the turned down bolt handle has completely toned to a pleasing brown patina. The straight grip hardwood buttstock with upper forend handguard rate very good overall with scattered dings and dents and a slightly faded but still visible cartouche on the right side of the butt and the serial number on the left side. A small brass plate with the number "37" is present on the toeline. Standard military carbine sights are affixed. A very good to near excellent example of a French Berthier carbine. (156983-50) {C&R} (150/250)
2721. **RUSSIAN MODEL 1891 MOSIN NAGANT RIFLE** serial #46880, 7.62x54R, 28 3/4" barrel with a very good, lightly oxidized bore. The metal surfaces retain 80-85% thinning original blue with a few small pinprick pits here and there and some oxidation staining; there are a series of small scratches on the left side of the receiver and the proofs and maker stampings are crisp. A lowercase "r" is present behind the "1922" date stamp indicating that this rifle was captured by the Germans and later reissued. The straight grip military hardwood buttstock rates good to near very good overall with some scattered dings and dents and mild mildew staining from poor storage. The rifle is affixed with the appropriate military sights and two leather straps are present in each sling slot. (156983-34) {C&R} (200/300)
2722. **JAPANESE TYPE 38 ARISAKA BOLT ACTION SPORTING RIFLE BY KOISHIKAWA** serial #0900883, 6.5 Arisaka, 31 1/2" barrel with a very good, dark bore. The metal surfaces retain 90% original blue and the mum is intact with some areas toning to a pleasing brown patina, mostly on the buttplate and triggerguard, and light oxidation staining here and there. The straight grip Asian hardwood military stock rates very good with some scattered dings and dents. The forend has been shortened just after the barrel band and the appropriate military sights are present. (156983-49) (150/250)
2723. **JAPANESE TYPE 38 ARISAKA BOLT ACTION RIFLE BY KOISHIKAWA** serial #49525, 6.5 Arisaka, 31 1/2" barrel with an excellent bore. The metal surfaces retain 92% arsenal blue finish with light thinning in some areas and scattered light surface oxidation; the mum has been removed from the receiver and the markings are crisp. The pistolgrip Asian hardwood two-piece buttstock rates good to near very good with moderate dings and handling marks from the years. The appropriate military sights are affixed and the cleaning rod is no longer present. (156983-64) {C&R} (200/300)
2724. **FINNISH MODEL 1939 SHORT RIFLE** serial #53786, 7.62x54R, 27" barrel with a bright excellent bore. The metal surfaces retain 97% arsenal blue with a bit of thinning here and there, primarily on the magazine and triggerguard; the "VKT" barrel mark and "1942" date stamping are crisp and legible. The plain pistolgrip hardwood two-piece stock rates excellent with a few scattered handling marks and a crisp "L" cartouche on the right side of the butt. The appropriate post front sight and graduated ladder-style military rear sight are present on the rifle. The original cleaning rod and a green adjustable sling are included. An excellent example of a Finnish martial rifle. (157017-21) {C&R} (300/500)

2725. **INTERARMS IMPORTED ASTRA CONSTABLE II SEMI-AUTO PISTOL** serial #F4150, 380 ACP, 3 1/2" barrel with an excellent, bright bore. The metal surfaces rate near very good and retain about 85% of their factory original blued finish, but do exhibit noticeable fading and some light handling marks. The checkered black synthetic grips rate very good plus exhibiting only minor signs of light handling. The pistol features a set of fixed sights, as well as decocker safety. Included with the pistol is a single magazine. (136916-23) (150/250)
2726. **CENTURY ARMS IMPORTED CZ MODEL 83 SEMI-AUTO PISTOL** serial #CZ8300340/12256, 380 ACP, 3 13/16" barrel with an excellent, bright bore. The metal surfaces rate very good and retain about 90% of their factory original blued finish, but do exhibit some light oxidation as well as slight fading of the finish and a few other general light handling marks. The checkered black synthetic grips rate very good but exhibit numerous handling marks. Included with the pistol is a single magazine. (136894-24) (200/300)
2727. **CENTURY ARMS IMPORTED ZASTAVA M70A SEMI-AUTO PISTOL** serial #Z-M70A-0002361, 9mm, 4 1/2" barrel with an excellent, bright bore. The metal surfaces rate excellent to like-new and retain about 99% of their factory original blued finish, lacking any discernible handling marks. The black synthetic grips rate near excellent and exhibit only negligible faint handling marks. Included with the pistol are two 8 round blued magazines, cleaning tool, chamber flag, manual and papers, and the factory original box. (136894-21) (200/300)
2728. **COLT 22 MODEL SEMI-AUTO PISTOL** serial #PH02123, 22 LR, 4 1/2" barrel with an excellent, bright bore. The stainless steel metal surfaces rate excellent and exhibit no discernible handling marks. The checkered black synthetic grips rate excellent and exhibit no discernible handling marks. The pistol features a set of fixed iron sights and a ventilated rib barrel. Included with the pistol are two 10 round magazines, allen wrench, factory hangtag, manual and papers, factory hardcase, and the factory original box. (136520-2577) [Richard "Stretch" Kennedy Collection] (300/500)
2729. **HIGH STANDARD DOUBLE-NINE DOUBLE ACTION REVOLVER** serial #1598413, 22 LR, 5 1/2" barrel with an excellent, bright bore. The metal surfaces rate very good and retain about 95% of their factory original blued finish, but do exhibit some minor light fading as well as isolated instances of minor faint surface oxidation. The brass surfaces rate near very good but exhibit extensive tarnish or stripping of their bright metal. The faux stag grips rate excellent and display no discernible marks. (136916-16) (100/200)
2730. **SMITH & WESSON VICTORY MODEL DOUBLE ACTION REVOLVER** serial #V264442, 38 Special, 4" pinned barrel with an excellent, bright bore. The parkerized metal surfaces rate very good, but do exhibit faint oxidation development in addition to some light fading particularly toward the grip areas. The checkered black rubber Pachmayr aftermarket grips rate near excellent and exhibit only negligible faint handling marks. The revolver features a set of fixed sights and a 6 shot fluted cylinder. (136916-27) (200/400)
2731. **COLT POLICE POSITIVE SECOND ISSUE DOUBLE ACTION REVOLVER** serial #340606, 38 Special, 4" barrel with a relatively oxidized and pitted bore. The metal surfaces rate near very good and retain about 90% of their blued finish, although exhibiting minor fading, wear, and some general light handling marks. The checkered walnut grips rate good, but do exhibit extensive wear. In addition, the left side grip exhibits a crack running the entire vertical length of the panel. The revolver features a set of fixed sights and a 6 shot fluted cylinder. (136916-24) {C&R} (200/300)
2732. **COLT COBRA DOUBLE ACTION REVOLVER** serial #36422, 38 Special, 2" barrel with an excellent, bright bore. The metal surfaces rate near very good but retain little of their blued finish, exhibiting both general fading as well as pronounced areas of bright silvering. The non-matching grips rate very good, but do exhibit a few light handling marks. The included grips are a left-side checkered walnut, with silver-colored Rampant Colt medallion, and a right side Barami Model DS-1 smooth black synthetic "hip grip". The revolver features a set of fixed sights and a 6 shot fluted cylinder. (136919-1) [Richard "Stretch" Kennedy Collection] (150/250)
2733. **CUSTOM COLT GOVERNMENT MODEL M1911A1 SEMI-AUTO PISTOL** serial #1003978, 45 ACP, 5" barrel with a near excellent bright bore. This pistol is a custom Colt 1911A1 which utilizes a military frames but heavily customized. The slide is a commercially manufactured Colt with a match barrel. The metal surfaces of the slide rate very good plus and retain about 96% of their likely factory original blued finish, but do exhibit some silvering along edges and contact points as well as a few light handling marks. The frame rates very good and retains about 95% of the applied blued finish. The pistol also retains its original military stampings along the right side of the frame: "United States Property" as well as "M1911A1 U.S. Army". In addition, although having become considerably faded, the ordnance bomb mark remains visible just rear of the grip. The checkered black rubber Pachmayr grips rate and feel very good, but there are some light signs of handling. The presence of the aftermarket grips also serve to obscure the hand stippling which spans from the bottom of the triggerguard down the front strap. The pistol features an adjustable target rear sight and an upgraded fixed front sight. Included with the pistol is a single blued 7 round magazine. (136520-4182) [Richard "Stretch" Kennedy Collection] (400/600)
2734. **LOT OF AMMUNITION** Consists of an assortment of boxed and loose ammo. Included are one box of Western Super X 22 LR which contains 50 unfired rounds of round nose cartridges, one box of Remington CBee22 low velocity 22 LR which contains 50 unfired rounds of round nose cartridges, one box of Federal Hi-Power 22 Short which contains 12 unfired rounds of round nose cartridges, and one box of Winchester 9mm which contains 10 unfired rounds of hollow point cartridges. Also included are 43 unfired cartridges of various calibers, as well as 3 lead balls. (133615-2)
2735. **LOT OF FIREARM RELATED PARTS AND ACCESSORIES** Consists of two items. The first item is a Lyman Mould Block for lead balls. The block rates excellent to like-new and comes packaged in its original box which is marked for use with small handles only; the mould block was shipped by itself and as such no handles are included with it. The second item is a top handguard for Mosin Nagant M91/30 bolt action rifles. The handguard rates very good but does exhibit its share of minor handling marks. This particular handguard section features the early brass end tabs. (133615-7)
2736. **LOT OF ASSORTED TOY CANNONS** Consists of five scaled items. Four of the cannons are of metal construction, rating very good and retaining most of their colors, but do exhibit some handling marks as well as isolated instances of sparse oxidation. For their part, all of these cannons feature articulation and moving wheels. The fifth cannon is of wooden construction and rates near very good. The cannon features a simple black color scheme and, unlike the other items in the lot, features only moving wheels. The left side of the cannon exhibits a crack which has separated a portion from the main body and will need to be reglued. Most of the cannons also display remnants of a moderate level of dust accumulation, but can be quickly and easily remedied with a more thorough cleaning. (133615-17)
2737. **HAENEL MODEL 28 AIR PISTOL**, .177 Caliber, 4" barrel. The metal surfaces rate very good and retain about 90% of their blued finish, but exhibit some areas of light surface oxidation as well as more general light fading. The smooth walnut grips rate very good plus and exhibit only a few minor light handling marks. The brass Haenel medallions in the grips rate very good plus, with only the left side medallion exhibiting some minor verdigris. The pistol features a fixed front and adjustable rear sight. Included with the pistol is a black leather holster. (136519-572A) {NON-GUN} (75/150)



2738. **HY-SCORE MODEL 803 SPORTSTER AIR PISTOL** serial #903171, .177 Caliber, 7 3/4" barrel. The metal surfaces rate near very good and retain about 90% of their factory original blued finish with some areas of light oxidation present. The left side of the frame displays a small area of foliate engraving. The checkered brown synthetic grips rate near excellent and exhibit only negligible faint handling marks. The pistol features a fixed front and adjustable rear sight. Included with the pistol are a manual and papers, factory original tag, factory wooden test target, container of pellets, and a factory box. While the box has been factory remarked to accompany the Model 803, it was originally marked for the Model 805, of which only 1-2 examples are believed to have been produced. The box rates good plus and retains most of its original detail, but has become considerably tattered along its edges with age. (136519-572B) {NON-GUN} (100/200)
2739. **HEALTHWAYS PLAINSMAN MODEL ML 175 CO2 SEMI-AUTO AIR PISTOL** serial #0054175, .175/BB Caliber, 6" barrel. The metal surfaces rate good and retain about 80% of their black finish, although exhibiting fading and general wear. The checkered black synthetic grips rate good, but exhibit wear as well as applied silver-colored paint. The serrations along the faux slide also exhibit applied silver-colored paint which easily rubs off upon contact. The pistol features a set of fixed iron sights. Included with the pistol are a manual, factory hangtag, and factory box. The box rates good plus and retains most of its original advertising detail, but has become considerably tattered along its edges with age. (136679-1) {NON-GUN}
2740. **LOT OF AIR GUNS** Consists of two Crosman air pistols. The first item is a Crosman Model 1600 Powermatic semi-auto air pistol serial #286237920, .175/BB Caliber, 6" barrel. The metal surfaces rate very good and retain about 90% of their factory original black finish, but exhibit loss of finish along edges as well as along the barrel and muzzle. The checkered faux wood grips rate near excellent and exhibit only negligible minor light handling marks. The pistol features a set of fixed iron sights and a 17 shot spring-fed integral magazine. The second item is a Crosman Model AAIL "Auto Air II" semi-auto BB / single shot pellet air pistol serial #991323460, .175/BB and .177/pellet Caliber, 7 1/4" barrel. The light gray plastic surfaces rate very good plus, but do exhibit some minor light marks and wear from age. The black synthetic grips rate very good plus but do exhibit some minor signs of prior handling. The pistol features an adjustable rear sight and fixed ramp front sight. (136856-1, 2) {NON-GUN}
2741. **SCOPE LOT** Consists of a single Charles Daly 4x32 riflescope. The scope rates near excellent and retains about 98% of its factory original gloss black finish, but does exhibit some minor light marks along its underside. The optic features a duplex reticle which displays a crisp, clear sight picture. (136520-1715A)
2742. **SCOPE LOT** Consists of a single Redfield 4x riflescope. The scope rates near excellent and retains about 98% of its factory original gloss black finish, but does exhibit some minor faint wear. The optic features a duplex reticle which displays a crisp, clear sight picture. Included with the scope is a set of leather lens covers. (136520-1606A)
2743. **SCOPE LOT** Consists of a single Weaver 3.8-12x44mm riflescope. The metal surfaces rate excellent and retain about 99% of their factory original matte black finish. The optic features a duplex reticle which displays a crisp clear sight picture. Included with the scope is a scopecoat, set of leupold scope rings, and factory box. (136943-4)
2744. **RIFLE STOCK LOT** Consists of a single Ruger Mini-14 rifle stock. The smooth walnut stock rates very good plus and exhibits some general faint to light handling marks as well as a minor 1/2" sliver missing from the right side of the stock, forward of the magazine well. The lot is limited to the stock and does not include a top handguard. (136721-294A)
2745. **LOT OF MAGAZINES** Consists of four 9mm Uzi magazines. All four magazines have a 50 round capacity. Two of the magazines rate near excellent to excellent, with both exhibiting only minimal faint to light marks. Another of the magazines rates very good plus and exhibits more general light marks as well as some slight discoloration. The remaining magazine rates near very good but does exhibit extensive marks as well as numerous patches of light surface oxidation. (136378-5A)
2746. **LOT OF MAGAZINES** Consists of four detachable box rifle magazines. Three of the items are 20 round capacity magazine for FAL pattern rifles. The magazines rate very good but exhibit numerous light handling marks. The remaining item is a single 30 round steel magazine for AK-47 pattern rifles. This magazine rates very good but does exhibit a few light handling marks. (135765-3)
2747. **LOT OF MAGAZINES** Consists of three detachable box magazines AR-15 rifles. Two of the magazines appear to be twenty round capacity, while the remaining magazine seems to be limited to only 5 rounds. All of the magazines are of an aluminum construction and rate about very good but do exhibit numerous faint to light handling marks. (136923-14C)
2748. **POWDER FLASK LOT** Consists of a single small-size eagle flask. The flask measures 4" tall with a fixed common top with fixed charging spout. Both sides of the body display a raised eagle with traces of original lacquer in the protected areas around the depiction. One side is smooth and un-dented, while the other exhibits a minor dent. The seams are tight and the top spring shows some minor light oxidation and good traces of original blue. The flask maintains its collar and cap, both of which maintain a very good degree of their original bright brass. (133615-1414A)
2749. **MISCELLANEOUS LOT** Consists of: (1) US military, green canvas M-67 carrying case which was designed to hold a military slide rule used for artillery aiming, marked as having belonged to Battery A 3rd Battalion of the 6th Field Artillery Regiment; (1) US military, green canvas double magazine pouch for 1911 magazines, marked "Avery 1943" along its back; (1) unmarked, green canvas scope cover; (1) East German "rain" camo canvas military pouch; (1) green canvas SKS chest rig with 10 pockets designed to hold loaded stripper clips; (1) tan leather dual ammo pouch which includes leather sling and cleaning kit; (1) set of servicing parts for M-14 rifle includes cleaning rod, oiler, and combination tool; (1) Browning Automatic Rifle combination wrench; (10) various types of oilers, one of which is stored in a tan leather pouch; (1) section of rope with metal end tabs. The items in this lot exhibit varying degrees of wear and range from very good plus to excellent condition overall. (136247-41A5A)
2750. **LOT OF MAGAZINES** Consists of two detachable rifle magazines. Both magazines feed 9mm and belong to an H&K Model 94 semi-auto carbine. Each magazine features a 15 round capacity. The magazines rate near excellent to excellent in condition. One of the magazines appears like-new, while the second exhibits some light silvering from use. (135996-4)
2751. **LOT OF MAGAZINES** Consists of two pistol magazines. Both magazines feed 22 rimfire and belong to a Walther P-22 semi-auto pistol. Each magazine features a 10 round capacity. The magazines rate very good plus, but do exhibit some minor light wear and handling marks. One of the magazines features a finger extension floorplate. (135996-8)
2752. **LOT OF MAGAZINES** Consists of three detachable rifle magazines. All of the magazines feed 22 rimfire and belong to an Anschutz 17HM2 bolt action rifle. Each magazine appears to feature a 10 round capacity. The magazines rate near excellent, but do exhibit some minor light wear. (135996-9)



2753. **MAGAZINE LOT** Consists of a single pistol magazine. The magazine feeds 22 rimfire and belongs to a High-Standard semi-auto pistol. The magazine is assumed to feature a 10 round capacity. The magazine rates near excellent but does exhibit some minor light wear stemming from use. (135996-10)
2754. **LOT OF MAGAZINES** Consists of two pistol magazines. The magazines feed 22 rimfire and are compatible with Colt Huntsman, Targetsman, and Woodsman models of semi-auto pistols. Both magazines feature a 10 round capacity. The magazines rate near excellent and exhibit some minor slight wear from use. (135996-11)
2755. **LOT OF MAGAZINES** Consists of two pistol magazines. The magazines feed 9mm and belong to a Walther P88 semi-auto pistol. Both magazines feature a 15 round capacity. The first magazine rates excellent and exhibits no discernible signs of handling or wear, while the second magazine remains in its original unopened packaging from Interarms. (135996-12)
2756. **LOT OF MAGAZINES** Consists of four detachable rifle magazines. The magazines feed 22 rimfire and are believed to belong to an H&K Model 270 semi-auto rifle. Each magazine features a 20 round capacity. The magazines rate near excellent but do exhibit some minor slight wear. (135996-13)
2757. **LOT OF MAGAZINES** Consists of two detachable rifle magazines. The magazines feed 22 WMRF and are believed to belong to an H&K Model 300 semi-auto rifle. Both magazines feature a 15 round capacity. The magazines rate near excellent but do exhibit some minor faint wear. (135996-14)
2758. **LOT OF ASSORTED AMMUNITION** Consists of two boxes of ammo. First is a box of Western Super-X 80 grain 243 Winchester soft point which contains 14 unfired cartridges as well as 6 fired casings. The second is a box of Federal Hi-Power 170 grain 8mm Mauser soft point which contains 20 unfired cartridges. (135161-9F)
2759. **LOT OF MILITARY AMMUNITION** Consists of three boxes of ammo. All of the ammo is divided between three 15-rd wedge-shaped packets from K.K. Kovia and is Finnish-made full metal jacket 303 British (7.7mm) believed to have been produced in 1940. The lot consists of a total of 40 unfired cartridges; while two of the boxes are full, the remaining box contains only 10 of its original 15 rounds. The primers of these rounds are assumed to be corrosive. One of the boxes rates near excellent and exhibits only minimal wear to the salmon-colored packaging labels, the two remaining boxes rate very good plus and features some applied clear cellophane tape in certain areas to maintain integrity of either the box or its labels. (135161-9H)
2760. **LOT OF MISCELLANEOUS AMMUNITION** Consists of various types of fired and unfired cartridges. The lot contains a total of approximately 230 unfired cartridges and 170 fired casings. The lot also contains a few bullet heads and lead balls, as well as a single stripper clip. Calibers include, but are not limited to: 32 S&W, 38 Short Colt, 38 Special, 32 S&WL, 12 Gauge, among others. Featured in the lot are about one hundred 380ACP black plastic enclosed flash blanks with instruction sheet, two blank firing rounds of 7.62 NATO, and seven US Navy MK 80 hand fired signal flares; all of the mentioned rounds remain unfired. (135161-9G)
2761. **AMMUNITION LOT** Consists of a single box of 30 Remington. The box of Peters High Velocity 170 grain 30 Remington inner-belted soft point contains its complete 20 unfired cartridges. The unfired cartridges rate in excellent condition, while the box rates near excellent and exhibits only minor light wear along its edges as well as a few minor light marks. (135996-1A)
2762. **AMMUNITION LOT** Consists of a single box of 30 Remington. The box of Peters High Velocity 170 grain 30 Remington inner-belted hollow point contains its complete 20 unfired cartridges. The unfired cartridges rate in excellent condition, while the box rates very good plus to near excellent and exhibits only minor light wear along its edges as well as some general fading of the box's colors. (135996-1B)
2763. **AMMUNITION LOT** Consists of a single box of 30 Remington. The box of Peters High Velocity 170 grain 30 Remington inner-belted hollow point contains its complete 20 unfired cartridges. The unfired cartridges rate in excellent condition, with the box rating excellent and exhibiting no mentionable wear and only a few minor light marks. (135996-1C)
2764. **AMMUNITION LOT** Consists of a single box of 30 Remington. The box of Peters High Velocity 170 grain 30 Remington inner-belted hollow point contains its complete 20 unfired cartridges. The unfired cartridges rate in excellent condition; the box rates near excellent, exhibiting no remarkable wear and only some minor light fading and marks. (135996-1D)
2765. **AMMUNITION LOT** Consists of a single box of 30 Remington. The box of Peters High Velocity 170 grain 30 Remington inner-belted hollow point contains its complete 20 unfired cartridges. The unfired cartridges rate in excellent condition, while the box rates near very good plus and exhibits some light wear as well as some general handling marks. (135996-1E)
2766. **AMMUNITION LOT** Consists of a single box of 224 Weatherby Magnum. The box of Weatherby Magnum Ultra-Velocity 55 grain 224 Weatherby Magnum soft point contains its complete 20 unfired cartridges. The unfired cartridges rate in excellent condition, with the box also rating excellent, exhibiting only extremely minor light wear along some edges. (135996-6)
2767. **AMMUNITION LOT** Consists of a single box of 358 Winchester. The box of Winchester-Western Super-X 200 grain 358 Winchester silvertips contains its complete 20 unfired cartridges. The unfired cartridges rate in excellent condition, while the box rates near excellent and exhibits some minor light fading and marks. (135996-18)
2768. **MILITARIA LOT** Consists of a single German field gorget. The gorget measures approximately 6 1/4" wide by 4 1/4" tall and belonged to the NSKK (National Socialist Motor Corps) division of the Nazi Party. During the Second World War, The NSKK served in the transport corps of the various service branches for Nazi Germany. The gorget is of an aluminum construction and rates very good, but does exhibit several light handling marks. The front surface displays the NSKK eagle in the center with the number 18352 overhead. The front of the gorget is also marked "NSKK Vekehrs - Erziehungsdienst". The back surface features a black felt lining. One of the clasps on the back of the gorget displays the Nazi swastika and is also marked "Afrika". An overall very good condition gorget which appears more-modern than 75-yrs old, but still a worthwhile addition to any WWII collection. (135996-19)
2769. **CROSMAN MODEL 454 SEMI-AUTO AIR PISTOL** serial #268169, .175 BB, 7 3/4" barrel. The metal surfaces rate very good plus and retain about 95% of their factory original black finish, but do exhibit several minor light handling marks. The checkered brown synthetic grips rate near excellent and display only some minor light signs of handling. The pistol features a fixed front and adjustable rear sight. Included with the pistol is a factory box which rates near very good but exhibits considerable wear along its edges. (136852-7) {NON-GUN}

2770. **LOT OF POCKET KNIVES** Consists of 15 Remington pocket knives. All of the pocket knives are manually opened. The majority of the knives are multi-blade; however, there is one which consists of only a single blade. Most of the knife handles are wooden, with others featuring synthetic grips. Additionally, one knife features a metal handle which displays foliate engraving along both sides. Blade types consist of a mixture of predominantly drop-point and clip-point blades. Two of the knives exhibit some minor cracks in their respective grips: the first knife, which features a "Petol Tools" shield in the left side of the black wood handle, displays an approximately 1/8" crack located just below the blade in the fixed position; the second knife features a lighter wood handle, with a metal shield embossed in the left side, which exhibits an approximately 1" crack in the left side extending foreword from the base. The knife also exhibits an approximately 1/2" crack in the right side located just below the blade in the fixed position. The knives rate from very good to excellent condition overall, with blades ranging from bright stainless steel to stained or worn surfaces. (135996-17)
2771. **MISCELLANEOUS LOT** Consists of: (1) what appears to be a replacement receiver cover for an FAL rifle, which features a non-picatinny mounting system; (1) AK-74 style muzzle brake; (1) packaged cleaning rod for Dragunov pattern rifles; (1) sight assembly for M203 grenade launcher, which features flip-up front and rear sights; (4) cleaning kits; (6) leather slings; (1) length of rope; various small parts. Most of the items rate in near excellent condition overall, exhibiting only minor faint wear or handling marks. The receiver cover and sight assembly both rate very good plus. The sight assembly exhibits some age-related wear, while the receiver cover exhibits silvering along edges and the flat mounting top. Additionally, one of the slings rates very good although exhibiting considerable light age-related wear. (136247-38A2)
2772. **STOCK LOT** Consists of a stock and forend for a J.C. Higgins rifle. The furniture set belongs to a J.C. Higgins rifle, believed to be compatible with Models 28, 29, 30, 31. The forend rates near very good, but does exhibit some cracks along the right side in the rear of the wood. These cracks measure approximately 1 1/16" and 7/8" respectively. The corresponding area along the left side exhibits wood putty where some wood has crumbled away. The stock likewise rates near very good, but exhibits two parallel cracks, each measuring about 1 3/16", in the right side located rear of the pistolgrip and appears to have been caused by bulging of the wood; additionally, the right side of the stock also exhibits a 1 1/16" crack running along the pistolgrip area. Both sides of the stock also display applied wood putty, particularly surrounding where the stock would meet the rifle. Featured with the stock is an integral red canvas sling. (135352-9A)
2773. **BRITISH HARRINGTON & RICHARDSON MARK I SINGLE SHOT BREAK ACTION FLARE GUN**, serial #1096, 37mm, 10" barrel with a near excellent, bright bore. The metal surfaces rate near very good, but retain little of their factory original blued finish; the barrel also exhibits isolated areas of considerable oxidation build-up. The stock rates very good but exhibits several light handling marks, mostly minor scratches; featured with the stock is an installed red recoil pad, which brings the length of pull to approximately 15 1/2". The gun features a set of sling mounts. This flare gun would make for an interesting display piece, but does still function properly if one wished to use the flare gun. (136519) [Richard "Stretch" Kennedy Collection] {NON-GUN} (300/500)
2774. **GERMAN GECO SINGLE SHOT BREAK ACTION SIGNAL PISTOL** serial #30170, 26.5mm, 6" barrel with a very good plus bore. The metal surfaces rate very good and retain about 93% of their factory original phosphate finish, but do exhibit numerous light handling marks along the barrel as well as a few minor light handling marks on the frame. The checkered brown plastic grips rate very good plus but do exhibit some minor light handling marks. The single action hammer still functions properly if one wished to use the pistol. (136739-7) {NON-GUN}
2775. **CZECH SHE69 SINGLE SHOT BREAK ACTION FLARE PISTOL** serial #K2993, 26.5mm, 6" barrel with a very good, although slightly dark bore. The metal surfaces rate very good and retain about 93% of their factory original blued finish, but do exhibit some light handling marks, some slight oxidation around the muzzle, as well as some use-related wear. The smooth plastic-infused wood grips rate very good plus and exhibit only some minor light handling marks. The pistol features a lanyard loop on the bottom of its grip. The single action hammer still functions properly if one wished to use the pistol. The She-69 is one of this writer's favorites. (136739-5) {NON-GUN}
2776. **SOVIET SPSH SINGLE SHOT BREAK ACTION FLARE PISTOL** serial #KA501, 26.5mm, 6" barrel with a very good, although somewhat dark bore. The metal surfaces rate very good and retain about 93% of their factory original blued finish, but do exhibit some light handling marks. The checkered black plastic grips rate very good plus and exhibit only some minor light handling marks. The pistol features a lanyard loop on the bottom of its grip. The single action hammer still functions properly if one wished to use the pistol. (136739-8) {NON-GUN}
2777. **SOVIET SPSH SINGLE SHOT BREAK ACTION FLARE PISTOL** serial #01573, 26.5mm, 6" barrel with a very good, mostly bright bore. The metal surfaces rate good and retain about 89% of their factory original blued finish, but do exhibit some light handling marks as well as some light pitting along the frame. The checkered black plastic grips rate very good plus and exhibit only some minor light handling marks. The pistol features a lanyard loop on the bottom of its grip. The single action hammer still functions properly if one wished to use the pistol. Included with the pistol is a green holster which features a pouch, five flare holders, and a green canvas shoulder strap. (136739-12) {NON-GUN}
2778. **R.F. SEDGLEY MARK 5 USN SINGLE SHOT BREAK ACTION FLARE PISTOL** serial #24-2692-A-2, 10 Gauge, 6" barrel with a very good, although somewhat dark bore. The metal surfaces rate good, but are subject to considerable marks, pitting, as well as some silvering around the muzzle. The checkered black synthetic grips rate very good but exhibit several light handling marks. The pistol features a lanyard loop on the bottom of its grip. The double action only trigger still functions properly if one wished to use the pistol. The top of the barrel identifies the pistol as having been produced in 1943. The pistol features a smooth bore; however, the pistol has been exempted from the NFA and transfers as a C&R handgun. (136739-6) {C&R} (50/100)
2779. **COSTON-SEDGLEY SINGLE SHOT BREAK ACTION PARACHUTE SIGNAL PISTOL** serial #2161, 37mm, 7 1/2" barrel with a very good, although somewhat dark bore. The metal surfaces rate very good and retain about 93% of their factory original finish, although the barrel and trigger do exhibit some light oxidation staining. The stainless steel checkered grip rates very good, but does exhibit some light handling marks as well as worn checkering. The pistol features a lanyard loop on the bottom of its grip. The double action only trigger still functions properly if one wished to use the pistol. (136739-13) {NON-GUN}
2780. **BRITISH NO2 MK5 SINGLE SHOT BREAK ACTION FLARE PISTOL** serial #119953, 1" flare cartridge, 3 5/8" barrel with a very good, although somewhat dark bore. The metal surfaces rate very good and retain about 93% of their factory original blued finish but do exhibit several minor light handling marks. The checkered black wooden grips rate good but do exhibit evident signs of handling as well as a few shallow cracks. The pistol features a lanyard loop on the bottom of its grip. The single action hammer still functions properly if one wished to use the pistol. (136739-9) {NON-GUN}
2781. **BRITISH NO4 MK1 SINGLE SHOT BREAK ACTION FLARE PISTOL**, 37mm, 4 1/8" barrel with a relatively dark bore. The metal surfaces rate near very good and retain about 89% of their factory original blued finish, but do exhibit some oxidation as well as light pitting. The checkered black synthetic grips rate very good but do exhibit some minor light handling marks along the base. The double action only trigger and hammer still function properly if one wished to use the pistol. (136739-1) {NON-GUN}



2782. **BRITISH WEBLEY & SCOTT MODEL "M" SINGLE SHOT BREAK ACTION FLARE PISTOL** serial #H724, 1 1/2" caliber, 4 1/8" barrel with a dark oxidized bore. The metal surfaces rate good but exhibit some oxidation, staining, and handling marks. The checkered black synthetic grips rate very good plus and displays only minor light signs of handling. The pistol features a lanyard loop on the bottom of its grip. The double action only hammer and trigger are stubborn, but still function properly if one wished to use the pistol. (136739-2) {NON-GUN}
2783. **INTERNATIONAL FLARE SIGNAL COMPANY SINGLE SHOT BREAK ACTION FLARE PISTOL** serial #11231, 26.5mm, 8 1/8" barrel with a dark oxidized bore. The metal surfaces rate near very good and retain about 91% of their factory original blued finish, but exhibit considerable light oxidation along the barrel. The brass frame and checkered grip both rate very good, but exhibit several minor light handling marks. The checkering of the grip is also somewhat worn. The pistol features a lanyard loop on the bottom of its grip. The single action hammer still functions properly if one wished to use the pistol. (136739-11) {NON-GUN}
2784. **UNMARKED POST-WWII EAST GERMAN SINGLE SHOT BREAK ACTION FLARE PISTOL** serial #1660, 26.5mm, 6 1/2" barrel with a very good, mostly bright bore. The metal surfaces rate very good and retain about 90% of their factory original blued finish, although exhibiting numerous light handling marks. The checkered black synthetic grips rate very good, but do exhibit some minor light signs of handling as well as a few instances of worn checkering. The pistol features a manual safety, as well as a lanyard loop on the bottom of its grip. The single action hammer still functions properly if one wished to use the pistol. (136739-10) {NON-GUN}
2785. **GERMAN WWII LUFTWAFFE DOUBLE BARREL BREAK ACTION FLARE PISTOL** serial #28833, 2.7 caliber, 6 1/2" barrels with very good, although slightly dark bores. The phosphate finished metal surfaces rate good, but exhibit extensive handling marks as well as bright silvering. The checkered black synthetic grips rate very good plus, but do exhibit some minor light signs of handling. The pistol features a manual safety, toggle switch between barrels, and a double trigger. Action does not appear to cock properly. (136678-19) {NON-GUN}
2786. **BRITISH WWI WEBLEY & SCOTT SINGLE SHOT BREAK ACTION FLARE PISTOL** serial #85144, 4 1/8" barrel with a near excellent, bright bore. The brass surfaces display bright nickel plating which covers approximately 98% of the metal. The smooth walnut grips rate very good, but do exhibit several light handling marks as well as the left side grip panel missing a portion of wood along its base. Stampings along the left side of the barrel and frame identifies the pistol as having been produced in 1918. The pistol features a lanyard loop on the bottom of its grip. The single action hammer still functions properly if one wished to use the pistol. (136520-4185) [Richard "Stretch" Kennedy Collection] {NON-GUN}
2787. **SMITH & WESSON MODEL 66-2 DOUBLE ACTION REVOLVER** serial #AHL4251, 357 Magnum, 3" barrel with an excellent, bright bore. The stainless steel metal surfaces rate very good plus, but do exhibit some minor light handling marks. The checkered black rubber Pachmayr grips rate near excellent and exhibit only a few minor light signs of handling. The revolver features a 6 shot fluted cylinder which displays a light turn ring. Additionally, the revolver features a ramp front and adjustable rear set of three-dot night sights; however, it would appear that their low-light function has since expired. Only 2,500 Smith & Wesson Model 66s were produced with a 3" barrel. (136520-1337) [Richard "Stretch" Kennedy Collection] (200/300)
2788. **CZ MODEL 75 SEMI-AUTO PISTOL** serial #166778, 9mm, 4 1/2" barrel with an excellent, bright bore. The metal surfaces rate very good plus and retain about 98% of their factory original blued finish, but do exhibit a few minor light handling marks. The checkered walnut grips rate near excellent and exhibit only a few minor light handling marks. The pistol features fixed iron sights and a lanyard loop. Included with the pistol is a single 16 round magazine. (136520-2616) [Richard "Stretch" Kennedy Collection] (250/450)
2789. **BROWNING CHALLENGER III SEMI-AUTO PISTOL** serial #655PW05961, 22 LR, 5 1/2" bull barrel with an excellent, bright bore. The metal surfaces rate excellent and retain about 99% of their factory original blued finish, exhibiting only negligible faint marks. The smooth walnut grips rate excellent to like-new and exhibit no discernible handling marks. The pistol features a ramp front and adjustable rear sight. Included with the pistol is a single 10 round magazine. (136520-180) [Richard "Stretch" Kennedy Collection] (150/250)
2790. **SMITH & WESSON MODEL 27-2 DOUBLE ACTION REVOLVER** serial #N217156, 357 Magnum, 3 1/2" pinned barrel with an excellent, bright bore. The metal surfaces rate very good and retain about 91% of their factory original blued finish, but do exhibit considerable loss along the cylinder and right side of the barrel. In addition to the general fading of its finish, the 6 shot fluted cylinder also displays a light turn ring. The textured black rubber Hogue grips rate very good plus and exhibit only some minor light handling marks. The revolver features a red-insert ramp front and white-outline adjustable rear sight. (136520-1256) [Richard "Stretch" Kennedy Collection] (300/500)
2791. **SMITH & WESSON MODEL 10-5 DOUBLE ACTION REVOLVER** serial #C602532, 38 Special, 4" pinned barrel with an excellent, bright bore. The metal surfaces rate excellent and retain about 98% of their factory original blued finish. The 6 shot fluted cylinder rates near excellent, but does display a slight turn ring. The checkered black rubber Pachmayr grips rate very good plus, but do exhibit some minor light signs of handling. The revolver features a set of fixed sights. (136520-2170) [Richard "Stretch" Kennedy Collection] (300/500)
2792. **SMITH & WESSON MODEL 10-8 DOUBLE ACTION REVOLVER** serial #AER3257, 38 Special, 4" barrel with an excellent, bright bore. The metal surfaces rate near excellent and retain about 95% of their factory original blued finish, but do exhibit some minor light handling marks. The 6 shot fluted cylinder rates excellent, but does display a faint turn ring. The checkered black rubber Pachmayr grips rate near excellent and exhibit only extremely negligible faint signs of handling. The revolver features a set of fixed sights. (136520-1194) [Richard "Stretch" Kennedy Collection] (300/500)
2793. **BRAZILIAN CONTRACT MODEL OF 1937 DOUBLE ACTION REVOLVER BY SMITH & WESSON** serial #166194, 45 ACP, 5 1/2" pinned barrel with an excellent, bright bore. The revolver seems to have been importer marked along the right side of the barrel, with what appear to be the letters "I.N.A.". Overall, the revolver retains about 95% of its current applied matte black enamel finish, with some flaking visible on the metal surfaces. The cylinder also displays a slight turn ring. The stampings on the barrel and frame largely remain crisp; however, the Smith & Wesson trademark and Brazilian crest have become considerably faded and soft with age. The checkered black rubber Pachmayr grips rate near excellent and exhibit only negligible faint signs of handling. The revolver features a set of fixed iron sights; however, the front sight has been altered from its original half-moon construction to a more boxy style. (136520-1177) [Richard "Stretch" Kennedy Collection] (200/400)

2794. **US MODEL OF 1917 DOUBLE ACTION REVOLVER BY SMITH & WESSON** serial #3654, 45 ACP, 5 1/2" pinned barrel with a very good plus, bright bore which shows strong rifling although with slightly dark grooves. The revolver is an Anniston Armory rebuild, as evidenced by the "A A" marking on the left side of the frame. The current commercially applied reblued finish was applied post-rebuild by some individual other than Anniston Armory, and retains about 90% of their color, although having since faded to a plum-gray shade. The metal surfaces rate very good but exhibit some minor silvering, isolated areas of very light oxidation, as well as pinprick pitting obscured by the reblued finish. The 6 shot fluted cylinder rates very good plus and retains about 85% of its original blued finish, although having faded to an acquired brownish-gray tone. The cylinder exhibits only some minor silvering, a light turn ring, and a few other general marks. The checkered black rubber Pachmayr grips rate near excellent and exhibit only faint signs of handling. The revolver features a half-moon front and U-notch rear set of fixed sights. Springfield Research Service records indicate that the revolver was shipped from Smith & Wesson to Springfield Armory on November 10th 1917. (136520-1473) [Richard "Stretch" Kennedy Collection] (300/500)
2795. **BERETTA MODEL 948 SEMI-AUTO PISTOL** serial #079020N, 22 LR, 3 1/2" barrel with an excellent, bright bore. The metal surfaces rate very good plus and retain about 96% of their factory original blued finish, but do exhibit a few minor light handling wear-related marks. The checkered black synthetic grips rate near excellent and exhibit only a few minor light signs of handling. The pistol features a set of fixed iron sights and includes a single 10 round magazine with finger-rest floorplate. (136530-3316) [Richard "Stretch" Kennedy Collection] (75/150)
2796. **BERETTA MODEL 21A SEMI-AUTO PISTOL** serial #DAA080087, 22 LR, 2 7/16" barrel with an excellent, bright bore. The metal surfaces rate very good and retain about 95% of their factory original matte blued finish but do exhibit some light oxidation accumulation along the top of the barrel and slide. The checkered black plastic grips rate near excellent and exhibit only extremely negligible faint signs of handling. The pistol features a set of fixed iron sights and includes a single 7 round magazine. (136520-3038) [Richard "Stretch" Kennedy Collection] (75/150)
2797. **INTRATEC SPORT-22 SEMI-AUTO PISTOL** serial #K006018, 22 LR, 4" barrel with a bright bore which exhibits fine rifling. The metal surfaces rate very good plus and retain about 96% of their factory original matte blued finish, but do exhibit some light wear and handling marks as well as an area of minor light oxidation along the barrel. Additionally, the stainless steel bolt carrier also exhibits pinprick pitting. The ribbed black synthetic grip rates very good plus and exhibits only minor light signs of handling. The pistol features a fixed front and adjustable rear sight; also featured are ambidextrous charging handle, safety, and magazine release. Included with the pistol is a single 10 round magazine. (136520-674) [Richard "Stretch" Kennedy Collection] (75/150)
2798. **STAR MODEL DK "STARFIRE" SEMI-AUTO PISTOL** serial #816012, 380 ACP, 3 1/8" barrel with an excellent, bright bore. The metal surfaces rate very good plus and retain about 95% of their factory original blued finish, but do exhibit some minor light wear and handling marks. The checkered brown synthetic grips rate very good plus, although exhibiting a few light handling marks. The pistol features a set of fixed iron sights. Included are two 6 round single-stack magazines. (136520-3310) [Richard "Stretch" Kennedy Collection] (200/300)
2799. **SMITH & WESSON MODEL 337 AIRLITE TI CHIEFS SPECIAL DOUBLE ACTION REVOLVER** serial #CDB8408, 38 Special +P, 1 7/8" barrel with an excellent, bright bore. The matte stainless steel and alloy metal surfaces rate excellent and exhibit no discernible handling marks. The matte gray 5 shot fluted cylinder rates near excellent and exhibits only a faint turn ring. The checkered black rubber grips rate near excellent and exhibit only extremely faint signs of handling. The revolver features a ramp front and fixed U-notch rear sight. (136520-1300) [Richard "Stretch" Kennedy Collection] (300/500)
2800. **SMITH & WESSON MODEL 64-2 DOUBLE ACTION REVOLVER** serial #1D55625, 38 Special, 2" pinned barrel with a near excellent, bright bore. The stainless steel metal surfaces rate very good plus, but do exhibit some light scratches and other handling marks. The 6 shot fluted cylinder also rates very good plus, and likewise exhibits some light scratches and other handling marks as well as a slight turn ring. The checkered black rubber Pachmayr grips rate excellent and exhibit only extremely negligible faint signs of handling. The revolver features a red-insert ramp front sight and fixed U-notch rear sight. (136520-1242) [Richard "Stretch" Kennedy Collection] (250/350)
2801. **SMITH & WESSON MODEL 37 CHIEFS SPECIAL AIRWEIGHT DOUBLE ACTION REVOLVER** serial #J974441, 38 Special, 3" barrel with an excellent, bright bore. The metal surfaces rate excellent and retain 98% plus of their blued finish. The 5 shot fluted cylinder rates excellent and retains 98% plus of its blued finish, but does exhibit a faint turn ring. The checkered walnut grips rate very good plus, but do exhibit some handling-related wear. The revolver features a ramp front and U-notch fixed rear sight. (136520-2517) [Richard "Stretch" Kennedy Collection] (250/450)
2802. **SMITH & WESSON MODEL 17-3 DOUBLE ACTION REVOLVER** serial #8K95847, 22 LR, 6" pinned barrel with an excellent, bright bore. The metal surfaces rate very good plus and retain about 95% of their factory original blued finish, but do exhibit some general light handling marks as well as an area of slight blemishing along the left side of the barrel, toward the muzzle. The 6 shot fluted cylinder rates very good plus and retains about 97% of its factory original blued finish, but does exhibit some silver as well as a light turn ring. The checkered walnut grips rate very good plus but do exhibit some light handling marks. The revolver features a pinned partridge front sight and an adjustable rear sight. (136520-1165) [Richard "Stretch" Kennedy Collection] (350/550)
2803. **AMT "BACK UP" SEMI-AUTO PISTOL** serial #A27041, 380 ACP, 2 5/8" barrel with a very good plus, bright bore. The stainless steel metal surfaces rate very good plus and exhibit only some minor light handling marks. The checkered black plastic grips rate near excellent and exhibit only a few minor faint signs of handling. The pistol features a set of fixed iron sights, as well as a frame mounted lever safety. Included with the pistol is a single 5 round stainless steel magazines. (136520-3867) [Richard "Stretch" Kennedy Collection] (100/200)
2804. **AMT HARBALLER SEMI-AUTO PISTOL** serial #B30465, 45 ACP, 5" barrel with an excellent, bright bore. The stainless steel metal surfaces rate very good plus, but do exhibit some light wear and handling marks. The checkered wraparound neoprene grips rate excellent and exhibit only negligible minor light handling-related wear. The pistol features a fixed front and adjustable rear sight. Included with the pistol is a single 7 round blued magazine. (136520-1273) [Richard "Stretch" Kennedy Collection] (200/400)
2805. **AMT LONG SLIDE HARBALLER SEMI-AUTO PISTOL** serial #B21452, 45 ACP, 7" barrel with an excellent, bright bore. The stainless steel metal surfaces rate near excellent and exhibits only a few minor light scratches, as well as what appears to be a powder burn mark along the left side of the barrel near the muzzle. The textured black rubber grips rate excellent and lack any discernible handling marks. The pistol features a fixed front and adjustable rear set of iron sights. Included with the pistol are two single-stack magazines, manual, and the factory original box. (136520-4044) [Richard "Stretch" Kennedy Collection] (300/500)

2806. **SMITH & WESSON MODEL 49 DOUBLE ACTION REVOLVER** serial #902J41, 38 Special, 2" pinned barrel with an excellent, bright bore. The metal surfaces rate near excellent and retain about 97% of their factory original blued finish, but do exhibit some minor light handling marks. The 5 shot fluted cylinder rates excellent and retains 98% plus of its factory original blued finish, exhibiting only an extremely faint turn ring. The checkered walnut grips rate excellent and exhibit no discernible handling marks. The revolver features a ramp front and fixed U-notch rear sight; additionally, the revolver also features a shrouded hammer. (136520-1589) [Richard "Stretch" Kennedy Collection] (250/350)
2807. **SMITH & WESSON MODEL 649 DOUBLE ACTION REVOLVER** serial #AFN1382, 38 Special, 2" barrel with an excellent, bright bore. The stainless steel metal surfaces rate very good but exhibit numerous light scratches. The stainless steel 5 shot fluted cylinder rates very good, but also exhibits numerous light scratches as well as a light turn ring. The checkered black rubber Pachmayr grips rate very good plus, but do exhibit some signs of light handling. The revolver features a ramp front and fixed U-notch rear sight; additionally, the revolver also features a shrouded hammer. (136520-1468) [Richard "Stretch" Kennedy Collection] (200/300)
2808. **COLT OFFICIAL POLICE DOUBLE ACTION REVOLVER** serial #840116, 38 Special, 4" barrel with an excellent, bright bore. The metal surfaces rate very good plus and retain about 90% of their factory original blued finish, but do exhibit some silvering along edges. The 6 shot fluted cylinder rates very good plus and also retains about 90% of its factory original blued finish, but does exhibit a faint turn ring. The checkered walnut grips feature a silver-colored Colt medallion in each panel and both rate excellent, exhibiting no discernible handling marks. The revolver features a set of fixed iron sights. Colt factory records indicate that this particular Official Police is a post-war model produced in 1955. (136520-2971) [Richard "Stretch" Kennedy Collection] {C&R} (250/350)
2809. **COLT AGENT DOUBLE ACTION REVOLVER** serial #A65868, 38 Special, 2" barrel with an excellent, bright bore. The metal surfaces on his first-issue rate very good plus and retain about 95% of their factory original blued finish, but do exhibit some silvering along edges. The 6 shot fluted cylinder rates very good plus and retains about 90-95% of its factory original blued finish, but is subject to instances of bright silvering as well as a slight turn ring. The checkered walnut grips feature a silver-colored Colt medallion in each panel and both rate excellent, exhibiting no discernible handling marks. The revolver features a set of fixed iron sights, as well as a shrouded hammer. Colt factory records indicate that this particular model was produced in 1969. (136520-226) [Richard "Stretch" Kennedy Collection] (250/450)
2810. **RUGER NEW MODEL SINGLE SIX CONVERTIBLE SINGLE ACTION REVOLVER** serial #68-78185, 22 LR / 22 Mag, 6 1/2" barrel with an excellent, bright bore. The metal surfaces rate near excellent and retain about 98% of their factory original blued finish, exhibiting only negligible faint marks. The 6 shot fluted cylinder rates excellent and retains about 98% of their factory original blued finish, but does exhibit a slight turn ring. The smooth walnut grips rate excellent and exhibit no discernible handling marks. The revolver features a ramp front and adjustable rear sight. Included with the revolver is an additional cylinder for 22 Win Mag which rates and excellent and retains about 99% of its factory original blued finish, exhibiting only an extremely faint turn ring. Also included is a red felt bag to house whichever cylinder is not being used. (136520-251) [Richard "Stretch" Kennedy Collection] (250/450)
2811. **E. WHITNEY POCKET MODEL SINGLE ACTION PERCUSSION REVOLVER** serial #7508, 31 Caliber, 5" barrel with a very good bore which exhibits light oxidation throughout the length of the barrel. The metal surfaces of this Second Model, First Type rate very good and retain about 95% of their applied nickel plated finish, but do exhibit some obscured pinprick pitting beneath the current finish. The 6 shot non-fluted cylinder rates very good and retains about 95% of its applied nickel plated finish, but does display two light turn rings, as well as some minor light scratches. The smooth walnut grips are numbered to the revolver and rate very good plus and exhibit only minor faint handling marks. (135620-2550) [Richard "Stretch" Kennedy Collection] {ANTIQUE} (300/500)
2812. **SMITH & WESSON MODEL 15-2 DOUBLE ACTION REVOLVER** serial #K600715, 38 Special, 4" pinned barrel with an excellent, bright bore. The metal surfaces rate excellent and retain about 97% of their factory original nickel plated finish; however, the bottom of the triggerguard has been crudely electro-penciled with a series of numbers. The 6 shot fluted cylinder rates near excellent and retains about 97% of its factory original nickel finish, but does exhibit a light turn ring. The checkered walnut grips rate very good plus, but do exhibit some minor light handling marks. The revolver features a ramp front and adjustable rear sight. Additionally, the revolver features a target hammer and trigger. (136520-1282) [Richard "Stretch" Kennedy Collection] (250/450)
2813. **SMITH & WESSON MODEL 10-6 DOUBLE ACTION REVOLVER** serial #D225261, 38 Special, 5" pinned barrel with an excellent, bright bore. The metal surfaces rate very good plus and retain about 95% of their factory original nickel plated finish, but do exhibit some light scratches as well as minor fading along the left side of the barrel toward the muzzle. The 6 shot fluted cylinder rates very good plus and retains about 97% of its factory original nickel plated finish, but does exhibit some faint scratches as well as a light turn ring. The checkered walnut grips rate near excellent and exhibit only extremely negligible light handling marks. The revolver features a set of fixed iron sights. (136520-667) [Richard "Stretch" Kennedy Collection] (250/350)
2814. **SMITH & WESSON MODEL 12-2 DOUBLE ACTION REVOLVER** serial #D235373, 38 Special, 2" pinned barrel with an excellent, bright bore. The metal surfaces rate very good plus and retain about 95% of their factory original blued finish, but do exhibit some silvering along edges as well as along the left side of the muzzle. The 6 shot fluted cylinder rates near excellent and retains about 97% of its factory original blued finish, exhibiting only extremely faint signs of a turn ring. The checkered walnut grips rate very good plus and exhibit only a few minor light handling marks. The revolver features a ramp front and fixed U-notch rear sight. (136520-2919) [Richard "Stretch" Kennedy Collection] (250/350)
2815. **SMITH & WESSON MODEL 12-2 DOUBLE ACTION REVOLVER** serial #D453695, 38 Special, 2" pinned barrel with an excellent, bright bore. The metal surfaces rate very good plus and retain about 90% of their factory original blued finish, but do exhibit several areas of silvering along edges as well as along the left side of the muzzle. The 6 shot fluted cylinder rates near excellent and retains about 85% of its factory original blued finish, silvering and other general light handling marks as well as a light turn ring. The checkered walnut grips rate very good plus, but do exhibit some minor light handling marks; the grips are numbered to the revolver. The revolver features a ramp front and fixed U-notch rear sight. (136520-2942) [Richard "Stretch" Kennedy Collection] (200/300)
2816. **HIGH STANDARD MODEL G-E SEMI-AUTO PISTOL** serial #322517, 22 LR, 4 1/2" bull barrel with an excellent, bright bore. The metal surfaces rate very good and retain about 75-80% of their factory original blued finish. The grip straps display the majority of the fading, with the metal shifting to a grayish-brown tone; in addition, the pistol also exhibits some minor silvering and oxidation staining predominantly along the barrel. Additionally, the trigger exhibits some machining marks from when a trigger shoe had once been installed. The deluxe walnut checkered grips with thumb-rest rate very good plus and exhibit only some minor light handling marks. The pistol features a partridge front and adjustable rear sight. The rear sight would have originally been a Davis adjustable sight, but has since been replaced with a Micro adjustable sight. The pistol also features a slide lock safety and includes a single 10 round magazine. The 4 1/2" was designed to be interchangeable with a 6 3/4" heavy barrel; however, no additional barrel is included with the pistol. These were deluxe top-of-the-line models, of which only approximately 2,900 were produced between 1949 and 1950. (136520-1422) [Richard "Stretch" Kennedy Collection] {C&R} (300/500)



2817. **HIGH STANDARD MODEL G-380 SEMI-AUTO PISTOL** serial #6870, 380 ACP, 5" barrel with a very good plus, bright bore which exhibits a few isolated pitting marks. The metal surfaces rate very good plus and retain about 90% of their factory original blued finish. The grip straps display the majority of the fading, with the metal shifting to a brownish-gray tone; in addition, the pistol also exhibits some light oxidation as well as faint signs of silvering. The checkered black plastic grips rate near excellent and exhibit only negligible light handling marks. The pistol features a set of fixed iron sights. The pistol also features a slide lock safety and slide catch, as well as an exposed hammer. Included with the pistol is a single 6 round magazine. Approximately only 7,400 units of this model were produced between 1947 and 1950. (136520-2932) [Richard "Stretch" Kennedy Collection] {C&R} (300/500)
2818. **COLT POLICE POSITIVE DOUBLE ACTION REVOLVER** serial #401832, 38 Police, 4" barrel with near excellent, bright bore which exhibits a small area of minor light oxidation. The metal surfaces of this Second Issue rate very good and retain about 85% of their factory original blued finish, but do exhibit extensive faint oxidation development. The 6 shot fluted cylinder rates very good and retains about 75-80% of their factory original blued finish, but exhibits considerable fading to a gun metal gray tint as well as a light turn ring. The checkered walnut grips feature a silver-colored Colt medallion in each panel and both rate near excellent, exhibiting only negligible light signs of handling. The revolver features a set of fixed iron sights. Colt factory records indicate that this particular Police Positive model was produced in 1942. (136520-1217) [Richard "Stretch" Kennedy Collection] {C&R} (300/500)
2819. **SMITH & WESSON MODEL 10-6 DOUBLE ACTION REVOLVER** serial #D72248, 38 Special, 4" pinned heavy barrel with an excellent, bright bore. The metal surfaces rate very good plus and retain about 90% of their blued finish, but do exhibit some minor silvering around the muzzle as well as light discoloration along the barrel and a few other general light handling marks. The cylinder rates very good plus and retains about 90% of its blued finish, but does exhibit some minor light silvering and general light fading as well as a bright turn ring. The checkered walnut grips rate near excellent and exhibit only a few minor light handling marks. The revolver features a ramp front and U-notch set of fixed iron sights. (136520-2187) [Richard "Stretch" Kennedy Collection] (200/300)
2820. **SMITH & WESSON MODEL 37 CHIEFS SPECIAL AIRWEIGHT DOUBLE ACTION REVOLVER** serial #194J32, 38 Special, 3" pinned barrel with a near excellent, bright bore. The metal surfaces rate near excellent and retain about 95% of their factory original blued finish, but do exhibit some areas of minor light silvering. The 5 shot fluted cylinder rates very good plus and retains about 90% of its factory original blued finish, but does exhibit some fading as well as scarce silvering and a light turn ring. The checkered walnut grips are numbered to the revolver and rate very good plus but do exhibit some minor light dings. The revolver features a ramp front and U-notch rear set of fixed iron sights. The revolver also displays gold-filled markings, although some of the color has begun to fade. (136520-1312) [Richard "Stretch" Kennedy Collection] (200/400)
2821. **SMITH & WESSON PRE-WAR .32 REGULATION POLICE DOUBLE ACTION REVOLVER** serial #366973, 32 S&W, 3 1/4" pinned barrel with a very good, bright bore which exhibits scattered light oxidation throughout the length of the barrel. The metal surfaces rate very good and retain about 80% of their factory original blued finish, exhibiting faint oxidation freckling in addition to light fading. The 6 shot fluted cylinder rates very good plus and retains about 90% of its factory original blued finish, but does exhibit some minor light silvering as well as a light turn ring. The checkered walnut grips are numbered to the revolver and rate very good, but do display some worn checkering as well as a few minor chips along the bases. The revolver features a half-moon front and U-notch rear set of fixed iron sights (136520-281) [Richard "Stretch" Kennedy Collection] {C&R} (300/500)
2822. **SMITH & WESSON MODEL 34-1 DOUBLE ACTION REVOLVER** serial #M17759, 22 LR, 4" pinned barrel with an excellent, bright bore. The metal surfaces rate very good plus and retain about 90% of their blued finish but do exhibit some silvering around the muzzle as well as general light fading. The 6 shot fluted cylinder rates very good and retains about 80% of its blued finish, but exhibits more considerable fading and silvering as well as a light turn ring. The color case-hardened trigger exhibits a few minor, extremely light marks from a trigger shoe having once been installed. The checkered walnut grips are numbered to the revolver and rate very good plus, exhibiting only a few minor light marks. The revolver features a ramp front and adjustable rear set of iron sights. (136520-1471) [Richard "Stretch" Kennedy Collection] (200/400)
2823. **HIGH STANDARD MODEL R-103 SENTINEL DOUBLE ACTION REVOLVER** serial #1577461, 22 LR, 2 3/8" barrel with an excellent, bright bore. The metal surfaces rate very good plus and retain about 95% of their factory original blued finish but do exhibit some light handling marks. The 9 shot fluted cylinder rates excellent and retain about 98% of its factory original blued finish, exhibiting only a slight turn ring. The checkered brown plastic grips rate very good plus and display only minor light signs of handling. The revolver features a set of fixed iron sights. (136520-2113) [Richard "Stretch" Kennedy Collection] (100/200)
2824. **IVER JOHNSON MODEL 50 SIDEWINDER DOUBLE ACTION REVOLVER** serial #E11155, 22 LR, 6" barrel with an excellent, bright bore. The metal surfaces rate very good and retain about 90% of their blued finish, but do exhibit some silvering as well as light handling marks. The 8 shot fluted cylinder rates very good and retains about 95% of its blued finish, but does exhibit an area of faint oxidation as well as some general light handling marks. The smooth walnut grips rate very good but exhibit several light scratches. The revolver features a fixed U-notch rear sight, but the front sight blade is missing. The model designation indicates that the revolver was manufactured prior to 1963. (136520-3990) [Richard "Stretch" Kennedy Collection] {C&R} (100/200)
2825. **SAVAGE MODEL 101 SINGLE SHOT SINGLE ACTION REVOLVER** serial #50082, 22 LR, 4 1/4" barrel with an excellent, bright bore. The metal surfaces rate very good plus and retain about 95% of their blued finish, but do exhibit some areas of light silvering as well as some light flaking. The barrel and cylinder comprise a single component part and both swing out to the right. The smooth faux walnut left grip panel rates excellent and exhibits no discernible handling marks, while the right side panel rates very good and exhibits two 3/4" cracks which run parallel through the Savage logo as well as a few minor light handling marks. The revolver features a set of fixed iron sights. (136520-3312) [Richard "Stretch" Kennedy Collection] (100/200)
2826. **TAURUS PT 145 DOUBLE ACTION ONLY SEMI-AUTO PISTOL** serial #NVG34947, 45 ACP, 3 1/4" barrel with an excellent, bright bore. The metal surfaces rate near excellent and retain about 98% of their factory original matte blued finish, exhibiting only a very few minor light handling marks. The textured black synthetic grips rate excellent and exhibit no discernible handling marks. The pistol features a set of white three-dot adjustable iron sights as well as a manual safety. Included with the pistol are two 10 round double-stack magazines, assist loader, cleaning tool, factory test-fired cartridge, manual and papers, and the factory original hardcase. (136520-1343) [Richard "Stretch" Kennedy Collection] (200/400)
2827. **HIGH STANDARD MODEL DM 101 DERRINGER** serial #2274163, 22 Magnum, 3 1/2" barrel with excellent, bright bores. The metal surfaces rate very good and retain about 90% of their factory original blued finish, but do exhibit some light handling marks as well as a couple of instances of sparse oxidation. The smooth faux ivory grips rate near excellent and exhibit no discernible handling marks. The derringer features a set of fixed iron sights. (136520-2190) [Richard "Stretch" Kennedy Collection] (75/150)

2828. **SMITH & WESSON VICTORY MODEL DOUBLE ACTION REVOLVER** serial #V407397, 4" pinned barrel with a very good plus, bright bore, although exhibiting what appears to be some light pinprick oxidation in some of the grooves. The metal surfaces rate near very good and retain about 60% of their factory original parkerized finish, but exhibit numerous bright scratches as well as bright silvering along edges and around the muzzle. The 6 shot fluted cylinder rates very good and retains about 70% of its factory original parkerized finish but does exhibit some light scratches and silvering as well as a light turn ring. The smooth walnut grips rate very good but exhibit several light dings. The revolver features a half-moon front and U-notch rear set of fixed iron sights, as well as a lanyard loop on the bottom of the grip. (136520-2591) [Richard "Stretch" Kennedy Collection] {C&R} (300/500)
2829. **SMITH & WESSON MODEL 457 DOUBLE ACTION ONLY SEMI-AUTO PISTOL** serial #VDL5199, 45 ACP, 3 3/4" barrel with an excellent, bright bore. The metal surfaces rate excellent and retain about 99% of their factory original matte blued finish, exhibiting no discernible handling marks. The checkered black synthetic grips likewise rate excellent and similarly exhibit no discernible handling marks. The pistol features a set of white three-dot iron sights. In addition, the pistol also features a slide mounted decocker safety. Included with the pistol are two 7 round stainless steel magazines, manual and papers, and the factory original hardcase. (136520-2152) [Richard "Stretch" Kennedy Collection] (250/450)
2830. **SMITH & WESSON MODEL CS40 CHIEFS SPECIAL DOUBLE ACTION ONLY SEMI-AUTO PISTOL** serial #EKW8965, 40 S&W, 3 1/4" barrel with a near excellent, bright bore. The metal surfaces rate very good and retain about 80% of their factory original blued finish, but exhibit considerable fading and silvering. The textured black rubber grips rate and feel excellent and exhibit only negligible extremely light signs of handling. The pistol features a set of white three-dot iron sights. In addition, the pistol also features a slide mounted decocker safety. Included with the pistol are three 7 round stainless steel magazines and the factory original hardcase. (136520-836) [Richard "Stretch" Kennedy Collection] (250/450)
2831. **SMITH & WESSON MODEL CS45 CHIEFS SPECIAL DOUBLE ACTION ONLY SEMI-AUTO PISTOL** serial #EKW4651, 45 ACP, 3 1/4" barrel with an excellent, bright bore. The metal surfaces rate very good plus and retain about 97% of their factory original matte black finish, exhibiting only a few minor light handling marks and some faint general fading. The dimpled black rubber factory standard Hogue grips rate excellent and exhibit only negligible faint signs of handling. The pistol features a set of white three-dot fixed iron sights, as well as a left side slide mounted decocker safety. Included with the pistol are one 6 round stainless steel magazine with finger extension floorplate, chamber flag, lock and key, manual and papers, and the factory original hardcase. (136520-1476) [Richard "Stretch" Kennedy Collection] (300/500)
2832. **SMITH & WESSON MODEL 22A "FRIENDS OF NRA" LIMITED EDITION SEMI-AUTO PISTOL** serial #UAR4328, 22 LR, 5 1/2" barrel with an excellent, bright bore. The metal surfaces rate excellent and retain 98% plus of their factory original matte blued finish. The smooth black hard plastic and rubber grips rate excellent to like-new and exhibit no discernible handling marks. The pistol features a fixed blade front and adjustable rear set of iron sights. In addition, the pistol also features an integral optic mounting rail. Included with the pistol are two 10 round stainless steel magazines, trigger lock, manual and papers, and the factory original hardcase. Markings on the left side of the frame identify the pistol as unit 464 of 550 of this limited edition NRA model run. (136520-2982) [Richard "Stretch" Kennedy Collection] (200/400)
2833. **HAMMERLI TRAILSIDE SEMI-AUTO PISTOL IMPORTED BY SIG ARMS** serial #E0014661, 22 LR, 4 1/2" barrel with an excellent, bright bore. The metal surfaces rate excellent to like-new and retain about 98% of their factory original two-tone finish. The smooth blue and black finished wooden grips feature thumb rests and rate excellent, exhibiting no discernible handling marks. The pistol features a fixed front and adjustable rear set of iron sights, as well as a manual slide safety. Included with the pistol are one 10 round magazine, factory shot and cased target, manual, and the factory original hardcase. (136520-1327) [Richard "Stretch" Kennedy Collection] (350/550)
2834. **SMITH & WESSON MODEL 10-9 DOUBLE ACTION REVOLVER** serial #CCK0300, 38 Special, 4" barrel with an excellent, bright bore. The metal surfaces rate excellent and retain about 98% of their factory original blued finish, exhibiting no readily discernible handling marks. The 6 shot fluted cylinder rates near excellent and retains about 98% of its factory original blued finish, but does exhibit a faint turn ring. The checkered black rubber Uncle Mike's combat grips rate excellent and exhibit only extremely negligible faint signs of handling. The revolver features a set of fixed iron sights. Included with the revolver are a trigger lock, manual and papers, and the factory original hardcase which displays some damage to its right portion. (136520-1040) [Richard "Stretch" Kennedy Collection] (300/500)
2835. **SMITH & WESSON MODEL 10-7 DOUBLE ACTION REVOLVER** serial #4D75924, 38 Special, 4" pinned barrel with an excellent, bright bore. The metal surfaces rate near excellent and retain about 95% of their blued finish, but do exhibit some minor light general handling marks. The 6 shot fluted cylinder rates near excellent and retains about 90% of its blued finish, but does exhibit some minor light scratches, as well as a slight turn ring. The checkered walnut grips are numbered to the revolver and rate very good plus, exhibiting only some light handling wear. The revolver features a set of fixed iron sights and includes a factory box. (136520-2978) [Richard "Stretch" Kennedy Collection] (250/450)
2836. **SMITH & WESSON MODEL 10-5 DOUBLE ACTION REVOLVER** serial #C709754, 38 Special, 6" pinned barrel with a very good, bright bore which exhibits some light oxidation throughout the length of the barrel. The metal surfaces rate very good and retain about 80% of their blued finish, but do exhibit some minor light oxidation blemishes and general fading, as well as light silvering along edges and around the muzzle. The 6 shot fluted cylinder rates very good and retains about 80% of its blued finish, but does exhibit some light silvering, scratches, and general fading, as well as a light turn ring. The checkered black rubber Pachmayr grips rate very good plus and exhibit only some light signs of handling. The revolver features a set of fixed iron sights. (136520-1403) [Richard "Stretch" Kennedy Collection] (150/250)
2837. **SMITH & WESSON MODEL 12-3 DOUBLE ACTION REVOLVER** serial #4D18750, 38 Special, 4" pinned barrel with an excellent, bright bore. The metal surfaces rate excellent and retain about 97% of their factory original blued finish. The 6 shot fluted cylinder rates excellent and retains about 98% of its factory original blued finish, exhibiting only an extremely faint turn ring. The checkered walnut grips are numbered to the revolver and rate very good, but do exhibit light wear and handling marks. The revolver features a set of fixed iron sights. Included with the revolver are a manual and papers, as well as the factory original box. (136520-1420) [Richard "Stretch" Kennedy Collection] (250/450)
2838. **SMITH & WESSON MODEL 12-2 DOUBLE ACTION REVOLVER** serial #D242169, 38 Special, 4" pinned barrel with an excellent, bright bore. The metal surfaces rate excellent to like-new and retain 98% plus of their factory original blued finish. The 6 shot fluted cylinder rates excellent to like-new and retains about 99% of its blued finish, exhibiting no discernible signs of a turn ring. The checkered walnut grips are numbered to the revolver and excellent to like-new, exhibiting no discernible marks. The revolver features a set of fixed iron sights. Included with the revolver is the factory original box. (136520-291) [Richard "Stretch" Kennedy Collection] (250/450)

2839. **HARRINGTON & RICHARDSON "SPORTSMAN" TOP BREAK DOUBLE ACTION REVOLVER** serial #D9567, 22 LR, 6" barrel with an excellent, bright bore. The metal surfaces rate very good plus and retain about 97% of their factory original blued finish, exhibiting only an isolated area of faint oxidation blemishing along the left side of the frame near the grip and some minor light scratches. The 9 shot fluted cylinder rates excellent and retains 98% plus of its factory original blued finish, with only faint signs of a developing turn ring. The checkered walnut grips rate very good plus, but do exhibit some worn checkering and other light handling marks. The revolver features a set of fixed iron sights. (136520-2124) [Richard "Stretch" Kennedy Collection] {C&R} (200/400)
2840. **WALTHER PPK SEMI-AUTO PISTOL** serial #A009435, 380 ACP, 3 1/4" barrel with an excellent, bright bore. The stainless steel metal surfaces rate excellent and display no discernible handling marks. The checkered black synthetic grips likewise rate excellent and similarly exhibit no discernible handling marks. The pistol features a set of orange post-and-dot fixed iron sights, as well as a decocker safety. Included with the pistol are two 6 round stainless steel magazines (one of which features a finger extension floorplate), manual and papers, and factory original fitted leather hardcase. The single action does function, but requires some mechanical attention as the hammer will not engage upon the initial trigger pull. (136520-3282) [Richard "Stretch" Kennedy Collection] (300/500)
2841. **COLT POCKET POSITIVE DOUBLE ACTION REVOLVER** serial #149581, 32 Police, 2 1/2" barrel with an excellent, bright bore. The metal surfaces on this Second Issue rate very good plus and retain 90% plus of their reblued finish, but do exhibit some areas of minor light oxidation staining as well as some general light fading. The 6 shot fluted cylinder rates very good and retains about 85% of its reblued finish, but does exhibit some light oxidation and minor light scratches, as well as a faint turn ring. The checkered brown hard rubber Colt grips rate very good, but do exhibit several minor light scratches as well as a small chip missing from the base of the right panel. The revolver features a half-moon front and notch rear set of fixed iron sights. Included with the revolver is a non-Colt box which is labeled to the revolver. It should be noted that the cylinder exhibits some timing issues and does not always lock-up properly, but does lock up strongly when the hammer is cocked. (136520-4004) [Richard "Stretch" Kennedy Collection] (100/200)
2842. **SMITH & WESSON PRE-WAR .32 REGULATION POLICE DOUBLE ACTION REVOLVER** serial #417351, 32 S&W, 4 1/4" pinned barrel with a very good, bright bore which exhibits scattered lighting oxidation throughout the length of the barrel. The metal surfaces rate very good plus and retain about 90% of their applied parkerized finish, exhibiting several minor light scratches. The 6 shot fluted cylinder rates very good plus and retains about 95% of its applied parkerized finish, but does exhibit a slight turn ring. The checkered walnut grips rate very good plus, but do display some light scratches, predominantly along the bases. The revolver features a half-moon front and U-notch rear set of fixed iron sights (136520-1412) [Richard "Stretch" Kennedy Collection] {C&R} (300/500)
2843. **SMITH & WESSON POST-WAR .38/32 TERRIER "PRE-MODEL 32" DOUBLE ACTION REVOLVER** serial #56461, 38 S&W, 2" pinned barrel with an excellent, bright bore. The metal surfaces rate very good plus and retain 90% plus of their blued finish, but do exhibit some light silvering around the muzzle and top strap, as well as general light fading. The 5 shot fluted cylinder rates very good plus and retains about 85% of its blued finish, but does exhibit silvering as well as a light turn ring. The checkered walnut grips are numbered to the revolver and rate very good plus, exhibiting only a few minor light handling marks. The revolver features a half-moon front and U-notch rear set of fixed iron sights. The four screw frame configuration identifies this particular Terrier as having been produced between 1953 and 1954. (136520-1203) [Richard "Stretch" Kennedy Collection] {C&R} (200/400)
2844. **COLT TROOPER 357 DOUBLE ACTION REVOLVER** serial #57168, 357 Magnum, 4" barrel with an excellent, bright bore. The metal surfaces rate near very good and retain 60% plus of their factory original blued finish, but do exhibit considerable fading as well as some light oxidation blemishes. The 6 shot fluted cylinder rates near very good and retains about 60% of its factory original blued finish, but does exhibit silvering, fading, and some light oxidation blemishes, as well as a light turn ring. The checkered walnut Colt target grips rate very good plus and exhibit only a few minor light dings along the grip bases. The revolver features a ramp front and adjustable rear set of fixed iron sights, as well as a non-standard wide hammer. Colt factory records indicate that this particular Trooper model was produced in 1966. (136520-2598) [Richard "Stretch" Kennedy Collection] (200/400)
2845. **COLT MUSTANG POCKETLITE SEMI-AUTO PISTOL** serial #PL17042, 380 ACP, 2 3/4" barrel with a very good plus, bright bore. The metal surfaces rate very good plus and retain about 90% of their blued finish, but do exhibit silvering along edges and general fading as well as an isolated area of minor light oxidation freckling along the rear right side of the slide. The checkered black synthetic Colt grips rate very good, but exhibit several light scratches as well as a few areas of slightly worn checkering. The pistol features a set of fixed iron sights. Included with the pistol are one 5 round blued magazine, papers, and a factory hardcase. (136520-976) [Richard "Stretch" Kennedy Collection] (300/500)
2846. **COLT MUSTANG POCKETLITE SEMI-AUTO PISTOL** serial #PL57382, 380 ACP, 2 3/4" barrel with a very good bore which displays dark oxidized grooves. The stainless steel metal surfaces rate very good, but do exhibit several light scratches. The checkered black synthetic Colt grips rate very good plus, exhibiting only a few areas of slightly worn checkering. The pistol features a fixed front and fixed white two dot rear set of iron sights. Included with the pistol is a single 5 round stainless steel. (136520-3320) [Richard "Stretch" Kennedy Collection] (200/400)
2847. **RUGER SPEED SIX DOUBLE ACTION REVOLVER** serial #159-86983, 357 Mangum, 2 3/4" barrel with an excellent, bright bore. The stainless steel metal surfaces rate very good but exhibit several light scratches. The 6 shot stainless steel cylinder rates very good plus and exhibits only a bright turn ring. The checkered walnut grips rate very good, but do exhibit some light scratches as well as some worn checkering. The revolver features a ramp front and notch rear set of fixed iron sights. Ruger factory records indicate that this particular Speed Six was produced in 1984. (136520-2160) [Richard "Stretch" Kennedy Collection] (200/400)
2848. **SMITH & WESSON MODEL 640-1 DOUBLE ACTION ONLY REVOLVER** serial #CCD7744, 357 Magnum, 2 1/8" barrel with an excellent, bright bore. The stainless steel metal surfaces rate excellent and exhibit no discernible handling marks. The 5 shot stainless steel cylinder rates excellent and exhibits only an extremely faint turn ring. The checkered black rubber Uncle Mike's Combat grips rate very good plus, but do exhibit a few light scratches. The revolver features a ramp front and U-notch rear set of fixed iron sights. (136520-2947) [Richard "Stretch" Kennedy Collection] (250/450)
2849. **ISSC M22 SEMI-AUTO PISTOL** serial #ABB647, 22 LR, 4" barrel with an excellent, bright bore. The metal surfaces rate excellent and retain 98% plus of their factory original blued finish, exhibiting no discernible handling marks. The stippled, finger-grooved black polymer grips feature thumb rests and rate near excellent, exhibiting only negligible extremely light signs of handling. The pistol features a fixed white block front and adjustable white-outline rear set of iron sights. In addition, the pistol also features an ambidextrous decocker safety, and integral picatinny frame mount for lights and lasers. Included with the pistol are one 10 round magazine, manual, and the factory original hardcase. (136520-334) [Richard "Stretch" Kennedy Collection] (200/300)



2850. **NORTH AMERICAN ARMS NAA PUG SINGLE ACTION REVOLVER** serial #PG14299, 22 Magnum, 1" barrel with a near excellent, bright bore. The stainless steel metal surfaces rate excellent to like-new and exhibit no discernible signs of handling. The 5 shot stainless steel fluted cylinder rates excellent and exhibits only an extremely faint turn ring. The oversized pebble textured rubber grips rate excellent and exhibit only negligible faint signs of handling. The revolver features a Trijicon tritium dot front and post rear set of fixed iron sights. Included with the revolver are the manual and papers, factory test-fired cartridge, 22 LR conversion cylinder, and the factory original hardcase. The 5 shot stainless steel non-fluted conversion cylinder rates excellent and exhibits only an extremely faint turn ring. (136520-788) [Richard "Stretch" Kennedy Collection] (150/250)
2851. **NORTH AMERICAN ARMS NAA .22 MAGNUM SINGLE ACTION REVOLVER** serial #W13589, 22 Magnum, 1 5/8" barrel with a very good plus, bright bore which displays some slightly dark grooves. The stainless steel metal surfaces rate excellent and exhibit only a few minor light signs of use. The 5 shot stainless steel fluted cylinder rates excellent and exhibits only a light turn ring. The smooth rosewood grips rate excellent and exhibit no discernible signs of handling. The revolver features a half-moon front and notch rear set of fixed iron sights. Included with the revolver is a 22 LR conversion cylinder. The 5 shot stainless steel fluted conversion cylinder rates excellent and exhibits only a faint turn ring. (136520-675) [Richard "Stretch" Kennedy Collection] (100/200)
2852. **NORTH AMERICAN ARMS NAA .22 MAGNUM SINGLE ACTION REVOLVER** serial #W38412, 22 Magnum, 1 1/8" barrel with a near excellent, bright bore. The stainless steel metal surfaces rate excellent and exhibit only a few minor light signs of use. The 5 shot stainless steel fluted cylinder rates excellent and exhibits only a few minor faint wear marks and a light turn ring. The smooth rosewood grips rate excellent and exhibit no discernible signs of handling. The revolver features a half-moon front and notch rear set of fixed iron sights. (136520-1011) [Richard "Stretch" Kennedy Collection] (75/150)
2853. **NORTH AMERICAN ARMS NAA .22 MAGNUM SINGLE ACTION REVOLVER** serial #E104092, 22 Magnum, 1 1/8" barrel with a very good plus, bright bore which displays some slightly dark grooves. The stainless steel metal surfaces rate excellent and exhibit only a few minor light signs of use. The 5 shot stainless steel fluted cylinder rates excellent and exhibits only a few minor faint handling marks and a light turn ring. The smooth rosewood grips rate near excellent and exhibit only a few minor light scratches. The revolver features a half-moon front and notch rear set of fixed iron sights. Included with the revolver are a factory test-fired cartridge, lock and key, manual and papers, brown leather holster, black leather softcase, and the factory original box. (136520-970) [Richard "Stretch" Kennedy Collection] (100/200)
2854. **FREEDOM ARMS MINI-REVOLVER SINGLE ACTION REVOLVER** serial #A70917, 22 LR, 1 1/4" barrel with a near excellent, mostly bright bore. The stainless steel metal surfaces rate very good plus but do exhibit some light verdigris and oxidation buildup around the front sight as well as a few general light use-related marks. The 5 shot stainless steel fluted cylinder rates excellent and exhibits only a few minor faint handling marks and a light turn ring. The smooth rosewood grips rate near excellent and exhibit only a few minor light scratches. The revolver features a ramp front and notch rear set of fixed iron sights. Included with the revolver is a brown leather holster with belt clip. (136520-2063) [Richard "Stretch" Kennedy Collection] (75/150)
2855. **CHARTER ARMS MODEL 79K SEMI-AUTO PISTOL** serial #C000019, 380 ACP, 3 1/2" barrel with an excellent, bright bore. The stainless steel metal surfaces rate very good plus and exhibit only some minor light handling marks. The checkered walnut grips rate very good plus but do exhibit some minor light worn checkering. The pistol features a set of fixed iron sights as well as a left side slide mounted manual safety. Included with the pistol are one 7 round stainless steel magazine with finger extension floorplate, manual and papers, and the factory original box. (136520-4043) [Richard "Stretch" Kennedy Collection] (150/250)
2856. **COLT COBRA DOUBLE ACTION REVOLVER** serial #B76363, 38 Special, 2" barrel with an excellent, bright bore. The metal surfaces rate near very good and retain about 80% of their factory original blued finish, exhibiting considerable bright silvering as well as a couple of minor light scratches. The 6 shot fluted cylinder rates near very good and retains about 80% of its factory original blued finish, exhibiting considerable bright silvering but only a faint turn ring. The checkered walnut grips rate very good plus and display only some faded checkering. The revolver features a set of fixed iron sights. Colt factory records indicate that this particular model was produced in 1971. (136520-2907) [Richard "Stretch" Kennedy Collection] (150/250)
2857. **BERETTA MODEL 20 SEMI-AUTO PISTOL** serial #01035, 25 ACP, 2 1/2" barrel with an excellent, bright bore. The metal surfaces rate very good plus and retain about 90% of their blued finish, but do exhibit some light fading as well as a few isolated instances of minor light oxidation. The checkered black synthetic grips rate near very good, but do exhibit several light scratches as well as some dings. The pistol features a set of fixed iron sights as well as a left side frame mounted manual safety. Included with the pistol is a single 9 round blued magazine. (136520-1489) [Richard "Stretch" Kennedy Collection] (75/150)
2858. **BERETTA MODEL 950BS SEMI-AUTO PISTOL** serial #BER77110Y, 22 Short, 2 1/2" barrel with an excellent, bright bore. The metal surfaces rate excellent and retain about 98% of their blued finish. The checkered black synthetic grips rate near very good plus, but do exhibit a few minor light scratches. The pistol features a set of fixed iron sights as well as a left side frame mounted manual safety. Included with the pistol are three 6 round blued magazines. (136520-3869) [Richard "Stretch" Kennedy Collection] (75/150)
2859. **NORTH AMERICAN ARMS NAA .22 LR SINGLE ACTION REVOLVER** serial #C33098, 22 LR, 1 1/8" barrel with a dark, oxidized bore. The stainless steel metal surfaces rate near very good but have become dirtied with age and use. The 5 shot stainless steel fluted cylinder rates very good but exhibits some light oxidation staining as well as a light turn ring. The smooth black plastic grips rate good but exhibit numerous light scratches as well as a few extensive cracks which permeate the right side panel. The revolver features a set of fixed iron sights. (136520-1210) [Richard "Stretch" Kennedy Collection] (50/100)
2860. **FREEDOM ARMS MINI-REVOLVER .22 LR SINGLE ACTION REVOLVER** serial #A37223, 22 LR, 1 1/4" barrel with a somewhat dark, oxidized bore. The stainless steel metal surfaces rate near very good but have become slightly faded with age as well as exhibiting some light scratch marks. The 5 shot stainless steel fluted cylinder rates very good but exhibits some light oxidation staining as well as a faint turn ring. The smooth black plastic grips rate good but exhibit numerous light scratches and dings along both panels. The revolver features a fixed notch rear sight; however, the fixed front sight has since fallen off. (136520-434) [Richard "Stretch" Kennedy Collection] (50/100)
2861. **SMITH & WESSON MODEL 38 AIRWEIGHT DOUBLE ACTION REVOLVER** serial #J881392, 38 Special, 2" pinned barrel with an excellent, bright bore. The metal surfaces rate excellent and retain about 98% of their factory original nickel plated finish. The 5 shot fluted cylinder rates excellent and retains 98% plus of its factory original nickel plating, exhibiting only an extremely faint turn ring. The checkered walnut grips rate excellent and exhibit no discernible signs of handling. The revolver features a ramp front and U-notch rear set of fixed iron sights, as well as a shrouded hammer. Included with the revolver are cleaning tools, manual and papers, and the factory original box. (136520-3971) [Richard "Stretch" Kennedy Collection] (200/400)

2862. **SMITH & WESSON MODEL 36-1 DOUBLE ACTION REVOLVER** serial #J913848, 38 Special, 3" heavy barrel with an excellent, bright bore. The metal surfaces rate excellent and retain 98% plus of their factory original nickel plated finish, exhibiting no discernible handling marks. The 5 shot fluted cylinder rates excellent and retains about 99% of its factory original nickel plating, exhibiting only an extremely faint turn ring. The checkered walnut grips rate near excellent and exhibit only a couple of minor light scuffs. The revolver features a ramp front and U-notch rear set of fixed iron sights. Included with the revolver are a manual and papers, and the factory original box. (136520-2559) [Richard "Stretch" Kennedy Collection] (300/500)
2863. **RUGER "OLD MODEL" SUPER BEARCAT SINGLE ACTION REVOLVER** serial #91-21658, 22 LR, 4" barrel with an excellent, bright bore. The metal surfaces rate near very good and retain about 40% of their factory original blued finish, but do exhibit considerable fading from holster wear as well as some light silvering around the muzzle and along edges; in addition, the top strap displays some light pitting. The 6 shot non-fluted cylinder rates near very good and retains about 30% of its factory original blued finish, although exhibiting considerable fading as well as some light pitting and a bright turn ring. The overall acquired state of the metal surfaces lends an authentic antique appearance to this modern production revolver, which functions like-new. Despite condition, the engraved scene along the cylinder maintains most of its fine detail. The smooth walnut grips rate excellent and exhibit no discernible handling marks. The revolver features a blade front and U-notch rear set of fixed iron sights. Included with the revolver are the manual and the factory original box. Ruger factory records indicate that this particular Super Bearcat was produced in 1971. (136520-1281) [Richard "Stretch" Kennedy Collection] (75/150)
2864. **RUGER NEW BEARCAT SINGLE ACTION REVOLVER** serial #93-23497, 22 LR, 4 1/4" barrel with an excellent, bright bore. The metal surfaces rate excellent and retain about 99% of their factory original blued finish. The 6 shot non-fluted cylinder rates excellent and retains about 98% of its factory original blued finish, with the factory engraved wildlife scene rating excellent and exhibiting no sign of fading; the cylinder does exhibit a light turn ring. The smooth walnut grips rate excellent and exhibit no handling marks. The revolver features a blade front and U-notch rear set of fixed iron sights. Included with the revolver are a manual and the factory original hardcase. (136520-1341) [Richard "Stretch" Kennedy Collection] (250/450)
2865. **CONSECUTIVELY NUMBERED RUGER "OLD MODEL" SUPER SINGLE SIX SINGLE ACTION REVOLVER** serial #521595, 22 LR, 6 1/2" barrel with an excellent, bright bore. The metal surfaces rate excellent and retain 98% plus of their blued finish, exhibiting no readily discernible handling marks. The 6 shot fluted cylinder rates very good plus and retains about 97% of its blued finish, exhibiting no visible light turn ring. The smooth walnut grips rate very good, but does exhibit a few minor light scratches as well as a scuff along the right side panel. The revolver features a partridge front and adjustable rear set of iron sights. Included with the revolver are an additional 22 Magnum cylinder, manual and papers, and the factory original box. The additional cylinder rates near excellent and retains 98% plus of its factory reblued finish, exhibiting no visible turn ring but does have a few isolated instances of sparse light pitting as well as a few areas of minor faint oxidation. Ruger factory records indicate that this particular Super Single Six was produced in 1966. The revolver has been converted to the transfer bar safety and includes factory documentation attesting to such; however, the original parts are included with the lot should one wish to reconvert the revolver. This revolver is consecutively numbered to the next lot. (136520-2570) [Richard "Stretch" Kennedy Collection] (300/500)
2866. **CONSECUTIVELY NUMBERED RUGER "OLD MODEL" SUPER SINGLE SIX SINGLE ACTION REVOLVER** serial #521596, 22 LR, 6 1/2" barrel with an excellent, bright bore. The metal surfaces rate excellent and retain 98% plus of their blued finish, exhibiting no discernible handling marks. The 6 shot fluted cylinder rates very good plus and retains about 98% of its blued finish, but do exhibit a light turn ring. The smooth walnut grips rate very good plus, but does exhibit a few minor light scratches. The revolver features a partridge front and adjustable rear set of iron sights. Included with the revolver are an additional 22 Magnum cylinder, manual and papers, and the factory original box. The additional cylinder rates near excellent and retains 98% plus of its blued finish, exhibiting no visible turn ring and only a few minor light wear marks. Ruger factory records indicate that this particular Super Single Six was produced in 1966. The revolver maintains its original factory configuration and does not feature the converted transfer bar safety. This revolver is consecutively numbered to the previous lot. (136520-2569) [Richard "Stretch" Kennedy Collection] (300/500)
2867. **THOMPSON CENTER ENCORE PROHUNTER KATAHDIN PERCUSSION RIFLE** serial #PS6564, .50 cal Magnum, 20 1/2" fluted barrel with a near excellent, bright bore. The stainless steel metal surfaces rate very good, but do exhibit some minor light marks along the barrel. The ribbed black synthetic and rubber forearm rate very good plus, exhibiting only some minor light handling marks. The finger grooved black synthetic and rubber Monte Carlo stock rates very good, but does exhibit several light handling marks as well as some minor light wear. The stock features a Limbsaver recoil pad, which brings the length of pull to 15". The rifle features a red fiber optic front and Williams adjustable peep aperture rear sight, as well as sling mount studs. Included with the rifle are its ramrod, lock and key, and the factory original box. (137006-6) (ANTIQUÉ) (200/400)
2868. **BARREL LOT** Consists of a single Thompson Center ProHunter Katahdin 500 S&W Mag, 20" fluted barrel with an excellent, bright bore. The stainless steel metal surfaces rate very good plus but do exhibit several light handling and wear marks. The ribbed black synthetic and rubber forearm rate very good plus, exhibiting only a few minor faint handling marks. The barrel features a green fiber optic front and Williams adjustable peep aperture rear sight. (137006-6A)
2869. **AMMUNITION LOT** Consists of one box of Winchester 500 S&W ammo. The box of Winchester ammunition contains a 20 count of 40 Grain nickel cased 500 S&W platinum tip hollow point cartridges. All of the rounds rate excellent and remain unfired. (137006-7)
2870. **BROWNING CHALLENGER III SEMI-AUTO PISTOL** serial #655PX28615, 22 LR, 6 3/4" barrel with an excellent, bright bore. The metal surfaces rate very good plus and retain about 96% of their factory original blued finish but do exhibit some faint oxidation staining as well as a few minor light handling marks. The smooth walnut grips rate near excellent but do exhibit some minor light handling marks. The pistol features a set of adjustable iron sights. Included with the pistol are one 10 round magazine, manual, and the factory original box. The serial number indicates that this particular Challenger model was produced in 1982. (136520-335) [Richard "Stretch" Kennedy Collection] (300/500)
2871. **KAHR P40 SEMI-AUTO PISTOL** serial #ZA6242, 40 S&W, 3 5/8" barrel with a near excellent, bright bore. The stainless steel metal surfaces rate excellent and exhibit no discernible handling marks. The textured black synthetic grips rate excellent and likewise lack any discernible signs of handling. The pistol features a set of fixed three-dot night sights, although their low-light functionality seems to have since worn out. Included with the pistol are two 6 round stainless steel magazines with finger extension floorplate, manual and papers, and the factory original hardcase. (136520-1288) [Richard "Stretch" Kennedy Collection] (300/500)
2872. **SMITH & WESSON MODEL SW40VE SIGMA SEMI-AUTO PISTOL** serial #PBK1043, 40 S&W, 4" barrel with an excellent, bright bore. The matte stainless steel metal surfaces rate near excellent, but do exhibit a few minor light scratches along the slide. The black synthetic frame with integrated checkered grips rates excellent and exhibit no discernible signs of handling. The pistol features a set of white three-dot fixed iron sights. Included with the pistol are two 10 round stainless steel magazines and the factory original hardcase. (136988-4) (300/500)

2873. **LEUPOLD SCOPE LOT** Consists of a single M8-2X 2x20mm extended eye relief optic. The metal surfaces rate very good plus and retain about 97% of their factory original gloss black finish, but do exhibit some minor light scratches. The optic features a duplex reticle which displays a crisp clear sight picture. (136520-4045A)
2874. **SMITH & WESSON MODEL 37 AIRWEIGHT DOUBLE ACTION REVOLVER** serial #195853, 38 Special, 1 7/8" pinned barrel with an excellent, bright bore. The metal surfaces rate very good plus and retain about 97% of their factory original blued finish, but do exhibit some minor light fading. The 5 shot fluted cylinder rates very good plus and retains about 97% of its factory original blued finish, exhibiting only a few minor faint handling marks as well as a bright turn ring. The checkered walnut Smith & Wesson grips are numbered to the revolver and rate near excellent, exhibiting only a few minor faint handling marks. The revolver features a ramp front and U-notch rear set of fixed iron sights; additionally, the revolver also features an early flatlatch cylinder release. Included with the revolver is a factory box which is marked to the gun. (137024-10) (200/300)
2875. **HIGH STANDARD MODEL HS1911-A1 SEMI-AUTO PISTOL BY ARMSCOR** serial #HS1001044, 45 ACP, 5" barrel with an excellent, bright bore. The metal surfaces rate very good plus and retain about 80% of their factory original parkerized finish, but do exhibit substantial light fading particularly along the slide and underside of the frame. The checkered walnut grips rate very good plus but do exhibit some areas of minor, slightly worn checkering. The pistol features a set of standard military fixed iron sights. Included with the pistol are a single 7 round blued magazine, factory test-fired cartridge, manual and papers, and the factory hardcase. (136520-4377) [Richard "Stretch" Kennedy Collection] (200/300)
2876. **HIGH STANDARD MODEL M-101 "DURA-MATIC" SEMI-AUTO PISTOL** serial #1099985, 22 LR, 6 1/2" barrel with an excellent, bright bore. The metal surfaces rate very good and retain about 90% of their factory original blue finish, but do exhibit considerable light fading, silvering around the muzzle and along edges, and some light oxidation developing along the rear portion and back of the slide. The checkered brown plastic grips rate near excellent and display only a few extremely minor light scratches as well as other negligible faint signs of handling. The pistol features a blade front and post rear set of fixed iron sights. Included with the pistol is a single 10 round magazine. The "Dura-Matic" line of pistols featuring the M-101 designation were manufactured between 1953 and 1970, with High Standard factory records indicating that this particular example was produced in 1959. (137024-19) {C&R} (100/200)
2877. **WALTHER PP SEMI-AUTO PISTOL** serial #471306, 32 ACP, 3 15/16" barrel with an excellent, bright bore. The metal surfaces rate very good and retain about 70% of their factory original blued finish, but do exhibit substantial light to bright silvering. The checkered black synthetic grips rate very good plus but do exhibit some minor light wear and handling marks. The pistol features a white post-and-dot set of fixed iron sights, as well as a left side slide mounted decocker safety. The bottom of the grip also features a lanyard loop. The slide will occasionally fail to lock-back and may need mechanical repair. Included with the pistol are two 8 round magazines with finger extension floorplates, cleaning rod, manual, and the factory original hardcase. (136520-4338) [Richard "Stretch" Kennedy Collection] (200/300)
2878. **WALTHER TPH SEMI-AUTO PISTOL BY INTERARMS** serial #G000318, 25 ACP, 2 13/16" barrel with an excellent, mostly bright bore. The metal surfaces rate near excellent and retain about 98% of their factory original finish, exhibiting only minor light silvering along some edges. The checkered black synthetic grips rate near excellent, but do exhibit some minor light handling marks. The pistol features a white dot front and post rear set of fixed iron sights, as well as a left side slide mounted decocker safety. Included with the pistol are two 6 round stainless steel magazines with finger extension floorplates, manual and papers, and a factory hardcase. (136520-4337) [Richard "Stretch" Kennedy Collection] (200/400)
2879. **WALTHER PP SEMI-AUTO PISTOL IMPORTED BY INTERARMS** serial #35494LR, 22 LR, 3 7/8" barrel with an excellent, bright bore. The metal surfaces rate very good plus and retain about 90% of their factory original blued finish, but do exhibit some minor light handling marks as well as considerable loss of finish along the front and back straps of the grip. The checkered black synthetic grips rate excellent and lack any discernible signs of handling. The pistol features a set of white post-and-dot fixed iron sights, as well as a left side slide mounted decocker safety. Included with the pistol are a single 10 round blued magazine and the factory original hardcase. (136520-4415) [Richard "Stretch" Kennedy Collection] (300/500)
2880. **SMITH & WESSON MODEL 12-3 AIRWEIGHT DOUBLE ACTION REVOLVER** serial #5D79660, 38 Special, 4" pinned barrel with an excellent, bright bore. The metal surfaces rate excellent and retain about 98% of their factory original blued finish, exhibiting only a faint turn ring along the 6 shot fluted cylinder. The checkered walnut grips are numbered to the revolver and rate near excellent, exhibiting only a few minor light handling marks. The revolver features a ramp front and U-notch rear set of fixed iron sights. Included with the revolver are a manual and papers, and the factory original box. (136520-4390) [Richard "Stretch" Kennedy Collection] (250/450)
2881. **SMITH & WESSON MODEL 66-1 DOUBLE ACTION REVOLVER** serial #69K5358, 357 Magnum, 4" pinned barrel with an excellent, bright bore. The stainless steel metal surfaces rate very good plus, exhibiting only a few minor faint handling marks as well as an area of bright wear along the right side of the barrel; the 6 shot fluted cylinder also exhibits some light marks in addition to a bright turn ring. The checkered walnut target grips rate very good but do exhibit several instances of noticeable light wear, as well as a slight cracked area in the right grip panel which measures approximately 1/2". The pistol features a fixed red-insert ramp front and white-outline adjustable rear set of iron sights. Included with the revolver are a manual and papers, and the factory original box. (136520-4440) [Richard "Stretch" Kennedy Collection] (200/400)
2882. **SMITH & WESSON MODEL 66-1 DOUBLE ACTION REVOLVER** serial #55K3375, 357 Magnum, 6" pinned barrel with an excellent, bright bore. The stainless steel metal surfaces rate very good plus, exhibiting only some minor faint-to-light handling marks and wear along the barrel; the 6 shot fluted cylinder also exhibits a few minor faint marks in addition to a light turn ring. The checkered walnut target grips rate excellent and exhibit no readily discernible signs of handling. The pistol features a fixed red-insert ramp front and adjustable rear set of iron sights. Included with the revolver are a cleaning kit and screwdriver, manual and papers, and the factory original box. (136520-4427) [Richard "Stretch" Kennedy Collection] (250/450)
2883. **RUGER P97DC SEMI-AUTO PISTOL** serial #663-00052, 45 ACP, 4" barrel with an excellent, bright bore. The stainless steel metal surfaces rate near excellent and exhibit only some minor light wear. The ribbed black synthetic grip rates excellent and exhibits no discernible handling marks. The pistol features a set of white three-dot iron sights, as well as an ambidextrous decocker. Included with the pistol are two 8 round stainless steel magazines, assist loader, lock, manual, and the factory original hardcase. (137007-2) (200/400)
2884. **WALTHER TPH SEMI-AUTO PISTOL BY INTERARMS** serial #T001435, 22 LR, 2 3/4" barrel with an excellent, bright bore. The stainless steel metal surfaces rate very good plus, but do exhibit several minor light scratches along the slide. The checkered black synthetic grips rate near excellent and exhibit only a couple of minor light scratches. The pistol features a set of orange post-and-dot fixed iron sights, as well as a left side slide mounted decocker safety. Included with the pistol is a single 6 round stainless steel magazine with finger-rest extension. (136520-4229) (250/450)



2885. **IVER JOHNSON TARGET MODEL 55 DOUBLE ACTION REVOLVER** serial #H5104, 22 LR, 4 1/2" barrel with an excellent, bright bore. The metal surfaces rate very good plus and retain about 95% of their factory original blued finish, but do exhibit some minor fading as well as noticeable marks from wear along the 8 shot non-fluted cylinder. The checkered brown synthetic grip with thumbrest rates near excellent, but does exhibit a few minor light handling marks. The revolver features a ramp front and notch rear set of fixed iron sights. Included with the pistol are a non-original green leather factory box and manual. (136940-274) {C&R} (100/200)
2886. **IVER JOHNSON TRAILSMAN SEMI-AUTO PISTOL** serial #FG07782, 4" barrel with an excellent, bright bore. The metal surfaces rate excellent and retain about 98% of their factory original blued finish, exhibiting no discernible handling marks. The checkered black synthetic grips rate excellent to like-new and exhibit no discernible signs of handling. The pistol features a set of fixed iron sights, as well as a left side frame mounted slide safety. Included with the pistol are a single 10 round magazine, manual and papers, and the factory original box. (136940-244) (200/300)
2887. **IVER JOHNSON MODEL X300 PONY SEMI-AUTO PISTOL** serial #0913US, 380 ACP, 3" barrel with an excellent, bright bore. The metal surfaces rate very good plus and retain about 90% of their factory original blued finish, but do exhibit general light fading as well as some minor light scratches and silvering around the muzzle. The checkered walnut grips rate very good plus but do exhibit some slightly worn checkering. The pistol features a fixed front and adjustable rear set of iron sights, as well as a left side frame mounted slide safety and a lanyard loop on the bottom of the grip. Included with the pistol are a four 6 round magazines, and a factory box. (136940-282) (200/300)
2888. **IVER JOHNSON TP22 SEMI-AUTO PISTOL** serial #AE52116, 2 7/8" barrel with an excellent, bright bore. The metal surfaces rate near excellent and retain about 95% of their factory original blued finish, exhibiting only a few minor light handling marks and fading concentrated on the front strap. The checkered black synthetic grips rate excellent and exhibit no discernible handling marks. The pistol features a set of fixed iron sights, as well as a left side slide mounted safety. Included with the pistol are a single 7 round magazine with finger-rest extension, and the factory original box. (136940-246) (150/250)
2889. **IVER JOHNSON MODEL 50SD SIDEWINDER "S" DOUBLE ACTION REVOLVER** serial #E30519, 22 LR / 22 Mag, 4 3/4" barrel with an excellent, bright bore. The metal surfaces rate very good plus and retain about 97% of their factory original blued finish, but do exhibit some minor faint scratches along the frame. The plastic imitation stag grips rate excellent and exhibit no discernible handling marks. The revolver features a set of adjustable iron sights and an 8 shot fluted cylinder. Included with the revolver are the factory original box and an additional 22 Mag cylinder. The 8 shot fluted cylinder rates excellent and retains about 98% of its factory original blued finish, exhibiting no discernible marks. (136940-273) (150/250)
2890. **IVER JOHNSON MODEL B224 BULLDOG DOUBLE ACTION REVOLVER** serial #K50199, 22 LR, 4 3/4" barrel with a very good plus, bright bore which displays some minor oxidation. The metal surfaces rate very good plus and retain about 97% of their factory original blued finish, exhibiting only a few minor faint scratches along the frame. The checkered brown synthetic grips feature a left side thumbrest and rate near excellent, but do exhibit some light scratches along the back strap and base. The revolver features a fixed ramp front and adjustable rear set of iron sights, as well as an 8 shot fluted cylinder. Included with the revolver are the factory original box and an ejector tool. (136940-276) (150/250)
2891. **IVER JOHNSON DOUBLE ACTION REVOLVER** serial #H97856, 22 LR, 4 3/4" barrel with a near excellent, bright bore. The metal surfaces rate very good plus and retain about 97% of their factory original blued finish, but do exhibit some minor faint scratches along the frame. The checkered brown synthetic grips feature a left side thumb-rest and rate near excellent, but do exhibit some light scratches along the back strap and base. The revolver features a blade front and notch rear set of fixed iron sights, as well as an 8 shot fluted cylinder. Included with the revolver is the factory original box. (136940-277) (150/250)
2892. **IVER JOHNSON MODEL 55S-A CADET DOUBLE ACTION REVOLVER** serial #H98615, 22 Mag, 2 1/2" barrel with an excellent, bright bore. The metal surfaces rate near excellent and retain about 97% of their factory original blued finish, but do exhibit some general light fading. The checkered black synthetic grips rate near excellent, exhibiting only a few negligible handling marks. The revolver features a ramp front and notch rear set of fixed iron sights, as well as an 8 shot fluted cylinder. Included with the revolver is the factory original box. (136940-250) (100/200)
2893. **IVER JOHNSON MODEL 55S-A CADET DOUBLE ACTION REVOLVER** serial #H98621, 22 Mag, 2 1/2" barrel with an excellent, bright bore. The metal surfaces rate very good plus and retain about 95% of their factory original blued finish, but do exhibit some general light fading and some minor light scratches along the frame. The checkered black synthetic grips rate near excellent, exhibiting only a few negligible handling marks. The revolver features a ramp front and notch rear set of fixed iron sights, as well as an 8 shot fluted cylinder. The revolver requires some mechanical attention, as the double action trigger pull currently fails to function. Included with the revolver is its factory original box. (136940-251) (75/150)
2894. **IVER JOHNSON MODEL 55S-A CADET DOUBLE ACTION REVOLVER** serial #H98613, 22 Mag, 2 1/2" barrel with an excellent, bright bore. The metal surfaces rate near excellent and retain about 97% of their factory original blued finish, but do exhibit some minor light fading. The checkered black synthetic grips rate excellent and exhibit no discernible handling marks. The revolver features a ramp front and notch rear set of fixed iron sights, as well as an 8 shot fluted cylinder. Included with the revolver is its factory original box. (136940-280) (100/200)
2895. **IVER JOHNSON MODEL 55S-A CADET DOUBLE ACTION REVOLVER** serial #H98623, 22 Mag, 2 1/2" barrel with an excellent, bright bore. The metal surfaces rate very good plus and retain about 96% of their factory original blued finish, but do exhibit some minor light fading as well as a few faint scratches. The checkered black synthetic grips rate excellent and exhibit no discernible handling marks. The revolver features a ramp front and notch rear set of fixed iron sights, as well as an 8 shot fluted cylinder. Included with the revolver is its factory original box. (136940-281) (100/200)
2896. **AMMUNITION LOT** Consists of a single box of 50 Action Express. The box of Samson Ultra ammo by Israeli Military Industries Ltd. contains its full 20 unfired rounds of 300 grain jacketed soft point cartridges. The ammunition and box rate excellent and exhibit no damage. (136520-2050A)
2897. **IVER JOHNSON MODEL 55S-A CADET DOUBLE ACTION REVOLVER** serial #G36361, 38 S&W, 2 1/2" barrel with an excellent, bright bore. The metal surfaces rate near very good and retain about 70% of their factory original blued finish, but exhibit considerable fading to a brown patina as well as light to bright silvering along edges. The smooth brown synthetic grips rate numerous light scratches as well as scuffs along the bases. The revolver features a blade front and notch rear set of fixed iron sights, as well as a 5 shot fluted cylinder. The revolver exhibits some noticeable play, but locks up when cocked. Included with the revolver is a manual and factory box. (136940-269) (50/150)

2898. **IVER JOHNSON TARGET MODEL 57A SPORTSMAN DELUXE DOUBLE ACTION REVOLVER** serial #J51423, 22 LR, 6" barrel with an excellent, bright bore. The metal surfaces rate near excellent and retain about 97% of their factory original blued finish, but do exhibit some minor light fading. The checkered brown synthetic grips feature a left side thumb rest and rate very good, but do exhibit a divot in the left side as well as some light scratches. The revolver features a set of adjustable iron sights; however, the rear sight post insert is missing from the revolver. In addition, the revolver also features an 8 shot fluted cylinder. Included with the revolver are a manual and papers, and the factory original box. (136940-264) (100/200)
2899. **IVER JOHNSON TARGET SEALED 8 FIRST MODEL DOUBLE ACTION REVOLVER** serial #M17862, 22 LR, 6" barrel with a very good plus, bright bore which displays some slightly darkened areas toward the cylinder. The metal surfaces rate near very good but retain only about 40% of their factory original blued finish, fading to a brown patina and exhibiting pewter along high edges and certain other areas; in addition to this fading, the metal surfaces exhibit several light scratches and other minor handling marks. The checkered walnut grips rate very good, but do exhibit slightly worn checkering, numerous light scratches, as well as a 7/8" crack and a 1 5/8" repaired crack running along the back strap. The revolver features a half-moon front and notch rear set of fixed iron sights, as well as an 8 shot fluted cylinder. Included with the revolver is a factory box. (136940-263) {C&R} (75/150)
2900. **IVER JOHNSON 22 SUPERSHOT SEALED EIGHT FIRST MODEL DOUBLE ACTION REVOLVER** serial #L17350, 22 LR, 6" barrel with a very good bore which displays darkened grooves. The metal surfaces rate near very good but have lost most of their factory original blued finish and now exhibiting a predominantly bright silver tone. The checkered walnut grips rate very good, but do exhibit worn checkering, some light scratches, and a negligible chip in the left side panel running along the front strap. The revolver features a half-moon front and notch rear set of fixed iron sights, as well as an 8 shot fluted cylinder. Included with the revolver is a factory box. (136940-262) {C&R} (50/150)
2901. **ROSSI M877 DOUBLE ACTION REVOLVER** serial #F447833, 357 Magnum, 2" barrel with a near excellent, bright bore which displays some stubborn residue toward the cylinder. The stainless steel metal surfaces rate very good plus, but do exhibit a few minor light scratches as well as some marks and a slight turn ring along the 6 shot fluted cylinder. The dimpled black rubber combat grips rate near excellent and exhibit only some minor light signs of handling-related wear. The revolver features a ramp front and notch rear set of fixed iron sights. (137075-S18409) (100/200)
2902. **POSTWAR-PRODUCTION WORLD WAR II GERMAN MILITARY HAT LOT** Consists of a single kepi-style field cap. The cap is comprised primarily of OD green wool with black accenting, featuring brown piping. The front of the cap displays a silver-colored Reichsadler medallion of the NSKK, translated as the National Socialist Motor Corps. The NSKK was a branch of the Nazi party which originated to train individuals in the operation and maintenance of motor vehicles, but from 1935 onward the NSKK also provided training for Panzer crews of the German Army. During wartime, the organization was folded into the transport corps of the various service branches. The cap also features a black leather chinstrap. The cap rates excellent and exhibits only some light wear. (135996-5A)
2903. **POSTWAR-PRODUCTION WORLD WAR II GERMAN MILITARY HAT LOT** Consists of a single kepi-style field cap. The cap is comprised primarily of OD green wool with black accenting, featuring brown piping. The front of the cap displays a silver-colored Reichsadler medallion of the NSKK, translated as the National Socialist Motor Corps. The NSKK was a branch of the Nazi party which originated to train individuals in the operation and maintenance of motor vehicles, but from 1935 onward the NSKK also provided training for Panzer crews of the German Army. During wartime, the organization was folded into the transport corps of the various service branches. The cap also features a black leather chinstrap. The cap rates excellent and exhibits only some negligible light wear. (135996-5B)
2904. **POSTWAR-PRODUCTION WORLD WAR II GERMAN MILITARY HAT LOT** Consists of a single kepi-style field cap. The cap is comprised of black fabric with silver piping. The front of the cap displays a silver-colored Reichsadler medallion as well as the SS Totenkopf (skull and crossbones). The label on the interior of the cap also displays the runic insignia of the Schutzstaffel (SS). The cap also features a black leather chinstrap. The cap rates excellent and exhibits no discernible signs of wear. (135996-5C)
2905. **POSTWAR-PRODUCTION WORLD WAR II GERMAN MILITARY HAT LOT** Consists of a single kepi-style field cap. The cap is comprised of black fabric with black-and-silver piping. The front of the cap displays a silver-colored Reichsadler medallion as well as the SS Totenkopf (skull and crossbones). The label on the interior of the cap also displays the runic insignia of the Schutzstaffel (SS). The cap also features a black leather chinstrap. The cap rates excellent and exhibits no discernible signs of wear. (135996-5D)
2906. **POSTWAR-PRODUCTION WORLD WAR II GERMAN MILITARY HAT LOT** Consists of a single Allgemeine SS officer's peaked cap. The cap is comprised of black wool with white piping. The front of the cap displays a silver-colored Reichsadler medallion as well as the SS Totenkopf (skull and crossbones). The label on the interior of the cap also displays the runic insignia of the Schutzstaffel (SS). The cap also features a black leather chinstrap. The cap rates excellent and exhibits no discernible signs of wear. (135996-5E)
2907. **POSTWAR-PRODUCTION WORLD WAR II GERMAN MILITARY HAT LOT** Consists of a single Wehrmacht panzer officer's peaked cap. The cap is comprised primarily of gray wool with dark bluish-green felt accenting, featuring pink piping. The front of the cap displays a silver-colored Reichsadler patch as well as a silver-colored wreath-and-cockade insignia patch. The cap also features a silver-colored bullion chincord. The cap rates excellent and exhibits no discernible signs of wear. (135996-5F)
2908. **POSTWAR-PRODUCTION WORLD WAR II GERMAN MILITARY HAT LOT** Consists of a single Luftwaffe general's peaked cap. The cap is comprised primarily of blue-gray wool with black fabric accenting, featuring gold-colored piping. The front of the cap displays a gold-colored Luftwaffe Eagle patch as well as a gold-colored wreath-and-cockade insignia patch. The cap also features a gold-colored bullion chincord. The cap rates excellent and exhibits no discernible signs of wear. (135996-5G)
2909. **POSTWAR-PRODUCTION WORLD WAR II GERMAN MILITARY HAT LOT** Consists of a single Wehrmacht general's peaked cap. The cap is comprised primarily of field gray wool with bluish-green felt accenting, featuring gold-colored piping. The front of the cap displays a gold-colored Reichsadler patch as well as a gold-colored wreath-and-cockade insignia patch. The cap also features a gold-colored bullion chincord. The cap rates excellent and exhibits no discernible signs of wear. (135996-5H)
2910. **POSTWAR-PRODUCTION WORLD WAR II GERMAN MILITARY HAT LOT** Consists of a single peaked cap designed to resemble one of several caps that were specifically made for Adolf Hitler. The cap is comprised primarily of field gray wool with brown felt accenting, featuring white and gold-colored piping. The front of the cap displays a gold-colored Reichsadler patch as well as a gold-colored wreath-and-cockade insignia patch. The cap also features a gold-colored bullion chincord. The cap rates excellent and exhibits no discernible signs of wear. (135996-5I)

2911. **POSTWAR-PRODUCTION WORLD WAR II GERMAN MILITARY HAT LOT** Consists of a single peaked cap designed to resemble one of several caps that were specifically made for Adolf Hitler. The cap is comprised primarily of light brown fabric with brown felt accenting, featuring white and gold-colored piping. The front of the cap displays a gold-colored Reichsadler patch as well as a gold-colored wreath-and-cockade insignia patch. The cap also features a gold-colored bullion chincord. The cap rates excellent and exhibits no discernible signs of wear. (135996-5J)
2912. **POSTWAR-PRODUCTION WORLD WAR II GERMAN MILITARY HAT LOT** Consists of a single officer's peaked cap. The cap is comprised primarily of white fabric with brown felt accenting, featuring maroon piping. The front of the cap displays a Reichsadler medallion as well as a gold-colored metal wreath-and-cockade insignia with swastika. The cap also features a gold-colored bullion chincord. The cap rates excellent and exhibits no discernible signs of wear. (135996-5K)
2913. **POSTWAR-PRODUCTION WORLD WAR II GERMAN MILITARY HAT LOT** Consists of a single officer's peaked cap. The cap is comprised primarily of light brown fabric with brown felt accenting, featuring blue piping. The front of the cap displays a Reichsadler medallion as well as a gold-colored metal wreath-and-cockade insignia with swastika. The cap also features a gold-colored bullion chincord. The cap rates excellent and exhibits no discernible signs of wear. (135996-5L)
2914. **POSTWAR-PRODUCTION WORLD WAR II GERMAN MILITARY HAT LOT** Consists of a single officer's peaked cap. The cap is comprised primarily of light brown fabric with brown felt accenting, featuring white piping. The front of the cap displays a Reichsadler medallion as well as a gold-colored metal wreath-and-cockade insignia with swastika. The cap also features a gold-colored bullion chincord. The cap rates excellent and exhibits no discernible signs of wear. (135996-5M)
2915. **POSTWAR-PRODUCTION WORLD WAR II GERMAN MILITARY HAT LOT** Consists of a single officer's peaked cap. The cap is comprised primarily of light brown fabric with brown felt accenting, featuring gold-colored piping. The front of the cap displays a gold-colored Reichsadler medallion as well as a gold-colored metal wreath-and-cockade insignia with swastika. The cap also features a gold-colored bullion chincord. The cap rates excellent and exhibits no discernible signs of wear. (135996-5N)
2916. **SCOPE LOT** Includes a Leupold Vari-X2 1x4 scope about 9 1/2" long. The high gloss finish rates excellent displaying a few light handling marks and light ring marks are present from being previously mounted to a rifle. This excellent low power scope features a duplex reticle with excellent optics. (6520-1855A)
2917. **SCOPE LOT** Includes a Thompson Center 4 x 18 power scope about 7 1/2" long. The matte black finish rates excellent with the exception of a few light handling marks. This scope features an illuminated dot reticle. Included are a set of lens covers. (176520-1155A)
2918. **WINCHESTER MODEL 12 SKEET SLIDE ACTION SHOTGUN** serial #816822, 16 ga, 23" matted rib shortened barrel with a bright excellent bore. The metal surfaces retain 98% original blue finish displaying a few light handling marks and light slivering on the magazine tube from operational use. The walnut checkered pistolgrip stock and forend rate excellent with the exception of a few light handling marks. A rubber Hawkins recoil pad has been added providing a length of pull of 13 3/4. (176520-3620) [Richard "Stretch" Kennedy Collection] (250/450)
2919. **COMPOUND BOW LOT** includes a right hand Hoyt Raider camouflage bow. This bow is in excellent working condition displaying a few light handling marks on the limbs and on the dual cams. The bows cable is in excellent overall condition with the exception of the string which is starting to dry out along the entire length. This bow has a 31" draw length and has a pull weight between 55 and 70 lbs. Included with this bow are a 3 pin fiber optic sight, camouflage stabilizer, arrow rest, quiver, and seven arrows measuring at different lengths. (176600-3A)
2920. **LEG HOLD TRAP LOT** Consists of three No. 1 long-spring traps. All three traps have moderate surface oxidation. All three traps are in excellent working condition. (176600-3A)
2921. **LEG HOLD TRAP LOT** consists of three No. 1 long-spring traps. All three traps have moderate surface oxidation. All three traps are in excellent working condition. (176600-3B)
2922. **RECURVE CROSSBOW LOT** consists of an unmarked crossbow about 31" in length. The bow has a wooden Monte Carlo stock which is in excellent condition with the exception of a few light handling marks. The limbs and sting appear to be in excellent condition overall. This crossbow is equipped with a rear peep sight and a front bead. Included are a dozen bolts with blue vanes that are in like-new condition. (176600-3B)
2923. **BINOCULAR LOT** Consists of a Carl Zeiss binocular 8x40 serial #1103004. This binocular has adjustable left and right eye focus which has bright excellent optics. Included is a leather neck strap and a leather hard case. This binocular is in excellent condition overall. (176600-10)
2924. **BINOCULAR LOT** Consists of a Luminous 7x50 binocular serial #633551. This binocular has amber coated lens and has bright excellent optics. Included is a black rubber neck strap and a hard leather case. (176600-10A)
2925. **AMMUNITION LOT** Consists of five full, twenty-round boxes of .30 M2 "30-06" ball ammo. The ammo was manufactured at the Eau Claire ordnance plant. All five boxes are unopened and appear to be in excellent condition. (176600-9A)
2926. **AMMUNITION LOT** Consists of five full, twenty-round boxes of .30 M2 "30-06" ball ammo. The ammo was manufactured at the Eau Claire ordnance plant. All five boxes are unopened and appear to be in excellent condition. (176600-9B)
2927. **AMMUNITION LOT** Consists of five full, twenty-round boxes of .30 M2 "30-06" ball ammo. The ammo was manufactured at the Eau Claire ordnance plant. All five boxes are unopened and appear to be in excellent condition. (176600-9C)
2928. **AMMUNITION LOT** Consists of three boxes of 47 miscellaneous rounds of 30-06 ball ammunition and ten 12 Ga Remington Shurshot shotgun shells which remain inside a red ammo can. All of the ammunition appears to be in excellent condition (176600-9D)
2929. **AMMUNITION LOT** Consists of four boxes of 9mm. The first box is a full Sellier & Bellot FMJ 115gr with 50 rounds of ammo. The second box is a full box of 50 rounds of Winchester WinClean 9mm 115gr ammo. The third box is a full box of 50 rounds of Winchester 9mm Silvertip 115gr hollow point. The last box is a partial box of American eagle which has 25 rounds of 124gr FMJ ammo with three 9mm brass casings. All ammo appears to be in excellent condition. (176600-9E)
2930. **AMMUNITION LOT** Consists of six boxes of Savage .30-30 170Gr round nose ammo. There are five full boxes and a partial box of 8 total rounds. All boxes remain in very good condition (176600-9G)
2931. **AMMUNITION LOT** Consists of two boxes of 45-70 Govt. The first box is a full 20 round box of PMC 405gr lead flat point. The second box is a partial box of 9 rounds of PMC 405gr lead flat point, the remainder of the box has 11 shell casings. (176600-9H)
2932. **AMMUNITION LOT** Consists of four boxes of 9mm ammo. The first box includes 50 rounds of Independence 115gr FMJ. The second box includes 50 rounds of Fiocchi 115gr FMJ. The third box includes 50 rounds of American Eagle 124gr FMJ. The final box includes 50 rounds of American Eagle 115gr FMJ. All ammunition remains in excellent condition overall. (176600-9J)



2933. **AMMUNITION LOT** Consists of three full 20 round boxes of Winchester Super-X, 45-70 Govt, 300Gr jacketed hollow point ammo. All ammo remains in excellent condition. (176600-9K)
2934. **AMMUNITION LOT** Consists of three full 20 round boxes of Winchester Super-X, 45-70 Govt, 300Gr jacketed hollow point ammo. All ammo remains in excellent condition. (176600-9L)
2935. **AMMUNITION LOT** Consists of seven full 100 round boxes of 22LR. The first six boxes contain Winchester Super-X 22 LR. Last box contains a full box of 100 rounds of miscellaneous 22lr ammunition. (176600-9M)
2936. **AMMUNITION LOT** Consists of seven full 100 round boxes of Winchester Super-X 22LR. All ammo appears to be in excellent condition overall. (176600-9N)
2937. **COLLECTIBLE AMMUNITION LOT** Consists of two full, twenty-round Winchester John Wayne commemorative 32-40 165gr soft point ammo. The boxes are in excellent condition displaying a picture of John Wayne and a printed signature. The boxes display a few light handling marks and remain in excellent overall condition. (176600-9P)
2938. **COLLECTIBLE AMMUNITION LOT** Consists of two full, twenty-round Winchester John Wayne commemorative 32-40 165gr soft point ammo. The boxes are in excellent condition displaying a picture of John Wayne and a printed signature. The boxes display a few light handling marks and remain in excellent overall condition. (176600-9Q)
2939. **AMMUNITION LOT** Consists of three boxes of 7mm Mauser. The first two boxes contain 20 rounds each of Remington 140gr soft pointed ammo. The third box contains 17 rounds of federal premium 140gr Nosler Partition. All ammo appears to be in excellent overall condition. (176600-9R)
2940. **AMMUNITION LOT** Consists of four boxes of 44-40 Winchester. The first two boxes contain 50 rounds of Winchester 200gr soft point. The final two boxes contain 50 rounds each of MagTech 44-40 200Gr L-Flat point. All ammo appears to be in excellent condition. (176600-9R)
2941. **AMMUNITION LOT** Consists of two boxes 45-70 Govt. The first box contains 20 rounds of Remington 405Gr soft point. The second box contains 19 rounds of Hornady 325Gr Evolution. Ammo appears to be in excellent condition. (176600-9S)
2942. **AMMUNITION LOT** Consists of four boxes of 250 Savage. The first two boxes contain 20 rounds of Winchester Savage 100gr silvertip. The final two boxes contain 20 rounds of Remington 100gr pointed soft point. All ammunition appears to be in excellent overall condition. (176600-9T)
2943. **AMMUNITION LOT** Consists of three boxes which contains 50 rounds of .45 M1911 caliber ball ammo. The boxes are a plain light brown and remain in excellent condition overall. (176600-9U)
2944. **AMMUNITION LOT** Consists of three boxes of 7mm Mauser. The first box contains 20 rounds Remington high velocity 140Gr pointed soft point. The second box contains 20 rounds of Remington high velocity 104Gr pointed soft point. The third box contains 20 rounds of Winchester super-X 145gr power-point. All ammo is in excellent condition. (176600-9V)
2945. **CASE KNIFE LOT** This is a special Case XX Kodiak knife commemorating the 20th Anniversary of the North American Hunting Club, 1978-1998. The Kodiak knife blade is beautifully engraved with the American eagle, Flag, and the Club's insignia. The blade is marked "Case XX Kodiak" and the reverse is numbered "3228". The stag handle on the knife is in excellent condition. It features a double brass guard. It comes with a manual, certificate of authenticity and an engraved wooden display box with the Eagle, Flag, and Club Insignia along with "20th Anniversary" and "1978-1998". (176600-2)
2946. **AMMUNITION LOT** Consists of six boxes of Remington 22lr Kleanbore. The first two boxes contain 50 rounds each of lubricated hollow point. The next two boxes contain 50 rounds each of hi-speed ammunition. The next box contains 50 rounds of .22lr klay bird shotshells. The last box contains 50 rounds of standard velocity ammo. All ammo appears to be in excellent condition overall. (176600-9W)
2947. **GUN MAINTENANCE LOT** Consists of four Birchwood Casey instant touch-up pens, two are blue pens and the other two are super black. Also included are nine miscellaneous gun cleaning bushes. The final item is a MTM case-guard gun cleaning vise. (176600-2)
2948. **AMMUNITION LOT** Consists of two boxes of Remington 32 S&W long 98gr lead. One box remains full and the second box is partial and contains 42 rounds along with 8 shell casings. All ammo appears to be in excellent condition. (176600-9X)
2949. **FISHING TACKLE LOT** Includes an Old Pal tackle box which is filled with miscellaneous fishing equipment. The tackle box is full which contains many unopened Rapala and trolling lures. There are also used lures that have light oxidation staining on the hooks, also there is fishing line, bobber's, hooks, weights, hard and soft baits. (176600-8)
2950. **RELOADING LOT** Consists of two boxes of reloading dies. The first one is a Redding 6mm/223 #10 shell holder die. The next die is a C-H tool die which is for a 8x60 Mauser two die set. Also included in this lot are two full boxes of brass RWS 8x60 casings. (175616-6A)
2951. **AMMUNITION LOT** Consists of five mixed shotgun boxes of game loads. The first two boxes are Winchester Dove & Quail 20ga 2 3/4 7/8oz #8 shot; both boxes are full and contain 25 rounds each. The next two boxes are Western upland 20ga 2 3/4" 7/8oz #8 shot; both boxes are full and contain 25 rounds each. The last box is a full box of Winchester Super-X 20ga 2 3/4" 1oz #6 shot which contains 25 rounds. All ammo is in excellent condition overall. (175632-3A)
2952. **AMMUNITION LOT** Contains six boxes of 20ga shotgun shells. The first box contains 25 rounds of Remington express 2 3/4" #6 shot. The second box contains 25 rounds of Remington express 2 3/4" # 7 1/2 shot. The third box contains 25 rounds of Remington express 2 3/4" #3 buck shot. The fourth box contains 25 rounds of Remington magnum express 3" #7 1/2 shot. The fifth box contains 10 rounds of Western super-x 2 3/4" #4 shot. The final box contains 15 rounds of Peters high velocity 2 1/2" #2 shot. All ammo appears to be in excellent condition overall. (175632-3C)
2953. **AMMUNITION LOT** Contains two-piece boxes of Winchester Repeater 16 Ga. with a mixed lot of 20 assorted 16 and 12 gauge shells, both are in good condition. (17563-73D)
2954. **AMMUNITION LOT** Contains four boxes of shotgun ammunition. The first two boxes are full and contain 5 rounds each of Federal 3" No. 2 buckshot. The next box contains Brenneke 16ga 2 3/4" slugs which contain 10 rounds each. The final box contains Brenneke slug's 20ga 3" slugs which contain 10 rounds each. All ammo appears to be in excellent condition overall. (176600-9Y)

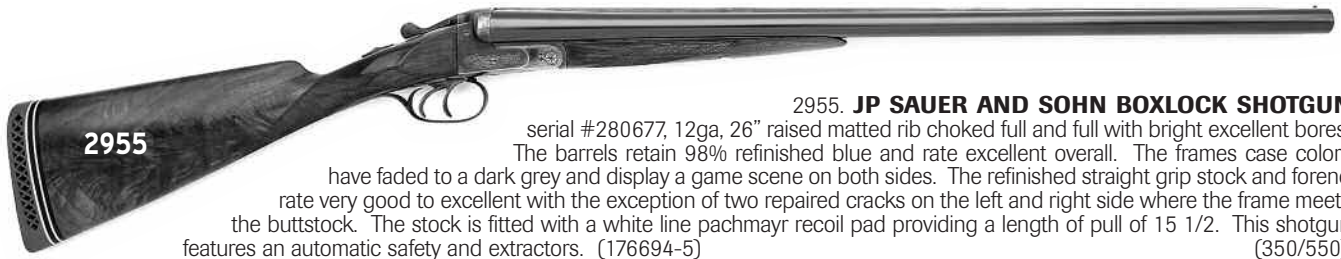

2955. **JP SAUER AND SOHN BOXLOCK SHOTGUN**

serial #280677, 12ga, 26" raised matted rib choked full and full with bright excellent bores. The barrels retain 98% refinished blue and rate excellent overall. The frames case colors have faded to a dark grey and display a game scene on both sides. The refinished straight grip stock and forend rate very good to excellent with the exception of two repaired cracks on the left and right side where the frame meets the buttstock. The stock is fitted with a white line pachmayr recoil pad providing a length of pull of 15 1/2. This shotgun features an automatic safety and extractors. (176694-5) (350/550)

2956. **SCOPE LOT** Includes a Weatherby Premier scope in outstanding condition. It is a 3x9x40mm with a wide field view with a duplex reticle that has bright excellent optics. There is a locking eyepiece focusing, and 1/4 click adjustments for windage and elevation. The tube is undented and has only minor ring marks from being previously mounted. (176520-1792A)
2957. **PISTOLGRIP LOT** Contains two hard rubber pistolgrips which fit a Smith and Wesson K frame revolver; one is a large grip and the other has a large butt fit. Grips come with screws and display a few light handling marks. (176600-2J)
2958. **IVER JOHNSON HERCULES GRADE BOXLOCK SHOTGUN** serial #27419, 12 Ga, 28" matted rib barrels choked modified and improved cylinder with bright excellent bores. The barrels retain 98% re-applied blue finish. The frame retains 75% of its original case colors. The walnut checkered pistolgrip stock and forend rates very good with the exception of a few light scratches and dings. This shotgun features an automatic safety, double triggers, and extractors. (176940-63) (75/150)
2959. **FLAG LOT** Includes a Kriegsmarine German flag that is in very good condition showing strong colors with very light fading in some small areas. The flag is designed with black and white stripes forming a cross pattern meeting in the center of the flag, forming a circle with a swastika in the center. The Iron Cross is stamped in one of the corners. There are markings on the left side of the flag that indicate the size of the flag, they read Kr.Fl. 80x133. The second set of stamps indicate the manufacturer and town where the flag was produced, Lorenz Summa Sohne, Oberkotau. A very good example of the German Navy standard between 1935 and 1945, during the Nazi regime. (175872-12B)
2960. **IGA STOGER CONDOR OVER UNDER SHOTGUN** serial #54964-00, 12 Ga, 26" ventilated rib screw-choke barrels with bright excellent bores. The barrels retain 98% original blue finish while the frame exhibits a light floral engraving on both sides. The walnut checkered pistolgrip stock and forend rate excellent with the exception of a few light handling marks. The shotgun comes with its original hard rubber recoil pad providing a length of pull of 14 1/2". Included is the original owner manual. This shotgun is in excellent condition overall. (176892-48) (350/500)
2961. **IVER JOHNSON CHAMPION SINGLE SHOT SHOTGUN** serial #66008A, 28 Ga, 28" plain barrel choked full with a very good lightly pitted bore. The metal surfaces exhibit an even brown patina with scratches and some surface oxidation present. The round knob pistolgrip stock and snap-on splinter forearm rate very good having numerous dings and scratches and showing two 1" hairline cracks at the upper tang. This shotgun shows some age but still functions and locks up tight. (176940-23) (50/100)
2962. **IVER JOHNSON CHAMPION SINGLE SHOT SHOTGUN** serial #HIFR, 12 Ga, 32" plain barrel choked full with a bright excellent bore. The barrel retains 98% original blue with the exception of a few light handling marks. The frame retains 90% of its original case colors showing light loss on the high edges. The walnut pistolgrip stock and snap on splinter forearm rate very good to excellent displaying a few light handling marks, there is also a 1" crack showing from the upper tang. This shotgun has an ejector and is in excellent condition overall. (176940-66) (50/100)
2963. **ITHACA MODEL 37 SLIDE ACTION SHOTGUN** serial #371423659, 12 Ga, 30" ventilated rib barrel choked modified with a very good lightly oxidized bore. The metal surfaces retain 80% original finish displaying scattered spots of surface oxidation along the barrel, frame and rib. The walnut checkered pistolgrip stock and forend rate very good displaying dings, and scratches along with some chips missing and light cracks where the stock meets the receiver. This shotgun is still in good working order. (176853-3) (150/250)
2964. **NAPLES TOWER 1860 PERCUSSION RIFLE**, 56 cal 21" barrel with a good oxidized bore. The metal surfaces are an overall brown patina with scattered spots of light silver, lock buttplate and hardware a slightly lighter smoky gray. The right sideplate is marked "1860 Tower" and shows light wear marks. The walnut straight grip stock rates good displaying numerous impact marks, a heavily cracked right side and is missing some wood. The stock wears a brass buttplate and left side mount which has two saddle rings. This rifle is in good condition overall. (176473-15) (250/350)
2965. **CHOKE TUBE LOT** Consists nine Invector Plus choke tubes. The first choke is a Primos Jelly Head extra-full ported choke with a .670 constriction and remains in its original factory case. The next choke is a Comp-N-Choke ported improved modified. The next choke is a Briley waterfowl choked light modified. The next two are unmarked chokes, extended improved cylinder tubes. The remainder choke tubes are Browning factory which are: improved modified, full, improved cylinder, and an extended light modified. Also included in this lot is a Allen choke tube case, a tube of super lube synthetic grease, browning hangtags and manuals, three choke wrenches and a pair of firm grip work gloves. (176935-6)
2966. **LEFEVER NITRO SPECIAL BOXLOCK SHOTGUN**, serial #340805, 20 Ga, 28" matted rib barrels choked full and improved modified with bright excellent bores. The refinished blue surfaces retain 95% finish displaying light scratches and show light finish loss at the muzzles. The lightly polished frame retains about 20% of its original case colors displaying an engraved duck scene on both sides of the frame. The refurnished walnut pistolgrip stock and forend rate very good displaying a few small cracks on both sides of the cheeks and lower and upper tang, each crack is about 1" to 2" in length. The stock wears a white line recoil pad providing a length of pull of 14". The gun features a single trigger, extractors, and an automatic safety. (176939-1) (300/500)
2967. **SCOPE LOT** Consists of a Redfield Revolution 3-9x50 rifle scope. The scope measures 12" and has a Accu-Range reticle with bright excellent optics. The scope displays very light ring marks from being previously mounted to a gun. This scope is in excellent condition overall. (176979-4A)
2968. **GERMAN MILITARY ARMBAND LOT** Consists of one woven, bright yellow cotton armband with a black printed Luftwaffe-style eagle in flight, clutching a swastika in one talon and block Latin script, "Deutsche Luftwaffe". The armband is in very good condition showing very light staining and the stitching is in excellent condition showing no signs of separation; it is post-war. (174945-8)
2969. **GERMAN MILITARY ARMBAND LOT** Consists of two items. The first armband is a Reichsbahn Service armband. This Railway armband features a Reichsbahn eagle in black above the "Reichsbahn". The band is cotton green and appears to be in very good condition showing some light stains. The second item is a light brown armband with a script, "im dienst der deutschen reichsbahn" with a Luftwaffe style eagle in flight, clutching a swastika on the right side. The band is in very good condition and shows some light stains and is of post-war manufacture. (175528-103A)



2970. **GERMAN MILITARY ARMBAND LOT** Consists of one 14" x 4 3/4" red Nazi armband. The band is woven red with a white circle with the swastika in the middle. This armband is in very good condition showing strong stitching and very little staining and is post-war. (175528-103B)
2971. **SIGNED AND NUMBERED LIMITED EDITION DUCK STAMP PRINT.** This is a very colorful image of hen and drake King Eiders standing on the banks of the coastal waters. The lovely print was done and signed by artist Nancy Howe of Vermont and numbered "5864/10350". Framed with the print is a 1991 federal Migratory Bird Hunting and Conservation Stamp. The view measures 9" by 6 1/2" and the print is framed in a modern black lacquer frame which shows some minor dings and some adhesive marks on the glass. The frame measures 16 1/2" wide by 15 1/2" tall. Also included is the original print sleeve which has the sleeve for the stamp enclosed on its interior. (176622-9A)
2972. **SIGNED AND NUMBERED LIMITED EDITION DUCK STAMP PRINT.** This is a very colorful image of a single Snow Goose which has its wings cupped in the landing position, coming into a marshy swamp. This lovely print was done and signed by Daniel Smith and numbered. Framed with the print is a 1988-1989 federal Migratory Bird Hunting and Conservation stamp. The view measures 9" by 9" and the print is framed in a modern black lacquer frame which shows some minor dings. The frame measures 16 1/2" wide by 15 1/2" tall. Included is the original print sleeve and a bio on the artist. (176622-9B)
2973. **SIGNED AND NUMBERED LIMITED EDITION DUCK STAMP PRINT.** This is a very colorful image of a drake and hen Greater Scaup flying sideways ready to land on some wind-driven waters. This lovely print was done and signed by artist Les C. Kouba and numbered "88/340". Framed with the print is a 1985 North Dakota resident duck hunting stamp. The view measures 9" by 9 1/2" and the print is framed in a modern black lacquer frame which rates excellent. The frame measures 16 1/2" wide by 15 1/2" tall. Included is the original print sleeve. (176622-9C)
2974. **SIGNED AND NUMBERED LIMITED EDITION 50TH ANNIVERSARY DUCK STAMP PRINT.** This is a very wonderful 50th anniversary edition full-color duck stamp print of the William C. Morris' 1984 duck stamp which features drake and hen American Widgeon against a turquoise-colored background, with the sky reflecting on the surface of the water. Framed with the print is a 1984 federal Migratory bird hunting and conservation stamp. This lovely print was done and signed by William C. Morris and numbered "15,148/20,400". The view measures 9" by 6 1/2" and the print is framed in a modern black lacquer frame which rates excellent. Included is the original print. (176622-9D)





2975. **SIGNED AND NUMBERED LIMITED EDITION DUCK STAMP PRINT.** This is a colorful image of drake and hen Canvasbacks flying over a wind-swept lake with a flock of fourteen geese flying in the distance above them. This lovely print was done and signed by artist David Maas and numbered "2,274/3,438". Framed with this print is a 1984 North Dakota Migratory bird hunting conservation stamp. The view measures 9" by 6 1/2" and the print is framed in a modern black lacquer frame which rates excellent. The frame measures 16 1/2" wide by 15 1/2" tall. Included is the original print sleeve with the artist's bio. (176622-9E)
2976. **SIGNED AND NUMBERED LIMITED EDITION DUCK STAMP PRINT.** This is a colorful image of a hen Wood Duck standing on a log with seven of her newborn ducklings. This lovely print was done and signed by artist Steve Dillard and numbered "419/10,064". Framed with this print are two resident and non-resident West Virginia Migratory bird hunting and conservation stamps. The print is framed in a modern black lacquer frame which rates excellent. The frame measures 16 1/2" wide by 15 1/2" tall. Included is the original print sleeve with the artist's bio. (176622-9F)
2977. **SIGNED AND NUMBERED LIMITED EDITION DUCK STAMP PRINT.** This is a colorful image of a hen and drake Redhead duck swimming near some cattails in an icy swamp. This lovely print was painted and signed by artist Rob Leslie and numbered "46/3438". Framed with this print is a 1989 North Dakota Migratory bird hunting conservation stamp. The view measures 9 1/2" by 6 1/2" and the print is framed in a modern black lacquer frame which rates excellent. The frame measures 16 1/2" wide by 15 1/2" tall. (176622-9G)
2978. **SIGNED AND NUMBERED LIMITED EDITION DUCK STAMP PRINT.** This is a colorful image of drake and hen White-winged Scoters flying over open water with a mountain scene in the background. This lovely print was painted by artist Louis Frinsino and numbered "1699/3438". Framed with this print is a 1988 North Dakota Migratory bird hunting conservation stamp. The view measures 9 1/2" by 6" and the print is framed in a modern black lacquer frame which rates excellent. The frame measures 16 1/2" wide by 15 1/2" tall. Included is the original print sleeve with the artist's bio. (176622-9H)



2979. **LIMITED EDITION DUCK STAMP PRINT.** This is a "First of the Nation" duck stamp from New Zealand. This is a colorful image of a drake and hen Shelduck standing on a lakes shoreline. This beautiful print was painted by artist Adele Earnshaw and numbered "655/6000". Framed with this print is the first ever New Zealand game bird habitat stamp. The view measures 9 1/2" by 6" and the print is framed in a modern black lacquer frame which rates excellent. The frame measures 16 1/2" wide by 15 1/2" tall. Included is the original print sleeve with the artist's bio. (176622-9I)

2980. **REMINGTON NO. 4 ROLLING BLOCK RIFLE** serial #332383, 25-10 RF, 22 1/2" barrel with a very good bore with moderate pitting. The metal surfaces have turned a brown patina with oxidation staining present. The straight stock and forend rate good to very good showing dings and scratches over a dark oiled finish and the crescent buttplate is turning brown. The rifle is equipped with a dovetailed blade front sight and a single standing leaf rear sight. The action functions fine. A solid little rolling block. (176892-26) {C&R} (200/400)

2981. **IVER JOHNSON TARGET MASTER SLIDE ACTION RIFLE** serial #001289, 22 Lr, 18" barrel with a bright excellent bore. The metal surfaces retain 98% original blue finish displaying light handling marks and light finish loss on the front barrel band. The straight grip walnut stock and grooved forend rate excellent displaying a few light handling marks. Included is the original factory box. This rifle is in excellent condition overall. (176940-27) (200/400)

2982. **EARLY IVER JOHNSON CHAMPION SINGLE SHOT SHOTGUN** serial #3, .410 bore, 26" round barrel choked cylinder with a bright excellent bore. The barrel retains 70% of its reapplied blue finish showing areas of cleaned pitting and oxidation stains. The frame has toned to a pleasing plum blue finish displaying scroll engraving of an outdoor scene with areas of light surface oxidation. The round knob walnut stock and snap on forend rate very good displaying light dings and scratches along with two 1/2" cracks on the upper tang. This gun wears its original hard rubber buttplate which shows light dings on the edges. This gun locks up tight and is in excellent working condition overall. (176891-7) (200/300)

2983. **REMINGTON MODEL 710 BOLT ACTION RIFLE** serial #71200526, 30-06, 22" barrel with a bright excellent bore. The metal surfaces retain 98% of their original matte black finish showing a few light handling marks. The light grey synthetic pistolgrip stock rates excellent. This rifle comes with a Bushnell banner 3x9x40 rifle scope which has a duplex reticle and excellent optics. This rifle is in excellent condition overall. (176520-1360) [Richard "Stretch" Kennedy Collection] (200/400)

2984. **RANGER MODEL 103-6 OVER UNDER SHOTGUN** serial #2465, 20 Ga, 28" plain barrel choked full and modified with bright excellent bores. The barrels retains 95% original blue displaying light finish loss at the muzzles along with light scattered scratches and oxidation along the barrel. The frame retains 80% original blue displaying majority of its finish loss on the underside. The walnut pistolgrip stock and forend rate very good displaying light scratches and dings over a fading finish. The gun features double triggers, extractors, and an automatic safety. This shotgun is in excellent condition overall. (176869-2) (100/200)

2985. **SCOPE LOT** consists of a Bausch & Lomb 4-16x50 rifle scope. The scope measures 14" in length. The scope is matte back finish and rates excellent displaying some light ring marks from being previously mounted to a firearm. The scope features a duplex reticle and has bright excellent optics. (17679-3A)

2986. **IVER JOHNSON CHAMPION SHOTGUN** serial #4440, 16 ga, 25 1/2 part octagon part round shortened barrel with a very good bore. The barrel retains 40% original blue finish with the majority of the barrel covered in an adhesive camouflage tape. The frame has been polished and retains about 20% of its colors which are fading to a dark brown patina. The walnut pistolgrip stock rates good displaying dings and a large crack on the right side of the wrist which has been repaired with two screws. The same adhesive tape is attached covering the entire area of the recoil pad and forearm. This shotgun still functions good and the lock up is loose. (176792-8) (25/75)

2987. **ALLEN AND WHELOCK PERCUSSION RIFLE** 32cal, 32" octagon barrel with a lightly frosted bore. The metal surfaces have toned to a dark pewter brown with scattered spots of oxidation stains; there are also multiple impact marks along the barrels high edges. The lightly cleaned stock rates good displaying a 1 1/2" crack on the left side where the wood meets the frame. The forend has become loose and will slide up the barrel but stays attached; There are also multiple chips missing from the forend on the top sides. Unfortunately the cleaning rod is not present with the gun. (175823-108) {ANTIQUÉ} (100/200)

2988. **MARLIN MODEL 99 SEMI-AUTO RIFLE** 22LR, 18" shortened barrel with a bright excellent bore. The metal surfaces retain 90% original blue finish showing light spots of surface oxidation. The barrel has been shortened and does not have provisions for a front sight. The walnut checkered pistolgrip stock and forend rate very good although the stock was cut at the wrist, then reattached with a rod so it can be used as a take down rifle overall, the stock displays a few light handling marks. Included is an unmarked 2x power scope and a wooden hard case. (176623-13) (50/150)

2989. **STEVENS MODEL 53C BOLT ACTION RIFLE** 22LR, 24" barrel with a bright excellent bore. The metal surfaces retain 80% original blue showing moderate scattered areas of surface oxidation. The walnut pistolgrip stock rates good to very good displaying light impact marks and scratches over a thinning flaking finish. The guns trigger assembly and bolt have been disassembled but are included, some repairs will be needed to make this a shooter again. Overall an excellent project gun. (176223-24) (25/50)

2990. **REMINGTON MODEL 514 BOLT ACTION RIFLE** 22Lr, 24" barrel with a bright excellent bore. The metal surfaces retain 30% blue displaying heavy surface oxidation along the barrel. The bolt handle, trigger and triggerguard are also almost completely covered in surface oxidation as well. The walnut pistolgrip stock rates very good displaying numerous dings and scratches over a dull dark fading finish. The rifle wears a post front sight and a rear adjustable elevation sight. This gun still functions very well. An excellent overall gun for a restoration project. (176855-1) (25/50)

2991. **BROWNING AUTO 5 SEMI-AUTO SHOTGUN** serial #9G58959, 12ga, 24" plain barrel choked modified with a lightly frosted bore. The barrel retains 80% original blue showing areas of surface oxidation primarily of the left side of the barrel. The frame retains 75% original blue showing finish loss on the top of the receiver and sides due to surface oxidation. The lightly cleaned walnut pistolgrip stock and forend rate very good displaying light handling marks over a dull fading finish. (176853-5) (300/500)
2992. **WINCHESTER MODEL 94AE WRANGLER II LEVER ACTION CARBINE** serial #5272943, 38-55 Win, 16" round tapered barrel with bright excellent bore. The metal surfaces retain 99% plus original blue finish. The satin finish plain walnut straight grip buttstock and forend both rate excellent. Both sides of the receiver are engraved with old west riding scenes. The original open sights are present as are the scope mount provisions unique to the Angle Eject design. The characteristic large loop lever, full length magazine tube and saddle ring are featured. A factory hang tag is included. This handy carbine is in nearly new condition. (176520-2344) [Richard "Stretch" Kennedy Collection] (350/500)
2993. **WINCHESTER MODEL 12 HEAVY DUCK SLIDE ACTION SHOTGUN** serial #1586953, 12 ga, (3"), 30" plain barrel choked full with a bright excellent bore. The metal surfaces retain 85% plus original blue showing areas of light scattered surface oxidation as well as some light handling marks. The walnut checkered pistolgrip stock and forend rate very good displaying impact marks and scratches over a fading flaking varnish. The gun wears its original red hard rubber recoil pad providing a length of pull of 13 3/4". This Winchester model 12 is still in very good working condition overall. (176520-3609) [Richard "Stretch" Kennedy Collection] (400/600)
2994. **ARMSTRONG HALF STOCKED PERCUSSION FOWLER** 8 bore, 40" part octagon part round damascus barrel with a very good bore. The barrel shows very light contrasting damascus pattern and has toned to a pleasing plum-brown patina showing light areas of pitting where the barrel meets the stock. The lock is a pleasing deep pewter patina as well as the sideplate which reads "ARMSTRONG". The walnut half-stock rates good displaying multiple cracks around the triggerguard, sideplate, and one on the left side of the stock about 8" long. The gun comes with what appears to be its original ramrod. (176759-55) {ANTIQUÉ} (200/400)
2995. **LC SMITH FIELD GRADE HUNTER ARMS SIDELOCK DOUBLE SHOTGUN** serial #65321, 16 ga, 26" solid rib barrels choked full and full with bright excellent bores. The barrels retain 80-85% blue finish showing scattered surface oxidation and light finish loss at the muzzles. There are also two light dings on the left barrel about 4 1/2" from the breech. The frame added finish has toned to a pleasing plum showing areas of very light surface oxidation and finish loss at the breech area. The cleaned checkered walnut round knob stock and forend rate very good displaying two cracks from both sideplate connecting to the upper tang. This gun wears hard rubber recoil pad which shows some light wear and provided a length of pull of 14 1/4". Overall a very good affordable LC Smith. (176691-37) (300/500)
2996. **FABRIQUE NATIONALE MODEL ANSON BOXLOCK DOUBLE SHOTGUN** serial #35796, 12 ga, 30" matted rib barrels choked full and improved modified with bright excellent bores. The barrels retain 85% reapplied blue finish displaying light handling marks and scattered spots of light surface oxidation. The frame retains 90% of its reapplied blue finish showing a few light spots of surface oxidation. The cleaned walnut round knob stock and splinter forend rates very good displaying light dings and scratches over a reapplied fading flaking varnish. An un-engraved monogram plate is installed in the toe line of the stock. This shotgun features an automatic safety, double triggers, and its original buttplate providing a length of pull of 14". (176520-2730) [Richard "Stretch" Kennedy Collection] (300/500)
2997. **IVER JOHNSON HERCULES GRADE BOXLOCK SHOTGUN** serial #11822, 16 ga, 28" matted rib barrels choked extra full and full with bright excellent bores. The barrels retain 80% of their reapplied blue finish with light handling marks and specks of scattered surface oxidation. The forend lug has been re-attached by a modern epoxy. The frame retains about 15% of its original case colors with the remainder of the frame toning to a dark gray brown patina. The walnut checkered pistolgrip stock and snap-on forend rate very good displaying dings and scratches over an added varnish. The stock wears its original buttplate which has a small chip missing from the toe. This shotgun features an automatic safety, double triggers, and extractors. (176940-65) {C&R} (200/400)
2998. **W. & C. SCOTT & SON SIDELOCK SHOTGUN** serial #61221, 12 ga, 24" shortened damascus twist barrels choked cylinder and cylinder with bright excellent bores. The barrels show a contrasting damascus pattern with scattered spots of surface oxidation stains present. There is also a small impact mark on the left muzzle and a small dent on the right barrel about 4" from the muzzle. The frame is embellished in a floral scroll engraving with a flying dove on both sides; the frame also shows some very light traces of original case colors in the protected areas. The walnut checkered round knob stock and forend rate good having two cracks around the wrist, there is also a repair at the top of the comb near the buttplate which has been sanded down and blended to the stock; there are also dings and scratches present over a dark oiled finish. (176520-3437) {ANTIQUÉ} [Richard "Stretch" Kennedy Collection] (300/500)
2999. **WARDS HERCULES MODEL 50 BOXLOCK SHOTGUN TWO BARREL SET** serial #C9705, 12 ga, 28" matted rib barrels choked cylinder and cylinder with bright excellent bores. The barrels retain about 85% reapplied blue finish showing light finish loss at the muzzles and light spots of missed blue on the rib. The second barrel is a 12ga, 32" matted rib barrel choked full and improved modified with bright excellent bores. The barrels retain 85-90% reapplied blue finish of showing loss at the muzzles and light spots of missed blue on the side of the matted rib. The frame is embellished in small areas of a American scroll. The frame has toned to a dark gray patina displaying very light areas of original case colors. The lightly cleaned walnut pistolgrip stock and forend rate excellent displaying a few light handling marks on a reapplied glossy varnish. The gun wears a Western Field hard rubber recoil pad that is starting to crack and slightly separate from the stock. This shotgun features an automatic safety and a single trigger. (176826-3) (350/550)
3000. **BROWNING AUTO 5 SEMI-AUTO SHOTGUN** serial #R39497, 16 ga, 27" plain barrel choked full with a bright excellent bore. The metal surfaces retain 80% reapplied blue finish showing handling marks and scattered spots of surface oxidation present along the barrel and frame. The round knob checkered stock and grooved forend rate very good displaying light handling marks over a lightly cleaned surface, the forend has a 2" crack on the bottom side. The gun wears its original buttplate which provides a length of pull of 14 1/2". (176853-2) (200/300)
3001. **FOREHAND AND WADSWORTH SINGLE BARREL HAMMER SHOTGUN** serial #3497, 12ga 30" twist barrel choked cylinder with a lightly oxidized bore. The barrel has turned a brown patina with surface oxidation and the frame exhibits 70% of an old nickel finish with spots of oxidation. The straight grip stock rates very good displaying light dings and dents over an added glossy finish. The original steel buttplate is present and retains 60% of its nickel finish. The lock up is slightly loose. (176857-15) {ANTIQUÉ} (25/100)
3002. **STEVENS DOUBLE HAMMER SHOTGUN** serial #A13188, 12 ga, 30" matted rib barrels choked full and modified with a lightly pitted but very good bore. The barrels retain 60% evenly thinning reapplied blue finish showing light surface oxidation and handling marks. The frame and hammers have toned to a light gray brown patina showing light traces of original case colors in the protected areas. The round knob stock and forend rate very good displaying dings and scratches over a refinished surface. There is a small 1" crack forming at the upper tang, and the checkering the stock is very faint but still visible. The gun wears its original buttplate and provides a length of pull of 14 1/2". (176916-55) {C&R} (100/200)





3003. **REMINGTON MODEL 14 1/2 SLIDE ACTION RIFLE** serial #19885, .44 WCF 22" barrel with a bright excellent bore. The metal surfaces have toned to a light gray with spots of dark brown patina showing areas of light to moderate pitting along the barrel. The walnut pistolgrip stock rates good to very good, the stock displays a few light handling marks over a reapplied finish which has become loose and displays two cracks on each side of the wrist. The grooved forend rates very good displaying a few light handling marks over a dark reapplied varnish. The rifle wears a post front sight and an adjustable rear sight. (176857-10) {C&R} (400/600)
3004. **BOITO OVER UNDER BOXLOCK SHOTGUN** serial #5750, 12 ga, 28" ventilated rib barrels choked full and modified with a very good bore. The metal surfaces retain 85% original blue finish showing finish loss at the muzzles and scattered spots of surface oxidation, there are also two small dings on the top barrel about 2" from the muzzles which can also be seen inside the bore. The checkered walnut pistolgrip stock and forend rate very good displaying light dings and scratches and a few 1/2" hairline cracks at the lower triggerguard over a flaking high gloss finish. The gun wears what appears to be its original buttplate which provides a length of pull of 15 1/4". The extractors have been removed and are not present with the firearm. Overall a good project gun. (176916-53) (100/200)
3005. **IAB SCHWABISCH OLYMPIC TRAP OVER UNDER SHOTGUN** serial #7202, 12 ga, 29" ventilated rib barrels choked full and modified with bright excellent bores. The barrels retain 90% original high gloss finish displaying scattered areas of surface oxidation along the barrels and rib. The scalloped boxlock frame rates excellent displaying 95% of its original case colors which has a light floral scroll engraving. The walnut checkered pistolgrip stock rates very good displaying a few light handling marks and a white " U.S. FEDERATION OF INTERNATIONAL MOVING TARGET SHOOTERS" sticker on the right side of the buttstock. The checkered forend rates very good to excellent displaying a few light handling marks and a light 1 1/2" crack from the release lever extending toward the frame. The recoil pad has been cut and has been attached to the stock with a black adhesive tape which provides a length of pull of 14". This gun features a single trigger, ejectors and a non-automatic safety. Overall and excellent beginners trap gun. (176873-24) (350/550)
3006. **UFC REVELATION SEMI-AUTO SHOTGUN** serial #V11256, 12 ga, 28" ventilated rib barrel choked modified with a bright excellent bore. The metal surfaces retain 95% original blue showing light scratches and blemishes. The walnut checkered pistolgrip stock and forend rate very good showing handling marks and dings over a strong dark finish, there is also a 1" chip missing out of the heel of the stock. Overall a very good, affordable, rainy day duck gun. (176758-7) (200/400)
3007. **HARRINGTON AND RICHARDSON MODEL 88 BREAK ACTION SHOTGUN** serial #AU600682, .410 bore, 25" round barrel choked full with a bright excellent bore. The metal surfaces retain 90% original blue showing scattered spots of surface oxidation and a few light scratches. The frame retains about 95% of its original case colors showing light areas of surface oxidation. The walnut pistolgrip stock and forend rates excellent with the exception of a few light handling marks. (177014-28) (75/150)
3008. **IVER JOHNSON CHAMPION CUT AWAY SHOTGUN** serial #5592, 28 ga., 26" plain barrel with a bright excellent bore. Barrel retains about 98% of its original blue finish showing a few light blemishes along the barrel. The frame shows a 1" x 1/2" cut-out on the left side and retains 98% of its case colors. Plain hardwood buttstock and splinter style forend rate very good as refinished. A nice brass plate has been made to cover the hole so the gun could be used afield; unfortunately it's missing two of its screws to attach the plate. There is no way to ascertain whether this is a factory job or not but it certainly appears to be, would also be a valuable training or hunter safety tool. (176940-145) (100/250)
3009. **WINCHESTER MODEL 88 LEVER ACTION RIFLE** serial #6583, .308, 22" barrel with a bright excellent bore. The metal surfaces retain 90% original blue displaying finish loss primarily toward the muzzle and light scattered spots of surface oxidation. The walnut checkered pistolgrip stock and forend rate very good to excellent displaying scratches and dings along with the finish that's flaking away in scattered areas. The gun features a single concave arrow detachable magazine. Overall an excellent fall hunting rifle. (177014-25) {C&R} (350/550)
3010. **ITHACA FIELD GRADE BOXLOCK DOUBLE SHOTGUN** serial #459035, 12 ga, 28" matted rib barrels choked full and improved modified with bright excellent bores. The barrels retain 85% original blue finish showing loss at the muzzles and breech areas. The frame including the top lever exhibits 85% vivid restored case colors showing light pitting of the left side. The checkered walnut pistolgrip buttstock and forend rate excellent displaying just a few light handling marks; the buttstock wears a hard rubber Pachmayr recoil pad providing a length of pull of 12 3/4". This shotgun features a single trigger, a non-automatic safety, extractors and cocking indicators. (177053-8) (350/550)
3011. **REMINGTON NEW MODEL POLICE PERCUSSION REVOLVER** serial #4838, .36cal, 4 1/2" barrel with a very good lightly pitted bore which shows strong rifling. The metal surfaces have toned to a dark brown patina which displays a few traces of original blue in the protected areas. There are some light impact marks on both sides of the frame in front of the cylinder and also minor pinprick pitting at the muzzle and around the cylinder near the nipples. The brass guard is a light goldenrod patina which has some light brown spots on the bottom side. The walnut grips rate very good displaying a few light chips and handling marks over a very dark oiled finish. (176889-226) {ANTIQUÉ} (350/500)
3012. **MANHATTAN NAVY TYPE PERCUSSION REVOLVER** serial #34, 36 cal., 5" octagon barrel with a good bore showing moderate pitting its full length. The barrel is an overall brown patina with pewter undertones showing areas of minor pitting and oxidation stains; the wedge pin screw is missing. The loading lever is primarily dark and oxidized showing areas of strong pitting. The cylinder has toned to a dark brown patina having moderate areas of pinprick pitting; the cylinder scene is still visible. The triggerguard and backstrap have tarnished to a dull ocher patina with minor dings and handling marks. The top backstrap extension on the right side where the screw passes through has broken off. The one-piece walnut grips rate good displaying multiple dings and scratches and a 1" chip is missing on the lower right side of the grips. This gun will require mechanical attention as the hammer will not stay in the locked position and the cylinder will not turn. (176655-1) {ANTIQUÉ} (75/150)
3013. **WINCHESTER MODEL 12 SLIDE ACTION SHOTGUN** serial #1219711, 12 ga, 30" ventilated rib barrel choked full with a bright excellent bore. The metal surfaces retain 99% reapplied blue finish displaying a very few light spots of surface oxidation. The checked walnut pistolgrip buttstock and forend rate excellent with the exception of a few light handling marks. The buttstock has a ventilated Pachmayr hard rubber recoil pad which provides a length of pull of 14 1/2". (177082-16) (200/400)

3014. **MARLIN GLENFIELD MODEL 30 LEVER ACTION RIFLE** serial #70-87786, 30-30, 20" barrel with a bright excellent bore. The metal surfaces retain 95% original blue finish displaying a few spots of finish loss from rub marks. The walnut checkered forend and pistolgrip buttstock rate excellent displaying an engraved deer scene over the pistolgrip checkering, there are a few light handling marks present. (177078-2) (200/400)
3015. **BACON POCKET MODEL PERCUSSION REVOLVER** serial # 204, 31 cal., 5" round barrel with a very good pitted bore. The barrel has toned to a dull pewter gray patina with overall light brown oxidation speckling and some scattered light pitting and impact marks. The barrel address is still legible and reads "Union Arms Co., N.Y.". The loading lever has toned to a smoke gray patina and displays a very thin hairline crack on the rod. The fluted cylinder has toned to a pewter gray and has various areas of light impact marks. The frame shows some loose open scroll on the flats and has toned overall to a gray patina. The walnut two-piece grips rate very good as refinished displaying a few light handling marks. All the numbers match including the wedge. This gun functions well mechanically. (176889-44) {ANTIQUE} (350/550)
3016. **MANHATTAN 22 CALIBER POCKET REVOLVER** serial #5782, 22 RF, 3" ribbed octagon barrel with an about good three-groove bore showing some light pitting it's full-length. The barrel on this first model, third variation is primarily a pewter gun metal gray with some minor brown oxidation speckling showing quality loose flowing scroll. The 7-shot cylinder has toned to a pewter gray and displays faint traces of its cylinder scene. The iron frame with circular brass sideplate are primarily a tarnished gun metal gray. The smooth walnut grips rate about very good with much original varnish and some minor dings and handling marks from the years, there is a 1" crack present on the right grip. All the numbers on the gun match. (176555-115) {ANTIQUE} [Manhattanfirearms.com Collection] (250/350)
3017. **EARLY MANHATTAN 22 CALIBER POCKET REVOLVER** serial #2, 22 RF, 3" ribbed octagon barrel with a good bore showing light pitting its full length. The barrel on this second model is primarily a dark gray patina that has some minor oxidation speckling and showing quality loose scroll. The 7-shot cylinder has toned to a pewter gray that is engraved with settlers and Indians in a battle scene. The frame with a circular side plate has toned primarily to a tarnished goldenrod patina having areas of light impact marks. The smooth walnut grips rate very good displaying a few light handling marks over a thinning varnish. The gun will require mechanical attention as the hammer will not stay locked when it is pulled. All numbers on the gun match. (176655-109) {ANTIQUE} [Manhattanfirearms.com Collection] (250/350)
3018. **MERCURY MAGNUM MODEL G-1032 BOXLOCK DOUBLE SHOTGUN** serial #69676, 10 ga, 31" matted rib barrels choked full and full with bright excellent bores. The barrels retain 95% original blue finish having light finish loss at the muzzles and light scattered oxidation stains. The frame is embellished in a floral scroll engraving which has light oxidation stains. The checkered walnut pistolgrip buttstock and beavertail forend rate excellent displaying just a few light handling marks. The gun wears a hard rubber recoil pad providing a length of pull of 13 1/4" and with drops of 1 1/4 and 2". (177056-2) (350/500)
3019. **CRESCENT FIREARMS COMPANY DOUBLE SHOTGUN** serial #279397, 12 ga, 18 3/8" shortened barrels with bright excellent bores. The barrels retain 90% original blue finish displaying scattered light scratches and finish loss at the muzzles. The sidelock frame retains 50% of its original case-hardened colors with the balance toning to a smoke gray. The checkered walnut buttstock and forend rate very good having scattered dings, scratches and adhesive tape on the buttstock; there is also a small 1/2" chip missing from the left side of the buttstock at the upper tang. The gun has double triggers, extractors and an automatic safety. (177022-110) [Mark Benenson Collection] (50/150)
3020. **REMINGTON MODEL 700 ADL BOLT ACTION RIFLE** serial #6442002, .270 Win, 22" barrel with a bright excellent bore. The metal surfaces retain 95% original blue finish having areas of light surface oxidation and finish loss at the muzzle. The walnut Monte Carlo stock with a flared left side cheek piece rates very good to excellent displaying scattered dings and scratches. The gun has adjustable rear sight and a front sight that has been slightly damaged. The frame is drilled and tapped and has 1" Weaver see-through rings that mount a Tasco 3-9x40 scope with a duplex reticle and bright optics. (177075-S18243) (300/500)
3021. **MOSSBERG MODEL 702 PLINKSTER SEMI-AUTO RIFLE** serial #EGG285496, 22 LR, 18" barrel with a bright excellent bore. The metal surfaces retain 99% original blue finish. The brown wood grain composite stock rates excellent overall. The gun has 1" rings and wears a Tasco 3-9x40 scope with a duplex reticle and bright optics. Included is a factory magazine. (177075-S18249) (50/150)
3022. **REMINGTON MODEL 721 BOLT ACTION RIFLE** serial #45302, 30-06, 24" barrel with a bright excellent bore. The metal surfaces retain 85% evenly thinning blue finish having areas of light surface oxidation. The walnut pistolgrip buttstock rates very good having added wood on the gripcap and on the forend tip, there is also a hole on the toe line in-which a swivel has been broken off, and the threads are still present. (177075-S18070) (250/450)
3023. **SMITH AND WESSON MODEL 1012 SEMI-AUTO SHOTGUN** serial #UCC3818, 12 ga, 24" ventilated rib screw choke barrel with a bright excellent bore. The included choke is "modified". The metal surfaces retain 99% of their original matte black displaying a few light handling marks. The black composite pistolgrip buttstock and forend rate excellent displaying a few light scratches. This shotgun is in excellent condition overall. Included is a soft gun case. (177075-S18258) (350/550)
3024. **SEARS AND ROEBUCK MODEL 200 SLIDE ACTION SHOTGUN** serial #P358393, 20 ga, 27 1/2" ventilated rib barrel choked poly with a bright excellent bore. The metal surfaces retain 98% original blue finish displaying a few light handling marks. The checkered walnut pistolgrip buttstock and forend rates excellent displaying a few light handling marks. The gun wears a ventilated hard rubber recoil pad which provides a length of pull of 14". Included is a camouflage soft case. (177075-S18257) (250/450)
3025. **MOSSBERG MODEL 283TB BOLT ACTION RIFLE** serial #420138, .410 bore, 24" plain barrel choked modified with a bright excellent bore. The metal surfaces retain 98% original blue finish displaying a few light handling marks. The walnut Monte Carlo pistolgrip stock rates excellent, as refinished, displaying a few light handling marks. There is a black buttplate present which provides a length of pull of 13 3/8". (177076-D29804) (75/150)
3026. **IVER JOHNSON MODEL CHAMPION SHOTGUN** serial #14069, .410 bore, 26" plain barrel choked full with a bright excellent bore. The metal surfaces have toned to a mottled brown having light handling marks and impact marks present. The walnut round knob stock and forend rate very good displaying dings and dents over a fading dull varnish. The original Iver Johnson buttplate is present. (176940-13) (50/150)
3027. **IVER JOHNSON MODEL EXCEL SHOTGUN** serial #8272XF, 16 ga, 28" plain barrel choked full with a bright excellent bore. The barrel retains 99% re-blued finish displaying a few light handling marks. The frame retains 98% of its original case-hardened colors. The walnut pistolgrip buttstock and forend rate excellent, as refinished, displaying a few light handling marks. The gun wears a grooved buttplate which provides a length of pull of 14 1/8". (176940-284) (50/150)
3028. **MARLIN MODEL 60 SEMI-AUTO RIFLE** serial #12552301, 22 LR, 22" barrel with a bright excellent bore. The metal surfaces retain 99% original blue finish displaying a few very light handling marks. The walnut Monte Carlo stock rates excellent displaying a few light handling marks and an adhesive sticker on the left side of the buttstock. The gun wears a Tasco 4x15mm rifle scope with a duplex reticle and excellent optics. (177075-S18255) (100/250)

3029. **MARLIN MODEL 39A LEVER ACTION RIFLE** serial #B82838, 22 LR, 24" barrel with a bright excellent bore. The metal surfaces retain 85% of its reapplied blue finish having areas of finish loss from light pitting that has been cleaned. The magazine tube has finish loss as well. The frame retains 80% of its reapplied case-hardened colors with the balance toning to a smoke gray. The walnut pistolgrip buttstock and forend rate excellent, as refinished, with the exception of a few light handling marks. The gun wears a side mount that is attached to the barrel and wears a 4X Weaver scope with a duplex reticle and has bright excellent optics. (177073-8) {C&R} (350/550)
3030. **GEHA MAUSER BOLT ACTION SHOTGUN** 12 ga, 27 1/2" plain barrel with a bright excellent bore. The metal surfaces retain 40% blue toning to brown and showing some oxidation spotting. The one-piece pistolgrip stock with fluted forend rates very good having numerous scuffs and dings with a crack behind the top tang and having a large piece in the stock that has been cut and replaced over a very thin oiled finish. There is a steel buttplate present and there is a sling swivel base inlaid into the toeline just behind the grip. (176916-57) {C&R} (100/200)
3031. **IVER JOHNSON MODEL CHAMPION SHOTGUN** serial #54411C, .410 bore, 26" plain barrel choked full with a bright excellent bore. The metal surfaces have toned to a brown patina overall displaying light scratches and oxidation stains. The walnut pistolgrip buttstock and forend rate very good overall displaying dings and scratches over a high gloss added finish. The buttstock wears its original buttplate which has a few chips missing around the edges which provides a length of pull of 14". (176940-15) (75/150)
3032. **MARLIN MODEL 60 SEMI-AUTO RIFLE** serial #22464310, 22 LR, 22" barrel with a bright excellent bore. The metal surfaces retain 95% original blue finish which displays a few light handling marks and light scattered surface oxidation. The walnut Monte Carlo stock rates excellent displaying a few light handling marks over a thinning varnish. The gun wears a Tasco 3-9x40 rifle scope with a duplex reticle with bright excellent optics; the scope is attached with only one scope ring. This gun functions very good and would make a great shooter. (177075-S18244) (100/250)
3033. **STEVENS MODEL 335 BOXLOCK DOUBLE SHOTGUN** serial #A15202, 16 ga, 28" matted rib barrels choked improved cylinder and cylinder with bright excellent bores. The barrels retain 80% original blue finish which displays areas of scattered finish loss, primarily towards the muzzles. The frame, which is lightly scroll engraved, is marked with the maker's name on both sides which retains about 50% original blue finish with the balance tonight to a smoke gray patina and having light areas of surface oxidation. The walnut checkered pistolgrip buttstock and forend rate very good, as refinished, having handling marks over a thinning flaking varnish. The gun features double triggers, a non-automatic safety, extractors and a black buttplate which provides a length of pull of 14". (177075-S18074) (200/300)
3034. **MARLIN MODEL 57 LEVER ACTION RIFLE** 22 mag, 24" barrel with a bright excellent bore. The metal surfaces retain 99% original blue finish displaying a few light handling marks. The walnut Monte Carlo stock rates excellent, as refinished, displaying a few light handling marks. The barrels front and rear sights has been removed and a pair or 1" rings are present. (177075-S18256) (250/350)
3035. **STEVENS MODEL 987 SEMI-AUTO RIFLE** serial #E246471, 20" barrel with a bright excellent bore. The metal surfaces retain about 20% original blue finish with the majority of the area being covered in surface oxidation. The walnut Monte Carlo stock rates very good displaying dings, scratches and areas of the varnish chipping off. The gun wears a Tasco 4x15 scope with a duplex reticle and foggy optics. (177075-S18402) (50/150)
3036. **WINCHESTER MODEL 1902 BOLT ACTION RIFLE** 22 LR, 18" barrel with a very good lightly pitted bore. The metal surfaces retain 98% reapplied blue finish displaying a few small impact marks and light surface oxidation. The walnut straight grip stock rates excellent, as refinished, displaying a few light handling marks. The triggerguard is missing one of its screws. The gun's overall length is 33" and would make an excellent shooter for a youth. (176864-6) {C&R} (50/150)
3037. **RANGER 101 BOLT ACTION SHOTGUN** 20 ga, 26" plain barrel choked modified with a bright excellent bore. The metal surfaces retain 100% original blue with the balance being polished and scattered areas of surface oxidation and pitting. The walnut pistolgrip stock rates excellent, as refinished, displaying a few light handling marks. The stock wears a grooved buttplate which provides a length of pull of 13 3/4". The gun does not come with a magazine. (177075-S18071) (50/150)
3038. **MOSSBERG MODEL 500 SLIDE ACTION SHOTGUN** serial #J597554, 12 ga, 28" ventilated rib barrel screw-in chokes with a bright excellent bore. The included choke is modified. The barrel is primarily wrapped in a camouflage adhesive tape that is starting to come apart. The frame retains about 95% original blue having areas of adhesive residue on the frame. The checkered walnut pistolgrip buttstock and forend rate very good displaying a camouflage adhesive tape; the areas that are not covered show some added black paint and there is a 1" crack on the right side where the wood meets the receiver. The gun comes with a hard rubber recoil pad which provides a length of pull of 14 1/4". Included is a soft gun case. (177075-S18319) (150/250)
3039. **INTERARMS MODEL JW-15 BOLT ACTION RIFLE** serial #9009267, 22 LR, 24" barrel with a bright excellent bore. The barrels retain about 80% evenly fading blue finish having areas of light scratches and oxidation. The walnut pistolgrip stock rates very good displaying a few scattered dings and scratches, there are also a few light chips missing on the toeline and the sling swivels have been removed leaving two small holes in the stock. The gun wears a Tasco 3x9x40 scope which has multiple handling marks that has a duplex reticle and bright excellent optics. This gun is missing its original magazine. (177075-S18077) (100/200)
3040. **HIGH STANDARD SLIDE ACTION SHOTGUN** serial #3144678, 12 ga, 28" ventilated rib barrel choked modified with a bright excellent bore. The metal surfaces retain 85-90% original blue finish displaying light handling marks and scattered surface oxidation. The ventilated rib has become unsoldered and is attached by black electrical tape. The walnut checkered pistolgrip buttstock and forend rate very good to excellent displaying a few light handling marks. The gun comes with a hard rubber recoil pad which provides a length of pull of 14 1/4". (177075-S18403) (100/200)
3041. **HARRINGTON AND RICHARDSON MODEL 88 SINGLE BARREL SHOTGUN** serial #AX525959, 20 ga, 26" plain barrel choked modified with a bright excellent bore. The barrel retains 95% original blue finish having light areas of surface oxidation. The case-hardened frame rates excellent which has a few areas of surface oxidation present. The smooth walnut pistolgrip stock and forend rate excellent with a few light handling marks. The buttstock wears a hard rubber recoil pad which provides a length of pull of 14 1/4". (177067-7) (75/150)
3042. **HARRINGTON AND RICHARDSON MODEL HUNTSMAN MUZZLELOADER** serial #AJ293997, 50 Cal., 28" plain barrel choked improved cylinder with a bright excellent bore. The metal surfaces retain 99% original blue finish. The case-hardened frame rates excellent overall having a few light handling marks. The walnut straight grip buttstock and forend rate excellent displaying a few light handling marks. Included is the original ramrod. (177015-5) (100/200)
3043. **REMINGTON MODEL 592 BOLT ACTION RIFLE** serial #1028260, 5mm Mag, 24" barrel with a bright excellent bore. The metal surfaces retain 98% original blue finish which displays a few light handling marks. The walnut Monte Carlo pistolgrip stock rates excellent, as refinished, displaying a few light handling marks over a glossy finish. The gun has an adjustable rear sight and front post sight. (177034-44) (200/300)



3044. **MARLIN MODEL 57 LEVER ACTION RIFLE**, 22 Mag, 24" barrel with a bright excellent bore. The barrel retains 98% original blue finish with the exception of a few light handling marks. The lever and full length magazine tube retains 99% original blue finish. The walnut Monte Carlo pistolgrip stock rates excellent displaying a few light handling marks. The gun has a front hooded sight and an adjustable rear sight and it is fitted with a Marlin 4x rifle scope with a duplex reticle which has bright excellent optics. (177056-6) (250/450)
3045. **WINCHESTER MODEL 255 LEVER ACTION RIFLE** serial #386989, 22 Mag, 20" barrel with a bright excellent bore. The metal surfaces retain 90% original blue finish displaying a few light scratches and spots of surface oxidation. The walnut checkered pistolgrip buttstock and forend rate very good displaying light dings, scratches and the letters J.H.T. are incise-carved on the left side of the stock; the forend is slightly loose. This gun functions very good. (177067-19) (100/250)
3046. **ELGIN ARMS SIDELOCK DOUBLE SHOTGUN** serial #300726, 12 ga, 30" matted rib barrels choked full and modified with bright excellent bores. The barrels retain 70% original blue finish displaying an evenly thinning loss along with scattered handling marks. The locks and frame have toned to a smoke gray patina which has scattered spots of surface oxidation and light impact marks; there are some very faint traces of original case colors on the watertable. The walnut checkered pistolgrip buttstock and forend rate excellent, as lightly refinished displaying multiple scratches and dings along with a repaired chip on the left side near the upper tang. The stock wears a smooth buttplate which has a few light chips missing around the edges which provides a length of pull of 14 1/4". The gun features double triggers, extractors and an automatic safety. (176892-30) (250/350)
3047. **WINCHESTER MODEL 1903 SEMI-AUTO RIFLE** serial #85506, 22 Winchester Auto, 20" barrel with a very good lightly frosted bore. The barrel retains 70% original blue having scattered light rub and handling marks. The frame appears to have been lightly polished and has toned to a gun metal gray. The walnut checkered pistolgrip buttstock and forend rate very good displaying scattered dings and scratches over what appears to be added finish. The barrel has a front post sight and scope QD mounts. The gun functions very good. (177022-64) {C&R} [Mark Benenson Collection] (200/350)



3048. **ITHACA MODEL 37 FEATHERWEIGHT THREE BARREL SET** serial #271763, 12 ga, 30" plain barrel choked modified with a bright excellent bore. The included barrels are a 18" plain deer slayer barrel with added Remington open sights with a bright excellent bore. The third barrel is a 25" plain barrel choked poly with a bright excellent bore. All three barrels are factory fitted and retain about 95-98% original blue finish and display a few scattered handling marks. The frame retains 90% original blue having a few light handling marks. The checkered walnut buttstock and forend are in very good to excellent condition with random scratches and scuff marks. The buttstock wears a hard rubber recoil pad which provides a length of pull of 13 3/4". Included is a Gun Guard case. (177022-114) [Mark Benenson Collection] (400/600)
3049. **REMINGTON MODEL 870 SLIDE ACTION SHOTGUN** serial #W994430M, 12 ga, 28" ventilated rib barrel choked full with a bright excellent bore. The barrel is primarily wrapped in a camouflage adhesive tape that is starting to come apart. The frame displays about 80% original blue having light surface oxidation and having half of its surfaces covered in camouflage adhesive tape. The checkered pistolgrip buttstock and forend rate very good displaying a few light handling marks and having much of its original varnish cleaned. The buttstock is fitted slightly loose and wears its original hard rubber recoil pad which provides a length of pull of 14". This gun functions fine and would make a great rainy day turkey gun. (17705-S18072) (250/450)
3050. **WINCHESTER MODEL 94 LEVER ACTION RIFLE** serial #3198893, 30-30, 20" octagon barrel with a bright excellent bore. The barrel retains 98% original blue finish having scattered very light oxidation stains. The frame, lever and full length magazine tube retain 98% original blue finish displaying light handling marks and light oxidation. The walnut straight grip buttstock and forend rate excellent with the exception of a few light handling marks. The gun is fitted with a Weaver side mount which wears a Weaver 4x scope which has a post and crosshair reticle and bright excellent optics. Included is a leather sling. (177056-1) (350-550)
3051. **SWISS VETTERLI MODEL 1878 BOLT ACTION RIFLE** serial #28478, .41 Swiss, 33" barrel with a very good bore displaying a few light pits towards the muzzle. The metal surfaces bear an overall brown patina with scattered light pinprick pitting, fine oxidation staining and faint traces of original blue in the protected areas. The frame displays light traces of original case colors with the balance toning to a charcoal gray. The straight grip buttstock and checkered full length forend rates very good, as refinished, which displays a few light dings and handling marks. Rifle features two barrel bands, rear sight graduated to 1000 meters, sling swivels and proper slotted end cleaning rod. A very good early variation Vetterli rifle. (176965-30) {ANTIQUE} (300/500)
3052. **SWISS VETTERLI MODEL 1878 BOLT ACTION RIFLE** serial #905, .41 Swiss, 33" barrel with a very good lightly pitted bore. The barrel has toned to a pleasing smooth plum brown patina having areas of surface oxidation and light pitting towards the muzzle. The frame has primarily toned to a brown patina having a few light traces of its original case colors. The walnut straight grip buttstock and full length forend rate excellent, as refinished, the forend has a 2" crack on the bottom side starting at the frame. The rifle wears two barrels bands, rear sight graduated to 1000 meters, sling swivels and proper slotted end cleaning rod. (176965-27) {ANTIQUE} (300/500)
3053. **SWISS VETTERLI MODEL 1878 BOLT ACTION RIFLE** serial #33105, .41 Swiss, 33" barrel with a bright excellent bore. The barrel has toned to a pleasing smooth brown patina. The frames metal surfaces have faded to a bright gunmetal gray and pewter. The walnut straight grip buttstock and full length forearm has several light dings and mild divots. The stock retains the cartouche on the right side of the butt and has inspector markings on the toeline. The rifle wears two barrels bands, rear sight graduated to 1000 meters, sling swivels and proper slotted end cleaning rod. (176965-28) {ANTIQUE} (350/500)
3054. **SWISS VETTERLI MODEL 1878 BOLT ACTION RIFLE** serial #109649, .41 Swiss, 26" shortened barrel with a bright excellent bore. The barrel retains 85% evenly thinning reapplied blue finish. The frames metal surfaces have faded to a dark gray patina. The walnut straight grip buttstock and checkered forend rate very good, as lightly refinished, displaying dings and handling marks over a glossy finish. The stock retains the cartouche on the right side of the buttstock. The rifle wears two barrels bands, rear sight graduated to 1000 meters, a front Redfield sight, sling swivels and proper slotted end cleaning rod. (176965-26) {ANTIQUE} (200/300)

3055. **SWISS VETTERLI MODEL 1878 BOLT ACTION RIFLE** serial #8311, .41 Swiss, 33" barrel with a bright excellent bore. The barrel bears an overall brown patina with scattered light pinprick pitting and fine oxidation staining. The frame is a oxidized brown and there is an outline of a loading gate, which is no longer present, on the right side of the receiver. The walnut straight grip buttstock and forend rate very good displaying light dings and handling marks over a dark oiled finish. The rifle wears two barrels bands, rear sight graduated to 1000 meters, sling swivels and proper slotted end cleaning rod. (176965-29) {ANTIQUE} (350/500)
3056. **SCHMIDT RUBIN MODEL 1889 STRAIGHT PULL BOLT ACTION RIFLE** serial #183625, 7.5 Swiss, 30 3/4" barrel with a bright excellent bore. The metal surfaces retain 50% original blue with the balance toning to a gray patina. The walnut buttstock and handguard rate excellent and have a few small handling marks and light added finish as well. There is a single Swiss shield stamping on the buttstock which remains crisp. The rifle is equipped with the correct sights. (176965-54) {ANTIQUE} (350/550)
3057. **SWISS VETTERLI MODEL 1878 BOLT ACTION RIFLE** serial #190418, .41 Swiss, 33" barrel with a very good lightly frosted bore. The metal surfaces have toned to a dark brown patina having areas of light pitting and surface oxidation. The walnut straight grip buttstock and forend rate very good, displaying scattered dings and dents over a dark oiled finish. The rifle wears two barrels bands, rear sight graduated to 1000 meters (the sight elevator is missing) and sling swivels. (176842-24) {ANTIQUE} (250/350)
3058. **ITALIAN MODEL 1870/87 VETTERI-VITALI BOLT ACTION RIFLE** serial #D8160, 10.35x47R, 28 1/2" barrel with a bright excellent bore. The metal surfaces retain 80% reapplied blue finish displaying scattered areas of surface oxidation and a light area about halfway down the barrel appears to be white drops of paint. The walnut full length stock rates very good displaying dings and handling marks over an added dark oiled varnish. There is a cartouche present on the right side of the stock. The rifle wears two barrels bands, rear sight graduated to 1000 meters and sling swivels. The ramrod is not present with the gun. (176965-23) {ANTIQUE} (150/250)
3059. **BEAUMOUNT MODEL 1871/88 BOLT ACTION RIFLE** serial #638, 11.3x51R, 32 1/2" barrel with a good bore that is dark but has strong rifling present. The metal surfaces have toned to a pewter-gray patina with small specks of dark freckling throughout the barrel and on the two-piece bolt handle. The receiver has a "P. STEVENS/MAASTRICHT" maker's stamp on the chamber. The walnut stock has a crisp "(crown)/W" Maastricht cartouche on the right side of the buttstock. The wood has an added military oil finish over numerous minor handling marks and small blemishes throughout and exhibits some small chips missing from around the edge of the buttplate. The gun is in good working condition and is missing its ramrod. (176965-11) {ANTIQUE} (250/350)
3060. **WINCHESTER MODEL 9422M LEVER ACTION RIFLE** serial #F107465, 22 Magnum, 20" barrel with a bright excellent bore. The barrel's metal surface has primarily faded to brown with some blue showing towards the muzzle and in protected areas. There is also some scattered light oxidation, a couple of small spots of light pitting and a couple of tiny scratches. The receiver and magazine tube retain about 90% original blue with some light freckling, some scattered light spotty oxidation and a few small spots of minor pitting. The smooth walnut stock and forend rate near excellent with multiple light dings and scratches, a couple of impact or tool marks on the front end of the forend, and a couple of tiny spots of flaking finish by the edge of the buttplate. The hard rubber buttplate rates very good to near excellent with multiple light handling marks. The gun is fitted with a Williams hammer spur. (126724-244) (100/200)
3061. **WINCHESTER MODEL 9422M LEVER ACTION RIFLE** serial #F21031, 22 Magnum, 20" barrel with a bright excellent bore. The metal surfaces retain 95-97% original blue with several small spots of light oxidation primarily on the receiver, a little silvering on some high contact areas of the receiver, and a few scattered minor scratches. The smooth walnut stock and forend rate near excellent with multiple light dings and scratches. Overall a very nice early production (1973) 9422. (126724-248) (100/200)
3062. **LOT OF MAGAZINES** This lot consists of three Para-Ordnance 12 round 45 ACP high capacity magazines for a model P12 pistol. The magazines are new in their original wrappers; two appear in excellent condition, the third appears to have a little light surface oxidation. (126777-25A)
3063. **LOT OF MAGAZINES** This lot consists of three Para-Ordnance 13 round 45 ACP high capacity magazines for a model P13 pistol. The magazines are new in their original wrappers and appear in excellent condition. (126777-25B)
3064. **LOT OF MAGAZINES** This lot consists of three Para-Ordnance 15 round 45 ACP high capacity extended magazines for a model P14 pistol. The magazines are new in their original wrappers and appear in excellent condition with possibly a little light superficial oxidation. (126777-25C)
3065. **LOT OF MAGAZINES** This lot consists of two Para-Ordnance 14 round 45 ACP high capacity magazines for a model P14 pistol. The magazines are new in their original wrappers and appear in excellent condition. (126777-25D)
3066. **RIFLE SLING LOT** This lot consists of a single Turner Saddlery military-style leather rifle sling new in its original packaging with brass hooks and ring. It appears in overall excellent condition showing a little tarnish on the brass fittings. (126777-26)
3067. **LOT OF MAGAZINES** This lot consists of three 10/22 magazines by Ram-Line. The first two are 30 and 50 round capacity gray translucent showing some light use with minor handling wear. The third is black with a 30 round capacity and appears unused. (126923-14A)
3068. **LOT OF AR MAGAZINES** This lot consists of three 30 round AR magazines from Brownells in excellent condition showing a little light handling wear. (126923-14B)
3069. **LOT OF AR MAGAZINES** This lot consists of three AR magazines by Colt. The first two are 20 round capacity with one in excellent condition showing a little light handling wear, and the second in near excellent condition showing some thinning of the gray finish on the corners and high contact areas. The third magazine holds 10 rounds and is gray metal over black plastic in excellent condition showing some light handling wear. All have Colt markings on their baseplates. (126923-14C)
3070. **LOT OF AMMUNITION** This lot consists of two boxes of Remington 38 S&W 146 gr lead round nose cartridges; one full 50 round box and one partial 41 round box in near excellent condition. (126748-1)
3071. **LOT OF AMMUNITION** This lot consists of three full 20 round boxes of Hornady 7.5x55 Swiss 150 gr SST cartridges in excellent condition. (126836-1A)
3072. **LOT OF AMMUNITION** This lot consists of four full 20 round boxes of 7.5x55 Swiss cartridges. Three boxes are 170 gr by FNM of Portugal; the fourth box is 174 gr by Prvi Partizan of Serbia. All are in excellent condition. (126836-1B)
3073. **LOT OF AMMUNITION** This lot consists of one unopened paper-wrapped brick containing six 10 round boxes of 7.5mm GP11 (7.5x55 Swiss) cartridges. (126836-1C)
3074. **LOT OF AMMUNITION** This lot consists of one full 20 round box of Hornady 458 Win Mag 500 gr cartridges in excellent condition. (126836-1D)

3075. **LOT OF COLLECTIBLE AMMUNITION** This lot consists of two full 50 round boxes of Western 25 Stevens rimfire ammunition. Both boxes are blue and yellow; all the cartridges have a diamond head stamp. The first box and its contents are in excellent condition. The second box shows some scuffs and light wear with a little light edge wear and what looks like some bleeding of the blue ink in a couple of places. The cartridges rate very good to near excellent with some light tarnish on the bullets and casings. (126744-7A)
3076. **LOT OF COLLECTIBLE AMMUNITION** This lot consists of a single full 50 round box of C-I-L Canuck 25 Stevens rimfire ammunition. The blue and yellow box is in excellent condition showing vibrant colors with a few spots of light scuffing and mild edge wear. The cartridges are also in near excellent plus condition with a little mild tarnish. All the casings are marked with a "D" head stamp. (126744-7B)
3077. **LOT OF COLLECTIBLE AMMUNITION** This lot consists of a single full 50 round box of C-I-L Canuck 25 Stevens rimfire ammunition. The blue and yellow box is in near excellent condition showing very lightly faded coloring, some edge damage, a torn flap and some remnants of something that was once stuck to the boxes bottom side. There is a distributor label affixed to a bottom edge and a pencil price mark on the top that appears that someone tried to erase. The cartridges are in excellent condition with a little light tarnish. All the casings are marked with a "D" head stamp. (126744-7C)
3078. **LOT OF COLLECTIBLE AMMUNITION** This lot consists of a single full 50 round box of Peters 25 Stevens rimfire ammunition. The blue and yellow box is in near excellent condition showing some edge damage, a small tear in one corner, a couple of mild scuffs and a little light handling wear. The colors are near vibrant showing only a little fading. The cartridges rate excellent with a little light tarnish. All the casings have a "P" marked head stamp. (126744-7D)
3079. **LOT OF AMMUNITION** This lot consists of two full 15 round boxes of German 8mm Mauser armor piercing ammunition with a steel casing and a 1943 head stamp. The cartridges are in excellent condition. The buff-colored boxes rate excellent with some light handling wear. The boxes white and blue printed end label contains manufacturer information and is also stamped in red letters "S.m.K.". (126744-7E)
3080. **LOT OF AMMUNITION** This lot consist of a single spam can containing 440 rounds of Russian 7.62x54R ammunition. The OD green can is unopened with a couple of tiny dents and a single 1/4" cut into the edge of the lid. The can's contents are marked in Russian on the lid. It comes with a can opener. (126744-6)
3081. **LOT OF AMMUNITION** This lot consists of five boxes of mixed rifle ammunition. First is a full 20 round box of Western Super-X 35 Remington 200 gr Silver Tip Exp. in excellent condition. Second is a partial box containing 16 rounds of 8mm Mauser; 13 are Remington soft point in excellent condition, three are Winchester ball also in excellent condition with a little light tarnish. Third is a full 20 round box of 8mm Mauser ball; 14 are German, and six are Winchester; all in excellent condition with a few showing a little light tarnish. And last are two partial boxes (total 36 rounds) of Italian 7.35 ball in excellent condition with some light tarnish; six rounds are loose, 30 rounds are in stripper clips. (126838-1)
3082. **LOT OF 22 LR AMMUNITION** This lot consists of one full brick (500 rounds) of Remington 22 Thunderbolt Hi-Speed 22 Long Rifle ammunition. The box is a little tattered but is intact. (126901-S17540A1)
3083. **LOT OF AMMUNITION** This lot consists of two boxes and one bag of mixed ammunition. First is a box of 38 Special with nickel cases including (46) Remington lead round nose, and three Winchester 38 Spl +P semi-wadcutter, two of which are cross-hatched on the tip. Second is a partial box containing 47 rounds of Blazer 40 S&W and one empty casing. Third is a bag containing eight 22 LR cartridges and three empty 38 Spl cartridges. (126901-S17540A2)
3084. **LOT OF AMMUNITION** This lot consists of a single unopened 50 round box of Hornady 17 HMR 17gr V-Max. (126943-3)
3085. **MARLIN MODEL 1894 LEVER ACTION RIFLE** serial #22029816, 44 Rem Magnum, 20" barrel with a bright excellent bore. The metal surfaces retain 99% original blue with a couple of faint handling marks. The walnut stock and forearm rate excellent with a couple of minor dings on the toeline. The hard rubber buttplate shows a little light soiling and a few minor scratches. This pre-cross bolt safety rifle appears to have seen little use. (126393-32) (300/500)
3086. **REMINGTON MATCHMASTER MODEL 513-T** serial #125536, 22 LR, 27" barrel with a bright excellent bore. The metal surfaces are a thin blue fading to brown with an area of oxidized gray towards the muzzle and a couple of spots with light tool marks or minor dings. The hardwood pistolgrip target stock rates about very good with multiple minor dings, some spotty discoloration, and an overall blotchy added finish. The initials "FJA" are stamped on the left side below the receiver and an RIA EB stamped cartouche is on the right side just behind the wrist. The textured metal buttplate shows some discoloration and hangs slightly proud of the wood at the toe and heel. This rifle comes with a Redfield front globe sight but does not come with a rear sight or magazine. (126869-14) {C&R} (150/250)
3087. **REMINGTON MATCHMASTER MODEL 513-T** serial #45510, 22 LR, 27" barrel with a bright excellent bore. The parkerized finish on this "U.S. Property" marked rifle is fading towards brown. The hardwood pistolgrip target stock rates near excellent with a darkened oil finish, some light soiling, a few minor handling marks, and "LEAD" stamped on the left side of the butt. The textured metal buttplate retains most of its original gray parkerized finish with a couple of tiny spots of oxidation. The gun is fitted with a Lyman 77 front globe sight and what appears to be the original Redfield rear aperture sight, but does not come with a magazine. (126869-13) (250/350)
3088. **MARLIN GOLDEN 39A MOUNTIE LEVER ACTION RIFLE** serial #V13520, 22 S,L,LR, 20" barrel with a bright excellent bore. The barrel's metal surface is blue fading towards gray with scattered light freckling and several small spots of oxidation. The magazine tube and flats of the receiver are blue with freckling and several small spots light oxidation. The top and bottom of the receiver are dark gray with some light freckling. The lever is blue that has primarily faded to brown with some spotty light oxidation. The walnut stock and forearm rate very good with multiple light dings and scratches and a dull finish. The target in the toeline is missing; the white insert between the buttplate and stock is recessed for most of its circumference. (126901-S18024) {C&R} (250/450)
3089. **REMINGTON MODEL 12-B GALLERY SPECIAL SLIDE ACTION RIFLE** serial #520484, 22 Short, 24" octagon barrel with a gray, moderately pitted bore. The metal surfaces retain about 90% refinished blue with some mottled gray and gray-brown spotting, several tiny scattered spots of oxidation, some light freckling and some light wear turning gray on the moving parts of the slide and magazine tube. The smooth semi-pistolgrip stock and grooved forearm rate very good with multiple light scratches and dings and added finish. There is a small crack on either side of the wrist running back from the receiver and another tiny crack running back from the lower tang. The crescent metal buttplate show good blue with thinning to gray in a couple of spots, some light scratches and a little light oxidation. (126868-30) {C&R} (300/500)
3090. **MARBLE-GOSS SIGHT LOT** This lot consists of a Marble-Goss Super Springfield No. 7 receiver mounted aperture sight. This sight is specifically designed for the Springfield 1903 rifle to be mounted replacing the magazine cutoff allowing its installation without any modification to the gun. It is in excellent condition with the adjustments working smoothly for their full range, a light flattening of one corner, a little light oxidation on the mounting surface and comes with a single aperture disc. (126384-1)



3091. **REDFIELD SIGHT LOT** This lot consists of a Redfield No. 70 receiver sight that fits the Springfield Model 03A3 rifle. This sight is in near excellent condition with the adjustments working smoothly for their full range. There are a few light handling marks showing; the mounting surface is gray and the blue on the adjustment knobs is beginning to fade towards gray. It comes with a 0.88" eyepiece with a small aperture. (126384-4)
3092. **REDFIELD SIGHT LOT** This lot consists of a Redfield No. 70 long range receiver sight that fits a Springfield Model 03A3 rifle. The sight has a long bridge and adjustment screw for long range shooting. It is in excellent condition showing only faint handling marks. The adjustments work smoothly for their full range. It comes with a small eyepiece with a 0.15" aperture. (126384-4A)
3093. **SPRINGFIELD MAGAZINE LOT** This lot consists of a single magazine for a 22 cal Model 1922 Springfield rifle. The magazine is a fading blue turning to gray with a few scattered light freckles and is in overall near excellent condition. (126384-3A)
3094. **SIGHT AND ACCESSORY LOT** This lot consists of a total of six sight and sight related items. First is a Redfield No. 66 dovetail base front globe sight with a set of inserts. Second is a Lyman 17 dovetail base front globe sight with a two position (post and aperture) reticle. Third is a Redfield adjustable rear aperture disc with eight aperture settings. Forth are two tins of Lyman 17A sight inserts with a total of 14 inserts plus an additional three inserts for a larger diameter sight. And last is a receiver-mounted sight block marked "R-40X". All appear in near excellent condition. (126384-3)
3095. **FRONT SIGHT AND SIGHT ALIGNMENT TOOL LOT** This lot consists of two items. First is a Sweany Site-A-Line sight alignment kit housed in a wood box with three bore spuds (.45, .30, .22) in excellent condition. Second is an RPA low profile front globe sight with three sight inserts. (126384-5)
3096. **SHOOTERS BOX LOT** This lot contains an OD green USMC marked wooden shooters box with metal reinforced edges and corners. It measures 16" W, 8" D, 7 1/2" H with a top lid that folds up and locks in place, a front panel that folds down, and a leather handle on top. The interior has five compartments and a cartridge block that holds 30 cartridges. It is marked inside "7/61 Continental Vogue Luggage Co" and "1005-630-7250". It appears like new and is likely unused. (126384-2)
3097. **SHOOTERS LOT** This lot contains five items. First is a two die set of Lyman reloading dies for 25-35 rifle cartridge. The set appears new and comes in its original orange plastic case with an instruction sheet. Second is a Lyman 56 rear sight for Winchester 94 rifle in good condition. The elevation retention knob has been replaced with a hex nut and the windage adjustment bar's end-piece is detached from the bar. The adjustment screws work smoothly for their full range. Includes the mounting screws. Third is a Remington ventilated recoil pad that appears new. Fourth is a pair of H&R 20 gauge nickel-plated snap caps that appear new and come in their original box. And last is a bag of approximately 100 unprimed fired 25-35 brass cases in very good condition showing some light tarnish. (126455-1)
3098. **WEIGHT SCALE LOT** This lot consists of two Chatillon IN-15 brass scales in their original packaging that appear new. The gauges will measure up to 15lbs in 4 oz increments and can be used to weigh small game, fish, or trigger pull. (126455-2)
3099. **LOT OF BOOKS** 6 Total The American Heritage Picture History of World War II, by C.L. Sulzberger; c. 1966 by American Heritage Publishing Co. 640 jacketed hardcover in excellent condition. Next are five soft cover books from the Ballantine's Illustrated History series, all are 160 pages and are in near excellent condition: Ludice, Sacrificial Village, by John Bradley; c.1972 by Ballantine Books. Luftwaffe, by Alfred Price; c. 1969 by Alfred Price. The Guns 1939-45, by Ian V Hogg; c. 1970 by Ian V Hogg. Waffen SS, the Asphalt Soldiers, by John Keegan; c. 1970 John Keegan. MacArthur in Japan, by Sydney L Mayer; c. 1973 by Ballantine Books. (126455-6)
3100. **UNERTL SCOPE LOT** This lot consists of a 24x Unertl target scope serial #36759. The scope is 26" overall length with a 2" objective aperture, a 1" ocular aperture, and a 1" tube. The optics show a slight fogginess with a fine crosshair. The surface retains about 95% original blue with minor light wear on the tube from use, a few light freckles, and a couple of minor scratches. There is a small impact mark on the back of the objective end. It includes front and rear target mounts, recoil spring, and screw on lens covers. (126699-5A)
3101. **DOUBLE RIFLE HARD CASE LOT** This lot consists of a single gray plastic Gun Guard hard case. It is semi-rectangular measuring 46"x14"x5" with a foam insert in excellent condition showing a few light handling marks. (126699-5B)
3102. **HARD CASE LOT** This lot consists of a single aluminum hard case that measures 50"x13"x4". It is in very good condition with tape remnants and light soiling on its exterior surface. The interior is loosely fitted with foam that shows some soiling. It has three latches with handles on both ends and another on one edge. (126393-119A)
3103. **LOT OF LONG GUN SLEEVES** This lot consists of 20 long gun sleeves. They are 52" long and made of a camo-colored canvas type fabric with a string fastened flap and are in good condition showing some light wear and soiling. (126965-58)
3104. **LOT OF LONG GUN SOFT CASE** This lot consists of six soft cases and one sleeve ranging from 40" to 50" in length and made of suede, vinyl, and fabric. One has a short zippered end, five have full zippers and the sleeve has string fastened flap. The cases range from good to very good condition showing some minor wear from usage. (126965-58A)
3105. **LOT OF HOLSTERS AND PISTOL RUGS** This lot consists of three holsters and two pistol rugs. First is a black leather S&W holster marked B21 34 in near excellent condition showing a few minor handling marks. Second is a brown Hunter leather holster marked 1100B17 in very good condition showing some minor handling marks and a couple of scuffs. Third is a fleece-lined two-toned brown suede flap holster by Brauer Bros marked AU006 1/2 A22 in good condition showing some light to moderate wear of the fleece lining and a little light wear of a few edges of the suede exterior. Last are two Browning fleece-lined black vinyl pistol rugs measuring 9" and 12" in length. They are in very good condition showing a few light handling marks. (126750-6)
3106. **LOT OF LONG GUN SOFT CASE** This lot consists of three vinyl cases ranging from 44" to 50" in length in good condition. One has a full length zipper, the last two have 1/4 length zippers. (126750-6A)
3107. **LOT OF AMMUNITION** This lot consists of five boxes and a bag of loose 22 rimfire ammunition. First are two full 50 round boxes of Western Super-X copper plated 40 grain cartridges in excellent condition. Second is an older full 50 round box of nickel-plated 22 LR Western Super-X in near excellent condition. Third is a partial box of Remington Kleanbore 22 LR containing about 40 rounds also in very good condition with some light tarnish. Fourth is a full box of Federal Champion 22 Short in excellent condition. And last is a bog of 22 LR containing 35 rounds of Western and UMC cartridges in near excellent condition. (126750-1)
3108. **LOT OF AMMUNITION** This lot contains two boxes of ammunition. First is a partial box containing 48 rounds of Peters nickel-plated 38 Special 158 grain lead round nose cartridges in excellent condition. Second is a full 50 round box of Peters 32 S&W Long 98 grain lead round nose cartridges also in excellent condition. (126750-1A)

3109. **SHOTGUN SHELL AND CLEANING KIT LOT** First is a bag containing about 50 shotgun shells of mixed 20, 16, and 20 gauge including both slugs and various shot sizes all in very good condition. Second is an Outers shotgun cleaning kit in a red metal container that includes a three piece cleaning rod, 12 ga bore brush, a patch holder, a tube of Gunslick, a partial bottle of Hoppe's solvent, and a container of oil. Also included are a tube of gun grease, a box of patches, a 20ga bore brush and two cartridge belts. All are housed in a blue canvas bag. (126750-3)
3110. **GUN CLEANING LOT** Total of three kits included. First is a Kleen Bore 30 cal kit that includes a three section rod, bore brush, patch holder, patches, and gun conditioner all housed in a plastic case. Second are two Outers cleaning rods, one is for 22 cal and the other is for 30 cal. Both are housed in plastic pouches and are in excellent condition. Third are two partial boxes of patches (22 and 30 cal). Next is a partial bottle of solvent. Also included is a Kershaw folding knife and a bag containing twelve 30-30 cartridges. All are housed in a white vinyl bag. (126750-2)
3111. **GUN REPORT LOT** This lot contains 527 issues (includes four double) of the periodical Gun Report. Starting with December 1963, there are sporadic issues up until 1967 with most years starting in 1968 having a complete 12 month set up until the October 2010 issue. The missing issues include Sept. 1983, February 1985, February 2001, August and September 2003. The periodicals are housed in two or three year increments in 21 open file boxes and generally appear in very good or better condition. (126982-1)
3112. **BOOK LOT** The Colt Heritage: The Official History of Colt Firearms from 1836 to the Present, by RL Wilson; 358 page jacketed hardcover. Jacket is in near excellent condition with minor tears and creases on some corners and edges. The cover is blue linen with silver embossed title on the front and on the spine, and is in very good to near excellent condition with a few small spots of moisture staining and a couple of spots of discoloration on the edges. The pages rate excellent showing little signs of use. (125953-30)
3113. **COLLECTIBLE BOOK LOT** Hell I Was There by Elmer Keith. © Elmer Keith 1979 (sixth printing 1989). 308 pages hardcover. Elmer Keith, His Life Story. The life, times and exploits of Elmer Keith who needs no introduction here. The dust cover bills: "Adventures of a Montana Cowboy Who Gained World Fame As a Big-Game Hunter". Rife with photographs and illustrations from his early childhood through his cowboy days to hunting and raising a family. Overall the volume is in excellent condition without tears, stains or foxing. The pages show a bit of and wear from being read and the chocolate-brown linen covering shows some very light scuffs on the very corners only, the gold gilt embossing of the spine still in excellent condition. The dust jacket shows a bit more wear with multiple tears, some staining on the back and a 1" by 1/2" triangular piece missing at the top front. A must-read for anyone interested in firearms or hunting in general, more-so for anyone unfamiliar with Mr. Keith's many accomplishments and contributions to the world of firearms and hunting that we take for granted today. (36512-8C)
3114. **HUMOROUS BOOK LOT** This lot consists of two volumes by Patrick F McManus of Field & Stream fame. The first volume is signed by the author and was his very first book in 1978, A Fine and Pleasant Misery. © Patrick F. McManus. 209 pages hardcover with the humorous, tongue-in cheek, and oftentimes laugh-out-loud humor of Mr. McManus. Generally detailing incidences from his childhood, or even grown-up exploits. The book remains excellent overall and is signed by the author on the inside front page, also below this is a 1982 Christmas dedication but not by the author. The brown mustard-tone cover with red-burgundy fabric spine-wrap remains excellent with the gilt along the spine still fully intact. The dust jacket rates about very good with a couple minor divots and a small rip on the front upper left corner. The second volume How I Got This Way. © Patrick F McManus 1994. 222 pages hardcover with the same wonderful and often roll-on-the-floor humor that we have come to expect from McManus. The volume rates excellent overall with the Goldenrod covers unblemished and the turquoise linen spine wrap similar with the gold gilt intact along the spine. The dust cover rates very good plus to near excellent with only light scuffing and no tears. Really two excellent volumes from this best-selling author that are must-read for anyone but the most stalwart curmudgeon. (36512-8)
3115. **LOT OF BOOKS** This is a three volume game bird/waterfowl lot. Getting the Most Out Of Modern Water Fowling by John Cartier © 1974 by the author. 396 pages hardcover. All topics waterfowl beginning with "duck hunting-what's it all about". Rife with illustrations, tips, techniques identification, decoy setups etc. Overall excellent without blemishes nor foxing. The blue linen covering is 100% intact as is the gold gilt spine. The dust jacket rates very good plus to near excellent. North American Ducks, Geese & Swans by Donald S Heintzelman © 1978 by the author. 236 pages hardcover. A checklist of all North American waterfowl as well as techniques of waterfowl study including the construction of blinds and use of decoys along with eclipse plumage and waterfowl migration routes and fly ways. Many photographs, maps and color plates. Overall excellent with only the beginning of some very light foxing along the very edges of the pages. The glossy royal blue linen covering and gilt spine title remain brilliant with the exterior dust jacket rating very good plus. The last volume Game Birds of North America by Leonard Lee Rue III © 1973 by the author. 490 pages hardcover. Covering all manner of Waterfowl, Upland, Shore and Nuisance birds (the Great Horned Owl covered in the last chapter!). Rife with photographs but also absolutely super color plates by artist Douglas Allen Jr., taken from his paintings. Overall excellent with only the very beginning of some light foxing on the edges of the pages. The chocolate-brown linen covering with an embossed waterfowl in-flight on the cover rating excellent, the dust jacket very good plus with a small tear at both front and rear. Really a nice lot of volumes overall for the hunter or even student of ornithology. (36512-8A)
3116. **LOT OF BOOKS** This is a three volume firearms student/collectors lot. Sporting Guns by Richard Akehurst © 1972 Octopus Books Ltd., 96 pages hardcover. Covers the guns and gunning from the sixteenth century to the development of the breechloader. Many fine photographs and antique illustrations. Really a fun read. Overall about excellent with the hardcovers showing identical illustrations and photos as the dustjacket; the dust jacket itself very good plus. The Treasury of Sporting Guns by Charles Waterman © 1979 Random House. 240 pages hardcover. Covers "The Beginning of Guns" from early match locks through flinter's, the early pioneer days in this country through the development of cartridges and guns, precision shooting, some notable "Sharpshooters and Showoffs", guns for flying game and highly embellished arms. Overall otherwise excellent but for a large 5" compression on the cover adjacent to the spine, it has creased the cover and the front two pages only but has not affected the balance of the book nor its readability. No dust cover is present. An informative read overall. The "Complete Collectors and Traders Guide" Guns of the World © 1977 Petersen Publishing, Hans Tanner ed. 400 pages hardcover. An interesting and eclectic collection of articles covering such things as Kentucky rifles, Sharps Arms, commemoratives, Bowie knives, Colt Firearms, M-1 carbines, free pistols, Japanese arms, Winchester model 70s, Smith & Wessons, Swiss rifles, Moisin Nagants, military rifle markings, P38's and Lugers, Mausers, rifled field guns, paper cartridges, and many more. Mostly black and white with color plates at the center; the rear-most section is an interesting identification and value guide for arms of the world, organized alphabetically by nation. Overall very good showing minor abrasions along the upper and lower edges of the covers, soiling along the edges of the pages, a number pages showing the remnants of having been folded-over and a very sparsely scattered pen underlining or notation here and there. The dust cover itself rates very good to very good plus. Still an informative read and identification guide even in this day. (36512-8B)
3117. **LOT OF BOOKS** 4 total A History of Browning Guns from 1831, c. 1942 by J.M. & M.S. Browning Co. 62 page hardcover. The Sharps Rifle, by Winston Smith; c. 1943 by Winston Smith. 138 page hardcover. Samuel Colt: A Man and an Epoch, by Martin Rywell; c. 1952-1955 by Martin Rywell. 200 page jacketed hardcover. The Flamboyant Mr. Colt and his Deadly Six-Shooter, by Bern Keating; c. 1978 by Bern Keating. 233 page jacketed hardcover. These books are in very good to near excellent condition showing some light superficial wear. (125953-20,22,24)

3118. **LOT OF BOOKS** 5 total The History of Weapons of the American Revolution, by George Neumann; c. 1967 by George Neumann. 373 page jacketed hardcover. Who Fought and Died, by Ralph Beebe; c. 1941 Coward-McCann, Inc. 329 page hardcover. Bullet and Shell, by Maj. George Williams; c. 1882 by George Williams. 454 page hardcover. United States Martial Pistols & Revolvers, by Arcadi Gluckman; c. 1956 by The Stackpole Co. 306 page jacketed hardcover. How to Shoot the U.S. Army Rifle, c. 1943 by The Infantry Journal. 122 page soft cover. These books are primarily in very good to near excellent condition showing some minor wear and handling blemishes. (125953-13,21,28,29,33)
3119. **LOT OF BOOKS** 11 total This lot consists of nine editions of the Lyman Reloading Handbook (the oldest being No 22 and the latest being 42nd edition) and two editions of the Belding and Mull reloading handbook (1939 & 1957). All are in good to very good condition showing some wear and tear from usage and storage. (125953-14,34)
3120. **LOT OF CATALOGS** 15 total This lot consists of catalogs No. 1, 12, 13 & 20 from Thompson Center; Mossberg 2001; Abercrombie & Fitch Camp Outfits, c. 1909; Lyman Sights No. 30 from 1945 including a price sheet; No. 46 from New York Sporting Goods Co.; King Modern Sights dated 1938; James Purdy & Sons (not dated); Kittery Trading Post 1976 Fall & Winter; Hunting & Fishing at the VE Lynch Camps (reprint dated 1974); September 1972 edition of Guns magazine; an NRA publication: Mauser Rifles, c. 1980, 1985; and Professional Guide's Manual, by George Herter; c. 1971 by George Herter. All publications are in various condition from good to near excellent with some missing covers and/or pages, some with taped covers, some with tattered edges. (125953-27,31,32,33,34,36)
3121. **LOT OF GUN TEST PERIODICALS** This lot consists of 91 editions of Gun Test starting with the November 1996 edition and ending with the March 2008 edition with multiple editions missing from the series. The periodicals are in very good condition. (125953-66)
3122. **LOT OF BOOKS** 4 total: Africa: a Return to the Long Grass, by Peter Capstick; c. 1987 by Peter Capstick. 213 page jacketed hardcover. Complete Book of Hunting, by Clyde Ormond; c. 1962 by Outdoor Life. 467 page jacketed hardcover. The jacket is a little tattered around its edges. The Hunting Rifle, by Jack O'Connor; c. 1970 by Jack O'Connor. 314 page jacketed hardcover. The jacket is tattered around its edges with a few pieces missing. The Accurate Rifle, by Warren Page; c. 1973 by Warren Page. 238 page jacketed hardcover. The jacket has a couple of small creases and tears. All books are in near excellent condition showing a little light handling with some markings on the inside of their covers. (125953-19,23,25,26)
3123. **TOMMY GUN VIOLIN CASE LOT** This lot consists of a "violin" hard case for a Thompson rifle. The case has black vinyl exterior with brass colored hardware. The interior is foam lined with a cutout for the classic drum magazine. The case is in excellent condition with a couple of very small minor blemishes. (126724-204A)
3124. **HARD CASE LOT** This lot consists of a Flambeau Tactical rectangular hard case that measures 41"x14"x4 1/2". This black plastic case is foam lined and is in overall excellent condition showing a few faint handling marks. (126559-2)
3125. **LOT OF LONG GUN SOFT CASES** This lot consists of 17 long gun sleeves and cases made of fabric or vinyl and ranging in length from 48" to 58". They are in good to near excellent condition. (126940-322)
3126. **TAKEDOWN SHOTGUN CASE LOT** This lot consists of one shotgun case that fits two takedown shotguns. This black plastic case measures 31"x10"x4 1/2", opens into two halves, has two clasps, and one combination latch that fits loosely to the case. The interior has a padded red fabric lining with a Velcro latched divider between the two gun compartments. Overall the case is in very good condition with several minor scuffs and scratches on the outside along with a couple of old stickers and some old sticker remnants. The interior shows a little light soiling and very minor wear. (126673-7C)
3127. **LEATHER SHELL POUCH LOT** This lot consist of a heavy leather pouch with a flap opening, brass hardware and a shoulder strap. The pouch is a single compartment and measures approximately 10"x7"x3" and is in near excellent condition with a few light handling blemishes. (126673-8)
3128. **AMMUNITION LOT** This lot consists of two boxes of ammunition. First is a full 50 round box of Winchester 9mm Parabellum with nickel casings and copper round nose bullets showing some tarnish. The brown box is missing one end flap. Second is a full 50 round box of Remington 22 LR high velocity ammunition in an unopened box in its original wrapping. (126935-4)
3129. **TARGET SHOOTERS LOT** This lot consists of a target stock, a hooked buttplate, and a palm rest. The stock is likely for a Walther or Anschutz target rifle and features a pistolgrip and cheek rest for a right handed shooter. There is added checkering on the grip and forend, and a pad on the cheek rest. The stock has multiple scratches and dings ranging from moderate to minor throughout its entire length. The stock comes without any hardware or a buttplate. Second is an AI Freeland hooked buttplate stamped 97A that is in near excellent condition but comes without its base. And last is a Canjar round wood palm rest with mount, but without the mount baseplate or retention screw. The wood rest has multiple light scratches and is in overall very good condition. (125087-4)
3130. **ACCESSORY LOT** This lot consists of six miscellaneous items. First is a Redhead stretch on rubber butt pad. Second is a bayonet sheath marked USM8A1. Third is an OD green web belt. Fourth are two unopened KleenBore silicone cloths. And last is an unknown leather harness. All are in good condition. (124946-15,16)
3131. **NAMBU AMMUNITION LOT** This lot consists of two full 15 round boxes and one partial box containing 17 rounds of 8mm Nambu ammunition. The two full boxes have Japanese writing on one edge. One box is cellophane wrapped with tape; the other box is wrapped in tape with one edge opened. The cartridges appear in very good condition. (124445-9B)
3132. **HOLSTER LOT** This lot consists of two holsters. First is an H.H. Heiser 415 leather holster that is 5" in overall length and appears to fit a short barrel revolver. It is in very good condition showing some wear primarily on its interior from the insertion and extraction of a firearm, and some exterior areas that have darkened from usage. Second is a rubber coated canvas sleeve marked "S&W Regulation Police" on the outside with an overall measurement of 7" in length and 4" wide at the top. (124467-2)
3133. **KNIFE LOT** This lot consists of two folding knives by Case. Both knives have two 4" blades and wood sides on the frame. First knife has pitted blades and a chip in the wood frame side. The second knife shows some light wear on the blades and is missing one of the wood sides on its frame. (125461-57,58)
3134. **LEATHER HOLSTER LOT** This lot consists of an old worn leather holster that likely fits an 1849 pocket revolver that is in good condition showing wear on its edges and the top of the flap as well as some verdigris around the rivets. (125706-44)
3135. **HOLSTER AND GRIP LOT** This lot consists of two items. First is a set of Pachmayr Gripper SN-G handgun grips that are new condition in their original packaging and fit S&W N-Frame and other revolvers. Second is a brown heavy leather Mexican-made Browning holster that likely fits a heavy-barreled Buckmark or similar pistol. The holster is in near excellent condition showing a few minor handling blemishes and some scrapes and wear on its interior. (125621-4,5)
3136. **CONTENDER STOCK LOT** This lot consists of one set of walnut Contender stocks that includes a forend and a right handed pistolgrip that are in near excellent condition showing several light scratches and a couple of dings. (125812-11B)
3137. **RIFLE SLING LOT** This lot consists of a single brown leather rifle sling with brass furniture in excellent condition. (125823-164A)



3138. **SHOOTERS LOT** This lot consists of three items. First are two opened tins of RWS No. 1081 percussion caps. The tins appear about 7/8 full. Second is a bag of 60 cal. lead balls containing about 35 balls. And last is a 62 cal. (20 ga) bore brush that is new in its original packaging. (125824-7)
3139. **BIPOD AND SIGHT LOT** This lot consists of a rifle bipod and two rear sights. First is a 1918 BAR bipod. The bipod is serial-numbered on both legs and on the mount. The numbers match on the legs, but are different on the mount. It is primarily OD green and in very good to near excellent condition showing some areas of light oxidation and a few minor dings and scratches. Second are two ladder rifle sights. One is for an Arisaka Type 99; it is mounted on a tube with a 19mm ID; it has aircraft wings. The second is likely German and is mounted on a tube with a 23mm ID. (125960-1)
3140. **LOT OF AMMUNITION AND BANDOLIERS** This lot consists of two bandoliers, one with ammunition. First is a six compartment bandolier containing 60 ball cartridges of 30-40 Krag ammunition. The bandolier is in excellent condition and is marked Remington Arms UMC Co. Its compartments are sewn shut with a pull tab on each. Second is a six compartment bandolier with cardboard cartridge holders intact, but no ammunition. The bandolier is in near excellent condition marked "Frankford Arsenal, Cal 30, model 1906, for model 1903 rifle". The markings are fading a bit. (125945-11,12)
3141. **E.A.A. PM2 ACCESSORIES LOT** This lot consists of three items for a European American Armory PM2 12 ga shotgun that include a folding stock, a pistolgrip, and a box magazine. All items are unmarked and are in near excellent condition with a little light oxidation on some of the metal surfaces. (125933-28)
3142. **PISTOL BENCH REST LOT** This lot consists of a Lee pistol bench rest with two pistol adaptors both for High Standard 22 cal. Model 106 & 7. It is in excellent condition showing little signs of use. (125869-2)
3143. **ACCESSORY LOT** This lot consists of nine items. First four items are 1911 45 ACP magazines. Three are unmarked, the last is unmarked except for a hand-etched number on its base. All are in near excellent condition with a little light spotty oxidation, primarily on one of the magazines. Second are two canvas OD green U.S. marked duel cavity magazine pouches in near excellent condition that fit 1911 magazines. Third is a model 1923 U.S. marked five pocket OD green canvas ammunition belt in excellent condition. Fourth is a Gould & Goodrich B501 34 black leather holster in near excellent condition showing some light wear and crazing from use. And last is a Bucheimer Defender B137A-42 black leather holster in near excellent condition showing a little light wear from use. (123765-16)
3144. **HOLSTER LOT** This lot consists of a single Triple K U.S. marked black leather flap holster in very good condition showing some scattered wear most prominent on its edges and on the flap. The holster is 13 1/2" long and fits a long barrel revolver. (124616-4A)
3145. **P-08 HOLSTER LOT** This lot consists of a single black leather flap holster for a P-08 pistol. The holster is unmarked and in very good condition showing multiple superficial scratches and other minor handling blemishes. Included are a loading tool and a FXO-marked plastic base magazine. (125693-27)
3146. **CARTRIDGE BELT LOT** This lot consists of a U.S. marked OD green 10 pocket ammunition belt in excellent condition showing some light soiling. (125945-10)
3147. **HOLSTER LOT** This lot consists of a military-style flap holster and belt. The holster and belt are made of tan leather and are in good condition showing some spotty staining but minimal signs of use. The metal rivets are tarnished with a couple of the rivets missing. The holster has a magazine pocket and another pocket for a cleaning rod. (124946-12B)
3148. **DUAL HOLSTER AND BELT LOT** This lot consists of a leather belt with two holsters. The holsters are dark brown western-style with carved outline and three small floral imprints that would fit a pair of full size revolvers. The 2 1/2" wide belt also has a couple of small floral imprints and will fit a 38-44" waist. The rig is in very good condition overall. (125679-28A,29A)
3149. **HOLSTER LOT** This lot consists of a single brown leather flap holster for a P-38 pistol. The holster is unmarked and in good condition showing some light wear and some minor staining. (125457-5)
3150. **HOLSTER LOT** This lot consists of a Lawrence tan leather flap holster that is marked "14 M 6". It is in very good condition with multiple light scuffs and scratches. (125810-55A)
3151. **HOLSTER LOT** This lot consists of a J.H. Pope marked black leather flap holster that fits a full size long barrel pistol. The leather is cracked and worn. There are some exterior areas where the outer layer of the leather has flaked off. (125871-42)
3152. **STOCK LOT** This lot consists of a Savage Model 1899 walnut pistolgrip buttstock. The wood is in excellent condition with a couple of very minor scratches and is nicely figured on its right side with a couple of worm holes and natural blemishes. No buttplate included. (125731-1)
3153. **LOT OF HOLSTERS** This lot consists of three unmarked holsters for small to medium sized handguns. First is a brown flap holster with brass furniture in very good condition showing some light wear, minor cracking and crazing and some tarnish on the brass. Second is a black leather holster with a safety strap in very good condition showing a few minor scratches and scuffs. And last is a short, open bottom tan leather holster that in good condition with a few cracks and scratches and a worn safety strap. (125092-45)
3154. **LOT OF COLLECTIBLE PUBLICATIONS** This lot consists of two 19th century publications. First is Forest and Stream, dated Thursday, October 26, 1882. This 28 page 16"x11" journal is in very good condition with some tattering of the edges. Second is The American Field, dated Saturday, August 8 1891. This 32 page journal is also 16"x11" and is in very good to near excellent condition showing some tattering of its edges. (125953-37)
3155. **LEAD MELTING POT LOT** This lot consists of a Lee electric lead melting pot. The pot is mounted on an aluminum base and appears in very good condition. (125872-24)
3156. **FISHING REEL LOT** This lot consists of a vintage Shakespeare Marhoff 1964 Model GE baitcasting reel. It has a green face on the lever side and appears unused and in like-new condition. It comes with its original box, cloth storage bag, wrench, and care pamphlet. (125872-29C)
3157. **FISHING REEL LOT** This lot consists of a vintage Shakespeare Silent Tru-Art deluxe automatic trout reel No. 1837 Model GB. This reel is used with fishing line on the reel and in very good condition showing some light wear and soiling to the green metal exterior. It comes with its original box. (125872-29B)
3158. **FISHING REEL LOT** This lot consists of a J.C. Higgins baitcasting reel Model 537.3105. The reel is in very good condition showing some light soiling. It comes with its original box and a care pamphlet. (125872-29D)
3159. **FISHING REEL LOT** This lot consists of a vintage Shakespeare 1920 Wondereel Model GE baitcasting reel. It is in excellent condition showing some light handling marks. It has fishing line wound on the reel. It comes with its original orange box and orange cloth storage bag. (125872-29E)

3160. **FISHING LOT** This lot consists of four items. First is a spool for a Martin Model 63 fly reel that appears new and comes in its original box. Second is a box of U.S. Line Company flyline. Third is a Trailsman Castomatic baitcasting reel that is in very good condition and comes in its original box. And last is a Johnson Model 80 spincasting reel that is in good condition. (125872-29F)
3161. **LOT OF SCOPES** This lot contains three scopes. All come with lens covers and rings. First is a Bushnell Sportview 3-9x rifle scope with clear optics and a duplex reticle showing some light scratches and minor handling marks on its gloss black finish. Second is a Tasco Silver Antler 3-9x rifle scope with clear optics and a duplex reticle showing an excellent matte black finish. Last is a Beeman Blue Ribbon Model 25 2x20 airpistol scope with clear optics and a duplex reticle that shows an excellent matte black finish. Also included is an extra set of lens covers. (126417-8B)
3162. **LOT OF CLAY THROWERS** This lot contains two hand-held clay throwers by Remington. First one is in excellent condition showing a few minor blemishes on its wooden handle, some light soiling and a little minor spotty oxidation on the clay holder. The second thrower is in very good condition with the wooden handle showing some flaking finish and the clay holder showing a little minor spotty oxidation and light soiling. (125872-30)
3163. **BINOCULARS AND COMPASS LOT** This lot contains one pair of binoculars and two pocket compasses. First is a pair of binoculars marked Sportiere, Paris and faintly stamped "Made in France". The optics are crisp, but a little dirty. They exterior is mostly covered with black leather and is showing some scuffs and scratches on both the metal surfaces and the leather cover. Next is a brass pocket compass marked "Cruchon & Emons Berne" on the bottom and "U.S. Engineering Corps" on top. It appears to be working fine with the glass needing a little cleaning. The cover flips up and includes a sighting slot for orienteering. Last is a silver pocket compass by Taylor of Rochester, NY. It is in good condition and is marked on its cover "Eng. Dept. USA 1918". (125872-22)
3164. **LOT OF LEATHER POUCHES** This lot contains two older unmarked leather pouches and a small coin purse in about good condition. The first measures approximately 7"x6" and is missing most of its shoulder strap. The leather shows some crazing and wear. The second measures approximately 5"x5" and is showing some crazing and cracks on its shoulder strap and a few tears in the flap cover. The wood closure button is still intact. And last is a small leather coin purse with metal snap closure that has a couple of stitched repairs. (122789-276)
3165. **BOX AND FLASK LOT** This lot contains three items. First is a wood pistol box with a hinged lid and four compartments, likely originally for a percussion pocket pistol. It is fabric lined and is missing its latch. It is in overall fair to good condition showing some soiling and need for repair with cracks in some of the joints and a piece missing where the latch should be. The remaining two items are small powder flasks measuring about 3 1/2" in length. The first is brass with an embossed eagle and shield over an "E Pluribus Unum" scroll on both sides that is in good condition showing some dings and scuffs with a frozen spout valve. The second flask is made of zinc showing an embossed bird-of-prey over a rabbit on each side with a brass top and spout. The spout valve appears to partially function. The flask shows some wear with evident soldering on the joint between the flask and brass top. (125872-15A)
3166. **LOT OF GERMAN MEDALS** This lot consists of two German medals that appear to be original. The first is an Iron Cross First Class in near excellent condition. It is silver-rimmed with an iron center, dated 1939. The second medal is the 1939 First Class Spange that goes with the aforementioned Iron Cross, also in near excellent condition. It is an eagle over a swastika and the year 1939. It comes with what appears to be its original presentation box. (125872-12A)
3167. **LOT OF PISTOL BOXES** This lot consists of three pistol boxes. First is a F.N. box that once held a High Power. The box is in good to very good condition with a folding lid and worn corners and edges. Second box is for a Remington .32 automatic pistol that is also in good to very good condition with a folding lid and worn edges and a couple of torn corners. It comes with manual, bore brush, magazine, and a cork-topped oil bottle. Last is a Colt box, likely for a small semi-auto imported pistol, in excellent condition with a few light blemishes. (126935-13)
3168. **SHOOTERS LOT** This lot consists of nine items. First are three HKS speed loaders marked Model PY-M, PY, and 586. Second is an unmarked pair of walnut target grips with adjustable heel flair for a right handed pistol shooter. Third is an unopened package of Crossman Copperhead 22 cal. airgun pellets containing 500 pellets. Fourth is an opened (250 count) tin of .177 airgun pellets that appears about 3/4 full. Fifth is a 100-round plastic container of Dynamic Nobel 6mm blank cartridges that appears near full. Sixth is a pistol cleaning rod. And last is a 15-round M1 carbine magazine marked R-C. All items are in very good to excellent condition. (126935-5)
3169. **PRESENTATION CASE LOT** This lot consists of a Ruger walnut presentation case marked "Police Marksman Association Limited Edition" on its cover that has a red fabric interior and fits two revolvers. This case was a part of a limited edition series of stainless steel Ruger revolvers, the Redhawk 44 Magnum and the Security-Six 357 Magnum, that were offered through the Police Marksman Association. The case is in very good to near excellent condition showing a few scratches and scuffs on its exterior. The locking latch has been removed but is included along with a key. Also included are eight 44 S&W American cartridges with tarnished brass and lead. (125693-43)
3170. **FRAMED ARTICLE LOT** This lot consists of a framed front page of Scientific American, dated January 25, 1852. The bulk of the page is an article detailing the improvement in breech-loading rifles focusing entirely on the Spencer Breech-Loading Rifle. The page is in near excellent condition with a piece missing from its upper edge, a little edge wear, and some water staining. The black wood frame is in near excellent condition. (125053-6)
3171. **TRIAL OF JOHN C. COLT ARTICLE** This lot is a 16 page article Trial of John C. Colt for the Murder of Samuel Adams dated Jan. 30, 1842 and printed in The Sun of New York as an Extra. The article includes several illustrations and a complete account of the trial. The pages are a little tattered along their edges and have multiple water staining marks, but are legible and are in very good condition overall. (125053-7)
3172. **HOOD FIREARMS ROBIN HOOD NO.1 SPUR TRIGGER REVOLVER** serial #7514, 22 RF, 2 1/2" barrel with a dark rusty bore. The metal surfaces retain about 95-98% antique re-nickel with fine pinprick pitting. The birdshead walnut grips rate very good with a few blemishes and possibly an older added light varnish. This revolver will require mechanical attention as parts are missing. Included with this gun is a main spring. (55870-6) {ANTIQUÉ} (20/40)
3173. **UNMARKED PERCUSSION PISTOL** about 45 cal., 5" part round part octagon barrel with an oxidized bore. The gun is European, likely Spanish and exhibits commensurate workmanship. The metal surfaces are an oxidized brown and gunmetal gray. The European walnut stock rates very good as lightly cleaned. The gun is not mechanically functional and the ramrod is not present. (5597-8) {ANTIQUÉ} (50/100)



3174. **RUGER SECURITY-SIX DOUBLE ACTION REVOLVER** serial #159-00000, 357 Magnum, 4" bull barrel with a bright excellent bore. The metal surfaces retain 99% original blue with a faint turn ring on the fluted cylinder. The checkered walnut target grips rate excellent showing a couple of faint handling marks. This revolver comes with a factory box, shipping sleeve and manual. (126520-4432) [Richard "Stretch" Kennedy Collection] (300/500)
3175. **RUGER SPEED SIX CONSECUTIVELY NUMBERED DOUBLE ACTION REVOLVER** serial #157-76941, 38 Spl, 2 3/4" barrel with a bright excellent bore. The brushed stainless steel finish rates excellent with a few light handling blemishes. The checkered walnut grips also rate excellent. This gun is consecutively numbered with the following revolver; it features a factory speed hammer (no hammer spur); and it comes with a factory box and manual. (126520-4447) [Richard "Stretch" Kennedy Collection] (300/500)
3176. **RUGER SPEED SIX CONSECUTIVELY NUMBERED DOUBLE ACTION REVOLVER** serial #157-76942, 38 Spl, 2 3/4" barrel with a bright excellent bore. The brushed stainless steel finish rates excellent with a few light handling marks. The checkered walnut grips also rate excellent. This gun is consecutively numbered with the previous revolver; it features a factory speed hammer (no hammer spur); and it comes with a factory box and manual. (126520-4448) [Richard "Stretch" Kennedy Collection] (300/500)
3177. **SMITH & WESSON 38 M&P PRE-MODEL 10 DOUBLE ACTION REVOLVER** serial #C375460, 38 Spl, 4" pinned barrel with a bright excellent bore. The metal surfaces on this mid 1950's four screw revolver retain 85% original blue with thinning towards gray, primarily on the right side of the gun, and on the front edge between the flutes on the cylinder and the upper backstrap. There is some oxidation on the triggerguard and the cylinder has a light turn ring. The trigger and hammer exhibit excellent case colors with some light oxidation on the trigger. The diamond-checkered Magna grips are numbered to the gun and rate very good to near excellent with the right side exhibiting a darker hue than the left. This revolver originally belonged to a police department and has "S.P.D. AUX 13 CD" stamped on the front gripstrap. It comes with a correct S&W box numbered to a different gun. (126520-4318) {C&R} [Richard "Stretch" Kennedy Collection] (200/400)
3178. **SMITH & WESSON 38 M&P PRE MODEL 10 DOUBLE ACTION REVOLVER** serial #C375560, 38 Spl, 4" pinned barrel with a bright excellent bore. The metal surfaces on this mid 1950's four screw revolver retain 80% original blue with holster wear on the muzzle, top of the frame, and on the front edges of the cylinder, frame and triggerguard. There is also some fading to brown on the gripstrap and a couple of scuffs on the front of the triggerguard. The case-hardened colors on the trigger and hammer rate excellent. The diamond-checkered Magna grips are numbered to the gun and rate very good with some flattening of the checkering and light handling wear. This revolver originally belonged to a police department and has "S.P.D. AUX 4 CD" stamped on the front of the gripstrap. It comes with a correct S&W box numbered to a different gun. (126520-4317) {C&R} [Richard "Stretch" Kennedy Collection] (200/400)
3179. **SMITH & WESSON MODEL 66-1 COMBAT MAGNUM DOUBLE ACTION REVOLVER** serial #94K3036, 357 Magnum, 2 1/2" pinned barrel with a bright excellent bore. The satin stainless steel finish rates excellent with a couple of faint handling marks and a light turn ring on the recessed cylinder. The checkered walnut Magna grips also rate excellent. The gun is stamped with an Alameda Police shield on the right side of the frame, it features a blued adjustable rear sight, and comes with its original factory box numbered to the gun, cleaning kit, and manual. (126520-4373) [Richard "Stretch" Kennedy Collection] (250/450)
3180. **SMITH & WESSON MODEL 10-5 DOUBLE ACTION REVOLVER** serial #D243702, 38 Spl, 6" pinned barrel with a bright excellent bore. The metal surfaces retain 98% original blue with a couple of small spots of silvering by the muzzle, a light turn ring on the cylinder, and a few light handling blemishes. The trigger and hammer exhibit excellent case colors. The checkered walnut Magna grips are numbered to the gun and rate excellent with a couple of faint handling marks. It comes with its original factory box numbered to the gun. (126520-4371) [Richard "Stretch" Kennedy Collection] (300/500)
3181. **SMITH & WESSON MODEL 66-1 COMBAT MAGNUM DOUBLE ACTION REVOLVER** serial #62K6333, 357 Magnum, 6" pinned barrel with a bright excellent bore. The satin stainless steel finish rates excellent with a few faint handling marks and a light turn ring on the recessed cylinder. The checkered walnut target grips rate excellent with a couple of minor handling blemishes. The gun features a blued adjustable rear sight and comes with its original factory box and manual. The box's end label has fallen off but is included with the box. (126520-4370) [Richard "Stretch" Kennedy Collection] (300/500)
3182. **SMITH & WESSON MODEL 37-1 CHIEF'S SPECIAL AIRWEIGHT DOUBLE ACTION REVOLVER** serial #BDA7473, 38 Spl, 1 7/8" barrel with a bright excellent bore. The bright nickel finish rates excellent with a faint turn ring on the five-shot fluted cylinder. The hammer and trigger exhibit excellent case-hardened colors. The checkered walnut grips rate excellent. Comes with its original factory box numbered to the gun, cleaning kit, and manual. (126520-4398) [Richard "Stretch" Kennedy Collection] (250/450)
3183. **SMITH & WESSON MODEL 37-1 CHIEF'S SPECIAL AIRWEIGHT DOUBLE ACTION REVOLVER** serial #BEW6720, 38 Spl, 1 7/8" barrel with a bright excellent bore. The metal surfaces retain 99% original blue with a light turn ring on the five-shot fluted cylinder. The case colors on the trigger and hammer rate excellent. The checkered walnut grips rate excellent. Comes with its original factory box numbered to the gun, manual and cleaning kit. (126520-4441) [Richard "Stretch" Kennedy Collection] (250/450)
3184. **SMITH & WESSON MODEL 469 SEMI-AUTO PISTOL** serial #TAB9355, 9mm, 3 1/2" barrel with a bright excellent bore. The satin nickel finish rates excellent as does the black synthetic textured grips. This pistol appears to have had little if any use and comes with its original factory box numbered to the gun, a total of two magazines, manual, and cleaning kit. (126520-4435) [Richard "Stretch" Kennedy Collection] (300/500)
3185. **SMITH & WESSON MODEL 22S SEMI-AUTO PISTOL** serial #UAL2913, 22 LR, 7" barrel with a bright excellent bore. The stainless steel finish rates excellent as does the textured synthetic grips. This pistol comes with a second (5 1/2") barrel also with a bright excellent bore. Both barrels have a raised solid rib with integrated scope rail and are fitted with adjustable rear sights. Included are a total of two magazines, manual and the original factory blue plastic case numbered to the gun. (126520-4289) [Richard "Stretch" Kennedy Collection] (300/500)
3186. **SMITH & WESSON MODEL 642-2 AIRWEIGHT REVOLVER** serial #CHK8129, 38 Spl.+P, 1 7/8" barrel with a bright excellent bore. The stainless steel barrel, cylinder and alloy frame rate excellent with a light turn ring on the cylinder. The black rubber Crimson Trace laser grips rate excellent. It comes with its original factory blue plastic case numbered to the gun, a Bianchi holster, the grips' manual and adjustment tools, the gun's manual, and a cable lock. (126520-4431) [Richard "Stretch" Kennedy Collection] (300/500)
3187. **IVER JOHNSON SAFETY AUTOMATIC TOP BREAK REVOLVER** serial #G2748, 32 CF, 3" ribbed barrel with a bright excellent bore. The bright nickel finish on this third model revolver rates near excellent with a couple of spots of bubbling and light oxidation. The trigger, hammer and barrel latch exhibit near excellent case colors with some light oxidation. The triggerguard is blue with a little minor oxidation. The hard rubber grips with owl's head on top rate excellent showing a couple of tiny blemishes. Comes with a leather holster. (126855-42) {C&R} (150/250)
3188. **FOREHAND & WADSWORTH SINGLE SHOT DERINGER** serial #354, 22 RF, 2" part octagon, part round barrel with a very good bore showing a little light pitting and oxidation. The nickel finish rates very good retaining about 85% finish with some areas flaking to a brown patina and a few minor handling blemishes. The birds head walnut grips are numbered to the gun and rate very good plus with a few minor handling marks and a chip on the corner of each side. The barrel and frame are numbered alike. (126894-29) {ANTIQUE} (50/100)



3189. **LOT OF HOLSTERS** This lot consists of four brown leather holsters. First is a Heiser heavy flap holster marked "1435" showing some scuffing on the inside, a little verdigris on the brass snap and some light exterior wear. Second is a Viking heavy snap holster that is marked "82" with some light wear and a little discoloration. Third is a Trufit snap holster marked "900M MP 38 4" with some light wear. And last is a Berns-Martin lightning holster showing a few scuffs, some light wear, and a little verdigris on the snaps. All are in very good to near excellent condition. (127024-24)
3190. **SMITH & WESSON MODEL 642-2 AIRWEIGHT DOUBLE ACTION REVOLVER** serial #CMN3612, 38 Spl, 1 7/8" barrel with a bright excellent bore. The matte stainless steel finish on the barrel and five shot fluted cylinder rate excellent showing a light turn ring on the cylinder. The finish on the alloy frame also rates excellent. The black rubber combat grips are in excellent condition. This hammerless revolver appears to have seen little use and comes with its original blue plastic case, manual, internal lock key, and cable lock. (127028-4) (250/450)
3191. **CRIMSON TRACE GRIP LOT** This lot consists of a single pair of black rubber Crimson Trace grips model LG-305 in excellent working condition that fit a S&W J frame round butt revolver. (127028-4A)
3192. **MARLIN 39M ORIGINAL GOLDEN LEVER ACTION CARBINE** serial #L4155, 22 S,L,LR, 18 1/2" barrel with a bright excellent micro-groove bore. The metal surfaces retain about 99% blue with a few faint handling marks. The receiver is a 1954-dated 39A receiver that has been rebarreled, likely by the factory, with a modern Original Golden 39M barrel. The barrel has been shortened to 18 1/2". The receiver has excellent blue with a few faint handling marks. The trigger is a nice dark plum; the hammer has some silvering due to rub wear. The straight walnut stock and forearm rate very good to near excellent with two cracks in the buttstock running back from the upper and lower tangs, and several light scratches and dings. The forearm fits slightly loose at the receiver. The gun is fitted with a Weaver K4 scope; the inner magazine tube is not present. (127022-182) (300/500)
3193. **SMITH & WESSON MODEL 32 REGULATION POLICE DOUBLE ACTION REVOLVER** serial #402693, 32 S&W Long, 4 1/4" pinned barrel with a very good bore showing several small spots of oxidation pitting. The metal surfaces on this pre-war five screw revolver retain 80% original blue with areas of flaking finish primarily on the cylinder and gripstrap. Also there is some light scattered spotty oxidation and freckling, a turn ring on the cylinder, and a couple of minor dings by the trigger. The trigger and hammer exhibit near excellent case colors with a few spots of light oxidation and minor pitting. The diamond-checked walnut extension grips rate near excellent showing a little flattening of the checkering and a couple of minor dings. They do not have a S&W monogram but are numbered to the gun and are marked on the butt "Pat June 5, 1917". The appropriate parts are serial-numbered alike. (127035-5) {C&R} (300/500)
3194. **SMITH & WESSON 38 REGULATION POLICE DOUBLE ACTION REVOLVER** serial #17644, 38 S&W, 4" barrel with a bright excellent bore showing a small spot of pitting near the muzzle. The metal surfaces on this pre-war revolver retain 98% factory refinished nickel with a couple of tiny spots of pitting and a handling mark or two. The trigger and hammer are gray with a little oxidation staining. The diamond checked walnut grips are numbered to the gun and rate very good with a few small chips and dings and some light to moderate handling wear. The base of the grip is marked "Pat. June 5, 1917". There is a factory refinish mark on the barrel and cylinder. All the appropriate parts are numbered alike. (127035-10) {C&R} (300/500)
3195. **LEUPOLD SCOPE LOT** This lot consists of a 36X Leupold target scope with a gloss black finish showing a couple of faint mounting and handling marks. It has an overall length of 14", a 1" tube, 40mm objective and 35mm ocular lenses and a fine crosshair center dot reticle with a clear crisp optics. It is in overall excellent condition and comes with a set of lens covers. (127076-D30227A)
3196. **SMITH & WESSON 38 MILITARY & POLICE MODEL 1905 REVOLVER** serial #334653, 5" barrel with a bright near excellent bore with several small spots of pitting primarily along one of the lands. The metal surfaces retain 75% original blue with the primary loss due to fading towards gray and brown along the gripstrap, triggerguard and on the sides of the barrel with several other small spots of fading and flaking, multiple light scratches, a couple of small spots of light pitting and a turn ring on the fluted cylinder. The case colors on the trigger and hammer are good but fading towards gray. The firing pin has been ground off the hammer leaving a light grind mark on the frame. The diamond-checked walnut grips with gold inlaid S&W medallions are numbered to the gun and rate very good plus with a worn spot and a small chip on the right side and moderately light wear to the checkering. The appropriate parts are numbered alike. (127024-4) {C&R} (300/500)
3197. **SMITH & WESSON MODEL 10-5, DOUBLE ACTION REVOLVER** serial #C859545, 38 Spl, 4" pinned barrel with a bright excellent bore. The metal surfaces retain 98% original blue with a slight silvering at the muzzle, a few scattered light freckles, primarily on the gripstrap and triggerguard, and a very faint turn ring on the fluted cylinder. The hammer and trigger exhibit excellent case-hardened colors. The checkered walnut target grips rate near excellent with a few scratches and several small spots of flaking finish. (126520-4462) [Richard Stretch Kennedy Collection] (300/500)
3198. **ENFIELD NO. 2 MK I\* DOUBLE ACTION REVOLVER** serial #L8016, 38 S&W, 5" barrel with a bright excellent bore. The metal surfaces retain 90-95% original matte blue finish with some thinning towards brown, some light silvering on high edges and a couple of worn spots and mild turn ring on the fluted cylinder. The hardwood grips rate very good plus with a few chips, several minor dings and scratches and some light wear to the grooved grip surface. The barrel, cylinder and frame are numbered alike. This top-break revolver features a spurless hammer and has a lanyard ring on the butt. It comes with an unmarked leather holster. (126983-29) (300/500)
3199. **SMITH & WESSON MODEL 10-5 DOUBLE ACTION REVOLVER** serial #C941661, 38 Spl, 5" pinned barrel with a bright excellent bore. The metal surfaces retain 97% original blue with a little wear to gray at the muzzle, a couple of small scuffs on the frame, a little thinning towards brown with some spotty oxidation on the backstrap, a few other minor handling marks and a turn ring and a couple of freckles on the fluted cylinder. The case-hardened colors rate excellent on the trigger and hammer with some minor fading towards gray on the trigger. The checkered walnut grips with S&W medallions are numbered to the gun and rate near excellent with a few light handling marks and a little minor flattening of the checkering. (127058-8) (300/500)
3200. **SMITH & WESSON MODEL 31-1 DOUBLE ACTION REVOLVER** serial #H146281, 32 S&W Long, 4" barrel with a bright excellent bore. The metal surfaces retain 99% original blue with a tiny spot of silvering at the muzzle and a couple of faint handling marks. The trigger and hammer retain excellent case colors. The checkered walnut target grips rate excellent with a couple of small handling marks. (127024-3) (300/500)
3201. **SMITH & WESSON 32 HAND EJECTOR MODEL 1903 REVOLVER** serial #31154, 32 S&W Long, 3 1/4" pinned barrel with a near excellent bore showing a little light oxidation, primarily towards the muzzle. The metal surfaces on this five screw revolver retain about 70% original blue with the barrel having mostly faded to gray-brown, some scattered light freckling, a few tiny spots of oxidation, a couple of small spots of fading towards gray and a turn ring on the fluted cylinder. The hammer and trigger display near excellent case colors with a little fading to gray on the trigger. The checkered hard rubber grips are numbered to a different gun and have begun to fade towards brown. They rate near excellent with a couple of faint handling marks. All the appropriate parts are numbered alike. (127035-17) {C&R} (350/550)

3202. **SMITH & WESSON 32 HAND EJECTOR MODEL 1903 REVOLVER** serial #120319, 32 S&W Long, 3 1/4" pinned barrel with an oxidized bore showing a few spots of moderate pitting. The nickel finish on this five screw revolver rates very good to near excellent retaining 95% original nickel with multiple small spots of flaking and oxidation, several light handling blemishes and a light turn ring on the fluted cylinder. The trigger and hammer exhibit very good case colors showing some fading to gray with a little light spotty oxidation. The black checkered hard rubber grips are numbered to the gun and rate excellent with a few light handling marks. All the appropriate parts are numbered alike. (127035-24) {C&R} (350/550)
3203. **SMITH & WESSON 32 HAND EJECTOR DOUBLE ACTION REVOLVER** serial #522664, 32 S&W Long, 6" pinned barrel with a bright near excellent bore showing a little light frosting towards the muzzle. The metal surfaces original nickel finish rates near excellent with a few tiny spots of flaking, multiple light handling marks and a light turn ring on the fluted cylinder. The hammer and trigger exhibit near excellent case colors showing a few spots of oxidation and a little light fading towards gray on the trigger. The backstrap has had a professional quality modification to fit the regulation police-style stepped grip. The diamond checkered grips are numbered to a different gun and rate about good with a couple of chips, multiple handling marks and the checkering severely worn on the right side. They appear to have been modified to fit this revolver. The appropriate parts on this third model hand ejector are numbered alike. (127035-34) (300/500)
3204. **SMITH & WESSON 32 HAND EJECTOR MODEL 1903 REVOLVER** serial #63766, 32 S&W Long, 6" pinned barrel with a bright near excellent bore showing a few small spots of oxidation. The metal surfaces retain 75% original blue with the bulk of the finish thinning towards brown and gray, and the backstrap has worn to gray. There is some scattered light spotty oxidation and minor freckling throughout, a turn ring on the fluted cylinder and a few dings on the triggerguard. The trigger and hammer exhibit near excellent case colors with the trigger face having faded to gray. The black hard rubber diamond checkered grips are numbered to the gun and rate near excellent with a few minor handling marks. All the appropriate parts are numbered alike. The gun will require mechanical attention as the action does not work consistently. (127035-33) {C&R} (200/400)
3205. **SMITH & WESSON 32 HAND EJECTOR MODEL 1903 REVOLVER** serial #96096, 32 S&W Long, 4 1/4" pinned barrel with an about very good bore showing some light to moderate pitting. The metal surfaces retain 95% original nickel finish with a little flaking, some scattered bubbling, a couple of small spots of oxidation and a turn ring on the fluted cylinder. The case colors on the trigger and hammer rate near excellent with a little minor oxidation, and some fading towards gray primarily on the trigger. The checkered hard rubber grips are numbered to a different gun and rate good with some significant wear. The appropriate parts are numbered alike. (127035-23) {C&R} (350/550)
3206. **SMITH & WESSON 38/32 TERRIER DOUBLE ACTION REVOLVER** serial #56456, 38 S&W, 2" pinned barrel with an oxidized pitted bore. The refinished metal surfaces on this post-war five screw revolver are matte black with pitting underneath and a couple of spots of rub wear that have turned silver. The trigger and hammer are in-the-white with some pinprick pitting. The diamond checkered walnut grips with S&W monogram are numbered to the gun and rate very good with a crack and a chip on the right side, a couple of dings and strong checkering. All the appropriate parts are numbered alike. (127035-26) {C&R} (150/250)
3207. **SMITH & WESSON 38 DOUBLE ACTION PERFECTED MODEL REVOLVER** serial #42552, 38 S&W, 6" barrel with a bright near excellent bore showing a couple of tiny spots of oxidation towards the muzzle. The metal surfaces retain 60-70% original blue with flaking and areas of oxidation and pitting on the barrel and cylinder, some scattered small spots of oxidation on the frame, a few dings on the butt and several light scratches throughout. The checkered and monogramed hard rubber grips are numbered to a different gun and rate excellent with a few faint handling blemishes. The gun's parts are numbered alike. (127035-6) {C&R} (200/400)
3208. **SMITH & WESSON 32 HAND EJECTOR MODEL 1903 REVOLVER** serial #66564, 32 S&W Long, 4 1/4" pinned barrel with a very good lightly pitted bore. The metal surfaces retain 90% original nickel with some scattered tiny spots of flaking and oxidation, primarily on the flats of the frame, and some areas of flaking and a turn ring on the fluted cylinder. The trigger and hammer are gray and brown with some light oxidation and pinprick pitting and a few remnants of original case colors. The pearl grips with S&W medallion rate near excellent with a chip on the left side. All the appropriate parts are numbered alike. (127035-28) {C&R} (300/500)
3209. **SMITH & WESSON 38 DOUBLE ACTION PERFECTED MODEL REVOLVER** serial #2972, 38 S&W, 4" barrel with a bright near excellent bore showing a few light freckles. The metal surfaces retain 75% original blue with the first couple of inches of the front of the barrel devoid of finish having turned gray with an abundance of pinprick pitting mostly on the left side. The remainder of the gun shows freckling, scattered small spots of oxidation and some thinning towards gray on the cylinder, gripstrap and triggerguard. The hammer and trigger's case colors rate very good with some thinning towards gray and a little oxidation. The checkered monogramed black hard rubber grips are numbered to the gun and rate very good with a few minor handling marks and a chip on the right side. The top barrel latch fits very tight and is hard to move. All the appropriate parts are numbered alike. (127035-15) {C&R} (250/450)
3210. **SMITH & WESSON 32 HAND EJECTOR FIRST MODEL REVOLVER** serial #19139, 32 S&W Long, 4 1/8" barrel with a very good bore showing some minor frosting and several light pits. The barrel has been recrowned. The metal surfaces are gray with some oxidation, a little light pitting, some oxidation staining and a few remnants of original blue. The checkered black hard rubber grips are numbered to the gun and rate very good to near excellent with several minor dings and scratches, a small chip on the edge of the monogram on the right side and a couple of hairline cracks in the butt. The frame, cylinder and barrel are numbered alike. (127038-32) {C&R} (250/450)
3211. **SMITH & WESSON 32 HAND EJECTOR MODEL 1903 REVOLVER** serial #7775, 32 S&W Long, 6" pinned barrel with frosted lightly pitted bore. The metal surfaces retain 65-70% original nickel with the bulk of the loss due to a worn flaking finish on the cylinder and flats of the frame. There are also a few small spots of oxidation and pitting and some flaking on the gripstrap. The trigger and hammer are gray with a few hints of original case colors. The custom mother-of-pearl grips are larger with an added aluminum frame running around the backstrap and butt of the gun. The grips are in excellent condition with a couple of minor chips on the edges. The gun's frame, barrel and cylinder are numbered alike. (127035-42) (350/550)
3212. **LOT OF SMITH & WESSON GRIPS** This lot consists of two sets of S&W wood grips. First is a set of diamond checkered walnut grips with silver S&W medallions in excellent condition that fit an I frame revolver. These grips are numbered to gun "62049" and come without the retention screw. Second is a pair of diamond checkered walnut target stocks with gold S&W medallions also in excellent condition that would be the proper extended grips for a third model single shot. This set of grips come with both retention screws. (127035-53)
3213. **SMITH & WESSON MODEL 640-1 DOUBLE ACTION REVOLVER** serial #CBK8307, 357 Magnum, 2 1/8" barrel with a bright excellent bore. The stainless steel finish on this hammerless revolver rates excellent with a few very minor handling marks and a faint turn ring on the five shot fluted cylinder. The black rubber Uncle Mike's Combat grips rate excellent. Comes with a black leather Towson holster. (127018-3) (350/550)
3214. **SMITH & WESSON 32 SAFETY HAMMERLESS DOUBLE ACTION REVOLVER** serial #25342, 32 S&W, 3 1/2" barrel with a frosted bore showing a few light pits. The nickel finish is very good to near excellent with some cloudiness throughout and showing multiple light handling marks, and a few small spots of light pitting. The trigger and triggerguard show near excellent blue with several tiny spots of oxidation. The mother-of-pearl grips rate near excellent with a small chip on the right side. The barrel, cylinder and frame are numbered alike. (126820-5) {ANTIQUE} (350/550)

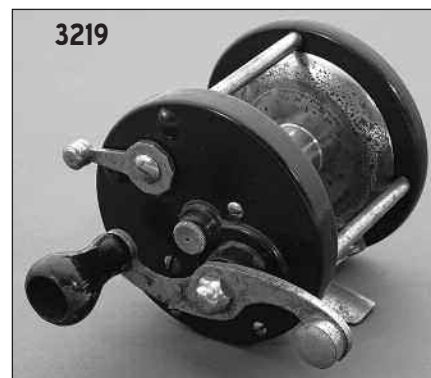

3215. **SMITH & WESSON 38 SAFETY HAMMERLESS DOUBLE ACTION REVOLVER** serial #234187, 38 S&W, 3 1/4" barrel with a bright excellent bore showing a couple of tiny spots of very light oxidation. The metal surfaces on this fifth model revolver retain 95% original blue with silvering at the muzzle and on some high edges, some light freckling, a couple of small spots of oxidation and a scratch mark on the left side of the frame and a spot of rub wear on the right. The trigger exhibits near excellent case colors that are thinning to gray on the trigger face. The hard rubber grips are numbered to the gun and rate about excellent showing a few faint handling marks. The barrel, cylinder and frame are numbered alike. (127052-7) {C&R} (200/300)
3216. **WINCHESTER MODEL 55 SINGLE SHOT RIFLE** 22 S,L,LR, 22" barrel with a bright excellent bore. The metal surfaces retain 97% original blue with several light scratches and a worn scuffed area on top of the receiver. The walnut stock rates near excellent with several light scratches, dings and impact marks. (127076-D30302) {C&R} (100/200)
3217. **FOX FISHING REEL LOT** This lot consists of a Fox fishing reel marked "FOX CO. PHILA. PA. U.S.A. 250 YD FREE SPOOL" on its foot. It is in about excellent condition showing a single tiny chip on the edge of one of the bakelite sides. The nickel-plated brass metal surfaces have some scattered tiny spots of superficial tarnish with the foot showing some flaking and wear. The brown wood knob is about excellent with a couple of small rub marks. This reel appears to function fully. (127034-76D)
3218. **FOX FISHING REEL LOT** This lot consists of a Fox fishing reel marked "A. H. FOX GUN CO. PHILADELPHIA, PA. 250 YD FREE SPOOL" on its foot. It is in about excellent condition with one small ding and several light handling marks on the bakelite sides. The nickel-plated metal surfaces show a little mild tarnish and the black wood handle has some light wear. This reel appears to function fully. (127034-76B)
3219. **FOX FISHING REEL LOT** This lot consists of a Fox fishing reel marked "FOX CO. PHILA. PA. U.S.A. 250 YD FREE SPOOL" on its foot. It is in very good to near excellent condition with a few light handling marks on the bakelite sides. The nickel-plated brass metal surfaces are flaking and tarnished with about 80% nickel still intact. The black wood knob rates about very good with some crazing and flaking finish. This reel appears to function fully. (127034-76A)
3220. **FOX FISHING REEL LOT** This lot consists of a Fox fishing reel marked "FOX CO. PHILA. PA. U.S.A. 250 YD FREE SPOOL" on its foot. It is in near excellent condition with several light scratches and dings on the bakelite sides. The nickel-plated brass metal surfaces are near excellent with a few light tarnishes and some worn finish on the foot. The black wood knob show some wear with about 70% paint left. This reel appears to function fully and comes with an almost full spool of line. (127034-76)
3221. **LOT OF FOX FISHING REELS** This lot consists of two Fox fishing reels. The first is marked "FOX CO. PHILA. PA. U.S.A. 250 YD FREE SPOOL" on its foot. It is in very good condition with the bakelite sides showing some crazing and having a small chip and a couple of tiny handling marks. The nickel-plated brass metal surfaces are flaking and tarnished with some spotty discoloration. The black wood handle is flaking with about 50% painted finish left. This reel appears to function fully. Second reel is marked "A. H. FOX GUN CO. PHILADELPHIA, PA. 250 YD FREE SPOOL" on its foot. It is good condition with a few light handling marks on its bakelite sides. The nickel-plated brass metal surfaces show some light tarnish with the center of the spool showing the bulk. The black wood handle is in near excellent condition with some fading to the painted surface. This reel does not function fully and will require some repair before using. (127034-76C,E)
3222. **BISLEY GRIP LOT** This lot consists of a set of Colt Bisley hard rubber grips in very good condition. The grips are checkered with a Rampant Colt logo showing moderate wear to the checkering with a few scratches and other minor handling marks. They have started to fade towards brown and are marked on the inside "3933", likely the last digits of the original guns serial number. There are other scratches and marks on the inside also. Includes the retention screw. (127034-75A)



3223. **BISLEY GRIP LOT** This lot consists of a set of Colt Bisley hard rubber grips in very good condition. The grips are checkered with a Rampant Colt logo showing light to moderate wear to the checkering with a few minor handling marks. They are primarily faded to brown. The retention screw is included. (127034-75B)
3224. **BISLEY GRIP LOT** This lot consists of a set of Colt Bisley hard rubber grips in very good condition. The grips are checkered with a Rampant Colt logo showing moderate wear to the checkering with some wear to the edge of the butt on the left side. There are a few scratches and a chip on the edge of the butt on the right side. They have started to fade towards brown. Includes the retention screw. (127034-75C)
3225. **BARREL THICKNESS GAUGE LOT** This lot consists of a Manson Precision barrel thickness gauge made by Dave Manson of Grand Blanc, MI and sold by Brownell's. It is in excellent condition showing a couple of minor handling marks. It has an aluminum bloc with steel arms and a Procheck brand dial indicator that measures to .001". (127034-73)
3226. **HARRINGTON & RICHARDSON MODEL 65 REISING SEMI-AUTO RIFLE** serial #9658, 22 LR, 23" barrel with a bright excellent bore. The metal surfaces are in-the-white, appearing gray, with some brown overtones, some light freckling, and a few spots of oxidation. The heavy pistolgrip military-style stock is dimensionally the same as an M-1 stock and is in about excellent condition showing a few minor handling marks. It is fitted with sling swivels and a semi-corrugated metal buttplate that is gray with some areas of oxidation. It has a protected military-style front blade sight and a Redfield adjustable rear aperture sight. It comes with a canvas sling, but without a magazine. (127076-D30185) {C&R} (250/450)
3227. **MOSSBERG MODEL 144LSA BOLT ACTION RIFLE** 22 LR, 26" barrel with a bright excellent bore. The metal surfaces retain 98% original blue with a couple of minor handling marks and some light scattered freckling. The pistolgrip walnut stock with semi-beavertail forearm rates about excellent showing a few minor handling marks and an added finish. The gun is fitted with a handstop and sling swivel mounted to a short accessory rail on the bottom of the forearm, a rear sling swivel, a globe front sight, and an adjustable rear aperture sight. It comes with a padded soft case, but does not include a magazine. (127075-S18320) (200/300)
3228. **WINCHESTER MODEL 67A BOLT ACTION RIFLE** 22 S,L,LR, 27" barrel with a bright excellent bore. The metal surfaces retain about 80% original fading blue turning toward brown with some areas of oxidation and multiple minor handling marks. The walnut pistolgrip stock rates about very good with a large chip near the breech on the left side, multiple minor dings and scratches, some spotty flaking, an added finish and "OFA" stamped on the right side of the butt. The barrel is drilled and tapped on the left side and it comes with a front sling swivel and a rear sling swivel base without the swivel. (127075-S18404) {C&R} (75/150)
3229. **MARLIN GLENFIELD MODEL 60 SEMI-AUTO RIFLE** serial #20590981, 22 LR, 22" barrel with a bright excellent bore. The metal surfaces retain 90% original blue with a few light handling marks and scattered spotty oxidation, primarily on the top of the barrel. The hardwood pistolgrip Monte Carlo stock with pressed checkered grip and forearm rates about near excellent with several light dings and scratches. (127075-S18069) (50/100)
3230. **SAVAGE MODEL 4 BOLT ACTION RIFLE** 22 S,L,LR, 24" barrel with a bright excellent bore. The metal surfaces retain 40% original blue fading to a brown patina with a few dings and light handling marks. The walnut stock rates about very good with multiple light dings and scratches, a couple of small repairs and an added finish. Comes with a rear aperture sight, but without a magazine. (127067-3){C&R} (30/60)
3231. **BSA METEOR AIR RIFLE** serial #TA02844, 22 cal, 18" rifled barrel with a bright excellent bore. The metal surfaces on this barrel cocking air rifle retain 95% original blue with multiple minor handling marks. The hardwood stock rates very good to near excellent with multiple light dings and scratches, and some spots of fading finish. The gun is grooved for the mounting of a scope and has an adjustable rear sight. (127075-S18258A) {NON-GUN} (100/150)
3232. **SAVAGE MODEL 1907 SEMI-AUTO PISTOL** serial #9272B, 380 ACP, 4 1/4" barrel with a bright excellent bore. The metal surfaces retain 90% original blue with areas thinning to gray and gray-brown at the muzzle, some high edges and areas of high contact. There are also a few spots of oxidation and a few spots of pinprick pitting. The trigger exhibits excellent case colors with some fading to gray on its face; the magazine release is gray with a hint of its original case colors. The black hard rubber grips rate near excellent with a few light handling marks. The right side grip has begun to fade towards gray with a tiny crack and a small blemish. (126724-23) {C&R} (200/400)
3233. **SAVAGE MODEL 1907 SEMI-AUTO PISTOL** serial #29895, 32 ACP, 3 3/4" barrel with a lightly pitted bore. The metal surface's refinished nickel rates about very good with a couple spots of flaking and lots of pinprick pitting. The hard rubber grips rate near excellent with a few minor handling marks and a small chip on the right side. (126724-15) {C&R} (100/200)
3234. **SAVAGE MODEL 1907 SEMI-AUTO PISTOL** serial #4577, 32 ACP, 3 3/4" barrel with a light to moderately pitted bore. The metal surfaces are gray-brown with about 20% original blue still present along the slide and in the protected areas. There are also some deep scratches on the barrel and some light pinprick pitting throughout. The metal grips rate good and are gray and brown showing wear to the checkering and logo with some light pinprick pitting along its edges. (126724-9) {C&R} (50/100)
3235. **SAVAGE MODEL 1907 SEMI-AUTO PISTOL** serial #155086, 32 ACP, 3 3/4" barrel with a bright excellent bore. The metal surfaces are primarily gray-brown with some remnants of original blue in protected areas. There are areas of light pitting and pinprick pitting scattered around. The hard rubber grips rate good with the right side grip showing a couple of cracks and scuffs. This pistol is fitted with a lanyard ring. (126724-61) {C&R} (50/100)
3236. **SAVAGE MODEL 1907 SEMI-AUTO PISTOL** serial #7809B, 380 ACP, 4 1/4" barrel with a light gray frosted bore. The metal surfaces retain 80% original blue with thinning to gray and brown on the gripstrap, silvering at the muzzle and high edges, multiple light scratches and other minor handling marks, and a few scattered spots of oxidation with some pinprick pitting. The case colors on the trigger and magazine release rate very good with the release having turned to brown and the trigger showing a little fading to gray and a little oxidation staining. The hard rubber grips have faded towards brown and rate very good to near excellent with a few minor handling marks. (126724-41) {C&R} (150/350)
3237. **SAVAGE MODEL 1907 SEMI-AUTO PISTOL** serial #8070B, 380 ACP, 4 1/4" barrel with a bright excellent bore. The metal surfaces retain 95% original blue with thinning to gray on the backstrap, silvering at the muzzle and high edges, and multiple minor scratches and dings. The trigger shows strong case colors with the front having faded to gray. The magazine release has faded to gray. The hard rubber grips have begun to fade to brown and rate about near excellent with a few little scratches and dings. (126724-24) {C&R} (300/500)
3238. **SAVAGE MODEL 1917 SEMI-AUTO PISTOL** serial #15939B, 380 ACP, 4 1/4" barrel with a very good bore showing about 50% moderate frosting. The metal surfaces retain 90-95% original blue with areas thinning to gray and brown, silvering at the muzzle and some high edges, a few tiny spots of oxidation and several light scratches. The trigger shows strong case colors with the front edge having faded to gray and the magazine release has also faded to gray. The hard rubber trapezoidal grips rate very good with a couple of small chips and dings and a crack on the left side. (126724-36) {C&R} (250/450)

3239. **SAVAGE MODEL 1917 SEMI-AUTO PISTOL** serial #248834, 32 ACP, 3 3/4" barrel with a lightly frosted bore. The metal surface's refinished nickel rates near excellent with multiple light superficial scratches and several spots of light pitting. The hard rubber trapezoidal grips rate good with significant wear and a couple of cracks on the left side. (126724-34) {C&R} (100/200)
3240. **SAVAGE MODEL 1907 SEMI-AUTO PISTOL** serial #17843, 32 ACP, 3 3/4" barrel with a gray frosted lightly pitted bore. The metal surfaces retain 95% original blue with some thinning towards gray-brown primarily on the gripstrap with several scratches and scuffs and some scattered light spotty oxidation. The trigger shows strong case colors with its front edge having faded towards gray. The magazine release is gray. The hard rubber grips rate near excellent with couple of dings and scratches and a tiny crack on the right side. (126724-16) {C&R} (200/400)
3241. **SAVAGE MODEL 1917 SEMI-AUTO PISTOL** serial #27619B, 380 ACP, 4 1/4" barrel with a bright excellent bore. The metal surface retains 97% original blue with some silvering at the muzzle and on some high edges, a little thinning towards brown on the gripstrap and some scattered freckling. The trigger exhibits excellent case colors and the magazine release has primarily faded to gray. The hard rubber grips rate near excellent with a few minor scratches and chips and a small crack on the right side. (126724-58) {C&R} (300/500)
3242. **SAVAGE MODEL 1917 SEMI-AUTO PISTOL** serial #247638, 32 ACP, 3 3/4" barrel with a bright near excellent lightly frosted bore. The metal surfaces retain 90-95% original blue with some fading towards brown on the gripstrap, a couple of small spots of oxidation and pitting, some scattered freckling and superficial oxidation and some silvering at the muzzle and on some high edges. The trigger exhibits very good case colors with its front edge having faded to gray. The magazine release has faded to gray and brown. The hard rubber grips rate very good with a few minor handling marks and a small crack on the right side. (126724-62) {C&R} (100/200)
3243. **SAVAGE MODEL 1907 SEMI-AUTO PISTOL** serial #11850, 32 ACP, 3 3/4" barrel with a bright excellent bore. The metal surfaces retain 85% original blue with primarily the high contact areas that have faded to gray-brown with some oxidation and oxidation staining and a couple of spots of light pitting. The trigger has turned to brown with a gray front edge and the magazine release has mostly faded to gray. The hard rubber grips rate near excellent with a few minor scratches. (126724-19) {C&R} (100/200)
3244. **SAVAGE MODEL 1903 SLIDE ACTION RIFLE** serial #83745, 22 S,L,LR, 24" octagon barrel with a moderately frosted bore. The metal surfaces retain about 70% original blue with areas of flaking and thinning finish that are turning brown. There are also a few minor dings and some spotty oxidation throughout. The pistolgrip walnut stock and grooved slide handle rate very good with multiple minor dings and scratches. The buttstock has been lightly cleaned; there is a 2" crack on its right side running forward from the buttplate and it has an added finish that is flaking. The crescent metal buttplate hangs slightly proud of the wood; it has the Savage logo imprinted on it and it has some small areas of oxidation and some worn finish. The gun is fitted with front bead and rear adjustable leaf sights and comes with a single magazine. (126828-2) {C&R} (200/400)
3245. **WINCHESTER MODEL 1890 SLIDE ACTION RIFLE** serial #589073, 22 Short, 24" octagon barrel with a moderately pitted bore. The barrel's metal surfaces on this third model takedown are primarily a brown patina with about 30% original blue still present. There are also several minor dings and other light handling marks. The magazine tube is a brown patina with a few minor handling blemishes. The frame and action are a gray patina with some brown undertones and a few light freckles. The triggerguard and tangs are a rich brown patina. The walnut stock and grooved slide handle rate about very good with the buttstock showing a couple of small chips and multiple minor dings and scratches. It has an added finish and there are short cracks by both the upper and lower tangs. (126892-46) {C&R} (250/450)
3246. **REMINGTON MODEL 510 TARGETMASTER BOLT ACTION RIFLE** 22 S,L,LR, 25" barrel with a bright excellent bore. The metal surfaces are a brown patina with multiple spots of oxidation and oxidation staining. The hardwood stock has multiple dings and scratches. The buttplate is homemade and made of Masonite. (126853-1) (20/40)
3247. **LEUPOLD SCOPE LOT** This lot consists of a Leupold 7.5X riflescope that is in overall excellent condition with a 25-infinity yard focus and a gloss black finish showing a couple of minor scratches and a faint ring mark. It has a duplex reticle with bright clear optics and an overall length of 12 1/2". (127034-72A)
3248. **SCOPE LOT** This lot consists of a Bushnell Sportview (4X) riflescope with a gloss black finish showing a few minor handling marks. It has a fine crosshair reticle with bright clear optics, an overall length of 12" and comes with a set of rings. It is in excellent condition. (127034-72B)
3249. **LEUPOLD SCOPE LOT** This lot consists of a Leupold 2-7 Vari-X II riflescope that is in excellent condition with a gloss black finish showing a couple of light scratches. It has a duplex reticle with bright clear optics and an overall length of 11". (127034-72C)
3250. **LEUPOLD SCOPE LOT** This lot consists of a Leupold 2-7 Vari-X Rimfire Special riflescope with a gloss black finish showing a couple of light ring marks and a couple of minor scratches. It has a fine duplex reticle with bright excellent optics and an overall length of 10". It is in about excellent condition overall. (127034-72D)
3251. **LEUPOLD SCOPE LOT** This lot consists of a Leupold M8-2X Extended Eye Relief scope with a matte silver finish showing a few light scratches. It has a duplex reticle with bright excellent optics and an overall length of 8". It is in about excellent condition overall. (127034-72E)
3252. **SCOPE LOT** This lot consists of a Charles Daly 4x32 riflescope with a gloss black finish showing several light scratches and scuffs, a couple of ring scars and scratches and a tiny ding. It has a duplex reticle with bright excellent optics, an overall length of 11 3/4" and is in very good condition overall. (127034-72F)
3253. **SCOPE LOT** This lot consists of a Weaver KV riflescope with a matte black finish showing multiple scratches, ring marks, some scattered freckling and some light spotty oxidation. It has fine crosshair reticle with foggy optics, an overall length of 11 1/2" and comes with a set of Weaver rings. (127034-72G)
3254. **LEUPOLD SCOPE LOT** This lot consists of a Leupold M8-2X Extended Eye Relief scope that is in overall excellent condition with a gloss black finish showing a couple of light handling marks. It has a duplex reticle with bright excellent optics and an overall length of 8". (127034-72H)
3255. **LEUPOLD SCOPE LOT** This lot consists of a Leupold Alaskan 6X riflescope with a matte black finish showing a couple of light handling and ring marks. It has a duplex reticle with bright excellent optics, an overall length of 10 3/4" and is in excellent overall condition. (127034-72I)
3256. **SCOPE LOT** This lot consists of a Simmons ProHunter Model 7738 extended eye relief scope that is in excellent overall condition with a matte black finish. It has a duplex reticle with bright excellent optics and an overall length of 8 3/4". (127034-72J)
3257. **LYMAN SCOPE LOT** This lot consists of a Lyman Alaskan 2.5X riflescope with a blue finish showing several scratches by the ocular end, a tiny scuff and a few other minor handling marks. It has a fine crosshair center dot reticle with bright excellent optics, an overall length of 11", is in near excellent condition and comes with a set of rings. (127034-72K)

3258. **LEUPOLD SCOPE LOT** This lot consists of a Leupold M8-4X extended eye relief scope with a target turret and a gloss black finish showing several tiny nicks and light scratches. It has a duplex reticle with bright excellent optics and an overall length of 8 1/4". It is in about excellent condition overall. (127034-72L)
3259. **SCOPE LOT** This lot consists of a Simmons ProHunter Model 822010 2-6x32 extended eye relief scope with a matte silver finish showing a couple of light scratches and light ring marks. It has a duplex reticle and clear bright optics, an overall length of 9 1/4" and is in excellent condition overall. (127034-72M)
3260. **LEUPOLD SCOPE LOT** This lot consists of a Leupold M8-3x riflescope with a plum color finish showing a couple of areas of the original gloss black. There are a couple of light scratches and ring marks. It has a duplex reticle and bright excellent optics, an overall length of 10 1/2" and is in very good condition overall. (127034-72N)
3261. **SCOPE LOT** This lot consists of a Nikon Buckmaster 4.5-14x40 side focus riflescope with a matte black finish showing some light ring marks. It has a duplex reticle with bright excellent optics, an overall length of 14" and is in excellent condition overall. It comes with a box and lens covers. (127034-72P)
3262. **SCOPE LOT** This lot consists of a Burris 4x Mini riflescope that is in excellent condition with a gloss black finish. It has a duplex reticle with bright excellent optics and has an overall length of 8". It comes with a box and two sets of lens covers. (127034-72Q)
3263. **SCOPE LOT** This lot consists of a Redfield 2-7x wide view riflescope with a gloss black finish showing multiple light dings and scratches. It has a duplex reticle with bright excellent optics, an overall length of 11 3/4" and is in very good condition overall. It comes with a Redfield box for a different model scope. (127034-72R)
3264. **SCOPE LOT** This lot consists of a Bushnell Sportview 3-9x32 air rifle scope with a gloss black finish. It has a duplex reticle with bright excellent optics, an overall length of 12" and is in excellent condition. It comes with its box and lens covers. (127034-72S)
3265. **LEUPOLD SCOPE LOT** This lot consists of a Leupold M8-2x extended eye relief scope with a gloss black finish showing a few minor scratches and a small area worn to silver. It has a duplex reticle with bright excellent optics, an overall length of 8" and is in about excellent condition. It comes with a mismatched Leupold box. (127034-72T)
3266. **LEUPOLD SCOPE LOT** This lot consists of a Leupold M8-2x extended eye relief scope with a gloss black finish with multiple ring marks and scars. It has a duplex reticle with bright excellent optics, and overall length of 8" and is in about very good condition. It comes with a mismatched Leupold box. (127034-72U)
3267. **SCOPE LOT** This lot consists of a Bushnell Sportview 3-9x32 riflescope with a gloss black finish showing light ring marks and a couple of minor scratches. It has a duplex reticle with bright excellent optics, an overall length of 11 1/2" and is in about excellent condition. (127034-72V)
3268. **SCOPE LOT** This lot consists of a Redfield 2-7Xx riflescope with duplex reticle and bright excellent optics. The metal surface is a gloss black with a few minor ring marks and a couple of small spots worn to silver. It is 11 1/4" long and comes with a box and a set of Butler Creek lens covers. (127034-72W)
3269. **LEUPOLD SCOPE LOT** This lot consists of a Leupold VX-1 3-9x40 riflescope with a duplex reticle and bright excellent optics. The metal surface is a gloss black and appears like new. It is 12 1/4" long and comes with its box. (127034-72X)
3270. **SCOPE LOT** This lot consists of a Redfield 2x rifle scope with an extended eye relief that is in overall excellent condition showing a few light handling marks on the gloss black finish. It has a crosshair reticle with bright excellent optics, a 3/4" tube and an overall length of 10 1/2". (127034-72Y)
3271. **LOT OF SCOPES** This lot consists of two scopes. First is a Tasco 3-12x40 riflescope with a duplex reticle and bright excellent optics. The gloss black metal surface shows multiple light ring marks, a few light scratches and a couple of abrasions. It is 12" long overall and in about very good condition. Second is a Weaver C4 rifle scope without any visible reticle. It is blue with some light freckling and in very good condition other than the missing reticle. The weaver scope comes with a box. (127034-72Z)
3272. **SCOPE ACCESSORY LOT** This lot consists of scope rings, bases and lens caps by various manufacturers and are in very good to near excellent condition. Included are seven sets of rings, one set of rings for a Thompson Contender with its associated base, two Weaver-style rails with mounting screws, and eight sets of lens covers. (127034-72AA)
3273. **LOT OF BOOKS** Total of seven. The Illustrated Encyclopedia of 19th Century Firearms, by Major F. Myatt MC; c. 1979 Salamander Books Ltd., this 1994 edition published by Crescent Books. 216 pages hardcover with jacket and four page pull-out section. Gun Digest Book of the 44, by John Taffin; c. 2006 John Taffin. 288 pages illustrated paperback that appears unused. America: The Men and their Guns that Made Her Great, edited by Craig Boddington; c. 1981 Peterson Publishing Co. 186 pages hardcover with jacket. Guns on the Early Frontiers: A History of Black Powder Weapons from Colonial Times to the Mexican War, by Carl P. Russel; c. 1957 Regents of the U. of California, this 1996 edition by Barnes & Noble, Inc. 395 pages hardcover (including index) with jacket. The Lure of Antique Arms, by Merrill Lindsay; c. 1976 Merrill Lindsay. 146 pages illustrated paperback from the Stoeger Sportsman's Library with several pages exhibiting underlining and check marks in red ink. Firearms, Traps, & Tools of the Mountain, by Carl P. Russel; c. 1967 Alfred A. Knopf, Inc., this 1977 edition by U. of New Mexico Press. 448 pages (plus index) illustrated paperback that appears unused. The Warner Collector's Guide to American Longarms, by H. Michael Madaus; c. 1981 The Main Street Press. 255 pages illustrated paperback serving as an identification guide and with jacket. The lot is in excellent condition overall with only very light blemishes on some. (75247-1)
3274. **LOT OF BOOKS** Total of four. Waffen-SS: Hitler's Black Guard at War, by Christopher Ailsby; c. 1997 Brown Packaging Books Ltd. 176 pages hardcover with jacket and packed with photographs. Spitfire: A Complete Fighting History, by Alfred Price; c. 1974 and 1975 Alfred Price. 301 pages hardcover with jacket. Objective analysis with hundreds of photos. Hurricane & Messerschmitt, by Chaz Bowyer & Armand van Ishoven; c. 1974 Chaz Bowyer & c. 1977 Armand van Ishoven. 320 pages hardcover with jacket. This edition combines two books. The Pacific War 1941-1945, by John Costello; c. 1981 Atlantic Communications, Inc. 742 pages paperback with markings in red ink throughout many pages. The lot rates excellent with the jackets showing a minor tear or creasing. (75247-2)
3275. **LOT OF BOOKS** Two total. Winchester: An American Legend, by R.L. Wilson; c. 1991 R.L. Wilson, this edition published 2004 by Chartwell Books. 404 pages hardcover with jacket. The Peacemakers: Arms and Adventure in the American West, by R.L. Wilson; c. 1992 R.L. Wilson. 392 pages hardcover with jacket. These copies of the popular works rate excellent with minor wear at some corners. (75247-3)



3276. **LOT OF BOOKS** Total of eleven. Real-World Survival: What Has Worked for Me, by Walt Rauch; c. 1998 R. Walter Rauch, second printing 2000. 157 pages paperback signed by the author. Guns: Who Should Have Them?, edited by David B. Kopel; c. 1995 David B. Kopel. 475 pages hardcover with jacket. The Snubby Revolver: The ECQ, Backup, and Concealed Carry Standard, by Ed Lovette; c. 2002 Ed Lovette. 109 pages paperback with underlining and check marks in red ink on many pages. Principles of Personal Defense, by Jeff Cooper; c. 1972, 1989, 2005 Jeff Cooper. Effective Defense: The Woman, The Plan, The Gun, by Gila May-Hayes; c. 1994 Gila-May Hayes and The Firearms Academy of Seattle Inc. 200 pages paperback with many pages exhibiting yellow highlighted sections. To Keep and Bear Arms: The Origins of an Anglo-American Right, by Joyce Lee Malcolm; c. 1994 President and Fellows of Harvard College. 232 pages hardcover with jacket. The Modern Technique of the Pistol, by Gregory Boyce Morrison; c. 1991 Gregory Boyce Morrison. 153 pages illustrated hardcover with gold embossed cover. Knives and the Law, by James R. Nielsen; c. 1980 James R. Nielsen. 58 pages paperback with numerous photos. Uniforms & Equipment of the Last Campaign 1916: The Pursuit of Pancho Villa, by William C. Machado; c. 1993 William C. Machado. 112 pages paperback with an address sticker attached to the back. Gun Digest Book of Holsters and other Gun Leather, by Roger Combs; c. 1983 DBI Books. 256 pages paperback. How to Make Knives, by Richard W. Barney and Robert W. Loveless; c. 1977 Beinfeld Publishing Inc. 182 pages paperback. The books are in excellent condition, the ink marks notwithstanding. (75247-4)
3277. **LOT OF BOOKS** Total of nine. The Luger Handbook, by Aaron Davis; c. 1997 Aaron Davis. 91 pages small paperback with high-lighted sections in yellow ink. Walther P-38 Pistol, by Major George C. Nonte; c. 1975 Desert Publications. 85 pages paperback with red ink markings. Know Your Walther PP & PPK Pistols, by E. J. Hoffshmidt; c. 1975 Blacksmith Inc. 87 pages paperback with high-lighted areas. P. 38 Automatic Pistol: The First 50 Years, by Gene Gangarosa Jr.; c. 1993 Gene Gangarosa Jr. 272 pages paperback with ink highlights and underlining on most pages. The Gun Digest Book of 9mm Handguns, by Steve Comus; c. 1993 DBI Books. 256 pages paperback with ink markings and several pages folded back at upper right corner. The Gun Digest Book of Smith & Wesson, by Patrick Sweeney; c. 2004 Patrick Sweeney. 312 pages paperback with only a few pages with red underlining. The Gun Digest Book of Sig-Sauer, by Massad Ayoob; c. 2004 Massad Ayoob. 256 pages paperback. The Collector's Book of Modern Handguns, by Rob Adam; c. 1996 Regency House Publishing Limited. 80 pages hardcover with high resolution color photos. Das grosse Buch der Sig-Pistolen, by Motorbuch Verlag and Verlag Stocker-Schmid; c. 1995 Verlag Stocker-Schmid AG. 240 pages illustrated hardcover with jacket. The book is written solely in German. Structurally, the lot rates excellent. (75247-5)
3278. **LOT OF BOOKS** Total of six. The Complete Encyclopedia of Pistols & Revolvers, by A.E. Hartink; c. 1996 Rebo International. 272 pages hardcover with jacket. Famous Pistols and Hand Guns, edited by A.J.R. Cormack; c. 1977 Profile Publications Limited. 160 pages hardcover with jacket and many photos. Handgun Stopping Power: The Definitive Study, by Evan P. Marshall and Edwin J. Sanow; c. 1992 Evan P. Marshall and Edwin J. Sanow. 223 pages hardcover with jacket. The Complete Handgun: 1300 to the Present, by Ian V. Hogg; c. 1979 Phoebus Publishing. 128 pages hardcover with jacket. The World's Great Small Arms, by Craig Philip; c. 1993 Brown Books. 176 pages hardcover with jacket and pullout sections. No ink markings. Modern Small Arms, by Ian Hogg; c. 1994 Brompton Books Corp. 160 pages hardcover with jacket and no ink markings. The books in this lot are in excellent condition but unless otherwise noted have most of their pages marked in red or yellow ink. (75247-6)
3279. **LOT OF BOOKS** Nine total. Jane's Guns Recognition Guide, by Ian Hogg; c. 1996 Jane's Information Group. 512 pages paperback. The next six books are authored and with copyrights by Duncan Long with several pages with ink markings. The Sturm Ruger 10/22 Rifle and .44 Magnum Carbine; c. 1988. 102 pages paperback. The Sig Handguns, by Duncan Long; c. 1995. 126 pages paperback. The Mini-14: The Plinker, Hunter, Assault, and Everything Else Rifle; c. 1987. 114 pages paperback. Glock's Handguns; c. 1996. 180 pages paperback. HK's Handguns; c. 1996. 142 pages paperback. Mini-14: Super Systems; c. 1991. 189 pages paperback. Gun Trader's Guide, edited by John E. Traister & Associates; c. 1999 Paul Wahl. 592 pages paperback. The Great Book of Guns: An Illustrated History of Military, Sporting, and Antique Firearms, by Chris McNab; c. 2004 Salamander Books Ltd. The books are in overall excellent condition. (75247-7)
3280. **LOT OF BOOKS** Five total. Glock: The New Wave in Combat Handguns, by Peter Alan Kasler; c. 1992 Peter Alan Kasler; 296 pages hardcover with jacket. The 100 Greatest Combat Pistols: Hands-On Tests and Evaluations of Handguns from Around the World, by Timothy J. Mullin; c. 1994 Timothy Mullin. 409 pages paperback. The CZ-75 Family: The Ultimate Combat Handgun, by J.M. Ramos; c. 1990 J.M. Ramos. 101 pages paperback. Great Combat Handguns, by Leroy Thompson and Rene Smeets; c. 1993 Cassell PLC. 255 pages hardcover with jacket. The Complete Encyclopedia of Pistols and Revolvers, by A. E. Hartink; c. 2002 Rebo Productions. 448 pages hardcover with jacket and free of any markings. The first four books in this lot have several pages showing underlining and highlighting with the overall condition rating excellent. (75247-8)
3281. **LOT OF BOOKS** Five total. The Colt .45 Automatic: A Shop Manual, by Jerry Kuhnhausen; c. 1990 Jerry Kuhnhausen. 202 pages paperback with no ink markings. The Tactical 1911: The Street Cop's and SWAT Operator's Guide to Employment and Maintenance, by Dave Lauck; c. 1998 Dave Lauck. 137 pages paperback. The Gun Digest Book of the .45, by Dean Grennell; c. 1989 DBI Books. 256 pages paperback with no ink markings. Pistol Guide, by George C. Nonte, Jr.; c. 1980 The Estate of George Nonti, this printing 1987. 280 pages paperback. The Gun Digest Book of The 1911, by Patrick Sweeney; c. 2001 Patrick Sweney. 334 pages paperback. Unless otherwise noted the books in this lot have several highlighted or underlined sections from an ink marker. (75247-9)
3282. **LOT OF BOOKS** Eight total. The Lee Enfield Number 4 Rifles, by Alan M. Petrillo; c. 1992 Alan M. Petrillo. 64 pages paperback. The Mauser Bolt Actions M91 through M98: A Shop Manual, by Jerry Kuhnhausen; c. 1991 Jerry Kuhnhausen. 224 pages paperback. The AR-15 Complete Owner's Guide Vol. I, c. 2000. 224 pages, and Vol. II, c. 2002. 155 pages, both by Walt Kuleck with Scott Duff; c. 2000 Walter J. Kuleck. 224 pages paperback. The M14 Complete Assembly Guide, by Walt Kuleck and Clint Mckee; c. 2006 Walter J. Kuleck. 250 pages paperback. Bolt Action Rifles: Expanded 3rd Edition, by Frank de Haas; c. 1995 DBI Books. 528 pages paperback. Rifles of the World: 3rd Edition, by John Walter; c. 2006 Krause Publications Inc. 616 pages paperback. The World's Great Rifles, by Roger Ford; c. 1998 Brown Packaging Books Ltd. 176 pages hardcover with jacket. The books in this lot are virtually blemish free and rate excellent overall. (75247-10)
3283. **LOT OF BOOKS** Total of eight. Beretta Automatic Pistols: The Collector's and Shooter's Comprehensive Guide, by J.B. Wood; c. 1985 Stackpole Books. 192 pages hardcover with jacket. Modern Beretta Firearms, by Gene Gangarosa Jr.; c. 1994 Gene Gangarosa. 288 pages paperback. Beretta 92F/M9: 9mm Semiautomatic Pistol; c. 1985 Desert Publications. 71 pages paperback that is a larger version of the owner's manual. Pistols of the World: Fully Revised, 3rd Edition, by Ian Hogg and John Weeks; c. 1992 Ian V. Hogg. 352 pages paperback with some ink markings. The Gun Digest Book of Beretta Pistols, by Massad Ayoob; c. 2005 Gun Digest. 287 pages paperback. Pistols of the World: Fully Revised 4th Edition, by Ian V. Hogg & John Walter; c. 2004 Ian V. Hogg, John Weeks and John Walter. 432 pages paperback. The last two books in this lot are annual product catalogs by Beretta for the years 2004 and 2005, 216 and 236 pages respectively. The lot is in excellent overall condition. (75247-11)
3284. **LOT OF BOOKS** Five total. Gun Trader's Guide: Twenty-third Edition, edited by Christopher R. Long; c. 2000 Paul Wahl. 584 pages paperback. Shooter's Bible: No. 96 2005 Edition, c. 2004 Stoeger Publishing Co. 576 pages paperback. The Encyclopedia of Sporting Firearms, by David E. Petzal; c. 1991 David E. Petzal. 370 pages hardcover with jacket. The Complete Encyclopedia of Hunting Rifles and Shotguns, by A. E. Hartink; c. 2004 Rebo International. 448 pages hardcover with jacket. The last item is a copy of the Browning Master Catalog for the year 2004. The books rate excellent overall. (75247-12)

3285. **LOT OF BOOKS** Five total. Handgun: From Matchlock to Laser-Sighted Weapon, by John Walter; c. 1988 Talos Books. 160 pages hardcover with jacket. Pistols: A Modern Encyclopedia, by Henry M. Stebbins together with Albert J. E. Shay and Oscar R. Hammond; c. 1961 Henry M. Stebbins. 379 pages hardcover with jacket. Classic Handguns of the 20th Century: A Shooter's and Collector's Guide, by David W. Arnold; c. 2004 David W. Arnold. 144 pages paperback. Pistols and Revolvers, by Jean-Noel Mouret; c. 1993 Editions Solar. 140 pages hardcover with jacket. Handguns of the World, by Edward C. Ezell; c. 1981 Edward C. Ezell. 704 pages hardcover with jacket with an isolated area towards the end with some pages highlighted in yellow ink but, like each of the books in this lot, rates excellent. (75247-13)
3286. **LOT OF BOOKS** Ten total. Twentieth-Century Small Arms, by Chris McNab; c. 2001 Amber Books Ltd. 320 pages hardcover with jacket. Military Small Arms of the 20th Century: 7th Edition, by Ian V. Hogg & John S. Weeks; c. 2000 Ian V. Hogg. 416 pages paperback. The World's Great Small Arms, by Craig Philip; c. 1993 Amber Books. 176 pages hardcover with jacket. How to Shoot Your M16/AR-15 in Training and Combat (no author or editor listed); c. 1996 Paladin Press. Approximately 50 pages paperback with highlighted areas. The AR-15/M16: A Practical Guide, by Duncan Long; c. 1985 Duncan Long. 160 pages paperback with highlighted areas. HK Assault Rifle Systems, by Duncan Long; c. 1991 Desert Publications. 120 pages paperback with a few highlighted areas. The Ar-15/M16 Sourcebook: What Every Shooter Needs to Know, by Duncan Long; c. 1992 Duncan Long. 223 pages paperback with some areas highlighted. The Gun Digest Book of the AR-15: Vol. 2, by Patrick Sweeney; c. 2007 Patrick Sweeney. 286 pages paperback that appears unused. The Gun Digest Book of Assault Weapons: 3rd Edition, edited by Jack Lewis; c. 1993 DBI Books. The overall condition of the books in this lot is excellent. (75247-14)
3287. **BOOK LOT** German Automatic Weapons of World War II, by Robert Bruce; c. 1996 Robert Bruce Photography, this impression 2000. 128 pages hardcover with jacket from the Live Firing Classic Military Weapons In Colour Photographs series. Instructional and informative offering highlighted by up close high resolution photography and in excellent condition. (76679-82)
3288. **LOT OF SHOTSHELLS** This lot consists of approximately 150 mixed shotshells, mainly 12 gauge in paper hulls. Manufacturers include Remington, Western, Cogswell and Harrison and Waidmanns. An about very good condition lot with some unusual examples. (76935-2)
3289. **LOT OF AMMUNITION** This lot consists of 96 rds. of 1949-dated Frankford Arsenal 30-06 contained in eight rd. en-bloc clips and two OD green bandoliers stamped "CAL 30 BALL M2/8 RD CLIPS/FA4075". The lot is in excellent condition. (76935-3)
3290. **LOT OF AMMUNITION** This lot consists of four full boxes of .303 cal. First are two full factory sealed 50 rd. boxes of Kynoch in buff colored boxes stamped "4/31". The bright red wraparound label has a top section with bold black print that reads "Kynoch/.303"/(British Mark VII Model)/cartridges/(Nitro Cellulose Powder)/In Chargers" with the company (I.C.I. Metals) name and address making up the bottom section. Also of interest is the lion's head logo on the front and rear of label. The sides of the boxes exhibit areas of brown oxidation staining and buildup. The last box is a 32 rd. box of English-manufactured cartridges with 1949-dated head stamps from the Radway Green Royal Ordnance Factory. The ammunition rates near excellent and the fully intact buff colored box retains original seal and stamps and exhibits some handwritten areas including a price. The last box is a 20 rd. box of Winchester Super Speed Power-Point in the one-piece yellow box with the big bold "W" and some price markings. The 303 British, 180 gr. soft point bullet cartridges rate excellent. (75612-1)
3291. **LOT OF BRASS** This lot consists of three full 50 rd. boxes of Midway Arms 8mm unprimed brass in excellent condition. (75612-2)
3292. **LOT OF AMMUNITION** This lot consists of three full 50 rd. boxes: (2) of Dominion 455 Colt (Webley) 265 gr. lead in excellent condition; (1) of Kynoch .455 Webley self-loading pistol cartridges, 224 gr., metal covered solid bullet in excellent condition. (75612-3)
3293. **LOT OF AMMUNITION** This lot consists of four categories. First is a full 50 rd. box of Remington 38 Short Colt 128 gr. lead bullet (heeled) in excellent condition. Second are 25 rds. of Remington consisting of six round nose lead and the balance metal case. The cartridges rate about very good with streaking evident along the cases. Next are 23 rds. of Remington .32 Long in a heavily tattered maroon box with several panels or sections missing. The ammunition rates good to very good with oxidized tips and some tarnished cases including one with a dent. The last item is a very good cartridge of 44 Henry Short Rimfire with "H" head stamp, clean ochre patina and only light oxidation to lead. (75612-4)
3294. **LOT OF AMMUNITION** Total of seven entries. First is a full 20 rd. box of Norma 7.5x55 (Schmidt-Rubin) 180 gr., soft point, semi-pointed boat tail in excellent condition. Next is a full 20 rd. box of Norma 7x57 150 gr., soft point, semi pointed boat tail rating very good to excellent with box missing a flap and showing a price in black marker. Next is an original box dated 1939 containing 18 rds. of Italian manufactured 7.35 cal. rating very good to excellent. The fourth category is four full plain tan 16 rd. boxes of 9x18 Makarov cal. also rating very good to excellent. Fifth are 80 rds. of 9mm Bergman Bayard ranging from good to very good with a few showing mild to moderate oxidation. Next is a full five rd. stripper clip of 7.62x54 with mild oxidation. Lastly are 33 M1 Carbine stripper clips that appear unused and exhibit light to mild oxidation staining. (75612-5)
3295. **LOT OF BELT PLATES AND SWIVEL** This is a lot of seven reproduction U.S. Army brass waist belt plates, apparently unused and in excellent condition with no maker markings: (5) eagle and wreath motif officer; (2) oval "US" enlisted man. Also included is an unmarked steel carbine cavalry scabbard sling buckle and hook used to secure to saddle and in near excellent condition with light wear and oxidation. (75497-6A, 15)
3296. **LOT OF HAT BADGES** This is a group of approximately 55 vintage badges with mainly a European and Canadian theme. They cover a wide range of interests and endeavors. Examples are a brass lion with "The King's Own" depicted below it, a brass maple leaf with "Alberta/89/Canada", three with the Winchester logo and one with "Old Reliable". Others commemorate Australia, Lunenburg, W.V.S. Civil Defense, Friends of Belgium and the U.S. Torpedo Boat "Cushing". Most are in very good to excellent condition with a few below that with mildew and tarnish. (75497-12)
3297. **LOT OF ACCESSORIES** This is a wide range of about a dozen vintage items. First is an unmarked bayonet scabbard for a Krag Jorgensen including the hook type swivel arm and rating very good, retaining about 90% finish with light oxidation staining, and only light handling marks. Next are three antique tins including one with an Eley Bros. of London label containing shot and one labeled for no. 1 primers. Also in this lot is a trapdoor rifle hammer marked "GT", an unmarked elevator sight, a U.S. Mod. 1879 combination tool, two nipple wrenches, and a medium caliber wood muzzle plug, approximately 20 small internal gun parts including extractors, pins and screws. The last item is an unmarked brass flask top with thumbpiece and functional spring. The overall condition of the lot is very good. (75497-14)
3298. **LOT OF CLEANING SUPPLIES** This is a lot consisting of approximately fifty pieces of gun cleaning equipment. Included are multi-piece rods for rifles, about a dozen various bore brushes, seven Silicoe Gun & Reel cloths in original packaging and a complete S&W kit. Other items are two partial containers of gun oil, a Mill Run Brite-Bore kit in original packaging as is a Coleman lantern generator. The overall condition is very good to excellent. (75497-5)

3299. **LOT OF AMMUNITION** This lot consists of six containers including the first four in zip-loc bags. The first one contains approximately 60 rds. of 1970-dated Remington Arms 38 Special FMJ and an about equal quantity of Remington 357 magnum semi-jacketed HP with both in excellent condition. Next is a bag of approximately 50 rds. of UMC 45 Colt rating very good to excellent. Next is a group of approximately 75 rds. of mixed rifle and hand gun ammunition and some brass rating near very good with some oxidation. The last bag is filled with a variety of gauges, lengths and manufacturers of shotshells rating about very good overall. Next is a 1916-dated Mills ammo pouch containing a full five rd. stripper clip of 30-06 rating good with moderate oxidation. The last item is a partial sleeve of CCI No. 109 shot shell primers containing 90 excellent rds. (75497-8)
3300. **LOT OF AMMUNITION** This lot consists of ten boxes of .22 LR.: (1) full 100 rd. plastic box and (1) containing 92 rds. of Remington Target standard velocity; (1) full 50 rd. of Remington Kleanbore Kleankote standard velocity; (1) full 50 rd. of Remington Rifle Match; (1) containing approximately 45 rds. of Remington HI-Speed shot cartridges; (1) containing approximately 47 rds. of Western Xpert greased lead bullet; (1) containing approximately 42 rds. of Western Xpert standard velocity (1) containing about 46 rds. of Winchester Super X Extra Power no. 12 shot; (1) with a missing end flap containing about 40 rds. of Winchester Leader Staynless; (1) wood box containing 40 rds. in fitted compartments and a center section with an additional 45 rds. or so of Remington. The box has the maker's (Al Freeland) label still attached to the inside lid. The lot rates very good to excellent overall. (75497-7)
3301. **LOT OF SHOTSHHELLS** This lot consists of nine boxes and one bag: (1) containing 21 rds. of Western Super X Mark 5 16 ga., 2 3/4", 1 1/8 oz., 6 shot; (1) containing 16 rds. of Winchester Super Speed 16 ga., 1 1/8 oz. 6 shot; (1) containing 20 rds. of Federal Game Load 12 ga., 2 3/4", 1 oz., 6 shot; (1) full 25 rd. of Remington Express 410 bore., 3 in., 3/4 oz., 6 shot; (1) full 25 rd. of Remington Express 410 bore., skeet, 3"; (1) full 25 rd. of Remington Express 410 bore Rifled Slug 2 1/2", (1) containing 13 rds. of Remington Express 410 bore, 3", 11/16 oz., 6 shot; (1) full 25 rd. and (1) containing 15 rds. of Winchester Super X Rifled Slug 410 bore, 2 1/2", 1/5 oz.; (1) mixed bag containing six 12 ga. and five 410 bore. The overall condition is very good to excellent with nearly all being plastic shells. (75497-7A)
3302. **LOT OF BOOKS** Total of seven. The Rifle and Rifle Shooting, by Geoffrey Boothroyd; c. 1965 G. Boothroyd. 158 pages hardcover with jacket. Modern Gunsmithing, by Clyde Baker; c. 1933 Small Arms Technical Publishing Co. 527 pages hardcover. Military and Sporting Rifle Shooting, by Captain Edward C. Crossman; c. 1932 Small Arms Technical Publishing Co. 499 pages hardcover with some handwritten notes and separation at the spine. Gunstock Finishing and Care, by A. Donald Newell; c. 1949 Thomas G. Samworth. 473 pages (plus index) hardcover with jacket and some retail notes written in pencil on front end paper. The Accurate Rifle, by Warren Page; c. 1973 Warren Page. 238 page hardcover with jacket. Early American Gunsmiths:1650-1850, by Henry J. Kauffman; c. 1952 The Telegraph Press. 94 pages hardcover with jacket and a previous owner's name written on a label attached to front end paper. The Art of the Gunmaker: Vol. I 1500-1660, by J. F. Hayward; c. 1962 J. F. Hayward. 303 pages hardcover with jacket and some markings on front end paper. The overall condition is very good with some small tears to some jackets, fading and light ingrained dirt and foxing along some edges and some corner and edge wear on a couple. (76563-1)
3303. **LOT OF BOOKS** Total of four. Colt Commemorative Firearms, by R.L. Wilson. c. 1969 Charles Kidwell. 125 pages paperback with color photos. Colt Peacemaker British Model, by Keith Cochran; c. 1989 Cochran Publishing Company. 160 pages hardcover with jacket. A History of the Colt Revolver: and the Other Arms Made by Colt's Patent Fire Arms Manufacturing Company from 1836 to 1940, by Charles F. Haven and Frank A. Belden. 711 pages hardcover with jacket. Colt Firearms: from 1836, by James E. Serven. 398 pages hardcover with jacket showing a liquid stain. The books in this lot rate very good to near excellent with some light dirt stains on edges and covers. (76563-2)
3304. **LOT OF BOOKS** Total of seven. Shotguns by Keith, by Elmer Keith; c. 1950 The Stackpole Company, this third printing 1955. 307 pages hardcover with some ink writing on title page. Game Gun, by Richard S. Grozik; c. 1986 Richard S. Grozik. 150 pages well illustrated hardcover with a personal note on front endpaper implying that the book was gifted and is signed by a representative of "The Boswell Company, EST. 1869". The Collecting of Guns, edited by James E. Serven; c. 1964 The Stackpole Company. 272 pages hardcover with jacket. Cody Firearms Museum, by Herbert G. Houze; c. 1991 Buffalo Bill Historical Center. 79 pages hardcover with jacket. Owning Western History: A Guide to Collecting Rare Documents, Historical Letters, and Valuable Autographs from the Old West, by Warren R. Anderson; c. 1993 Warren R. Anderson. 118 pages paperback dedicated by the author on the title page. Winchester: The Gun that Won the West, by Harold F. Williamson; c. 1952 Association of the U.S. Army. 494 pages hardcover with jacket. The last item is auction catalog vol. I for the Richard A. Bourne Co., Inc. sale of The James Elwood Jones, Jr. Arms Collection in September of 1981. This hardcover volume covers lots 1 through 828 and includes the post auction price list highlighted by lot 103, a pair of Dutch ivory stocked pistols by Jean Louroux of Maastricht, Holland, circa 1650-1655 that reportedly sold for \$125,000. The gold embossed green pebble grained covered book rates excellent with the balance of the lot rating very good to excellent with varying degrees of foxing and ingrained dirt. Also evident are the usual small jacket tears and edge wear. (76563-3)
3305. **LOT OF BOOKS** Total of six. Modern Gunsmithing, by Clyde Baker; c. 1933 Small Arms Technical Publishing Co. 527 pages hardcover with pencil markings on front end paper and ID label adhered to back end label. European Firearms, by J. F. Hayward; c. 1955 Philosophical Library, Inc. approximately 75 pages hardcover with a 1956 dated personal note on an attached label on front end paper. Antique Pistol Collecting: (1400-1860), by James Frith and Ronald Andrews; c. 1960 James Frith and Ronald Andrews. 122 pages hardcover. Colt Peacemaker British Model, by Keith Cochran; c. 1989. 160 pages hardcover with jacket. A History of the Colt Revolver and the Other Arms Made by Colt's Patent Fire Arms Manufacturing Company from 1836 to 1940, by Charles T. Haven and Frank A. Belden; c. 1940 Charles T. Haven and Frank A. Belden. 711 pages hardcover with jacket showing a name written on upper right corner. European Hand Firearms of the 16th, 17th, & 18th Centuries, by Herbert J. Jackson; c. first published 1923, this edition by Bramhall House. 108 pages hardcover with jacket. The overall condition of the lot is very good with instances of foxing, wear and sun fading in varying degrees. (76563-4)
3306. **LOT OF BOOKS** Five total. Arms and Armor, edited by Russel E. Belous; c. 1968 The Ward Ritchie Press. 128 pages illustrated paperback covering the "distinguished collection on permanent display at the Los Angeles County Museum of Natural History" and with a personal note on front end paper. Arms and Armor in Colonial America 1526-1783, by Harold L. Peterson; c. 1956 Harold L. Peterson. 350 pages hardcover with jacket. American Military Equipage 1851-1872, Vol. III, by Frederick P Todd; c. 1978 The Company of Military Historians. This volume, pages 523-719. As-new condition hardcover with shrink wrap removed at this inspection. Melton & Pawls Guide to Civil War Artillery Projectiles, by Jack W. Melton & Lawrence E Pawl; c. 1996 Jack W. Melton, Jr., and Lawrence E. Pawl. 96 pages hardcover that appears unused. The History and Development of Small Arms Ammunition Vol. I Martial Long Arms; Flintlock through Rimfire, by George A. Hoyem; c. 1981 Armory Publications. 230 pages hardcover with jacket and removed from shrink wrap at time of this inspection which reveals this copy to be in as-new condition. The first two books in this lot rate about very good with light wear and ingrained dirt. (76563-5)



3307. **LOT OF BOOKS** Five total. Standard Catalog of Smith & Wesson, second edition, by Jim Supica and Richard Nahas; c. 2001 Jim Supica and Richard Nahas. 318 pages hardcover that appears unused. High Standard: A Collector's Guide to the Hamden & Hartford Target Pistols, by Tom Dance; c. 1991 Tom Dance. 191 pages excellent condition paperback. Remington Handguns, by Charles Lee Karr, Jr. and Carroll Robbins Karr; c. 1947 Charles Lee Karr, Jr. and Carroll Robbins Karr. 125 pages hardcover with jacket signed by the authors on front end paper which also has an ID label affixed to it. Textbook of Automatic Pistols, by R. K. Wilson; c. 1943 Thomas G. Samworth; 349 pages hardcover. Grenadine Etching, by Robert C. Ruark; c. 1947 Robert C. Ruark. 270 pages hardcover. The last three books in this lot rate about very good with wear, ingrained dirt and fading from the years. (76563-6)
3308. **LOT OF BOOKS** Six total. Military & Sporting Rifle Shooting, by E. C. Crossman; c. 1932 Small Arms Technical Publishing Co. 499 pages hardcover with a separating spine and a liquid stain on the top edge. Remington Handguns, by Charles Lee Karr, Jr. and Carroll Robbins Karr; c. 1960 Charles E. Karr, Jr., and Carroll Robbins Karr. 152 pages hardcover with jacket and some light foxing on bottom edge. Collecting Military Antiques, by Frederick Wilkinson; c. 1976 Frederick Wilkinson. 208 pages hardcover with jacket. European Hand Firearms of the Sixteenth, Seventeenth & Eighteenth Centuries, by Herbert J. Jackson; first published 1923, this edition published by Bramhall House. 108 pages hardcover. Gun Powder Cans & Kegs, by Ted & David Bacyk & Tom Rowe; c. 1998 Rowe Publications. Melton & Pawl's Guide to Civil War Artillery Projectiles, by Jack W. Melton, Jr., & Lawrence E. Pawl; c. 1996 Jack W. Melton, Jr., and Lawrence E. Pawl. 96 pages hardcover. The last four books listed in this lot rate excellent with virtually no blemishes. (76563-7)
3309. **LOT OF SHOTSHELLS** This lot consists of seven 25 rd. size boxes and one zip-loc bag of 12 ga. First are the boxes: (1) full of Remington Express 2 3/4", 1 1/4 oz., 7 1/2 shot; (1) full of Remington Kleanbore Nitro Express Extra Long Range 2 3/4", 1 1/4 oz., 6 shot in the old style pale yellow box with green and red graphics and with a missing top flap and moderate edge wear; (1) full of Western Super X Magnum 3", 1 7/8 oz., 2 shot; (1) full of Winchester-Western 2 3/4", 1 1/4 oz., 6 shot; (1) full of Peters High Velocity Long Range 2 3/4", 1 1/4 oz., 4 shot in paper shells in the yellow box with mallard duck scene; (1) containing 22 rds. of Western Xpert 2 3/4", 1 oz., 8 shot; (1) full of mixed; and (1) bag containing approximately 35 mixed rds. The overall condition of the lot is very good to excellent. (75288-8)
3310. **LOT OF MAGAZINES** This lot consists of four unmarked AK47 20 rd. magazines. The steel magazines retain about 90% of their parkerized finish with loss due to handling marks and contact wear. These appear to have seen little use and retain strong springs. The magazines are housed in an OD green U.S. military ammo can. (75354-4C)
3311. **LOT OF GRIPS** This lot consists of five sets of grips. First is a Herret's Automatic Target Gun Stock for a S&W M. 41. The walnut stock retains 99% finish with a repaired one inch crack at the top right and a chip on the left. The stock shows minimal use with crisp diamond checkering. Included is the original factory shipping box. Next is a pair of Pachmayr camouflage grips suitable for a Colt Python revolver. The rubber grips rate excellent with some minor white spotting on the right panel. Next are two unmarked one-piece checkered pistol style grips for a semi-auto rifle. The black plastic grips rate excellent and appear unused. Last are two more unmarked plastic grips for a semi-auto rifle. The smooth dark gray grips rate excellent with light handling marks. (75354-4B)
3312. **LEATHER AND KNIFE LOT** This lot consists of six leather items and a knife beginning with an unmarked flap holster for a European small frame pistol. The dark brown leather flap holster appears unused and features a spare magazine pouch, cleaning tool slots and belt loops. Next is a similarly constructed holster stamped "Md 11/63/TGL 108 1010" with a brown shell, light handling marks and with a spare magazine pouch and no provision for a cleaning rod. The belt loop, snap and strap are all intact. Next is a slightly larger holster with a very similar design and little signs of usage. The leather is starting to stiffen and the unmarked interior is crazing. The fourth item is a German M71/84 ammo pouch with canvas insert. The outer shell is marked "V. Wurt. Inf. Regt. No. 123" and the top flap is stamped "53.R.J.R.I.B. 1888". The dark brown leather is a bit stiff with minor edge wear, the stitching fully intact and also lightly worn. The brass pieces are fully intact and the left strap is missing as is the back loop. Next is a small tan leather ammo pouch rating excellent with belt loop and chrome snap featuring a star logo. Next is an unmarked and apparently unused black pouch measuring approximately 8"x6"x3" with a side pouch on each side. The custom folding knife has a brass frame with hardwood panels showing hand-carved images of a buck, Indian warrior on horseback, a horse standing on its back legs and a teepee. The sharpened steel blade is 6" long with an ochre patina and areas of dark oxidation staining. A rugged and unusual item sure to draw attention. (75354-4A)
3313. **LOT OF MAGAZINES** This lot consists of two FAL 20 rd. metric 7.62x51 blued steel magazines. The first one retains approximately 90% finish with loss due to wear and scattered oxidation staining and the floorplate showing a minor ding. The second magazine retains about 85% finish with a few more scratches and less oxidation. (75354-4E)
3314. **LOT OF LEATHER EQUIPMENT** This lot contains a variety consisting of 32 items total: (3) law enforcement dump pouches; (2) two speed loader pouches for law enforcement practice, as they do not have covers, each capable of holding three loaders; (7) law enforcement speed loaders with covers and in various capacities; (1) baton holder; (1) mace holder; (1) handcuffs holder (4) left handed sidearm holsters; (10) right handed sidearm holsters; (3) duty belts. The leather is dark brown or black and overall the condition is very good with varying degrees of scuffing and stiffness and a few with light mildew. (75354-2)
3315. **COLLECTIBLE AMMUNITION BOXES** This lot consists of seven empty boxes including five by Winchester with the first four being of two-piece construction. The first has maroon labels including a top one that includes ".30 U.S. Government Model 1906, Long Range" and a front one with the image of the round at the top and "180 Gr." in large font below it. The back is plain except for a small label that reads "For Winchester Model 1895 Rifles/Chambered for this Cartridge". Included is the internal compartmentalized tray. The next also has the internal separators along with two correct fired cases and a tan top label that contains ".401 Caliber Winchester Self-Loading Model 1910" and a front label with the image and informing that it is 200 grains. The next three are for handguns with the first having a red top label that includes ".32 Smith & Wesson Smokeless", a picture of said caliber revolver, and "85 Gr. Lead Bullets". The top shows some tape repairs and is joined with what is possibly a replacement bottom tray. The next box has a tan top label that includes ".32 S. & W. 'Lesmok' Cartridges" and an image of an appropriate revolver. The last Winchester box is a one-piece with a navy blue background and reads below the image of the cartridge "9mm Luger Hollow Soft Point/For Luger Automatic Arms/Non-Mercuric/Stayless". Included is the correct tray. Next is a green one-piece Remington UMC Kleanbore dog bone style box that reads at the upper top ".32 Colt Police Positive" and includes tray and a bottom panel with a piece of masking tape attached to it but not for repair purposes as the box is intact and but wavy at the top. Next is one-piece 25 rd. size Peters box for 12 ga. with the mallard duck as a focal point on the front panel. This is the blue and white box that reads "Long Range Hard Hitting". Also included in this lot is an empty magazine box for a Remington Woodsmaster Models 740 and 742. The boxes in this lot rate about very good overall and show varying degrees of edge wear, foxing and ingrained dirt. (75354-5H)
3316. **LOT OF ACCOUTREMENTS** Nine items total. First is an excellent condition powder can retaining about 98% red paint and features a label that covers the entire face of the can and reads "Dupont/Superfine/FFg/Gunpowder/Wilmington/Delaware". The label exhibits some foxing and is 99% intact. The one lb. size can measures 6"x4" and has a small dent in the back. What appears to be the correct cap is included. Next are five tins for percussion caps, each with original tops and bottoms. Included is one by Remington with a tan lid that reads "100 United States Musket Caps", one by UMC reading "Central Fire Ground Edge Foil Lined", another by J. Goldmark with identification written in French. The last two consist of one by Winchester with a maroon label and one with a top reading "100 Hicks Caps G.D" and a bottom announcing that it was made by Waterbury Brass Co. The Winchester can rates about good plus with moderate oxidation and the balance rates about very good. The last category is three vintage fired cases that rate good with moderate oxidation and no legible stamps. (75354-5A)

3317. **SHOOTER'S LOT** This is a Pachmayr Gun Works shooter's box with an enclosed Mossberg & Sons Model A "Spotshoot" spotting scope with cloudy optics and measuring 12 1/2" in length and housed in the box by a metal clamp attached to the lid. The box is of wood construction with a black vinyl covering and measures 16 1/2"x12"x8" with a pullout tray suitable for four handguns and a separate compartment at the bottom. The exterior of the box has numerous handling marks and some vinyl is missing from the right side, the pullout tray has some tape repairs. An NRA patch is attached to the face and the lid interior has an attached sight adjustment card and a patch from a Haverhill Mass. gun club. The snap closure has some oxidation and is fully functional as is the well-worn and repaired leather carry handle. Also included is an owner's manual for S&W M&P Pistols. (75354-1)
3318. **LOT OF AMMUNITION** This lot consists of two 50 rd. size boxes of Western Super Match 38 Special Mid-Range, 148 gr. lead, clean cutting bullet: (1) full and (1) containing 45 rds. The ammunition and boxes rate excellent. (75354-5F)
3319. **LOT OF SHOTSHELLS AND BRASS** This lot consists of four 25 rd. size boxes: (1) full and (1) containing 19 rds. of Western Super X 20 ga., 2 3/4", 1 oz., 6 shot with paper hulls and in the original boxes; (1) full and (1) containing eight rds. of 45-70 Govt. brass with painted heads and contained in mismatched boxes. The overall condition is very good. (75354-5C)
3320. **LOT OF AMMUNITION** This lot consists of four boxes: (1) full 20 rd. of Peters 30-40 Krag paper bullet blanks rating near very good ; (1) containing 18 rds. of Western 32-40 Win., 165 gr. soft point in near very good condition with some tarnish; (1) containing about 46 rds. of Winchester .38 Colt New Police lead bullet rating excellent with a torn end flap; (1) containing approximately 40 rds. of Remington Kleanbore 38 S&W, 146 gr. lead bullet rating excellent with just the beginning of a light powder forming on the tips. (75354-5E)
3321. **LOT OF PROJECTILES** This lot consists of collector ammunition, blanks and primers. First is a factory-sealed 50 rd. two-piece oval box by Remington UMC with an orange top label that includes the red dot logo, an image of the cartridge with ".22 Long Rifle" written in it and also "40 Grs. Bullet". All three labels are fully intact and the black marbled box exhibits mild edge wear and foxing. Next is another vintage oval type two-piece 50 rd. size box by Remington UMC. This one is opened and contains 24 rds. of correct .32 Colt Police Positive rating about very good with a couple showing up to moderate tarnish but most are very clean. The tan box and label combo have a few stains but only light wear with the inner compartment separated from the outer shell. Next are seven loose rds. of Remington .32 and after that are two excellent condition factory-sealed 100 rd. boxes with yellow labels and black print that reads "Winchester/No. 6 Primers./Adapted to/Winchester Repeater/Paper Shotshells/Using Smokeless Powders. Next are two nearly full 50 rd. boxes of Remington UMC .32 S&W Blank Cartridges in the tan box with red vertical stripes and blue text. The last item is an approximately half filled box of Western 22 short blanks rating near excellent. (75354-5G)
3322. **LOT OF SHOTSHELLS** This lot consists of three 25 rd. size boxes of Western Super X maximum load 20 ga., 2 3/4", 1 oz. in the yellow, blue and gold box with paper shells: (1) full and (1) containing nine rds. of 6 shot; (1) full of 7 1/2 shot. The overall condition is very good with some showing light tarnish and the boxes showing storage fading and wear from the years. (75354-5D)
3323. **LOT OF SHOTSHELLS** This is a lot of two vintage 25 rd. size boxes. The first one is by Federal and features front and rear panels showing the mallard duck in flight and sides with an image of the enclosed shell, all against an aqua-colored backdrop. The box reads "Hi-Power Shotshells" in yellow and blue text and contains 22 rds. of the correct 16 ga., 1 1/8 oz., 6 shot. The box is somewhat weak with some minor tears but fully intact with some dirt staining and the paper shells have fading, discoloration and tarnish on some. The second box is a two-piece U.M.C. Nitro Club with the sunburst scene with duck in flight as the top and image of shell on front with notice out back. The label is fully present and adhered and the lower sections have drawn some of the staining present on the bottom which has evidently come in contact with a brownish liquid. The enclosed 22 paper shotshells may have been affected as well. They do show some green staining on some of the brass. There are two types of shells (both paper) consisting of about half being the correct Nitro Club 10 ga. 1 1/4 oz., 6 shot and the balance New Club 1 1/4 oz., 8 shot. The overall condition of the structurally sound box and the shells are good to very good. (75354-5B)
3324. **LOT OF AMMUNITION** This is a full 500 rd. size brick of Western Xpert 22 LR 40 gr. lead lubricated bullet. The ammunition is contained in ten individual 50 rd. size boxes with yellow, blue and red graphics. These boxes and the ammunition within rate excellent while the one-piece white outer box bearing blue and white graphics has a torn off but present end flap and has areas of grime. (75354-9B)
3325. **LOT OF AMMUNITION** This is a full 500 rd. size brick of Western Xpert 22 LR 40 gr. lead lubricated bullet. The ammunition is contained in ten individual 50 rd. boxes with yellow, blue and red graphics. The outer brick box is white with blue and red graphics. The lot is in excellent overall condition. (75354-9A)
3326. **LOT OF AMMUNITION** This is a full 500 rd. size brick of Western Xpert 22 LR 40 gr. lead lubricated bullet contained in ten yellow, blue and red 50 rd. size boxes. These boxes and the ammunition rate excellent and the white outer box with blue and red graphics shows a few spots of grime. (75354-9C)
3327. **LOT OF AMMUNITION** This is a full 500 rd. size brick of Western Xpert 22 LR 40 gr. lead lubricated bullet contained in ten yellow, blue and red 50 rd. size boxes and the outer box is the white with blue and red graphics. The lot is in excellent overall condition. (75354-9D)
3328. **LOT OF SHOTGUN BARRELS** This lot consists of two Mossberg 500 12 ga. blued barrels with excellent bores. The first is 24" rifled slug and retains about 94% finish with a couple of handling marks and scattered light surface oxidation. It features a ramp front and folding rear sights. The second one is 28" with ventilated rib and bead sights and retains about 90% finish with most loss due to scattered surface oxidation. Each barrel has a small strip of masking tape applied for the purpose of identification. (75354-3A, B)
3329. **LOT OF HANDGUN ACCESSORIES** This lot consists of five items. First is a two pocket Uncle Mike's nylon magazine pouch with Velcro closure and belt loop. Next is an injection molded Blackhawk double stack holder for a single magazine, with tension spring and removable belt clip. The last three items are left handed holsters beginning with an Uncle Mike's size 21 polymer. Next is a Don Humme H217 No. 26 leather and last is a Don Humme Jit Slide No. 2 also in leather. Each of the items are black and the conditions are excellent with some appearing unused. (74328-1A)
3330. **LOT OF HANDGUN ACCESSORIES** This is a group of items by Uncle Mike's beginning with a medium size 2" nylon duty belt that currently has three other Side Kick items attached. First are two right-handed holsters including a size 1 for a small semi-auto and an unmarked example suitable for about a 6" revolver. The last item is an ammo pouch with Velcro closure. The lot rates very good, showing little usage and areas of dirt and light liquid spotting. (74281-5B)
3331. **LOT OF BOOKS** This is a lot of two famous classics by the legendary R.L. Wilson and in excellent condition with original jackets: The Peacemakers: Arms and Adventure in the American West; c. 1992 R. L. Wilson. 391 pages hardcover. Colt: An American Legend; this sesquicentennial edition c. 1985 Robert Lawrence Wilson. 406 pages hardcover. Both books are loaded with outstanding color photography and are in excellent condition with virtually no blemishes and a partial price sticker attached to the front jacket of The Peacemakers. (75524-10A)

3332. **LOT OF BOOKS** Total of six. The World of Beretta: An International Legend, by R.L. Wilson; c. 2000 R. L. Wilson. 370 pages hardcover with jacket. The Art of Gun Engraving, by Pietro Sabatti; c. 1998 Knickerbocker Press. First English language edition 1999. 159 pages hardcover with jacket. Glock: The New Wave in Combat Handguns, by Peter Alan Kasler; c. 1992 Peter Alan Kasler. 296 pages hardcover with jacket. The Gun Digest Book of Sig-Sauer, by Massad Ayoob; c. 2004 Massad Ayoob. 256 pages paperback. The Complete AR-15/M16 Sourcebook: What Every Shooter Needs to Know, by Duncan Long. 224 pages paperback. The Complete World Encyclopedia of Guns, by Will Fowler, Anthony North, Charles Stronge & Patrick Sweeney; c. 2008, 2009 Anness Publishing Ltd. 512 pages paperback of heavy construction and fold-in end flaps and a wavy overall profile. The lot rates excellent with a few minor blemishes along the lines of a small jacket tear, a creased page and very light edge wear. (75524-10B)
3333. **LOT OF BOOKS** Total of five. Hunting Trips in the Land of the Dragon: Anglo and American Sportsmen Afield in Old China, 1870-1940, by Dr. Kenneth P. Czech; c. 2005 Clive Kay. 271 pages hardcover with jacket. Where Lions Roar: Ten More Years of American Hunting, by Craig T. Boddington; c. 1997 C. Boddington. 349 pages hardcover with jacket. Safari Rifles: Doubles, Magazine Rifles, and Cartridges for African Hunting, by Craig Boddington; c. 1990 Craig Boddington. 428 pages hardcover with jacket. The Hunting Rifle, by Jack O'Connor; c. 1970 Jack O'Connor. 314 pages hardcover with jacket. The Modern Rifle, by Jim Carmichael; c. 1975 Jim Carmichael. 342 pages hardcover with jacket. The first three books listed rate excellent while the last two are showing their age somewhat with varying degrees of fading, foxing and wear but about very good overall. (75524-10C)
3334. **LOT OF BOOKS** Three total. Winchester: An American Legend, by R. L. Wilson; c. 1991 R. L. Wilson. 404 pages hardcover with jacket and a stain on the lower edge. NRA: An American Legend, by Jeffrey L. Rodengen. c. 2002 Write Stuff Enterprises. 304 pages hardcover with jacket showing areas of grime and a small liquid stain. The Art of Gun Engraving, by Pietro Sabatti; c. 1998 Knickerbocker Press. First English translation 1999. 159 pages hardcover with a few minor handling marks. The overall condition of the lot is excellent. (75524-10D)
3335. **LOT OF BOOKS** Five total. Best Guns, by Michael McIntosh; c. 1989 Michael McIntosh, fourth printing 1995. 288 pages hardcover with jacket providing advice on buying and shooting fine older guns. The Complete Encyclopedia of Hunting Rifles and Shotguns, by A. E. Hartnik; c. 2004 Rebo International. 448 pages hardcover written in English and Spanish with a few pages exhibiting folded back corners and the jacket showing minor handling marks. The book is signed by the author on the title page. The World of Beretta: An International Legend, by R. L. Wilson; c. 2000 R. L. Wilson. 370 pages hardcover signed by the author as no. 178 of 1000 copies of the leather bound and gold embossed edition. L.C. Smith Double Takedown Guide; c. 2003 Radocy Products, Co. full size instruction manual with step by step photos and protective plastic cover. (75524-10E)
3336. **LOT OF MAGAZINES** This is a lot of two blued .32 cal. two line Colt Type VII magazines. The first one retains about 90% finish with loss due to contact wear and a couple of small areas of surface oxidation. The second one retains about 80% finish with patches of surface oxidation mainly on the right side plate which also has a letter scratched in. The springs remain strong bringing the overall rating to near very good. (75497-13C)
3337. **SCABBARD LOT** This is a vintage leather saddle carbine scabbard measuring 31" in length and features strap with hardware and side ring. The right side is marked "H1 2/9/19", the left side "2" and the dark brown leather is rigid with scattered mild wear and flaking. The interior shows contact wear and all stitching is intact to bring the overall rating to about near very good. (75497-2B)
3338. **SPOTTING SCOPE LOT** This is a vintage model 321, 13-40 power, 40mm zoom telescope by Jason. The scope features a gray tube with light handling marks, crisp optics, tripod base, and lens covers, all housed in original slightly tattered box with manual and papers. The overall condition is near excellent. (75497-4A)
3339. **LOT OF ACCOUTREMENTS** This lot consists of three items. First is an unmarked powder horn measuring 11" long with a wood base and leather carry strap. The body is very good with light decomposition occurring at the base area. Next is a leather shot pouch with moderate wear and crazing and showing a 1" length of stitching separation. Included is a wood stopper. The last item is a two cavity bullet mould measuring 3 1/2" in length and experiencing moderate oxidation. (75497-6B)
3340. **LOT OF ACCESSORIES** This is a lot of four items beginning with a Gun-Tote Rifle & Shotgun Carrier Model 1511, capable of carrying two guns within vehicle. These are fabricated of mild steel frames with spring steel gun hooks and then covered with a soft, resilient red coating. Item appears unused and in excellent condition with screws and in original packaging. Next in the lot are two Poly-Choke Gunner's Guides, compasses used to find one's way back to camp by way of installing in gun. Each kit rates excellent and includes compass, screws, drill bit, instruction manual and plastic storage box. The last item is a six rd. ammunition clip for 7.5 mm that has a small tear at the bottom but otherwise intact. (75497-10, 11)
3341. **KNIFE LOT** This is a George Wostenholm & Son Washington Works Sheffield England-marked model I\*XL measuring 10" in overall length with a 6" blade. The unsharpened blade retains about 98% finish with loss due to dark oxidation spotting. The brass guard and stag grips rate excellent with virtually no handling marks. Included is a mismatched and unmarked black leather sheath showing light contact wear to the interior which is a bit wide for the knife and an excellent outer with leather belt loop and large brass rivets and snaps. (75497-1B)
3342. **LOT OF KNIVES** This is a lot of three folding knives beginning with a Buck 110 Hunting with an overall length of 7" and a 3" blade. The sharpened blade shows several small chips near the tip and the brass-frame handles exhibit mild verdigris and the grip panels show very little wear. Included is a tan leather sheath in excellent condition and an ID written in ink on the inside flap. The next item is a Rigid Apache model with an overall length of 9" and a 3 1/2" excellent condition and sharpened blade. The wood grips have deep finger grooves and show very little wear. The brass hardware shows light spots of verdigris over an ochre patina. Included is a fairly well-worn original brown leather case with company logo on top flap. The last item is a Schrade Cutlery Old Timer marked 510T measuring 8" in length including an excellent unsharpened 3 1/2" blade. The brown synthetic grips also rate excellent and metal hardware exhibits light verdigris. Included is a lightly used tan leather case and original box. (75497-9A)
3343. **LOT OF GUN PARTS AND MAGAZINES** This lot includes three magazines beginning with an excellent condition 15 rd. M1 Carbine magazine retaining about 98% blue. Next is a Star Model BM 9mm with scattered surface oxidation and a strong spring. The third magazine is a Colt 1911 with a lanyard loop and tempered two-tone body indicative of those from serial #125,000 through early 1942. The magazine exhibits mild scattered oxidation. Also included in this lot are two pistol slides beginning with a Colt 1911 retaining about 85% finish with mild surface oxidation and pitting. The second is for a P38 in about good to very good condition with mild to moderate oxidation. Lastly is about 20 small parts for pistols including hammer, springs pins and a trigger. (75497-13)
3344. **LOT OF LEATHER** This lot consists of 13 items including 11 holsters with one being left-handed: an excellent condition Hunter-marked "1100 11L" for a semi-auto. Other examples are a very good to excellent Buheimer marked SS 95 and labeled for a Ruger Single Six and a vintage dark brown leather example with a 35 loop cartridge belt for a small cartridge revolvers. The other two items are a British cartridge pouch marked "L15" rating good and a Buck knife holder showing moderate wear. (75497-2A)
3345. **BARREL AND FOREARM LOT** This is a Winchester Model 94 25-35 cal. barrel with excellent bore and retaining about 97% blue finish with a few light handling marks. The walnut forearm rates near excellent with a few minor blemishes. (75497-3)



3346. **MAGAZINE AND GRIP LOT** This lot begins with three blued unmarked Colt 1911 magazines consisting of two seven rd. and an eight rd. that have seen light usage and retain about 97% finish overall. Next are two Thompson Center 22 LR classic magazines, one ten rd. and one five rd., that are apparently unused and in original packaging. The grips are N frame S&W, square butt with panels exhibiting mismatched walnut grain, strong checkering and excellent overall condition. (75521-2, 3, 5)
3347. **LOT OF MAGAZINES** This lot consists of four .380 auto magazines including a nickel with Colt marked base plate, a stainless by U.S.A. Magazines and two unmarked stainless. The magazines have seen minimal use and show only very light contact wear and some minor scattered dark staining on a couple. (75521-1)
3348. **LOT OF LEATHER** This lot consists of eleven items including nine holsters, all right handed with examples being a Bianchi #111 "Cyclone", suitable for a 6" Colt .357, a S&W Model BLW-29 made limited edition Model 29-3 44 Combat Magnum, apparently unused and in original package, a Bianchi #5BH for a large S&W revolver and two Bianchi 105's, consisting of a size 9 and a size 14. The last two items are magazine pouches for Colt 1911 magazines consisting of a two pocket marked "B 110W" by Gould & Goodrich and a single pocket marked "947" by Strong. Both are black with basket weave pattern. The overall condition of the lot is near excellent with light overall wear and a few with light verdigris. (75521-2A, 6)
3349. **LOT OF AMMUNITION** This lot consists of three boxes of .380 auto: (1) full 20 rd. of Federal Premium Personal Defense 90 gr., Hydra-Shok JHP in the plastic box and tray; (1) full 50 rd. of Remington UMC 95 gr., MC and an ink written note on an end flap; (1) containing 35 rds. of Focchi 90 gr. FMJ HP. The lot rates excellent. (75521-7A)
3350. **LOT OF AMMUNITION** This lot consists of three containers of pistol ammunition: (1) box containing 18 rds. of Speer Gold Dot 45 Auto 185 gr. GDHP in excellent condition; (1) box containing 29 rds. of Winchester Supreme SXT 45 Auto 230 gr., FMJ also rating excellent; (1) zip-loc bag containing approximately 50 rds. of very good to excellent condition mixed caliber and manufacturer, with examples being 357 magnum, 45 Auto and 380 Auto. (75521-7B)
3351. **SPOTTING SCOPE** This is a Cabela's Model SSY75 with a light green tube and retaining 99%+ finish and measuring 15" in overall length. Item appears unused with crisp clear optics and included are lens caps and original factory box. (75521-8)
3352. **LOT OF SHOTSHELLS AND ACCESSORIES** First are two full five rd. boxes of Federal Premium Buckshot 20 ga., 2 3/4", 3 Buck maximum, 20 pellets with the boxes showing notes in black marker. Next are 22 rds. of mixed 10 and 12 ga. comprised of 17 paper and 5 plastic. The conditions range from about very good to excellent. Next is a BSA 4x32 Rifle Scope suitable for a .22 and includes lens caps, ring mounts and appears unused in original packaging. Also included are two MTM Case Gard 150 loading trays suitable for "all rifles & 38-357" in near excellent condition with light handling marks and areas of dirt. The last item is a very sturdy steel box measuring 29"x11 1/2"x11" and retaining about 97% of its gray paint. It includes the original lid secured by way of six heavy duty latches and features side steel carry handles. (75521-7, 9, 13)
3353. **LOT OF MILITARY COLLECTIBLES** First is an ensemble of illustrations measuring 17"x11" and titled Illustrated Memoir of the World War; c. 1930 National Publishing Co. Inc. Consisting of about 40 pages and featuring a blue soft cover that has separated and is highlighted by the image of "Living Flag Of Blue Jackets at Salute". Item exhibits mild edge wear and areas of discoloration. Next is a similarly sized 128 pages hardcover titled Collier's New Photographic History of the World's War; c. 1918 P.F. Collier & Son, a compilation including sketches, drawings and painting made by artists at the front. The front and back covers are completely separated and they are experiencing edge wear and small areas of peeling, and some of the pages are creased with ingrained dirt along the edges. Next is a 416 pages hardcover Regulations for the Army of the United States: 1913 Corrected to April 15, 1917, rating very good with foxing and mild staining and only light wear. Also included is a 110 pages paperback World War II Allied Military Currency, by Raymond S. Toy and Carlton F. Schwan, fourth edition, c. 1974 R.S. Toy, C.F. Schwan and rating very good plus with light foxing and a somewhat wavy profile. The last item is a U.S. War Department Technical Manual TM 11-971 for Power Unit PE-162-B and dated July 1945. This is a 145 pages paperback with light wear and mild liquid staining on the cover. (74449-12)

3354. **LOT OF MILITARY COLLECTIBLES** This is a collection of WWII home front tribute insignia pins from Kellogg's Pep cereal in the form of prizes provided in the cereal boxes in 1943. Each pin back button measures 13/16" in diameter and this lot consists of 31 different insignias, each commemorating a different U.S. squadron. Each pin includes the identification on its side. Many were collected and worn on beanies common during the era and the complete set was comprised of 36 pins. The examples in this lot rate about very good overall with most retaining virtually all of their color illustrations and some showing more wear with one in particular showing moderate oxidation as well. Each retains its original attachment pin. Examples of squadrons depicted are Marine Fighter Squadron VNF 224, 29th Bombardment Squadron, Marine Bombing Squad 433 and 27th Fighter Squadron. (74449-11)



3355. **LOT OF MILITARY COLLECTIBLES** Eight items total beginning with a lighthearted WWII-era postcard with a personal letter written on the back but never stamped or postmarked and measuring 5 1/2" x 3 1/2". Next are two U.S. military-issued driver's licenses issued in 1944 and 1946. Next are two U.S. issue stamp books for the purchase of savings bonds, each with several stamps affixed. Also included are two excellent condition shoulder patches beginning with a gray one measuring 6"x4" with three black chevrons connected to an arc with heavily embroidered eagle with reflective coating at top. The second patch is considerably smaller with a red bottom and blue top with an inverted white "E" enclosed. The last item is a U.S. issued brown leather money belt with three pockets with brass snaps with extensive separation occurring to stitching. The leather is soft and well-worn with the overall condition about good plus. (74449-8, 13)

3356. **LOT OF MILITARY COLLECTIBLES** First is a set of 42 cards dated 1992 from Mother Productions sized slightly larger than playing cards with the faces depicting a different example of WWII aircraft nose art from actual color photos. The second item is a full deck of U.S. Playing Cards brand titled Marines from the Patriotic Series and cards identified with shoulder rank patches. The next item is an April 1946 dated issue of Air Trails, a heavily illustrated periodical based on all things aviation. The bottom fifth of the heavily tape repaired cover is missing. The pages are in better condition with fading and light wear. Next is a 47 page photograph based paperback titled Special Forces in Action, by Tim O'Shei; c. 2002 and in very good condition with creasing and folding on the back corner. Next is a group of four color photos circa early 1970's measuring 10"x8 1/2" including a 1" border depicting U.S. aircraft over scenic backdrops. The sheets have foxing and other staining in isolated spots, mainly on the backs. The last item in the lot is a 9" wide promotional cardboard hanger for the U.S. Navy with one side reading "Go NAVY" in white against a navy blue backdrop and the flip side reading "Be someone special/GO NAVY" with the color scheme inverted. (74449-12A)
3357. **LOT OF MANUALS AND BOOKS** This lot consists of 14 items beginning with a U.S. Navy Diving Manual dated September 1958, a U.S. Rifle Caliber .30, M1 manual dated Oct. 1951 by the departments of the Army and the Air Force, a manual for the U.S. Rifle Caliber .30 M1903 dated Sept. 30, 1943 by the War Dept. and a 112 page manual with a missing cover for U.S. Rifle Caliber .30, M1. Also included is a reprint of an original manual, this one dated 1964 by Normount Armament Company for Carabines Cal. .30 M1, M1A1, M2, and M3 with a somewhat distorted shape due to a compromised spine. Two manuals of Navy Training Courses for Aircraft follows, being that of Communications and Radio Equipment. Another War Dept. manual in this lot is a 1942-dated Elementary Meteorology. Next are two American Rifle reprints: U.S. Cal. .30 Carbine and The .45 Automatic. Also in this lot is a 1945-dated Navy Dept. manual, Shallow Water Diving and a 1969-dated Naval History Division Civil War Naval Ordnance with a name written in ink on the front cover. Next is a manual c. 1969 by Donald B. Mclean, second printing 1973 with a cover that reads "the/1873 'Trapdoor'/Springfield Rifle/and Carbine/& .45 revolvers :/Colt's M1873/S & W 'Schofield'. The last item is an excellent condition 1977-dated issue of Flayderman's. Unless otherwise specified the items in the lot rate about very good. (75472-5)
3358. **LOT OF ACCESSORIES** This is a lot of items pertaining to the Colt 1911. First is a two pocket brown leather magazine holder marked "U. S./Boyt-46" having seen minimal use as the leather is stiff and showing light internal and edge wear. The outer shell exhibits some mildew spotting. The cover and belt loop are fully intact as are all brass components which have very light verdigris. Next is another two pocket magazine holder, this one being OD green canvas in excellent condition and stamped "L.C.C./39 L.C.C. & CO.1918". Lastly are two unmarked blued magazines with one retaining about 95% finish and the other about 80% with most loss due to contact wear and with fully functioning springs. (75472-1A)
3359. **HOLSTER LOT** This is a U.S. M-7 Pistol Holster marked "USMC/Boyt/45". This brown leather shoulder holster is the version with the series of punched holes along the strap. The stiff leather shows little if any use with a large liquid stain running the length of the front edge with related spotting along the back. The U.S. logo is very crisp. All straps and hardware are intact and also showing storage spotting. (75472-1B)
3360. **LOT OF ACCESSORIES** This is a lot pertaining to the U.S. M1 carbine. The first item is referred to as Carbine Carrying Bag, a green canvas bag measuring 38" in length with fully intact zipper that runs half of the length. The U.S. stamp is still pronounced with the outer showing light scattered wear and a few small spots of grime. The sewn-on shoulder strap still rates excellent as does the leather reinforcement and handle loop. Next is a U.S. issued magazine holder suitable for two 30 rd. magazines and with additional storage in front. This 1952-stamped example rates near excellent with minor corner wear. It currently houses three magazines beginning with a near excellent condition 30 rd. marked "A1/M2" and retaining 97% with light scattered flaking. Next is a five rd. rating good to very good with mild oxidation staining and the third one is a ten rd., unused and in original wrap. (75472-4A)
3361. **MILITARY ACCESSORIES** This is a lot pertaining to the U.S. M1 Carbine. First is an excellent condition bayonet with guard marked "U.S. M4/CASE" with a blade retaining 98% finish with light contact wear and edge showing very light oxidation staining. The grooved leather grip shows light handling marks. The bayonet is housed in a scabbard marked "U. S. M8A1/B. M. CO." and retains 98% OD green finish with all hardware intact and canvas showing light wear and ingrained dirt. The other item is a muzzle brake retaining 98% parkerized finish, apparently unused and housed in original box with Underwood Corp. ID label. (75472-3A)
3362. **LOT OF ACCESSORIES** First is a brown leather sling for a U.S. M. 1903 exhibiting mild scattered wear and mildew staining with all hardware intact. Next are 18 En bloc clips for the M1 Garand rating about near very good with mild handling marks. The last item is a reproduction U.S. peace powder flask measuring 9" in overall length with a mottled ochre and brown patina with moderate oxidation occurring to the still functional spring and surrounding area. The overall condition is near very good with virtually no handling marks. (75472-2, 3B, 4B)
3363. **LOT OF BOOKS** Total of seven. Tracks and Trailcraft: A Fully Illustrated Guide to the Identification of Animal Tracks in Forest and Field, Barnyard and Back Yard, by Ellsworth Jaeger; c. 1948 The Macmillan Company, third printing 1967. 381 pages hardcover with jacket. No Room for Bears, by Frank Dufresne; c. 1965 Frank Dufresne. 252 pages hardcover with jacket. Serves as a tribute by way of combining an ordering of the evolution of bears along with a collection of adventure tales. Big Game Animals, by Bill Stevens; c. 1971 Federal Cartridge Corporation. 23 pages staple bound paperback. The Art of Hunting Big Game in North America, by Jack O'Connor; c. 1967 Jack O'Connor. 404 pages hardcover. Use Enough Gun: Ruark on Hunting Big Game, by Robert Ruark; c. 1966 Harold Matson. 331 pages hardcover with jacket. The Hunter's World, by Charles F. Waterman; published by Random House (no c. date). 250 pages hardcover with jacket showing a 4" tear on the front. Illustrated offering that focuses on the animals' behavior patterns. Big Game Animals of North America, by Jack O'Connor; c. 1961 Outdoor Life, third printing 1964. 264 pages large (13"x10") hardcover by the former gun editor of Outdoor Life Magazine and showing moderate mildew staining along the spine and ingrained dirt along the perimeter of cover and spots of grime on back. Structurally sound with clean pages. The overall condition of the lot is very good with light fading and wear. (74349-1A)
3364. **LOT OF BOOKS** Seven total. The Whitetail Deer Guide: A Complete, Practical Guide to Hunting America's Number One Big-Game Animal, by Ken Heuser; c. 1972 Ken Heuser. 208 pages hardcover with jacket. Field Dressing, Skinning, Butchering and Cooking Deer, by Joe DeFalco; c. 1969 Joe DeFalco. 62 pages staple bound paperback by the professional deer dresser and food expert. Shots at Whitetails, by Lawrence R. Koller; c. 1970 Alma D. Koller. 359 pages hardcover with jacket and introduction by Jack O'Connor of Outdoor Life Magazine serving as an update on guns, loads and scopes to the original classic c. 1948 Lawrence R. Koller. Great Whitetails of North America, by Robert Rogers; c. 1981 Texas Hunting Services. 223 pages hardcover with jacket that covers over 100 of the largest whitetail deer ever taken in North America. Deer Hunting: Tactics and Guns for Hunting All North American Deer, by Norman Strung; c. 1973 Norman M. Strung. Hunting Trophy Deer, by John Wooters; c. 1977 John Wooters. 252 pages hardcover with jacket. Whitetail: Fundamentals and Fine Points for the Hunter, by George Mattis; c. 1980, 1969 George Mattis. 248 pages hardcover with jacket and a note written in pen on the front end paper. The books in this lot rate very good overall with instances of foxing, fading and edge wear. (74349-1B)
3365. **LOT OF BOOKS** Three total. Complete Book Of Rifles and Shotguns, by Jack O'Connor; c. 1961, 1965 Outdoor Life. 477 pages hardcover with jacket serving as a guide to the use of modern sporting guns and accessories. A Sporting Chance: Unusual Methods of Hunting, by Daniel P. Mannix; c. 1967 Daniel P. Mannix. 253 pages hardcover with jacket. The New Hunter's Encyclopedia, completely revised third edition; c. 1966 The Stackpole Company. 1131 pages very large hardcover with jacket separated in two sections and various other smaller tears, edge wear to the cover and light grime on the main edge. The first two books are in better condition with light foxing. (74349-1C)



3366. **LOT OF BOOKS** Total of six. Pageant of the Gun, by Harold L. Peterson; c. 1967 Maco Publishing Co. 352 pages hardcover with jacket and comprised of 55 informative and entertaining stories covering ten centuries of arms development. The Firearms Dictionary, c. 1970 The Stackpole Co. 288 pages hardcover with jacket. The Gun and its Development, by W. W. Greener; ninth edition, no c. date. 804 pages hardcover with jacket. Sporting Guns, by Richard Akehurst; c. 1968 R. Akehurst. 96 pages hardcover with jacket. Richly illustrated and covers the sixteenth century to modern day. The Treasury of Sporting Guns, by Charles F. Waterman; c. 1979 Random House Inc., The Ridge Press Inc. 240 pages hardcover with jacket covering 500 years of evolution. The Great Guns, by Harold L. Peterson and Robert Elman; c. 1971 Grossett & Dunlap, Inc., The Ridge Press Inc. 252 pages hardcover with jacket covering some of the finest examples that history offers. The overall condition of the lot is about very good with the books showing varying degrees of ingrained dirt, edge wear, foxing and fading. (74349-1D)
3367. **LOT OF BOOKS** Six total. Hunting the American Wild Turkey, by Dave Harbour; c. 1975 Dave Harbour. 256 pages hardcover with jacket. The Art of Hunting Big Game in North America, by Jack O'Connor. 403 pages hardcover showing loss of surface color along the edge from apparent contact with liquid. The Young Sportsman's Guide to Hunting, by Gil Paust; c. 1961 Thomas Nelson & Sons. 96 pages hardcover with jacket. High Life: Animals of the Alpine World, c. 1996 John Winnie Jr. 129 pages excellent condition paperback with high resolution photos. Complete Guide to Hunting Across North America, by Byron W. Dalrymple; c. 1970 Byron Dalrymple. 847 pages hardcover with jacket. Sections are broken down by individual states or provinces. Our Vanishing Wilderness, by Mary Louise & Shelley Grossman and John N. Hamlet; c. 1969 Grossett & Dunlap Inc. 324 pages hardcover with jacket using an ecological viewpoint. Unless otherwise specified the books in this lot rate about very good with varied blemishes including small jacket tears, foxing mainly to the top edges, and minor fading. (74349-1E)
3368. **LOT OF BOOKS** Total of seven. Complete Guide to Game Fish: A field Book of Fresh and Saltwater and Saltwater Species, by Byron Dalrymple; c. 1968, 1981 Byron Dalrymple. 506 pages hardcover with jacket. Spin-Fishing: The System that Does it all, by Norman Strung and Milt Rosko; c. 1973 Norman Strung and Milton Rosko Jr. 339 pages hardcover with jacket. Trout Fishing in New England, by Harold Blaisdell; c. 1973 Stone Wall Press. 108 pages paperback. Boating for Sportsmen, by Jim Emmett and Jack Seville; c. 1967 Jim Emmett and Jack Seville. 186 pages paperback. Getting the Most from Your Game & Fish, by Robert Candy; c. 1978 Garden Way Associates, Inc. 278 pages paperback. Complete Guide to Fishing Across North America, by Joe Brooks; c. 1966 Joe Brooks. 613 pages hardcover with jacket and an accompanying folding map. Alaska Blues: A Fisherman's Journal, by Joe Upton; c. 1977 Joe Upton. 236 pages hardcover with jacket. The overall condition is very good with instances of light foxing, wear, jacket tears, dirt and/or fading. (74349-1F)
3369. **LOT OF BOOKS** Total of eight. Complete Book of Camping, by Leonard Miracle with Maurice Decker; c. 1961 Outdoor Life, sixth printing 1965. 594 pages hardcover with jacket. Complete Book of Outdoor Lore, by Clyde Ormond; c. 1964 Outdoor Life. 498 pages hardcover with jacket. Home Book of Cooking Venison and Other Natural Meats, by Bradford Angier; c. 1975 Bradford Angier. 192 pages hardcover with tape-repaired jacket. Skills for Taming the Wilds: A Handbook for Woodcraft Wisdom, by Bradford Angier; c. 1967 Bradford Angier. 286 pages hardcover with jacket showing a couple of 1" to 2" tears and includes a folding illustrated chart on American woodland trees. Hunting Dogs, by F. Philip Rice and John I. Dahl; c. 1967 F. Philip Rice and John I. Dahl. 186 pages paperback from The Outdoor Life Skill Book Series. Getting the Most out of Modern Water Fowling, by John O. Cartier; c. 1974 John O. Cartier. 396 pages hardcover with jacket. Song of the Paddle: An Illustrated Guide to Wilderness Camping, by Bill Mason; c. 1988 Key Porter Books Ltd. 186 pages paperback with a spot of grime on the lower right corner. Canoeing Basics, by Melinda Allan; c. 1994 Melinda Allan. 134 pages paperback with a black ink mark across the top edge. The books rate very good overall with the usual areas of light foxing, jacket tears, wear, dirt and fading on several. (74349-1G)
3370. **LOT OF BOOKS** Total of six. Shooting Star: A Biography of John Wayne, by Maurice Zolotow; c. 1974, 1979. 432 pages paperback with a personal sticker attached to inside front cover. Old John Country: A Selection from the Works, by Mari Sandoz; c. 1965 Nebraska Press. 319 pages hardcover with jacket. Nonfiction accounts of life on the plains. Treasury of True, edited by Charles N. Barnard; c. 1956 A. S. Barnes and Co., Inc. 397 pages faux leather pebble grain hardcover and gilt edges serving as an anthology of 20 years of True Magazine. Golden Fox, by Wilbur Smith; c. 1990 Wilbur Smith. 433 pages hardcover with jacket. This is a novel on international intrigue. Survival: 23 True Sportsmen's Adventures, by Ben East; c. 1967, Ben East; 371 pages hardcover. Historical Atlas of the Outlaw West, by Richard Patterson. 232 pages excellent condition hardcover with jacket serving as a guide of the acts of outlaws broken down by regions. Overall the conditions of these books are very good with light wear and foxing on some. (74349-1H)
3371. **LOT OF BOOKS** Total of six. The Firearms Dictionary, by R. A. Steindler; c. 1970 The Stackpole Co. 288 pages hardcover with jacket and ink stamp and notes on front end paper. The Right to Hunt, by James B. Whisker; c. 1981 James B. Whisker. 173 pages hardcover with jacket. Complete Book of Rifles and Shotguns, by Jack O'Connor; c. 1961, 1965 Outdoor Life. The Hunting Rifle, by Jack O'Connor; c. 1970 Jack O'Connor. 314 pages hardcover with jacket. The Rifle Book: A Complete Guide to the Rifle, by Jack O'Connor; c. 1949 Jack O'Connor. 332 pages hard cover with jacket and a few penciled notes on front end paper. Small Arms Lexicon and Concise Encyclopedia, by Chester Mueller and John Olson; c. 1968 Chester Mueller and John Olson. 309 pages hardcover with tape-repaired jacket. This is a very good condition lot with typical light blemishes and mild foxing particularly on the top edges of a couple. (74349-1I)
3372. **LOT OF BOOKS** Total of eleven. Guns, Crime, and Freedom, by Wayne LaPierre; no c. info to this abridged version in the form of a small 96 pages paperback. Hunting Scent Book, by Wildlife Research Center, Inc.; c. 1990 Wildlife Research Center, 2nd printing 1991. 63 pages staple bound paperback. Gun Laws of America: Every Federal Gun Law on the Books, by Allan Korwin; c. 1999 Alan Korwin. 360 pages paperback in excellent condition. Supreme Court Gun Cases: Two Centuries of Gun Rights Revealed, by David B. Kopel, Stephen P. Halbrook, Ph.D., Alan Korwin; c. 2004 Alan Korwin. 659 pages paperback that includes plain English summaries. How to Catch Trophy Freshwater Gamefish, by David Richey; c. 1979 David Richey. 394 pages hardcover with jacket. The following four paperback titles form a set contained within a green cardboard sleeve minimal wear and a small affixed strip of masking tape: Small Game Hunting, by Clyde Ormond; c. 1967 Clyde Ormond. 126 pages. Hunting the Whitetail Deer, by Russell Tinsley; c. 1965 Outdoor Life. 144 pages. Sportsman's Camping Guide, by Leonard Miracle; c. 1965 Outdoor Life. 160 pages. Game Cookery, by E. N. and Edith Sturdivant; c. 1967 E. N. and Edith Sturdivant. 166 pages. The following two listings are also enclosed in their original cardboard sleeve: Complete Book of Hunting: Game Animals, Waterfowl, Upland Birds, by Clyde Ormond; c. 1962 Outdoor Life. 467 pages hardcover with jacket. Complete Book of Fresh Water Fishing, by P. Allen Parsons; c. 1963 Outdoor Life. 332 pages hardcover. The overall condition is near excellent with light foxing on some top edges and scattered light wear and dirt. (74349-1J)
3373. **LOT OF BOOKS AND PERIODICALS** Total of 14. Outdoor Life: 100 Years in Pictures. essays by Charles Elliott; c. 1998 Cowles Creative Publishing, Inc. and Times Mirror Magazines Inc. 223 pages excellent condition hardcover with jacket. Colonial Frontier Guns, by T.M. Hamilton; c. 1980 T. M. Hamilton. 176 pages paperback. Winchester's 30-30. Model 94: The Rifle America Loves, by Sam Fadala; c. 1986 Stackpole Books. 223 pages hardcover with jacket. The Remington Historical Treasury of American Guns, by Harold L. Peterson; c. 1966 Specialized Publishing Co. 159 pages paperback. Antique Guns, by Hank Wieand Bowman; c. 1953 Fawcett Publications, Inc. 144 pages staple bound paperback with a separated cover. The Bedford County Rifle and Its Makers, by Calvin Hetrick; c. 1973, 1975 George Shumway. 41 pages paperback. Also included in this lot are six issues of Gray's Sporting Journal circa 1976-1978: (3) Water Fowl; (2) Expeditions & Outings; (1) Big Game. Lastly are two issues of Outdoor Life consisting of Oct. 1953 and Dec. 1956. The overall condition of the lot is very good with the typical examples of small tears, fading and other minor discoloration. (74349-1K)



3374. **LOT OF BOOKS** Total of eleven. The Modern Kentucky Rifle: How to Build Your Own, by R.H. McCrory; c. 1968 R.H. McCrory. 71 pages paperback. Lock Stock and Barrel: Antique Gun Repair, by R.H. McCrory; c. 1966 R.H. McCrory. Home Gun Care & Repair, by Parker O. Ackley; c. 1969 The Stackpole Company. 191 pages hardcover. Recreating the American Longrifle, by William Buchele and George Shumway. C. 1970 George Shumway. 190 pages paperback. Gunsmith Kinks, by Bob Brownell; c. 1969 F. Brownell & Son. 496 pages hardcover with jacket. How to Build Gun Cabinet & Racks Including Fishing Rod Rack, by Donald R. Brann; c. 1970 Directions Simplified Inc. 63 pages paperback. The Art of Building the Pennsylvania Longrifle, by Dave Ehrig. c. 1978 Dixon Muzzleloading Shop Inc. 179 pages coated paperback with plastic spine. How to Build Your Own Percussion-Rifle or Pistol, edited by George Lauber; c. 1975 Plainsman Publications Ltd. 32 pages paperback with large pullout section. The Mauser M91 Through M98 Bolt Actions: A Shop Manual, by Jerry Kuhnhausen; c. 1991 Jerry Kuhnhausen. 224 pages paperback. Guns: And How They Work, by Ian V. Hogg; c. 1979-84 Chartwell Books Inc. 185 pages hardcover with jacket. The last listing is a 2005-dated issue of the periodical Woodsmith. Also included are a few pullout diagrams for gun making purposes. (74249-1L)
3375. **LOT OF LITERATURE** This lot consists of a variety of paperback books, booklets, catalogs and related material in the amount of about 40 items. Some examples are: The M14-Type Rifle: A Shooter's and Collector's Guide, by Joe Poyer; c. 1997 North Cape Publications. 82 pages and excellent condition. The World of Big-Game Hunting; c. 1999 Creative Publishing International. 160 pages excellent condition compilation of stories from Field & Stream's greatest writers. Examples of period catalogs are Golden Age Arms, Gunberths Cabinets, Heritage Firearms, Track of the Wolf, Log Cabin Shop, Navy Arms, Eagle Arms, Brownell's, Dixie Gun Works, Gun Digest, The Grizzly's Den, Affordable Gunsmithing and Mountain State Muzzleloading. Also included are copies of early Flayderman's Guides, booklets on marksmanship, telescopic sights and shooting blackpowder guns. A very diversified lot with a nostalgic theme and very good condition overall. (74349-1M)
3376. **LOT OF VINTAGE CATALOGS** This lot consists of nineteen original issues of The Shooter's Bible, by Stoeger. Included are the versions for 1945, 1949, 1952, 1953 and 1954 each with varying degrees of light to mild foxing, edge wear and dirt. The more recent issues show similar condition traits and are from the following years: (1956 (2), 1957, 1960, 1961, 1963, 1966, 1968, 1969, 1970, 1980 and one 1970-dated Treasury issue consisting of the best from 65 editions. (74349-1N)
3377. **LOT OF VIDEOS** This is a lot of 12 hunting related video cassettes from two series by the North American Hunting Club, each consisting of six videos. The first set is titled A Taste of Wild Game with the following individual titles: Delicious Game Dinners, Grilling, Venison, Jerky, Sausage and Slow-Cooked Venison, Camp Cooking and A Game Feast. The copyright dates range from 1995 through 1999. The second group is from The North American Hunting Odyssey Video Collection and is called A Celebration of American Heritage with each cassette containing several segments. Examples of these are Locked Antlers, Midwest Duck Hunt, Severe Case of Buck Fever, Rocky Mountain Elk Hunt, and South Dakota Pheasants. The videocassettes appear to be in excellent condition and are housed in handsome brown vinyl cases with gold embossed titles and are virtually blemish free. There are no running times depicted on these and we cannot guarantee their level of function. (74349-1P)
3378. **LOT OF VIDEOS** This is a lot of seven DVD's and five videocassettes with most based on hunting whitetail. Examples of DVD titles are Knight & Hale Bustin' Bucks (consisting of two discs), Deer School Best of 1, 2, & 3 and Prime Time Bulls III. Examples of the vhs tapes are Monster Bucks XII and The Art of game recovery. Two of the DVD's are fishing related and the other two are ones issued by the ATF dated 2008: State Laws and published Ordinances and Collector Pro 2002 Firearms Edition. The overall condition looks excellent but they have not been tested for quality. (74349-1Q)
3379. **CHRONOGRAPH LOT** This is a Competition Electronics Pro Chrono Chronograph capable of velocity measurements for rifles, pistols, arrows, shotguns, pellet and paintball guns. Item operates by way of 9 volt battery and appears as-new in original box with instruction sheet, wire guides and diffuser switch. (74349-22)
3380. **LOT OF RELOADING SUPPLIES** This lot consists mainly of bullets, patches, and tools including an Osborne No. 149 Arch Punch, 1 1/8", with mild usage wear and Lyman mould blocks in original box. Also included are approximately 800 rds. of assorted lead balls and hundreds of assorted patches. Also of note are two factory sealed 20 rd. packages of Powerbelt .45 HP bullets in excellent condition. Overall the lot rates very good and is contained in an interesting wood box with upper level tray and brass plate marked "N.E.P.C.O. 902", measuring approximately 24"x12"x12" with brass side handles and exhibiting mild wear and handling marks. (74349-23)
3381. **LOT OF MAGAZINES** This lot consists of four magazines. First are two 20 rd. magazines for the M1 Carbine beginning with a Union Hardware-manufactured example with scattered areas of surface oxidation and pitting and the second one still factory sealed in the original tan wrap. Next is a 10 rd. 9mm for the Kel Tec P11 by Megar. The Italian-manufactured magazine is marked "MG-KTP11-10" and retains about 97% blue with loss due to contact wear and light oxidation staining on base. The last magazine is also a ten rd. 9mm, this one being unmarked with a plastic base plate and retaining 99% blue with very light contact wear. They are currently housed in a black nylon dual pocket pouch with Velcro covers, belt loop and plastic buckles. Also included in the lot are four excellent en bloc clips. (74249-18)
3382. **LOT OF SCOPE RINGS AND BASES** This lot consists of three sets of rings and three bases, all apparently unused and in excellent condition in the original packaging. First is a set of Tasco 30 mm for grooved receivers on most .22 rifles. Next are two weaver-style Angle-Loc sets by Millett: a 30 mm and a 1" high. The bases are all by Weaver, consisting of two 401's and a 74. (74349-17A)
3383. **LOT OF ACCESSORIES** This lot consists of four items beginning with a Tasco #30/35E shot saver bore sighter, complete with 14 bore studs and in original protective cases and apparently unused in original box with papers. Next is an antler mount kit by Quaker Boy also apparently unused and in original packaging. The third item is a two-piece hinged wood display box featuring an artist's rendition of a grizzly bear pouncing on a salmon on the interior lid with matching 4" folding knife and pocket watch with chain lanyard. Items appear unused and in excellent condition. The last item is an empty factory box with end label indicating that it is for a .32 cal. Colt Police Positive revolver with a 4" barrel. The hinged two-piece dark brown box rates near excellent with minor wear, a somewhat concave shaped lid and a bottom numbered 373660. (74349-24C, 8, 22)
3384. **LOT OF SCOPES** Total of four. First is a Tasco 3-7x20 rimfire with rings, mounts, excellent optics and in original box. Next is a BSA .22 Special with rings, mounts, covers and excellent optics. The third item is a Daisy 4x15, also with rings, mounts, covers and excellent optics. The last scope is a Burrell 5x in need of mechanical attention. The scopes in this lot retain nearly all of their original blue finish with loss due to contact wear. (74349-16)
3385. **LOT OF PARTS** This lot consists of approximately 30 parts and hardware for Mauser bolt action rifles including bolts, trigger assemblies, barrel bands, and buttplate. The parts about very good overall with areas of grime and handling marks. (74349-6)
3386. **LOT OF ACCESSORIES** This lot consists of a wide range of items including WWII Russian military gear in the form of a cartridge pouch, sling, bayonet holder, one-piece of a rifle cleaning rod, brass oiler with canvas pouch, lanyard and muzzle cap. The leather items rate about good plus with areas of mildew with the balance somewhat better. The next item is an apparently unused Outers Universal Cleaning Kit that includes rod, solvent, oil, patches and some added bore brushes. Next is a retail-size box currently housing four full and one partial box of Hoppe's no. 4 size cleaning patches. Also included is a partial box of Hoppe's small bore patches. The last item is a Gun Smoke miniature carbide lamp, unused and in original plastic box with instruction sheet. (74349-8A)

3387. **LOT OF AMMUNITION** This lot consists of four categories: (1) box containing 45 rds. of Remington Express Rifle 32-20 Win. 100 gr. round nose lead; (1) bag and (1) tray containing a total of 20 rds. of Remington 30-30 Win. round nose lead; (2) loose rds. of Remington 30-06 dated 1957; (1) box containing approximately 1500 rds. of Chinese-manufactured Industry Brand 4.5 mm lead pellets. The lot rates very good to excellent overall with some of the 30-30 Win. experiencing mild to moderate verdigris. (74349-7A)
3388. **LOT OF AMMUNITION** This lot consists of four boxes of .308 Win: (2) full 50 rd. of Speer Nitrex 165 gr. Grand Slam contained in five packs; (1) full 20 rd. of Winchester Supreme 150 gr. Ballistic Silvertip; (1) generic box containing 20 rds. of Remington soft tip on five rd. en bloc clips and 16 rds. of 1979-dated Lake City FMJ in eight rd. en bloc clips. The ammunition in the clips comes in at very good with the balance excellent. (74349-7B)
3389. **LOT OF AMMUNITION** This lot consists of three boxes: (1) full 20 rd. and (1) containing 11 rds. and nine fired cases of Remington Express Core-Lokt 30-40 Krag 180 gr. PSP; (1) containing 11 rds. and nine fired cases of Winchester Super X 45-70 Govt. 300 gr. JHP. Overall the ammunition rates very good to excellent. (74349-7C)
3390. **LOT OF RELOADING SUPPLIES** This lot consists of brass and lead including approximately 470 rds. of mixed primed and unprimed brass including fired cases and calibers 45-70, 44 Rem. Mag., 43 Spanish, 30-06, and 22-250 among others. The bullets in this lot are by Beartooth Bullets with a quantity of about 400 and in calibers 45 rifle, 32-20, and also .439 dia. Also included are about 20 rds. of empty 20 ga. shells. The conditions range from very good to excellent. (74349-9)
3391. **LOT OF ACCESSORIES** This lot consists of mainly hunting aides including a Magellan Meridian Color handheld GPS as-new in original box with papers. Also included is a Phantom Caller Pro Series with four chips and modules and owner's manual. Next is a Mini Phantom Digital caller and a clip-on camo pouch for any of these devices. Also included is a wood duck call and some wiring and batteries. None of the equipment has been tested and the overall condition is excellent. (74349-13, 14)
3392. **LOT OF AMMUNITION AND CASE** This lot consists of four boxes: (1) containing 13 rds. of Remington High Velocity 357 Rem. Max. 180 gr. semi-jktd. HP ammunition; (1) containing 15 rds. of Remington High Velocity 357 Rem. Max. 158 gr. semi-jktd. Hp ammunition; (1) containing nine rds. of Federal 357 Max., 180 gr. JHP; (1) factory sealed 50 rd. of Speer Grand Slam 375 Cal., 285 gr. bullets. The ammunition rates very good to excellent. The items come in an excellent condition tan-colored Gun Guard pistol case with foam inserts and measuring 18"x14" (74349-4A, 7D)
3393. **LOT OF RELOADING KITS** This is a lot of five, all by Lee. The first four come in the two-piece cardboard box and are for the following: .410 bore, 20 ga., 12 ga., and 30-30 Win. The last one comes in a hinged plastic case. Each contains priming chamber, bullet seater, decapping chamber, stop collar, lock nut, sizing die, body, powder measure, decapper and priming rod. Each kit appears unused and in excellent condition with instruction manual. (74349-10A)
3394. **LOT OF DIES** First are two dies from what was originally a three die set for 45-70 by Hornady New Dimension. Next are two sets by RCBS, an SB sizer for .30-06 and a three die for .43 Spanish. Also in this lot is a multi-expand powder charge die with instruction sheet by Lyman and a Hornady new dimension 8mm two die set. Lastly is a three die set by Lee for 30-06 Springfield. The overall condition of the lot is excellent. (74349-10B)
3395. **LOT OF AMMUNITION** This lot consists of six containers: (1) full 20 rd. box of Winchester WWX 45 Colt, 225 gr., Silvertip HP; (1) zip-loc bag containing 70 rds. of mixed military and commercial 45 auto; (1) box containing 18 rds. of Western 38 Special and 32 rds. of mixed 9mm; (1) box containing 12 rds. of Western Super X 38 Super Auto, 130 gr. FMJ; (1) box containing 20 rds of Remington 380 auto 85 gr., metal case; (1) box containing 26 rds. of Remington High Velocity 380 auto, 88 gr. JHP. The conditions range from very good with light oxidation to excellent. (74349-7E)
3396. **LOT OF AMMUNITION** This lot consists of five boxes of 38 Special: (1) containing approximately 47 rds. of Remington in a mismatched box; (1) containing about 25 rds. of Remington also in a mismatched box. (1) containing 34 rds. of Federal Match 148 gr., lead wadcutter; (1) full 50 rd. and (1) containing 27 rds. of Remington 148 gr., lead wadcutter. The overall condition is very good to excellent. (74349-7F)
3397. **LOT OF AMMUNITION AND BRASS** This lot consists of four boxes: (1) full 20 rd. and (1) containing 19 rds. of Remington 30-30 Win. 150 gr., Core-Lokt soft pt.; (1) full 20 rd. of Remington 30-30 fired cases; (1) containing about 24 rds. of mixed .348 brass. The overall condition is very good with some showing tarnish and the boxes having mild wear and markings. (74349-7G)
3398. **LOT OF AMMUNITION** This lot consists of four boxes: (1) virtually full 50 rd. of 1969-dated Lake City 30 cal. rating excellent; (2) containing a total of approximately 65 rds. of mixed military head stamp 30 cal. rating very good; (1) full partially sealed 20 rd. of Remington 30-06 with 1945-dated head stamps and rating very good. (74349-7H)
3399. **LOT OF COLLECTIBLE AMMUNITION** This lot consists of two full 20 rd boxes of Remington Kleanbore 41 Swiss. The first box has the dog bone logo at the center with ".41 Swiss" in very large font above it and the front and sides also have the callout "(Vetterli Rifle)". The box has tape-repaired end flaps and liquid stains and the cartridges have a mild to moderate white coating on the tips. The second box bears the 8941 code and is missing both end flaps and a smaller section separated but present. The box has a nice clean surface overall and the cartridges show only light oxidation on some. (76679-49A)
3400. **COLLECTIBLE CARTRIDGES AND BOXES** This lot consists of five Winchester boxes including two for .22 cal. consisting of one for "Conical Bullet Breech Caps" with a faded green label and missing part of a top panel with "Black Powder" stamped in red and running diagonally with 12 enclosed rds., one full 100 rd. still sealed but with split end caps revealing excellent ".22 Caliber B.B. Special Government Cartridges" on a tan label. Next is an empty 100 rd. size buff colored box with black text that includes "No. 1 Bullet Breech Caps For Use In Gallery Rifles" that has creasing separated but mostly present end flaps. Also included is a buff colored box for ".32 Short Blank Cartridges Extra Loud" currently housing about 25 rds. The last item is labeled ".38 Short Rim Fire Blank Cartridges Extra Loud" with the full 50 rds. enclosed and rating excellent. The box lid has a front panel that has separated but is present. Overall the lot has nice bold print over some fading and foxing on these uncommon items. (76679-49B)
3401. **COLLECTIBLE AMMUNITION BOXES** This lot consists of five 50 rd. size Winchester boxes for .32 cal. and the first four being two-piece beginning with an empty example with a green top and orange side label and the image of the round at the top center with "Long" along the case. The next one is also for .32 long but with a white top label with red orange left side and very little foxing and ten correct rds. enclosed. Next is one with a light green label marked ".32 Caliber Short" and retaining orange side label and ten cartridges. Also included is an empty one with a faded green top label marked ".32 Caliber Winchester "Lesmok" above the image of the cartridge. The top left panel has begun to separate and the back has a note written in pencil. The last one is a more recent example as it is a one-piece with empty tray and mainly blue text over a red and yellow backdrop, only very light edge wear. (76679-49C)
3402. **COLLECTIBLE AMMUNITION BOXES** This is a lot of two, Winchester two-piece boxes beginning with a 50 rd. size for 9mm Long Shot Cartridges and with an excellent red label that extends to the sides and also reads "Adapted to Model 36 Shot Gun, cal. 9mm" and now housing five excellent rds. with tan paper hulls. The other is a ten rd. size with a darkened yellow top label that reads ".41 Swiss Rim Fire Shot Cartridges" and a matching color front label with larger font. The lid has a back flap that is separating and some pencil notes written on the back and all text is strong. The box retains nine original rds. with light tarnish and oxidation. Overall the boxes show minor edge wear and some ingrained dirt. (76679-49D)

3403. **LOT OF COLLECTIBLE BOXES** This lot consists of three boxes by Winchester. The first of the two-piece examples has a faded olive green top label that reads “.41 Short Rim Fire” and retains orange side label showing tape residue. The lid features thumb cutouts including a back one with abutting label peeling back a bit. The 540 rd. size box is still fully intact and retains a sample cartridge. Next is a full 50 rd. size box of “.38 Caliber Short Rim Fire” with faded green top label and a side label now exhibiting various faded shades of yellow, green and orange. There are light liquid stains and a small puncture to the top. The cartridges show moderately oxidized tips. The last box is a 100 rd. size with bright green labels including a top one identifying this as “No. 22” with “Short” in the image of the cartridge. The box houses about 80 correct rds., most rating very good with light oxidation. Overall the boxes show the usual small label tears and some light foxing. (76679-49E)
3404. **COLLECTIBLE AMMUNITION BOXES** This lot of three 50 rd. size Winchester two-piece boxes begins with one with a red label with a somewhat faded top section that identifies this as .25 Short Stevens. The thumb cutout style lid has a penciled-in note on the front and the beginning of a tear at the rear cutout. The box shows very little wear and the enclosed original 50 cartridges in excellent condition contribute to the collectability. The second box has an olive green top label that reads “.32 Smith & Wesson Long ‘Lesmok’” with the cartridge image at the very center. The entire gray side label is also present and this empty example has separation at the right side corners of the lid but otherwise fully intact. The last item retains its original bright green label with mild foxing and states that this box is for 22 short of which nine very good rds. are enclosed. The front inner wall is separating and the back hinge is still sealed. The boxes have some of the typical ingrained dirt but not much evidence of wear. A nice variety for the Winchester box collector. (76679-49F)
3405. **LOT OF COLLECTIBLE BOXES** This is a lot of seven vintage one-piece 50 rd. size, Western Cartridges boxes with tray, each with the old style navy blue, yellow and red graphics beginning with one for 38-40 Winchester 180 gr. SP center fire with a missing end flap the and the other side with a separated flap. Enclosed within are about 45 correct cartridges rating excellent with nice clean tips and bright cases. Next is a full 50 rd. box of 30 Luger 93 gr. metal case in excellent condition. The third item is a 25 Stevens, 65 gr., bullet box with a missing right end flap and all but one part of the left side missing and enclosed is one correct rd. and four correct caliber but metal case cartridges. The last four are for .22 LR beginning with an empty one that reads “Super-X” in large font with a missing right flap. The next one is fully intact with identical graphics with the exception of this one also reads “Hollow Point” and includes four enclosed rds. Next is a fully intact and excellent condition example of “Xpert”. The last example is “Super Match Mark III 40 Grain Lead Greased Bullet” in excellent condition with virtually no wear and housing the full 50 rds. of excellent condition cartridges. Unless otherwise specified the boxes rate about very good with varying degrees of edge wear and minor discoloration. (76679-49G)
3406. **LOT OF COLLECTIBLE BOXES** This lot consists of six boxes by Western from the period of blue, yellow and red graphics and all one-piece 50 rd. size boxes with trays, beginning with a full one with near excellent condition cartridges and showing a tape repair and torn but present end flaps. Next is a full box of excellent condition 30 Luger with all flaps and panels intact. The third is an “Xpert 22 Short” with a scuff mark on the front and a small dark stain on the back and three rds. enclosed. The last three are all 22 LR starting with a full box with ID text that reads “.22 Long Rifle” and “40 Grain Lead Lubricated Bullet” and housing excellent and clean cartridges. Next is an empty “Super X” box rating good to very good with multiple tears but all flaps present. The next one is also “Super X” but this one is marked “(H.P.)”, of which about 30 near excellent rds. are enclosed. This box also has a torn but present end flap. (76679-49H)
3407. **COLLECTIBLE AMMUNITION BOX** This is an opened two-piece UMC box with the rounded corners and “wallpaper” style backdrop to a fully intact and somewhat faded light orange top label with an upper section that reads “50 .32 Cal., Long/Rim-Fire Cartridges/Swaged Bullets”. The deep red, side sealing label is about 60% present with most loss at the rear with bold color throughout and the length of the front still sealed. The bottom guarantee label is fully intact with scattered scuffing. The black text is bold on all three labels and the box overall shows light edge wear and a small spot of dirt on the top. The plaid “wallpaper” has a 1” area that has peeled off of the back and the interior front right corner is beginning to separate. Enclosed are approximately 40 rds. of correct cartridges with a coating of white oxidation on the tips that has transferred to the cases. Overall a very good example of a desirable box with the added plus of original cartridges. (76679-49I)
3408. **COLLECTIBLE AMMUNITION BOX** This is an opened two-piece UMC box of the rounded corner construction with the plaid wallpaper style backdrop to deep red colored labels. The top one has an upper section that reads “50 .32 Cal. Short/Rim-Fire Cartridges/Swaged Bullets”. This one is the version with the trademark head stamp “U” on each side of the cartridge image. The top label shows a slightly mottled maroon under the fully legible text and is 99% present with loss due to wear extending from the edges. The side label has the typical peeling where the seal was broken and is currently about 85% present. The bottom label is fully present with mild scuffing. The lid shows an old light repair to the corners and the bottom tray has a small tear at the back. The enclosed correct ammunition amounts to about 48 rds. and rates about near very good with oxidation transfer from tips to cases now showing a darkened appearance. This is a nice find for the UMC collector. (76679-49J)
3409. **COLLECTIBLE AMMUNITION BOXES** This lot consists of two UMC boxes with the two-piece construction, rounded corners and plaid backdrop. The first one is from the period that includes the Remington red dot logo, this one on the left side of the image of the .32 Short cartridge on the dark red top label which is fully intact with scattered handling marks causing a somewhat tan speckling. The side and bottom labels are 99% intact and also showing similar wear. The 50 rd. size box currently houses about 25 correct cartridges showing white oxidized tips that has transferred to a light dusting onto the metal. The box is strong and most wear is evident along the top front edge. The other box is empty with a top label showing nice clear text that states “50 .32 Cal., Long” and the trademark “U” logos are presented above “The Union Metallic Cartridge Co.” over what was likely the salmon color top section that was used for the bottom guarantee labels on this style box. It has faded to a very light shade with a small scuff on the bottom right. The side maroon and bottom label retain strong color with side label separating but 98% present. This is a nice combination .32 short and long pairing for the UMC/Remington collector. (76679-49K)
3410. **COLLECTIBLE AMMUNITION BOXES** This lot consists of two Remington one-piece boxes with the dog bone style Kleanbore logo as their focal points. The first one has bold green and red color accenting white text pronouncing this as .32 Short Rim Fire. The R140 coded box rates excellent with crisp edges and retains the full 50 rds. with mildly oxidized tips and bright cases. The second box comes with an empty tray and is slightly faded and discolored text that identifies this as .32 Long Rim Fire. This R142 coded example shows most wear on the right end which has a separated but present flap and a tray torn at either side. A nice .32 long and short combination. (76679-49L)





3411. **COLLECTIBLE AMMUNITION BOXES** This lot consists of three Remington Kleanbore one-piece boxes beginning with an apparently full 250 rd. size with a lid that reads "22 Short/Gallery Special/Spatter-Less" and front and rear panels that includes "22 Short/Gallery" within a red stripe. All graphics are clear and bold and the box exhibits crisp edges and a bottom panel with a rear portion showing some tan discoloration. This 5722 coded box rates excellent as does the enclosed ammunition. Next is a full 50 rd. box of Hi-Speed .22 Long Rifle with the R23 code and exhibiting the red dot and oval company logos, light wear along one edge and the white portions fading to a darker tone. The box rates just about excellent with clean ammunition within. The third box rates about excellent as well, this one being "22 Long Rifle Palma" and exhibiting the 6222 code with the "dog bone"-style Kleanbore logo. This example has flaps and tray fully intact with a number written in pencil on right side of tray. An interesting grouping for the Remington or .22 collector. (76679-49M)

3412. **LOT OF COLLECTIBLE AMMUNITION** This lot consists of two 50 rd. size boxes of UMC .25 Stevens including a first one that is factory sealed with bright green labels, the top one slightly faded and reading ".25 Cal. Stevens/Rim-Fire Cartridges/Swaged Bullets" with the "U" head stamp logos on either side and just above "Manufactured By/The Union Metallic Cartridge Co." All labels including the bottom are virtually fully intact with the ends each reading ".25 Stevens/Rim Fire" below the oval U.M.C. logo. This is a very nice box showing only the slightest of edge wear, light foxing and soiling. The other box is a one-piece with a darker green color as a backdrop for ".25 Stevens Lesmok" and the red dot Remington UMC logo and the code 56 A.S. on the top and a front that includes the red dot with only "UMC" within it and the oval Remington logo to its right. The left flap is missing and the edges exhibit mild wear particularly at the corners. The tray has a split beginning on one of the corners and the enclosed 49 cartridges have clean tips and dark casings. This is a nice pair of not so common items. (76679-49N)

3413. **COLLECTIBLE AMMUNITION BOX** This is a scarce, empty two-piece, buff colored UMC box with a top label that reads "20 .58 Cal., Joslyn/Rim-Fire Cartridges" (an image of the cartridge with diagonally presented "Joslyn" and "Carbine" on either side)/Manufactured By The (with the "U" head stamp trademark logo on either side)/ Union Metallic Cartridge Co./Bridgeport, Conn., U.S.A.". The label is 99% present and exhibits a mottled black, tan and to a lesser extent pinkish surface under easily legible text. The cardboard is somewhat brittle and fully intact after glue repairs to each corner with the exception of the front lid panel which is missing, and the beginning of a split on the upper right side of lid. The bottom guarantee label is fully adhered and legible and showing a lighter mottled tan appearance than the cardboard panels. There are some minor areas of scuffing and peeling mainly around the edges. An opportunity to acquire an item not frequently made available. (76679-49P)



3413

3414. **COLLECTIBLE AMMUNITION BOX** This is a two-piece cardboard box with blue diagonal wallpaper style cover and a light green top label that reads "50 .44 Cal., Short/Rim-Fire Cartridges/Swaged (image of cartridge) Blanks (on the maroon surcharge label)" with the "U" trademark logos and the company name and address below that. Approximately 70% of the plain maroon side label remains and the entire bottom label is present with guarantee statement about 90% legible. The top label has a somewhat wavy appearance and is peeling, particularly at the lower right where a small section is missing. Also evident is light to mild foxing and a glue repaired top left corner. The bottom shows a small puncture at the front lower right and a glue repair to the left. This is an about near very good example box with mild scuffing along the edges. Enclosed are approximately 40 correct and rare blanks. (76679-49Q)



3414

3415. **COLLECTIBLE AMMUNITION BOXES** This lot consists of three UMC two-piece 50 rd. size boxes starting with a buff colored box with a tan top label and red text stating that the contents are ".25 Automatic Colt Pistol" and "50 grs. Bullet Metal Cased". The label has a handwritten black ink mark over the image of the cartridge located to the right of the UMC dot logo. The tan side label is 80% present and the bottom label is fully attached. The edges show mild scuffing and enclosed are approximately 30 correct cartridges rating very good to excellent. The next box is taller as it is for .25 Stevens R. F. as depicted on the dark green top label that shows a tan area where the dot logo was located. The side label is about 60% present with remaining areas starting to peel and the bottom label, though present shows mild to moderate scuffing. The top is darker overall likely from contact with grime. Included are approximately 20 near excellent correct cartridges. The last box has what could be described as shale blue labels on the top and sides, both of which are nearly entirely present. The top one states that it holds ".32 cal., Extra Short" at the top line and below that is "Swaged Bullets" along with the customary for the period "U" head stamp logos and the UMC name and address. The labels have a backdrop of the dark marble pattern over the panels. The lid has a concave profile and edge wear. Three of the lid's corners are split and the fully intact bottom houses eight cartridges with oxidized tips and near excellent casings. An interesting trio of UMC boxes overall. (76679-49R)

3416. **COLLECTIBLE AMMUNITION BOXES** This is a lot of three Dominion Cartridge Co. 50 rd. size two-piece boxes beginning with a factory sealed example with a one-piece wraparound dark red label with white text that reads "32 Long Shot/(trademark logo) Adapted to the Various Arms of this Caliber/Manufactured by the/Dominion Cartridge Co. Limited/Montreal, Canada". The label has bold graphics and the buff colored box featuring thumb cutouts shows only isolated minor wear and dirt. Next is an empty box with apparently the same shade of red used on the label but this one showing fading and mild handling or storage marks. The top portion of the label reads "32 Short (image of cartridge) Black/(trademark logo) Adapted to the Various Rim Fire Arms of this Caliber/Dominion Cartridge Co. Limited/Montreal, Canada. This one also has a lid with thumb cutouts and exhibits light wear ingrained dirt and a faded penciled in note on the buff colored front panel. Both sections are fully intact and the tray retains the original packing slip. The last item has a yellow, red and white label with a top section that reads "32 Long (image of cartridge) Lesmok/ Adapted to the Various Arms of this Caliber/Made in Canada by/Canadian Industries Limited/Dominion Ammunition Division/Montreal, Canada". The label is missing the left side panel portion and the top is peeling back beginning at the lower left. The bottom has a small hand written note, written in pencil, and overall the box shows light wear and some ingrained soiling. This is a group of uncommon items that don't reach the market frequently. (76679-49S)

3417. **COLLECTIBLE AMMUNITION BOXES** This lot consists of five Peters 50 rd. size boxes beginning with a two-piece with a faded orange top label for .22 Win. Automatic Mushroom with the code 838 at the lower right. The labels are virtually entirely intact and the box rates near excellent with sharp edges, bold text and uneven fading to the labels. The bottom panel is stamped July, 1914 and a large "#1" is handwritten in ink. Enclosed is one excellent sample cartridge. Next is another vintage two-piece, this one with the back panel label acting as a hinge, and a tan or faint green top label that identifies this as ".22 Automatic Smokeless" and also states "For Winchester Automatic Rifle" with the code 700 depicted at the bottom right. Next is a gold-colored one-piece with red and white text that includes "High Velocity Long Range .22 Winchester" against a dark blue top panel which also includes the "P" logo at the lower right. The left end flap is missing and the right one declares that this is "No. 2291". The box shows mild edge wear and the tray shows a tear to an end panel and houses 49 correct and excellent cartridges. The next is also one-piece but in excellent condition as are the full 50 rds. that it holds. It is mainly a dark red with a top section displaying a white target beneath black text that includes "Target .22 Long" and the end panels include "No. 2218". The last box is also a full one-piece of .22 LR., this one having mainly red and white backdrops and a top panel declaring this as "golden bullet" and also includes a dark blue company name logo on the left as well as the end flaps. The bottom panel includes the guarantee and the code "No. 2283". Overall the box shows minimal wear with crisp edges and some light foxing. A nice variety representing several periods from the famous company. (76679-49T)

3418. **COLLECTIBLE AMMUNITION BOX** This is a full and opened two-piece box by Peters with a maroon wraparound label with a top section that reads "50 .22 Cal., Long/ Rim Fire Rifle Cartridges/Swaged Bullet (image of cartridge) Trade Mark (P logo)/The Peters Cartridge Co./ Cincinnati, O., U. S. A. 671". The sides each read "Peters (within oval)/.22 Long/ Rim Fire" and the bottom portion contains the guarantee. The label has a small area of fading at the top and is about 98% present with loss due to scuffing at the bottom, the left panel is starting to peel back. The buff colored box has a lid featuring thumb cutouts and shows some light label ink runoff, and minor ingrained dirt. The bottom is mostly clean with ammunition showing mildly oxidized tips that has transferred to form a white dusting over the casings. Overall this is a near excellent condition example complete with the original 50 rds. (76679-49U)



3418

3419. **COLLECTIBLE AMMUNITION BOX** This is an empty two-piece box by Peters with a maroon wraparound label with a top section that is slightly lighter than the balance and reads "50 .22 Cal. Short/Rim Fire Rifle Cartridges/Semi-Smokeless Powder (image of cartridge) Trade Mark (P logo)/The Peters Cartridge Co./Cincinnati, O., U. S. A. 665". Each side has the Peters oval logo above ".22 Short/Rim Fire.". The bottom panel is comprised of the guarantee. The label is 99% intact with loss due to the unsealing with a clean surface and the buff colored box has a lid with thumb cutouts and the front has a small hand written ID attached that reads "B3". Overall the box rates excellent with virtually no edge wear and very slight contact marks on the front panel. (76679-49V)



3419

3420. **COLLECTIBLE AMMUNITION BOXES** This lot consists of four 50 rd. one-piece Peters boxes beginning with deep yellow one with empty tray and a dark blue top section stating this is 22 Remington Auto Loading and includes a red "Rustless" oval and Circular "P" logos. The side panels add that this is "Lead Bullet" and "N. 2239". Next is a silver, black and white one with approximately 47 rds. of High Velocity .22 Short as depicted on this code 2267 example with silver background to the top which includes the "P" and "Dupont" logos. The next has the same colors but is for .22 LR and the code 2246 box includes "Rustless Filmkote". The last one is Target 22 Long in the red box coded 2218 and currently holding about 47 rds. The ammunition in this lot rates excellent with the last box showing very light oxidation and the boxes range from very good to excellent with light edge wear and soiling on some. (76679-49W)

3421. **LOT OF AMMUNITION BOXES** This is a pair of collectible two-piece boxes from different manufacturers of 41 Swiss. The first is by Peters and has the index code 4102 with the salmon colored labels with the top one consisting of a first line that reads "20 Peters .41 Swiss Rim Fire 20" and the bottom right including the code 1309. The front label includes an image of the cartridge and also the code 1473. The labels, including the rear guarantee are about 97% intact and the lid shows significant glue repair and some additional splitting at the seams. The box bottom has a couple of penciled-in marks and the empty tray is solid. Also noteworthy is some light edge wear and soiling. The other one is by Remington UMC and has a tan lid label that includes ".41 Swiss (Vetterli Rifle)" on the top and a front with the image and red dot logo. The label is 98% intact with peeling evident as well as loss from corner wear. The bottom label has less wear and includes the guarantee. The entire outer surfaces are a mottled tan with some spots of light grime and penciled-in notes. The compartment piece currently houses three very good mixed rds. of the correct caliber. This is a nice pair of boxes not easily obtained. (76679-49X)

3422. **COLLECTIBLE AMMUNITION BOXES** This lot consists of three empty 500 rd. brick-sized boxes from Canadian Industries Limited. The first one rates excellent with crisp edges and clean panels. It measures 4"x2 1/2"x2 1/2" and is a plain buff color with blue text that states on the top that it is for .22 Short Dry Lubricated Bullet and in large font in the very center "Super-Clean" and below that in smaller font "Non-Mercuric - Non-Rusting" with the company name and address below that. The second one measures about 6"x2"x2" and combines a yellow and black color scheme with the top left in the form of a cartridge tip and within it is "Imperial/22 Short/High Velocity" This example rates very good to excellent with light wear and a little foxing, the lid just slightly creased and misshapen at the far left. The last one is larger (9"x3 1/2"x2 1/2") with yellow, dark blue and white graphics that include on the top "Canuck/22 Long Rifle/Standard Velocity", the oval C-I-L logo beneath it and an image of the cartridge at the right. The condition is very good to excellent with a minor lid crease and light grime on the bottom. (76679-49Y)

3423. **COLLECTIBLE AMMUNITION BOXES** This lot consists of five one-piece boxes from Canadian Industries Limited, all 50 rd. size and beginning with a clean .22 Long Shot with a pencil note on the bottom, crisp edges and currently housing 21 rds. Next is an empty .22 Automatic with a top that also states "Adapted to Winchester 1903 Automatic Rifle" and rates near very good with a separated right corner and remnants of an old tape repair. The third box is .22 Long with "Super Clean" in white within the center blue stripe which also contains the company logo to the left. Enclosed is one cartridge. These first three listed above include "Dominion Ammunition Division" as part of the company identification and all share the color scheme of yellow, blue and white. The last two exhibit nearly identical graphics as the cartridge image is to the far left with red used for Super Clean and the calibers: 22 Long Rifle and 22 Short and within a blue stripe resides the C-I-L oval logo. These two empty examples rate very good to near excellent with the LR showing tan staining on the rear panel. (76679-49AA)



3424. **LOT OF COLLECTIBLE AMMUNITION** This is a full 50 rd. size brick containing ten 50 rd. boxes of Canadian Industries Limited 22 Long Rifle. The outer box has the customary yellow blue and red graphics and measures approximately 6 1/2"x2 1/2"x2 1/4" with a top panel that includes a large image of the cartridge and below it is "Shooting is Fun with Super-Clean". Also included is the C-I-L logo and "22 Long Rifle/Greased". This box has a nice clean surface outside of some light dirt on the right end. Also noteworthy are the crisp edges and even a bold purple inspector's stamp on the bottom. The 50 rd. size boxes rate virtually as-new and feature the somewhat angular cartridge image at the top left and a yellow oval with blue "C-I-L" within, with "Standard Velocity" below it. The enclosed ammunition is excellent. This is a rare opportunity to obtain a full brick, particularly in this condition. (76679-49Z)

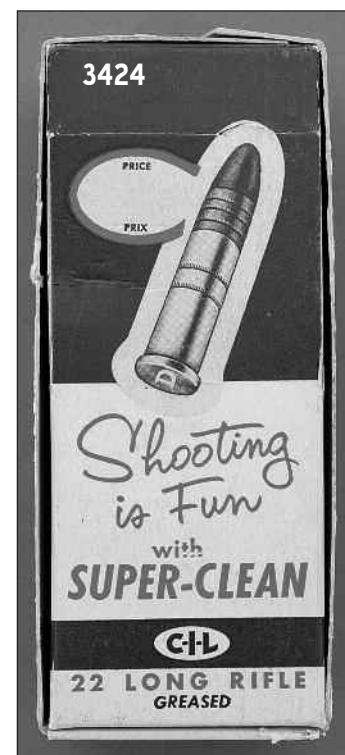

3425. **COLLECTIBLE AMMUNITION BOX** This is a full and excellent condition 50 rd. box by Canadian Industries. The box has an almost entirely yellow backdrop surface with a top panel that has a blue stripe that consists of "25 Long Stevens (image of cartridge) Smokeless" above a yellow stripe that consists of "Super-Clean" within a rectangle and to its right resides an extensive listing of arms that it has been adapted to. The stripe below it is the sole buff colored area on the box and it consists of blue text that reads "Rim Fire Cartridges". The side panels include the C-I-L oval logo and also indicate that it contains 65 gr. bullet. The box and enclosed ammunition are virtually blemish free but there is somewhat faded number written in what appears to be pencil on the bottom panel. (76679-49AB)



3425

3426. **COLLECTIBLE AMMUNITION BOX** This is a full one-piece box from Canadian Industries with yellow blue and white print and a top section that reads "22 Short (image of cartridge) Smokeless Dry Lubricated Bullets/(company oval logo) Super-Clean"/ Made in Canada by/Canadian Industries Limited/Dominion Ammunition Division/ Montreal Canada". The edges, despite showing scattered areas of color loss are actually quite crisp as the entire box is overall housing similarly conditioned ammunition. (76679-49AC)

3427. **COLLECTIBLE AMMUNITION BOXES** This lot consists of two one-piece 50 rd. size boxes for .25 Stevens beginning with a very good to near excellent condition example from Peters with yellow, blue, red; and white graphics with a blue backdrop to the top which includes "Rustless" within a red oval trademark logo and the "P" logo at the bottom right. This version which includes front and rear panels featuring "Rustless" laid out diagonally in red includes the code No. 2505 on the end panels. Contained in the excellent condition tray are approximately 30 correct cartridges in excellent condition. The second box is in a lesser state of condition but is by United States Cartridge Co., this one of the dark blue background with mainly orange logos. The top section reads within the logo "50 .25 Calibre/Stevens/Rim Fire/United States Cartridge Co./New York N.Y. U.S.A.", with the lower portion displaying the Lesmok Logo. This example is missing both end flaps and the main body has tearing occurring at the upper corners and the side panels have residue from applied labels or tape. The correct empty tray has a significant puncture to a side panel. Overall the rating of this box is about good to good plus. (76679-49AD)

3428. **COLLECTIBLE AMMUNITION BOXES** This is a lot of two 50 rd. size boxes from Dominion. First is a two-piece with a red wraparound label with white text that has a top portion that reads "32 Long/Adapted to/ The Various Arms of this Caliber/ Manufactured by the/Dominion Cartridge Co. Limited/Montreal, Canada/Subsidiary of Canadian Industries Limited". Also included on the top is the image of the cartridge, the diamond shaped "D" logo and the affixed label "Super Clean Priming". Also of interest is a sticker attached to the bottom with a matching red center and a border reading "Beauvais Hardware Co. Montreal". The label and buff colored box featuring thumb cutouts rate excellent and the enclosed ammunition amounting to approximately 20 correct rds. rates very good with some light oxidation occurring to the lead. The second box is a one-piece containing about 35 correct and excellent rds. of what is depicted on the top panel in blue and yellow sections as 25 Short Stevens, Super Clean with the "Adapted to" message and the company name section including both Canadian Industries Limited and Dominion Ammunition Division. The box rates about very good with tape residue, mild corner wear and ink markings on the bottom. (76679-49AE)



3428

3429. **LOT OF COLLECTOR AMMUNITION** This is a pair of 50 rd. size boxes from the United States Cartridge Co. with the Lowell, Mass. address and blue backgrounds and orange oval logos. First is a one-piece with a top logo that reads "50 .22 Calibre/Winchester/Rim Fire/(company name and address)" and front and rear including "Winchester/Lesmok Rim Fire". The left end flap is separated but present and the right is missing and has been replaced with a strip of tape that extends well onto the front rear and bottom. The box shows scattered edge scuffing and the tray contains about 45 correct and excellent cartridges. The second one is a full two-piece with a top logo that includes "50 .22 Calibre/Long Rifle/Rim Fire" and side and rear panels read "22 NRA Long Rifle Lesmok". The top label remains about 70% intact with loss at the lower portion and the lower right is peeling back up to the "22" of the logo. The side wraparound label is fully present with one corner peeling back a bit. The edges remain crisp and the graphics are still bold as are the inspector stamps on the bottom. Enclosed are two company-issued red caution slips, a U.S. Shot-Shells chart and very good ammunition with some oxidation on tips. (76679-49AF)



3430. **COLLECTOR AMMUNITION BOXES** This lot consists of three empty boxes by the United States Cartridge Co. The first one is the one-piece variation with the slide out tray and faded orange labels with a top section that includes in black, the company shield logo at the center with "Lowell Mass." below it and on the sides in vertically arranged text and what appears to be faded red "50 Rim Fire Cartridges" and "Calibre 22 Short". The front panel reads "50/target Cartridges." and the sides "22 Short." and about 90% of it remains. The box is fully intact with areas of ingrained dirt and light edge wear and is an impressive survivor overall. The last two have the grayish blue labels with black print including top sections that feature the circular "U.S." logo at the upper left with one reading "Fifty-Calibre .32-Short/Metallic Cartridges/Rim Fire" and the other "50 Cal. .22/Cartridges/Long Rifle/Rim Fire and each includes the Lowell address. The .32 short rates about good to very good with the left flap separated but present and the box shows evidence of having made contact with some liquid as some mold is present mainly on the bottom and about 40% of the blue is no longer present. The tray has torn corners and liquid stains. The .22 box is in much better condition and rates near excellent with sharp edges and text, the labels fully intact with the front still sealed and the top having faded nicely to allow for a blue border and buff interior. (76679-49AG)

3431. **LOT OF COLLECTIBLE AMMUNITION** This lot consists of a full 50 rd. two-piece box from the United States Cartridge Co. including royal blue colored labels with a top one that is faded to more of a sky blue and text that includes the "U.S." logo at the upper left and "50/Cal. .38/Short, R. F./Black Powder/Metallic Cartridges/Made by the/United States Cartridge Co., Lowell, Mass.". The side label has identical front and rear sections that include "Target Cartridges" and in addition the sides feature "Black Powder". Overall the black print is bold as are the blue side label and the bottom purple stamp. Also noteworthy are the crisp edges and the still sealed front. The ammunition shows oxidized tips with some powder having transferred to the cases. A very solid and full collectible overall. (76679-49AH)

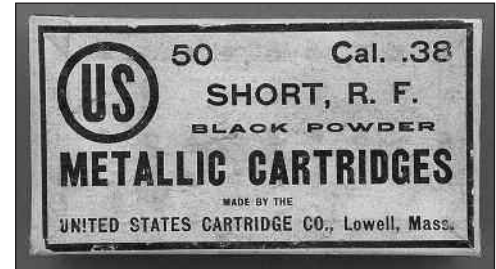

3431

3432. **COLLECTIBLE AMMUNITION BOXES** This lot consists of two U.S. Cartridge Co. one-piece square shaped boxes for blanks. The first one is light brown with black text and a top section that includes the circular U.S. trademark logo at the upper center and "50" to its left and ".22" to its right. Below it the layout is as follows: "Blank Cartridges/Manufactured by the/U.S. Cartridge Co./Lowell, Mass.". Each of the side panels reads ".22 Blank" and the back has a large circle and within it is "U.S." with three dots at the mid points of the letters. The box has only light edge wear and a couple of dirt spots. The lid has separated but is present and the box is nearly full of correct, near excellent rounds. The second box is empty and a more recent version as it has the blue backdrop to the orange, white and blue graphics including a top panel featuring the oval logo with the customary US at the left and in this instance 32 to the right. Additionally, the logo contains "50 .32/Short/Blank/Cartridges/Made By/United States Cartridge Co./Lowell, Mass." Below it is an image of the blank and each of the identical sides has the logo with "U.S. Short Blanks Rimfire 32" and the bottom is plain blue. The box retains nice color with mild edge wear and light scuffing. The right end flap is separated but present. A nice combination from the desirable maker. (76679-49AI)

3433. **COLLECTIBLE AMMUNITION BOXES** This is a lot of three empty two-piece boxes by American Metallic Cartridge Company. Each has top labels exhibiting the eagle scene as its focal point and the So. Coventry Conn. address info. at the bottom, with the first one also including within the ribbon border "50 Special Target Cartridges Swaged Bullets 32-100 Cal. Short". The dark orange side label has a front that reads "Target Cartridges.", the rear: "Double Waterproof," and the sides: "32 Short". The box shows a split top corner, foxing, wear and glue repairs to two sides of the bottom for a near very good rating. The second box rates excellent with a clean top section that includes "50 Shot Cartridges" at the top and "22 Long R.F." on either side, the left panel also adds "Chilled Shot". All other side panels are a plain brown. The third box has a similar layout, though it is of square configuration but features the plain brown side panels with the exception of the left, which reads "25 Shot Cartridges/32 Long R.F./Pat. Sept 9th 1879". The mottled tan one-piece label continues to the top that includes an upper section that reads "25 Shot Cartridges". This example has held up well and rates perhaps very good to excellent. (76679-49AJ)

3434. **COLLECTIBLE AMMUNITION BOX** This is a factory sealed 50 rd. box from U.S. Cartridge Co. with a top label that features the shield logo at the center with "Lowell Mass." at its base. Also included are ovals on either side and within them in red print are "Metallic/50/Cartridges" on the left side, the right has "No. 30/30/100/Calibre". The faded orange side label exhibits "Target Cartridges", the sides "30 Short", the back is plain. Only very light wear is evident and there is scattered light ingrained dirt. The upper left corner of the top label is just beginning to peel back slightly. Overall a near excellent condition and very collectible item. (76679-49AK)



3434

3435. **LOT OF COLLECTIBLE AMMUNITION BOXES** This lot consists of three 50 rd. one-piece plain buff colored boxes with strong black print and from different manufacturers of .32 blanks. The first of the square shaped boxes is by U.S. Cartridge Co. and includes the Lowell address on the front and the U.S. circular logo on each panel. The box apparently has come into contact with some liquid, causing a rough and wrinkled texture mainly on two sides and the back. The fully intact box also shows some dark spotting and is nearly full of correct rds. with verdigris forming on some. The second one is an empty UMC and has a somewhat darker shade, particularly on the front, which exhibits the "U" head stamp logo above the identification and address. The back reads "Bevel Crimped Blanks/Extra Loud Report." and all other panels have the U.M.C. logo above ".32 Blanks, Rim Fire". This example is missing the top right insert flap and the top is separated but present. The last one is Winchester and exhibits the best condition with the only significant blemish being a scuff on the right side panel. The front includes the trademark circular H logo just above "Star Crimp/Blank Cartridges/Extra Loud Report.". The back has "Winchester" in large font and the sides a variety of callouts. The box is virtually full of near excellent correct rds. (76679-49AL)

3436. **LOT OF COLLECTIBLE BOXES** This is a lot of three one-piece 50 rd. size buff colored boxes of Winchester blanks with a first one for .32 Short that opens to reveal an empty box with an inner flap marked "No. 1763-K. D." This version has mainly black text but there is red used for the company name on the front and left panels and the big bold W top and bottom. There is scattered grime evident and a bottom side flap is missing and its main flap is separated but present bringing the condition rating to about near very good. The second one rates about excellent however, a .32 Short with all black text and the H trademark logo on the front and also includes "Star Crimp Blank Cartridges Extra Loud Report". This is an apparently full box with crisp edges and only a couple of minor spots. The third also rates excellent but is considerably smaller as it is .22 blanks. The box features only red print with a front that includes the H logo, identification and company name and address. The box appears to have the entire 50 rds. that rate excellent as well. (76679-49AM)

3437. **COLLECTIBLE AMMUNITION BOXES** This lot consists of three full 100 rd. size one-piece boxes from different manufacturers of B.B. caps beginning with a buff colored example by Western that features red and blue print and a front panel that reads "100/Western/Bulletbreach Caps/Lubaloy/Smokeless Powder/Non Corrosive Priming" above the company name and address. Next is a Winchester with the red and yellow background and a front featuring "Winchester" over the "W" logo in the top red section with the lower yellow including "100 Cartridges. Stayless/for 22 Caliber Rim Fire Rifles" and the side flaps include the code "W 22 BB". The third one is Remington UMC with the Kleanbore dog bone style logo and the code "R2" evident on the lower right front of the green box with plain tan bottom. All three boxes are in tremendous condition, virtually as new and have probably never been opened prior to this inspection which reveals excellent B.B. caps throughout. (76679-49AN)

3438. **COLLECTIBLE AMMUNITION BOXES** This is a lot of four 100 rd. size boxes for caps with the first three by UMC and the fourth of the Remington UMC period. These are square shaped boxes with the UMC's featuring the customary rounded corners and the first one having the deeper profile, measuring 1 3/4"x1 3/4"x 1" and having the marble-style backdrop. The faded orange label includes "100 .22 Cal./B.B. Caps/Swaged Ball", the bottom label has separated but is present and the box houses about 60 very good correct rds. The others measure 2 1/2"x2 1/2"x1/2" with the first one having the dark marble but with the fully intact green top label declaring this as "100 .22 Cal./C.B. Caps/Conical Bullets". The side label is a brighter green and about 85% intact and the bottom label is also completely present. The box shows mild edge wear and foxing. The next one rates about good plus overall as the lid is mis-shapen and stiff with the beginning of a split occurring, the bottom much better with good color to the wallpaper-style cover. The top label states that this is .22 Cal. B.B. Gov't Cartridges. The last one features the Kleanbore dog bone style logo below "C.B. Caps" in large white print. The box rates very good to excellent with staining mainly at the bottom and is currently about 70% full of correct rds. (76679-49AP)

3439. **COLLECTIBLE AMMUNITION BOX** This is a factory sealed 100 rd. box by UMC with a bright orange fully intact top label that reads "100 .22 Cal. Long Cartridges/With Swaged Bullets/Adapted to/The/Standard Revolver" with the customary company name and address at the bottom. Also included are images of the cartridge, revolver and company logo. Portions of the black are fading but all are legible. The front of the matching orange seal is the guarantee, the left side has simply "22", the back: "Made Expressly for Target and Gallery shooting.". The labels are affixed to the diagonal pattern plaid covering, the bottom panel is plain buff and clean. There is scattered mild edge wear and some splitting to the side label but this remains a very collectible specimen. (76679-49AQ)



3439

3440. **COLLECTIBLE AMMUNITION BOXES** This lot consists of three UMC 50 rd. two-piece boxes for .22 LR with the dark marble style body with rounded corners. The first one is square shaped with orange labels including a top one that is about 80% intact with loss mainly at the upper left that originally had "22 Long" in large font just below "50". The matching color side label is 95% intact and each side has ".22 Long" in large font and the box shows mild edge wear. Enclosed are about 20 cartridges with white oxidation and no discernable head stamps. The other two boxes are the more common rectangular configuration with the first one having the same shade orange labels as the one described above. This box like the one above has no image of the cartridge on the label. It is all text, arranged in horizontal lines with the largest reading ".22 Long Cartridges.". The front is the warranty, the sides each read ".22 Long", the back plain. This has light edge wear and the back portion of the label has a small missing section. Enclosed are about 25 rds. with U head stamps. The last box is empty and the top label features the image of the cartridge at the center and to its left is the U red dot logo and to its right is "40 gr. Bullet". Above these are the identification and below is the company name and address in the slightly curved layout. The front and rear portions of the nearly fully intact matching tan side label have warnings and the sides feature the red dot UMC logo serving as a backdrop to ".22 Long Rifle R.F./Smokeless". The bottom label is fully intact and the box shows light to mild wear. (76679-49AR)

3441. **LOT OF COLLECTIBLE AMMUNITION** This is a lot of two 50 rd. boxes from Remington UMC beginning with a full and opened two-piece with the rounded corners and a tan top label that reads ".38 Long Colt Smokeless/50 Central Fire Cartridges/(Remington UMC red dot logo) (image of cartridge) 148 Grs. Bullet/(company name and address)". The label is 90% intact with loss at lower right corner. Nearly all of the side label remains with loss at the seams. The plaid under layer shows mild to moderate edge wear and the bottom label though fully intact has scuffing that has obliterated some text. The enclosed correct full 50 rds. rate near excellent with clean tips. The second box is a one-piece green box with the Kleanbore dog bone style logo at the center and at the top in large white text is ".45 Automatic Colt" and the end caps clarify that it is metal cased. The box shows mild wear with weakened and slightly split corners, a missing right inner end flap and a scuff at the lower top. The full tray houses about 40 near excellent correct rds. with the balance having Super X head stamps. (76679-49AS)

3442. **LOT OF COLLECTIBLE AMMUNITION** This lot consists of four 50 rd. size boxes of .22 LR starting with a two-piece with rounded corners with a bright green top label that has a lower section stating that it is from "The Union Metallic Cartridge Co." with the upper portion reading "50 .22 Cal. Long/Shot Cartridges" and the middle consisting of the U logo, image of cartridge and "Rim Fire". The box rates near very good with three correct rds. enclosed. The second is by Remington UMC and is a one-piece green box of a similar shade but rates excellent with light edge wear and some ingrained dirt. This is the version with the image of the rifle on the front panel for which the .22 Long R.F. Lesmok cartridges are designed for. This box code 24-B.S. has a tray currently housing about 25 correct and very good condition cartridges. The last two are the dark green one-piece with the Remington UMC Kleanbore dog bone style logos at their centers with the first one being Lubricated Bullets of which this one retains the full 50 rds. in excellent condition as is the R17L coded box itself. The last one is coded R21L and is in a lesser state of condition showing mild wear, splitting and creasing on the upper left, and overall fading and discoloration. The box is for "Lubricated Hi-Speed Bullets" and currently houses about 30 rds. of mixed .22 LR. (76679-49AT)

3443. **LOT OF COLLECTIBLE AMMUNITION** This lot consists of four full 50 rd. one-piece boxes of Remington Kleanbore in the dark green boxes with red and white print, including the first three that feature the Remington UMC dog bone logos on the top panels beginning with one coded 6222 of Palma Lubricated Bullets rating near excellent with stains on left panel and excellent ammunition. The second example is identified as .22 Long Rifle Lubricated Bullets and coded R17L, showing mild edge wear and tarnish to cartridges. The third is code R31 with an upper top panel that reads ".22 Automatic Rifle Rim Fire/Winchester Model 1903" with crisp edges and writing evident top and bottom and excellent ammunition. The last box rates near excellent with the white areas now a light tan overall and the top panel of the R20 box reading Remington/(red dot Remington logo) Kleanbore (red oval Dupont logo)/Hi-Speed/.22 Klay Bird/For Miniature Trap & Skeet Shooting. The ammunition shows tarnish forming. (76679-49AU)

3444. **COLLECTIBLE AMMUNITION BOXES** This is a lot of five 50 rd. size boxes of .22 LR from different manufacturers beginning with a two-piece by United States Cartridge Company with the T-48 code, labels with blue background to orange and white graphics including a top section that is about 40% intact and missing most of the left side including the portion that indicated that the box was manufactured during the Lowell Mass. period. The side label is 98% intact and indicates that this is 22 NRA Lesmok HP. Overall the box is crisp as are the inspector stamps on the bottom and the included shot-shell sheet. The ammunition shows oxidized tips. The other four boxes are one-piece beginning with a Peters containing approximately 49 rds. of excellent and correct High Velocity Filmkote HP as depicted on the top of this No. 2284 box featuring silver, black and white graphics. Box rates near excellent with a scuff to top lower right corner. Next is a near very good example of Remington UMC Kleanbore Lubricated Bullets, code R14L with moderate scuffing, mild stains, splits and discoloration that houses 13 correct and mostly clean cartridges. Next is an excellent Western Super-X long range with crisp edges, bold graphics and enclosed is an excellent but empty tray. The last one also includes an empty tray, this one being by Canadian Industries Limited, a buff colored box with blue and red graphics featuring an angular image of the cartridge, "Super-Clean" and "Standard Velocity". The box could be rated excellent plus were it not for a scuff at the lower right corner of the bottom panel. (76679-49AV)
3445. **LOT OF COLLECTIBLE AMMUNITION** This lot consists of four full 50 rd., one-piece boxes by Canadian Industries Limited of Whiz-Bang .22 and exhibiting yellow, red, blue and white graphics. The first three are high velocity and open at the top flap including the first one, coded RF-21, that shows a left side with the cartridge image and also indicates that it is 22 Long. The second box, coded RF 23, is 22 Long Rifle with the image on the right side, and the third, coded RF24, is 22 LR Mushroom with the image displayed at an angle on the left side. The last box opens by way of end flaps, the left one indicating that this is code TT-54, with graphics that include a horizontal positioning of the cartridge image on the right side and also "Super-Clean" and "Mushroom". The boxes and ammunition are clean and rate excellent overall. (76679-49AV)
3446. **COLLECTIBLE AMMUNITION BOXES** This lot consists of six one-piece .22 LR 50 rd. size boxes by Winchester beginning with a full, buff colored example with blue and red print indicating Staynless Kopper Klad Bullet. The box has crisp edges, scattered spotting, is missing the right flap and the left one is nearly entirely separated. The ammunition rates near excellent. The next one is fully intact with an unusual layout as the top panel bears a blue center section with "Leader Staynless" in yellow, with red company logos above and below. The K2388R coded box is empty with the exception of a wood block used for support. Another interesting pattern is exhibited on the next box, coded K 2236 R which has a blue stripe with "Smokeless EZXS" within it and a red area above with company logo and yellow used as a backdrop for the front panel which adds "Staynless Priming" to this collectible with an overall rating of near excellent. Next is a K2207 R coded red, yellow and white box for Super Speed H.P. rating near very good with mild wear and a separated but present right end flap. Enclosed are about 40 mixed .22 LR. The last two are empty and rate good to very good consisting of a "Leader", coded K2388 R but different from the one described above as this has no blue and a mainly red layout with "LEADER" in white as the central focal point. It has a missing flap and ink scribbles. The last one is K2208 R, mainly yellow with blue and red with a top upper section that includes the company name logo above "Super Speed". Overall, a nice representative variety for the period. (76679-49AY)
3447. **COLLECTIBLE AMMUNITION BOXES** This is a lot of four boxes of .22 cal. representing various periods of Winchester boxes beginning with a two-piece that remains sealed on the left side with a green top label that reads "50 (image of cartridge with ".22 Long" within it) No. 22"/Metallic Cartridges/Manufactured by the/Winchester Repeating Arms Co./New Haven, Conn: U.S.A.". Also included are the "H" logo on the left and "Stetson's Patent Oct. 24, 1871" logo on the left. The nearly fully intact side label reads "22 Long. 1/2/Target Cartridges." on the front, "22/Long. 1/2" on the right and "Process of Lubricating Pat'd Sept. 12, 1882"/Winchester Repeating Arms Co." on the back. The top label has some loss of green due to wear but the black text has held up well. The edges show light wear and some ink writing is evident on bottom panel. A strong box with 50 mixed correct caliber cartridges with the majority being Winchester. The next two-piece box rates very good to excellent, has a fully intact and solid green top label that includes "50 (colored image of cartridge) .22 Cal./Rifle Cartridges." with Smokeless displayed diagonally in red over it. This 15 10-B coded box has a fully intact orange side label indicating that this is .22 Short. The tray is slightly mis-shapen on one length and currently holds eight correct rds. The third box is full of excellent correct Super Speed .22 Short as depicted on this code K2214 R box that rates very good with edge and corner wear, general discoloration, and a penciled in note. The last item is a one-piece buff box with black print identifying it as Ball. Cal. .22 Long Rifle Lot W.R.A. 22095 from the Olin Matheson plant. The box is empty with tray and is crisp with some mild stains. (76679-49AZ)

3448. **COLLECTIBLE AMMUNITION BOXES** This is a lot of three Winchester two-piece boxes beginning with a .41 Short RF with a turquoise like top label that is fully intact and reads "50 Metallic Cartridges No. 41/Stetsons Patent (image of cartridge) October 24th 1871/ (H trademark logo) "Manufactured by the" over the company name in very large font. Also distinguishable of this example is a lemon yellow side label that reads "41 Short R. F." front and rear. The bottom has glue repairs and the top shows a split on the upper left corner. Also evident is light foxing and ingrained dirt to this empty box that retains its bottom panel label and rates about near very good overall. The second one has a fully intact top green label with strong black print indicating that it is for 50 No. 46, with a large image of the cartridge top center with "Long" within it and below is "Metallic Cartridges" and below that is the company name in large font along with the H and Stetson logos. No other label is present and the box has undergone several repairs, mainly glue and rates about good with some separated but present components and three good to very good correct cartridges enclosed. The third box rates good as well with evidence that it has come into contact with considerable liquid and displays an uneven stance with much staining throughout including the top green label with a top line that reads "Trademark H (in Logo form) 50 Cartridges 44/100"/Stetsons Patent Oc. 24th 1871 (in small font)/Short for Pistols (in very large font) with the image at the lower left and the company name beside it. The box houses nine correct rds. with oxidized tips. (76679-49BA)



3449. **COLLECTIBLE AMMUNITION BOX** This is a full two-piece Winchester box with the bright green top label that reads "50 (image of cartridge with "Short" along the case) No. 38/Metallic Cartridges/ (H logo) manufactured by the (Stetsons logo)/ (company name and location in large font). The front and rear of the deep orange side label consist of "38 Short R. F." and the sides are plain. The top label shows mild scuffing, very faint foxing, a nice emerald green-like color and strong black text. The side label is about 70% intact with liquid stains and tape repair residue. Three corners of the left side of this box are split and there are areas of ingrained dirt, the bottom also including a penciled in note. The original ammunition rates near very good with oxidized tips. A nice find with all 50 rds. (76679-49BC)



3450. **COLLECTIBLE AMMUNITION BOX** This is a two-piece box with rare purple labels including a top one that is fully intact and reads "50 Winchester 50/ (trademark statement)/.44 Winchester Smokeless Soft Point/Center Fire Cartridges (image of cartridge with enclosed ID) 200 gr. Soft Point Bullets/For Winchester Model 1873 and 1892 and other Rifles and Revolvers" above the customary company name and location. The side label is 99% intact and exhibits a front that reads ".44 Winchester Smokeless/Soft Point Cartridges/Models 1873 and 1892/Winchester Make". The sides have identical text and are quite redundant to the front with ".44 Winchester/Smokeless/Soft Point/Winchester Make". The back consists of a seven line guarantee statement and the code 705 4-14. The box remains sealed at the back panel and rates about very good or perhaps slightly less as there are splits at the rear lid corners and bottom right rear. Also evident is mild edge wear and a few letters of the otherwise strong black print have worn away. In addition the top label exhibits light foxing and a slightly inconsistent faded appearance. The enclosed 48 rds. are correct and very good with only a light amount of white on the tips and darkening to the cases. An uncommon box that has held up quite well. (76679-49BB)
3451. **COLLECTIBLE AMMUNITION BOXES** This lot consists of two Winchester two-piece boxes beginning with a .32 short that bears the turquoise-like green top label including a top line that features the image of the cartridge with the word Short within it and on its left is "50", to its right "No. 32". Below that is "Rifle Cartridges" and below that in large font are the company name and location with the H and Stetsons logos in their customary positions. The label is fully intact with mild foxing and some soiling. There is a somewhat concave profile and the box has nice edges with only light wear. The deep orange colored side label is 98% intact and reads "32 Short. R.F.", the right exhibits an abbreviated version: "32 Sht. R. F." and a faded lid section, the lower left, faded as well shows a black spot. The rear is the guarantee statement and enclosed are about 30 very good and correct rds. The second box has a fully intact lemon yellow top label with identification occurring on the two upper lines in the form of "100 (cartridge image including "Short") No. 22/Metallic Cartridges" with the usual company name, location and logos for this period in their appropriate positions. This label, and the box in general exhibit much dark spotting likely from grime and contact with a small amount of liquid. The green side label is the version with front, sides and rear that read "No. 22 Short" and is about 70% intact. This example rates about near very good with a glue repaired lid that has begun to separate once again at the back right, still a nice find with the yellow label and an enclosed correct cartridge. (76679-49BD)
3452. **COLLECTIBLE AMMUNITION BOXES** This is a lot of two empty two-piece Winchester boxes. The first one has a light blue top label that reads "50 No. 30" with a plain image of the cartridge at the center and a second line with "Metallic Cartridges". This resides over the company name, location and logos. All text is strong with some of the blue label having worn to reveal the buff colored panel. Interestingly the original side label is the bright green color and bears a front exhibiting a somewhat obliterated "No. 30", and all other sides plain green, the back still mostly sealed. This is a very good overall example with no extreme blemishes, just the typical fading and ingrained dirt from the years. The second box exhibits a fully intact olive green top label with different and plainer text without the sharp edged lettering. It consists of a top line of "50 (picture of cartridge with ".32 Short" along case) .32 Caliber./Rifle Cartridges" above the manufacturer's information and this one with a smaller H within the trademark logo. The orange side label consists of a still sealed front with the guarantee statement, a back with ".32 Short R. F." and sides with ".32 Sh't. R. F./Winchester Make". The bottom panel bears a still affixed and nearly fully legible guarantee label with red print. Another very good and desirable example with very light edge wear and a somewhat overall dark appearance. (76679-49BD)
3453. **COLLECTIBLE AMMUNITION BOXES** This lot consists of two empty two-piece Winchester boxes for .32. The first one has a lightly faded olive green top label with the upper section declaring this as "50 .32 Caliber." with the picture of the cartridge displayed between the quantity and the caliber with ".32 Long" on the case, and "Rifle Cartridges" below it. The lower portion consists of company name, location and trademark logos. A small portion of the upper left is torn off and a smaller one at the right is peeling back and all text is strong and legible. The orange side label has held up well, as it is virtually fully intact and not all that faded, the front panel still sealed and reading "Process of Lubricating Pat'd Sept. 12, 1882" above the company name in script. The back contains the guarantee statement and each side: ".32 Long. R. F./Winchester/Make. Overall the box is very good with light edge wear and some scattered spotting with panels that have retained their shape and structure nicely. The second box is in a lesser state of condition, but should be considered desirable none the less as this one is coded 234 with the 7-7 date as depicted on the bottom of the green top label that also reads "50 Cartridges (in a curved layout) .32 Caliber./for/Winchester .32 Cal. Rifles./Center Fire. (cartridge picture with cal. depicted within it) Solid Head (in straight line)" over the trademark info and the name and location taking up the lower portion. The front of the buff colored side label is the guarantee statement and below it the code 622 and 7-7, the back, "Winchester Make" with another image of the cartridge. The sides include the big bold red W and "Model 1873 and 1892. The box has a dark overall appearance, mainly from ingrained dirt, the lid has split corners and an excellent pink interior label coded 1732 and 10-6. (76679-49BE)

3454. **COLLECTIBLE AMMUNITION BOX** This is a factory sealed two-piece Winchester box with a virtually fully intact bright green top label with an upper line consisting of "50 (image of cartridge including "Long") No. 38/Metallic Cartridges". Below it are the logos displayed at the sides of the company name and location. The text is bold and the label has scattered small scuffs and foxing. The side label is now a salmon-like shade of orange, almost pink in areas with a front section that is splitting but not enough to keep this as being classified as sealed and the front, rear and right side each read "38 Long. R. F.", the left is plain. Overall the box displays little edge wear and small dark spots of dirt particularly at the bottom. A nice and collectible box from the famous maker that has never been opened. (76679-49BF)



3454

3455. **LOT OF COLLECTIBLE AMMUNITION** This is a group of three 50 rd. size, two-piece .22 boxes by Winchester beginning with a factory sealed example with a fully intact and faded olive green top label that has "50" at each upper corner along with "Winchester" between them and the small font trademark info below it. The center portion begins with the H logo and includes the cartridge image including ".22 Long Rifle" and then "Rim Fire". Below that is "Lesmok Rifle Cartridges". The yellow side label, also fully intact bears a front with the guarantee statement above the codes 143 and 8-20. Also noteworthy is the remnant of a small strip of tape, perhaps a surcharge label. The sides include the big bold W and the back adds that these are "Target Cartridges". Also evident are crisp edges and scattered light dark spots. The second box shares some identical characteristics as it is a full box of original cartridges, these however being .22 Short, a faded olive green top and a yellow side label. This example has been opened and reveals very good ammunition. The top label has identical layout with the exception of the right center having the Stetson patent info rather than "Rim Fire". The side label is coded 141 and 9-14 and the box shows mild wear and an overall brownish patina. The last box is empty with the code 15 at the lower right and 10-8 lower left of the green top label declaring this as .22 Short. This is the version with "Smokeless" presented in red in a diagonal layout over "Rifle Cartridges". This has virtually entirely intact labels, mild wear and a dark overall appearance with spots of grime. A nice trio of examples for the Winchester or .22 box collector. (76679-49BG)

3456. **LOT OF COLLECTIBLE AMMUNITION** This is a group of three 50 rd. size, two-piece .22 boxes by Western, all of which are for .22 Short and are buff colored with thumb cutouts with the first two being factory sealed with wraparound labels. The first one has extremely bright colors including a red border of a green top section that has the diamond logo as its center focal point. This WT-24 code box also exhibits the image of the cartridge over a big red 22 on the right side panel, the left somewhat redundant to the top as it also includes the diamond and "Lesmok Powder". The box exhibits scattered scuffs to the otherwise outstanding condition. The other sealed collectible has a more faded overall label, this one green with a blue border and declaring that it is "Gallery Special". This is a clean box with scattered wear marks and nice edges. The last box is empty with a split to the lid just above the front thumb cutout, with a corresponding area at the back stamped "B A 13". This is the mainly blue and yellow version with the large company name logo in red and strewn across the blue upper front. The lower section includes ".22 Short/Lubaloy Coated Bullet. The side and bottom labels are also intact and the bottom compartment is somewhat mis-shapen from handling, bringing this box to a rating of near very good. A diversified and desirable grouping including some top rate condition. (76679-49BH)
3457. **COLLECTIBLE AMMUNITION BOXES** This is a group of five .22 boxes consisting of two by Winchester and three identified by the Western logo. First is an empty two-piece Winchester with thumb cutouts and an olive green upper and yellow side portions to the fully intact wraparound label indicating that this is .22 Long Rifle Lesmok Target Cartridges. This is a near excellent condition example with nice edges and light wear including a clean bottom with label. The other Winchester is coded K 2208 R, representative of the one-piece yellow, blue and red graphics for Super Speed Long Rifle Staynless Kopperklad. This one has the tray with wear essentially at the edges only. The first of the Westerns is a two-piece with a wraparound label featuring deep green, red and black graphics with the diamond logo at the center of the top section which, like the sides, makes it clear that the contents are .22 Short, of which about 30 correct and very good cartridges are enclosed. This box shows little soiling or wear but has the residue of a removed strip of tape once used to reinforce the lid which shows a separation of the left flap. Very good to excellent with bold green color. The last two are empty one-piece beginning with a near excellent K1222R coded example indicative of .22LR 40 gr. lead lubricated bullet with sharp edges and color, a small scuff/tear to the right flap and the original tray. The last one is about an increment down condition wise, this being the yellow XP22LR code for Xpert with the big red X top center and the front panel identifying it as 40 gr. lead Special Lubricant. The tray is included and is mostly clean overall with a scuff and peeling to the top left. This one has the Winchester New Haven address in addition to the Western East Alton. An interesting grouping for those interested in the two companies. (76679-49BI)
3458. **COLLECTIBLE AMMUNITION BOXES** This is a lot of two empty two-piece picture boxes by UMC for .32 cal. short with the bright orange labels with the pistol images on the top and the plaid surface design. The first one has a top line that reads "Fifty No.2 or 32-100 Short" and is missing the right lid panel. This is the version with the front panel that reads "Warranted to fit and guaranteed superior to any in the market" with this example showing some obscured text at the separation. It shows mild edge wear but still sound and crisp overall. The second, which is slightly smaller reads "Fifty .32 Calibre. Short/Pistol Cartridges./No. 2/With/Swaged Bullets" with the guarantee on the back panel of the seal label which is about 60% intact and exhibits glue repairs, splits, wear and a scuff to the lower right of the top label causing it to peel back. An opportunity to acquire a couple of uncommon boxes. (76679-49BJ)
3459. **COLLECTIBLE AMMUNITION BOXES** This is a lot of two UMC two-piece picture boxes with the plaid design beginning with a .22 box with a fully intact faded olive green top label that reads "100 .22 Calibre./No. 1/Cartridges./With Swaged Bullets." and features the revolver image on the right just below the logo. The virtually fully intact orange sealing label has a front with the guarantee and a rear panel that reads "Made Expressly for Target and Gallery shooting". The left side reads ".22 Short" and the right is plain. The lid has splits at the front corners, the top label shows some foxing and the edges showing light wear bringing the rating to about very good. Enclosed within is about 80% of the lid to a similar .22 picture box with a bright green label. The second box has a deeper olive green and fully intact top label that has an upper section with "50" at the left corner and the right has ".30 Calibre.". Additionally there is "Cartridges/for XXX/Standard Revolver (in large font)/And Other Pistols Of This Calibre." All of this is accented by a large image of the revolver. The side label in this version is blue with the warranty statement on the back and the balance plain. About 80% of the label is intact, the glue repaired lid has two splits on the left and the box has an uneven profile with average wear and foxing. Enclosed are about 30 correct cartridges with mild oxidation and tarnish. A very collectible pair of picture boxes overall. (76679-49BK)
3460. **COLLECTIBLE AMMUNITION BOXES** This lot consists of two 50 rd. size picture boxes with the rounded corners by UMC including a mismatched one with the combination Remington name and red dot logo on the left side of its bright green and fully present top label with a top line that reads "44 Winchester". To the left of the logo is the image of the cartridge with "UMC/44 Winchester" and to its right is "200 grs. Bullet", with the combination name in curved layout below it. The empty bottom section is a mismatch with a similar green label and picture of the rifle on the front and the red dot logos on the sides. The back is the warranty for both top and bottom which has a 371 code. The bottom 4-H label is present and the compartments each rate about very good. The second box is all matching and has a fully intact light green top label that exhibits the old UMC logo at each upper corner and between them is "Fifty Cartridges./38 Cal. Winchester.". The center consists of a large image of the cartridge and within it is "38. C. F. W." and it lies between "Solid" and "Head." and above "Central Fire Reloading.". The UMC name and location takes up the bottom in straight horizontal layout. The side sealing label is nearly fully intact with some peeling evident. It has a front section consisting of the guarantee, a back with the picture of the rifle and sides that have somewhat obscured: ".38 Cal. C.F. Winchester Solid Head". The lid has glue reinforcements at each corner and a very good purple stamp on the interior that reads "In Reloading these Shells, Use U.M.C. no. 1 Copper Primer.". The box overall is very good with light wear and spots of grime. Enclosed are five cartridges and about 44 fired cases. (76679-49BL)
3461. **LOT OF COLLECTIBLE AMMUNITION** This lot consists of three boxes of Remington UMC Kleanbore in one-piece green boxes with white and red graphics and the dog bone style logos at the centers of the tops. First is a full 50 rd. of .41 Short Rim Fire coded R318, with separated but present end flaps, light edge wear and about very good cartridges with oxidized tips and bright cases. The second box, coded R188XK is a 20 rd. size that is in better condition with brighter graphics and less wear. It currently houses 17 correct rds. of .32 Winchester Special, 165 gr., Mushroom Bullet and three of Western. The last box is a 50 rd. size for .32 S.&W., 88 gr. lead bullet currently containing about 25 excellent cartridges. The R167 coded box rates about good plus with a missing right flap, scuffs and dark soiling over a large portion of the top surface and extending to the other panels. The tray is beginning to tear from handling. This is an efficient manner to acquire a variety of calibers from the famous maker. (76679-49BR)

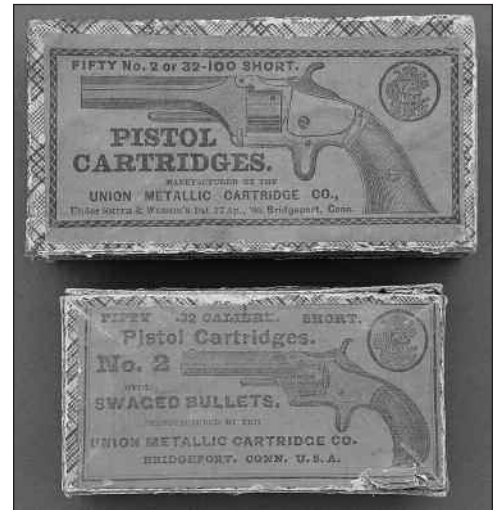

3458



3462. **COLLECTIBLE AMMUNITION BOXES** This is a lot of two empty UMC two-piece boxes with green top labels with black print including one that reads "50 .42 Cal., No.64/Rim-Fire Cartridges". Below that and in the center is a picture of the cartridge with ".42/F&W,.64" within it and at its sides is "Swaged" and "Bullets". Also included is the trademark U logo on each side and the company name in curved arrangement below. The tan side label has the guarantee in the front, a rear with a message pertaining to accuracy and sides with ".42 No. 64. Rim Fire". Some of the text is missing due to label loss. The bottom guarantee label is fully intact with some shelf wear evident and the box has overall crisp edges with areas of grime. Both top and bottom show glue repairs. The second box has a top label with a small section missing from the lower left and text that reads "50 44 Cal., Short/Rim-Fire Cartridges" with the balance in the same configuration as described above. This example has the plaid covering with extensive tape repair over it and a lid that is split across the left side and extending to the front. Overall it rates good to very good with liquid stains, mild wear causing loss of the plaid and a fully intact bottom label. A pair of desirable vintage models. (76679-49BM)



3462

3463. **LOT OF COLLECTIBLE AMMUNITION** This lot consists of two boxes by UMC with two-piece construction with the rounded corners and plaid wallpaper cover. The first one has a blue-green top label with black print that reads "50 .38 Cal. Short/Rim-Fire Cartridges/Swaged (picture of cartridge with ".38 Short" within) Bullets". Also included are the U logos on either side and below that Manufactured By/The Union Metallic Cartridge Co./Bridgeport, Conn., U.S.A.". The red side label shows scattered loss and is about 70% intact with much of the loss to the front message and less loss at the rear guarantee. This is the version where the sides read ".38 Short./Rim Fire. The box has mild edge wear, a fully intact bottom label and some fairly minor fading. Enclosed are the full 50 correct cartridges with a light coating of white on the tips and bright cases. The second box, which is empty, is for .38 long and has a green top label that exhibits the trademark U.M.C. oval logo at each upper corner with "50 Rim Fire./Rifle Cartridges/.38 Long. (image of cartridge with caliber denoted within) With Swaged Bullets" and below that the UMC name and address. The box has a nearly entirely intact orange side label with a small hand written ink note and the guarantee statement on the front, ".38 Long." on the left with an accompanying penciled in "85" above it and the balance plain. The box and labels show scattered mild wear and fading. (76679-49BN)

3464. **COLLECTIBLE AMMUNITION BOXES** This is a lot of three UMC boxes, all two-piece and of square configuration with fully intact top labels including a first one that is brown and exhibits the trademark oval U.M.C. logo at the upper left corner and to its right is "20 Cartridges./Rim Fire./58 Calibre Musket./Manufactured By The/Union Metallic Cartridge Co./Bridgeport, Conn./U. S. A./Under Smith & Wesson's Patent, Apr. 17, 1860." Stamped diagonally in red across the center is "Blank" in red ink. The buff colored empty box rates excellent with virtually no wear marks, some spots of grime and a fully intact orange colored guarantee label on the bottom with a small hand written abbreviation and date. The second box has a tan top label with an upper section that reads "20 .58 Cal. Musket/Rim-Fire Cartridges". The center of the label has a large image of the cartridge and within it is ".58 Musket & Carbine", to the sides is "Swaged" and "Bullets", and the lower section includes the company name in a semicircle-like layout, the location and two trademark logos. This box has a plain buff paper outer layer that has a right side that reads ".58 Roberts/20 Cartridges/Central Fire/Black Powder" and exhibits in red, the UMC red dot logo on the left and Remington name logo on the right. The left panel has a penciled in note. The bottom retains the guarantee label and has a penciled in note. The third box is considerably smaller, as the top brown label reads "50/Blank/Cartridges/.30 Calibre" and includes the UMC info below it. Also included is a retailer's label on the bottom of this example which retains about 50% of its black outer layer and a sample round. The box is structurally sound with mild wear and a small ID label with a handwritten number affixed to one bottom panel. Overall a trio of rare vintage UMC collectibles. (76679-49BP)

3465. **LOT OF COLLECTIBLE AMMUNITION** This lot consists of five 50 rd. size boxes by Remington /UMC beginning with an empty bright green two-piece with a fully intact maroon top label that reads "50 .22 Cal. Short/Rim-Fire Cartridges/Swaged Bullets (cartridge picture) (trademark head stamp)/The Union Metallic Cartridge Co. (incurved layout)/Bridgeport, Conn., U.S.A.". The box has the rounded corners and edges showing mild wear, an unevenly faded patina and the fully intact bottom label. A handwritten note is evident on the front panel. The remaining four boxes are one-piece with the first one being a nearly full maroon example with buff colored text that reads ".22 Short R.F. Lesmok" over the Remington UMC dot logo, cartridge image and trademark statement. The bottom includes both the Remington and UMC names and this 53-S code box rates very good with a dark grime spot on the top and is nearly full with oxidized cartridges. The last three are Remington Kleanbore Hi-Speed LR with the first one full of excellent HP and coded R23 with an unglued front panel to this otherwise excellent mainly green box. The next one consists of the same green, red and white design with this one being empty and coded R21. The last one is an empty code 1552 which has a mainly red backdrop to green and white graphics. The last two rate excellent. A nice lot representing different eras. (76679-49BQ)

3466. **LOT OF COLLECTIBLE AMMUNITION** This lot consists of two full one-piece .22 boxes by Canadian Industries Limited with the yellow, blue and white color pattern beginning with one with an end flap code of TT-51 and a top panel with horizontally arranged sections including an upper one that exhibits the picture of the cartridge at the center and the caliber depicted within it and also to its left as "22 Long Rifle", to its right is "Smokeless Dry Lubricated Bullets". The middle consists of the CIL/Dominion oval logo and "Super Clean" within a rectangular border. The lower section has the manufacturer name and location. The box rates excellent with light edge wear and excellent clean cartridges within. The other one also has clean, excellent ammunition that is accessed by way of a top opening flap with bold inspector's stamps on the interior. The exterior is virtually blemish free with sharp edges and it features a three section horizontally arranged layout on the top panel that identifies this as .22 W.R.F. Winchester with the image of the cartridge top center where it abuts "Smokeless Greaseless". Also depicted below it is "Super-Clean" enclosed within a border and the extensive list of models for which it has been adapted. The manufacturer info section includes both the CIL and Dominion names. An excellent pair of collectibles from the mid-20th century. (76679-49BS)

3467. **LOT OF COLLECTIBLE AMMUNITION** This is a lot of two full one-piece boxes of .22 by Canadian Industries Limited with the yellow, blue and white color scheme beginning with a rare 100 rd. size box with a TT-57 coded flap and a rear panel that is date stamped Nov. 6 1941 below the message "This carton contains "Dominion" .22 Long Rifle Greased Cartridges, property of the Department of National Defense.". The front panel includes the cartridge image at the top, an expansive middle section that includes the logo and "One Hundred Cartridges". The lower section consists of both the CIL and Dominion names. The box shows light edge wear and rates excellent as does the enclosed target ammunition. The second box rates near excellent with a separated but present right end flap, some light liquid staining on the back panel and a hand written price in ink on the top flap that opens to reveal excellent cartridges, in this case, 22 Automatic, as depicted at the upper left section of the top panel. Also included is the cartridge image and to its right "Smokeless Greaseless". The middle section consists of the Super-Clean box logo and beside it is "Adapted to Winchester Model 1903 Automatic Rifle". The lower section is plain buff and reads "Rim Fire Cartridges". An opportunity to acquire two rare items with one bid. (76679-49BT)



3468. **COLLECTIBLE AMMUNITION BOXES** This is a lot of five .22 boxes by Canadian Industries Limited. The first of these one-piece 50 rd. size boxes is a rare Bisley as depicted in large font on the red-orange upper section of the top panel which includes a large yellow middle that portrays the cartridge image at an angle and an oval C-I-L logo between "Rim Fire Cartridges" and "Intermediate Velocity". The lower section of this RF-37 coded box reads "22 Long Rifle Greased". The enclosed tray contains eight excellent correct cartridges. The box shows a little dark spotting on top, a slight tear and average wear and fading. The remaining four boxes are Whiz-Bang with the top flap opening construction including one with blue and yellow horizontal sections that include ".22 Long "Super Clean"" and the horizontally positioned cartridge image. This one shows mild edge wear and includes one sample cartridge. The last three are empty beginning with a 22 Short Mushroom that includes blue with the red and white scheme and the cartridge displayed on the top left. This one has mild edge wear and an ink number on the bottom which also shows a small tear. The last two are .22 LR, rating near excellent with red and yellow graphics only, with the exception of the mushroom box coded RF 24 which announces that, in blue, at the bottom right panels. The other box, coded RF 23 shows a small tear to the top flap. A nice grouping to begin or augment a collection of the Montreal maker. (76679-49BU)
3469. **LOT OF COLLECTIBLE AMMUNITION** This lot consists of four .22 boxes by Canadian Industries Limited. The first of these one-piece 50 rd. size boxes is full and rates excellent with virtually no blemishes or wear and uses maroon, yellow and white graphics to announce that it is 22 Long Rifle Lesmok Powder Super-Accurate and that Dominion is included in the company info. The ammunition is mainly clean with tarnish in spots. The last three are Whiz-Bang beginning with an excellent condition 22 LR High Velocity, full with excellent condition cartridges. This example has the RF-33 coded end flap and the red, yellow, blue and white graphics include the angular cartridge image at the top left, a middle section with the oval C-I-L logo and a bottom panel that includes "1954" as part of the company information. The next one is also full with clean ammunition that matches the box condition as it shows only very light edge wear. The TT-60 coded box is a rather plain off white and navy blue scheme with "22 Long Rifle Shot" serving as identification at the upper section of the top panel. The last one in this lot would rate excellent were it not for an area mainly on the top of some coating, possibly a factory QC issue of excess aqueous coating. This RF-11 coded box features the top opening access, red, yellow and white graphics announcing this as 22 Short high velocity and with an image of the cartridge in a vertical stance. A nice variety with some top notch condition for the .22 or CIL collector. (76679-49BV)
3470. **LOT OF COLLECTIBLE AMMUNITION** This is a full, excellent condition, brick size box of Canuck 22 LR, standard velocity, greased rim fire cartridges. This RF 566 outer box houses ten 50 rd. size RF 66 boxes that contain excellent condition cartridges in plastic trays. The outer box and its inner smaller counterparts share identical yellow, dark blue and white color schemes and include the cartridge picture to the far right and the C-I-L oval logos on the top and side panels. A nice change from the usual individual and much more common 50 rd. collectible. (76679-49BW)
3471. **LOT OF COLLECTIBLE AMMUNITION** This lot consists of three 50 rd. one-piece .22 boxes by American Cartridge Co. including the first two which indicate manufacture at the Kansas City location. The first of these with black and white graphics set to a red backdrop is an empty example with A 22-1-S C coded end flaps that also include ".22 Short/Smokeless/Non-Corrosive/Copper Coated". The top panel includes "American Eagle" in large font above the copyright image of the bird below it. The front and rear panels consist of the company name and "Kansas City, U. S. A.", the bottom, a guarantee statement. The box rates near excellent with bold color, a partially separating right flap and an inner tray with a separated end flap. The next one exhibits a somewhat faded red area of the top panel which also includes a large "S" at the far left as part of "Superior Cartridges" and "Fast Flight" along with a small American Eagle copyright logo of the image of the eagle and the company name and address below. The end panels inform that this is .22 Long non-fouling. The box is clean and structurally excellent, likely benefitting from the wood block within the tray which also houses nine correct and excellent cartridges with clean lead tips. The last box has a tray with 49 excellent and correct cartridges with the copper tips but with the same identification as the one described above. This is the yellow box with black print that mimics the design pattern as the one listed above but includes the Minneapolis address and the white warning sticker applied to the lower portion of the top panel. The guarantee statement, as is the case with the other two in this lot makes up the bottom panel. This example rates excellent with sharp edges and bold color. (76679-49BX)
3472. **LOT OF COLLECTIBLE AMMUNITION** This lot consists of four, one-piece .22 boxes by Sears, Roebuck and Co. beginning with one with code No. 302, a gray box with maroon and white graphics informing us that this is .22 LR Sta-Klean, Lead Lubricated, Xtra-Range, of which four near excellent cartridges with the correct XR head stamps are enclosed in the fully intact tray. This version has the warning as the top panel and the large Sta-Klean logo as the focal points of the front and back. This example is missing the left end flap, shows mild edge wear overall and some fading and peeling. The next three boxes are full 50 rd. and in excellent condition. The first one features a mainly orange surface with blue and white graphics proclaiming this as .22 Short Sta-Klean Kopper Kote with the top panel's lower portion exhibiting the company name and below it, the slogan "The World's Largest Store". The next one has the same design and color pattern but this one opens to reveal a right end flap with the code 90-CSR and a tray full of .22 LR Kopper Kote with some cartridges showing light verdigris. The last one has a mainly blue background to orange and white graphics that includes a wraparound stripe on the left and a top section indicating that this is 22 Short. Also included is the Sta-Klean logo and end flaps with "Lead Lubricated/No.330". The ammunition has clean lead tips and light tarnish on some cases. It should be emphasized that the condition of the last three boxes in this lot is outstanding with even the inspector's stamps on the inside flaps still crisp. Overall a tremendous sampling from the iconic American retailer. (76679-49BY)
3473. **LOT OF COLLECTIBLE AMMUNITION** This lot consists of two factory sealed 50 rd. two-piece boxes of .22 Short by The Clinton Cartridge Co. in excellent condition. The first one has the red background to green and white graphics including the company logo at the center and against a somewhat faded top panel that also includes "Lesmok Powder Cartridges". The side panels reiterate info provided on the top but in white and within a bold green box in the form of "22-Short-22/Rim Fire/Lesmok Powder/Cartridges". The second box, currently covered securely by clear shrink wrap displays essentially the same graphic design but with the colors inverted in that the one-piece wraparound label has a bold forest green backdrop to the red and white logo and the side panels have red boxes. The most notable difference is that this one reads "Smokeless Cartridges". Also noteworthy is the upper left corner is beginning to peel back, likely from storage as these boxes which feature thumb cutouts are very clean with virtually no wear. A great pair from the Chicago based company. (76679-49BZ)



3473

3474. **LOT OF COLLECTIBLE BOXES** This lot consists of four, one-piece 50 rd. size boxes beginning with a buff colored with black print that reads "50 Patronen/Zielmunition Kal. 5,6/"lang fur Buchsen"/faa/1943". This is representative of the Deutsche Waffen-und Munitionsfabriken A.-G., Karlsruhe, Germany factory. The box is mainly clean overall with some brown spotting on the bottom panel and the top has a tear that runs about halfway across. The box houses an excellent original tray with 14 apparently correct cartridges rating very good to excellent. Second is a full box with a white body and red text that includes ".22 Blanks/For Use With The/Webley/Target Launcher/Webley & Scott LTD., Park Lane/Handsworth, Birmingham 21, England". The box is excellent from a structural standpoint but the white body allows the bottom area's tan discoloration, likely from liquid and handling, to stand out. The enclosed original rds. rate excellent. Next are two empty examples from CCI, a Dart 22 Short in white, blue and red with green "HP", with tray and mild wear and a High Velocity Blazer .22 LR in white with red and black accents and some moderate brown staining. The 0022 code box includes the plastic tray. A diversified and interesting lot overall. (76679-49CA)

3475. **LOT OF COLLECTIBLE BOXES** This is a lot of two 50 rd. size boxes of .32 blank cartridges beginning with an empty example from Union Cap and Chemical Co. This is a buff colored box with black print that includes the Maltese Cross logo on the top panel and also above it "50 Rim Fire .32" and below it is "Short/Blank Cartridges" with the manufactured by info at the bottom, including "East Alton, Ill.". Also included from the text are side panels with "The Loudest Yet" on this fully intact and structurally strong box showing only very light wear and some mild to moderate dark splattered staining in isolated areas. The second box is also buff but more of a tan than the more off white one described above, and also with strong black print. This one is by The U.S. Cartridge Co. with the Lowell, Mass. address with a top panel upper section that reads "50 (trademark circular logo) .32/Blank Cartridges". All of the four side panels consist of ".32 Blank" in large font and the bottom has a large circular company logo. The box shows a small separation at the bottom left and a top inner flap is half separated but is otherwise quite sound and currently houses what appears to be very close to the original 50 rds. Additionally the box has a fairly dark stain from liquid or grease on the bottom that extends to one side. A rare combination of boxes in very acceptable condition. (76679-49CB)



3475

3476. **LOT OF COLLECTIBLE BOXES** This is a lot of two full 50 rd. size boxes of .32 blank cartridges beginning with one from Remington UMC with the R139 code which features a bold red stripe pattern with blue text over a buff colored or possibly faded white box. The front panel features the red dot logo between "50" and ".32"/Blank/Cartridges/Rim Fire". Also interesting is the back panel which reads "Bevel Crimped Blanks/Extra Loud Report". The second box is by Peters and is about the same shade of off-white and also has excellent sharp text including the main panel that identifies it in red print with "50 (P.C.C. trademark logo) .32 Cal./Rim Fire/Extra Loud/Blank Cartridges./Peters Cartridge Co./Cincinnati, O., U. S. A.". The back panel reads "Extra Loud/Blank Cartridges./Unexcelled.". Each box is clean with sharp edges and rates excellent, though the Peters has a scuff on the bottom that has obliterated some text. The cartridges are bright overall with some tarnish forming on a few. A nice pair of items sure to please the discerning collector. (76679-49CC)



3476

3477. **LOT OF COLLECTIBLE BOXES** This lot consists of three 50 rd. size, two-piece boxes by Peters beginning with a full one of .38 Cal. Short with red labels including a top one with the image of the cartridge at the center and the trademark logos on either side. The box and labels are fully intact with mild wear and scuffing and the ammunition rates good to very good with oxidized tips and mild tarnish. The second box has a light green top label and a code of 776 for .32 Long R.F. shot cartridges. Also included is "Loaded with (image of cartridge with .32 Shot within it) Chilled Shot.". The bottom is a possible mismatch and has a red side label with the correct caliber depicted on the sides and a small puncture hole for a rating of good to very good. The last box rates about good with damage to each of the three components to this faded red .32 cal. short box. (76679-49CD)

3478. **LOT OF COLLECTIBLE AMMUNITION** This lot consists of three two-piece 50 rd. size boxes by Peters beginning with a factory sealed one for .25 Cal. Stevens with fully intact red labels including a slightly faded red top with the picture of the cartridge at the center between "Swaged" and "Bullets." Included on the bold red side label is a front section explaining that it is adapted to .25 Stevens rifles. The box rates about very good with mild wear and some dark staining, mainly towards the bottom, from contact with liquid. The second box is coded 35A and is for .32 Long R.F. Shot and rates about very good with thumb cutouts and a fully intact but discolored label. Included are three correct cartridges. The third box rates good with missing side panels and a darkened red patina to the label indicating that it is .38 cal. long. (76679-49CE)

3479. **LOT OF COLLECTIBLE AMMUNITION** This is a lot of two Peters 50 rd. size boxes beginning with a two-piece for .32 Short R.F. Semi Smokeless with the mainly green top label with red border and yellow accents. The 1156 coded label is fully intact and features a perforated coded surcharge and the matching color scheme side label is 90% intact. The bottom panel has a retailer surcharge stamp by "Eugene Gun Store". Overall the box rates near excellent with only light wear and enclosed are about 43 correct and very good cartridges. The second box is a one-piece coded 2502 and features the blue, yellow, red and white color combination with the top and side panels stating that this is 25 Short Stevens lubricated lead bullet. It contains what appears to be 49 rds. of clean and original cartridges in a tray separating on one end. A nice and not so common pairing for the Peters collector. (76679-49CF)

3480. **COLLECTIBLE AMMUNITION BOXES** This is a lot of two 50 rd. size two-piece boxes by Peters beginning with an 865 coded example of .45 Auto. Colt Smokeless C.F. The faded orange top label has the exaggerated P and within it the image of the cartridge. The side label is less faded and both show areas that have scuffed away. The box in general rates good plus to very good with a puncture to the lid which shows glue repairs, moderate edge wear and some splitting. The bottom section has an inner wall that has separated but it contains 14 rds. of excellent condition and correct ammunition. The second box is in better structural condition with no repairs or splitting to the exterior. The green bordered top label, coded 909, is nearly fully intact and indicates that this is .44-40 Semi-Smokeless and features graphics as described in the example above. The empty box has an inner wall showing creasing and a small split at the right rear. The top and bottom panels have ink and pencil markings bringing this rating to perhaps near very good. (76679-49CG)

3481. **LOT OF COLLECTIBLE AMMUNITION** This is a lot of two Winchester two-piece boxes for .32 short beginning with one with an olive green top label that is fully intact and exhibits the cartridge image with the head stamp with "H" visible and within the case is ".32 Short". To its right is ".32 Caliber" and below is "Rifle Cartridges". The 90% intact red side label has a front section with the patent date and a penciled in note, the back and sides provide the caliber. The bottom label is fully intact and the panel has some additional pencil markings. The empty box is still sealed at the back and overall rates near very good with foxing and light soiling. The second box is in better condition with the bright green top label still quite bold with virtually no foxing or wear. This version differs from the one described above in that the image does not show the head stamp and reads simply "Short" within the picture. To its right is "No. 32" and below is "Metallic Cartridges". The orange side label is fully intact with a small spot of creasing and the front and rear markings inverted from that of the above. The box houses the full 50 original cartridges with oxidized tips and darkened casings. A near excellent condition box overall with light wear and a small spot of a hardened gray substance at the lower left of the lid. (76679-49CF)
3482. **LOT OF COLLECTIBLE AMMUNITION** This is a lot of two Winchester two-piece boxes beginning with a .30 Long with a darkened turquoise top label with the cartridge image top center without the head stamp showing and with "Long" enclosed. Beside it is "No. 30." and below is "Metallic Cartridges". The label is about 97% intact with light scuffing. The side label is in a much lesser state as the lid portion retains most of a cellophane tape covering and the bottom is about 15% present and there is no text present. The lid shows a glue repair and the box currently holds what appears to be 49 correct rds. with a white coating over the lead, and darkened cases. The box shows edge wear and ingrained dirt bringing the overall rating to near very good. The second box rates about very good to excellent containing about 47 correct rds. of .25 Stevens with clean tips and casings showing an uneven light coating that has transferred from the noses. The box has a light green top label that is about 97% intact with loss due to a scuff just above the large image of the cartridge at the center. This is the version with the visible head stamp and to its left is the trademark info, and to its right is "11 Grs. Powder/65 Grs. Bullet." which shows a handwritten "6" over it in thin marker. The orange side label is nearly fully intact with an isolated area showing white staining and the lid has splits at both back corners. The bottom has areas of grease and grime stains, the box with scattered ingrained dirt. An interesting pair of nearly full vintage boxes for the Winchester collector to consider. (76679-13)
3483. **COLLECTIBLE AMMUNITION BOXES** This lot consists of two empty large caliber boxes beginning with a Winchester with a green top label with an upper section that reads "50 (image of cartridge with short displayed within) No.46/Metallic Cartridges". The lid side label is about 40% present and the bottom half of the box appears to be a mismatch and is split at three sides. The box rates good overall with a missing right lid panel and hand written notes on the bottom panels. The second box is by UMC and rates about good as well with a green top label with faded black print with a top line that reads "50 Metallic Cartridges .44-100", the lower portion has "Winchester Repeating Rifle". The lid has a concave profile with the center area scuffed away and a portion of the back missing and another split. Additionally there is moderate wear, foxing and soiling overall. (76679-12)
3484. **LOT OF COLLECTIBLE AMMUNITION** This is a lot of two Winchester boxes for .38 Win. beginning with one with a fully intact, faded olive green top label marked "3-19" at the bottom right, and also includes ".38 Winchester Cartridges/Center Fire (picture of cartridge and within it is ".38 Winchester") 180 Gr. Lead Bullets"/For Winchester Rifles Models 73 and 92". The side label is virtually fully intact with minor loss at the split and shows fading at the front lid. Enclosed are approximately 35 apparently original rounds with mostly clean tips, and tarnish forming on some of the metal. The overall rating is very good to excellent with light foxing and wear, the bottom panel with a penciled in number. The second box is empty and has the code 1-8 at the bottom of the faded red top label exhibiting a second line with ".38 Caliber W.C.F. Smokeless Cartridges" and a center with the cartridge image with ".38 Winchester Smokeless Soft Point" within it. To its left is the 1884 trademark info and to its right is "Smokeless Powder/180 Gr. Soft Point/Metal Patched Bullets.". Another variation from the box described above is "For Winchester Models 1873 and 1892 Repeating Rifles.". The side label, having retained very close to all of its original color is a considerably deeper red and is about 90% intact with a little additional peeling, the bottom label fully intact with a dark stain. The lid is still partially attached to the label at the front which also shows a split at the middle and another at the right that extends to the side. The box rates very good with some foxing and spots of grime on the top label, a slightly mis-shapen inner tray and evidence of contact with liquid at the bottom right rear. (76679-11)
3485. **COLLECTIBLE AMMUNITION BOXES** This lot consists of two empty two-piece Winchester boxes for 32 Long beginning with the older of the two with a light blue top label with a top line of "50 (image of cartridge without head stamp exposed but with "Long" on case) No.32/Rifle Cartridges". The orange side label is fully intact with the front still sealed. The box rates very good to excellent with mild edge wear, foxing and a couple of penciled in notes. The second box, coded K3221R features thumb cutouts and has a red wraparound label with a faded top that includes the trademark company name top center, and below it "32 Long" and below that the image of the cartridge with the H head stamp exposed. The box rates excellent and is still sealed at the left and overall has only very light wear and soiling. (76679-2)
3486. **LOT OF COLLECTIBLE AMMUNITION** This is an opened full 50 rd. box of Western .41 Short with a light green top label that has "50" at each upper corner and between them in a rounded layout is "Rim Fire Cartridges". Below that is ".41 Cal. Nublend Powder (Red Diamond middle company logo) Short 130 Gr. Bullet" and below that is the company name and location and at the far lower right resides in small font "W.B. 20-60". The maroon-colored side label is about 95% intact with loss at the seal. The lid has splits at each corner and the box overall has very few blemishes or wear marks. The original 50 rds. are mainly clean with a little tarnish bringing the overall rating to near excellent to excellent. A very collectible and rare item. (76679-5)
3487. **LOT OF COLLECTIBLE AMMUNITION** This is a lot of four 50 rd. size boxes for .22 blanks from different manufacturers beginning with a two-piece manufactured at the Kynoch Factories of Imperial Chemical Industries Limited in England. The box has a faded white wraparound label that is still sealed at the back and indicating that it once held long blanks. It rates excellent with bold red and black print. The other three are one-piece and apparently full of their respective short blanks. First is a U.S. Cartridge Co., from the era of blue, orange and white graphics with the Lowell address. Next is a Western buff colored box with red and blue print and a scuff at the upper right front panel. Last is a buff tone one by UMC with black print with a front that reads "Bevel Crimped Blanks/Extra Loud Report". (76679-4A)
3488. **COLLECTIBLE AMMUNITION BOX** This is a scarce two-piece box for Kynoch .41 Swiss. The buff colored box has a white label with a top section that reads in bold black print "20/.41 Smokeless Cartridges/For Swiss Vetterli Rifle, information that is repeated on the front panel which also adds the company name and location. This example is missing that part of the label that extends to the bottom compartment where the Kynoch name was originally depicted. Also missing is the right panel portion of the label, the left, 90% intact and reads "20/Cartridges/.41/Smokeless. The lid shows a split and tape residue at the back right corner. The bottom is fully intact and retains its original 20 compartment cartridge holder which rates excellent. The surfaces exhibit a mottled tan patina with some evidence of contact with liquid and a small three digit number written in pencil on the lid top. Overall a desirable item in about near very good condition. (76679-6A)



3489. **COLLECTIBLE AMMUNITION BOX** This is a scarce two-piece empty box by Remington UMC for .41 Swiss Blank. This has matching light blue labels including a top one coded 325 and an upper section of the top portion that reads “.41 Swiss (Vetterli Rifle) Blank/20 Rim Fire Cartridges” and the front exhibits the red dot logo, “Blank Cartridges” within a box and “For Swiss Vetterli and Other Rifles”. The bottom has UMC and Remington logos on either side of the guarantee and the right side includes a handwritten number on the lid portion, the left is somewhat scuffed. The labels overall are about 97% intact and show nice colors and some contact marks. The inner separator tray rates excellent bringing the overall condition to near excellent. (76679-6B)
3490. **LOT OF COLLECTIBLE AMMUNITION** This is a full 50 rd. two-piece UMC box with a darkened blue label with a top section that reads “50 .41 Cal., Short/Rim-Fire Cartridges/Swaged (picture of cartridge with U head stamp emphasized and .41 Short within it) Bullets. Below that are the trademark logos at either side, and the company name in curved format below that. This version has the red side label, of which about 65% remains, and a large fully intact guarantee label on the bottom. The top label is fully intact as well showing an applied varnish that extends to the edges which show glue repairs at three corners. This box features the plaid “wall-paper” that shows mild wear and discoloration in areas and the onset of splits. The box houses 42 correct rds. rating near very good and eight additional cartridges with V head stamps and rating excellent. (76679-5A)
3491. **COLLECTIBLE AMMUNITION BOXES** This lot consists of two UMC boxes that are square shaped beginning with one with a faded orange label with the old UMC logo at the upper left and to its right is “20 Cartridges./Rimfire./For/58 Calibre Musket.”. The lower half of the label consists of “Union Metallic Cartridge Co./Bridgeport, Conn., U.S.A./Under Smith & Wesson’s Patent, April 17th, 1860”. The label is separating from the surface and exhibits rigid texture resulting from an applied coating. The two-piece buff box is fully intact, with an uneven alignment, wrinkling and creasing likely as a result of contact with some liquid. The inner wall is still attached and the box rates about very good with some scattered soiling and not much wear. A real survivor. The second box is another two-piece, this one with a green top label presented in a diamond shape and reads “25/(oval U.M.C. trademark logo)/Primed/Metallic Cartridges/For/Sporting (image of cartridge with .56-46 Spencer Sporting within it) Rifle/(manufacturer’s info)”. The matching color side label is about 50% present and includes a complete panel that features the oval logo above “56-46 Spencer/Sporting.” And two other panels include the cartridge image. The bottom guarantee label is fully intact with four strips of tape applied. The box is missing a lid panel and the bottom has tape across the perimeter. This is an about good to very good condition item with much staining to the top label. (76679-10)
3492. **COLLECTIBLE AMMUNITION BOXES** This is a lot of four 50 rd. size UMC boxes beginning with a one-piece with maroon backdrop to black and gold graphics including a top panel that reads “.32 Long R. F.” as the top line and also includes The Remington UMC red dot, the cartridge image and “Shot” presented diagonally on the right side. This 142-S coded box has both the Remington Arms and UMC Bridgeport Works names and is missing both end flaps, shows mild edge wear and contains six correct rds. The other three are two-piece beginning with a code 141 with light blue labels and a bright red dot logo to the left of “32 Extra Short R.F.”, the cartridge picture and “54 Grs. Bullet”. This is from the period when the company name read “The Remington Arms Union Metallic Cartridge Company Inc.” as depicted on this one in semi-curve layout. The side label is about 80% intact with aftermarket labels applied at each side and the guarantee label makes up the bottom. The box shows scattered mild staining and wear. The next one has the plaid body and tan labels informing that this is 32 Cal., LR. The top label includes the image with the caliber and the U logos at each side. The inner tray holds seven very good correct cartridges and has separated at the seam. The edges show mild to moderate wear and the box has an overall uneven brownish patina. The last box has an even darker appearance, enough to cause the text to be difficult to discern. This box, like the last one described, has the rounded corners and this one is of a configuration suitable for .32 Short R.F. as depicted on the top label exhibiting the aforementioned discoloration and wear. The empty box has a small puncture in the lid bringing the overall condition of this lot to about near very good. This is an interesting sampling representative of different eras. (76679-2)
3493. **COLLECTIBLE AMMUNITION BOXES** This is a lot of three empty UMC two-piece picture boxes starting with one with an orange top label that is about 96% intact with loss at the lower right corner and includes “50 No. 2 Pistol Cartridges.” and “.32 Calibre. Short.” above the picture of the revolver and beside the company logo. The lid has three split corners and the box rates very good with edge wear and portions of the side label missing. The second one is in a lesser state of condition as the lid is missing the rear and right panels but it does exhibit an excellent turquoise top label with an upper section that has “50 Metallic Cartridges. With Swaged Bullets. 30 Calibre. For XXX Standard Revolver, and other Pistols of this Calibre.” This information is laid out around the large picture of the gun serving as the main focal point. The bottom is a possible mismatch and is fully intact with a note written in ink on the bottom and some moderate scuffing on the sides. The last box rates near very good with a bright green top label with “100 No. 1./Pistol Cartridges.” Also included is a large picture of the revolver, the company logo and “22/100”. This version, like the ones above, has the plaid design and this .22 box has the orange side label with the caliber depicted on the right side. This is a near very good example with small portions of the rear lid missing, split rear lid corners and tape residue at each of its corners. A nice combination of three, not typically easily obtained picture boxes available by way of one successful bid. (76679-2A)
3494. **LOT OF COLLECTIBLE AMMUNITION** This lot consists of two UMC two-piece 50 rd. size boxes with the rounded corners beginning with a factory sealed example with tan labels and red print including a top one that includes “.25 Automatic Colt Pistol/50 Central Fire Cartridges/(the UMC red dot logo) (image of cartridge with head stamp and caliber depicted) Smokeless 50 Grs. Bullet Metal Cased/Manufactured by/The Union Metallic Cartridge Co.” The sealed side label has a few scuffs, as does the bottom guarantee label, and the top label has a large two letter ink marking at its center. The second box is empty and has lime green labels including a top one that includes “.25 Stevens R.F.”, separate UMC and Remington logos on either side of the cartridge image and the company information as follows “Remington Arms Union Metallic Cartridge Co. (in curved layout)/Ammunition & Firearms/Union Metallic Cartridge Works/Bridgeport, Conn., U.S.A.”. The label has some faded handwritten numbers at the center. The side label is about 70% present and the fully intact bottom label bears the 4-B code. The box is structurally sound and shows light edge wear. Overall a very good lot for the UMC or Remington collector. (76679-4B)
3495. **COLLECTIBLE AMMUNITION BOXES** This is a lot of four 50 rd. size Remington .22 boxes including the first two that are two-piece with the rounded corners and from the period of the association with UMC beginning with one for .22 Automatic Rifle. It has labels with the lime green, red, and black color scheme with trademark logos displayed prominently including a top one with the image of the cartridge with a gold colored casing and a gray nose. The nearly fully intact end caps include “Winchester 1903” and the bottom label, also fully present bears the code 7-A and includes the dual language guarantee. The box exhibits light wear and soiling, a top label with scuffs that have obscured some text and enclosed are approximately 47 excellent and correct cartridges. The second box is .22 Remington Autoloading HP Bullet and exhibits an overall tan patina including fully intact labels. The front panel has perfectly aligned top and bottom seams allowing for an impressive picture of the Remington Autoloading Rifle and the bottom label exhibits a surface with nearly entirely worn text. Overall, the 27-O coded box shows much less wear and this near excellent condition example includes one correct cartridge. The last two boxes are one-piece Kleanbores with the red and white over green color schemes including a .22 Short coded RIOL with the dog bone style Remington UMC logo and rating good to very good with a missing right flap. The other one is a .22 LR Hi-Skor coded R-21H, rating very good with all panels present with creasing and light soiling. A diversified combination for the .22 or Remington collector. (76679-5B)

3496. **COLLECTIBLE AMMUNITION BOX** This is a two-piece UMC box with a royal blue top label that reads "Primed Metallic Ammunition, /50 No. 41/ Breech-Loading Derringers, /And other Pistols of this Calibre, /With Swaged Bullets," above the manufacturer name and location. Also included is a bottom line of "Under Smith & Wesson's Patent, April 17, 1860." This version has the orange side label over the plaid pattern wallpaper and consists of a right side that consists of simply "41" and a back with the warranty/guarantee statement with the balance of the nearly fully intact label being plain. The lid shows glue repairs at each corner and along the length of the front and the bottom, on the left end. Also noteworthy on this scarce box is that the top label is missing a couple of small sections and shows the onset of a small split near the center and the edges show mild wear. Enclosed are approximately 20 very good correct caliber cartridges with no head stamps and mildly oxidized tips. Also included is a loose label that reads "Primed Metallic Ammunition/50 Cartridges./41-100 Long," with the name and location below it, and below that is the S&W patent date, but as opposed to the April 17 date, this one reads "April 16, 1860". The tape-repaired tan label has stains and soiling and a small section missing at the upper left corner. (76679-6C)



3496

3497. **LOT OF COLLECTIBLE AMMUNITION** This lot consists of four full 50 rd. boxes of Remington .22 cal. with the traditional dark green, red and white colors including two with top panels featuring the Remington UMC dog bone style logo. The first of these is coded R31 and the upper top panel reads ".22 Automatic Rifle Rim Fire/Winchester Model 1903". Also notable on this box with light to mild edge wear is the bottom panel exhibiting English and Spanish guarantee statements. The last three boxes have clean crisp edges and rate excellent. The second "dog bone" box is coded R17L for .22 LR Lubricated Bullets. The next example is Kleanbore Hi-Speed .22 LR with The Remington and Dupont logos and coded R23 and the last box has an identical layout but is .22 Short and is coded R11. The ammunition enclosed in this lot rates excellent as well. (76679-5D)
3498. **COLLECTIBLE AMMUNITION BOXES** This lot consists of five Remington Kleanbore, one-piece .22 cal., 50 rd. size boxes with the dark green, red and white graphics beginning with an R24B coded example with a top panel featuring the Remington UMC dog bone style logo and a top line that reads ".22 Long Shot Rim Fire". The box is missing most of the left end flap and exhibits mild edge wear and overall soiling. Enclosed is one correct cartridge with moderate tarnish. The second box, like the balance of this lot, features the Remington red dot and the Dupont red oval logos. This empty example, coded R20 is missing its entire left end flap and has less wear and soiling than that of the above described and has a top panel that includes "Hi-Speed/.22 Klay Bird/For Miniature Trap & Skeet Shooting". The next three rate excellent overall with crisp edges beginning with an empty 6122 code box for Standard Velocity LR. Next is a 6322 code Police Targetmaster .22 LR Lubricated with four excellent rds. enclosed. The last one is a full R23 code for Hi-Speed LR HP that is virtually blemish free but has a front panel that has become unglued and excellent and clean cartridges. (76679-5E)
3499. **COLLECTIBLE AMMUNITION BOX** This is the outer brick box for Remington Kleanbore Hi-Speed .22 Short coded R11 and includes the Remington and Dupont logos amongst the red and white graphics over the deep green backdrop. The box has some fading, mainly of the white areas, some scattered mild edge and corner wear, a right end with the inner flaps showing small tears and a slightly pushed in profile with creasing evident on the back panel. Included is a full and excellent 50 rd. size box also coded R11 from this brick. An uncommon find for the Remington or .22 collector. (76679-5F)
3500. **LOT OF COLLECTIBLE AMMUNITION** This lot consists of a full 500 rd. size brick coded 1054 NS of Remington-UMC .22 LR NRA Target Lesmok Powder Cartridges. The buff colored brick houses ten excellent condition 50 rd. boxes coded 54-N.S. with the orange backdrop to black and white text and the red dot logo. The ammunition has oxidation forming on the tips that has transferred to the metal causing mild tarnish. The outer box is somewhat brittle with mild edge wear, a separated inner right end flap, some seam splitting, light liquid stains and soiling. The graphics remain strong and include a top panel with the Remington UMC red dot logo as its centerpiece. Also noteworthy is that this is a picture box, with the back panel including "These Cartridges are specially recommended for use in Remington NRA Target Rifle." with a picture of the rifle displayed prominently in an angular layout. Also included is the address section with both "Remington Arms Company, Inc. (in a rounded presentation)" and the "UMC Bridgeport Works" names. A not frequently encountered package by the famous maker. (76679-5G)
3501. **LOT OF COLLECTIBLE AMMUNITION** This is a lot of three 50 rd. size boxes for .22 cal by Canadian Industries Limited including the first two being full Whiz-Bang High Velocity examples that open by way of the top flap and feature dark orange, yellow and black graphics with the cartridge image on the left of the flap and the C-I-L oval logo at the center. The first of these is coded RF 23 and is for 22 LR with the box rating near excellent with overall strong graphics and edges, light dirt spots and the bottom flap beginning to split at each end. The second box, like the first exhibits "Whiz-Bang" at the upper right, "Dry Lubricated" bottom right and the caliber, in this case 22 Short, at the lower left. This RF-11 box rates excellent with just a small wear mark at the top front crease and extremely faint scattered soiling. The last box has a top line that includes "Bisley" in large font and below we are informed that this is Intermediate Velocity 22 LR Greased. The RF-37 coded box exhibits more of a red tone to accompany the yellow and black graphics that also include the cartridge picture at the left and the oval logo at the center. This box is in a slightly lesser state of condition, showing that it has been handled a bit, with light wear marks and only one cartridge has been removed. The remaining 49 cartridges like those of the full boxes rate excellent. (76679-5H)
3502. **COLLECTIBLE AMMUNITION BOXES** This lot consists of five one-piece .22 cal boxes by Canadian Industries Limited. These are Whiz Bang boxes that open by way of the top flap including the first two from the period when the Dominion name was mentioned in the lower blue section of the top panel on these boxes which also include red-orange, yellow and white graphics. The first one has a top blue section that consists of ".22 Long Mushroom "Super Clean"" and a middle section that includes the cartridge image in a horizontal position. The box has a separated but present right inner flap and houses about 45 rds. of original cartridges. The second box houses 49 rds. of the .22 Short "Super-Clean" as depicted on the upper section of this offering, which has identical configuration to the one described above. The other three boxes are from the period when the company information was on the bottom and the name did not include anything but "Canadian Industries Limited". The graphics include the colors red-orange, yellow and white with vertical positioning of the cartridge picture at the top panel's right side and are composed of gold and gray colors. These are all high velocity, with the first one being simply "22 Long", coded RF-21 and currently holding two rds. The next one is an RF-25 with "22 Long Rifle Shot" provided for identification and the last one, "22 Short Mushroom" is coded RF-12. Unless otherwise mentioned the boxes in this lot are fully intact and like their ammunition rate excellent. (76679-5I)

3503. **LOT OF COLLECTIBLE AMMUNITION** This is a lot of two boxes by Dominion Cartridge Co. with the first of this duo of opened two-piece 50 rd. boxes having a faded red top label that reads "50 (image of cartridge at an angle to emphasize the D head stamp with .38 Short within it and Dominion immediately below it) .38/Metallic Cartridges/The Primed Shells Are Manufactured By (in small font)/Dominion Cartridge Co., Ltd./Montreal, Canada.". The side label is still a bold cranberry red and reads ".38 Short/R. F." on each panel. Both labels are nearly entirely present but the top one shows moderate scattered scuffing and the lid has a tape-repaired rear left corner and a split front one. The bottom panel has a large penciled in note and enclosed are the full and original 50 cartridges with oxidized tips that has transferred to the metal. Clearly an uncommon item to hit the market. The next item appears to contain 48 original rds. and is also a scarce item, a .32 Long Cal. buff colored box with a virtually fully intact brown top label with gold print and configured similar to the one described above but also includes the trademark logo at the bottom left. The sides feature red text with the front and rear panels announcing the company name, while the right and left bear ".32/ Long R.F./Shot. The box is delicate, split at the lengths of the lid and bottom and there is another split at the upper rear left corner. The ammunition has darkened and rates very good. (76679-2A)
3504. **COLLECTIBLE AMMUNITION BOXES** This lot consists of four boxes by Dominion/CIL including the first two of these 50 rd. size two-piece examples that were produced during the period of when the manufacturer was named Dominion Cartridge Co. Limited, as depicted on the wraparound labels on these, including one that has red and gray horizontal sections that run across the top panel. This one also has a red upper section that indicates that it is .22 LR and is "Smokeless Powder" and the sides are gray with red text including the right which is mostly missing. The emerald green colored box has a moderately soiled lid with all corners split and the bottom houses the original full 50 cartridges rating very good. The other Dominion has a fully intact red and white label indicating that it is 32 Long Black Powder and like all of the boxes in this lot contains a top middle section with the company logo and the "Adapted to" statement. The label and buff colored empty box have mild soiling and a couple of white stains. The other two boxes have red and yellow wraparound labels that include lower top panels with "Made in Canada By/Canadian Industries Limited/Dominion Ammunition Division" The first of these has a fully present label declaring that it is 22 Long Shot Super Clean of which it contains the full 50 rds. rating near very good with tarnish. The box, like all in this lot, features thumb cutouts and this one has light dirt and wear and some peeling at the right side label. The second of these is in a lesser state of condition with overall moderate soiling and uneven label surfaces with the left side missing on this 32 Long Lesmok box. A convenient lot to obtain both .22 and .32 boxes from different eras of the Montreal maker(s). (76679-2B)
3505. **LOT OF COLLECTIBLE AMMUNITION** This is a full 500 rd. size brick of CIL Imperial 22 LR High Velocity Mushroom. The RF-563 coded outer box features yellow and black graphics and shows only light wear and soiling and a small split on the left flap of the top opening panel. The excellent condition ammunition comes in plastic trays within the brick fresh RF-63 coded gold embossed boxes that feature red, black and white print and the picture of the cartridge in a vertical position on the right top panel. A not often encountered full brick, especially in this state of condition. (76679-4C)
3506. **COLLECTIBLE AMMUNITION BOXES** This is a lot of five .22 boxes from three different manufacturers beginning with a two-piece by Clinton, a .22 short box with a faded red top section to the fully intact and well-worn wrap-around label. Also noteworthy on this empty box with thumb cutouts is the green portions of the label, including the company logo front and center, have retained a bold appearance and the fully intact buff colored box has only light soiling and wear. The other four boxes are one-piece with trays including two by Sears beginning with an empty .22 Short Sta-Klean Kopper Kote No. 316, rating excellent with the dark blue background to orange and white graphics (reminiscent of U.S. Cartridge). The other is .22 LR Shot Sta-Klean Kopper Kote coded 90 SR with an orange background to blue and white, showing mild edge wear, a lower right top panel beginning to peel back and currently housing six cartridges with no discernable head stamps. The last two are by Montgomery Ward beginning with a fully intact and empty 60-905 with a red background to black and white text identifying this as .22 LR Long Range showing bold color and only light wear. The other one features a finger cutout at the top right panel, a slide out tray design, free of end flaps and a green background to black and white print informing that this is .22 LR Lesmok. Enclosed are two correct sample cartridges. Overall a very good to near excellent and interesting lot. (76679-5J)
3507. **LOT OF COLLECTIBLE AMMUNITION** This lot consists of four .22 cal. one-piece boxes by Peters beginning with a Dewar Match 22 LR No.2296 with gold, black and white graphics including a top panel where the gold has faded to silver in areas. The box currently houses a perfectly fitting wood support box. The last three are of the silver, black and white design pattern with the first being No. 2283, a .22 LR High Velocity Rustless, currently housing about 15 mixed rds. of the caliber. Next is a No. 2270, for High Velocity Filmkote .22 Long HP housing the full and excellent 50 rds. The last one is also a full 50 rd. box., No. 2267, also with excellent ammunition, this being High Velocity Filmkote .22 Short. Overall this is an excellent condition representation of .22 Peters for the period. (76679-5K)
3508. **COLLECTIBLE AMMUNITION BOXES** This lot consists of six one-piece Peters boxes beginning with an apparently full 100 rd. box of excellent .22 Cal. Smokeless C.B. Caps in a pink box with a top panel that has faded to white. The box has crisp graphics and edges and has a split at the bottom left panel. In addition there are two empty boxes as described above except one has a minor liquid stain at the lower front panel and the other a more pronounced and larger stain extending from that panel to the ends. These are housed in their original 500 rd. outer, a buff colored box with black print and top and bottom panels that read "Peters Smokeless"/(P trademark logo)/C.B. Caps/ (company info.). The front and rear panels include "500 in Package. 100 in Each Box." and "Sure Fire and Accurate. For Gallery and Target Practice in .22-Caliber". Next is another empty 100 rd. size box for 22 cal. B.B. Caps, but this one from the era of yellow, red, blue and white print, this one a No. 2212 rating excellent with a front panel that includes "Rustless" in the red stripe. The next one is also empty with the same colors, this one larger and for 38 Smith & Wesson blank. The box has a little fading on one panel, some light corner wear and the text includes "Extra Loud Report". Also evident is some creasing and a missing inner top flap. Something unusual for the Peters or box collector. (76679-5L)
3509. **LOT OF COLLECTIBLE AMMUNITION** This is a brick consisting of 500 rds of Winchester .22 C.B. Caps contained in five 100 rd. size boxes. The outer box, coded K 2006 R, is buff colored with blue and red text that includes the trademark Winchester name logo as well as "Staynless" alongside the big bold W logo. The box shows a slightly inconsistent faded appearance with a couple of splits on the top flaps and a somewhat brittle texture in areas. The inner boxes feature the red, blue and yellow graphics including matching product code. The box packed at the top exhibits foxing or contact with liquid on the top panel but the balance of the contents including the cartridges rates excellent. A nice find as it is a complete brick with the right condition contents. (76679-5M)
3510. **LOT OF COLLECTIBLE AMMUNITION** This is a full 500 rd. size brick with a front panel that consists of the Winchester trademark name logo at the top and below it is "Boy Scouts of America/22 Long Rifle Rimfire/75th Anniversary/Commemorative Ammunition". The box appears as new and was under shrink wrap and appeared to have never been opened until the time of this inspection, however upon opening, the left inner flap shows the number 118 handwritten in pencil. The contents rate as-new as well, with the ten 50 rd. size boxes exhibiting the illustration of the young boy scout shooting a lever action rifle, a scene incorporated into a greater Boy Scout themed collage that makes up the front panel of the outer box. A great find in premium condition. (76679-5N)



3511. **LOT OF COLLECTIBLE AMMUNITION** This is a factory sealed two-piece .22 cal. Winchester box with fully intact green labels including a top one that has a top line with "50 (image of cartridge with H head stamp and Short on case) No.22"/Rifle Cartridges". Also included are the H trademark and Stetson's Oct. 31, 1871 Patent logos. The panels exhibit various levels of faded green labels with strong black print on each, including a front panel that reads ".22 Cal. Short, 1/2/Target Cartridges/Winchester Make". Each side reads ".22 Cal./Short, 1/2" and the back consists of the guarantee. The box rates excellent with a light blemish on the front panel far left and the beginning of a split on the right side label. A nice clean and crisp example for the Winchester or .22 box collector. (76679-5P)



3511

3512. **LOT OF COLLECTIBLE AMMUNITION** This is a lot of two of the early Winchester one-piece boxes for .22 cal. with the dark blue background to horizontally-arranged graphics in red, white and blue. The first of these 50 rd. size offerings is .22 Auto Kopperklad Bullet in a fully intact outer that has a penciled in "1931" on the lower top panel and "Du 1931" on the bottom. The box also exhibits a scuff on the left side of the front panel and rates near excellent as does the approximately 45 rds. of correct cartridges included. The second box contains 49 rds. of a combination of correct 22 LR Staynless cartridges with most being clean and excellent and the balance near very good with mild oxidation. The box has separated but present end flaps and overall there is light fading and wear showing, bringing the condition to about very good. These boxes feature the Winchester name trademark logo at the top and also include the image with H head stamp at the center and the W logo at the lower left. A nice pair of vintage Winchester. (76679-5Q)

3513. **LOT OF COLLECTIBLE AMMUNITION** This is a lot of two opened two-piece 50 rd. boxes of .22 Winchester Rim Fire. The first of these boxes by Winchester has an olive green top label coded 9 and 3-20 and includes the company name logo top center, the image at the immediate center and below it is "Lesmok Rifle Cartridges". The front panel consists of the guarantee and the rear includes "For Winchester Model 90 Rifle" and the codes 144 and 4-20. Each side includes the big bold W in orange and "Model 90" and the box is full of excellent original cartridges with clean tips. The labels are essentially intact with mild fading and wear. The second box is a slightly different variation for the same caliber. This one has a brown top label coded 9 and 10-15 with slightly different font of the same text to the label described above. The front guarantee label includes 144 and 9-15 and the back differs in font and that it reads "Model 1890" as opposed to simply "90" as mentioned above. This box is in a somewhat lesser state of condition as it has splits at the right lid corners, more pronounced scuffing and a small portion missing at the upper right top label. This box contains 49 very good and correct cartridges. A couple of nice period examples of the same caliber. (76679-5R)

3514. **LOT OF COLLECTIBLE AMMUNITION** This is a full 500 rd. brick by Western with an off-white outer box with red and blue print including that on the top which includes the company trademark name logo and below it is "Super-Match Mark II/22 Long Rifle Cartridges/40 Grain Lead Greased Bullet". This outer box, stamped "WCC6171", has some separation of the right end flap but is otherwise intact with mild edge wear, a few scattered light scuffs and some ingrained dirt. The enclosed ten 50 rd. size one-piece boxes rate excellent as does the ammunition contained within. They exhibit bold blue, yellow and white graphics, crisp edges and like the outer box, the code K1267R. A not too common package for the .22 box collector. (76679-5S)

3515. **LOT OF COLLECTIBLE AMMUNITION** This is a full 500 rd. brick by Remington UMC of .22 Long Rifle Lesmok Powder, as depicted on the end flaps, which include white surcharge labels that read "Indoor Target/For Use Only In Single Shot Rifles". This buff colored outer is somewhat brittle with some splits occurring along with mild wear and soiling. This is a picture box with the back panel exhibiting "These Cartridges are specially recommended for Remington-UMC Repeating Rifles" and the image of the rifle displayed between the company logos. The front panel includes the Remington name exhibited in its curved layout above "UMC Bridgeport Works". The ten 50 rd. size boxes contained within are of two-piece construction with all remaining factory sealed by way of the still bright orange side label which also contains the image of the repeater rifle, in this case on the front panels. Each of the smaller boxes also includes on their top panels, the same white surcharge labels except these show no fading or wear and have bold black print. Also noteworthy is the code 20 depicted on the lower right of the rear panels. These boxes rate excellent with a few showing some scattered dark spotting. This is a great find for the .22 box or Remington UMC collector. (76679-5T)

3516. **COLLECTIBLE AMMUNITION BOXES** This lot consists of three two-piece, square style boxes by UMC beginning with one with teal-blue labels including a top one with an upper section that reads "25 .56-56 Spencer". This example, like the other two in this lot, exhibits a large image of the cartridge at the center with the caliber depicted within it, and above it in large font is "Rim-Fire Cartridges", below is the trademark U logo on either side and below that is the company name and location. Included on this box is a maroon surcharge label that informs that in this case the box was actually packed with blanks, of which one sample is enclosed. The box is fully intact with a small puncture at the lower top panel, portions of the side label missing, mild soiling but nice edges overall. The second has labels of different shades of green, perhaps as a result of fading to the top light green label, stating that this is .56-46 and the nearly fully intact emerald green side label has bold black print. This box, like the one above, also retains a nice salmon colored bottom panel guarantee label. The last box is .56-52 Spencer and is in a lesser state of condition with two side panels missing from the lid and another showing a glue repair and a possibly mismatched lower section with an upside-down sealing label, a missing bottom label, a punctured and split inner wall and indications of contact with liquid. Three, not usually very easily acquired, UMC items available in one lot. (76679-9)



3516

3517. **LOT OF COLLECTIBLE AMMUNITION** This is a factory sealed 50 rd. box of Remington UMC 9mm Caps with red labels that feature the image at the center, red dot logo above it and on either side of it is "Cartuchos/Cal. 9mm". Below that on one side is "Con Bala" and on the other "Com Bala" and below that is "Cartouches A Balle Cal 9mm". Each company name is depicted in the lower section. The front and rear panels read "Specially adapted for Cal 9mm Flober and other Rifles". The box rates excellent with light fading and wear to the top label and strong print throughout including the rubber stamp at the bottom. (76679-26)
3518. **LOT OF COLLECTIBLE BOXES.** This is a lot of three UMC items beginning with a factory sealed box of 250 No. 1 1/2 Brass Primers. It has a green wraparound label with a top section that also includes "For Pistol and Rifle Cartridges./Adapted to Black Powder." The label has some staining resulting from contact with liquid and has a pencil marking on the bottom. The box is excellent structurally. The other two items are empty two-piece boxes with the rounded corner design beginning with a small one with the black marble-like background to fully intact orange labels including a top one that reads "100 No.1/Bullet Breech Caps./For .22 Calibre /Pistols And Rifles." with the UMC info below. The box shows mild edge wear with corners reinforced with a light offering of glue and a name written in pencil on the interior lid. The last item has the plaid wallpaper style panels with maroon labels including an excellent top one with the UMC logos at each upper corner and between them is "Fifty .38 Cal./Rim Fire/Blank Cartridges./For Pistols". The lower portion contains the UMC name and location. The box rates near very good with much of the side label missing, mild edge wear and housing a second guarantee label. A diversified lot for the UMC aficionado. (76679-11A)
3519. **LOT OF COLLECTIBLE AMMUNITION** This lot consists of two boxes by UMC with the first of the two-piece offerings with the plaid walls having yellow labels including a top one that features the old UMC logo at each upper corner and between them is "50 Cartridges./30 Calibre—Long.". The lower half of the label consists of "Manufactured By The Union Metallic Cartridge Company./Bridgeport, Conn.". The lid has split corners on its left and a slightly uneven profile, likely from the liquid that left a stain over much of its surface. Otherwise the box has mild edge wear and houses about 40 cartridges with a light coating of white powder, having transferred to its cases. The other box has blue labels including a slightly faded top one with an upper section that reads "50 .30 Cal., Short/Rim-Fire Cartridges/Swaged (image of cartridge with U head stamp and .30 Short on case) Bullets". Below that is the U head stamp at each side and the company name and address. The side label is about 70% intact, the bottom 100% with mild scuffing. The box has nice edges and the typical areas of fading to tan. Enclosed are eight correct sample cartridges with a thorough coating of oxidation powder. (76679-13A)
3520. **LOT OF COLLECTIBLE AMMUNITION** This is a lot of two picture boxes by UMC starting with a .32 Short that has the rounded corners and the plaid design under orange labels. The top one features the UMC logo top left and a top line that reads "Fifty. .32 Calibre Short. No. 2". The large image of the revolver makes up a good portion of the surface and below it is "Pistol Cartridges/With Swaged Bullets.". The side label has a matching shade of orange and is about 80% intact. Moderate corner wear is evident and the box houses approximately 25 oxidized cartridges. The next box is larger, as this is for .32 Long, and has the conventional rectangular design with the plaid panels. The top label contrasts with the bright orange side label as it is a tan or almost salmon shade with strong black text that reads on the left side "Fifty No.2 Pistol Cartridges.". To its right resides an impressive picture of the revolver and above that is ".32 Calibre." and the UMC logo. This top label is fully intact, the side one about 80%. This example has mild wear and is quite clean overall. Enclosed are maybe 35 correct rds. with the oxidation limited to the tips for the most part. A couple of collectible pieces certainly worthy of consideration and very good representatives of their era. Also included is a loose top label from a "32-100 Short" box. The bright green label features a strong picture of the No. 2 Revolver. (76679-2B)
3521. **COLLECTIBLE AMMUNITION BOXES** This is a lot of six one-piece 50 rd. size Remington Kleanbore .22 boxes. First is a dog bone style coded R16 for .22 Long Rim Fire with four darkened cartridges within. The second has dog bone style similarities but the logo does not taper towards the middle but retains enough white background to hold "Hollow Point" as in .22 Winchester Hi-Speed with Silvadry Bullets. This R28AS example is missing the right end flap and currently houses about 40 near excellent rds. The third one is LR Hi-Speed Kleanbore Kleankote, an empty example coded R23K. The next two are also Hi-Speed with the first being for Long, coded R16 and holding about 25 excellent rds., and the second holding the full 50, and also excellent rds. of Short within the R11 box. The last one is coded 5522, this one for standard velocity Short, of which about 30 near excellent cartridges are enclosed. A nice variety, rating very good to near excellent overall which should prove helpful in filling gaps in one's Remington .22 box collection. (76679-5U)
3522. **COLLECTIBLE AMMUNITION BOXES** This is a lot of five empty one-piece boxes by CIL/Dominion beginning with three of the 500 rd. variety. The first one is a .22 Short that has a separated top panel stating that it is "Made In Canada By/Canadian Industries Limited/Dominion". This is the style with the buff colored box with blue graphics, this one rating good plus with a small portion cut out and missing. The second box has the same color scheme, this one slightly larger as it is for .22 LR Whiz-Bang and, as is the case for the one above, Super Clean Dry Lubricated Bullet. The top flap is partially split with the balance intact. The front panel has an ink note bringing the overall condition to near very good for this No. 713 coded example that exhibits only the CIL name. The last of the 500 rounder's is a yellow and black outer brick box for Imperial 22 LR and rates very good with a moderate scuff on the right panel and tape residue. The other two are 50 rd. size beginning with an excellent RF-32, a buff colored .22 LR Super Clean standard velocity with blue and red graphics. Lastly is one that opens at the RF-11 coded top flap, a 22 Short Whiz-Bang with the red, yellow and blue graphics and rating excellent. (76679-28)
3523. **LOT OF COLLECTIBLE AMMUNITION** These are four 50 rd. size boxes representative of the evolution of Dominion/CIL beginning with an empty two-piece for .32 Long R.F. This is from the period when the manufacturer was solely Dominion Cartridge Co., Ltd. and has a fully intact red-orange top label that includes as a central focal point in large font: "Metallic Cartridges". Each of the sides of the buff colored box has strong text under an old tape application, bringing the rating to very good. The other two-piece example in this lot is in a slightly lesser state of condition with more wear and soiling, a dark gray, almost green colored box with thumb cutouts and a maroon and white wraparound label indicating that this is for .22 Long R.F. The company name on this is also Dominion Cartridge Co. Limited. The last two are full one-piece boxes in excellent condition and with ammunition also clean and excellent. The first, coded TT-59 is off white with dark blue and is for .22 LR Smokeless Greased Super Clean and the other is .22 LR Super Clean Whiz-Bang with the blue, yellow and red print and is coded TT-52. The last two boxes exhibit the name "Canadian Industries Limited/Dominion Ammunition Division". A nice diverse lot by the Montreal maker. (76679-2C)
3524. **LOT OF COLLECTIBLE AMMUNITION** This lot consists of four full 50 rd. .22 boxes by CIL beginning with a buff colored two-piece with thumb cutouts of 22 Long Super Clean Whiz-Bang Graphited Bullet. This has a wraparound label that includes the Dominion name and with mild wear and peeling, the box has light creasing. The other three are one-piece boxes beginning with another Whiz-Bang, this one being 22 LR High Velocity Mushroom, with a left end flap including the code RF-34. The bottom panel includes "Canadian Industries (1954) Limited" and the box is crisp with scattered and light tan spotting. The last two are the style that opens at the top, including an RF-21 rating excellent, and a top that informs that this is Whiz-Bang High Velocity 22 Long. The last one, an RF-10, has a split front left corner and a top that includes 22 Short Super-Clean Standard Velocity. The box has a few light scuffs and rates about very good. All of the ammunition in this lot rates excellent. (76679-49CG)

3525. **COLLECTIBLE AMMUNITION BOXES** This lot consists of four 50 rd. size boxes by the United States Cartridge Co. The first one is essentially a one-piece but with a side label that once sealed the now empty pull out tray and a top label that includes "Smith & Wesson's .32 Automatic Ejecting Revolvers" and a large image of the revolver below it. The light blue label is peeling back and exposes the left side of another U.S Cartridge label, this one with the shield logo at the center. The faded orange side label reaffirms that this is a .32 S&W box and it rates good plus with soiling and wear. The second box is in a similar state as it is missing both end flaps, has a split tray and exhibits moderate wear on its surfaces that consist of the dark blue backdrop to orange and white graphics, in this case for .32 Short R.F. The third box has the same color scheme and design but is a factory sealed example with text informing us that this is 22 NRA Long Rifle Lesmok. This one has strong color but there is a moderate scuff running nearly the full length of the upper top panel. The last box is a near excellent one-piece with the New York address and features black, white and faded copper colored graphics that indicate that this is .22 Long Copperhead Speedsters, of which there are currently 49 excellent rds. enclosed in the tray with a split corner. (76679-2D)
3526. **LOT OF COLLECTIBLE AMMUNITION** This is a lot of two 50 rd. size boxes by U.S. Cartridge Co. from the period of two-piece construction and top labels with the shield logo at their center. First is an opened but full box of 30 Long, or as depicted at the right side of the label, "30/100 Long Calibre" which also includes a yellow side label with a front panel that reads "Target Cartridges" and the sides stating the caliber. This example has a nearly perfect upper/lower compartment alignment with sharp edges but there is discoloration, likely mainly foxing and the ammunition has only light oxidation. Also noteworthy is that it retains the original information sheet in excellent condition. The second box does not line up nearly as well, with a lid that is tape-repaired and with an uneven profile. The top label is fully intact and has a right side that reads "No. 32 Long 32/100 Calibre." over an uneven tan liquid staining or foxing. The orange side label has identical text design to the one described above. The bottom compartment is fully intact and currently houses 35 very good cartridges showing an onset of white powder to the tips. An interesting sampling from the very collectible maker. (76679-13A)
3527. **LOT OF COLLECTIBLE AMMUNITION** This is a lot of three 50 rd. size U.S. Cartridge boxes including two factory sealed examples beginning with a .32 Short, rating near excellent with light staining evident on the top label and an only slightly faded orange side label that is also fully intact with sharp black print that includes on the front panel between the logos "Target Cartridges" and "32 Short" on each side. The second sealed box is more recent, featuring the blue backdrop to orange and white graphics, including a top label with the oval logo and a moderate scuff running the length of its lower portion. The side sealing label is excellent and fully intact with bold text proclaiming that the contents are "22 NRA Lesmok". The third box, an open two-piece from the period of the first one listed above, with the shield as the central figure on the top label, rates about good to good plus. To the right of the shield on this one the oval includes "No. 22 22/100 Calibre". The lid has missing side panels and has a very dark patina over a wavy surface. The bottom is fully intact but shows stains from contact with liquid. (76679-2E)
3528. **LOT OF COLLECTIBLE AMMUNITION** This lot consists of four Peters one-piece, 50 rd. .22 boxes including two full ones starting with a No. 2237 code, indicative of the yellow, blue and red graphics depicting 22 Winchester Automatic Rustless lead bullet, the likes of which, in this instance, rate excellent as housed in the correct and excellent condition tray. Also rating excellent is the 22 LR High Velocity contained in the red and blue box with white text including the code No. 2283. The third box in this lot is no. 2216 R which has a top panel with yellow borders around a blue backdrop to a red oval with white text stating that this is Rustless .22 Long Rifle of which 49 near excellent cartridges are enclosed. The last one exhibits the silver, black and white graphics used to identify the contents which in this instance is .22 Short Rustless Filmkote. This No. 2242 coded example has a tray with a separated end flap and currently holds 12 excellent and correct samples. A great find for the .222 or Peters box collector. (76629-49CH)
3529. **COLLECTIBLE AMMUNITION BOXES** This is a lot of four empty Peters 50 rd. size boxes beginning with a two-piece with thumb cutouts and a wraparound maroon label with a slightly faded top section that includes ".22 Cal. Long" on the top line and a middle section with "Swaged Bullet (image of cartridge and trademark P logo)". The box rates very good to excellent with light wear, ingrained dirt and other minor dark spots. The next is also a two-piece, rating good to very good with rear and left panels missing to the lid that has a nearly fully intact maroon top label indicating that this is .32 Cal. Short and includes P trademark logos on each side of the cartridge picture. This is the version with the matching color side label with a front section that includes "These Cartridges are loaded with King's Semi-Smokeless Powder". The bottom panel is pushed in, evidently impacted by something that also caused the lower left corner to split. The inner wall has come unglued and has been structurally compromised as well. The other two are one-piece boxes in excellent condition with red, blue and white print with the first exhibiting the large Peters circular logo to the left of "New High Velocity 22 Long Rifle". The last box in this lot is code No. 2214, an excellent condition example which features the bullseye target as a backdrop to text identifying this as 22 Short Standard Velocity Target. The last two boxes contain the Remington name and location on the bottom panels, contributing to the diversity of this Peters lot. (76679-2F)
3530. **COLLECTIBLE AMMUNITION BOXES** This is a lot of five factory sealed but empty cardboard boxes with faux wood surfaces and made for display purposes only. The first four are of equal dimensions, measuring 3 1/4" X 2 1/4" X 1", including two that have the top portions of their buff colored wraparound labels including "Dixie Gun Works/Made Especially For/Model 1874/Sharps Rifles" with one 40-65 WCF and the other 45-70. The others are 50-70 Government and 45-70 Government. The last one is larger, a picture box measuring 3 1/2" X 3 1/2" X 1" has text that includes "50-90 X 2 1/2 Straight/ Big Fifty/Made Expressly For /Sharps Rifles" with the image of the rifle just above this. A cool and unusual lot awaiting creative input for your display. (76679-44)
3531. **LOT OF COLLECTIBLE BOXES** This lot consists of six boxes, all one-piece and beginning with a full 50 rd. buff colored box with red print, including a faded ID panel that includes "50 (Trademark H Logo) .22/Blank Cartridges" above the Winchester name and location. The box rates excellent as do the enclosed cartridges. Next is another buff colored box with red print, this one reads "National Repeating Cane and Pistol Ammunition" on the top and bottom and "250 Shots" on the sides. Enclosed are five rolls of original caps. The third item is an empty buff box with red and blue print that reads "Boa Constrictors/National Fireworks" and rates excellent. The next one has red, white and blue graphics including a top that reads "Stallion Round Caps" and includes a circular "N" logo. The front panel of this empty box states that it is by Nichols Industries, Inc. of Jacksonville, Texas and the rear reads "Designed For Stallion Six Shooters". Next is a National Fireworks box with red, white and blue graphics indicating that it is National Repeating Caps. One roll is enclosed in this box with a missing end flap. The last one is an empty for Wingo WG 5-30, a small white cube-shaped example with blue and red text indicating that this is by Olin Winchester Western Division. A fine lot of specialty items. (76679-44A)
3532. **LOT OF COLLECTIBLE BOXES** This lot consists of six one-piece boxes and one lid only. First is a full buff colored Winchester box of .22 Blank Extra Loud exhibiting strong red text with the exception of the main information panel which in this case is the back of this example with a thumb cutout top flap. The box is in excellent structural condition but with scattered dark staining and the cartridges rate very good to excellent with some tarnish. The next one is the Remington UMC version of the above described and in similar condition. This one has the banner with vertical red and buff stripes and mainly blue text including the R9 code. The next one is another Remington UMC similar to the previous box but with black text other than the red dot logos and rating good to very good with missing flaps and a small puncture. The next one is by CIL, coded RF2, features a dark blue backdrop to white graphics that include French verbiage stating that this also is .22 Blanks. This one holds the full 50 rds. in excellent condition and the front panel has a large grease pencil or possibly ink marking. Next is an excellent and empty 100 rd. CIL B.B. Caps box with a buff background to green text that includes the Dominion name. The last box is a good condition example by Western for .22 Short Blanks. This is one of the scarce Maltese Cross boxes. The last item as mentioned above is a lid only but with a fully intact orange label that includes "100 Winchester Conical Bullet Breech Caps .22 Caliber Rifles only." and rates excellent with light fading. A nice group of items not often encountered. (76679-44B)



3533. **LOT OF COLLECTIBLE AMMUNITION** This lot consists of two factory sealed packages of military ammunition beginning with one with a fully intact but split, light blue label that reads "10/Rim-Primed Blank Cartridges,/Spencer Carbine, Cal: .50./Frankford Arsenal 1870". The paper packet is structurally excellent with scattered tan discoloration and the original string is intact. The second item is a plain gray box with a tan label with a front section that reads "20 Cartridges/Pistol Ball/Caliber .45 M1911/Ammunition Lot Rem./Remington Arms Company, Inc.". In addition, the label is stamped 5019 and the back reads "Disposal of Emptied Cartridge Cases Must Be Made as Prescribed by A. R.". The box rates excellent overall. (76679-46)
3534. **COLLECTIBLE AMMUNITION BOXES** This is a lot of four Winchester 50 rd. size .22 boxes beginning with an empty two-piece with fully intact burgundy labels including a top one with the trademark name logo top center and below it on this code 81 and 10-6 label is ".22 Long Rifle/Smokeless Cartridges". The right side features the sunburst and the left side has the silver Big Bold W. This is a desirable box with a few dark stains. The other three are one-piece boxes with yellow, blue and red print beginning with a full and excellent .22 Long Lead Lubricated Leader Staynless coded K2386R. Next is the .22 Short version of the one above and also rating excellent with 48 rds. and coded K2383R. The last one is .22 LR Staynless Kopperklad and rates good with the two end flaps and a portion of the rear panel missing and the tray shows a tape repair. (76679-49C)
3535. **LOT OF COLLECTIBLE AMMUNITION** This is a full 500 rd. brick with a buff colored outer box with red and blue print and a main panel that reads "(Winchester trademark name logo)/Leader/Staynless/.22 Long Rifle (Big Bold Red W) Rim Fire Cartridges/Lubricated Lead Bullet". Below this is the company name and location and as part of that is "Division of Western Cartridge Company". Also worth mentioning is this is a picture box and includes the image of the target rifle on the back panel. The right exterior end flap and one of the interior flaps are missing and the left flap is separated but present. The K2388R coded internal boxes feature bold yellow, blue and red graphics and rate excellent as does the ammunition contained within. Outstanding boxes on their own and even more desirable as a brick package. (76679-28A)
3536. **LOT OF COLLECTIBLE AMMUNITION** This is a full brick of Western Super-X Long Range 22 Short HP. The outer box is buff with blue and red print and shows mild edge wear, a couple of small tears and is missing a total of three end flap pieces. In addition there is a name and number written in crayon on the back panel. The 50 rd. boxes are in considerably better condition as the K1209R coded boxes with the yellow, blue and red boxes rate excellent as does the ammunition that they contain. (76679-28B)
3537. **LOT OF COLLECTIBLE AMMUNITION** This lot consists of four Western 50 rd. size one-piece boxes with the yellow, blue and red print. First is a code SX22S, a Super-X Long Range 22 Short containing about 45 rds. and rating excellent overall. Next is a 22 LR version of the one above but this one, coded SX22 LR, has a missing left end flap and contains seven cartridges. These two .22 boxes have the Winchester and Olin Mathieson Chemical names. The other two are older with more wear and soiling and exhibit the target on the top panel and the image of the cartridge on the bottom which shows simply "Western Cartridge Company" and also "Division of Olin Industries". The first one is for 44-40 Winchester Center Fire 200 gr. SP Lualoy and rates about good plus with a missing right end flap, a split but attached left one, moderate edge wear and a white area of discoloration on the top. Included are about 25 rds. of mixed head stamp but correct caliber rating very good. The last box is an empty, fully intact K1243R for 32 Short RF 80 gr. Bullet with moderate wear and soiling. Also evident are small splits and applied cellophane tape. (76679-7)
3538. **LOT OF COLLECTIBLE AMMUNITION** This is a lot of four 50 rd. size boxes by Western beginning with a two-piece with thumb cutouts and a green wraparound label with black and red accents. The trademark diamond logo is featured at the center and to its left is ".22 Cal. Short", to its left is "Gallery Special". Enclosed are the full 50 original rds. with oxidized tips bringing the overall rating to very good. The second box rates excellent as do the approximately 47 correct rds. of Super-X Long Range 22 LR as depicted on this one-piece box with end flap marked "90CN". The last two boxes, like the previous one, are one-piece and feature the yellow, blue and red print and like the other two in this lot, the Western Cartridge Co. name only. The first of these is a square shaped example for 32 Short Blank stamped "K1242R", rating near excellent with crisp edges, a separated but present inner flap and about 20 excellent and correct cartridges. The last box is an empty, coded K1244R for 32 Long Lualoy 90 gr., Coated Bullet that rates good to very good with missing flaps and mild wear and ingrained dirt. (76679-2G)
3539. **COLLECTIBLE AMMUNITION BOXES** This is a lot of two empty UMC two-piece boxes featuring the rounded corners and plaid panels. The first one has a teal-blue top label that has darkened to the extent that it blends somewhat with the black print that reads "Fifty (U.M.C. oval logo) .38 Cal./Primed Metallic/Case Cartridges, (in large font)/For Pistols/With Swaged Bullets" over the company name and location. There is no side label present, allowing for the possibility that the fully intact bottom could be a mismatch. Its left side has the caliber handwritten in ink and the overall rating is perhaps good to very good with the lid showing moderate wear and is missing much of the plaid covering, the bottom is plain buff. The second box has original matching components including a lid with a green top label that includes "50 .38 Cal., Long/ Rim-Fire Cartridges/Swaged (image of cartridge including U head stamp and "38 Long") Bullets". Also included are the U trademark logos at each side and the bottom consisting of the company name in curved format and location below it. This version has a maroon side label, which in this case is about 80% present with most loss at the front. The box is fully intact with as is the bottom guarantee label and exhibits mild to moderate wear particularly at the edges. (76679-3)
3540. **LOT OF COLLECTIBLE AMMUNITION** This lot consists of three 50 rd. size boxes for .22 Short beginning with a full UMC two-piece with the yellow-green body under maroon labels including a top one with a middle section with "Black Powder" at the left followed by the picture with caliber enclosed and to its right resides the white U circular logo. The lower portion consists of the rounded layout of "The Union Metallic Cartridge Co.". The side label is about 50% present, the bottom one nearly fully present with some text scuffed away. Scuffing is also evident in scattered areas overall as is some dark staining and the ammunition exhibits moderately oxidized tips. The second box is a maroon one-piece 53-S coded picture box with a middle section of the slightly faded top beginning with the Remington UMC red dot logo with the cartridge image to its right and a dual language trademark statement to its right. The right panel exhibits a nice picture of the Remington Repeater Rifle and the edges show up to moderate scuffing in areas. Enclosed are about 35 rds. of darkened but clean correct "Lesmok" cartridges. The third box is Remington Kleanbore 22 Short Spatter-Less in the customary green, red and white colors and bearing a 5822 code. The box has a top panel that also features separate Remington circular red dot and Dupont oval logos and the tray holds about 45 excellent condition original cartridges. A great addition for a .22 collection especially considering it covers various phases of UMC and Remington. (76679-5C)
3541. **COLLECTIBLE AMMUNITION BOXES** This is a lot of Remington/UMC boxes and components. First is a matching two-piece with red labels including a faded top one stating that it is .38 Short R.F. The code 230 is visible at the bottom right as is a large two digit number written in thick marker near the cartridge picture at the center. The box shows tape repairs and a missing but present left lid panel. Enclosed are about 30 correct cartridges. The second item is a lid and inner wall only with the light blue top label informing that this is .56-56 Spencer. This is the square shaped 25 rd. size with the red dot logo including both companies and rating good to very good with a dark stain at the lower left and abutting the ink marking. Also included are two UMC lids, beginning with a .22 Cal. Short with a maroon label over lime green and a .22 Cal Long with green over buff. These two rate about near very good overall with no splits. Lastly we have two loose top labels with bold color and text and including both company logos consisting of a red .22 Short and a green .22 Extra Long. A variety that can possibly fill gaps or upgrade currently owned items. (76679-9B)

3542. **COLLECTIBLE AMMUNITION BOXES** This is a lot of two UMC boxes beginning with a square shaped two-piece with turquoise labels including a fully intact top one that includes "25 .56-56 Spencer/Rim-Fire Cartridges" and exhibits a large image of the cartridge between "Spencer Carbine". The side label is about 60-70% present and the bottom label, though its entire surface is affixed, shows moderate wear and scuffing. The lid shows a light old glue repair at the front and its label has a mostly darkened surface with scattered brighter areas, likely from recent wear. The box overall emits an almost even, or intentionally dark appearance and has a glue repaired bottom currently housing 14 correct cartridges. The second box is empty and features the rounded corners and the plaid cover and above it resides a fully intact tan top label indicating that this is .38 Cal. Automatic Colt Pistol. It exhibits strong text and a crisp cartridge image at its center and a handwritten number in pencil at its left. The box rates about very good overall with the usual wear and fading. (76679-9A)

3543. **LOT OF COLLECTIBLE AMMUNITION** This lot consists of four Remington one-piece, 50 rd. size .22 boxes beginning with a full and excellent condition R28S code for .22 Winchester Hi-Speed Kleanbore with sides that include "Model 1890/.22 Remington Special". Next is the first of two with code No. 6622, with the first having a somewhat faded overall appearance including a top panel with an upper section that reads "Remington/Match" and a tray housing six sample cartridges. The second is empty but virtually as-new with bold color and sharp edges and a top panel with its upper section reading "Remington/Rifle Match". The last item, coded R11K, for .22 Short Hi-Speed Kleanbore Kleankote is close to excellent in rating but does exhibit white areas that have faded to tan and some minor edge wear. (76679-49CH)

3544. **LOT OF COLLECTIBLE AMMUNITION** This lot consists of five Remington Kleanbore one-piece boxes, beginning with a code 5322, a square shaped and apparently full 100 rd. of 22 B. B. Caps rating excellent overall. The second item is also an apparently, or if not, virtually full 100 rd. size, this one with a lower profile as it is for 22 C. B. Caps and coded 5622 and in excellent condition. Next is an R58 for .267 Remington Hi-Speed and, like the last two in this lot, is empty. This one is structurally sound with mild corner wear and a few small scuffs but near excellent with white areas that have darkened to tan. The last two are for .32 Long beginning with an R142 code with the dog bone style logo as the focal point of the front, that like much of the structurally intact box exhibits dark staining. The last one exhibits a somewhat weaker stance with no inner tray and scattered wear and creasing. This version shows the caliber within the red stripe on the ends and "Kleanbore" against the green backdrop. A diversified lot for collectors interested in all things Remington. (76679-2H)

3545. **COLLECTIBLE AMMUNITION BOXES** This is a lot of three UMC two-piece 100 rd. size boxes, each with an overall square and low profile presentation beginning with a rounded corner style with the dark marble-like backdrop to, in this instance, light green labels, including a top one that includes ".22 Cal. Extra Long", and like the other two in this lot features "Rim-Fire Cartridges" above the section with the cartridge image between "Swaged Bullets" and below that is the trademark U logo, with the bottom consisting of the company name in a curved configuration and the location below that. This first box is missing most of its side label and the inner wall has been compromised to the extent that is split and pliable in areas, and the bottom compartment currently holds 14 correct and very good cartridges bringing the overall rating to about good plus as the lid shows glue repairs and the bottom has a sticker attached to the fully present guarantee label. The last two are empty and also have green labels, this second box having an emerald green-like shade with strong print declaring it as .22 Cal. Short. The bottom guarantee and orange side sealing are virtually fully intact with nice color and text bringing the rating to very good plus with light glue reinforcements to the lid corners and the sealing label still attached to at the left side. The last item rates good with significant glue repairs and a top label indicating that it is .25 Cal. Short. (76679-49CJ)

3546. **COLLECTIBLE AMMUNITION BOXES** This lot consists of three Remington/UMC boxes of the two-piece, 50 rd., rounded corner with plaid panel variety. The first one is empty and has a faded orange top label with equally faded text indicating that this is for ".32 Calibre Long No. 2 Pistol Cartridges". Also included is the old style UMC logo at the top left and the image of the cartridge as the main focal point. The United Metallic Cartridge Company name and location make up the bottom. The side sealing label is more than 90% present and is a brighter orange with darker text. The two compartments merge nicely and the box shows only mild edge wear and the panels retain nearly all of their "wallpaper". The lid has a handwritten ink note at the top line and the interior shows light glue reinforcements. The other two boxes have mismatched tops and bottoms, beginning with a top with a sky blue label, with a top line that reads ".38 Short R. F." and a bottom that reads "Blank Cartridges" on what remains of its side label. The last box has two top labels with the first one reading ".38 Long R.F." and "150 Grs. Bullet", it has peeled back to reveal an affixed label that includes "Long Colt Smokeless" and "148 Grs. Bullet". Additionally, the box is currently nearly full of two different calibers. An interesting lot that can be used to upgrade one's existing components. (76679-3A)

3547. **LOT OF COLLECTIBLE AMMUNITION** This is a lot of four one-piece .22 boxes beginning with two full ones by CIL beginning with an RF-21 coded Whiz-Bang 22 Long High Velocity with the red-orange and yellow graphics, which in this instance have an ink scribble just to the left of the cartridge image but otherwise rates excellent, as do each of the boxes in this lot. The second is coded TT-50 and is from the period where blue, yellow and white graphics were laid out in a horizontal configuration, in this case including a top section that reads ".22 Long Rifle" to the left of the image and to its right resides "Smokeless Greased". The next box is empty and is by Western Auto Stores & Associates and has a black top panel that includes in large yellow cursive "Revelation" and also evident is "Super Range" and "22 Long Rifle Non Fouling". The last box has a blue background to white and red graphics that include the end panels that provide the caliber: .22 LR and also reiterates "Xcess Speed". The front panel informs us that the manufacturer is Federal Cartridge Corp. of Minneapolis, Minn. Enclosed are two sample rds. with the HP head stamp. A diversified lot in excellent condition to add to your .22 box collection. (76679-49CJ)

3548. **LOT OF COLLECTIBLE AMMUNITION** This lot consists of two boxes by Dominion Cartridge Co. The first of these two-piece boxes with maroon labels is a full 25 rd. size of 56-46 with a top label exhibiting a large "25" above the cartridge image and the box has areas of mild to moderate soiling including a large dark stain at the upper left top panel. The lid has a glue repaired right panel and a missing left one, the back being split, the front with a hand written note. The bottom is in a better state with significantly less soiling and intact glue repairs. The ammunition appears to be original and rates very good with a small amount of white powder on the lead. The second box is an empty .32 Long and its top label has a different layout than that of the above as this one has a top line with "50 (image of cartridge with "Long" within it) .32" and, like the first one, follows with "Metallic Cartridges" and the company info and logo below that. The side label is a buff color, virtually identical to the box panels, with most of its text still legible and showing a tape repair on the bottom portion. The bottom has a split at the front and right panels and a fully intact but moderately scuffed guarantee label. (76679-9A)



3542

3549. **LOT OF COLLECTIBLE AMMUNITION** This is a full, two-piece 50 rd. box of Dominion Cartridge Co. .38 Short with a faded maroon top label with the top line of black print showing the cartridge image with “.38 Short” displayed along the case. The quantity is at its left and the caliber to its right, below is “Metallic Cartridges”, and the company name, location and logo reside below that. The label shows numerous small storage marks, apparently from weight pressing against the enclosed cartridges. The side sealing label retains bold maroon color with the exception of the right side which has faded about evenly with the top label. The black text is equally bold and the front and right provide the caliber, the back shows the company name and the left is plain. Structurally the box is quite sound with the right side showing tears to the lid corners and the bottom with a wavy appearance, possibly from moisture. The correct 50 cartridges rate good plus to very good with light oxidation and tarnish. (76679-11B)
3550. **COLLECTIBLE AMMUNITION BOXES** This is a lot of three boxes for Poultney's Metallic Cartridges. These are 10 rd., buff colored boxes and labels, each with strong legible black print that includes “Patented December 15th, 1863”, including a first one with a lid that remains slightly attached at the front and has a label stating that it is “12 Caps./For/Smith's Breech-Loading Carbine./No. 1 50-100 Caliber/Address, Poultney & Trimble, Baltimore Md.”. The box includes a loose second top label of identical text and an apparently correct sample cartridge. The second box also has a sample cartridge and is in a slightly better state of condition, rating perhaps near very good with less foxing and cleaner overall and, like the one described above, exhibits a lid with a curved profile, this one still attached at the rear. The top label is peeling back slightly and indicates that this is “12 Caps./For/Gallager's Breech Loading Carbine./50/100 Calibre.”. The last one is an emptied and meticulously re-sealed example with a top label that includes “12 Caps./For/Maynard's Breech Loading Carbine./50-100 Calibre./Manufactured By/B. C. English, Springfield, Mass”. This interesting piece rates very good with mild foxing. (76679-14)
3551. **COLLECTIBLE AMMUNITION BOX** This is a two-piece box with a fully intact green top label with a decorative border and text that reads “Forty-Two, Primed/Metallic Cartridges/For/Spencer Carbine./Cal. 50, - - Model 1865./Manufactured By/ Sage Ammunition Works./Middletown Conn.”. A small portion of the green has worn to the buff tone of the lid which is a different hue, almost pinker than that of the bottom compartment. The lid shows an interior with tape reinforced corners and exterior corners with tape residue. The bottom also shows tape repaired corners and is filled with form cut layers of corrugated cardboard acting as support and quite successfully as this is a sturdy outfit as configured. Overall the box shows light scattered ingrained dirt and the bottom panel showing minor darker spotting, likely grime. (76679-14A)
3552. **COLLECTIBLE AMMUNITION PACKETS** This is a lot of two empty packets by H. W. Mason, beginning with one “Made of American Powder Co.'s Powder” for “Revolving Holster Pistol, 44-100 inch Calibre”. The empty six rd. packet remains hinged at the back and retains bold black print and strong varnish. The second packet, “Made of Hazard's Powder” is also empty but opened at its left side and exhibits a darker patina over strong black text that includes “Police Pistols,/36/100 Calibre. An about very good condition lot overall. (76679-14B)
3553. **LOT OF COLLECTIBLE BOXES** This lot consists of two empty vintage two-piece boxes beginning with a very rare item by the short lived manufacturer C. D. Leet of Springfield Mass. The lid has a yellow top label with strong black print that includes “Forty-Two/Smith & Wesson's/Patent Metallic/Primed Cartridges (in the largest font of the label)/Patented April 17, 1869./For Spencer Carbine-Calibre 50./Model 1865”. The bottom has a front panel also retaining its original label, this one with the header “Directions for Loading Spencer Repeating Rifle”. This label has more foxing and wear than the top one causing much of the very small font text to be difficult to discern, if at all in isolated areas. In addition the box shows areas of moderate dark spotting, particularly the left panel which is essentially a mottled dark brown. The lid and bottom show some glue repairs, but overall this is a very acceptable survivor. The other item in this lot is by “Sharp's Rifle Manuf'g Co.” as depicted at the lower portion of the top label which also states that it once held “10 Cartridges/12 Caps/For Sharps' Improved Rifle/52/100 Calibre”. Also noteworthy is that it retains a portion of a label depicting the names of intersecting streets and their likeness in illustrated form. The condition is about good to very good with the top layer of the upper right portion of the top label missing and a separated and split lid at that side. (76679-14C)
3554. **COLLECTIBLE AMMUNITION BOX** This is a salesman's sample box by Robin Hood Ammunition Co. for 12 gauge shotgun shells. The purple pebble-grained one-piece box opens to reveal the lid's white inner label with black text that includes “Not In A Trust/Samples/Loaded Paper Shot Gun Shells/From The/ Robin Hood Ammunition Company/Swanton, Vermont, U. S. A.”. The box rates about good to very good with a weakened hinge and moderate scuffing and evidence of contact with liquid. Currently enclosed in this rare box are a few mixed fired cases with Robin Hood head stamps and an alloy medallion of the company logo. (76679-14D)
3555. **COLLECTIBLE AMMUNITION BOXES** This lot consists of two boxes from different manufacturers beginning with a Crittenden & Tibbals, an empty two-piece with the marble-like pattern cover layer and with nearly fully intact emerald green labels including a top one that reads “Fifty/Primed Metallic Cartridges./No. 46-100./For Remington Carbine./Manufactured by the/Crittenden & Tibbals Manuf'g Co./South Coventry, Conn., U. S./Under Smith & Wesson's patent, Issued April 17th,1860”. The label has a few small scuffs and is peeling back a bit at the lower left but is in better condition than the balance of the box that has three holes, including the front lid corners and the bottom left rear. Overall the box rates about good plus with glue and tape repairs and moderate scattered scuffing. The second box is also a two-piece, this one with an orange body and a dark brown top label with faded gold text indicating that this is by National Revolver Cartridges and once contained “Fifty No. 1”. The box rates good plus with bright orange color with moderate tape residue and a large marking in ink on the right side. The lid has a hole and a missing front panel. Also included are a loose “No. 32” lid with the same label color scheme with bolder text and a loose label with the header “Round Teat No. 2”. (76679-14E)
3556. **LOT OF COLLECTIBLE AMMUNITION** This is an opened and full 50 rd. Winchester box with emerald green labels including a top one that includes “50 (cartridge image with no exposed head stamp and along the case “Extra Long”) No. 32/Metallic Cartridges/Manufactured By The/Winchester/Repeating Arms Co./New Haven Conn. U.S.A.”. Also included are the H trademark logo at the left and the Stetsons at the right center. The label is fully intact with nice color and black text but does have an area of moderate scuffing at the company name. The side label is 90% intact with a layer of cellophane tape, now darkened and covering most of its surface that includes the cartridge on each panel and a number written at the lid's rear. The box shows wear mainly at the upper left and the ammunition rates about good to very good with mild oxidation. (76679-21)



3551



3557. **COLLECTIBLE AMMUNITION BOXES** This is a lot of two Winchester two-piece 50 rd. size boxes for .32 Long beginning with one with an olive green top label of the version with the cartridge image at the upper middle with an exposed H head stamp and displaying .32 Long along the casing and to its left resides the quantity and to its right is “.32 Caliber”. Below it is “Metallic Cartridges.” And below that is the customary manufacturer info and logos. The orange side label on this version features the lubricating patent statement on the front, “.32 Long R. F. Winchester Make” on each side and the guarantee on the back. The box rates near excellent with a pencil marking on the bottom panel, very few wear marks and some light ingrained dirt. The box houses about 48 rds. of mild to moderately oxidized cartridges. The second box is empty and of the period where the light green top label bears an upper section with “50 32 Long, Rim Fire./Shot Cartridges”. It also features an orange and faded side label with the cartridge info at each panel and a rubber stamped “dust,” on the front and rear. The box has a lid that remains sealed at the back and with splits on the left side corners. The bottom is missing an inch of its front panel and the inner wall is separating, the bottom label being 70% present. (76679-2J)
3558. **LOT OF COLLECTIBLE AMMUNITION** This lot consists of two boxes by different manufacturers starting with a Winchester two-piece that features a lid with thumb cutouts and a wraparound label with a vibrant dark green top section and black print that includes the Winchester trademark name at the upper center with “50” at each side and below it is “.32 Short”. Below that is the cartridge image and to its sides, the company logos and “Rim Fire”. The remainder of the label is orange and depicted in those sections is the code K325R. The lid has splits at three corners and the bottom is structurally sound and currently houses about 47 correct cartridges with a light coating of white powder at the lead tips. The second box is a one-piece Savage box with a red backdrop to gold and white text that includes at the upper left “50 cartridges/88 grain /Lead Bullet” and a lower section that has “.32 S&W (Smokeless)/Savage”. The sides include the Savage logo and the bottom exhibits the guarantee. The box rates about good plus with a portion of the lid’s right side missing and splits at the end panels. Included are 18 correct and very good cartridges. (76679-2K)
3559. **AMMUNITION DISPLAY CASE** This is an original Peters display case designed for retailers to use at their counters. This model measures 13”x12”x6” and features four vertically arranged sections to stack the boxes within and a scratch free glass front that opens upwards for access. The authentic case exhibits green red and white graphics that include a top section above the glass that reads “Peters “high-velocity” 22s” and the bottom contains “the most POWERFUL you can buy!” between two oval Dupont logo. The box is of finger groove wood construction and is structurally excellent with a few minor handling marks evident. (76679-4D)
3560. **AMMUNITION DISPLAY CASE** This is an original retailer’s counter display box with a front section that reads “Remington “Hi-Speed” 22’s/For Real Power-Bulls-Eye Accuracy” at the top panel above the excellent glass face that reveals five vertically-aligned compartments. Below the glass is a bottom panel exhibiting the phrase “With “Kleanbore” Priming to keep your gun barrel Bright and Clean”. The case is of finger groove wood construction and measures 16”x10”x6”, with sides that include the Remington and Dupont logos. All print remains a vibrant red and the top has an original Remington data sheet with a filled-in section reserved for the retailer to list contents and prices. The white sheet has brown overtones and some liquid stains. This is a near excellent condition item overall with light handling marks, soiling and fading. (76679-4E)
3561. **DISPLAY CASE LOT** This is a matching pair of finely crafted wood display cases by Tomway, each measuring 10”x7 1/2”x 2 1/2”. Each features a neat pair of wood hinges allowing for frontal access to six vertically arranged compartments suitable for knife display. However the wood separators are removable and therefore allowing for displaying of larger items such as handguns. Adding to the overall level of quality are the blemish free beveled glass front panels and the padded velour bottom interior surface. A classy and versatile set in excellent overall condition. (77071-7)
3562. **LOT OF BOOKS** Total of five. The Deringer in America, Vol. I: The Percussion Period, by R.L. Wilson & L.D. Eberhart; c. 1985 L.D. Eberhart and R.L. Wilson. 271 pages hardcover with jacket. The Deringer in America, by R.L. Wilson & L.D. Eberhart; c. 1993 L.D. Eberhart and R.L. Wilson. 280 pages hardcover with jacket and signed and dated (2/7/13) by the authors. Excellent condition pair with light jacket tears and creasing. The Collecting of Deringers Manufactured by Moore, National and Colt, by L.D. Eberhart; c. 2011 L.D. Eberhart; 109 page, large table sized hardcover with jacket and rating excellent. Southern Derringers of the Mississippi Valley, by Turner Kirkland; c. 1972 Pioneer Press, 102 pages paperback rating excellent. Henry Deringer’s Pocket Pistol, by John E. Parsons; c. 1948, 1952 John E. Parsons. 255 pages currently bound in a three ring binder and with edge wear and liquid stains. (77071-8A)
3563. **LOT OF BOOKS** Two total. Gunmakers of London 1350-1850, by Howard L. Blackmore; c. 1986 Phaidon-Christie’s Limited, Oxford, 222 pages hardcover with jacket. Gunmakers of London Supplement 1350-1850, by Howard L. Blackmore 156 pages hardcover with jacket showing a small liquid stain at the spine area. This is an excellent condition two book set contained in their original hard sleeve with a couple of light handling marks. (77071-8B)
3564. **LOT OF BOOKS** Total of four. Great British Gunmakers 1540-1740, by W. Keith Neal and D.H.L. Back; c. 1984 W. Keith Neal and D.H.L. Back, 479 pages clothbound hardcover published in a limited, numbered edition of which this is No. 492. Virtually blemish free with the beginning of separation at the spine. English Gunmakers: The Birmingham and Provincial Gun Trade in the 18th and 19th Century, by De Witt Bailey and Douglas A. Nie; c. 1978 De Witt Bailey and Douglas A. Nie, c. 1978 Lionel Leventhal Limited, 127 pages hardcover with jacket. The Queen Anne Pistol 1660-1780, by John W. Burgoyne; c. 2002 Museum Restoration Service. 114 pages hardcover which is No. 1 in the Historical Arms New Series. English Pistols, by Howard L. Blackmore; c. 1985 The Trustees of the Armouries. 72 pages paperback with a small area of discoloration at the top right of cover. The books in this lot rate excellent overall. (77071-8C)
3565. **LOT OF BOOKS** Total of five. Georgian Pistols: The Art and Craft of the Flintlock Pistol, 1715-1840, by Norman Dixon; c. 1971 Norman Dixon, c. 1971 Lionel Leventhal Limited. 184 pages hardcover with slightly torn jacket and clear sleeve. Confederate Handguns: Concerning the Guns, the Men who Made them and the Times of their Use, by William A. Albaugh, III, Hugh Benet, Jr. and Edward N. Simmons; c. 1963 George Shumway. 249 pages hardcover with jacket, foxing along top edge and an ink-written message on front end paper. Antique Guns and Gun Collecting, by Frederick Wilkinson; c. 1974, 1990 Hamlyn Publishing Group Limited. 96 pages hardcover with jacket, illustrated end papers with sticker attached and price written in pencil and illustrated frontis piece. Ethan Allen and Allen & Wheelock: their guns and their legacy, by Paul Henry; c. 2006 Paul Henry. 230 pages hardcover with jacket and greetings label affixed to front end paper and signed by the author. The previous two listings rate excellent. Ethan Allen, Gunmaker: His Partners, Patents & Firearms, by Harold R. Mouillesseaux; c. 1973 Museum Restoration Service. 170 pages hardcover with jacket showing several small tears and with a protective clear sleeve over it, foxing along end paper spine area, a penciled in price and light ingrained dirt. (77071-8D)
3566. **LOT OF BOOKS** Total of seven. London Gunmakers and the English Dueling Pistol 1770-1830, by Keith R. Dill; c. 1995 Museum Restoration Service. 36 pages staple-bound booklet that is No. 34 in the Historical Arms Series. The Blunderbuss 1500-1900, by James D. Forman; c. 1994 Museum Restoration Service, this printing 2012. 40 pages staple-bound paperback that is Historical Arms Series No. 32 and has a creased front cover. The Story of Allen and Wheelock Firearms, by H. H. Thomas; c. 1965 H. H. Thomas, this printing 1991. 125 pages paperback rating excellent with a penciled in price on front end paper. Duelling Pistols: and some of the Affairs they Settled, by John A. Atkinson; c. 1964 John A. Atkinson, this edition 1966. 142 pages excellent condition hardcover with an impression on each edge of the front cover but very clean. The Mantons: Gunmakers, by W. Keith Neal and D. H. L. Back; c. 1966 W. Keith Neal and D. H. L. Back. 300 pages hardcover with jacket showing evidence of repair, attached library envelope and label, library stamp along top and bottom edges, and overall mild soiling from use. British Pistols and Guns 1640-1840, by Ian Glendenning; c. 1951 Cassell and Company Limited; 195 pages hardcover with slightly uneven fading and mild corner wear. The British Dueling Pistol, by John A. Atkinson; c. 1978 Museum Restoration Services. 108 pages hardcover with jacket showing contact soiling on the front, still an excellent condition book. (77071-8E)

3567. **LOT OF BOOKS** Total of five. English, Irish and Scottish Firearms Makers: When, Where, and What They Made From the Middle of the Sixteenth Century to the End of the Nineteenth Century, by A. Merwyn Carey; c. 1954 A. Merwyn Carey. 121 pages hardcover that was once property of a library and retains stickers and ink markings with a rating of good plus with additional items affixed and torn cover at spine. The Art of the Gunmaker: Vol. I 1500-1660, by J. F. Hayward; c. 1962 J. F. Hayward. 303 pages hardcover with jacket and scattered ink stamps indicating that this was a library book that currently rates near very good with modest edge soiling. Scottish Firearms, by Claud Bairand Robert Woosnam-Savage; c. 1994 Museum Restoration Service, 2nd printing 1999. 52 pages staple bound paperback rating excellent. Early Firearms of Great Britain and Ireland: from the collection of Clay P. Bedford, introduction by Clay P. Bedford and Stephen V. Granscay; c. 1971 The Metropolitan Museum of Art. 187 pages hardcover with jacket showing tears and signed by Bedford. Near excellent condition. The Mortimer Gunmakers: 1753-1923, by H. Lee Munson; c. 1992 H. Lee Munson. 313 pages hardcover with jacket and in excellent condition. (77071-8F)
3568. **DISPLAY CASE LOT** This lot consists of two illuminated wood cases measuring 15"x10"x2" each and of identical construction and featuring seven clear Plexiglas shelves arranged to be effective at displaying small items and have been found to be ideal for .22 cal ammunition boxes. The condition is excellent with only faint blemishes and included are functional lights with cords and power switches and hardware installed for hanging. A cool way to present your collector ammunition. (76679-4F)
3569. **DISPLAY CASE LOT** This is a lot of four unmarked wood display units suitable for collector ammunition boxes or similarly sized items beginning with one with a 13 1/2"x8" front glass plate and rear access hinged back. The other three are all wood with mainly small square shaped compartments including the first two measuring 12"x12" and 25"x12" and sized to fit .22 cal. boxes. The last one measures 18"x17" and features three different size compartments suitable for larger caliber boxes. The two larger ones come with hanging hardware attached. The overall condition is about near very good with a variety of finishes and handling marks. (76679-4G)
3570. **LOT OF COLLECTIBLE AMMUNITION** This is a lot of four Winchester boxes including two 50 rd. size one-piece for .22 Short beginning with a full Leader Staynless Lead Lubricated with clean and excellent ammunition in a crisp box with a few storage scuffs. The K2383R coded box shows vibrant yellow, orange and dark blue graphics as does the K2277R box with the substitution of red for the orange, with this near excellent condition box containing about 46 excellent rds. of Staynless Kopperclad. The third box is also for .22 Short, but this one from the period of two-piece 100 rd. size boxes with this example featuring vibrant green labels including a top one with the cartridge image top center with the H head stamp logo and "Short" prominently displayed within it. This is the version with the left side and rear label reading ".22 Short/Target Cartridges.". The lid has made contact with a sharp item as there are several small slices towards the top. Enclosed are about 80 correct cartridges rating good to very good. The fourth box is an empty two-piece with a now mottled tan top label identifying this as a 25 rd. size for .56-50 Rim Fire Blank Cartridges. This example rates about very good with two split lid corners, a separating inner wall and mild foxing. Also included in this lot is a loose lid with a very good top label indicating that it is by Winchester and for .56-56 with a large cartridge image at the upper section and a lower left that includes "For Spencer Arms". The lid is missing the right and front panels. A nice variety to fill gaps in your Winchester collection. (76679-9B)
3571. **LOT OF WOOD CRATES** This is a lot of three Remington ammunition crates beginning with one from the UMC period that is quite large, measuring in at 18"x9 1/2"x13", of finger joint construction and featuring inlet side handles. The black stamps remain strong with the front and rear panels reading "1120 8mm Lebel Cartridges/Packed In Paper Boxes/Cartridge Lot No./Muzzle Velocity 2300 Feet Per Second/The Remington Arms Union Metallic Cartridge Co. Inc./Swanton, Vermont". Also included at the upper right is a large ordnance bomb and at the middle are faded red vertical stripes. This is an impressive, fully intact crate retaining a strong coat of varnish over the exterior and interior. The next box is approximately 14"x12"x6" and features strong red and green stamps indicating that this is code R16 and that it once contained 10,000 .22 Long Hi-Speed Kleanbore. This is a sound box with inlet handles and bound by nails and exhibits some dark interior staining and some minor white exterior discoloration. The last one is smaller, measuring 14"x6"x6" and the strong green stamp indicates that it is for 410 Ga., 2 1/2", 9 shot Skeet Load. This is the qty. 500 size with the red portion of the stamp fully faded away on three sides and the bottom panel of the nail construction box likely a replacement. A versatile lot of nice looking wood crates. (76679-42A)
3572. **LOT OF SHOTSHELLS** This lot consists of a variety of vintage shells with paper hulls, about half of which are empty. This is a group of different gauges, lengths, manufacturers and conditions but overall about very good, with soiling and some with tarnish. Examples are Winchester Leader 1061, U. S. Climax, Alcan 10 ga., Winchester Repeater, UMC No. 16, and U.S. New Rapid. The total quantity is maybe 125 and contained in a vintage wood ammunition crate by Syracuse Ind. Sales Co. for .22 Long Blanks. A nice find for the shot shell collector with the bonus of an uncommon crate. (76679-55A)
3573. **LOT OF SHOTSHELLS** This is a lot of approximately 300 shotshells, mostly paper but some plastic and including a few empties. Included are a wide range of sizes and manufacturers, with some examples being Peters Referee, Pawam Pionki, Koln Rotweil, Savage B.P.D. Roma and Winchester Super Speed. The overall condition is about very good with light soiling. The shells are housed in a cool U.S. Cartridge Co. Shot-Shells wood crate. (76679-55B)
3574. **LOT OF SHOTSHELLS** This is a lot of mixed 16 ga., mainly 2 3/4" in the amount of about 180 rds. including some in their original boxes. Most common within the group is Western in paper hulls and Remington in plastic. This lot rates very good overall and is contained in a National Lead Co. wood crate for air rifle shot. (76679-55C)
3575. **LOT OF BRASS** This lot consists of two different calibers of fired cases with mixed head stamps. They are separated and housed in metal cans. The first can contains about 450 rds. of 44 Rem. Mag. And the other holds about 350 of 44-40. The condition is very good to excellent and included is a 500 rd. size wood crate for Western Shotshells. (76679-54A)
3576. **LOT OF BRASS** This lot consists of two calibers of fired cases beginning with approximately 100 rds. of Winchester 38-40 WCF and about 200 rds. of mixed 32-40. The calibers are stored in their own metal cans and rate very good to excellent. The cans are housed in a Peters Victory Shot Shell wood crate. A great find for the re-loader. (76679-54B)
3577. **LOT OF BRASS** This is a lot of two different calibers of fired cases beginning with about 120 rds. of mixed head stamp 45 Colt rating very good to excellent and contained in a metal can. Also contained in its own metal can are approximately 300 rds. of mixed 45 Auto rating very good to excellent. Also included in this lot are about 400 rds. of 45 Auto in a lesser state of condition and rating about good to good plus and contained in a vintage Peters wood crate. A substantial quantity of brass for the re-loader. (76679-54C)
3578. **LOT OF BRASS** This lot consists of four calibers of fired cases beginning with about 75 mixed rds. of 32-40 WCF. The next caliber is 45-70 Govt., with a quantity of about 40 mixed rds. The next is 32-20 WCF, also with mixed head stamps and, like the two mentioned above, is contained in its own metal can. Also included is a nearly full box of fired cases with the box marked "A360/64 Cartridges/9mm Ball CDN MKI". The lot is housed in a vintage Peters wood ammunition crate originally for 500 rds. of 20 ga. The overall condition of the lot is very good. (76679-54D)
3579. **LOT OF BULLETS** This lot consists of eight apparently full 100 rd. boxes of Herter's .358, 148 gr. swaged lubricated wad cutter bullets in very good condition. (76679-57A)

3580. **LOT OF BULLETS** This lot consists of six opened 100 rd. size boxes of .38 cal.: (1) virtually full and (1) nearly full of Speer 146 gr. JHP; (1) approximately half full of Speer 148 gr. hollow base wadcutter; (1) containing about 96 rds. of Speer 160 gr. solid point; (1) containing approximately 45 rds. of Sierra 110 gr. jacketed hollow cavity; (1) containing about 25 rds. of Hornady 158 gr. pistol bullet. The overall condition of the lot is very good to excellent. (76679-57B)
3581. **LOT OF AMMUNITION BOXES** This lot consists of about 100 empty .22 cal. boxes of mainly late 20th century manufacture. Some may be doubles, but this is a very diversified group in very good to excellent overall condition. Some examples of manufacturers are Winchester, Western, Lapua, RWS, Eley, PMC, Focchi, Canuck, and Ruko. A wide range of perhaps future collectibles. (76679-44B)
3582. **LOT OF PRIMERS** This lot consists of two full 1000 rd. boxes of Winchester Primers, each containing ten 100 rd. trays and in excellent condition: (1) Large Pistol for standard or magnum pistols; (1) Large Rifle for standard rifle loads. (76679-40A)
3583. **LOT OF PRIMERS** This lot consists of three boxes of primers in 100 rd. trays with sleeves: (1) full ten tray of CCI Large Pistol; (1) containing four full and one partial tray of 43 rds. of CCI Small Rifle; (1) containing two full and one containing 49 rds. of Remington No. 9 1/2 Large Rifle and two full Winchester Large Pistol. The lot is in excellent condition. (76679-40B)
3584. **LOT OF DIES** This lot consists of five RCBS boxes with contents and three empty and excellent boxes with Redding labels attached: (1) 9mm Luger; (1) three die carb. set for .45 ACP SWC with instructions and data sheet; (1) seater 38 Special WC; (1) bullet puller with collet; (1) three die for .38 Special SWC. The conditions of the items in this lot range from very good to excellent. (76679-61A)
3585. **LOT OF DIES** This lot consists of four boxes (1) Dillon box 44 magnum box consisting of three RCBS dies for the caliber; (1) Dillon Conv. 9mm/38 SUP.; (1) RCBS 3 die set for 44/40 WCF RN; (1) with Lyman 3 die and RCBS one die for 9mm Luger. The lot show use and rates about very good overall. (76679-61B)
3586. **TUMBLER LOT** This is a Dillon CM-500 Case/Media Separator complete with tub and in near excellent condition with some areas of dust and dirt. The manual operated item functions well and comes with original tub. No media included. (76679-52A)
3587. **CASE CLEANER LOT** This is a Dillon CV 750 Electric Tumbler Case with media enclosed and has been tested for operation and motor runs fine and is equipped with power switch. Item measures 12"x12" and has a capacity of about 500 for 45 ACP or about 200 30-06 as examples. Included are two partial bottles of polish. (76679-52B)
3588. **CASE CLEANER LOT** This is a Thumler's Tumbler Model B, a fully functional metallic device used for brass cleaning. Item runs by electric motor and shows mild wear and surface oxidation. (76679-59)
3589. **LOT OF BULLET MOULDS** This is a lot of five bullet moulds beginning with two by Rapine. The first one is marked 515370 and rates excellent and apparently unused with some contact marks. Included is the original box with the Wt. section stamped 370 and papers. The other one is marked 544475 and showing light use. Next is an Ideal-marked 454/250 and a Lyman 575213/593 with each fully intact and functional with a good application of lubricant. The last one is in a lesser state of condition with a tape repair to the handle and marked OB03. (76679-60)
3590. **LOT OF AMMUNITION** This lot consist of 12 full 18 rd. boxes of Italian-manufactured 7.35. All but one of the buff colored and quite brittle boxes is marked "N. 18/Cartucce a Pall cal. 7.35/per Fucile Corto o Moschetto/Polvere alia Nitrocellulosa Pura/Camp Tizzoro E. B. S.M.I.-1939/Collaudate". The other box is similarly marked and includes "Per Armi Mod. 38". The ammunition is contained in their original six rd. stripper clips and the cases are quite bright overall but do exhibit scattered tarnish on some. Overall the boxes have a stained and somewhat grimy patina and the ammunition has apparently been stored unattended and will require minor cleaning of cobwebs and associated dirt. This vintage lot comes in a small Remington UMC wood crate. (76679-50)
3591. **LOT OF AMMUNITION** This is a very diversified lot of pistol ammunition with some suitable for shooting and some perhaps serving better as collectible. First is a large coffee can containing about 12 lbs. of mixed old Rimfire cartridges including most with Winchester or UMC head stamps. Included is likely nearly the full gambit of calibers and the qty. is likely about 500 cartridges. Next is a smaller jar containing about 40 rds. of mixed .45 Colt and also we have a cigar box housing a box of maybe 125 rds. of excellent and mixed .22, another with very good .38 Special, a partial and mixed tray of centerfire, three clay targets and an empty tin. Another cigar box contains a tray of good plus .38 Spl. and about 60 rds. of mixed caliber center fire. All of this is contained in a vintage Remington wood crate originally for .22 Long. (76679-48)
3592. **LOT OF AMMUNITION** This is a lot of loose rifle ammunition, much of which was once intended to be sold individually as there are price stickers taped on to them and included are military and sporting cartridges. Some examples are Weatherby .257 magnum, Norma 6.5x55., Rem.-UMC 50-70., Holland .375 Magnum. U.S.C. Co. 45-70, Kynoch .280 and Winchester .38-55. This is only a very small sampling as this is a lot of approximately 200 rds. in very good condition overall. The cartridges come in a wood Winchester crate originally used for .22 Sort Staynless HP. An interesting lot bound to fill gaps in one's cartridge collection. (76679-57A)
3593. **MILITARY CHEST LOT** This is a U.S. M1917 Rifle Armorer's Chest. This is essentially a wood crate with steel hardware including wraparound straps functioning as lock hinges and with edge reinforcements. The metal surfaces retain about 85% OD green finish with loss due to oxidation staining and handling marks. The wood retains about 90% of its OD green finish and each side features black stencil that reads "Arm Repair/Chest.M17.For/U.S.M17.Rifles". The left side is bold and fully legible, the right shows some wear and fading. The top exhibits remnants of ink markings that someone has attempted to clean off. The font reveals two sections devoid of paint, the beginning of a split and that the leather handle is missing. Also missing are the interior compartments as this one is bare and with well-preserved wood. The lid interior retains 85% of the contents list, a document that lists the dozens of tools and parts and their quantities that once made up this scarce item. A nice find for the military or antique collector. (76679-58)
3594. **LOT OF HOLSTERS** This is a large and diversified compilation of gear used mainly for personal transport of guns and accessories. These are of different eras, manufacturers, walks of life and conditions. First we have 14 belt or hip holsters including a few European leather military examples, cowboy style and a few nylon ones. There is a shoulder holster, a nice tan leather one by Hunter, marked "33 30 4H". Another interesting item is a two pocket magazine pouch with a back that reads "U S/L-F CO/1951/MRT 10-51 and in near excellent condition. In addition there is a U.S. Signal Corps Pouch Type CS-36 and a fine tan leather cartridge pouch. The total quantity of items for this lot is 26, with the balance consisting of military belts, pistol rugs and other containers. The overall condition is very good. (76679-41)
3595. **LOT OF AMMUNITION** This is a very diversified collection of likely upwards of 200 loose rifle cartridges, most with prices attached and most in about very good condition. Included are military and civilian with examples such as Kynoch 500 Nitro and 360B Nitro, UMC 44 X.L., Western .35 Newt., DWM 515 and REM-UMC 348. This is a very small sampling of this lot contained in a Western wood crate for 12 Ga. Super Trap Load, a nice box in its own right. This is a great way to fill gaps or expand your cartridge collection. (76679-57B)
3596. **LOT OF AMMUNITION** This lot consists of about 250 individual loose cartridges, mainly rifle and most with old prices attached. The cartridges are in about very good overall condition and some examples are Kynoch 1500 Nitro, UMC 45-35, Rigby 550 Magnum Nitro, Winchester Super X 264 Win Mag. And Weatherby .340 Magnum. This is an easy source, sure to upgrade or expand a cartridge collection. The lot is currently housed in a 1941-dated Winchester crate that once held 1000 rds of .303 Ball. (76679-57C)



3597. **LOT OF GUN CLEANING SUPPLIES** This lot consists of three rifle cleaning kits beginning with an Outers Gunslick No. 477 with an excellent red metal box that opens to reveal a complete kit that has seen very little use, in fact the brass brush has virtually no wear or dirt. Included are a three piece aluminum rod, patches, a tube of Gunslick and solvent. Next is an excellent Hoppe's kit, another three piece that includes original case and partial bottle of solvent. Also with original packaging is an apparently unused J.C. Higgins No. 653 270 cal. cleaning rod. Included with this lot is a small box containing about 15 brushes and a few swabs. (76679-43A)
3598. **LOT OF MILITARY SUPPLIES** This lot consists of two U.S. issued items beginning with a bipod in its original OD green carry case marked "Case, Carrying, Bipod, XM3/DSA 100-69-C-0745/1005-999-2430". The case has a zippered front pouch now holding several cleaning supplies. The bipod retains 98% original parkerized finish and, like the case, shows very little wear and excellent condition. The other item is an OD green case only, with mild wear and soiling and a stamp that reads "Case, Cleaning Rod, M15/C64274A P.M.&S.Co.1944". (76679-43B)
3599. **LOT OF TARGETS** This is a lot of 14 KleenBore Bad Guy Situation Targets featuring the black and white image of a man aiming revolver and with K5 shaded areas. These Municipal Police Training Council combat targets measure 35"x24" and retain their rolled up shape. Near excellent condition with some wear and creasing along the edges. (76679-53)
3600. **FLARE AND TOY GUN LOT** This is a lot of three items beginning with an unmarked flare pistol requiring mechanical attention and rating about good with moderate oxidation over the gunmetal surfaces. It features a 6" barrel with a poor bore and very good grooved wood grips. Next is a Daisy Detailed Replica of a Walther P38 25 cal. semi-auto pistol. The black plastic surfaces exhibit light handling marks. The other toy is a metal replica of a small revolver retaining about 40% black finish and most of the white "G MAN" logo. It exhibits moderate oxidation spotting over its entire surface. (76679-43B)
3601. **MAGAZINE AND BAYONET LOT** This lot includes four steel 30 rd. 7.62x39 magazines for the AK-47 retaining about 96% blued finish with faint wear marks and light scattered spots of surface oxidation. The magazines come in their original camo pouch rating excellent. Also included is an AK-47 bayonet with scabbard and hanger. The lightly sharpened blade remains bright with light contact wear and the brown plastic grips are fully intact with minor wear. The scabbard retains 98% blue finish with light handling marks. (76679-47A)
3602. **LOT OF MAGAZINES** This is lot of four AK-47 magazines in the original four capacity camo pouch showing fading at its lower half. The magazines exhibit strong springs and retain about 99% blue finish with a few scattered speckles of surface oxidation. These excellent condition magazines appear unused. (76679-47B)
3603. **LOT OF AMMUNITION** This is a lot of 208 loose rds. of 5.56 FMJ with the majority being 1992-dated Lake City head stamps. The ammunition rates very good to excellent with light tarnish on some. (76679-57C)
3604. **LOT OF MAGAZINES** This is a lot of six AR15 magazines by Okay Industries. The .223 Rem. 30 rd. magazines have a mostly gold patina with gray finish in protected areas. There are some with minor handling marks but the overall condition is very good with strong springs. (76679-43C)
3605. **LOT OF MAGAZINES** This is a lot of five 30 rd. .223 Rem AR15 magazines by Adventure Line Mfg. Co. Inc. Overall they retain about 85% gray finish with a couple thinning to the anodized gold and one exhibiting yellow enamel at the floorplate. This is a very good to excellent condition lot overall. (76679-43D)
3606. **LOT OF MAGAZINES** This lot consists of five metal 30 rd. AR15 magazines: (4) by Parsons Precision Products; (1) by Colt Industries. The overall condition is near excellent with minor handling marks to the gray finish. (76679-43E)
3607. **LOT OF MAGAZINES** This is a lot of five 20 rd. magazines for the AR15 that retain about 80% original finish and exhibit light handling marks. The black floorplates indicate all are manufactured by Colt. (76679-43F)
3608. **LOT OF MAGAZINES** This is a lot five metal 20 rd. .223 magazines for the AR15, all with Colt-marked floorplates. The magazines exhibit significant thinning of the gray finish to reveal gold anodized alloy. Magazines seem to function effectively and rate very good overall. (76679-43G)
3609. **LOT OF MAGAZINES** This lot consists of four AR15 20 rd. magazines in very good condition: (3) Colt; (1) Simmonds Precision Industries, Universal Industries Div. The magazines show light handling marks and a mottled gray-gold patina. (76679-43H)
3610. **COLLECTIBLE CATALOG LOT** This is a Peters Ammunition Catalogue No. 40, a terrific publication measuring 10"x7" and likely the 1934 edition. This is a 126 page offering with detailed color illustrations throughout including realistic and accurate portrayals of each cartridge being offered at the time. The beginning pages provide a history and overview of employee lifestyle at King Mills, Ohio where the plant was located. Included is an impressive two-page portrait of the facility and the ensuing pages exhibit actual photos of various departments. The impressive cover is a mottled gray heavy paper with raised letters in the form of gold "Peters Ammunition" including a light blue border. Below that is the company "P" logo in orange and the bottom contains a smaller "Catalogue No. 40". The back cover features a larger company logo. The cover has a few light liquid stains, and some minor creasing and tears where it extends slightly beyond the papers' edge. The spine retains its glue binding and has a small tear at the top and the end paper has a couple of numbers written in pencil. A great addition to any ammunition collection but certainly something to raise your Peters (display) to another level. (76679-18B)
3611. **COLLECTIBLE VINTAGE PUBLICATION** This is a staple-bound booklet with a gray heavy paper cover with raised blue lettering that reads "Colt Fire Arms" in large font at the center and in a smaller presentation at the bottom "The Arm of Law and Order". The 10"x7 1/2" cover opens to reveal an impressive first page that begins with the Colt name logo and below it is "Revolvers and Automatic Pistols" above the illustration of the Rampant Colt and overlapping diagonally positioned revolver and semi-auto pistol. The book contains 40 pages of product information and at the beginning is a summary of the history and impact on the military and law enforcement as well as the "development of mining, cattle raising, agriculture and transportation". The cover shows mild soiling and wear and the pages show a tear and some lesser spotting. Included is a January 1931-dated price list of corresponding items. Also of interest and included in this lot is a mid-20th century era Colt pamphlet titled "Colt handguns today" an eight fold color illustrated offering promoting the handguns available at that time. (76679-18A)

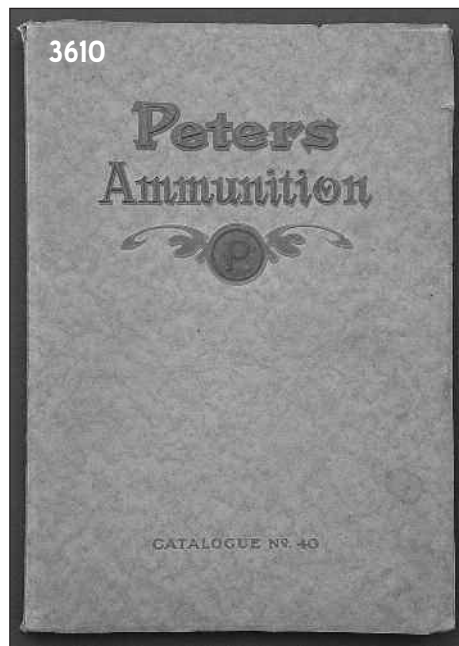

3612. **COLLECTIBLE CATALOG LOT** This is the Savage Firearms and Ammunition catalog Number 63 which has a handwritten "1927" written just below "SAVAGE" as presented in bold black font with gold bordering at the bottom of the cover just below the drawing of a bear in the wilderness. The back cover of this paperback features the iconic Savage logo of the Indian in headdress and extending his Model 99. This is a small (8"x5") staple-bound booklet style catalog that is 32 pages in length and on that last page, an impressive aerial view of the factory and surrounding area is presented. Despite its size, the catalog gives a great overview of the product line at the time with several pages enhanced with illustrations of animals of prey. Included on page 20, which provides the information on the Model 14, is an official company stamp stating in red ink on the otherwise entirely black and white pages: "The Model 14 rifle has been discontinued and replaced by the Model 25." An interesting peek into how updated information was provided during the period. (76679-18C)
3613. **LOT OF COLLECTIBLE BOOKLETS** This lot consists of three vintage UMC/Remington price lists that are essentially pocket sized. The first one is slightly larger than the others, measuring 7"x4" and with a white paper cover with black and red graphics that include "July, 1907/Metallic Cartridges/empty and Loaded/Paper Shells/Primers, Gun Wads/(red dot UMC trademark logo)/Percussion Caps/Brass Shotshells, Etc./Ammunition for Rapid-Fire Guns". Below that is the company name and location. This is a 77 page booklet with some illustrations and hand written notes in red ink. The cover has some penciled in notes and minor creasing and tears. The other two booklets, unlike the one described above, includes the Remington name and are the 1910 and 1911 versions of their price lists and are 71 and 83 pages respectively. Their covers are much more basic, simply exhibiting the year and company logos in red orange. The 1910 issue features a white cover and is a bit cleaner with a price written in pencil on the front end paper. The 1911 year has a light green cover with some modest soiling and extensive handwriting in pencil on the inside cover and extending onto the end paper. The format is similar for both with information provided in a concise manner, using tables in some instances. Some rare items for the UMC or UMC/Remington collector. (76679-18D)
3614. **LOT OF VINTAGE PERIODICALS** This is a lot of several, mostly sporting related examples from the early 20th Century beginning with a September, 1907 issue of The Outer's Book, rating near very good with a small section of the back cover missing as well as a smaller one at the front where a liquid stain can be observed. Next is an April 1942 issue of Outdoor Life, with a tape repaired cover but otherwise excellent and a November 1955 True with a couple of tears and peeling but still intact. Next is a rare item, a November 1925 dated issue of Hunter Trader Trapper, with all 136 pages intact on this very good rating example. Next are four issues of Yank, all from the September, October period of 1943 and rating about very good overall. Also included is an undated issue of National Sportsman, as the covers are missing but the contents rate near excellent. Other items that come with this lot are a couple of recent S&W catalogs, U.S. Navy Ships newsletters, Winchester and Stevens vintage labels, a 1950's political pamphlet, vintage Brunswick Maine Fur Club by laws, gun club documents, 1900 dated Interstate Assoc. booklet, and crisp sales receipts dated 1892. A wide range of interesting materials, most of which show very good condition. (76679-19)
3615. **LOT OF CATALOGS** This is a lot of bulk catalogs for Marlin Sporting Firearms in the following approximate quantities and years issued: (17) of 1973; (50) of 1974; (40) of 1976; (90) of 1978; (40) of 1979. These are all unused with virtually no wear and some showing light evidence of storage in a moist environment. These are staple-bound full size and color publications covering the product line with prices included. (76679-51A)
3616. **LOT OF CATALOGS** This is a lot of bulk catalogs by Remington Sporting Firearms & Ammunition in the following approximate quantities and years issued: (30) of 1973; (70) of 1976; (1) of 1978; (30) of 1979. These full sized, staple-bound publications were never issued individually and as a result show virtually no wear but they exhibit minor characteristics of having been stored in mild humidity. (76679-51B)
3617. **LOT OF CATALOGS** This is a lot of bulk catalogs from three different manufacturers: (8) of 1973 Winchester Sporting Arms & Ammunition measuring 8 1/2"x11"; (approx. 50) of 1976 Winchester Western 1976 Sporting Arms, Ammunition & Reloading Components, Bicentennial Edition measuring 7 1/2"x 5 1/2"; (15) of Browning 1976 measuring 6"x8"; (approx. 45) of Browning 1978 Centennial measuring 6"x8"; (10) of 1978 Savage; (12) of 1979 Savage. These catalogs have no address stickers and are unused with some minor storage blemishes evident on some. (76679-51C)
3618. **LOT OF LITERATURE** This lot consists of several publications with the highest quantities being in the form of catalogs beginning with approximately 40 copies of undated "Smith & Wesson Leather Products" and eight of "S&W Sporting Goods". Also included are six copies of the 1975 issue of "Vermont's Fisheries Annual" and six issues of American Firearms Industry, circa 1977. Also included are some Lyman brochures and law enforcement related periodicals from about that period. The overall condition is very good and apparently unused. (76679-51D)
3619. **LOT OF AMMUNITION** This lot consists of three full 50 rd. boxes of Federal Classic 9mm Luger 115 gr., Hi-Shok, JHP in very good to excellent condition. (76679-48A)
3620. **LOT OF AMMUNITION** This lot consists of three full 50 rd. boxes of Federal Classic 9mm Luger (+P+), 115 gr. Hi-Shok JHP in excellent condition. (76679-48B)
3621. **LOT OF AMMUNITION** This lot consists of four 50 rd. size boxes of Federal Classic 9mm Luger (+P+), 115 gr. Hi-Shok JHP in excellent condition: (3) full; (1) containing 47 rds. (76679-48C)
3622. **LOT OF AMMUNITION** This lot consists of three 50 rd. size boxes of 9mm Luger: (1) full of Federal Hi-Power 124 gr., metal case bullet; (1) full of Federal Hi-Power 147 gr. Hydra-Shok Jacketed H.P.; (1) containing nine rds. of Federal Hi-Power Hydra-Shok J.H.P., 13 rds. of Speer JHP and one of CCI metal case bullet. The overall condition is excellent. (76679-48D)
3623. **LOT OF AMMUNITION** This lot consists of three full 50 rd. boxes of Winchester 9mm Luger Subsonic 147 gr.: (2) Super-X JHP; (1) Jacketed-Controlled Expansion. The ammunition is in very good to excellent condition. (76679-48E)
3624. **LOT OF AMMUNITION** This lot consists of three 50 rd. size boxes of 9mm Luger: (1) of Speer Gold Dot Duty Ammunition, 124 gr., GDHP; (1) full of S&W 100 gr., JSP; (1) containing 32 rds. of Federal Premium 147 gr., Hydra-Shok, JHP, 14 rds. of Winchester Silvertip, JHP, two rds. of Winchester JHP and one rd. of Remington JHP. The ammunition rates excellent. (76679-48F)



3612

3625. **LOT OF AMMUNITION** This lot consists of Federal Premium Personal Defense 38 Special Hydra Shok: (2) factory sealed 20 rd. boxes of 110 Gr.; 30 loose rds. The lot rates excellent. (76679-48G)
3626. **LOT OF AMMUNITION** This lot consists of three full 50 rd. boxes of Yugoslavian-manufactured .45 Auto., 230 gr., FMJ in excellent condition. The white boxes with red and blue stripes have prices written in ink and stickers indicating that the distributor is Century Arms. (76679-48H)
3627. **LOT OF AMMUNITION** This lot consists of two 50 rd. size boxes of Remington 45 Auto. Rim, 230 gr. lead: (1) full older style with green and red print (Index 7545); (1) containing 40 rds. and ten fired cases of High Velocity with green and yellow print (R45AR). The ammunition rates excellent and the second box listed exhibits modest wear. (76679-48I)
3628. **LOT OF AMMUNITION** This lot consists of five 50 rd. size boxes: (1) Dominion 9mm Luger 124 gr., M.C. containing 46 correct rds. and four 1942 dated Defence Industries and of Canadian manufacture; (1) full of Winchester 9mm 115 gr., ball in the white box with "Made in USA" logo; (1) containing 45 rds. of Remington High Velocity 32 Automatic, 71 gr., metal case; (1) containing 35 rds. and 15 fired cases of Remington Kleanbore 38 S&W, 146 gr., lead bullet (torn end flaps); (1) containing 21 correct rds. of Winchester 32 S&W Long, 98 gr., lead bullet and 11 rds. of REM-UMC lead bullet. Also included is one rd. of Eldorado Cartridge Co. 9mm JHP. The overall condition is very good to excellent. (76679-48J)
3629. **LOT OF AMMUNITION** This lot consists of three 20 rd. size boxes of 32-40 Winchester soft point bullet: (1) full of Western 165 gr., Lubaloy rating excellent and missing an end flap; (1) containing 15 rds. of Remington Kleanbore 165 gr., with the box showing tears, wear and ink markings; (1) full tray only with REM-UMC head stamps. The last two rate very good with a small amount of white powder on the tips. (76679-48K)
3630. **LOT OF AMMUNITION** This lot consists of nine full 50 rd. boxes of Winchester Super-Speed 22 LR HP in excellent condition. The boxes are housed in their original brick outer box, which like a few of the smaller boxes shows light mildew stains. (76679-57D)
3631. **LOT OF AMMUNITION** This lot consists of a 500 rd. size brick of Winchester Super Speed 22 LR HP in excellent condition. Upon inspection the boxes are not exactly full but are short, averaging perhaps 48 rds. per box, a possible factory QC issue or simply a case of someone removing them from the slide out trays. In any event, this lot could be summarized as approximately 480 rds. of clean bright cartridges with the outer box and some of the inner ones showing light mildew or foxing. (76679-57E)
3632. **LOT OF AMMUNITION** This lot consists of one full 500 rd. size brick of Remington Standard Velocity Kleanbore 22 LR, coded 6122 and containing ten full 50 rd. size boxes of excellent ammunition. The outer box shows light wear and ingrained dirt and the inner boxes are crisp and clean. (76679-57F)
3633. **LOT OF AMMUNITION** This is a full 525 rd. Golden Bullet Value Pack of Remington 22 LR brass-plated HP in excellent condition. (76679-57G)
3634. **LOT OF AMMUNITION** This 500 rd. size box of Winchester Dynapoint GT Target 22 LR HP, 40 gr., copperplated bullet appears virtually full, with some settling likely having occurred and the ammunition rating excellent. (76679-57H)
3635. **LOT OF AMMUNITION** This lot consists of four factory sealed 100 rd. plastic boxes of Remington High Velocity 22 LR solid bullet in excellent condition and housed in their original factory carry case. The plastic boxes exhibit light foxing along the top portions of the labels. (76679-57I)
3636. **LOT OF AMMUNITION** This lot consists of nine 50 rd. size boxes of Armscor Precision 22 LR High Velocity; 36 gr., HP: (7) full; (1) containing approximately 35 rds.; (1) containing approximately 20 rds. With the exception of about ten cartridges showing surface oxidation at the head stamps, this lot rates excellent. (76679-57J)
3637. **LOT OF AMMUNITION** This lot consists of eight boxes of .22 cal.: (2) factory sealed 50 rd. and (1) containing 20 rds. of CCI 22 LR Stinger; (1) containing eight rds. of I.C.I. .22 LR Mark 2; (1) full 50 rd. of Federal Hi-Power 22 Short Xcess Speed; (1) full 28 rd. of Peters "Thunderbolt" 22 Short; (1) full 28 rd. of Remington "Rocket" 22 Short; (1) full 50 rd. of Western Super X 22 Dummy cartridges with the box having a label affixed that reads "Action Proving Dummy Cartridges" The overall condition of the lot is excellent. (76679-57K)
3638. **LOT OF AMMUNITION** This lot consists of three full 50 rd. boxes of 22 Win. Mag. Rimfire JHP: (1) containing 44 rds. of Federal and six rds. of Western Super X; (1) of Western Super X; (1) of CCI. The conditions range from very good to excellent. (76679-57L)
3639. **LOT OF AMMUNITION** This lot consists of five 50 rd. size boxes of 25 Auto 50 gr. metal case: (1) full of American Eagle in two plastic trays; (1) containing approx. 43 rds. of Federal; (1) containing approx. 42 rds. of Western; (1) apparently full and (1) containing approx. 30 rds. of Winchester Western X. The overall condition is very good to excellent. (76679-48L)
3640. **LOT OF AMMUNITION** This lot consists of five full 40 rd. boxes of Portuguese-manufactured 5.56 mm, 55 gr., ball. The ammunition is contained in buff colored boxes with white seals and black print that includes "LOT FNM-82-16". Four boxes remain factory sealed and one has been opened to reveal cartridges that are bright with isolated tarnish on some. (76679-57M)
3641. **LOT OF AMMUNITION** This lot consists of five full 40 rd. boxes of Portuguese-manufactured 5.56 mm, 55 gr., ball. The ammunition is contained in buff colored boxes with white seals and black print that includes "LOT FNM-82-16". Four boxes remain factory sealed and one has been opened to reveal bright cartridges with isolated tarnish on some. (76679-57N)
3642. **LOT OF AMMUNITION** This lot consists of six full 40 rd. boxes of Portuguese-manufactured 5.56 mm, 55 gr., ball. The ammunition is contained in buff colored boxes with white seals and black print. Five boxes remain sealed and one has been opened to reveal bright excellent cartridges with head stamps "FNM 80-13", as depicted on the labels. (76679-57P)
3643. **LOT OF AMMUNITION** This lot consists of five full 40 rd. boxes of Portuguese-manufactured 5.56 mm, 55 gr., ball. The ammunition is contained in buff colored boxes with white seals and black print. Four of the boxes remain sealed and one has been opened to reveal bright excellent cartridges with head stamps "FNM-80-13", matching the labels. (76679-57Q)
3644. **LOT OF AMMUNITION** This is a lot of five full 40 rd. boxes of Portuguese-manufactured 5.56 mm, 55 gr., ball. The ammunition is contained in buff colored boxes with white seals and black print. Four of the boxes remain factory sealed and one has been opened to reveal bright excellent cartridges with head stamps that match the seals: "FNM-80-13". (76679-57R)
3645. **LOT OF AMMUNITION** This is a lot of four full 40 rd. boxes of Portuguese-manufactured 5.56 mm, 55 gr., ball. The ammunition is contained in plain buff boxes that are sealed with white labels with black stamps that include "LOT FNM 80-13" that match the head stamps as observed in the one box that has the seal broken and containing bright excellent cartridges. (76679-57S)
3646. **LOT OF AMMUNITION** This lot consists of three full 50 rd. boxes of UMC 9 mm Luger, 115 gr., metal case in the yellow box with black print that includes the Remington name and Lonoke AR address. The ammunition rates very good to excellent. (76679-57T)
3647. **LOT OF AMMUNITION** This lot consists of four 50 rd. size boxes of 9mm Luger 115 gr., FMJ: (1) full and (1) containing 24 rds. of Winchester in the white box with USA logo; (1) full of UMC in the yellow box with Remington Arkansas address; (1) full with mixed Winchester and Remington head stamps. The conditions range from very good to excellent. (76679-57U)



3648. **LOT OF AMMUNITION** This is a lot of four full 50 rd. boxes of Olin Winchester 9mm, 115 gr., ball, in the white box with the "Made In USA" logo. The ammunition is in excellent overall condition. (76679-57V)
3649. **LOT OF AMMUNITION** This is a lot of four full 50 rd. boxes of Olin Winchester 9mm, 115 gr., ball, in the white box with the red "Made In USA" logo and in excellent condition with light scattered soiling to the boxes. (76679-57W)
3650. **LOT OF AMMUNITION** This lot consists of four full 50 rd. boxes of Olin Winchester 9mm, 115 gr., ball, in the white box with red USA logo and in excellent condition. (76679-57X)
3651. **LOT OF AMMUNITION** This is a lot of five 50 rd. size boxes of Olin Winchester 9mm, 115 gr., ball, in the white box with red USA logo: (3) full; (1) containing approx. 45 rds.; (1) containing about 30 rds. The ammunition is in excellent condition. (76679-57Y)
3652. **LOT OF AMMUNITION** This is a lot of seven full 20 rd. boxes of Malaysian-manufactured 5.56 mm ball in excellent condition with 1985 dated head stamps. The ammunition is housed in plain white boxes with areas of light grime and with black stamps that also include "M193" and "Lot 14". (76679-57Z)
3653. **LOT OF AMMUNITION** This lot consists of seven full 20 rd. plain white boxes with black stamps that read "20 BUTIR/5.56 MM/BALL M193/LOT 14 MAL 4-85". The ammunition is in excellent condition with very bright cases and the boxes have scattered soiling and a few isolated spots of foxing. (76679-57AA)
3654. **LOT OF AMMUNITION** This lot consists of six full 70 rd. boxes of Chinese-manufactured 7.62x25mm Tokarev with 1987 head stamps and in very good condition. The boxes are plain buff with black stamps of Chinese characters and "7.62/51 (code for steel core)/70". The lot is housed in a green metal U.S. ammunition can. (76679-57AB)
3655. **LOT OF AMMUNITION** This lot consists of six full 70 rd. boxes of Chinese-manufactured 7.62x25mm Tokarev with 1987 head stamps and in very good condition. The boxes are plain buff with black stamps of Chinese characters and "7.62/51 (code for steel core)/70". The lot is housed in a green metal U.S. ammunition can. (76679-57AC)
3656. **LOT OF AMMUNITION** This lot consists of seven full 25 rd. boxes of 1949-dated Fabrique National with white labels that include "7.92 SS". Six of the boxes remain mostly sealed, with a few scattered splits. The opened box reveals very good to excellent condition cartridges and the lot comes in a green U.S. military can originally marked for .45 cal. (76679-57AD)
3657. **LOT OF AMMUNITION** This lot consists of eight full 25 rd. boxes of 1949-dated Fabrique National with white labels that include "7.92 SS". Seven of the boxes remain mostly sealed, with a few scattered splits. The opened boxes reveal very good to excellent condition cartridges and the lot comes in a green U.S. issue ammunition can. (76679-57AE)
3658. **LOT OF AMMUNITION** This is a lot of 30 total rds. of vintage ammunition with head stamps "DWM K K 358C". Twenty of them are housed in a 20 rd. box with a front portion of the sealing label that includes "Patronen No. 358c mit Rand/zum Mannlicher-Gewehr/8x50/Rundkopf-Geschoss Nr. 113A 8-32/Ladung 2,70 gr.Rottw. P. Nr. 5/ohne Laderahmen Normalladung/Made in Germany". The other ten come in correct five rd. stripper clips. The round nose cartridges and the box itself are in very good condition with a few on the stripper clips showing dings. (76679-57AF)
3659. **LOT OF AMMUNITION** This is a lot consisting of a wide range of military cartridges beginning with 36 rds. of 7.62x51 on M60 disintegrating links with five being blanks and the balance fired blanks. Next is a ten rd. stripper clip of 5.56 blanks and another clip with six blanks and two cartridges of 5.56. Next are three full ten rd. stripper clips of 7.62x39 Soviet and the last category is a zip-loc bag with approximately 45 rds. of military cartridges and a few fired cases. The majority of the cartridges are 7.92x57 and the overall condition of the lot is very good. Included is a metal military ammunition can. (76679-57AG)
3660. **LOT OF AMMUNITION** This lot consists of approximately 220 linked rds. of 7.92x57 in very good to excellent condition and enclosed in a metal military ammunition can. The head stamps indicate that this was manufactured in Egypt in 1957. (76679-57AF)
3661. **LOT OF AMMUNITION** This lot consists of 13 boxes of a variety of military calibers: (4) full 15 rd. and (1) containing eight rds. of Egyptian-manufactured 7.5 MAS dated 1957; (4) full 15 rd. and eight loose rds. of Sellier & Bellot 7.62x52 dated 1954; (1) full ten rd. in five rd. stripper clips and a label that includes "8 mm M. 30 scharfe/S-Patronen/Rottw./XI 1938" (all over a large S); (2) full 15 rd. and (1) containing four rds. of 8mm with labels that include "Fur MG" and over it in smaller font "fva 5 L 1943". The ammunition rates very good overall. The boxes have liquid stains with a few showing hand written identification and tape. The lot is housed in a green military ammo can. (76679-57AG)
3662. **LOT OF AMMUNITION** This lot consists of 13 containers: (6) full 16 rd. boxes of 9mm Makarov in plain buff boxes and head stamps "71/88"; (1) containing 39 rds. of Russian-manufactured 1951-dated 7.62 Russian Tokarev on eight rd. stripper clips; (1) strip-clip containing nine rds. of Winchester 7.63x25 Mauser JHP; (1) full ten rd. clip of 7.63x25 Mauser FMJ with head stamps "11/87"; (1) clip containing eight rds. of 7.63x25 Mauser FMJ with illegible head stamps; (1) full 15 rd. box of 1985-dated Yugoslavian 7.62 Metak; (1) full 50 rd. box of Evansville Ordnance Plant .45 ball (1) box containing about 30 fired cases of 1943-dated Evansville Ordnance 45 cal. The conditions of the items in this lot range from near very good to excellent and are contained in a metal military ammunition can. (76679-57AH)
3663. **LOT OF MAGAZINES** This is a lot of five, blued, steel, seven rd., 45 ACP magazines with finish retentions between 85%-98%. These unmarked magazines are in very good overall condition. (76679-43I)
3664. **LOT OF MAGAZINES** This lot consists of four blued steel magazines: (2) seven rd. .45 ACP by Check-Mate Industries with base plates marked "19299/ASSY 5508694/MFR. 1M291" retaining about 96% finish with one fading to plum in areas; (1) unmarked two tone seven rd. 45 ACP with mild contact wear; (1) unmarked 25 cal. with plastic floorplate and rating near excellent. (76679-43J)
3665. **LOT OF PRIMERS** This is a full brick containing ten inner boxes, each housing 100 Federal No. 150 Large Pistol size primers and in excellent condition. (76679-40C)
3666. **LOT OF PERCUSSION CAP AND PRIMER TINS** This is a total of 20 collectible tins from several manufactures including Eley, UMC, Winchester, United States Army Caps, Peters, Holmes Booth & Hayden's, Wolcotville and Hicks. Some are housing caps including originals and many are empty. The conditions range from good plus to very good. A great way to start or add to a percussion cap or antique accoutrement collection. (76679-27A)
3667. **LOT OF PERCUSSION CAP AND PRIMER TINS** This is a total of 20 collectible tins, many with the original or substitute caps enclosed and in about very good overall condition. Examples are U.S. Military Musket Caps, UMC Nitro Primers No. 8 1/2, UMC No. 2 primers, U.S. Army Caps, Hicks, Eley and Atlas Blasting Caps. A great way to begin or augment an existing tin collection. (76679-27B)
3668. **LOT OF TINS** This lot consist of twenty collectible tins, including some for blasting caps with examples being Dupont No.5, Atlas No.6, Hercules No.8 and American No.6. Also included are U.S. Military Caps, U.S. Percussion Cap Association of France, U.S. Army Caos, Cox's, J. Goldmark's and UMC. (76679-27C)

3669. **LOT OF TINS** This lot consists of 20 collectible tins, including some for blasting caps with examples being Lion Brand, Atlas and M.C. Mfg. Works. Also included are cap tins, some with contents and by makers UMC, J. Goldmark, Winchester and Hicks. Also noteworthy is a Peters No. 2 Primers and an Alcan. Co. made in France with several enclosed. The conditions vary but overall the lot rates very good. (76679-27D)

3670. **LOT OF TINS** This is a lot of about 25 items in about very good overall condition including tins for BB Caps by Alcan and of Italian manufacture, RWS, Vorderlader Zundhutschen, some with caps enclosed, blasting caps by Trojan, Austin and Hercules. Also included are manufacturers UMC, Winchester and Navy Arms. (76679-27E)

3671. **LOT OF POWDER TINS** This is a lot of two collectible tins each measuring about 3 1/2"x1 1/2"x 4" beginning with one by Canadian Industries Limited with a front that identifies it as Black Sporting Powder Snap Shot with the image of the just-shot duck over the marsh. It features bold colorful graphics consisting of a black backdrop to a red and yellow circular identification: "Black Sporting Powder/Snap Shot" and what appears to be the original cap. Also evident is a dent in the rear which features the CIL logo and a scratched in name and date on the bottom. The second one is in a slightly lesser state of condition with a paper label that is 90% intact and reads "American Powder Co./Dead Shot Rifle/F.G.". This is a red can retaining about 90% finish with most loss due to contact wear. There is no cap present. (76679-25A)

3672. **LOT OF POWDER TINS** This is a lot of two collectible cans beginning with a red bodied example by Oriental Powder Mills of Portland ME. It features black and white labels that are virtually fully intact including a front one with the illustration of a couple of duck hunters and their dog in the foreground of an aquatic habitat with ducks in flight. The diamond shaped rear label identifies this as Wing Shot Powder No. 3. This example comes complete with cap and shows mild handling marks and surface oxidation in isolated areas. The other can is a forest green with a front label that is separating in areas and exhibits a duck in flight over a body of water and a periphery that reads "Snap Shot/Manufactured At Warren Powder Mills.". The back label shows more aging and identifies this as No. 2 Grain. A desirable tin with scattered handling marks and complete with cap. (76679-25B)

3673. **LOT OF POWDER TINS** This is a lot of two tins beginning with an American Powder Mills example that measures about 3 1/2"x1 1/2"x4" with a red body with cap included and front and rear labels with the illustration of hunter walking through forest with dog and text stating that this is "Triple Refined Dead Shot Sporting Powder. Manufactured by the American Powder Mills". The front featuring the image of Indian with headdress as part of a full color illustration indicative of "Indian Rifle Gun Powder" and "Manufactured By The Hazard Powder Company". The oval-shaped back label informs that this is "Hazard's Gunpowder/FFF G/New York". There is no spout or cap present on this desirable can. (76679-25C)

3674. **LOT OF POWDER CANS** This is a lot of two Smokeless Powder 1 lb. examples by Dupont. The first one is forest green in color with scattered minor handling marks and crazing noticeable along the periphery of the top and bottom which also exhibit the illustration of the dogs in forest above "Smokeless Powder" and "Directions for Loading" respectively. The second one is identical in shape and size, this one being a red color with image of buck on the top and the bottom exhibiting "Smokeless Rifle Powder/No.1" at the upper section. This one shows less handling marks, scattered dark spotting and a hand written mark on the bottom. Each is complete with cap. (76679-25D)





3675. **LOT OF POWDER CANS** This lot consists of two vintage cans beginning with a rectangular 4"x1 1/2"x7" example by John Hall & Son. This is a burgundy-colored tin with the front label also stating that it is "The Rifle Gunpowder" and "Purposely Prepared & Adapted to Rifle & Percussion Guns of Every Gauge". The back label adds "Under the Patronage of H.R.H. Prince Albert". The second is ovular in configuration, a bit shorter and with spout cap. Based on the bright red bottom panel this one exhibits a faded body with moderate flaking. The large paper front label is nearly fully intact and reads "Eagle Gun Powder/Duck Shooting/No.2/Dupont/Wilmington Delaware". A nice pair to add to your powder can collection. (76679-25E)



3676. **POWDER CAN LOT** This is a rare salesman's sample of Hazard Smokeless with the bottom label also adding "For Shotguns Only". This is a 2 1/2" x2" drum shaped tan or copper colored can with a gray stripe along the center perimeter and exhibiting a few minor handling marks. The top cleverly exhibits a faux cap with a small circular seal affixed. Very good to excellent overall condition. (76679-25F)

3677. **POWDER CAN LOT** This is a lot of eight cans, five of which measure approximately 3 1/2"x1 3/4"x5", all by Dupont and consist of the following powders: Pistol Number 6, Sporting Rifle Number 80 (qty. 3) and Military Number 21. The next two are slightly smaller and feature the wreath bordering the red and white striped flag with one identified as Dupont and the other, Hercules. The last can in the lot is also Dupont, still smaller and unlike the others, has rounded corners and features the old style label with the Indian in hunting mode, the back reads FFFg. Each of the cans comes with original cap and the overall condition is very good with some having hand written markings, fading and general handling marks. (76679-25G)



3678. **LOT OF POWDER TINS** This lot consists of three with black surfaces with caps included, beginning with a Hazard Powder Co., J.C. Loverin Agent, size 1/2 lb. with a faded gold ID and minor dings and handling marks. The second one has no discernable ID but is likely the 1/4 lb. size version of the one described above. This has considerably less black finish retention, or approximately 40% as opposed to the 97% of the other one. The third one is 7" tall, has no discernable markings and exhibits moderate flaking on one side and scattered minor dings and handling marks. It comes with a reproduction Eagle Sporting Gunpowder label in excellent condition. (76679-25H)

3679. **LOT OF POWDER TINS** This is a lot of two vintage tins beginning with one by American Powder Mills: a red can measuring 4"x1 1/4"x6" that shows significant crazing and fading causing the lithos to be barely discernable but a vague image of the duck in flight is present on the front, as is "Dead Shot". The back circular image likely originally depicted the hunter in forest scene and the top which includes brass cap, "FG". The second item also exhibits a red surface, this one without crazing but retaining about 70% with the bottom panel retaining 20% black finish. The front panel retains about 85% of its graphics with loss due to handling marks and fading and indicates that this is an example by Mass. Powder Works with text including "A.C.Fay.Potter&Cilley./Officer 14 City Wharf./Boston". This is a small rectangular tin measuring 3 1/4"x1 1/4"x4" and missing the cap. An opportunity to acquire a couple of uncommon items. (76679-25I)

3680. **LOT OF POWDER TINS** This lot consists of three cans with ovular configuration beginning with a Laflin & Rand Smokeless Powder for Shotguns with a crazed and mottled olive green and off-white finish including the image of the striped flag with wreath border on the front and extensive instructions on the rear. The top and bottom retain most of their gold finish and there is some white discoloration around top and bottom seams. The other two are by Hazard with the first being a small red tin with a nearly fully intact white label with hunter taking a shot with dog at his side and above it reads "Kentucky Rifle Gunpowder G". The can retains about 80% finish with loss due to handling marks and some oxidation at top seam. The last one is taller (6") and features a strong green surface and front ID section accented by illustration of duck hunter having much success and stating that this is Hazard Smokeless for Shotguns Only. The back has a healthy loading instructions section and a included is a nice brass cap bringing the condition of this can to near excellent with the other two which also include caps come in at about near very good. (76679-25J)

3681. **LOT OF POWDER CANS** This lot consists of three cans by different manufacturers starting with a small round one with fancy bordering around "Superior Rifle Gun Powder" to a nice orange background and with a red top area showing moderate handling marks. The second one is more ovular in design but with the same color scheme and reading on the front which features an impressive close-up image of dog: "Imperial Gun Powder", and the back reads "Manufactured by Eureka Powder Works New Durham N. H.". The third one is taller, that being 5 1/2" to the other's 3 1/2" and with a red background to an impressive large image of falcon as the focal point of this Oriental Powder Mills Falcon Duck Powder of Boston, Mass. The back exhibits a bright royal blue logo that reads "Falcon Duckling No. 3 Gunpowder". The can exhibits modest handling marks and moderate black spotting, perhaps grime. The cans are missing the caps and the first and third in this lot are also missing the spouts. (76679-25K)

3682. **POWDER CAN LOT** This is a large red can that is 7 1/4" tall with a diameter of 6 1/4" and a fully intact white label that includes "Rifle/Cartridge Powder/Manufactured expressly For Loading Cartridge Shells/(image of lever rifle)/(image of cartridge with "U.S. Govt. 45" enclosed)/By the/American Powder Mills/Boston Mass.". The label also exhibits brown stains resulting from oxidation occurring in that area which also includes a small whole. The balance of the can shows scattered handling marks and oxidation pitting with the greatest amount at the seam. The top has less blemishes and includes original cap. (76679-25L)

3683. **LOT OF POWDER TINS** This is a lot of three of similar size, (approximately 5"-6" in height) and beginning with a dark green example with a label that reads "Dupont Superfine Fg Gunpowder /Wilmington Delaware". The label shows extensive staining from underlying oxidation that is also noticeable throughout much of the surface. This one has no spout or cap. Second is a better condition orange colored tin with strong black print that includes "Shotgun E.C. Powder./Manufactured By The American E.C. Powder Co. Works Oakland, N.J.". Can includes spout cap and about half of the top sealing label, bringing the rating to near excellent. The last one is a bright orange with detailed forest scene including deer, raccoons and dog. The text read "Prepared & Adapted to Rifle Percussion Guns". The top portion includes a red surface with scattered handling marks, spout and no cap. The wraparound label is excellent but provides no maker name. (76679-25M)



3684. **LOT OF POWDER TINS** This is a lot of three beginning with a 4" tall oval shaped example with a black body and faded identification that retains enough of the bottom section to indicate that this is by Stryon & Co. and a middle section with intersecting long arms in the form of an X. Also evident are handling marks and a bent spout with cap attached. The next one is about an inch taller with the same general shape and less black finish. Still attached is a round white label with black print that reads at the top "American Rifle Gunpowder/Lafkins, Smith & Boies" and "Successors To/Lafkins & Smith", with the illustration of the man standing by his dog. This one also includes spout cap. The last one is round with no cap present and no maker name on label that reads "Prepared & Adapted to Rifle Percussion Guns". The label shows moderate black staining, likely from contact with some liquid and the red top retains about 60% red finish with loss due to contact wear. The overall condition of the lot is good to very good. (76679-25N)
3685. **LOT OF POWDER TINS** This lot of three begins with one with an orange wraparound label that reads "Imperial Gun Powder" on the front and the back indicates that the manufacturer is Eureka Powder Works of New Durham N.H. The can has a red top and shows only light edge wear and no cap is present. The next one is Kentucky Rifle Gunpowder by the Hazard Powder Co., a once black finished tin that is now almost entirely bare metal with scattered light oxidation spots and a faded label with the picture of the hunter aiming his gun with dog in full stride. The cap is included with this one. The last one, unlike the others which have an oval form, is designed with sharp edges and is taller, measuring 7" in height with a red body and orange label that reads "Mathewson's FFF Gun Powder". This one retains about 95% finish but not its spout or cap. (76679-25P)
3686. **LOT OF TINS** This lot of two tins begins with a large, approximately 6 lb. size Dead Shot Gunpowder can by H. Howell & Co. with about 85% black finish retained and showing small dents and dings. Much of the gold identification has faded or worn away and the cap is included. The other tin is for Pastime Plug Tobacco, a red box measuring 12"x9"x4" and featuring an illustration of hunter in field shooting birds of prey with dog by his side. This box by John Finzer & Bros. of Louisville, KY. opens to reveal a colorful equestrian scene on the interior lid and retains the three brass hooks. There is some edge wear and the lid front has a somewhat wavy profile. A nice looking box that will fit in nicely with a gun powder can or sporting display. (76679-25Q)
3687. **LOT OF POWDER TINS** This lot of three 1 lb. tins starts off with a Hazard Powder Co. identified as Duck Shooting Gunpowder on the nearly fully intact label depicting duck in standing position. The back label is about 50% present and the can has no cap and several handling scratches dings and dents. Next is a New York Sporting Powder by Laflin & Rand with yellow-orange label of waterfowl in habitat and exhibiting significant peeling to back side. The top exhibits moderate oxidation including the cap. The last one shows moderate crazing to its mottled olive green and tan surfaces allowing for little in the way of discernable text. It is clear that this is Hazard Smokeless and the tin retains its cap. A good plus to near very good condition lot overall. (76679-25R)
3688. **POWDER CAN LOT** This is a 6 1/4 lb. size with a body that retains about 30% faded red finish with the top showing mostly a mottled faded thin paint, surface oxidation and bare metal. The bottom retains about 50% bright red with the balance in the white and bears about 80% of the original label. The faded white label with black print features the picture of the dog in pointing mode and above it is "Telegraph Sporting Gunpowder" and below is "Amer. Powder Company/Henry J. Hosmer,Treas.". Included is the spout cap. (76679-25S)
3689. **LOT OF POWDER TINS** This lot consists of four cans. First is a 1 lb. size Hercules Powder Black Sporting with a very good label with the trademark image of the Greek god with club over shoulder. The can has very few handling marks with scattered grime and original cap. The other three in this lot are smaller 1/2 lb. size beginning with an "Orange Extra Sporting" by Laflin & Rand of New York, a mostly tan color with moderate crazing and a discernable striped flag logo and an oxidized cap with logo. The next one also states that it is Orange Rifle Powder, also by Laflin & Rand, this one stating Newark and with cap, but this one being in a lesser state of condition with the label mostly a mixture of dark brown and off white with metal surfaces exhibiting an almost even brown oxidation. The last one rates about good with no spout or cap present and about 50% of a front label present and peeling. The metal surfaces exhibit a mottled thinned and faded black finish and bare metal. The label indicates that it is by Hamilton Powder Co. (76679-25T)
3690. **LOT OF POWDER TINS** This is a lot of four 1 lb. cans beginning with a Dupont with a fully intact label with illustrations of animals at each corner and oval interior section stating that it is Superfine FF Gunpowder and manufactured in Wilmington, Delaware. It retains its original cap, 99% red finish and has a large dent to the back panel. Next is a red body can with cap and mild flaking and oxidation with a very faded identification that includes "Boston Sporting Powder" and "Faneuil Hall Sq.". The last two are of a more rectangular configuration as opposed to the previous two with a more oval design with both having spouts and caps intact. The first of these has a diamond shaped label over a red painted surface that exhibits considerable wear and or flaking with light oxidation forming along the top. The label is a mottled tan and gold and includes "Laflin Rand Powder Co. The last one retains only about 10% red finish and a portion of the label indicating that it is also a Laflin & Rand product. (76679-25U)
3691. **WOOD POWDER KEG** This is a 6 1/4 lb. size measuring 9"x6 1/2" with a fully intact white bottom label with black print that features the illustration of hunter with dog and hilly background. Bordering that is "Kentucky Rifle Gunpowder FFG" and "Manufactured at Hazardville, Conn. by the Hazard Powder Co.". The label shows only light foxing and the keg has a small piece cut out of the top wall and rates very good to excellent with minor handling marks and is missing three lower support bands. There are holes at the top and side but no caps included. (76679-25V)
3692. **LOT OF WOOD CRATES** This is a lot of two vintage crates each measuring about 14"x9"x8 1/2" with the first being of finger joint construction by Robin Hood Ammunition Co. with front and rear panels exhibiting the company logo at the center and above it is "Loaded Shot Gun Shells". The sides add that it is "500 16 Ga. Indian Black Powder". This is an excellent box with strong black stamps. The other one is in a lesser state of condition with darkened panels and some mild mildew staining. It is a nice collectible nevertheless, it being a hard to find example by the United States Cartridge Co. with the New York address. The box is bound by nails and retains most of the stamping including red company logos and black text identifying it as "12 Ga. Shot-Shells". A couple of rare boxes available in a single lot. (76679-25W)
3693. **LOT OF TRENCH ART** This lot consists of three brass pieces that would make great vases or display pieces. Each has bases of approximately 3 1/2" with the first two measuring about 13" in height with tapered and "scalloped" lower sections. The first one has a dark patina with an oak leaf and acorn motif and above it in large font is "France 1918". The second one has a lighter tone and also includes an oak and shield motif alongside intersecting flags and above them is "Franco-America". The shield includes "Alsace 1918". The third one is shorter (9" tall) and plainer with a ribbed top area and the base is marked "St. 174", "JULI", and "Ke" below a crown. (76679-31A)
3694. **LOT OF TRENCH ART AND PROJECTILES** This is a lot of eight decorative pieces that could be added to a display, with some of the items converted into specific items. First is a pen holder with a round wood base holding eight linked cartridges with nickel casings around a larger centerpiece cartridge. Next is a shell measuring eight inches in height that has been transformed into a coin bank and marked "1 1/2" Shell Bank" with a vertical slot at the head. There is also a similarly sized example with decorative heart with arrow and period "courters". Also included is a nickel paperweight and three decorative cartridges. The last item is has a 12" long hinged two-piece wood base holding 20 fired casings. All cartridges are inert in this diverse lot. (76679-31B)
3695. **LOT OF GUN CARE ITEMS** This lot consists of a range of mainly maintenance and cleaning supplies. First is a group of five period oil cans, mainly empty and for collector purposes with four being 3 oz. size and from Remington, Winchester and Hoppe's, with a larger one by H.S. Howard. Next are unused tubes of Gunslick and Rig, an excellent four-piece brass cleaning rod for rifles and about 15 additional pieces of cleaning accessories and tools. The lot is contained in a metal military ammunition can. (76679-46A)

3696. **LOT OF BINOCULARS** This is a set of vintage Carl Zeiss binoculars with original leather strap and carry case. This is a small pair measuring 4" in length with the left side of frame marked in script "Carl Zeiss Fena/DRP". The optics remain crisp and the overall condition is near excellent with the case showing mild handling marks. (76679-30A)
3697. **LOT OF BELT BUCKLES** This lot consists of two vintage German brass belt buckles marked "Gott Mit Uns" above the crown motif on each. The belts rate very good to excellent with very light isolated verdigris. (76679-30B)
3698. **LOT OF CLEANING KITS** This is a lot of two rifle cleaning kits in original metal cases beginning with a Marbles U.S.A. No. 99, an unused and excellent condition four piece brass in self-contained case with screw on cap. The second one is a German K98 cleaning kit rating near very good, showing mild use and the case showing areas of oxidation with pin prick pitting and handling marks. (76679-30C)
3699. **LOT OF ART AND LITERATURE** This is a diversified lot beginning with a Remington wall calendar for 1975 featuring 14 reproductions of full color events and endeavors of the wild west. Next is a six piece ensemble titled "A Collection of Colt Historical Prints 1836-1873" with sleeve and envelope. Also included is another set with envelope marked "Second Printing Nov. 1936 Set no. 73/100 6 pc." and signed "Geo. T.". Next is a copy of Sid Latham's Great Sporting Posters of the Golden Age, a compilation of 23 full-color framable posters and dated 1978. Also included is a copy of the July 12, 1963 issue of Life Magazine featuring Steve McQueen on the cover. Next are two wall posters featuring an arrangement of pins, metals and trinkets celebrating gun powder, shotshells and other gun related items. The last category are some partial issues of 1892-dated Forest and Stream periodicals. The conditions of the items in this lot range from about good plus to near excellent with the main negative being foxing on some. (76679-19Z)
3700. **LOT OF MEMORABILIA** This lot consists of a wide range of items beginning with a 1958-dated Winchester Retail Price List with the front cover consisting of the popular illustration of the hunters gathering wood and making breakfast with deer in background. The staple-bound 41 page booklet rates very good with minor tears and some black discoloration along the top. Next are four small cardboard targets by Robin Hood with company logo and images of cartridges featured. Next are about 20 Daisy Air Rifle targets and a metal retail counter display for J.C. Higgins 22 cal. ammunition. Also included is a hinged two-piece wood box marked "Westchester Trading Post" and constructed to house 50 rds. of .22 cal., of which 43 mixed rds. are now stored. Next is a small key chain size flashlight in the form of a Winchester shotshell, which is also the form of an included lapel pin in original display card. Also included are two U.S. Navy coat buttons, a DWM key chain and a S&W medallion. (76679-19Y)
3701. **LOT OF GUN PARTS** This is a lot of parts for Colt including a partial conversion kit with no slide or barrel but with three extra springs and a set of plastic grips for the 1911. Also included are three sets of grips for Single Action Army ranging from good to very good with one showing several cracks and the others with mild wear. Also included is a set of S&W med. frame and a set of white plastic revolver grips. The last item is a 22 mag. cylinder in excellent condition. (76679-43K)
3702. **LOT OF GUN PARTS** This is a lot of AR-15 conversion parts including an adaptor and three white plastic 22 LR magazines. Adapter seems to function properly and is marked "Conv. Kit: M261". The magazines are very good with mild ingrained dirt and grime. (76679-24)
3703. **LOT OF GUN PARTS** This is a lot of MP40 parts consisting of two bolts with pins, three spring guides, three front tubes, three middle tubes, one firing pin and one outer firing pin coil spring. The overall condition is very good. (76679-45)
3704. **LOADING PRESS LOT** This is a Dillon RL550 version 7 that seems to function properly and is in excellent condition and is missing some components but does come with 9mm dies. Manual and paperwork are included. (76679-34A)
3705. **LOT OF DIES** This is a lot of two sets of reloading dyes consisting of a four piece 44-40 WCF by RCBS attached to Dillon Precision tool head stand with locator buttons and a four-piece 45-70 Govt. with stand, buttons and shell holder. Excellent condition lot. (76679-34B)
3706. **LOT OF DIES** This lot consists of two separate Dillon reloading four dye sets, each with Dillon tool head stand, locator buttons and shell holder for 45 ACP and 45 Colt and in excellent condition. (76679-34C)
3707. **LOT OF DIES** This lot consists of two separate die sets, each with Dillon tool head stand, locator buttons and shell holder: (1) four dye Redding 38-40 Win; (1) three dye RCBS 32-40 WCF. The lot is in excellent condition. (76679-34D)
3708. **LOT OF DIES** This lot consists of two separate die sets, each with Dillon tool head stand, locator buttons and shell holder: (1) four dye Redding 32-20 Win.; (1) three pc. RCBS 38 Spec. The lot is in very good to excellent condition. (76679-34E)
3709. **RELOADING LOT** This lot begins with an RCBS Model 5-0-5 reloading scale that appears complete and unused and in original box with papers. Next is an RCBS 3 die set for 9mm Luger in original plastic case with papers. Lastly are several components and parts for a small Dillon Precision loading press. The overall condition is excellent. (76679-34F)
3710. **LOT OF POWDER TINS** This is a lot of three flask shaped 1/2 lb. sized tins beginning with a Hercules Black Sporting, an attractive gold colored example with a strong front illustration with a small hole at its bottom. The back has a darker mottled gold with some small dents and light surface oxidation. The next one has a brown surface with moderate flaking leaving a spotted patina and the label is nearly fully intact with a very darkened tone causing the text and illustration to be somewhat obscured. It does indicate that this is Boston Sporting Gunpowder and "A.G. Fay, Agent" and "City Wharf" and like the one listed above comes with cap. The last item in this lot does not include a cap and exhibits a mottled dark gray and brown patina with a few small dents. It features a brass oval ID plate stating that it is by Hazard Powder Co. (76679-25Y)
3711. **POWDER CAN LOT** This is a large, bright green, drum-shaped can that is 11"x9 1/4" by Oriental Powder Mills of Boston. The top retains two circular labels, each indicating that it is Western Sporting Gunpowder with the smaller black one adding that it is "1FG". Also noteworthy is that there is no cap present and between the labels is a very good stamp: "31/59". The bottom retains a larger black label that reiterates the others and adds "FF" and "G" within shield backdrops. The near excellent condition drum retains about 90% green finish with most loss occurring at the rib extensions and showing light scattered dents. (76679-25Z)
3712. **POWDER CAN LOT** This is a large drum shaped tin measuring 11"x9 1/4" with a green finish fading and thinning to a whitish tone and mixed with scattered spots of brown oxidation. The can has a round white bottom label identifying this as "Sporting Powder" and manufactured by D.H. Bisbee of Camden, ME. The wall shows a small label with an orange border that reads "Snap Shot #2 and the bottom has a red circular one that reads "Snap Shot Number 2 Grain". The can retains its original cap and the top shows scattered flakes of bright orange paint affixed to its surface. (76679-25AA)
3713. **LOT OF TOOLS** This is a lot of two vintage tools beginning with a British Pattern No. 1 Privates' Wrench (combination tool) for the 1853 Enfield that is now a mainly mottled smoky gray and bare metal patina with minor usage marks and complete with wiper, cone pick and fluted thumbscrew and oil dripper. The second item is a vise and quite possibly a mainspring vise with a simple wing nut adjustment capability and overall very good with a dark brown patina and mild edge wear. (76679-60A)
3714. **LOADING TOOL LOT** This original Winchester 44 W.C.F. tool retains about 30% original blue with the metal surfaces exhibiting a smoky gray patina with the handles mainly a gray and pinprick pitting occurring along the left side. The mechanism functions properly. (76679-60B)

3715. **LOADING TOOL LOT** This original Winchester 32-40 tool retains about 20% finish with the surfaces showing a mottled smoky gray and bare metal patina. The tool operates correctly and retains sharp checkering. (76679-60C)
3716. **LOADING TOOL LOT** This is an original Winchester loading tool for .38 W.C.F. that retains about 80% blue with loss due to scattered oxidation with markings remaining crisp. The tool comes with two powder measures and original de-capping pins marked 32W and 38W. The items are housed in the original factory box showing a liquid stain and a couple of separated corners. (76679-60D)
3717. **LOADING TOOL LOT** This is a Nye Creaser Crimper used for shotshells. This one is marked "10" and with an 1884 patent date. It retains about 85% of its copper-colored finish with loss due to wear, particularly at the handles, including the right side where there is green discoloration. This rare item comes with its original box lid with soiled label fully intact. (76679-60E)
3718. **BULLET MOULD LOT** This is an original Winchester 44 W.C.F., two groove, single cavity, flat nose bullet mould. The sprue cutter functions properly and the cavity is clean of debris. There are peen marks noticeable on the side of body and the wood handles and brass hardware rate very good to excellent. (76679-60F)
3719. **BULLET MOULD LOT** This is a Winchester 38 W.C.F., two groove, single cavity, flat nose bullet mould. The sprue cutter functions properly and the cavity is clean of debris. The metal surfaces retain about 90% blue with most loss due to oxidation staining and the wood handles are excellent. (76679-60G)
3720. **LOT OF BULLET MOULDS** This lot of two begins with a Colt mould marked "44H", a 5" long example retaining about 85% blue with peen marks evident on the body. This is a dual cavity single groove conical and ball mould. The second is a 7" unmarked brass bodied, dual conical and ball cavity .38 cal. with scattered peen marks on the mottled goldenrod and ochre surfaces. (76679-60H)
3721. **LOT OF BULLET MOULDS** This lot of two begins with an unmarked 4 1/4" mould with a brass body showing mild peen marks and a little pitting occurring. It is round dual cavity for .31 cal. Next is an unmarked four round cavity mould for .25 cal. rating good to very good with scattered oxidation and pitting. (76679-60I)
3722. **KNIFE LOT** This spring operated switch blade has no maker markings and measures 11" with a 5 1/4" blade with a ricasso marked "Rostire Import". The unsharpened blade is bright with a few minor scratches and the stag handles are excellent. This is available to N.H. residents only. (76679-29A)
3723. **KNIFE LOT** This spring operated switch blade has no maker markings and measures 10 3/4" with a 5 1/4" blade with a ricasso marked "INOX". The stainless steel blade has been lightly sharpened and remains bright with a few minor marks. The faux mother-of-pearl handles exhibit only very light handling marks. The spring shows the onset of light surface oxidation. This is available to N.H. residents only. (76679-29B)
3724. **LOT OF KNIVES** This lot consists of two switchblades beginning with a 7" long example by Schrade Cutlery Company of Walden N.Y. The spring activation will require mechanical attention and the sharpened 3 1/4" blade exhibits scattered dark spots with an emphasis at the ricasso and the edge shows a small chip. The brown and tan celluloid handle is very good with a chip at the top right panel. The other one is 8" long with a 3 3/4" blade marked "Rostfrei" (stainless) that is lightly sharpened and remains bright with a few minor contact marks. The faux mother-of-pearl also have light marks with the right side having been personalized with "Redbone" and a couple of symbols scratched in. This lot is available to N.H. residents only. (76679-29C)
3725. **LOT OF KNIVES** This lot consists of two switchblades beginning with one that is 7" in overall length including a 3 1/4" blade with a ricasso marked "B Cutlery/Italy". The sharpened blade has some minor scattered dark surface staining and the wood handles rate very good with light handling wear. The second one has no maker name and measures 8" in overall length, with a bright 4" blade that is marked "rostfrei" (rust free) that has been lightly sharpened and shows several light scratches. The impressive dark brown wood panels show only very light handling marks. This lot is available to N.H. residents only. (76679-29D)
3726. **KNIFE LOT** This is a Camillus Vietnam era U.S. Air Force pilot's survival knife measuring 9 1/4" in overall length with a 5" blade that is mainly a smoky gray with a sharpened blade and the serrated portion having smoothed considerably. The grooved leather handle shows a few minor handling marks and the included original sheath is supple with creasing occurring and the back is scratched "RN". The brass hardware has moderate verdigris occurring. (76679-29E)
3727. **KNIFE LOT** This is a reproduction Remington R1173 "Baby Bullet" folding knife with two stainless steel blades marked "1983" and "R1173" respectively and is equipped with a jugged brown plastic handle. The overall length is 6 1/2" and the blades are each 3" long. The knife appears unused and in excellent condition and comes in the original two-piece box with paper. (76679-29F)
3728. **KNIFE LOT** This is a spring activated switchblade measuring 7 3/4" overall with a 3 1/2" bright stainless steel blade marked "Boker/Solingen Germany". The left side of the blade is embossed with the Boker company tree logo and below that is "712R/Germany Alemania/Rostfrei". The jugged dark brown plastic handle is excellent with a perfect alignment to the nickel guard and spring release switch. This is available to N. H. residents only. (76679-29G)
3729. **SHOT POUCH AND POWDER FLASK LOT** This is a 4 lb. pouch with an excellent 6" brown leather body with dual side medallion of dog in bush. The leather exhibits only light handling marks and a few dark spots. As compared to most shot pouches, this one has nice supple leather and strong seam stitching. This also comes with its original two position charger marked "AM. FLASK & CAP CO.". Also included is an intact and original hanger to this pouch featured which is 1458 in Riling. The other item is a 6 1/2" brass bodied flask by Dixon that has a screw off top with adjustable three position charger with maker marking. This is a one sided dog and hunter medallion motif with body showing a ochre tone with brown and green highlights. The collar has a strong spring and the near excellent condition flask retains its four original hangers and strong seams. This is no. 700 in Riling. (76679-20A, C)
3730. **POWDER FLASK LOT** This is an 8" brass-bodied flask with fixed common top and strong spring. This has dual sided dog and hunter motif and mixed ochre patina with a couple of dings. Both hangers are present with one showing a repair and the seams are strong. (76679-20B)
3731. **POWDER FLASK LOT** This is a 7 1/2" brass-bodied Batty peace flask with removable top and charger and a broken spring. One side seam is splitting with the balance intact as are the two original hangers. The brass surfaces are a pleasing dark ochre and the top is marked "N. Pame" and "1838". (76679-20D)
3732. **LOT OF POWDER FLASKS** This is a lot of two brass-bodied flasks each measuring 6" in length beginning with a dual sided dog and hunter scene identified as 879 in Riling with a narrow body, removable dual position charger and collar with strong spring. The seams are tight and the flask has a few minor dings and a nice ochre tone. The second one also has a removable charger and a strong spring and seams and dual sided bird motif identical to Riling No. 731. The lot rates very good overall. (76679-20E)
3733. **LOT OF POWDER FLASKS** This is a lot of two flasks, each with 7" brass bodies beginning with a dual sided flag motif with removable charger, two hangers and some green discoloration mainly towards the top. In Riling's book this is Colt 823. The other one is a Batty peace flask with top missing and retaining both hangers. It has a dark overall tone and the lot rates very good with virtually no handling marks. (76679-20F)



3734. **LOT OF POWDER FLASKS** This lot consists of two brass-bodied flasks with dual panel motifs, removable chargers and broken springs beginning with one measuring 6" in length with a few dings, a three position charger, marked "Sheffield". This flask (no. 372 in Riling) features a nice bright tone and the seams are separating a bit. The other one is no. 355 and measures 6 1/2" with a very dark body, a 4 position charger, tight seams and a few dings. The four hangers are present as is what is possibly the original lanyard. (76679-20G)
3735. **LOT OF POWDER FLASKS** This is a lot of two plain flasks beginning with a 6 1/2" long that is No. 216 in Riling with three position charger, good spring, all four hangers and several dings and dents over the golden tone body. The other one has a much darker tone and less dings and dents, repaired hangers with attached leather strap, three position charger and strong spring. (76679-20H)
3736. **FLASK AND HORN LOT** This lot consists of two reproduction powder flasks and one horn. The first is a 6" long that is very similar to Colt 820 in Riling with a dark plum-like color, strong spring and mild dents in the back. The second one has a bright gold tone, a broken spring and dual sided diamond checkered pattern with barely a blemish. The last item is an 8" period powder horn in excellent condition with no markings. (76679-20I)
3737. **LOT OF POWDER TINS** This lot consists of four items beginning with a plain brown unmarked powder can measuring 4" tall with mild surface oxidation and missing the cap. Next is a slightly larger unmarked black can converted to a shot pouch and the other two items are powder can screw on caps. (76679-20J)
3738. **SHOULDER STOCK LOT** This is an unmarked reproduction wood shoulder stock for a Luger P-08 semi-auto pistol. This is an excellent condition piece retaining 99% finish and showing a few scattered tiny white spots that could possibly be paint. (76679-43I)
3739. **LOT OF GUN PARTS** This lot consists of several parts for the MG34 machinegun including bolt, bolt head, barrel buffer, barrel buffer spring, rip, pin, covers, and housing. The parts are in excellent condition. (76679-43J)
3740. **LOT OF GUN PARTS** This lot consists of AR15 parts including one bolt stripped, one bolt assembly, two hammer springs, one ejection port cover and a buffer spring. Lastly is an AK47 gas block. The smaller parts have a moderate coating of oil. (76679-43K)
3741. **LOT OF GUN PARTS** This is a lot of a variety of small parts to several different models beginning with an unknown grip screw and escutcheon. Next is a P-08 Luger ejector, an S&W K or N frame hammer spring and a Colt SAA-style hammer spring. Also included are Ithaca 37 parts: two safeties and a trigger group screws. This lot also has an S&W sliding hammer block for a K or N frame and two K frame hammers, that being an early one and a grooved one with patent marking. The next item is a modern ejector rod head and there is also a Winchester 1885 firing pin. Lastly we have two single action or black powder revolver cylinder hands. The overall condition is very good. (76679-43L)
3742. **LOT OF GUN PARTS** This is grouping of Colt 1911 style parts starting with an unmarked two tone 45 ACP magazine showing very little wear and some surface oxidation on the base plate. Next is a barrel bushing and two slide stops consisting of checkered and grooved variations. Next we have a main spring and two firing pin springs followed by a short stamped trigger. Next are two springs: (1) hammer; (1) plunger tube. The last two items are a triangle adjustable rear sight and a stake-on white line front. A useful lot in very good to excellent condition. (76679-43M)
3743. **LOT OF GUN PARTS** This is a wide range of mainly antique parts starting with two Sharps rifle hammers for locks with self-priming mechanisms including one with impressive case hardened color muting to a pleasant gray tone. Next is a Sharps Carbine buttplate with a mottled gray patina and the interior showing some surface oxidation and for a trapdoor buttstock, a tumbler for muzzleloader or trapdoor lock and a modern muzzleloader tumbler with fly. Also included is a modern muzzle loader sear, three hammer stirrups, a lock screw and a wad/patch worm. The overall condition is very good. (76679-43N)
3744. **LOT OF GUN PARTS** This is lot of parts for the Femaru 37 M pistol starting with a slide retaining 90% blue finish with scattered light handling marks and the onset of surface oxidation in isolated areas. Also included is a set of original grooved wood grips with screw with light wear and soiling. The balance of the lot are internal parts in very good to excellent condition. It consists of 23 pieces including springs, pins, extractors, catches, trigger etc. (76679-43P)
3745. **GUN SIGHT LOT** This is a Lyman rear folding sight marked "2A DA" for Winchester Model 1894 in 25-35, 30-30 and .25 Special in excellent condition with very light contact wear. (76679-43Q)
3746. **COLLECTIBLE LEAD SHOT** This is a lot of 21 vintage tubes of lead air rifle shot from various manufacturers including Winchester, Remington, Benfred Corp., Daisy and Western. Most of them are full and the condition is excellent with crisp stamps. (76679-14F)
3747. **COLLECTIBLE AMMUNITION BOXES** This lot represents a wide range of products, much of which are empty vintage boxes but also included are a few full or nearly full boxes of blanks, an example of which is an near excellent Remington UMC of .32 S&W blanks in the white box with red striped banner marked R180. Examples of empty boxes are: one marked "64 Cartouches/Mle. 1866 D/R. H. and another "Fabrique/De Balles Et Cartouches/25 Revolvers Cartouches Lefauchaux/de 12 millimetres". A couple of interesting Remington boxes are a full "Modi-Pac" and one that reads "Yacht Gun Blanks" and a two-piece buff Winchester that includes "500/22 Long/Dummy Cartridges/For Gun Shop Only". The total quantity is about 25 pcs. including a few loose vintage labels. The items are contained in a collectible wood crate indicating that it is for Remington 22 LR. A diversified grouping in about very good overall condition. (76679-14G)
3748. **COLLECTIBLE SHOTSHELLS** This is a lot of 25 empty brass hulls, mostly 12 ga., but including some 10 ga. with a variety of head stamps, examples of which are Winchester 10 L, Parker, Fiocchi Lecco, Fowler, D.C. CO., U.M.C. No. 10. The conditions vary somewhat but that is based mainly on amount of tarnish as these exhibit sound bodies virtually free of dings and dents. (76679-14H)
3749. **LOT OF ACCESSORIES** This lot consists of a wide variety of items such as an HKS Mark 3A speed loader, rifle muzzle cap, miniature toy flintlock rifle and revolver, wrench, stripper clip, brass cartridge holder, reloading implements, metal casings in tin box marked "J. Chein & Co.". Also included are a metal tray measuring 16"x12" with 30 compartments, an SMLE Lee Enfield No. 1 MK. III rear sight, a bag of large patches, some small gun parts and Lyman bullet mould components. Lastly are about 25 glossy photos of collectible ammunition boxes and cartridges. The overall condition is about very good to excellent. (76679-43R)
3750. **LOT OF AMMUNITION** This lot contains several calibers and also a couple of fired Mauser anti-tank shells, a 50 cal. dated 1943, two stamped 18 P T67, a few with nickel cases and stamped "Hi-Vo Reaiwaaavi" and several loose mixed center fire cartridges. The total quantity is probably about 80 and contained in a metal military ammunition can. (79979-14I)
3751. **COLLECTIBLE AMMUNITION BOXES** This lot consists of 11 items pertaining mainly to .22 cal. from a variety of manufacturers with the most by Winchester beginning with two partial boxes containing a total of approximately 75 rds. of Leader Staynless .22 Short in the code K2383R box. Next are two empty Super Speed LR Kopperclad code K2208R boxes. Next are three empty Western Xpert LR boxes including one with a missing end flap and a C-I-L LR box with a torn flap and ink markings. The last empty is a Peters LR High Velocity with the blue, red and white graphics. The last two items are a nearly full 50 rd. box of Winchester 22 Blank and a partial box of Eagle Brand Roll Caps. Unless specified the items in this lot rate excellent. (76679-14J)

3752. **COLLECTIBLE AMMUNITION** This is a lot of four plastic trays, each used to display samples of vintage cartridges and shells. The first tray measures about 17"x10" each with about 60 slots and is filled with something of an overview of rimfire cartridges, containing dozens of calibers and by different manufacturers. There are also some examples of very early center fire cartridges and several paper cartridges. Some examples of the contents appear to be Burnside Carbine .54 cal., .37 cal. Maynard Rifle, 56-52 Spencer, and .38 cal. for Prescott & Bacon revolver. The bullets are experiencing white oxidation in many instances. The second tray has nearly as many items but covers a wider range with an accompanying smaller tray displaying several bullets and other Civil War era cartridges, examples that appear to be 11mm long and short for pinfire revolver, and 7mm for pin fire revolver. Also, there are dummy shotshells, a Colt-Noark 250 volt fuse, promotional decorative cartridges and a few center fire samples such as 357 Rem. Max, black tip 8mm carb. by IMI and one with head stamp ICCA 1983 416 Rigby. The third tray is a display with an emphasis on shotshells, many by Robin Hood with additional items including vintage center fire cartridges and a couple of boxes for Robin Hood Primers. Examples of the shells are R.H.A. Tiger, Robin Hood dated 1903, and others marked Indian. Most of the cartridges have R.H.A. head stamps. The last tray is actually cut in half with one containing mainly more Robin hood shells and the other is primarily vintage Rimfire with some having head stamps such as Winchester, V.V. & Co., C.D.L. and UMC. A very diversified collection with impressive condition that clearly took a great amount of effort to put together. (76678-77C)

3753. **LOT OF KNIVES** This lot consists of seven folding knives measuring between 2 1/2" and 6 3/4" in overall length. One is marked Browning on the white plastic panel and features two blades. Another, the largest in the lot is marked "Curtis Dura-Toro" on the handle and "Hand-Honed/Curtis Hi CV Stainless Taiwan." Another one is marked on the handle "1934 Imperial Council Session" on the handle with the flip side indicating that it had something to do with Minnesota. The last three of these pocket size knives have no markings and consist of one with brass panels, one with separated checkered chrome panels and the last one with plain smooth metallic handles showing verdigris and brown surface oxidation. The knives rate about near very good overall. (76679-29H)

3754. **LOT OF KNIVES** First is a folding knife with a 5" blade marked "Davy & Sons Exchange/Sheffield" and showing an uneven gray patina. One of the faded white panels is cracked and the fancy knife features an eagle's head brass pommel and a dual sided eagle motif. The next knife is also folding but has an 8" blade as part of its overall 12". The Solingen, Germany marked blade has a broken tip and a thick (1") stag handle. It fits nicely in an accompanying leather sheath. The next knife also has a leather sheath, this one with light mildew and the beginning of stitching separation and holds a Remington marked "73" with a mildly worn blade and a stag handle with verdigris stains. The last one is marked "Made in China" and "No.8818394" under the image of a star on the 5" blade held in a green plastic combination sheath/handle. The lot rates about very good overall and is housed in a Robin Hood Powder Co. wood crate that has been reduce to 5 " in height. (76679-29J)

3755. **LOT OF KNIVES** This lot consists of four pocket knives measuring 3" to 4 1/2" in their folded state. All four have brown and tan jugged handles including a Remington with three blades. Two are unmarked including one of those with two blades and the last one has three blades including a combo screwdriver bottle opener. An overall very good condition lot. (76679-29J)

3756. **LOT OF KNIVES** This is a lot of three folding knives beginning with one measuring 6 1/2" in length with a 3" blade marked "Uncle Henry (in script)/SCHRADE+/LB5 U.S.A.". The lightly sharpened blade remains bright and the handle has smooth rosewood panels. The knife is housed in a tan leather belt holder marked "MST". The next one is marked "Sabre/Japan" with two blades and 7" in overall length. The handle consists of brown and tan jugged plastic with a green marking on one panel. The third one is a little smaller and marked "Old Timer" and features three blades and finely checkered brown and tan plastic panels. (76679-29K)

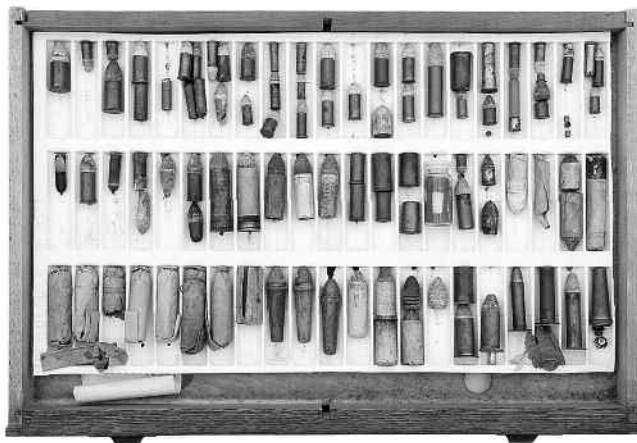
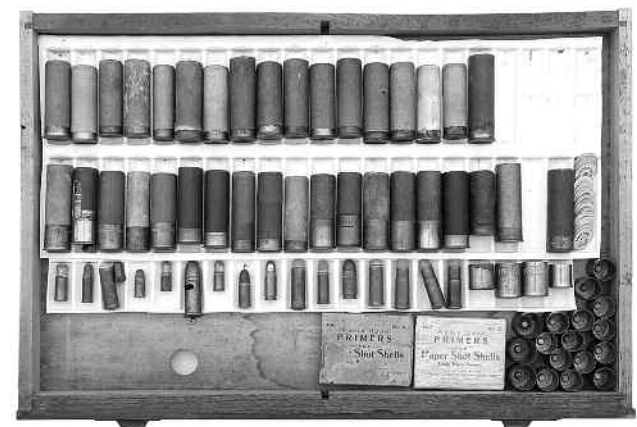



3757. **LOT OF KNIVES** This is a lot of three fixed knives with sheaths starting with one measuring 10 1/2" including a bright 6" blade with fancy etching that reads "Made in Finland". The brown birdshead-shaped handle has the image of a rabbit etched on one side. The middle eastern style sheath has a loose tip and a belt loop. The next one measures 9" with a 5" very bright lightly sharpened blade that is marked Case XX and 323-5. It features thumb serrations and a leather handle. It comes in its original sheath also rating near excellent. The third item is in a lesser state of condition with overall moderate wear and marked "Marbles/Gladstone". This one also has a leather grooved handle but the index finger area has worn through to form a few small holes. This knife and its brown sheath rate about good plus. (76679-29L)
3758. **LOT OF KNIVES** This is a lot of four spring activated "switch blades" beginning with a New York Knife Co. marked "Hammer Brand" on the blade ricasso and has a broken tip and a red handle with gold and white stripes. The second one has a brown plastic jugged handle and a blade marked "Schrade/Walden/NY USA" with scattered areas of smoky gray patina. The third one is a Springer with a blade that has turned to a mainly black tone and the blade does not fully retract. The last one has a bright blade marked "Rostfrei" (rust free) and a black and tan handle that is beginning to separate in areas. This is a very good condition lot overall. [This lot is available to NH residents only.](76679-29M)
3759. **COLLECTIBLE SHOTSHELLS** This is a lot of two vintage 4 bore shells with empty paper hulls. The first one is tan and stamped "Made in England" with head stamp "J.P.&S.". The second one is a light green with scattered minor spotting and a head stamp "Gevelot/Paris". A couple of rare items in near excellent condition. (76679-14L)
3760. **LOT OF AMMUNITION** This lot consists of approximately 300 rds. of Rimfire ammunition, the majority being excellent shooting .22 LR but several dozen of various calibers of vintage collectible rimfire as well. Some of these are collectible blanks by Peters and UMC with others showing Western and Winchester head stamps. A nice variety with most in excellent condition. (76679-14K)
3761. **GUN CASE LOT** This is a Daskocil Gun Guard Deluxe Edition Double Rifle/Shotgun Case that holds two rifles or shotguns. The 52"x11"x4" lockable case is the tan color, features high impact luggage grade plastic with 4" of protective foam and appears as-new in original factory box with keys. (76608-1A)
3762. **LOT OF GUN CASES** This lot consists of three padded nylon cases that are 48" long and designed for scoped rifles. These rugged cases have quilted interiors, zipper closure, dual carry handles, end loops, large Velcro exterior pockets and have "Made in U.S.A." tags but no maker name. These unused cases are in excellent condition with two being black and the other blue. (76608-1B)
3763. **LOT OF GUN CASES** This lot consists of nine soft long gun cases and a soft case for a tripod: (1) 52" Blue and tan padded nylon and zippered Gun Club by Bob Allen; (1) U.S. manufactured 43" padded black nylon with outside pocket; (1) unmarked tan fabric with string; (1) used brown canvas 47" for scoped rifle with brass buckles, leather handles and reinforced muzzle and owner's name in ink; (5) gray and unused Sackups cloth sock style; (1) black vinyl tripod with zipper and shoulder strap and ingrained dirt. (76608-1C)
3764. **LOT OF GUN CASES** This is a lot of pistol cases consisting of four foam-lined hard cases with sliding latches and 12 zippered pistol rugs. The first of the hard plastic cases is a gray double level marked Gun Guard and measures 16"x13"x6" showing some scratches on the bottom. The second one is also a gray Gun Guard and like the others in this lot is for a single hand gun. The other two are black Daskocil with one appearing unused as do most of the soft pistol cases that come in a number of materials, colors and manufacturers. (76608-1D)
3765. **LOT OF BOOKS** This lot consists of twelve annually published well renowned books beginning with Gun Digest in the following issues: 1970, 1974, 1981, 1992 and 1996 with each retaining at least very good condition. Next is Shooter's Bible in the years 1963, 1971, 1988, 1991, and 1997 with the 1963 beginning to separate at the spine and the conditions reflective of their respective age leading up to the 1997 which is shrink wrapped and apparently unused. Also included is a 1989 issue of Modern Guns Identification & Values and a 2009 issue of Dixie Gun Works Inc., each rating about excellent. (76608-2)
3766. **LOT OF GUN PARTS** This lot consists of ten items beginning with two twenty rd. magazines for the M14 rifle consisting of one that is apparently unused and the second retaining 98% parkerized finish. Next are two Remington-marked five rd. blued .22 LR magazines for the model 511, 512, 513 etc. with a few handling marks and light oxidation. Also included is a bolt for a Remington 513 with case hardened color in protected areas and light surface oxidation along the carrier. Next is a parkerized and near excellent trigger-guard and magazine clip guide for the model 513. The next item is a steel buttplate for the 513. Rounding out the lot are a web sling for an M-1 and a nylon web sling for the M-14. (76608-6)
3767. **PART AND ACCESSORIES LOT** This lot includes a scope mount for the M1 Garand marked "B Square" and in excellent condition. Also included are seven En bloc clips for the M1 Garand with light handling marks and a few spots of brown adhesive. (76608-6A)
3768. **LOT OF MAGAZINES** This lot consists of two ten rd. stainless steel magazines for the Colt 1911 .45 beginning with a Ram-Line Mac 4510 featuring extended black plastic floorplate. The other one is an Italian-manufactured Mec-Gar. Each appears unused and in excellent condition. (76608-6B)
3769. **LOT OF MAGAZINES** This lot consists of three Italian-manufactured, ten rd., 9mm magazines for the Beretta 92 beginning with two stainless steel Mec-Gar in their original factory sealed packaging. The third has no maker markings but rates excellent retaining 99% blue with loss due to very light wear. (76608-6C)
3770. **LOT OF GRIPS** This is a lot of two sets of wood grips suitable for S&W N frame in excellent condition including one pair with round butt, S&W medallions, sharp diamond checkering and complete with screw. The other ones are unmarked finger groove square butt with no screw, a dark brown finish and light handling marks. (76608-6D)
3771. **LOT OF GRIPS** This is a lot of two sets of unmarked and excellent condition right handed wood target grips with the first having no finish on the smooth surface and marked "40" in red grease pencil on the inside of each panel. The second set has a brown finish over stippled and smooth surfaces. No screws are included. (76608-6E)
3772. **LOT OF GRIPS** First is a pair of Pachmayr Gripper Model for S&W K and L frame revolvers. These excellent condition black synthetic rubber checkered grips with screw, box and papers. Second is a pair of original Colt Cobra grips with excellent checkering and medallions. Also included are a pair of chipped and damaged Colt plastic grips and single panels for S&W and U.S. Revolver. (76608-6F)
3773. **LOT OF ACCESSORIES** This lot consists of four items beginning with an Ultra Scope No. 034494 by Oakshore Electronic Sights Inc. in excellent condition with mount. Next is a B-Square Weaver-style base for Colt Python or Anaconda in excellent condition with silver finish and hardware. The next item is also a B-Square Weaver-style base rating excellent with black finish and suitable for Ruger MK I and II. The last item in the lot is a factory sealed package of Tasco Rifle Scope 40 mm Haze Filter Caps. (76608-6G)
3774. **LOT OF MAGAZINES** This is a lot of two Ruger marked 30 rd. .223 cal. steel magazines for the Ruger Mini-14 beginning with retaining 40-50% thinning blue finish with scattered wear. The second one retains over 90% parkerized finish with isolated areas of oxidation staining and very little indication of usage. (76608-6H)



3775. **LOT OF DIES** First is a set of two RCBS full length dies for 308 Win. in original package. Next are two Lee dies each in their original cases with papers for 45 ACP and 357 Magnum. The lot rates excellent. (76608-6I)
3776. **SIGHT LOT** This is a Redfield Olympic globe target front sight that is quick detachable and comes in original factory sealed packaging with interchangeable inserts and comes with factory box. (76608-6J)
3777. **LOT OF SHOTSHELLS** This lot consists of three boxes of 12 ga.: (1) full 25 rd. of Winchester AA Heavy Target Load 2 3/4", 1 1/8 oz., 7 1/2 shot; (1) full 25 rd. of Western Xpert Mark 5 Super Trap Load 2 3/4", 1 1/8 oz., 7 1/2 shot. (1) generic box containing 20 rds. of a variety of mainly Remington and Western. This lot also contains about 30 rds. of mixed caliber ammunition. The conditions in this lot range from near very good to excellent with the some shotshells showing tarnish and discoloration and the cartridges showing oxidized tips. (76608-5A)
3778. **LOT OF BULLETS** This lot consists of ten containers of .22 cal: (3) factory sealed 100 rd. of Speer 52 gr., .224", HP-Boat Tail; (1) containing about 35 rds. of Speer 52 gr., .224", HP; (1) factory sealed 100 rd. of Sierra 69 gr., .224", HPBT-Match; (1) containing about 35 rds. of Sierra 53 gr., .224" HP with light tarnish; (1) containing about 80 rds. of Sierra 45 gr. .224 Spitzer; (1) containing about 60 rds. of Hornady 50 gr., .224 SX; (1) containing about 30 rds. of Midway HP; (1) bag marked 190 rds. of .223" 55 gr. FMJ. Unless otherwise specified, the bullets rate excellent. (76608-3A)
3779. **LOT OF BULLETS** This lot consists of seven containers: (2) boxes of Sierra 30 cal., 168 gr. International totaling about 170 rds.; (2) boxes of Sierra .25 cal., 100 gr., .257 Spitzer totaling about 100 rds.; (1) box containing about 35 rds. of Hornady .25 cal., 75 gr., .257 HP; (1) box containing about 70 rds. of Speer .30 cal., 150 gr., type WR SP; (1) can containing about 250 rds. of .30 cal. (76608-4A)
3780. **LOT OF PRIMERS** This lot consists of 27 trays: (4) factory sealed 100 rd. and (1) containing 53 rds. of C-I-L No. 8 1/2; (10) full 100 rd. of CCI 400 Small Rifle Primers in the outer brick sized box; (2) full 100 rd. and one containing 29 rds. of CCI large rifle no. 250; (2) full 100 rd., (1) containing 60 rds. and (1) containing 50 rds. of CCI 200 Large Rifle; (3) full 100 rd. and (1) containing 13 rds. of CCI No. 157 Remington size shotshell primers. The lot is in excellent overall condition. (76608-3B)
3781. **LOT OF BRASS** This lot consists of several bags of fired cases and unprimed brass including the following calibers: 45 Colt, 41 mag., 380 (approx. 500), 40 S&W (approx. 1100). Also included are factory boxes with fired cases of 38 S&W. Total pieces= approx. 1800-2000 in about very good overall condition. (76608-4B)
3782. **LOT OF BRASS** This lot consists of several steel cans filled with fired cases of calibers including 257 Roberts, 250 Savage, 5.56mm, 30-06, and 30 M1 Carbine. The total quantity is approximately 800 with a condition rating of very good. (76608-5B)
3783. **HIGH STANDARD SENTINEL R-100 REVOLVER** serial #6794 22 S, L, LR, 3" barrel with bright excellent bore. The barrel and cylinder retain 90% plus original blue with light silvering near the muzzle with several small scratches and has a moderate turn ring visible on the cylinder. The aluminum frame retains nearly all of its anodized matte blue finish with several scratches on the left side between the cylinder and triggerguard. The hammer and trigger show strong case color. The Sentinel medallion is missing and the brown plastic checkered square butt grips rate excellent with sharp points on the diamonds. (106520-1228) {C&R} [Richard "Stretch" Kennedy Collection] (50/100)
3784. **DUPONT SMOKELESS POWDER CAN** This is a round 1/2 lb. 3 3/4" x 3 1/4" green painted can with painted top and bottom labels. The tan top label shows picture of two dogs on wood-line and two birds hanging on the fence. The bottom label lists instruction for use. Both labels remain 98% intact with light dirt and oxidation staining. The can rates very good with tight seams, a few pin-sized specks of chipping along the edges along with a couple light dings and modest light oxidation. Metal remains structurally strong and what appears to be the proper cap is present. (106958-1)
3785. **AMMUNITION LOT** Includes five full 50 round boxes of Blazer Brass 9mm Luger, 115 gr., FMJ cartridges in excellent condition. (106519-7G)
3786. **LOT OF BALL AMMUNITION** Includes 360 rounds of 30 carbine cartridges on ten-round stripper clips. The cartridges are marked "L C / 73" on the head stamps and come in green cloth bandoleers with a loading tool in each all in excellent condition. (106519-211E)
3787. **LANCHESTER MAGAZINE LOT** Includes one 50 round Lanchester machine gun magazine. The magazine retains 85% original phosphate finish with spots of light to perhaps moderate fine oxidation staining. There are several light scratches in the finish as well. The spring remains strong and the magazine is in very good overall condition. (106738-26)
3788. **FANTASY KNIFE BY EDGE CO** A 15" overall "King Cobra" fantasy knife with spiked handle. The curved stainless steel blade measures 9" with a full tang contoured handle that has ten 3/4" spikes spaced evenly along the knuckle guard. The handle is made of a black textured synthetic material and is attached with brass rivets. The knife is in excellent condition and comes with a fitted black leather sheath. (106737-5)
3789. **CALICO 9MM MAGAZINE** A 100 round helical magazine for the M-900 rifle. The magazine appears complete and in very good overall condition. (106737-2)
3790. **LOT OF M76 MAGAZINES** Includes two 30 round Valmet M76 (.223) magazines in plain white cardboard shipping sleeves. The magazines appear to have never been used and are marked "MCP" in the upper right corner on the left side flat. Both magazines are in excellent condition. (106737-2A)
3791. **LOT OF M76 MAGAZINES** Includes two 30 round Valmet M76 (.223) magazines in plain white cardboard shipping sleeves. The magazines appear to have never been used and are marked "MCP" in the upper right corner on the left side flat. Both magazines are in excellent condition. (106737-2B)
3792. **CALICO 9MM MAGAZINE** A 100 round helical magazine for the M-900 rifle. The magazine appears complete and in very good overall condition. (106737-2C)
3793. **CALICO 9MM MAGAZINE** A 100 round helical magazine for the M-900 rifle. The magazine appears complete and has a folding two-position rear sight. It is in very good overall condition and comes in its original shipping sleeve. (106737-2D)
3794. **LOT OF M76 MAGAZINES** Includes two 30 round Valmet M76 (.223) magazines in plain white cardboard shipping sleeves. The magazines appear to have never been used and are marked "MCP" in the upper right corner on the left side flat. Both magazines are in excellent condition. (106737-2E)
3795. **LOT OF M76 MAGAZINES** Includes three 30 round Valmet M76 (.223) magazines in plain white cardboard shipping sleeves. The magazines appear to have never been used and are marked "MCP" in the upper right corner on the left side flat. All three magazines are in excellent condition. (106737-2F)

3796. **CARTRIDGE COLLECTOR'S LOT** This lot includes a large variety of shotshells, pistol and rifle cartridges and blanks. There is a mixture of ball and commercial cartridges in calibers from, but not limited to, .22 through 12 ga. to .308. The cartridges vary in condition with some showing light oxidation on the brass and traces of white oxidation on the lead. This is a very interesting assortment that remains in overall very good condition. Some of the cartridges are loose in a bag or in divided wooden trays and lastly housed in a 24 compartment metal divider. (103593-5)
3797. **CALICO 9MM MAGAZINE** A 100 round helical magazine for the M-900/950 rifle. The magazine has a fixed molded rear sight. It is in very good overall condition and comes in its original shipping sleeve. (106737-2E)
3798. **CALICO 9MM MAGAZINE** A 100 round helical magazine for the M-900/950 rifle. The magazine has a fixed molded rear sight. It is in very good overall condition and comes in its original shipping sleeve. (106737-2F)
3799. **ORDNANCE LOT** This lot includes miniature cannon on carriage and three inert training grenades. First is a Mills, possibly WWI era, inert bomb. The steel body is mostly oxidized and the grenade is in good overall condition. Second are two contemporary reproduction training grenades with M228 fuses, missing the strikers, in excellent condition. Last is a 5" miniature cannon on a naval carriage that is mostly oxidized in good overall condition. (105648-2)
3800. **AIR RIFLE** This lot includes a Sheridan Blue Streak 5mm, 19" rifled barrel with bright excellent bore. The metal surfaces retain 95% original black finish with spots of even thinning nearly overall. The two-piece smooth pistolgrip and forend rates excellent, showing a few light scratches in the clear coat. Included with this air rifle is a correct box that is missing an endflap and has a hole from the bolt in its bottom side. (106519-416)
3801. **LOT OF GUN PARTS** This lot includes an assortment of 15 handguards and two cut sections from Mauser rifle stocks. They vary in levels of condition with some showing moderate dings, scratches and cracks. Also included in this lot are two cut forend sections, both with retention springs and one with bayonet lug. Items are in good to very good condition. (103765-12A)
3802. **LOT OF GUN PARTS** This lot includes 32 parts for Mauser rifle stocks as follows: (2) front bands with bayonet lugs, (6) buttplates, (11) front bands, (2) sight protectors, and (11) rear barrel bands. The items are all in good to very good overall condition with some showing light to perhaps moderate amounts of oxidation staining mostly on the buttplates. (103765-12C)
3803. **LOT OF GUN PARTS** This lot includes 15 triggerguards for a 98 Mauser rifle. There are (9) that are completely stripped, (2) with floorplates still attached, and (4) with springs and followers. Items are in good to very good overall condition with some showing light to moderate amounts of oxidation and or staining. (103765-12D)
3804. **LOT OF HOLSTERS** This lot contains three leather, U.S. marked Model 1897 flap holsters. The holsters all show moderate crazing and verdigris staining near the brass rivets and studs. There are several cracks, scrapes and usage marks present. The leather is still somewhat supple and the stitching remains tight. (104892-57A)
3805. **LOT OF GUN PARTS** This lot includes parts for the G41 rifle. First is a triggerguard that is numbered 1155 with strong amounts of blue remaining with spots of moderate oxidation, most prevalent in the magazine well and screw holes. Second is a gas cylinder with sight also marked 1155 showing traces of blue with tones of brown and pewter. Third is what appears to be a near complete bolt assembly, marked 1341, with some of the metal showing pinprick pitting, light oxidation staining and tones of pewter and blue. All parts are in very good overall condition. (103765-12)
3806. **LOT OF SHOTSHELLS** Lot includes a mixture of 12 ga shotshells in a plastic carry case that measures 12" x 7 1/2" x 7 1/2". The case includes: two full 25 round boxes of Remington Dove/Quail 12 ga, 2 3/4", 1 oz, No. 8 shot, two full five round boxes of Remington Slugger 12 ga., 2 3/4", 1 oz, HPRS, one full five round box of Winchester Super-X 12 ga., 3", 4 Buck, and 19 loose assorted 12 ga., shotshells from multiple manufacturers all in very good to excellent condition. (103765-30)
3807. **LOT OF PRESSURE CYLINDERS** Lot includes a variety of copper pressure cylinders for cannons with tarage table and a small box of pistol and revolver cylinders included. The items come in a small wooden box with paper end labels that read "500 Cannon / Copper Pressure Cylinders / With Tarage Table / Metal of 1940/ Annealed June 1941 / UNCOMPRESSED / Comp. Curve DWG. FD 11244 / S.O.1 / Frankford Arsenal" Items appear to be in very good condition. (101096-32W)
3808. **LOT OF ACCESSORIES** This lot includes two aftermarket accessories: First is a MSAR P/N 218 sight rail with screws and wrench, second is an unmarked swivel stud with screws for use on a Picatinny rail system. Both items are in excellent condition. (104427-131A1A, 104A)
3809. **LEATHER CARTRIDGE CASES** Lot includes two U.S. / R.I.A. marked leather cartridge cases with wooden inserts. Each case is designed to carry twelve cartridges and closes with a brass stud. The bottoms are marked Rock Island Arsenal / 1908. One case has additional markings on the back side and the other has separations along the top seam. (105276-7)
3810. **GRIP LOT** Includes a pair of smooth walnut Herret grips missing hardware in excellent condition. These grips could possibly be for an S&W Model 52 or similar pistol. (105300-11)
3811. **LOT OF BULLET MOULDS** There are four single cavity moulds, first is a brass body .62 cal. round ball mould with a clean cavity. Second is a steel .32 cal. round ball mould with curved legs marked 125 with moderate oxidation staining present. Third is a steel .45 cal. round ball mould marked 70 along the leg with a clean cavity. Last is a .32 cal round ball mould mark 110 along the leg with a clean smooth cavity. Items in this lot are in very good overall condition. (105276-3A)
3812. **LOT OF BULLET MOULDS** This lot includes four moulds, first is a single cavity .36 cal. conical-shaped brass-bodied mould with spots of light oxidation staining present with a clean cavity. Second is a .62 cal. round ball single cavity steel body mould with spots of active oxidation staining present in the cavity and on the body. Third is a three cavity .32 cal. round and conical-shaped brass mould with light scroll engraving. The left leg was crudely repaired with lead which has since broken again. With a proper repair, this could make a neat case filler or usable tool for any .32 cal percussion revolver. Fourth is a dual cavity .45 cal round ball brass body mould with wooden legs. Items are in this lot are in overall very good to excellent condition. (105276-3B)
3813. **GUN PARTS LOT** includes two items, first a complete trigger assembly for a Remington Model 1100 shotgun. The group functions but will need to have the carrier / lifter adjusted. The word SPARE has been scratched on the left side of the triggerguard and the item is in overall very good condition. Second is an in-the-white underhammer marked Pat. APR. 10, 1880 with spots of light pinprick pitting and oxidation staining present in very good overall condition. (105053-16H, 16I)
3814. **LOT OF MIXED BULLETS AND BRASS** Lot includes a mixture of pistol and rifle cartridges with a 40mm artillery shell. The shell is marked "40MM M25 / Lot 153-23141-29 / S.M.G.1943" with light tarnish near all over in general very good condition. Also included are two bags of mixed manufactured ball and commercial ammunition in 9mm, 38 Special, 32 S&W, 30-06, 8mm, all in good overall condition. (105053-16)
3815. **LOT OF PLIERS AND MAGNIFIERS** Lot includes an assortment of specialty tools to include eyelet punch with eyelets, paper punch, staple puller, dykes and small pliers as well as two folding unmarked magnifying glasses and a 7x Hastings Triplet jewelers loop. All items are in very good condition. (105178-5, 9)

3816. **BLASTING CAP CRIMPING TOOL** Lot includes a multi-function blasting cap tool made by G. Ibberson & Co. Sheffield Eng. The tool is in good working order with spots of light fine oxidation staining. (105232-3)
3817. **LOT OF GUN PARTS** This lot consists of a full stock, barrel with sights, cleaning rod, bolt and trigger assembly for a GEW 98 rifle. The stock is complete with top handguard, attaching iron, buttplate and sling swivel. It shows light handling marks under an added layer of varnish with drying cracks visible on the right side emanating from the buttplate. The barrel is Danzig-marked and has a bright excellent bore with all the metal parts showing strong blue. There is no receiver and all parts are in excellent condition overall. (105170-53)
3818. **AR-15 ACCESSORY LOT** Includes a Firearms System & Design Ultimate Trigger Actuator. This is a cast handle designed to replace the pistolgrip on an AR-15, making for improved shooting performance. This was invented by Patrick Teel and patented in May of 1984. The item is in excellent condition. (106737-1A)
3819. **GLOCK ACCESSORY** Includes a Fobus Model GLR 440 tactical pistol stock. This moulded collapsible stock will fit the following models 17, 19, 20, 22, 31, 32, 34, 35, 37 and 38. It is designed to help enhance shooting performance and is in excellent condition. All NFA restrictions apply. (106737-1B)
3820. **LOT OF CALICO ACCESSORIES** This lot includes three items. First is a Model 925 scope mount with canvas pouch and three of the four mounting screws in excellent condition. Second are two 9mm rotary loading tools, one is missing its crank handle and both are in excellent overall condition. The plastic speed loaders are designed for use with the Calico helical magazines one comes in original shipping sleeve and the other with instruction sheet. (106737-1)
3821. **FLARE GUN HOLSTERS AND BARREL LOT** This lot has four items. First is an M8, 37mm flare gun barrel showing traces of original finish blending mostly to a smooth brown patina. The barrel is unmarked and in good overall condition. Second is a leather holster likely for a No.4 MK1 flare gun with an aluminum strip added to the front in good overall condition. Third is likely a Czech VZ 61 leather flare gun holster in excellent condition. Fourth is a canvas Israeli military issue flare gun holster dated '71 in excellent condition. (106737-4)
3822. **LOT OF MAGAZINES** Includes three steel unmarked AR-15 style 40 round magazines. The magazines show typical light scratches and handling marks associated with use with spots of oxidation and staining present on two of the magazines. They are in overall good to very good condition. (106737-3H)
3823. **LOT OF MAGAZINES** Includes four steel 30 round AR-15 style magazines. There is a single unmarked, a single BFI Industries, and two A.S.C. Ltd. (still in sealed plastic baggies) all in very good to excellent condition. (106737-G)
3824. **LOT OF MAGAZINES** Includes four polymer 30 round AR-15 magazines. These are Thermould C7 magazines with maple leaf insignia on base, built for the Canadian government but never issued in overall excellent condition. (106737-3C)
3825. **LOT OF MAGAZINES** Includes four polymer 30 round Thermould AR-15 magazines all in very good overall condition. (106737-3E)
3826. **LOT OF MAGAZINES** Includes four aftermarket 30 round Mini-14 magazines. First are two polymer Thermould magazines in very good to near excellent condition. Second is an Eagle International clear plastic magazine in excellent condition. Third is a Precision Mag Industries brushed chrome finished magazine in excellent condition. (106737-3F)
3827. **LOT OF MAGAZINES** Includes four aftermarket 30 round AR-15 style magazines. First are two Eagle plastic model 1630 magazines still in sealed original packaging. Second are two Orlite-Eng. Co. polymer magazines in good overall condition showing some signs of moderate use. (106737-3B)
3828. **LOT OF MAGAZINES** Includes three 32 round unmarked 9mm Uzi magazines in a black tanned leather pouch. The pouch shows several light scratches and handling marks with spots of mildew and verdigris staining present. The magazines are in good overall condition with spots of light oxidation and verdigris present. (106737-3)
3829. **LOT OF MAGAZINES** Includes three 30 round, 9mm, aftermarket SP89 magazines in excellent condition. The magazines have a parkerized finish with LIQ marking on the lower right front corner and are still with their original boxes, all in excellent condition. One box is missing an endflap. (106737-3A)
3830. **LOT OF MAGAZINES** Includes four steel AR-15 style magazines. First is a Universal Industries 20 round magazine that has been converted to .22 cal. The magazine shows light use marks and is in excellent overall condition. Second is an A.S.C. LLC 30 round magazine in its original sealed plastic wrap. Third is an Adventure Line Mfg. Co., 30 round with overall light scratches consistent with use. Fourth is an O Kay Industries 30 round magazine in excellent condition. (106737-3D)
3831. **LOT OF SCOPES** Includes two fixed power scopes. First is a Lyman 438-Field 4X scope with standard crosshair reticle with overall cloudy optics. The tube, bell and ocular lense still show traces of blue beneath the layer of oxidation staining that now covers nearly all of the scope. It is missing its front mount. Second is a Weaver 330 Scope M8 with mounting bracket and leather lens caps that are separated at the cup. The metal surfaces show strong traces of blue with some silvering along the edges of the mount with overall oxidation and staining present. The scope has overall cloudy optics and a standard crosshair reticle and would benefit from a proper cleaning. (105180-8A, 8B)
3832. **LOT OF TRINKETS** This lot includes five items. First is a handmade pocket fishing jig with heavy line, large weight, and two large gauge hooks. Second is a matchbox containing six hand-tied flies in varying conditions. Third is a metal tin of Mustad-Cincinnati Bass Hooks with bright color and near all of its enamel finish remaining on the label. Fourth is an Austrian-made brass "trench" lighter, likely WWII era, in excellent condition. Fifth is a leather tobacco pouch marked Benson & Hedges London, New York & Montreal, with the initials H.M.C. embossed on the front. The hard sided pouch shows light scuffing and spots of mildew staining and is filled with an assortment of barrel brushes, patches and related cleaning supplies in overall very good condition. The balance of the aforementioned items are in very good overall condition. (105178-3, 10)
3833. **LOT OF GRIPS** Includes two unmarked custom walnut target grips. First is a set of checkered grips likely to fit a Browning Medalist pistol. The checkering remains robust and the lines clean. There is a section along the right top that shows a red tint from rubbing inside, perhaps a presentation case, and the grips rate very good to excellent overall. Second is a pair of smooth target grips likely for a Colt Officers Model revolver. The grips have a repaired chip on the right panel and added filler inside but remain in very good overall condition. Also included with this lot is a home-made muzzle brake; it is uncertain what it goes to. (105105-8)
3834. **LOT OF WEB GEAR** Includes an assortment of related holsters magazine pouches carry bags and belts. There are three knife holsters, five magazine pouches, six sealed bandages, three pouches with straps, four tent stakes, a camo padded piece, light beacon and two belts, all items in very good overall condition. (106357-S17150A)
3835. **LOT OF WINCHESTER 1897 PARTS** This lot includes a barrel, magazine tube, forend, trigger assembly, triggerguard, firing pin, seal and several screws with an aftermarket buttstock. The metal surfaces retain 70% blue flaking to brown in places with scattered areas of silvering along the working parts. The ribbed forend rates near excellent, retaining nearly all of its original finish with a spot or two of flaking near the ends. The checkered buttstock rates very good plus with several light dings and spots of flaking varnish with robust checkering present along the pistolgrip. This is an overall excellent grouping of mostly original Winchester parts that could be helpful in a restoration. (104396-141)



3836. **LOT OF WEB GEAR** Includes a belt, cloth machine gun link and a holster. First is a Model 1916 holster marked U.S. on the front with moderate handling wear to include scratches and gouges with a cut in the holster to possibly allow a similar-framed pistol to fit. It is missing its closure and is in fair overall condition. Second is an unmarked web belt with four small magazine pouches in good overall condition. Third is a converted 50 caliber cloth machine gun link that was converted into a 6' tie strap in good overall condition. (106129-3P)
3837. **LOT OF G.I. GEAR** Lot includes an assortment of G.I. related head, foot, and related gear. First are several sewing kits, badges, and buttons, all in good overall condition. Second is a small spade trenching tool with moderate oxidation nearly all over in good overall condition. Third is a pair of electric shoe inserts, two hoods, straps, a canteen cover, pouch and satchel. Fourth is a bag containing three mugs, a flash light, warming plate and nine U.S. marked eating utensils. Items are in good overall condition. (104687-21)
3838. **LOT OF ACCESSORIES** This lot includes a collection of carry bags, glasses, slings and straps, a stamp kit, shoe shine kit, several pair of shoelaces and some tobacco memorabilia. The tobacco memorabilia includes parts of three matchbooks (Modesto Service Men's Club, Jackson Barracks Area, and a section of Leon & Eddies), an old empty pack of Lucky Strike with green label and a fair condition empty box of Dills Best Smoking Tobacco all in a W.M. Penn cigar box. Also included is a canvas rifle sleeve likely for a M1 carbine. All items are in good overall condition unless otherwise noted. (104687-22)
3839. **LOT OF GUN PARTS** Includes the following list of parts for an M1 carbine; three prong gas piston nut wrench, trigger, hammer pin, (2) extractor, hammer, (2) piston nut, (2) trigger spring, (2) firing pin, magazine catch, and operating spring. The majority of the parts are in labeled paper bags and all are in excellent condition. (103765-12H)
3840. **FIRING PIN LOT** Includes a P.08 Luger firing pin with grooves. The pin is un-numbered and shows a small weld mark over a crack in the body forward of the lug. Item is in good overall condition. (103765-12K)
3841. **MAUSER BOLT** Includes a complete Mauser bolt assembly that is mostly in-the-white with spots of light oxidation and staining all over. The bolt is made up with non-matching numbered parts and is in good overall condition. (103765-12G)
3842. **LOT OF MAUSER PARTS** Lot includes two triggers, a baggie with multiple springs, a screw, (3) bolt assembly stops, (3) floor-plates, magazine follower, and rear sight. The parts are all in very good used condition. (103765-12I)
3843. **LOT OF MAUSER PARTS** Lot includes multiple bolt parts to include; bodies (3 with bent handles), firing pins, safeties and bolt sleeves. The items are in varying levels of condition from good to very good overall. (103765-12J)
3844. **M-16 ACCESSORY** Includes a Colt-Marked carry handle scope mount with nut. The left side is marked Colt next to the Rampant Colt emblem and the right side is marked Arms-M16A2. The mount is in very good overall condition. (104807-9)
3845. **LOT OF MILITARIA** Lot includes several items to include gun parts, cleaning aids and propaganda. First is a German WWII-era tin cleaning kit complete in very good condition with the name G. Appel / 1937 engraved on the bottom. Second is a spike bayonet for an SKS-style rifle in excellent condition. Third are a 30 caliber chain and 3 piece cleaning rod set in very good condition. Fourth is a triggerguard with floorplate, magazine spring and follower, with Waffenamts marked winter trigger. Items show traces of blue under a moderate layer of oxidation staining. Fifth is a pamphlet in German for the Hitler youth, explain their rights and privileges for being part of the organization. Sixth is range targeting aid designed to allow the instructor to see as the shooter sees in hopes to help the learning process. (103765-12B)
3846. **SHOOTERS LOT** This lot contains an assortment of pistol and rifle cartridges, primers, lead balls and other shooting-related materials. First is an assortment of cartridges that range in size from 32 ACP through 30-06 Springfield and include some dummy rounds and fired casings. The cartridges range in condition from fair to very good with some showing light active oxidation and/or staining on either the brass or lead. Second are 26 full and/or partial collectible tins and boxes of assorted pistol and rifle primers to include Winchester, U.M.C, Hicks and several others, all in good overall condition. Third is an assortment of lead shot and balls. There is a partial bag of No.4 lead shot, a tin of 000 pellets (mixed copper and lead), and a tin of .50 caliber balls all in very good overall condition. (102836-8)
3847. **LOT OF BRASS** This lot includes a mixture of fired casings and primed brass to include; 20 Remington 300 Win. Mag., primed cases, 63 mixed manufactured 300 H&H primed cases and 145 fired cases of 9.3x74R. All in very good overall condition some showing light fine oxidation staining on the brass. (10302-70)
3848. **SHOOTERS LOT** Includes an assortment of sporting items. First is a mixture pistol and rifle cartridges to include some rimfire cartridges as well, they range from 22 LR through 45 ACP up to 416 Rigby and rate fair to excellent with some showing light traces of white oxidation on the lead or traces of fine oxidation staining on the brass. Second is a pair of Weaver see-through rings in excellent condition. Third is a pair of letter openers, one in a leather case and a home-made one from a spackling trowel. Fourth is a near full box of Nosler/Winchester Fail Safe 30 Cal. 150 gr., hunting bullets. Fifth is a pair of checkered wooden grips with moderate wear marks on the tops of the panels, likely for a medium frame cowboy action-style revolver. Sixth is a 20mm bullet and 40mm casing both in good overall condition. (106935-7)
3849. **LOT OF BOOKS** Includes five unrelated books. First is a 384 page soft cover title A Dynasty of Western Outlaws, by Paul I. Wellman, copyright 1961. The book is very good condition with some lightly rounded edges. Second is a 64 page illustrated soft cover title George Turner's Book of Gun Fighters, copyright 1972 in very good condition. Third is a reprint of an American Rifleman article from the June 1960 issue titled The .45 Automatic, in very good condition with some light ingrained dirt staining on the cover. Fourth is an illustrated 487 page hardcover title Identifying Old U.S. Muskets, Rifles and Carbines, by Colonel Arcadi Gluckman, copyright 1965 in very good condition with near complete dust cover missing a small section in the upper right corner. Fifth is a 303 page hardcover title Hands Up!, by Fred E. Sutton and A.B. Macdonald, copyright 1927 in good overall condition with weakening of the spine and several lightly tattered edges. (106935-8)
3850. **BARREL LOT** Includes an octagon Zimmerstutzen 4mm barrel with good overall frosted bore showing strong rifling. The barrel retains near 80% blue flaking to brown with spots of light fine oxidation staining and perhaps some very minor pitting mostly by the rear dovetail. The barrel is marked System Steigele and numbered 1208 near the loading lever. (106935-9)
3851. **GUNSMITHING TOOL LOT** This lot includes a Maryland Gun Works, LTD., yoke lock drill fixture in its original packaging. The label states that this particular tool is intended for use on Smith & Wesson K, L, and N frame revolvers. Included with the fixture are a punch, two drill bits, 10 assorted springs, 7 bearings and a pin, all in excellent condition. (106935-10)
3852. **GUNSMITHING TOOL LOT** This lot includes two taps and dies. First is a Brownells N-frame tap and die part numbers 080-598-671 and 080-598-670 both appear to be in excellent condition. Second is a K-Frame tap and die part numbers 080-598-540 and 080-598-541 both appear in excellent condition. (106935-10A)

3853. **GUNSMITHING TOOL LOT** This lot includes five deburring tools and an extractor tool. First is a Brownells 1/2" revolver deburring tool & cutter. This cutter is designed for chambers in .32 through .45 and is in excellent condition. Second is an ejector rod tool marked only KLN with proper fitting Allen wrench in excellent condition. Third are two yellow handled yoke / crane reamers measuring .246 and .313 in diameter both in excellent condition. Fourth are two reamers marked L&I in 3/8" and 31/64" both in excellent condition. (106935-10B)
3854. **GUNSMITHING TOOL LOT** Includes a Brownell's Barrel Set-Back Fixture. This is a master kit containing the following, fixture body, 3 Allen wrenches, carbide cutter, pilot carrier, and six pilots for 22RF, .32, .38/.357, .41, .44, and .45 barrels all parts come in a white cardboard box and are in excellent condition. (106935-10C)
3855. **LOT OF GUN PARTS** Includes Four triggers and a safety lever. First is an Accokeek Sports adjustable D-1 trigger with slide safety for a Mauser rifle. The trigger comes with instruction sheet in a small white box. Second are two Mark II trigger mechanisms one with springs both in original boxes and for either a Springfield or Mauser rifle in excellent condition. Third is a Mark II right-hand safety lever in its original packaging in excellent condition. Fourth is a Jaeger adjustable trigger for a Mauser rifle in fair condition missing the right side mounting loop. This trigger is still a great parts lot in itself. (106935-10D)
3856. **LOT OF GUN PARTS** Includes four triggers, two safety levers and three screws. First are two Mauser low scope safeties with three guard screws all in excellent condition. Second are two Dayton Traister Co. adjustable triggers likely for a Mauser or Springfield rifle both in excellent condition. Third are two Timney trigger mechanisms, one for a Mauser rifle the other for a Ruger both in excellent condition. (106935-10E)
3857. **LOT OF GUNSMITHING TOOLS** Includes an assortment of "GO / NO-GO" gauges in the following calibers; 9mm, .45, 10mm, and .40 all in excellent condition. (106935-10F)
3858. **LOT OF REVOLVER RANGE RODS** Lot includes five rods with handles ranging in size from 9mm through 45ACP all with all showing light oxidation staining and tape residue on the handles and shafts. Items are in good overall condition. (106935-10G)
3859. **LOT OF CASES** Includes three items. First is a wood grain Colt box missing both end flaps and showing heavy scuffing along its edges in fair overall condition. Second is a home-made wooden cartridge box designed to hold 50 loose .22 caliber cartridges and a single box of similar cartridges. It has brass hardware and is in very good overall condition measuring 7"x3"x1 1/2". Third is a contemporary crafted wooden presentation case likely for a medium to large frame open top revolver with red lined interior that is starting to pull apart. There is a small section of one end that has broken off but is present and the case has several scratches and nicks present. A fixer upper with some life possibly left in it. (106020-53A)
3860. **LUGGAGE CASE** This lot includes a maroon colored leather and canvas Ducks Unlimited case measuring 28"X10"X4" with brass hardware and keyed locks (keys included). This case will accommodate a double gun with 26" barrels and is in excellent overall condition. (106519-396B)
3861. **RENATO GAMBA LUGGAGE CASE** This lot includes a locking hard plastic take down case for a double gun with up to 30" barrels. The case measures 32"X10"X3" with a black and white checkered interior in overall excellent condition. (106519-396A)
3862. **LUGGAGE CASE** This lot includes an unmarked hard canvas case with black fur interior measuring 31"X10"x4". This case is dressed with chrome hardware and is lockable by combination. It will accommodate a takedown semi-auto with barrels up to 28 inches in length and is in near excellent condition. (106519-396)
3863. **SHOOTERS LOT** This lot contains the following items; a Birchwood Casey muzzleloader's barrel and stock kit (plum brown) opened and complete. Second is a Nicholson X.F. 5 1/2" round handle needle file kit containing 13 assorted files. Third is a plastic oiler, likely from an M1 and a set of leather lens covers that would fit a small fixed scope with 1" bell and 3/4" bell. Fourth is a Boy Scout first aid kit with flashlight and bandages. Fifth is an unmarked 9mm magazine with blue finish similar in design to a Browning Hi Power with a wider front. Sixth is a U.S.N. marked brass combination lock by Corbin Sesamee. Seventh are three 50mm sunshades to include a 2", 3" and 4" with various patterns and finish. All items in this lot are in very good to near excellent condition. (106935-11)
3864. **LOT OF GUNSMITHING TOOLS** Lot includes an assortment of punches, reamers, two custom-made Smith & Wesson trigger tools, set of barrel calipers and a .38 ceramic burnisher. Items are in very good overall condition. (106935-10H)
3865. **LOT OF FISHING RODS** This lot includes two vintage wooden deep sea fishing rods. The first rod is a two-piece measuring 6 1/2" with a combination of metal and ceramic eyes with no reel mounting hardware. The second rod is measures 9 1/2" and is one-piece with a combination of metal and ceramic eyes with reel mounting hardware. The reels are in good overall condition and would make a fantastic addition to any décor or nautical collection. (106935-14)
3866. **CLEANING ACCESSORY** This lot includes a moulded plastic Tipton Gun Vise. The vise appears complete in very good working condition. (106519-43)
3867. **GUN SIGHT** This lot includes a Lyman No.56A receiver sight. The sight retains near all of its original blue finish with spots of light silvering along the sharp edges with spots of light fine oxidation staining present as well. The adjustments work smoothly. This is a quality item sure to dress up any of your Winchester lever or slide action rifles. (106562-6A)
3868. **WINCHESTER MODEL 67 ACTION** 22 Short, 27" barrel with a bright very good bore showing spots of light fine oxidation staining with a few scratches through the blue and has been drilled and tapped to receive the Lyman mount. The bolt is complete retaining 85% plus of its original chrome finish with some light oxidation staining around the handle and safety. The Lyman 422 Expert scope rates about good overall showing several light scratches in the 3/4" tube with standard crosshair reticle and hazy optics. Transferable as a modern firearm. (106020-31)
3869. **LOT OF GUN PARTS** This lot includes a dovetailed buttplate, likely for a Model 52 target rifle, and an Al Freeland front Globe sight likely for a similar style rifle. Both items are in very good to near excellent condition. (104132-4A, 2B3)
3870. **LOT OF COLLECTIBLE SHOTSHELLS** This lot consists of (2) plastic boxes containing 14 collectible shotshells and hulls. Included are: Western 12 ga. #6, Western 12 ga. #4, Western 12 ga. #8 Super Trap, Eley Grand Prix 12 ga. #6, Remington 16 ga. #2 Express, Western 16 ga. #6, Winchester 12 ga. #4, (2) 12 ga. pinfire shells, a U.M.C. 12 ga. paper hull, and a Parker 12 ga. brass hull. All are in very good to excellent condition and most are paper hull shells. Next is a bag of loose shotshells containing (39) 12 ga. paper hull loads, (2) 16 ga. paper hull loads, (2) 20 ga. paper hull loads, and (6) 410 ga. paper hull loads. The types vary and brands include Western, Peters, Federal, Remington and C.C. Co.. All are in excellent overall condition. Last is a bag consisting of (36) loose rounds of various 20 ga. ammunition. Included are U.S., Remington, Super DD, Winchester with a few unmarked as well and vary in style. All are in very good to excellent condition, most are paper hulls. (103023-1S1,1V1,1Y1)
3871. **LOT OF SWIVELS** This lot includes a pair of Winchester, Sheppard Hook swivels. The swivels are mostly a brown patina with specks of silver showing through and are in near excellent condition. (104395-2P)

3872. **SIGHT LOT** This lot includes a complete Lyman No. 57 SM receiver sight. The sight retains 85% original blue finish with spots of silvering along the sharp edges. The Micro adjustment knobs function smoothly and the aperture is present. The sight is in very good condition and ready to mount. (104395-2P1)
3873. **LOT OF GUN PARTS** This lot contains an assortment of parts and accessories likely for a Krag bolt action rifle. The parts include; (2) barrel bands (one front, one rear), swivel base, three sections of a takedown cleaning rod, and a rear military ramp sight. The sight retains near 90% blue with spots of fine light oxidation staining present and has crisp legible markings. Also included are four wire bore brushes. (104395-2P2)
3874. **LOT OF MISCELLANEOUS GUN PARTS** This lot Includes an assortment of sight parts, swivels, a forend nosecap, trigger shoe, and Colt barrel bushing wrench. The sight parts include a D.W. King buckhorn rear, slot blank, Lyman No. 37 VA front sight with white bead, Williams WGRS sight with aperture, and (5) elevator inserts. The parts in this lot are all in excellent condition. (104395-2P3)
3875. **LOT OF BUTTPLATES** This lot includes five rifle buttplates to include; (2) Likely Winchester Model 70 checkered steel, (1) U.S. marked Model 1873 steel buttplate, (1) Winchester Model 1873 checkered hard rubber (with logo), and one unmarked checkered steel, likely for a Model 94 rifle. The buttplates are all in near excellent condition. (104395-2P4)
3876. **LOT OF GUN RELATED VIDEOS** Lot contains 16 videos to include several technical / instructional, hunting, and general gun history. Some of the titles include Guns of Valor, Waco, The Big Lie, Gunfighters of the Old West and many more. Please note these videos have not been previously viewed by Amoskeag Auction Company and are sold as-is. (104299-68)
3877. **MAUSER 98 BARRELED ACTION** serial #P54022, 8mm, 23 1/2" barrel with bright about excellent bore. The metal surfaces are mostly a plum color along the barrel showing spots of light fine oxidation staining along with several light scratches. The receiver has spots of light to perhaps moderate pitting under an applied blue finish. The action has a Lyman No. 57 SME sight (missing aperture) and a Weaver K4 Scope with standard crosshair reticle and clear optics in a set of Griffin and Howe side mount rings and base. An overall very good condition action and barrel lot needing only a stock. (106020-132)
3878. **LOT OF GUN RELATED ITEMS** This lot includes the following; (11) assorted gun manuals from Rossi, Savage Browning and others, Tapco (likely 20 round) AK-47 style magazine, (6) factory padlock and cable gun locks, a canvas sling, wool gun sleeve, and two sets of oil bottles. The items are in very good overall condition. (106006-4)
3879. **HUNTING AND FISHING LOT** Includes two items: first is a triggerguard, likely for an '03 bolt action rifle. The triggerguard retains near all of its original parkerized finish with several light scratches and spots of fine oxidation staining present. Second is a Pflueger Progress fly reel. The metal surfaces show light oxidation staining from years of use. The gears appear to be tight and this little reel, with a solid cleaning, would make a fantastic addition to your pack. (104281-10G, 3)
3880. **MARKHAM-KING CHICAGO AIR RIFLE** .180 cal. BB, 10" barrel liner with overall oxidized bore. The two-piece folding maple stock rates very good overall with signs of a light cleaning and crazed reapplied finish, predominately at the wrist and along the forend and the stamp markings are no longer visible. The metal hardware is an overall brown patina. The air rifle appears complete and is in overall very good condition. (105120-2)
3881. **KRAG CLEANING KIT** Includes a three piece steel rod and oiler for an 1898 Krag Rifle. Items are in very good condition with some light fine oxidation staining present. (103763-25A)
3882. **STEVENS POCKET RIFLE STOCK** serial #25159, with metal surface retaining 90% plus original nickel finish with a few light flakes and a couple of scratches present. The threads of the attaching screw are slightly damaged and may need to be chased but overall this is a very good plus accessory that would enhance any Stevens it was paired to. (106519-253A)
3883. **UNMARKED WIRE STOCK** Nickel-plated cast steel with large adjustment. This stock was designed to fit a large variety of revolvers. The metal surfaces retain 85% nickel plate with spots of flaking and fine oxidation staining present. The adjustment screw and knurled roller work freely and the stock is in overall very good condition. (106519-253B)
3884. **BROWNING LUGGAGE CASE** Measures 32"x9"x4" with fake white fur lining. The stitching has popped in several places along the lid and there are four small holes in the center where a plaque once set. The interior of the case is solid and will accommodate a set of over / under barrels up to 30" in length. This is an overall very good condition case that would be great to transport your take down out into the field. (104777-4A)
3885. **MACHINEGUN BARREL** Likely a Breda M-37 machine gun barrel with overall bright excellent bore. The barrel retains 80% blue with spots of light fine oxidation staining and several light scratches. The flash suppressor shows overall light pitting and is mostly in-the-white with some blended areas of brown patina. The barrel appears to be in very good overall condition. (106519-629A)
3886. **LOT OF BOOKS** Includes a partial set of hardcover titles New York in the War of the Rebellion 1861-1865, by Frederick Phisterer. This is a third edition print dated 1912 under the publishers information. This was originally a six book set containing volumes I-V plus an index now it currently has volumes I, II, IV, and the index all showing light toning on the pages and a few light handling marks around the edges in excellent overall condition. (102364-41)
3887. **GERMAN LUFTWAFFE 2ND MODEL OFFICERS DAGGER BY B.&A.** 15 1/4" overall measurement with a 10 1/8" double edge blade. This is a nice example of the post WWII daggers made for commercial sale. The blade is marked "Solingen 1939" and has the cross B.&A. logo and remains wrapped in an orange-colored onion paper. The post-war Third Reich-style fittings are all cast aluminum and show a couple of light marks near the eagles head and right wing. There are light amounts of fine oxidation staining present on the grip ferrule and the wire wrapped celluloid handle is yellowing as well. A very nice example of these daggers made for commercial sale. (105872-8A)
3888. **TIKKA CHOKE TUBES** Includes a set of three tubes and wrench in a plastic case. The tubes are marked with the following hashes and should likely be I-(Full), II-(Improved Modified), and IIII-(Skeet). They are in very good overall condition. (105515-10A)





3889. **1912 DUPONT ADVERTISING CALENDAR** Measures 20"x30" overall with a single calendar page (December 1912). The bands are missing and there light fold marks and a few small tears visible. Under the image the following description "DuPont Powder Wagon Carrying Powder to Lake Erie for Commodore Perry" is bordered in the DuPont logo. This is an attractive piece in overall very good condition. (106935-34)

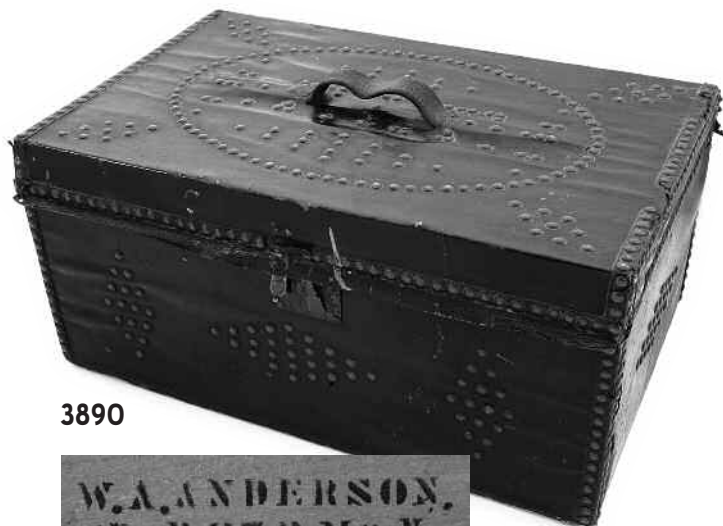

3890



3890. **LEATHER TRUNK LOT** A small leather covered trunk measuring 18 1/8"x11 5/8"x8 1/2" decorated with brass tacks once belonging to Pvt. William A. Anderson. The leather covering is in good overall condition showing some light damage with several small tears, heaviest around the corners. The interior of the lid is stenciled in ink, "W.A.Anderson./Co.H.27.R.Me.V". Private Anderson enlisted on September 30, 1862 and mustered into Co. H. 27th Maine Infantry on the same day. This unit was sent to the D.C. area and engaged in picket duties in nearby Arlington as well as manning defense of the capitol. After returning to Maine with his regiment Pvt. Anderson mustered out on July 17, 1863. This is a neat identified Civil War era personal belonging that would make a nice addition to one's collection. (104962-78)
3891. **M1 CARBINE ACCESSORIES** This lot includes a U.S. marked OD green zippered canvas case and sling for an M1 Carbine. Both items are in very good overall condition. The metal hardware does have a few light spots of fine oxidation staining and works freely. (103629-12A)
3892. **FLAG LOT** This lot consists of two flags. First is a small red pennant with white lettering that measures 13" long in excellent condition. The lettering is as follows "S.P.Y.C. 4 / 2". There are many references for yacht clubs with these initials, but the origin of this particular flag is unknown. Second is a 3'x5' Christian flag in very good condition. The flag has a white field and royal blue canton with a red crucifix in center. It has gold fringe trim around three sides and there are a few small insect holes present and the canton has some fading and discoloration. The origin of this flag is also unknown. (104687-26I)
3893. **LOT OF NAMBU CARTRIDGES** This lot includes two full boxes of early Japanese-manufactured 8mm Nambu cartridges. The boxes are complete with each having a few apologies. The first box has minor ingrained dirt staining, moisture spots, and a couple of split seams along one side. It however is intact and complete and the ink stenciled characters are crisp and legible. The second box has spots of ingrained dirt staining with several small splits in its seams. The boxes and cartridges appear to be in near very good overall condition. (106520-4501A)
3894. **LOT OF GUN GUARD PISTOL CASES** Includes two light brown keyed clasp briefcase-style travel cases. The cases are identical and measure 18"x14"x4 1/2" and do not come with keys. The cases are in overall excellent condition. (106935-35)
3895. **LOT OF ACCESSORIES** Includes five items. First is a 1" adjustable leather rifle sling with brass hardware. The leather is somewhat crazed in areas but remains supple. Second is a leather scope cover with fit lenses measuring 30mm and 28mm outside diameters. Third is a leather fixed blade sporting knife sheath that will accommodate a buck-style knife with blade up to 4 1/2". The leather is supple and shows some light crazing and teeth marks, likely from an adolescent bird dog. Fourth is a partial metal cased Outers Gunslick Rifle Kit. Fifth is a partial cardboard boxed Bridgeport Gun Implement Company cleaning kit. The items in this lot are in very good to near excellent condition. (106935-36)
3896. **REPLICA DUELING PISTOLS** This lot includes a pair of die cast metal flintlock Deringers with cannonstyle barrels and working actions. The metal surfaces retain an aged bronze colored finish and the scroll-engraved plastic grips are colored to look like aged ivory or bone. A neat set of functioning replica pistols in near excellent condition. (106935-37A)
3897. **SET OF REPLICA MIGUELET FLINTLOCK PISTOLS** Includes two well-made replica toy guns with gold washed tin inlays and have foliate engraving on the pan, spring and hammer. The cast barrels are cannon-shaped measuring 10 1/2" overall. These are a handsome looking set of replica pistols with some functioning parts in excellent condition. (106935-37)

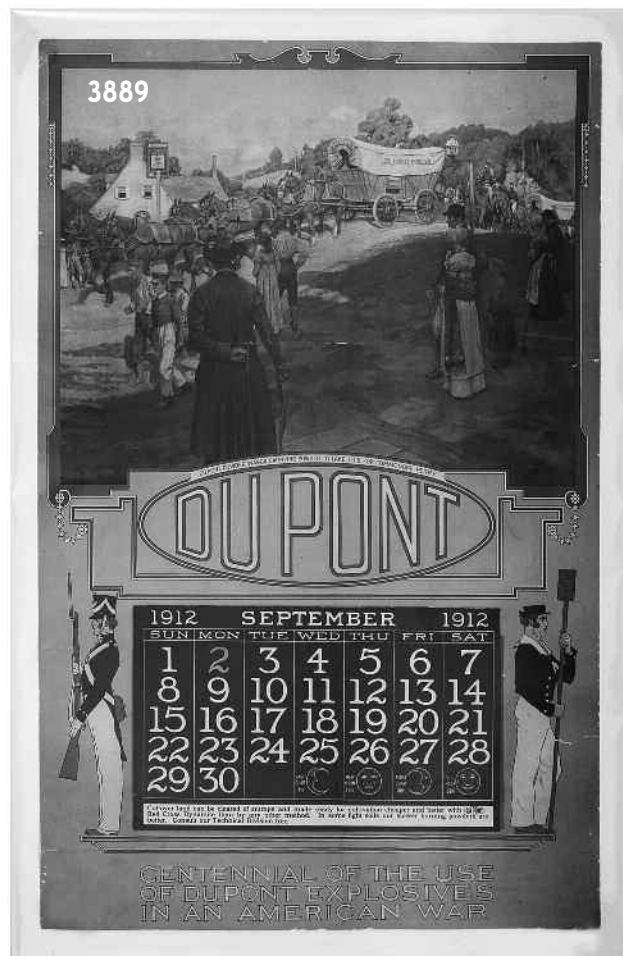

3898. **REPLICA PISTOL AND COMBINATION DIRK / PISTOL** Includes a die cast replica Scottish flintlock belt pistol with floral engraving and cannon-style barrel. There are three inlaid crests with fake jewels that read "VR LACESSIT" and unfortunately the frizzen has been broken off. Second is a Dirk measuring 15" overall with a 9 1/2" double edge blade with small bore flintlock pistol attached to it. The edges are unsharpened and the lock functions flawlessly. These are two interesting replicas that would make fantastic additions to any décor. (106935-37B)
3899. **REPLICA PISTOL LOT** Includes two flintlock pistols. First is a blunderbuss-style belt pistol with working lock however missing its ramrod. Second is a Miguelet-style pistol covered with foliate engraving and also has a functioning lock complete with ramrod. An interesting set of replica flintlocks that would make great wall hangers. (106935-37C)
3900. **LOT OF MILITARY BAGS** Includes three canvas and leather "B4" style bags stenciled with black ink belonging to different enlisted men. Each case shows some type of liquid staining and has spots of wear, or popped stitching. One of the bags has a small hole in the exterior pocket. Overall these bags are in good shape and would fit nicely in any martial collection. (104687-20)
3901. **LOT OF COLLECTIBLE CARTRIDGES** Lot includes three boxes. First is a full 50 round one-piece blue and yellow box of Peters High Velocity .357 Magnum, 158 gr., lead bullets. The box is complete with some minor light scuffing present along some of the edges and has a small area of pencil markings on the left side lower corner. The cartridges are in very good overall condition with some having light amounts of fine white oxidation present on the lead. Second are two partial boxes of .32 caliber Smith & Wesson blank cartridges. The boxes are in very good and excellent condition retaining 90% of all of their labels and contain 18 cartridges between the two. (106935-25)
3902. **LOT OF POCKET KNIVES** This lot includes three Case XX pocket knives. First is a two blade folder measuring 3 1/2" with a 2 1/2" clip point and 2" drop point blade. Second is a two blade folder measuring 3 3/8" with a 2 1/2" clip point and 2" drop point blade. The two larger rivets show signs of tooling marks in the wood where perhaps a miss-strike happened. Third is a three blade folder measuring 3 5/8" with a 2 3/4" clip point, 2" sheep's foot and 1 3/4" spey point blade. The knives are in excellent overall condition and appear to have never been sharpened. (106935-26)
3903. **LOT OF COLLECTIBLES** Includes two items. The first item is a Sportsman Utility Scale. The scale has a patent date of May 3, 1913, measures 5 1/2" overall with the following stamped on the body "NOT LEGAL FOR USE IN TRADE". The scale functions correctly and is in excellent condition. Second is a Hazard Powder Co., "Kentucky Rifle Gun Powder" FFG can. The can measures 5 1/2" tall and has multiple flakes and a few impressions in the red painted body with a near perfect stuck-on label. The can is missing its spout and cap and has some spots of fine oxidation where the paint has flaked however the seams remain tight and the can is in good overall condition. (106935-27)
3904. **LOT OF KELLER & CO., CARTRIDGE TINS** Lot includes three full and partial tins of Flobert caps. There are two 4mm (one full one partial) and one full 7mm. Also included with these items are an empty tin and a label in a standing plastic display. All items in good overall condition. (106935-24)
3905. **POST CIVIL WAR ERA KEPI** Includes a wool Kepi with flat leather brim. There is no longer a maker's mark present on the hat however a red diamond patch and C 17 on the lid likely signify 1st Division, Company C, 17th regiment. The hat is in good overall condition with some minor insect damage and dirt staining. The thin leather chinstrap is still intact and held on by brass eagle buttons. An overall good example. (106935-38)
3906. **CIVIL WAR ERA KEPI** Marked Baker & McKenney / Military Goods / 141 Grand St / New York in gold stencil on the inside lid. The leather chinstrap is intact with brass buckle and eagle / shield buttons. The hat has suffered some moderate insect damage and has several small holes. Interestingly, in 1864 Baker and McKenney had a contract for 10,000 infantry accoutrements, perhaps this may have been one. (106935-22)
3907. **LOT OF ACCESSORIES** Includes three items. First item is an unmarked AR-15 cloth forend cover in good overall condition. Second is a Bucheimer right-hand draw, small frame automatic pistol holster. The black leather is somewhat dry but still supple with several light scratches in good overall condition. Third is an HKS 10-A speed loader in good working condition. (104214-8,9)
3908. **GUN CASE** This lot includes a single Gun Guard travel case measuring 36"x11 1/2"x4 1/2" black in color with lockable clasp closure keys and booklet included. Item is in near excellent condition. (106655-138)
3909. **LOT OF PISTOL CASES** Includes two Plano Gun Guard cases measuring 16"x14"x6" non-lockable clasp closure in excellent condition. (106655-138A)
3910. **LOT OF MTM 1400 CASES** This lot includes three lockable pistol cases measuring 18.5"x13.5"x5" black in color, all three with keys in excellent condition. (106655-138B)
3911. **LOT OF MTM 1400 CASES** This lot includes three lockable pistol cases measuring 18.5"x13.5"x5" black in color, all three with keys in excellent condition. (106655-138C)
3912. **LOT OF PISTOL CASES** This lot includes three hard sided cases. First is a Cabela's lockable clasp case measuring 14"x10"x4 1/2" brown in color with keys. Second is a Dorskocil case with sliding closures measuring 17"x13"x6" black in color. Third is a Dorskocil case with lockable closure measuring 18"x14"x4 1/2" brown in color no keys included. All three cases are in excellent condition. (106655-138D)
3913. **SHOOTERS LOT** This lot includes a wooden shooters chest measuring 22 1/4"x10 1/4"x4 1/2" containing an assortment of related tools, lead, moulds and parts. The tools include a large assortment of bullet moulds, turn screws, and reamers. There is a bag of assorted lead bullets. Also included are several small metal parts that are mostly covered with active oxidation and staining. A total of seven Lyman mould blocks are included as well as two Maxi-Ball mould blocks ranging in size from 40 through 50 caliber. This is an interesting collection of shooting and loading items in fair to good overall condition. (106848-6)



3914. **SHOOTERS LOT WITH TIES TO L.W. TISDEL** This lot includes a wooden chest measuring 14"x7 1/2"x 4 1/2" containing an assortment of tools and loading equipment. There are two brass bullet moulds, the first is a single cavity conical shape mould measuring .485 across the base. The second one is a two cavity conical shape mould in 32-40 and has Tisdell's name and address stamped in the side. Also included are a powder flask, scoop measure, tack hammer, loading tool (32-40), bag of assorted parts and screws and two calipers. Several of the items are marked with L.W. Tisdell and the items are in very good overall condition. (106848-5)
3915. **SCHMID & COMPANY CROSSBOW** Vintage 50's era crossbow with walnut stock, brass barrel and one-piece lath. These well-constructed crossbows with full foot stirrup were heavily advertised for sale in magazines like Popular Mechanics and Popular Science. This particular one is in very good overall condition. (106161-28B)
3916. **UNMARKED CROSSBOW** This contemporary crossbow is stocked in walnut with simple trigger group, brass barrel, and one-piece lath. The stirrup is a T-shape design that has slight left to right play. This is an overall good example and should be gone over by a qualified armorer before attempting to shoot. (106161-28A)
3917. **UNMARKED CROSSBOW** This contemporary crossbow is stocked in walnut with a simple trigger design with side safety, brass barrel, and one-piece lath. The stirrup is T-shaped and there are adjustable sights installed. The stock has an inlaid panther on the right side at the butt. This is an overall good example that should be gone over by a qualified armorer before attempting to shoot. (106161-28C)
3918. **BROWNING COMPOUND BOW** A Drake Flight Master right hand bow with wooden limbs. The bow has an adjustable draw length of 29"-30" at 60lbs pull and 28"-29" at 50lbs pull with 50% let off. There are a few light scratches in the limbs and the bow should be serviced by a qualified technician prior to use. (106161-24)
3919. **BEAR RECURVE BOW** A Kodiak Hunter serial #KT66085, AMO-60", 45lb draw weight. There are several light scratches in the finish along the limbs and riser but bow appears to be free of defects and is in excellent condition overall. Also included with this lot is a string and leather shooting fingers. (106161-23)
3920. **BEAR RECURVE BOW** A Super Kodiak serial #8Z2456, AMO-60", 50lb draw weight. The limbs and riser show several light scratches in the finish and there is a complete three pin adjustable Bear sight incorporated into the riser. The bow remains in excellent condition and included are a string and set of leather shooting fingers. (106161-23A)
3921. **LOT OF ARCHERY ACCESSORIES** This lot includes a wall hung display rack and two quivers. The rack will hold two long bows horizontally and 24 arrows vertically and is disassembled in good overall condition. The first quiver contains 10 assorted wood and aluminum cross-bow bolts with broadheads and fieldpoints and the other a mixture of 23 wood and aluminum arrows with broadheads and fieldpoints. Some of the arrows are missing fletchings but remain in very good overall condition. These would be great practice or fishing arrows. (106161-22)
3922. **MELTING POT** A Lyman Model 61 bottom pour metal melting pot. The temperature is adjustable from 450-850 degrees Fahrenheit; it appears complete with power cord and cooling tray in overall near excellent condition. (106161-26)
3923. **MELTING POT** A Lee Pro 4-20 bottom pour metal melting pot. Included with the pot are the instruction sheet and original box. Item appears to be in good overall condition. (106161-26A)
3924. **RELOADING PRESS** A Dillon Precision Square Deal B reloading press. Currently set for reloading 45 ACP, appears complete with carry bag and manual. (106161-26B)
3925. **RELOADING PRESS** A Lyman All American Comet reloading press. The press is in overall good condition and is missing a bolt. This is a solid single-stage press with lots of hours left in it. (106161-26C)
3926. **RELOADING PRESS** A Lyman All American Turret reloading press. The press is in excellent overall working condition and comes with a set of 45 ACP dies. (106161-26D)
3927. **RELOADING LOT** Includes 32 full and partial boxes of assorted unprimed pistol brass and 15 plastic cartridge cases. There are 18 boxes of 9mm, nine boxes of assorted 38 cal., one box of 44 Rem. Mag., and four boxes of 380 ACP. The majority is brass with several boxes of nickel-plated brass mixed in. (106161-30)
3928. **RELOADING LOT** Includes an assortment of unprimed rifle brass and plastic storage boxes to include the following; 200 casings of surplus 30-06 brass, mostly head stamp marked RA / 54 and RA / 55 in a yellow plastic shooters box, 120 rounds of 300 H&H casings (80 new), and 52 assorted Nickel plated and brass casings all in very good condition. (106161-30A)
3929. **LOT OF GUN LEATHER** This lot contains an assortment of 30 +/- pistol, revolver, and magazine holsters, (3) belts, (3) rifle slings and cartridge boxes ranging in condition from fair to excellent. (106161-13)
3930. **LOT OF RELOADING ACCESSORIES** This lot includes an assortment of reloading components to include two powder scales, a small Lyman press, lead ladle, case trimmer, lube pad, 5 lubricator dies and a couple of related parts. The items are in very good overall condition. (106161-26E)
3931. **LOT OF GUN CARE PRODUCTS** This lot includes an assortment of six sectional rifle and pistol cleaning rods, brushes, lubricants, conditioners and cleaners all relating to firearm maintenance. The items are in good overall condition. (106161-29)
3932. **RANGE BOX AND ACCESSORIES** This lot includes a leather-covered shooters range box measuring 17"x13 1/2"x9" with two slide out drawers. One drawer is designed to store small items such as tools, ammo, glasses and so forth; the other to hold four hand guns. The case is in very good overall condition and the contents list as follows; two shooting ear muffs, two sets of shooting glasses, three partial boxes of 22 RF cartridges, assorted screwdrivers, related tools, papers, rag, spotting scope and lastly a recoil absorbing pad. This box is nearly set for your next range trip, just add the guns and ammo. (106161-27)
3933. **BENCH VISE** A hand-crafted wooden bench vise measuring 26"x9 1/2" with carpeted jaws. A very well crafted shooting and/or cleaning vise that was made by a talented individual that still has useful life left in it. (106161-26F)
3934. **LOT OF SHOTSHELLS** Includes a full 100 round value pack of Remington 12 ga., 2 3/4", 1 1/8 oz, No. 7 1/2 Sport Loads. The boxes are sealed and in excellent condition. (107075-S18250A)
3935. **LOT OF SHOTSHELLS** Includes a full 100 round value pack of Remington 12 ga., 2 3/4", 1 1/8 oz, No. 8 Sport Loads. The boxes are sealed and in excellent condition. (107075-S18250A1)
3936. **LOT OF SHOTSHELLS** Includes a full 100 round value pack of Remington 12 ga., 2 3/4", 1 1/8 oz, No. 7 1/2 Sport Loads. The boxes are sealed and in excellent condition. (107075-S18250A2)
3937. **LOT OF SHOTSHELLS** Includes 11 full five-round boxes of Winchester Super-X 12 ga., 2 3/4", 1 oz, RHPS. The shotshells are in excellent condition. (107075-S18250A3)
3938. **LOT OF SHOTSHELLS** Includes eleven full five-round boxes of 12 ga slugs. There are two full boxes of Remington 12 ga., 2 3/4", 1 oz, rifled slugs, one full box of Winchester Super-X 12 ga., 2 3/4", 1 oz, HPRS and eight Federal Classic 12 ga., 2 3/4", 1 oz, HPRS all in very good condition. (107050-S18250A4)



3939. **LOT OF FEDERAL RIMFIRE AMMUNITION** Includes two sealed 550 round boxes of Federal .22 LR, 36 gr., copper-plated HP rimfire cartridges in excellent condition. (107075-S18250B)
3940. **LOT OF FEDERAL RIMFIRE AMMUNITION** Includes two sealed 550 round boxes of Federal .22 LR, 36 gr., copper-plated HP rimfire cartridges in excellent condition. (107075-S18250B1)
3941. **LOT OF REMINGTON RIMFIRE AMMUNITION** Includes two near full 550 round boxes of High Velocity 22 LR, 36 gr., HP golden bullets in excellent condition. The boxes show minor compressions in and around the corners and are missing part of the end flap. (107075-S18250B2)
3942. **LOT OF REMINGTON RIMFIRE AMMUNITION** Includes two near full 550 round boxes of High Velocity 22 LR, 36 gr., HP golden bullets in excellent condition. The boxes are in good overall condition showing some light scuffing and compression on the corners missing part of the end flap. (107075-S18250B3)
3943. **LYMAN TANG SIGHT** No. 1 first variation combination tang sight on what appears to be a Maynard base. The sight has the correct patent date of "Jan 28, 79" stamped in the base and the finely knurled elevation thimble works flawlessly. The sight has an overall brown patina with strong remnants of blue in protected areas. The underside of the base does not have an application code stamped in it. This is an overall fine example of these early sights. (107026-9A)
3944. **LOT OF RIMFIRE AMMUNITION** Includes 22 LR cartridges from Remington and Federal. First is a partial near full 550 round box of Federal 22 LR, 36 gr., copper-plated HP cartridges in excellent condition. Second is a full 500 round brick of Remington Thunderbolt 22 LR, 40 gr., standard velocity cartridges in excellent condition. The outer sleeve shows some light scuffing and has a small abrasion, likely from a sticker being removed. (107075-S18250B4)
3945. **LOT OF PETERS AMMUNITION** This lot contains a full 20 round box of Peters Rustless 401 Win, 200 gr., SP centerfire cartridges. The blue and yellow one-piece box rates very good overall with some light scuffing present on opposing corners and a few seams. The colors remain vibrant overall with spots of light ingrained dirt staining. The cartridges are in very good overall condition with clean brass and spots of light fine white oxidation on the tips of the lead. (107036-5)
3946. **LOT OF AMMUNITION** This lot contains three boxes of 45 GAP cartridges. First is a full 50 round box of Remington UMC 45 GAP, 230 gr., JHP cartridges in excellent. Second are two full 50 round boxes of Winchester 45 GAP, 230 gr., FMJ cartridges with some of the brass showing spots of light fine oxidation staining in overall very good condition. (107036-4)
3947. **LOT OF REMINGTON AMMUNITION** Includes four full 20 round boxes Remington Express Core-Lokt 30-30 Win., SP cartridges. There are three boxes of 170 gr., and one box of 150 gr., in very good overall condition. (107075-S18250C)
3948. **LOT OF REMINGTON AMMUNITION** Includes four boxes. First are two 20 round boxes (one full, one ((10 round) partial) of Express Core-Lokt 270 Win., 130 gr., PSP cartridges with spots of light oxidation on the brass in very good overall condition. Second are two full 20 round boxes of Express Core-Lokt 270 Win., 150 gr., SP cartridges with spots of light oxidation on some of the brass in excellent condition. (107075-S18250C1)
3949. **LOT OF WINCHESTER AMMUNITION** Includes five boxes. There are four full 20 round boxes and a partial (4 rounds) of Super-X CXP2 30-30 Win., 170 gr., Power-Point cartridges. The cartridges are in overall very good condition with some showing light spots of oxidation staining on the brass. (107075-S18250C2)
3950. **LOT OF REMINGTON AMMUNITION** Includes four full 20 round boxes of Express Core-Lokt 30-06 Springfield, 180 gr., SP cartridges in overall very good condition with some of the cartridges showing specks of light oxidation staining. (107075-S18250C3)
3951. **LOT OF AMMUNITION** Includes four full 20 round boxes. First is a box of Winchester Super-X CXP2, 30-30 Win., 170 gr., Power-Point cartridges. Second is a box of Remington Express Core-Lokt 30-30 Win., 150 gr., SP cartridges. Third are two boxes of Remington Express Core-Lokt 30-30 Win., 170 gr., SP cartridges. The cartridges in this lot are in very good overall condition with a few showing spots of light fine oxidation staining. (107075-S18250C4)
3952. **LOT OF MIXED SHOTSHELLS** Includes three full and or partial boxes and an assortment of loose shotshells. First is a full 25 round box of Remington 12 ga., 2 3/4", 1 1/8 Oz, No 7 1/2 Sport Loads. Second is a partial box (17) of Remington 12 ga., 2 3/4", 1 1/8 Oz, No 7 1/2 Sport Loads. Third is a partial box (16) of Federal Duck & Pheasant 20 ga., No. 6 shot. Also includes are a mixture of (30) 12 ga., and (9) 20 ga., shotshells all in very good overall condition. (107075-S18250-A5)
3953. **LOT OF AMMUNITION** Includes three boxes. First is a full 20 round box of Remington Express Core-Lokt 30-06 Springfield, 180 gr., PSP cartridges in excellent condition. Second is a full 20 round box of Winchester Super-X, CXP2, 30-06 Springfield, 150 gr., Power-Point cartridges in very good condition. Third is a partial (11) box of Winchester Super-X, CXP2, 30-06 Springfield, 150 gr., Power-Point cartridges in very good overall condition. (107075-S18250C5)
3954. **AMMUNITION LOT** Includes an assortment of 22 rimfire cartridges. First is a partial 20 round box (18) of CCI 22 shotshells. Second is a full 50 round box of Winchester 22 LR, No. 12 shot cartridges. Third is a full 50 round box of mixed manufacture 22 LR cartridges in an American Eagle box. Fourth is a full 50 round box of American Eagle high velocity 22 LR, 40 gr., solid cartridges. Fifth is a full 50 round tray of Remington 22 LR cartridges stored in a CCI Quick-Shok box. All items are in very good overall condition. (107075-S18250B5)
3955. **LOT OF PRIMERS** Includes three 100 round packs. First are two CCI 209 shotshell primer packs one full, one containing 95, both in excellent condition. Second is a partial Fiocchi box containing 76 shotshell primers in good overall condition. (107075-S18250D)
3956. **LOT OF MIXED SHOTSHELLS** Includes four boxes. First is a five round box of Remington 12 ga., shotshells to include three 000 Buck and two hollow point slugs. Second is a 25 round cartridge box with 24 mixed 12 ga., and 16 ga., shotshells that are mostly tarnished on the brass. Third is a partial ten round box (5) of Remington Premier Magnum 12 ga., 3", 2 Oz, No. 4 shot shotshells. Fourth is a partial 25 round box (14) of Federal Hi-Power 16 ga., 2 3/4", 1 1/8 Oz, No. 6 shot. Items in this lot are in good overall condition. (107075-S18320A)
3957. **LOT OF RIMFIRE AMMUNITION** Includes four boxes and a brick. First are four boxes of Federal 22 LR, 40 gr., solid bullets in excellent condition. There are three full 50 round boxes and a partial containing 20 all in very good condition. Second is a full brick of Blazer 22 LR, 40 gr., cartridges in excellent condition. (107075-S18331A1)
3958. **LOT OF AMMUNITION** Includes eight full 20 round boxes of Russian-manufactured Tul Ammo 7.62x39mm, 122 gr., FMJ, steel cased ammunition. The cartridges are non-corrosive Berdan-primed in excellent condition. (107075-S18331A2)
3959. **LOT OF AMMUNITION** Includes seven boxes and a bag of mixed cartridges. First are seven full 20 round boxes of Russian-manufactured Tul Ammo 7.62x39mm 122 gr., FMJ steel cased cartridges. They are non-corrosive and Berdan-primed in excellent condition. Second is a mixed bag of 7.62x39mm cartridges in good overall condition. (107075-S18331A3)



3943

3960. **LOT OF MIXED SHOTHELLS** Includes a partial 25 round box (10) of Federal Multi-Purpose 12 ga., 2 3/4", 1 1/8 oz, No. 7 1/2 shot and eight loose mixed manufactured (6) 28 ga., and (2) 20 ga., all in very good overall condition. (107075-S18078A)
3961. **SHOOTER LOT** Includes a mixture of ammunition and a pistol magazine in a leather bag. The bag measures 10"x6" with a single zipper that runs full length through the middle. The ammunition includes 12 surplus 303 cartridges in good overall condition with light to perhaps moderate discoloration of the brass, 24 assorted 38 special cartridges in very good condition, 13 assorted 9mm Luger cartridges in very good condition, 6 Winchester marked 32 ACP cartridges in very good condition, 6 Remington 380 ACP cartridges in good overall condition. Also includes are a full 250 round box of Remington Gallery 22 Short, 15 gr., special composition bullets in good overall condition showing some oxidation on the lead, one full 50 round box CCI Maxi Mag 22 Magnum cartridges in very good condition, one full box of Remington 38 Special, 158 gr., Lead bullets in good overall condition. This lot also includes a single unmarked 380 ACP magazine with what appears to be an added floorplate. (107075-18037A)
3962. **MANHATTAN FIREARMS DUAL CAVITY BULLET MOULD** This .36 caliber round ball and grooved conical shaped mould has an overall plum brown patina with blended silver highlights prominent around the sharp edges. There is a crisp stamp on the face of the sprue cutter that reads "Manhattan Firearms / Manufg / Co / N.Y." The condition of the cavities rates fair overall with some light oxidation staining and peen marks. (106655-127) [Manhattanfirearms.com collection]
3963. **MANHATTAN FIREARMS DUAL CAVITY BULLET MOULD** This .36 caliber round ball and grooved conical shape mould is an overall brown patina with spots of smokey grey blending. The mould has a couple of spots of light oxidation with multiple tiny peen marks along the body and back edge. The stamp is somewhat washed out but still mostly legible and the condition of the cavities rates about excellent. (106655-129) [Manhattanfirearms.com collection]
3964. **CUSTOM MANHATTAN FIREARMS BULLET MOULD** This custom dual .36 caliber round ball and grooved conical shape mould has a crisp stamp that reads "Manhattan Firearms / Manufg / Co / N.Y." on the sprue cutter blade. The sprue cutter screw has broken flush with the body. There are a set of wooden handles added to this mould making it much more user-friendly and the overall condition rates good. (106655-126) [Manhattanfirearms.com collection]
3965. **UNMARKED DUAL CAVITY BULLET MOULD** This .31 caliber dual round ball mould is an overall blended brown patina with patches of grey. It has an interesting set of metal handles with the right side curving in slightly at the end and the left side has a circular end with a 5/8" octagon cut out. There is no sprue cutter attached to the mould and the condition of the cavities is very good overall. This is a neat screw barrel single shot percussion pistol mould in very good overall condition. (106655-125) [Manhattanfirearms.com collection]
3966. **MANHATTAN DUAL CAVITY BULLET MOULD** This .36 caliber round ball and grooved conical shape mould is an overall smokey grey with spots of light fine oxidation staining and active oxidation. The "Manhattan Firearms / Manufg / Co / N.Y." stamp is crisp and legible on the sprue cutter blade. The condition of the cavities rates good plus with some light to perhaps moderate oxidation staining present. (106655-134) [Manhattanfirearms.com collection]
3967. **UNMARKED DUAL CAVITY BULLET MOULD** This .36 caliber round ball and conical shape mould retains 70% flaking blue finish with perhaps a few spots fine pinprick pitting near the handles and spots of fine oxidation staining prevalent along the body. The condition of the cavities rates excellent. (106655-123) [Manhattanfirearms.com collection]
3968. **MANHATTAN DUAL CAVITY BULLET MOULD** this .36 caliber round ball and grooved conical shape mould remains mostly in the white with spots of fine oxidation staining present. There are spots of light fine pitting scattered near all over with perhaps a few slightly more moderate patches near the handles. The "Manhattan Firearms / Manufg / Co / N.Y." stamp is mostly worn but still visible. The condition of the cavities rates about very good with some light fine oxidation present. (106655-133) [Manhattanfirearms.com collection]
3969. **MANHATTAN DUAL CAVITY BULLET MOULD** This .28 and .36 caliber dual round ball mould is an overall plum brown patina with flakes of grey blending in. There are some areas of light fine oxidation staining and the condition of the cavities rates near excellent. The "Manhattan Firearms / Manufg / Co / N.Y." stamp is crisp and legible and this is a very good overall example. (106655-131) [Manhattanfirearms.com collection]
3970. **MANHATTAN DUAL CAVITY BULLET MOULD** This .36 caliber round ball and grooved conical shape mould has a pleasing overall plum brown patina with spots of silvering along the sharp edges and working parts. The "Manhattan Firearms / Manufg / Co / N.Y." remains crisp and legible and the condition of the cavities rates very good overall. (106655-130) [Manhattanfirearms.com collection]
3971. **MANHATTAN DUAL CAVITY BULLET MOULD** this .36 caliber round ball and grooved conical mould has an overall brown and molted grey patina. The right side of the body has multiple tiny peen marks and the "Manhattan Firearms / Manufg / Co / N.Y." stamp is crisp and legible. There are spots of fine oxidation staining present along the handles and also in the cavities. This is an overall very good condition mould. (106655-136) [Manhattanfirearms.com collection]
3972. **CUSTOM MANHATTAN DUAL CAVITY BULLET MOULD** This .36 caliber round ball and grooved conical mould is mostly in-the-white with spots of fine oxidation staining and patches of light pin-prick pitting. The body has several light peen marks and the "Manhattan Firearms / Manufg / Co / N.Y." stamp is still legible. The cavities are in good overall condition with light oxidation and staining present. The back side of the mould has what appears to be a milled .20 caliber round ball cavity added. This is an overall good example with an interesting custom third cavity. (106655-132) [Manhattanfirearms.com collection]
3973. **MANHATTAN DUAL CAVITY BULLET MOULD** This .36 caliber round ball and grooved conical mould retains remnants of blue toning mostly brown and pewter with spots of fine oxidation present at the hinge. There are light peen marks present along the legs and body and the "Manhattan Firearms / Manufg / Co / N.Y." stamp is crisp and clearly legible. The condition of the cavities rates excellent. (106655-135) [Manhattanfirearms.com collection]
3974. **MANHATTAN DUAL CAVITY BULLET MOULD** This .36 caliber round ball and conical mould is an overall plum colored patina with spots of active oxidation present most prevalent at the bottom of the legs. The "Manhattan Firearms / Manufg / Co / N.Y." is slightly washed but still legible. The condition of the cavities rates very good overall with a spot of fine oxidation staining present. (106655-137) [Manhattanfirearms.com collection]
3975. **CUSTOM MANHATTAN DUAL CAVITY BULLET MOULD** This .36 caliber round ball and conical mould is an overall brown with spots of light and moderate oxidation that has had an applied finish added. The sprue cutter screw is missing and the "Manhattan Firearms / Manufg / Co / N.Y." stamp appears to have been brushed clean. The back side of the mould has an additional partially milled round cavity and includes two cast lead bullets that are covered with white oxidation. (106655-128) [Manhattanfirearms.com collection]
3976. **LOT OF MIXED CALIBER AMMUNITION** Includes six full and or partial boxes of handgun ammunition in an OD green ammo can. First is a 50 round box of 3-D remanufactured 9mm, 125 gr., LRN cartridges. Second is a partial 50 round box (24) of Bullseye Ammunition remanufactured 38 Special, 158 gr., SWC bullets. Third is a partial 50 round box (36) of Federal 357 Magnum, 158 gr., JSP bullets. Fourth is a near full mixed 100 round value pack of Remington UMC 9mm Luger, cartridges that also contains some nickel brass cartridges by Federal. Fifth is a partial 20 round box (10) of Winchester Black Talon 357 Magnum, 180 gr., SXT bullets. Sixth is a partial 20 round box (12) of Federal Premium Personal Defense 9mm Luger, 135 gr., Hydra-Shok JHP bullets. Items in this lot are in good to very good overall condition. (107075-S18331A)

3977. **LOT OF MANHATTAN CARTRIDGES** This lot includes a partially sealed package with label that reads "Five Seamless Skin / Cartridges with Caps / for five shot pistols of 36-100 caliber / made by the / Manhattan Fire Arms Man'g Co". The lead bullets appear to have white oxidation on them and the wooden and paper-wrapped package remains about 90% complete missing a small section along the bottom and has been sealed in a clear plastic film. This is an overall very good condition item sure to enhance any cased Manhattan or cartridge collection. (106655-122) [Manhattanfirearms.com collection]



3977

3978. **LOT OF MANHATTAN CARTRIDGES** This lot includes a partially sealed package with label that reads "Five Seamless Skin / Cartridges with Caps / for five shot pistols of 36-100 caliber / made by the / Manhattan Fire Arms Man'g Co". The conical shaped bullets are in good overall condition with traces of white oxidation starting to form. The label is 70 percent complete and the package has been sealed in clear plastic film. An interesting period cartridge case in good overall condition. (106655-121) [Manhattanfirearms.com collection]



3978

3979. **LOT OF BALLARD BRASS** Includes a mixture of 65 primed and unprimed cases of mixed head stamp 32-40 Ballard casings stored in plastic cartridge boxes in overall excellent condition. (107026-5A)

3980. **LOT OF BALL AMMUNITION** This lot includes 48 rounds of 30 caliber ball ammunition with head stamp markings "LC / 69" in en bloc clips housed in a green cloth bandoleer. The cartridges are in very good overall condition. (103748-1A)

3981. **LOT OF P08 MAGAZINES** Includes two aluminum bodies with wood base magazines. First is unmarked with wood and metal base complete in working condition. Second is a wooden base numbered 9500 t missing the follower and follower spring stud. (103615-4B)

3982. **RIMFIRE AMMUNITION LOT** Includes a partial brick and three boxes of 22 caliber cartridges. First is a nearly full brick containing 472 Winchester Super-X T22 Target 40 gr., lead standard velocity cartridges in excellent condition. Second is a partial 50 round box (9) of Western Super-X 40 gr., Lubaloy-coated bullets in excellent condition. Third is a partial 50 round box (33) of Western Super-X 22 Short, HP bullets in very good overall condition with some light discoloration on the brass. Fourth is a full 50 round box of Remington C Bee 22 low velocity copper coated cartridges in excellent condition. (103615-2B)

3983. **LOT OF MIXED CALIBER AMMUNITION** This lot contains a mixture of 30 caliber ball, 30 carbine, 22 rimfire, 308 Win, and 32 S&W. First is a full 20 round box of Winchester Super-Speed 308 Win., 180 gr., SP cartridges in excellent condition. Second is a partial 50 round box of Federal Classic 32 S&W Long, 98 gr., LWC containing 24 casings and 25 cartridges in very good overall condition. Third are 19 loose assorted manufacture 38-55 cartridges in fair condition with varying levels of oxidation and or corrosion. Fourth is a bag of mixed cartridges containing (8) 30 Luger cartridges, (29) 22 Rimfire cartridges and (45) 30 carbine cartridges all in very good condition. Fifth are 37 rounds of mixed head stamp 30 caliber ball ammunition in five round stripper and 8 round en bloc clips in good overall condition. (103615-2D)

3984. **BUCCANEER TRAVEL PACK** Includes a Berkley five section 7' spinning rod in its opened original packaging. The rod is antique, white in color with tan and white accents and all metal eyelets. Each section measures approximately 18" and would fit nicely in a travel bag or knapsack. The cork handle has slightly darkened with age and is in excellent condition. (103615-3C)

3985. **LOT OF SHOTSHELLS** This lot contains five boxes. First is a full 25 round box of Winchester Super-Speed 12 ga., 2 3/4", 1 oz, rifled slug. These paper hull shotshells are in very good overall condition. Second is a partial 25 round box (21) of Winchester Super-Speed 12 ga., 2 3/4", 1 1/4 oz, No. 6 paper hull shotshells in very good condition. Third is a full 25 round box of Winchester Super-Speed 12 ga., 2 3/4", 1 1/4 oz, No. 4 shot paper hull shotshells in very good condition. Fourth are two 25 round boxes, one full, one partial (23) of Canuck Field Load 12 ga., 2 3/4", 1 oz, No. 6 shotshell in very good condition. (103615-2A)

3986. **LOT OF SHOTSHELLS AND WADS** Includes two bags of wads and five containers of shotshells. First are two full 250 count bags of Federal Champion size 7/8 12 ga., plastic wads in excellent condition. Second is a partial 25 round box (20) of Winchester Upland 10 ga., 2 7/8", Blank Loads (black powder) in very good condition. Third is a partial 25 round box (23) of Winchester Ranger 12 ga., 2 3/4", 1 1/8 oz, No. 8 shot paper hull shotshells in excellent condition. Fourth is a full 25 round box of Remington Express 10 ga., 2 7/8", 1 5/8 oz, No. 4 Shot shotshells in excellent condition. Fifth is a bag of assorted 12 ga., paper and plastic hull shotshells from multiple manufactures in a variety of configurations that should be examined carefully before attempting to shoot. Sixth is a full 25 round box of Federal Game Load 12 ga., 2 3/4", 1 oz, No. 6 shot shotshells in very good condition. (103615-2C)

3987. **JAPANESE FLAG LOT** Includes a silk World War II-style "meatball" flag measuring 27"x36" and is free of any markings in excellent condition. (104445-14MBJ1)

3988. **GERMAN FLAG LOT** Includes a banner-style double sided party flag measuring 48"x112" with hand-sewn Swastikas. There are no markings on this flag to indicate its time of manufacture or origin and is likely a reproduction in very good overall condition. (104476-19B)

3989. **JAPANESE FLAG LOT** Includes two World War II-style "meatball" flags. The first flag measures 10"x 11" and is in very good overall condition. The second flag measures 27"x36" with leather reinforced corners with steel grommets. There is moderate insect damage to the flag and it has no additional markings. (104476-19C)

3990. **AMERICAN FLAG LOT** Includes a 36"x56" American flag with light soiling in near excellent condition. (104476-19A)

3991. **RELOADING LOT** Includes an Ideal hand loading tool with 30-06 die set in an M13 spare parts roll. The tool is in excellent working condition and is complete for hand loading 30-06 cartridges. The M13 roll is of heavy canvas with leather tie also in excellent condition. (103738-21)

3992. **GI LOT** Includes four items. First is a U.S. marked Union Instrument Corp., Magnetic Compass in what appears to be working condition. Second is a cloth ammo pouch marked "7.62mm NATO / Linked / Ball M30 / 100 RDS / LOTLCL 500-7 / LAX / Aug. 1967 in very good condition. Third is a canvas ammunition pouch U.S. marked with mostly worn stenciling on the back side. Fourth is a M10 30 caliber cleaning rod in waxed cardboard tube missing the end cap in excellent condition. (103738-11)



3993. **LOT OF 1911 ACCESSORIES** Includes three blue finish 1911 magazines and an assortment of grips. First are two unmarked magazines in excellent condition and one two line marked "Colt / 45 Auto" also in excellent condition. Second are five grip panels to include the following: 1 set of Series 70 smooth factory grips, 1 pair of Coltwood plastic grips with mould numbers (1&7), strengthening ribs and reinforcing rings, and a single Keyes early-style with reinforcing ring and strengthening rib all in excellent condition. (103738-7A, 7B)
3994. **GUNSMITH LOT** Includes a variety of related gun parts and tools. First is a bag containing five sets of assorted scope rings, bases and a grip adapter. Second is a bag containing assorted checkering tools, lubricants, springs and screws. (103738-1, 12)
3995. **LOT OF AMMUNITION** Includes a full box of Hansen Cartridge Company 30 Mauser, 85 gr., FMJ cartridges in excellent condition. Also included in this lot are 17 loose 38 S&W cartridges in overall good condition. (103738-6F)
3996. **LOT OF PERSONAL PROTECTION EQUIPMENT** This lot includes two sets of shooting earmuffs, six assorted safety vests in a variety of colors (orange, yellow, and silver), five pairs of safety glasses (four clear, one amber), four yellow "Street Belts", emergency water bag, "call police" banner, marine whistle with compass, spotting mirror, seat belt cutter, compass, orange tape, emergency beacon, bite kit and seven pairs of lightweight gloves. The items in this lot are in excellent condition. (103880-1)
3997. **LOT OF TACTICAL GEAR** This lot includes four belts (three shotshell, one plain), nine assorted magazine holsters, shoulder holster for medium frame semi-auto pistol, 12 assorted shotshell or cartridge holders and an E&L MFG. Co., brass catcher. Items are in very good overall condition some having light mildew stains. (103880-3A)
3998. **LOT OF KNIVES** This lot includes two folding knives. First is a Buck No. 426 Bucklite lock blade knife measuring 4 3/4" with a 3/4" clip point blade and orange camouflage holster. Second is an unmarked large folding gut hook knife measuring 4 1/4" with 2 1/2" gut hook blade and black nylon holster. Both knives are in near excellent condition. (103880-1A)
3999. **LOT OF MAGAZINES AND SPEED LOADERS** This lot contains six aftermarket 45 ACP magazines and 18 SafariLand speed loaders. There are two different style loaders 13 are marked "S&W / L8C" and five are marked "S&W / K2C" all in excellent condition. There are three blue and three nickel-plated magazines, all from multiple manufactures, which include Wilson, Falcon, Amertec and others. There are two bodies only, the rest are complete and are in good overall condition. (103880-4)
4000. **MEDIA LOT** Includes nine 15 oz boxes of Thumler's Tumbler brass polish in very good overall condition. (103880-10)
4001. **LOT OF SURPLUS AMMUNITION** Includes 80 rounds of KA / 73 head-stamped 30-06 ball ammunition in 8 round en bloc clips. The cartridges show light discoloration on the brass and are in overall excellent condition. (103880-12)
4002. **LOT OF SURPLUS AMMUNITION** Includes 80 rounds of KA / 72 and KA / 73 head-stamped 30-06 ball ammunition in 8 round en bloc clips. The cartridges are in overall very good condition with some light discoloration on the brass. (103880-12A)
4003. **LOT OF SURPLUS AMMUNITION** Includes 80 rounds of KA / 70, KA / 72 and KA / 73 head-stamped 30-06 ball ammunition in 8 round en bloc clips. The cartridges rate very good overall with a few showing light oxidation on the base and overall discoloration of the brass. (103880-12B)
4004. **LOT OF AMMUNITION** Includes two full 50 round boxes of Federal Premium 10mm Auto, 180 gr., Hydra-Shok, JHP nickel-plated brass cartridges in overall very good condition. The boxes have some moderate water damage but the cartridges remain mostly unaffected. There are a few that show some light discoloration on the bullets. (103880-11)
4005. **LOT OF SURPLUS AMMUNITION** Includes 80 rounds of KA / 72 and KA / 73 head-stamped 30-06 ball ammunition in 8 round en bloc clips. The cartridges rate good to very good overall with some having varying light oxidation staining and overall discoloration of the brass. (103880-12C)
4006. **LOT OF SURPLUS AMMUNITION** Includes 80 rounds of AMA / 91, KA / 70, and KA / 73 head-stamped 30-06 ball ammunition in 8 round en bloc clips. The cartridges are in overall near excellent condition with varying levels of discoloration on the brass. (103880-12D)
4007. **SHOOTERS LOT** Includes four items. First is a MCM #807 handgun case. Second is a Past right hand shooting pad. Third is an Ox-Yoke Zip Kit with holster complete in unused condition. Fourth is a Tasco 3-7x20 scope with duplex reticle and clear optics. Items are in very good to excellent condition. (103880-3)
4008. **LOT OF GUN LEATHER** Lot includes a total of 30 +/- pistol, revolver, magazine, and speed loader holsters from a variety of manufacturers to include but not limited to; SafariLand, Dillon, Hunter, and Bianchi. The holsters range from good to excellent with a few still in their original packaging. (103880-5)
4009. **LOT OF DUTY GEAR** This lot includes a large assortment of items to include 4 belts, 6 assorted pistol and revolver holsters, 7 magazine pouches, multiple handcuff and baton holders all in very good to excellent condition. (103880-6)
4010. **LOT OF GUN LEATHER** This lot includes 29 items. They are as follows; 11 leather belts (sizes 38-42), (4) medium frame semi-automatic pistol shoulder holsters, 8 mixed Kydex and Cordura-style holster for semi-automatic pistols, and six magazine holster. All items are in very good to excellent condition. (103880-5A)
4011. **LOT OF BATONS AND NUNCHUCKS** Lot includes two batons and a set of unmarked nunchucks. First is a Monadnock PR-24-S one-piece nightstick with overall light wear consistent with carry in overall very good condition. Second is a Monadnock PR-24XTS expandable nightstick in excellent condition. Both items come with manuals. Third is a set of unmarked wooden practice nunchucks with 4" chain in excellent condition. (103880-6A) [Please check local laws regarding possession of these items]
4012. **LOT OF B.D.U. PANTS** Includes five pairs of XL-Regular pants in three patterns. They are desert camo, black, and grey. There are two pairs of camo and black and a single pair of grey all in very good condition. (103880-2)
4013. **LOT OF B.D.U. PANTS** Includes five pairs of XL-Regular pants in three patterns. They are desert camo, sand, and black. There are three pairs of camo, one black and one sand all in good overall condition. (103880-2B)
4014. **LOT OF B.D.U. PANTS** Includes five pairs of XL-Regular pants in three patterns. They are black, desert camo, and tan. There are two black, two camo, and one tan all in very good overall condition. (103880-2C)
4015. **LOT OF RELOADING COMPONENTS** Lot includes a Dillon No. 20675 large media separator. It appears complete in an unassembled state in its original packaging. (103880-13)
4016. **LOT OF WEB GEAR** This lot includes an assortment of belts pouches and holsters ranging in condition from very good to near excellent. (103880-5B)
4017. **LOT OF HUNTING GEAR** Includes the following items; (3) blaze orange face masks, XL insulated orange camo bibs, XL blaze orange chamois shirt, two safety vest, deer drag harness and nine pairs of assorted gloves and mittens all in very good to excellent condition. (103880-1B)

4018. **LOT OF HUNTING GEAR** Includes the following items; (2) pairs of Lectra-Sox (in original packaging), Size XL insulated snow pants (color brown), (5) assorted canteens, an emergency blanket and two cushioned seats. Items in this lot are in very good overall condition. (103880-7)
4019. **LOT OF EN BLOC CLIPS** Includes 119 clips that vary in condition from very good to excellent with some showing light fine oxidation staining and most with scratches from use. (103880-3B)
4020. **LOT OF EN BLOC CLIPS** Includes 119 clips that vary in condition from very good to excellent with several showing light fine oxidation staining or light to moderate scratches consistent with use. (103880-3C)
4021. **LOT OF G.I. GEAR** Includes five items. First are three Stocker & Yale Inc., U.S. marked magnetic compasses with lanyards and web pouch. All three in very good overall condition. Second is a U.S. marked rifle cleaning kit that includes 4 piece rod, nylon bristle brush, oil, patch cloth, jag, and bore brush in a web pouch in excellent condition. Third is a 5 quart collapsible canteen U.S. marked with instruction on the back in what appears to be excellent condition. (103880-3D)
4022. **ACCESSORY LOT** Includes a fanny pack and five assorted power adapters. First is a Black Claw Cordura two pocket fanny pack in good overall condition that has a few spots of mildew staining. Second are two Archer two outlet cigarette lighter adapters in original packaging. Third is a three outlet Radio Shack cigarette lighter adapter. Fourth is a Radio Shack 60 watt power inverter. Seventh is a Vector 150 watt pocket power inverter. All items appear to be in excellent condition. (103880-1C)
4023. **COLLECTION OF L.W. TIDEL PHOTOGRAPHS** Lot includes an assemblage of period photographs, reprints, and papers all pertaining to the man. There are seven photographs (one has a torn corner) depicting images of the man, his shop and guns he made. There is a period business card, photo copies of a business add and an illustrated page of a scratchpad, possibly the creative works of a related child. Items are in overall very good condition. (106848-8)
4024. **LOT OF BUTTSTOCKS** Lot includes four assorted manufacture shotgun and rifle buttstocks. First is a Marlin 336 buttstock with bulls-eye insert in fair condition. There are several light to moderate scratches, impressions and general handling marks nearly all over. There is also a crack that runs through the wrist, top and bottom, held together by a novice repair. Second are two Remington stocks likely for an 1100 and 870 shotgun. Both are in fair to good condition with moderate chipping around the top of the wrist where it would meet the receiver, and one is missing its buttpad. Third is likely a Savage 311 checkered stock that has multiple scratches and a repair to the top of the wrist along the tang inlet. There are several small chips missing near that repair as well. The stock rates fair with an ill fitted buttpad. (103658-7A, 7B, 7C, 7D)
4025. **LOT OF ASSORTED SHOTSHELL WADS** Lot includes 16 full and partial 250 count bags of assorted manufacturer's plastic shotshell wads to include the following bore sizes; 12, 20, and 28 all in excellent condition. (106935-39)
4026. **HELMET LOT** Includes a Norwegian M35 helmet. The helmet appears complete with intact leather liner and chinstrap. The helmet has spots of light oxidation present with moderate light scratches near all over and the leather remains soft and supple. The painted shields are 80% complete and the helmet is in very good to near excellent condition. (104476-7)
4027. **HELMET LOT** Includes a WWI-era style doughboy helmet with liner and chinstrap. The helmet is complete and has several spots of writing in ink that has faded over the years with the most legible being the name "Bobby Benson" on the inside of the brim. The helmet is in very good overall condition with some light scratches and spots of flaking and white overspray specks near all over. (104476-8B)
4028. **HELMET LOT** Includes a Spanish Model 1930 steel helmet. The leather liner is intact and remains supple, the chinstrap is missing. The helmet has an added layer of green enamel over a mostly oxidized surface. It is an about good example of these style helmets. (104476-8E)
4029. **HELMET LOT** Includes a Swedish M26-style helmet with leather liner missing the chinstrap. The helmet is a grey / blue color with several light scratches in the finish in overall very good condition. (104476-8F)
4030. **HELMET LOT** Includes a French M15 style helmet. This appears to be a complete piece with intact liner and chinstrap. It has a reapplied layer of green enamel over the entire lid that shows spots of oxidation, flaking and several small scratches in good overall condition. (104476-8G)
4031. **HELMET LOT** Includes a U.S. M1 Helmet with liner, and chinstrap. The liner and strap are in very good overall condition and the shell of the helmet has moderate flaking in its applied green enamel. The helmet remains in good overall condition. (104476-8A)
4032. **LOT OF GUN PARTS** This lot includes three triggerguards. First are two percussion rifle style triggerguards, one measuring 11" and the other 10" overall. They are unmarked and one is coated in a black enamel the other has a nickel-silver finish, both in very good overall condition. This is a triggerguard with bottom metal for a 1903 rifle in very good overall condition. (104476-17A, 17B, 17C)
4033. **LONDON BRASS BARREL FLINTLOCK PISTOL** .58 caliber flint, with overall lightly oxidized bore. The pistol is partially disassembled and missing parts. The ramrod, hammer, and part of the frizzen are missing as well as all of the mounting screws. The wood is in overall fair condition missing several chips and splinters, predominately along the right side. (104476-1) {ANTIQUE}
4034. **LOT OF POWDER HORNS AND SHOT FLASKS** This lot includes a total of six items. There are three shot flasks in varying states of condition as well as three powder horns. First is a horn measuring 11" overall missing the spout plug in good overall condition. Second is a horn measuring 9" overall missing the spout and plug with spots of light insect damage in fair condition. Third is a complete horn measuring 6" overall in very good condition. Fourth is a leather flask with hanging hare and quails. The stitching is coming apart and the leather has dried and become very brittle in fair condition. Fifth is a partial floral brass flask missing the neck and spout. Sixth is a leather and brass flask that is unmarked in fair condition. (104476-14)
4035. **LOT OF LEATHER** Includes two items. First is a McKeever-style cartridge box with provision for 20 cartridges. The leather is mostly dried and crazed under a layer of mildew and dirt staining. The brass plate and hardware are mostly a brown mustard color and have spots of active verdigris. The second item is a U.S. marked Model 1912 holster that bears no maker's mark. The leather is dry and lightly crazed but is still supple. The brass hardware shows spots of active light verdigris and has turned an overall brown mustard color. Items in this lot are in fair to good condition. (104476-16)
4036. **LOT OF LOADING TOOLS** Includes two moulds and a recapping tool. First is a dual cavity .25 caliber three groove conical shape brass mould. The mould is in overall very good overall condition with spots of oxidation staining along the body, legs and trace amounts in the cavities. Second is a five cavity cast steel .28 caliber round ball and three groove flat nose bullet mould. The mould has overall light oxidation staining with some in the cavities as well. The mould is in overall very good condition. Third is an unmarked steel recapping tool likely for 12 ga., shotshells in good overall condition. (104476-15A)
4037. **LOT OF LOADING TOOLS** Includes three bullet moulds and a re-capping tool. First is an unmarked .36 caliber round ball mould. The steel body is an overall plum brown patina and the cavities have light fine oxidation staining present. Second is an unmarked brass single cavity .36 caliber three groove round nose bullet mould with overall light oxidation staining present and clean cavity. Third is an unmarked .38 caliber two groove round nose bullet mould with overall light oxidation staining and clean cavity. Fourth is a brass recapping tool likely for 12 ga., shotshells. All items in this lot are in good to very good overall condition. (104476-15B)

4038. **LOT OF BLACK POWDER ACCESSORIES** Lot includes eight items. First are three partial or empty cap tins from the following manufacturers U.M.C., Dr. J. Goldmarks, and U.S. Military Musket Caps all in very good overall condition. Second is a powder scoop measure showing light oxidation on the metal parts, but still legible and functional. Third is a small tin funnel. Fourth are three assorted leather and horn flasks all in fair condition. The horn flask is missing its spout and the two leather flasks are dry and crazed with loosening stitching. Items in this lot are in good to about very good condition. (104476-15C)
4039. **LOT OF POWDER CANS** This lot includes two, first is an unmarked can measuring 5" with proper cap, tight seams and overall flaking black enamel finish. Second is a DuPont Super Fine FFg 1lb can. The red enamel can has a complete white illustrated label with black lettering. Both cans are complete with caps and in overall very good to excellent condition. (104476-18A, 18B)
4040. **HERTER'S RELOADING PRESS** This Super Model 3 press takes standard size dies and has a No. 3 shell holder attached. The press has an overall brown patina with spots of active oxidation and is currently seized, it should however free up after an oil bath. (103081-1)
4041. **LOT OF GUN PARTS** Includes four walnut handguards for military bolt action rifles to include one for a Krag Carbine. The handguards are in overall good to very good condition. (104395-2)
4042. **LOT OF GUN PARTS** Includes three walnut forends. There is one for a Winchester Model 1910 rifle that has a repaired full length crack that runs the entire length in good overall condition. Second is for a Model 1907 rifle that has two cracks one has been repaired the other is has re-opened in good overall condition. Third is a smooth walnut forend likely for a Winchester Model 1200 / 1300 shotgun in very good overall condition. (104395-2A)
4043. **SAKITRON SHOOTING GAME** Includes a laser pistol and targeting sight intended for fun and improving targeting skills in its original box in good overall condition. (104449-7)
4044. **LOT OF MAGAZINES** Includes five rifle magazines. First are four Ruger-marked Mini-14 magazines. There is a single 5 round, two 10 round, and one 20 round magazine all in very good to excellent condition. Also included with this lot is a single 15 round M1 carbine magazine with overall scratching consistent with use and marked IA on the back flat. (104395-2B)
4045. **LOT OF ACCESSORIES** Includes three military-style cleaning kits in pouches and an assortment of commercial rods, brushes and other related items all in good overall condition. This lot also includes a left hand hip holster for a J-frame revolver, and three rifle slings (one leather, two canvas) all in good overall condition. (104395-2C)
4046. **LOT OF GUN PARTS** This lot includes several parts, likely for an M14 rifle. The parts included are; operating rod and spring, bolt, rear sight, complete trigger group, buttplate, barrel band, flash suppressor and sealed bag of related pins, springs, and other gas piston parts. Also included is a section of a receiver that appears to have been destroyed. Parts are in excellent condition. (104395-2D)
4047. **SLING SWIVEL LOT** This Indian War-style swivel is for a trapdoor rifle, differing from a Civil War-style having the elongated "D" shaped loop for a wide strap and the extra loop between the band and clip. There are spots of light fine oxidation present and the swivel is in excellent condition. (104395-2E)
4048. **CORRECTIONS LOT** Includes a set of Harvard Lock Company irons with keys and an unmarked billy club. The moulded plastic club measures 11" overall with a 10" leather lanyard and is in very good overall condition. Second is a set of 14" leg irons in proper working condition with much original blue remaining under some spots of light oxidation staining. This is a neat collection of retired law enforcement items sure to enhance any collection. (104395-2F)
4049. **SHOOTERS LOT** Includes five items. First are two pair of 3M 1435 earmuffs in their original packaging. Second is a three pack of Western Safety P-35710 safety goggles in their original sealed packaging. Third is a Weaver D4 scope with clear optics and standard crosshair reticle in its original box. Fourth is a set of Kalimar 7x50 binoculars with leather carry case. The optics are crisp and clear and leather case is missing its carry strap. The items in this lot are in overall excellent condition. (104395-2G)
4050. **STOCK LOT** This lot includes a two-piece semi-inleted walnut stock for a Johnson semi-automatic rifle. Stock is in excellent condition. (104395-2H)
4051. **LOT OF HOLSTERS** This lot contains four assorted leather holsters. First is a black leather bdr 42 marked P38 holster with Waffenamit in about good overall condition showing heavy scuffing in the dry crazed leather with overall scratches and wear marks. Second is a reproduction U.S. marked Model 1912 style holster black in color in overall very good condition. Third are two quick draw-style for medium frame revolvers with 4" barrels. One is Colt marked and the other is from S.D. Myers both in very good condition. (104395-2I)
4052. **WWI ERA ALUMINUM BRODIE PARADE HELMET** This is a vintage helmet made by George Evans & Co., Uniform makers Philadelphia Pa. The helmet has what appears to be an original leather lining with company logo that is lightly crazed and flaking in spots. The brim has a small wave in it along one edge but overall this is a near excellent example of these parade helmets. (104395-2J)
4053. **LOT OF MILITARY GEAR** Includes two belts and two garrison caps. First is a Mills Model 1914 duty belt with ten pockets in very good overall condition. Second is an unmarked web belt with two pocket magazine pouch in very good overall condition. Third are two wool garrison caps in overall excellent condition. (104395-2K)
4054. **KRAG SIGHT LOT** Includes a Model 1901 rear sight. The sight is missing the leaf slide assembly but remains in overall very good condition and comes with one mounting screw that has minor slot damage. (104395-2L)
4055. **KRAG SIGHT LOT** Includes a Model 1902 rear sight. The sight appears complete in good working condition with much original blue finish remaining with a few spots of light fine oxidation staining. This is an overall very good example. (104395-2M)
4056. **KRAG SIGHT LOT** Includes what appears to be a Model 1892 rear sight, retaining much blue finish with spots of silvering along the sharp edges and areas of light fine oxidation is present as well. This is an overall very good example of these sights. (104395-2N)
4057. **KRAG OILER LOT** Includes three third variation oilers. The oilers are unmarked and in excellent condition. (104395-2P)
4058. **LOT OF M1 CARBINE PARTS** Includes six items. First is an OD green canvas sling in good overall condition. Second is a handguard in excellent condition. Third are four bayonet lug adapters all in excellent condition. (104395-2Q)
4059. **LOT OF GUN PARTS** Includes parts likely for an M14 / M1 Garand rifle to include; sight adjusters, springs, pins, trigger, triggerguards (4), handguard ferrule and screws all parts are in very good overall condition. (104395-2R)
4060. **LOT OF GUN PARTS** Includes an assortment of bolt parts and safeties likely for the Model 1903 bolt action rifle. This lot also includes triggers, triggerguards, springs, pins and screws all in good to very good condition. (104395-2S)
4061. **LOT OF GUN PARTS** Includes an assortment of barrel bands, triggers, safeties, swivels, bolt parts and other related items likely for Mauser-style rifles. All parts are in very good overall condition. (104395-2T)





4062. **LOT OF MISCELLANEOUS GUN PARTS** This lot includes a variety of parts for several military style bolt action rifles. It includes buttplates, triggerguards, magazine wells, springs and followers. The items are likely for Krag, 1903 and Mauser style rifles all in very good condition. (104395-2U)
4063. **SHOOTERS LOT** Includes an assortment of black powder shooting accessories in a leather satchel. The items include; several assorted bullet lubes, caps, powder flask, powder measure, shooting glasses and a small box of assorted jags and brushes. Items are in good overall condition. (104395-2V)
4064. **LOT OF PMC AMMUNITION** Includes two full 20 round boxes of 40-65 Winchester, 260 gr., lead flat point cartridges. The cartridges are in very good overall condition with some light discoloration on the brass. (107023-6)
4065. **LOT OF PMC AMMUNITION** Includes two full 20 round boxes of 40-65 Winchester, 260 gr., flat lead point cartridges. There is overall light discoloration on the brass and the cartridges remain in very good overall condition. (107023-6E)
4066. **WINCHESTER AMMUNITION LOT** Includes a full 20 round box of Super-X, 375 H&H Magnum, 270 gr., power-point SP cartridges. The cartridges are in excellent condition with a few having light specks of discoloration on the brass. (107023-12)
4067. **WINCHESTER AMMUNITION LOT** Includes a full 20 round box of Super-X, 375 H&H Magnum, 270 gr., power-point SP cartridges. The cartridges rate excellent overall with a few cases having light specks of discoloration on the brass. (107023-12A)
4068. **LOT OF HORNADY AMMUNITION** Includes three full 20 round boxes of Light Magnum, 257 Roberts, 117 gr., BTSP cartridges all in excellent condition. (107023-12B)
4069. **LOT OF PMC AMMUNITION** Includes two full 20 round boxes of 40-65 Winchester, 260 gr., flat lead point cartridges. The cartridges are in good overall condition with overall light tarnish on the brass. (107023-6D)
4070. **LOT OF PMC AMMUNITION** Includes two full 20 round boxes of 40-65 Winchester, 260 gr., flat lead point cartridges. The cartridges have overall light tarnish on the brass and are in good overall condition. (107023-6C)
4071. **LOT OF RWS AMMUNITION** Includes two full 20 round boxes of 9,3x74R, 293 gr., cartridges in excellent overall condition. (107023-6A)
4072. **LOT OF PMC AMMUNITION** Includes two full 20 round boxes of 40-65 Winchester, 260 gr., flat lead point cartridges. The cartridges have overall light tarnish on the brass and are in good overall condition. (107023-6B)
4073. **REMINGTON RIMFIRE AMMUNITION** A full 500 round brick of C Bee 22 low velocity 30 gr., copper coated solid point cartridges in excellent condition. (107023-12C)
4074. **LOT OF RIMFIRE AMMUNITION** Lot includes four full 50 round boxes of Old Western Scrounger .22 Winchester Automatic, 45 gr., rimfire cartridges for the model 1903 rifle. Cartridges are in excellent overall condition. (107023-12D)
4075. **LOT OF KYNOCH AMMUNITION** Includes two full ten round and one partial (9 with unprimed casing) box of .35 Winchester, 250 gr., metal covered soft nose cartridges. The boxes are moderately scuffed and stained, missing parts or the entire end flap. The cartridges rate good overall with light tarnish on the brass and traces of fine white oxidation on the lead. (107023-12E)
4076. **LOT OF NORMA AMMUNITION** Includes two ten round boxes one full one partial (8 with fired casing) of 8mm, 195 gr., soft point cartridges. The boxes are scuffed up and have near complete labels. The cartridges rate about good with overall light tarnish on the brass. (107023-12F)
4077. **LOT OF CANADIAN INDUSTRIES LIMITED AMMUNITION** Includes two full 20 round boxes of Dominion 6.5mm, 160 gr., high velocity SP cartridges. The blue and yellow boxes rate about good with light ingrained dirt staining and scuffing along most of the edges. The cartridges rate from fair to good plus with varying levels of tarnish and oxidation on the brass and or lead. (107023-12G)
4078. **LOT OF WINCHESTER AMMUNITION** Includes a full 20 round two-piece box of .35 Winchester 250 gr., metal patched SP cartridges. The box rates about good with moderate dirt and mildew staining. There is a tape repair to the right side rear corner on the lid and the label is near complete with spots of ingrained dirt staining but remains legible. The cartridges are in about very good overall condition having light tarnish nearly all over on the brass. (107023-12H)
4079. **WINCHESTER AMMUNITION LOT** Includes a full 20 round box of .405 Winchester, 300 gr., SP cartridges. The red and yellow box rates fair with a few small tears and is missing a sliver of the top right side corner. The cartridges rate about very good overall with light amounts of tarnish present on some of the brass. (107023-12I)
4080. **LOT OF REMINGTON AMMUNITION** Includes four full 20 round boxes of High Velocity 30-40 Krag, 180 gr., Core-Lokt, PTD SP cartridges in overall excellent condition. (107023-12J)
4081. **LOT OF WESTERN AMMUNITION** Includes three full 20 round boxes of Super-X, 303 Savage, 190 gr., silvertip exp. cartridges in overall excellent condition. (107023-12K)
4082. **LOT OF REMINGTON AMMUNITION** Includes two full 20 round boxes of High Velocity, 300 H&H Magnum, 180 gr., Core-Lokt PTD SP cartridges in very good overall condition with light tarnish evident on some of the brass. (107023-12L)
4083. **LOT OF REMINGTON AMMUNITION** Includes two full 20 round boxes of High Velocity, 300 H&H Magnum, 180 gr., Core-Lokt PTD SP cartridges in very good overall condition some with light tarnish evident on the brass. (107023-12M)
4084. **LOT OF HORNADY AMMUNITION** Includes four full 20 round boxes of Custom Light Magnum, 30-06 Springfield, 150 gr., SP cartridges in overall excellent condition. (107023-12N)
4085. **LOT OF RIMFIRE AMMUNITION** Includes ten full and or partial boxes of various .22 caliber cartridges. First are five full 50 round boxes of Remington 22 Subsonic 38 gr., low noise HP cartridges in excellent condition. Second are three full 50 round boxes of Western Xpert .22 LR, 40 gr., lead standard velocity cartridges in excellent condition. Third is a full 50 round box of Winchester Super-X 22 Magnum, 40 gr., JHP cartridges in excellent condition. Fourth is a partial box of mixed .22 LR cartridges in a subsonic box in good overall condition. (107023-12P)
4086. **LOT OF REMINGTON AMMUNITION** Includes two full 20 round boxes of High Velocity, 25-06 Remington, 120 gr., Core-Lokt PTD. SP cartridges in overall very good condition with a few having minor amounts of white oxidation on the lead. (107023-12Q)
4087. **LOT OF RWS AMMUNITION** Includes three full 20 round boxes of 9,3x74R, 293 gr., Original-Brenneke-Torpedo cartridges in excellent condition. (107023-12R)
4088. **LOT OF RWS AMMUNITION** Includes two full factory sealed 20 round boxes of 9,3x74R, 247 gr., cone point cartridges in presumed excellent condition. (107023-12S)

4089. **LOT OF WESTERN AMMUNITION** Includes five full 20 round boxes of Super-X 30-40 Krag, 180 gr., power point SP cartridges in very good overall condition. The boxes all have light compression marks on one end that does not affect the cartridges. The cartridges rate very good with a few having light tarnish on the brass. (107023-12T)
4090. **LOT OF WESTERN AMMUNITION** Includes five full 20 round boxes of Super-X 30-40 Krag, 180 gr., power point SP cartridges in about very good condition. The boxes have several smudge marks and light compression marks on the ends and the cartridges have overall light tarnish on the brass. (107023-12U)
4091. **LOT OF RWS AMMUNITION** Includes two factory sealed 20 round boxes of 9,3x74R, 247 gr., cone point cartridges in presumed overall excellent condition. (107023-12V)
4092. **LOT OF RWS AMMUNITION** Includes two full 20 round boxes of 9,3x74R, 247 gr., cone point cartridges in excellent condition. (107023-12W)
4093. **LOT OF WESTERN AMMUNITION** Includes five full 20 round boxes of Super-X 30-40 Krag, 180 gr., power point SP cartridges in about very good condition. The boxes show moderate scuffing and staining with minor compression marks along the ends. The cartridges are overall lightly tarnished along the brass with a few having minor oxidation staining at the base. (107023-12X)
4094. **LOT OF WESTERN AMMUNITION** Includes five full 20 round boxes of Super-X 30-40 Krag, 180 gr., power point SP cartridges in overall very good condition. The boxes have light dirt staining and smudging. (107023-12Y)
4095. **FEDERAL AMMUNITION LOT** Includes a full 20 round box of Premium Safari 300 H&H Magnum, 180 gr., Nosler Partition nickel-plated brass cartridges in excellent condition. (107023-12Z)
4096. **FEDERAL AMMUNITION LOT** Includes a full 20 round box of Premium Safari 300 H&H Magnum, 180 gr., Nosler Partition nickel-plated brass cartridges in excellent condition. (107023-12AA)
4097. **LOT OF WESTERN AMMUNITION** Includes five full 20 round boxes of Super-X 30-40 Krag, 180 gr., power point SP cartridges in good overall condition. The cartridges have light tarnish on the brass with a few spots of oxidation staining near the bases. (107023-12AB)
4098. **WINCHESTER AMMUNITION** Includes a full 20 round box of Supreme 300 H&H Magnum, 180 gr., Fail Safe cartridges. These CXP3 nickel-plated cartridges are in excellent condition. (107023-12AC)
4099. **WINCHESTER AMMUNITION** Includes a full 20 round box of Supreme 300 H&H Magnum, 180 gr., Fail Safe cartridges. These CXP3 nickel-plated cartridges are in excellent condition. (107023-12AD)
4100. **LOT OF FEDERAL AMMUNITION** Includes two boxes and a partial belt clip of Federal Premium 7-30 Waters, 120 gr., BTSP cartridges in very good overall condition. There is a full box, a partial containing 10 cartridges and 10 fired casings and a belt clip holding eight rounds. (107023-12AE)
4101. **LOT OF FEDERAL AMMUNITION** Includes two full 20 round boxes of Hi-Power 7-30 Waters, 120 gr., BTSP cartridges in overall very good condition. (107023-12AF)
4102. **LOT OF WINCHESTER AMMUNITION** Includes two full 20 round boxes of Super-X 38-55 Win., 255 gr., SP cartridges in very good overall condition. The cartridges show light amounts of tarnish on the brass. (107023-12AG)
4103. **LOT OF WINCHESTER AMMUNITION** Includes two full 20 round boxes of Super-X 375 Winchester, 250 gr., power point SP cartridges in overall excellent condition. (107023-12AI)
4104. **LOT OF 22 LR MAGAZINES** Includes two Steyr Zephyr five round magazines. The magazines retain near all their original blue finish with several light scratches consistent with use in excellent condition. (107023-14)
4105. **LOT OF HORNADY BULLETS** Includes five full factory sealed 100 round boxes. There are four with labels that read "22 cal., .227 / 70 gr., SP W/C / qty: 100 #2280" and one that reads "100 32280 / 22 cal., 70 gr. / .227 Spire Point" all in presumed excellent condition. (107023-12AJ)
4106. **LOT OF REMINGTON AMMUNITION** Includes three boxes. First are two full 20 round boxes of Express Core-Lokt 35 Rem., 200 gr., SP cartridges in excellent condition. The third box contains 14 fired casings in good overall condition. (107023-12AK)
4107. **LOT OF WINCHESTER AMMUNITION** Includes two full 20 round boxes of Super Speed 219 Zipper, 56 gr., HP cartridges in overall excellent condition. The red, white and yellow boxes rate about very good overall with light scuffing and handling marks missing the inside ears of the end flaps. The cartridges show light discoloration on the brass. (107023-12AL)
4108. **LOT OF REMINGTON AMMUNITION** Includes three boxes of Hi-Speed 257 Roberts. There are two full 20 round boxes of 100 gr., mushroom bullets and a partial 20 round box (six) of 87 gr., mushroom bullets all in very good overall condition with some cartridges showing light tarnish on the brass. (107023-12AM)
4109. **LOT OF WINCHESTER AMMUNITION** Includes two boxes of Super Speed 219 Zipper, 56 gr., HP cartridges in about very good condition. The cartridges show varying levels of light tarnish and oxidation on the brass and lead. The red, yellow and white boxes rate good with a missing end flap and overall light scuffing along the edges. (107023-12AN)
4110. **LOT OF REMINGTON AMMUNITION** Includes three boxes of 257 Roberts. First is a full 20 round green and red box of Express 117 gr., Core-Lokt SP cartridges in very good overall condition showing light tarnish on some of the brass. Second is a full 20 round box of High Velocity 117 gr., Core-Lokt SP cartridges in excellent condition. Third is a full 20 round box of Express 117 gr., Core-Lokt SP cartridges in excellent condition. (107023-12AP)
4111. **LOT OF FEDERAL AMMUNITION** Includes three full 20 round boxes of Hi-Shok 270 Winchester, 130 gr., SP cartridges in excellent condition. (107023-12AQ)
4112. **LOT OF AMMUNITION AND BRASS** Includes four boxes. First are two full 20 round boxes of Federal High Energy 270 Win., 140 gr., extended range boat tail cartridges in very good overall condition. Second are two 20 round boxes of mixed brass, one is full, the other a partial containing 18. (107023-12AR)
4113. **LOT OF PETERS AMMUNITION** Includes two full 20 round boxes of 303 Savage, 180 gr., SP cartridges in about very good overall condition. The blue and yellow boxes rate very good with overall light scuffing on the edges and some light staining present as well. The cartridges show light overall tarnish on the brass. (107023-12AS)
4114. **LOT OF AMMUNITION** Includes three partial boxes of mixed caliber rifle ammunition. First is a partial 20 round box (14) Western Super-X, 303 Savage, 190 gr., expanding silvertip bullets in very good overall condition. The standing bear box rates very good plus with a few light scuffs and pencil marks. The cartridges are overall lightly tarnished and remain in very good condition. Second is a partial 20 round box of Remington 303 Savage, housed in a Winchester Staynless box in good overall condition. Third is a partial 20 round box (16 plus 4 fired casings) of Winchester Super-X, 375 H&H Magnum, 270 gr., power-point SP cartridges in about excellent condition. (107023-12AT)

4115. **LOT OF WINCHESTER AMMUNITION** Includes five boxes. First are four full 20 round boxes of Super-X 30-40 Krag, 180 gr., power-point SP cartridges in about very good condition with varying levels of light tarnish on the brass. Second is a partial box of Super-X, 30-40 Krag containing 3 cartridges and 14 fired casings in good overall condition. (107023-12AU)
4116. **LOT OF AMMUNITION** Includes three boxes. First is a full 20 round box of Winchester Super-X, 257 Roberts +P, 117 gr., PP cartridges in very good overall condition. Second is a full 20 round box of Federal Premium, 257 Roberts +P, 120 gr., Nosler Partition cartridges in about very good overall condition. Third is a full 20 round box of Western Super-X, 257 Roberts, 100 gr., silvertip cartridges in about very good condition with varying amounts of tarnish on the brass. (107023-12AV)
4117. **LOT OF WESTERN AMMUNITION** Includes two 20 round boxes of Super-X, 300 H&H Magnum, 150 gr., expanding bullets in overall very good condition with varying amounts of light tarnish on the brass. There is one full 20 round box and one partial 20 round (13 cartridges 4 fired casings). (107023-12AW)
4118. **LOT OF WINCHESTER AMMUNITION** Includes three boxes. First are two full 20 round boxes of Super-Speed 300 H&H Magnum, 180 gr., expanding silvertip cartridges in about good overall condition. The bear boxes are mostly scuffed and tattered and the cartridges have varying levels of tarnish and oxidation both on the brass and lead. Third is a full 20 round box of Super-Speed, 300 H&H Magnum, 220 gr., expanding silvertip cartridges in fair overall condition. The red and yellow box has spots of light staining and scuffing along its edges and the cartridges have moderate to heavy oxidation on the brass and lead. (107023-12AX)
4119. **LOT OF AMMUNITION** Includes two boxes. First is full 20 round box of Winchester Supreme, 300 H&H Magnum, 180 gr., fail safe cartridges in excellent condition. Second is a full 20 round box of Remington High Velocity, 300 H&H Magnum, 180 gr., Core-Lokt PSP cartridges in very good overall condition. (107023-12AY)
4120. **LOT OF WESTERN AMMUNITION** Includes three full 20 round boxes of Super-X, 250 Savage, 87 gr., PSP cartridges in very good overall condition. (107023-12AZ)
4121. **LOT OF WINCHESTER AMMUNITION** Includes three full 20 round boxes of Super-X, 250 Savage, 100 gr., silvertip cartridges in excellent overall condition. (107023-12AAA)
4122. **LOT OF MIXED CALIBER AMMUNITION** Includes four boxes of mixed caliber rifle ammunition. First is a full 20 round box of Federal 7-30 Waters, 120 gr., BTSP cartridges in very good overall condition. Second is a full 20 round box of Prvi Partizan 22-250 Remington, 55 gr., SP cartridges in very good condition. Third is a full 20 round box of Sellier & Bellot 8x57JR, 196 gr., SP cartridges in excellent condition. Fourth is a partial box of Federal High Energy, 270 Win., 140 gr., trophy bonded bear claw cartridges in excellent condition. (107023-12AAB)
4123. **LOT OF MIXED BRASS** Includes a variety of rifle brass. First are three 20 round boxes of Federal unprimed 30-30 Win., brass. Second is a full 50 round box of Winchester / Western un primed 218 Bee cases. Third are two full 20 round boxes of Winchester / Western unprimed 30-40 Krag Brass. Fifth is a 100 round bag of primed Winchester 303 Savage brass. All items in this lot are in very good to excellent in overall condition. (107023-12AAC)
4124. **LOT OF AMMUNITION** Includes four boxes. First are two full 20 round boxes of Federal Hi-Power, 6mm Remington, 80 gr., SP cartridges in excellent condition. Second is a full 20 round box of Western Super-X, 6mm Remington, 80 gr., SP cartridges in very good overall condition. Third is a full 20 round box of Winchester Super-X, 6mm Remington, 80 gr., PSP cartridges in excellent condition. (107023-12AAD)
4125. **LOT OF AMMUNITION** Includes five boxes. First are two full 20 round boxes of Remington High Velocity, 30-40 Krag, 180 gr., Core-Lokt PSP cartridges in excellent condition. Second is a full 20 round box of Remington Kleanbore 30-40 Krag, 220 gr., SP cartridges in very good overall condition. Third is a full 20 round box of Western Super-X, 30-40 Krag, 180 gr., expanding silvertip cartridges in very good overall condition. Fourth is a partial 20 round box (18) of Western Super-X, 30-40 Krag, 180 gr., power-point SP cartridges in good overall condition. (107023-12AAE)
4126. **LOT OF REMINGTON AMMUNITION** Includes two full 20 round boxes of High Velocity 35 Whelen, 250 gr., SP cartridges in excellent condition. (107023-12AAF)
4127. **LOT OF REMINGTON AMMUNITION** Includes one full 20 round and one partial (14) box of High Velocity 35 Whelen, 250 SP cartridges in excellent condition. (107023-12AAG)
4128. **LOT OF WINCHESTER AMMUNITION** Includes two full 20 round blue and white boxes of Winchester Staynless 35 Win., 250 gr., SP cartridges in very good overall condition. The boxes are in good overall condition with light to moderate spots of scuffing and one has multiple tape repairs. The cartridges have varying levels of light tarnish on the brass. (107023-12AAH)
4129. **LOT OF WINCHESTER AMMUNITION** Includes two boxes. First is a full 20 round blue and white box of Winchester Staynless 35 Win., 250 gr., SP cartridges. The box rates about good, missing an endflap, and has overall light scuffing along the edges. The cartridges have varying levels of tarnish and are in very good overall condition. Second is a partial 20 round (19) red, yellow and blue box of Winchester Staynless 35 Win., 250 gr., SP cartridges. The box is in good condition with overall light scuffing, a couple of split seams and ingrained dirt staining. The cartridges have varying levels of light tarnish and the brass remains mostly bright. (107023-12AAI)
4130. **LOT OF WINCHESTER AMMUNITION** Includes two full 20 round red, yellow and blue boxes of Staynless 35 Win., 250 gr., SP cartridges. The boxes rate about fair with missing end flaps, overall, light and moderate scuffing, ingrained dirt staining and split seams. The cartridges have varying levels of tarnish with some showing light fine white oxidation on the lead. (107023-12AAJ)
4131. **LOT OF AMMUNITION AND BRASS** This lot includes a mixture of Winchester and Remington cartridges and fired casings. First are 26 Winchester head stamp 35 Win., cartridges are in good overall condition showing light tarnish on the brass with a few having light amounts of white oxidation on the lead. Second are 13 Winchester brass fired casings in good overall condition. Third is a full 20 round dog bone box of Remington 35 Winchester, 250 gr., SP cartridges. The box is missing both end flaps, has several spots of light to perhaps moderate scuffing on the edges and flats. The cartridges rate about very good with varying levels of light tarnish present on the brass. Also included are two Remington head stamp fired casings. (107023-12AAK)
4132. **LOT OF SELLIER & BELLOT AMMUNITION** Includes four full 20 round boxes of 5.6X52R, 70 gr., SP cartridges in excellent condition. (107023-12AAL)
4133. **LOT OF MIXED CALIBER AMMUNITION** Includes three boxes of centerfire rifle cartridges. First is a full 20 round box of Remington Hi-Speed, 250 Savage, 100 gr., Core-Lokt mushroom cartridges in very good overall condition. The green and red box rates good overall with several scuffs, seam separations and ingrained dirt staining. Second is a full 20 round box of Western Super-X, 250 Savage, 87 gr., SP cartridges in very good condition. The blue and yellow box rates about good with torn end flap, ingrained dirt staining and overall scuffing. Third is a full 20 round dog bone box of Remington 22 Savage High Power, 70 gr., metal cased cartridges in overall very good condition. The box is about good with spots of light to perhaps moderate scuffing, tape repaired end flap and a couple of small splits in the seams. (107023-12AAM)



4134. **LOT OF MIXED HANDGUN AMMUNITION** Includes four different calibers. First is a partial 50 round box (25) of M1911, 45 ACP ball cartridges from Twin Cities Arsenal. The head stamps are marked TW / 56 and the cartridges are in excellent condition. Second is a partial 50 round box (46) of American Eagle 45 ACP 230 gr., FMJ cartridges in excellent condition. Third are 40 loose Peters 38 special (9 brass 31 nickel plated) cartridges in good overall condition. Fourth is a partial 50 round (40) box of Winchester 9mm Luger, 115 gr., silvertip HP cartridges in excellent condition. Fifth are two 50 round boxes of Federal Classic 44 Special, 200 gr., SWC cartridges one full one partial (26 cartridges / 24 casings) both in excellent condition. (107023-12AAN)
4135. **LOT OF 12LB GRAPESHOT** This lot includes seven modern cast steel balls measuring 2.06" in diameter and weighing approximately 1.3 lbs each. The balls have varying levels of condition from good to excellent. The balls vary due to levels of oxidation from light amounts to slightly more moderate amounts on others. Typically a total of nine balls were stacked in a special shaped cylinder and shot from a 12lb cannon. (106519-138)
4136. **LOT OF 12LB GRAPESHOT** This lot includes eight cast steel balls measuring 2.06" in diameter and weighing approximately 1.3 lbs each. The balls have varying levels of light oxidation on some to perhaps moderate amounts on others. These modern cast balls are in very good overall condition. (106519-138A)
4137. **LOT OF 12LB GRAPESHOT** This lot includes eight cast steel balls measuring 2.06" in diameter and weighing approximately 1.3 lbs each. The balls have varying levels of light oxidation on some to perhaps moderate amounts on others. The modern cast balls are in very good overall condition. (106519-138B)
4138. **LOT OF 12LB GRAPESHOT** This lot includes eight cast steel balls measuring 2.06" in diameter and weighing approximately 1.3 lbs each. The balls have varying levels of light oxidation on some to perhaps moderate amounts on others. These modern cast balls are in very good overall condition. (106519-138C)
4139. **LOT OF FEDERAL AMMUNITION** Includes two full 20 round boxes of Premium Vital-Shock, 7-30 Waters, 120 gr., Sierra Game King BTSP-FN cartridges in overall excellent condition. (107023-12AAP)
4140. **LOT OF FEDERAL AMMUNITION** Includes two full 20 round boxes of Premium Vital-Shock, 7-30 Waters, 120 gr., Sierra Game King BTSP-FN cartridges in overall excellent condition. (107023-12AAQ)
4141. **LOT OF FEDERAL AMMUNITION AND BRASS** Includes two full 20 round boxes of Premium Vital-Shock, 7-30 Waters, 120 gr., Sierra Game King BTSP-FN cartridges in overall excellent condition. Lot also includes 35 fired casings in very good condition. (107023-12AAR)
4142. **LOT OF FEDERAL AMMUNITION AND BRASS** Includes two full 20 round boxes of Premium Vital-Shock, 7-30 Waters, 120 gr., Sierra Game King BTSP-FN cartridges in overall excellent condition (107023-12AAS)
4143. **LOT OF WINCHESTER / WESTERN AMMUNITION** Includes two full 20 round boxes of Super-X, 250 Savage, 87 gr., PSP cartridges in very good overall condition. A few of the cartridges have spots of light tarnish and some of the lead has light amounts of white oxidation as well. (107023-12AAT)
4144. **LOT OF WESTERN RIMFIRE AMMUNITION** Includes six full and or partial 50 round boxes. First is a partial box (21) of Super Match, Mark III, 22 LR, 40 gr., lead greased bullets. Second are six boxes five full and one partial (27) of Super-X, 22LR, wax coated bullets in very good to excellent condition. (107023-12AAU)
4145. **LOT OF RIMFIRE AMMUNITION** Includes nine boxes of 22 Short. First is a full 50 round box of Remington Hi-Speed 22 Short, "Golden Bullet" in very good overall condition. Second are eight full 50 round boxes of Western Xpert, 22 Short, 29 gr., lead greased bullets in excellent condition. (107023-12AAV)
4146. **LOT OF PETERS RIMFIRE AMMUNITION** Includes a partial 500 round brick containing nine full 50 round boxes and one partial box containing 30, all in excellent overall condition. The outer sleeve is missing parts of the end flap and is scuffed up along the edges and the individual boxes are in excellent condition. (107023-12AAW)
4147. **LOT OF RWS AMMUNITION** Lot includes 79 loose rounds of 8x57JR SP cartridges in overall very good condition showing light tarnish on some of the brass. (107023-12AAX)
4148. **LOT OF LOOSE MIXED CALIBER AMMUNITION AND BRASS** This lot contains a mixture of centerfire and rimfire rifle and pistol cartridges to include commercial and ball ammunition. First are 50 mixed rounds of 30-40 Krag, in various configurations to include ball and soft point cartridges. Second are 49 assorted 22 LR cartridges some lead, some copper coated hollow points. Third are 19 rounds of 7.63 Mauser ball ammunition. Fourth are eight rounds of assorted 30-30 soft point and silvertip cartridges. Fifth are 40 rounds of assorted head stamp 32 ACP ball cartridges. Sixth are 50 mixed 9mm, and various .38 caliber cartridges, most with white oxidation on the lead. Seventh is a bag of 11 mixed cartridges to include the following; (1) Kynoch 600 Nitro, (1) Kynoch 475 No.2 Nitro, (1) Remington 40-72 Win., (1) Winchester 35 W.C.F., (1) Remington 256 Newton, (2) 300 Magnum, (1) 300 Weatherby Magnum, (1) U.M.C. 405 C.F., (1) Western 44-40, (1) Twin City 45 ACP. Also included with this lot are approximately 100 unprimed Norma 7x61 Super brass, and 98 assorted fired casings to include; 30-40 Krag, 30-30 Win., 25-20, 45 ACP and a few others all in overall very good condition. (107023-12AAY)
4149. **LOT OF MIXED CALIBER AMMUNITION** Includes three boxes. First is a full 20 round box of Herter's 6,5x55, 90 gr., HP cartridges in excellent condition. Second is a full 20 round box of Norma 6,5x55, 156 gr., SPRN cartridges in excellent condition. Third is a full 20 round box of Norma 7x61 Super, 160 gr., SPBT cartridges in excellent condition. (107023-12AAZ)
4150. **LOT OF MIXED CALIBER AMMUNITION** Includes four full and or partial boxes. First is a full 20 round box of German-manufactured 7.62 ball (.308) cartridges with MEN 85 head stamps. Second is a full 50 round mixed box of 22 Hornet containing Peters and Winchester cartridges. Third is a partial 20 round box (16 cartridges 1 casing) of Winchester .35 Win., 250 gr., SP cartridges. Fourth is a partial 20 round box (19) of Sellier & Bellot 5,6x52R, 70 gr., SP cartridges. Items in this lot are in very good overall condition. (107023-12AAAA)
4151. **LOT OF SHOTSHELLS** This lot contains a mixture of 12 ga. and 20 ga., shotshells. First are four loose 12 ga. shells to include; (1) Federal No. 6 duck & pheasant, and (3) paper hull Western Xpert all in good overall condition. Second is a partial five round box (4) of Winchester Super-X 12 ga., 2 3/4", 1 oz, HPRS in excellent condition. Third is a full 25 round box of Federal duck & pheasant 12 ga., 2 3/4", 1 1/4 oz, No. 6 shot in very good condition. Fourth is a full 25 round box of Remington Express 20 ga., 2 3/4", 1 oz, No. 7 1/2 shot in very good condition. (107023-12AAAB)
4152. **LOT OF AMMUNITION** Lot includes two full 20 round boxes of Garrett's remanufactured 45-70 GVT, 405 gr., JSP cartridges. The label on the box reads "Garrett's .45-70 Government Cartridges / (Modern Rifles Only) / 405 GR JSP at 1700 FPS / 2600 Foot Pounds / For Marlin, Ruger, and Browning Rifles Only / Garrett Cartridges (206) 736-0702". The cartridges are in very good condition. (107023-12AAAC)
4153. **REDFIELD SCOPE LOT** Includes a 1-4x rifle scope with standard crosshair reticle and crisp clear optics. There are light ring marks evident on the 1" tube and the scope remains in near excellent condition. (107023-16)

4154. **LEUPOLD SCOPE LOT** Includes a Vari-XIII 1.5x5 rifle scope with fine duplex reticle with crisp clear optics. There are faint ring marks present on the 1" diameter tube and the scope remains in excellent condition. (107023-16A)
4155. **REDFIELD SCOPE LOT** Includes a 1-4x IER rifle scope with standard crosshair reticle and crisp clear optics. There are light ring marks and a few scratches on the 1" diameter tube and the scope is in very good overall condition. (107023-16B)
4156. **LEUPOLD SCOPE LOT** Includes a Vari-XIII 1.75x6 rifle scope with heavy duplex reticle and crystal clear optics. The scope has a set of unmarked quick release Picatinny-style rings and is in overall excellent condition. (107023-16D)
4157. **LOT OF WEAVER SCOPES** Lot includes four. First is a K1 rifle scope with MOA Dot reticle and clear crisp optics with overall light scratches and faint ring marks on the 1" tube in overall very good condition. Second is a K 2.5 rifle scope with overall light scratches, spots of fine oxidation staining and faint ring marks along the 1" diameter tube with post and crosshair reticle with slightly cloudy optics in good overall condition. Third is a K3 rifle scope with overall light fading, scratches and fine oxidation staining present on the bell and 1" tube. There are faint ring marks and the scope has a post and crosshair reticle with crisp clear optics. Fourth is a K4 rifle scope with standard crosshair reticle with slightly cloudy optics. There are light scratches and faint ring marks present on the 1" tube and the scopes are all in good to very good overall condition. (107023-16E)
4158. **P.08 TAKEDOWN TOOL** Marked only with W154 retaining nearly all of its finish with silvering along the back flat in overall excellent condition. (103765-12F)
4159. **ANSCHUTZ ACCESSORY LOT** Includes three items for a model 54 rifle. First is an instructional booklet with slightly curled pages. Second is an Anschutz No. 6702 Micro Sight with rubber eye cup and No.6522-1 globe front sight with single insert. Third is a "home-made" brass single shot adapter with articulating palm rest marked "A. Tarr / Verona PA.". The items are in very good to excellent overall condition. (104418-26)
4160. **GERMAN HAT** This lot includes a wool M-43-style cap with "F V" markings along the inner band. The hat is in near very good condition with a few light stains and minor insect damage. (103593-1)
4161. **BACON ARMS COMPANY REVOLVING PEPPERBOX PISTOL** serial #452, .22 RF, 2 7/16" six-barrel cluster with oxidized bores. The metal surfaces are an overall lightly oxidized brown patina with one half of the barrels a pewter gray patina. There is overall light oxidation staining and light pinprick pitting with the manufacturer's marking still mostly visible. The smooth rosewood grips rate very good. The cylinder pin is a non-gun replacement. The cylinder will index but lockup is very loose. (36535-16) {ANTIQUE} (250/400)
4162. **UNMARKED BELGIAN CENTER HAMMER PERCUSSION PISTOL WITH FOLDING BAYONET** .46 cal., 3" octagon barrel with a oxidized and pitted smoothbore showing a protruding screw from attachment of the folding bayonet. The metal surfaces are an overall adult gunmetal gray and brown oxidized patina with the right side chiefly oxidized overall. There is light scroll engraving on the frame flats and at the tang. The under-folding bayonet is roller-spring loaded and features an old 1 3/4" triangular bayonet. The bag-shaped European walnut grip rates very good and is nicely checkered with scalloped cheeks at the frame. The gun will hold on the half cock notch which is worn; it does not hold at full cock. (36535-10) {ANTIQUE} (250/400)
4163. **UNMARKED BELGIAN BRASS-BARRELED CENTER HAMMER PERCUSSION PISTOL WITH FOLDING BAYONET** .50 cal, 6 1/2" cannon-belled muzzle, lightly flaring in the bore. The bore is moderately oxidized. The brass surfaces are a dark ocher patina with a very light engraving on the left and right frame flat. The iron surfaces are an overall light brown and oxidized patina. The under-folding bayonet is spring-loaded and has a 5 1/2" triangular lightly oxidized blade. The bag shaped European walnut grip is smooth and rates about very good, as lightly refinished many years ago, retaining some minor dings and handling marks. The mechanism seems to function well although the half cock notch can be overcome. (36535-14) {ANTIQUE} (250/450)
4164. **UNMARKED FLINTLOCK COAT PISTOL** About 48 cal., 6" part octagon part round barrel with a moderately oxidized bore. The metal surfaces of the barrel are a brown patina with overall moderate oxidation, they exhibit facsimile British proofs on their left diagonal flat. The lockplate has an unbridled frizzen and faceted pan with gooseneck cock and light engraving, it is a brown patina with the upper components showing light oxidation. There is no triggerguard but there is a simple teardrop shaped cylindrical trigger present, it would appear as though this bottom metal is of more rudimentary construction than the upper components. There is a ramrod thimble and tailpipe of brass as well as a lightly engraved sideplate. The walnut stock appears to be of later construction and is somewhat rudimentary, likely using salvaged parts from an older pistol to build this arm. It rates about very good with minor dings and handling marks and a few light cracks. (36855-36) {ANTIQUE} (200/400)
4165. **DISPLAY MODEL FLINTLOCK CENTER HAMMER PISTOL** This is a brass frame-barrel pistol model of a center hammer flintlock coat pistol. There is a part octagon part round "barrel" with a cannon-belled muzzle, 3 1/2" long. The "bore" is actually bored clean through into the mechanism area of the frame and the working parts can be observed from the muzzle. The triggerguard, hammer, frizzen and trigger are a dull gunmetal gray, lightly oxidized. The bag-shaped walnut grip is somewhat rudimentary and rates about good. The mechanism seems to function although there is no provision for a frizzen spring (there is no need for one as this is not a working firing pistol. (36710-4) {non-gun}
4166. **CUSTOM STEVENS DIAMOND NO. 43 PISTOL** serial #23477, 22 RF, 6" part octagon, part round barrel with a good bore. The barrel is an overall dull gray patina with light oxidation speckling and light pitting. The frame retains about 70% original nickel, the loss along the top edge near the backstrap. There has been a custom backstrap added and custom frontstrap with a very large brass triggerguard which would easily accommodate a gloved hand; the workmanship is rather rudimentary. There are large walnut slab grips now affixed with a dual screws through a brass escutcheon. The mechanism seems to work, the sights are replacements. (36842-14) (50/150)

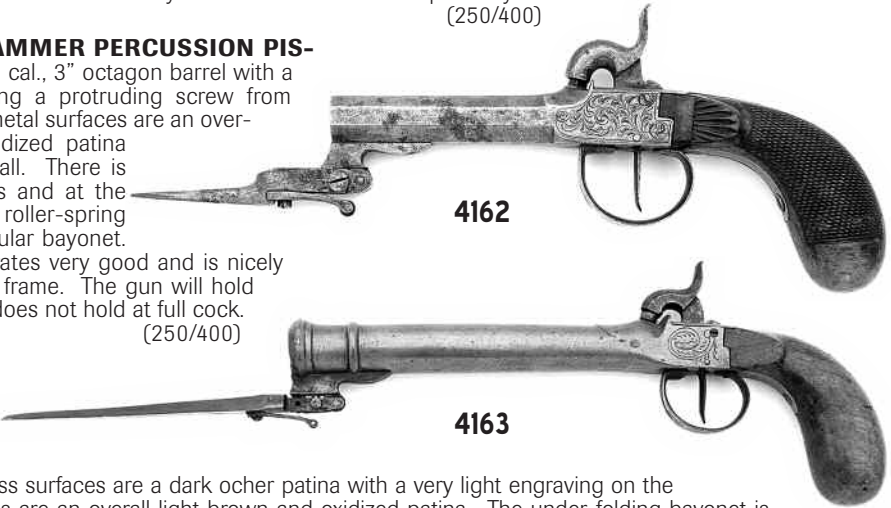

4167. **GERMAN PERCUSSION DOUBLE ACTION REVOLVER BY BAADER** .38 cal., 6" octagon barrel with an oxidized bore. This is an interesting revolver and was somewhat fancy in its day. The design of its trigger would suggest it is double action however it will not work double action, it seems to work rather well single action with some manipulation. The metal surfaces are an over dull gun-metal gray beneath a light coating of oxidation and areas of light pitting, there are some areas of moderate oxidation. The frame flats, hammer and triggerguard bow all show some nice quality light loose flowing scroll, the top flat inlaid in silver "F Baader in Munchen". The one-piece ebony or very dark walnut grip rates about very good, it is smooth and has shrunken somewhat with the years. One nipple is missing in it appears as though there are other small parts missing, likely including the trigger spring as it must be held forward to catch the hammer. (36873-6) {ANTIQUÉ} (150/250)
4168. **BRITISH PERCUSSION COAT PISTOL BY DUNDERDALE, MARSON & LABRON** .52 Cal, 7" octagon barrel with an oxidized bore. The metal surfaces are an overall oxidized brown patina with some light engraving on the tang. The lockplate is maker marked and shows some very light engraving, the lock appears to be an older flint lock salvaged for this arm. The lock once held a sliding rear safety, it is no longer present and the hammer has no cut for it. The bottom furniture is iron with the triggerguard front extension showing a light pineapple finial. The stock rates is about good and is very dark showing overall minor dings and handling marks from the years and nice checkering in the area of the grip. There is what appears to be an original or at least a period ebony ramrod present and the lock is mechanically functional. (36535-22) {ANTIQUÉ} (250/450)
4169. **FRENCH MODEL 1892 ORDNANCE REVOLVER BY ST. ETIENNE** serial #L2870, 8mm ordnance, 4 5/8" part octagon barrel with an oxidized about good bore. The metal surfaces are dark gray-blue with some wear to pewter on the high edges and contact points, also with a near overall coating of light, and some moderate, active oxidation. The straw-tempered parts have all faded to a gunmetal gray. The two-piece walnut checkered grips rate very good. The lanyard loop is no longer present but the gun seems to function well mechanically albeit a bit sluggishly. (36873-11) {C&R} (150/250)
4170. **IVER JOHNSON 38 SAFETY HAMMER TOP-BREAK REVOLVER** serial #I3513, 38 S&W, 3 1/4" barrel with a lightly pitted bore. This second model revolver retains about 90% plus original nickel finish with most of the flaking on the barrel forward of the cylinder along with additional loss to the muzzle and cylinder. The hammer and trigger retains strong case-hardened colors with light wear. The checkered hard rubber grips remain in near excellent condition with light handling marks. Included is an original two piece un-numbered purple box with a lightly damaged lid but is correctly end labeled to the gun. The box warns against the use of smokeless powder. (86940-49) {C&R} (150/250)
4171. **IVER JOHNSON 32 SAFETY HAMMERLESS TOP-BREAK REVOLVER** serial #B57677, 32 S&W (short), 3" barrel with an excellent bore. This third model revolver retains about 90% original blue finish with intermittent thinning on the grip frame, silvering at the muzzle and scattered light oxidation blemishes. The trigger retains strong case-hardened colors with light wear marks. The checkered hard rubber grips remain in near excellent condition with light handling marks but the rear of the left panel has a small chunk of hard rubber missing around the escutcheon. Included is an original hinged un-numbered brown box that is correctly end labeled to the gun and also includes a period bore brush and a small corked period vile of 3-in-1 oil. (86940-265) {C&R} (150/250)
4172. **IVER JOHNSON 38 SAFETY HAMMERLESS TOP-BREAK REVOLVER** serial #R20556, 38 S&W, 3 1/4" barrel with an excellent bore. This second model revolver retains about 90% original blue finish with thinning backstrap, high edge wear, random scratches and oxidation blemishes. The trigger retains fading case-hardened colors that are drifting to silver. The checkered hard rubber grips remain in near excellent condition with light handling marks. Included is an original two piece un-numbered brown box that is correctly end labeled to the gun and shows light edge wear and damage to one edge of the cover. (86940-255) {C&R} (125/225)
4173. **IVER JOHNSON 100 YEAR COMMEMORATIVE MODEL 50A SIDEWINDER DOUBLE ACTION REVOLVER** serial #517E, 22 LR, 5 3/4" barrel with an excellent bore. This revolver retains about 50% original blue finish with most of the loss to the recessed cylinder with flash control rim and barrel which have flaked to a brown hue. The in-the-white hammer and trigger have freckling present. The oversized imitation stag factory grips are in very good condition with light stains and scratches. The revolver includes a jewelry-style hard case with moderate handling wear and a watch fob with Iver Johnson and Cycle works medallion attached. The revolver is marked 1871 / IJ / 1971 on the right side of the frame near the barrel. (86940-243) (50/100)
4174. **SMITH & WESSON MODEL 36 CHIEFS SPECIAL REVOLVER** serial #615665, 38 Special, 1 7/8" pinned barrel with an excellent bore. This revolver retains about 80% plus original blue finish with the grip frame flaking to a mottled mix of brown, gray and blue. The frame, barrel and cylinder have a mix of gray and brown from wear and oxidation blemishing. The Magna trigger and standard hammer retains robust case-hardened colors. The checkered walnut stocks with silver S&W medallions are in very good condition with scattered handling marks. This J-frame still times and locks up correctly and would the perfect concealed carry or home defense gun. (87075-S18034) (250/350)
4175. **IVER JOHNSON MODEL 57 TARGET REVOLVER** serial #J19042, 22 LR, 4 3/8" barrel with an excellent bore. This revolver retains about 70% original blue finish with most of the loss to the barrel, frontstrap and forward section of the frame. The one-piece checkered synthetic thumb-brest factory grips rate good to very good with scattered handling marks. The revolver features a windage-adjustable rear sight and elevation-adjustable front sight. An original factory hinged box with green leatherette covering and a manual are included. The only marking on the box is the company's name in script on the cover. (86940-275) {C&R} (75/150)
4176. **ROMANIAN CONTRACT MODEL 1934 SEMI-AUTO PISTOL BY BERETTA** serial #06435, 380 ACP, 3 3/8" barrel with a frosted bore. This pistol retains about 75% original blue finish with the grip frame flaking to gray and additional wear on the slide and high edges. The black synthetic grips are in very good condition with light wear and handling marks. The slide is marked "Cal 9 Scurt" and is dated 1941. The frame, barrel and slide have correct matching serial numbers and a single magazine is included. The Romanians contracted for about 20,000 guns at the start of the war. This would be a nice addition to a WWII Axis firearms collection. (86849-4) {C&R} (200/300)
4177. **BERETTA MODEL 1934 SEMI-AUTO PISTOL** serial #568029, 32 ACP, 3 3/8" barrel with an excellent bore. This pistol retains about 85% plus original dull blue finish with the grip frame thinning to a brown color with additional high edge wear and handling marks. The black synthetic grips are in very good condition with light handling marks. The slide is dated 1944 and the frame, barrel and slide have correct matching serial numbers. A single magazine is included. This would be a nice addition to a WWII Axis firearms collection. (87017-7) {C&R} (250/350)
4178. **RUGER MODEL SR9C COMPACT SEMI-AUTO PISTOL** serial #332-87668, 9mm, 3 1/2" barrel with an excellent bore. This pistol retains about 99% original black finish on the metal surfaces and the polymer frame remains in excellent condition. The pistol has three dot adjustable sights and includes a pair of ten round magazines with finger extension base. This pistol has seen minimal use and would be a great concealed carry or home defense gun. (87075-S18330) (350/550)
4179. **RUGER MODEL SR9C COMPACT SEMI-AUTO PISTOL** serial #332-35101, 9mm, 3 1/2" barrel with an excellent bore. The stainless steel surfaces and the polymer frame are in excellent condition. The pistol has three dot adjustable sights and includes a pair of ten round magazines with finger extension base. This pistol has seen minimal use and would be a great concealed carry or home defense gun. (87075-S18329) (350/550)



4180. **SMITH & WESSON MODEL SW9C SEMI-AUTO PISTOL** serial #PBA3903, 9mm, 4" barrel with an excellent bore. This pistol retains about 99% original black finish on the metal surfaces with some slight high edge wear and the polymer frame remains in excellent condition. The pistol is equipped with three dot sights. Included are an excellent condition Gould & Goodrich black leather thumb break holster, a pair of ten round magazines and a single sixteen round magazine. (87075-S18425) (300/500)
4181. **BAUER FIREARMS SEMI-AUTO PISTOL** serial #008397, 25 ACP, 2 1/8" barrel with an excellent bore. The stainless steel surfaces are in excellent condition. The white pearlite grips are in excellent condition. The pistol includes a single magazine and a factory soft case with Bauer Firearms embossed on the top. (87022-164) [Mark Benenson Collection] (200/300)
4182. **LLAMA MODEL IA SEMI-AUTO PISTOL** serial #63978, 32 ACP, 3 3/4" barrel with an excellent bore. This pistol retains about 70% original blue finish with the gripframe and slide flaking to a gunmetal gray with interspersed brown colors. The checkered walnut factory grips are in very good condition with light handling wear. This miniature Model 1911-style pistol is proof dated 1943 and includes a single magazine. (86849-6) {C&R} (100/200)
4183. **CHARTER ARMS EXPLORER II SEMI-AUTO PISTOL** serial #B034415, 22 LR, 5 1/2" detachable barrel with an excellent bore. Overall, the pistol retains about 98% original black paint finish with a few scattered chips along the high edges. The plastic pistol grips remain in excellent condition. Based on the AR-7 Explorer rifle this pistol includes fully adjustable rear sight and manual safety. The pistol includes a single magazine. (86957-3) (50/100)
4184. **TAURUS FALCON MODEL DOUBLE ACTION REVOLVER** serial #504549, 38 Special, 4" barrel with an excellent bore. This S&W Model 15 clone retains about 98% original blue finish with some scattered light freckling. The straw colors on the hammer and trigger remain strong. The checkered hardwood grips with gold "Falcon" medallions are in very good condition with the only blemish a small check on the left panel near the frame. The revolver appears to have seen only light use. (87075-S18401) (150/250)
4185. **PIETTA MODEL 1851 CONFEDERATE NAVY REVOLVER** serial #284602, .44 cal. percussion, 7 3/8" barrel with a near excellent bore with light oxidation blemishes in the grooves. The barrel and cylinder retains about 98% original blue finish with a few light handling marks. The cylinder has a light impact mark to the face which raised some metal on the edge between two chambers. The brass frame is in excellent condition and the hammer and loading lever retain strong case-hardened colors. The smooth walnut grips are very good to excellent condition with a few light handling marks. The screw connecting the loading lever with the rammer has been replaced with a Phillips head machine screw. (86821-6) {ANTIQUÉ} (75/150)
4186. **HIGH-STANDARD MODEL 101 DURA-MATIC SEMI-AUTO PISTOL** serial #1947405, 22 LR, 4 1/2" barrel with an excellent bore. This pistol retains about 97% original blue finish with scattered light handling and disassembly marks. The checkered one-piece synthetic grips are in near excellent condition with a few light handling marks. No magazine is provided but it should not be too difficult to locate one. (86957-1) (200/300)
4187. **A.C.H.A. "LOOKING GLASS" SEMI-AUTO PISTOL** serial #42655, 2 1/16" barrel with a lightly frosted bore. This pistol retains about 95% original blue finish with some random oxidation blemishes and handling marks. The frame is starting to drift to plum and the right grip panel is missing. The left checkered hard rubber panel is in near excellent condition. No magazine is provided. (86842-5) {C&R} (75/150)
4188. **RAMLINE EXACTOR MODEL SEMI-AUTO PISTOL** serial #P5-31-09809, 22 LR, 5 1/2" ventilated rib barrel with a near excellent bore with a shallow ring present. The metal surfaces retain about 98% original black finish with the remaining polymer surfaces in near excellent condition. No magazine is provided with the pistol. (87076-D30207) (100/200)
4189. **PONSNESS-WARREN MODEL 800 SHOTSHELL RELOADING PRESS** serial #9265, .410 bore. This classic cast aluminum base press features star gear indexing, 7/8" diameter cross shaft, Tru-Crimp tooling, spring-loaded wad ram and metal star gear housing, gravity fed primer tray, plastic primer catcher, plastic powder and shot tubes. The press is in primarily excellent condition with a light stained swab. These 20 year old plus units were top-of-the-line in their day however parts are no longer manufactured. (56778-4)
4190. **PONSNESS-WARREN MODEL 800 SHOTSHELL RELOADING PRESS** serial #9349, 12 ga. This classic cast aluminum base press features star gear indexing, 7/8" diameter cross shaft, Tru-Crimp tooling, spring loaded wad ram and metal star gear housing, gravity fed primer tray, plastic powder and shot tubes. The press is in primarily excellent condition with a light stained swab. These 20 year old plus units were top-of-the-line in their day however parts are no longer manufactured. (56778-5)
4191. **PONSNESS-WARREN MODEL 800 SHOTSHELL RELOADING PRESS** serial #9361, 16 ga. This classic cast aluminum base press features star gear indexing, 7/8" diameter cross shaft, Tru-Crimp tooling, spring loaded wad ram and metal star gear housing, gravity fed primer tray, plastic powder and shot tubes. The press is in primarily excellent condition with a light stained swab. These 20 year old plus units were top-of-the-line in their day however parts are no longer manufactured. (56778-7)
4192. **PONSNESS-WARREN MODEL 800 SHOTSHELL RELOADING PRESS** serial #9330, 20 ga. This classic cast aluminum base press features star gear indexing, 7/8" diameter cross shaft, Tru-Crimp tooling, spring loaded wad ram and metal star gear housing, gravity fed primer tray and plastic primer catcher, plastic powder and shot tubes. The press is in primarily excellent condition with a light stained swab. These 20 year old plus units were top-of-the-line in their day however parts are no longer manufactured. (56778-6)
4193. **CUSTOM 1898 KRAG MAGAZINE SPORTING RIFLE** serial #308298, 30-40 Krag, 22" plain barrel with a very good plus bore having some sparse spots of light oxidation closest to the muzzle, marked "ALLEN'S" at the left side in front of the receiver. The metal surfaces retain 99% quality added blue. The walnut stock rates very good overall having been shortened to 10" from the muzzle, still with crisp left side cartouche, firing proof and rack number at the heel just in front of the buttplate tang along with light handling marks and perhaps a little added oil finish. The trapdoor buttplate is primarily dull brown with scattered pinprick pitting and oxidation staining. There is no evidence of sight mounting on the barrel but a Weaver K25 scope with post and crosshair reticle and clear optics has been mounted to the left side of the receiver. (57022-119) [Mark Benenson Collection] (300/500)
4194. **WINCHESTER MODEL 74 SEMI-AUTO RIFLE** serial #73113, 22 Short, 24" barrel with a bright excellent bore. The metal surfaces retain about 92% original blue light toning to brown with a few sparse specks of fine oxidation and a perhaps a very light nick here and there. The plain pistolgrip walnut rates fine with a few light marks and blemishes. A nice example WWII era model 74 rifle. (57022-173) {C&R} [Mark Benenson Collection] (200/400)
4195. **WINCHESTER MODEL 74 SEMI-AUTO RIFLE** serial #43871, 22 LR, 24" barrel with a very good plus bore having some very light oxidation staining. The metal surfaces retain about 85% original blue toning to a dull brownish-gray under ambient light with a few light scuffs and light silvering along the high edges. The plain pistolgrip fancy walnut stock rates very good with nice grain structure in the buttstock having numerous light dents, handling marks and flaking original finish along the belly of the buttstock. An overall nice example early second year of production model 74 rifle. (57022-190) {C&R} [Mark Benenson Collection] (200/400)
4196. **NAVY ARMS ZOUAVE PERCUSSION RIFLE** serial #6521, .58 cal., 33" round barrel with a very good bore having scattered spots of oxidation more prevalent towards the muzzle. The barrel retains about 95-97% original blue with scattered spots of oxidation and pinprick pitting more defined around the bolster area. The lock retains nearly all its bright crisp case colors and the brass hardware has a nice goldenrod patina with a few light impact marks. The stained hardwood stock rates fine with a few light handling marks and spots of flaking original varnish. The proper trumpet tip ramrod is present. (56869-5) {ANTIQUÉ} (275/375)

4197. **F.LLI PIETTA MODEL 1851 NAVY PERCUSSION REVOLVER** serial #468349. .36 cal., 7 1/2" octagon barrel with a bright excellent bore. The barrel and engraved cylinder retain 99% original blue with a couple light scratches from storage. The frame and loading lever retain equal brilliant case colors and the brass backstrap and triggerguard remain bright. The one-piece stained hardwood grip rates excellent. Revolver includes an original factory cardboard box with reproduction powder flask, spare wedge, nipples and manual. (57017-28) {ANTIQUÉ} (75/150)
4198. **C.M.C. PERCUSSION PEPPERBOX PISTOL** serial #24334P. .36 cal., 3" four barrel cluster with bright excellent bores. The steel surfaces retain 98% original brown finish and the brass frame is primarily goldenrod with a dime size spot of oxidation on the right side of the nipple shield. The walnut grip rates excellent. (56834-3) {ANTIQUÉ} (75/150)
4199. **SOVIET MAKAROV SEMI-AUTO PISTOL** serial #BA8671, 9mm Makarov, 3 1/2" barrel with a bright excellent bore. The metal surfaces retain about 90% original blue toning to gray with scattered pinprick pitting; the decocking lever and hammer are a dull purple brown. The checkered one-piece brown plastic grip rates near excellent with a few light handling marks. Soviet issue equipped with a fixed rear sight. Dated 1966, a single magazine is included. (57015-6) {C&R} (100/200)
4200. **SOVIET MAKAROV SEMI-AUTO PISTOL** serial #VM1275, 9mm Makarov, 3 1/2" barrel with a bright excellent bore. The metal surfaces retain about 85% original blue toning to gray with the decocking lever having traces of purple brown. The checkered one-piece brown plastic grip rates very good showing light wear. Soviet issue with fixed rear sight. Dated 1981, a single magazine is included. (57015-8) {C&R} (100/200)
4201. **EAST GERMAN MAKAROV SEMI-AUTO PISTOL** serial #EV2520, 9mm Makarov, 3 1/2" barrel with a bright excellent bore. The metal surfaces on this importer-marked pistol retain about 98% armory-added blue with light silvering along the edges, slide and frame are numbered alike. The checkered one-piece brown plastic grip rates near excellent with a couple light handling marks. Equipped with a Soviet style fixed rear sight, two magazines are included. (57015-7) {C&R} (200/400)
4202. **HOPKINS & ALLEN DOUBLE ACTION NO. 6 REVOLVER** serial #6725, 32 S&W, 2 1/2" octagon barrel with a good bore having moderate oxidation and pitting. The metal surfaces retain about 98% original nickel with scattered specks of light flaking. The checkered H&A hard rubber grips rate fine with minor light wear. The action is in need of mechanical attention as the cylinder does not advance properly. (57014-37) {C&R} (100/200)
4203. **IVER JOHNSON SAFETY HAMMERLESS TOP BREAK DOUBLE ACTION REVOLVER** serial #R1568, 32 S&W, 3 1/4" ribbed barrel with a very good bore having some scattered light frosting and a couple specks of very light pitting. The metal surfaces retain about 85% original blue toning to brown with scattered fine oxidation staining. the checkered hard rubber owl's head grip rates fine with a few light handling marks. (57014-9) {C&R} (150/250)
4204. **L.W. SEECAMP LWS-32 CALIFORNIA EDITION SEMI-AUTO PISTOL** serial #049308, 32 ACP, 2" barrel with a bright excellent bore. The stainless steel metal surfaces rate excellent with a few light scuffs and blemishes. The checkered black nylon grips rate excellent. The action does not function properly; the magazine and some internal parts are no longer present. (57075-S18535) (100/175)
4205. **STAR MODEL 43 FIRESTAR PLUS SEMI-AUTO** serial #2131649, 9mm, 3 3/8" barrel with a bright fine bore. The metal surfaces on this alloy frame pistol retain 98% Starvel finish with a few scattered light scuffs. The checkered black grips rate excellent. Included is a single magazine.
4206. **AMT BACK UP SEMI-AUTO PISTOL** serial #A19490, 380 ACP, 2 1/2" barrel with a bright fine bore. The metal surfaces on this two-tone stainless steel pistol show a few light nicks and scuffs. The aftermarket clear checkered plastic grips rate very good. Included are two finger rest magazines. (57075-S18035) (175/275)



4207. **INLAND BROWNING 1919A6 NON-FIRING DUMMY GUN** The metal surfaces on this demilled U.S. military rifle retain about 90% of a black enamel finish with areas of light handling and edge wear present. The right side of the receiver has been restamped with a modern type, the original factory markings are faint but still partially visible underneath. The GI shrouded barrel has been plugged at the chamber and the A4 receiver is made up of both working GI and non-working fabricated parts. No ammunition can be chambered or fired. A folding A6 bipod, carry handle and the A6 shoulder stock are included. A terrific example of these classic U.S. military arms, perfect for the military re-enactor or for a World War I or II military display. (46857-24) {NON-GUN} (800/1200)



4208. **MODEL GUN CORPORATION GERMAN MP40 REPLICA MACHINEGUN**

This lot consists of an all-metal replica of the infamous German MP40 machinegun. The metal surfaces retain most of their original finishes with light handling wear and some light flaking along some of the edges. What appear to be original military parts are included and have minor flaking and are mostly brown. The plastic grip panels rate like-new. The left side is lightly etched "039-40-0025" and the top is stamped "MP40 / mgc68". Two small machine screws are holding the tube to the frame portion and are clearly not the original or correct screws but seem to be doing the job. A correct style leather sling, stamped "1 GBA 56", is included; no magazine is present. The bolt mechanism operates and would function with reusable plug fire cartridges in the full auto mode but the chamber adapter is not present. The barrel assembly has been plugged and filled with rod stock and cannot fire live ammunition. An excellent looking 1968 vintage replica arm that has some original military parts and is considered to be a rare collectible in its own right. (46857-31) {NON-GUN} (400/600)

4209. **UNMARKED REPLIC M3 SUBMACHINE GUN** This non-firing, all-metal replica has a gray enamel finish with some light flaking but has most of the finish intact. This is a non-operating side-handle replica that has been made with some original military parts, including a numbered "B.G.L.-GL-" triggerguard. This grease gun includes a bolt and barrel with a correct M9 flash hider and has a collapsible wire stock. An original magazine and a green canvas sling included. Though no ammunition can be chambered and the ejection port covered, this would still make a great example for re-enactment or display use. (46857-30) {NON-GUN} (300/500)
4210. **UNMARKED REPLIC THOMPSON SUBMACHINE GUN** This non-firing replica of the classic M1 Thompson submachine gun appears to be comprised of military and fabricated parts and rates excellent overall. The metal surfaces retain a military-grade blue finish over areas of light pitting and have light handling wear on the edges. The GI walnut stocks rate very good and have light dings and handling marks. The pistolgrip appears to have been lightly sanded and the buttstock has two arsenal repairs. The 11" barrel appears to be original military and has a very good bore with a few light pits about midway down. The lower receiver porting also appears to be original military and is numbered "196321". The upper receiver portion is unmarked and the bolt mechanism does not operate or fire. A portion of the bolt does move and is released by the trigger in the open bolt position but no ammo can be chambered and the moving portion does not make contact with the chamber. An unmarked military stick magazine is included. A very good example overall that would make a great display or replica for use in re-enacting. (46857-32) {NON-GUN} (300/500)
4211. **MILITARY SLING LOT** This lot consists of a tan canvas Nobuckl sling. The sling is in excellent condition save a few minor areas of light fraying to the canvas. The perfect accessory for your vintage military long arm. (46857-32A)



4212. **UNMARKED REPLIC U.S. 1918 BAR RIFLE** This non-firing replica is built from U.S. military and fabricated parts and is in very good overall condition. The GI barrel is marked "M / (ordnance bomb) / 11 18" and has an excellent bore. The non-functioning cast block receiver features a military trigger group and bolt which is pinned in place. The buttstock is synthetic and has the folding buttplate, the handguard is wood and rates excellent. Rifle is equipped with correct military issue sights, carry handle and has a correct folding bipod. A single magazine is included. An excellent replica of a classic U.S. military arms with a nice assortment of original military parts, perfect for the re-enactor or a World War II display. (46857-25) {NON-GUN} (400/600)
4213. **REPLIC U.S. M1 "BAZOOKA" ROCKET LAUNCHER** This accurate recreation of the World War II M1 grenade launcher measures 55" long and would fit the 2.36" rocket-propelled grenades. The tube and body is painted OD green and the grip and shoulder mount are of laminate wood. A canvas sling is mounted along the underside. The left side has a rudimentary sight system, the rear sight has been repaired. An excellent representation of the original design in near excellent condition. The perfect accessory for the World War II military re-enactor. (46857-27) {NON-GUN} (200/400)
4214. **GI PARACHUTE LOT** This lot consists of a U.S. GI T-5 series parachute bag and harness assembly. The tan/green colored canvas material has appropriate U.S. Military markings and is marked "Reliance MFG. CO." with date of "5-43". Reliance was a military contractor in World War II and made canvas items and parachute bags and harnesses. This parachute assembly is similar to those used by the 101st Airborne and other World War II military units during the numerous drops and invasions in both Europe and the Pacific. The bags and straps are in like-new condition and included are a main bag, back-bag and the appropriate straps and bindings for each. A unique and interesting accessory for the military re-enactor. (46857-33)
4215. **REPLIC U.S. M2 MORTAR LOT** This lot consists of a OD green replica dummy tube M2 60mm mortar launcher with base and an M4 sight. The sight, base and M5 bipod assembly appear to be original GI and included is a modern production sling with leather "muzzle" cover. The bipod assembly was made by the Firestone T&R Co. and is dated "1945". An excellent mock-up of the original military M2, perfect for the re-enacting group or individual display. (46857-28)
4216. **SWEDISH K PARTS KIT** This lot consists of a Swedish M45 submachine gun parts kit. The kit appears to be complete and includes the internal parts, bolt assembly, recoil spring, barrel, wood grip and folding buttstock. The top of the receiver tube and the portion just rear of the magazine well have been torched and cut. The rear sight has been cut away but is still present and the barrel has an excellent bore. Included is a tan leather magazine pouch, one stick magazine and a spare barrel. The parts retain most of their original military finish and appear to be in excellent condition, minus the intentional damage that was done to demill the receiver. A great assortment of spare parts for your M45 "K". (47006-1)
4217. **ANTIQU AIR CANE GUN** .38 Caliber, 18" barrel with a very good, micro groove bore. The body features a black japanned-type finish that has some minor flaking and light abrasions. The brass tip and cover have a light tarnish and some minor tool marks around the edges. The steel surfaces are a rich brown and have light surface oxidation. The upper half of the cane has some tape residue along the side and has a shaped horn handle that threads into the top. The handle has some minor chipping along the edges. The cane appears to be good working order however the tools to operate and cock the air gun system are not present. A very good example overall. (46778-2) {NON-GUN} (400/600)
4218. **BRITISH ENFIELD NO.1 MK III\* RIFLE BY BSA** serial #J87972, 303 British, 25" barrel with an excellent bore. The metal surfaces retain about 90% of what appears to be arsenal blue with light edges and handling wear throughout. The hardwood stocks rate about very good and have added finish over light dings and handling marks. The buttstock has "B.L.R." stenciled in white on the left side with "69" and a small brass oval disc marked "16" at the toe. The forearm is cracked and has a sliver missing on the right side by the magazine, the handguard is cracked near the front of the rear sight. The bolt is not matching and there are no visible import markings. A single detachable magazine is included. A very good example overall. (46983-58) {C&R} (200/300)
4219. **BRITISH ENFIELD NO.1 MK I\* RIFLE BY BSA** serial #G2107, 303 British, 25" barrel with an excellent bore. The metal surfaces retain about 90% arsenal blue that is flaking to brown and blending with a few areas of very light surface oxidation. The hardwood stocks rate very good to near excellent and have light dings and handling marks under added finish. The buttstock has a small brass oval disc marked "24" installed at the toe. The wire wrapped handguard has a few small chips and is equipped with the volley sight on the left side. The bolt is not matching but is the correct style with the charger attachment. Rifle does not appear to be importer marked and is in very good condition overall. (46983-70) {C&R} (200/400)



4220. **BRITISH ENFIELD NO.4 MK I\* RIFLE BY LONG BRANCH** serial #17L9382, 303 British, 25" barrel with a near excellent bore that is mostly bright but has a few small pits near the chamber. The metal surfaces retain about 80% arsenal blue that is flaking to brown with areas of light edge and handling wear. The walnut stocks rate near excellent and have a few light dings and light handling marks throughout. The buttstock has a small oval brass disc marked "6" installed at the toe. The receiver is dated "1942" and the numbers appear to be matching, also there does not appear to be any visible importer markings. A single detachable magazine is included. A near excellent example of these Canadian-built Enfield rifles. (46983-54) {C&R} (200/400)
4221. **YUGOSLAVIAN MODEL 1924 MAUSER RIFLE** serial #209463, 8mm Mauser, 23 1/4" barrel with a gray, oxidized and pitted bore. The metal surfaces are mostly a mottled brown fading to gray and are mixing with areas of light surface oxidation. The hardwood stocks rate near excellent and have several light dings and a few minor divots, mostly toward the muzzle-end of the forearm and handguard. The buttstock has a small brass oval disc marked "70" installed at the toe and the stock is numbered to the receiver. The barrel bands and cleaning rod are missing. The bolt is not matching and rifle does not appear to be importer marked. An about very good example overall. (46983-39) {C&R} (150/250)
4222. **AUSTRIAN/GREEK MODEL 1888-90 MANNLICHER RIFLE** serial #1754, 8mm Mauser, 23" barrel with an excellent bore. The metal surfaces retain about 99% of a later, arsenal quality blue finish with a few light handling marks visible along the edges and some light oxidation mingling about. The metal surfaces have been buffed and some of the receiver markings removed. The walnut buttstock and handguard have been lightly sanded but rate near excellent and have some minor dings and handling marks as well. The buttstock has a small oval brass disc marked "23" installed at the toe. This rare conversion rifle features the later M95 style rear sights and has the permanently mounted magazine clip in the action. Rifle appears to be complete and matching, and is in near excellent condition overall with no visible importer markings. (46983-11) {C&R} (400/600)
4223. **AUSTRIAN MODEL 1895 MANNLICHER CARBINE** serial #7692J, 8x50R, 19 1/2" barrel with a gray, lightly pitted and oxidized bore. The metal surfaces are mottled gray with areas of light surface oxidation and fine pinprick pitting. The walnut stocks rate about very good and have numerous light dings and handling marks. The handguard has a small crack at the forward edge and the forward barrel band is missing. The buttstock has an arsenal-type repair at the toe which has a small brass oval disc marked "61" installed. The left side of the butt is notched out for a sling swivel. An about very good example overall. (46983-42) {C&R} (100/200)
4224. **AUSTRIAN MODEL 1895 MANNLICHER INFANTRY RIFLE** serial #285Y, 8x50R, 30" barrel with a dark, oxidized bore. The metal surfaces are overall a mottled gray and brown with areas of light oxidation present. The walnut stocks rate very good and have the usual assortment of light handling marks typical with service use. The left side of the butt is numbered to the receiver and has a "X" or cross carved into the side, there is also a small oval brass disc installed at the toe marked "14". Rifle appears to be complete and does not have any visible importer marks. A very good condition example overall. (46983-35) {C&R} (200/400)
4225. **ITALIAN MODEL 1891/1941 (1941) CARCANO RIFLE** serial #AV8397, 6.5 Carcano, 27" barrel with an excellent bore. The metal surfaces retain about 99% of an arsenal quality blue finish with areas of light edge wear. The bolt is mostly a mottled brown with areas gray blending through. The hardwood stocks rate very good and have light handling marks. The buttstock has a small crack at the upper tang. The left side of the buttstock has a crisp cartouche and is numbered to the receiver. There is a small brass oval disc marked "27" installed at the toe. Rifle is missing the cleaning rod but is otherwise complete and not importer marked. A near excellent example overall. (46983-55) {C&R} (150/250)
4226. **JAPANESE ARISAKA TYPE 38 TRAINING RIFLE** serial #Z4, 6.5 Arisaka blank, 30 1/2" smoothbore barrel with a good, moderately pitted bore. The metal surfaces have toned to a pleasing brown patina throughout with the floorplate toned to bright gun-metal gray; the barrel ring is stamped with a star in place of the mum. The one-piece Asian hardwood buttstock rates very good overall with some dings and dents from the years and a 1" crack on the right side of the receiver stemming from the rear edge of the cutout notch. This rifle featured standard Arisaka front and rear sights and the cleaning rod is no longer present. A good example overall. (156983-36) {C&R} (100/200)
4227. **SEDGLEY BABY HAMMERLESS REVOLVER** serial #118, 22 Short, 1 1/4" barrel with a near very good bore which displays light oxidation development throughout the length of the barrel. The metal surfaces rate near excellent and retain about 97% of their factory original nickel-plated finish, although exhibiting a few faint scratches. The 6 shot fluted cylinder rates very good plus and retains about 96% factory original nickel plated finish, but does exhibit a pair of light turn rings as well as some minor flaking toward the muzzle. The genuine mother-of-pearl grips rate very good plus, exhibiting only some minor light signs of handling-related wear. The revolver features a half-moon front sight, with no rear sight. In addition, the revolver also features a folding trigger. The revolver requires mechanical attention as the cylinder does not cycle unless the muzzle is pointed in a downward position and the trigger will not always engage. (136940-302) {C&R} (75/150)
4228. **IVER JOHNSON LOVELL SWIFT HAMMER TOP BREAK REVOLVER** serial #1238, 38 S&W, 3 1/4" barrel with a near very good bore which displays oxidation development throughout the length of the barrel. The metal surfaces rate very good plus and retain about 95% of their factory original nickel-plated finish, but do exhibit some light scratches as well as some areas of minor flaking. The 5 shot fluted cylinder near very good but exhibits a light turn ring, light scratches and minor light flaking. The checkered black synthetic "Owl Head" grips rate near excellent, exhibiting only a couple of minor handling marks along the butt of the grip. The revolver features a half-moon front and post rear set of fixed iron sights. (136940-128) {ANTIQUÉ} (200/300)
4229. **IVER JOHNSON AMERICAN BULLDOG FIRST MODEL REVOLVER** serial #3643, 38 S&W, 2 1/2" octagon barrel with a near very good bore which displays light oxidation development throughout the length of the barrel. The metal surfaces rate very good plus and retain about 95% of their factory original nickel plated finish, but do exhibit some light scratches. The 5 shot fluted cylinder very good plus, but exhibits a slight turn ring and some light scratches. The brown synthetic grips feature an eagle design and rate excellent exhibiting no discernible handling marks. The revolver features a blade front and notch rear set of fixed iron sights. The revolver requires some mechanical attention as the cylinder stop fails to lock-up the cylinder; the cylinder does lock-up when cocked. (136940-300) {ANTIQUÉ} (150/250)
4230. **IVER JOHNSON SECOND MODEL SAFETY HAMMER TOP BREAK REVOLVER** serial #R46198, 38 S&W, 3" barrel with a near very good bore which displays some minor light oxidation development. The metal surfaces rate very good and retain about 70% of their factory original nickel-plated finish, but do exhibit a few scratches, some light fading and several areas of flaking. The 5 shot fluted cylinder rates very good and retains about 70% factory original nickel plated finish, but exhibits general fading with some light flaking. The trigger guard exhibits a brownish-gray patina. The checkered black synthetic "Owl Head" grips rate excellent and exhibit no discernible handling marks. The revolver features a half-moon front and notch rear set of fixed iron sights. The revolver requires mechanical attention as the cylinder stop fails to lock-up the cylinder; the hammer will not cock in single action. (136940-185) {C&R} (100/200)

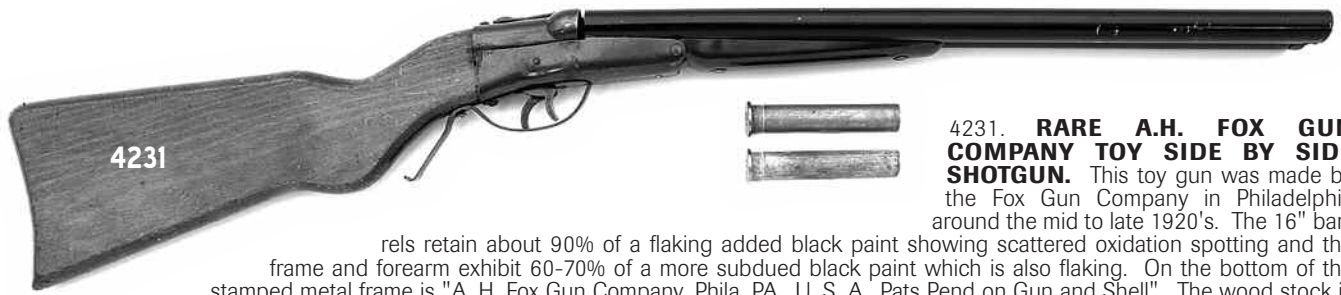

**4231. RARE A.H. FOX GUN COMPANY TOY SIDE BY SIDE SHOTGUN.**

This toy gun was made by the Fox Gun Company in Philadelphia around the mid to late 1920's. The 16" barrels retain about 90% of a flaking added black paint showing scattered oxidation spotting and the frame and forearm exhibit 60-70% of a more subdued black paint which is also flaking. On the bottom of the stamped metal frame is "A. H. Fox Gun Company, Phila, PA., U. S. A., Pats Pend on Gun and Shell". The wood stock is carved with a round knob grip and has a plain wood butt which provides a length of pull of 11 3/4" with drops of 1 1/8" and 1 3/4". The stock rates very good showing scattered dings, scratches and dry cracks with chipping evident around the action that is starting to become loose from the frame. The gun has two operable triggers and top lever and comes with two metal cartridges about 28 ga in diameter and 3 1/4" long in size which are tarnished. (176429-1) {NON-GUN} (300/500)

4232. **FN SUPREME MAUSER BOLT ACTION RIFLE** serial #1224523, 23" barrel with a bright excellent bore. The metal surfaces retain 80-85% original blue finish which is starting to evenly thin and has light areas of surface oxidation. The FN supreme frame rates excellent and wears Pachmayr side mount scope 1" rings which pivots to the left so the rifle sights can be used. Attached to the frame is an Armstrong aperture rear sight. The walnut checkered pistolgrip stock rates very good to excellent displaying a few light handling marks and an added 6" piece of wood to raise the comb. The gun comes with double triggers and sling swivels. (176894-6) (200/400)
4233. **ENFIELD BOLT ACTION RIFLE** serial #Z5498, 25 1/4" barrel with a good bore displaying pitting and oxidation its full length. The metal surfaces retain 85% reapplied blue finish displaying light handling marks and scattered oxidation. The hardwood stock rates very good and have a few small chips and cracks and small arsenal repairs. The stocks have light dings and handling marks overall. Included is a leather sling and a bayonet. (177075-S18037) {C&R} (100/250)
4234. **MOSSBERG MODEL 935KB BOLT ACTION SHOTGUN** serial #1161027, 12 ga, 28" plain barrel choked poly with a very good bore with a few light pits. The barrel retains 50% of its original blue finish with the balance bearing scattered surface oxidation. The bolt is oxidized as well. The walnut Monte Carlo pistolgrip stock rates excellent as refinished displaying a few light handling marks. The gun comes with a three round magazine and remains in good working condition. (176901-S18223) (75/150)
4235. **REVELATION MODEL 350 BREAK ACTION SHOTGUN** serial #P595581, 12 ga, 30" plain barrel choked full with a bright excellent bore. The metal surfaces retain 98% original blue finish displaying a few light handling marks and a few light spots of surface oxidation. The walnut pistolgrip buttstock and forend rate excellent, as refinished, displaying a few light handling marks. (177014-35) (50/150)
4236. **ATI IMPORTED GSG-5 SEMI-AUTO RIFLE** serial #A311570, 22 LR, 16 1/4" barrel with a bright excellent bore. The metal surfaces rate excellent and retain 98% plus of their factory original blued finish with extremely light handling marks. The black synthetic buttstock and forend rates near excellent overall displaying a few light handling marks. The included with the rifle is a faux sound suppressor, a 22-round magazine and its original box with manual. (177006-8) (300/500)
4237. **ATI IMPORTED GSG-5 SEMI-AUTO RIFLE** serial #A331134, 22 LR, 16 1/4" barrel with a bright excellent bore. The metal surfaces retain 99% of its smoke gray stainless surfaces. The black synthetic buttstock and forend rate excellent displaying a few light handling marks. The factory 22-round magazine is not included. The proper ATF barrel shroud is included. (176724-301) (300/500)
4238. **MOSSBERG MODEL 183D BOLT ACTION SHOTGUN**, .410 bore, 24" plain barrel choked full with a bright excellent bore. The metal surfaces retain 95% original blue finish displaying areas of light handling marks and very light spots of surface oxidation. The walnut Monte Carlo pistolgrip buttstock and forend rate excellent displaying a few scattered light handling marks. This shotgun functions very good. (177018-8) (150/250)
4239. **SEARS ROEBUCK BOLT ACTION SHOTGUN** serial #103741, .410bore, 24" plain barrel choked modified with a bright excellent bore. The metal surfaces retain 95% original blue finish displaying a few light handling marks and light scattered surface oxidation. The walnut pistolgrip buttstock rates very good displaying light handling marks and a 1/2" crack on the right side of the butt near the recoil pad. This shotgun is missing its front bead and it functions very good. (177018-7) (50/150)
4240. **BELGIAN T. BARKER DOUBLE HAMMER SHOTGUN** serial #2915, 12 ga, 30" Damascus twist barrels choked improved cylinder and modified with very good, lightly pitted bores. The barrel shows nice contrasting darker gray-brown pattern nearly it's full-length and shows good damascus pattern under the forearm. The frame and sideplates have toned to a smoke gray patina that shows areas of light oxidation stains and traces of original case colors in the protected areas. The walnut pistolgrip buttstock and forend rate very good displaying moderate dings and scratches along with light chips around the edge of the buttplate. The hammer on the left side of the lock is not present and the right hammer will not lock into place. The gun features double triggers and an automatic safety. (176900-40) {C&R} (100/200)



4242

**4241. WINCHESTER MODEL 24 BOXLOCK DOUBLE SHOTGUN** serial #22003, 16 ga, 28" matted rib barrels choked full and modified with bright excellent bores. The barrels retain 85-90% of its reapplied blue finish having very light areas of pinprick pitting and scattered light handling marks; the forend latch has been re-soldered to the barrel. The smooth walnut pistolgrip buttstock and forend rate very good, as refinished, displaying light handling marks and dings around the buttplate. The buttstock wears its original checkered buttplate which provides a length of pull of 14 3/8". The gun features double triggers, extractors and an automatic safety. A good field gun for certain. (177067-5) {C&R} (300/500)

4242. **JAPANESE TYPE 14 NAMBU SEMI-AUTO PISTOL BY NAGOYA** serial #(series 2)7377, 8mm Nambu, 4 1/2" with an excellent bore. The metal surfaces retain about 97-98% of the original arsenal finish with light wear along the edges and some light handling marks present. The grooved hardwood grips rate excellent. Pistol features the later style, large ring triggerguard and the frame is dated "18.12" or December of 1943. The markings remain crisp and all of the parts including the grips and aluminum base magazine are matching. A really super condition, all-matching Type 14 pistol. (47017-11) {C&R} (350/550)

4243. **STEVENS MODEL 94 SINGLE BARREL SHOTGUN** serial #D493438, 20 ga, 28" plain barrel choked modified with a bright excellent bore. The barrel retains 98% original blue finish having a few light spots of surfaces oxidation. The frame retains 99% of its original case-hardened colors. The walnut straight grip stock and forend rate very good, as refinished, displaying a few light handling marks. This gun is in excellent condition overall. (176900-D29758) (75/150)
4244. **IVER JOHNSON CHAMPION SINGLE BARREL SHOTGUN** serial #FXII, 20 ga, 28" plain barrel choked full with a bright excellent bore. The barrel retains 85% original blue finish displaying light scratches and finish loss along the barrel. The frame retains 80% of its original case-hardened colors with the balance toning to a smoke gray. The smooth walnut checkered pistolgrip buttstock and forend rate very good displaying a few light dings, with the majority on the toeline, there is a chip and a 2" crack present near the upper tang. The gun has a bead front sight and an ejector. (176940-9) (75/150)
4245. **IVER JOHNSON CHAMPION SINGLE BARREL SHOTGUN** serial #RXIC, 12 ga, 30" plain barrel choked full with a bright excellent bore. The metal surfaces retain 95% original blue displaying light scratches and very light areas of surface oxidation. The frame retains 95% of its original case-hardened colors with the balance toning to a smoke gray on the edges. The smooth walnut checkered pistolgrip buttstock and forend rates excellent displaying a few scattered scratches and handling marks. The gun comes with its original buttplate which provides a length of pull of 14". The gun has a single bead front sight and an ejector. (176940-84) (75/150)
4246. **IVER JOHNSON MODEL MATTED RIB SINGLE BARREL SHOTGUN** serial #77840XC, 20 ga, 28" raised matted rib barrel choked full with a bright excellent bore. The barrel has toned to a smooth brown patina displaying generous traces of original blue in the protected areas. The frame retains 50% of its evenly fading case-hardened colors with the balance toning to a smoke gray patina. The walnut checkered pistolgrip buttstock and checkered forend with a schnabel forend tip rates excellent displaying a few light handling marks. The gun comes with its original buttplate which provides a length of pull of 14". The gun has a single bead front sight and an ejector. (176940-91) {C&R} (100/250)
4247. **IVER JOHNSON CHAMPION SINGLE BARREL SHOTGUN** serial #HUFF, 20 ga, 28" plain barrel choked full with a bright excellent bore. The barrel retains 95% original blue finish which displays a few light handling marks and very light scattered surface oxidation. The frame has toned to a smoke gray but displays generous amounts of its case colors in the protected areas. The smooth walnut pistolgrip buttstock and forend rate excellent displaying a few light handling marks, there is a small chip missing at the upper tang. The buttstock is slightly loose and it wears its original buttplate which provides a length of pull of 13 3/4". The barrel has a single bead front sight and an ejector (176940-25) (75/150)
4248. **IVER JOHNSON CHAMPION SINGLE BARREL SHOTGUN** serial #1400A, 20 ga, 30" plain barrel choked full with a bright excellent bore. The barrel has toned to a brown patina which has areas of light impact marks and handling marks. The frame has toned to a brown patina and exhibits light impact marks and dark brown spotting. The walnut round knob buttstock and forend rate very good, as lightly cleaned, displaying a few light handling marks and a 1 1/2" crack on the left side starting at the upper tang and continuing to the wrist. The gun wears its original buttplate and provides a length of pull of 14". The barrel has a single bead front sight and an ejector. (176940-3) (50/100)
4249. **IVER JOHNSON SPECIAL TRAP SINGLE BARREL SHOTGUN** serial #T7720, 12 ga, 32" ventilated rib barrel choked full with a bright excellent bore. The barrel has toned to a mottled brown patina having areas of cleaned pitting and light handling marks. The frame has toned to a smoke gray patina with brown freckled highlights. The checkered walnut pistolgrip buttstock and forend rate very good, as refinished, displaying a few light impact marks along with a small repair at the upper tang. The gun wears a hard rubber recoil pad which provides a length of pull of 14 3/8". The barrel has a single bead front sight and an ejector. (176940-88) {C&R} (100/200)
4250. **IVER JOHNSON HERCULES BOXLOCK DOUBLE SHOTGUN** serial #3888, 12 ga, 30" matted rib barrels choked full and modified with bright excellent bores. The barrels have toned to a mottled brown with pewter undertones displaying a few light handling and impact marks. The frame has toned to a smoke gray patina with areas of light brown freckling. The checkered walnut round knob buttstock and forend rate very good, as refinished, displaying dings, scratches and light chips missing around the edges. The buttplate is slightly undersized to the buttstock and appears to be a replacement. The gun features a single bead front sight, extractors, double triggers and an automatic safety. The stock and lock up is slightly loose. (176940-62) {C&R} (200/300)
4251. **IVER JOHNSON CHAMPION SINGLE BARREL SHOTGUN** serial #33225, .410 bore, 26" plain barrel choked cylinder with a very good lightly pitted bore. The barrel has toned to a mottled brown patina with areas of light oxidation and original blue in the protected areas. The frame has toned to a dark gray brown with pewter undertones. The smooth walnut pistolgrip buttstock and forend rate very good, as refinished, displaying a few light handling marks. The buttstock wears its original buttplate which provides a length of pull of 13 3/4". The barrel has a single bead front sight and an ejector. (176940-14) (75/150)
4252. **STOCK LOT** This lot consists of a reproduction buttstock and forearm for 28 gauge Parker shotgun that are in excellent, like-new condition showing a very nicely figured grain and a bright lacquer finish with a couple of very faint blemishes. The pistolgrip stock is checkered with a plastic gripcap that is marked "Parker By Winchester", it has nicely carved cheeks with dropper points facing to the rear and there is a brass oval inlaid in the belly. Featured is an engraved metal skeleton buttplate around the checkered butt of the stock. The forearm is also checkered and has recesses for fitting the hardware and a nose cap. Both pieces are stamped on the inside "3328". (127034-77)
4253. **GUNSMITH ACCESSORIES** This lot consists of a total of seven gunsmithing accessories. First is a set of 13 Site-A-Line spuds ranging from 22 to 45 caliber in excellent condition and housed in a vinyl compartmentalized pouch. Second is a pair of Brownell's scope ring alignment rods in their original packaging. Third is a pair of Brownell's bolt extractor pliers in an unopened package. Fourth is a B-Square T Handle Weaver scope ring wrench in its original packaging. Fifth is a Weaver scope adjustment chart. Sixth is a round nylon bench block. And last is a 12 gauge snapcap. All are in very good to excellent condition. (127023-2AE)
4254. **LOT OF MEASURING TOOLS** This lot consist of two sets of micrometers, a caliper, a level and a set of scope rings. First are two sets Chuan Brand micrometers that are made in China, housed in wooded cases and have three calipers each sized 0-1", 1-2" and 2-3". In the first set, the micrometers are sealed in plastic and they come with an adjustment spanner and directions. The second set includes the three micrometers, spanner, two master adjustment rods and directions. Next is a Starrett stainless steel slide caliper in a wood case. Third is an 8" Starrett machinist level in a wood box. The small cross level is broken. And last is a Weaver 1" side mount scope ring set. All items are in very good to excellent condition. (127023-18B)
4255. **MAUSER MEASURING TOOL LOT** This lot consists of a Mauser slide caliper with accessories housed in a wood box. The caliper is in working condition with some scattered tiny spots of oxidation. (127023-18)
4256. **LOT OF MEASURING TOOLS** This lot consists of two micrometers and a caliper. First is a Starrett 1-2" micrometer in excellent condition that is housed in a hard case with adjustment tools. Second is a German 0-1" micrometer in near excellent condition that is also housed in a hard case with its adjustment tool. And last is a small inside/outside caliper in a leather pouch. (127023-18A)
4257. **LOT OF SAKO RINGS** This lot consists of 2 1/2 sets of 1" Sako split ring scope rings that fit a wedged-shaped mounting block. The two sets are boxed with an additional loose ring. All are in excellent condition. (127023-2DJ)



4258. **SAKO ACCESSORY AND PARTS LOT** This lot consists of parts and accessories for Sako rifles that include: First are two pair of 7/8" one-piece rings that fit on wedge-shaped mounting blocks and a pair of offset 1" rings missing one of the mounting wedges. These rings show a few spots of light oxidation. Second is a pair of sling swivels. Third is a box magazine for 25-20 cartridges that is showing some light pitting throughout. Fourth is a rear aperture sight with a spinning adjustable aperture marked 100 & 200. Fifth are a triggerguard and trigger plate. And last is an unmarked chrome-plated trigger. All items are in very good to excellent condition. (127023-2DI)
4259. **COLT 1911 22 LR CONVERSION KIT LOT** This lot consists of a complete conversion kit in its original box that includes a barrel with a floating chamber and a bright excellent bore, barrel bushing, slide with firing pin and extractor, recoil spring, ejector, 10 round magazine, and a slide stop. The sights are not original with the rear sight being replaced with a micro-click target sight and the front sight to a wider blade. The parts are in overall near excellent condition with the external blue showing several light handling marks. (127023-29)
4260. **LUGER MAGAZINE LOT** This lot consists of a single unmarked wood base P-08 Luger magazine in overall near excellent condition showing some scattered tiny spots of superficial oxidation and a couple of tiny dings on the bright steel surface. (127023-30)
4261. **MINI-14 22 LR CONVERSION KIT LOT** This lot consists of a Hohrein 22 LR conversion kit for a Ruger Mini-14 rifle that is in very good condition and includes: 22 caliber chamber adaptor, bolt with firing pin and extractor, operating rod, return spring and rod, three aluminum adaptors, a large capacity 22 LR magazine, Allen wrench and instructions. This kit comes in its original foam-lined plastic case with some of the foam lining missing. (127023-31)
4262. **WINCHESTER STOCK LOT** This lot consists of a walnut buttstock for a Winchester 1885 High Wall or Low Wall that is in near excellent condition showing a couple of mild scuffs and multiple minor dings and scratches. It is fitted with a hard rubber buttplate that has a Winchester Repeating Arms Co. logo with several minor handling marks. (127023-9A)
4263. **STOCK LOT** This lot consists of a Savage 99 pistolgrip buttstock and forearm that are in near excellent condition with non-factory checkering. Both pieces were likely lightly cleaned with and added finish. The buttstock shows multiple dings and scratches, and is fitted with a hard rubber gripcap and a partially corrugated metal buttplate that shows some light thinning towards brown on the heel and toe. The forearm has a couple of very minor blemishes. (127023-3A)
4264. **STOCK LOT** This lot consists of a Savage 99 straight stock and schnabel tipped forearm that are in very good condition. The buttstock has several minor dings and scratches, a small repaired spot on the left side and a faint crack running back from the upper tang cut-out. It is fitted with a partially corrugated metal buttplate that has a little light wear and hangs slightly proud at the toe. The forearm has a few minor dings and scratches, a small crack by the forend and a couple of minor chips. It comes with its retention screw. (127023-3B)
4265. **STOCK LOT** This lot consists of a Browning 1885 rifle buttstock and forearm that are in excellent to like-new condition showing a couple of minor superficial scratches and a few faint handling marks in the bright gloss finish. Both pieces are nicely checkered and fitted with sling swivel studs. The buttstock is also fitted with a like-new condition crescent buttplate and the forearm has two escutcheons for the retention screws (not included). (127023-9B)
4266. **TRAPDOOR ADJUSTABLE TUMBLER LOT** This lot consists of a drop-in modern replacement tumbler for a Springfield trapdoor rifle. This tumbler is made of graphite-impregnated steel and is adjustable for engagement. It comes with installation directions. (127023-13M)
4267. **COLT SUPER 38 PARTS LOT** This lot consists of a barrel, slide, and recoil springs for a Colt Super 38. The slide is in near excellent condition with "Colt Super 38 Automatic" marked on the left side and showing strong blue that is beginning to fade towards plum with a few minor handling marks. It has an overall length of 7 1/2" and is fitted with a Bo-Mar adjustable rear sight and a Dinan barrel bushing. The barrel is unmarked with a bright excellent bore. It is 7" long, in-the-white, with the last 2" at the muzzle-end exhibiting an excellent blue. There are also three recoil springs, two are 6 3/8" and one is 5 3/8" long, and an extractor included. (127023-13N)
4268. **LOT OF MAGAZINES** This lot contains two Colt 38 AMU magazines in excellent likely unused condition. (127023-13P)
4269. **LOT OF MAGAZINES** This lot contains two 45 ACP 1911 magazines with a two-tone finish and a pinned base in very good to near excellent condition. Both magazines show some scattered light oxidation with one having a "B" stamped on its base. They come with a military two-pocket canvas magazine pouch. (127023-13Q)
4270. **MAGAZINE AND GRIP LOT** This lot contains two 45 ACP 1911 magazines and a set of grips. The magazines are unmarked and in very good condition showing some light oxidation. One magazine is two-tone with a lightly worn base and the other is blue with a lanyard ring on its base. The checkered brown Keyes fiber grips rate excellent with a few very minor handling marks. (127023-13R)
4271. **MAGAZINE LOT** This lot contains three 45 ACP 1911 magazines. All are in near excellent to excellent condition with a couple of mild spots of oxidation and a few light handling marks. Two are marked "G" on the base, the third is marked "L". They come with a brown leather two-pocket magazine pouch. (127023-13S)
4272. **GRIP LOT** This lot consists of a set of unmarked custom fitted checkered walnut target grips for a C96 Broomhandle Mauser in very good condition showing a few light handling marks and a crack on the top of the right side. (127023-18A)
4273. **KNIFE AND TOOL LOT** This lot consists of three knives, a letter opener and two tool sets. First is a U.S.A. made Leatherman in excellent condition with its belt pouch. Second is an Opinel folding knife with sheath. Third is a Duluth Trading folding pocket knife. Fourth is a Krag bayonet-shaped letter opener. Fifth is a Smith's sharpening stone with a leather pouch. Sixth is a ratcheting screw driver with multiple interchangeable tips in a gray plastic case. And last is a German-made tool kit in a leather pouch containing a saw, hammer, file, screw driver, knife without its handle. All are in very good or better condition. (127023-18C)
4274. **GRIP AND MAGAZINE LOT** This lot contains three magazines and a set of light green plastic grips for a Bauer 25 ACP pistol. All are in excellent condition with the grips showing a little light soiling. (127023-18D)
4275. **LOT OF BOOKS** German Sidearms and Bayonets: 1740-1945, by Klaus Lubbe; c. 2000 NIEMANN Verlag Hamburg. 361 pages hardcover. Illustrated guide with values written in German and English and appears unused. Walther Pistols, by W. H. B. Smith; c. 1946 The Military Service Publishing Company. 94 pages hardcover with moderate wear and a grease stain at the top front corner overall a nice clean cover. A History of Firearms, by Major Hugh Bertie Campbell Pollard; reprinted 1973 of the 1936 ed. published by Houghton Mifflin. 320 pages hardcover with jacket and clear plastic sleeve. The Art of the Gunmaker: Vol. I 1500-1660, by J. F. Hayward; c. 1962 J. F. Hayward. 303 pages hardcover with jacket and plastic sleeve. The last two books in this lot rate very good to excellent. (76531-1A)
4276. **LOT OF BOOKS** Small Arms, by Frederick Wilkinson; c. 1965 Frederick Wilkinson, first American edition 1966. 256 pages hardcover with jacket. Modern American Pistols and Revolvers, by A. C. Gould; c. 1888 A. C. Gould & Co., c. 1894 Bradlee Whidden, re-published in 1946 Thomas G. Samworth. Collector's Guide to American Cartridge Handguns, by De Witt E. Sell, Ph.D.; c. 1963 Dewitt E. Sell, Ph.D. 244 pages hardcover with jacket. The Revolver: 1865-1888, by A. W. F. Taylerson; c. 1966 A. W. F. Taylerson. 292 pages hardcover with jacket. The overall condition of the lot is very good to excellent with light wear and foxing. (76531-1B)

4277. **LOT OF BOOKS** Gunstock Finishing and Care, by A. Donald Newell; c. 1949 Thomas G. Samworth. 473 pages hardcover with jacket showing mild liquid stains as do several back pages and inside back cover. Front end paper has pencil notes and light grime and foxing. Outdoor Life Complete Book of Rifles and Shotguns, by Jack O'Connor; c. 1961 Outdoor Life. 477 pages hardcover with tape repaired jacket showing areas of grime. Shots Fired in Anger, by Lt. Col. John B. George; c. 1947 Thomas G. Samworth; 421 pages hardcover with illustrated frontispiece, a personal label adhered to front end paper and scattered moderate foxing. The Westerners, by Dee Brown; c. 1974 George Rainbird Ltd. 288 pages hardcover with jacket and scattered mild foxing. (76531-1C)
4278. **LOT OF BOOKS** Total of three. Big Game Rifles and Cartridges, by Elmer Keith; originally published by Thomas G. Samworth 1936, reprinted July 1984. 161 pages hardcover that is copy no. 757 of 1500 of the Wolfe Library Classics Limited Edition featuring gilt edges, illustrated frontis piece and linen page keeper and protected by wax paper jacket. The American Rifle for Hunting and Target Shooting, by C. E. Hagie; c. 1944 The MacMillan Company, third printing 1946. 174 pages hardcover with jacket. Inside front cover has ink written notes; title page is separating from webbing; mild scattered foxing. Elephant-Hunting in East Equatorial Africa, by Arthur H. Neumann; originally published 1898 R. Ward, this edition 1994. 454 pages hardcover with foxing, dirt, grime and ink markings. (76531-1D)
4279. **LOT OF BOOKS** Total of three. United States Single Shot Martial Pistols, by Charles Winthrop Sawyer; intro. dated 1971 all rights reserved WE Inc. with ink written note: "First Pub. In 1913" 101 pages hardcover with light foxing, corner wear and fading at spine. Modern American Pistols and Revolvers, by A. C. Goul; originally published 1888, this copy 757 of 1500 of Wolfe Library Classics Limited Edition printed 1987. 222 pages hardcover that appears unused and features gold embossed edges, linen page keeper, leather extended spine area and illustrated frontispiece. Collector's Guide to American Cartridge Handguns, by DeWitt E. Sell, Ph.D.; c. 1963 DeWitt E. Sell, Ph.D. 244 pages hardcover with jacket with price sticker, penciled in marking, isolated ink spots and light foxing on top edge. (76531-1E)
4280. **BOOK LOT** The Pennsylvania-Kentucky Rifle, by Henry J. Kaufman; c. 1960 Henry J. Kaufman. 374 pages hardcover with jacket showing small tears at front bottom that have allowed for a long crease to peel back. Jacket also shows ingrained dirt as does the top edge and end papers show light foxing and a pencil note on top left. The overall condition is very good to near excellent. (76531-1F)
4281. **LOT OF BOOKS** Two total. A Glossary of the Construction, Decoration and Use of Arms and Armor: In all Countries an in all Times, by George Cameron Stone; c. 1934 Southworth Press, c. 1961 Jack Brussel. 694 pages hardcover with jacket with ingrained dirt and tears, book with light foxing and soiling at bottom corner. Winchester: The Gun that Won the West, by Harold F. Williamson; c. 1952 The Association of the U.S. Army, third printing 1963. 494 pages hardcover with well-worn and stained jacket. Edges show varying levels of soiling and overall the books in this lot rate very good. (76531-1G)
4282. **LOT OF BOOKS** Total of four. Optics for the Hunter, by John Barsness; c. 1999 John Barsness. 255 pages hardcover with jacket. Unused and excellent condition. The Hunting Rifle, by Jack O'Connor; c. 1970 Jack O'Connor. 314 pages hardcover with jacket. North American Big Game: 1971 Edition; c. 1971 Boone & Crocket Club. 403 pages hardcover with jacket and containing tabulations of outstanding trophies. Small Arms Design and Ballistics: Vol. I: Design, by Colonel Townsend Whelen; c. 1945 Thomas G. Samworth. 376 pages hardcover. Also included are several ballistics charts in folded form. The last three books listed rate about very good with combinations of small jacket tears, ingrained dirt, fading and foxing. (76531-1H)
4283. **LOT OF BOOKS** Total of four. Modern Shotguns and Loads, by Charles Askins; c. 1929 Small- Arms Technical Publishing Co. 416 pages hardcover with a 1933-dated owner's signature in pencil on front end paper. Automatic and Repeating Shotguns, by Richard Arnold; c. 1958 Nicholas Kaye Limited. 173 pages hardcover with jacket. Shotgun Ballistics for Hunters, by Rolla B. Boughan; c. 1965 A. S. Barnes and Co., Inc. 159 pages hardcover with jacket. The Shotgun Book, by Jack O'Connor; c. 1965 Jack O'Connor. 332 pages hardcover with jacket with separated inner front flap, other smaller tears and tape repairs. The lot rates very good overall with the expected blemishes for books of this age, namely foxing, scattered soiling and fading. (76531-1I)
4284. **LOT OF BOOKS** Total of three. Six Guns by Keith: The Standard Reference Work, by Elmer Keith; c. 1955, 1961 Elmer Keith. 335 pages hardcover with jacket. Samuel Colt Presents: A Loan Exhibition of Percussion Colt Firearms, (exhibition catalog); c. 1961 Wadsworth Atheneum, Hartford. 293 pages hardcover. A History of the Colt Revolver, by Charles T. Haven and Frank A. Belden; c. 1950 Charles T. Haven and Frank A. Belden, this printing 1978. 711 pages hardcover with jacket showing creasing and tear and faded spine. The books in this lot rate about very good to excellent with varying degrees of foxing, fading and general soiling. (76531-1J)
4285. **LOT OF BOOKS** Total of four. Arms Fabricators: Ancient and Modern, by Robert Edward Gardner; c. 1934 R. E. Gardner. 337 pages hardcover with illustrated frontispiece and dedicated by the author on the front end paper which also has other ink and pencil notations. American Firearms Makers, by A. Merwyn Carey; c. 1953 A. Merwyn Carey. 141 pages hardcover with jacket. The Story of Allen and Wheelock Firearms, by H. H. Thomas; c. 1965 H. H. Thomas. 125 pages hardcover. Underhammer Guns, by Herschel C. Logan; c. 1960 Herschel C. Logan. 249 pages hardcover with jacket. Overall the books in this lot rate about very good plus, very acceptable for their age, showing wear around the corners and edges. Also evident are penciled in ID's on the end covers and foxing along the tops. (76531-1K)



4286. **VINTAGE AIR RIFLE** This is a Markham-King Model 1892 King with frame patent marking including "King Repeater". This desirable .180 large BB cal. air rifle measures 31" in overall length with an 18" barrel. The sheet metal surfaces retain 60% frosted nickel finish fading to gray with scattered oxidation present. The wood stock rates very good without oval logo on this variation. This example retains the muzzle cap and front sight while the rear sight base shows a solder repair with the balance missing. (76569-2)

4287. **BULLET MOULD LOT** This is a Colt two cavity bullet mould with sprue cutter for .44 cal. Dagoon. The round and two groove conical cavity original Colt mould measures 5" in length and retains about 60-70% blue finish with loss due to thinning and handling. (76950-1)

4288. **LOT OF LITERATURE** Included in this lot are periodicals published in the late 1990's: 23 issues of Rifle Sporting Firearms Journal; 7 issues of Petersen's Rifle Shooter. Next is a March 2010 copy of American Rifleman, a Sept.-Oct. 1975 issue of Rifle The Magazine for Shooters, a 1962-dated Parker-Hale Price List, a 1946 Parker-Hale catalog with cover missing. Another interesting vintage piece is a June 1930 copy of Parker's catalog. Also included are an edition no. 62 of Parker-Hale Everything For Shooting. Literature on cartridges includes Mr. Single Shot's Cartridge Handbook, by Frank de Haas; c. 1994 Frank de Haas. 116 pages paperback. Handloader/Rifle Master Index 1966-1996, compiled by M.A. Wescott; c. 1998 M.A. Wescott. 94 pages paperback. Also included is a 16 page supplement. Next are Wildcat Cartridges Vol. II, intro. by Al Miller; c. 1992 Wolfe Publishing Co. 971 pages paperback. Also included in this lot is an undated National Target & Supply Co. Handbook and catalog and the novel The Hornblower Companion, by CS Forester; c. 1964 Casette Productions, this edition 1998. 140 pages paperback. The conditions of the items in this lot range from a few at good to very good and most about excellent. (77023-32)

**M.K. BENENSON SIGHT LOTS**



4289. **REDFIELD SIGHT LOT** A series No. 100 receiver sight likely for a Winchester Model 52 target rifle. There is no application code present on the sight and the 1/4 minute micrometer adjustments all work freely. The sight is mostly blue with some silvering along the sharp edges and has a few spots of light fine oxidation staining present. An overall very good condition sight with lots of life left in it. (107023-2S)
4290. **PARKER HALE SIGHT LOT** A Model 10 Sportarget tang sight likely for Winchester rifle models 79, 92 and 94. It has 1/2 minute adjustments that work freely and the sight retains nearly all of its blue finish with some light fine oxidation staining present under the base. This is an about excellent condition example. (107023-2B)
4291. **LYMAN SIGHT LOT** A No. 57ES receiver sight and 17A target front sight. The sights retain near all of their original finish with some light spots of oxidation staining mostly on the front target sight. The set is complete with mounting screws and the 1/4 minute adjustments all work freely. A nice set of Lyman sights for many small bore Winchesters, select Remington or H&R rifles. (107023-2AG)
4292. **LYMAN SIGHT LOT** A 48K micrometer receiver sight with long slide and stay set knobs. This third variation sight is complete with orange and black correctly labeled box, instructional sheet, mounting screws and eyecup. This is an excellent condition as-new in the box sight intended for use on a Krag-style rifle. (107023-2Q)
4293. **KING SIGHT LOT** A Model No. 200 micro metered auto-locking peep site with application code S 99 on the bottom of the base. For use on The Savage 99 lever rifle this sight remains overall excellent condition with near all its original blue finish remaining and comes with mounting screws and one small eyecup. (107023-2A)
4294. **PARKER HALE SIGHT LOT** A Model 10 Sportarget tang sight likely for Winchester rifle models 79, 92, and or 94. The 1/2 minute adjustments work freely and the sight retains near all of its original finish with a crisp Parker Hale / England stamp on the base. (107023-2N)
4295. **CARBINE REAR SIGHT LOT** Includes an original Winchester Model 44A and a modern reproduction facsimile sight. The ladder has graduations from 0-20 and the Winchester sight is an overall brown patina and is complete in excellent condition. The unmarked reproduction sight has a bright fire blue base with similar markings along the ladder and also is in excellent condition. (107023-2AX)
4296. **PARKER HALE SIGHT LOT** Includes a Model 10 Sportarget tang sight with 3" long flat base, with 1.15" center distance between screw holes. The Parker Hale stamp is crisp and the sight retains near all of its original finish. There are a couple of spots of light fine oxidation staining present along the base. (107023-2K)
4297. **PARKER HALE SIGHT LOT** Includes a Model 10 Sportarget tang sight likely for a Savage 99 lever rifle. The sight retains most of its original finish with spots of light fine oxidation staining present. The sight parts work freely and a small eyecup is included. An overall very good example from this English maker. (107023-2M)
4298. **FRONT SIGHT LOT** Includes two items first is a C.R. Pederson & Son ramp kit for a Krag rifle with peep, still in its original packaging in excellent condition. Second is an unmarked front ramp with removable hood, similar in design to a Lyman No. 17AXNB, also in very good condition. (107023-2L)
4299. **LOT OF TRIGGERS** Includes a Timney and Jaeger adjustable trigger both likely for a Springfield 1903 rifle. The triggers appear complete and in good working condition. (107023-2J)
4300. **AGA / PARKER HALE SIGHT LOT** A No. 2 Foresight with single insert. The sight is marked "Made in England / AGA / Model 2" and has a single medium disc insert in excellent condition. (107023-2AA)
4301. **AGA / PARKER HALE SIGHT LOT** A model 10 Sportarget tang sight with small eyecup and center hole measurement of 1.15" between screw hole and stud. The adjustments work freely and the sight is in overall excellent condition. (107023-2E)
4302. **AGA / PARKER HALE SIGHT LOT** A Model 10 Sportarget tang sight with large eyecup and center hole measurement of 1.12" between screw hole and stud. The adjustments work freely and the sight is in excellent condition. (107023-2C)
4303. **AGA / PARKER HALE SIGHT LOT** A Model 10 Sportarget tang sight with large eyecup and center hole measurement of 2.18". The sight is mostly a pewter color patina with strong traces of blue left in protected areas and the adjustments work freely. The sight is likely for a Winchester rifle in very good overall condition. (107023-2)
4304. **1903 SIGHT LOT** Includes three items. First is P.J. O'Hare rear sight cover for a 1903 rifle. It is parkerized and the stamping is crisp and legible. Second is a brass rear sight adjustment tool also from O'Hare with most of the stampings remaining crisp with the exception of the name. Third item is a Watson-marked globe style front sight with dovetail and single post. Items are in very good to excellent condition. (107023-2BB)
4305. **REAR SIGHT LOT** Includes three items. First is a Savage 99 rear sight with dovetail missing the elevator. The sight is marked "Savage Arms Corp. / Utica N.Y. Pat'-Pen'd" in very good overall condition. Second is a Savage rear sight with windage adjustment and dovetail marked "Savage Arms Co. / Pat' Oct-18,1914" in overall very good condition. Third is a stamped sheet metal rear sight with windage adjustment likely for a small caliber rifle with screw hole for attaching to rifle in overall very good condition. (107023-2AJ)
4306. **LYMAN SIGHT LOT** A No. 1 combination tang sight with 1" eyecup. The bottom of the sight is not marked with an application code and the screw holes measure 1.46" center to center. The sight is complete and all parts work freely. This is an excellent condition sight with what appears to be a Maynard base. (107023-2Z)
4307. **LOT OF GUN SIGHTS AND PARTS** This lot consists of a 10"x10"x11 1/2" four drawer cabinet containing gun sights and parts for various sight manufacturers including Redfield and Lyman. The parts include: globe sights, globe sight inserts, rubber eye cups, rear sight apertures, sight mounting blocks, mounting screws, and other miscellaneous items. All are in various conditions from good to excellent with some packaged and labeled, and some loose. (124457-8)

**End of Silent Auction - Thank you • All Silent Auction Bids are due by 2:00 pm on March 29, 2015.  
Results will be available on Wednesday, April 1, 2015.**







# TERMS AND CONDITIONS OF SALE

## ABSENTEE BIDDING

---

- Bidders without prior credit approval are required to submit a 20% deposit prior to bids being accepted (credit cards may be used for absentee deposits). Absentee bids will be bid in a competitive manner and an absentee bidder needs only to outbid another buyer i.e. bidding will not be opened at the maximum bid unless that is the next competitive bid. Buyer is responsible for any and all shipping charges.
- Amoskeag Auction Co., Inc. will not be held responsible for errors or omissions of any type that may occur during this service.
- All Silent Auction bids are due by 2:00pm on the day of the sale. If you are planning on bidding on an excessive amount of items we request that your bid sheets be turned in on the Friday before the sale. Please do not call the gallery once the auction has started (after 10:00am) as we will not be able to make changes to bids. Faxed bid sheets will be accepted for the **silent auction** until 2:00pm.
- All absentee/telephone bidder invoices are mailed within a few days of the sale, are due upon receipt, and are to be paid either by cash, check or credit card. All items not paid for within 20 business days from sale date shall be considered abandoned as well as any deposit that was made on those items and Amoskeag Auction Company, Inc. shall have sole discretion as to their disposal. **NOTE:** If paying by cash or check, the buyer's premium will be a discounted 15% versus 17.5% for those paying by credit card.

**IF YOU FAX YOUR BID SHEET INTO OUR OFFICE,  
PLEASE CALL TO CONFIRM THAT WE DID RECEIVE IT. THANK YOU. 603/627-7383**

## SILENT AUCTION VIEWING

---

Viewing will be available from Monday, March 9th through Friday, March 27th, by appointment, as well as on the day of sale from 7:30am to 2:00pm. We do have a few select evenings available for viewing and those times and dates can be obtained by calling our office.

## SHIPPING

---

- Amoskeag Auction Company, Inc. will make every effort to ship items in a timely fashion; most orders are shipped within 48 hours of payment. All items, with the exception of modern handguns, are shipped via UPS Ground unless other arrangements have been made.
- All modern handguns are shipped via UPS Next Day Air service.
- Buyer is responsible for any and all shipping charges.

## PICKING UP MERCHANDISE

---

- **OUR OFFICE WILL BE CLOSED MONDAY AND TUESDAY FOLLOWING THE SALE.** No merchandise will be delivered on those days. We will resume normal business hours on Wednesday.
- Our office hours are Monday through Friday - 8:00 am to 4:00pm. Please call ahead prior to arriving to pickup your merchandise.

## DIRECTIONS

---

FROM SOUTH: Rt. 93 North to Rt. 101 West in Manchester to Rt. 293 North to Exit 5 (Granite Street). At end of ramp go right onto Granite Street to first set of lights. Go left on Commercial Street and we are located in the Waumbec Commercial Center, which is 1/8 mile up on the left. OR Rte. 3 (Everett Turnpike) North through Bedford tolls then off at Exit 5 (Granite Street). At bottom of ramp go right, take first left onto Commercial Street, 1/8 mile on left. FROM NORTH: Rt. 93 South to Rt. 293 South to Exit 5 (Granite Street), at end of ramp turn left onto Granite Street to first set of lights. Go left on Commercial Street and we are located in the Waumbec Commercial Center, which is 1/8 mile up on the left. ELEVATOR: Go around to the back of the building (river side), there is a set of three stairs with a glass door, enter the lobby through the door that is marked "ELEVATOR", go to 3rd floor and follow signs. STAIRS: Enter South entrance, go up stairs and follow hallway and signs.





# AMOSKEAG

AUCTION COMPANY INC.

250 commercial street • suite 3011 • manchester, new hampshire 03101  
603/627-7383 fax 603/627-7384 • [www.amoskeagauction.com](http://www.amoskeagauction.com)  
jason & melissa devine • nh license no. 2555