



SILENT AUCTION

AMOSKEAG
AUCTION COMPANY INC.

AUCTION NO. 119
AUGUST 25, 2018

AMOSKEAG AUGUST 25, 2018 - SALE NO. 119 - SILENT

TERMS AND CONDITIONS OF SALE

GENERAL STATEMENTS

- The Silent Auction is by absentee bidding only. Absentee bidders must register by filling out and signing an absentee bid sheet.
- The highest bidder acknowledged by the auctioneer shall become the owner upon the fall of the hammer. The auctioneer has sole discretion in the case of a dispute among bidders.
- Amoskeag Auction Company, Inc. has taken great care in the preparation of the descriptions in this catalog. Although we believe everything in the descriptions to be true, we do not guarantee any part of any description. We recommend that the bidders view the items in person and form their own opinions as to condition, originality, origin, etc. Amoskeag Auction Company, Inc. will consider all requests for refunds. If a customer is unhappy with a purchase we will be happy to discuss a remedy with them.
- Amoskeag Auction Company, Inc. reserves the right to reject any bid in order to protect our consignors interests.
- Bidding on any item in the sale indicates the bidder's full acceptance and understanding of all terms and conditions of sale.

PAYMENT POLICY

- Amoskeag Auction Company, Inc. will accept cash, check, MasterCard, Visa, and American Express as payment for items purchased by those customers who attend the sale. Amoskeag Auction Company, Inc. reserves the right to demand cash or hold merchandise until funds are collected in full. There will be a \$35.00 charge for all returned checks.
- There will be a Buyer's Premium of 17.5% added to all purchases. A discounted Buyer's Premium of 15% will apply to all purchases paid by cash or check.

GUIDELINES FOR FIREARM PURCHASES

- All Federal, State and Local firearms laws will be observed. FFL holders may take possession of any firearm on day of sale when they present a signed copy of their Federal Firearms License. New Hampshire residents over the age of 21 may take possession of any firearm on day of sale providing the proper paperwork is filled out and the transfer has been approved either through the NH State Police or the FBI NICS System. While most NICS and State approvals are immediate, approvals could take up to 3 days. Most non-residents may take possession of long guns on day of sale after completing the proper forms and successfully completing a NICS check; modern handguns will need to be shipped to an FFL holder in the buyer's home state. Buyer is responsible for any and all shipping charges and all items must be paid for on day of sale. Bidders should be familiar with their local and state laws.

Firearms are marked as follows:

ANTIQUA - no paperwork required

C&R - for firearms that fall under the ATF Curio & Relics licensing and if purchased by a person with a "C&R License" no paperwork is required. **NOTE:** Items that meet the age requirements but have been altered from their original configuration may NOT be delivered on a C&R License.

Firearms that are not marked with one of these notations are considered to be "MODERN" and all proper paperwork is required unless you are an FFL Dealer.

FIREARMS WARNING

Amoskeag Auction Company, Inc. **does not** warranty the safety of any article it sells. Therefore, it is **imperative** that, before you use any firearm purchased here or anywhere else, you have it examined by a qualified gunsmith to determine whether or not it is safe to use.

250 Commercial Street - Suite 3011 - Manchester, New Hampshire 03101
Phone (603) 627-7383 Fax (603) 627-7384 www.amoskeagauction.com
Jason & Melissa Devine - NH license No. 2555

TERMS AND CONDITIONS OF SALE

ABSENTEE BIDDING

- Bidders without prior credit approval are required to submit a 20% deposit prior to bids being accepted (credit cards may be used for absentee deposits). Absentee bids will be bid in a competitive manner and an absentee bidder needs only to outbid another buyer i.e. bidding will not be opened at the maximum bid unless that is the next competitive bid. Buyer is responsible for any and all shipping charges.
- Amoskeag Auction Co., Inc. will not be held responsible for errors or omissions of any type that may occur during this service.
- All Silent Auction bids are due by 3:00pm on Saturday. If you are planning on bidding on an excessive amount of items we request that your bid sheets be turned in on the Friday before the sale. Please do not call the gallery once the auction has started (after 9:00am) as we will not be able to make changes to bids. Faxed bid sheets will be accepted for the silent auction until 3:00pm on Saturday.
- All absentee/telephone bidder invoices are mailed within a few days of the sale, are due upon receipt, and are to be paid either by cash, check or credit card. All items not paid for within 20 business days from sale date shall be considered abandoned as well as any deposit that was made on those items and Amoskeag Auction Company, Inc. shall have sole discretion as to their disposal.
NOTE: If paying by cash or check, the buyer's premium will be a discounted 15% versus 17.5% for those paying by credit card.

**IF YOU FAX YOUR BID SHEET INTO OUR OFFICE,
PLEASE CALL TO CONFIRM THAT WE DID RECEIVE IT. THANK YOU. 603/627-7383**

SILENT AUCTION VIEWING

Viewing will be available from Monday, August 13th through Friday, August 24th, by appointment, as well as on the day of sale from 7:30am to 3:00pm. We do have a few select evenings available for viewing and those times and dates can be obtained by calling our office.

SHIPPING

- Amoskeag Auction Company, Inc. will make every effort to ship items in a timely fashion. All items, with the exception of modern handguns, are shipped via UPS Ground unless other arrangements have been made.
- All modern handguns are shipped via UPS 2nd Day Air service.
- Buyer is responsible for any and all shipping charges.

PICKING UP MERCHANDISE

- **OUR OFFICE WILL BE CLOSED MONDAY AND TUESDAY FOLLOWING THE SALE.** No merchandise will be delivered on those days. We will resume normal business hours on Wednesday.
- Our office hours are Monday through Friday - 8:00 am to 4:00pm. Please call ahead prior to arriving to pickup your merchandise.

DIRECTIONS

FROM SOUTH: Rt. 93 North to Rt. 101 West in Manchester to Rt. 293 North to Exit 5 (Granite Street). At end of ramp go right onto Granite Street to first set of lights. Go left on Commercial Street and we are located in the Waumbec Commercial Center, which is 1/8 mile up on the left. OR Rte. 3 (Everett Turnpike) North through Bedford tolls then off at Exit 5 (Granite Street). At bottom of ramp go right, take first left onto Commercial Street, 1/8 mile on left.

FROM NORTH: Rt. 93 South to Rt. 293 South to Exit 5 (Granite Street), at end of ramp turn left onto Granite Street to first set of lights. Go left on Commercial Street and we are located in the Waumbec Commercial Center, which is 1/8 mile up on the left. **ELEVATOR:** Go around to the back of the building (river side), there is a set of three stairs with a glass door, enter the lobby through the door that is marked "ELEVATOR", go to 3rd floor and follow signs. There is also an Elevator up to the third floor from the front entrance. **STAIRS:** Enter South entrance, go up stairs and follow hallway and signs.

Silent Auction No. 119

TABLE OF CONTENTS

Firearms.....	page 2
Edged Weapons.....	page 82
Ammunition.....	page 88
Magazines.....	page 93
Optics.....	page 96
Sights.....	page 100
Miscellaneous.....	page 100
Books.....	page 135
Gun Parts.....	page 138

ABSENTEE ONLY BIDDING

The Amoskeag Auction Gallery is located in the historic Manchester Millyard at 250 Commercial Street. The auction, as well as viewing, will take place at this location. Directions can be found in the back of the live catalog. Results of the Silent Auction will not be available until August 29, 2018.

VIEWING

AUGUST 13TH - AUGUST 25TH

Viewing will be available from August 13th through August 24th by appointment, as well as on the day of the sale, from 7:30am to 3:00pm. We do have a few select evenings available for viewing and those times and dates can be obtained by calling our office. Our office is not open for viewing on the weekends.

INFORMATION

PLEASE READ OUR TERMS & CONDITIONS OF SALE

Located on the inside front and back covers of our catalog you will find our Terms and Conditions of Sale, Absentee Bidding Information, Pre-Registration Forms and other General Information. Please read and become familiar with our Terms and Conditions of Sale.

There will be a Buyer's Premium of 17.5% added to all purchases. A discounted Buyers Premium of 15% will apply to all purchases paid by cash or check.

PLEASE NOTE: OUR OFFICE WILL BE CLOSED FOR VISITORS ON MONDAY AND TUESDAY FOLLOWING THE SALE. No merchandise will be delivered on those days. We will resume normal business hours (8:00am to 4:00pm) on Wednesday August 29, 2018.

SILENT BIDDERS:

SILENT BID SHEETS ARE DUE ON SATURDAY • AUGUST 25, 2018 BY 3:00 PM (EST)

If you are planning on bidding on an excessive amount of items we request that your bid sheets be turned in on Friday, August 24th.

Catalog Production/Descriptions

Jason Devine • Don Ellison • John Michno • Ray Drabble • Garry Boucher • Glenn Dubois
Marc Cammack • Tom Kulik • Josh Cresswell • Brian Lockhart • Richard Comeau • Jared Devine
Emma LaPierre • Delani Quintal • Jennifer Topouzoglou

Photography & Design: Jason & Melissa Devine • Delani Quintal • Amanda Bowen

250 Commercial Street, Suite 3011 - Manchester, NH 03101 603/627-7383 - Fax 603/627-7384

www.amoskeagauction.com Jason & Melissa Devine - NH License No. 2555

Firearms

1100

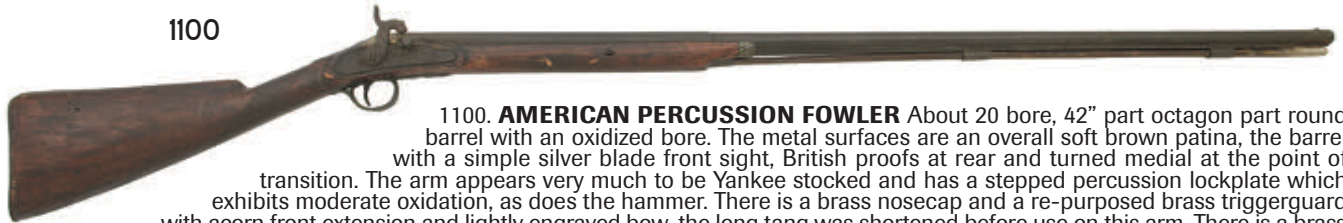

1100. AMERICAN PERCUSSION FOWLER About 20 bore, 42" part octagon part round barrel with an oxidized bore. The metal surfaces are an overall soft brown patina, the barrel with a simple silver blade front sight, British proofs at rear and turned medial at the point of transition. The arm appears very much to be Yankee stocked and has a stepped percussion lockplate which exhibits moderate oxidation, as does the hammer. There is a brass nose cap and a re-purposed brass trigger guard with acorn front extension and lightly engraved bow, the long tang was shortened before use on this arm. There is a brass buttplate with lightly engraved tang and a brass monogram plate atop the wrist. The American walnut stock rates otherwise near very good with coarse checkering but showing a crack through the left side of wrist up through the tang and lock which was lightly repaired during the period of use, or at least many years ago, it will still flex. The lock functions loosely mechanically and there is an antique wooden ramrod included retained in iron thimbles. A Spartan American-stocked Fowler with some period repurposed parts. Very "Yankee" in appearance. (38619-1) {ANTIQUE} (200/400)

1101. UNMARKED MEDITERRANEAN FLINTLOCK PISTOL About 58 caliber, 9" damascus barrel with a lightly oxidized bore. Unlike most "tourist" pistols, this example appears as though it was made to be used, the barrel is quite thick and nicely vented. Damascus twist pattern can be seen and there are the remnants of some light engraving, the rear-most portion at breech semi-octagonal and with a nice dovetailed tang which is lightly engraved. There is a makers name, perhaps in Arabic, atop the barrel it is no longer legible and there is a sunken gold touch mark at the breech which is partially legible. The banana-shaped lock plate has a pronounced teat at the rear and shows light engraving as does the swan neck cock. All iron surfaces are primarily a light plum and pewter patina. The frizzen is deeply ridged and bridled and the end of the frizzen spring is lightly chiseled. The iron sideplate is semi-ornate and very lightly engraved, with the front extension of the trigger guard lightly engraved, the trigger with a curlicue-tip. The stock rates about very good with light relief carving, the ramrod one-piece carved with the stock with faux iron thimble and tailpipe. There is a silver butt cap which is lightly engraved and features dual straps the length of the grip, the engraving remains quite nice and is un-softened, there is a similar wrist escutcheon which is un-engraved and maybe some manner of German silver or brass. The lock does function well mechanically and the left side of the lock shows two small cracks which were properly repaired. An interesting and somewhat ornate Mediterranean flintlock. (38935-35) {ANTIQUE} (200/400)

1101

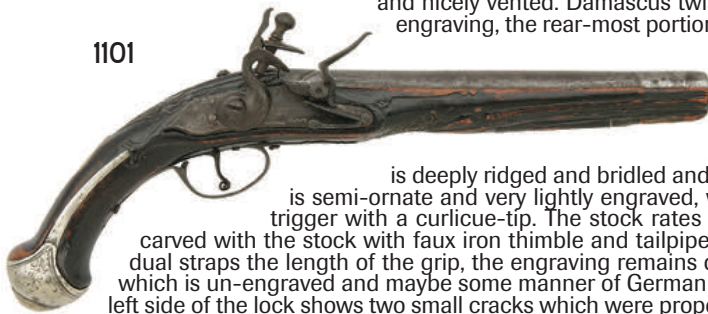

1102. AMERICAN PERCUSSION FOWLER About 12 bore, 45" part octagon part round barrel with an oxidized bore. The metal surfaces on this percussion fowler are an overall soft brown oxidized patina with pewter undertones. The barrel exhibits facsimile British proofs and is marked "London" on its top flat and shows a good deal of erosion in the area of the nipple barrel. The "A Harrington/Poughkeepsie"-marked lock shows evidence of once having been flint, now percussion-converted. The American walnut stock rates about good showing a moderate chip and dings at the point of comb, nearly devoid of varnish, showing remnants of some coarse checkering at the wrist. There is a brass nose cap and an acorn finial front extension trigger guard, the bow with light engraving. The lock does function and there is a later steel martial ramrod included with the arm. (38888-10) {ANTIQUE} (200/400)

1103. EUROPEAN PERCUSSION-CONVERTED MUSKET About .72 cal., 35 1/2" barrel with an oxidized bore. The metal surfaces are an overall dull pewter gunmetal gray and show remnants of light oxidation and light pinprick pitting. Very much appearing to be a Prussian 1809 hammer and breech, the lockplate is more Württemberg-like although the trigger guard is conventional on this example without the grip swell. The arm certainly exhibits Bavarian or Austrian proofs and markings along its left barrel flat. The stock rates good showing an old refinish and is heavily varnished with a number of drying cracks near the butt. There are the remnants of some light military markings on the left flat with remnants of dings and dents here and there. The lock seems to function mechanically and what is likely an original ramrod from the period is included. (38888-1) {ANTIQUE} (400/600)

1104



1104. AUSTRIAN MODEL 1849 PERCUSSION GARIBALDI RIFLE .72 cal, 32 1/2 part octagon part round barrel with an oxidized bore. The metal surfaces are soft brown oxidized patina with scattered oxidation and light pinprick pitting, the gunmetal gray base metal beneath also prevalent. There is quite a bit of erosion and pitting in the area around the nipple holster. Front and rear sights are arsenal replacements. The brass trigger guard and buttplate are a dull goldenrod patina. The stock rates otherwise good to about very good having been cut-off and shortened 9 1/2" ahead of the front of the lockplate. There has been an oak forearm extension added and there is a simple barrel band and aluminum ramrod with brass head fitted; a leather wrap conceals the joint in the stock. The lock functions mechanically. Just over 26,000 Garibaldi rifles were purchased by ordnance for the Civil War. (38888-7) {ANTIQUE} (300/500)

1105. PERCUSSION-CONVERTED FOWLER About .75 cal, 40" round barrel with an oxidized bore. The barrel is an overall soft brown patina and would appear otherwise to be for a combination fowler-militia musket, but there is no provision for bayonet stud and the front sight is a simple bead-style. There is moderate pitting in the area of the nipple bolster, the nipple and percussion hammer showing a good deal of erosion as well. The lock is marked "R Ashmore", it and the hammer are soft brown patina. The ramrod thimbles are brass as is the simple trigger guard with a geometric sideplate and buttplate. The stock rates about good showing a crack completely through the wrist which has been repaired during the period of use with small wood screws. The barrel is retained to the stock through field expedient wedges, there have also been escutcheons affixed rather amateurishly during the period of use, and there are no sling swivels present. Stock features coarse wrist checkering and a flared left side shadowline cheekpiece, the lock seems to function mechanically and there is an antique ramrod present. There is a modern brass nose cap included which is not affixed to the stock and was designed for an octagon-barrel rifle. (38888-9) {ANTIQUE} (250/400)

1106. **FRENCH MAUBEUGE MODEL 1825 POLICE MUSKETOON PERCUSSION CARBINE** About .75 cal, 25" barrel, shortened during the period of use, with an oxidized bore. The barrel and lockplates are soft brown oxidized patina, the muzzle slightly flared from an impact. There is a simple blade front sight, the rear is tombstone-style affixed to the tang. The lockplate is "Tower" marked although it is clearly an original French lockplate. The triggerguard and long lower tang have small ridged finger grasps and sling swivel at its rear, the swivel however is no longer present. The arm is stocked in European walnut, the stock rating about good showing a field expedient repair to the left of the buttplate tang and having been stretched or repaired at the forearm at the rear-most band retainer spring. The lock seems to function well mechanically and there is a tulip-shaped ramrod included which appears to be more modern. (38888-12) {ANTIQUE} (350/550)
1107. **HIGH STANDARD MODEL 107 MILITARY SUPERMATIC TOURNAMENT SEMI-AUTO PISTOL** serial #2009590, 22 LR, 5 1/2" heavy barrel with an excellent bore. This Hamden, Connecticut-made pistol retains about 95% original blue finish with the grip frame starting to partially thin to pewter, high edge wear and scratches. The case-hardened colors on the trigger and magazine release remain bold but there is light oxidation staining on the trigger face. The checkered walnut thumb rest grips rate excellent. The pistol features a Patridge front sight, slide mounted adjustable rear sight, the barrel is drilled and tapped for weights, and it has a push button barrel release. Included with the gun is a factory box that is numbered to the gun, (3) magazines, magazine loader, an extra replacement driving spring plug, old driving spring plug and paperwork. The box rates about good to very good with scuffed edges and torn corners. One magazine is missing the blue finished floorplate extension but it still works, although it takes extra effort to seat it. This gun is ready for some serious "paper punching" or an enjoyable day of casual shooting. (88852-53) {MODERN} (350/550)
1108. **COLT NEW FRONTIER 22 SCOUT CONVERTIBLE REVOLVER** serial #G42585, 22 LR / 22 Magnum, 4 3/8" barrel with an excellent bore. This 1972-made revolver retains about 95% original finish. The blue finish on the barrel and both cylinders is excellent with a barely discernible turn ring on both cylinders. The anodized aluminum frame has a few minor handling marks and most of the frame retains robust case-hardened colors except for the scattered lightly cleaned oxidized pin-prick pitting on the sides, which accounts for most of the finish loss. The checkered synthetic "eagle" grips with a Rampant Colt in an oval rate excellent. The revolver features a serrated ramp front sight and Colt Accro rear sight. It includes the original factory box that is correctly end-labeled and numbered to the gun, the aforementioned 22 Magnum cylinder and warranty card. The box rates fair to good showing fading color, edge wear and duct tape repairs on all four corners. The writing on the label is fading and it has fallen off the end flap but is provided. Timing and lock up are excellent and it should make a great shooter or start up collectible. (88873-376) {MODERN} (350/550)
- 
1109. **HIGH STANDARD SHARPSHOOTER SEMI-AUTO PISTOL** serial #2496635, 22 LR, 5 1/2" bull barrel with an excellent bore. This lovely slant grip Hamden, Connecticut, made pistol retains about 99% original blue with a few handling marks and a couple of minor oxidation blemishes. The checkered walnut factory thumb rest grips rate excellent. The pistol features a Patridge front sight and adjustable rear sight. The Sharpshooter pistol was marketed as an entry level target pistol and given a slant grip to differentiate it from its premier Military series. It was given many features desired by bullseye shooters at an economical price point. This gun appears to have seen very little use and remains an excellent example of the genre. (88873-434) {MODERN} (350/550)
1110. **ANDERSON MANUFACTURING AM-15 SEMI-AUTO CARBINE** serial #15151471, 5.56 NATO, 16" pencil barrel with a 1:9" rate of twist and an excellent bore. The metal surfaces retain about 95% original phosphate finish, the majority of the loss on the right side of the triggerguard which has been ground and the mounting wing removed on that side. Carbine is equipped with a Magpul MOE Krytek pattern handguard and pistolgrip, the stock is a Bushmaster fixed "collapsible" style that has been wrapped in black paracord. The receiver has a picatinny flattop rail with a NcStar Mark III 4x32 tactical rifle scope mounted to it. The scope features an illuminated mil-dot reticle and has bright optics. The battery is not functioning, but lens covers are included. There is no flash hider or bayonet but carbine does have a brass deflector and forward assist. A single magazine and a black nylon zippered case are included. Very good carbine that should still make a decent plinker. (48900-12S21341) {MODERN} (350/550)
1111. **SMITH & WESSON MODEL 37 AIRWEIGHT CHIEFS SPECIAL REVOLVER** serial #J388135, 38 Special, 1 7/8" pinned barrel with an excellent bore. The metal surfaces retain about 98-99% original blue and anodized finishes with a light turn ring on the cylinder and a series of numbers very lightly and neatly scratched across the sideplate. The service hammer and trigger retain bold case-hardened colors with minor operational wear. The checkered walnut factory square butt grips with silver S&W medallions are numbered to the gun and rate excellent. Includes a factory box that is correctly end-labeled and numbered to the gun, cleaning kit and paperwork. An excellent condition Airweight for concealed carry or home defense. (88903-23) {MODERN} (350/550)
1112. **SMITH & WESSON MODEL 34-1 22/32 KIT GUN REVOLVER** serial #M99595, .22 LR, 2" barrel with a bright shiny bore. The blued surfaces retain about 85% original blue with a couple scattered handling marks with most of the loss of finish coming off the sideplate. The hammer and trigger show very attractive case hardened colors. The grips rate excellent and are smooth rosewood with two finger grooves and showing the brand name as ACE with each letter inside the leaf of a clover. The front sight is a serrated blade ramp and the rear is an adjustable blade that appears to have an impact mark on the right side. This revolver shows its age but these 22/32 kit guns are highly desirable. (228889-14) {MODERN} (350/550)



1113. **SPRINGFIELD ARMORY 1911-A1 SEMI-AUTO PISTOL** .45 ACP, 5" barrel with an excellent bore. The stainless steel finish is about very good with some operational wear near the muzzle, multiple handling marks in the matte finish on the top of the slide and some scratches near the slide stop where the pistol has been disassembled. The black rubber Pachmayr grips with gold lion medallion rate excellent and are very comfortable to the hand. This pistol features an adjustable LPA rear sight, a raised blade front sight, combat trigger, grip safety, non-extended thumb safety, a single magazine and a standard spur hammer. (228896-181D33886) {MODERN} (350/550)



1114. **SMITH & WESSON MODEL 30-1 REVOLVER** serial #H68612, 32 S&W Long, 2" pinned barrel with an excellent bore. The metal surfaces of this good-looking revolver retain about 99% original nickel plate with a light turn ring on the cylinder and a few minor handling marks. The service hammer and trigger show the wonderful case-hardened colors Smith & Wesson in known for. The smooth un-numbered gonzalo alves factory Magna grips with silver S&W medallions rate excellent. Timing and lock up are perfect and the little J frame includes a silver factory box that is correctly end-labeled and numbered to the gun, cleaning kit and a spare set of checkered walnut factory J-frame Magna grips with silver S&W medallions. The spare grips rate near excellent with a few light handling marks. This gun appears to have seen little if any use. If you need a real clean model 30 for your collection the search is over. (88903-25) {MODERN} (350/550)

1115. **GLOCK MODEL 27 SEMI-AUTO PISTOL** serial #CL-D213US, .40 S&W, 3 3/8" barrel with a bright excellent bore. The metal surfaces retain 95% of their Tenifer finish with some light edge wear and superficial scratches. The polymer frame on this third generation pistol rates very good plus with some light handling marks. The pistol is sighted with Trijicon night sights however they no longer illuminate. Included with the pistol is a single nine round factory magazine. (108896-183D34192) {MODERN} (350/550)

1116. **RUGER SP101 DOUBLE ACTION REVOLVER** serial #574-32836, .357 Magnum, 2 1/4" barrel with a bright excellent bore. The stainless surfaces rate excellent with a few light scratches and faint turn ring along the cylinder. The revolver has pinned ramp front sight with square notch rear sight and the rubber grips with grooved black plastic inserts rate excellent. Included with the revolver is a factory grey plastic case that is end-labeled and numbered for the range or as a personal defense weapon. (108896-136D33885) {MODERN} (350/550)

1117. **GLOCK MODEL 19 SEMI-AUTO PISTOL** serial #MD677US, 9mm, 4 1/8" barrel with a bright excellent bore. The metal surfaces retain 95% of their original Tenifer finish that shows light fading and a few minor scratches with spots of silvering along the high edges. The black textured polymer grip rates excellent on this second generation pistol and the pistol features Trijicon night sights that still illuminate. Included with this pistol are two ten round magazines, a factory Tupperware case that is end-labeled and numbered to the gun. The end label indicates this gun went back to the factory and shows a rebuild date of 11/99 with no indications of why it went for service. The gun appears complete and should make a nice shooter. (108900-39S21517) {MODERN} (350/550)

1118. **SMITH & WESSON MODEL 60-12 CHIEFS SPECIAL REVOLVER** serial #CCW6376, .38 Special +P, 1 7/8" barrel with a bright excellent bore. The stainless surfaces rate very good to about excellent having numerous light scratches and a few scattered spots of oxidation staining and a faint turn ring along the cylinder with some small scattered dings along the rib, at the muzzle, and front sight. The standard hammer and smooth combat trigger show mottled case-hardened color with overall light wear and are toning to a dark pewter. This double action revolver features standard sights and is stocked with Uncle Mike's checkered rubber combat grips that remain in excellent condition. (108900-1S21489) {MODERN} (350/550)

1119. **GLOCK MODEL 23 SEMI-AUTO PISTOL** serial #KDT932, .40 S&W, 4" barrel with a bright excellent bore. The metal surfaces retain 98% of their Tenifer finish with a couple of minor spots of wear along some of the high edges. The polymer frame on this third generation pistol rates excellent. It has night sights that still illuminate however they are dull, but noticeable and included is a single 13 round magazine. (108896-184D532725) {MODERN} (350/550)

1120. **RUGER NEW VAQUERO SINGLE ACTION REVOLVER** serial #512-78205, .357 Magnum, 5 1/2" barrel with a bright excellent bore. The high polish stainless surfaces rate excellent aside from a few minor light scratches and a faint turn ring along the cylinder. The revolver has standard sights and the laminate grips with phoenix medallions rate excellent. This would make a great shooter or cowboy action gun. (108900-18S21450) {MODERN} (350/550)

1121. **INTERARMS G33/50 BOLT ACTION CARBINE (SPORTERIZED)** serial #34828, 6.5x55 Swedish, 17" barrel with a bright excellent bore. The metal surfaces of this converted Swedish M94 carbine retain 98% reapplied blue with some light oxidation on bolt, a few spots of flaking to brown, and some spots of blued-over pitting. The checkered Mannlicher stock rates excellent with a few handling marks. The stock is fitted with a Pachmayr recoil pad giving it a 14 1/4" length of pull, the gun is sighted with a Lyman peep rear sight and a ramped white bead front sight. A handy little sporting carbine. (208898-1D34255) {MODERN} (250/450)

1122. **U.S. MODEL 1903A3 BOLT ACTION RIFLE BY REMINGTON** serial #3461192, 30-06, 24" 3-43 dated 4-groove Remington barrel with a very good bore that shows scattered frosting but strong rifling. The barrel retains 90% reapplied blue with some light dings under the blue and scattered flaking to brown. The other parts retain 92% arsenal parkerized and blued finishes with a spot of oxidation on front band, scattered light dings, thinning and flaking to brown. The Remington stock rates very good plus as lightly cleaned with an added oil finish, a partially faded circled "P" firing proof, a partially faded "FJA" cartouche, a faint ordnance wheel and scattered handling marks. The parts all appear to be of Remington manufacture and there are no recoil bolts present in the stock. A solid 1903A3 that may prove to be a good shooter. (208885-6) {C&R} (350/550)

1123. **BRAZILIAN MODEL 1908 BOLT ACTION RIFLE BY DWM** serial #5825d, 7mm Mauser, 29" barrel that has a light bulge near muzzle but otherwise rates very good with some frosting and sparsely scattered light pitting. The in-the-white receiver and bolt remain mostly bright with some minor oxidation staining and a couple tiny spots of light pitting. The blued parts retain 80% original finish with a small spot of lightly cleaned pitting on barrel and scattered flaking to brown. The European walnut stock rates very good with a crisp cartouche on the right side, scattered dings and handling marks. All visible serialized parts are matching to the receiver and there is a Springfield Armory Inc. import mark on the barrel. This rifle includes a black leather military sling that shows scattered crazing. A very good example of these early South American Mauser rifles. (208879-12) {C&R} (300/500)
1124. **U.S. MODEL 1903A3 BOLT ACTION RIFLE BY SMITH CORONA (SPORTERIZED)** serial #4756459, 30-06, 24" 5-43 dated Smith Corona barrel with a bright excellent bore. The metal surfaces retain 95% gray arsenal parkerized finish with some oil staining on receiver, light fading on the exposed edges, a couple small spots of light oxidation on barrel and some light silvering. The aftermarket Monte Carlo stock rates near excellent with a couple light dings and some minor handling marks. The bolt is of Smith Corona manufacture and the rifle retains its original military sights. A great candidate for restoration to military configuration. (208873-653) {MODERN} (300/500)
1125. **U.S. MARKED WINCHESTER SECOND MODEL HOTCHKISS BOLT ACTION CARBINE** serial #12555, 45-70, 24" barrel with a very good bore that shows some scattered oxidation and light pitting but strong rifling. The barreled action has been cleaned to bright with some light pitting on frame, a few light dings, scattered freckling and oxidation staining. The lower tang and barrel band are a dull gray patina with overall oxidation staining and some light pitting. The walnut stock rates very good with a strong 1878 dated cartouche, a strong circled "P" firing proof, the beginnings of a small crack at upper tang, a few dings and handling marks. The saddle bar and ring are present but there is no nose cap assembly present. A good restoration candidate. (208735-22) {ANTIQUE} (400/600)
1126. **RUSSIAN SKS SEMI AUTO RIFLE BY TULA** serial #V04205, 7.62x39, 20" barrel with an excellent bore. The metal surfaces of this 1954-dated rifle retain 90% arsenal blue with a couple large patches of flaking on blued bayonet, some light pitting on top cover latch, some fading around the edges and the outline of a few holes, likely where an aftermarket mount once was. The hardwood birch stock and laminated handguard rate very good with a strong 1951 Tula cartouche, scattered flaking shellac, dings and handling marks. The stock is force-matched but the remaining parts appear to be matching. The rifle is fitted with a slip-on rubber butt pad giving it a 13 1/2" length of pull and there is a Century import mark on the barrel. A very good arsenal refurbished Soviet SKS. (208852-2) {C&R} (350/550)
1127. **U.S. MODEL 1898 KRAG BOLT ACTION RIFLE BY SPRINGFIELD ARMORY** serial #317286, 30-40 Krag, 30" barrel with a very good bore that shows some light pitting and frosting but strong rifling. The metal surfaces retain 99% reapplied blue finish. The walnut stock rates very good plus as lightly cleaned with an added varnish, a strong 1899 dated cartouche, a strong circled "P" firing proof, a few minor dings and some handling marks. The rifle is equipped with a 1902 rear sight and a 1902 handguard. A solid example for the fledgling martial collector. (208877-3) {C&R} (350/550)



1127

1128. **JAPANESE TYPE 38 ARISAKA BOLT ACTION RIFLE BY KOKURA** serial #31736, 6.5 Japanese, 31" barrel with a bright excellent bore. The metal surfaces of this 25th series rifle retain 97% original blue and straw with some silvering on floorplate and light flaking to brown on the exposed edges. The Asian hardwood stock rates very good as lightly cleaned with strong Kanji stamps, a light chip at heel, a tiny crack on rear of handguard, a 2" crack behind lower tang, a few dings and scattered handling marks. All of the visible parts appear to match with the extractor and bolt stop matching by assembly number and the Chrysanthemum is fully intact. An in-the-white cleaning rod and an original dust cover, that is numbered to a different gun, are both included. An excellent example of a late production Type 38 Arisaka rifle. (208879-15) {C&R} (350/550)
1129. **STEYR 1886 MANNLICHER BOLT ACTION RIFLE** serial #4552II, 11mm Werndl, 32" barrel with a very good plus bore that shows a few light pits and scattered frosting but strong rifling. The barreled action is an overall dull gray patina with several spots of lightly cleaned pitting and some added white paint on rear sight. The bottom metal retains 97% reapplied dull blue with some moderate pitting at front and a few spots of blued over light pitting. The hardwood stock rates good with an armory oil finish, the letters "NB" carved upside down on right side of butt, a few abrasions, scattered dings and handling marks. The stock is numbered matching to the barrel, the other parts appear un-numbered and the rear sight is graduated out to 2300 schritt. A well-used but solid example of a seldom seen military rifle. (208852-24) {ANTIQUE} (300/500)
1130. **ITALIAN 91/28 TS CARCANO BOLT ACTION CARBINE BY BERETTA** serial #B8724, 6.5 Carcano, 18" barrel with a very good bore that shows scattered frosting but strong rifling. The metal surfaces of this 1933 dated carbine retain 85% arsenal blue with some blued-over over pitting on magazine body, some white paint remnants on underside of magazine, oxidation throughout the buttplate and overall flaking to brown. The beech stock rates very good with faint indiscernible numbers on the left side of butt, a small crack at upper tang, a large chip on left side, scattered dings and handling marks. A solid interwar Carcano carbine. (208852-32) {C&R} (200/300)
1131. **DANISH 1867/96 ROLLING BLOCK RIFLE** serial #48183, 11.35mm, 35" barrel with a very good bore that shows scattered light pitting but strong rifling. The metal surfaces are a dull gray patina with overall oxidation staining. The hardwood stock rates good as lightly refinished with an added varnish, a few chips, a 2" crack on the left side of wrist, scattered dings and handling marks. The breechblock has two firing pin holes and the left side of the barrel has a crown marking indicating that this rifle was updated to fire the 11.35mm cartridge. A solid example of these Danish military rifles. (208882-14) {ANTIQUE} (300/500)

1132. **YUGOSLAVIAN M48A BOLT ACTION RIFLE** serial #L41439, 8mm Mauser, 24" barrel with a fair bore that shows oxidation throughout but evident rifling. The metal surfaces retain 93% arsenal blue with scattered surface oxidation and some dings on the front band. The elm stock rates very good with a couple armorer repairs, some dirt stains on the left side and scattered handling marks. All serialized parts are matching, there is no cleaning rod present but a leather military sling and muzzle cover are included. There is a Sarco import marking on the underside of the barrel. A solid Yugo Mauser rifle. (208873-718) {C&R} (200/400)
1133. **INTRATEC TEC-DC9 SEMI AUTO PISTOL** serial #D028747, 9mm, 5" barrel with an excellent bore. The metal surfaces retain 98% original phosphate with some light silvering on the receiver and heatshield. The polymer frame rates excellent with a few light handling marks. A single 20 round magazine is included. An interesting piece of firearms history. (208903-58) {MODERN} (300/500)
1134. **JAPANESE TYPE 99 ARISAKA BOLT ACTION RIFLE BY NAGOYA** serial #56423, 7.7 Japanese, 25" barrel with a very good plus bore that shows some minor frosting. The metal surfaces of this 5th series rifle retain 85% original blue with the bottom metal exhibiting rough wartime machining, scattered light oxidation and fading. The Asian hardwood stock rates very good as lightly refinished with a few dings and scattered handling marks. The Chrysanthemum is fully intact, the front band is matching but the bolt is mismatched. A mismatched dustcover and cleaning rod are present but one of the front band screws is missing. A very good transitional Type 99 rifle. (208898-27D34230) {C&R} (200/300)
1135. **JAPANESE TYPE 99 ARISAKA BOLT ACTION RIFLE BY TOKYO JUKI KOYGO** serial #12712, 7.7 Arisaka, 25" barrel with a very good bore that shows some light pits and frosting but strong rifling. The metal surfaces of this 37th series rifle retain about 60% original blue with scattered oxidation, fading to gray and some scarring around one of the front band screws. The Asian hardwood stock rates about very good with a partially faded Kanji stamp on the underside of butt, a few abrasions, scattered dings and handling marks. The Chrysanthemum is ground, the rifle has early war features and all serialized parts are matching. The follower, anti-aircraft rear sight wings and cleaning rod are missing. A good restoration candidate. (208868-5) {C&R} (150/250)
1136. **U.S. MODEL 1884 TRAPDOOR "CARBINE" BY SPRINGFIELD ARMORY** serial #457478, 45-70, 22" barrel with a very good plus bore that shows some scattered frosting. The lockplate and barrel band have been cleaned to bright with some scattered oxidation staining. The barrel retains 97% reapplied blue with some light flaking to brown and minor oxidation specks. The breechblock retains strong traces of original case colors with some minor freckling. The triggerguard and lower tang retain 98% reapplied blue with some light freckling. The walnut stock rates very good plus as lightly cleaned with an added oil finish, the faint outline of an inspector's cartouche and a few light handling marks. The rear sight is the 1873 model, the front sight appears to be a civilian replacement and this Trapdoor appears to be an assembled carbine. A solid Trapdoor for the budding collector. (208903-14) {ANTIQUE} (200/400)
1137. **CANADIAN NO. 4 MK 1* ENFIELD BOLT ACTION RIFLE BY LONG BRANCH** serial #93L3332, 303 British, 25" barrel with an excellent bore. The metal surfaces of this 1950-dated rifle retain 95% arsenal blue with a couple large spots of dried grease on the magazine, some light silvering and flaking to brown on the exposed edges. The walnut stock rates very good with an added oil finish, scattered dings and handling marks. The bolt is numbered matching to the rear band, the other parts appear un-numbered and the rear sight is a target type. A fine late Long Branch that likely shoots well. (208852-18) {C&R} (300/500)
1138. **EGYPTIAN HAKIM SEMI AUTO RIFLE (SPORTERIZED)** serial #1769, 8mm Mauser, 23" barrel with a good plus bore that shows frosting and oxidation throughout but strong rifling. The metal surfaces retain 85% arsenal blue and added black enamel with some flaking, fading and silvering on the exposed edges. The cutdown beech stock rates very good as-refinished with an added varnish, the buttplate being proud of wood, scattered dings and handling marks. The bayonet lug and front sight areas were removed during conversion to sporter and there is a Century import marking on the barrel. An interesting take on these Egyptian rifles. (208852-21) {MODERN} (200/400)
1139. **COMMERCIAL M1 CARBINE BY UNIVERSAL FIREARMS** serial #111289, 30 Carbine, 18" barrel with an excellent bore. The metal surfaces retain 97% original blue and arsenal parkerized finishes with some light fading on the exposed edges and some minor dings on the barrel. The walnut stock rates very good plus with an added varnish, scattered handling marks and minor dings. The rifle appears to have both USGI and commercial parts, there is no bolt hold open and the inside left of the receiver has two holes for scope mounting. A Union Hardware 15 round magazine that shows the remnants of a sticker and a GI green canvas sling are included. A very good commercial carbine that will likely be a good plinker. (208809-52) {MODERN} (300/500)
1140. **SWEDISH M96 BOLT ACTION RIFLE BY CARL GUSTAFS** serial #485939, 6.5x55 Swedish, 29" barrel with a bright excellent bore. The metal surfaces of this 1920-dated rifle retain 93% arsenal blue with a couple spots of lightly cleaned pitting on floorplate and some light flaking to brown on the exposed edges. The beech stock rates very good plus as lightly refinished with an added varnish, a few dings and scattered handling marks. The rear sight is mismatched but the other visible parts are matching. There is no cleaning rod present and there is a Century import mark on the barrel. A fine Swede that will likely make a good shooter. (208885-7) {C&R} (300/500)
1141. **SWEDISH M96B BOLT ACTION RIFLE BY MAUSER OBERNDORF** serial #24526, 6.5x55 Swedish, 29" armory threaded barrel with a very good bore that shows some frosting in the grooves. The metal surfaces of this 1899-dated rifle retain 97% arsenal blue with some light scratches on the bandkeeper and some light flaking to brown on the exposed edges. The beech stock rates very good with two strong Swedish crowns on the wrist, an armorer repair at toe, the beginnings of a small hairline crack at upper tang, the outline of a sight adjustment plate on the left side of butt, a few dings and scattered handling marks. The bolt parts are matching, there is the remnants of yellow paint on the cocking piece and the other parts are mismatched. The rear of the receiver has two added holes likely for a Swedish civilian rear sight and there is a Century import mark on the barrel. A very good arsenal reconditioned Swede Mauser. (208877-24) {C&R} (200/400)
1142. **DANISH M89 KRAG BOLT ACTION RIFLE (SPORTERIZED)** serial #R.2849, 8x58R, 24" barrel with a good bore that shows scattered frosting and light pitting but evident rifling. The metal surfaces of this 1913 dated rifle retain 93% of a dull reapplied blue with the sideplate and triggerguard being a dull gray patina. The cutdown hardwood stock rates very good as-lightly cleaned with the beginnings of a couple tiny cracks behind the upper tang, a couple armorer repairs and some handling marks. The bolt is mismatched, the other visible parts are matching and the stock retains its brass disc that reads "JDB/820". An interesting Krag overall. (208877-19) {MODERN} (200/300)
1143. **NORINCO TU-KKW BOLT ACTION RIFLE** serial #9100470, 22 LR, 26" barrel with an excellent bore. The metal surfaces retain 98% original blue with some minor flaking to brown on the front band. The hardwood stock rates very good plus with a lightly added varnish, a few minor dings and some handling marks. There is a Navy Arms import marking on the left side of the receiver and a single magazine is included. An excellent condition Norinco trainer style rifle overall. (208879-8) {MODERN} (300/400)
1144. **U.S. MODEL 1903 PARADE BOLT ACTION RIFLE BY SPRINGFIELD ARMORY** serial #1526262, 30-06, 24" 8-42 dated Springfield barrel with an about very good bore that shows scattered frosting and light pitting but strong rifling. The metal surfaces retain 97% reapplied chrome finish with a couple spots of oxidation and flaking. The World War Two era stock rates very good as lightly cleaned with an added oil finish, a faint inspector's cartouche on the left side, a faint circled "P" firing proof, a 1" crack on left side of butt, a chip on right side of butt, some scarring from band removal and a few handling marks. A white leather parade style sling is included. An interesting 1903 that likely saw plenty of use by a VFW or the like. (208809-40) {C&R} (300/500)

1145. **NATIONAL ORDNANCE MODEL 1903A3 BOLT ACTION RIFLE** serial #5012452, 30-06, 24" 7-44 dated 4-groove Remington barrel with a very good plus bore that shows scattered light frosting. The metal surfaces of this commercially assembled rifle retain 98-99% original and arsenal parkerized finishes. The scant stock rates very good plus with a strong "FJA" cartouche, a strong ordnance wheel, a strong "RA" marking, some light scarring from rear band removal and a few handling marks. Other than the receiver, most of the parts appear to be of USGI manufacture and a green canvas sling is included with this rifle. An excellent condition commercial 1903A3 rifle. (208809-179) {MODERN} (300/500)
1146. **U.S. MODEL 1917 PARADE BOLT ACTION RIFLE BY REMINGTON** serial #434075, 30-06, 26" 12-18 dated Eddystone barrel with a good bore that shows oxidation and pitting throughout but evident rifling. The metal surfaces retain 97% reapplied chrome finish with a few spots of flaking. The walnut stock rates very good plus as lightly refinished with an added varnish and a few handling marks. The magazine follower does not appear to be working right and the bolt is sluggish. A parade style white sling is included. An interesting 1917 Enfield rifle overall. (208809-123) {C&R} (300/500)
1147. **U.S. MODEL 1898 KRAG PARADE BOLT ACTION RIFLE BY SPRINGFIELD ARMORY** serial #254913, 30-40 Krag, 30" barrel with a good bore that shows a few pits and scattered frosting but evident rifling. The metal surfaces retain 95% reapplied chrome with scattered scratches and some flaking. The walnut stock rates very good as lightly cleaned with an added oil finish, a strong 1901 dated cartouche, a strong circled "P" firing proof, scattered dings and handling marks. The rifle is equipped with a 1901 rear sight and a 1901 handguard. A white leather parade style sling is also included with this rifle. An interesting piece of U.S. military history. (208809-105) {C&R} (300/500)
1148. **U.S. MODEL 1903 PARADE BOLT ACTION RIFLE BY SPRINGFIELD ARMORY** serial #260308, 30-06, 24" 1-10 dated Springfield barrel with a good bore that shows scattered pitting and frosting but evident rifling. The metal surfaces retain 97% reapplied chrome finish with a few spots of flaking. The two-bolt walnut stock rates good plus as-cleaned with a rack number "AB/68" on right side of butt, a faint word that appears to be "ARMORY" on the right side of butt, a couple large chips near buttplate, a patch of oil staining at front of handguard, a 1" crack behind upper tang and scattered handling marks. A search of the Springfield Research Service identifies this rifle as being issued to the 165th New York National Guard Infantry in 1923. The 165th was also known as the Fighting 69th, which famously fought in the Civil War, World War One and in the Pacific during World War Two. A white parade sling is included. As with all low-numbered 1903 rifles no thought should be given to the loading or firing of this arm, but would be fun to carry in a parade. (208809-41) {C&R} (300/500)
1149. **U.S. MODEL 1903A3 PARADE RIFLE BY REMINGTON** serial #3598022, 30-06, 24" 3-43 dated 4-groove Remington barrel with a very good bore that shows scattered frosting. The metal surfaces retain 95-97% reapplied chrome with some flaking on the exposed edges. The two-bolt walnut stock rates very good as-lightly cleaned with an added varnish, a crisp "FJA" inspector's cartouche, a partially faded ordnance wheel, a crisp "RA" marking, the beginnings of a small crack at upper tang and scattered handling marks. A white leather parade sling is included. A neat rifle for the military collector. (208809-42) {C&R} (300/500)
1150. **BRITISH NO. 4 MK 1* BOLT ACTION RIFLE BY SAVAGE** serial #59C2492, 303 British, 25" barrel with a very good plus bore that shows one patch of pitting toward muzzle. The metal surfaces are an overall dull gray patina with scattered oxidation staining and some spots of light pitting. The birch stock rates very good plus as-cleaned with a few light handling marks and a couple small chips on the right side. The parts are mismatched but the bolt and front band are both of Savage manufacture. There is a faint "FTR" rebuild marking on the left side of the receiver and there are British proofs on the barrel. The rear band and sling swivel are a bit loose. A solid example that may be a good shooter. (208877-12) {C&R} (200/300)
1151. **ARGENTINE MODEL 1891 BOLT ACTION RIFLE BY LUDWIG LOEWE** serial #M6183, 765 Argentine, 29" barrel with an excellent bore. The metal surfaces retain 97% arsenal blue with the typical ground crest, a small ding on magazine and some light flaking to brown. The walnut stock rates very good plus with strong Argentine cartouches, a few minor dings and scattered handling marks. All visible serialized parts are matching to the receiver including the cleaning rod. A modern green sling is included. A very fine example of these early Mauser rifles. (208879-13) {ANTIQUÉ} (300/500)
1152. **CHINESE SKS SEMI AUTO RIFLE** serial #2308781, 762x39, 20" barrel with a bright excellent bore. The metal surfaces of this factory 0138 rifle retain 97% arsenal blue with the typical brown area on topcover and light silvering on the exposed edges. The Asian hardwood stock rates very good with an armory shellac finish, a couple armorer repairs and a few handling marks. This rifle appears to be the milled receiver variant and all visible serialized parts are matching. There is a Century import marking on the receiver and this rifle includes a Com-Bloc style sling and a green soft case. An excellent commercial SKS overall. (208900-13S21412) {MODERN} (300/500)
1153. **CHINESE SKS SEMI AUTO RIFLE** serial #6-1615415, 762x39, 20" barrel with a bright excellent bore. The metal surfaces retain 97% original blue with some freckling on the top cover. The black synthetic Dragunov style stock rates excellent displaying a few light handling marks. The bolt and triggerguard are serial numbered matching to the receiver, we are unable to see the topcover serial number. The magazine is a 30 round aftermarket type and the follower will sometimes stick. There is no bayonet or cleaning rod present. There is a small CSI import marking on the left side of the receiver. (208898-49D33951) {MODERN} (200/400)
1154. **INDIAN 2A1 ENFIELD BOLT ACTION RIFLE BY ISHAPORE** serial #B9837, 762 NATO, 25" barrel with a very good plus bore that shows some minor pitting. The metal surfaces of this 1965 dated rifle retain 85% black arsenal enamel with scattered flaking. The hardwood stock rates very good with an added varnish, a small crack on handguard, a couple armorer repairs, some paint stains, scattered dings and handling marks. All serialized parts are matching with the stock appearing force matched. A very good Indian Enfield in a modern caliber. (208852-39) {C&R} (200/400)
1155. **U.S. MODEL 1898 KRAG BOLT ACTION RIFLE BY SPRINGFIELD ARMORY (SPORTERIZED)** serial #477018, 30-40 Krag, 22" shortened barrel with an about very good bore that shows scattered oxidation and light pitting but strong rifling. The barrel and band are drifting to a dull brown patina with a few patches of pitting, some light oxidation and minor dings. The action is turning to a dull gray patina with generous traces of the original oil quenching and scattered oxidation staining. The cutdown walnut stock rates very good as-cleaned with a faint circled "P" firing proof, the beginnings of a small crack at upper tang, scattered dings and handling marks. The rifle is equipped with an 1896 rear sight, a commercial bead front sight and an 1896 handguard. A solid sporterized Krag rifle. (208873-693) {MODERN} (200/300)
1156. **NORINCO SKS SEMI AUTO RIFLE** serial #122023494, 762x39, 20" barrel with an excellent bore. The metal surfaces retain 95% original blue with some light freckling and flaking to brown on the exposed edges. The Ram-Line black folding stock and ventilated handguard rate very good plus with some handling marks. All visible serialized parts are matching, there is no bayonet present, the rifle retains its original 10 round magazine and there is a Century import marking on the left side of the receiver. (208898-28D33837) {MODERN} (300/500)
1157. **U.S. MODEL 1888 TRAPDOOR RIFLE BY SPRINGFIELD ARMORY** serial #558694, 45-70, 32 5/8" barrel with a very good plus bore that shows some light oxidation. The metal surfaces are an overall dull gray patina with some scattered oxidation staining. The walnut stock rates very good with an added varnish, a faint cartouche, a faint circled "P" firing proof, scattered dings and handling marks. The rifle is equipped with a correct Buffington rifle rear sight and a correct ramrod bayonet. A solid 1888 Trapdoor that will likely be a good shooter. (208852-13) {ANTIQUÉ} (350/500)

1158. **U.S. MODEL 1898 KRAG BOLT ACTION RIFLE BY SPRINGFIELD ARMORY (SPORTERIZED)** serial #367756, 30-40 Krag, 22" shortened barrel with a good bore that shows frosting throughout and a few light pits. The barrel retains 85% of an older reapplied blue with a couple tiny spots of blued-over pitting and scattered flaking to brown. The action is a gray patina with scattered traces of oil quenching and oxidation staining. The cutdown walnut stock has been modified giving it a thinner profile and it rates about very good with a few drying cracks on the butt, three added pins on left side, scattered dings and handling marks. The rifle is equipped with an aftermarket peep rear and a blade front sight. A solid sporterized Krag overall. (200/300)
1159. **FRENCH MAS-36 BOLT ACTION RIFLE BY ST. ETIENNE** serial #L7413, 308 Winchester, 22 1/2" barrel with a very good plus bore that shows some light frosting in the grooves. The metal surfaces retain 98% gray arsenal parkerized finish with scattered silvering. There is a small chip of metal missing at the rear of the front lower tang. The beech stock rates excellent with a few handling marks. The bolt is matching, the other parts appear un-numbered or mismatched. The rifle was converted by Century Arms to take .308 Winchester and there is an SKS style safety present on the right side of the receiver. There is a small CAI import mark on the right side of the receiver and a tan MAS-36 sling is included. An interesting take on a French military classic. (208879-4) {MODERN} (200/400)
1160. **CZECH VZ-52 SEMI AUTO CARBINE** serial #S36113, 7.62x45, 20" barrel with a bright near excellent bore that shows some minor frosting. The metal surfaces of this "she 55"-coded carbine retain 85% arsenal gray parkerized finish with some light dings on receiver cover, silvering on the barrel, scattered thinning and fading. The hardwood stock rates very good with an armory varnish finish, a couple abrasions on left side of butt, scattered dings and handling marks. The stock appears un-numbered and there do not appear to be any import markings on this carbine. A very good example of these interesting Cold War carbines. (208913-4) {C&R} (300/500)
1161. **RUSSIAN 91/30 MOSIN NAGANT BOLT ACTION RIFLE BY IZHEVSK** serial #9130457224/PL9275, 7.62x54, 28 3/4" barrel with a very good bore that shows scattered frosting. The metal surfaces of this 1942 dated rifle retain 98% arsenal refurbished blue with a couple spots of cleaned light pitting on the floorplate and some silvering on the exposed edges. The post-war stock rates very good plus with an armory added shellac, some light flaking and scattered handling marks. The numbers are arsenal force matching and there is a PW Arms import marking on the left side of the receiver. A fine arsenal reconditioned 91/30 Mosin Nagant. (208913-2) {C&R} (200/300)
1162. **CHILEAN 1912 BOLT ACTION RIFLE BY STEYR** serial #B9534, 7mm Mauser, 29" barrel with a very good plus bore that shows some light frosting in the grooves. The in-the-white receiver, bolt and buttplate have been lightly cleaned to bright with a couple small spots of oxidation staining and a couple pinprick pits. The front band has been cleaned to a silver pewter with a few minor dings, while the rear band, barrel and bottom metal retain 85% arsenal blue with scattered flaking to brown and some minor freckling. The walnut stock rates very good plus as lightly cleaned with an added oil finish, a small chip at left rear of handguard, some minor band removal markings on underside and scattered handling marks. The bolt handle is numbered matching but all other parts appear to be mismatched. An about very good example of these South American Mauser style rifles. (208917-1) {C&R} (200/400)
1163. **RUSSIAN 91/30 MOSIN NAGANT BOLT ACTION RIFLE BY IZHEVSK** serial #IX1133/9130454662, 7.62x54, 28 3/4" barrel with a very good bore that shows scattered frosting but strong rifling. The metal surfaces of this 1942 dated rifle retain 95% arsenal refurbished blue with a couple armory cleaned areas of pitting on the buttplate. The wartime stock rates very good as arsenal refinished with some scattered flaking shellac, a couple armorer repairs, a few dings and scattered handling marks. All serialized parts are matching and do not appear to be force matched. There is a PW Arms import marking on the receiver. A fine example of a World War Two Russian infantry rifle. (208890-2) {C&R} (200/300)
1164. **W.W. GREENER MARTINI SHARPSHOOTER'S CLUB TAKEDOWN RIFLE** serial #09928, 357 Mag, 23" barrel with an excellent bore. The metal surfaces retain 70% good quality later blue with a tiny spot of light pitting on barrel and scattered fading to gray. The lever is toning to a gray patina with some light oxidation stain spots and traces of the original case colors. The walnut stock rates near excellent as-refinished with an added varnish and a few scattered handling marks. The rifle is sighted with a BSA folding peep sight that is mounted behind the receiver and a ramped blade front sight. Barrel-to-frame fit is very slightly loose. A very good Greener Martini overall converted to a more readily available caliber. (208784-18) {C&R} (350/550)
1165. **COMMERCIAL UNIVERSAL M1 CARBINE** serial #408257, 30 Carbine, 18" barrel with a very good bore that has some frosting in the grooves. The metal surfaces retain 97% original blue with silvering along the edges of the magazine well and light fading along the barreled action. The paratrooper folding stock rates very good with some flaking near pistolgrip, a couple light chips behind upper tang, a few dings and handling marks. There is no wire stock, upper tang screw or magazine present. A solid commercial carbine that will benefit from finding a proper wire stock. (208898-88D34085) {MODERN} (200/400)
1166. **COMMERCIAL UNIVERSAL M1 CARBINE** serial #452948, 30 Carbine, 18" barrel with a very good bore that shows some light frosting in the grooves. The metal surfaces retain 97% original blue with some light fading on the edges. The hardwood stock rates very good plus with some light scratches on the underside of butt and a few minor handling marks. Included are a GI 15 round magazine and a gray aftermarket hardcase. A fine commercial carbine that will likely be a fun plinker. (208900-47S21540) {MODERN} (300/500)
1167. **COMMERCIAL IVER JOHNSON M1 CARBINE** serial #AA28287, 30 Carbine, 18" barrel with a bright excellent bore. The metal surfaces of this commercial carbine retain 98% original blue with some light silvering on the exposed edges. The birch stock rates excellent with a couple handling marks. This carbine includes a reproduction green canvas sling and a 15 round USGI magazine made by Inland marked "AI". An excellent condition commercial carbine that will likely be a fun plinker. (208873-673) {MODERN} (300/500)
1168. **COMMERCIAL IVER JOHNSON M1 CARBINE** serial #AA54966, 30 Carbine, 18" barrel with an excellent bore. The metal surfaces of this commercial retain 99% original blue. The birch stock rates excellent with a couple minor dings from band removal and a couple light handling marks. No magazine is included but they are widely available. An excellent condition commercial carbine. (208873-615) {MODERN} (300/500)
1169. **UNIVERSAL ENFORCER SEMI AUTO PISTOL** serial #138770, 30 Carbine, 10 1/2" barrel with an excellent bore. The metal surfaces retain 98% original nickel and arsenal parkerized finish with some light fading on triggerguard. The walnut stock rates very good with a tight 1" crack behind the upper tang and some scattered handling marks. The safety operates stiffly, a single nickel 15 round and two nickel 30 round magazines are included. An interesting commercial carbine style pistol. (208903-56) {MODERN} (300/500)
1170. **YUGOSLAVIAN 98/48 BOLT ACTION RIFLE** serial #S7294, 8mm Mauser, 24" barrel with a very good plus bore that shows some minor frosting. The metal surfaces retain 98% arsenal blue with some light fading. The laminated stock rates very good with a couple light chips at heel, a couple minor lamination separations and some handling marks. The bolt is mismatched while the floorplate and stock are matching. These rifles were made using German K98k actions with Yugoslavian barrels and there is a Century import marking on the right side of the barrel. No cleaning rod is present and this rifle will likely be a very good example for the budding military collector. (208852-47) {C&R} (300/500)

1171. **YUGOSLAVIAN M48A BOLT ACTION RIFLE** serial #G65890, 8mm Mauser, 23" barrel with an about very good bore that shows scattered oxidation but strong rifling. The metal surfaces retain 97% arsenal blue with couple spots of dings on the bands and some light silvering on the exposed edges. The birch stock rates very good with a few dings and scattered handling marks. The bolt is mismatched, the floorplate and stock are matching to the receiver. The rear sight and replaced with an NC Star 2-7x power scope on a B-Square mount. The optics of the scope are clear and a set of bikini covers are included. There is an Intrac import marking on the barrel. A neat "Scout" style Mauser rifle. (208852-11) {C&R} (200/400)
1172. **STEYR M95 BOLT ACTION RIFLE** serial #6198Y, 8x50 Mannlicher, 30" barrel with a fair bore that shows oxidation and pitting throughout the grooves but evident rifling. The metal surfaces are an overall dull gray patina with scattered oxidation and a few spots of light pitting. The birch stock rates very good with an armorer repair at front, scattered dings and handling marks. There is no handguard or stacking hook present and the rear band appears to be a replacement. The barrel is matching to the receiver but the other parts are mismatched and the rifle does not appear to have been updated to fire 8x56. A good restoration candidate. (208852-42) {C&R} (100/300)
1173. **GERMAN GEW 98 BOLT ACTION RIFLE BY AMBERG (SPORTERIZED)** serial #1062n, 7mm CF, 24" barrel with a very good bore that shows scattered frosting. The metal surfaces of this 1916 dated rifle are drifting to a brown patina with scattered traces of arsenal blue and scattered oxidation staining. The checkered Monte Carlo stock rates very good with a couple patches of moderate flaking on the left side, a few dings and scattered handling marks. There are four added screws on the receiver that are protruding upward, all visible serialized parts are matching and the bolt has been turned down. The rifle has an unmarked barrel in a 7mm caliber but we are unable to properly determine what caliber it is in. As with any arm of unknown caliber it is imperative that this arm be checked out by a competent gunsmith prior to firing. An interesting sporterized Mauser 98 rifle. (208873-654) {MODERN} (200/400)
1174. **ARGENTINE MODEL 1891 BOLT ACTION RIFLE BY LUDWIG LOEWE** serial #E5482, 7.65 Argentine, 29" barrel with a very good plus bore that shows some light frosting. The metal surfaces are mostly a gray patina with the bands retaining much arsenal blue, some light pitting on triggerguard and scattered light oxidation. The walnut stock rates very good with the beginnings of a small crack at upper tang, scattered handling marks and a few dings. The barrel is matching to the receiver, the other parts are mismatched, the crest is ground and there is a no handguard present. A good example of these early Mauser rifles. (208911-1) {ANTIQUE} (200/400)
1175. **SWEDISH M96 BOLT ACTION RIFLE BY CARL GUSTAFS** serial #464063, 6.5x55 Swedish, 29" barrel with a bright excellent bore. The metal surfaces of this 1919-dated rifle retain 90% arsenal blue with scattered flaking to brown and fading to gray. The beech stock rates very good plus with four small holes on the right side of butt where a data plate once was, a pair of faded Swedish crown proofs on underside of wrist, a couple spots of light staining and some handling marks. The bolt parts, buttplate, bolt stop and rear sight parts are matching but the other parts appear to be mismatched and the stock disc indicates this gun has been armory rebarreled. There is a Century import marking on the right side of the barrel. A very fine arsenal refurbished Swede Mauser that will likely be a great shooter. (208911-2) {C&R} (300/500)
1176. **STEYR M95 BOLT ACTION RIFLE** serial #3169A, 8x56 Mannlicher, 30" barrel with a very good plus bore that shows a few light pits and some frosting but strong rifling. The metal surfaces of this "S" marked rifle retain 98% arsenal refurbished blue with some silvering at muzzle and oxidation on magazine. The hardwood stock rates very good plus as arsenal refinished with the beginnings of a tight 1 1/2" hairline crack on right side of butt, a few dings and handling marks. The bolt is electropenciled matching and the other parts are stamped matching. Five Mannlicher clips are included. An excellent M95 that was arsenal refurbished between the wars. (208877-23) {C&R} (200/400)
1177. **AUSTRALIAN MKIII* SMLE BOLT ACTION RIFLE BY LITHGOW** serial #D45633, 303 British, 25" barrel with a very good bore that shows scattered frosting but strong rifling. The metal surfaces of this 1942 dated rifle retain 97% gray arsenal parkerized finish with some minor oxidation staining on the triggerguard and some light silvering on the exposed edges. The coachwood stock rates very good with a crisp "MA/5/46" rebuild marking, a strong 1941 date, a strong "HV" marking, a moderate chip on right side of receiver, scattered dings and handling marks. The bolt appears renumbered to match, the other parts are un-numbered and the safety is a No. 4 style replacement. An Enfield style sling is included and there is a small I.A. Co. import mark on the receiver. A fine example of these Aussie Enfield rifles. (208917-2) {C&R} (300/500)
1178. **JAPANESE TYPE 99 ARISAKA BOLT ACTION RIFLE BY NAGOYA** serial #61409, 7.7 Arisaka, 25" barrel with an excellent bore. The metal surfaces of this third series rifle retain 85% original blue with some light oxidation on floorplate, scattered freckling and thinning. The Asian hardwood stock rates good with a tight 2" crack on each side of wrist, a couple abrasions, scattered dings and handling marks. The front band is matching but the bolt is mismatched. The Chrysanthemum is ground and the rear sight is missing its anti-aircraft ears. An original cleaning rod is included with this rifle. A very good early Nagoya Type 99 Arisaka. (208913-6) {C&R} (200/300)
1179. **SWISS MODEL 1911 BOLT ACTION RIFLE** serial #469481, 7.5x55 Swiss, 30 3/4" barrel with a very good bore that shows scattered frosting but strong rifling. The metal surfaces retain 80% original blue with the magazine being a gray patina showing oxidation staining, scattered light oxidation and flaking to brown. The walnut stock rates about very good with an added varnish, a crisp Swiss cross cartouche, a few abrasions, scattered dings and handling marks. The bolt and barrel are matching, the magazine is mismatched and the cocking knobs un-numbered. The rubber cocking knobs show a missing section at both the top and bottom. There is a "P" marking on the receiver indicating that this rifle was retained by a soldier after his service. A solid Swiss long rifle that will likely be a good shooter. (208852-38) {C&R} (200/400)
1180. **JAPANESE TYPE 99 ARISAKA BOLT ACTION RIFLE BY KOKURA** serial #83229, 7.7 Arisaka, 25" barrel with a very good bore that shows some light oxidation. The metal surfaces of this 21st series rifle retain 85% original blue with scattered flaking to brown, some oxidation on lower tang and triggerguard. The Asian hardwood stock rates very good with crisp Kanji stamps, scattered dings and handling marks. The Chrysanthemum is ground, the bolt is mismatched but the front band is matching. The rifle exhibits early war features, no cleaning rod is present but an original monopod is included. A very good early Type 99 Arisaka rifle. (208852-43) {C&R} (200/400)
1181. **JAPANESE TYPE 99 ARISAKA BOLT ACTION RIFLE BY NAGOYA** serial #51563, 7.7 Arisaka, 25" barrel with a very good bore that shows scattered frosting but strong rifling. The metal surfaces of this fourth series rifle retain 60% original blue with overall fading to gray and some light oxidation. The Asian hardwood stock rates very good with an added varnish, a few abrasions, scattered dings and handling marks. The front band is matching to the receiver but the bolt is a later type and is mismatched. The Chrysanthemum is fully intact and an original monopod is present but no cleaning rod is included. A solid early Type 99 Arisaka rifle. (208873-687) {C&R} (300/500)

1182. **FRENCH M16 BERTHIER BOLT ACTION RIFLE BY ST. ETIENNE** serial #FK65588, 8mm Lebel, 31" barrel with a fair bore that shows oxidation throughout but evident rifling. The metal surfaces retain 60% arsenal quality blue with blued-over over dings on magazine box, moderate pitting along the barrel and receiver, further pitting on bolt body and scattered oxidation staining. The hardwood stock rates very good with a couple armorer repairs, a 1" crack behind the right side of bolt, scattered dings and handling marks. The rifle does not appear to be balle "N" marked and the serial numbers are mismatched. A well-used example of an M16 Berthier rifle. (208911-4) {C&R} (200/400)
1183. **SWISS MODEL 1889 BOLT ACTION RIFLE** serial #110275, 7.5x53 Swiss, 30" barrel with a very good plus bore that shows light frosting. The metal surfaces retain 93% original blue, the loss mostly due to light flaking to brown along the exposed edges. The walnut stock rates very good with strong Swiss cross cartouches, scattered dings and handling marks. The plastic cocking knob shows a few cracks and is un-numbered. All of the visible serialized parts are matching, a muzzle cap and leather sling are included. There is a Century Arms import marking on the right side of the receiver. A very fine Swiss Schmidt Rubin rifle. (208913-1) {ANTIQUE} (300/500)
1184. **YUGOSLAVIAN M98/48 BOLT ACTION RIFLE** serial #J2182, 8mm Mauser, 24" barrel with a very good bore with scattered frosting. The metal surfaces retain 98% Yugo arsenal blue. The blonde laminated stock rates very good with a couple lamination separations on the butt and scattered handling marks. The bolt, floorplate and stock are all matching as renumbered by the Yugoslavians. A very fine German K98k that saw post war service in the Yugoslavian army. (208911-5) {C&R} (300/500)
1185. **CZECH VZ-52 SEMI AUTO CARBINE** serial #E35630, 7.62x45, 20 1/2" barrel with a fair bore that shows worn rifling with scattered oxidation and moderate pitting. The metal surfaces of this 1956 dated carbine retain 80% arsenal parkerized finish with some freckling on magazine, a few light dings on barrel, scattered silvering and thinning. The hardwood stock rates good with a 1" crack behind triggerguard, a couple smaller cracks at rear of handguard, flaking throughout the butt, scattered dings and handling marks. The stock is loose and is numbered to a different gun. A good example of these Cold War Czech carbines. (208877-25) {C&R} (200/400)
1186. **FINNISH M39 MOSIN NAGANT BOLT ACTION RIFLE BY VKT** serial #72932, 7.62x54R, 27" barrel with an about very good bore that shows scattered oxidation, a few pits and frosting but strong rifling. The metal surfaces of this 1944-dated rifle retain 85% arsenal blue with a couple cleaned areas on the barrel, scattered silvering and fading. The post war stock rates about good with a 5" crack on the top of butt, a few other cracks, a patch of armorer repairs on the left side, chipping at toe, a few dings and handling marks. The bolt is numbered matching, the floorplate is mismatched and there is an Inter Ordnance import marking on the receiver. A good "Example" of these Finn Mosin rifles. (208852-44) {C&R} (200/400)
1187. **SWEDISH M96 BOLT ACTION RIFLE BY CARL GUSTAFS** serial #509737, 6.5x55 Swedish, 29" barrel with an excellent bore. The metal surfaces of this 1924-dated rifle retain 65% arsenal blue with silvering throughout the floorplate, further silvering on bands and fading to gray throughout the barrel. The beech stock rates very good with two partially faded Swedish crown markings on the wrist, the beginnings of a tiny crack behind the bandkeeper, a few dings and handling marks. There are four small holes on the right side of the butt where a data plate once was and the stock disc has a "2" for bore condition. The bolt parts, bolt stop and buttplate are matching but the other visible parts are mismatched. There is a Sarco import marking on the underside of the barrel. A fine Swede Mauser that will likely be a great shooter. (208852-49) {C&R} (300/500)
1188. **TURKISH M38 BOLT ACTION RIFLE BY ANKARA ARSENAL** serial #213744, 8mm Mauser, 29" barrel with a very good bore that shows some light pitting and frosting but strong rifling. The metal surfaces of this 1945-dated rifle retain around 70% dull arsenal blue with overall fading and a few minor dings. The beech stock rates very good as-cleaned with a lightly added varnish, a 3" drying crack on the left side of butt, a small crack behind upper tang, some cosmoline residue near rear sight, scattered dings and handling marks. The bolt is mismatched but the other visible parts appear to match and there is a PW Arms import mark on the right side of barrel. An about very good 1938 style Turk Mauser rifle. (208877-11) {C&R} (150/250)
1189. **FINNISH MARKED 91/30 MOSIN NAGANT BOLT ACTION RIFLE BY TULA** serial #SG1958, 7.62x54R, 28 3/4" counterbored barrel with a very good bore that shows scattered frosting. The metal surfaces of this 1939-dated rifle retain 93% Finnish blue with some silvering and fading on the exposed edges. The two piece Finnish birch stock rates very good with a crisp Finn cartouche, a couple tight cracks on the handguard, some dings and handling marks. The bolt was renumbered to match by the Finns, the other parts are un-numbered, there are "D", "41" and boxed "SA" marking on the barrel shank. There is a Century Arms import marking on the barrel. A fine Finn used 91/30 rifle overall. (208911-3) {C&R} (200/300)
1190. **CZECH 98/22 BOLT ACTION RIFLE BY BRNO** serial #B7155, 8mm Mauser, 29" barrel with a bright near excellent bore. The metal surfaces retain 97% of a reapplied gray parkerized finish with a few small spots of parkerized over pitting, some silvering and light fading. The nicely figured hardwood stock rates very good plus as lightly refinished with a few handling marks. The serialized parts are mismatched, there is a Turk crescent moon marking on the bolt handle and there is a Navy Arms import mark on the receiver. A solid Mauser type rifle that should be a good shooter. (208885-12) {C&R} (200/300)
1191. **JAPANESE TYPE 38 ARISAKA BOLT ACTION RIFLE BY TOKYO ARSENAL** serial #1451553, 6.5 Arisaka, 31" barrel with a very good bore that shows scattered frosting. The metal surfaces of this early no-series rifle are turning to a pleasing gray patina with some spots of dried varnish, a couple tiny spots of light pitting on triggerguard and scattered traces of arsenal blue. The Asian hardwood stock rates very good as lightly refinished with an added varnish, a small crack at rear of handguard, scattered dings and handling marks. The Chrysanthemum is fully intact, no cleaning rod is present, the floorplate and front band match each other by assembly number but the other parts appear mismatched. A solid early Type 38 Arisaka rifle. (208885-4) {C&R} (200/400)
1192. **FINNISH MARKED 91/30 MOSIN NAGANT BOLT ACTION RIFLE BY IZHEVESK** serial #PB5568, 7.62x54R, 28 3/4" barrel with an about very good bore that shows scattered frosting but strong rifling. The metal surfaces of this 1940-dated rifle are turning to a gray patina with some light oxidation and a few spots of blued-over pitting. The two-piece Finnish stock rates very good as-refinished with a faint cartouche on the right side, the grip appearing thinner, a chip behind upper tang with a crack protruding from it, an armorer repair on left side of butt, scattered dings and handling marks. There are Finnish "D" D166 and "SA" Army markings on the barrel shank. The bolt has been turned down, it is mismatched and the other parts are un-numbered. The metal is proud of wood overall and there is a Century import mark on the barrel. A Soviet style canvas sling is included with this rifle. (208885-9) {C&R} (150/250)
1193. **ARGENTINE MODEL 1879 ROLLING BLOCK RIFLE BY REMINGTON** .43 Spanish, 35" barrel with a very good plus bore that shows light frosting. The metal surfaces are a dull gray patina with oxidation staining throughout. The walnut stock rates very good with an added varnish, a faint rack number on the left side of butt, a couple chips on left side of butt, scattered dings and handling marks. The rifle is equipped with a saber style bayonet lug. A solid Rolling Block military rifle. (208852-37) {ANTIQUE} (200/400)

1194. **ROSS M1910 BOLT ACTION RIFLE (SPORTERIZED) 303** British, 25" shortened barrel with a very good bore that shows scattered frosting and a couple pits. The metal surfaces retain 30-40% original blue with overall fading to gray and some light oxidation staining. The cutdown walnut stock rates very good plus as-cleaned with a lightly added oil finish, a few dings and handling marks. The military sights are intact and the bolt has the added rivet to prevent incorrect disassembly. An interesting and infamous rifle. (208852-19) {MODERN} (200/400)
1195. **RUSSIAN MOSIN NAGANT 91/30 EX-DRAGOON BOLT ACTION RIFLE BY IZHEVSK** serial #9130477674/56522, 7.62x54R, 28 3/4" barrel with a bright very good plus bore that shows some minor frosting. The metal surfaces of this 1927-dated rifle retain 97% arsenal refurbished blue with some light silvering on the exposed edges. The prewar Soviet stock rates very good as-arsenal refinished with an added varnish, scattered flaking, a small armorer repair in front of magazine and some handling marks. All serialized parts are matching as arsenal renumbered and this rifle started life as a Dragoon but was later converted to 91/30 configuration. A matching numbered 91/30 bayonet is included and there is a Century import marking on the receiver. A fine example of a Mosin that had a long service life. (208913-3) {C&R} (200/400)
1196. **POLISH M44 MOSIN NAGANT BOLT ACTION CARBINE BY RADOM** serial #DK20051, 7.62x54R, 20" barrel with a bright excellent bore. The metal surfaces of this 1952-dated carbine retain 99% arsenal blue finish. The beech stock rates excellent with strong Polish cartouches and a few handling marks. All serialized parts are matching and there is an Intrac import marking on the bayonet mount. An excellent Polish Mosin carbine. (208879-14) {C&R} (300/500)
1197. **AUSTRALIAN MKIII BOLT ACTION RIFLE BY LITHGOW** serial #73159, 303 British, 25" 1950-dated barrel with a good bore that shows scattered oxidation but strong rifling. The metal surfaces of this 1917-dated rifle retain 97% gray arsenal parkerized finish with some light oxidation on nose cap and scattered light silvering on the exposed edges. Interestingly the bolt head has an added case color finish. The coachwood stock rates very good as-cleaned with a 1 1/2" crack in front of the charger bridge, a 1/2" crack on rear handguard and a few handling marks. The barrel and rear sight are arsenal renumbered matching to the receiver but the other parts appear mismatched or un-numbered. The rifle bears "FTR" and "MA/50" rebuild markings and there is a small John Jovino import marking on the right rear of the receiver. Included with this rifle are an Enfield style sling and canvas action cover. A solid example of a World War One Lithgow Enfield. (208885-2) {C&R} (200/400)
1198. **SWEDISH M96B BOLT ACTION RIFLE BY CARL GUSTAFS** serial #245526, 6.5x55 Swedish, 29" armory threaded barrel with a bright excellent bore. The floorplate retains 95-97% of an added black enamel with some flaking. The other parts retain 97% arsenal blue with a few spots of minor dings, some light oxidation and minor fading. The beech stock rates very good plus as lightly cleaned with an added oil finish, a crisp "(Crown)/CG" marking on underside of wrist and a few handling marks. The bolt parts are matching but the other parts appear un-numbered and the stock disc has a "2" for bore condition. The rifle has a bent bolt, threaded muzzle cap, front sight hood and a tan Swedish sling is included. The receiver is dated 1909 and there is a Century import mark on the barrel. A very fine Swede Mauser rifle overall. (208885-13) {C&R} (300/500)
1199. **FINNISH M28/30 MOSIN NAGANT BOLT ACTION RIFLE BY SAKO** serial #46736, 7.62x54R, 27" counterbored barrel with a very good bore that shows scattered frosting and a couple pits but strong rifling. The metal surfaces of this 1936 dated rifle retain 80% of a dull reapplied blue finish with scattered flaking to brown, some moderate pitting on buttplate and a few spots of freckling. The birch stock rates very good as-cleaned with a partially faded 1939 Civil Guard cartouche and a few handling marks. The parts are mismatched, the rifle has a "D" marking indicating update to the D166 cartridge, an "SA" army marking and a Civil Guard district number of "43737" for Pirkka-Hame. The bolt handle has been turned down and there is a Marathon Products import marking on the receiver. A Soviet style canvas sling is included with this rifle. A good example for the budding Mosin Nagant collector. (208885-3) {C&R} (200/400)
1200. **CHINESE T53 MOSIN NAGANT BOLT ACTION CARBINE** serial #3052023, 7.62x54R, 20" barrel with a good bore that shows scattered dried cosmoline but strong rifling. The metal surfaces of this 1955-dated, factory 26 carbine retain 85% arsenal blue with scattered flaking to brown and some oxidation. The Asian hardwood stock rates very good as lightly refinished with a few dings and handling marks. The bolt is mismatched but the other parts are matching. There does not appear to be any import markings on this carbine. A solid example of these Cold War carbines. (208868-7) {C&R} (200/300)
1201. **FINNISH M28 MOSIN NAGANT BOLT ACTION RIFLE BY SAKO** serial #17322, 7.62x54R, 26" barrel with a good bore that shows frosting throughout but evident rifling. The metal surfaces retain 95% arsenal blue with some light fading along the edges. The one-piece Russian stock rates good as-cleaned with a spurious "SA" marking in the right grasping groove, a couple tight cracks on butt, a large splice repair at toe, a few plug reinforcements, dings and handling marks. The parts are mismatched, the rifle is "SY" and "SA" marked and there is a "D" marking indicating update for the D166 bullet. There is a Civil Guard district number of "S8426" for Helsinki, a couple screws exhibit slot damage and there is a Marathon products import marking on the barrel. A solid Finnish M28 Civil Guard rifle. (208852-48) {C&R} (250/450)
1202. **PERSIAN M49 BOLT ACTION CARBINE** serial #20530-29, 8mm Mauser, 18" barrel with a very good plus bore that shows some light frosting in the grooves. The metal surfaces retain 97% reapplied blue with some light fading and flaking to brown on the exposed edges. The beech stock rates very good plus with an added varnish, strong Persian markings, an English number "25359" on the left side of stock, scattered dings and handling marks. The bolt is matching, the stock appears mismatched and there is a small added screw hole on the left side of the receiver for reasons unknown. A brown leather military style sling is included. An interesting Persian Mauser carbine. (208882-12) {C&R} (300/500)
1203. **ARGENTINE MODEL 1909 BOLT ACTION RIFLE BY DWM** serial #G9573, 7.65 Argentine, 29" barrel with an about very good bore that shows a couple pitting spots and scattered frosting but strong rifling. The metal surfaces retain 90% arsenal refurbished blue with some light pitting on floorplate and scattered flaking to brown on the exposed edges. The walnut stock rates very good with an added dark oil finish, two added holes on the right side of butt, the letters "XX" lightly carved near heel, scattered dings and handling marks. The bolt and floorplate are matching to the receiver but the other parts are mismatched and there is an NHM import mark on the barrel. A good example for the budding Mauser collector. (208852-22) {C&R} (300/400)
1204. **INTERESTING JAPANESE GEW 88 TRAINING RIFLE BY DANZIG** serial #2475d, 8mm Mauser, 27" barrel with a poor oxidized bore. The metal surfaces of this 1890 dated rifle retain 75% of a reapplied blue finish with a spot of light pitting on barrel, some oxidation on bottom metal and scattered fading. The Asian hardwood stock rates very good with an added varnish, a red paint number "8" on the right side of butt, scattered dings and handling marks. This rifle was a Commission 88 that was likely captured in China by the Japanese and converted to a single shot trainer. A couple of the bolt stop parts and the rear sight elevator appear to be missing and the trigger does not appear to be functional. An interesting piece of history that could surely tell a story or two. (208050-850) {ANTIQUÉ} (200/400)

1205. **BRAZILIAN 1908 BOLT ACTION RIFLE BY DWM** serial #225r, 7mm Mauser, 29" barrel with a fair bore that shows oxidation and frosting throughout but evident rifling. The in-the-white bolt and receiver are a dull gray patina with oxidation staining throughout. The other parts retain 65% original blue with overall flaking to brown and some light oxidation. The European walnut stock rates very good with an added oil finish, a crisp Star-of-David cartouche, a white painted rack number "8" on right side, scattered dings and handling marks. The stock, floorplate, triggerguard, bolt handle, safety and cocking piece are all matching to the receiver but the other parts appear un-numbered. There is a Springfield Armory Inc. import marking on the right side of the barrel. A good example of these South American contract rifles. (208852-41) {C&R} (200/400)
1206. **RUSSIAN M44 MOSIN NAGANT BOLT ACTION CARBINE BY IZHEVSK** serial #LD6907/RC013047, 7.62x54R, 20" barrel with a very good plus bore that shows some minor frosting in the grooves. The metal surfaces of this 1944-dated carbine retain 98% arsenal refurbished blue with a couple small spots of light oxidation on the buttplate. The Soviet hardwood stock rates very good as arsenal refinished with a faint Izhevsk roundel on the right side of butt, an armorer patch repair on the left side, a few minor dings and some handling marks. All serialized parts are matching with the floorplate being force-matched. There is a PW Arms import mark on the receiver and a Com-Bloc style sling is included. A fine example of these Mosin Nagant carbines. (208890-4) {C&R} (200/400)
1207. **DUTCH CONTRACT FN 1922 SEMI AUTO PISTOL** serial #37508, 380 ACP, 4 1/2" barrel with a fair bore that shows scattered oxidation and some pitting but evident rifling. The metal surfaces retain 60% original blue with the slide drifting to a brown patina and the straps fading to gray. The FN hard rubber grips rate very good with some flattened points and handling marks. The pistol is marked with a "(Crown)/W" on the slide for Queen Wilhelmina and visible serialized parts are matching to the frame. There is no lanyard ring present but two magazines are included, one is numbered "9865" and the other un-numbered. A solid example of these FN-made Dutch pistols. (208873-356) {C&R} (200/400)
1208. **BERETTA MODEL 71 SEMI AUTO PISTOL** serial #62557, 22 LR, 3 1/2" barrel with an excellent bore. The metal surfaces retain 95% original blue with some silvering along barrel, light freckling on slide and high edge wear. The checkered hard plastic grips rate very good with an area of flattened points on the right panel, a few dings and scattered handling marks. A very good plus Beretta 71 pistol overall. (208873-159) {MODERN} (200/300)
1209. **BERSA THUNDER 380 SEMI AUTO PISTOL** serial #502459, 380 ACP, 3 1/2" barrel with an excellent bore. The satin nickel rates excellent with a few light handling marks. The slide retains 99% original matte black finish. The Bersa checkered grips rate very good plus with a few light handling marks. A single magazine is included and there is an RSA Enterprises import marking on the slide. (208873-394) {MODERN} (200/300)
1210. **BERETTA MODEL 70S SEMI AUTO PISTOL** serial #B55538U, 22 LR, 3 1/2" barrel with an excellent bore. The metal surfaces retain 95% original blue with some light high edge wear and a couple patches lightly cleaned to gray on the left side of the slide. The checkered Beretta grips rate very good with scattered light scratches and handling marks. A single magazine is included with this pistol. (208873-338) {MODERN} (200/300)
1211. **CZ70 SEMI AUTO PISTOL** serial #663604, 32 ACP, 3 1/2" barrel with an excellent bore. The metal surfaces retain 99% original blue with a couple tiny specks of surfaces oxidation on the frame. The hard rubber CZ grips rate very good with a few handling marks and light scratches. There is a Century Arms import mark on the frame, a single magazine and a correct box properly end-labeled to the gun are included with this pistol. An excellent CZ pistol that will likely make a good carry gun. (208873-91) {MODERN} (200/300)
1212. **ASTRA CONSTABLE SEMI AUTO PISTOL** serial #1298606, 22 LR, 3 1/2" barrel with an excellent bore. The metal surfaces retain 99% original blue finish. The checkered plastic grips rate about very good with a 1" crack on the right panel and a few light handling marks. A single magazine is included and there is an Interarms import marking on the slide. A very fine Astra compact auto. (208873-47) {MODERN} (200/300)
1213. **POLISH WZ-48 BOLT ACTION RIFLE BY RADOM** serial #ZM1885, 22 LR, 25" barrel with an excellent bore. The metal surfaces of this 1956-dated rifle retain 93% original blue with scattered light flaking to brown and some silvering on buttplate. The beech stock rates very good plus with a few dings and handling marks. The bolt and buttplate are both numbered matching to the barrel shank and there is an Intrac import marking on the barrel. A fine example of these Polish training rifles. (208879-7) {C&R} (200/300)
1214. **MOSSBERG MODEL 46M BOLT ACTION RIFLE** 22 S,L,LR, 23" barrel with an excellent bore. The metal surfaces are mostly a gray patina with scattered freckling. The hardwood stock rates very good plus with a couple dings and a few handling marks. The grooved black buttplate has a small crack at bottom and some scattered staining. The rifle retains its factory sights and there are no sling swivels present. A solid example of a classic rimfire rifle. (208853-5) {C&R} (125/250)
1215. **MOSSBERG MODEL 144-LS BOLT ACTION RIFLE** 22 LR, 26" barrel with an excellent bore. The metal surfaces retain 99% original blue with some minor freckling on the floorplate. The walnut stock rates very good plus with an added varnish, some flaking and handling marks. The rifle is sighted with a Lyman peep sight that is mounted on the rear of the receiver and a globe front sight. The rifle is also equipped with a handstop just behind the front sling swivel. An excellent Mossberg rimfire rifle. (208853-12) {C&R} (200/400)
1216. **MOSSBERG MODEL 590 SLIDE ACTION SHOTGUN** serial #K748743, 12 Ga, 20" plain barrel choked cylinder with an excellent bore. The metal surfaces retain 98% original blue with some light operational wear on the magazine tube. The Speedfeed style stock and grooved forend rate excellent with some light handling marks. The shotgun is sighted with a bead and it has a bayonet lug. A nice 590 that will likely be suitable for home defense. (208852-17) {MODERN} (200/400)
1217. **SAVAGE MODEL 340C BOLT ACTION RIFLE** serial #156475, 22 Hornet, 22" barrel with an excellent bore. The metal surfaces retain 98% original blue with some light silvering and flaking to brown near muzzle. The hardwood stock rates excellent with a couple minor handling marks. This rifle includes a single factory 5-round detachable magazine. An excellent condition Savage 340C rifle. (208853-4) {C&R} (250/450)
1218. **WINCHESTER MODEL 77 SEMI AUTO RIFLE** serial #146085, 22 LR, 22" barrel with an excellent bore. The metal surfaces retain 93% original blue with some light flaking to brown and freckling on the barrel. The walnut stock rates very good with some scattered flaking and a few handling marks. A single factory magazine is included and the stock has two sling studs. A very fine Winchester rimfire rifle. (208873-716) {MODERN} (150/250)
1219. **ROSSI OVERLAND DOUBLE HAMMER COACH SHOTGUN** serial #T43031, 20 Ga, 20" solid rib barrels choked modified and full with bright excellent bores. The metal surfaces of this "Coach" style shotgun retain 98% original blue with some light flaking to brown and minor silvering at muzzle. The hardwood stock rates very good plus retaining most of its factory varnish with scattered handling marks. The arm appears to function well and it will likely be great for the cowboy enthusiast. (208873-711) {MODERN} (200/300)

1220. **MOSSBERG MODEL 42M(B) BOLT ACTION RIFLE** 22 LR, 23" barrel with an excellent bore. The metal surfaces retain 98% original blue with some light silvering on the exposed edges and some light fading to gray on front of triggerguard. The hardwood stock rates very good plus with scattered handling marks and a few light dings. The rifle is equipped with both a standard rear sight and a receiver mounted S-100 peep sight. A single magazine is included and this is an excellent Mossberg 42M(b) rifle overall. (208873-715) {C&R} (200/300)
1221. **REMINGTON 870 EXPRESS MAGNUM SLIDE ACTION SHOTGUN** serial #AB2351960, 20 Ga, 25 1/2" ventilated rib barrel choked modified with a bright excellent bore. The metal surfaces retain 95% original parkerizing with a few spots of light oxidation staining and some silvering on the exposed edges. The laminated stock rates very good plus with a few handling marks and light flaking spots. The shotgun is fitted with a Remington recoil pad giving it a 13 3/4" length of pull. A very fine 870 that will likely be a great bird gun. (208856-6) {MODERN} (200/300)
1222. **WINCHESTER MODEL 490 SEMI AUTO RIFLE** serial #J031172, 22 LR, 22" barrel with an excellent bore. The metal surfaces retain 99% original blue finish. The checkered walnut stock rates excellent with a couple tiny light handling marks. A single magazine is included with this rifle. An excellent rimfire rifle that may be a fun plinker. (208873-594) {MODERN} (200/300)
1223. **HARRINGTON & RICHARDSON MODEL 165 "LEATHERNECK" SEMI AUTO RIFLE** serial #2941, 22 LR, 23" barrel with a very good plus bore that shows some minor frosting. The metal surfaces retain 85% original blue with some silvering on the triggerguard, scattered light flaking to brown and some light oxidation near muzzle. The walnut stock rates very good showing scattered light dings and handling marks. A single magazine is included and this is a fine "Reising-style" rifle. (208873-656) {C&R} (200/300)
1224. **CZECH VZ-52 SEMI AUTO RIFLE** serial #K62805, 7.62x45, 20" barrel with a poor bore. The metal surfaces of this "she-55"-coded rifle show a fading arsenal parkerized finish with scattered dings and oxidation spots. The hardwood stock rates about good with a few cracks, a repair at heel, scattered dings and handling marks. There is no handguard present, the bayonet is loose, there is a Century import mark on the barrel and there are a couple patches of tape remnants on both the metal and wood. A good restoration candidate. (208852-31) {C&R} (100/200)
1225. **REMINGTON NYLON 77 SEMI AUTO RIFLE** serial #2193704, 22 LR, 19 1/2" barrel with a bright excellent bore. The metal surfaces retain 95% original blue with some light freckling on receiver and light flaking to brown on barrel. The brown plastic stock rates very good plus with a few light handling marks. A very good Nylon 77 that will likely make a great plinker. (208873-689) {MODERN} (150/250)
1226. **U.S. MODEL 1888 TRAPDOOR RIFLE BY SPRINGFIELD ARMORY** serial #511522, 45-70, 32 5/8" barrel with a fair bore that shows scattered oxidation and pitting. The metal surfaces are a dull gray patina with scattered older light-to-moderate pitting. The walnut stock rates fair with an older added oil finish, a strong 1891 dated cartouche, a strong circled "P" firing proof, an added disc on the right side of butt, couple large chunks missing around lock, a repaired crack on right side of lock, a few chips, scattered dings and handling marks. The rifle is equipped with a Buffington rear sight, an aftermarket front blade sight and a proper ramrod bayonet. The front band has two added brass fastening screws. A good restoration candidate overall. (208810-2) {ANTIQUÉ} (200/400)
1227. **UNMARKED TRAPDOOR SINGLE SHOT RIFLE** 45-70, 32 5/8" barrel with a poor bore. The metal surfaces of this assembled rifle are a dull gray oxidized patina. The walnut stock rates fair with a large chunk missing at front, a few cracks, chips, dings and handling marks. The rifle appears to have been assembled by Bannerman or the like with the breechblock being from a U.S. 1873 Trapdoor and the lock marked simply "1884". There is no rear sight or ramrod present and there are two added holes in the buttplate. An interesting wallhanger. (208894-6) {ANTIQUÉ} (50/100)
1228. **ANTONIO ZOLI ZOUAVE PERCUSSION RIFLE** serial #14558, .58 Cal, 33" barrel with a very good bore that shows scattered light oxidation. The barrel retains 98% original blue with some light oxidation in breech area, while the lock and hammer retain nearly all of their case colors. The brass parts are turning to a dull yellow color with some light oxidation staining. The hardwood stock rates very good with an added varnish, a few dings, a 1 1/2" chip to right of upper tang, some paint stains and scattered handling marks. The lock appears to function well and there is a spare nipple in the patchbox. (208898-107) {ANTIQUÉ} (150/250)
1229. **SWISS MODEL 1889 BOLT ACTION RIFLE (SPORTERIZED)** serial #105439, 7.5x53 Swiss, 23" shortened barrel with a very good plus bore that shows a couple light pits. The metal surfaces retain 90% original blue with scattered flaking to brown and some light oxidation spots. The cutdown walnut stock rates very good plus with an added varnish, a strong Swiss cross cartouche, a few dings and scattered handling marks. The barrel is matching but the other parts are mismatched, the rifle is equipped with a receiver mounted Lyman rear peep sight and the military rear aperture has been removed. The plastic knob shows some chips and cracks and there is a small import marking on the receiver. (208852-45) {ANTIQUÉ} (100/200)
1230. **INDIAN MK III* ENFIELD BY ISHAPORE** serial #3441AD, 303 British, 25" barrel with a bright excellent bore. The metal surfaces of this 1986-dated rifle retain 50% arsenal black enamel with overall flaking. The hardwood stock rates good plus with a strong "SA" Indian marking on the right side of butt, a large repaired chip between the rear band and charger bridge, a crack running beneath the aforementioned chip, a few smaller chips and some handling marks. All serialized parts are matching including the magazine and there is a TG import mark on the receiver. A solid late production Enfield rifle. (208852-40) {MODERN} (200/400)
1231. **ARGENTINE MODEL 1891 BOLT ACTION RIFLE BY DWM** serial #T2884, 7.65 Argentine, 29" barrel with a fair bore that shows oxidation and pitting but evident rifling. The barreled action is a dull brown patina with some scattered oxidation. The other parts show a flaking reapplied chrome finish with scattered oxidation staining. The walnut stock rates very good with an added varnish, a black paint "61" rack number on either side of butt, scattered flaking, dings and handling marks. The Argentine crest is hard-to-see but it remains intact, the barrel is matching but the other parts appear to be mismatched. There is a Century Arms import marking on the right side of the barrel. (208852-23) {C&R} (100/200)
1232. **GERMAN GEW 88/05 BOLT ACTION RIFLE BY DANZIG** serial #4756e, 8mm Mauser, 29" barrel with a very good bore that shows some scattered frosting but strong rifling. The metal surfaces of this 1891-dated rifle are an overall dull gray patina with some light dents in the barrel jacket, light pitting along the woodline and scattered light oxidation. The hardwood stock rates very good with an added dark oil finish, a few chips along the edges of the barrel, scattered dings and handling marks. The barrel is matching, the other parts are mismatched, the rifle is "S" marked and a few parts have Turkish crescent moon markings. There is no cleaning rod or rear sight slider present. A solid Gew 88 for the fledgling military collector. (208852-26) {ANTIQUÉ} (200/300)
1233. **ARGENTINE MODEL 1891 BOLT ACTION CARBINE BY LUDWIG LOEWE (SPORTERIZED)** serial #F7089, 7.65 Argentine, 22" shortened barrel with an about good bore that shows oxidation and pitting throughout but evident rifling. The metal surfaces retain 65% arsenal blue with overall flaking to brown and scattered oxidation. The cutdown walnut stock rates very good with scattered dings and handling marks. All serialized parts are matching, this appears to be a rifle that was cutdown to carbine length, the bolt handle has been turned down, the crest scrubbed and the front sight ears removed. An interesting take on an early Mauser style rifle. (208852-36) {ANTIQUÉ} (100/200)

1234. **WINCHESTER MODEL 490 SEMI AUTO RIFLE** serial #J041412, 22 LR, 22" barrel with an excellent bore. The metal surfaces retain 98% original blue with some minor handling marks. The checkered walnut stock rates very good plus with a couple dings, some light flaking spots and a few handling marks. No magazine is included with this rifle. A fine Winchester semi auto rimfire rifle. (208873-720) {MODERN} (200/300)
1235. **ROMANIAN M69 BOLT ACTION TRAINING RIFLE** serial #T3947, 22 LR, 23" barrel with an excellent bore. The metal surfaces retain 90% original blue with the loss primarily due to fading to gray on the exposed edges. The hardwood stock rates very good with an added varnish, scattered flaking, a few dings and handling marks. The rifle is dated 1971, the barrel is matching but the bolt is mismatched. There is a small Century import marking on the receiver. An affordable military training rifle. (208873-612) {MODERN} (100/200)
1236. **SWISS K11 BOLT ACTION CARBINE (SPORTERIZED)** serial #59697, 7.5 Swiss, 23" barrel with a very good bore that shows some oxidation but strong rifling. The metal surfaces retain 75% arsenal blue with the bottom metal being mostly a gray patina, further fading to gray on the barreled action and some scattered oxidation staining. The cutdown walnut stock rates very good plus as-cleaned with two small holes for sling hardware, a partially faded Swiss cross cartouche, a small chip at upper tang and some handling marks. All of the serialized parts are matching and the rear sight is loose. A good restoration candidate. (208923-14) {MODERN} (100/200)
1237. **BERNARDELLI STANDARD MODEL SEMI AUTO PISTOL** serial #450, 22 LR, 3 1/4" barrel with an excellent bore. The metal surfaces of this 1951-dated pistol retain 80% original blue with some high edge silvering, a few small spots of light oxidation, a couple small pits on the right side of slide, scattered flaking to brown and light freckling. The hardwood grips rate good with an added varnish, several flaking spots and some crackling. A single magazine is included with this pistol. (208873-265) {C&R} (200/300)
1238. **ARMSCOR M1600 SEMI AUTO RIFLE** serial #A775870, 22 LR, 18" barrel with an excellent bore. The metal surfaces of this AR-15 style rimfire rifle retain 99% original blue. The hard-plastic body rates excellent with a couple minor handling marks on the butt. The rifle has a KBI import mark, it retains its factory sticker on the magazine and hang tag. Also included are the original box and manual. An excellent M16 style rimfire rifle. (208873-723) {MODERN} (150/250)
1239. **ITALIAN M38 CARCANO BOLT ACTION CARBINE BY TERNI (SPORTERIZED)** serial #AR4207, 6.5 Carcano, 21" barrel with a very good bore that shows scattered frosting but strong rifling. The metal surfaces of this 1940 dated carbine retain 80% of arsenal refurbished blue with scattered light oxidation. The cutdown Italian stock rates about very good as-cleaned with a plug repair behind upper tang, a large chip at toe and a few handling marks. The military sights are intact and there is an import marking on the receiver. A good restoration candidate. (208873-667) {MODERN} (75/150)
1240. **WINCHESTER MODEL 77 SEMI AUTO RIFLE** serial #85341, 22 LR, 22" barrel that has a light bulge 1/3 of the way down from the muzzle but otherwise rates very good plus. The metal surfaces retain 98% original blue with some light freckling on the exposed edges. The walnut stock rates very good with some light flaking oil finish, a few minor dings and some handling marks. A single factory magazine is included with this rifle. (208873-604) {MODERN} (100/200)
1241. **WINCHESTER MODEL 62 SLIDE ACTION RIFLE** serial #421612, 22 Short, 23" octagon barrel with a very good bore that shows some light pitting in the grooves. The metal surfaces retain 97% dull reapplied blue with a few small spots of light oxidation. The walnut stock and grooved forend rate very good as-cleaned with a small crack at the upper tang and a few handling marks. The lower tang number is mismatched, one of the upper tang screws is missing and the barrel has a mail order proof mark. The arm appears functional and it may prove to be a good plinker. (208873-663) {C&R} (150/250)
1242. **MOSSBERG 44US(A) BOLT ACTION RIFLE** serial #143948, 22 LR, 26" barrel with an excellent bore. The metal surfaces retain 97% gray-arsenal grade parkerized finish with some light silvering on the barrel. The hardwood stock rates very good plus with a lightly added varnish, a few minor dings and some handling marks. The rifle is U.S. property marked and there is no magazine present. A very good military trainer that will likely make a great shooter. (208873-581) {C&R} (200/300)
1243. **SMITH & WESSON MODEL 10-8 MILITARY & POLICE REVOLVER** serial #5D70206, 38 Special, 4" pinned heavy barrel with an excellent bore. The metal surfaces retain about 97% original blue finish with most of the loss due to muzzle wear in addition to scattered light high edge wear, turn ring on the cylinder and other handling marks. The standard trigger and hammer retain bold case-hardened colors with light operational wear. The replacement checkered rubber Pachmayr "Gripper" grips rate very good with light handling wear. Timing and lock up are excellent and it should make a great shooter. (86520-1991) {MODERN} [Richard "Stretch" Kennedy Collection] (300/500)
1244. **SMITH & WESSON MODEL 1905 MILITARY & POLICE HAND EJECTOR TARGET REVOLVER** serial #115087, 38 Special, 6" barrel with an excellent bore. This second change gun was factory refurbished on June, 1925 and includes a "[diamond] B" refinish mark but has seen heavy use since. The metal surfaces retain only a few scant patches of the factory reapplied blue finish in the protected areas, the rest having toned to brown / gray with oxidation stains, scratches, old and new pitting and a turn ring on the cylinder. The hammer and trigger appear to have been blue finished at one time and are now dark with freckling and operational wear. The grips are replacement Herrett's checkered finger rest walnut Model RK Shooting Star's that rate good with moderate scuffs to the edge, dents and dings. The revolver still times and locks up correctly and all appropriate parts are correctly serial numbered to the gun. The revolver features a factory adjustable rear sight and Patridge front sight modified with a small notch possibly for an insert. This well used old five-screw still has some life left in it as a shooter. (86520-227) {MODERN} [Richard "Stretch" Kennedy Collection] (200/400)
1245. **SMITH & WESSON NO. 1 1/2 2ND ISSUE TIP-UP REVOLVER** serial #101669, 32 RF, 3 1/2" barrel with an excellent bore. The metal surfaces of the frame and barrel assembly retain about 97% original nickel plate with flaking on the barrel and to a lesser extent the frame around the barrel-frame joint. The fluted cylinder has been cleaned to pewter with moderate to heavy pitting, several deep gouges in the metal and compression damage distorting the chamber mouths on four of the five. The hammer has bold case-hardened colors with the trigger face mostly gray. The smooth rosewood grips are numbered to the gun and rate very good plus with minor scuffing. The barrel is assembly numbered to the frame but no numbers are visible on the cylinder. The gun still times and locks up correctly plus the barrel-to-frame fit has slight play. (86520-310) {ANTIQUE} [Richard "Stretch" Kennedy Collection] (150/250)

1246. **SMITH & WESSON NO. 1 THIRD ISSUE TIP-UP REVOLVER** serial #109232, 22 Short, 3 3/16" barrel with a frosted bore. The metal surfaces retain about 20-30% original blue finish with most of it remaining on the frame, the rest having been cleaned to pewter in addition to fine scratches from the cleaning, oxidation stains, pitting and other handling marks. The hammer and trigger are gray with light freckling. The smooth rosewood grips rate very good to excellent with light handling wear. The grips are numbered to the gun. The cylinder and barrel are assembly numbered to the frame but the assembly number on the barrel is difficult to read due to erosion from firing. Timing and lock up are in need of attention and barrel-to-frame fit has slight play. (86520-2098) {ANTIQUE} [Richard "Stretch" Kennedy Collection] (150/250)
1247. **CROWN CITY ARMS 1911A1 SEMI-AUTO PISTOL** serial #A04803, 45 ACP, 5" Colt barrel with an excellent bore. The frame is a light dull brown showing some gray Parkerizing around the triggerguard and the Colt Government model slide shows solid medium gray Parkerizing. The arched mainspring housing, grip safety, thumb safety and hammer are blue finished with light operational and handling wear giving the gun an overall rating of about 60%. The gun has smooth unmarked aftermarket walnut grips that rate very good plus with light handling marks. The gun features a Miniature Machine Company adjustable white outline rear sight, serrated factory ramp front sight, long trigger, an extended recoil spring guide with dual recoil springs and the remainder 1911A1 style parts and controls. The gun is currently missing the bushing, recoil spring plug, ejector, ejector pin and possibly other parts. (86520-165) {MODERN} [Richard "Stretch" Kennedy Collection] (200/400)
1248. **ECLIPSE SINGLE SHOT SWING BARREL DERINGER** serial #1912, 22 RF, 2 1/2" smooth bore barrel with an oxidized and pitted bore. The metal surfaces of this side swing Deringer retain about 90% original nickel plate with scattered oxidation blemishes, pitting, flaking finish and handling marks. The smooth walnut grips rate about very good as lightly refinished and varnished showing some old scuffs and dings under the new finish. The backstrap is cracked at the juncture of the frame but the gun still works mechanically. (86520-2630) {ANTIQUE} [Richard "Stretch" Kennedy Collection] (50/150)
1249. **COLT THUER THIRD MODEL DERINGER** serial #35568, 41 RF, 2 1/2" barrel with a partially oxidized and pitted bore. The metal surfaces of the barrel, hammer and trigger have worn to gunmetal gray with a few oxidation stains, pits and handling marks. The frame is ochre with no traces of original silver plate and displays scattered light scratches and other handling marks. The smooth walnut factory grips rate about good with flaking finish, scuffs, dents and dings. The barrel is numbered to the gun, barrel-to-frame fit is tight and it remains fully functional. (86520-4109) {C&R} [Richard "Stretch" Kennedy Collection] (200/400)
1250. **COLT OFFICIAL POLICE REVOLVER** serial #685125, 38 Special, 6" barrel with an excellent bore. The metal surfaces of this mid-war (1943) revolver retain about 85% plus original blue finish with the backstrap and butt thinning to brown, oxidation stains, lightly cleaned areas on the barrel, limited pitting, handling marks and a light turn ring. The checkered walnut factory grips are numbered to the gun but are faint and they rate fair to good with light to moderate diamond point wear, handling marks and a shallow 1/4" chip missing from the left toe. Timing and lock up are excellent and the gun should make a fine shooter. (86520-2596) {C&R} [Richard "Stretch" Kennedy Collection] (200/400)
1251. **U.S. MODEL 1894 ARMY REVOLVER BY COLT** serial #102553, 38 Long Colt, 6" barrel with a very good bore showing oxidation stains at the muzzle and breech ends of the barrel. This gun was manufactured in 1898 and the metal surfaces are mainly brown-gray with a mottled mix of blue, brown and gray on the forward section of the frame, cylinder and barrel for a rating of about 20%. There are also oxidation blemishes, minor dings, limited pitting and handling marks found. The hammer and trigger are mostly gray with a few traces of nitre blue. The smooth walnut factory grips are assembly numbered to the gun and rate very good plus as reworked. Rinaldo A. Carr's inspection marks are crisp on the cylinder but only starting to soften on the frame. There are rework marks on the cylinder latch and barrel plus a rework number on the cylinder. The gun works intermittently and the lanyard loop is missing. (86520-2887) {ANTIQUE} [Richard "Stretch" Kennedy Collection] (150/250)
1252. **COLT POLICE POSITIVE 22 TARGET REVOLVER** serial #41777, 22 LR, 6" barrel with an excellent bore. This 1936-made Colt retains about 60-65% original blue, the grip frame having worn to pewter along with the sides of the frame and barrel. There is moderate high edge wear, dual turn rings on the cylinder, stains from oxidation, pitting and handling marks. The checkered walnut factory grips with silver Rampant Colt medallions rate about good with light diamond point wear, mostly by the butt, scratches, scuffs and a shallow 3/8" long chip on the heel of the left panel. The revolver features a windage adjustable black blade rear sight with light impact marks on the top and elevation adjustable Patridge front sight. There are small impact marks around the chamber and cylinder face from hammer strikes and the gun still functions mechanically. (86520-1989) {C&R} [Richard "Stretch" Kennedy Collection] (200/400)
1253. **COLT 38 POLICE POSITIVE REVOLVER** serial #109084, 38 Colt New Police (S&W), 4" barrel with an excellent bore. This 1919 made revolver retains about 90% original blue with the backstrap thinning to brown, high edge wear, freckling, oxidation blemishes and scratches. The checkered fleur-de-lis hard rubber grips with stylized "C" around the escutcheon and "Colt" in an oval rate very good plus showing light diamond point wear but are numbered to another gun. The gun still functions mechanically. (86520-3044) {C&R} [Richard "Stretch" Kennedy Collection] (200/400)
1254. **SMITH & WESSON MODEL 15-3 COMBAT MASTERPIECE REVOLVER** serial #5K44050, 38 Special, 4" pinned barrel with an excellent bore. The metal surfaces of this early 1970's gun retain about 80-85% original blue with the backstrap toned to brown, scattered oxidation blemishes, the occasional pinprick pit, scratches, assembly marks, moderate high edge wear and the usual turn ring on the cylinder. The standard trigger and hammer retain bold case-hardened colors with light operational wear and minor freckling. The checkered walnut factory Magna grips with silver S&W medallions rate about good with scattered light dents, dings, scuffs, scratches and a small shallow chip missing from the top of the left panel. The grips are un-numbered and likely from another gun as the wood is proud of the metal in the butt and several other areas. The gun features a Baughman ramp front sight and black blade adjustable rear sight. This gun appears to have spent some time in a holster. (86520-1017) {MODERN} [Richard "Stretch" Kennedy Collection] (200/400)
1255. **THOMPSON CENTER CONTENDER SINGLE SHOT PISTOL** serial #262305, 22 LR, 10" heavy barrel with an excellent bore. The metal surfaces retain about 99% original blue finish with slight high edge wear and few very light handling marks. The pistolgrip is a replacement one-piece checkered rubber Pachmayr Presentation Grip that rates excellent. The forend is a black factory Rynite stock that rates excellent. The pistol features a Patridge front sight and factory black blade adjustable rear sight. This later Contender features the hammer mounted selector/safety lever. A great gun for target shooting and small game hunting with the ability to add a variety of barrel/cartridge combinations. (86520-158) {MODERN} [Richard "Stretch" Kennedy Collection] (200/400)

1256. **HIGH STANDARD "THE GUN / HIGH SIERRA" DOUBLE ACTION REVOLVER** serial #M028779, 22 LR, 7" octagon barrel with an excellent bore. High Standard ran a contest to name this revolver when it was introduced in February 1973 and referred to it as "The Gun". It later became known as the "High Sierra" after the contest and they starting marking the model name on them in November 1973. This early gun does not have High Sierra or any markings referring to model type. The metal surfaces retain about 98% original blue and nickel plate finishes with scattered light scratches, limited edge wear and a light turn ring on the cylinder. The one-piece grip frame assembly is nickel plated contrasting nicely with the blue and showing some limited clouding. The smooth walnut factory grips with gold High Standard medallions rate very good plus with a few light handling marks and a scuff on the left panels butt. This gun features a blade front sight, drift adjustable rear sight, swing out cylinder with spring loaded extractor and faux ejector rod housing for that Western look. (86520-190) {MODERN} [Richard "Stretch" Kennedy Collection] (250/450)
1257. **SMITH & WESSON MODEL 31-1 REGULATION POLICE REVOLVER** serial #786809, 32 S&W Long, 4" pinned barrel with an excellent bore. Built between 1966 and 1969, this lovely little J frame retains about 99% original blue with some light muzzle wear, a few handling marks and a turn ring on the cylinder. The standard hammer and trigger retain wonderful case-hardened colors with very light operational wear. The replacement checkered rubber Pachmayr Compac grips rate excellent. The revolver features a Baughman ramp front sight, fixed rear and it still times and locks up correctly. (86520-360) {MODERN} [Richard "Stretch" Kennedy Collection] (250/450)
1258. **SMITH & WESSON DOUBLE ACTION FOURTH MODEL TOP-BREAK REVOLVER** serial #73327, 32 S&W (Short), 3" barrel with very light scattered pinprick pitting in the bore. The metal surfaces retain about 90% original nickel and blue finishes with scattered light oxidation stains, some showing light cleaning plus scratches, turn ring on the cylinder and edge wear. The diamond checkered hard rubber grips rate about good with moderate diamond point wear and light handling marks. The hammer and trigger have strong to fading case-hardened colors with moderate operational wear. Timing will need attention in the near future but lock up is good and the barrel-to-frame fit has slight play. The grips and all appropriate parts are correctly numbered to the gun. (86520-418) {ANTIQUÉ} [Richard "Stretch" Kennedy Collection] (200/400)
1259. **COLT COBRA REVOLVER** serial #5622-LW, 38 Special, 2" barrel with an excellent bore. The metal surfaces of the aluminum frame on this 1951-made revolver retain about 80% later non-factory applied black paint and about 80% of the original blue finish on the cylinder and barrel remain. There are scattered light oxidation blemishes, moderate edge wear, scratches and a turn ring on the cylinder. The unmarked checkered walnut factory grips with gold Rampant Colt medallions rate about very good plus with scattered light dings to a few of the diamond points. The gun still times and locks up correctly and will still make a good concealed carry gun. "She ain't purdy" but she'll get the job done. (86520-228) {MODERN} [Richard "Stretch" Kennedy Collection] (100/200)
1260. **COLT POCKET POSITIVE REVOLVER** serial #157789, 32 Colt Police Positive (S&W Long), 2" barrel with an excellent bore. This 1938-made revolver retains about 80% original blue finish with moderate edge wear, scattered light oxidation stains, scratches, turn ring on the cylinder and what looks like "W 8 / I-I" is scratched on the right-side frame and "XX" on the sideplate. The checkered hard rubber grips with Colt in an oval rate fair with light handling wear but a 5/8" long chip missing from the butt of the left panel. The gun still times and locks up correctly and should make a good shooter. (6520-2453) {C&R} [Richard "Stretch" Kennedy Collection] (200/400)
1261. **COLT PRE-WOODSMAN SEMI-AUTO TARGET PISTOL** serial #49745, 22 LR, 6 5/8" medium barrel with an excellent bore. The metal surfaces of this 1926-made pistol retain about 60% original blue with moderate to heavy wear on the finish, limited pitting, a few oxidation stains and handling marks. The checkered walnut factory grips rate about good with moderate diamond point wear, scattered dings and other handling marks. The pistol features an elevation adjustable bead front sight and windage adjustable rear sight. It includes a single factory magazine. (86520-766) {C&R} [Richard "Stretch" Kennedy Collection] (200/400)
1262. **CHARTER ARMS EXPLORER II SEMI-AUTO PISTOL** serial #B012968, 22 LR, 8" barrel with an excellent bore. The metal surfaces retain about 96% original black enamel crackle paint with scattered scratches, edge wear, flaking and other handling marks. The synthetic factory grips show light handling wear but rate near excellent overall. The pistol features a ramp front sight, adjustable rear sight, storage areas in the grip for a spare magazine (not provided), uses the same magazines as the AR-7 explorer and has a removable barrel. This pistol includes a single magazine. (86520-2551) {MODERN} [Richard "Stretch" Kennedy Collection] (50/100)
1263. **COLT OFFICERS MODEL TARGET REVOLVER** serial #600055, 38 Special, 6" barrel with an excellent bore. The metal surfaces of this 1936-made revolver retain about 50% original blue with the barrel pitted and cleaned to pewter, lightly cleaned oxidized pitting on the remaining surfaces, high edge wear, scratches and a turn ring. The un-numbered checkered walnut factory grips with silver Rampant Colt medallions rate excellent. The gun features an elevation adjustable Patridge front sight and windage adjustable black blade rear sight. The revolver still functions mechanically and should make a good shooter or project gun. (86520-2447) {C&R} [Richard "Stretch" Kennedy Collection] (200/400)
1264. **COLT POLICE POSITIVE REVOLVER** serial #166654, 38 S&W, 4" barrel with a few light oxidation stains in the bore. The metal surfaces of this 1926-made gun retain about 80% original blue finish with moderate edge wear, scratches, turn ring and oxidation stains, a few having been lightly cleaned. The unmarked checkered walnut factory grips with silver Rampant Colt medallions rate about good with light to moderate diamond point wear and handling marks. The gun still functions mechanically. (86520-953) {C&R} [Richard "Stretch" Kennedy Collection] (150/350)
1265. **COLT MODEL 1855 ROOT SIDEHAMMER PERCUSSION REVOLVER** serial #7004, 31 cal., 3 1/2" round barrel with a lightly oxidized and pitted bore. The metal surfaces of this Model 5 1863-made revolver have toned to mostly brown with strong traces of original blue in the full-length flutes of the cylinder and protected areas of the barrel and frame. They also show scattered oxidation stains, pitting and scratches. The smooth one-piece walnut grips rate good as repaired and left unfinished around the repair. The grips are numbered to the gun and show a 1" x 1 1/4" professional added piece of wood to the frontstrap area in addition to scratches, a small check and other scattered handling wear. The remaining original finish shows moderate wear and flaking. Markings vary from strong to soft with an "ADRESS COL. COLT / NEW-YORK U.S.A." barrel address, patent date on the cylinder, barrel numbered to the gun but no serial numbers remain visible on the cylinder. The gun still functions mechanically. (86520-2555) {ANTIQUÉ} [Richard "Stretch" Kennedy Collection] (200/400)
1266. **ALLEN & THURBER BAR HAMMER PEPPERBOX PERCUSSION PISTOL** serial #50, 31 cal., 3" fluted six-barrel cluster with oxidized and pitted bores. The metal surfaces have toned to brown along with scattered oxidation and pitting. The frame and nipple shield are accented with light engraving. The smooth walnut bag-shaped grips rate fair with moderate to heavy dents, dings and scratches. The triggerguard while present, is disconnected from the frame in the rear and moves. The double action mechanism still works but the barrels do not advance. (86520-3085) {C&R} [Richard "Stretch" Kennedy Collection] (100/300)

1267. **COLT MODEL 1908 VEST POCKET HAMMERLESS SEMI-AUTO PISTOL** serial #253009, 25 ACP, 2" barrel with a lightly frosted bore. This 1920-made pistol retains about 80% original blue with the grip safety worn to gray, high edge wear, slide thinning to purple and pewter, light scratches, oxidation stains and pinprick pitting. The trigger still has good robust case-hardened colors but the safety and grip safety are gray with some color still present on the sides of the grip safety. The checkered hard rubber factory grips with Rampant Colt rate very good with light diamond point wear. The pistol includes a two-tone factory marked magazine. (86520-2165) {C&R} [Richard "Stretch" Kennedy Collection] (200/400)
1268. **COLT MODEL 1908 VEST POCKET HAMMERLESS SEMI-AUTO PISTOL** serial #14555, 25 ACP, 2" barrel with a few light pits in the bore. This 1909-made pistol is mostly gray with some original finish in the protected areas plus a few oxidation stains, scattered light pitting and handling marks. The case-hardened colors on the appropriate parts have all faded and worn to gray. The checkered hard rubber factory grips with Rampant Colt in a stylized "C" rate fair with light diamond point wear but the right panel has the 1/2" x 3/4" section of grip broken off (not provided). The pistol includes an unmarked magazine. (86520-2078) {C&R} [Richard "Stretch" Kennedy Collection] (100/300)
1269. **SMITH & WESSON MODEL 12-2 MILITARY & POLICE AIRWEIGHT REVOLVER** serial #D417748, 38 Special, 4" pinned barrel with an excellent bore. The metal surfaces retain about 90% plus original blue and anodized finishes with high edge wear, thinning finish on the cylinder, scratches and a turn ring on the cylinder. The replacement pebble grain rubber finger groove Hogue Bantam grips rate excellent. The standard trigger and hammer retain bold case-hardened colors with light operational wear. The gun features a serrated ramp front sight with few light dings and fixed rear sight. The gun still times and locks up correctly and should make a good shooter, carry gun or home defense gun. (86520-1024) {MODERN} [Richard "Stretch" Kennedy Collection] (200/400)
1270. **COLT POLICE POSITIVE 38 REVOLVER WITH EAST HARTFORD P.D. MARKINGS** serial #170243, 38 S&W, 2" Detective Special replacement barrel. The metal surfaces have been buffed and left in-the-white with original blue finish found in the flutes of the cylinder. The unmarked checkered walnut factory grips with silver Rampant Colt medallions rate about good with light to moderate diamond point wear, heaviest on the right panel, in addition to scattered light scratches, dents and dings. There is a matching factory rework number on the butt, cylinder and extractor; the barrel shows no rework numbers but was changed out for one marked "Detective Special / 38" and the gun still functions mechanically. The butt is stamped "E.H.P.D." and Book of Colt Firearms by R.L. Wilson indicates a number were sold to East Hartford P.D. It should make a good start up gun for the budding police firearms collector. (86520-437) {MODERN} [Richard "Stretch" Kennedy Collection] (100/300)
1271. **SMITH & WESSON DOUBLE ACTION FOURTH MODEL TOP-BREAK REVOLVER** serial #47664, 32 S&W, 3" barrel with scattered light oxidation and pitting in the bore. The metal surfaces retain about 99% professionally re-applied non-factory nickel and blue finishes with a light turn ring and few handling marks. The diamond checkered hard rubber grips rate excellent. The hammer and trigger have fading case-hardened colors with moderate operational wear. The grips and all appropriate parts are correctly numbered to the gun. The top latch is difficult to release probably due to a buildup of plating but the gun still functions mechanically. (86520-1004) {ANTIQUÉ} [Richard "Stretch" Kennedy Collection] (100/200)
1272. **SMITH & WESSON MODEL 10-6 MILITARY & POLICE REVOLVER** serial #D944429, 38 Special, 4" pinned heavy barrel with an excellent bore. The metal surfaces retain about 97% original blue finish with high edge wear, turn ring on the cylinder, scratches and few other minor handling marks. The standard trigger and hammer retain bold case-hardened colors with minor operational wear. The replacement checkered rubber one-piece wrap around Pachmayr "Gripper" grip rates excellent. A useful gun for a variety of shooting endeavors. (86520-1990) {MODERN} [Richard "Stretch" Kennedy Collection] (200/400)
1273. **SMITH & WESSON NO. 1 SECOND MODEL TIP-UP REVOLVER** serial #90134, 22 Short, 3 3/16" barrel with an oxidized and pitted bore. The barrel has toned to brown, the cylinder to gray with brown overtones and both show scattered light oxidation blemishes, pitting, scratches and other handling marks. The frame has amazing amounts of silver plate left that is tarnished with a few light scratches, minor dings and edge wear for a rating of about 98%. The smooth rosewood grips are numbered to the gun and rate about very good plus with lightly flaking finish and a few scratches. The barrel is assembly numbered to the gun but the cylinder is assembly numbered to another gun and no patent dates remain visible. Barrel-to-frame fit is tight and the gun still functions mechanically. (86520-959) {ANTIQUÉ} [Richard "Stretch" Kennedy Collection] (150/350)
1274. **BELGIAN FOLDING TRIGGER REVOLVER** serial #15, 25 ACP, 1 5/8" barrel with a very good bore showing slight frosting. The barrel and cylinder retain about 80% original blue with light edge wear and the frame shows muted case-hardened colors with areas of brown patina. The ebony checkered grips rate near excellent. The "F" and "S" safety indicators are inlaid gold. The firing pin is missing and the cylinder does not advance properly all the time. (86520-143) {C&R} [Richard "Stretch" Kennedy Collection] (30/60)
1275. **COLT NEW LINE REVOLVER** serial #4012, 38 CF, 2 1/4" barrel with a near excellent bore showing very light scattered pinprick pitting and oxidation stains. The metal surfaces of this second model have toned to mostly brown with scattered oxidation stains, pitting and handling wear. There are some strong traces of original blue in the flutes of the cylinder and the occasional flecks on the nonfluted portions. There is strong nitre blue remaining on the underside of the spur and arch on the back of the hammer. The cylinder and barrel are numbered to the gun. The smooth un-numbered rosewood grips rate very good plus with light scuffs and handling wear. The mechanism works intermittently and will need professional attention. (86520-1005) {ANTIQUÉ} [Richard "Stretch" Kennedy Collection] (75/150)
1276. **FABRIQUE NATIONALE MODEL 1900 SEMI-AUTO PISTOL** serial #492454, 32 ACP, 4" barrel with a slightly frosted bore. The metal surfaces retain about 96% reapplied arsenal type black enamel finish with scattered high edge wear, scratches, dings on the rear of the slide and other handling marks. The checkered pressed horn factory grips with "FN" logo rate about good with moderate diamond point compression and edge wear to the black dye. The safety is labeled in French, the gun features a lanyard loop and includes a single FN marked magazine. (86520-822) {C&R} [Richard "Stretch" Kennedy Collection] (300/500)
1277. **RUSSIAN MODEL 1895 NAGANT REVOLVER BY TULA** serial #30856, 7.62x38R Nagant, 4 1/2" barrel with a very lightly pinprick pitted bore. The metal surfaces of this 1936-dated Tula revolver retain about 65% original arsenal grade blue with the grip frame toned to brown, the cylinder and barrel smoky gray plus scattered oxidation blemishes, scratches and pitting. The checkered hardwood grips rate about fair to good with moderate to heavy diamond point compression plus a few handling marks. The gun still times and locks up correctly but the chambers appear to have been lightly reamed or polished at the breech end and ball end of the chambers. The space in-between shows light corrosion and a slight shoulder is now present but 7.62x38R ammo seems to chamber well. The sideplate is numbered to the frame but the cylinder is numbered to another gun. (86520-2627) {C&R} [Richard "Stretch" Kennedy Collection] (125/225)

1278. **MAUSER MODEL 1914 SEMI-AUTO POCKET PISTOL** serial #337682, 32 ACP, 3 1/2" barrel with a lightly frosted bore. The metal surfaces have toned to mostly gray or brown with traces of original blue in the protected areas of the frame. There is scattered light pitting, a few oxidation stains, light dings and scratches. The sides of the trigger show some moderately toned original straw color. The wrap-around walnut factory grips with scored crisscross diamond pattern rate about good as lightly refurbished with moderate wear to the diamond pattern from light sanding in addition to light to moderate dents and dings. The pistol includes a single magazine. (86520-2916) {C&R} [Richard "Stretch" Kennedy Collection] (100/200)
1279. **COLT POLICE POSITIVE 32 TARGET REVOLVER** serial #78565, 32 Colt Police Positive (S&W Long), 6" barrel with a near excellent bore exhibiting a few stray minor pinprick pits. This 1910-made Target Model retains about 40% original blue with most of the metal surfaces toned to brown showing scattered pitting, oxidation stains and various handling marks. There is strong nitre blue remaining on the trigger and hammer with scattered freckling. The replacement checkered walnut factory grips with silver Rampant Colt medallions rate about good with lightly compressed diamond points, a few handling marks and the backstrap areas have been lightly rasped and sanded to fit the frame better, then re-varnished but the left panel backstrap has had more sanding after the re-applied finish. The gun features an elevation adjustable bead front sight, windage adjustable "U" notch rear and a Rampant Colt with intertwined "C" stamped on the sideplate plus timing and lock up are good. The condition of the finish indicates this gun may have spent some time in perhaps an outdoorsman's holster but it appears to have plenty of shooting life left in it. (86520-2044) {MODERN} [Richard "Stretch" Kennedy Collection] (300/500)
1280. **COLT MODEL 1901 NEW NAVY REVOLVER** serial #193547, 41 Colt, 4 1/2" barrel with a near excellent bore showing a few stray pinprick pits. The metal surfaces of this 1903-made revolver retain perhaps 20% original blue, strongest in the flutes and on the frame with the rest a mottled mix of gray and pewter. There is scattered oxidized pitting showing light to moderate cleaning, scratches, turn rings and other handling marks. The checkered hard rubber grips with "Colt" in an oval are assembly numbered to the gun and rate very good to excellent with a few light handling marks. The cylinder has a refurbish number plus the crane and cylinder latch are assembly numbered to the gun. This gun did not receive the accuracy updates (reduced bore and chamber mouth diameters) of the 1903 model and was probably made from remaining parts. Colt did not waste any parts in those days. It still times and locks up good. A well-used example of a commercial New Navy revolver. (86520-2437) {C&R} [Richard "Stretch" Kennedy Collection] (100/200)
1281. **COLT POLICE POSITIVE 22 TARGET REVOLVER** serial #7449, 22 W.R.F., 6" barrel with a partially pitted bore. The metal surfaces of this 1911-made revolver retain about 70-75% original blue with moderate high edge wear, turn ring on the cylinder, oxidation blemishes, a few minor pinprick pits, a few dings around the muzzle and handling marks. The hammer has strong nitre blue with the hammer spur and trigger thinning from handling. The checkered fleur-de-lis factory hard rubber grips with stylized "C" around the escutcheon are scratch numbered to the gun and rate excellent. As with most target models of this era, the front sight is an elevation adjustable bead and the rear sight a "U" notch windage adjustable black blade. The gun is still mechanically functional. (86520-1998) {C&R} [Richard "Stretch" Kennedy Collection] (300/500)
1282. **HARRINGTON & RICHARDSON SPORTSMAN SINGLE ACTION TOP-BREAK REVOLVER** serial #2042, 22 LR, 6" barrel with an excellent bore. This revolver has the mainspring assembly removed but is provided. The metal surfaces retain about 96% original blue finish with muzzle wear, slight pitting on the left side of the muzzle, scattered stains from oxidation, thinning finish on the cylinder and handling marks. The one-piece checkered wrap-around walnut factory grips rate very good plus with light handling marks. The pistol features an elevation adjustable Patridge front sight and windage adjustable rear sight that is missing the slider. Barrel-to-frame fit has slight play. (86520-2541) {C&R} [Richard "Stretch" Kennedy Collection] (200/400)
1283. **COLT MODEL 1862 POLICE PERCUSSION REVOLVER** serial #1625, .36 cal., 4 1/2" thoroughly oxidized and pitted bore. The metal surfaces of this 1861-made revolver are brown from heavy oxidation with some scale and even pitting of the metal. The brass grip frame has no visible silver plate and has toned to ochre with moderate tarnish and handling marks. The one-piece walnut factory grips rate about fair with moderate scuffs, scratches and dents and 1 1/8" chip missing from the left toe. The backstrap screws have heavy slot damage precluding their removal without professional assistance. The mechanism does not fully function, the cylinder is "frozen" in place, the front backstrap screw is missing, the ram and lever assembly is missing, and the wedge is missing, a thin flat piece of wood having been substituted. This gun could be worked up into a nice display or wall hanger. (86519-569) {ANTIQUÉ} [Richard "Stretch" Kennedy Collection] (100/300)
1284. **SMITH & WESSON MODEL 1 1/2 SINGLE ACTION TOP-BREAK REVOLVER** serial #81961, 32 S&W, 3" barrel with scattered light pitting. The metal surfaces retain about 95% original nickel plate with scattered light oxidation blemishes, bubbling, scratches and a few assembly marks. The hammer has robust case-hardened colors but moderate operational wear and the trigger has toned to gray. The diamond checkered hard rubber grips with S&W logo rate about excellent and fit well but any scratch numbers are no longer visible. All appropriate parts are correctly numbered to the gun, barrel-to-frame fit has slight play, this later model features a strain screw and it still times and locks up correctly. (86520-3974) {ANTIQUÉ} [Richard "Stretch" Kennedy Collection] (200/400)
1285. **SMITH & WESSON 38 REGULATION POLICE HAND EJECTOR REVOLVER** serial #29807, 38 S&W, 4" barrel with a near excellent bore exhibiting scattered light pinprick pits. The metal surfaces of this prewar five-screw I frame revolver retain about 50-55% original blue with most of the loss to the frame and the barrel to a lesser extent. There is cleaned scattered pitting, light scratches and a turn ring is present. The standard hammer and trigger retain beautiful case-hardened colors. The diamond checkered walnut factory stepped extension grips are numbered to the gun and rate good to very good with light to moderate dents, dings and scratches. All appropriate parts are correctly numbered to the gun plus timing and lock up are good. (86520-2064) {C&R} [Richard "Stretch" Kennedy Collection] (150/250)
1286. **SMITH & WESSON 1ST MODEL SAFETY HAMMERLESS REVOLVER** serial #84548, 32 S&W, 3" barrel with scattered light pitting. The gun has a factory rework date of August 1921 on the frame, clearly for mechanical service, as the finish appears original. The metal surfaces of this New Departure retain about 90% original nickel plate and blue finishes with scattered stains from oxidation, scattered pinprick pitting, freckling, muzzle and barrel wear from handling, and clouding finish. The trigger has the bold case-hardened colors Smith & Wesson is noted for with minor freckling. The smooth unmarked mother-of-pearl grips rate about excellent. The gun still times and locks up correctly. (86520-2060) {ANTIQUÉ} [Richard "Stretch" Kennedy Collection] (250/450)

1287. **SMITH & WESSON DOUBLE ACTION FOURTH MODEL TOP-BREAK REVOLVER** serial #204662, 32 S&W, 3" barrel with very light scattered pinprick pitting in the bore. The metal surfaces retain about 90% original nickel and blue finishes with light cleaning to the sides of the frame that left scratches, clouding and removed limited finish. There are also scattered light scratches, a turn ring on the cylinder and a few oxidation stains. The hammer and trigger have bold case-hardened colors with light operational wear. The diamond checkered hard rubber grips rate excellent. Timing will need attention in the near future but lock up is good and the barrel-to-frame fit is tight. The grips and all appropriate parts are correctly numbered to the gun. (86520-2629) {ANTIQUE} [Richard "Stretch" Kennedy Collection] (200/400)
1288. **COLT POCKET POSITIVE REVOLVER** serial #102246, 32 Colt Police Positive (S&W Long), 3 1/2" barrel with an excellent bore. This 1921-made revolver retains about 75% original blue finish with moderate high edge wear, oxidation stains, scattered light pitting and handling marks. The hammer and trigger have strong nitre blue with freckling and operational wear. The checkered hard rubber factory grips with "Colt" in an oval are numbered to the gun and rate fair showing minimal wear with chips missing from the toes of both panels. The gun still functions mechanically and the front sight has been lightly "regulated" to adjust point of impact. This gun should make a good shooter. (86520-2199) {C&R} [Richard "Stretch" Kennedy Collection] (150/250)
1289. **COLT POCKET POSITIVE REVOLVER** serial #154855, 32 Colt Police Positive (S&W Long), 3 1/2" barrel with an excellent bore. This 1936-made revolver retains about 60% original blue finish with most of the loss to the cylinder and barrel. These surfaces have toned to gray with scattered light pitting, handling marks and a few minor oxidation stains. The hammer and trigger show faded and worn nitre blue with stains from oxidation. The checkered hard rubber factory grips with "Colt" in an oval are numbered to the gun and rate fair to good showing light scuffs and a chip missing from the toe of left panel. The gun still times and locks up correctly. This gun should make a good shooter. (86520-2478) {C&R} [Richard "Stretch" Kennedy Collection] (100/200)
1290. **SMITH & WESSON DOUBLE ACTION FOURTH MODEL TOP-BREAK REVOLVER** serial #179485, 32 S&W, 3 1/2" barrel with very light scattered pinprick pitting in the bore. The metal surfaces retain about 60% original blue finish with scattered moderate to heavy wear toning to brown / purple in addition to oxidation stains, pinprick pitting and handling marks. The hammer and trigger have bold case-hardened colors with moderate operational wear. The diamond checkered hard rubber grips rate excellent. Timing and lock up are good, the barrel-to-frame fit has just a hint of play and the hammer holds well at full cock but the release will need attention. The grips and all appropriate parts are correctly numbered to the gun. (86520-3975) {ANTIQUE} [Richard "Stretch" Kennedy Collection] (100/200)
1291. **COLT NEW POLICE REVOLVER** serial #8784, 32 Colt New Police (S&W Long), 6" barrel with scattered light pitting in the bore. The metal surfaces of this 1899-made revolver have mostly toned to smoky gray with perhaps 10-15% original blue remaining in the flutes and protected areas. There are also scattered light pits, oxidation blemishes, scratches and handling marks. The hammer and trigger have faded to mostly gray with stains from oxidation. The checkered hard rubber factory grips with "Colt" in an oval are scratch numbered to the gun and rate excellent. There is a factory rework number on the cylinder but no others were found. The sideplate and left side barrel have correct markings for a New Police but the barrel address and patent dates read "COLT'S PAT FIRE ARMS MFG CO / HARTFORD CONN USA / PAT'D AUG 5, 1884 JUNE 5, 1900" with signs this was over stamped on another marking. (86520-2548) {C&R} [Richard "Stretch" Kennedy Collection] (75/150)
1292. **COLT POLICE POSITIVE 38 REVOLVER** serial #29683, 38 Colt New Police (S&W), 4" barrel with a near excellent bore exhibiting several small spots of pitting about mid-bore. This 1909 made gun has factory rework marks on the frame, cylinder and remnants on the barrel. It appears the gun probably had parts replaced and / or refinished at the factory and later was given another non-factory blue finish over all surfaces. The dull blue reapplied finish is starting to thin to smoky gray with about 80% remaining in addition to oxidation blemishes, fine pitting under the new finish and some handling marks. The hammer and trigger have strong blue with operational wear and oxidation stains. The checkered fleur-de-lis factory grips with a stylized "C" around escutcheons are numbered to the gun and rate about good with light handling wear but a small chip missing from the heel of the left panel. The gun still times and locks up correctly and the Rampant Colt with stylized "C" on the sideplate is still partially visible. The gun should make a good shooter. (86520-3046) {C&R} [Richard "Stretch" Kennedy Collection] (100/200)
1293. **HIGH STANDARD MODEL C SEMI-AUTO PISTOL** serial #2600, 22 Short, 6 3/4" barrel with an excellent bore. The metal surfaces retain about 75% original blue with moderate high edge wear, light pitting, scratches and few minor oxidation stains. The checkered hard rubber factory grips rate about very good with a few lightly compressed diamond points and scratches. The pistol features a Patridge front sight, drift adjustable rear sight and type I-A take down. It includes a single two-tone magazine. (86520-801) {C&R} [Richard "Stretch" Kennedy Collection] (175/275)
1294. **COLT NEW LINE REVOLVER** serial #5456, 22 Long, 2 1/4" barrel with an oxidized and pitted bore. This 1874 made 1st model revolver retains about 85% original nickel plate with moderate to heavy wear in areas, general light edge wear, flaking, oxidation stains and the majority of the frame and cylinder's finish clouded to silvery gray. The smooth rosewood grips rate about very good plus as re-varnished and show scattered light dents, dings and scratches under the new finish. The barrel and cylinder are numbered to the gun and it still times and locks up correctly. (86520-142) {ANTIQUE} [Richard "Stretch" Kennedy Collection] (200/400)
1295. **COLT NEW LINE REVOLVER** serial #16340, 32 CF, 2 1/4" barrel with a near excellent bore exhibiting scattered light pinprick pitting. The metal surfaces have toned to mostly brown with perhaps 5-10% original nickel plate in the protected areas. Oxidation stains, limited pitting, scratches and other handling marks are present. The un-numbered checkered factory hard rubber grips with "Colt" in an oval show a repair to a check that runs from the edge to the escutcheon on the left panel. The gun still times and locks up correctly and no serial numbers are found on the barrel or cylinder. (86520-2558) {ANTIQUE} [Richard "Stretch" Kennedy Collection] (100/200)
1296. **CHARTER ARMS BULLDOG REVOLVER** serial #828405, 44 Special, 3" barrel with an excellent bore. The stainless steel surfaces rate about excellent with a few light scratches and a turn ring on the cylinder. The checkered rubber finger groove factory grips with silver Charter Arms medallions rate excellent. This gun features a stainless steel semi-Patridge front sight, fixed rear sight and a spurless "pocket" hammer serrated on top to allow manual cocking. This gun does not appear to have seen much use and should be a good gun for personal defense. (86520-2934) {MODERN} [Richard "Stretch" Kennedy Collection] (250/350)
1297. **LLAMA MODEL XV "ESPECIAL" SEMI-AUTO PISTOL** serial #539632, 22 LR, 3 5/8" barrel with an excellent bore. The metal surfaces of this 1971 proof dated pistol retain about 95% original blue with most of the loss to the frontstrap toning to smoky gray, plus high edge wear and a few handling marks. The checkered finger rest synthetic factory grips with the Llama "flame" logo rate very good to excellent showing scattered light scratches. This miniature variation of the 1911 features a ventilated rib on the slide, ramp front sight, windage adjustable rear sight and is Stoeger Arms importer marked. Includes a single factory magazine and should be a fun little gun to shoot. (86520-4490) {MODERN} [Richard "Stretch" Kennedy Collection] (125/225)

1298. **STEVENS HUNTER'S PET POCKET NO.34 SINGLE SHOT RIFLE** serial #1757, 30 CF, 18"octagon barrel with a lightly oxidized and pitted bore. The barrel has toned to brown with showing scattered occasional light oxidation, pitting and handling marks. The iron frame retains about 50% original nickel plate with the remainder oxidized. The smooth walnut grips rate very good to excellent as lightly refinished. The grips and barrel are correctly numbered to the gun, barrel-to-frame fit has just a hint of play and the action remains crisp. This gun features a globe front sight with pinhead post plus a small half-moon shaped blade mounted on the top of the globe and a folding ladder rear sight featuring a small peep in the blade with a "V" notch on top. (86520-1800) {ANTIQUÉ} [Richard "Stretch" Kennedy Collection] (200/300)
1299. **SMITH & WESSON NO. 1 1/2 SECOND ISSUE TIP-UP REVOLVER** serial #88117, 32 RF, 3 1/2" barrel with scattered light oxidation blemishes and pitting in the bore. The metal surfaces retain about 85% original nickel plate with most of the loss due to scattered oxidation stains in addition to pitting, flaking plate and handling marks. The hammer and trigger are a mix of brown and gray. The smooth rosewood grips are numbered to the gun and rate very good plus with light handling marks. The barrel and fluted cylinder are assembly numbered to the frame. The gun still times and locks up correctly plus the barrel-to-frame fit has slight side play. (86520-280) {ANTIQUÉ} [Richard "Stretch" Kennedy Collection] (200/400)
1300. **SMITH & WESSON NO. 1 1/2 FIRST ISSUE TIP-UP REVOLVER** serial #16740, 32 RF, 3 1/2" barrel with scattered oxidation blemishes and pitting in the bore. The metal surfaces have been cleaned to pewter with scattered fairly even pitting, a few stains from oxidation and handling marks. The hammer and trigger are also pewter. The smooth unmarked ivory square butt grips rate good to very good with a few light dings at the butt and a small chip repaired on the base of the right panel. The barrel and unfluted cylinder are assembly numbered but corrosion has left the numbers indistinguishable and no longer visible on the side of the frame. There is a five-pointed rework star on the frame but no rework date remains visible. The gun still times and locks up correctly, and the barrel-to-frame fit has slight play. (86520-4011) {ANTIQUÉ} [Richard "Stretch" Kennedy Collection] (200/400)
1301. **SMITH & WESSON 32 SAFETY HAMMERLESS SECOND MODEL TOP-BREAK REVOLVER** serial #114474, 32 S&W, 3" barrel with an excellent bore. The metal surfaces retain about 90% original nickel plate and blue finishes with scattered oxidation blemishes, light scratches, bubbling, flaking finish plus a turn ring on the cylinder and rings from assembly. The trigger has robust case-hardened colors with light operational wear and a few oxidation stains. The diamond checkered hard rubber grips with S&W logo rate excellent. The grips and all appropriate parts are correctly numbered to the gun, barrel-to-frame fit remains tight and it is still mechanically functional. (86520-248) {C&R} [Richard "Stretch" Kennedy Collection] (200/400)
1302. **SMITH & WESSON NO. 1 1/2 SINGLE ACTION TOP-BREAK REVOLVER** serial #80792, 32 S&W, 3" barrel with a lightly oxidized and pitted bore. The metal surfaces of this later production, strain screw equipped revolver retain about 85% original nickel plate with the left side of the barrel worn to pewter, scattered oxidation blemishes, bubbling, flaking and handling wear. The diamond checkered hard rubber factory grips with S&W logo rate excellent. All appropriate parts are correctly numbered to the gun but the scratch numbers on the grips are no longer discernable. Barrel-to-frame fit is tight, it still locks up and times correctly but the front sight and sight pin are missing. (86520-3040) {ANTIQUÉ} [Richard "Stretch" Kennedy Collection] (100/200)
1303. **SMITH & WESSON 38 SINGLE ACTION SECOND MODEL TOP-BREAK REVOLVER** serial #70848, 38 S&W, 3 1/4" barrel with a lightly oxidized and pitted bore. The metal surfaces have all toned to brown with bright nickel plate left on portions of the grip frame and clouded nickel plate found on percentages of the cylinder. The hammer has strong case-hardened colors remaining, the rest toned gray and showing operational marks. The diamond checkered factory hard rubber grips with S&W logo rate fair with little wear, but a chip missing off the butt section of both panels. The gun still times and locks up but does occasionally bind, barrel-to-frame fit is tight and the grips and all appropriate parts are numbered to the gun. The sideplate / hammer pivot screw is broken, the head and a short section of the shaft now missing, and the second sideplate screw shows heavy slot damage. (86520-1429) {ANTIQUÉ} [Richard "Stretch" Kennedy Collection] (100/200)
1304. **HARRINGTON & RICHARDSON HAMMERLESS TOP-BREAK REVOLVER** serial #346, 38 S&W, 3" barrel with an excellent bore. The metal surfaces retain about 97% professionally reapplied satin blue finish with a series of moderate longitudinal scratches on the cylinder and few areas of oxidized pitting. The checkered hard rubber factory grips with "Bullseye" logo rate excellent. The gun still times and locks up correctly, barrel-to-frame fit is tight but the cylinder retention lug often fails on opening and explains the series of scratches on the cylinder. The grips, cylinder, barrel and extractor are numbered to the gun. (86520-1311) {C&R} [Richard "Stretch" Kennedy Collection] (75/175)
1305. **SMITH & WESSON 38 SINGLE ACTION SECOND MODEL TOP-BREAK REVOLVER** serial #68593, 38 S&W, 4" barrel with a lightly oxidized and pitted bore. The metal surfaces retain about 85% original nickel plate with scattered light oxidation stains, pinprick pitting, flaking finish on the cylinder, backstrap worn to pewter, a few scratches and turn ring on the cylinder plus assembly rings on the cylinder. The hammer has toned gray with light operational use. The diamond checkered factory hard rubber grips with S&W logo rate good to very good with light to moderately worn diamond points and a heavy scratch on the bottom of the right panel. The gun still times and locks up correctly, barrel-to-frame fit is tight and the grips plus all appropriate parts are correctly numbered to the gun. (86520-1438) {ANTIQUÉ} [Richard "Stretch" Kennedy Collection] (200/400)
1306. **THOMPSON CENTER CONTENDER SINGLE SHOT PISTOL** serial #14486, 45 Colt / 410 Bore, 8 1/8" octagon barrel with an excellent bore. The metal surfaces retain about 60% original blue with scattered oxidation blemishes and pitting, mostly on the frame plus a few light handling marks. The checkered thumb rest walnut factory pistolgrip rates fair to good as re-varnished with scattered dents, dings and other handling wear. The checkered walnut factory forend rates poor as re-varnished with crazing finish, dents, dings, repaired crack on the left side extending to the bottom and a missing section on the right side that covers the barrel pivot pin. The external screw-in choke is missing as is the rear sight assembly and plug screws. This is an early version with the "screwdriver" style selector on the hammer and no hammer-mounted safety. Its not very pretty and shows some hard use but the action is crisp, the barrel-to-frame fit is tight and it still has many years of service left in it. Find a screw in choke, rear sight assembly and it will make a dandy trail gun. (86520-2134) {MODERN} [Richard "Stretch" Kennedy Collection] (100/200)
1307. **SMITH & WESSON PERFECTED MODEL DOUBLE ACTION TOP-BREAK REVOLVER** serial #28320, 38 S&W, 6" barrel with an oxidized and pitted bore. The metal surfaces retain about 95% non-factory reapplied nickel plate with flaking on the butt, cylinder, muzzle and breech end of the barrel in addition to light oxidation stains and pitting. The trigger and hammer have remnants of case-hardened colors remaining but are mostly stained from oxidation. The smooth unmarked mother-of-pearl grips rate excellent with minor chipping on the base of the right panel. Timing will need attention but is usable, lock up is good, barrel-to-frame fit has slight play and all appropriate parts are correctly numbered to the gun. (86520-181) {C&R} [Richard "Stretch" Kennedy Collection] (150/250)

1308. **SMITH & WESSON PERFECTED MODEL DOUBLE ACTION TOP-BREAK REVOLVER** serial #45721, 38 S&W, 4" barrel with a near excellent bore showing a few light scattered pinprick pits. The metal surfaces retain about 75% original blue finish with the grip frame toned to brown, moderate wear on the barrel and cylinder, light pitting, scratches and a turn ring on the cylinder. The standard trigger and hammer retain strong case-hardened colors with moderate operational wear. The diamond checkered hard rubber grips with S&W logo are numbered to another gun but fit and condition are excellent. All appropriate parts are correctly numbered to the gun, timing and lockup are excellent and barrel-to-frame fit is tight. (86520-2022) {C&R} [Richard "Stretch" Kennedy Collection] (250/450)
1309. **HOPKINS & ALLEN XL REVOLVER** serial #2789, 38 S&W, 3" octagon barrel with a pitted bore. The metal surfaces retain about 95% original nickel plate with scattered light oxidation blemishes, scratches and a series of small impact marks around the trigger pivot pin. The un-numbered checkered hard rubber grips rate excellent. The gun is still mechanically functional. (86520-3949) {ANTIQUÉ} [Richard "Stretch" Kennedy Collection] (100/200)
1310. **AUTO ORDNANCE MODEL 1911A1 SEMI-AUTO PISTOL** serial #AOC1630, 45 ACP, 5" barrel showing a hint of frosting in the bore. The metal surfaces retain about 97% original blue with scattered light scratches, light high edge wear, assembly marks and operational wear. The checkered walnut Colt replacement grips have a gold Rampant Colt and rate very good plus with light edge wear and handling marks. This gun has a replacement high visibility serrated ramp front sight dovetailed into the slide and an unmarked replacement fully adjustable black blade rear sight that appears to be by L.P.A. The hammer spur has been partially ground off, perhaps to speed lock time or reduce hammer bite. A single magazine is provided. The gun appears to have seen light use and should make a good shooter. (86520-657) {MODERN} [Richard "Stretch" Kennedy Collection] (200/400)
1311. **HARRINGTON & RICHARDSON "THE AMERICAN" DOUBLE ACTION REVOLVER** serial #641, 32 S&W, 2 1/2" octagon barrel with an oxidized and pitted bore. The metal surfaces, to include the triggerguard, retain about 90% original nickel finish with oxidation blemishes, a few pits and handling marks. The checkered hard rubber grips rate excellent. The mainspring has been removed (provided) and the mechanism will need professional attention. (86520-257) {ANTIQUÉ} [Richard "Stretch" Kennedy Collection] (25/50)
1312. **HIGH STANDARD H-D MILITARY MODEL SEMI-AUTO PISTOL** serial #212388, 22 LR, 4 1/2" heavy barrel with an excellent bore. The metal surfaces retain about 90% original blue finish with moderate wear on the barrel, edge wear, minor pinprick pitting and handling marks. The checkered walnut factory grips rate about good to very good with light to moderate edge wear at the butt, a few dents and dings. The pistol features a serrated Patridge front sight, adjustable rear sight and type II take down. No magazine is included. All that is needed is a magazine to make a classic shooter. (86520-3995) {C&R} [Richard "Stretch" Kennedy Collection] (200/400)
1313. **SMITH & WESSON 1ST MODEL LADY SMITH REVOLVER** serial #4518, 22 Long, 3 1/2" barrel with a lightly oxidized and pitted bore. This gun is in need of mechanical attention. The metal surfaces of this Model M revolver retain about 90% clouded original nickel finish with most of the loss to flaking finish on the barrel in addition to scattered stains from oxidation, bubbling, limited pitting and handling marks. The hammer has strong to robust case-hardened colors with the trigger mostly pewter. The diamond checkered hard rubber factory grips are numbered to the gun and rate about fair with little wear but a 5/8" chip along the butt of the left panel. The trigger return spring is broken and the mechanism no longer functions consistently. (86520-1996) {C&R} [Richard "Stretch" Kennedy Collection] (300/500)
1314. **RUGER NEW MODEL SUPER SINGLE SSM REVOLVER** serial #650-12315, 32 H&R Magnum, 4 3/4" barrel with an excellent bore. The metal surfaces retain about 80% original blue and anodized finishes with most of the loss to the cylinder that is thinning to a mix of faded blue and pewter, high edge wear and a few scattered light dings. The smooth walnut factory grips with silver Ruger Phoenix rate good plus with scattered light dents, dings and scratches. A handy gun for the woods or the recoil shy. (86520-3025) {MODERN} [Richard "Stretch" Kennedy Collection] (150/350)
1315. **BROWNING MODEL 1910 SEMI-AUTO PISTOL BY FABRIQUE NATIONALE** serial #174016, 32 ACP, 3 7/16" barrel showing moderate oxidized pitting. The metal surfaces retain about 90% original blue finish but the frame is starting to thin to purple under strong light in addition to scattered oxidation, pitting and various handling marks. The checkered hard rubber factory grips with "FN" logo rate about very good with a few handling marks and light wear but a series of fine checks forming around the edges. The pistol includes a single factory magazine. (86520-2004) {C&R} [Richard "Stretch" Kennedy Collection] (200/400)
1316. **DEUTSCHE WERKE ORTGIES POCKET SEMI-AUTO PISTOL** serial #46413, 32 ACP, 3 7/16" barrel with a bright excellent bore. The pistol retains about 50% original blue with most surfaces fading to gray in addition to scattered oxidation blemishes, pitting, high edge wear and handling marks. There is some strong nitre blue left on the sides of the trigger but the rest is worn to pewter. The smooth walnut factory grips with gold Ortgies medallions rate about good with scattered dents, dings and handling marks. The pistol includes a single factory magazine that is interchangeable between calibers and is marked "9MM" on the left side and "7.65MM / [Heinrich Ortgies trademark]" on the right side. (86520-3306) {C&R} [Richard "Stretch" Kennedy Collection] (50/150)
1317. **COLT POCKET POSITIVE REVOLVER** serial #51064, 32 Long Colt, 3 1/2" barrel with an excellent bore. The metal surfaces of this 1910-manufactured revolver retain about 55-60% original blue fading to a brown-pewter mix on most of the surfaces in addition to high edge wear, light scratches, moderate scratches on the right side of the frame from an attempt to clean light oxidized pinprick pitting, scattered oxidation stains, light pitting and handling marks. The hammer and trigger retain strong fire blue colors with light operational wear and freckling. The checkered hard rubber grips with "COLT" in an oval are scratch-numbered to the gun and rate about good with light wear, limited dents and a chip missing from the toe of the left panel. There is a rework number on the cylinder under the extractor, the Rampant Colt has the stylized C used on early guns and it still times and locks up correctly. (86520-660) {C&R} [Richard "Stretch" Kennedy Collection] (200/400)
1318. **SMITH & WESSON DOUBLE ACTION FOURTH MODEL TOP-BREAK REVOLVER** serial #134143, 32 S&W (Short), 3" barrel with a few scattered light pinprick pits in the bore plus a narrow strip of pitting at the muzzle encompassing about half the circumference of the bore. The metal surfaces retain about 90% original nickel plate and blue finishes with scattered oxidation blemishes, limited bubbling and handling marks. The hammer and trigger have fading case-hardened colors with moderate operational wear. The diamond checkered hard rubber grips rate near excellent with a few light handling marks. Timing is in need of attention but lock up is good and the barrel-to-frame fit has a small amount of play. The grips and all appropriate parts are correctly numbered to the gun. (86520-2005) {ANTIQUÉ} [Richard "Stretch" Kennedy Collection] (200/300)
1319. **ROLLIN WHITE POCKET REVOLVER** serial #7232, 22 RF, 3" octagon barrel with a lightly oxidized bore. The metal surfaces of the barrel and unfluted cylinder have toned to brown with oxidation blemishes, pinprick pitting, handling marks and a few small impact marks on the front edge of the cylinder. The brass frame retains about 75-80% original silver plate with scattered moderate wear, scratches and other handling marks. The smooth walnut grips rate very good with light dents, dings and wear. The mainspring is broken with the main portion of it missing, the cylinder no longer times and the barrel is marked "MADE FOR SMITH & WESSON BY ROLLIN WHITE ARMS CO. LOWELL, MASS". (86520-282) {ANTIQUÉ} [Richard "Stretch" Kennedy Collection] (75/175)

1320. **IVER JOHNSON DEFENDER SOLID FRAME REVOLVER** serial #T285, 22 RF, 2 1/4" barrel with moderate to heavy oxidation in the bore. The metal surfaces retain about 60% original nickel plate with most of the loss to oxidation stains plus bubbling finish, scratches and other handling marks. The smooth walnut factory birds head grips rate fair with light wear and 1/2" crack forming on the top of the right panel. The gun no longer times and corrosion has seized the center pin in place (some Kroil may free it up). (86519-530) {ANTIQUÉ} [Richard "Stretch" Kennedy Collection] (25/75)
1321. **SMITH & WESSON MODEL 12 AIRWEIGHT MILITARY & POLICE REVOLVER** serial #C474603, 38 Special, 2" pinned barrel with an excellent bore. The metal surfaces of this early 1960's improved flat latch revolver retain about 95% original blue and anodized finishes with light to moderate high edge wear, turn ring on the cylinder and handling marks. The standard trigger and hammer retain robust case-hardened colors. The diamond checkered walnut factory grips with silver S&W medallions are numbered to the gun and rate very good plus with light handling marks. The revolver still times and locks up correctly and should make a great carry or home defense gun. (86520-230) {C&R} [Richard "Stretch" Kennedy Collection] (250/350)
1322. **IVER JOHNSON DEFENDER 89 SOLID FRAME REVOLVER** serial #4629, 22 RF, 2 1/4" barrel with a lightly oxidized and pitted bore. The metal surfaces retain about 97% original nickel plate with scattered light oxidation blemishes, dents, scratches and the occasional pit. The hammer has remnants of case-hardened colors present. The unmarked smooth walnut factory grips rate poor with a 1 5/8" slice of right panel broken off on the rear section and a 1 1/4" long check forming in the same area of the left panel plus moderate dents, dings and scuffs. The gun no longer times and the trigger return spring does not function. (86519-533) {ANTIQUÉ} [Richard "Stretch" Kennedy Collection] (25/75)
1323. **REMINGTON NEW MODEL CARTRIDGE CONVERSION POCKET REVOLVER** serial #22834, 32 RF, 3 1/2" octagon barrel with a lightly oxidized and pitted bore. The metal surfaces have toned to brown with a few stray wisps of original blue in addition to scattered light dings, scratches and a few areas of pitting. The unmarked smooth walnut factory grips rate about fair with scattered light to moderate dents, dings and a shallow 5/8" long chip missing off the heel of the left panel. The gun is still fully functional, the barrel is serial numbered to the gun and the cylinder is numbered "387". (86520-1206) {ANTIQUÉ} [Richard "Stretch" Kennedy Collection] (200/300)
1324. **STEVENS DIAMOND NO. 43 SINGLE SHOT PISTOL** serial #46464, 22 RF, 6" part octagon part round barrel with a lightly frosted bore. The metal surfaces of this second issue pistol have been cleaned to pewter with light stains from oxidation and some pitting. There are traces of original nickel plate still visible on the iron frame and some original blue around the chamber areas. The smooth walnut factory grips rate near excellent as lightly cleaned. Barrel-to-frame fit is loose and it still functions mechanically. (86520-1266) {C&R} [Richard "Stretch" Kennedy Collection] (75/150)
1325. **PARKER SAFETY HAMMERLESS DOUBLE ACTION REVOLVER BY OTIS SMITH** serial #2120, 32 S&W, 3 3/16" barrel with a lightly pitted and oxidized bore. The metal surfaces retain about 97% original nickel plate with scattered light scratches, dents, dings and oxidation blemishes. The highly decorated factory hard rubber grips have encircled rosettes, floral border and fine checkering molded into the center of the panels. They rate fair to good with little wear but a 5/16" chip is missing from the front top of the right panel. The mechanism functions but tends to hang up, the small knurled safety wheel no longer works, the mainspring has been removed (but provided) and the center pin may be incorrect as it does not fully seat or lock in place causing side-to-side play in the cylinder affecting functioning. The patent dates on the barrel are poorly marked and only a small portion is visible. (86520-2120) {ANTIQUÉ} [Richard "Stretch" Kennedy Collection] (100/200)
1326. **BELGIAN FOLDING TRIGGER POCKET REVOLVER** serial #199, 30 CF, 1 11/16" octagon barrel with an oxidized and lightly pitted bore. The metal surfaces have toned to brown with a few remnants of original blue, scattered oxidized pitting and a few handling marks. The checkered hard rubber factory grips rate about excellent with a few light handling marks. The trigger does not fully reset without manual assistance but the mechanism does seem to function properly from the full reset position. The trigger pivot pin has been substituted with a later added ad-hoc replacement which may contribute to the reset issues. The little revolver includes a period style flap belt holster that rates fair to good with scattered moderate wear, scuffs, crazing and repaired stitching on the seams and belt loop. (86520-2979) {C&R} [Richard "Stretch" Kennedy Collection] (50/100)
1327. **FRENCH PERCUSSION COACH PISTOL BY ROGUET** .68 cal., 7" smooth bore barrel with an oxidized and lightly pitted bore. The lightly cleaned in-the-white metal surfaces show light freckling, oxidation stains, pitting and handling marks. The brass buttcap, triggerguard and noseclip are an even ochre patina with light handling marks. The one-piece checkered walnut stock rates good to very good as lightly varnished showing dents, scratches and a series of powderpost beetle holes on the pistolgrip section. The lock remains crisp, the steel ramrod is present and the steel frontstrap is slightly proud of the wood at the butt. The side of the lockplate is marked "-Roguet- / St. Etienne" in an oval. The tang has a small "V" notch rear sight but the front sight blade is just a nub. (86520-2533B) {ANTIQUÉ} [Richard "Stretch" Kennedy Collection] (200/400)
1328. **U.S. GOVERNMENT CONTRACT SMITH & WESSON LEND-LEASE VICTORY MODEL REVOLVER** serial #V375039, 38 S&W, 5" barrel with an excellent bore. The metal surfaces of the barrel and cylinder have toned to gray with the Parkerizing on the frame starting to thin for a rating of about 50%. Additionally, there is edge wear present, stains from oxidation and some areas of moderate to heavy pitting. The standard hammer and trigger retain robust case-hardened colors with light operational wear. The grips have been replaced with contemporary checkered walnut factory Magna grips featuring silver S&W medallions that rate near excellent with light handling wear. The hammer and mainspring have been removed but are provided and will likely need professional attention. All appropriate parts are numbered to the gun and the top strap is U.S. property marked. (86520-279) {MODERN} [Richard "Stretch" Kennedy Collection] (100/200)
1329. **INTRATEC PROTECT-25 MODEL SEMI-AUTO PISTOL** serial #005184, 25 ACP, 2 1/2" barrel with an excellent bore. The matte silver finish on this double action only pistol has toned to mostly black tarnish on the left side of the frame and slide with more of a spotted mottled tarnish on the right. Additionally, there are scattered light scratches, high edge wear and corrosion damage to the rear of the frame above the knuckle. The checkered synthetic wraparound factory grips with Intratec logo and model name molded into the panels rate about excellent. The pistol includes a single factory magazine. (86520-1227) {MODERN} [Richard "Stretch" Kennedy Collection] (25/50)
1330. **VINCENZO BERNARDELLI VEST POCKET MODEL SEMI-AUTO PISTOL** serial #34961, 25 ACP, 2 1/8" barrel with a lightly frosted bore. The metal surfaces of this 1950 proof-dated pistol retain about 50% original blue with the remaining surfaces a mottled mix of brown and purple in addition to light scratches from cleaning on the right side of the frame, scattered handling marks, pitting and oxidation blemishes. The checkered hard rubber factory grips with "VB" logo rate about very good with light handling wear. The pistol includes a single magazine. (86520-2917) {C&R} [Richard "Stretch" Kennedy Collection] (50/100)

1331. **BERETTA MODEL 75 JAGUAR SEMI-AUTO PISTOL** serial #45543, 22 LR, 6" barrel with an excellent bore. The metal surfaces of this 1960 proof-dated pistol retain about 90% plus original blue and anodized finishes with high edge wear, operational wear, scratches, the finish on the frontstrap is starting to tone to plum and a few other handling marks. The checkered synthetic wrap-around factory grips with Beretta logo rate good to very good with scattered light to medium handling marks. The pistol features a Patridge style front sight and drift adjustable rear sight. It includes a single factory magazine with finger extension. This gun should make a fun little plinker. (86520-1001) {C&R} [Richard "Stretch" Kennedy Collection] (125/225)
1332. **GERMAN MODEL 626B SEMI-AUTO PISTOL BY FABRIQUE NATIONALE** serial #107764, 32 ACP, 4 1/2" barrel with a lightly frosted bore. The metal surfaces have been lightly cleaned to pewter with scattered light scratches, stains from oxidation and pitting. The checkered walnut factory grips rate about good with scattered dents, dings and scratches. The pistol has matching serial numbers on the frame, barrel, slide extension and slide plus there are "[Eagle]/WaA140" Waffenamt marks on the slide and frame. The thumb safety, thumb safety spring, recoil spring, firing pin and firing pin spring have been removed but are provided and are in need professional services. No magazine is provided. (86520-1000) {C&R} [Richard "Stretch" Kennedy Collection] (100/200)
1333. **MAUSER MODEL 1910 SEMI-AUTO PISTOL** serial #278893, 25 ACP, 3" barrel with an excellent bore. The metal surfaces retain about 75-80% original blue with the frontstrap and portions of the frame toning to brown, scattered oxidation blemishes, pitting and a few light scratches from cleaning and handling. The one-piece checkered walnut factory grips rate very good to excellent with light dents on the right side. The pistol includes a single unmarked magazine that is in-the-white with scattered oxidation blemishes. (86520-2196) {C&R} [Richard "Stretch" Kennedy Collection] (200/400)
1334. **HIGH STANDARD MODEL GB SEMI-AUTO PISTOL** serial #316976, 22 LR, 6 3/4" barrel with an excellent bore. The metal surfaces retain about 90% original blue with most of the loss to the grip frame having toned to a mix of pewter and brown in addition to edge wear and light handling marks. The checkered synthetic factory grips with High Standard logo rate excellent. This gun features a lever barrel take down system, Patridge front sight and drift adjustable rear sight. The pistol includes a single two-tone factory magazine. This gun should make a great trainer, plinker or hunting gun. (86520-2457) {C&R} [Richard "Stretch" Kennedy Collection] (200/400)
1335. **COLT WOODSMAN SPORT MODEL SEMI-AUTO PISTOL** serial #107616, 22 LR, 4 1/2" barrel with an excellent bore. The metal surfaces of this 1937-made first series pistol retain about 80% original blue with most of the loss due to light cleaning on the barrel and wear on the grip frame in addition to high edge wear, scratches, pitting and handling marks. The checkered walnut factory grips rate about good with light to moderate diamond point wear and other handling marks. The pistol features a fixed serrated ramp front sight and windage adjustable rear sight. It includes a single two-tone factory magazine. A great little camp gun, plinker or trainer. (86520-2557) {C&R} [Richard "Stretch" Kennedy Collection] (250/450)
1336. **COLT MODEL 1908 POCKET HAMMERLESS SEMI-AUTO PISTOL** serial #51578, 380 ACP, 3 3/4" barrel with a moderately frosted bore. The metal surfaces of this 1921-made pistol retain about 65-70% original blue with scattered oxidation blemishes, pitting, high edge wear and handling marks. The checkered hard rubber factory grips are correct for the period of manufacture and rate about good with light wear but a tiny chip at the top of the left panel below the safety and a 5/8" scuff on the right panel. No magazine is included. (86520-1245) {C&R} [Richard "Stretch" Kennedy Collection] (200/400)
1337. **COLT POLICE POSITIVE SPECIAL REVOLVER** serial #703107, 38 Special, 4" barrel with an excellent bore. The metal surfaces of this 1957-made revolver retain about 90% original blue finish with the backstrap toned to pewter, high edge wear, turn ring on the cylinder and handling marks. The grips are unmarked smooth replacement stag in excellent condition and add a little touch of panache to the gun. The little D-frame still times and locks up as good as the day it left Colt. The gun appears to have spent more time in a holster than on the range. (86520-2042) {MODERN} [Richard "Stretch" Kennedy Collection] (200/400)
1338. **COLT POLICE POSITIVE SPECIAL REVOLVER** serial #703103, 38 Special, 4" barrel with an excellent bore. The metal surfaces of this 1957-made revolver retain about 85% original blue finish with the backstrap toned to pewter, moderate high edge wear, turn ring on the cylinder and scratches. The checkered walnut factory grips with silver Colt medallions rate good with light to moderate diamond point compression on the left panel more moderate to heavy on the right in addition to handling marks on both. The gun still times and locks up correctly and should make a good shooter. (86520-965) {C&R} [Richard "Stretch" Kennedy Collection] (150/250)
1339. **COLT POLICE POSITIVE SPECIAL REVOLVER** serial #531066, 32 Colt New Police (S&W Long), 4" barrel with an excellent bore. The metal surfaces of this 1949-made revolver retain about 85% original blue with most of the loss on the grip toning to gray with high edge wear, scattered oxidation blemishes, scratches and a turn ring on the cylinder. The un-numbered checkered walnut factory grips with silver Colt medallions rate about good with little wear but there is a check on the butt of the left panel that extends across the bottom and roughly 3/4" up the grip panel. The grip looks repairable, timing and lock up are good and it should make a good shooter. (86520-3033) {C&R} [Richard "Stretch" Kennedy Collection] (150/250)
1340. **COLT POCKET POSITIVE REVOLVER** serial #44286, 32 Colt New Police (S&W Long), 2 1/2" barrel with a few scattered oxidation blemishes and pits in the bore. The metal surfaces of this 1908-made revolver retain about 75% original blue with the grip frame and portions of the frame toned to brown, moderate high edge wear and handling marks. The checkered hard rubber factory grips with "Colt" in an oval are numbered to the gun and rate about fair to good with little wear but there is a small chip missing from the toe of the both panels. The sides of the front sight blade show what appears to be deep tool marks and strong magnification shows a non-factory repair to reattach the blade. The gun still times and locks up correctly and should make a good shooter. (86520-1559) {C&R} [Richard "Stretch" Kennedy Collection] (175/275)
1341. **COLT NEW POLICE REVOLVER** serial #11518, 32 Long Colt, 4" barrel with a few scattered oxidation blemishes and pits in the bore. The metal surfaces of this turn of the century made (1900) revolver retain about 75% original blue with the grip frame and cylinder toned to a mix of pewter and brown in addition to oxidation cleaned to pewter on the barrel, turn ring on the cylinder and handling marks. The screws, hammer and trigger have some bright nitre blue with light operational wear. The checkered hard rubber factory grips with "COLT" in an oval are numbered to the gun and rate near excellent with minor wear. The gun still times and locks up correctly. (86520-1274) {C&R} [Richard "Stretch" Kennedy Collection] (200/400)

1342. **COLT NEW POLICE REVOLVER** serial #44598, 32 Colt New Police (S&W Long), 4" barrel with a few scattered oxidation blemishes and pits in the bore. The metal surfaces of this 1906-made revolver retain about 75-80% original blue with grip frame toning to brown, high edge wear, scattered oxidation blemishes, freckling, pitting and a turn ring on the cylinder. The hammer and trigger have remnants of nitre blue but are mostly worn to gray. The checkered hard rubber factory grips with "COLT" in an oval are numbered to the gun and rate near excellent with light handling wear. One oddity of this gun is the left side of the barrel is correctly stamped with "Colt New Police 32" with the Rampant Colt surrounded by "Colt's New Police" but the right side of the barrel is also stamped "Police Positive" and has the patent dates of the Police Positive (last date of July 4, 1905). The bottom of the butt is engraved "L.T. 1906" and there is no indication of its significance. The gun still times and locks up correctly. (86520-455) {C&R} [Richard "Stretch" Kennedy Collection] (200/400)
1343. **COLT NEW POLICE REVOLVER WITH NEW YORK CITY POLICE MARKINGS** serial #3190, 32 Colt New Police, 4" barrel with an oxidized and pitted bore. This first year (1896) production revolver retains about 10-20% original blue with most surfaces toned to a gray-brown mix plus light scratches from cleaning attempts, oxidation blemishes, pitting and other handling marks. The trigger, hammer and screws have only remnants of nitre blue with the rest worn to gray-brown mix. There are no grips provided with the gun and the ejector rod head and crane lock screw are missing. The backstrap is engraved "NEW YORK POLICE" and this gun is part of a shipment of 4500 guns sent to New York City under the direction of Commissioner Theodore Roosevelt. The gun still functions but lock up is in need of attention. (86520-172) {ANTIQUE} [Richard "Stretch" Kennedy Collection] (100/200)
1344. **HY HUNTER FRONTIER SIX-SHOOTER MODEL SINGLE ACTION REVOLVER** serial #01600, 22 LR, 5 1/2" barrel with an excellent bore. This revolver is in need of mechanical attention and retains about 90% original black enamel finish. The mainspring has been removed but is provided, the trigger return spring is in need of repair, the cylinder stop is missing or broken and there may be other internal mechanical issues. The bottom of the hand slot in the window of the frame shows a small 1/4" crack with metal bulging outward. The grips are faux stag that rate poor with cracks radiating from the escutcheons on both screws. (86519-571) {MODERN} [Richard "Stretch" Kennedy Collection] (20/40)
1345. **COLT MODEL 1878 DOUBLE ACTION REVOLVER** serial #14432, 45 Colt, 7 1/2" barrel with a moderately frosted bore. This gun has a number of parts missing. The metal surfaces of this 1885-made gun retain about 90-95% later non-factory poorly applied nickel finish with scattered areas of flaking, clouding and visible handling marks under the new finish. In addition to the frame the cylinder, loading gate, ejector rod assembly, trigger, hand and a few other internal parts are present. All other parts including the triggerguard and sideplate are not present. The cylinder is numbered to the gun but the loading gate has a different assembly number from the frame. The front sight is an ad-hoc blade dovetailed into the barrel. (86519-572) {ANTIQUE} [Richard "Stretch" Kennedy Collection] (50/150)
1346. **LOT OF THREE REVOLVERS** Hopkins & Allen Double Action No.6 Revolver serial #8532, 32 CF, 2 1/2" octagon barrel with scattered light oxidation. There is about 98% original nickel plate with a few oxidation stains. The right grip panel with Forehand & Wadsworth logo rates excellent but the left is in poor condition with the upper half missing. The gun still functions but timing will need attention and the center pin refuses to move. Smith & Wesson No. 1 1/2 Single Action Top-Break Revolver serial #30926, 32 S&W (Short), 3 1/2" barrel with a lightly oxidized and pitted bore. There is about 50% original nickel plate left with scattered oxidation and pitting. The un-numbered grips rate fair with light wear and a 5/8" chip off the bottom of the left panel. The mainspring is missing and the gun no longer times or functions. Smith & Wesson No. 1 1/2 Single Action Top-Break Revolver serial #24590, 32 S&W (Short), 3" barrel with an oxidized and pitted bore. There is about 60% original nickel plate left with scattered oxidation and pitting. The grips are numbered to the gun and rate very good with light wear and handling marks. The mainspring is missing and the gun no longer times or functions. All appropriate parts on both antique S&W revolvers are correctly numbered to their respective frames. (86519-578) {C&R} (86519-577 & 580) {ANTIQUE} [Richard "Stretch" Kennedy Collection] (50/100)
1347. **MERWIN, HULBERT & CO. SINGLE ACTION POCKET REVOLVER BY HOPKINS & ALLEN** serial #2300, 38 Merwin & Hulbert (S&W), 3 1/2" barrel with scattered oxidation and pitting in the bore. The metal surfaces of this second type revolver retain about 95% original nickel plate with scattered oxidation blemishes, bubbling, clouding finish in areas, pitting and handling marks. The checkered hard rubber factory grips with setter's head, scalloped edges and floral design around the escutcheons rate excellent with minor handling wear. The top of the barrel has the Hopkins & Allen address and patent dates with "MERWIN HULBERT & CO. / NEW YORK U.S.A." on the left side of the frame. The hammer has toned to gray, the rear sideplate screw is missing, there is a replacement screw proud of the frame above the trigger and timing no longer functions but lock up still works. (86519-57) {ANTIQUE} [Richard "Stretch" Kennedy Collection] (200/400)
1348. **BERETTA MODEL 100 SEMI-AUTO PISTOL** serial #L68647, 32 ACP, 6" barrel with an excellent bore. This 1970 proof-dated pistol retains about 97% original blue and anodized finishes with light edge wear and a few handling marks. The checkered synthetic wraparound extended factory grips rate near excellent with a few minor handling marks. The pistol features a Patridge style front sight and fully adjustable black blade rear sight. The pistol includes a single factory magazine with finger rest baseplate and spacer. (86520-2452) {MODERN} [Richard "Stretch" Kennedy Collection] (175/275)
1349. **LOT OF THREE REVOLVERS** Smith & Wesson 38 Single Action Second Model Top-Break Revolver serial #55748, 38 S&W, 3 1/4" barrel with scattered light oxidation and pitting in the bore. The metal surfaces have been cleaned to an even matte pewter with handling marks. The hammer retains strong case-hardened colors and there are no grips. The gun no longer functions and all appropriate parts are numbered to the frame. Smith & Wesson 32 Double Action Third Model Top-Break Revolver serial #39170, 32 S&W (Short), 3 1/2" barrel with scattered light oxidation and pitting in the bore. There is about 85% plus original nickel plate and blue finishes with scattered oxidation blemishes, pitting and handling wear. The diamond checkered hard rubber grips with S&W logo rate very good plus with light handling marks. The grips and all appropriate parts are numbered to the gun, the mainspring is not present and the gun is in need of mechanical attention. Smith & Wesson 32 Safety Hammerless Second Model Top-Break Revolver serial #67862, 32 S&W (Short), 3 1/2" barrel with scattered light oxidation and pitting in the bore. There is about 85% later non-factory applied nickel plate and blue finishes with most of the loss due to flaking on the cylinder and muzzle areas in addition to pitting, scratches and the triggerguard toned to gray with traces of blue. The un-numbered diamond checkered hard rubber grips with S&W logo rate very good plus with light handling marks. All appropriate parts are numbered to the gun, the mainspring is not present and the gun is in need of mechanical attention. (86519-573, 574 & 588) {ANTIQUE} [Richard "Stretch" Kennedy Collection] (75/150)
1350. **STEVENS OFFHAND TARGET NO. 35 SINGLE SHOT PISTOL** serial #28476, 22 RF, 8" part round part octagon barrel with an oxidized and pitted bore. The metal surfaces retain about 70% original blue on the barrel with lightly cleaned oxidation and pitting, edge wear and a few handling marks. The frame retains about 90% original nickel plate with scattered light flaking, oxidation blemishes, evidence of limited light cleaning, edge wear and some pitting. The smooth walnut grips are pencil numbered to the gun and rate very good to excellent with a few light handling marks. The gun features a bead front sight, step adjustable rear sight, the barrel is numbered to the frame, it still functions mechanically and barrel-to-frame fit shows slight play. (88910-1) {C&R} (200/400)

1351. **SMITH & WESSON MODEL 41 SEMI-AUTO PISTOL** serial #A583980, 22 LR, 7" barrel with an excellent bore. The metal surfaces retain about 25% original blue finish with all of the barrel and large portions of the slide and frame toned to brown along with a few light oxidation blemishes and handling marks. The checkered walnut finger rest grips rate about very good to excellent with a few scattered light handling marks. This pistol features a Patridge front sight but the rear sight assembly is missing and includes a single factory magazine. The pistol is only in need of a rear sight to get back into shooting condition or perhaps it would be a good candidate for the installation of a red dot sight. (88896-216D34164) {MODERN} (300/500)
1352. **SMITH & WESSON MILITARY & POLICE HAND EJECTOR REVOLVER** serial #S827702, 38 Special, 4" tapered barrel with an excellent bore. This post-war pre-model 10 M&P retains about 80% original blue with the grip frame toned to brown, light to moderate edge wear, scratches, oxidized pitting and a turn ring on the cylinder. The service trigger and hammer retain bold case-hardened colors with light to moderate handling and operational wear. The diamond checkered walnut factory grips with silver S&W medallions rate about good with moderate wear to the diamond points and handling marks. The grips are numbered to another gun but all other appropriate parts are correctly numbered to the frame and it is fully functional. This gun has seen some honest use over the years. (88903-68) {C&R} (200/400)
1353. **COLT TROOPER MK III DOUBLE ACTION REVOLVER** serial #J88474, 357 Magnum, 4" heavy barrel with an excellent bore. The metal surfaces of this 1970-made revolver retain about 80% original blue with the backstrap toned to brown, high edge wear, scattered light oxidation stains, handling marks and oxidized pitting on the barrel. The checkered walnut factory target grips with silver Rampant Colt medallions rate about fair to good with moderate handling wear around the butt, light diamond point compression and repaired crack on the left panel. The gun has a serrated ramp front sight and Colt Accro rear sight. The gun still locks up correctly but the timing will need attention. It should make a good shooter. (88897-6D34137) {MODERN} (250/450)
1354. **HARRINGTON & RICHARDSON MODEL 300 ULTRA BOLT ACTION RIFLE** serial #53311, 30-06 Springfield, 22" barrel with an excellent bore. The metal surfaces retain about 97% original blue and anodized finishes with the triggerguard starting to thin to gray, wear on the floor plate, edge wear at the muzzle and scratches. The bolt body is in-the-white with light machine turning on the extractor. The one-piece pistolgrip Monte Carlo walnut stock with rollover cheekpiece has checkered wrist and panels of checkering on the forend. It rates good to very good with scattered light dents, oil soaking and finish extending from the bolt release around the rear of the action and up to the safety. The thin red rubber recoil pad with H&R logo rates excellent. The rifle features sling swivel studs, Williams "V" notch rear sight, brass bead front sight on a ramp, hinged floor plate, FN-made receiver and flat bolt knob with checkered bottom. (88898-6D32895) {MODERN} (300/500)
1355. **SMITH & WESSON MILITARY & POLICE HAND EJECTOR REVOLVER** serial #C338456, 38 Special, 4" tapered barrel with an excellent bore. This early 1950's-made pre-model 10 revolver retains about 80% original blue with light to moderate high edge wear, handling marks, a moderate cleaned area of pitting on the left side of the frame and a turn ring on the cylinder. The diamond checkered walnut factory Magna grips with silver S&W medallions rate about good to very good with light to moderate dents, dings and scratches. All appropriate parts and the grips are correctly numbered to the gun and it still times and locks up correctly. (88821-102) {C&R} [Stuart Floam Collection] (200/400)
1356. **THOMPSON CENTER CONTENDER SINGLE SHOT PISTOL** serial #34030, 32 H&R Magnum, 10" bull barrel with an excellent bore. T/C 32 H&R barrels were bored .30 caliber with a groove diameter of .308" allowing a wider range of bullets which was more attractive to the silhouette shooters. The metal surfaces of this pistol retain about 97% original blue with most of the loss on the triggerguard area. The checkered thumb rest walnut one-piece factory grip with plastic butt bearing a T/C logo rates about excellent with a few minor handling marks. The smooth walnut forend rates about very good to excellent with a few scattered light dents. This gun features the early hammer with no safety and screwdriver style selector on the hammer nose. Both factory sights have been removed and replaced with a Weaver style rail and a Swift red dot sight that still functions and has clear optics. (88821-100) {MODERN} (200/300)
1357. **SMITH & WESSON MODEL 64-3 MILITARY & POLICE REVOLVER** serial #1D81481, 38 Special, 4" pinned barrel with an excellent bore. The stainless steel surfaces rate about good to very good with scattered light scratches, turn ring on the cylinder and a small area of moderate to heavy pitting on the topstrap by the rear sight. The service trigger and hammer have full hard chrome finish. The smooth rosewood factory target grips with silver S&W medallions have been altered by moderately rounding the butt and rate about very good as reconfigured. The grips should make concealed carry a little more comfortable and feel nice in the hand. Timing and lock up are good and it should make a good shooter. (88896-3D33936) {MODERN} (200/300)
1358. **SMITH & WESSON MODEL 64-1 MILITARY & POLICE REVOLVER** serial #1D28093, 38 Special, 4" pinned barrel with an excellent bore. The stainless steel surfaces rate about very good with scattered light handling marks, turn ring on the cylinder and edge wear. The service trigger and hammer have full hard chrome finish. The checkered goncalo alves factory target grips with silver S&W medallions have been altered by lightly rounding the butt and rate about good to very good as reconfigured with scattered handling marks. The reconfigured grips remove the sharp corners of the factory square butt target grips making them more comfortable to handle. Timing and lock up are good and it should make a good shooter or home defense gun. (88896-13D33428) {MODERN} (200/300)
1359. **SMITH & WESSON MODEL 64-3 MILITARY & POLICE REVOLVER** serial #AUV4549, 38 Special, 4" barrel with an excellent bore. The stainless steel surfaces rate about very good with scattered light handling wear, turn ring on the cylinder and fine scratches. The service hammer has full hard chrome finish but the smooth combat trigger was narrowed to about the width of the original serrated service style trigger with hard chrome missing from the two sides that were tooled. The replacement checkered rubber Pachmayr "Gripper" grips rate excellent. Timing and lock up are good and it should make a good all-around gun for shooting, defense and training. (88896-8D33659) {MODERN} (200/300)
1360. **SMITH & WESSON MODEL 28-2 HIGHWAY PATROLMAN REVOLVER** serial #N84458, 357 Magnum, 6" pinned barrel with a bright bore exhibiting a bulge about 1" from the breech end. The metal surfaces of this early 1970's-made revolver retain about 60% original blue with the grip frame, triggerguard and lower frame toned to brown, the cylinder is brown also with some color in the flutes, high edge wear, handling marks and a turn ring on the recessed cylinder. The service trigger and hammer have bold case-hardened colors with operational wear, limited oxidation staining and the right side of the trigger toned to gray. The checkered walnut factory Magna grips with well worn silver S&W medallions are numbered to the gun and rate about good with light to moderate handling wear and flaking finish. The gun features a Baughman ramp front sight and a micro adjustable rear sight with a damaged black blade slide. The gun still times and locks up correctly and should make a good shooter or field gun with the rear sight slide replaced. (88896-208D34145) {MODERN} (150/350)

1361. **SMITH & WESSON MODEL 28-2 HIGHWAY PATROLMAN REVOLVER** serial #N508362, 357 Magnum, 4" pinned barrel with a bright excellent bore. The metal surfaces of this late 1970's-made revolver retain about 95% original blue with the finish starting to thin on the sides of the barrel and frame, lightly cleaned oxidation stains, areas of pitting and a turn ring all present on the recessed cylinder. The service trigger and hammer have bold case-hardened colors with light operational wear. The unmarked checkered replacement hardwood target style grips rate about excellent with minor handling marks. The gun features a Baughman ramp front sight and black blade micro adjustable rear sight. The frame under the crane, and to a lesser extent the crane itself, show heavy tool marks that have defaced the serial number (number on the butt is present and untouched) and partially removed the model number. The gun still times and locks up correctly and should make a good shooter or field gun. (88896-209X12728) {MODERN} (400/600)
1362. **SMITH & WESSON MODEL 37 AIRWEIGHT CHIEFS SPECIAL REVOLVER** serial #J480771, 38 Special, 1 7/8" pinned barrel with an excellent bore. The metal surfaces of this mid 1970's-made revolver retain about 98% original nickel plate with scattered light scratches, turn ring on the cylinder, bubbling finish on the sideplate and the grip frame starting to cloud. The service trigger and hammer retain bold case-hardened colors with light operational wear. The checkered walnut factory square butt Magna grips with silver S&W medallions are numbered to another gun but rate about very good to excellent with a ding on the right panel's heel. Timing and lock up are excellent and the gun should make a great concealed carry handgun. (88896-22D33386) {MODERN} (300/500)
1363. **SMITH & WESSON MODEL 36 CHIEFS SPECIAL REVOLVER** serial #1J09559, 38 Special, 1 7/8" barrel with an excellent bore. The metal surfaces of this early 1980's-made revolver retain about 98% original nickel plate with scattered light scratches, turn ring on the cylinder, the edge of one flute worn and oxidized toward the rear, a tiny spot of cleaned pitting on the cylinder and the backstrap is starting to cloud. The service trigger and hammer retain robust case-hardened colors with light to moderate operational wear. The un-numbered checkered walnut factory square butt Magna grips with silver S&W medallions rate good with scuffing and scrapes on the right panel and a few dings scattered about. Timing and lock up are excellent and the gun should make a great concealed carry handgun. (88896-16D33995) {MODERN} (300/500)
1364. **SMITH & WESSON MODEL 36 CHIEFS SPECIAL REVOLVER** serial #J250880, 38 Special, 1 7/8" pinned barrel with an excellent bore. The metal surfaces of this mid 1970's-made revolver retain about 99% original nickel plate with scattered light handling marks, turn ring on the cylinder and the grip frame is starting to cloud. The service trigger and hammer retain bold case-hardened colors with light to moderate operational wear and freckling. The checkered walnut factory round butt Magna grips with silver S&W medallions are numbered to the gun and rate good with scuffing, scrapes and a few dings. Timing and lock up are excellent and the gun should make a great concealed carry handgun. (88896-26D33503) {MODERN} (300/500)
1365. **SMITH & WESSON MODEL 40-1 CENTENNIAL CLASSIC REVOLVER** serial #DBU4462, 38 Special, 1 7/8" barrel with an excellent bore. The metal surfaces of this 21st century-made revolver retain about 97% original nickel plate with scattered light scratches, turn ring on the cylinder and a lightly cleaned oxidized area of pinprick pitting and worn finish on the left top section of the frame, probably from a high thumb hold. The M.I.M.'s smooth combat trigger retains strong but unremarkable case-hardened colors. The un-numbered diamond checkered walnut factory round butt Magna grips with silver S&W medallions rate good to very good with several lightly dinged diamond points and moderately flaking finish. This gun is fashioned after the original Centennials and feature a grip safety. Timing and lock up are excellent and the gun should make a great concealed carry handgun. (88896-20D33975) {MODERN} (300/500)
1366. **SMITH & WESSON MODEL 36 CHIEFS SPECIAL REVOLVER** serial #73J454, 38 Special, 1 7/8" pinned barrel with an excellent bore. This lovely little J frame retains about 99% original blue finish with a light turn ring on the cylinder. The service trigger and hammer retain bold case-hardened colors with light operational wear. The checkered walnut factory round butt Magna grips with silver S&W medallions are numbered to the gun and rate excellent. This gun appears to have seen minimal use and still times and locks up correctly. A classic handgun for concealed carry. (88894-5) {MODERN} (400/600)
1367. **SMITH & WESSON CHIEFS SPECIAL HAND EJECTOR REVOLVER** serial #95042, 1 7/8" barrel with an excellent bore. This little improved flat latch J frame revolver has been returned to the factory twice, once in January 1966 and a second time on August 1977. The rework marks indicate at least one "re-blue standard" and it is obvious the barrel, cylinder and extractor have been replaced. The metal surfaces retain about 95% reapplied blue finish with the backstrap starting to thin, high edge wear, scratches and a turn ring on the cylinder. The service trigger and hammer retain bold case-hardened colors with light operational wear. The diamond checkered walnut factory round butt Magna grips are numbered to a different gun and rate near excellent with a few handling marks. The barrel, cylinder and extractor are not numbered but the crane is numbered to the gun and still times and locks up correctly. A classic Hand Ejector for concealed carry. (88896-18D33389) {C&R} (200/400)
1368. **SMITH & WESSON MODEL 36 CHIEFS SPECIAL REVOLVER** serial #8J940, 38 Special, 1 7/8" pinned barrel with an excellent bore. This J frame retains about 95% original blue finish with a light turn ring on the cylinder, high edge wear, cleaned pitting on the sideplate in addition to oxidized pitting on the frame and cylinder. The service trigger and hammer retain bold case-hardened colors with light freckling. The checkered walnut factory round butt Magna grips with silver S&W medallions are numbered to the gun and rate excellent. This gun still times and locks up correctly and would make a great concealed carry gun. (88896-19D33540) {MODERN} (250/350)
1369. **SMITH & WESSON MODEL 37 AIRWEIGHT CHIEFS SPECIAL REVOLVER** serial #78J108, 38 Special, 1 7/8" pinned barrel with an excellent bore. The metal surfaces retain about 95% original blue and anodized finishes with the backstrap starting to thin, high edge wear, a few oxidation stains, scratches and a turn ring on the cylinder. The service trigger and hammer still have strong case-hardened colors but the trigger and hammer spur are toning to pewter. The checkered walnut factory round butt Magna grips with silver S&W medallions are numbered to the gun and rate very good to excellent with light handling wear. This gun times and locks up correctly and would make a great lightweight concealed carry gun. (88896-23D34216) {MODERN} (250/350)
1370. **SMITH & WESSON MODEL 36 CHIEFS SPECIAL REVOLVER** serial #672173, 38 Special, 1 7/8" pinned barrel with an excellent bore. The metal surfaces retain about 85% original blue finish with a light turn ring on the cylinder, high edge wear, scattered scratches, an attempt to clean a small spot of pitting on the sideplate with a Cratex wheel and few oxidation blemishes. The service trigger and hammer are mostly gray with some case-hardened colors visible in addition to scattered oxidation stains. The checkered walnut factory round butt Magna grips with silver S&W medallions are numbered to the gun and rate about good showing light to moderate dents, dings and scratches. This gun times and locks up correctly and still has many years left in it as a concealed carry gun. (88896-25D33867) {MODERN} (200/300)

1371. **SMITH & WESSON MODEL 36 CHIEFS SPECIAL REVOLVER** serial #722370, 38 Special, 1 7/8" pinned barrel with an excellent bore. The metal surfaces retain about 85% original blue finish with a light turn ring on the cylinder, light to moderate high edge wear, scattered scratches and the backstrap toned to brown. The service trigger and hammer retain bold case-hardened colors with moderate operational and handling wear. The replacement checkered rubber Pachmayr Compac grips rate good with light to moderate diamond point wear. This gun times and locks up correctly and could do double duty as a concealed carry or home defense firearm. (88896-17D33050) {MODERN} (200/300)
1372. **SMITH & WESSON MODEL 30-1 REVOLVER** serial #738811, 32 S&W Long, 2" pinned barrel with an excellent bore. The metal surfaces of this early 1960's-made improved flat latch J frame revolver retain about 90% original blue with most of the loss due to the grip frame toning to purple / brown, high edge wear, minor freckling, handling marks and turn ring on the cylinder. The service trigger and hammer retain bold case-hardened colors with light operational wear. The diamond checkered walnut factory Magna grips with silver S&W medallions are numbered to the gun and rate near excellent with minor handling marks. The gun still times and locks up correctly and should make a good shooter or defensive gun for the recoil sensitive. (88896-21D33692) {C&R} (100/200)
1373. **SMITH & WESSON MODEL 12-2 MILITARY & POLICE AIRWEIGHT REVOLVER** serial #D379718, 38 Special, 2" pinned barrel with an excellent bore. The metal surfaces of this early 1970's-made revolver retain about 80% original blue and anodized finishes with most of the loss due to the cylinder which is a mottled mix of gray, brown and blue in addition to edge wear, scratches, oxidation stains, turn ring and pitting. The service trigger and hammer retain bold case-hardened colors with freckling and operational wear. The checkered walnut factory square butt grips with silver S&W medallions rate near excellent with light handling marks. The grips are numbered to another gun but it still times and locks up correctly. This gun should make a great concealed carry for those who like the sixth shot over the J frames. (88896-131D34208) {MODERN} (150/250)
1374. **SMITH & WESSON MODEL 10-5 MILITARY & POLICE REVOLVER** serial #2D02391, 38 Special, 4" pinned tapered barrel with an excellent bore. The metal surfaces of this later 1970's-made revolver retain about 96% original blue finish with light turn ring on the cylinder, high edge wear, backstrap thinning and handling marks. The service trigger and hammer retain robust case-hardened colors with very light freckling and operational wear. The checkered walnut factory square butt grips with silver S&W medallions are numbered to the gun and rate very good with a small chip missing on the left panels checkering border and a few other scuffs on the butts. The mainspring, hammer and hammer block have been removed but they are provided and the gun will probably need professional attention. (88896-11D33984) {MODERN} (100/200)
1375. **SMITH & WESSON MODEL 10-5 MILITARY & POLICE REVOLVER** serial #3D34597, 38 Special, 4" pinned tapered barrel with an excellent bore. The metal surfaces of this late 1970's-made revolver retain about 85% original blue finish with a turn ring on the cylinder, moderate high edge wear, grip frame toning to brown and handling marks. The service trigger and hammer appear to have been lightly cleaned to pewter with scattered light freckling and operational wear. The checkered walnut factory square butt grips with silver S&W medallions are numbered to the gun and rate very good to excellent with light handling marks. The gun still times and locks up correctly and should make a good all-around shooter or defensive gun. (88896-29D34175) {MODERN} (150/250)
1376. **SMITH & WESSON MILITARY & POLICE HAND EJECTOR REVOLVER** serial #C423281, 38 Special, 4" tapered barrel with an excellent bore. The metal surfaces of this late 1950's-made four-screw pre-model 10 revolver retain about 90% original blue with the backstrap toned to brown, high edge wear, handling marks and a turn ring on the cylinder. The service style trigger and hammer retain bold case-hardened colors with light operational wear and minimum freckling. The replacement checkered rubber Pachmayr "Gripper" grips rate about excellent. The crane and barrel are not numbered to the gun but all the other appropriate parts are. There are no factory rework marks found on the gun and those factory replacement parts were probably professionally installed. The gun still times and locks up correctly and should make a good shooter. (88896-14D33722) {MODERN} (200/300)
1377. **CUSTOM SMITH & WESSON SECOND MODEL 44 HAND EJECTOR REVOLVER** serial #19114, 44 Special, 3 1/2" tapered barrel with a lightly pitted bore. This 1922-made revolver has been customized and currently retains about 97% non-factory later applied nickel plate with limited high edge wear, oxidation stains, light freckling, handling marks, old pitting under the new finish and a turn ring on the cylinder. The service trigger and hammer have been nicked with about the same condition. The grips are replacement target style Fitz "StaGrip" faux stag that rate very good with light soiling, handling wear and a small check forming on the back of the right panel at the backstrap below the knuckle. The barrel was cut back to the current length, all appropriate parts are matching the gun and the hammer and mainspring has been removed but are provided. The gun will be in need professional services. (88896-15X12929) {MODERN} (300/500)
1378. **ROSSI MODEL 88-2 DOUBLE ACTION REVOLVER** serial #W078353, 38 Special, 2 1/8" barrel with an excellent bore. The stainless steel surfaces rate about good to very good with scattered light to moderate scratches, a moderate ding by the muzzle, turn ring and other handling marks. The serrated stainless steel combat trigger and semi-target hammer rate excellent. The checkered dark walnut factory grips with Rossi logo rate good with scattered dents and dings. The gun is still fully functional. (88896-157D33668) {MODERN} (100/200)
1379. **RUGER MK I SEMI-AUTO TARGET PISTOL** serial #17-26928, 22 LR, 6 7/8" tapered barrel with an excellent bore. This 1981-made pistol retains about 99% original blue finish. The checkered factory Delrin grips with silver Ruger Phoenix rate excellent. The pistol features an undercut Patridge front sight and black blade factory adjustable rear sight. It includes an unlabeled factory yellow and black hinged box, manual, paperwork and a single magazine. This pistol has seen very little use and is ready for a day of plinking, hunting or target shooting. (88896-106D33718) {MODERN} (200/300)
1380. **RUGER OLD MODEL SINGLE SIX REVOLVER** serial #130673, 22 LR, 5 1/2" barrel with an excellent bore. This 1959-made revolver retains about 90% original blue and anodized finishes with high edge wear, scratches, oxidized pitting and the frame toning to plum. The checkered hard rubber factory grips with black Ruger Phoenix rate very good plus with scattered worn diamond points and handling marks. Timing and lock up are excellent and the gun features a serrated half-moon front sight and drift adjustable rear sight. The transfer bar safety update has not been done to this gun. A nostalgic "six-gun" for the field. (88896-84D33985) {C&R} (150/250)
1381. **RUGER NEW MODEL SUPER SINGLE SIX REVOLVER** serial #65-04409, 22 LR, 6 1/2" barrel with an excellent bore. This 1977-made revolver retains about 96% original blue and anodized finishes with high edge wear and scratches. The smooth walnut factory grips with silver Ruger Phoenix rate very good plus with scattered handling marks. Timing and lock up are excellent and the gun features a serrated ramp front sight and adjustable rear sight. The gun has seen some honest use but should be great for the range or field. (88896-86D33598) {MODERN} (200/300)
1382. **RUGER OLD MODEL SINGLE SIX CONVERTIBLE REVOLVER** serial #21-18581, 22 LR / 22 Magnum, 6 1/2" barrel with an excellent bore. This 1972-made revolver retains about 98% original blue and anodized finishes with light edge wear, a few scratches and a turn ring on the cylinder. The 22 Magnum cylinder has a very light turn ring and several areas of oxidation and pitting. The smooth walnut factory grips with silver Ruger Phoenix rate very good with scattered handling marks. Timing and lock up are excellent and the gun features a serrated half-moon front sight and drift adjustable rear sight. The transfer bar safety update has not been done to this gun. A handy gun for the field. (88896-82D32756) {MODERN} (250/350)

1383. **HERITAGE ROUGH RIDER SINGLE ACTION REVOLVER** serial #HR27614, 22 Magnum, 4 3/4" barrel with an excellent bore. The metal surfaces retain about 96% original black finish with scattered light edge wear, scratches and thinning finish. The smooth hardwood factory grips rate very good to excellent with a few scattered handling marks. The revolver features an unfluted cylinder with caliber markings and fixed sights. The barrel is marked "22 LR" but the long rifle cylinder is not present. (88896-165D31438) {MODERN} (100/200)
1384. **RUGER NEW MODEL BLACKHAWK REVOLVER** serial #37-39313, 357 Magnum, 6 1/2" barrel with an excellent bore. The stainless steel surfaces rate about very good with scattered light to moderate scratches, turn ring on the cylinder and other handling marks. The smooth hardwood factory grips with silver Ruger Phoenix rate very good with scattered light dents and handling marks. The gun features a black ramp front sight and black blade adjustable rear sight. The gun still times and locks up correctly and should make a great field gun. (88896-78D33675) {MODERN} (300/500)
1385. **RUGER NEW MODEL BLACKHAWK REVOLVER** serial #32-30651, 357 Magnum, 6 1/2" barrel with an excellent bore. The metal surfaces retain about 97% original blue and anodized finishes with scattered light scratches, turn ring on the cylinder and high edge wear. The unmarked replacement smooth faux ivory grips rate excellent. The gun features a black ramp front sight and black blade adjustable rear sight. This gun still times and locks up correctly and should make a great field gun or good shooter. (88896-95D33866) {MODERN} (300/500)
1386. **RUGER NEW MODEL BLACKHAWK REVOLVER** serial #32-99909, 357 Magnum, 6 1/2" barrel with an excellent bore. The metal surfaces retain about 98% original blue and anodized finishes with a few light scratches, small dings on the butt, turn ring on the cylinder and edge wear. The smooth hardwood factory grips with silver Ruger Phoenix rate about excellent with a few minor handling marks. The gun features a black ramp front sight and black blade adjustable rear sight. This gun still times and locks up correctly and should make a great shooter. (88896-98D32630) {MODERN} (300/500)
1387. **RUGER NEW MODEL SUPER BLACKHAWK REVOLVER** serial #85-90881, 44 Magnum, 7 1/2" barrel with an excellent bore. The metal surfaces retain about 98% original blue and anodized finishes with the backstrap starting to thin, edge wear, turn ring on the cylinder and a few handling marks. The smooth walnut factory grips with silver Ruger Phoenix rate about excellent with a few minor handling marks. The gun features a black ramp serrated front sight, black blade adjustable rear sight and an unfluted cylinder. This revolver still times and locks up correctly and should make a great gun for the shooter or hunter. (88896-88D33290) {MODERN} (300/500)
1388. **RUGER NEW MODEL SUPER BLACKHAWK REVOLVER** serial #82-86231, 44 Magnum, 7 1/2" barrel with an excellent bore. The metal surfaces retain about 95% original blue and anodized finishes with the backstrap starting to thin, light to moderate edge wear, turn ring on the cylinder and other scattered handling marks. The smooth walnut factory grips with silver Ruger Phoenix rate about good with light to moderate dents, dings and scuffs. The gun features a serrated black ramp front sight, black blade adjustable rear sight and an unfluted cylinder. This revolver has seen some use but still times and locks up correctly. (88896-83D33206) {MODERN} (250/450)
1389. **RUGER NEW MODEL SUPER BLACKHAWK REVOLVER** serial #81-04770, 44 Magnum, 7 1/2" barrel with an excellent bore. The metal surfaces retain about 96% original blue and anodized finishes with the grip frame starting to thin, light edge wear, turn ring on the cylinder, limited pitting and other scattered handling marks. The smooth laminated hardwood factory grips with silver Ruger Phoenix rate about excellent with light handling marks. The gun features a serrated black ramp front sight, black blade adjustable rear sight and an unfluted cylinder. This revolver still times and locks up correctly and should be a good shooter. (88896-97D34133) {MODERN} (300/500)
1390. **SMITH & WESSON M&P BODYGUARD 380 SEMI-AUTO PISTOL** serial #EAT1669, 380 ACP, 2 3/4" barrel with an excellent bore. This pistol retains about 99% original black finish and the polymer frame rates excellent with a few minor assembly marks. The pistol features a serrated dovetail ramp front sight and Novak-style dovetailed rear sight and is equipped with a laser. The laser is not functioning but is probably in need of a battery. The pistol includes a pair of six-round factory magazines with finger rest floor plate. (88896-52D32639) {MODERN} (200/400)
1391. **SMITH & WESSON MODEL CS40 CHIEF SPECIAL SEMI-AUTO PISTOL** serial #EKW7741, 40 S&W, 3 1/4" barrel with an excellent bore. The metal surfaces retain about 98% original blue and anodized finishes with light high edge wear, scuff on knuckle and a few scratches. The pebble grain rubber Hogue factory grips with S&W logo rate good to very good showing light wear and light surface cuts on the upper right side. This pistol features Novak-style three dot sights, spurless hammer, slide mounted decocker/safety plus double and single action capability. The pistol includes a single factory magazine. A nice concealed carry gun. (88896-68D33760) {MODERN} (300/500)
1392. **RUGER STANDARD MODEL SEMI-AUTO PISTOL** serial #17-34676, 22 LR, 4 3/4" barrel with an excellent bore. This 1982-made pistol retains about 99% original blue finish with light edge wear and handling marks. The checkered Delrin factory grips with silver Ruger Phoenix medallion rate excellent. The pistol has a Patridge front sight and drift adjustable rear sight. It includes a pair of Ruger magazines and a Hunter model 1100P5 holster that rates about good. A nice little pistol ready for your next plinking session at the range. (88887-2) {MODERN} (150/250)
1393. **DETONICS POCKET 9 SEMI-AUTO PISTOL** serial #P3443, 9mm, 3" barrel with an excellent bore. The soft matte stainless steel surfaces rate near excellent with a small spot of oxidized pitting on the rear of the slide and an oxidation stain. The grooved black aluminum grips rate very good with a scuff on the left panel and scratches on the right. The pistol features double/single action, slide-mounted manual firing pin block, front sight is set into a slide length groove that also forms the rear sight and the front of the triggerguard is squared-off and grooved for finger forward hold. The pistol includes a single magazine. (88896-162D33688) {MODERN} (250/450)
1394. **THOMPSON CENTER CONTENDER "SUPER 14" SINGLE SHOT PISTOL** serial #113406, 41 Magnum, 14" bull barrel with an excellent bore. Super 14's were all the rage with silhouette shooters in the early years of the discipline. They had excellent adjustable sights, long sight radius and increased velocity which were important for knocking down the rams. The metal surfaces of this pistol retain about 99% original blue with limited edge wear. The smooth finger groove thumb rest walnut factory grip rates very good plus with lightly flaking finish. The smooth walnut forend rates about very good with scattered light dents. This gun features the later style hammer with lever style safety-selector on the hammer nose. The gun has a factory post front sight with angled top and silhouette style fully adjustable rear sight. In addition to silhouette shooters, hunters favored this style Contender for use on a variety of game. (88896-167D34168) {MODERN} (200/300)
1395. **SMITH & WESSON MODEL 17 K-22 MASTERPIECE REVOLVER** serial #K379577, 22 LR, 6" pinned barrel with an excellent bore. This 1959-made four-screw revolver has seen some heavy use over the years and currently retains about 70% original blue with the grip frame toned to brown, moderate high edge wear, scratches, dents, oxidation blemishes, a few minor pits and a turn ring on the recessed cylinder. The service trigger and hammer are gray with the occasional streak of case-hardened color showing operational wear and oxidation stains. The checkered walnut factory Magna grips with silver S&W medallions are numbered to another gun and rate good to very good with soiling, dents, dings and other handling marks. The front sight is a Patridge modified into a ramp with red insert, the rear is a white outline micro adjustable factory sight. There is a prominent dent on the sideplate, dings on the rear sight slide and the triggerguard is bent upwards. The gun still times and locks up correctly and remains fully functional. This gun has some "character" but still has plenty of life left in it. (88897-21D33045) {C&R} (200/400)

1396. **SMITH & WESSON M&P 40C SEMI-AUTO PISTOL** serial #DWS0757, 9mm, 3 1/2" barrel with an excellent bore. The metal surfaces retain about 99% original black finish and the polymer frame rates excellent. The pistol features three-dot night sights that no longer glow, ambidextrous slide stops and abbreviated picatinny rail on the dust cover. It includes the original factory hard case correctly end-labeled and numbered to the gun, (1) magazine with flat base, (1) magazine with finger rest base, replacement backstraps in small and large size, fired case, manual and paperwork. This gun appears to have seen little if any use. (88896-46D33929) {MODERN} (250/350)
1397. **SMITH & WESSON MODEL 642-1 AIRWEIGHT CENTENNIAL REVOLVER** serial #CTV8901, 1 7/8" barrel with an excellent bore. This revolver retains about 99% original frosted satin finish on the frame and the stainless steel surfaces of the barrel and cylinder rate excellent with a faint turn ring. The smooth M.I.M.'s combat trigger retains full case-hardened colors. The pebble grain rubber factory boot grips with S&W logo rate excellent. The gun includes a factory box that is correctly end-labeled and numbered to the gun, manual and paperwork. The gun appears to have seen little use and would make a great concealed carry gun. (88896-30D34243) {MODERN} (300/500)
1398. **SMITH & WESSON MODEL 22A-1 SEMI-AUTO PISTOL** serial #UBT5047, 22 LR, 5 1/2" bull barrel with an excellent bore. The metal surfaces retain about 99% original applied Real Tree camouflage. The synthetic factory finger rest grips also retain about 99% original applied Real Tree camouflage. The gun has a solid full-length rail with built in Weaver style mounts featuring a Patridge front sight and black blade fully adjustable rear sight. The pistol includes a factory hard case that is correctly end-labeled and numbered to the gun, a pair of factory magazines, fired case, a pair of spare recoil spacers, manual and paperwork. This appears to have seen little if any use. It is optics ready and should make a good all-around gun for a variety of shooting tasks. (88896-32D34258) {MODERN} (250/350)
1399. **RUGER NEW MODEL SUPER SINGLE SIX REVOLVER** serial #63-55583, 22 LR, 5 1/2" barrel with an excellent bore. The metal surfaces retain about 99% original blue and anodized finishes with scattered light scratches and a light turn ring on the cylinder. The smooth walnut factory grips with silver Ruger Phoenix medallions rate very good to excellent with light handling marks. The gun features a ramp front sight and adjustable rear sight. Due to timing or other issues the revolver will not cock consistently and will be in need of professional services or a trip back to the factory. (88897-17D33392) {MODERN} (100/200)
1400. **RUGER NEW MODEL SUPER SINGLE SIX REVOLVER** serial #62-65288, 22 Magnum, 6 1/2" barrel with an excellent bore. The metal surfaces retain about 80% original blue and anodized finishes with the backstrap and the sides of the triggerguard strap buffed in-the-white in addition to moderate high edge wear, scratches, oxidation stains and the finish fading overall from handling and holster wear. The smooth walnut factory grips with silver Ruger Phoenix medallions rate good to very good as lightly refinished with light handling wear. The gun features a ramp front sight, adjustable rear sight and the top strap has a pair of holes drilled and tapped for a scope mount. The gun has seen moderate use but still times and locks up correctly. (88897-19X12496) {MODERN} (100/200)
1401. **RUGER SECURITY-SIX DOUBLE ACTION REVOLVER** serial #152-43668, 357 Magnum, 4" barrel with an excellent bore. The metal surfaces retain about 95% original blue with light edge wear, scratches, the bottom of the triggerguard has toned to brown and the cylinder is fading to plum. The unmarked replacement checkered hardwood grips rate very good to excellent with light handling marks. The gun features a serrated ramp front sight and black blade adjustable rear sight. Timing and lock up are excellent and it should make a good all-around shooter. (88896-81D33871) {MODERN} (200/300)
1402. **COLT TROOPER 357 DOUBLE ACTION REVOLVER** serial #35226, 357 Magnum, 4" heavy barrel with an excellent bore. The metal surfaces of this 1962-made revolver retain about 99% non-factory reapplied blue finish with a faint turn ring on the cylinder and old pitting visible under the new finish. The checkered walnut factory target grips with silver Rampant Colt medallions rate good to very good with scattered chipped diamond points on the left panel plus other handling marks. The gun features a serrated ramp front sight, Colt Accro rear sight, service trigger, service hammer and the barrel is marked "TROOPER 357". The crane lock detent refuses to move and the crane lock spring is missing. A little time and Kroil should free up the detent and it should make a good shooter. (88897-3D34217) {C&R} (200/400)
1403. **SMITH & WESSON M&P 9 SEMI-AUTO PISTOL** serial #DWJ4604, 9mm, 4 1/4" barrel with an excellent bore. The metal surfaces retain about 99% original black finish and the polymer frame rates excellent. The pistol features three dot sights, ambidextrous slide stops and Picatinny rail on the dust cover. The gun includes a factory hard case that is correctly end-labeled and numbered to the gun, a pair of ten-round magazines, UpLULA magazine loader/unloader, chamber flag and fired case. A multi-use handgun that has seen only light use. (88896-42D33899) {MODERN} (250/350)
1404. **SMITH & WESSON M&P 9 SEMI-AUTO PISTOL** serial #HAF5722, 9mm, 4 1/4" barrel with an excellent bore. The metal surfaces retain about 99% original black finish and the polymer frame rates excellent. The pistol features three dot sights, ambidextrous slide stops and a Picatinny rail on the dust cover. The gun includes a factory hard case that is correctly end-labeled and numbered to the gun, (3) ten-round magazines, factory Blade-Tech Kydex holster, Blade-Tech double magazine pouch, UpLULA magazine loader/unloader, chamber flag, fired case, factory earplugs, cable lock with a pair of keys, manual and paperwork. This handgun appears to have seen only light use and should make a good shooter. (88896-43D34054) {MODERN} (300/500)
1405. **HIGH STANDARD MODEL GD SEMI-AUTO TARGET PISTOL** serial #323920, 22 LR, 6 3/4" barrel with an excellent bore. The metal surfaces retain about 85% original blue with most of the loss due to the grip frame toned to light gray in addition to high edge wear, scratches and other handling marks. The checkered hardwood factory grips rate good with flattened diamond points, scuffs, gouges and other handling marks. The pistol features the lever style barrel takedown, Patridge front sight and adjustable rear sight. It includes a single two-tone factory magazine. (88897-13D33583) {C&R} (250/450)
1406. **HIGH STANDARD MODEL 107 MILITARY SUPERMATIC CITATION SEMI-AUTO PISTOL** serial #2171403, 22 LR, 5 1/2" bull barrel with an excellent bore. The metal surfaces retain about 80-85% original blue with most of the loss due to the grip frame worn to pewter in addition to high edge wear, some surfaces starting to fade to brown, scratches and other handling marks. The trigger has strong case-hardened colors with light freckling. The checkered walnut factory thumb rest grips rate about very good with light scattered diamond point compression, handling marks and tiny dings. The rear sight blade is bent and the extractor, extractor plunger and extractor spring are missing. It includes a single factory magazine with red synthetic floorplate extension. (88897-12D33337) {MODERN} (200/300)
1407. **RUGER LC9 SEMI-AUTO PISTOL** serial #320-83864, 9mm, 3 1/8" barrel with an excellent bore. The metal surfaces retain about 97% original blue that is fading to purple along with high edge wear, scratches and minor freckling. The polymer frame rates near excellent with some light handling wear. The pistol features dovetailed three dot sights, manual safety, loaded chamber indicator and double action only. The pistol includes a single factory magazine with finger rest floorplate. This gun would be good for concealed carry. (88900-11S21340) {MODERN} (200/300)

1408. **RUGER 22/45 MK III SEMI-AUTO PISTOL** serial #228-25317, 22 LR, 5 1/2" bull barrel with an excellent bore. The metal surfaces retain about 80% original blue with barrel having been partially cleaned resulting in a circumferential series of scratches and a mix of pewter and blue, heaviest toward the muzzle. The polymer frame rates excellent. The front sight is loose and the screw appears to be incorrect as it bottoms before it secures the blade. Included is a single magazine. It will not be pretty but a little cold blue on the barrel and new front sight screw and you should have a good shooter. (88897-16D33923) {MODERN} (100/200)
1409. **BERETTA MODEL 92FS SEMI-AUTO PISTOL** serial #BER598657, 9mm, 5" barrel with an excellent bore. The metal surfaces retain about 97% original Beretta Bruniton finish with the grip frame showing signs of thinning, high edge wear and scratches. The checkered synthetic factory grips with Beretta logo rate excellent. It features three dot sights, ambidextrous slide mounted safety/de-cockers and a lanyard loop. No magazine is provided but they are readily available. (88900-55S21523) {MODERN} (300/500)
1410. **BERETTA MODEL 92F SEMI-AUTO PISTOL** serial #BER050664Z, 9mm, 5" barrel with an excellent bore. The metal surfaces retain about 97% original Beretta Bruniton finish with high edge wear and scratches. The replacement checkered rubber wraparound Pachmayr grips with gold Pachmayr logo rate excellent. The gun features von Stavenhagen-style sights, ambidextrous slide-mounted safety/de-cockers and a lanyard loop. A single factory magazine is provided. (88896-188D33940) {MODERN} (300/500)
1411. **BERETTA MODEL 96D SEMI-AUTO PISTOL** serial #BER066251M, 40 S&W, 5" barrel with an excellent bore. The metal surfaces retain about 97% original Beretta Bruniton finish with the grip frame showing signs of thinning, high edge wear and scratches. The checkered synthetic factory grips with Beretta logo rate about very good with scattered light diamond point compression and a few other handling marks. It features three-dot night sights that no longer glow, spurless hammer, double action only and a lanyard loop. A single factory magazine is provided. (88896-187D34176) {MODERN} (300/500)
1412. **RUGER SR22 SEMI-AUTO PISTOL** serial #363-11518, 22 LR, 3 1/2" barrel with an excellent bore. The metal surfaces retain about 99% original black finish and the polymer frame rates excellent. The gun features three dot fully adjustable sights, ambidextrous frame-mounted safety/de-cocker, interchangeable grip and ambidextrous magazine release to name a few. The pistol includes the original factory box that is correctly end-labeled and numbered to the gun, a pair of magazines, small rubberized grip, (2) spare flat floorplates (finger extension floorplates installed), open packet with fired case, chamber flag, Ruger-marked nylon soft case and paperwork. This gun appears to have seen little use and would be great for plinking or training. (88900-36S21514) {MODERN} (200/300)
1413. **SMITH & WESSON MODEL 5903 SEMI-AUTO PISTOL** with Atlanta Georgia P.D. Markings serial #TEC8407, 9mm, 4" barrel with an excellent bore. The metal surfaces rate about good with moderate edge wear, scratches and holster wear on the stainless steel surfaces and satin finished aluminum frame. The sides of the triggerguard show heavy wear apparently from the Bianchi "Pinch" style holsters used by A.P.D. The checkered black synthetic wraparound factory grips with S&W logo rate about good showing moderate wear and handling marks. The A.P.D. pistols were factory equipped with a spurless hammer with cocking serrations on the top, ambidextrous slide mounted safety/de-cockers, Trijicon three dot sights that no longer glow, double/single action capability, fourteen round magazines and a squared off triggerguard. The right side of the frame is marked "ATLANTA POLICE" and a single fourteen-round magazine is provided. A nice find for the police firearms collector. (88896-66D34146) {MODERN} (250/450)
1414. **SMITH & WESSON MODEL 6906 SEMI-AUTO PISTOL** serial #VCK2100, 9mm, 3 1/2" barrel with an excellent bore. The metal surfaces rate about excellent with light edge wear and handling marks on the stainless steel surfaces and satin finished aluminum frame. The checkered black synthetic wraparound factory grips with S&W logo rate about very good showing light handling marks. The pistol is equipped with a spurless hammer without cocking serrations on the top, ambidextrous slide mounted safety/de-cockers, three dot Novak-style sights, double/single action capability and a rounded triggerguard with checkered front. Provided are a single twelve-round stainless steel factory magazine with finger extension floorplate and a single twelve-round blue-finished factory magazine also with finger extension floorplate. A nice concealed carry handgun. (88896-212D32538) {MODERN} (250/450)
1415. **SMITH & WESSON MODEL 910S SEMI-AUTO PISTOL** serial #BDK4848, 9mm, 4" barrel with an excellent bore. The 910S was designed as a value version of the higher priced 5900 series. The metal surfaces rate about excellent with light edge wear and handling marks on the stainless steel surfaces and satin finished aluminum frame. The checkered black synthetic wrap-around factory grips with S&W logo rate near excellent showing a few handling marks. The pistol is equipped with a single slide mounted safety/de-cocker and three dot Novak-style sights. A single ten-round factory magazine is provided. It should be a good shooter. (88896-70D33678) {MODERN} (200/300)
1416. **SMITH & WESSON MODEL 59 SEMI-AUTO PISTOL** serial #A369333, 9mm, 4" barrel with an excellent bore. The metal surfaces retain about 97% original blue and anodized finishes with scattered high edge wear and light scratches. The checkered synthetic factory grips with S&W logo rate very good with light scuffing and scratches. The pistol features a yellow insert front sight, windage adjustable white outline rear sight, single slide mounted safety/de-cocker and a lanyard loop. The pistol includes a single factory magazine. It should be a good shooter. (88896-71D33991) {MODERN} (250/350)
1417. **SMITH & WESSON MODEL 459 SEMI-AUTO PISTOL** serial #A731174, 9mm, 4" barrel with an excellent bore. The metal surfaces retain about 99% original nickel plate and blue finishes with scattered light scratches. The hammer, trigger and other controls are blue finished. The replacement checkered rubber Pachmayr grips rate about excellent with very light handling wear. The pistol features a nickel-plated Baughman ramp front sight, adjustable black blade rear sight with protective "ears", single slide mounted safety/de-cocker and a lanyard loop. The pistol includes a single factory magazine. A nice example of one of the early "wonder nines". (88896-62D34143) {MODERN} (300/500)
1418. **SMITH & WESSON MODEL 459 SEMI-AUTO PISTOL** serial #TBB0308, 9mm, 4" barrel with an excellent bore. The metal surfaces retain about 97% original blue and anodized finishes with scattered light scratches and edge wear. The smooth goncalo alves factory grips with silver S&W medallions rate good with the finish starting to cloud, crazing, scratches and minor flaking. The pistol features a Baughman ramp front sight, adjustable black blade rear sight with protective "ears" and a single slide mounted safety/de-cocker. The pistol includes a single factory magazine. The mainspring has been removed but is provided and the gun will need professional attention. (88896-58D33719) {MODERN} (200/300)
1419. **SMITH & WESSON MODEL 48-4 K-22 MAGNUM MASTERPIECE REVOLVER** serial #76K6954, 22 Magnum, 6" pinned barrel with an excellent bore. This 1980-made gun retains about 99% non-factory reapplied blue finish with a light turn ring on the cylinder. The .500" target hammer and replacement smooth .400" semi-target trigger have been buffed and engine turned on the sides. The hammer still shows robust case-hardened colors on the top and back and the trigger has full hard chrome finish remaining on the face and back. The checkered walnut factory target grips with silver S&W medallions rate very good to excellent with some light scuffing and chipping on the toe of the right panel. The gun features a red ramp front sight and white outline micro adjustable rear sight. It still times and locks up correctly and should make a great field gun. (88923-7) {MODERN} (350/550)

1420. **SMITH & WESSON MODEL 31-1 REGULATION POLICE REVOLVER** serial #H51392, 32 S&W Long, 4" pinned barrel with an excellent but bulged bore. The bulge is about a third of the way from the breech end of the barrel. The metal surfaces retain about 95% original blue with most of the loss due to edge wear at the muzzle and on the cylinder plus there is a turn ring on the cylinder and handling marks. The service trigger and hammer retain bold case-hardened colors with light operational wear. The replacement checkered rubber finger groove Pachmayr "Gripper" grips rate excellent. The gun still times and locks up correctly and should be a fun shooter. (88923-10) {MODERN} (200/300)
1421. **RUGER SECURITY-SIX DOUBLE ACTION REVOLVER** serial #159-46679, 357 Magnum, 6" barrel with an excellent bore. The stainless steel surfaces rate very good plus with scattered light scratches and a light turn ring on the cylinder. The replacement checkered rubber finger groove Pachmayr "Gripper" grip rates near excellent with minor handling wear. The revolver features a red ramp front sight and black blade adjustable rear sight. It still works mechanically and should make a good gun for the shooter or outdoorsman. (88852-59) {MODERN} (200/300)
1422. **CHARTER ARMS OFF DUTY DOUBLE ACTION REVOLVER** serial #901459, 38 Special, 1 7/8" barrel with an excellent bore. The satin stainless steel surfaces rate excellent with a turn ring on the cylinder. The smooth hardwood factory grips with Charter Arms silver medallions rate excellent. The gun still times and locks up correctly, has a small orange dot on the semi-ramp front sight and appears to have seen only light use. It should make a great concealed carry gun. (88852-66) {MODERN} (150/250)
1423. **REMINGTON NEW MODEL 1858 PERCUSSION REVOLVER BY ARMI SAN MARCO** serial #B61029, .44 cal., 8" octagon barrel with an excellent bore. The stainless steel surfaces rate very good to excellent with scattered light scratches and a turn ring on the cylinder. The brass triggerguard strap rates excellent but is tarnished. The smooth walnut factory grips are numbered to the gun and rate excellent. (88852-56) {ANTIQUÉ} (75/150)
1424. **ITALIAN REPLIC COLT MODEL 1860 ARMY-STYLE PERCUSSION REVOLVER** serial #112, .44 cal., 7 1/2" octagon barrel with an excellent bore. The cylinder and barrel retain about 95% original blue with several oxidation blemishes and handling marks. The brass frame and grip frame rate about excellent and have toned to goldenrod but several areas show heavier tarnish. The case-hardened colors on the loading arm are present but remain light. The gun does not time and is in need of professional services. (88852-54) {ANTIQUÉ} (25/75)
1425. **TAURUS MODEL 416 RAGING BULL REVOLVER** serial #XD184671, 41 Magnum, 6 1/2" full lug ventilated rib factory ported barrel with an excellent bore. The satin stainless steel surfaces rate excellent with some light high edge wear and a few other handling marks. The smooth stainless steel semi-target trigger and hammer rate excellent. The replacement one-piece rubber finger groove Pachmayr Diamond Pro grips rate excellent. The gun features a Patridge front sight and fully adjustable black blade rear sight. This large and heavy handgun should be excellent for hunting or silhouette. (88852-60) {MODERN} (400/600)
1426. **SCARCE RUGER NEW MODEL BLACKHAWK REVOLVER** serial #48-21873, 45 Colt, 5 1/2" barrel with an excellent bore. New Model Blackhawks in this configuration are considered scarce. This is a great find for the Ruger collector and a handy gun for the outdoorsman. The stainless steel surfaces rate very good to excellent with light scuffing on the right side of the topstrap, muzzle wear, scratches and a turn ring on the cylinder. The laminated hardwood factory grips with silver Ruger Phoenix rate near excellent with a few light handling marks. The gun features a serrated black ramp front sight and black blade adjustable rear sight. This gun should make a great shooter or fine field gun. (88852-63) {MODERN} (400/600)
1427. **RUGER MODEL P91DC SEMI-AUTO PISTOL** serial #340-10954, 40 S&W, 4 1/2" barrel with an excellent bore. The matte and polished stainless steel surfaces rate very good plus with scattered fine scratches, assembly marks and other handling wear. The replacement rubber finger groove pebble grain Hogue wraparound grips rate excellent. This pistol features an ambidextrous slide mounted de-cocker, three dot sights, ambidextrous magazine release and lanyard loop. It includes a pair of factory magazines. (88852-65) {MODERN} (200/400)
1428. **THOMPSON CENTER G2 CONTENDER SINGLE SHOT PISTOL** serial #G8886, 22 LR Match, 14" bull barrel with an excellent bore. The metal surfaces retain about 95% original blue with most of the loss due to the underside of the barrel showing thinning finish from light cleaning, oxidized pitting and other handling marks. The replacement checkered rubber finger groove Pachmayr pistolgrip and the checkered rubber Pachmayr forend rate excellent. The pistol has no sights but a stainless steel Millett Weaver style scope base has been installed and the hammer has an extension for easier cocking when scoped. The pistol also features a match 22 LR chamber, overtravel stop mounted on the triggerguard, later style hammer with selector/safety mounted on the nose and a sling swivel stud on the butt. This pistol but should be capable of fine accuracy from a rested position. (88923-9) {MODERN} (250/350)
1429. **RUGER NEW MODEL BLACKHAWK REVOLVER** serial #33-39431, 357 Magnum, 6 1/2" barrel with an excellent bore. The stainless steel surfaces rate about good with scattered fine scratches, scuffs, edge wear and a few tool marks. The grips are unmarked hand-filling replacement stag that rate excellent. The original ramp front sight and adjustable rear sight are present but the topstrap has been drilled and tapped with knurled hex head screws present. There is an added block soldered to the barrel with the same style screw present. There is also a small detent drilled into the right side of the hammer and was probably used to secure a hammer extension when a scope was mounted. The iron sights are usable with the screws in place. (88923-12) {MODERN} (150/250)
1430. **HIGH STANDARD MODEL H-D MILITARY SEMI-AUTO PISTOL** serial #261976, 22 LR, 6 3/4" barrel with an excellent bore. The metal surfaces of this pistol retain about 99% professionally re-applied blue finish with a small spot of oxidized pitting on the barrel plus a few light handling marks. The checkered walnut factory grips rate very good with a few scattered light dings on the diamond points. The pistol includes a single magazine. If you want a nice shooter this should fill the bill nicely. (88873-405) {C&R} (200/300)
1431. **HIGH STANDARD MODEL B SEMI-AUTO PISTOL** serial #52981, 22 LR, 6 3/4" barrel with an excellent bore. The metal surfaces are a mix of pewter and brown with scattered oxidation blemishes, light pitting and handling marks. The checkered hard rubber factory grips with High Standard logo rate about good with scattered light diamond point compression, dings and wear. The recoil spring is in need of attention as it appears weak but may be due to oxidation in the mechanism that could use a good cleaning. It includes a single two-tone magazine. This should make a good project gun. (88873-323) {C&R} (75/150)
1432. **HIGH STANDARD MODEL A SEMI-AUTO PISTOL** serial #38073, 22 LR, 6 3/4" barrel with an excellent bore. The metal surfaces are a mix of smoky gray and brown with traces of original blue finish in the protected areas for a roughly 5% rating. The surfaces show light cleaning in places along with scattered oxidation blemishes, light pitting and handling marks. The smooth walnut factory grips rate excellent as refinished and there is a U.S. dime inserted on each panel. The slide stop is missing but the gun features the scarce Type I-B takedown. It includes a single magazine. (88873-114) {C&R} (100/200)

1433. **HIGH STANDARD DOUBLE NINE LONGHORN REVOLVER** serial #1297245, 22 LR, 9 1/2" barrel with an excellent bore. The metal surfaces of this series W-104 revolver retain about 97% original blue and anodized finishes with high edge wear, scratches, oxidation blemishes and a turn ring on the unfluted cylinder. The smooth hardwood factory grips with gold High Standard medallions rate very good to excellent with light scuffing on the edges of the butt. The revolver features a drift adjustable rear sight, half-moon front sight that has been "regulated", swing out cylinder with spring loaded extractor and double/single action capabilities. The double action is heavy but it should be a fun gun to shoot in single action mode. (88873-490) (MODERN) (300/500)
1434. **HIGH STANDARD DOUBLE NINE REVOLVER** serial #1082544, 22 LR, 5 1/2" barrel with an excellent bore. The metal surfaces of this series W-101 revolver retain about 90% original blue and anodized finishes with the receiver toned to gray, moderate wear on the recoil shields, high edge wear, scratches and a turn ring on the fluted cylinder. The smooth faux ivory factory grips with gold High Standard medallions rate about very good with scattered light handling marks. The revolver features a drift adjustable rear sight, half-moon front sight, swing out cylinder with non-spring-loaded extractor and double/single action capabilities. (88873-534) (MODERN) (150/250)
1435. **HIGH STANDARD DOUBLE NINE CONVERTIBLE REVOLVER** serial #M059243, 22 Magnum, 5 1/2" barrel with an excellent bore. The metal surfaces retain about 95% original nickel plate with most of it starting to cloud in addition to edge wear, scattered fine scratches, oxidation blemishes around the front sight and a turn ring on the unfluted cylinder. The smooth hardwood factory grips with gold High Standard medallions rate excellent but have shrunk and show a few light handling marks. The revolver features a drift adjustable rear sight, half-moon front sight, swing out cylinder with spring loaded extractor and double/single action capabilities. The 22 LR cylinder is not provided. (88873-481) (MODERN) (150/250)
1436. **HARRINGTON & RICHARDSON MODEL 949 "FORTY NINER" REVOLVER** serial #AC24840, 22 LR, 5 1/2" barrel with an excellent bore. The metal surfaces of this 1969-made gun retain 99% original blue finish with minor oxidation stains and a turn ring on the cylinder. The smooth one-piece hardwood grip rates near excellent with a few minor handling marks. This gun is a hybrid of a double and single action revolver and features single action revolver style loading gate requiring one-at-a-time loading and ejection. It also features a half-moon front sight and drift adjust rear sight. This looks like it would be a fun little gun to shoot. (88873-441) (MODERN) (150/250)
1437. **TAURUS PT 92C SEMI-AUTO PISTOL** serial #TKL26455/CD, 9mm, 4" barrel with an excellent bore. The metal surfaces retain about 99% original blue and anodized finishes with very light high edge wear and scratches. The smooth walnut factory grips with gold Taurus medallions rate near excellent with a few light scratches and handling marks. The gun features three dot sights, frame mounted ambidextrous safeties/de-cockers that allow a variety of carry modes and double/single action capabilities. A nice size gun for all-around use. (88873-115) (MODERN) (300/500)
1438. **TAURUS MODEL 66 DOUBLE ACTION REVOLVER** serial #KF452195, 357 Magnum, 4" heavy barrel with an excellent bore. The stainless steel surfaces rate near excellent with scattered light handling marks, edge wear and a turn ring on the cylinder. The smooth semi-target trigger and service hammer rate excellent. The checkered hardwood factory grips with Taurus medallions rate about very good with some scuffing on the toe of both panels. The gun features a red ramp front sight and white outline adjustable rear sight. The gun includes a factory hard case that is unlabeled. A good all-around gun for the range, defense and the field. (88873-321) (MODERN) (250/350)
1439. **TAURUS 45/410 "THE JUDGE" REVOLVER** serial #CM731461, 45 Colt/410 Bore, 3" barrel with an excellent bore. This Judge will accept 3" 410 shotshells. The metal surfaces retain about 99% original blue with a few minor handling marks and a light turn ring on the cylinder. The smooth combat style trigger and semi-target hammer retain strong case-hardened colors. The cushion rib rubber one-piece factory grip with Taurus medallions rate excellent. The revolver features a fiber optic insert front sight and fixed rear sight. The gun includes a factory box that is correctly end-labeled and numbered to the gun, trigger lock with a single key, a pair of internal lock keys, Allen key, silicon cloth, manual and paperwork. (88871-12) (MODERN) (300/500)
1440. **SIG SAUER MOSQUITO SEMI-AUTO PISTOL** serial #A038939, 22 LR, 4 5/8" threaded barrel with an excellent bore. The metal surfaces retain about 99% original black finish and the polymer frame rates excellent. The textured synthetic factory grips with Sig logo rate excellent. It features three dot sights, frame mounted de-cocker, slide mounted safety and threaded barrel with thread cover. It includes a factory hard case correctly end-labeled and numbered to the gun, a single magazine, wrench for thread cover, spare recoil spring, spare different height front sights, front sight tool, lubricant, chamber flag, cable lock with a pair of keys and manual. This gun appears to have little if any use and should make a nice little gun for plinking or training. (88873-380) (MODERN) (250/350)
1441. **MAVERICK FIREARMS MODEL JS-9MM SEMI-AUTO PISTOL** serial #016291, 9mm, 4 1/2" barrel with an excellent bore. This pistol retains about 97% original black enamel and crackle paint with several areas worn to bare metal on the right front of the slide. The textured black synthetic grips rate excellent. This big blowback pistol includes a factory "Tupperware" box that is labeled with the gun's information on the cover and a single magazine. (88873-372) (MODERN) (75/150)
1442. **SMITH & WESSON MODEL 422 SEMI-AUTO TARGET PISTOL** serial #TFN5096, 22 LR, 6" barrel with an excellent bore. The metal surfaces retain about 99% original blue and anodized finishes. The checkered walnut factory grips with gold S&W medallions rate excellent. This pistol features a Baughman ramp front sight, black blade micro adjustable rear sight and frame mounted thumb safety. The pistol includes a factory box that is correctly end-labeled and numbered to the gun, a pair of magazines, takedown tool and manual. This pistol appears to have seen little use and would be a fun gun for the range or the field. (88873-482) (MODERN) (300/500)
1443. **SMITH & WESSON MODEL 681 DISTINGUISHED SERVICE MAGNUM REVOLVER** serial #AAK9223, 357 Magnum, 4" full lug barrel with an excellent bore. The stainless steel surfaces rate about very good with high edge wear, scratches, turn ring on the cylinder and other handling marks. The service trigger and hammer retain full hard chrome finish. The replacement rubber pebble grain finger groove Hogue Monogrips rate very good to excellent with light wear but are not the correct size for this frame and are for an N frame revolver. The gun still times and locks up correctly and the front sight has been "regulated". It includes a factory hard case that is labeled and numbered to another gun. (88873-28) (MODERN) (200/400)
1444. **RUGER STANDARD MODEL SEMI-AUTO PISTOL** serial #13-36276, 22 LR, 6" barrel with an excellent bore. The metal surfaces retain about 90% original blue with most of the wear along the grip frame in addition to high edge wear, scratches and other handling marks. The checkered Delrin factory grips with silver Ruger Phoenix medallion rate about very good with light diamond point wear. The pistol includes a single factory magazine. (88873-395) (MODERN) (100/200)
1445. **COLT PRE-WOODSMAN TARGET SEMI-AUTO PISTOL** serial #4739, 22 LR, 6 5/8" barrel with a bright bore showing light scattered pitting. The metal surfaces of this 1917-made pistol retain about 97% non-factory reapplied nickel plate with some light flaking on the barrel and backstrap. The unmarked replacement black synthetic grips with decorative oakleaf and acorns pattern on the panels rate excellent. The pistol has the original windage adjustable rear sight and elevation adjustable bead front sight. It includes a single two-tone factory magazine. (88873-41) (MODERN) (200/400)

1446. **COLT POLICE POSITIVE SPECIAL REVOLVER** serial #726635, 38 Special, 4" barrel with an excellent bore. This 1959-made gun retains about 30% original blue finish with most of the surfaces toned to smoky gray, the strongest remaining finish on the cylinder and portions of the barrel, plus there is a turn ring on the cylinder and handling marks. The checkered walnut factory grips with silver Rampant Colt medallions rate about good as lightly re-varnished with moderate to heavy diamond point wear. Timing and lock up remain excellent and it should make a good shooter. (88873-168) {C&R} (100/200)
1447. **COLT POLICE POSITIVE SPECIAL REVOLVER** serial #44573, 32-20 W.C.F., 4" barrel with an oxidized and pitted bore. This 1911-made gun is mostly brown with traces of original blue in the protected areas, widespread oxidized pitting and handling marks. There are traces of nitre blue present on the trigger and hammer but have mostly toned to gray with oxidation stains. The checkered fleur-de-lis hard rubber factory grips with stylized "C" around the escutcheons rate near excellent. The left panel is numbered to the gun but the right is not and the metal is slightly proud of the panel at the butt. The gun still functions correctly. (88873-107) {C&R} (100/200)
1448. **REMINGTON MODEL 51 SEMI-AUTO PISTOL** serial #PA18964, 380 ACP, 3 1/4" barrel with a very good bore showing some light oxidation, minor frosting and strong rifling throughout. The metal surfaces of this pistol retain about 65-70% original blue thinning throughout with moderate high edge wear, gripstraps toning to gray patina, scattered freckling and handling marks. There are a few moderate dings at the rear of the slide and a small ding at the top edge of the ejection port. The safety and magazine release still retain some strong remnants of nice fire blue. The black checkered hard rubber grips remain in very good plus condition showing a few small dings, scuffs, light staining and handling marks. This variation has nine wide slide serrations and no caliber marking on the chamber. The pistol seems to function well mechanically and includes one original magazine. (136520-951) {C&R} [Richard "Stretch" Kennedy Collection] (350/550)
1449. **MAUSER MODEL 1914 SEMI-AUTO PISTOL** serial #283362, 32 ACP, 3 1/2" barrel with a fair bore showing oxidation, moderate pitting and some good rifling throughout. The metal surfaces of this pistol retain about 80% mix of original and older reapplied blue with some spots on the frame, top of the slide and sideplate showing what appear to be remnants of older reapplied blue toning to a blue-gray patina and a few pinprick pits underneath the finish on the sideplate. The remaining surfaces show some moderate high edge wear, tiny pinprick pits, scattered freckling and some small dings here and there. The trigger retains some faint remnants of original fire blue and the markings remain mostly crisp and visible. The one piece checkered walnut grip remains in about good-very good condition showing an added coat of varnish, a repaired 3" crack at the rear, some smoothed-over small chips and handling marks. The mechanism seems to function well mechanically and the pistol includes one original magazine. (136520-117) {C&R} [Richard "Stretch" Kennedy Collection] (200/400)
1450. **WINCHESTER MODEL 1910 SEMI-AUTO RIFLE** serial #15496, 401 SL, 20" barrel with a very good bore showing some light oxidation and strong rifling throughout. The metal surfaces of this rifle retain about 65-70% original blue with moderate spots of dried preservative throughout, high edge wear, areas flaking to gray-brown patina and some light pinprick pitting. The smooth pistolgrip walnut buttstock and forend remain in fair condition, the buttstock fitted a little loose, 5 1/2" cracks at the top edge of either side of the forend, 2" u-shaped crack at the upper tang, some further scattered scratches, dings and handling marks. The buttstock is fitted with a vintage Red Head red rubber ventilated buttplate that shows cracking at the toe and light staining. The rifle seems to function well mechanically and includes one original magazine. (136520-2283) {C&R} [Richard "Stretch" Kennedy Collection] (300/500)
1451. **WINCHESTER MODEL 1907 FANCY SEMI-AUTO SPORTING RIFLE** serial #22452, 351 SL, 20" barrel with a bright near excellent bore. The metal surfaces of this rifle retain about 80% older reapplied blue showing some moderate scratches and thinning to gray patina along the barrel, high edge wear, light oxidation staining scattered about and a few pinprick pits. Some areas show evidence of light buffing but the markings are still quite clear. The deluxe checkered pistolgrip buttstock and forend remain in good-very good condition as refinished long ago showing an added varnish, some moderate scratches, thin 1 1/2", 2" and 3" hairline cracks behind the nosecap, light dings and handling marks. The wood still shows some nice grain figure throughout despite the refinishing. The original black hard rubber buttplate and pistolgrip cap are present showing some overall smoothing, a small shallow chip at the toe and minor discoloration. There is a sling swivel stud present on the toe line but the stud for the nose cap is missing. The rifle is sighted with a Marble's semi-buckhorn rear leaf, the elevator is missing its screw and a Marble's No. 6 ivory bead front. No magazine is included and the mechanism seems to function well mechanically. A rather well-used but good representative example of the more deluxe fancy sporting rifle. (136520-3582) {C&R} [Richard "Stretch" Kennedy Collection] (350/550)
1452. **SAVAGE SPORTER 23C BOLT ACTION RIFLE** serial #74667, 32-20, 25" barrel with a bright excellent bore. The metal surfaces of this rifle are mostly a light gray patina showing small spots of light oxidation staining and freckling scattered about. The smooth pistolgrip walnut stock with schnabel tip remains in very good condition as refinished long ago showing a 5 1/2" scratch on the left side butt, a small piece of old stubborn tape on the left side, smaller dings and handling marks. The original front sight is present but the rear is filled-in with a blank and a Weaver C4 rifle scope is mounted to the receiver and features a crosshair reticle and slightly discolored but very good optics. One original magazine showing some small dings is included and the rifle seems to function well mechanically. (136520-2690) {C&R} [Richard "Stretch" Kennedy Collection] (150/250)
1453. **REMINGTON NO. 4 ROLLING BLOCK RIFLE** serial #J216562, 22 RF, 22 1/2" octagon barrel with a very good bore showing a few spots of light oxidation and strong rifling throughout. The barrel of this takedown rifle has mostly toned to a blue-gray patina showing moderate oxidation staining and some light pitting throughout. The frame retains some strong case-hardened colors throughout mingling with light oxidation staining and freckling. The smooth straight grip walnut buttstock and forend remain in very good condition as lightly refinished long ago showing a few small chips around the edges, scattered scratches, dings and handling marks. The rifle is sighted with fixed rear notch, plain post front and seems to function well mechanically. A very nice example overall that would probably be a fun shooter. (136520-1835) {C&R} [Richard "Stretch" Kennedy Collection] (300/500)
1454. **STEVENS MODEL 22-410 COMBINATION GUN** 22 LR / 410 bore, 24" barrels with bright near excellent bores the shotgun barrel choked full. The barrels retain about 80% original blue thinning throughout and toning to gray patina under bright light with scattered light scratches and spots of minor oxidation staining. The frame retains some strong remnants of color case-hardening in the more protected areas mostly toning to a light gray-brown patina showing scattered oxidation staining. The checkered brown Tenite buttstock and forend remain in very good plus condition showing some moderate scratches, scuffs and handling marks but no cracks noted. This gun features a right side frame selector button, the original sights are intact, lockup is tight and the mechanism seems to function well mechanically. (136520-2653) {C&R} [Richard "Stretch" Kennedy Collection] (200/300)

1455. **SAVAGE MODEL 24C COMBINATION GUN** serial #B577427, 22 LR / 20 ga, 20" barrels with bright near excellent bores the shotgun barrel choked cylinder and showing some minor fouling. The barrels of this "Camper's Companion" are mostly a blue-gray patina with moderate scratches, areas worn to gunmetal patina and patches of moderate pitting throughout. The frame retains some faint remnants of case-hardened colors mostly toned to gray patina showing scattered oxidation staining and moderate pitting throughout. The smooth straight grip hardwood buttstock and forend remain in very good condition as refinished showing an added coat of varnish, a few small hairline cracks at the frame junction, light dings and handling marks. The buttstock features a compartment to store a spare shotgun cartridge. The rear sight is missing its elevation slider, lockup is solid and the mechanism seems to function well mechanically. (136520-743) {MODERN} [Richard "Stretch" Kennedy Collection] (200/300)
1456. **REMINGTON NO. 4 ROLLING BLOCK RIFLE** serial #J271654, 22 S,L, 22 1/2" octagon barrel with an about good bore showing some moderate oxidation but strong rifling throughout. The barrel of this rifle retains about 80% reapplied black-blue finish showing moderate high edge wear, areas thinning to gray patina scattered about and some areas of moderate old pitting underneath the finish. The frame is mostly a mottled gray-blue patina showing some high edge wear and light scratches. The smooth straight grip walnut buttstock and forend remain in about very good condition showing a small chip forming at the heel, scattered moderate scratches throughout, dings and handling marks. The original sights are intact and this example features the lever-style takedown release, the barrel exhibiting a little bit of play. The mechanism otherwise seems to function well. (136520-526) {C&R} [Richard "Stretch" Kennedy Collection] (200/400)
1457. **HARRINGTON & RICHARDSON MODEL 65 REISING SEMI-AUTO RIFLE** serial #12603, 22 LR, 23" barrel with a very good bore unfortunately showing a slight bulge near the muzzle. The metal surfaces of this rifle are mostly a medium gray patina showing some very light oxidation staining and freckling scattered about. The smooth straight grip walnut stock remains in about very good condition as cleaned showing some small dings, scratches and small spots of white paint scattered about. The rifle is equipped with an adjustable Redfield peep sight, front blade whose sight protector ears have been milled off and the sling swivels are intact. There are three additional holes on the receiver for mounting sights, the magazine release shows an old amateur brazing repair and no long completely secures the magazine but the original 10-shot magazine is still present. The rifle still seems to function well mechanically. (136520-1538) {C&R} [Richard "Stretch" Kennedy Collection] (100/200)
1458. **HARRINGTON & RICHARDSON MODEL 65 REISING SEMI-AUTO RIFLE** serial #6891, 22 LR, 23" barrel with a bright excellent bore. The metal surfaces of this rifle are mostly a smooth gray patina showing some light scratches, a few small spots of light oxidation staining and minor freckling throughout. The smooth straight grip walnut stock remains in very good condition showing scattered light scuffs, scratches, small dings, a thin 2" with-the-grain drying crack on the right side butt and handling marks. The correct Redfield rear peep sight is present, the sling swivels are intact, one original 10-round magazine is included and the rifle seems to function well mechanically. A very nice example overall that will probably be a fine shooter. (136520-1747) {C&R} [Richard "Stretch" Kennedy Collection] (200/400)
1459. **WINCHESTER THUMB TRIGGER MODEL SINGLE SHOT RIFLE** 22 S,L,EL, 18" barrel with an oxidized bore showing some evident rifling throughout. The metal surfaces have been lightly cleaned to silvery-gunmetal showing areas of light oxidation staining, freckling and small dings. The markings are still very clear except for the Winchester proofs which have softened from the cleaning. The rear sight is a replacement wide notch showing some moderate dings and the front sight appears to be original although has been regulated. The hardwood stock is an un-finished replacement showing some holes where a triggerguard may have been attached, a rather crudely carved left-side cheekpiece, a number of large drying cracks scattered about and a replacement steel buttplate. The extractor is not retracting properly but the mechanism otherwise seems to function well mechanically. This scarce gun is a worthy restoration project. (136520-1144) {MODERN} [Richard "Stretch" Kennedy Collection] (100/200)
1460. **HARRINGTON & RICHARDSON SELF-LOADING SEMI-AUTO PISTOL** serial #10515, 32 ACP, 3 1/2" barrel with a bright near excellent bore showing just a hint of light frosting. The metal surfaces of this pistol retain about 97% original blue showing some light scratches, a few small spots of light oxidation staining on the top of the slide, minor freckling and handling marks. The triggerguard retains nearly all of its original bright nickel finish and the trigger has toned to a smoky gray patina with faint remnants of case-hardened colors. The black checkered hard rubber grips with H&R logos are pencil-numbered to the gun and remain in near excellent condition showing a small scuff at the base of the left panel and a 3/4" chip on the left side panel underneath the manual safety that is unobtrusive when the safety is engaged. One original nickel-plated magazine is included and the pistol seems to function well mechanically. An excellent example that has evidently seen very little use. (138873-412) {C&R} (200/400)
1461. **FRENCH MODEL 1892 DOUBLE ACTION REVOLVER BY ST. ETIENNE** serial #H25059, 8mm French Ordnance, 4 1/2" barrel with a good bore showing some light oxidation, frosting and strong rifling throughout. The metal surfaces of this 1905-dated pistol retain about 70% original blue with the barrel mostly worn to gray patina, scattered moderate oxidation staining, some light pitting and high edge wear. The small parts retain remnants of straw color mostly toned to a dark gray-brown patina. The checkered walnut grips remain in about good overall condition showing significant smoothing and worn finish overall, small dings, a few tiny chips and handling marks. All of the markings are still clear, the lanyard ring is present and the mechanism functions very well with excellent timing and lockup. A very good example of these Great War revolvers overall. (138873-273) {C&R} (250/450)
1462. **BERETTA MODEL 1934 SEMI-AUTO PISTOL** serial #701003, 380 ACP, 3 1/2" barrel with an about good bore showing some light oxidation and a bulge about 3/4 of the way down. The metal surfaces of this 1938-made pistol retain about 90% original blue with the slide toned to a lovely plum patina overall, some high edge wear, a few spots of light oxidation staining, a few small dings and scratches around the front end of the frame, some very small pinprick pitting at the high edges and light freckling. The barrel is mostly a gray patina and some of the letters on the slide marking appear to have been poorly struck. The left side frame is Italian Army marked with "(Crown) / RE". The metal-backed black plastic grips with stylized "PB" remain in near excellent condition showing a few small dings and handling marks. The barrel and slide are matching the frame, the mechanism seems to function well mechanically and one magazine marked "MADE IN ITALY CAL. 9 CORTO P.B." on the spine is included. (138873-202) {C&R} (300/500)
1463. **JAPANESE TYPE 14 SEMI-AUTO PISTOL BY NAGOYA TORIIMATSU** serial #26749 (Series 2), 8mm Nambu, 4 1/2" barrel with a bright very good plus bore showing just a few very tiny spots of light oxidation. The metal surfaces of this March 1944-made pistol are mostly a dark gray patina with scattered light pitting and oxidation staining throughout. The grooved Asian hardwood grips are stamp-numbered to the gun and remain in about very good condition having darkened from the years and showing light staining, small dings and handling marks. All of the serialized parts are matching although the firing pin tip is broken and the pistol is missing its extractor, magazine safety plunger and plunger spring. The mechanism otherwise seems to function well mechanically and included is a single blue-bodied aluminum base magazine with front retainer cutout numbered "648" and showing a couple spots of light pitting and oxidation staining along the body. Overall a well-used Japanese pistol worthy of restoration. (138873-22) {C&R} (300/500)

1464. **BRITISH NO. 2 MKI* DOUBLE ACTION REVOLVER BY ENFIELD** serial #F8207, 38-200 (38 S&W), 5" barrel with a bright near excellent bore showing a few spots of light frosting. The metal surfaces of this 1939-dated revolver retain about 96% arsenal-grade reapplied Parkerizing with some light high edge wear, small scratches, operational wear and some light pitting scattered throughout underneath the finish. Some of the markings are still visible but most are no longer present. The black grooved Bakelite grips remain in very good plus condition showing a few small dings and some light staining. This revolver has no doubt been arsenal refurbished as the cylinder has been re-stamped to match the frame and the 1941-dated barrel has also been re-stamped to match. Barrel-to-frame fit shows a little bit of play and the mechanism will require some mechanical attention as timing gets off every now and then and the cylinder retainer does not properly hold the cylinder causing it to jump out of the gun when attempting to extract. (138873-354) {C&R} (150/250)
1465. **SAVAGE MODEL 1907 SEMI-AUTO PISTOL** serial #222241, 32 ACP, 3 3/4" barrel with a mostly bright very good plus bore showing a few small spots of oxidation and strong rifling throughout. The metal surfaces of this pistol retain about 96% original matte blue showing some light high edge wear, a few spots of oxidation staining at the base of the grip, scattered freckles and light scratches. The magazine release is a smoky gray patina while the trigger retains bold case-hardened colors. At some point the chamber exterior and magazine follower were jeweled. The black checkered hard rubber grips remain in about good condition although both panels are cracked through about 1" from the top edge but are still secured to the frame along with some further smaller dings, tiny chips and handling marks. This late production pistol features the thin slide serrations and spur cocking piece. One magazine is included that appears to be from a 1915 model although the follower is from a standard model. The pistol seems to function well mechanically and will probably make for a good shooter. (138873-464) {C&R} (200/400)
1466. **RUSSIAN MODEL 1895 NAGANT REVOLVER BY TULA** serial #N0393/84069, 7.62 Nagant, 4 1/2" barrel with a very good bore showing some light oxidation in the grooves and strong rifling throughout. The metal surfaces of this 1931-dated revolver retain about 98% arsenal reapplied blue showing some light silvering at the muzzle, small dings and minor scratches scattered about. The markings have softened a little from Soviet refurbishment but are still mostly visible. The checkered reddish brown Bakelite grips remain in excellent condition with just a few minor handling marks. The sideplate is matching the frame as is the arsenal replacement cylinder and most of the parts are Tula star-marked. The gun seems to function well in single and double action and includes a post-war vinyl holster and blued cleaning rod. (138852-67) {C&R} (200/400)
1467. **COLT NEW POLICE DOUBLE ACTION REVOLVER** serial #24421, 32 Colt New Police, 4" barrel with a bright very good plus bore showing one small patch of light oxidation. The metal surfaces of this 1904-made revolver retain about 94% original blue with the gripstraps starting to fade to gray patina, a few spots flaked to gray patina on the topstrap and scattered light freckling. The screw heads show some light slot damage but retain bold fire blue that also remains quite striking on the trigger and back of the hammer. The black checkered hard rubber grips are scratch-numbered to the gun and remain in near excellent condition showing some minor discoloration and a few small handling marks. All of the markings remain quite crisp although the Rampant Colt was struck a little lightly, the crane is matching the frame and timing and lockup are excellent. (138737-184) {C&R} [Dr. Louis C. March Jr. Collection] (300/500)
1468. **U.S. MODEL 1894 REVOLVER BY COLT** serial #1346, 38 Long Colt, 6" barrel with a mostly bright very good plus bore showing a few small spots of minor oxidation. This revolver has no doubt been through a number of arsenal overhauls. There is what appears to be an arsenal-added lanyard ring through the model designation but it seems so read "MODEL / 1894" although the serial number dates this gun to 1892 production. The metal surfaces retain about 75% factory blue finish showing moderate high edge wear, scratches, small dings, areas toning to silver-gray patina and freckling. The back of the hammer still retains some vibrant fire blue and the sides are mostly bright. The smooth walnut non-factory replacement grips remain in very good condition with a small repaired chip at the heel of the right panel, small dings and handling marks. Most of the screw heads show some slot damage, the sideplate is rather poorly fitted as is the crane which is numbered "369", the cylinder is also mismatched and the last patent date on the barrel is "MAR.5.95", probably a factory replacement. The hammer is functional although the mechanism will require mechanical attention as timing and lockup are very poor. This revolver has seen some hard use but is still a very early example. (138882-19) {ANTIQUÉ} (200/400)
1469. **CZ MODEL 27 SEMI-AUTO PISTOL** serial #382307, 32 ACP, 3 7/8" barrel with a mostly bright near excellent bore showing a hint of light frosting. The metal surfaces of this fnh-coded pistol retain about 90% arsenal blue and phosphate finishes with some high edge wear, scratches along the frame, patches of light pitting on the sideplate and the slide mostly toned to a dark plum patina. The dark brown checkered plastic grip with CZ logos remains in very good plus condition showing a small chip at the rear top edge, small scratches and handling marks. The slide and barrel are stamped with Nazi eagles, there is a faint "(Eagle) / WaA76" on the frame and the slide is matching the frame. Included with this pistol are two magazines and a black leather flap holster. One magazine has a blank floorplate and is electro-penciled to the gun and the other is marked "P.MOD.27" on the floorplate. The holster is unmarked but has clearly been with the pistol for a long time and remains in good condition showing moderate scuffs, minor cracking of the finish, staining and some verdigris around the brass hardware. (138873-55) {C&R} (300/500)
1470. **AUSTRIAN M.95 BOLT ACTION CARBINE BY STEYR** serial #9924S, 8x56mmR, 20" barrel with a bright very good plus bore showing some light frosting in the grooves and strong rifling throughout. The metal surfaces of this rifle retain about 98% arsenal reapplied blue finish with some scattered light scratches, small dings and areas toning to a brown-plum patina under bright light. The arsenal replacement hardwood stock and forend remain in very good plus condition showing a few small dings, dents and handling marks. The stock is re-stamped numbered to the gun, the bolt is electro-penciled matching and the barrel and forward band are matching the receiver. There is a small import mark on the underside of the barrel and the carbine includes four clips that show some light oxidation staining. This arsenal-refurbished carbine will probably be a fine shooter. (138877-24) {C&R} (250/450)
1471. **GREEK M1907-15 BERTHIER BOLT ACTION CARBINE BY CHATELLERAULT** serial #B54431, 8mm Lebel, 17 3/4" barrel with a mostly bright very good plus bore showing some light oxidation in the grooves and strong rifling throughout. The metal surfaces of this carbine retain about 90% arsenal-reapplied blue showing some light high edge wear, some small areas toning to brown-gray patina, freckling and light pitting scattered about underneath the finish. The bolt is still mostly bright with some scattered old light pitting and spots toning to gray patina. The straight grip hardwood stock remains in about very good condition showing some scattered light dings, dents, some small abrasions along the comb and a 1 1/4" crack on the left side near the buttplate. The stock numbers are faint but do not appear to match and there is a Greek 1932 conversion date visible on the right side butt. The barrel is Chatellerault-made and 1916-dated, it is not marked for Balle N which would be consistent for a rifle used outside of the French military. These carbines were converted from long rifles by Greece and this example is in three-shot configuration with the correct Greek front blade sight sleeve, modified front band, rear sight modified to a notch, straight bolt handle and the right side of the barrel stamped "5002". The sling ring is a little bent and none of the serialized parts are matching but the bolt seems to function well mechanically. A very solid example of a rather hard-to-find and interesting Berthier variant. (138879-2) {C&R} (250/450)

1472. **GERMAN P.626 (B) SEMI-AUTO PISTOL BY FABRIQUE NATIONALE** serial #36569, 32 ACP, 4 1/2" barrel with a bright near excellent bore. The metal surfaces of this early occupation pistol retain about 70% original blue with some moderate high edge wear, thinning to gray patina along the slide, moderate freckling and a spot of light oxidation on the right side slide. The black checkered plastic grips with "FN" logo remain in very good condition showing a small chip at the corner of the left panel, some compressed points and handling marks. The barrel and end cap are numbered to the frame and the slide and frame are stamped with the appropriate "(Eagle) / WaA103" Waffenamts. Included with this pistol are two original magazines with FN logo and one unmarked brown leather flap holster. The magazines show some moderate operational wear and the holster remains in very good plus condition showing some overall scuffs, light staining and handling marks. (138873-204) {C&R} (300/500)

1473. **COLT MODEL 1908 POCKET HAMMERLESS SEMI-AUTO PISTOL** serial #54288, 32 ACP, 3 3/4" replacement 32 ACP barrel with a bright excellent bore. The metal surfaces of this 1922-made pistol retain about 60% original blue with light oxidation staining on the gripstraps, scattered freckling, some patches of light pitting on the right side slide and some heavier cleaned pitting across the left side slide and frame. The checkered walnut grips with silver Colt medallions may be later replacements but remain in near excellent condition showing some light handling marks. The slide is matching the frame and the left side of the barrel is stamped "COLT 32 AUTO". One 380-marked magazine showing some moderate operational wear is included and the pistol seems to function well mechanically. (138873-155) {MODERN} (200/300)

1474. **JOHNSON, BYE & CO. TYCOON SINGLE ACTION REVOLVER** serial #224, 38 RF, 2 1/2" octagon barrel with a fair bore showing a couple patches of moderate oxidation and good rifling throughout. The metal surfaces of this revolver retain about 90% original nickel finish clouding slightly throughout with most of the loss along the cylinder showing spots toning to dark gray patina and scattered light freckling. The knurled base pin is a dark gray-brown patina while the hammer is mostly a smooth gray. The smooth rosewood grips remain in very good condition retaining a healthy amount of varnish and showing some light scratches, minor flaking and a tiny chip at the forward edge of the left panel. The revolver functions very well mechanically with excellent timing and lockup. (138875-9) {ANTIQUÉ} (100/200)

1475. **INTERESTING HOOD FIREARMS VICTORIA SINGLE ACTION REVOLVER** serial #8471, 32 RF, 10" round barrel with an about good bore showing light oxidation and strong rifling throughout. The metal surfaces of this "pocket rifle" style revolver retain perhaps 65% original nickel finish with the barrel mostly worn to a smooth gray patina along the right side, some small spots of pinprick pitting scattered throughout, light oxidation staining and wear on the knurled base pin. The black hard rubber grips feature a Lady Liberty relief holding an anchor and shield with the words "UNION"; they remain in near excellent condition showing a very small crack at the heel of the left panel, minor discoloration and handling marks. The grip screw and hammer pivot screw show some light slot damage and are older replacements. The butt is drilled and tapped for a period shoulder stock and the only markings are "VICTORIA" on the top of the barrel and Hood's patent date of April 6, 1875 on the left side barrel. The revolver is sighted with a brass blade front and elevation adjustable rear notch. The mechanism is functional with a robust hammer and good timing although the cylinder stop spring is weak and does not completely engage the notches on the cylinder. An interesting example for the antique arms collector. (138875-6) {ANTIQUÉ} (200/400)

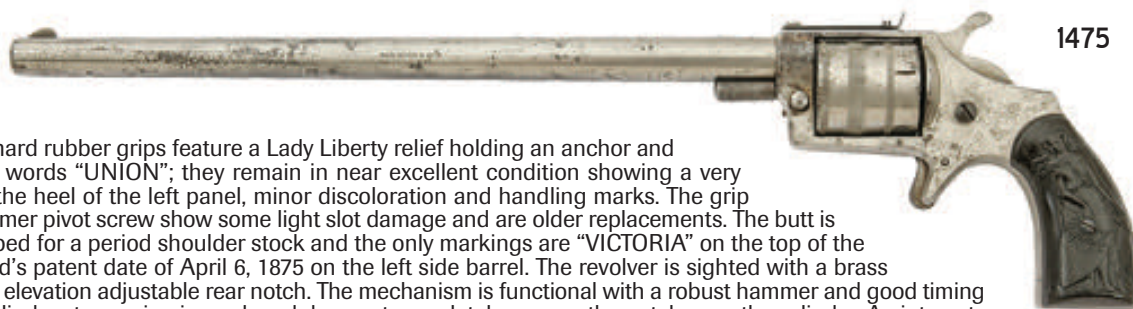

1476. **HOPKINS & ALLEN RANGER NO. 2 SINGLE ACTION REVOLVER** serial #9529, 32 RF, 5" octagon barrel with a mostly bright very good plus bore showing some minor frosting. The metal surfaces of this revolver retain about 85% original nickel finish with small spots flaking to gray patina throughout, some scattered patches of light oxidation staining, freckling and handling marks. The black checkered hard rubber grips with dog's head reliefs remain in near excellent condition showing some slight discoloration and minor handling marks. The barrel and cylinder are numbered to the frame and the mechanism functions well with good timing and lockup. A very good example with particularly nice grips and an uncommon barrel length. (138875-4) {ANTIQUÉ} (100/200)

1477. **ENGRAVED HARRINGTON & RICHARDSON VICTOR NO. 3 SINGLE ACTION REVOLVER** serial #922, 32 RF, 2 1/2" round barrel with an about good bore showing some moderate oxidation and good rifling throughout. The metal surfaces of this revolver retain about 90% original nickel finish with small spots flaking to gray-brown patina throughout, light scratches, handling marks and some moderate dings around a few of the chamber mouths. The revolver is embellished with period zigzag geometric shapes, large punch-dots, foliate flourishes and a large finely detailed dog's head on the left side. The un-numbered period mother-of-pearl grips remain in very good plus condition showing a few tiny chips around the edges of the left panel, minor discoloration and handling marks. The mechanism still functions well with good timing and lockup. (138875-8) {ANTIQUÉ} (150/250)

1478. **WHITNEY MODEL NO. 1 1/2 SINGLE ACTION REVOLVER** serial #3765B, 32 RF, 2 1/2" octagon barrel with an oxidized bore showing some visible rifling throughout. The metal surfaces of this brass frame revolver retain about 92% original nickel finish showing a few small spots flaked to dark gray patina scattered about the barrel and cylinder, some small patches of tiny pinprick pitting, a very tiny pit on the left side frame, light freckling and handling marks. The barrel markings are rather soft and poorly stamped but visible overall. The hammer retains strong case-hardened colors with mild toning to gray patina while the trigger and cylinder stop still show some faint fire blue. The black checkered hard rubber grips with "W" at the top are pencil-numbered to the gun and remain in near excellent condition showing some light staining and a few handling marks. The barrel and cylinder are numbered to the gun and the mechanism functions very well with solid timing and lockup. (138875-5) {ANTIQUÉ} (150/250)

1479. **STEVENS OLD MODEL POCKET PISTOL** serial #2448, 22 RF, 3 1/2" part round part octagon barrel with an oxidized bore showing some evident rifling. The metal surfaces of the brass frame retain about 60% original nickel finish flaking to dark ocher patina showing some small dings and handling marks. The barrel, hammer and trigger are a dark gray patina with some light pitting and small dings scattered throughout and all of the screw heads show some moderate slot damage. The smooth rosewood grips are pencil-numbered to the gun and remain in good condition showing worn finish and moderate smoothing overall, small dings and tiny chips on the base and handling marks. The barrel is numbered to the gun, barrel-to-frame fit is a little loose but the mechanism is otherwise functional. (138875-1) {ANTIQUÉ} (50/100)

1480. **IVER JOHNSON FAVORITE NO. 1 SINGLE ACTION REVOLVER** serial #6721, 22 RF, 2 1/2" octagon barrel with a fair bore showing a few rings of oxidation but strong rifling throughout. The metal surfaces of this revolver retain about 90% original nickel finish flaking along the barrel along with a couple of small spots flaked to brown-gray patina, some scratches and tool marks on the underside of the barrel and around the base pin and scattered light oxidation staining. The smooth rosewood grips are stamp-numbered to the gun and remain in very good plus condition retaining a healthy amount of varnish with a couple small flakes, minor dings and handling marks. The barrel, cylinder and base pin are numbered to the frame and the mechanism will require some mechanical attention as cylinder will not rotate, with the cylinder removed the hammer functions normally. (138875-3) {ANTIQUÉ} (50/100)
1481. **ENGRAVED HOOD FIREARMS ALEXIS SINGLE ACTION REVOLVER** serial #5353, 22 RF, 2 1/2" octagon barrel with an oxidized bore showing some good rifling throughout. The metal surfaces of this revolver retain perhaps 40% original nickel finish flaking and blending evenly with silvery gunmetal patina along with scattered light freckling and a few spots of fine pinprick pitting. There are a few tool marks on the base pin and the hammer retains some faint case-hardened colors toning to dark gray patina overall. The revolver is lightly embellished with zigzag motifs, large punch-dots and some foliate motifs on the frame. The left side frame is Turner & Ross wholesaler-marked "T&R". The smooth black synthetic grips remain in very good plus condition showing a few tiny chips around the edges and light handling marks. The left panel is stamp-numbered to the gun and the right is un-numbered. The hammer is functional but the mechanism will require mechanical attention as timing and lockup are off. (138875-2) {ANTIQUÉ} (50/100)
1482. **ASTRA MODEL 1921 SEMI-AUTO PISTOL** serial #2754, 9mm Largo, 5 7/8" barrel with an about very good bore showing light oxidation, frosting and strong rifling throughout. The metal surfaces of this early pistol are mostly a blue-gray patina throughout showing high edge wear, scratches, spots of light pinprick pitting and some remaining older reapplied arsenal-quality blue throughout. The checkered walnut grips remain in good condition showing overall smoothing, some old small chips, dings and handling marks. The slide and barrel are numbered to the frame, all of the markings are still quite clear and the pistol seems to function well mechanically. There is a discreet import mark on the right side frame and one original parkerized magazine is included. (138852-72) {C&R} (200/300)
1483. **BERETTA MODEL 1934 SEMI-AUTO PISTOL** serial #963819, 380 ACP, 3 1/2" barrel with a mostly bright very good plus bore showing some light frosting. The metal surfaces of this 1942-dated pistol retain about 84% original blue the majority of loss due to a large patch of light pitting and toning to gray patina along the left side frame and slide along with freckling, high edge wear and handling marks throughout. The black synthetic metal-backed grips with PB logo remain in near excellent condition showing some light handling marks and the grip screw heads show some moderate slot damage. The pistol does not appear to be Italian Army or German military-marked and there is a boxed "IE" inspector stamp on the right side triggerguard. The slide and barrel are matching the frame and the pistol seems to function well mechanically. Included is one reproduction magazine. (138873-476) {C&R} (250/350)
1484. **SPANISH IDEAL SEMI-AUTO PISTOL BY ARIZMENDI** serial #28745, 32 ACP, 3 1/4" barrel with a good bore showing light frosting and strong rifling throughout. The metal surfaces of this Ruby-style pistol are mostly a plum-brown patina with remnants of older reapplied blue throughout, scattered freckling and a few spots of tiny pinprick pitting. The smooth walnut grips are attached via older replacement brass screws and have certainly been with this pistol for quite some time. The grip panels are devoid of finish but remain in very good plus condition showing just a few minor handling marks. The left side frame is marked with F. Arizmendi's manufacturer code "AG" and the markings are in French. These features would suggest use by the French military during World War One although there are no visible French star acceptance stamps. The slide is matching the frame and the pistol is functional although the recoil spring is rather weak and ought to be replaced. Included is one magazine that shows some prominent dings on the spine and a 5/8" crack toward the top. (138873-386) {C&R} (100/200)
1485. **MAUSER MODEL 1910/34 SEMI-AUTO PISTOL** serial #581310, 32 ACP, 3 1/2" barrel with a bright near excellent bore showing just a hint of light frosting. The metal surfaces of this late commercial pistol retain about 96% original blue with some light high edge wear, a couple tiny pinprick pits at the high edges, minor handling marks and some areas of the frame toning to brown-plum patina under bright light. The one piece checkered walnut grip remains in very good plus condition retaining a healthy amount of original finish and showing a few light handling marks, some dings around the edges and a tiny chip at the rear top edge. The grip screws retain some hints of fire blue, all of the markings are clear and the pistol is marked with "(Eagle) / N" proof marks. The barrel, slide, sideplate and frame are all matching and one original Parkerized magazine is included. A very nice example of these popular pistols produced during the Nazi era. (138873-538) {C&R} (300/500)
1486. **SMITH & WESSON 38 DOUBLE ACTION THIRD MODEL REVOLVER** serial #125716, 38 S&W, 3 1/4" ribbed barrel with an about very good bore showing a few spots of light pitting and strong rifling throughout. This revolver remains in lovely condition retaining nearly 98-99% original nickel finish with just a few small cloudy blemishes, a couple pinprick flakes to gray patina and some minor handling marks. The latch and triggerguard retain about 98% original blue finish with just a few small areas flaking to brown patina. The trigger and hammer retain some case-hardened colors that have mostly washed out to a smooth gray patina. The black checkered hard rubber grips remain in excellent condition with just a few spots of light staining and handling marks. The right panel is scratch-numbered to the gun, the left is un-numbered and the patent date on the bottom of the left panel is remarkably clear. All of the markings are crisp, the serialized parts are all matching, barrel-to-frame fit is solid and the mechanism functions very well with excellent timing and lockup. Overall a very fine example for the Smith & Wesson or antique arms collector. (138737-185) {ANTIQUÉ} [Dr. Louis C. March Jr. Collection] (350/550)
1487. **SAVAGE MODEL 1907 SEMI-AUTO PISTOL** serial #65067, 32 ACP, 3 3/4" barrel with a fair-good bore showing some moderate oxidation and good rifling throughout. The metal surfaces of this pistol retain about 88% original blue with high edge wear, some spots of light oxidation staining, gripstraps thinning to gray patina and a patch of moderate scratches on the slide near the front sight. The trigger retains some faint remnants of case-hardened colors mostly toned to a smooth gray patina. The black checkered hard rubber grips with "SAVAGE / QUALITY" and Indian head logo remain in very good plus condition with just some very slight warping, a few minor stains, handling marks and the "TRADEMARK" still visible in the headbands on both panels. Included is one original magazine that shows some heavier use overall with moderate oxidation staining and spots of light pitting. A solid example overall that seems to function well mechanically. (138896-164D34260) {C&R} (250/450)
1488. **ENGRAVED BELGIAN LEFAUCHEUX PATENT DOUBLE ACTION PINFIRE REVOLVER** serial #30994, 9mm Pinfire, 3 1/2" barrel with a heavily oxidized bore showing some evident rifling. The metal surfaces of this revolver are mostly a gunmetal gray patina with spots of light oxidation staining, scratches, freckling and a few streaks of nickel finish here and there. The cylinder bears Belgian proofs, there are a number of inspector marks scattered about and the left side of the barrel is patent-marked "E. LEFAUCHEUX / INV BREVETE". The metal surfaces are embellished with very nice quality foliate motifs along the frame and circumference of the cylinder. The checkered walnut grips remain in very good plus condition with tiny chips at the heels, minor smoothing, staining and retain some remnants of original varnish. The front sight and ejector rod are missing and the mechanism generally functions well with good timing and lockup although the trigger return spring will require some mechanical attention as the trigger needs to be reset manually. No doubt this revolver was quite attractive back in the day; it still has some old world charm. (138898-117) {ANTIQUÉ} (200/400)

1489. **WHITNEY MODEL NO. 1 1/2 SINGLE ACTION REVOLVER** serial #4159B, 32 RF, 3" octagon barrel with a fair-good bore showing a few patches of heavy oxidation along with bright areas and strong rifling. The metal surfaces of this revolver retain about 92% original nickel finish with scattered light flaking to gray-brown patina, some spots of light oxidation staining and scratches. The sideplate screw, trigger and cylinder stop spring still retain some nice fire blue while the hammer shows some mottled case-hardened colors underneath moderate oxidation staining. The black checkered hard rubber grips with "W" at the top are pencil-numbered to the gun and remain in near excellent condition showing a couple small dings, light staining and handling marks. All of the serialized parts are matching and the mechanism functions very well with excellent timing and lockup. (138898-113) {ANTIQUÉ} (150/250)
1490. **IVER JOHNSON SECOND MODEL SAFETY AUTOMATIC HAMMER REVOLVER** serial #A78983, 32 S&W, 3" barrel with a fair bore showing some spots of moderate oxidation, strong rifling and exhibiting a slight bulge near the breech. The metal surfaces of this black powder model retain about 70% original blue flaking to brown patina along the frame, gripstraps worn to gray-brown patina, some spots of light oxidation staining and freckling. The trigger and hammer retain some faint case-hardened colors now mostly toned to a smooth gray patina. The black checkered hard rubber grips with owl head motifs remain in very good condition with some light handling marks and the left panel toned to brown. Barrel-to-frame fit shows some slight play and the mechanism functions very well with solid timing and lockup just a hair loose. (138865-95) {C&R} (75/150)
1491. **CUSTOM GERMAN LP.08 ARTILLERY LUGER PISTOL** serial #562e, 9mm, 7" shortened barrel with a bright very good plus bore showing some minor frosting. This pistol is mismatched and missing a significant amount of parts and will make for a nice restoration project. The metal surfaces retain about 85% arsenal blue with moderate high edge wear, spots of freckling, minor pinprick pitting, light oxidation staining and areas worn to silvery gray patina most notably along the right side rail and end of the shortened barrel. The barrel is numbered "9340b" and has been mated to a 1915-dated receiver numbered "1548" that is actually not cut for a tangent sight. The tangent rear sight currently on the barrel is mismatched and the front sight base has been rather competently raised. The frame is curiously lacking any proof or acceptance stamps. The receiver is complete with its ejector, sear bar and sear bar spring but no toggle train is present and the frame is missing all of its parts except for the main spring and main spring lever arm. Please see the Luger parts lots available in this silent auction. (138050-164) {FIREARM} (250/450)
1492. **FRENCH M16 BERTHIER BOLT ACTION CARBINE BY CHATELLERAULT** serial #A14520, 8mm Lebel, 17 1/2" barrel with a mostly bright very good bore showing some light frosting, a small shallow pit about 3/4 down and strong rifling. The metal surfaces of this carbine are mostly a dark gray patina with spots of silvering along the barrel, a few patches of light pitting, oxidation staining and freckling. The bolt is still mostly bright and the rear sight spring retains some faint fire blue. The straight grip hardwood stock is mismatched numbered "E13757" and remains in fair-good condition showing a small chip and thin 1 1/2" crack at the lower tang, a 2 3/4" crack at the toe, an older repaired chip and thin 3" crack at the upper tang, some further small dings, scratches and handling marks. The receiver is marked only "M16" in large font, the carbine is still equipped with a three-round magazine assembly that is mismatched, the bolt is re-stamped to match, the bolt head is not matching and the barrel is Chatellerault-made and 1932-dated. The bolt handle has a slight rearward swoop and there is a small import mark on the barrel. Two 3-round clips and one 5-round clip are included. Overall a rather salty Berthier that has no doubt been through a number of rebuilds. (138852-33) {C&R} (200/400)
1493. **FEG PA-63 SEMI-AUTO PISTOL** serial #AU1319, 9mm Makarov, 4" barrel with a bright excellent bore. The metal surfaces of the slide and triggerguard retain about 80% original blue with the triggerguard mostly toned to dark gray patina and showing overall high edge wear, moderate freckling and thinning to gray. The bright alloy frame remains in about very good plus condition showing some moderate scratches and handling marks along the straps and the black checkered plastic grips with left side thumb rest remain near excellent condition showing a few minor scuffs, light staining and handling marks. The slide is matching the frame, there is a small import mark on the right side frame and the pistol seems to function well mechanically although no magazine is included. (138896-155D34179) {MODERN} (150/250)
1494. **NORINCO MODEL 54-1 SEMI-AUTO PISTOL** serial #3700026599, 7.62x25mm, 4 1/2" barrel with a bright excellent bore. The metal surfaces of this Tokarev clone retain about 96% original blue with some light scratches, handling marks and areas toning to a plum patina under bright light. The grooved black plastic grips remain in near excellent condition showing a few scattered tiny dings. All of the serialized parts are matching, the frame is equipped with a factory manual safety and one magazine numbered to the gun is included. An excellent condition pistol made for the commercial market that will probably be a fun shooter. (138896-154D33861) {MODERN} (200/300)
1495. **WALTHER P.38 SEMI-AUTO PISTOL** serial #185981, 9mm, 5" barrel with a bright excellent bore. The metal surfaces of this post-war alloy frame pistol retain about 96% original Parkerized and black anodized finishes showing some light high edge wear, a few small scratches and handling marks. The black checkered plastic grips remain in very good plus condition with some scattered light scuffs, dings and scratches. The right side of the slide is dated "10/62", there is a cancelled German federal property "BMI" stamp on the right side frame and a small import mark on the left side. All of the serialized parts are matching and stamped with West German inspector marks and one original magazine is included. A very nice post-war gun that will probably be a fine shooter. (138897-5D34186) {C&R} (350/550)
1496. **COLT MODEL 1903 POCKET HAMMERLESS SEMI-AUTO PISTOL** serial #397453, 32 ACP, 3 3/4" barrel with a mostly bright very good plus bore showing a couple tiny pinprick pits, light frosting and strong rifling throughout. The metal surfaces of this 1921-made pistol retain about 65% original blue showing moderate high edge wear, gripstraps worn to gray patina, some spots of light oxidation staining, a few pinprick pits and scratches. There are a couple shallow dings at the muzzle on the barrel and slide. The top surface of the slide has a matte finish and all of the markings including the Rampant Colt are very clear. The black checkered hard rubber grips with "COLT" in a straight line remain in very good plus condition showing some minor smoothing overall, small dings and light staining. One original magazine is included. A rather well-used but solid example that will probably make for a fine shooter. (138897-23D34151) {C&R} (300/500)
1497. **SPANISH "RUBY EXTRA" DOUBLE ACTION HAND EJECTOR REVOLVER** serial #19195, 38 Special / Long Colt, 6" barrel with a bright very good plus bore showing some light frosting. The metal surfaces of this Smith & Wesson copy retain about 95% original nickel finish showing some small spots of flaking to gray-brown patina scattered about, light scratches, handling marks and evident holster wear at the muzzle. The hammer and trigger retain bold case-hardened colors along with some light oxidation staining and freckling. The smooth mother-of-pearl grips remain in very good condition with a small chip at the heel of the right panel, a tiny shallow chip at the top of the left panel, some scattered small cracks, spots of discoloration and handling marks. This is a fairly early Spanish copy and is stamped with a rampant lion proof mark on the barrel, frame and cylinder along with a proof date code "(Star) / A" that corresponds to 1927. The revolver is marked in a similar fashion as those it imitates with "Ruby extra" in a circle on the left side frame, patent dates along the top of the barrel and two cartridge designations, "38 LONG CTG" on the left and "38 SPECIAL CTG" on the right. The front sight is just a little bent out of shape, all of the numbered parts appear to be matching by assembly number and the mechanism functions very well with solid timing and lockup. Although technically a "knock-off" of the Smith & Wesson 1905 this is still a very attractive and sturdy revolver made to a high standard of fit and finish. (138897-15D33969) {C&R} (250/450)

1498. **WEBLEY & SCOTT MARK IV DOUBLE ACTION REVOLVER** serial #A63717, 32 S&W Long, 3" barrel with a bright near excellent bore. The metal surfaces of this revolver retain about 96% original blue with some light high edge wear, some scattered scratches most prominent on the left side frame, a couple small dings and areas toning to plum patina under bright light. The latch screw head shows some light slot damage and the recoil shield retains most of its lovely straw color. The black checkered plastic grips are scratch-numbered to the gun and remain in near excellent condition showing just a few small dings and handling marks. All of the serialized parts are matching, barrel-to-frame fit is excellent and unfortunately the mainspring is missing but timing and lockup are very solid when tension is applied. This is a rather hard-to-find variant of the Mark IV and well worth it to restore to its former glory. (137022-157) {C&R} [Mark K. Benenson Collection] (300/500)
1499. **SMITH & WESSON 32 SAFETY SECOND MODEL DOUBLE ACTION REVOLVER** serial #147919, 32 S&W, 3" ribbed round barrel with a mostly bright very good plus bore showing a few spots of light frosting and stubborn fouling. The metal surfaces of this revolver retain about 97% original nickel finish with a couple very small flakes to gray-brown patina mostly at the high edges and a spot on the left side barrel, scattered scratches and handling marks. The latch is mostly a dark gray patina retaining a few flakes of original blue while the triggerguard retains perhaps 70% original blue toning to gray patina with areas of light oxidation staining. The trigger shows some strong remnants of case-hardened colors mostly toned to a smooth medium gray patina with some moderate freckling. The left black checkered hard rubber grip panel remains in near excellent condition with just a few light handling marks while the right panel rates fair-good with a large chip out of the base and a 1 1/4" crack at the top. The right panel is appropriately numbered to the gun, all of the other serialized parts are matching, barrel-to-frame fit is excellent and the mechanism functions very well with excellent timing and lockup showing just a little bit of play. (138897-4D33925) {C&R} (200/300)
1500. **SMITH & WESSON 32 SAFETY FIRST MODEL DOUBLE ACTION REVOLVER** serial #47659, 32 S&W, 3" ribbed round barrel with an oxidized bore showing some faint rifling. The metal surfaces of this revolver retain about 80% original nickel finish most of the loss due to flaking throughout the cylinder which has mostly toned to dark brown patina, a spot on the right side frame flaked to gray-brown patina and some smaller spots of light flaking throughout. The triggerguard has mostly toned to a dark gray patina with some streaks of original bright blue shining through here and there. The black checkered hard rubber grips remain in fair-good condition showing a 7/8" chip at the base of the left panel, right panel toning to brown, minor smoothing and handling marks. The right panel is appropriately scratch-numbered to the gun, barrel-to-frame fit is excellent and the barrel and cylinder are matching the frame. The mechanism is functional but timing is off on a few of the chambers. (138887-1) {ANTIQUE} (150/250)
1501. **FABRIQUE NATIONALE MODEL 1910/22 SEMI-AUTO PISTOL** serial #158400, 380 ACP, 4 1/2" barrel with a bright excellent bore. The metal surfaces of this post-war commercial pistol retain about 90% original blue showing moderate freckling, areas thinning under bright light, light pinprick pitting on the gripstraps and handling marks. The checkered black plastic grips remain in near excellent condition with just a few tiny dings and handling marks. One original magazine is included. A very nice example overall that will probably be a fine shooter. (138873-119) {MODERN} (300/500)
1502. **MAUSER MODEL 1914 SEMI-AUTO PISTOL** serial #272172, 32 ACP, 3 1/2" barrel with a moderately oxidized bore showing evident rifling throughout. The metal surfaces of this pistol retain perhaps 50% original blue mostly toning to a blue-gray patina throughout with some fine scattered pinprick pitting, high edge wear and freckling. The trigger and extractor are a similar gray patina with some faint remnants of fire blue on the trigger. The checkered one piece walnut grip remains in about good overall condition showing significant smoothing throughout, a few moderate dings and tool marks near the magazine release and handling marks. All of the visibly numbered parts are matching and the pistol is proofed with German "(Crown) / (Crown) / U" proof marks. Two magazines are included, one with an unmarked floorplate showing some dings on the right side body and another more worn example with a weak replacement spring and floorplate made from a stripper clip. (138873-182) {C&R} (150/250)
1503. **POLISH TTC SEMI-AUTO PISTOL BY RADOM** serial #PC14009, 7.62x25mm, 4 1/2" barrel with a very good bore showing some light frosting throughout. The metal surfaces of this pistol retain about 94% arsenal blue showing some moderate freckling scattered about, small dings, scratches and handling marks. The top of the slide is marked with the "[11]" factory code and dated 1952 and there is a Century import mark on the left side of the slide as well as an importer-added thumb safety on the left side of the frame. Strangely the pistol is wearing a set of Romanian black plastic grooved grips with star and "RPR". They remain in good overall condition showing some scattered scuffs, tiny chips and dings. The left panel fits well but the right is rather poorly-fitted. One magazine number "CX214" is included and the pistol seems to function well mechanically. (138852-62) {C&R} (150/250)
1504. **HARRINGTON & RICHARDSON PREMIER SECOND MODEL SMALL FRAME REVOLVER** serial #502205, 32 S&W, 3" ribbed round barrel with a bright very good plus bore showing a little light frosting. The metal surfaces of this revolver retain about 95% original blue showing some light high edge wear, some light scattered freckling, a couple moderate dings on the left edge of the backstrap and scratches along the cylinder from improper removal. The hammer retains some faint case-hardened colors while the barrel latch is mostly a smooth gray patina. The un-numbered checkered black plastic grips remain in very good plus condition showing some light scuffs and small dings scattered about. Barrel-to-frame fit is very solid and the mechanism functions well with excellent timing and lockup. (138896-152D33902) {C&R} (100/200)
1505. **U.S. MODEL 1868 TRAPDOOR RIFLE BY SPRINGFIELD ARMORY** serial #23869, 50-70, 32 1/2" barrel with a very good plus bore showing some spots of light oxidation and strong rifling throughout. The metal surfaces of this rifle are mostly worn to pewter-gunmetal patina showing some patches of light oxidation staining, freckling and pinprick pitting scattered throughout. All of the markings are still clearly visible, the breechblock is dated 1869 and the lock 1863. The smooth straight grip walnut stock remains in about good condition as lightly refinished long ago with flaking varnish throughout, a couple small cracks and tiny chips around the buttplate, a small hole drilled below the lockplate, scattered moderate dings, scratches and abrasions. The original sights, slotted ramrod and sling swivels are present although strangely the triggerguard appears to be installed backwards. The mechanism will require some mechanical attention as the hammer no long holds at half or full cock and the breechblock lever is loose and will fall out of the action. Also included is a period socket bayonet in good overall condition showing evidence of a light cleaning with moderate old pitting throughout and a faint "US / S" stamp. A good entry level example or restoration project. (138892-1) {ANTIQUE} (300/500)
1506. **UNMARKED EUROPEAN PERCUSSION PISTOL** .79 cal, 8 1/2" octagon barrel with a lightly oxidized bore. The metal surfaces of this pistol are mostly a mix of gunmetal gray patina and darker brown with moderate old pitting scattered throughout. There are faint remnants of foliate scrollwork embellishment on the lockplate and upper tang, now quite worn. The hammer shows some old repairs and the lock mechanism is a simplistic affair with two external sears for half and full cock. The walnut stock shows faint remnants of checkering on the grip and features a small compartment on the butt and left-side belt hook. The stock remains in about good overall condition as refinished showing a 3/4" crack forward of the lock plate, a 4" stretch of chipped slivers along the left side edge, some further smaller cracks, dings and handling marks. No ramrod is present and the lock is functional on both half and full cock. (138888-21) {ANTIQUE} (200/400)

1507. **MARLIN MODEL 336 SC LEVER ACTION CARBINE** serial #K5100, 30-30, 20" barrel with a mostly bright near excellent bore showing a hint of light frosting. The metal surfaces of this rifle retain about 90% original blue showing a patch of moderate dings on the rear sight base and around the ejection port, lever toning to gray patina, scratches, freckling and handling marks scattered throughout. A couple of the screw heads show some moderate slot damage, the bolt is mostly bright and strong blue remains on the extractor. The smooth pistolgrip walnut buttstock and forend remain in very good condition showing mostly worn finish, scattered small dings, scratches and handling marks. There are sling swivels stud on the toe line and secured to the magazine tube, the original sights and sight hood are intact and the mechanism seems to function well mechanically. (138869-1) {C&R} (250/450)
1508. **SAVAGE MODEL 1899 LEVER ACTION RIFLE** serial #270128, 30-30, 20" round barrel with a very good bore showing a slight bulge about 5" from the muzzle. The metal surfaces of this rifle retain about 98% good quality reapplied blue showing evidence of buffing, some remnants of light pitting underneath the blue scattered about, a few light scratches and handling marks. The barrel markings are still quite crisp while the model markings on the receiver are rather faint. The lever has been blued-over and the bolt is still quite bright. The plain straight grip walnut buttstock and schnabel forend remain in near excellent condition as nicely refinished showing a few small filler repairs, a few small dings and handling marks. The rifle wears an original grooved steel buttplate with "SVG" logo, the original rear leaf sight is intact and the front is a Marble's Sheard brass bead. (138856-28) {C&R} (200/400)
1509. **MARLIN MODEL 97 LEVER ACTION RIFLE** serial #405709, 22 S,L,LR, 24" octagon barrel with a lightly oxidized bore showing good rifling and a bulge about 6" from the muzzle. This rifle appears to be some sort of put-together gun as the various parts do not quite fit together perfectly and there is a small Odin importer mark on the bottom of the frame. The barrel and magazine tube retain about 30% original blue scattered about mostly in the more protected areas with the balance toned to gray-brown patina with light oxidation staining and freckling throughout. The action retains perhaps 40% original blue the balance toned to blue-gray patina showing light freckling, scratches and minor oxidation staining. Most of the screw heads show some light to moderate slot damage and the markings are still mostly clear having softened a bit along the barrel. The plain straight grip walnut buttstock and forend remain in fair condition as refinished with a heavy coat of varnish. There is a small 1" repaired chip on the right side of the forend and the buttstock shows a screw through the wrist and a number of large poorly repaired cracks and chips throughout, a sliver missing at the heel and moderate dings and handling mark. The rifle is sighted with Marble's rear leaf, large brass bead front and still seems to function mechanically. (138315-56LTS285) {C&R} [Lewis T. Steadman Collection] (200/400)
1510. **SMITH & WESSON NO. 1 SECOND ISSUE REVOLVER** serial #105964, 22 RF, 3 3/16" ribbed octagon barrel with an oxidized bore showing some evident rifling. The metal surfaces of this revolver retain about 95% later gold wash showing some remnants of a protective lacquer, a few spots of light flaking and some moderate pits on the sideplate still present after the metal preparation. The barrel address is faint but still mostly visible. The smooth walnut grips remain in very good plus condition retaining some original varnish lightly flaking throughout, small dings and handling marks. The right panel is appropriately stamp-numbered to the gun and the assembly numbers on the barrel and cylinder are no longer visible. The mainspring is broken but the hammer still cocks and the revolver is mounted on a shield-shaped walnut plaque that shows some light staining and handling marks. This revolver would make for a nice display piece. (138895-2) {ANTIQUE} (200/400)



1510

1511. **SAVAGE MODEL 72 SINGLE SHOT RIFLE** serial #B434788, 22 S,L,LR, 22" octagon barrel with a bright near excellent bore showing one tiny pit. The barrel of this rifle retains about 98% original blue showing some light handling marks and a few small scratches. The lever and receiver retain a healthy amount of washed-out case-hardened colors with some moderate freckling and light oxidation staining scattered about. The plain straight grip walnut buttstock and forend remain in near excellent condition showing just a few errant handling marks. The rifle is equipped with its original sights and is a near excellent example overall. (138909-25) {MODERN} (100/200)

1512. **AUSTRIAN M.95 BOLT ACTION CARBINE BY STEYR** serial #9651S, 8x56mm, 20" barrel with a mostly bright very good bore showing some light frosting and darkness in the grooves but strong rifling throughout. The metal surfaces of this carbine retain about 97% arsenal-reapplied blue with the magazine toning to plum under bright light, scattered light freckling, high edge wear and some spots of light pitting underneath the blue. The smooth pistolgrip hardwood stock and handguard remain in very good plus condition as arsenal-refinished showing some scattered light scratches, small dings and handling marks. The sling swivels and stacking rod are intact, the stock has been re-stamped to match and the bolt is electro-penciled matching. There is a discreet import mark on the barrel. Included is one original en-bloc clip that shows some light oxidation staining, operational wear and "GR" stamp on the spine. A nice arsenal refurb that will probably be a good shooter. (138852-3) {C&R} (250/450)

1513. **BROWNING "BABY" MODEL SEMI-AUTO PISTOL** serial #429999, 25 ACP, 2" barrel with a very good bore showing some light frosting throughout. The metal surfaces of this pistol retain about 90% original blue showing a few moderate scratches on the right side of the slide, a couple small patches of pinprick pitting on the left side and high edges along with some light freckling throughout. The black checkered synthetic "BROWNING" grips remain in about good condition the left panel showing a repaired 1 1/2" chip at the back edge and some further light handling marks. Included with this pistol is one FN-marked magazine, black leather belt holster that shows some moderate scuffing and light staining and original Browning pistol rug that shows a little light wear on the exterior and minor staining on the red interior. (138863-26) {MODERN} (300/500)
1514. **CZ MODEL 70 SEMI-AUTO PISTOL** serial #644819, 32 ACP, 3 3/4" barrel with a bright near excellent bore. The metal surfaces of this pistol retain about 92% original blue showing some high edge wear, light scratches scattered about and freckling. The black checkered synthetic grips remain in very good plus condition showing some light scratches and minor dings scattered about. The left side of the slide is acceptance-dated 1980 and there is a "dP" stamp on the right side slide. There is a Century import mark on the left side frame and one magazine is included. (138896-159D33875) {MODERN} (150/250)

1515. **HECKLER & KOCH HK-4 SEMI-AUTO PISTOL** serial #HR00837, 380 ACP, 3 1/4" barrel with a bright excellent bore. The metal surfaces of this Harrington & Richardson-imported pistol retain about 94% original blue showing some light high edge wear, scattered light freckling and handling marks. The H&R address plate on the left side of the slide and trigger retain about 85% gold plating showing some moderate high edge wear and light flaking throughout. The checkered black plastic grip with left-side thumb rest remains in very good plus condition showing some light scuffs and scratches scattered about. One original magazine marked for 7.65 is included although 380 cartridges seem to seat fine. A nice example for the H&K or H&R enthusiast. (138896-172D33998) {MODERN} (300/500)
1516. **MAUSER HSC SEMI-AUTO PISTOL** serial #01.28618, 380 ACP, 3 1/4" barrel with a bright excellent bore. The metal surfaces of this Interarms-imported pistol retain about 88-90% original blue showing some high edge wear, moderate oxidation staining scattered throughout and light scratches. The checkered walnut grips remain in very good condition showing small dings at the heel of the right panel, scattered light handling marks and some tape residue on the left panel. The grip screw heads show some light slot damage and no magazine is present. (138896-153D33878) {MODERN} (150/250)
1517. **COLT 25 AUTOMATIC SEMI-AUTO PISTOL** serial #0D16128, 25 ACP, 2 1/4" barrel with a bright near excellent bore. The metal surfaces of this pistol retain about 80% original blue with areas toning to plum and gray patina throughout, high edge wear and moderate freckling. The trigger and hammer are mostly a gray-brown patina. The checkered walnut grips with silver Colt medallions remain in very good plus condition showing overall smoothing and light handling marks. Included is one original nickel-plated magazine and the pistol seems to function well mechanically. (138896-37D33892) {MODERN} (100/200)
1518. **COLT ARMY SPECIAL DOUBLE ACTION REVOLVER** serial #510924, 38 Special, 6" barrel with a bright near excellent bore showing just a little bit of frosting. The metal surfaces of this 1924-made revolver retain about 80-85% original blue showing moderate wear along the sides of the barrel and cylinder toning to gray patina, turn line on cylinder, gripstraps toning to gray-brown patina and scattered moderate freckling. All of the markings including the Rampant Colt are crisp and clear. The black checkered hard rubber grips with stylized "C" are scratch-numbered to the gun and remain in very good condition showing a tiny chip at the heel of the right panel, a few more moderate scuffs and scratches along the right panel and minor discoloration. The mechanism functions very well with solid timing and lockup and the crane is matching the frame. This revolver has seen some honest use but will probably still be a fine shooter. (138852-57) {C&R} (250/450)
1519. **COLT POLICE POSITIVE SPECIAL DOUBLE ACTION REVOLVER** serial #253439, 32-20 WCF, 4" barrel with a bright near excellent bore. The metal surfaces of this 1922-made revolver retain about 80-85% mostly original blue with gripstraps toning to gray-brown patina, high edge wear, some spots of light oxidation staining scattered about and a few areas with tiny pinprick pitting. The topstrap shows some older reapplied blue covering up some patches of light pitting and the sides of the hammer are toning to gray patina. All of the markings are still quite crisp including the Rampant Colt. The black checkered hard rubber grips with stylized "C" are scratch-numbered to the gun and remain in very good plus to near excellent condition showing some minor smoothing and a few light handling marks. The crane is matching the frame and the mechanism functions very well with solid timing and lockup. (138737-467) {C&R} [Dr. Louis C. March Jr. Collection] (250/450)
1520. **COLT POLICE POSITIVE DOUBLE ACTION REVOLVER** serial #146318, 38 Colt New Police, 4" barrel with a mostly bright very good plus bore showing a couple tiny pits and light frosting. The metal surfaces of this 1922-made revolver retain about 70% original blue with gripstraps toned to gray-brown patina, moderate high edge wear, areas toning to gray patina scattered about, freckling and light scratches. The sides of the hammer are mostly toned to gray patina, all of the markings are still quite crisp including the Rampant Colt and the right side of the frame is neatly electro-penciled with the name "Jack Downing". The black checkered hard rubber grips with stylized "C" are scratch-numbered to the gun and remain in good-very good overall condition with a 1/2" thin crack at the heel of the left panel, some moderate white paint transfer mostly along the butt and right panel, overall minor smoothing and handling marks. The crane is matching the frame and the mechanism functions well with solid timing and lockup. (138897-18D34261) {C&R} (200/300)
1521. **COLT MODEL 1908 VEST POCKET HAMMERLESS SEMI-AUTO PISTOL** serial #336381, 25 ACP, 2 1/8" barrel with a bright near excellent bore. The metal surfaces of this 1924-made pistol retain about 90% original blue showing a few moderate dings scattered about the high edges, light scratches, high edge wear and freckling. The grip safety has mostly toned to gray-brown patina while the trigger and manual safety retain some strong case-hardened colors along with spots toning to brown-gray patina. All of the markings are still quite crisp including the Rampant Colt on the slide. The black checkered hard rubber grips remain in very good condition with a few more moderate scuffs on the forward edge of the right panel, scattered lighter dings and handling marks. The slide is matching the frame and the pistol includes one two-tone magazine with a social security numbered scratched into it. (138897-2D34211) {C&R} (200/400)
1522. **COLT ARMY SPECIAL DOUBLE ACTION REVOLVER** serial #459381, 32-20 WCF, 6" barrel with a bright near excellent bore showing a tiny spot or two of light oxidation. The metal surfaces of this 1920-made revolver retain perhaps 50% original blue the balance toning to gray-brown patina with moderate high edge wear, some spots of light pinprick pitting along the high edges, freckling and light oxidation staining. The sides of the hammer are mostly gray-brown patina while all of the markings are still quite crisp including the Rampant Colt. The walnut grips with silver Colt medallions have been cleaned smooth long ago and no number is visible on their interiors. They remain in otherwise very good condition showing some light handling marks, small dings and minor staining. The crane is matching the frame and the mechanism functions well with solid timing and lockup. (138865-96) {C&R} (200/300)
1523. **COLT MODEL 1908 VEST POCKET HAMMERLESS SEMI-AUTO PISTOL** serial #229972, 25 ACP, 2 1/8" barrel with an oxidized bore showing evident rifling throughout. The metal surfaces of this 1919-made pistol retain about 75% original nickel finish with most of the loss present on the right side slide now toning to gray patina with spots of light pitting, some further more minor flaking at the high edges, scratches and handling marks. All of the markings are still quite crisp including the Rampant Colt. The black checkered hard rubber grips remain in about very good condition showing moderate overall smoothing, a tiny chip at the heel of the left panel and scattered handling marks. The slide is matching the frame and the pistol includes one original nickel-plated magazine that shows a shallow dent on the right side body. (138839-1) {C&R} (200/400)
1524. **FOREHAND & WADSWORTH PIONEER SINGLE ACTION REVOLVER** serial #2433, 32 RF, 2 3/4" round barrel with an oxidized bore. The metal surfaces of this revolver retain about 85% original nickel with the majority of loss around the breech area that has flaked to gray-brown patina, some flaking near the muzzle, scratches and handling marks. The hammer retains some faint case-hardened colors mostly toned to a dark gray patina. The black checkered hard rubber monogram grips remain in very good plus to near excellent condition the right panel showing some ingrained staining, scattered small dings and handling marks. The cylinder and base pin are matching the frame and the mechanism will require some mechanical attention as the trigger spring is broken and the hammer does not hold. When manual pressure is applied to the back of the trigger the mechanism functions well with good timing and lockup just a little loose. (138898-114) {ANTIQUE} (50/125)

1525. **FOREHAND & WADSWORTH TERROR SINGLE ACTION REVOLVER** serial #6369, 32 RF, 2 7/8" octagon barrel with an oxidized bore. The metal surfaces of this revolver retain about 80% original nickel showing moderate flaking and oxidation staining scattered throughout and two small spots of heavier oxidation and pitting on the left side frame. The barrel address on the left side barrel and "TERROR" marking on the topstrap are still quite clear and the hammer retains some hints of case-hardened colors mostly obscured by oxidation staining. The smooth rosewood grips are stamp-numbered to the gun by assembly number and remain in about very good condition showing a small chip at the toe of the right panel, light flaking varnish, dings and handling marks throughout. The base pin is a replacement that appears to be stuck in place, all visible numbered parts are matching and the mechanism will require mechanical attention as the hammer does not stay cocked and the cylinder does not rotate. (138898-115) {ANTIQUÉ} (40/80)
1526. **LEE ARMS RED JACKET NO. 3 SINGLE ACTION REVOLVER** serial #55750, 32 RF, 2 3/4" octagon barrel with a fair bore showing some good rifling throughout and a ring of heavy pitting near the muzzle. The metal surfaces of this revolver retain about 90% original nickel finish showing some light flaking to gray-brown patina, scattered scratches, freckling and clouding of the finish. The hammer and trigger have mostly toned to gray patina and some of the screw heads show some light slot damage. The grips are ad-hoc heavily varnished and rather bulbous synthetic replacements that show some flaking and small chips throughout. All of the visibly numbered parts are matching and the mechanism is functional with good timing and lockup a little loose. (138898-111) {ANTIQUÉ} (50/100)
1527. **LOT OF ANTIQUE PISTOLS** Two total, one revolver and one percussion pistol. First is a Robin Hood No. 3 spur trigger revolver serial #684, 32 RF, 2 1/4" round barrel with an oxidized bore. The metal surfaces retain perhaps 20% original nickel finish with the balance showing moderate to heavy oxidation and pitting throughout. The trigger retains some remnants of fire blue and the smooth rosewood grips remain in fair-good condition showing some moderate abrasions scattered about, a 1" crack on the right panel and scattered small chips. The hammer cocks appropriately but the hand is missing and the cylinder lock does not engage. Second is a more modern unmarked reproduction percussion muff pistol about .36 cal, 2" screw barrel with a lightly oxidized bore. The barrel and hammer are mostly a blue-gray patina with light oxidation staining while the brass frame retains perhaps 90% black enamel finish showing some light high edge wear and small flakes. The brown synthetic grips are pinned in place and remain in about very good condition with a small crack at the base of the right panel and light handling marks scattered about. The hammer is functional at half and full cock. (138898-112, 116) {ANTIQUÉ} (40/80)
1528. **J. STEVENS OFFHAND TARGET NO. 35 PISTOL** serial #42661, 22 RF, 7 3/4" part round part octagon barrel with an oxidized bore showing some faint rifling. The barrel has mostly toned to a light gray-brown patina with scattered light oxidation staining and areas of pinprick pitting. The two-line barrel address is still quite clear and the hammer and trigger retain just a hint of fire blue mostly toned to dark gray patina. The frame retains about 85% original nickel finish with small spots flaking to gray-brown patina throughout, light scratches and small dings. The smooth walnut grips are pencil-numbered to the gun and remain in very good condition showing mostly worn finish, a few small dings and handling marks scattered about. The pistol is sighted with a simple rear notch and wide front blade, the barrel is matching the frame, barrel-to-frame fit shows a little bit of play and the hammer functions crisply at half and full cock. (138898-110) {C&R} (100/200)
1529. **REPRODUCTION TOWER FLINTLOCK PISTOL** by Dixie Gun Works serial #451, .70 cal, 9" round barrel with a good very lightly oxidized bore. The surfaces of the barrel and lock are still mostly bright showing some light freckling and spots of fine oxidation staining here and there. The lockplate is marked with a facsimile "(Crown) / GR" and "TOWER" behind the cock and the brass hardware is a pleasant light ocher patina. The walnut stock remains in good condition with a thin 2 1/4" crack emanating from the ramrod thimble, some further tiny chips and light dings scattered about. A steel ramrod is included and the lock seems to function well mechanically. A solid Japanese-made reproduction for the black powder enthusiast. (138898-120) {ANTIQUÉ} (100/200)
1530. **REPRODUCTION JUKAR PERCUSSION DERINGER PISTOL** serial #121966, .50 cal, 3" rifled barrel with a bright excellent bore. The barrel of this Spanish-made pistol is mostly a light gray-brown patina showing some oxidation staining throughout while the lock retains some mottled unremarkable case-hardened colors also showing scattered light oxidation staining. The lockplate is stamped "DERINGER / PHILADELPHIA" and the brass hardware is a light ocher patina. The smooth hardwood stock remains in very good condition showing some shallow chipping around some of the edges, small dings and handling marks. There appears to be a small wood screw missing from the rear of the lockplate but the lock still functions fine. (138898-119) {ANTIQUÉ} (40/80)
1531. **STOGER 1873 SINGLE ACTION ARMY REVOLVER BY UBERTI** serial #J71419, 38 Colt / Special, 5 1/2" barrel with a bright near excellent bore. The metal surfaces of the barrel, cylinder and grip frame retain about 99% original blue showing just some light handling marks. The frame and hammer retain some strong case-hardened colors toning to smooth gray overall with a couple errant freckles. The smooth walnut grip remains in excellent condition showing perhaps a handling mark or two. The mechanism seems to function well mechanically with solid timing and lockup and has evidently seen very little if any use. The original box and manual are included the box showing a small tear on the lid. (138893-19) {MODERN} (300/400)
1532. **CIMARRON 1873 SINGLE ACTION ARMY REVOLVER BY UBERTI** serial #J78888, 32-20 / 32 H&R Magnum, 4 3/4" barrel with a bright excellent bore. The metal surfaces of the barrel, cylinder and grip frame retain about 99% original blue showing a few light handling marks here and there. The frame and hammer retain some remnants of case-hardened colors mostly toned to smooth gray patina. The smooth walnut grip remains in excellent condition. The revolver includes an extra 32 H&R magnum cylinder and seems functions well mechanically with either cylinder installed. Also included is the original box with factory paperwork. (138893-13) {MODERN} (300/400)
1533. **STOGER 1873 SINGLE ACTION ARMY REVOLVER BY UBERTI** serial #J44111, 22 LR, 5 1/2" barrel with a bright near excellent bore. The metal surfaces of the barrel and six-shot cylinder retain about 96% original blue showing a few light handling marks and operational wear along the cylinder. The hammer and frame retain some strong case-hardened colors mostly toning to smooth gray patina with a few scattered freckles. The brass backstrap and triggerguard are a light goldenrod patina showing a few small stains here and there. The smooth walnut grip remains in excellent condition showing just a minor handling mark or two. The mechanism seems to function well mechanically with solid timing and lockup. This revolver has seen just a little bit of use and will probably be a fun plinker. (138893-21) {MODERN} (200/300)
1534. **HARRINGTON & RICHARDSON SPORTSMAN DOUBLE ACTION REVOLVER** serial #B7200, 22 LR, 6" barrel with a bright near excellent bore. The metal surfaces of this revolver retain about 92% original blue showing some high edge wear, moderate turn ring on the cylinder, frontstrap toning to gray patina and scattered freckling throughout. The hammer is still mostly bright showing some light freckling. The checkered walnut grip remains in very good condition showing some minor smoothing of the points, small dings and handling marks. All of the visible serialized parts are matching and the adjustable sights are intact. Barrel-to-frame fit exhibits moderate play and the mechanism is functional with good timing and lockup somewhat loose. (138893-14) {C&R} (250/350)

1535. **RUGER OLD MODEL BEARCAT SINGLE ACTION REVOLVER** serial #80754, 22 LR, 4" barrel with a bright excellent bore. The metal surfaces of this 1967-made revolver retain about 95% original blue and anodized finishes showing some light high edge wear, a couple tiny dings and minor thinning along the left side of the barrel. There is a light turn ring on the cylinder and the brass-anodized triggerguard is a light goldenrod color. The back and top of the hammer is toning to plum patina while the sides and the trigger are bright. The smooth walnut grips with silver phoenix medallions remain in very good plus condition showing a few very small dings along the edges and minor handling marks. The transfer bar safety update has been performed on this revolver and the mechanism functions well with solid timing and just a little hint of play during lockup. A fine example overall that ought to be a great plinker. (138893-20) {C&R} (200/400)
1536. **SWISS MODEL 1869/71 VETTERLI BOLT ACTION RIFLE BY BERN** serial #120496, 41 Swiss RF, 33" barrel with a fair bore showing moderate oxidation and good rifling throughout. The metal surfaces of this rifle are mostly a plum-brown patina showing spots of light oxidation staining and patches of light pitting. The straight grip walnut buttstock and checkered forend remain in about good overall condition showing overall smoothing and darkening from the years, a couple thin drying cracks scattered about, dings, scratches and light staining. The cartouches are very soft, the barrel is matching the receiver but the bolt and most of the other parts are a mix of numbers. The rear sight has been bent down flat for some reason, the cleaning rod is present, the bolt has not been converted to centerfire, the firing pin seems a little loose and the lifter operates very sluggishly and could probably use a good cleaning. (138900-4S21492) {ANTIQUÉ} (100/200)
1537. **SWISS MODEL 1878 VETTERLI BOLT ACTION RIFLE BY BERN** serial #185621, 41 Swiss RF, 33" barrel with a mostly bright very good plus bore showing some light frosting throughout. The metal surfaces of this rifle retain about 90% arsenal quality re-applied blue showing areas toning to plum patina throughout, high edge wear, light freckling and spots of light pitting underneath the finish. All of the markings are still quite crisp and clear. The smooth straight grip walnut buttstock and forend remain in very good condition as likely armory-refinished showing a couple small old chips and minor cracks where the buttstock meets the frame and upper tang, light dings, scratches and handling marks. The cartouche on the right side buttstock is quite soft but the heel is stamped with a crisp "[D2 (Swiss Cross) C1]". The rear sling swivel is missing, the cleaning rod is present and all visible serialized parts appear to be matching. The mechanism operates very smoothly and the bolt has been converted to centerfire. Please also see the lot of centerfire brass available in the silent auction. (138877-16) {ANTIQUÉ} (200/300)
1538. **SMITH & WESSON 38 SAFETY HAMMERLESS FIFTH MODEL REVOLVER** serial #241143, 38 S&W, 3 1/4" ribbed round barrel with a mostly bright very good bore showing a few small spots of very light oxidation. The metal surfaces of this revolver retain about 96% original nickel finish showing a few tiny flakes toning to gray patina scattered about, some clouding, scratches and handling marks. The latch and triggerguard retain about 95% original blue showing some minor high edge wear and a couple freckles and the trigger retains some nice case-hardened colors with overall toning to smooth gray patina and light freckling. The black checkered hard rubber grips are likely replacements as they are un-numbered and not perfectly fitted to the frame. The grips remain in very good condition showing a few moderate scuffs, light staining and handling marks. All of the serialized parts are matching although curiously the number on the frame appears to have been re-stamped, possibly a corrected factory error. Barrel-to-frame fit is solid and the mechanism functions very well with excellent timing and lockup showing just a bit of play. (138873-167) {C&R} (175/275)
1539. **HARRINGTON & RICHARDSON AUTOMATIC EJECTING FIRST MODEL REVOLVER** serial #594, 38 S&W, 4" ribbed round barrel with an about good bore showing some moderate oxidation but strong rifling throughout. The metal surfaces of this second variation revolver retain about 80-85% original nickel finish that is clouding throughout with spots flaking to gray-brown patina mostly along the high edges and cylinder, scattered oxidation staining and freckling. The black checkered hard rubber grips remain in about very good condition showing a few moderate scuffs on the left panel, moderate smoothing on the right and handling marks. The right panel is scratch-numbered to the gun and the visibly-numbered parts are matching. Barrel-to-frame fit shows a little play, the hammer does not hold at full cock but is functional in double action with good timing but loose lockup. (138873-463) {ANTIQUÉ} (50/100)
1540. **BERETTA MODEL 1934 SEMI-AUTO PISTOL** serial #E58197, 380 ACP, 3 1/2" barrel with a bright near excellent bore showing a tiny spot or two of very light oxidation. The metal surfaces of this 1965 proof-dated commercial pistol retain about 80% original blue showing moderate high edge wear, areas toning to plum patina, gripstraps thinning to gray and some moderate oxidation staining mostly on the right side slide. There are a few small dings along the slide and one on the right side rear sight. The black checkered plastic grips with Beretta arrow logo remain in very good condition showing some small areas of compressed points, minor dings and handling marks. One magazine is included and the pistol seems to function well mechanically. (138873-272) {C&R} (200/400)
1541. **SPANISH 32 HAND EJECTOR DOUBLE ACTION REVOLVER** serial #10575, 32 S&W Long, 4 1/8" barrel with an about good bore showing light frosting and a few small pits. The metal surfaces of this Spanish S&W copy retain about 30% original blue the balance toning to a gray-brown patina along with light oxidation staining and rather heavy pitting along the left side of the barrel. The hammer retains some remnants of case-hardened colors. The checkered walnut grips with "GH" medallions remain in very good condition showing some lightly chipped points, small dings and handling marks. The mechanism is functional with good timing but lockup rather loose and the trigger reset is sluggish. This revolver lacks Spanish proofs indicating it was likely made prior to 1923. (138873-556) {C&R} (50/100)
1542. **REPRODUCTION COLT MODEL 1862 POLICE PERCUSSION REVOLVER BY UBERTI** serial #A50043, .36 cal, 5 1/2" barrel with a bright excellent bore. The metal surfaces of the barrel and cylinder retain about 99% original blue with just a light handling mark or two. The frame, loading lever and hammer retain nice case-hardened colors with some overall toning to smooth gray patina on the frame. The brass backstrap and triggerguard are a mellow goldenrod showing a few errant freckles. The smooth walnut grip remains in excellent condition with no appreciable wear. The mechanism functions well with excellent timing and lockup and the revolver includes its original box, tin of RWS percussion caps and sealed box of 100 Hornady lead balls. This reproduction has seen little if any use. (138893-23) {ANTIQUÉ} (200/300)
1543. **CANADIAN NO. 4 MK I* BOLT ACTION RIFLE (SPORTERIZED)** serial #23L8300, 303 British, 25" barrel with a bright near excellent two-groove bore. The metal surfaces of this 1943-dated rifle retain about 75% arsenal blue toning to gray-brown patina near the muzzle and along the magazine, scattered freckling and light oxidation staining. The hardwood stock has been cut down and there is no handguard present. The forend and pistolgrip buttstock remain in about very good condition showing some scattered dings, tiny chips, scratches and a large added screw on the left side. One forward barrel band is present although loosely fitted, there is a sling swivel present on the toe line and the bolt is matching. (138916-8) {MODERN} (100/200)

1544. **HARRINGTON & RICHARDSON MODEL 922 FACTORY CUTAWAY REVOLVER** serial #W14224, 22 LR, 6" barrel

with a good bore. According to the consignor this revolver was obtained from the H&R factory and has been neatly cut away to expose the mechanism and all parts of the lock work have been color-coded. The metal surfaces have been coated in a heavy protective lacquer showing some moderate oxidation staining scattered throughout and lightly flaking paint on the interior parts. The barrel markings are crisp and clear and the cream-colored synthetic right grip panel is present showing some light staining and handling marks throughout. The base pin appears to be stuck in place and the mechanism functions well in double action but does not hold at full cock as the single action sear spring is weak. An interesting example produced in 1960. (138899-52) {C&R} (100/200)

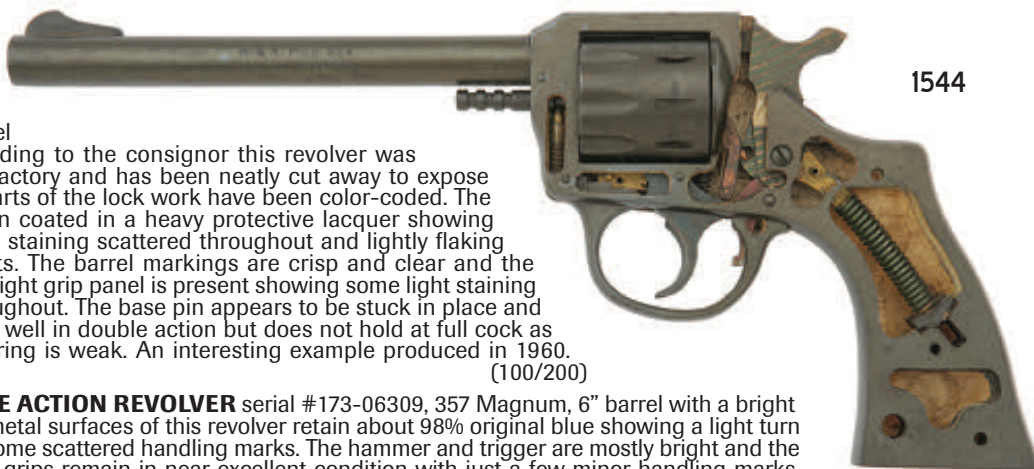

1545. **RUGER GP100 DOUBLE ACTION REVOLVER** serial #173-06309, 357 Magnum, 6" barrel with a bright near excellent bore. The metal surfaces of this revolver retain about 98% original blue showing a light turn ring on the cylinder and some scattered handling marks. The hammer and trigger are mostly bright and the black rubber wood insert grips remain in near excellent condition with just a few minor handling marks. The mechanism functions well with solid timing and lockup. This very lightly-used revolver will probably be a fine shooter. (138841-3) {MODERN} (350/550)

1546. **DAN WESSON 15V DOUBLE ACTION REVOLVER** serial #128176, 357 Magnum, 6" ventilated rib barrel with a bright near excellent bore. The metal surfaces of this revolver retain about 97% original blue showing some light high edge wear, handling marks, light turn ring on cylinder and a small ding on the left side edge of the rib and barrel. The checkered walnut grip with "DWA" medallions remains in about good condition showing a large 2" repaired chip at the forward edge behind the trigger-guard, some small chips around the edges, scattered dings and lightly flaking varnish. The frame lug on the left side is missing causing the whole cylinder to start coming out when the ejector rod is pushed; the mechanism otherwise functions well when the cylinder is closed with excellent timing and lockup. This revolver could probably be easily repaired and would likely make for a fine shooter. (138896-168D33994) {MODERN} (300/500)

1547. **DAN WESSON 15VE DOUBLE ACTION REVOLVER** serial #351491, 357 Magnum, 6" ventilated rib barrel with a mostly bright near excellent bore. This revolver has been subjected to some poor storage and retains perhaps 75% original blue most of the loss due to spots of rather heavy pitting scattered throughout. The revolver wears a set of checkered black rubber Pachmayr "Gripper" grips that remain in very good condition showing some light staining and minor scuffs. The end of the front sight is broken off with the rear portion still there providing a functional sight picture. The mechanism still functions very well with solid timing and lockup. (138896-169D34178) {MODERN} (200/400)

1548. **CHARTER ARMS POLICE UNDERCOVER DOUBLE ACTION REVOLVER** serial #1117827, 38 Special, 2 1/4" barrel with a bright near excellent bore. The satin stainless steel and anodized surfaces of this revolver remain in near excellent condition showing some light handling marks, a minor turn ring and the backstrap and triggerguard taking on a mild gray color. The factory black checkered rubber grips remain in very good plus condition showing some light scuffs and handling marks scattered about. This example has the Stratford barrel address and cylinder retainer frame lug. The mechanism functions well with solid timing and lockup. (138896-149D33232) {MODERN} (150/250)

1549. **COLT OFFICIAL POLICE DOUBLE ACTION REVOLVER** serial #687936, 38 Special, 4" barrel with a bright near excellent bore showing just a couple tiny spots of light oxidation. The metal surfaces of this revolver retain about 97% professionally reapplied nickel finish showing a few tiny spots flaking to gray patina at some of the high edges, a couple small areas of bubbling and some remnants of cleaned pinprick pitting underneath the finish. The markings are still mostly clear although the Rampant Colt on the sideplate is completely gone. The trigger and hammer show some light oxidation staining and freckling retaining some remnants of blue. The checkered walnut grips with silver Colt medallions are most likely replacements and are grease penciled "0841" on their interiors remaining in about good overall condition showing heavy smoothing throughout, the right panel almost completely smooth. The crane is matching the frame and the mechanism still functions well with timing a little off in single action but final lockup solid once the trigger is pulled. (138896-35D34142) {C&R} (200/300)

1550. **COLT JUNIOR SEMI-AUTO PISTOL** serial #24972CC, 22 Short, 2 1/4" barrel with a bright near excellent bore. The metal surfaces of this 1965-made pistol retain about 95% original blue showing some high edge wear, a few tiny spots of oxidation staining, minor freckling and large areas starting to tone to plum patina under bright light. The trigger and hammer are mostly bright with a few small spots toning to gray patina. The checkered walnut grips with silver Colt medallions are mostly devoid of finish but remain in very good plus condition showing some light staining and handling marks. One original nickel-plated magazine is included and the pistol seems to function well mechanically. (138896-38D33855) {C&R} (200/300)

1551. **BUTLER ASSOC., INC. SINGLE SHOT DERINGER** serial #08559, 22 Short, 2 1/2" barrel with a mostly bright very good bore showing a few small spots of light oxidation. The metal surfaces retain about 99% original nickel finish showing just a few spots of minor bubbling and clouding. The smooth white synthetic faux ivory grips remain in excellent condition showing a few minor handling marks. The mechanism is functional and the pistol includes its original green velvet case with orange lining showing some light staining and a few small tears in the interior. (138903-31) {MODERN} (200/300)

1552. **RUGER OLD MODEL BLACKHAWK SINGLE ACTION REVOLVER** serial #3334, 30 Carbine, 7 1/2" barrel with a bright near excellent bore. The metal surfaces of this revolver retain about 97% original blue and anodized finishes showing some very light high edge wear, a minor turn ring on the cylinder, some light scratches and a few tiny dings scattered about. The polished sides of the hammer show some light freckling and minor oxidation staining and there is a single added hole on the topstrap for adding additional sights. The smooth walnut grips with black phoenix medallions remain in near excellent condition showing some light handling marks and flaking black paint in the medallions. The mechanism functions very well with solid timing and lockup and the transfer bar safety update has not been performed. Included is the original factory box which shows some minor scuffs and light staining. (138903-28) {MODERN} (350/550)

1553. **RUGER OLD MODEL SUPER BLACKHAWK SINGLE ACTION REVOLVER** serial #6124, 44 Magnum, 7 1/2" barrel with a bright excellent bore. The metal surfaces of this revolver retain about 94% original blue and anodized finishes showing a light turn ring on the cylinder, minor high edge wear, scattered light scratches and the ejector rod housing thinning to dark gray patina. The smooth walnut grips with black phoenix medallions remain in very good plus condition showing some light dings and handling marks scattered throughout. The transfer bar safety update has not been performed and the mechanism functions very well with solid timing and lockup. A lightly used example that will probably be a fine shooter. (138903-29) {C&R} (300/500)

1554. **PARKER HALE PATTERN 1853 ENFIELD PERCUSSION RIFLE** serial #5549, .577 cal, 39" barrel with a very lightly oxidized bore. The barrel and bands retain about 90% original blue with the muzzle mostly worn to gray patina, scattered scratches, freckling and a few spots of minor oxidation staining. The lockplate retains strong case-hardened colors with some light scratches, hammer toning to smooth gray patina and is marked with a crisp "(Crown) / P-H" and "1853 / ENFIELD". The brass triggerguard and buttplate are a mix of goldenrod and ocher patina the buttplate showing some moderate dings throughout. The straight grip walnut stock remains in about very good condition with an added varnish, a 2 1/2" thin crack at the heel, scattered dings, scratches and handling marks. There are remnants of an old sticker on the right side butt and the Parker Hale cartouche has softened a little but is mostly visible. There are two added holes at the upper tang, the original rear sight has been removed, the front sight has been modified to a tall blade and an adjustable peep sight has been rather crudely affixed to the left stock flat. The cleaning rod and sling swivels are present and the lock functions crisply. A solid customized example that has seen some honest use. (138894-8) {ANTIQUE} (300/500)
1555. **EUROARMS KENTUCKIAN PERCUSSION RIFLE** serial #15425, .44 cal, 35" octagon barrel with a very lightly oxidized bore. The barrel of this Italian-made rifle retains about 90% original blue with high edge wear and light oxidation staining scattered about. The lock retains some strong remnants of case-hardened colors, the hammer mostly toned to pewter patina showing light oxidation staining. The remaining brass hardware is mostly a pleasant ocher patina showing just some scattered light staining. The straight grip walnut stock remains in about very good condition showing some light chipping at the upper tang, a small spot of old sticker residue on the right side, scattered dings, moderate scratches and handling marks throughout. The lock is functional and a ramrod is included. (138894-9) {ANTIQUE} (100/200)
1556. **SPANISH REPRODUCTION FULLSTOCK FLINTLOCK SPORTING RIFLE** .44 cal, 33 1/2" octagon barrel with a lightly oxidized bore. The metal surfaces of the barrel and lock are mostly a dark blue-gray patina with spots of oxidation staining and freckling scattered throughout. The lock is lightly embellished with simple foliate scrollwork and the brass crescent buttplate, patch box, triggerguard and remaining hardware is mostly an ocher patina with spots of light staining. The straight grip hardwood stock features deeply engraved foliate patterns throughout and remains in very good condition showing some lightly flaking varnish, scattered small dings, scratches and handling marks. The frizzen spring screw is a more modern replacement, a wooden ramrod is included, no sights are present and the lock is functional. (138898-97) {ANTIQUE} (75/125)
1557. **ITALIAN REPRODUCTION BROWN BESS STYLE FLINTLOCK MUSKET** .75 cal, 37" barrel with an oxidized bore. The metal surfaces of the barrel are mostly a pewter-gunmetal patina showing scattered oxidation staining and cleaned light pitting throughout. The lockplate is marked "GRICE / 1762" along with a "(Crown) / GR" and is still mostly bright showing some smaller spots of oxidation. The brass hardware is a mix of goldenrod and ocher patina showing a few spots of verdigris staining and the triggerguard is warping slightly away from the stock. The walnut stock has a dark varnish and remains in very good condition showing some light scattered staining, a few small chips, scratches and dings. A steel ramrod and black leather sling are included. The hammer screw is a later replacement, the top jaw and its screw are missing and the hammer cocks but the mainspring is broken. (138894-10) {ANTIQUE} (100/150)

1558



1558. **UNMARKED AMERICAN BACK ACTION FOWLER** about 12 bore, 38 1/4" barrel with a very good bore showing a few spots of oxidation. The metal surfaces of this fowler are mostly a gray-brown patina showing light oxidation staining and some spots of old light pitting scattered throughout. The gun features a fancy triggerguard and a rib on the underside of the barrel holding the ramrod thimbles that is starting to separate. The straight grip hardwood buttstock and forend remain in very good condition with a dark applied finish, scattered light flaking, a few small older repaired chips around the lockplate, dings, scratches and handling marks. This is a cartridge-firing break action gun, the right side hammer hitting the firing pin as it runs diagonal through the breech and the break action is operated by a left side button release with wide transverse bar. The gun is sighted with a rudimentary rear notch and brass blade front and includes an antique ramrod with brass tip and iron ferrule. The barrel is slightly off-face and exhibits a little bit of play, the action gets hung up on the firing pin when opening or closing and the lock is functional. An interesting example for above the mantel. (138898-108) {ANTIQUE} (300/500)

1559. **DUTCH M71/88 BEAUMONT-VITALI BOLT ACTION RIFLE (SPORTERIZED)** serial #3258 / C489, 11x52mmR, 33" barrel with a good bore showing spots of light pitting and oxidation but strong rifling throughout. The metal surfaces of the barrel, magazine and triggerguard are mostly a dark brown patina showing old pitting and oxidation staining throughout. The bolt and receiver are a mix of lighter pewter-gray and gray-brown patina with light pitting and oxidation staining. Most of the markings are still clearly visible and the barrel is dated 1874. The straight grip walnut stock has been cut down but the front barrel band has been retained, now secured about halfway down the barrel. The stock otherwise remains in about very good condition as refinished long ago with scattered light staining, tiny chips, dings and scratches. The cartouches are rather soft but mostly visible and someone has lightly scratched the model name into the left side butt. The barrel and buttplate are numbered "3258" while the receiver and bolt parts are all matching by number "C489". No cleaning rod is present but the sling swivels are intact and the rifle seems to function well mechanically. (138852-20) {ANTIQUE} (100/200)
1560. **ITALIAN M1870/87/15 VETTERLI BOLT ACTION RIFLE** by Torre Annunziata serial #XZ5892, 6.5 Carcano, 34" barrel with a moderately oxidized bore showing visible rifling throughout. The metal surfaces of this 1880-dated rifle are mostly a mottled gray-brown patina throughout with scattered light oxidation staining and old pitting. The walnut stock is stamp-numbered to the gun and remains in about good overall condition with moderate staining, a 1" thin crack at the right side near the noscap, some small scattered chips, dings and scratches throughout. The sling swivels and ramrod are present and the rifle seems to be fully functional although the headspace is way off. A good wall-hanger or "example" piece. (138852-27) {ANTIQUE} (100/200)
1561. **BRITISH NO. 1 MKIII SMLE BOLT ACTION RIFLE BY BSA** serial #B48775, 303 British, 25" barrel with a very good bore showing some frosting and oxidation in the grooves but strong rifling throughout. The metal surfaces of this 1916-dated rifle are mostly pewter-gray patina with scattered moderate oxidation staining, cleaned light pitting and remnants of military black and green paint. The walnut stocks and handguard remain in about good overall condition as cleaned long ago with an armory repair at the heel now showing moderate cracks on either side, a number of further scattered small cracks, chips, dings and scratches throughout. The stock is stamp-numbered to the gun and the disc cutout is vacant. The "*" on the socket has been crossed out and the rifle retains a magazine cutoff and all of the serialized parts are matching, although the rear sight has been re-stamped to match and the barrel is "HV"-stamped, likely an Australian replacement. Included is a brown plastic Parker Hale oiler and tan canvas sling showing some moderate staining overall. A rather salty but interesting example overall. (138888-14) {C&R} (200/400)

1562. **CIMARRON MODEL 1866 LEVER ACTION RIFLE** serial #76802, 44-40, 24" octagon barrel with a bright near excellent bore. This rifle has been rather nicely "antiqued", the barrel, magazine tube and lever now a pewter-gunmetal patina showing some fine pitting and darker staining scattered about. The brass frame, crescent buttplate and noseclip are a nice other patina with small dings and spots of minor staining. The straight grip walnut buttstock and forend remain in very good condition showing light dings, scratches and handling marks throughout along with a few spots of flaking varnish. The original sights are intact and the mechanism seems to function very smoothly. A great rifle with a lot of added character for the cowboy action enthusiast. (138864-49) {MODERN} (350/550)
1563. **SAVAGE MODEL 99-F LIGHTWEIGHT LEVER ACTION TAKEDOWN RIFLE** serial #223603, 303 Savage, 20" barrel with a bright very good plus bore showing a few tiny spots of light oxidation. The metal surfaces of this rifle are mostly a lightly cleaned gunmetal-gray patina showing light freckling scattered throughout, a few small spots of oxidation staining and pinprick pitting. The model marking on the receiver ring is curiously absent perhaps buffed away during the cleaning but all other markings are still very clear. The lever still retains strong case-hardened colors in the protected areas. The smooth straight grip walnut buttstock and schnabel forend remain in about good-very good condition showing a thin 1 1/4" hairline crack at the upper tang, thin 1 1/2" crack forward of the takedown button, some light chips near the schnabel tip, some further minor dings and handling marks. There is a Redfield peep sight mounted at the tang, a blank in the dovetail and ivory bead front. A rather well-used but solid example produced in 1920, the first year of production for the 99-F. (138852-50) {C&R} (300/500)
1564. **REMINGTON NO. 2 ROLLING BLOCK RIFLE** serial #11097, 32 RF, 26" octagon barrel with a good bore showing light pitting and strong rifling throughout. The metal surfaces of this rifle are mostly a gray-brown patina showing light pitting and some small dings throughout. The markings have softened some but are still mostly visible and both the breechblock tab and upper tang show professional welding repairs. The straight grip walnut buttstock and forend with steel noseclip remain in good condition the forend showing a moderate 1/2" ding on the right side and the buttstock showing a number of professionally repaired sections along the toe line and left side lower tang along with some further light dings and handling marks. The original sights are intact and the hammer functions crisply. (138863-30) {C&R} (300/500)
1565. **WINCHESTER MODEL 1902 SINGLE SHOT RIFLE** 22 S,L, 18" barrel with an about good bore showing light oxidation and strong rifling throughout. The metal surfaces of this rifle retain perhaps 20% original blue mostly remaining at the rear of the action with the balance flaking and toning to blue-gray patina and showing spots of cleaned light pitting near the muzzle. The bolt is a light gray patina the knob toning more to brown. The smooth gumwood stock remains in very good condition showing a few scattered shallow chips, abrasions and scratches mostly concentrated on the left side. The original sights and buttplate are intact, the buttplate showing some minor scuffs. (138865-64) {C&R} (100/200)
1566. **HIGH STANDARD SENTINEL DOUBLE ACTION REVOLVER** serial #S79079, 22 LR, 4" barrel with a bright near excellent bore showing some light fouling. The metal surfaces of this revolver retain about 95% original blue with a light turn ring on the cylinder, high edge wear, scratches and handling marks. The frame is stamped with a "V" indicating some cosmetic defects were noted after manufacturing and there are some slight imperfections in the markings on the left side barrel. The sides of the hammer and trigger are mostly bright and the smooth walnut grips remain in near excellent condition showing mostly worn finish and some light handling marks. The revolver features an adjustable rear sight and seems to function well mechanically with excellent timing and lockup. (138873-351) {MODERN} (200/300)
1567. **MARLIN MODEL 336 SC LEVER ACTION CARBINE** serial #G21046, 32 Special, 20" barrel with a bright excellent bore. The metal surfaces of this carbine retain about 65-70% original blue with even thinning to blue-gray patina along the barrel, moderate high edge wear and toning to pewter-gray patina along the action, scattered freckling and spots of light oxidation staining. The top of the receiver is factory matted and has no added holes. The smooth pistolgrip walnut buttstock and forend remain in very good plus condition showing some scattered light dings, scratches and handling marks throughout. The original Marlin buttplate with white line insert and bull's eye on the toe line are intact. The rifle is also equipped with sling swivels, retains its original sights and front sight hood. A solid example that ought to be a good shooter. (138856-26) {C&R} (250/450)
1568. **SIAMESE MAUSER TYPE 45 BOLT ACTION RIFLE BY KOKURA** serial #24473, 8x50mmR Siamese, 29 1/2" barrel with a very good bore showing some light oxidation in the grooves. The metal surfaces of this rifle retain about 90% arsenal reapplied blue with the floorplate toning to gray patina, a few scattered dings, high edge wear and some evidence of pinprick pitting underneath the blue. The Siamese Chakra crest on the receiver has softened a little bit but is mostly visible and the sliding dust cover is present. The Asian hardwood pistolgrip stock and handguard remain in very good condition showing some worn finish throughout, scattered moderate dings, scratches and handling marks. No cleaning rod is present and the rifle seems to function well mechanically. A very nice example overall of these interesting military bolt rifles. (138871-18) {C&R} (200/400)
1569. **SPANISH M43 MAUSER BOLT ACTION RIFLE BY LA CORUNA** serial #B2990, 8mm Mauser, 24" barrel with a very good bore showing some light frosting. The metal surfaces of this 1945-dated rifle are mostly a gray-brown patina with strong remnants of arsenal blue remaining on the receiver, scattered light oxidation staining and areas of moderate to heavy pitting throughout. The magazine follower retains some remnants of fire blue and the straight handle bolt has been cleaned still showing spots of moderate pitting and gray freckling. The smooth pistolgrip hardwood stock and handguard remain in about good overall condition as cleaned long ago showing a small crack at the upper tang, a few old small chips, moderate dings and spots of oil soaking scattered throughout. All of the visible serialized parts are matching although no number is visible on the bolt, the cleaning rod and all of the sling swivels are intact and there is a small import mark on the right side barrel. (138911-6) {C&R} (100/200)
1570. **N. R. DAVIS & SONS BOXLOCK DOUBLE SHOTGUN** serial #29, 12 ga, 28" barrels choked improved modified with very good plus bores showing some light fouling. The barrels of this shotgun are mostly a pewter-gunmetal patina showing patches of oxidation staining and light pinprick pitting throughout and still retaining some strong remnants of damascus pattern. The action retains some strong case-hardened colors blending throughout with silvery patina and spots of oxidation staining. The checkered capped pistolgrip walnut buttstock and splinter-style forend remain in very good condition showing some areas of worn finish, a few tiny chips, scratches and handling marks. The black hard rubber pistolgrip cap is a little loose but it and the grooved buttplate are otherwise in near excellent condition. The name "E M Tracy" is inscribed on the inside of the forend and the shotgun features a matted top rib with single brass bead front sight, double triggers, extractors and automatic safety. Lockup is solid although the lever rests a little left of center. (138453-4) {C&R} (125/225)
1571. **BRITISH ENFIELD NO. 4 MK I BOLT ACTION RIFLE (SPORTERIZED)** serial #AZ11383, 303 British, 22 1/4" shortened barrel with a bright very good two-groove bore showing some light frosting. The metal surfaces of this rifle are mostly a dark gray patina showing some toning to lighter gray along the barrel, spots of oxidation staining scattered throughout and remnants of Suncoite here and there. The markings are rather soft and the rifle was no doubt arsenal-refinished a number of times, no maker mark is discernible and the date is difficult to read, perhaps 1943. The walnut stock has been cut down and remains in very good condition as refinished long ago showing some light staining, small dings and handling marks scattered throughout. There is a vacant sling swivel hole at the forend and the rifle is sighted with a Williams receiver-mounted peep sight and added ramped bead front sight. The bolt and magazine are numbered to the rifle and everything seems to function fine mechanically. (138916-9) {MODERN} (100/200)

1572. **SAVAGE STEVENS MODEL 87J SEMI-AUTO RIFLE** 22 LR, 20" barrel with a bright near excellent bore. The metal surfaces of this rifle retain about 90% original blue with some overall thinning throughout, light scratches, freckling and a spot of oxidation staining near the muzzle. The smooth pistolgrip hardwood stock remains in very good condition showing some lightly faking finish, a few small dings, scratches and handling marks. The rifle is fitted with an Apache rimfire riflescope with crosshair reticle and slightly cloudy optics. (138871-17) {MODERN} (75/125)
1573. **RUGER 10/22 SEMI-AUTO CARBINE** serial #113-55866, 22 LR, 18 1/2" barrel with a bright very good bore showing some minor fouling throughout. The metal surfaces of this rifle retain about 95% original blue and anodized finishes showing some light scratches and minor flaking along the top and high edges of the receiver, a few errant freckles and scratches along the barrel. The smooth pistolgrip walnut stock remains in about very good condition showing a stretch of moderate scratches along the left side, a couple tiny shallow chips, dings and handling marks. The original folding rear sight and brass bead front sight are present and one factory magazine is included. (138871-19) {MODERN} (150/250)
1574. **WINCHESTER MODEL 59 SINGLE SHOT RIFLE** 22 S,L,LR, 23" barrel with a bright near excellent bore. The metal surfaces of this rifle retain perhaps 45-50% original blue thinning and toning to a mottled gray patina throughout along with some light freckling and scratches. The barrel markings are all still quite crisp and clear. The smooth pistolgrip hardwood stock remains in good condition as refinished with an added coat of varnish and showing thin 2 1/4" and 1" hairline cracks at the left side tip, some moderate scratches, small dings and handling marks. The original buttplate is intact showing some small chips and abrasions around the edges. The original sights are present and the mechanism seems to function well mechanically. A somewhat well-used but solid example of these low-production Winchester single shots. (138865-74) {C&R} (350/550)
1575. **BRITISH PERCUSSION DOUBLE HAMMERMUN BY MANTON** 12 bore, 32" barrels with oxidized bores. The metal surfaces of this shotgun are mostly gray-brown patina throughout with spots of light oxidation staining, scratches and some dings at the muzzles. The barrel rib is faintly marked "LONDON FINE TWIST" and the lockplates feature simple geometric border embellishment and are marked only "MANTON". The straight grip checkered walnut stock remains in good overall condition showing an older repaired break at the wrist, a couple tiny cracks at the toe, scattered staining, small chips and handling marks. The left hammer shows an old brazing repair, there are British proofs present on the undersides of the barrels and an antique slightly warped ramrod is included. The locks still function quite crisply at both half and full cock. (138887-4) {ANTIQUE} (150/250)
1576. **BRITISH DOUBLE HAMMERMUN BY W. RICHARDS** serial #1490, 12 ga, 30" barrels with bright near excellent bores. The metal surfaces of this shotgun are mostly a mix of pewter-gray and gray-brown patina showing some old scattered pitting and freckling. The barrels retain some faint damascus pattern here and there and the top rib is marked "LONDON LAMINATED STEEL". The frame is embellished with rudimentary geometric borders, foliate motifs and the sides marked "W. RICHARDS". Almost all of the major parts are also stamped in small font "F.B. Day". The checkered round knob pistolgrip walnut buttstock and forend remain in fair-good condition showing numerous hairline cracks throughout the wrist, overall smoothing, a vacant spot on the toe line that once held a monogram, overall dings and scratches. The buttstock still shows some nice grain figure, the forend is loose and poorly fitted causing the barrels to come off the frame when the action is opened. Lockup is still quite solid although the lever rests far left and the hammers function crisply. (138692-6) {C&R} (125/225)
1577. **PORTUGUESE M1886 KROPATSCHEK BOLT ACTION RIFLE BY STEYR** serial #G276, 8mm Kropatschek, 32" barrel with a very good bore showing some light frosting, minor oxidation and strong rifling throughout. The barrel of this 1886-dated rifle is mostly a dark brown patina showing small patches of light pitting and minor oxidation staining. The receiver and rear sight base retain some strong remnants of original blue mostly toning to gray patina with scattered freckling and light staining. The left side of the receiver is marked with a soft but visible Portuguese royal crest "(Crown) / L.I.". The walnut stock remains in very good condition as perhaps lightly cleaned long ago showing scattered light dings, scratches, spots of oil soaking and a couple moderate chips at the toe. The stock and barrel are numbered to the gun and the cleaning rod is intact. The bolt is mismatched and provided disassembled with all parts present except for the safety spring and may require mechanical attention. (138852-14) {ANTIQUE} (250/350)
1578. **GERMAN ARMY-MARKED MAUSER HSC SEMI-AUTO PISTOL** serial #915798, 32 ACP, 3 1/2" barrel with a bright near excellent bore showing some very light frosting. The metal surfaces of this pistol retain about 96% older reapplied blue showing some light high edge wear, a few minor scratches, evidence of light pinprick pitting underneath the blue and overall toning to plum. The markings are still quite clear overall and the left side triggerguard is stamped with a "(Eagle) / WaA135" Waffenamt. The walnut grips are have cleaned smooth and remain in otherwise very good condition showing a couple very thin hairline cracks on the left panel and minor handling marks. The mechanism seems to function fine in single action but will require some mechanical attention as the hammer drops sooner than normal in double action and the slide closes when the magazine is released. One unmarked magazine is included. Overall a good "example" piece of an army-issued HSc. (138050-254) {C&R} (300/500)
1579. **MAUSER HSC SEMI-AUTO PISTOL** serial #970333, 32 ACP, 3 1/2" barrel with a bright excellent bore. The metal surfaces of this pistol retain about 90% military-grade reapplied phosphate finish showing some high edge wear and light to moderate pitting underneath the finish scattered throughout. The markings are still clear although there is no commercial Nazi proof visible and the butt is also stamped "459". The checkered walnut grips are of the correct style with a bit of added refreshed checkering and remain in otherwise very good condition showing some light dings and handling marks. One unmarked magazine with similarly reapplied phosphate finish is included and the pistol seems to function well mechanically. (138050-251) {C&R} (200/400)
1580. **MAUSER HSC SEMI-AUTO PISTOL** serial #862979, 32 ACP, 3 1/2" barrel with a bright excellent bore. The metal surfaces of this pistol retain about 94% original blue showing some high edge wear, light scratches, gripstraps thinning and a few spots of light oxidation staining. The markings are clear and the right side triggerguard and slide are marked with commercial "(Eagle) / N" proofs. The smooth walnut grips are replacements closely modeled after the originals; they show outlines of where the checkering would be but are otherwise smooth showing some light dings and handling marks. The right panel is rather poorly fitted and its screw is not seating properly. One unmarked magazine is included showing some light pitting along the body and reapplied blue on the floorplate. The pistol seems to function well mechanically and would benefit from a new set of grips. (138050-244) {C&R} (250/450)
1581. **WINCHESTER MODEL 77 SEMI-AUTO RIFLE** serial #27369, 22 LR, 22" barrel with a bright near excellent bore. The metal surfaces of this rifle retain about 88% original blue showing thinning and toning to gray-brown patina along the top of the receiver and sides of the barrel, scattered freckling and small spots of very light oxidation staining. The smooth pistolgrip walnut buttstock remains in very good condition showing mostly worn finish throughout, some moderate staining along the toe line, light scratches and handling marks. The original buttplate is present showing some scattered staining and one magazine is included. (138841-15) {C&R} (150/250)



1582

1582. U.S. MODEL 1873 TRAPDOOR CUSTOM SPORTING RIFLE serial #143426, 45-70, 26 1/2" shortened barrel with a mostly bright very good bore showing some very light oxidation in the grooves and strong rifling throughout. The metal surfaces of this rifle are mostly a mix of gray and brown patina showing scattered light oxidation staining and light to moderate old pitting throughout. All of the markings are still very clear with strong firing proofs at the breech, nice Federal Eagle and "U.S. / SPRINGFIELD / 1873" on the lockplate. The buttplate and triggerguard are both from different rifles. The checkered pistolgrip walnut stock has been rather nicely

customized with a very slightly raised comb and large pistolgrip that have been professionally spliced on. There is a black hard rubber pistolgrip cap present and the sides of the buttstock feature rather competently done relief engraving of a buck on the right side and another buck with fawn on the left. The splices on the stock show some very minor beginnings of separation, there are a few thin cracks around the lockplate, an about 2 1/2" u-shaped crack emanating from the rear escutcheon on the left side along with some further small dings and handling marks. A single barrel band is affixed and the rifle is sighted with a later Buffington rear sight that has one replacement adjustment screw and an added matted ramp front sight with brass bead. The three-position lock still functions crisply. Overall a rather attractive and well-done sporter. (138841-23) {ANTIQUE} (350/550)

1583. **REMINGTON NYLON 66 SEMI-AUTO RIFLE** 22 LR, 19 5/8" barrel with a bright near excellent bore. The metal surfaces of this 1960-made rifle retain about 90% original blue showing some light oxidation staining and freckling along the frame, high edge wear and light scratches. The checkered pistolgrip Mohawk brown Zytel stock remains in about very good condition showing some small patches of moderate scuffing most noticeable on the left side comb and forend, scattered scratches and handling marks. The magazine tube is present and the original sights are intact. Overall a lightly used example that will probably be a fun plinker. (138864-52) {C&R} (200/400)
1584. **REMINGTON NYLON 66 SEMI-AUTO RIFLE** 22 LR, 19 5/8" barrel with a bright excellent bore. The metal surfaces of this 1961-made rifle retain about 97% original blue showing some high edge wear, a few tiny spots of light oxidation staining and scattered light scratches. The checkered pistolgrip Mohawk brown Zytel stock remains in near excellent condition showing just a few light scratches and handling marks. The magazine tube is present and the original sights are intact. A near excellent example overall that has evidently seen very little use. (138864-53) {C&R} (250/450)
1585. **REMINGTON NYLON 66 SEMI-AUTO RIFLE** serial #2116218, 19 5/8" barrel with a bright excellent bore. The chrome surfaces of this "Apache Black" rifle remain in very good plus condition showing some light scratches and a few small dings mostly on the left side receiver. The checkered pistolgrip Apache black Zytel stock remains in about very good condition showing some moderate scratches, scuffs and a few small dings scattered throughout. The magazine tube is present and the original sights are intact although the forward front sight screw is missing. This rifle has seen a bit of honest use but is a solid example in a desirable configuration. (138864-54) {MODERN} (350/500)
1586. **U.S. MODEL 1861 CONTRACT RIFLE-MUSKET CONVERTED TO FOWLER** about 16 ga, 33 1/2" barrel with an oxidized bore. The barrel of this fowler is mostly a light gray patina while the lockplate is a darker gray-brown all of the surfaces showing some remnants of cleaned moderate pitting throughout. The lockplate is dated 1861 at the rear along with "US" and a clear Federal Eagle. Most of the parts are marked with assembly number "18" and the single barrel band with a "U". The cut down straight grip walnut stock remains in about good-very good condition as cleaned now rather shy of the buttplate with a couple of drying cracks at the butt, scattered dings and scratches. The gun has a single brass bead sight, no ramrod is present and the lock seems to function well mechanically. (138809-150) {ANTIQUE} (100/200)
1587. **REMINGTON NO. 4 ROLLING BLOCK RIFLE** serial #87260, 22 RF, 22 1/2" octagon barrel with a fair bore showing moderate oxidation but some good rifling throughout. The metal surfaces of this rifle are mostly a plum-brown patina showing scattered small tool marks, oxidation staining and spots of pinprick pitting. A number of the screw heads show some light slot damage and the rear tang screw and stock escutcheon are likely older replacements. The smooth straight grip walnut buttstock and forend remain in fair condition showing numerous dings, tiny chips, scratches, spots of old tape residue and a few thin cracks at the upper tang. The rifle is sighted with a fixed rear notch and plain post front. No buttplate is present and the end of the mainspring appears to have broken; it is included but not installed. A good candidate for restoration or parts. (138799-31) {C&R} (50/125)
1588. **RUGER NEW BEARCAT SINGLE ACTION REVOLVER** serial #93-24255, 22 LR, 4" barrel with a bright excellent bore. This stainless steel revolver is in as-new condition with the surfaces bright and the factory rosewood grips absent of any handling marks. The revolver includes an original factory plastic case with safety lock and manual. (58821-104) {MODERN} [Stuart Floam Collection] (300/500)
1589. **RUGER COLLECTOR'S ASSOCIATION MARK II TARGET SEMI-AUTO PISTOL** serial #18-45205, 22 LR, 5 1/2" bull barrel with a bright excellent bore. The metal surfaces retain 99% original blue with intertwined "RCA / 2055" on top of frame in front of ejection port. Included with pistol is an original factory RCA yellow and red hinged cardboard box with wood "salt cod" outer box and manual. An as-new Mark II Target made specifically for the Ruger Collector's Club. (58821-64) {MODERN} [Stuart Floam Collection] (350/550)
1590. **RUGER SECURITY SIX LIBERTY MODEL DOUBLE ACTION REVOLVER** serial #152-56884, 357 Mag., 4" barrel with a bright excellent bore. The stainless steel surfaces rate excellent, the left side of the frame is marked "MADE IN THE 200th YEAR / OF AMERICAN LIBERTY". The factory checkered walnut grips rate excellent as well. Revolver includes an original red and black hinged factory cardboard box. (58821-63) {MODERN} [Stuart Floam Collection] (300/500)
1591. **RUGER MARK II STANDARD 50TH ANNIVERSARY SEMI-AUTO PISTOL** serial #222-60030, 22 LR, 4 3/4" tapered barrel with a bright excellent bore. The metal surfaces retain 99% original blue with 50th Anniversary logo on the top of frame in front of the ejection port. The black checkered Delrin grips with red medallions rate excellent as well. Pistol is in as-new condition and includes an original factory red plastic case with extra magazine, padlock and manual. (58821-108) {MODERN} [Stuart Floam Collection] (275/375)
1592. **RUGER OLD MODEL BEARCAT SINGLE ACTION REVOLVER** serial #17449, 22 LR, 4" barrel with a bright excellent bore. The metal surfaces retain 99% original blue, the brass triggerguard has a smooth even finish. The plain epoxy resin rosewood grips rate excellent as well. Revolver includes a red and black factory box. The transfer bar safety update has not been performed on this revolver. (58821-99){C&R} (350/550)
1593. **RUGER NEW MODEL BLACKHAWK 50TH ANNIVERSARY REVOLVER** serial #520-04219, 357 Mag., 4 5/8" barrel with a bright excellent bore. The metal surfaces of this flat top frame revolver retain 99% original blue. The factory checkered black plastic grips rate excellent. Revolver is in as-new condition and includes the original factory red plastic case with cable lock and manual. (58821-109) {MODERN} [Stuart Floam Collection] (350/550)

1594. **RUGER NRA FOUNDATION WILLIAM RUGER MARK II SEMI-AUTO PISTOL** serial #NRA-05779, 22 LR, 4 3/4" tapered barrel with a bright excellent bore. The metal surfaces retain 99% original blue with roll mark NRA endowment logo and facsimile William Ruger signature along top of frame. The checkered white plastic faux ivory grips with red background medallions rate excellent. Pistol is in as-new condition and includes an original factory red plastic case with extra magazine, cable lock and manual. (58821-114) {MODERN} [Stuart Floam Collection] (275/375)
1595. **RUGER 10/22 MANNLICHER TALO EXCLUSIVE SEMI-AUTO CARBINE** serial 826-76587, 22 LR 18 1/2" barrel with a bright excellent bore. This is a Talo Distributors exclusive model that closely resembles the older checkered walnut International model with addition of a red rubber buttplate and extended magazine release. The metal surfaces retain 99% original blue and the checkered walnut Mannlicher stock rates excellent. A single factory magazine is included. (58821-70) {MODERN} [Stuart Floam Collection] (350/550)
1596. **RUGER 10/22 SEMI-AUTO CARBINE** serial #354-55862, 22 LR, 18 1/2" barrel with a bright excellent bore. Although it can't be certain this model appears to be another Talo or other special distributor's model with an extended magazine release and small Ruger logo in top of the wrists and not in the butt as seen on the Classic models. The metal surfaces retain 99% original matte blue. The checkered black walnut straight grip stock rates excellent. A single factory magazine is included. (58821-120) {MODERN} [Stuart Floam Collection] (175/275)
1597. **RUGER 10/22 CABELA'S 50TH ANNIVERSARY SEMI-AUTO CARBINE** serial #CB61-1250, 22 LR, 18 1/2" barrel with a bright excellent bore. One of 750 rifles manufactured to commemorate Cabela's 50th anniversary. The metal surfaces retain 99% original blue. The checkered Circassian Walnut stock rates excellent. The stock features a raised cheekpiece, schnabel forend and engraved Cabela's 50th anniversary logo on the gripcap. Carbine is also equipped with an extended magazine release and includes an original factory cardboard box, single factory magazine, scope rail, padlock and manual. (58821-122) {MODERN} [Stuart Floam Collection] (275/375)
1598. **REMINGTON MODEL 552 SPEEDMASTER SEMI-AUTO RIFLE** serial #1829069, 22 S,L,LR, 23" barrel with a bright excellent bore. The metal surfaces retain about 98% original blue with sparsely scattered fine oxidation staining. The plain pistolgrip walnut stock and forearm rate near excellent with a few light handling marks. The sights and case deflector are present and intact. (58898-56D30529) {MODERN} (150/250)
1599. **MARLIN GLENFIELD MODEL 60 SEMI-AUTO RIFLE** serial #18313056, 22 LR, 22" barrel with an excellent bore. The metal surfaces retain about 90% original blue with scattered patches of oxidation and light edge wear. The plain hardwood pistolgrip stock rates very good plus with a few light handling marks. (58900-10S21529) {MODERN} (50/100)
1600. **WINCHESTER MODEL 1300 DEFENDER SLIDE ACTION SHOTGUN** serial #L3155742, 12 ga., 18 1/2" plain barrel with a bright excellent bore choked open. The metal surfaces retain 98% original blue, loss due to light wear along the edges. The plain hardwood pistolgrip stock and grooved forearm rate excellent. (58898-23D33370) {MODERN} (150/250)
1601. **MARLIN MODEL 25N BOLT ACTION RIFLE** serial #10740038, 22 LR, 22" barrel with a bright excellent bore. The metal surfaces retain 98% original blue with a couple tiny scratches and light contact wear along the bolt. The smooth hardwood pistolgrip stock rates excellent with a couple minor handling marks. A single factory magazine is included. (58898-59D34082) {MODERN} (75/150)
1602. **THOMPSON/CENTER 56 S.B. PERCUSSION MUZZLELOADING SHOTGUN** serial #91706, .56 cal., 26" octagon smooth-bore barrel with an oxidized bore. The iron surfaces retain about 75% original blue with overall scattered oxidation, the hardware having more modest oxidation. The lock retains equal fading case colors and surface oxidation. The plain walnut stock rates good to very good with scratches and patches of white staining. The rear sight insert and ramrod are no longer present. (58898-104) {ANTIQUÉ} (25/75)
1603. **SAVAGE MODEL 3C BOLT ACTION RIFLE** 22 S,L,LR, 24" barrel with an excellent bore. The metal surfaces retain 95-97% original blue with scattered fine oxidation staining and edge wear. The plain pistolgrip walnut stock rates near excellent with a couple light handling marks. The rear sight has been replaced with a Marble's slot blank and a Redfield No. 80 aperture sight is mounted on the rear of the receiver. (58898-63D30964) {C&R} (50/100)
1604. **ITHACA MODEL 37 DEERSLAYER SLIDE ACTION SHOTGUN** serial #371532728, 12 ga., 20" Featherlight slug barrel with a bright excellent bore. The metal surfaces retain 95-98% original blue, loss due to light contact and edge wear along with a few light scratches. The checkered walnut pistolgrip stock and forearm rate very good with a couple thin drying cracks in the left side of the stock. Equipped with an orange plastic blade ramp front sight and a folding leaf on short rib rear sight. (58898-11D26458) {MODERN} (100/200)
1605. **WINCHESTER MODEL 1300 RANGER TURKEY SLIDE ACTION SHOTGUN** serial #L2132080, 12 ga., 22" ventilated rib Winchoke barrel with a bright excellent bore. The metal surfaces retain 99% original matte blue with a very light scratch on the right side of the frame that does not penetrate the metal. The plain walnut-stained hardwood stock and forearm rate excellent. Shotgun is sighted with a single brass bead and the included choke tube is extra full. (58898-26D33819) {MODERN} (100/200)
1606. **WINCHESTER MODEL 1897 SLIDE ACTION SHOTGUN** serial #969904, 12 ga., 30" plain barrel with a bright excellent bore marked full measuring improved modified. The barrel and magazine have toned to a brown and gray patina with good amounts of original blue in the protected areas along with light edge and contact wear, some sparse light scratches and spots of fine staining. The action retains about 85% original blue toning to brown with scattered scratches and a couple spots of light pitting. The plain pistolgrip walnut stock and grooved forearm rate very good with light handling marks still retaining much original finish. The stock has been fitted with a slightly oversized White Line ventilated recoil pad with spacers providing a 13 5/8" length of pull. (58898-90D33638) {C&R} (300/500)
1607. **MOSSBERG MODEL 500A SLIDE ACTION SHOTGUN** serial #J799588, 12 ga., 24" Slugster barrel with a bright excellent bore. The metal surfaces retain 95-97% original blue with loss due to light contact and edge wear. The checkered hardwood pistolgrip stock and forearm rate near excellent with light handling marks. The factory open sights are in place. (58898-30D33367) {MODERN} (100/200)
1608. **WINCHESTER MODEL 190 SEMI-AUTO CARBINE** serial #B1444986, 22 S,L,LR, 20 1/2" barrel with an excellent bore. The metal surfaces retain 97-98% original blue with scattered light oxidation and edge wear. The plain hardwood pistolgrip stock and forearm rate very good plus with light handling marks. Mounted on the grooved receiver is a Weaver Marksman 4X scope with crosshair reticle and clear optics. (58898-52D33455) {MODERN} (50/100)
1609. **WINCHESTER MODEL 61 SLIDE ACTION RIFLE** serial #53596, 22 S,L,LR, 24" round barrel with a bright excellent bore. The metal surfaces retain about 95% original blue with scattered light scratches, contact and edge wear. The plain walnut stock and grooved forearm rate about very good with a 5/8" chip at the right side of the wrist along with light dents and handling marks. The original sights are intact and a Weaver G4 scope with crosshair reticle and clear optics has been installed in a N5 side-mount base. (58898-79D33840) {C&R} (300/500)

1610. **REMINGTON APACHE 77 BOLT ACTION RIFLE** serial #A2355332, 22 LR, 19 5/8" barrel with a bright excellent bore. The metal surfaces retain 97-98% original matte blue with light edge wear and scattered fine oxidation. The checkered green pistolgrip nylon stock and forearm rate very good with light handling marks. A single factory magazine is included. (58898-65D34097) {MODERN} (150/250)
1611. **STEVENS SPRINGFIELD MODEL 5100 DOUBLE SHOTGUN** 16 ga., 28" solid rib barrels with bright excellent bores choked improved cylinder and modified. The barrels retain about 95% evenly thinning original blue with scattered fine scratches, staining and light edge wear at the muzzle and breech. The rear sight bead is broken. The frame retains about 98% original case colors with light wear and oxidation along the edges. The checkered walnut pistolgrip stock and forend rate very good with light handling marks. (58898-33D33642) {MODERN} (100/200)
1612. **WINCHESTER MODEL 1300 XTR SLIDE ACTION SHOTGUN** serial #LX33509, 12 ga., 28" ventilated rib barrel with a bright excellent bore choked cylinder but marked modified. The barrel retains 97-98% original blue with scattered rub marks and spots of fine oxidation. The alloy frame retains about 98% original black anodized finish with scattered light scratches. The checkered walnut pistolgrip stock and forearm rate very good with light handling marks, some flattened points and a chip that is starting to lift under the finish on the right side of the stock. (58898-32D33281) {MODERN} (150/250)
1613. **MOSSBERG INT'L 702 PLINKSTER SEMI-AUTO RIFLE** serial #EGF279212, 22 LR, 18" barrel with a bright excellent bore. The metal surfaces retain 99% original blue. The checkered synthetic Dura-Wood stock rates excellent. Installed on the receiver is a UTG Picatinny scope base and a single magazine is included. (58898-53D33793) {MODERN} (50/100)
1614. **WINCHESTER MODEL 94 LEVER ACTION CARBINE** serial #4313779, 30-30 Win., 20" barrel with a bright excellent bore. The metal surfaces retain about 98% original blue with a peppering of fine oxidation. The plain walnut straightgrip stock and forend rate very good plus with tiny dents and handling marks. The front sight hood is present. (58898-38D34099) {MODERN} (300/500)
1615. **CONNECTICUT VALLEY ARMS ECLIPSE HUNTER MAGNUM INLINE MUZZLELOADING RIFLE** serial #61-13-051148-02, .50 cal., 209 ignition, 24" barrel with an oxidized bore. The metal surfaces retain 95% original blue with scattered light oxidation and scratches, the oxidation more moderate at the breech area. The checkered Mossy Oak Breakup pistolgrip synthetic stock rates very good plus showing light wear. The front and rear sights have been removed and the three remaining filler screws show light slot wear. What appears to be a proper wooden ramrod is present. (58898-100) {ANTIQUE} (25/75)
1616. **REMINGTON MODEL 870 WINGMASTER SLIDE ACTION SHOTGUN** serial #V823761V, 12 ga., 20" slug barrel with a bright excellent bore. The metal surfaces retain about 95% original blue with scattered spots of surface oxidation, light edge wear and contact wear on the magazine tube and slide arm. The checkered walnut pistolgrip stock and forearm rate about very good with handling marks and a large area of finish on the right side of the buttstock that has been removed with steel wool. The rear sight elevator is no longer present. (58898-47D33164) {MODERN} (150/250)
1617. **MOSSBERG MODEL 40 BOLT ACTION RIFLE** 22 LR, 24" barrel with a bright excellent bore. The metal surfaces have toned to brown under a covering of moderate oxidation and flaking dried varnish. The plain walnut pistolgrip stock with fingergroove forearm rates about fair with a 6 1/2" crack in the bottom of the stock from the stock bolt through the trigger along with numerous handling marks and chips. The No. 3 aperture sight is missing the extra disc. (58900-9S21528) {C&R} (25/50)
1618. **REMINGTON MODEL 600 BOLT ACTION RIFLE** serial #51861, 308 Win., 18 1/2" ventilated rib barrel with a bright excellent bore. The metal surfaces retain about 95% evenly thinning original blue with light muzzle and edge wear, the bolt handle is toning to a gray-brown patina. The checkered walnut pistolgrip stock rates very good with numerous handling marks and spots of flaking finish. The nylon triggerguard is slightly warped and does not seat properly against the stock. (58898-93D33635) {MODERN} (175/275)
1619. **SEARS J.C. HIGGINS MODEL 583.20 BOLT ACTION SHOTGUN** 12 ga., 28" plain barrel with a bright excellent bore choked improved modified. The metal surfaces retain about 75% original blue toning to gray-brown with scattered fine oxidation becoming moderate in areas. The plain hardwood stock rates very good with an abundance of handling marks and areas of worn flaking finish. (58900-3S214-1) {C&R} (25/75)
1620. **MOSSBERG MAVERICK MODEL 88 SLIDE ACTION SHOTGUN** serial #MV80849T, 12 ga., 20" plain cylinder bore barrel with a very good bright bore. The metal surfaces retain 98% original blue with light wear along the edges. The black synthetic pistolgrip stock and forearm rate excellent. Equipped with a single bead front sight and full length magazine. (58898-35D32550) {MODERN} (100/200)
1621. **WINCHESTER RANGER MODEL 120 SLIDE ACTION SHOTGUN** serial #L1824955, 12 ga., 28" ventilated rib barrel with a bright excellent bore choked modified. The metal surfaces retain about 98% original blue with light contact wear on the magazine tube and a few tiny nicks on the alloy frame. The checkered hardwood pistolgrip stock and grooved forearm rate very good plus with light dents and handling marks. (58898-15D34100) {MODERN} (100/200)
1622. **REMINGTON MODEL 522 VIPER SEMI-AUTO RIFLE** serial #3099981, 22 LR, 20" barrel with a bright excellent bore. The metal surfaces retain 95-98% original blue with scattered light scratches and fine oxidation staining. The checkered black synthetic pistolgrip stock rates excellent. The front sight has been removed and there is no magazine present. (58898-51D30894) {MODERN} (75/150)
1623. **MOSSBERG MODEL 42B BOLT ACTION RIFLE** 22 S,L,LR, 24" barrel with a very good bright bore showing sparse pitting. The metal surfaces retain about 85% original blue flaking to brown with scattered fine oxidation, the floorplate has toned to overall brown with light oxidation. The plain hardwood pistolgrip stock rates very good with handling and areas of flaking finish. The rear aperture sight and magazine are no longer present. (58898-61D30794) {C&R} (25/75)
1624. **E.R. AMANTINO/GAUCHA IGA CONDOR 1 OVER UNDER SHOTGUN** serial #26099, 12 ga., 26" ventilated rib multi-choke barrels with bright excellent bores. The metal surfaces retain 98-99% original blue with a couple tiny nicks and scratches. The checkered pistolgrip walnut stock rates excellent with a few light handling marks. Shotgun features a single trigger, extractors and the included choke tubes are modified and improved cylinder. (58898-94D34240) {MODERN} (175/275)
1625. **BROWNING AUTO-5 LIGHT 20 SEMI-AUTO SHOTGUN** serial #6Z7497, 20 ga., 25 1/2" ventilated rib barrel with a very good bright bore choked open. The metal surfaces retain 95-97% original blue with light edge wear, sparse light nicks and scattered fine oxidation with some larger spots of oxidation on the frame and tangs. The barrel is numbered to a different gun and there are some rough edges along the muzzle possibly from being shortened. The checkered walnut round knob pistolgrip stock rates very good light numerous light scratches, spots of dried white paint and crackling in the finish mainly in the grip area. The checkered forearm rates fair to good with a large indentation, numerous scratches, handling marks, worn checkering and flaking along the bottom of the forearm and overall vertical crackling in the gloss finish. The rib is equipped with a single large front bead. (58898-89D34201) {C&R} (275/375)

1626. **SAVAGE AUTOMATIC SEMI-AUTO SHOTGUN** serial #14333, 12 ga., 30" barrel with a very good bright bore marked full now measuring improved modified. The Savage Model 720 is an authorized copy of the Auto-5 only this model is marked "SAVAGE AUTOMATIC" above company address on the left side of the frame with "JOHN M. BROWNING PATENT 1900" in the lower rear corner. The metal surfaces retain about 80% evenly thinning original blue toning to brown with scattered fine oxidation, scratches and light edge wear. The checkered walnut pistolgrip stock rates good having been shortened to a 13 1/2" length of pull and showing moderately flaking finish with the majority of loss on the right side of the stock and along the edges of the black plastic buttplate. The forearm rates fair with a 6 1/2" crack along the right side and light handling marks with about 60% flaking finish remaining. (58788-1) {C&R} (100/200)
1627. **WINCHESTER MODEL 1300 SLIDE ACTION SHOTGUN** serial #L3282977, 12 ga., 28" ventilated rib Winchoke barrel with a bright excellent bore. The metal surfaces retain 95-97% original blue with light contact and edge wear along with a couple tiny rub marks. The checkered hardwood pistolgrip buttstock and forearm rate near excellent with a couple light handling marks. The included choke tube is improved cylinder. (58898-12D34271) {MODERN} (100/200)
1628. **REMINGTON MODEL 1100 SEMI-AUTO SHOTGUN** serial #N625968V, 12 ga., 26" single bead ventilated rib barrel with a bright excellent bore choked improved cylinder. The metal surfaces retain about 98% original blue, the receiver having a peppering of fine oxidation and a spot of light pitting. The checkered walnut pistolgrip buttstock and forearm rate very good plus with a few light handling marks and scratches. (58898-48D33817) {MODERN} (275/375)
1629. **REMINGTON MODEL 1100 SEMI-AUTO SHOTGUN** serial #239125V, 12 ga., 28" single bead ventilated rib barrel with a bright excellent bore choked modified. The metal surfaces retain about 95% evenly thinning original blue toning to brown with light edge wear. The trigger pins are bright, most likely later replacements. The checkered walnut pistolgrip buttstock rates about very good with light handling marks and some modest flaking at the toe while the forearm rates very good plus with fewer handling marks. (58898-92D33836) {MODERN} (300/500)
1630. **ITHACA MODEL 37 DEERSLAYER SLIDE ACTION SHOTGUN** serial #371514377, 12 ga., 20" Featherlight barrel with a bright excellent bore choked cylinder. The metal surfaces retain about 95% original blue with scattered spots of oxidation and light edge wear. The checkered walnut pistolgrip buttstock and forearm rate very good with light handling marks and spots of flaking finish. Equipped with an orange plastic blade ramp front sight and adjustable sporting rear sight. (58898-91D33833) {MODERN} (100/200)
1631. **REMINGTON MODEL 742 WOODSMaster SEMI-AUTO RIFLE** serial #A7029828, 30-06, 22" barrel with a bright excellent bore. The metal surfaces retain 98% original blue with some tiny impact marks to the left of the front sight and at the upper rear of the ejection port. The checkered walnut pistolgrip buttstock and forearm rate near excellent with very light handling marks and blemishes. A single factory magazine is included. (58898-31D33827) {MODERN} (175/275)
1632. **MARLIN MODEL 25N BOLT ACTION RIFLE** serial #05425214, 22 LR, 22" barrel with a bright excellent bore. The metal surfaces retain 98% original blue with a couple tiny nicks and light silvering along the edges. The checkered hardwood pistolgrip stock rates very good plus to near excellent with a handful of light handling marks. The rear sight has been removed and mounted to the grooved receiver is a Bushnell Sportview 4x32 mm scope with duplex reticle and clear optics. A single factory magazine is included. (58898-67D31147) {MODERN} (75/150)
1633. **THOMPSON CENTER FIRE HAWK IN-LINE PERCUSSION RIFLE** serial #S9637, .50 cal., 24" barrel with a lightly oxidized bore. The matte stainless steel metal surfaces rate about very good with light scratches and scattered oxidation staining at the breech and rear of the frame. The checkered black synthetic pistolgrip stock rates very good with light handling marks. The front and rear sights have been removed and two-piece Weaver style bases mounted to the top of the frame. There is no ramrod present. (58898-98) {ANTIQUÉ} (50/100)
1634. **SAVAGE MODEL 24J-DL COMBINATION GUN** serial #A327944, 22 Win. Mag./20 ga., 24" barrels with bright excellent bores, shotgun barrel choked improved modified. The metal surfaces retain 99% original blue. The checkered walnut pistolgrip buttstock and forearm rate very good with light handling marks. The finish shows light crazing and crackling behind the comb on the buttstock and there are remnants along the edges of the buttplate. (58898-81D33816) {MODERN} (300/500)
1635. **SEARS J.C. HIGGINS MODEL 20 SLIDE ACTION SHOTGUN** 16 ga., 28" single bead plain barrel with a very good bright bore. The metal surfaces retain about 90% original blue with scattered fine oxidation and scratches, loss due to muzzle, edge and contact wear. The checkered walnut pistolgrip buttstock and forearm rate very good with light handling marks. There is an inlaid monogram plate in the bottom of the buttstock, the magazine cap is missing and the threads show light wear. (58900-2S21490) {C&R} (50/100)
1636. **REMINGTON MODEL 742 WOODSMaster SEMI-AUTO RIFLE** serial #A7273468, 30-06, 22" barrel with a bright excellent bore. The metal surfaces retain 98% original blue with very light edge wear and specks of fine oxidation mainly along the bottom of the receiver. The checkered walnut pistolgrip stock and forearm rate near excellent with a couple light handling marks. A single factory magazine is included. (58898-25D34014) {MODERN} (175/275)
1637. **MOSSBERG MODEL 500ABR SLIDE ACTION SHOTGUN** serial #G329598, 12 ga., 24" Slugster barrel with a bright excellent bore. The barrel and magazine retain about 95% original blue with some scattered very fine oxidation staining, loss due to light muzzle and edge wear and slide contact wear on the magazine tube and guide arm. The alloy receiver retains about 98% original blue with tiny light scratches and a spot of slide contact wear at the front left side of the receiver. The checkered walnut pistolgrip buttstock and forearm rate about very good with handling marks and spots of flaking finish. (58898-42D34084) {MODERN} (75/150)
1638. **CVA KODIAK MAGNUM IN-LINE MUZZLELOADING RIFLE** serial #6113-029080-05, .50 cal., 209 ignition, 28" barrel with an oxidized bore. The metal surfaces retain 95-97% original blue with scattered light rub marks and oxidation. The Mossy Oak synthetic pistolgrip stock rates near excellent showing light edge wear. What appears to be the correct aluminum ramrod is present. (58898-102) {ANTIQUÉ} (50/100)
1639. **WINCHESTER MODEL 12 SLIDE ACTION SHOTGUN** serial #248994, 12 ga., 28" single bead plain barrel with a bright excellent bore choke improved modified but marked full. The metal surfaces retain about 85% evenly thinning original blue toning to brown with scattered fine oxidation, loss primarily due to wear along the edges and slide contact wear on the magazine tube and guide arm. The plain walnut pistolgrip buttstock and grooved forearm rate good to very good with an abundance of light handling marks and spots of flaking finish. (58887-6) {C&R} (250/450)
1640. **REMINGTON MODEL 24 SEMI-AUTO RIFLE** serial #114029, 22 LR, 21" barrel with a bright excellent bore. The metal surfaces retain 95% evenly thinning original blue toning to brown with a couple tiny nicks and specks of very fine staining. The plain walnut pistolgrip buttstock and forearm rate good to very good with a couple light handling marks and a small chip at the toe in an added varnish that has an orange peel finish, the forend somewhat smoother than the buttstock. The barrel is numbered to the frame. The original sights are intact and a Picatinny style scope base has been installed on top of the receiver. (58905-18) {C&R} (400/600)

1641. **REMINGTON MODEL 597 SEMI-AUTO RIFLE** serial #C2777429, 16 1/2" heavy barrel with a bright excellent bore. The metal surfaces retain 99% original matte blue. The OD green synthetic pistolgrip stock rates excellent. Equipped with a Picatinny scope rail on top of the receiver, included are (3) factory magazines. (58916-16) {MODERN} (100/200)
1642. **BERNARDELLI SINGLE BARREL FOLDING SHOTGUN** serial #8217, 410 bore, 28" plain barrel with a bright excellent bore choked improved cylinder. The metal surfaces retain about 98% original blue with a few specks of oxidation on the left side of the breech and a handful of tiny nicks and scratches. The checkered walnut pistolgrip buttstock and forearm rate very good plus with light handling marks. (58850-8) {MODERN} (100/200)
1643. **BROWNING BL-22 LEVER ACTION RIFLE** serial #7B01607, 22 S,L,LR, 20" barrel with a bright excellent bore. The metal surfaces retain 98% plus original blue with a couple tiny specks of oxidation. The plain straight grip walnut stock and forearm rate near excellent with light handling marks. The factory sights are in place and a Bushnell Banner .22 scope equipped with a duplex reticle and clear optics has been mounted on the grooved receiver. (58850-13) {MODERN} (275/375)
1644. **SAVAGE MODEL 340 BOLT ACTION RIFLE 30-30 WIN.** 22" barrel with a very good bright bore. The metal surfaces retain about 90% evenly thinning original blue toning to gray brown with scattered pitting, oxidation and some more moderate pitting and oxidation at the muzzle and the first 9" on the left side. The plain walnut pistolgrip stock rates very good with a couple blemishes under an added light varnish. A single factory magazine is included. (58877-7) {MODERN} (100/200)
1645. **REMINGTON MODEL 510 BOLT ACTION RIFLE** 22 S,L,LR, 25" barrel with a very good bore showing some light fine oxidation. The metal surfaces retain 90% thinning original blue with scattered fine oxidation. The plain walnut pistolgrip stock rates fair having been sanded and amateurishly incised carved with a deep curtain and circle dot motif at the butt and started checkering at the wrist. There are three notches cut in the front of the comb along with a swivel stud hole at the heel and two at the forend. (58923-6) {MODERN} (25/75)
1646. **REMINGTON MODEL 870 MAGNUM SLIDE ACTION SHOTGUN** serial #W318836M, 12 ga., 20" rifled slug barrel with a bright excellent bore. The barrel retains 98% original matte blue with a couple light rubs and scratches. The finish is different than the rest of the gun so the barrel is most likely a later replacement. The remaining metal surfaces retain 95-98% original blue with loss due primarily to edge and contact wear. The plain walnut pistolgrip buttstock and grooved forearm rate very good with a couple light dents and scratches in an added light varnish. The stock has been fitted with a LimbSaver slip-on rubber recoil pad and a Bushnell Banner 1-4 x 30mm scope with Circle-X reticle and clear optics has been mounted on a Weaver solid base with rings. (58923-2) {MODERN} (200/300)
1647. **REMINGTON MODEL 513-T BOLT ACTION RIFLE** serial #92761, 22 LR, 27" tapered barrel with a bright excellent bore. The metal surfaces retain about 90% evenly thinning original blue toning to brown with light muzzle and edge wear along with a couple tiny impact marks and specks of fine oxidation. The rear of the bolt retains strong bright case colors. The plain walnut pistolgrip stock rates good overall with a few light handling marks and a 3 1/2" thin crack through the heel. The globe style front sight, Redfield aperture rear sight and hand stop rail are in place. Also included with the rifle is an aluminum hand stop, single factory magazine and swivels. (58903-19) {MODERN} (200/300)
1648. **SAVAGE STEVENS MODEL 820B SLIDE ACTION SHOTGUN** 12 ga., 28" single bead plain barrel with a bright excellent bore choked improved cylinder. The metal surfaces retain about 85% original blue toning to brown with scattered fine oxidation, muzzle, edge and contact wear. The plain pistolgrip walnut stock and grooved forearm rate very good with a few light handling marks in an added gloss finish that has a few small spots of flaking. (58916-10) {C&R} (100/200)
1649. **HENRY REPEATING ARMS HENRY LEVER ACTION RIFLE** serial #328882H, 22 LR, 18 1/2" barrel with a bright excellent bore. The metal surfaces retain 99% original blue. The plain straight grip walnut stock and forend rate good with a handful of tiny nicks in the buttstock along with a large 3/4" chip at the toe. (58916-4) {MODERN} (150/250)
1650. **REMINGTON MODEL 870 EXPRESS SLIDE ACTION SHOTGUN** serial #C245020M, 12 ga., 18 1/2" ported barrel with a bright excellent bore choked improved cylinder. The metal surfaces retain about 95% original graphite black Cerakote finish, the majority of loss due to rub wear on the magazine tube extension, contact and edge wear. The checkered hardwood pistolgrip buttstock and forearm rate very good with light handling marks. Shotgun is also equipped with rifle sights and a TacStar sidesaddle has been installed on the left side of the receiver. (58916-3) {MODERN} (150/250)
1651. **SAVAGE STEVENS MODEL 311A DOUBLE SHOTGUN** 20 ga., 28" solid rib barrels with bright excellent bores choked improved modified and improved cylinder. The barrels retain about 80% evenly thinning original blue toning to brown with light wear along the muzzle and edges. The barrels show scattered fine oxidation, tiny nicks and scratches and a small ding in the right side of the barrel. The frame retains about 90% original case colors muting to gray and brown with some sparse fine staining and the aluminum triggerguard retains 85% black enamel flaking to gray. The plain walnut pistolgrip buttstock and forend rate very good with light handling marks and age staining under an added light varnish which is also present along the edges of the buttplate. (58916-7) {C&R} (175/275)
1652. **STEVENS MODEL 107B SINGLE BARREL SHOTGUN** 12 ga., 30" single bead plain barrel with a very good bright bore choked improved modified. The barrel retains about 95% thinning original blue with scattered fine oxidation. The frame and forearm iron retain 95% original bright case colors with scattered fine oxidation and a few patches of more modest oxidation. The plain walnut pistolgrip buttstock and forearm rate very good with four small chips in the left side of the buttstock along with some other light handling marks. (58889-4) {C&R} (50/100)
1653. **NAVY ARMS MODEL 1873 LEVER ACTION TRAPPER CARBINE BY UBERTI** serial #53036, 357 Mag, 16 1/8" barrel with an excellent bore. The metal surfaces retain about 95-97% of the original polished blue finish and have some light wear and a few small tool marks throughout. The brass loading block has a mild tarnish. The walnut stocks rate very good and have several light dings and other marks. The original sights remain intact as does the dust cover. A near excellent example of these quality reproduction Winchester carbines that has seen some use but would still be a great asset at the Cowboy Action range. (48889-8) {MODERN} (400/600)
1654. **STEVENS SPRINGFIELD MODEL 87A SEMI-AUTO RIFLE** 22 LR, 24" barrel with a very good bore. The metal surfaces retain about 70% original blue with scattered fine oxidation and tiny light nicks. The plain pistolgrip hardwood stock rates good to about very good with moderately flaking finish and handling marks. (58923-5) {MODERN} (40/80)
1655. **MOSSBERG MODEL 144 BOLT ACTION RIFLE** 22 LR, 26" barrel with a very good bright bore. The metal surfaces retain about 75% original blue toning to brown and gray with scattered fine oxidation, a couple tiny scratches and some modest oxidation on the left side of the front sight hood. The plain walnut pistolgrip buttstock with raised cheekpiece rates very good plus with light handling marks and is equipped with a hand stop rail and sling swivels. Rifle is equipped with a factory front sight, grooved receiver, Lyman 57MS aperture sight, hand stop and a single factory magazine. (58887-3) {C&R} (175/275)

1656. **REMINGTON MODEL 700 ADL BOLT ACTION RIFLE** serial #E6432897, 7MM-08, 22" barrel with a bright excellent bore. The metal surfaces retain 99% original matte blue. The checkered matte black synthetic pistolgrip stock rates excellent and is equipped with a raised cheekpiece. Equipped with open sights, two-piece Burris bases and rings are mounted on the receiver. (58923-4) {MODERN} (300/500)

1657. **WINCHESTER MODEL 60 BOLT ACTION RIFLE** 22 S,L,LR, 23" barrel with a bright excellent bore. The metal surfaces retain about 85% evenly thinning original blue toning to brown with some sparse tiny impact marks and fine oxidation staining. The plain walnut pistolgrip stock rates excellent and is fitted with a checkered hard rubber factory logo buttplate. (58903-17) {C&R} (200/400)

1658. **CHINESE BRASS BODY PERCUSSION BELT PISTOL** about 40 cal., 4" octagon barrel equipped with a cannon bell muzzle and an oxidized bore. The brass surfaces have a mellowed tarnished patina with sparse fine oxidation becoming more moderate around the nipple and show light scroll engraving on the sides of the frame, trigger-guard and belt hook. The curved tip iron hammer and trigger are an overall brown patina with scattered pitting and oxidation. The large bag-shaped rosewood grip rates very good with light handling marks and is equipped with a lanyard hole decorated with a scalloped brass and copper escutcheon on the left side, no longer present on the right. The pistol is equipped with a hinged brass ramrod which is secured in the front of the triggerguard with a thin iron spring clip. The clip and swing arm have become loose with age and the lock does not function properly. A neat brass body percussion pistol. (58448-17) {ANTIQUE} (100/200)

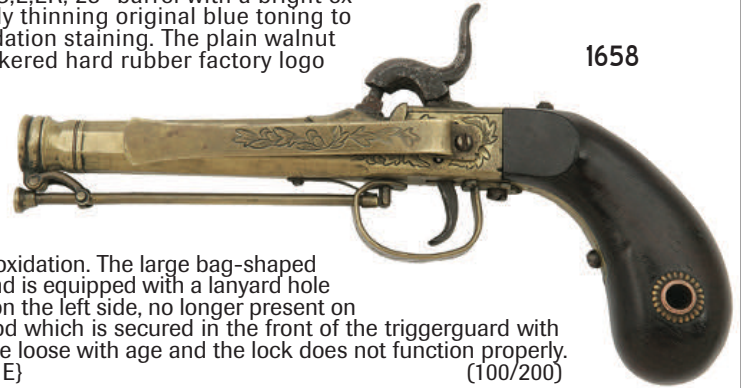

1658

1659

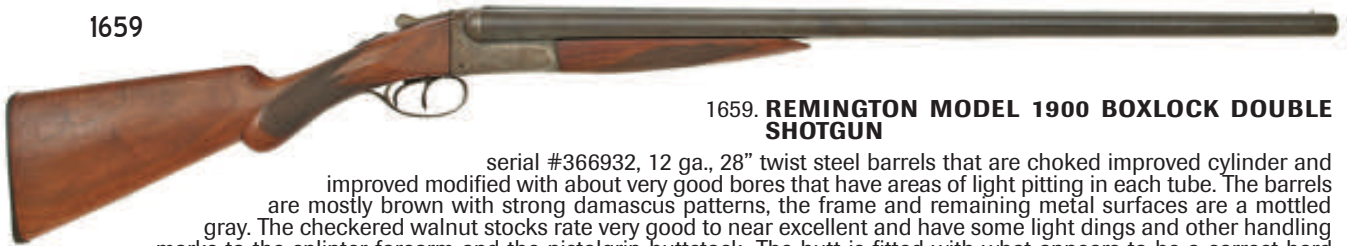

1659. **REMINGTON MODEL 1900 BOXLOCK DOUBLE SHOTGUN**

serial #366932, 12 ga., 28" twist steel barrels that are choked improved cylinder and improved modified with about very good bores that have areas of light pitting in each tube. The barrels are mostly brown with strong damascus patterns, the frame and remaining metal surfaces are a mottled gray. The checkered walnut stocks rate very good to near excellent and have some light dings and other handling marks to the splinter forearm and the pistolgrip buttstock. The butt is fitted with what appears to be a correct hard rubber buttplate that is slightly oversized. There are no cracks visible, but the buttstock does have some lateral play. The action locks-up tight and the mechanisms, including the ejectors appear to function correctly. Overall a very good 1907 vintage example that would benefit from some minor attention from a qualified gunsmith. (48445-16) {C&R} (400/600)

1660. **THOMPSON/CENTER TRIUMPH BONE COLLECTOR INLINE PERCUSSION RIFLE** serial #VDU2093, .50 Cal, 28" fluted barrel with an excellent bore. The metal surfaces retain about 99% original Weathershield blue with a few very light handling marks noted. Rifle has Realtree Camo stocks which rate excellent. The stocks feature "comfort-tech" technology and have black rubber inserts and a Limbsaver recoil pad. The fiber optic front sight remains intact, the rear sight has been removed. Mounted to the barrel is a Bushnell Trophy XLT 3-9X40 riflescope. The scope features a DOA reticle and has excellent optics and a set of Butler Creek flip-up lens covers. The rifle features a 1:28" rate of twist barrel that can handle up to 150 grain loads when used with a sabot style projectile. The original ramrod is included. An excellent example of these modern technology inline black powder rifles. (48841-21) {ANTIQUE} (400/600)

1661. **SAVAGE FOX MODEL BSE DOUBLE EJECTORGUN**

1661

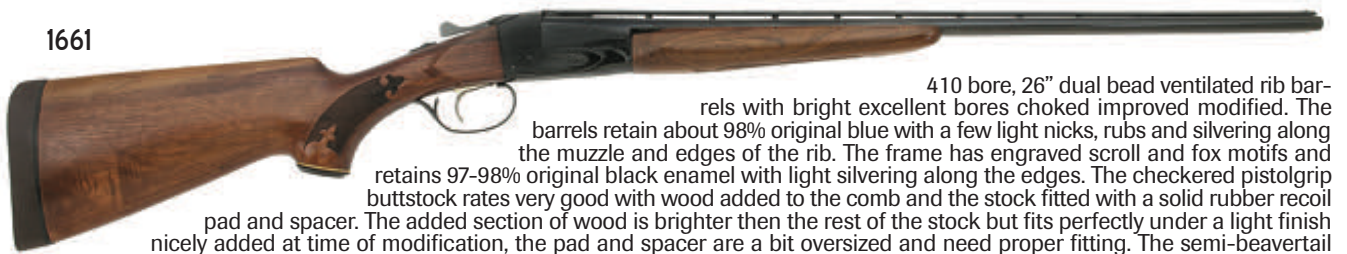

410 bore, 26" dual bead ventilated rib barrels with bright excellent bores choked improved modified. The barrels retain about 98% original blue with a few very light handling marks noted. The frame has engraved scroll and fox motifs and retains 97-98% original black enamel with light silvering along the edges. The checkered pistolgrip buttstock rates very good with wood added to the comb and the stock fitted with a solid rubber recoil pad and spacer. The added section of wood is brighter than the rest of the stock but fits perfectly under a light finish nicely added at time of modification, the pad and spacer are a bit oversized and need proper fitting. The semi-beavertail forearm rates excellent with a couple light blemishes. The shotgun features ejectors and a single trigger. The stock has drops of 1 5/8" and 2 1/2" and a 14 1/4" length of pull. A very good slightly modified "hunter" BSE. (58889-2) {MODERN} (600/800)

1662



1662. **UBERTI MODEL 1866 YELLOW BOY LEVER ACTION CARBINE** serial #W35733, 38 Special, 19" barrel with an excellent bore. The barrel, magazine tube, barrel bands, loading gate, bolt and trigger retain about 97-98% original blue with some light handling wear along the edges and bearing surfaces. The brass receiver and buttplate have a mild tarnish with areas of speckled patina throughout. The hammer and lever retain nearly all the original factory case colors with light gray patina along the edges. The walnut stocks rate excellent and have a few light handling marks. The original sights remain intact. This is a terrific example of the iconic Winchester carbine that was imported by Stoeger and is chambered in an ideal Cowboy Action cartridge. (48889-9) {MODERN} (450/650)

1663. **MARLIN 1895SS LEVER ACTION RIFLE** serial #09065084, 45-70, 22" micro-groove "JM"-marked barrel with an excellent bore. The metal surfaces retain about 95% original blue that has areas of light wear along the edges and bearing surfaces and has some scattered light specks of oxidation and fine pitting throughout. The smooth walnut stocks rate excellent and have some light dings and other handling marks. The original front sight is intact minus its hood, the rear sight has been removed and the dovetail left vacant. Mounted to the rear of the receiver is a Williams rear aperture sight. A leather sporting sling is included, a hammer extension is installed on the hammer and the rifle features a crossbolt safety. An excellent example of these popular lever rifles. (48877-9) {MODERN} (400/600)
1664. **WINCHESTER MODEL 70 FEATHERWEIGHT BOLT ACTION RIFLE** serial #G1959981, 30-06, 22" barrel with an excellent bore. The metal surfaces retain about 98% original blue with some scattered light surface oxidation and some light wear along the edges of the floorplate and triggerguard. The black synthetic stock rates excellent and is equipped with nickel swivel studs and a poorly-fitted Limbsaver recoil pad. There are no sights but mounted to the receiver is a Simmons Prohunter 3-9X40 riflescope. The scope features a duplex reticle and has very good optics. A terrific rifle in overall excellent condition that would benefit from a properly fitting recoil pad. (46520-856) {Richard "Stretch" Kennedy Collection} (400/600)
1665. **ST. HUBERT MODEL U-9 BOLT ACTION RIFLE** serial #16711, 458 Win Mag, 23" ported barrel with an excellent bore. The metal surfaces retain about 90% original blue with light wear and fading along the bearing surfaces and some specks of very light oxidation scattered about. The checkered walnut Monte Carlo stock rates excellent and has some light dings and other handling marks. The stock features a rosewood forend tip and grip cap, two magnum crossbolts, a rollover comb and a Limbsaver recoil pad. The forward swivel stud has been removed and the hole filled, a ring style stud has been mounted to the barrel. The original sights remain intact and mounted to the receiver are a set of Weaver bases with 1" quick-detach rings. There is not much information on the St. Hubert company but the rifle is marked with British nitro proofs and very closely resembles a BSA Monarch in its style and design. An excellent big bore sporting rifle. (48852-4) {MODERN} (400/600)
1666. **WINCHESTER PRE-64 1894 LEVER ACTION CARBINE** serial #2208491, 30-30 Win, 20" barrel with a very good bore that has strong rifling with areas of very light pitting and oxidation throughout. The metal surfaces retain about 98-99% of a later applied blue finish that covers areas of light pitting and other marks. The majority of the markings are still mostly visible and four additional holes have been drilled on the left side of the receiver. The walnut stocks have been refinished as well, the wood itself rating excellent. The left side of the butt has a small check from a knot and there is a very small Masonic emblem inlaid in the wrist. The front sight is a newer replacement, the rear sight is correct. An about very good example made in 1955 that should be a decent shooter. (48877-8) {C&R} (300/500)
1667. **RUGER SR-22 SEMI-AUTO RIFLE** serial #280-10561, 22 LR, 16" target crowned barrel with an excellent bore. The metal surfaces retain about 99% original matte blue and anodized finishes with just a few light handling marks noted. Rifle features a vented aluminum tubular handguard, a Hogue-style pistolgrip and has a fixed buttstock. Rifle is equipped with a set of flip-up Diamondhead sights that are mounted to the picatinny top rails. A metallic pink-colored extended magazine release has been installed, there is no magazine present but replacements are plentiful. An excellent example of these tactical-designed sporting rifles. (48923-1) {MODERN} (300/500)
1668. **HUSQVARNA MODEL 610 BOXLOCK DOUBLE SHOTGUN** serial #214432, 12 ga., 27 1/2" barrel choked a light and tight full with very good bores that have some light pitting toward the chambers. The barrels retain about 80% original blue that is flaking and toning to brown with areas of speckled light surface oxidation throughout. The remaining metal surfaces are a mottled gray, the frame has some nice factory engraved patterns. The checkered hardwood stocks rate excellent and feature a schnabel-tipped forend and English-style straight gripped buttstock. The buttstock has its original hard rubber buttplate and a 14-3/4" length of pull to the forward trigger. Shotgun is equipped with swivels. The action is tight with no lateral play and the mechanisms all appear to function correctly. This is a quality made 1949 vintage double the is very good condition and should provide lots of good opportunities in the field. (48881-1) {C&R} (300/500)
1669. **REMINGTON MODEL 870 SPECIAL PURPOSE SLIDE ACTION SHOTGUN** serial #X087793M, 12 ga., 20" cantilever slug barrel with a rifled choke tube and an excellent bore. The metal surfaces retain about 97-98% original parkerized finish with areas of light wear and handling marks. The checkered walnut stocks rate excellent, the buttstock features a factory vented recoil pad and has an added leather comb raiser installed. Included are a set of 1" scope rings that are mounted to the cantilever. An excellent example of these hardy and versatile hunting shotguns. (48806-8) {MODERN} (300/500)
1670. **CENTURY ARMS CETME SPORTER SEMI-AUTO RIFLE** serial #C52791, 308 Win, 19 1/2" barrel with compensator that has a very good, freckled bore. The metal surfaces retain about 95-97% arsenal finish with areas of light handling wear throughout. The hardwood stocks and synthetic grip rate near excellent and have some light handling marks. The original sights remain intact and included is a military style leather sling and safety warning tag. There is no magazine present, but replacements are available. A near excellent example overall of these popular H&K clones. (48873-725) {MODERN} (300/500)
1671. **CUSTOM REMINGTON MODEL 31 SLIDE ACTION SHOTGUN** serial #92193, 12 ga., 30" barrel choked full with a custom ventilated rib and an excellent bore. The metal surfaces retain about 95-97% of a professionally applied blue finish that has some areas of light wear along the edges and bearing surfaces. Shotgun is fitted with a set of deluxe grade checkered walnut stocks that feature a beavertail forearm and a pistolgrip buttstock with a capped grip and a vented Pachmayr recoil pad. The stocks rate excellent and have some lovely figure. The rib is equipped with a single white bead front sight. A classic sporting shotgun with some lovely upgrades that put it into another bracket of use and style. (48906-11) {MODERN} (300/500)
1672. **REMINGTON MODEL 4-S ROLLING BLOCK RIFLE** serial #5326, 22 LR, 24" shortened barrel with a very good bore that has some areas of light pitting but has strong rifling throughout. The metal surfaces are overall a mottled gray with some areas of light pitting and some light surface oxidation throughout. The left side of the frame is stamped "MILITARY MODEL" and a few of the screws have minor slot damage. The walnut stocks rate about very good and have added finish. The handguard, forend and buttstock all have a few small cracks and repairs, the buttstock is marked with "BS" on the left side of the wrist with two large cut grooves. The buttplate is faded but correct and the original barrel bands and sights are intact. The front sight was moved back when the barrel was shortened. An original military style sling is included. A very good custom example overall of these classic boys cadet training rifles that should make a decent shooter. (46520-3640) {MODERN} (300/500)
1673. **SIG SAUER P522 SEMI-AUTO PISTOL** serial #32A004299, 22 LR, 10 1/2" barrel with flash hider and an excellent bore. The metal surfaces retain about 99% original blue with only a few light handling marks. The black polymer frame and handguard rate excellent. Pistol is not equipped with a buffer tube or brace nor does it have any sights mounted to the picatinny top rail. The handguard is the standard sporting model, an additional handguard with under rail and two 22 LR magazines are included. An excellent sporting pistol by a quality manufacturer. (48913-7) {MODERN} (300/500)

1674. **CZ MALLARD 104A OVER-UNDER SHOTGUN** serial #15S3289, 20 Ga., 28" ventilated rib barrels with screw-in chokes and excellent bores. The barrels feature a single brass bead sight and retain about 99% plus original blue with no visible signs of wear. The remaining coin-finished metal surfaces retain about 99% satin silver finish and have a few very light handling marks. The checkered Turkish walnut stocks rate excellent and have a few light dings, small scratches and a couple of flattened points. Five chokes are included: full, improved modified, modified, improved cylinder and cylinder. A fine sporting shotgun in excellent condition. (48858-1) {MODERN} (300/500)
1675. **SMITH & WESSON MODEL B BOLT ACTION RIFLE** serial #327628, 30-06, 20 3/4" barrel with an excellent bore. The metal surfaces of this Husqvarna-made rifle retain about 95% original blue with light handling and light tool marks as well as a few spots of very light surface oxidation throughout. The bolt is finished in-the-white and has a small amount of brown freckling on the extractor and on the knob. The checkered walnut Monte Carlo stock features a schnabel tip forend, black plastic grip cap and factory butt plate and has nicely figured wood. The stock rates excellent and has some light dings and other handling marks, there is a small non-structural crack in the left side of the forend due to a knot. The original sights are intact and a set of see-thru mounts are installed on the receiver. Included is a leather sporting sling. This is a well-made Mauser action sporting rifle in fine overall condition. (46520-1654) {MODERN} [Richard "Stretch" Kennedy Collection] (300/500)
1676. **SAVAGE MODEL 12FV LEFT HAND BOLT ACTION RIFLE** serial #G211579, 223 Rem, 26" heavy barrel with an excellent bore. The metal surfaces retain about 99% original blue with scattered light handling marks throughout. The checkered black synthetic stock rates excellent and has some light handling marks as well. There are no provisions for sights, a set of Weaver bases have been mounted to the receiver. Rifle is equipped with the Savage Accutrigger. An excellent example of these left hand target and varmint rifles. (48849-5) {MODERN} (300/500)
1677. **AUSTIN & HALLECK MODEL 420 CLASSIC INLINE PERCUSSION RIFLE** serial #0002316, .50 Cal, 27" half round half octagon barrel with an excellent bore. The metal surfaces retain about 99% original blue with a few light handling marks noted. The checkered fancy maple stock rates excellent and has some light dings and other handling marks. Rifle is equipped with fiber optic sights and a set of see-thru rings is mounted to the receiver. One of the rings is missing a top screw the other a base screw. The original ramrod is included. An excellent example of these quality inline black powder rifles. (48879-10) {ANTIQUE} (300/500)
1678. **TRADITIONS PENNSYLVANIA PERCUSSION RIFLE** serial #14-13-055260-99, .50 Cal, 40 1/4" octagon barrel with a 1:66" rate of twist and a near excellent bore that has some small areas of light oxidation. The barrel retains about 99% original blue with some light handling marks noted. The lock retains nearly all of its original case colors. The full-length hardwood stock rates excellent and has some light handling marks, the brass furniture remains mostly bright. The original sights remain intact and the ramrod is included. An excellent example of these quality reproduction arms. (48885-14) {ANTIQUE} (300/500)
1679. **REMINGTON MODEL 1100 MAGNUM SEMI-AUTO SHOTGUN** serial #N099474M, 12 ga., 30" ventilated rib barrel choked full with an excellent bore. The metal surfaces retain about 99% original blue with a few light handling marks visible. The checkered walnut stocks rate excellent and have a few light dings and other marks as well. The buttstock is fitted with a factory vented recoil pad. A canvas gun sleeve is included. A terrific magnum 1100 that would be ideal for the fall and spring waterfowl seasons. (48869-5) {MODERN} (250/450)
1680. **CZ MODEL 452-2E AMERICAN BOLT ACTION RIFLE** serial #A645585, 22 LR, 17" barrel with a threaded muzzle and an excellent bore. The metal surfaces retain about 99% original blue with only a few light handling marks noted. The checkered American walnut stock rates excellent and has some very nice figure and a few very light handling marks as well. There are no provisions for sights, but the receiver is factory grooved for rings. The original box, manual, test target, a knurled thread protector and a single 10-round magazine are included. An excellent "suppressor ready" example of these quality sporting rifles. (48924-4) {MODERN} (250/350)
1681. **MOSSBERG MODEL 500A SLIDE ACTION SHOTGUN** serial #L509651, 12 ga., 28" ventilated rib Accu-Choke barrel with an excellent bore. The metal surfaces retain about 99% original blue with some very light handling marks. The receiver has factory scroll engraving. The checkered hardwood stocks rate excellent and have a few small dings and other markings. The buttstock is fitted with a factory vented recoil pad. The rib is equipped dual bead sights, the base is loose and will need to be re-soldered by a qualified gunsmith. A modified choke is included. A near excellent example of these all-purpose field guns. (48869-2) {MODERN} (150/250)
1682. **SAVAGE/STEVENS MODEL 311 BOXLOCK DOUBLE SHOTGUN** 20 ga, 28" barrels choked improved cylinder and modified with very good lightly freckled bores that show some light fowling. The barrels, top lever and triggerguard retain about 90% original blue that is toning to brown and has light wear and handling marks along with a few specks of light oxidation throughout. The frame retains about 40-50% of the factory case colors, the balance being a mottled gray and brown. This classic utility shotgun features brown tenite stocks which rate very good and have some light scratches and other handling marks. A very good example overall of these prolific field guns. (48563-8) {MODERN} (150/250)
1683. **MARLIN MODEL 883SS BOLT ACTION RIFLE** serial #07583520, 22 WMR, 22" barrel with an excellent bore. The stainless steel surfaces rate excellent and have just a few light handling marks. The laminated hardwood stock rates excellent and has a few light dings. The original sights are intact and mounted to the grooved receiver is a Bushnell 3X-7X Custom .22 rifle-scope. The scope features a crosshair reticle and has very good optics. A quality rimfire rifle package in excellent condition. (48879-18) {MODERN} (150/250)
1684. **J.P. SAUER & SOHN WESTERN MARSHAL REVOLVER** serial #11515/2, 22 LR, 5 1/2" barrel with an excellent bore. The metal surfaces retain about 90% original blue with areas of light wear scattered throughout. The brass frame has a mild ochre patina. The laminate hardwood grips rate excellent and have some light handling marks. The revolver appears to time well and lock up correctly. Included is a brown leather belt with cloth cartridge loops and drop holster with tooled foliate patterns. A great single action plinker in very good overall condition. (48883-9) {MODERN} (150/250)
1685. **CUSTOM MAUSER MODEL 98 BOLT ACTION RIFLE** serial #10815, 8mm Mauser, 24" military barrel with a gray bore that has some light pitting but strong rifling throughout. The metal surfaces retain about 40% original blue, the balance having faded to a mottled gray with brown patina blending throughout. Rifle is fitted in a checkered walnut Whitworth sporting stock that features an ebony forend tip, steel-capped pistolgrip, left side cheek rest and a solid recoil pad. The stock rates very good and has some light to minor dings and other marks. Swivel studs have been added and the original military sights remain intact. The "byf" receiver is dated "44" and has an additional Iraqi stamping in the middle. There are also several Waffenamt stamps still visible. A very good sporting Mauser that will likely make a decent shooter. (48868-1) {MODERN} (200/300)
1686. **SEARS J.C. HIGGINS MODEL 33 SLIDE ACTION RIFLE** 22 S.L.LR, 24" barrel with an excellent bore. The metal surfaces retain about 95% original blue with some light fading along the bearing surfaces. The walnut stocks rate about very good with light dings and other handling marks throughout. The forearm has a small crack on the left side along its leading edge. The original sights and magazine tube remain intact and the receiver is grooved for mounts. A great sporting 22 that should make a terrific plinker. (48883-7) {C&R} (75/150)

1687. **MOSSBERG MODEL 151M(A) SEMI-AUTO RIFLE** 22 LR, 20" barrel with an excellent bore. The metal surfaces retain about 90% original blue that is toning to brown and mixing with areas of light surface oxidation. The walnut stock rates very good and has some light dings and other handling marks. The forward portion of the Mannlicher-style forend is missing. The sights have all been removed and mounted to the grooved receiver is a Bushnell 3X-7X Custom .22 riflescope. The scope features a duplex reticle and has very good optics. A very good example overall that should make a great shooter. (48883-2) {MODERN} (75/150)
1688. **SEARS RANGER MODEL 101.13 BOLT ACTION RIFLE** 22 LR, 24" barrel with an excellent bore. The metal surfaces retain about 95% original blue that is toning to brown and mixing with scattered light specks of surface oxidation throughout. The hardwood stock rates near excellent and has some light handling marks, the swivels have been removed and the holes remain vacant. The original sights remain intact. There is no magazine present but as this model is similar to the Stevens Model 84 bolt action 22's, a replacement should be obtainable. A very good example that should make a great plinker. (48883-1) {C&R} (50/100)
1689. **REMINGTON MODEL 740 WOODSMaster SEMI-AUTO RIFLE** serial #149740, 308 Win, 22" barrel with a near excellent bore that has just a few very small pits noted. The metal surfaces on this 1957-vintage rifle retain about 98-99% original blue with some light wear and a few specks of light surface oxidation scattered about. The walnut stocks rate excellent and have a few light handling marks as well, the buttstock has some minor fading to the original varnish. The original sights remain intact and a single detachable magazine is included. The action appears to be free of any chatter marks internally. A solid example of these classic sporting rifles that is in excellent condition overall. (48883-8) {C&R} (200/300)
1690. **REMINGTON MODEL 29A SLIDE ACTION SHOTGUN** serial #76142, 12 ga., 26" plain barrel choked cylinder with a near excellent bore that has light freckling and a few small pits toward the breech. The metal surfaces are mostly a mottled brown with areas of light to minor surface oxidation throughout. The walnut stocks rate fair and have added finish with evidence of sanding and loss toward the butt. The buttstock has a few minor cracks and some moderate chips missing along either side of the trigger-guard, the buttplate is missing its mid-section. A fair to good example overall of these vintage shotguns that appears to function correctly mechanically. (48883-3) {C&R} (50/75)
1691. **CUSTOM RUGER 10/22 SEMI-AUTO RIFLE** serial #4188, 22 LR, 20" Butler Creek heavy barrel with an excellent bore. The metal surfaces retain about 95% original blue that is mixing with some areas of very light surface oxidation and staining, most of the loss is noticed along the bottom metal. Rifle is fitted to a Butler Creek black synthetic stock that has a few minor handling marks but rates excellent overall. There are no sights but a Simons Blaser 3-9X32 scope is mounted to the receiver. The scope features a duplex reticle and has excellent optics. A single magazine and a black nylon sling are included. An excellent custom 10/22 with a 1965-vintage receiver that should make a superb shooter. (48889-7) {MODERN} (150/250)
1692. **MARLIN MODEL 917VS BOLT ACTION RIFLE** serial #94604141, 17 HMR, 22" fluted barrel with a bright, excellent bore. The stainless steel surfaces rate excellent and have a few light handling marks. The gray/black laminate hardwood stock rates excellent with a few light handling marks as well. There are no provisions for sights but a factory scope base is mounted to the grooved receiver is a BSA Sweet 17 4X32 riflescope. The matte finish scope features a duplex reticle and has excellent optics. The original box with lock, a single magazine and a factory leather sling are included. An excellent example of these super varmint rifles. (48889-5) {MODERN} (200/400)
1693. **RUGER 10/22T SEMI-AUTO RIFLE** serial #246-16346, 22 LR, 20" heavy hammer-forged barrel with an excellent bore. The metal surfaces retain about 99% original blue that has a few light handling marks. The target laminate hardwood stock rates excellent and has a few light marks as well. There are no provisions for sights but a factory scope base is mounted to the receiver. The original box is included, however there is no magazine or other accessories present. An excellent example overall of these quality target model 22's. (48923-3) {MODERN} (250/450)
1694. **HENRY PUMP ACTION RIFLE** serial #P17171T, 22 S,L,LR, 20" octagon barrel with an excellent bore. The metal surfaces retain about 99% blue with a few light handling marks scattered about. The grooved walnut forearm and straight grip buttstock rate excellent and have a few light handling marks. The original brass bead front and semi-buckhorn rear sights remain intact and a picatinny style rail is mounted to the top of the receiver. A terrific example of these classically-inspired slide action rifles. (48916-5) {MODERN} (300/500)
1695. **STEVENS MODEL 30G FAVORITE FALLING BLOCK RIFLE** serial #800162, 22 LR, 21" part round part octagon barrel with an excellent bore. The metal surfaces retain about 99% original blue with just a few light handling marks present. The oil-finished walnut stocks rate excellent and have a few light handling marks as well. The original sights remain intact and included is the original factory box with manual and test target. An excellent condition example of these modern Stevens Favorites. (48889-10) {MODERN} (200/300)
1696. **STEVENS MODEL 416 BOLT ACTION RIFLE** 22 LR, 26" barrel with an excellent bore. The metal surfaces are a mottled gray and brown with small scattered specks of light oxidation and traces of original blue still visible. The walnut stock rates excellent and has a few light handling marks. The wood appears lightly sanded with an oil finish added, the steel buttplate remains proud of the wood. Rifle is equipped with a globe type front sight and has a Lyman aperture rear mounted to the left side of the receiver. A set of Weaver bases have been mounted to the barrel and receiver. A detachable magazine is included, the release lever has been removed. A modern military style sling is included. A very good example that will likely be a good shooter. (48885-1) {C&R} (75/150)
1697. **THOMPSON/CENTER RENEGADE PERCUSSION RIFLE** serial #119405, .54 Cal, 27" octagon barrel with a very good bore that has strong rifling and areas of light oxidation throughout. The metal surfaces are a mottled brown and gray with areas of light pitting and traces of blue remaining. The lock retains most of its original case color. The walnut stocks rates very good and has added finish over light dings and other marks. The lock appears to function correctly and the original sights are intact. The correct ramrod is included. A very good example of these classic traditional black powder rifles. (48888-11) {ANTIQUÉ} (150/250)
1698. **THOMPSON/CENTER OMEGA Z5 INLINE PERCUSSION RIFLE** serial #Z79591, .50 Cal, 28" barrel with a very good bore that has some areas of light oxidation throughout. The matte stainless steel surfaces rate excellent and have a few light handling marks. The blued-over parts and furniture have all their original finish. Rifle sits in a synthetic thumbhole buttstock that has a Realtree Hardwoods camo finish and rates excellent. Rifle features include fiber optic sights, QLA muzzle, an aluminum ramrod and 209 primer ignition. Rifle has 1:28" twist rate and is capable of firing sabot loads with up to 150 grain powder loads. An excellent example of these modern inline percussion rifles. (48879-11) {ANTIQUÉ} (250/450)
1699. **THOMPSON/CENTER THUNDER HAWK INLINE PERCUSSION RIFLE** serial #S19519, .50 Cal, 21" barrel with an excellent bore. The stainless steel surfaces rate excellent and have just a few light handling marks. The checkered black synthetic stock rates excellent and has a solid recoil pad. The original sights remain intact and a set of Weaver type bases are mounted to the receiver. The original ramrod and the rubber nipple protector with factory hang tag are included. Also included is a Butler Creek padded sling. An excellent example of these early inline black powder rifles that likely has seen very little use. (48841-22) {ANTIQUÉ} (150/250)

1700. **RUGER 10/22 STANDARD SPORTER SEMI-AUTO CARBINE** serial #358-06650, 22 LR, 18 1/2" barrel with a bright excellent bore. The metal surfaces retain 99% of their satin black finish with a few minor light scratches. The carbine has standard sights and an added one-piece Weaver style base. The checkered walnut pistolgrip stock rates excellent aside from a few light scattered handling marks and the points of the checkering remain crisp. The hard rubber buttplate with pad remains in excellent condition and the carbine comes with sling swivels, extended magazine release, and one 10-round factory magazine. (108898-75D33344) {MODERN} (200/400)
1701. **WINCHESTER MODEL 94 LEVER ACTION CARBINE** serial #4449768, 30-30 Win., 20" barrel with a bright excellent bore. The metal surfaces retain 95% original blue finish with spots of freckling, light scratches, light wear along the working parts and silvering along some of the high edges. The rifle is sighted with a raised bead front and adjustable sporting rear and the hood protector is present. The straight grip smooth walnut stock and forend rate near excellent with slight variations in color and both have a few light handling marks. (8898-39D34101) {MODERN} (300/500)
1702. **REMINGTON MODEL 870 TACTICAL SLIDE ACTION SHOTGUN** serial #RS89412B, 12 ga., 18" plain barrel with a bright excellent bore. The metal surfaces retain 99% of their original black oxide finish with a few minor scattered scratches. The shotgun features a raised bead front sight, Picatinny style rail with ghost ring rear sight, extended magazine tube and giant head left-side safety. The included screw-in choke is a Remington tactical extended cylinder and the black synthetic pebbled pistolgrip stock and grooved forend rate excellent. (108898-34D34249) {MODERN} (250/450)
1703. **REMINGTON MODEL 1100 SYNTHETIC SEMI-AUTO SHOTGUN** serial #R075925K, 20 ga., 26" Rem Choked, ventilated rib barrel with a bright excellent bore. The metal surfaces retain 98% of their original matte blue finish and have a couple of light scuffs along the barrel. The shotgun is sighted with a single silver bead front sight and the included chokes are improved cylinder and skeet. The black synthetic checkered stock and forend rate excellent aside from a couple of very light handling marks and included is the original factory box that is correctly end-labeled and numbered to the gun with manual. (108849-2) {MODERN} (200/400)
1704. **RUGER MODEL M77 BOLT ACTION RIFLE** serial #770-68058, 7mm Rem. Mag., 24" barrel with a bright excellent bore. The metal surfaces retain 97% original blue and anodized finishes with some scattered light scratches, minor flaking on the floorplate, spots of light fine oxidation staining and silvering along select high edges. The rifle has integrated scope base with no other sight provisions. The checkered walnut pistolgrip stock rates very good plus with scattered light handling marks and mostly crisp points remaining in the checkering. (108898-2D34066) {MODERN} (250/450)
1705. **SAVAGE MODEL 10 FLP BOLT ACTION RIFLE** serial #G124742, 308 Win., 24" heavy barrel with a bright excellent bore. The metal surfaces retain 98% original matte blue finish with a couple of light superficial scratches. This left-handed model features an AccuTrigger and is sighted with a BSA 4-16x40 illuminated reticle scope with mil-dot reticle and crisp clear optics. It will need batteries to confirm if the reticle illuminates. The checkered synthetic stock with Limb Saver recoil pad rates near excellent with some light handling marks and mostly crisp points remaining. A nice pairing for the fall woods. (108898-82D34246) {MODERN} (350/550)
1706. **BROWNING AUTO-5 LIGHT TWELVE SEMI-AUTO SHOTGUN** serial #71G69948, 12 ga., 27 1/2" ventilated rib barrel choked modified with a bright excellent bore. The metal surfaces retain 75 to perhaps 80% original blue finish with areas that are thinning and toned to pewter, light scratches, spots of oxidation staining and silvering along all of the high edges. The shotgun is sighted with a single brass bead and there are impact marks in the rib at the vent closest to the breech. The checkered pistolgrip buttstock and finger groove forend rate very good overall. The added supreme ventilated recoil pad fits proud of the shortened stock with a new length of pull at 13 1/4" and the checkering patterns and tones are slightly different between forend and buttstock. There are several light handling marks and spots of flaking varnish as well. A nice Belgian-made light twelve that should still hunt well. (108898-10D33363) {MODERN} (400/600)
1707. **WINCHESTER MODEL 77 SEMI-AUTO RIFLE** serial #76921, 22 LR, 22" barrel with a bright excellent bore. The metal surfaces retain 95% original blue with some scattered light scratches, minor high edge wear and specks of fine oxidation staining. The rifle is sighted with raised silver bead front and adjustable sporting rear. The smooth walnut pistolgrip stock rates good plus showing a repaired chip at the toe, a light cleaning and added finish. Included is a single ten-round factory detachable box magazine. (108900-25S21457) {C&R} (100/200)
1708. **REMINGTON MODEL 597 SEMI-AUTO RIFLE** serial #C2731258, 22 LR, 20" barrel with a bright excellent bore. The metal surfaces retain 95% original matte finish with oxidation staining running the length of the barrel along the edge of the stock and a few minor light scuffs on the barrel. The rifle is sighted with a 3-9X32 Remington scope with duplex reticle and crisp clear optics. The synthetic grey stock rates excellent and included is a single ten-round factory magazine and light duty Promax travel case. A nice package deal that is likely to shoot well. (108900-54S21503) {MODERN} (100/200)
1709. **WINCHESTER MODEL 94 LEVER ACTION CARBINE** serial #4673172, 30-30 Win., 20" barrel with a bright excellent bore. The metal surfaces retain 98% original blue with light scratches, light silvering along some of the high edges and have scattered specks of fine oxidation staining. The carbine has a hooded raised bead front sight and an adjustable sporting rear sight. The straight grip walnut stock and smooth forend rate near excellent. (108898-37D34203) {MODERN} (300/500)
1710. **WESTERN FIELD MODEL 770A BOLT ACTION RIFLE** serial #65580, 30-06 Springfield, 22" barrel with a bright excellent bore. The metal surfaces on this German-proofed rifle retain perhaps 90% blue finish that is toning to brown with areas of loss at the muzzle, high edge wear, scattered light scratches and spots of fine oxidation staining. The floor plate has a game scene and is fading to pewter color patina. The rifle has a fixed front sight with folding leaf rear sight and a Tasco 3-9X32 rifle scope with duplex reticle and clear crisp optics has been added. The checkered hardwood Monte Carlo stock rates near excellent with some scattered light handling marks throughout and has added swivel studs. This rifle is similar to the Mauser 3000 made by Heym and was likely imported for sale by Montgomery Wards. (108898-21D34274) {MODERN} (200/400)
1711. **MARLIN MODEL 25MN BOLT ACTION RIFLE** serial #06411609, 22 Magnum, 22" barrel with a bright excellent bore. The metal surfaces retain 95% original blue with areas of carry wear, light scratches, silvering along some of the high edges and spots of scattered light fine oxidation staining. The rifle is sighted with standard sporting sights and the press-checkered hardwood stock rates near excellent aside from a few minor handling marks. No magazine is included and they are still available through many online retailers. (108898-60D34114) {MODERN} (75/150)
1712. **O.F. MOSSBERG & SONS MODEL 142-A BOLT ACTION RIFLE** 22 LR, 18" barrel with a bright excellent bore. The metal surfaces retain 95% original blue with some areas of silvering at the muzzle and rear of the bolt as well as some silvering along a few of the high edges. The rifle has standard post front sight and aperture rear and the bolt is mostly a pewter color with vibrant case-hardened colors on the T-Shaped handle. The smooth hardwood stock rates excellent and included is a single seven-round factory magazine. (108898-24D34225) {C&R} (100/200)

1713. **RUGER MODEL M77 BOLT ACTION RIFLE** serial #74-61840, 7mm Rem. Mag., 24" barrel with a bright excellent bore. The metal surfaces retain 99% original blue with some scattered superficial light scratches and two minor spots of oxidation staining, one on the bolt release the other on the rear swivel stud. The rifle has integral bases and a set of 1" rings are included with no other sight provisions. The checkered walnut pistolgrip stock rates about excellent with a few scattered light handling marks and with a couple of very small minor abrasions along the toe. Paired with your favorite optics this should make a great sporting partner. (108898-4D32320) {MODERN} (300/500)
1714. **MARLIN MODEL 336 CS LEVER ACTION CARBINE** serial #14030652, 30-30 Win., 20" round barrel with a bright excellent bore. The metal surfaces retain 98% original blue with some scattered light fine oxidation staining along the barrel and a spot or two on the lever. The carbine is sighted with a hooded raised bead front sight and adjustable sporting rear sight. The smooth walnut pistolgrip stock and forend rate very good plus with scattered light handling marks, spots of crazed and flaking varnish throughout and the bullseye, buttplate and pistolgrip cap all remain in excellent condition. (108888-6) {MODERN} (300/500)
1715. **RUGER MODEL M77 BOLT ACTION RIFLE** serial #72-35781, 270 Win., 22" barrel with a bright excellent bore. The metal surfaces retain 98% original blue finish with a few scattered light scratches and specks of fine oxidation staining. The rifle has integral bases with no other sight provisions and the checkered walnut pistolgrip stock rates near excellent aside from a few light handling marks and spots of flaking varnish. A nice-sized rifle in a very versatile caliber that should make a great hunting companion this fall. (108898-40D33848) {MODERN} (300/500)
1716. **RUGER MODEL SP101 DOUBLE ACTION REVOLVER** serial #571-99058, 357 Magnum, 2 1/4" barrel with a bright excellent bore. The stainless steel surfaces rate excellent aside from a few light specks of fine oxidation staining and a faint turn ring along the cylinder. The revolver has standard sights and the rubber grips with grooved black panel inserts rate excellent. (108896-125D32344) {MODERN} (300/500)
1717. **RUGER 10/22 STANDARD SEMI-AUTO CARBINE** serial #241-64170, 22 LR, 18 1/2" barrel with a bright excellent bore. The metal surfaces retain 98% original blue and anodized finishes with a few light scratches and spots of silvering along some of the high edges. The carbine has standard sights and the smooth hardwood pistolgrip stock rates excellent aside from a few minor light handling marks. Included is a single 10-round factory magazine. (108898-73D34112) {MODERN} (200/300)
1718. **RUGER MODEL 10/22 CANADIAN CENTENNIAL SEMI-AUTO CARBINE** serial #C2675, 22 LR, 18 1/2" barrel with a bright excellent bore. The metal surfaces retain 97% original blue and anodized finish with all of the lettering retaining its gold-colored fill. The carbine has a gold bead front sight with folding leaf rear sight. The checkered hardwood stock with finger groove forend rates very good plus having a few light impressions along the toe with scattered light handling marks. The stock has an inlaid medallion on the right side and sling swivels. The Ruger Logo grip cap and grooved buttplate rate excellent. Included is a single 10-round factory magazine. (108903-16) {MODERN} (300/500)
1719. **RUGER 10/22 STANDARD SEMI-AUTO CARBINE** serial #113-07461, 22 LR, 18 1/2" barrel with a bright excellent bore. The metal surfaces retain 98% original blue and anodized finishes with scattered light scratches and spots of silvering along some of the high edges. The bolt remains mostly bright with scattered light fine oxidation staining. The carbine has standard sights and the smooth pistolgrip hardwood stock rates excellent aside from a few light handling marks. The carbine is missing its buttplate and does not include a magazine. (108898-76D32927) {MODERN} (150/250)
1720. **MOSSBERG MODEL 100 ATR SUPER BANTAM BOLT ACTION RIFLE** serial #BA136035, 243 Win., 20" barrel with a bright excellent bore. The metal surfaces retain 98% matte black finish with a few superficial scratches and spots of fine oxidation staining on the receiver. The rifle is sighted with a Mossberg 3-9X40mm scope with fine duplex reticle and clear crisp optics. The checkered black synthetic stock rates excellent. (108898-84D34251) {MODERN} (200/300)
1721. **RUGER 10/22 STANDARD SEMI-AUTO CARBINE** serial #117-54122, 22 LR, 18 1/2" barrel with a bright excellent bore. The metal surfaces retain 95% original blue and anodized finishes with scattered light scratches, spots of fine oxidation staining and silvering along some of the high edges. The carbine has standard sights and the smooth hardwood pistolgrip stock and forend rates very good with some scattered light handling marks and areas of adhesive residue and staining. No magazine is included. (108898-69D33959) {MODERN} (150/250)
1722. **RUGER 10/22 STANDARD SEMI-AUTO CARBINE** serial #129-96517, 22 LR, 18 1/2" barrel with a bright excellent bore. The metal surfaces retain about 90% original blue and anodized finishes with overall light scratches, spots of fine oxidation staining, flaking on the receiver and silvering along some of the high edges. The carbine has standard sights and an added Weaver-style one-piece base. The smooth hardwood pistolgrip stock rates good to perhaps good plus with overall light handling marks, a moderate scratch along the right side below the receiver, spots of staining, flaking varnish, light impressions and adhesive residue. There is a spot on the belly at the magazine well where there appears to be grind marks that chewed up the wood and part of the magazine well but does not affect its function. Included is a single 10-round factory magazine. (108898-71D33277) {MODERN} (100/200)
1723. **HARRINGTON & RICHARDSON MODEL 755 SAHARA SINGLE SHOT RIFLE** 22 LR, 18" barrel with a bright excellent bore. The metal surfaces retain 95% original blue with light freckling scattered about and some silvering along a couple of the high edges. The rifle has a post front sight with sporting rear that is missing the elevation wedge. The full-length Mannlicher-style stock rates excellent aside from a few light handling marks and a couple spots of flaking varnish. (108894-2) {MODERN} (50/100)
1724. **REMINGTON NYLON 77 APACHE SEMI-AUTO RIFLE** serial #A2347285, 22 LR, 19 5/8" barrel with a bright excellent bore. The metal surfaces retain 99% black enamel finish with specks of oxidation staining overall. The rifle has standard sights and the dark olive green Zytel stock rates excellent aside from a few light handling marks. Included is a single ten-round magazine. (108898-66D34092) {MODERN} (150/250)
1725. **MOSSBERG MODEL 100 ATR NIGHT TRAIN SPECIAL BOLT ACTION RIFLE** serial #BA356917, 308 Win., 22" fluted barrel with a bright excellent bore. The metal surfaces retain 99% original matte black finish with a few light scratches. The rifle has an adjustable LBA trigger and affixed Picatinny style base with no other provisions for sights. The black checkered synthetic stock rates excellent and an Advanced Technology bipod has been installed. (108900-41S21519) {MODERN} (250/450)
1726. **RUGER 10/22 STANDARD SEMI-AUTO CARBINE** serial #355-62734, 22 LR, 18 1/2" barrel with a bright excellent bore. The metal surfaces retain 99% matte black finish with a couple of light superficial scratches. The carbine has a standard bead front sight and folding leaf rear sight and extended magazine release. The smooth hardwood pistolgrip stock rates excellent aside from a few very minor handling marks. No magazine is included but replacements are readily available. (108898-70D33343) {MODERN} (150/250)
1727. **RUGER 10/22 STANDARD SEMI-AUTO CARBINE** serial #255-24822, 22 LR, 18 1/2" barrel with a bright excellent bore. The metal surfaces retain 98% original blue and anodized finishes having a few light scratches and spots of light silvering along some of the high edges. The carbine has standard sights and an added BSA RD30 red dot sight that likely needs batteries. The smooth hardwood pistolgrip stock rates very good plus aside from a couple of light handling marks and very small chip missing from the grip on the lower left front. No magazine is included but they are readily available at all of you favorite sporting goods retailers. (108898-55D33255) {MODERN} (200/300)

1728. **REMINGTON MODEL 870 EXPRESS MAGNUM SLIDE ACTION SHOTGUN** serial #B384831U, 20 ga., 21" ventilated rib Rem-Choke barrel with a bright excellent bore. The metal surfaces on this youth model shotgun retain 98% parkerized finish with a small section of loss at the barrel lug and has a few scattered light scratches. The shotgun has a silver single bead front sight and the included screw-in choke is improved cylinder. The press-checkered laminate stock rates excellent aside from a couple of light handling marks. (108898-13D33795) {MODERN} (200/400)
1729. **REMINGTON MODEL 11-87 SPS SEMI-AUTO SHOTGUN** serial #PC537528, 12 ga., 28" ventilated rib Rem-Choke barrel with a bright excellent bore. The metal surfaces retain 98% parkerized finish with a few scattered light scratches. The shotgun has dual bead sights silver at the rear and white at the front and the included screw-in choke is marked "Turkey XFULL lead shot only". The checkered black synthetic stock rates excellent. (108898-45D34111) {MODERN} (250/450)
1730. **RUGER 10/22 STANDARD SEMI-AUTO CARBINE** serial #247-98951, 22 LR, 18 1/2" barrel with a bright excellent bore. The metal surfaces retain 98% original blue and anodized finishes with a couple of scattered superficial light scratches and spots of silvering along a couple high edges. The carbine has standard sights and the smooth hardwood pistolgrip stock rates very good with some scattered shallow impressions, light handling marks and has a tiny chip missing at the rear of the receiver. No magazine is included but they are readily available. (108898-72D33134) {MODERN} (150/250)
1731. **RUGER 10/22 STANDARD SEMI-AUTO CARBINE** serial #127-29476, 22 LR, 18 1/2" barrel with a bright excellent bore. The metal surfaces retain about 95% original blue with light scratches and spots of scattered fine oxidation staining. The anodized surfaces rate excellent aside from a few spots of silvering at the heavily contacted areas. The carbine has standard sights and the smooth hardwood pistolgrip stock rates excellent. A single ten-round factory magazine is included. (108898-74D34076) {MODERN} (200/300)
1732. **REMINGTON 870 EXPRESS MAGNUM SLIDE ACTION SHOTGUN** serial #D200009M, 12 ga., 26" ventilated rib barrel with a bright excellent bore. The metal surfaces retain 98% matte finish with some light wear marks along the working parts of the slide, light scratches and silvering along some high edges with spots of fine oxidation staining heaviest on the left side of the receiver. The shotgun has a single silver bead sight and the included screw-in choke is full. The checkered black synthetic stock and forend rate excellent aside from a few very light handling marks. (108898-29D33830) {MODERN} (150/250)
1733. **REMINGTON NYLON 77 APACHE SEMI-AUTO RIFLE** serial #A2327571, 22 LR, 19 5/8" barrel with a bright excellent bore. The metal surfaces retain 98% matte black finish with some light discoloration on the front sight. The rifle has a raised bead front sight with adjustable rear sporting sight and the dark olive green Zytel plastic stock rates excellent aside from a few minor handling marks. No magazine is included with the rifle however they are still obtainable. (108898-64D34252) {MODERN} (150/250)
1734. **REMINGTON 870 EXPRESS MAGNUM SLIDE ACTION SHOTGUN** serial #A997353M, 12 ga., 28" ventilated rib Rem-Choke barrel with a bright excellent bore. The metal surfaces retain 98% parkerized matte finish with some scattered light scratches, spots of operational wear and fine oxidation staining along the slide and bottom of the barrel. The shotgun has a single silver bead front sight and the included screw-in choke is modified. The press-checkered hardwood stock rates near excellent with scattered light handling marks and a couple of shallow impressions along the right side of the stock. (108898-44D34109) {MODERN} (175/275)
1735. **REMINGTON MODEL 870 SLIDE ACTION SHOTGUN** serial #AB943011U, 20 ga., 26" ventilated rib Rem-Choke barrel with a bright excellent bore. The metal surfaces retain 98% original parkerized finish with a few scattered scratches and some light operational wear along the working parts of the slide. The shotgun has a single silver bead front sight and the included screw-in choke is modified. The press-checkered laminate stock rates excellent. A nicely configured field gun in a versatile caliber. (108898-17D33807) {MODERN} (200/300)
1736. **MOSSBERG MODEL 590 SPECIAL PURPOSE SLIDE ACTION SHOTGUN** serial #P334202, 12 ga., 20" plain barrel choked cylinder with a bright excellent bore. The metal surfaces retain 95% original blue with light scratches and minor operational wear along the working parts of the slide. The shotgun has a single brass bead front sight, 4-round shell holder affixed to the receiver, extended magazine tube, bayonet lug and a heat shield on the barrel. The black smooth synthetic pistolgrip stock and grooved forend rate excellent. (108898-87D34263) {MODERN} (250/450)
1737. **MOSSBERG MODEL 500 SLIDE ACTION SHOTGUN** serial #K689607, 12 ga., 28" ventilated rib Accu-Choke barrel with a bright excellent bore. The metal surfaces retain 95% original blue and anodized finishes with scattered light scratches areas of wear along the working parts of the slide and some scattered light fine oxidation staining. The shotgun has dual bead sights white front, and brass rear and the included screw in choke is modified. The press checkered hardwood pistolgrip stock and forend rate excellent with a few light handling marks. (108898-46D33806) {MODERN} (175/275)
1738. **HENRY REPEATING ARMS GOLDEN BOY LEVER ACTION RIFLE** serial #GB328815, 22 LR, 20" octagon barrel with a bright excellent bore. The barrel, hammer, trigger, and lever retain 99% original blue finish with all lettering retaining its gold fill. The receiver, barrel band and buttplate retain 99% of their Brasslite finish. The rifle is sighted with a raised brass bead front sight and adjustable sporting rear and the smooth walnut straight grip stock and forend rate excellent aside from a few very light handling marks. (108900-23S21455) {MODERN} (250/450)
1739. **ITHACA MODEL 37 FEATHERLIGHT MAGNUM SLIDE ACTION SHOTGUN** serial #MAG-371763278, 12 ga., 28" ventilated rib barrel choked modified with a bright excellent bore. The metal surfaces retain 95% original blue with light scratches, silvering at the muzzle and along some of the high edges with light operational wear along the working parts of the slide and bottom of the barrel. The shotgun has a high visibility red bead sight and the press checkered pistolgrip stock and forend rate about very good with light handling marks and cracks at either side of the wrist where the wood and metal meet. They do flex and this would be a great candidate for a fix up and comes with a camouflaged padded zipper case. (108900-50S20852) {MODERN} (200/400)
1740. **REMINGTON MODEL 870 EXPRESS MAGNUM SLIDE ACTION SHOTGUN** serial #C357940M, 12 ga, 20" rifled barrel with a bright excellent bore. The metal surfaces retain perhaps 85% plus of their original parkerized finish with scattered staining overall. The shotgun is sighted with a raised bead front sight and adjustable sporting rear sight and the press checkered hardwood pistolgrip stock rates very good with light handling marks, an off center swivel stud added in the toe line, and has mostly worn points in the checkering. (108898-14D33792) {MODERN} (150/250)
1741. **NEW ENGLAND FIREARMS PARDNER SINGLE BARREL SHOTGUN** serial #NB20063, 20 ga., 25 1/2" plain barrel choked full with a bright excellent bore. The metal surfaces retain 95% blue finish along the barrel, hammer, trigger and other small parts with some light scratches and scattered specks of fine oxidation staining. The frame shows vibrant case-hardened colors with some scattered specks of fine oxidation staining. The smooth hardwood stock and forend rate excellent aside from a few light handling marks and some left over adhesive residue near the butt on both sides. (108869-6) {MODERN} (50/75)

1742. **MOSSBERG MODEL 500 CROWN GRADE SLIDE ACTION SHOTGUN** serial #L509658, 12 ga., 28" ventilated rib Accu-Choke barrel with a bright excellent bore. The metal surfaces retain 95% original blue and anodized finishes with scattered light scratches, specks of oxidation staining and light wear along the working parts of the slide. The receiver has loose floral laser scroll engraving and the gold plated trigger retains most of its shiny luster with some scattered light oxidation. The shotgun has dual bead sights white front and brass rear and the included screw in choke is modified. The checkered hardwood pistolgrip stock and finger grooved forend rate excellent. (108869-3) {MODERN} (175/275)
1743. **MARLIN MODEL 880 BOLT ACTION RIFLE** serial #11504507, 22 LR, 22" barrel with a bright excellent bore. The metal surfaces retain 90% plus of their original thinning blue with overall scattered light fine oxidation staining, light scratches, and silvering along some of the high edge. The rifle has standard sights and the front sight hood is no longer present. The press checkered hardwood stock rates very good with light staining near the butt and scattered light handling marks. Included is a single seven round factory magazine. (108898-54D33456) {MODERN} (75/150)
1744. **SMITH & WESSON MODEL 64-1 DOUBLE ACTION REVOLVER** serial #1D6634, 38 Special, 4" pinned barrel with a bright excellent bore. The stainless surfaces rate very good overall with scattered scratches, spots of clouding and wear with an evident turn ring along the cylinder. The standard hammer and trigger retain near all of their hard chrome finish with some very light specks of fine oxidation visible. The revolver has standard sights and the rubber Uncle Mike's checkered combat grips rate excellent. (108896-9D33717) {MODERN} (250/450)
1745. **MOSSBERG MAVERICK MODEL 88 SLIDE ACTION SHOTGUN** serial #MV23569F, 12 ga., 28" ventilated rib, Accu-choke barrel with a bright excellent bore. The metal surfaces retain perhaps 95% plus of their original matte green and black finishes with scattered light scratches and light operational wear. The shotgun features dual bead sights, gold rear, white front and the included screw in choke is modified. The black synthetic stock and grooved forend rate excellent aside from a few scattered light handling marks. (108898-20D33374) {MODERN} (75/150)
1746. **MOSSBERG MODEL 500 SLIDE ACTION SHOTGUN** serial #K758498, 12 ga., 20" plain barrel choked cylinder with a bright excellent bore. The metal surfaces retain 90% thinning blue with areas of wear to bare metal along the slide, extended magazine tube and bottom of the barrel. There are numerous scratches and a couple of spots that are toning more of a plum color patina. The shotgun has a single bead brass front sight and the black synthetic pistolgrip stock and grooved forend rate excellent aside from a few scattered light handling marks. (108898-95D33634) {MODERN} (100/200)
1747. **MOSSBERG MAVERICK MODEL 88 SLIDE ACTION SHOTGUN** serial #MV63309T, 12 ga., 18 1/2" plain barrel choked cylinder with a bright excellent bore. The metal surfaces retain 98% original blue with a few light scratches and silvering along some of the high edges. The shotgun has a single brass bead front sight and the black synthetic pistolgrip stock and grooved forend rate excellent aside from a few light handling marks. (108900-43S21472) {MODERN} (150/250)
1748. **REMINGTON MODEL 341-P BOLT ACTION RIFLE** .22 LR, 24" barrel with a bright excellent bore. The metal surfaces are mostly a brown patina with some silvering along the high edges and scattered light oxidation staining. The rifle has standard sights and the elevation adjustment screw is missing from the rear aperture. The bolt body and handle are a mix of gun metal grey and brown patinas with scattered oxidation staining overall. The smooth hardwood stock rates about excellent with several scattered light handling marks. (108898-68D34254) {C&R} (75/150)
1749. **O.F. MOSSBERG & SONS MODEL 346KA BOLT ACTION RIFLE** .22 LR, 24" barrel with a bright excellent bore. The metal surfaces retain 65% original blue toning to brown with scattered scratches, oxidation staining and silvering along the high edges. The rifle has standard sights and an added Weaver C4 fixed power scope with crosshair reticle and crisp optics. The smooth hardwood stock rates near excellent with scattered light scratches and handling marks. (108898-58D30796) {C&R} (50/75)
1750. **WINCHESTER MODEL 190 SEMI-AUTO RIFLE** serial #605304, .22 LR, 20 1/2" barrel with a bright excellent bore. The metal surfaces retain 90% plus original blue and anodized finishes with scattered light scratches, freckling, and silvering along some of the high edges. The rifle has standard sights and an added Weaver C4 fixed power scope with crosshair reticle and slightly cloudy optics. The smooth hardwood stock and forend rate excellent with light scattered handling marks. (108898-62D29829) {MODERN} (75/150)
1751. **SAVAGE STEVENS MODEL 940 SINGLE BARREL SHOTGUN** .410 bore, 26" plain barrel with a bright excellent bore. The metal surfaces are mostly a brown patina with blue undertones and spots of pewter where they are worn through. The shotgun has a single bead sight and an ejector. The smooth hardwood stocks rate very good with scattered light handling marks. (108916-6) {MODERN} (50/100)
1752. **SEARS ROEBUCK AND CO. MODEL 3T SEMI-AUTO RIFLE** serial #13624, .22 LR, 20 1/2" barrel with a bright excellent bore. The metal surfaces retain 95% original blue and anodized finishes with scattered freckling, light scratches and spots of silvering along some of the high edges. The rifle has standard sights and an added Nichols fixed power scope with fine duplex reticle and slightly cloudy optics. The smooth hardwood stock and forend rate about very good with numerous small chips, handling marks and spots of added finish. (108898-57D30471) {MODERN} (50/100)
1753. **REMINGTON MODEL 512-P SPORTMASTER BOLT ACTION RIFLE** .22 LR, 25" barrel with a bright excellent bore. The metal surfaces retain 90% original blue with areas of flaking, freckling and oxidation staining scattered throughout. The bolt and trigger show mottled remnants of case hardened colors and are mostly a mix of pewter and brown patinas. The rifle has standard sights and the smooth walnut stock rates very good plus having a light cleaning and some added finish with light handling marks scattered about. (108916-1) {C&R} (75/150)
1754. **ROSSI MATCHED PAIR COMBINATION RIFLE / SHOTGUN** serial #SP905640, 22 LR / .410 Bore, 18 1/2" rifled barrel with a bright excellent bore and 22" plain barrel choked cylinder with a bright excellent bore. The metal surfaces retain 95% original blue finish with overall light oxidation staining and a few light scratches. The rifle barrel is sighted with fiber optic bead and adjustable sporting rear and the shotgun barrel has a single brass bead. This model has an internal lock however no keys are provided. The checkered black synthetic stock rates very good and included is a canvas carry case with the Rossi Logo. (108900-7S21411) {MODERN} (75/150)
1755. **REMINGTON MODEL 870 CUSTOM SLIDE ACTION SHOTGUN** serial #AB869565M, 12 ga., 18 1/2" plain barrel choked cylinder with a bright excellent bore. The metal surfaces retain 95% of their original matte finish that is toning more to a brown patina with scattered scratches, adhesive residue staining on the receiver, spots of oxidation staining and shows light operational wear along the slide and bottom of barrel. The shotgun has a single silver bead front sight and extended magazine tube. The R870 marked black pistolgrip and Tiger Stripe Products grooved forend with digital camo pattern rate very good plus with some light scratches and handling marks visible on the grip and spots of flaking on the forend. (108900-5721526) {FIREARM} (150/250)

1756. **HENRY REPEATING ARMS MINI-BOLT BOLT ACTION RIFLE** serial #MB16196, .22 LR, 16" barrel with a bright excellent bore. The stainless surfaces rate excellent aside from a few light scratches and some scattered specks of fine oxidation staining. The rifle has Williams Hi Visibility sights and the black checkered synthetic stock rates excellent. (108898-96D32386) {MODERN} (150/250)
1757. **OREGON ARMS INC. CHIPMUNK BOLT ACTION RIFLE** serial #19381, .22 LR, 16 1/8" barrel with a bright excellent bore. The metal surfaces retain 90% plus original blue that has brown undertones with scattered scratches, spots of oxidation and oxidation staining near overall. The bolt is toned to a pewter color with oxidation staining near overall. The rifle has a ramp front sight and the rear aperture is no longer present. The smooth hardwood Monte Carlo stock rates very good with some scattered light handling marks, a couple of tiny chips and spots of blue paint scattered about the left side. (108898-78D34204) {MODERN} (50/100)
1758. **MOSSBERG 500 SLIDE ACTION SHOTGUN** serial #U230515, 12 ga., 18 1/2" plain barrel choked cylinder with a bright excellent bore. The metal surfaces on this tactical style shotgun retain 98% original blue and anodized finishes with some light wear along the working parts of the slide. The shotgun has a single brass bead front sight and added one-piece Picatinny style rail atop the receiver. The Blackhawk six position pistolgrip stock and forend rate excellent with a few light handling marks and may need to be tightened as the fit is somewhat sloppy. A padded nylon sling is included. (108900-42S21520) {MODERN} (175/275)
1759. **SAVAGE MODEL 93R17 BOLT ACTION RIFLE** serial #0210006, .17 HMR, 21" barrel with a bright excellent bore. The stainless surfaces rate excellent aside from a few light scratches. The rifle has no provisions for sights however a Simmons 3-9x40mm 8 Point scope with fine duplex reticle and crisp clear optics has been added. The checkered black synthetic stock rates excellent and this all-weather style rifle would make a great target or varmint gun and comes with a single five round detachable magazine. (108850-11) {MODERN} (200/300)
1760. **MOSSBERG MAVERICK MODEL 88 SLIDE ACTION SHOTGUN** serial #MV38267C, 12 ga., 24" slug barrel with a bright excellent smooth bore. The metal surfaces retain perhaps 90% original blue and anodized finishes with scattered oxidation and fine oxidation staining with moderate slide wear along the magazine tube. The shot gun has a ramp front sight with folding leaf rear sight and the black synthetic pistolgrip stock and grooved forend rate excellent. (108806-4) {MODERN} (75/150)
1761. **J.C. HIGGINS MODEL 46 LEVER ACTION RIFLE** .22 LR, 22" barrel with a bright excellent bore. The metal surfaces retain 98% original blue and anodized finishes with scattered light fine oxidation staining, spots of minor flaking on the receiver with some light scratches and silvering along some of the high edges. The rifle is sighted with a raised bead front and adjustable sporting rear. The smooth laminate pistolgrip stock rates excellent aside from a few light handling marks. Included is a single 10 round magazine. (108853-3) {C&R} (150/250)
1762. **REMINGTON MODEL 870 WINGMASTER SLIDE ACTION SHOTGUN** serial #317141W, 16 ga., 28" plain barrel choked modified with a bright excellent bore. The metal surfaces retain about 90% original blue with overall light fine oxidation staining, scratches, silvering along high edges and wear consistent with use along the bottom of the barrel and magazine tube. The shotgun has a single silver bead sight and the checkered pistolgrip stock and grooved forend rate about good overall with the stock missing several splinters along the wrist with amateurish attempts at securing the splintered pieces and has an added Decelerator pad that is poorly fit. The forend has some scattered light handling marks and aside from two spots of worn finish remains in very good condition. (108864-60) {MODERN} (75/150)
1763. **WINCHESTER MODEL 1903 SEMI-AUTO RIFLE** serial #51900, 22 Win. Auto, 20" barrel with a bright about very good lightly frosted bore. The metal surfaces are mostly a blend of pewter and brown patinas with scattered light fine oxidation staining, with areas of fine pinprick pitting scattered about. The rifle has its original standard bead and sporting rear sights and the smooth straight grip walnut stock and forend rate very good plus having numerous light handling marks and much of the original finish remains. A salty example that would look great as a wall hanger or has the potential for a refinish. (108903-20) {C&R} (150/250)
1764. **MARLIN MODEL 990 SEMI-AUTO RIFLE** serial #22528242, 22" barrel with a bright excellent bore. The metal surfaces retain perhaps 90% of their original blue and anodized finishes having spots of flaking, silvering, oxidation staining near overall. The rifle has standard sights and the trigger retains near all of its gold plated finish. The Monte Carlo press checkered pistolgrip stock rates about good with scattered dings, nicks, and other handling marks with a 4"x3" section of adhesive residue staining on the right side over some writing in black sharpie. (108900-8S21527) {MODERN} (50/75)
1765. **IVER JOHNSON ARMS & CYCLE WORKS CHAMPION MODEL 36 SINGLE BARREL SHOTGUN** serial #54064C, .410 bore 26" plain barrel choked full with a bright excellent bore. The metal surfaces retain perhaps 60% thinning original blue mostly along the barrel with the frame more of a dark pewter color with remnants of what might have been case hardened colors. The shotgun has a single brass bead front sight and ejector. The smooth hardwood pistolgrip stock and splinter style forend rate very good plus. The action seems tight and this would make a lovely shooter or wall hanger. (108900-26S21458) {C&R} (100/200)
1766. **SMITH & WESSON MODEL 916A SLIDE ACTION SHOTGUN** serial #687B11, 12 ga., 26" plain barrel choked cylinder with a bright excellent bore. The metal surfaces retain 95% original blue with some loss on the magazine tube due to operational wear of the slide, light freckling, and spots of fine oxidation staining. The shotgun has a single brass bead and thumb safety and the smooth hardwood pistolgrip stock and grooved forend rate excellent with a few minor light handling marks. (108898-86D34256) {MODERN} (75/150)
1767. **REMINGTON MODEL 870 WINGMASTER SLIDE ACTION SHOTGUN** serial #T930097V, 12 ga., 20" slug barrel with a bright smooth bore. The metal surfaces retain 90% original blue with spots of wear along the magazine tube, abrasions on the right side of barrel and scattered light scratches, spots of oxidation staining and silvering along some of the high edges. The shotgun has rifle style sights, sling swivel studs and the smooth walnut pistolgrip buttstock and grooved forend rate very good plus with light handling marks and are slightly different shades. (108898-16D33140) {MODERN} (150/250)
1768. **CVA BOBCAT PERCUSSION MUZZLE LOADING RIFLE** serial #60-13-004948-95, .50 Cal., 26" octagon barrel with a bright excellent bore. The metal surfaces retain 95% original blue with scattered light scratches and spots of fine oxidation staining with areas of oxidation on the hammer and lock plate surrounding the touchhole. The rifle is sighted with a brass blade front and adjustable sporting rear and the checkered black synthetic stock rates excellent aside from a few light handling marks. (108852-52) {ANTIQUE} (50/100)
1769. **O.F. MOSSBERG MODEL 200K SLIDE ACTION SHOTGUN** 12 ga., 28" plain barrel with C-Lect choke and bright excellent bore. The metal surfaces retain 95% original blue with scattered light scratches, dings, spots of oxidation staining and silvering along some of the high edges. The smooth pistolgrip stock rates good plus having added finish with light handling marks and a repair through the middle of the stock that is visible from both sides. The repaired crack seems stable and the black checkered plastic slide remains in excellent condition. Included is a detachable 3 round box magazine. (108894-1) {C&R} (75/150)

1770. **O.F. MOSSBERG & SONS MODEL 146B BOLT ACTION RIFLE** .22 LR, 26" barrel with a bright excellent bore. The metal surfaces retain 95% original blue with overall scattered freckling a few light scratches and some silvering along some of the high edges. The bolt body remains mostly bright and the T-shaped bolt hand shows mottled case-hardened colors. The rifle has standard sights and the smooth pistolgrip stock rates excellent aside from a few light scratches. (108898-50D34202) {C&R} (150/250)
1771. **THOMPSON CENTER ARMS HAWKEN FLINTLOCK MUZZLE LOADING RIFLE** serial #31466, .45 Cal., 27" octagon barrel with a dark lightly oxidized bore. The metal surfaces retain 95% original blue finish with scattered light fine oxidation staining throughout. The hammer and lock show strong case-hardened colors and the brass furniture has a nice ochre patina. The rifle has a blade front sight, adjustable sporting rear sight and dual set triggers. The smooth straight grip walnut stock rates near excellent with scattered scratches and light handling marks. (108898-105) {ANTIQUÉ} (75/150)
1772. **CVA BLAZER PERCUSSION MUZZLE LOADING RIFLE** serial #85 340348, .50 Cal., 28" octagon barrel with a dark about very good lightly oxidized bore. The metal surfaces retain 95% original blue with scattered light fine oxidation staining with some areas of oxidation and light pinprick pitting. The rifle has brass blade front sight and fixed leaf rear and the smooth hardwood pistolgrip stock rates very good overall having light handling marks. (108898-101) {ANTIQUÉ} (50/75)
1773. **THOMPSON CENTER ARMS THUNDER HAWK SHADOW IN-LINE MUZZLE LOADING RIFLE** serial #18099, .50 Cal., 24" round barrel with an about very good dark lightly oxidized bore. The metal surfaces retain 95% original blue with scattered fine oxidation staining throughout and spots of oxidation and light scratches as well. The rifle has a raised bead front that is missing the bead, adjustable sporting rear sight. The checkered pistolgrip synthetic stock rates excellent with a few light handling marks. (108898-103) {ANTIQUÉ} (50/75)
1774. **KNIGHTS WOLVERINE IN-LINE MUZZLE LOADING RIFLE** serial #722243, .50 Cal., 22" round barrel with an about good dark oxidized bore. The metal surfaces retain 90% of their matte blue finish with light scratches, loss at the muzzle, oxidation and scattered light fine oxidation staining. The rifle has hi-visibility front and rear sights and the checkered synthetic pistolgrip stock rates excellent aside from some minor handling marks. (108898-99) {ANTIQUÉ} (50/75)
1775. **RUGER P95 DC SEMI-AUTO PISTOL** serial #311-76573, 9mm, 3 7/8" barrel with a bright excellent bore. The stainless surfaces rate very good plus with some scattered light scratches and minor carry wear. The black polymer frame rates excellent with grooved grip panels that have Ruger logo's. The pistol features an ambidextrous decocker and magazine release with fixed three dot sights. The pistol comes with a factory hard case that is end-labeled and numbered to the gun with two Ruger marked bright body magazines. (108896-109D33926) {MODERN} (175/275)
1776. **SMITH & WESSON MODEL 65-2 DOUBLE ACTION REVOLVER** serial #7D00716, .357 Magnum, 4" pinned barrel with a bright excellent bore. The stainless surfaces rate about very good with some scattered light scratches, spots of light holster and carry wear with a light turn ring along the cylinder. The standard trigger and hammer retain near all of their hard chrome finish with a few specks of light fine oxidation staining visible. The revolver has standard sights and the Pachmayr Gripper grips rate excellent. (108896-132D34232) {MODERN} (200/400)
1777. **RUGER P89DC SEMI-AUTO PISTOL** serial #309-04075, 9mm, 4 3/8" barrel with a bright excellent bore. The metal surfaces retain 95% original blue finish that is toning more toward a plum color with scattered light scratches and spots of silvering along the high edges. The alloy frame retains 97% of its matte black finish with light scratches and spots of flaking. The black grooved grip panels rate excellent and the pistol features three dot sights, ambidextrous decocker and magazine release. Included are a grey factory hard case that is not labeled and two aftermarket magazines. (108896-112D33713) {MODERN} (150/250)
1778. **RUGER P345 SEMI-AUTO PISTOL** serial #664-81265, .45 ACP, 4 1/8" barrel with a bright excellent bore. The stainless surfaces rate excellent aside from a few light scratches. The polymer frame with lower Picatinny style rail rates excellent and the checkered portion of the grips remain crisp. The pistol features low profile three dot sights, ambidextrous decocker, and comes with a factory hard case that is end-labeled and numbered to the gun with two 8 round factory magazines, loading tool, and manual. (108896-114D33900) {MODERN} (200/400)
1779. **RUGER NEW MODEL SINGLE-SIX CONVERTIBLE SINGLE ACTION REVOLVER** serial #64-00512, .22 LR / .22 Magnum, 6 1/2" barrel with a bright excellent bore. The metal surfaces retain 97% original blue and anodized finishes with some light silvering at the muzzle, scattered superficial scratches, specks of fine oxidation staining and a light turn ring on the long rifle cylinder. The magnum cylinder retains a similar amount of blue with a light turn ring and scattered patches of oxidation staining and comes with a tattered factory box and red pouch. The revolver has a ramp front sight and black blade adjustable rear sight and the faux ivory grips with Ruger medallions rate excellent. (108897-9D32608) {MODERN} (200/300)
1780. **RUGER SECURITY-SIX DOUBLE ACTION REVOLVER** serial #154-96300, .357 Magnum, 2 3/4" barrel with a bright excellent bore. The metal surfaces retain 95% original blue with scattered specks of fine oxidation staining, flaking, wear along the grip straps, and silvering along some of the high edges. The polished sides of the hammer and trigger exhibit specks of fine oxidation staining and the revolver has a ramp front sight with black blade adjustable rear sight and the walnut diamond checkered grips with Ruger medallions rate near excellent with minor light handling marks. (108896-127D34136) {MODERN} (200/300)
1781. **SMITH & WESSON MODEL M&P 9 SEMI-AUTO PISTOL** serial #DTZ6569, 9mm, 4 1/4" barrel with a bright excellent bore. The metal surfaces retain 98% of their original black Melonite finish with a few superficial light handling marks and minor spot of wear atop the square part of the barrel. The polymer frame with textured grips and integral lower rail rates excellent. The pistol features low profile three dot sights, ambidextrous magazine release and comes with a single 10 round factory magazine. (108896-213D34172) {MODERN} (300/500)
1782. **SMITH & WESSON MODEL M&P 40 SEMI-AUTO PISTOL** serial #DUW4326, .40 S&W, 4 1/4" barrel with a bright excellent bore. The metal surfaces retain 98% of their original black Melonite finish with some light high edge wear near the muzzle. The polymer frame rates excellent with integrated lower accessory rail and the textured grip have some very light staining in the grooves. The pistol features low profile three dot sights, does not have a thumb safety and comes with a single ten round factory magazine. (108896-56D34156) {MODERN} (300/500)
1783. **RUGER SECURITY-SIX DOUBLE ACTION REVOLVER** serial #159-17837, .357 Magnum, 6" barrel with a bright excellent bore. The metal surfaces retain 98% original blue with some light handling marks, spots of silvering along select high edges and has a light turn ring along the cylinder. The thumb latch is a little stiff and the revolver has a red ramp front sight with adjustable black blade rear sight. The checkered walnut grips with logo medallions rate very good plus with light handling marks and slightly worn points. (108896-89D33680) {MODERN} (200/400)
1784. **RUGER SECURITY-SIX DOUBLE ACTION REVOLVER** serial #161-48719, .357 Magnum, 4" barrel with a bright excellent bore. The stainless surfaces rate very good overall with scattered scratches, spots of oxidation staining and areas of light wear and has a visible dual turn ring along the cylinder. The revolver has a red ramp front sight with black blade adjustable rear sight and the checkered Pachmayr presentation grip rates very good plus with overall lightly worn points in the checkering. (108896-133D33935) {MODERN} (200/400)

1785. **SMITH & WESSON MODEL M&P 9 SEMI-AUTO PISTOL** serial #DSS6337, 9mm, 4 1/4" barrel with a bright excellent bore. The metal surfaces retain 98% of their black Melonite finish with some minor high edge wear at the muzzle. The polymer frame with integrated lower accessory rail rates excellent and the pistol features low profile three dot sights, interchangeable palm swell, ambidextrous slide release and comes with a single ten round factory magazine. (108896-63D33655) {MODERN} (300/500)
1786. **TAURUS PT945 SEMI-AUTO PISTOL** serial #NRK89401, .45 ACP, 4 1/4" barrel with a bright excellent bore. The stainless surfaces rate near excellent with scattered light scratches, spots of wear at the muzzle likely from holstering, and has a few scattered spots of light fine oxidation staining. The pistol features low profile three dot sights, and three position ambidextrous safety / decocker. The checkered black plastic grips rate excellent and a single blued-over body eight round factory magazine is included. (108896-144D34134) {MODERN} (250/450)
1787. **INTRATEC TEC-22 SCORPION SEMI-AUTO PISTOL** serial #005601, 22 LR, 4" barrel with a bright excellent bore. The metal surfaces retain 98% of their original phosphate finish with scattered light scratches and has some light wear along the moving parts of the bolt. The pistol has stamped sheet metal front and rear sights and the polymer frame rates very good plus with a few light handling marks. Included is an Eagle International clear plastic 10 round magazine. (108896-163D33700) {MODERN} (175/275)
1788. **SMITH & WESSON M&P 40 SEMI-AUTO PISTOL** serial #MPM8116, .40 S&W, 4 1/4" barrel with a bright excellent bore. The metal surfaces retain about 95% faded original black Melonite finish with scattered scratches, wear at the muzzle and along the high edges. The pistol features low profile three dot sights, ambidextrous slide release, and integral lower accessory rail. The polymer frame rates about very good with some light handling marks and staining at the muzzle end. A factory hard case that is end-labeled and numbered to the gun is include however, no magazine is provided. They are readily available at most sporting goods stores. (108900-52S21501) {MODERN} (200/400)
1789. **SMITH & WESSON M&P 40 SEMI-AUTO PISTOL** serial #DSU6649, .40 S&W, 4 1/4" barrel with a bright excellent bore. The metal surfaces retain 98% of their black Melonite finish with a couple of light superficial scratches. The polymer frame with integral lower accessory rail rates excellent and the pistol features low profile three dot sights with ambidextrous slide release. Included are a factory hard case that is end-labeled and numbered to the gun, two ten round factory magazines, manual and two additional back straps. (108896-50D3391) {MODERN} (300/500)
1790. **SMITH & WESSON M&P 9 SEMI-AUTO PISTOL** serial #MRM5778, 9mm, 4 1/4" barrel with a bright excellent bore. The metal surfaces retain 98% of their black Melonite finish with a couple of light superficial scratches. The polymer frame with integral lower accessory rail rates excellent and the pistol features low profile three dot sights with ambidextrous slide release. Included are a factory hard case that is end-labeled and numbered to the gun, two ten round factory magazines, manual and related papers and two additional back straps are also included. (108896-33D34270) {MODERN} (300/500)
1791. **SPRINGFIELD ARMOY MODEL XD-40 SEMI-AUTO PISTOL** serial #US360000, .40 S&W, 4" barrel with a bright excellent bore. The stainless surfaces rate near excellent with some light superficial handling marks and specks of fine oxidation staining scattered about. The Dark Earth polymer frame with integral lower accessory rail rates excellent. The pistol has drift adjustable three dot sights, dual magazine release and included are factory hard case labeled and numbered to the gun, two 12 round magazines, Kydex style holster, magazine pouch, loading tool and bore brush. (108896-180D34158) {MODERN} (300/500)
1792. **RUGER SECURITY-SIX DOUBLE ACTION REVOLVER** serial #153-64655, .357 Magnum, 6" barrel with a bright excellent bore. The stainless surfaces rate near excellent aside from some light scattered scratches, specks of oxidation staining and has an evident turn ring along the cylinder. The revolver has an orange insert ramp front sight with white outline adjustable blade rear sight and the Pachmayr presentation grips remain in excellent condition. (108896-92D3381) {MODERN} (200/400)
1793. **RUGER MODEL SP101 DOUBLE ACTION REVOLVER** serial #573-43027, .357 Magnum, 2 1/4" barrel with a bright excellent bore. The stainless surfaces of this double action only revolver rate near excellent with a few scattered scratches and light turn ring along the cylinder. The revolver features a bobbed hammer, ramp front sight with square notch rear sight and the smooth rubber grips with grooved black inserts rate near excellent. A great candidate for home defense or as a conceal carry weapon. (108896-128D32571) {MODERN} (300/500)
1794. **RUGER SR45 SEMI-AUTO PISTOL** serial #380-29938, .45 ACP, 4 1/2" barrel with a bright excellent bore. The metal surfaces retain 99% of their black Nitride finish with some light operational wear on top of the square spot of the barrel. The pistol features adjustable three dot sights, ambidextrous safety and magazine release, lower accessory rail and the polymer frame with checkered grip panels rates excellent. Included with the pistol are a factory hard case that is correctly end-labeled and numbered to the gun and two ten round factory magazines. (108896-108D33870) {MODERN} (250/450)
1795. **SMITH & WESSON MODEL SW9VE SEMI-AUTO PISTOL** serial #PDY8556, 9mm, 4" barrel with a bright excellent bore. The stainless surfaces rate excellent and the pistol features three dot sights, and an integrated accessory rail. The polymer frame rates excellent and included are two ten round factory magazines, manual, sticker, and factory hard case that is end-labeled and numbered to the gun. (108896-45D33874) {MODERN} (200/300)
1796. **SMITH & WESSON MODEL SW40VE SEMI-AUTO PISTOL** serial #RBT3677, .40 S&W, 4" barrel with a bright excellent bore. The stainless surfaces rate very good overall with scattered scratches and areas of fine oxidation staining. The polymer frame rates very good with some light handling marks and minor wear along the grips. The pistol has three dot sights, integrated accessory rail and comes with a factory hard case that is end-labeled and numbered to the gun, one ten round factory magazine and manual. (108896-44D34064) {MODERN} (150/250)
1797. **SMITH & WESSON MODEL SW9VE SEMI-AUTO PISTOL** serial #PDW3088, 9mm, 4" barrel with a bright excellent bore. The stainless surfaces rate very good plus with some scattered light scratches and spots of wear associated with carrying. The polymer frame rates about very good with wear light handling and wear marks. The pistol has three dot sights, integrated accessory rail and comes with a factory hard case that is end-labeled and numbered to the gun with one 15 round factory magazine, manual and related papers. (108896-47D33877) {MODERN} (175/275)
1798. **SMITH & WESSON MODEL 410 SEMI-AUTO PISTOL** serial #VJF5479, .40 S&W, 4" barrel with a bright excellent bore. The metal surfaces retain 98% original blue and anodized finishes with scattered light scratches and some minor high edge wear. The pistol features left side safety, three dot sights and the synthetic black checkered grips rate very good plus with light handling marks and mostly crisp points remaining. Included is a single 10 round factory magazine, hard case that is end-labeled and numbered to the gun, chamber flag, and an assortment of S&W papers. (108896-48D33575) {MODERN} (200/400)
1799. **RUGER MODEL P345 SEMI-AUTO PISTOL** serial #664-21261, .45 ACP, 4 1/8" barrel with a bright excellent bore. The stainless surfaces rate excellent and the pistol features fixed three dot sights, ambidextrous decocker, and the polymer frame with lower accessory rail and checkered grips rate excellent. Included are an original factory hard case that is correctly end-labeled and numbered to the gun with manual and related papers, loading tool and one factory eight round magazine. (108896-111D34257) {MODERN} (200/400)

1800. **WALTHER / INTERARMS PPK SEMI-AUTO PISTOL** serial #A003293, .380 ACP, 3 1/8" barrel with a bright excellent bore. The stainless surfaces rate about excellent with overall light scratches and an area at the back of the slide that shows a moderate abrasion. The pistol has fixed sights and the checkered black banner logo grips rate about very good with several scratches, abrasions, and slightly rounded points. Included is a single eight round Walther marked finger rest magazine. (108897-22D33295) {MODERN} (200/400)
1801. **RUGER MODEL SR9C SEMI-AUTO PISTOL** serial #336-17142, 9mm, 3 1/2" barrel with a bright excellent bore. The stainless surfaces rate excellent and the black polymer frame with lower accessory rail and checkered grip panels rate excellent. The pistol has adjustable three dot sights, ambidextrous safety and mag release and comes with a single ten round factory magazine, hard case that is correctly end-labeled and numbered to the gun with manual and loading tool. This pistol appears to have seen little if any use. (108896-135D33883) {MODERN} (200/400)
1802. **SMITH & WESSON MODEL 36-1 CHIEFS SPECIAL REVOLVER** serial #J427789, .38 Special, 3" pinned barrel with a bright excellent bore. The stainless surfaces rate very good with overall light scratches and areas of clouding, wear and has an evident turn ring along the cylinder. The standard hammer has been shortened at the spur and both the hammer and service trigger show mottled remnants of case-hardened color. The revolver has standard sights and the checkered walnut Magna grips with S&W medallions rate about very good with light handling marks, worn points and a few light handling marks. (108896-24D34167) {MODERN} (200/400)
1803. **CHARTER ARMS OFF DUTY DOUBLE ACTION REVOLVER** serial #1110041, .38 Special, 2" barrel with a bright excellent bore. The metal surfaces retain 95% of their original blue finish with a light turn ring along the cylinder, areas of fine light oxidation staining, high edge wear, and scattered light dings. The revolver has a ramp front sight, square notch rear sight, and the checkered rubber logo combat style grips rate very good with some light wear. (108896-151D33669) {MODERN} (75/150)
1804. **SMITH & WESSON MODEL 442-2 AIRWEIGHT REVOLVER** serial #CRT9330, .38 Special +P, 1 7/8" barrel with a bright excellent bore. The metal surfaces retain 98% of their original matte black finish showing a few minor scratches and light turn ring along the cylinder. This double action only revolver has a 1/8" serrated ramp front sight and square notch rear, integral lock (no key provided) and the textured rubber logo boot grips rate near excellent showing some light wear associated with carrying. (108896-27D33880) {MODERN} (200/300)
1805. **SMITH & WESSON MODEL 342 PD AIRLITE CENTENNIAL REVOLVER** serial #CTA6355, 1 7/8" barrel with a bright excellent bore. The metal surfaces retain 98% of their original matte black finish with a few tiny chips in the finish. The titanium cylinder has a brushed natural look with a light turn ring and a few minor scuffs. The revolver has a red ramp front sight with square notch rear sight, integral lock (no key provided), and the Hogue Bantam grips with S&W logos rate very good plus showing light wear and some minor ingrained dirt staining. (108896-28D33922) {MODERN} (300/500)
1806. **SMITH & WESSON M&P BODYGUARD SEMI-AUTO PISTOL** serial #KCH3174, .380 ACP, 2 3/4" barrel with bright excellent bore. The stainless slide retains 98% original black Melonite finish and the polymer finger grooved grip frame rates excellent. The pistol features standard sights, textured grip skins, belt clip, thumb safety and a single six-round magazine is included. A great candidate for a concealed carry piece. (108896-211D34231) {MODERN} (175/275)
1807. **RUGER LC9 SEMI-AUTO PISTOL** serial #321-42163, 9mm, 3 1/8" barrel with a bright excellent bore. The metal surfaces retain 85% to perhaps 90% faded and worn blue finish, showing holster wear, silvering along the high edges and at the muzzle with some scattered light oxidation staining. The nylon checkered grip frame rates about excellent with some light soiling between the crisp points of the checkering and the pistol features three dot sights and comes with a single finger rest factory magazine. (108896-118D31387) {MODERN} (175/275)
1808. **SMITH & WESSON MODEL SW99 SEMI-AUTO PISTOL** serial #SAA4543, 9mm, 4" barrel with a bright excellent bore. The metal surfaces retain 95% original matte black finish with some spots of light silvering along a few high edges, spots of fine oxidation staining at the rear of the slide with areas having plum undertones blending through under bright light. The black textured polymer frame rates about excellent with some scattered light handling marks. This D/A pistol features three dot sights, ambidextrous magazine release, decocking lever, cocking indicator, and comes with one Mec-Gar replacement magazine. (108896-53D33720) {MODERN} (250/450)
1809. **CHARTER ARMS OFF DUTY DOUBLE ACTION REVOLVER** serial #863813, .38 Special, 2" barrel with a bright excellent bore. The metal surfaces retain 90% of their original blue finish with a light turn ring along the cylinder, areas of fine light oxidation staining, high edge wear, flaking along the grip straps and scattered light dings. The revolver has a ramp front sight, square notch rear sight, and the smooth hardwood grips with logo medallions rate excellent. (108896-150D34177) {MODERN} (75/150)
1810. **SMITH & WESSON MODEL SW99 SEMI-AUTO PISTOL** serial #SAD2993, .40 S&W, 4 1/8" barrel with a bright excellent bore. The metal surfaces retain 98% original matte black finish with expected light operational wear along the working parts. The textured polymer frame with integrated lower rail rate excellent. This D/A pistol features night sights that still faintly glow, ambidextrous magazine release, decocking lever, cocking indicator, and comes with one factory magazine. (108896-64D33695) {MODERN} (300/500)
1811. **SMITH & WESSON MODEL SW40VE SEMI-AUTO PISTOL** serial #DSJ1213, .40 S&W, 4" barrel with a bright excellent bore. The stainless surfaces rate excellent with some light oxidation staining in some of the slide serration grooves. The black polymer frame with checkered grip rates excellent and the pistol features three dot sights, an integrated accessory groove and comes with a single 10 round factory magazine. (108896-192D33895) {MODERN} (200/300)
1812. **SMITH & WESSON MODEL SW9V SEMI-AUTO PISTOL** serial #PAV7295, 9mm, 4" barrel with a bright excellent bore. The stainless surfaces rate about excellent with scattered light scratches and handling marks. The smooth black polymer frame with coarse checkered front and back grip straps rates about excellent with some scattered light handling marks. The pistol has three dot sights and comes with a single 10 round factory magazine. (108896-205D33677) {MODERN} (200/300)
1813. **WALTHER P22 SEMI-AUTO PISTOL** serial #104751, 22 LR, 3 3/8" barrel with a bright excellent bore. The metal surfaces retain about 98% original matte black finish with some light handling marks and spots of silvering along some of the high edges. The grooved and stippled polymer frame with integrated lower accessory rail rates excellent. The pistol features three dot sights, internal trigger lock (no key provided) ambidextrous magazine release and thumb safety, and comes with a single 10 round finger rest factory magazine. (108896-174D34002) {MODERN} (150/250)
1814. **SMITH & WESSON MODEL 36 CHIEFS SPECIAL REVOLVER** serial #J787933, .38 Special, 1 7/8" pinned barrel with a bright excellent bore. The metal surfaces retain perhaps 75-80% of their original blue finish with the back strap now mostly a brown patina. There are spots of moderate wear along the left side of the frame and along the cylinder with scattered patches of light to perhaps some moderate oxidation staining near overall. The standard hammer and trigger are now mostly a dark pewter color with scattered oxidation staining and the revolver has a 1/10" serrated blade front sight and square notch rear. The checkered walnut Magna grips with S&W medallions rate good plus with most of the finish worn or flaked away, rounded points on the checkering, and light handling marks. It appears to have been well used with timing and lock up remaining tight and would make a great pack or carry gun. (108900-44S21537) {MODERN} (200/400)

1815. **GLOCK MODEL 42 SEMI-AUTO PISTOL** serial #ABBY269, .380 ACP, 3 1/4" barrel with a bright excellent bore. The metal surfaces retain 99% of their Tenifer finish and the Gen 4 style polymer frame rates excellent. The pistol has fixed white outline sights and comes with a single six round factory magazine, hard case that is labeled and numbered to the gun with bore mop. This pistol appears to have seen little if any use. (108896-182D34206) {MODERN} (250/450)
1816. **SIG SAUER SP2022 SEMI-AUTO PISTOL** serial #24B053448, 9mm, 3 3/4" barrel with a bright excellent bore. The metal surfaces retain 98% of their original black Nitride finish and the polymer frame with integrated lower Picatinny rail rates excellent. The pistol has Siglite sights that no longer illuminate and comes with a single 10 round factory magazine and hard case that is numbered to the gun. (108900-34S21354) {MODERN} (250/450)
1817. **SMITH & WESSON M&P 9C SEMI-AUTO PISTOL** serial #MPW4595, 9mm, 3 1/2" barrel with a bright excellent bore. The metal surfaces retain 95% of their original black Melonite finish with some light fading and silvering along some of the high edges. The compact polymer frame rates excellent and the pistol features integrated lower accessory rail, Novak Lo-Mount carry sights, ambidextrous slide release, and comes with a single 10 round factory magazine. (108896-65D33712) {MODERN} (250/450)
1818. **SMITH & WESSON M&P 40C SEMI-AUTO PISTOL** serial #DUK4652, .40 S&W, 3 1/2" barrel with a bright excellent bore. The metal surfaces retain 98% of their original black Melonite finish with some light wear at the front of the slide along its high edges. The compact polymer frame rates excellent and the pistol features Novak Lo-Mount carry sights, ambidextrous slide release, integral lower accessory rail and comes with a single 10 round factory magazine that is numbered 13-12298 in electric pencil. (108896-59D34150) {MODERN} (250/450)
1819. **SMITH & WESSON M&P 40 SHIELD SEMI-AUTO PISTOL** serial #HBL8018, .40 S&W, 3" barrel with a bright excellent bore. The metal surfaces retain 98% of their original black Melonite finish with very minor wear along the high edges of the slide and top of the barrel at the breech. The polymer frame rates excellent and the pistol features three dot sights, left side thumb safety and comes with a single seven round factory magazine. (108896-72D33850) {MODERN} (200/400)
1820. **TAURUS PT111 MILLENNIUM G2 SEMI-AUTO PISTOL** serial #TG057789, 9mm, 3 1/8" barrel with a bright excellent bore. The metal surfaces retain 95% of their original matte black finish with a few superficial scratches and some light wear along the high edges. The polymer frame with ambidextrous thumb rests and lower accessory rail, rates excellent and the pistol has three dot sights with the rear sight adjustable for elevation and windage. The pistol comes with a single 12 round factory magazine. (108896-147D34205) {MODERN} (150/250)
1821. **SMITH & WESSON M&P 40C SEMI-AUTO PISTOL** serial #MPV6118, .40 S&W, 3 1/2" barrel with a bright excellent bore. The metal surfaces retain 98% original black Melonite finish with some light holster wear on the slide at the muzzle. The compact polymer frame with integral accessory rail rates excellent. The pistol features ambidextrous slide release, loaded chamber indicator and has three dot sights. Included is a single ten round factory magazine that is scratch-numbered 04-03317 near the base on the right side. (108896-61D33648) {MODERN} (250/450)
1822. **AMT HARDBALLER II SEMI-AUTO PISTOL** serial #A05282, .45 ACP, 5" barrel with a bright excellent bore. The stainless steel surfaces rate very good plus with some light scratches and minor oxidation staining along the unpolished surfaces. The pistol features an adjustable blade rear sight that has wear on the right side of the blade, thumb and grip safeties and an adjustable trigger. The wrap around Pachmayr Signature Model grip rates very good plus with some light staining in the grooves and has slightly worn points in the checkering. Included is a single stainless Colt marked 1911 style magazine. (108900-5S21535) {MODERN} (200/400)
1823. **SMITH & WESSON MODEL 22A SEMI-AUTO PISTOL** serial #UAL7171, .22 LR, 4" barrel with a bright excellent bore. The pistol retains 99% of its black anodized finish and the two-piece polymer grips rate excellent. The pistol features an adjustable sporting rear sight with fixed front blade, thumb safety, and comes with factory hard case that is end-labeled and numbered to the gun, manual, related papers, and two ten round factory magazines. (108896-51D33253) {MODERN} (150/250)
1824. **WALTHER PK380 SEMI-AUTO PISTOL** serial #PK088606, .380 ACP, 3 5/8" barrel with a bright excellent bore. The metal surfaces retain 45 to perhaps 50% or their original black finish that is fading to brown with the right side of the slide having heavy oxidation its entire length. The chamber area of the barrel shows heavy oxidation and the polymer frame remains in near excellent condition. The pistol includes a factory hard case that is properly end-labeled and numbered to the gun with manual, fired casing, related papers, internal lock key, and a single eight round magazine. (108900-6S21504) {MODERN} (100/200)
1825. **AMT BACK UP II SEMI-AUTO PISTOL** serial #DA21909, .380 ACP, 2 1/2" barrel with a bright excellent bore. The stainless surfaces rate very good plus with some scattered light scratches and spots of fine oxidation staining. The black carbon fiber grips rate good with crisp points in the checkering and a large sliver is missing along the top edge of the left panel. Included with the pistol is a single five round factory magazine and hard case that is not labeled but has the AMT logo on the lid. (108896-137D33905) {MODERN} (75/150)
1826. **RUGER MODEL SR40C SEMI-AUTO PISTOL** serial #343-16576, .40 S&W, 3 1/2" barrel with a bright excellent bore. The metal surfaces retain 98% of their original Nitridox black finish with a few light superficial scratches and handling marks. The polymer frame with integral lower accessory rail rates excellent with crisp points along the checkered portions of the grip. The pistol has adjustable three dot sights, ambidextrous thumb safety and comes with an original factory hard case that is correctly labeled and numbered to the gun with two magazines, 2 additional magazine bases, and loading tool. (108896-113D33978) {MODERN} (250/450)
1827. **RUGER MODEL SR9C SEMI-AUTO PISTOL** serial #334-41049, 9mm, 3 1/2" barrel with a bright excellent bore. The metal surfaces retain 98% of their original Nitridox black finish with a few superficial light handling marks. The polymer frame rates excellent and the pistol features adjustable three dot sights, ambidextrous thumb safety and magazine release. Included are a factory hard case that is end-labeled and numbered to the gun with two factory magazines with finger rest bases. (108896-134D33930) {MODERN} (250/450)
1828. **RUGER MODEL MKIII 22/45 SEMI-AUTO PISTOL** serial #275-00171, 22 LR, 4" heavy barrel with a bright excellent bore. The metal surfaces retain 98% original blue finish and the pistol features an undercut Patridge front sight with adjustable black blade rear sight. The polymer frame with checkered grip panels rates excellent and included are two factory magazines, internal lock key, manual, one piece Ruger scope base and unlabeled factory hard case. (108896-110D33790) {MODERN} (200/300)
1829. **WALTHER MODEL PPK/S SEMI-AUTO PISTOL** serial #7914BAE, .380 ACP, 3 1/4" barrel with an about very good lightly frosted bore. The two-tone finish on this American made pistol rates about very good with overall light scratches, high edge wear, with scattered spots of clouding along the polished portions of the slide. The pistol has fixed sights and the black plastic banner grips rate very good with slightly rounded points and a few light scratches. Included with the pistol are a factory hard case correctly end-labeled, manual, fired casing and bright flat base factory magazine. (108900-53S21502) {MODERN} (175/275)

1830. **WALTHER MODEL PPS SEMI-AUTO PISTOL** serial #AE8426, .40 S&W, 3 1/8" barrel with a bright excellent bore. The metal surfaces retain 98% of their original matte black finish with some scattered superficial scratches and minor wear along the high edges. The polymer frame rates excellent. The pistol features three dot sights, ambidextrous magazine release, and comes with a single blued-over factory magazine with finger extension base. (108896-175D33990) {MODERN} (250/450)
1831. **SMITH & WESSON MODEL SW40VE SEMI-AUTO PISTOL** serial #DSW5189, .40 S&W, 4" barrel with a bright excellent bore. The stainless finish rates excellent showing some very light operational wear at top of the breech end of the barrel. The polymer frame rates excellent with crisp points remaining in the checkered grip. The pistol has three dot low profile sights and comes with a single ten round factory magazine. (108896-202D34003) {MODERN} (175/275)
1832. **SMITH & WESSON MODEL SW9VE SEMI-AUTO PISTOL** serial #DVN9334, 9mm, 4" barrel with a bright excellent bore. The stainless finish rates excellent aside from a few minor scratches and tiny spots of operational wear at the top of the barrel. The polymer frame rates excellent with crisp coarse checkering on the grip. The pistol has low profile three dot sights and comes with a single ten round factory magazine. (108896-197D33938) {MODERN} (175/275)
1833. **SMITH & WESSON MODEL SW40VE SEMI-AUTO PISTOL** serial #PBR8052, .40 S&W, 4" barrel with a bright excellent bore. The stainless finish rates very good with a few scattered light scratches, minor high edge wear and has some scattered spots of fine oxidation staining. The polymer frame rates about excellent with some minor wear under the accessory groove and the coarse checkering remains mostly crisp. The pistol has low profile three dot sights and comes with a single ten round factory magazine. (108896-67D33536) {MODERN} (150/250)
1834. **AUTO-ORDNANCE MODEL ZG-51 "PIT BULL" SEMI-AUTO PISTOL** serial #AOC18769, .45 ACP, 3 5/8" barrel with an excellent bore. The metal surfaces retain about 95% original blue with several scratches, high edge wear and the slide is toning to plum. The pistol has a fixed ramp front sight and drift adjustable rear sight and the plastic checkered grips with logo medallions rate excellent. This compact pistol is designed after the 1911 and comes with a single blued-over body seven round magazine. (108896-185D33549) {MODERN} (150/250)
1835. **SIG SAUER MODEL P229 SEMI-AUTO PISTOL** serial #AE31673, .40 S&W, 3 7/8" barrel with a bright excellent bore. The metal surfaces retain perhaps 75% faded Nitron and anodized finishes with scattered scratches near overall, operational and high edge wear and spots of flaking on the frame. The pistol has night sights (no longer illuminate) and decocker. The plastic textured grips rate very good with some spots worn smooth and included is a single 12 round blued-over body magazine marked "Restricted Law Enforcement / Gov't Use Only" the shows moderate finish loss expected from use. (108896-178D33412) {MODERN} (200/400)
1836. **SMITH & WESSON MODEL SW9VE SEMI-AUTO PISTOL** serial #RBA7394, 9mm, 4" barrel with a bright excellent bore. The stainless surfaces rate excellent with a few scattered superficial scratches and some specks of fine oxidation staining. The polymer frame rates excellent and the coarse checkering around the grip remains crisp. The pistol has low profile three dot sights and comes with a single 16 round factory magazine. (108896-203D33992) {MODERN} (175/275)
1837. **SMITH & WESSON MODEL 915 SEMI-AUTO PISTOL** serial #VYK0531, 9mm, 4" barrel with a bright excellent bore. The metal surfaces retain 97% of their original matte blue and anodized finishes with some scattered light scratches and spots of high edge wear. The pistol has drift adjustable sights, thumb safety, and the checkered logo grip rates about excellent with some light wear marks and slight rounding of the points. (108896-215D344269) {MODERN} (200/400)
1838. **BERETTA MODEL 900S SEMI-AUTO PISTOL** serial #SN011962, .40 S&W, 3 1/2" barrel with a bright excellent bore. The metal surfaces of this type F pistol retain 98% of their original matte black finish and the molded rubber grips rate excellent. This single / double action pistol has night sights (that no longer illuminate), ambidextrous safety / decocker, and comes with a single ten round factory magazine. (108896-189D34221) {MODERN} (200/400)
1839. **TAURUS MODEL PT 92 AFS SEMI-AUTO PISTOL** serial #TRH43296, 9mm, 5" barrel with bright excellent bore. The stainless and polished alloy surfaces rate very good plus with some scattered light scratches and operational wear marks. The pistol has three dot sights, ambidextrous safety, and the checkered rubber logo grips rate excellent with overall crisp points remaining. Included is an unmarked blued-over body aftermarket magazine. (108896-145D34264) {MODERN} (200/400)
1840. **TAURUS MODEL PT 99 AF SEMI-AUTO PISTOL** serial #TIF86533, 9mm, 4 7/8" barrel with a bright excellent bore. The satin nickel finish rates about excellent with some light scratches, minor wear and specks of fine oxidation staining heaviest in the slide grooves. The pistol has a fixed blade front sight with adjustable blade rear sight, ambidextrous safety and the smooth walnut grips with gold colored logo medallions rate very good plus with some light handling marks and spots of flaking varnish. Included with the pistol is a single unmarked blued-over body aftermarket magazine. (108896-143D33686) {MODERN} (250/450)
1841. **STAR / INTERARMS M43 FIRESTAR SEMI-AUTO PISTOL** serial #1937447, 9mm, 3 1/4" barrel with a bright excellent bore. The nickel surfaces remain in near excellent condition with scattered light scratches and spots of fine oxidation staining. The pistol features fixed three dot sights, ambidextrous safety and the checkered rubber logo grips rate excellent. Included with the pistol is a single seven round factory magazine with expected light wear consistent with use and is scratch-numbered 09-02360. (108896-161D33654) {MODERN} (150/250)
1842. **STAR / INTERARMS M40 FIRESTAR SEMI-AUTO PISTOL** serial #2040830, .40 S&W, 3 1/4" barrel with a bright excellent bore. The nickel surfaces rate excellent aside from some very light fine oxidation staining scattered about the frame and several superficial light scratches. The pistol has three dot sights, ambidextrous safety and the checkered rubber logo grips rate excellent with some minor softening of some of the points. Included is a single factory six round magazine that is marked "Lenny" in electric-pencil along one of the sides. (108896-160D34259) {MODERN} (150/250)
1843. **TAURUS MODEL PT 908 SEMI-AUTO PISTOL** serial #TMJ15840, 9mm, 3 3/4" barrel with a bright excellent bore. The metal surfaces retain 85% original blue and 97% of its anodized finish with scattered light scratches, high edge wear and loss due to fading. The pistol has drift adjustable three dot sights, ambidextrous thumb safety / decocker and the checkered plastic logo grips rate about very good with light scratches, handling marks and are missing one of the grip screws. No magazine is included but they are still available through aftermarket sources. (108896-148D34000) {MODERN} (100/200)
1844. **RUGER MODEL P89 SEMI-AUTO PISTOL** serial #310-39168, 9mm, 4 1/4" barrel with a bright excellent bore. The metal surfaces retain 95% of their original blue and matte finishes with the slide toning more to a plum color patina. The pistol features three dot sights, ambidextrous safety / decocker, and ambidextrous magazine release. The grooved plastic grips with name and logo rate excellent and a single blued-over body aftermarket magazine is included. (108896-122D32119) {MODERN} (175/275)
1845. **RUGER MODEL P95 SEMI-AUTO PISTOL** serial #316-52177, 9mm, 4" barrel with a bright excellent bore. The metal surfaces retain 95% original blue toning to plum with some scattered light scratches, high edge wear and fine oxidation staining near overall. The polymer frame rates very good plus with numerous light handling marks and wear associated with use. The pistol has fixed three dot sights, ambidextrous magazine release and safety / decocker and it includes a single, likely 10 round, factory magazine. (108896-124D33997) {MODERN} (150/250)

1846. **RUGER MODEL P95DC SEMI-AUTO PISTOL** serial #315-10057, 9mm, 4" barrel with a bright excellent bore. The metal surfaces retain 95% original blue that is toning more toward a plum color patina showing spots of high edge wear and scattered light fine oxidation staining. The polymer frame rates near excellent with a few light handling marks. This model features fixed three dot sights and a decocker only with ambidextrous magazine release. Included is a single unmarked aftermarket magazine. (108896-117D33653) {MODERN} (150/250)
1847. **SMITH & WESSON MODEL M&P40 SHIELD SEMI-AUTO PISTOL** serial #HBD6856, .40 S&W, 3" barrel with a bright excellent bore. The metal surfaces retain 98% of their original black Melonite finish and the textured polymer frame rates excellent. The pistol features fixed three dot sights, thumb safety and comes with a single six round factory magazine. (108896-74D33887) {MODERN} (200/400)
1848. **SMITH & WESSON MODEL SW9VE SEMI-AUTO PISTOL** serial #PBR2598, 9mm, 4" barrel with a bright excellent bore. The stainless surfaces rate near excellent aside from a few superficial scratches and specks of scattered fine oxidation staining along the slide. The polymer frame rates near excellent with a few minor handling marks and spots of light wear consistent with use. The pistol has low profile three dot sights and includes a single ten round factory magazine. (108896-69D33535) {MODERN} (150/250)
1849. **SMITH & WESSON MODEL SW40VE SEMI-AUTO PISTOL** serial #RBT3675, .40 S&W, 4" barrel with a bright excellent bore. The stainless surfaces rate excellent aside from a few scattered light scratches. The polymer frame with coarse checkered grip rates excellent showing a few minor handling marks with crisp points remaining. The pistol has three dot sights and includes a single ten round factory magazine. (108896-201D34157) {MODERN} (175/275)
1850. **SMITH & WESSON MODEL SW40V SEMI-AUTO PISTOL** serial #PAZ5889, .40 S&W, 4" barrel with a bright excellent bore. The stainless surfaces rate very good plus with some scattered light scratches and spots of fine oxidation staining along the top of the slide and in the grooves of the slide serrations. The polymer frame rates very good plus with minor wear associated with use and has a few light scratches. The pistol has three dot sights and a single ten round factory magazine with plastic base that has several dings and abrasions along the bottom edge is included. (108896-193D33738) {MODERN} (100/200)
1851. **SMITH & WESSON MODEL SW9VE SEMI-AUTO PISTOL** serial #RAZ8064, 9mm, 4" barrel with bright excellent bore. The stainless surfaces rate excellent aside from a few light scratches. The polymer frame remains in excellent condition and the coarse checkered grips still have crisp points. The pistol has three dot sights and included is a single 16 round factory magazine. (108896-194D33666) {MODERN} (175/275)
1852. **SMITH & WESSON MODEL SW9GVE SEMI-AUTO PISTOL** serial #RBN6613, 9mm, 4" barrel with bright excellent bore. The stainless surfaces rate excellent and NATO green polymer frame remains in excellent condition. The pistol features three dot sights and comes with a single factory ten round magazine and appears to have seen very little if any use. (108896-195D33914) {MODERN} (200/300)
1853. **SMITH & WESSON MODEL SW99 COMPACT SEMI-AUTO PISTOL** serial #SAE4854, 9mm, 3 1/2" barrel with a bright excellent bore. The metal surfaces retain 95% of their original matte black finish with some light scratches, minor high edge wear and the textured polymer grip frame remains in near excellent condition with spots of light wear along the contact points. The pistol features three dot low profile sights, ambidextrous magazine release, and decocking lever. The pistol does not come with a magazine and a replacement should be easily obtainable. (108896-73D32128) {MODERN} (200/400)
1854. **RUGER MODEL SR9C SEMI-AUTO PISTOL** serial #33-21973, 9mm, 3 1/2" barrel with an excellent bore. The metal surfaces retain 98% of their black Nitride finish with a few light scratches, and minor wear along the high edges at the muzzle. The polymer frame with fine checkered grip panels rates excellent and the pistol features a lower rail, three dot sights, loaded chamber indicator and ambidextrous magazine release. Includes two factory 10 round magazines, and a right hand black canvas open top holster by Elite. (108900-35S21355) {MODERN} (200/400)
1855. **RUGER MODEL P94 SEMI-AUTO PISTOL** serial #340-87008, .40 S&W, 4 1/8" barrel with a bright excellent bore. The metal surfaces are toning mostly to a plum color along the slide with the frame retaining near all of its matte black finish. The pistol features three dot sights, ambidextrous safety and magazine release and the mis-matched rubber synthetic checkered grips rate excellent. Included is a single blued-over body factory magazine. (108896-119D33919) {MODERN} (150/250)
1856. **WALTHER MODEL PPK/S SEMI-AUTO PISTOL** serial #36660BAT, .380 ACP, 3 1/4" barrel with a bright excellent bore. The stainless surfaces on this American made (S&W Houlton ME) pistol rate excellent with a few superficial light handling marks. The black plastic checkered banner logo grips rate excellent and the pistol comes with two bright bodied factory 7 round magazines. Pistol appears to have seen little if any use. (108900-19S21451) {MODERN} (200/400)
1857. **WALTHER MODEL PPS SEMI-AUTO PISTOL** serial #AC6563, 9mm, 3 1/4" barrel with a bright excellent bore. The metal surfaces retain about 95% of their original matte black finish with scattered light scratches and spots of high edge wear. The polymer frame with checkered finger grooves and integral rail rates excellent. The pistol features three dot sights, cocking indicator, ambidextrous safety and comes with a single seven round factory magazine that is scratch-marked 10-01094 along its side. (108900-14S21512) {MODERN} (200/400)
1858. **SMITH & WESSON MODEL 2206 SEMI-AUTO PISTOL** serial #TEW6121, 22 LR, 4 1/2" barrel with a bright excellent bore. The stainless surfaces rate about excellent aside from a few light handling marks and spots of fine oxidation staining. The pistol has a Patridge style front sight with adjustable black blade rear sight and the plastic checkered logo grips rate excellent. Include is a single ten round factory magazine. (108896-214D34138) {MODERN} (175/275)
1859. **SMITH & WESSON MODEL 908 COMPACT SEMI-AUTO PISTOL** serial #VUV3075, 9mm, 3 1/4" barrel with a bright excellent bore. The metal surfaces retain 98% of their original matte black finish having a few very light handling marks. The pistol features low profile three dot carry sights, thumb safety / decocker, and the plastic checkered logo grips rate excellent. Included is a single unmarked, eight round, bright body, aftermarket magazine. (108896-57D33210) {MODERN} (250/350)
1860. **RUGER STANDARD MODEL "LIBERTY MODEL" SEMI-AUTO PISTOL** serial #13-57799, 22 LR, 6" barrel with bright excellent bore. The metal surfaces retain 98% original blue with some light scratches, spots of wear on the working parts and spots of fine oxidation staining. The 1976 manufactured pistol has fixed sights and the checkered hard rubber grips remain in excellent condition. Included is a single nine round magazine and the barrel is marked "Made in the 200th Year of American Liberty". (108896-99D33292) {MODERN} (200/300)
1861. **RUGER STANDARD MODEL SEMI-AUTO PISTOL** serial #1694745, 22 LR, 4 3/4" barrel with a bright excellent bore. The metal surfaces on this 1981 manufactured pistol retain 95% original blue with some minor high edge wear, light scratches and specks of fine oxidation staining. The pistol has standard sights and the checkered hard rubber grips rate excellent. No magazine is included and they are still readily available. (108896-103D30912) {MODERN} (175/275)

1862. **RUGER STANDARD MODEL SEMI-AUTO PISTOL** serial #443345, 22 LR, 6" barrel with a bright excellent bore. The metal surfaces on this 1967-manufactured pistol retain 90% evenly fading blue with scattered scratches, spots of fine oxidation staining and wear along the high edges and working parts. The pistol has fixed sights and the checkered hard rubber grips rate about very good with worn points and light ingrained dirt staining in the grooves. Included is a single factory 9 round magazine. (108896-100D33488) {C&R} (175/275)
1863. **SMITH & WESSON MODEL SW40VE SEMI-AUTO PISTOL** serial #PBC5454, .40 S&W, 4" barrel with a bright excellent bore. The stainless surfaces rate very good plus with some minor scattered fine oxidation staining and light handling marks. The polymer frame rates excellent with crisp points remaining in the checkering. The pistol features low profile three dot sights, integral accessory rail and comes with a single 10 round factory magazine. (108896-60D33565) {MODERN} (175/275)
1864. **SMITH & WESSON MODEL SW9VE SEMI-AUTO PISTOL** serial #PBN5113, 9mm, 4" barrel with a bright excellent bore. The stainless surfaces rate about excellent aside from a few light scratches and some specks of oxidation staining in the slide serrations heaviest on the right side. The polymer frame rates very good plus with some very minor handling marks and ever so slightly worn points in the checkering. The pistol features low profile three dot sights and has an integral accessory rail. No magazine is included they are however still easily obtainable. (108896-199D33737) {MODERN} (150/250)
1865. **SMITH & WESSON MODEL SW40VE SEMI-AUTO PISTOL** serial #PBE7619, .40 S&W, 4" barrel with a bright excellent bore. The stainless surfaces rate near excellent with some light scratches and spots of minor wear along the working parts. The polymer frame rates very good plus with light handling marks and some minor wear along the carry points of the grip. The pistol features low profile sights, integral lower accessory rail and comes with a single ten round factory magazine. (108896-196D33973) {MODERN} (175/275)
1866. **RUGER MODEL 22/45 TARGET SEMI-AUTO PISTOL** serial #220-02143, 22 LR, 5 1/4" barrel with a bright excellent bore. The stainless surfaces rate excellent aside from a couple of light handling marks. The Zytel frame with Ruger logo grip panels rate excellent. The pistol has a fixed Patridge style front sight and an adjustable black blade rear sight. Included is a single ten round factory magazine. (8896-102D33907) {MODERN} (150/250)
1867. **WALTHER MODEL P22 SEMI-AUTO PISTOL** serial #Z123309, 22 LR, 3 3/8" barrel with a bright excellent bore. The metal surfaces retain 98% of their original black matte surfaces and the textured polymer frame with integral lower accessory rail rates excellent. The pistol features interchangeable front sight inserts (3 included), adjustable black blade rear sight, additional palm swell, and related tools. The pistol still has lots of life left in it and includes a factory hard case end-labeled and numbered to the gun and a single ten round factory magazine. (108896-176D34171) {MODERN} (125/225)
1868. **WALTHER MODEL P22 SEMI-AUTO PISTOL** serial #WA017197, 22 LR, 3 3/8" barrel with a bright excellent bore. The nickel plated surfaces rate excellent and the textured polymer frame with integral accessory rail rates excellent. The pistol features three dot sights with interchangeable front sight inserts, adjustable blade rear sight, ambidextrous magazine release and safety, and interchangeable palm swells. The pistol comes with addition sight inserts, wrench and punch, factory ten round magazine and hard case that is end-labeled and numbered to the gun. This pistol has seen little if any use. (108896173D33881) {MODERN} (150/250)
1869. **TAURUS MODEL PT-22 SEMI-AUTO PISTOL** serial #AMJ16171, 22 LR, 2 3/4" barrel with a bright excellent bore. The metal surfaces retain near all of their original matte blue finish and the pistol has standard ramp front and fixed rear sights. The smooth hardwood grips with logo medallions rate excellent aside from a few very light scratches. Included is a single eight round magazine with fingertip extension. (108896-146D34236) {MODERN} (100/200)
1870. **DAVIS INDUSTRIES MODEL D9 O/U DERINGER** serial #D079821, 9mm, 2 3/4" barrels with bright excellent bores. The metal surfaces retain near all of their original blue finish with a few light flakes and chips along the high edges. The black plastic textured grips rate excellent and the original box that is end-labeled and numbered to the gun, manual and related papers are included. (108896-158D33552) {MODERN} (75/150)
1871. **SMITH & WESSON MODEL SW40VE SEMI-AUTO PISTOL** serial #RBP5163, .40 S&W, 4" barrel with a bright excellent bore. The stainless surfaces rate excellent with a few minor light handling marks. The polymer grip with integrated accessory rail rates near excellent with crisp points in the checkering and a couple of very minor handling marks on the frame. The pistol has low profile three dot sights and comes with a single 14 round factory magazine. (108896-191D33963) {MODERN} (200/300)
1872. **SMITH & WESSON MODEL 659 SEMI-AUTO PISTOL** serial #TAC8411, 9mm, 4" barrel with a bright excellent bore. The stainless surfaces rate near excellent having scattered light scratches, small spots of light fine oxidation staining and light holster wear. The pistol has a ramp front sight with drift adjustable blade rear sight and left side thumb safety. The black plastic checkered grips rate very good with scattered light handling marks and have a Hogue Handall grip sleeve that remains in very good plus condition. Included with the pistol are a bright bodied 15 round factory magazine and a De Santis D8 black leather high rise holster. The leather remains in excellent condition. (108900-30S21534) {MODERN} (200/400)
1873. **SMITH & WESSON MODEL SW40VE SEMI-AUTO PISTOL** serial #PBD5674, .40 S&W, 4" barrel with a bright excellent bore. The stainless surfaces rate very good plus with numerous light scratches and light fine oxidation staining showing some wear along the working and high edges. The polymer frame rates very good showing overall light wear consistent with use. The pistol has fixed three dot sights and comes with a single ten round factory magazine. (108896-200D33697) {MODERN} (125/225)
1874. **BERETTA MODEL 950 BS JETFIRE SEMI-AUTO PISTOL** serial #BR76282V, .25 ACP, 2 3/8" barrel with a bright excellent bore. The metal surfaces retain 90% of their original blue and anodized finishes with some spots of flaking around the frame, areas of wear along the high edges, barrel and slide. The black plastic checkered logo grips rate near excellent with some light handling marks and mostly crisp points remaining in the checkering; included is a single blued-over body factory magazine. (108900-33S21409) {MODERN} (100/200)
1875. **RUGER MARK II TARGET SEMI-AUTO PISTOL** serial #214-14894, 22 LR, 5 1/2" bull barrel with a bright excellent bore. The metal surfaces retain 90% original blue finish with several light scratches, a couple small dings at the muzzle, with areas of wear around the muzzle, grip straps and high edges. The bolt body is covered with fine oxidation staining and has toned more toward a pewter color. The action seems to function well and the pistol has a Patridge style front sight with adjustable black blade rear sight and the black checkered hard rubber grips rate near excellent with overall crisp points and a few very minor handling marks. Included is a single blued-over body factory magazine. (108896-120D33721) {MODERN} (100/200)
1876. **SMITH & WESSON M&P 40 SHIELD SEMI-AUTO PISTOL** serial #HSP4868, .40 S&W, 3" barrel with a bright excellent bore. The metal surfaces retain 98% of their original black Melonite finish and the polymer frame with stippled grips rates excellent. The pistol features three dot sights, left side thumb safety and comes with a single six round magazine. (108900-45S21538) {MODERN} (200/400)

1877. **INTRAC ARMS INTERNATIONAL BACK UP SEMI-AUTO PISTOL** serial #M00092, .380 ACP, 2 1/2" barrel with a bright excellent bore. The stainless surfaces rate very good plus with overall light scratches and spots of fine oxidation staining. The pistol has fixed sights, grip and thumb safeties and the checkered black plastic grips rate excellent. Included is a single five round bright body magazine with fingertip extension. (108896-141D33983) {MODERN} (100/200)
1878. **AMT BACK UP SMALL FRAME SEMI-AUTO PISTOL** serial #DAA01642, .380 ACP, 2 1/2" barrel with a bright excellent bore. The stainless surfaces on this DA only pistol rate excellent aside from a couple of superficial light scratches. The black checkered Lexan grips rate excellent and included is a single five round bright body magazine. (108896-138D33968) {MODERN} (125/225)
1879. **INTRAC ARMS INTERNATIONAL BACK UP SEMI-AUTO PISTOL** serial #MO7919, .380 ACP, 2 1/2" barrel with a bright excellent bore. The stainless surfaces rate very good with scattered light scratches and areas of light fine oxidation staining. The pistol has fixed sights, grip and thumb safeties, and the checkered plastic grips rate excellent with overall crisp points. Included is a single five round fingertip extension magazine. (108896-139D33856) {MODERN} (100/200)
1880. **AMT BACK UP SMALL FRAME SEMI-AUTO PISTOL** serial #DA10209, .380 ACP, 2 1/2" barrel with a bright excellent bore. The stainless surfaces on this DA only pistol rate very good with scattered light scratches and spots of fine oxidation staining. The black checkered Lexan grips rate about excellent with a couple of light handling marks and the included five round bright body magazine is scratch-numbered 10-11280. (108896-140D33859) {MODERN} (100/200)
1881. **AMT BACK UP SMALL FRAME SEMI-AUTO PISTOL** serial #D10209, .380 ACP, 2 1/2" barrel with a bright excellent bore. The stainless surfaces rate about very good with light scratches high edge wear and scattered fine oxidation staining near overall. The black checkered Lexan grips rate near excellent with ingrained dirt staining and mostly crisp points. Included with the pistol are two modified factory five round magazines and an in the pocket leather holster that is mostly crazed and flaking. The magazine floor plates have an added piece that is amateurishly affixed but functions well in the aid of removing the magazines. (108900-29S21536) {MODERN} (75/150)
1882. **SMITH & WESSON MODEL SW380 SEMI-AUTO PISTOL** serial #RAC1057, .380 ACP, 3" barrel with a bright excellent bore. The metal surfaces retain 95% of their original anodized finish with scattered scratches and spots of flaking. The polymer frame rates very good plus with some light handling marks and the pistol has a fixed front sight and grooved rear sight and comes with a single six round factory magazine. (108896-54D33216) {MODERN} (75/150)
1883. **SMITH & WESSON MODEL SW380 SEMI-AUTO PISTOL** serial #RAC0000, .380 ACP, 3" barrel with a bright excellent bore. The metal surfaces retain about 90% of their original anodized finish with scattered scratches, spots of flaking and high edge wear. The polymer frame rates very good showing light wear on the checkered grip straps and a few light handling marks. The pistol has a fixed front sight with grooved rear sight and comes with a single six round magazine. (108896-55D33915) {MODERN} (75/150)
1884. **HOPKINS & ALLEN MFG. CO FOREHAND TOP-BREAK REVOLVER** .32 CF, 3" barrel with an about good, moderately pitted bore. The metal surfaces have been cleaned bright, with areas of fine oxidation staining and scattered pitting near overall. The checkered hard rubber grips rate very good plus with slightly rounded points, and a few minor handling marks, they are missing the grip screw. The action seems to function and this would make a great parts gun. (108900-21S21453) {ANTIQUÉ} (25/50)
1885. **SMITH & WESSON MODEL SW9VE SEMI-AUTO PISTOL** serial #DSU2295, 9mm, 4" barrel with a bright excellent bore. The stainless surfaces rate about excellent with a few minor light scratches and a couple of small spots of fine oxidation staining. The polymer frame rates very good plus with some light handling marks and mostly crisp points remaining in the checkering. The pistol has low profile three dot sights and comes with a factory 10 round magazine that is toning from bright to black and is numbered 12-02568 in sharpie along the back edge. (108896-198D34169) {MODERN} (175/275)
1886. **RUGER MODEL P95DC SEMI-AUTO PISTOL** serial #313-27039, 9mm, 4" barrel with a bright excellent bore. The metal surfaces retain 95% original blue that is toning more toward a plum color patina showing spots of high edge wear and scattered light fine oxidation staining. The polymer frame rates near excellent with a few light handling marks. This model features fixed three dot sights and a decocker only with ambidextrous magazine release and includes bright body factory magazine. (108896-123D33752) {MODERN} (150/250)
1887. **SMITH & WESSON MODEL SW9V SEMI-AUTO PISTOL** serial #PAW9973, 4" barrel with a bright excellent bore. The stainless surfaces rate very good overall with scattered scratches, specks of oxidation staining and has a shallow abrasion at the muzzle on the left side of the slide that crosses the frame as well. The frame rates very good with light wear and several handling marks and the pistol has low profile three dot sights and comes with a single 10 round factory magazine. (108896-204D33759) {MODERN} (150/250)
1888. **SMITH & WESSON MODEL SW9VE SEMI-AUTO PISTOL** serial #PDX9106, 4" barrel with a bright excellent bore. The stainless surfaces rate excellent with a few scattered superficial scratches and some specks of fine oxidation staining. The polymer frame rates excellent and the coarse checkering around the grip remains crisp. The pistol has low profile three dot sights and comes with a single 10 round factory magazine. (108896-190D33761) {MODERN} (175/275)
1889. **RUGER MODEL P95DC SEMI-AUTO PISTOL** serial #315-15586, 9mm, 4" barrel with a bright excellent bore. The metal surfaces retain 95% original blue that is toning more toward a plum color patina showing spots of high edge wear and scattered light fine oxidation staining. The polymer frame rates near excellent with a few light handling marks. This model features fixed three dot sights and a decocker only with ambidextrous magazine release and includes a single bright body factory magazine. (108896-115D339297) {MODERN} (150/250)
1890. **RUGER MODEL P89 SEMI-AUTO PISTOL** serial #309-85822, 9mm 4 3/8" barrel with a bright excellent bore. The metal surfaces retain 95% original blue that is toning plum with scattered scratches, light high edge wear and some scattered light fine oxidation staining. The pistol has three dot sights, ambidextrous safety and magazine release, and the grooved synthetic grips with logo medallions rate excellent. Included is a single blued-over body factory magazine. (108896-116D33749) {MODERN} (150/250)
1891. **RUGER STANDARD MODEL SEMI-AUTO PISTOL** serial #11-93884, 22 LR, 6" barrel with a bright excellent bore. The metal surfaces on this 1973 production pistol retain about 95% original blue with scattered light scratches spots of light fine oxidation staining and silvering along some of the high edges. The pistol has fixed sights and the checkered walnut grips with silver logo medallions rate about excellent with lightly worn points and spots of staining inside the grooves. The pistol comes with a single nine round magazine. (108896-105D33553) {MODERN} (200/300)
1892. **RUGER MODEL P345 SEMI-AUTO PISTOL** serial #664-49846, .45 ACP, 4 1/8" barrel with a bright excellent bore. The metal surfaces retain 98% original blue toning to plum with some scattered light scratches and light high edge wear. The pistol features fixed three dot sights, cocking indicator, and Picatinny style lower rail. The polymer frame rates excellent with crisp points remaining on all of the checkered panels and a single eight round bright bodied factory magazine is included. (108896-121D33332) {MODERN} (200/400)

1893. **SMITH & WESSON MODEL 22A-1 SPORT SERIES SEMI-AUTO PISTOL** serial #UCL43777, 5 1/2" bull barrel with a bright excellent bore. The metal surfaces retain 98% of their original matte black finish. The pistol features a full length scope rail, fixed front sight, adjustable sporting rear sight, thumb safety and magazine release on the front grip strap. The laminate finger rest target grips with laser cut S&W medallions rate excellent with a slight palm swell and give this pistol a very comfortable feel. A single 10 round factory magazine is included. (108896-77D34154) {MODERN} (175/275)
1894. **RUGER STANDARD MODEL SEMI-AUTO PISTOL** serial #16-70603, 22 LR, 4 3/4" barrel with a bright excellent bore. The metal surfaces retain about 98% original blue that is starting to tone more of a plum color. The barrel has been modified at the muzzle, it has been drilled 3/4" deep and tapped the first 1/2" of its length, for some non-factory accessory. This 1980's production pistol has fixed sights and the hard rubber grips rate excellent. Included is a single nine round magazine. (108896-130D33734) {MODERN} (75/150)
1895. **RUGER STANDARD MODEL SEMI-AUTO PISTOL** serial #237357, 22 LR, 6" barrel with a bright excellent bore. The metal surfaces retain 97% original blue finish with a few minor light scratches and some silvering at the muzzle and along select high edges. The pistol has fixed sights and the hard rubber grips rate very good with mostly worn points and a few light handling marks. Included with this 1962 production pistol is a single nine round magazine. (108896-101D34224) {C&R} (175/275)
1896. **RUGER STANDARD MODEL SEMI-AUTO PISTOL** serial #91370, 22 LR, 4 3/4" barrel with a bright excellent bore. The metal surfaces retain 97% original blue with some scattered light scratches and specks of fine oxidation staining with perhaps a pit or two and some light silvering along select high edges. The pistol has fixed sights and the checkered hard rubber grips rate very good plus with lightly worn points and some staining in the grooves. A single nine round magazine is included with this 1954 production pistol. (108896-104D32787) {C&R} (175/275)
1897. **TRADITIONS BUCK SKINNER PERCUSSION PISTOL** serial #14-13-018307-95, .50 Cal., 10" octagon barrel with a bright excellent bore. The metal surfaces retain 98% original blue finish with a few speckles of light fine oxidation staining. The hammer and lock show mottled case-hardened colors with some spots of fine oxidation staining. The stock rates near excellent with a couple of scratches and minor handling marks. (108900-48S21450A) {ANTIQUÉ} (50/100)
1898. **DAVIS INDUSTRIES MODEL DM-22 DERRINGER** serial #375958, .22 Magnum, 2 1/2" barrels with bright excellent bores. The chrome surfaces rate near excellent aside from a couple of very small minor spots of flaking. The pistol has fixed sights and the smooth hardwood grip panels rate excellent. (108896-166D33168) {MODERN} (50/100)
1899. **PHOENIX ARMS MODEL HP22 SEMI-AUTO PISTOL** serial #4200538, 22 LR, 5" barrel with a bright excellent bore. The satin nickel finish rates excellent aside from a few minor scratches and a couple of specks of fine oxidation staining. The pistol features fixed sights, thumb safety, and has a spare 3" barrel with a bright excellent bore that has some scattered light scratches in the satin nickel finish. The checkered plastic grips rate excellent and include is a single 11 round factory magazine. (108896-156D34187) {MODERN} (75/150)
1900. **RAVEN ARMS MODEL P-25 SEMI-AUTO PISTOL** serial #405830, .25 ACP, 2 3/8" barrel with a bright excellent bore. The metal surfaces retain near all of their chrome plated finish with spots of bubbling near overall, light scratches and areas of clouding. The pistol features fixed sights and a thumb safety with the smooth walnut grip panels remaining in excellent condition. Included is a single six round magazine. (108900-46S21539) {MODERN} (50/75)
1901. **DAVIS INDUSTRIES MODEL P-380 SEMI-AUTO PISTOL** serial #AP275376, .380 ACP, 2 3/4" barrel with a bright excellent bore. The metal surfaces retain 90% of their black Teflon finish with areas of oxidation, spots of pitting, and a few scattered abrasions. The pistol has fixed sights, left side safety, includes a single five round magazine. The black grooved synthetic grips with DI logos rate excellent. (8900-51S21410) {MODERN} (50/75)
1902. **SMITH & WESSON M&P .45** serial #DWL6777, .45 ACP, 4 1/2" barrel sporting an excellent bore. The Armornite finish shows very little signs of wear and rates 99% with the only blemish being the typical rub marks where the barrel meets the slide at the ejection port. The black polymer frame rates excellent. The three Palmwell grips rate excellent with the middle size currently affixed to the gun. The sights are white three dot with a Novak lo-mount carry sight on the back and a dovetail on the front. This pistol also features a Picatinny rail and ambidextrous slide stop. Included with this pistol are two 10-round factory magazines and a hard case showing a matching serial number to the gun. (228896-49D34161) {MODERN} (350/550)
1903. **GLOCK MODEL 17 SEMI-AUTO PISTOL** serial #AGH259US, 9mm, 4 1/2" barrel with an excellent bore. The slide retains about 99% original Tenifer finish while the polymer frame and textured grips remain excellent. The sights are three dot tritium with some slight damage to the right of the rear sight, possibly from some type of impact. The sights do not appear to glow. This is a 2nd generation pistol and comes with cleaning tools, extra factory magazine, a speedloader and factory papers all sealed in a Glock "Tupperware" box with matching factory label. (228873-375) {MODERN} (300/500)
1904. **RUGER MINI-14 SEMI AUTO RIFLE** serial #183-90122, .223 Remington, 18 1/2" barrel with an excellent bore. The blued-over surfaces retain about 96% original finish with handling marks throughout and most of the finish loss near the receiver. The hardwood stock is about very good with dings and scratches throughout, indicative of days in the field. The plastic buttplate appears to be a replacement, it is slightly smaller than the stock. The rear sight is an adjustable ghost ring and the front is an aftermarket black blade attached to a flash hider. Included is a single 5 round magazine. (8873-562) {MODERN} (300/500)
1905. **BERETTA MODEL 8045F COUGAR SEMI-AUTO PISTOL** serial #061239MC, .45 ACP, 3 3/4" barrel with an excellent bore. This gun retains 98% factory finish with light handling marks throughout, high edge wear toward the muzzle on both the slide and the dust cover. The checkered black factory grips are excellent with scarce signs of handling. Featured is an ambidextrous slide mounted safety and standard Beretta fixed white dot sights. Included is a Factory hard case and one extra magazine. (228873-263) {MODERN} (300/500)
1906. **ASTRA MODEL A-100 SEMI-AUTO PISTOL** serial 5462A, 9mm, 3 5/8" barrel with an excellent bore. This Sig clone retains 99% factory blue finish with a small spot of freckling near the ejection port and handling marks scattered throughout. The black checkered grips rate excellent. The sights are fixed white dot and there is a frame mounted decocker. Included is a green hard case with matching serial number and related paperwork. (228873-262) {MODERN} (250/350)
1907. **SMITH & WESSON MODEL 59 SEMI-AUTO PISTOL** serial #A364885, 9mm, 4" barrel with an excellent bore. This pistol retains 99% factory blue finish with a couple small marks on the top of the slide and some very light handling marks. The checkered black nylon grips are excellent with light signs of use. The rear sight is a black adjustable blade and the front is a serrated ramp. This gun sports a slide mounted safety/decocker and a lanyard loop. Included is an extra factory magazine. (228873-128) {MODERN} (300/500)

1908. **SMITH & WESSON MODEL 10-5 MILITARY & POLICE REVOLVER** serial #D569645, .38 Special, 2" barrel with an excellent bore. The blue finish still covers 99% of this gun's metal surfaces with slight thinning in two very small spots near the muzzle, light handling marks and a handful of freckle spots on the frame near the cylinder. The hammer and trigger show attractive case hardened colors. The factory checkered square butt walnut grips with gold S&W medallions rate very good with some finish loss on the high edges and near the butt. The rear sight is integral and the front sight is a fixed serrated ramp. (228873-292) {MODERN} (350/550)
1909. **RUGER MARK I TARGET SEMI-AUTO PISTOL** serial #14-68620, .22 LR, 5 1/2" barrel with an excellent bore. This target pistol retains about 97% factory finish with the majority of loss on the barrel and frontstrap. The black checkered factory grips are excellent with some signs of handling and a silver Phoenix medallion displayed on the right panel. The sight system is a Bushnell Magnum Phantom 2.5x scope with a fine crosshair reticle. (228873-337) {MODERN} (100/200)
1910. **ASTRA CADIX REVOLVER** serial #25400, .22 LR, 4" barrel with an excellent bore. The gun displays about 97% original blued-over finish with the barrel and parts of the frame thinning to a slight plum color. The checkered brown plastic grips rate excellent with small signs of handling. The rear sight is an adjustable black blade and the front is a serrated ramp. (228873-17) {C&R} (100/200)
1911. **LLAMA MARTIAL MODEL DOUBLE ACTION REVOLVER** serial #675568, 6" ventilated rib barrel with an excellent bore. The gun retains about 97% original finish with thinning on the frame and handling marks throughout. The hardwood checkered grips rate about very good with handling marks and a matching serial number on the bottom of the left panel. The front sight is a serrated ramp and the rear is a black blade. (228873-459) {MODERN} (125/250)
1912. **ERMA MODEL RX22 SEMI-AUTO PISTOL** serial # J04292, .22 LR, 3 1/2" barrel with an excellent bore. This Excam imported pistol retains 99% factory finish with scattered signs of handling throughout. The checkered brown plastic grips are about excellent with minimal signs of use. The sights are fixed with the slide featuring top serrations and a thumb safety. Included are two magazines with finger rest floorplates. (228873-340) {MODERN} (75/150)
1913. **WINCHESTER MODEL 1894 ROOSEVELT COMMEMORATIVE LEVER ACTION RIFLE** serial #TR53388, 30-30, 26" octagon barrel with a bright excellent bore. The barrel and magazine tube retain 95% original thinning blue with some light oxidation and light pitting. The frame, forend cap and buttplate retain 98% original nickel finish with light flaking and scratches. The walnut stock rates very good plus with handling marks, scratches and light flaking. The bead from the front sight is missing but the rear adjustable sight is still intact. A very good example of a Roosevelt Commemorative 1894. (1X98624-31) {C&R} (300/500)
1914. **SAVAGE / FOX MODEL BSE CUTAWAY DOUBLE EJECTOR GUN** serial #RD407, 12 ga, 28" barrels with excellent bores choked cylinder and cylinder. This cutaway is well done but not factory quality. This gun was probably cutaway by an unknown professional for training purposes and will still handle that chore nicely. The metal surfaces retain about 80% original blue with most of the loss to the right barrel showing signs it was cleaned to pewter to remove or minimize oxidation and pitting in addition to a few light handling and operational marks. The checkered pistolgrip buttstock with factory buttplate rates about very good with light dents, dings and scratches in addition to small chips around the later added cut outs on the wrist area. The beavertail checkered forend also rates very good with light scuffs, dents and dings. The gun appears mechanically functional but obviously cannot fire live ammunition due to the cutaway chambers. A great trainer for hunter safety and other firearms related classes. (1X86520-4129) {MODERN} [Richard "Stretch" Kennedy Collection] (200/400)
1915. **DAISY VL SINGLE SHOT RIFLE** serial #A031692, 22 cal. VL, 18" barrel with an about very good bore. The metal surfaces rate about very good showing some minor flaking or crazing to the factory baked enamel finish, the cocking lever hanging down slightly on the underside of the stock. The plastic stock rates very good as well with some minor dings and handling marks. The original open sights are intact. See ammunition listed elsewhere in the silent auction. (1X38735-29) {C&R} (100/200)
1916. **MOSSBERG MODEL 30 BOLT ACTION SINGLE SHOT RIFLE** .22 LR, 24" barrel with an about excellent bore. The metal surfaces are a faded dull gray blue and a plum patina with some sparsely scattered oxidation stains here and there and the oddly scattered minor handling marks as well. The trigger and bolt retain all their original chrome plate. The smooth hardwood stock rates very good plus with only minor dings and handling marks from the years. There is a large nut holding the barreled action to the stock, it is more automotive in nature than firearm. The front sight is intact, the rear receiver sight bridge is missing. (1X38829-20) {C&R} (50/100)
1917. **REMINGTON MODEL 11 SEMI-AUTO SHOTGUN** serial #347271, 12 ga., 18 1/4" plain barrel with an excellent bore exhibiting streaks of plastic fouling. This Model 11 started life as a sporting shotgun with a full choke barrel and was cut down and refinished into a riot gun configuration. The metal surfaces retain about 99% later applied Parkerized finish with a few minor handling marks. The checkered walnut factory pistolgrip buttstock rates about very good to excellent as lightly refinished with a few minor handling marks. The checkered walnut factory forend also rates near excellent as lightly refinished with a few light chips at the forend / receiver juncture. A later added Remington marked hard rubber buttplate is present and rates about excellent although the fit leaves portions of the wood or buttplate proud of the each other in certain areas. The barrel is numbered to the gun and it appears to still function correctly. (1X86520-550) {MODERN} [Richard "Stretch" Kennedy Collection] (150/250)
1918. **MOSSBERG TROPHY HUNTER BOLT ACTION RIFLE** serial #BA388912, 243 Win., 20" free-floating barrel with a bright excellent bore. The metal surfaces retain 98% original matte blue with a few light rub marks on top of the barrel. The checkered pistolgrip hardwood stock rates excellent with a couple light blemishes. Mounted on receiver is a Redfield Accu-Ranger 3-9x42 mm scope with range finding reticle and clear optics in two-piece rings and bases. A single detachable magazine is included. (1X58803-30) {MODERN} (300/500)
1919. **STEVENS MODEL 755 SEMI-AUTO SHOTGUN** serial #554815, 12 ga., 30" single bead barrel with a bright excellent bore choked improved modified. The metal surfaces retain about 95% evenly thinning original blue with some scattered fine oxidation staining and light rub marks. The receiver is decorated with engraved scroll, and dog and game bird scenes. The checkered pistolgrip buttstock and forearm rate about very good with light handling marks, a small chip at the front of the forearm, a small thin hairline crack in the stock behind the triggerguard and a 3 1/2" thin crack in the bottom of the forearm from the checkering to the rear edge. The forearm does not seat properly against the receiver. (1X58825-86D33368) {C&R} (75/150)
1920. **REMINGTON SPORTSMAN SEMI-AUTO SHOTGUN** serial #431825, 12 ga., 30" plain barrel with a very good bright bore marked "full", now measuring improved modified. The metal surfaces retain about 95% evenly thinning original blue with light edge wear, sparse fine oxidation and spots of light carry wear. The checkered pistolgrip buttstock and forearm rate very good with light handling marks and a couple thin cracks at the rear edge of the forearm. (1X58825-99D33165) {C&R} (100/200)
1921. **MOSSBERG MODEL 500B SLIDE ACTION SHOTGUN** 16 ga., 28" plain barrel with a bright excellent bore marked "modified" now measuring improved cylinder. The barrel and magazine retain about 60% original blue toning to brown with scattered fine oxidation, light muzzle wear and contact wear on the magazine tube. The receiver retains about 95% original blue with light edge wear, scratches and a previous owners social security number scratched onto the right side of the receiver. (1X58763-5) {C&R} (50/100)

1922. **SAVAGE MODEL 19-M N.R.A. BOLT ACTION RIFLE** serial #60227, 22 LR, 28" heavy barrel with an excellent bore. The metal surfaces retain about 95% original blue that is mixing with brown and areas of scattered light surface oxidation throughout. The bolt is a mottled gray and the steel buttplate has some minor pitting. The walnut military style stock rates very good and has several light dings and other abrasions and small handling marks. There is a small crack at the butt on the right side that is the result of a knot. Rifle is equipped with a globe style front sight and a Lyman adjustable rear aperture sight. The barrel is tapped for an additional target block mount, but one is not present. A single detachable magazine is included. An overall very good example of these classic target rifles. (1X48726-12) {C&R} [Dr. Lewis C. March Collection] (150/250)
1923. **BERETTA MODEL 1200 FIELD SEMI-AUTO SHOTGUN** serial #T01723E, 12 ga., 28" ventilated rib barrel that is choked modified and has an excellent bore. The metal surfaces retain about 98-99% original blue finish with a few light handling marks throughout. The checkered walnut stocks rate excellent and have a few light dings and other light handling marks as well. An excellent field gun for everyday shooting. (1X48825-98D33953) {MODERN} (150/250)
1924. **AMERICAN GUN CO KNICKERBOCKER SIDEPLATE DOUBLE SHOTGUN** serial #197962, 16 ga., 29 1/2" barrel choked improved cylinder and full with near excellent lightly frosted bores. The barrels retain about 90% original blue that is flaking to brown and has areas with light handling marks and the right barrel tube has a small incursion about mid-length due to an electric weld. The frame retains about 40-50% of the original case colors the balance toning to a mottled gray/brown with areas of light surface oxidation and pinprick pitting which is heaviest on the left side. The checkered walnut stocks rate about very good and have light scratches and other handling marks along with minor chipping and a few hairline cracks scattered about. The buttstock has some moderate flaking to the varnish and has the original hard rubber grip cap and buttplate. A European style front sling mount has been added under the rib in front of the forend. The action locks-up tight and mechanisms appear to function correctly. A very good example of the early 1900's trade brand shotguns. (1X48643-2) {C&R} (100/200)
1925. **BROWNING AUTO-5 "AMERICAN BROWNING" SEMI-AUTO SHOTGUN** serial #A13564, 16 ga, 26 1/4" overall plain Polychoked barrel with a bright excellent bore. The metal surfaces of this Remington-produced and Browning-marked shotgun retain about 92% original thinning blue with operational wear, areas of minor pinprick pitting and oxidation staining with most of the fading at the bottom of the receiver ahead of the triggerguard. The checkered round knob pistolgrip buttstock and fingergroove forend rate about very good with minor handling marks, some white paint transfer on the left side and a small chip with a 1 1/2" crack at the rear of the forend. This shotgun is equipped with a Browning embossed buttplate and gold bead front sight. (1X218803-15) {C&R} (200/400)
1926. **J. C. HIGGINS MODEL 103.16 BOLT ACTION RIFLE** 22 S,L,LR, 24" barrel with a bright near excellent bore. The metal surfaces retain about 50% original thinning blue with scattered areas of pinprick pitting and oxidation staining. The smooth walnut pistolgrip stock rates near excellent with only minor blemishes and finish loss. This classic Sears rifle features sling swivels and standard open sights and includes a single detachable magazine. Also included is a J. C. Higgins 4X scope by Weaver mounted to the receiver. (1X218831-25) {C&R} (100/200)
1927. **J. C. HIGGINS MODEL 103.18 BOLT ACTION RIFLE** 22 S,L,LR, 24" barrel with a bright near excellent bore. The metal surfaces retain about 90% original thinning blue with only minor blemishes; the bolt handle and knob remain mostly bright. The smooth walnut pistolgrip stock rates excellent with only minor handling marks. This classic Sears rifle is equipped with standard open sights. (1X218806-3) {C&R} (100/200)
1928. **SPRINGFIELD MODEL 87A COMBINATION RIFLE** 22 S,L,LR, 24" barrel with a bright near excellent bore. The metal surfaces of this "gill gun" have toned to brown with scattered areas of light pinprick pitting and oxidation staining. The smooth walnut pistolgrip stock rates very good with moderate blemishes and minor handling marks. This rifle can be fired both semi-automatic with long rifle ammo only or lock the bolt handle and fire as a single shot only. This rifle is equipped with a bead front and adjustable sporting rear sight. (1X218806-7) {C&R} (100/200)
1929. **MOSSBERG MODEL 44 U.S.(B) BOLT ACTION RIFLE** 22 LR, 26" heavy barrel with a bright near excellent bore. The metal surfaces retain about 40% original blue, toning to brown with scattered areas of moderate pinprick pitting and oxidation staining. The smooth hardwood pistolgrip stock rates near very good with minor handling marks and flakes in the finish and the green safety dot is missing but the red fire dot is present. The stock is fitted with a grooved steel buttplate and QD sling swivels with a green canvas web sling. The bolt has the dust cover intact and the rifle is equipped with a ramped and hooded front sight with target insert and a Mossberg S-130 fold-away rear peep sight. Included is a single detachable magazine. Overall a nice example of these classic military training rifles. (1X218809-86) {C&R} (200/400)
1930. **REMINGTON MODEL 11 SPORTSMAN SEMI-AUTO SHOTGUN** serial #504503, 12 ga, 26" ventilated rib barrel choked improved cylinder with a bright near excellent bore. The metal surfaces have mostly toned to brown with the usual operational wear on the bottom of the barrel and a moderate amount of pinprick pitting and oxidation staining in the receiver. The checkered walnut capped pistolgrip buttstock and fingergroove forend rate near very good with most of the points worn smooth and only minor handling marks. This shotgun is equipped with an ivory bead front sight. (1X218806-11) {MODERN} (150/250)
1931. **DAISY V/L STANDARD RIFLE** serial #B020338, 22 V/L, 18" barrel with a very good bore showing some light frosting throughout. The metal surfaces of this rifle retain about 92% original black enamel finish showing a few spots of flaking, scratches, some light freckling and oxidation staining scattered about. The checkered pistolgrip plastic wood grain stock remains in very good condition showing a few light scratches and scuffs mostly on the right side of the stock. The original black grooved plastic "VL" buttplate is present and the rifle is fitted with factory open sights. These interesting rifles used proprietary caseless ammunition ignited by compressed air and were only made for about one year before Daisy ceased production. This rifle remains a very good example and would make for a more peculiar addition to any firearms collection. See ammunition in the "ammunition" section. (2X138446-9) {C&R} (100/200)
1932. **ITHACA FLUES MODEL BOXLOCK DOUBLE SHOTGUN** serial #385544, 20 ga., 26" barrels choked improved cylinder and modified with bright about excellent bores showing perhaps a few very widely scattered spots of very light oxidation. The barrels retain 75% later restored blue finish, now reacquiring scattered minor oxidation and a handful of light handling marks. The frame is primarily a smoky mottled silvery and gray case-hardened patina with maker marked left and right flats, each with pointing game dogs. The checkered walnut pistolgrip buttstock and splinter style forend rate very good showing much original varnish with flat-top checkering and a period Noshoc recoil pad installed; length of pull is 14". The gun locks up well and seems to function mechanically however the very thinnest sliver of light can be seen between the breeches and the standing breech. (1X38825-78D33271) {C&R} (200/400)

1933. **LEFEVER ARMS COMPANY DS GRADE SIDELOCK DOUBLE SHOTGUN** serial #70650, 12 ga., 28" barrels choked modified in both with about very good bores, the right tube showing scattered oxidation and light pits, the left tube mostly bright with a good deal less oxidation and pitting. The barrels are an overall dull gunmetal gray patina with scattered light oxidation and remnants of damascus pattern, perhaps showing some sparsely scattered light pinprick pits. The frame and lockplates are a mottled smoky silvery and gray case-hardened patina, with a small handful of very light oxidation specks here or there. The checkered walnut round knob pistolgrip buttstock rates very good with remnants of original varnish, checkering flat-topped and the expected dings and handling marks that come from the years. There is an extremely well done and difficult-to-detect repair at the wrist from the rear of both sideplates to the rear of the upper tang. Length of pull to the checkered hard rubber LeFever buttplate is 13 3/8" with drops of 1 7/8" and 3 1/4". The splinter style forend rates very good, the gun locks up well, is on-face and seems to function well mechanically. (1X38825-96D33263) {C&R} (200/400)
1934. **MARLIN MODEL 1898 SLIDE ACTION SHOTGUN** serial #25060, 12 ga, 30" barrel choked full with a mostly bright near excellent bore. The metal surfaces of this shotgun are mostly worn to gunmetal gray patina toning more to darker gray patina along the barrel with some light oxidation staining, tiny pinprick pitting and a few streaks of original bright blue still lurking about in the more protected areas of the frame. The grooved walnut forend and smooth pistolgrip buttstock remain in good to about very good overall condition with flaking varnish throughout, a thin 2" crack on the left side of forend, a couple hairline cracks near the tangs and frame junction, small dings and handling marks. No buttplate is present. The mechanism still seems to function normally. (1X138819-4) {C&R} (75/150)
1935. **SAVAGE MODEL 6A COMBINATION SEMI-AUTO/BOLT ACTION RIFLE** 22 S,L,LR, 24" barrel with a very good plus bore showing some light frosting. The metal surfaces of this rifle retain about 94% original blue with a couple moderate scratches on the left side barrel, a few small spots of oxidation staining here and there and light freckling scattered about. The checkered pistolgrip walnut stock remains in very good plus condition showing some small dings, scratches, handling marks and light staining scattered throughout. The original iron sights with side hood are intact and the receiver is drilled and tapped for a scope mount and rear aperture sight. No additional sights are present but a Weaver 1" side mount with rings is included. This example appears to have seen very little use overall. (1X138476-38) {C&R} (50/100)
1936. **REMINGTON NO. 4 ROLLING BLOCK RIFLE** serial #10565, 32 RF, 24" octagon barrel with an oxidized bore. The metal surfaces of this solid frame rifle have mostly toned to dark gray-brown patina with old pitting scattered throughout and light oxidation staining. The barrel address is soft but visible and the frame screws are more modern replacements that show some dings and light slot damage. The smooth walnut forend and straight grip buttstock remain in about good overall condition as lightly cleaned showing numerous thin drying cracks on the left side butt, some moderate smoothed-over chips on the forend, small dings, dents and handling marks. The buttstock is now rather shy of the tang and its screw and escutcheon are more modern replacements. The hammer spur has broken off and the mechanism will require mechanical attention as the hammer drops to half cock when the breechblock is closed. (1X138611-4) {C&R} (50/100)
1937. **WINCHESTER MODEL X-150 INLINE MUZZLELOADING RIFLE** serial #61-13-091080-02, .45 cal., 26" fluted barrel with 209 primer ignition and a bright near excellent bore showing minor oxidation at the muzzle. The metal surfaces retain about 98% original finish with only minor freckling and the bolt, handle and knob remain bright. The checkered synthetic pistolgrip stock rates excellent and features a raised cheekpiece, Winchester sling swivels holding a Winchester padded sling and a ventilated rubber recoil pad which provides a 14 3/4" length of pull; the ramrod is also present. This rifle is equipped with the original fiber optic sights, however, the front sight insert is missing. Also included is a Simmons 3-9x32 Prosport scope with duplex reticle, clear optics and bikini style lens covers mounted to the receiver. (1X218806-16) {ANTIQUE} (75/150)
1938. **RUGER AMERICAN PREDATOR BOLT ACTION RIFLE** serial #695-72019, 6.5 Creedmoor, 22" threaded barrel with muzzle-brake and an excellent bore. The metal surfaces retain about 99% original matte and polished blue finish with just a few very light handling marks noted. The moss green composite stock rates excellent. There are no provisions for sights, however and factory picatinny rail is mounted to the receiver. The original box is included which has the manual, lock and the threaded muzzle cover. No magazine is included, but a replacement should be easy to locate. A near-new-in-box example that is ready for your choice of fine optics. (48763-3) {MODERN} (200/400)
1939. **STEVENS FAVORITE FALLING BLOCK RIFLE** serial #Z108, 25 Stevens, 24" octagon barrel with a good plus bore showing minor pitting along its length. The barrel has toned to a warm brown patina with silvering along the edges and several deep scratches along its length. The frame and lever are a mix of mottled smoky case-hardened patina with no colors remaining; the takedown screw is equipped with a lanyard loop. The smooth walnut straight grip buttstock remains near very good with minor handling marks and wears a Stevens Favorite embossed buttplate. The smooth walnut forend rates near very good with a 1" chip missing from the front. The barrel is fitted with a Rocky Mountain blade front sight and v-notch sporting rear. (1X218803-17) {C&R} (100/300)
1940. **SAVAGE STEVENS MODEL 95 BREAK ACTION SHOTGUN** 12 ga, 28" barrel choked improved modified with a bright near excellent bore. The barrel and frame retain about 85% original thinning finish with scattered areas of pinprick pitting and oxidation staining throughout, most notably at the muzzle. The smooth walnut pistolgrip buttstock and grooved forend rate near very good with moderate areas of flaking finish and handling marks. This hammer fired shotgun is equipped with a silver bead front sight. (1X218563-1) {MODERN} (50/100)
1941. **STEVENS MODEL 320 SLIDE ACTION SHOTGUN** serial #132812A, 12 ga, 18 1/2" plain barrel choked cylinder with a bright near excellent bore. The metal surfaces retain about 98% original blue finish with operational wear on the magazine tube. The black synthetic pistolgrip stock and forend rate excellent displaying just a few light handling marks. This shotgun features a sling slot in the buttstock, front sling swivel stud, a solid rubber recoil pad which provides a 14 1/4" length of pull and an adjustable ghost ring rear and front fiber optic sight. Overall a nice home defense shotgun (1X218562-2) {MODERN} (150/250)
1942. **ARGENTINE MODEL 1891 BOLT ACTION RIFLE BY DWM (SPORTERIZED)** serial #W0332, 7.65 Argentine, 22" shortened barrel with a good bore that shows oxidation throughout but evident rifling. The metal surfaces retain 80% arsenal blue with the typical ground crest, a few spots of freckling and scattered flaking to brown. The cutdown hardwood stock rates very good as-re-finished with an added varnish, a 1/2" tight crack behind upper tang, some dirt staining, scattered dings and handling marks. The barrel and magazine are matching to the receiver but the other parts are mismatched. The front sight is an aftermarket blade type and the rear sight is an original Argentine military sight. The safety plunger screw is a non-gun replacement. A solid sporterized Argentine Mauser rifle. (1X208803-33) {MODERN} (100/200)
1943. **SAVAGE MODEL 111 BOLT ACTION PACKAGE RIFLE** serial #H124241, 7mm Rem Mag, 24" barrel with a bright, excellent bore. The metal surfaces rate as-new with no signs of visible wear. The checkered black synthetic stock rates like-new as well. Mounted to the receiver is a factory mounted 3-9X40 riflescope. The scope features a duplex reticle and has excellent optics. Included are three factory detachable magazines. An excellent to as-new condition example overall. (1X48803-1) {MODERN} (350/550)

1944. **CHILEAN MODEL 1895 BOLT ACTION RIFLE BY LUDWIG LOEWE (SPORTERIZED)** serial #D1738, 7mm Mauser, 28" barrel with a very good plus bore that shows some scattered frosting. The metal surfaces retain 90% arsenal blue with an area of gray where a rear sight assembly once was and scattered flaking to brown. The cutdown walnut stock rates very good with a crisp Chilean cartouche, scattered dings and handling marks. The bolt handle has been turned down and the stock appropriately modified for this change. There are no iron sights present and the rifle is equipped with a Tasco Woodland 4x32 power scope that has clear optics and a duplex crosshair reticle. A fine sporterized Chilean Mauser rifle. (1X208825-74D33257) {ANTIQUE} (100/200)
1945. **ALFA BOXLOCK DOUBLE SHOTGUN** serial #70889, 12 ga., 28" barrels choked modified and full with bright excellent bores. The barrels, lever and triggerguard retain about 90% original blue with scattered light scratches and freckling near overall. The triggers show faded gold color that is toning to a tarnished brass color and the lightly embellished frame shows vibrant case-hardened colors. The checkered walnut pistolgrip stock and forend rate good overall with rounded points on the checkering, numerous light scratches and dings with a deep 1 3/4" gouge at the right side wrist. The brass shield style monogram plate is engraved with a "Zoro" pattern series of Z's and Redhead Ventilated recoil pad has been added. The shotgun features a crossbolt safety, extractors, sling swivels, and non-automatic safety and is sighted with a single brass bead. (1X108829-27) {MODERN} (100/200)
1946. **RUGER MK III SEMI-AUTO TARGET PISTOL** serial #227-97375, 6 7/8" barrel with an excellent bore. This 2008-made pistol appears as new in the box. The metal surfaces retain about 99% original blue finish. The checkered Delrin factory grips with single silver Ruger Phoenix medallion rate excellent. The pistol features an undercut Patridge front sight, adjustable black blade rear sight, frame mounted magazine release, thumb safety, loaded chamber indicator and it is drilled and tapped for optical sight base. The pistol includes a factory hard case that is correctly end-labeled and numbered to the gun, a pair of factory magazines, Weaver style scope base, a pair of internal lock keys, padlock with a pair of keys, fired case, manual and paperwork. A great gun for formal or informal target shooting. (1X88816-13) {MODERN} (175/275)
1947. **RUGER MK III SEMI-AUTO TARGET PISTOL** serial #227-22745, 6 7/8" barrel with an excellent bore. This lovely 2005-made pistol appears as new in the box. The metal surfaces retain about 99% original blue finish. The checkered Delrin factory grips with single silver Ruger Phoenix medallion rate excellent. The pistol features an undercut Patridge front sight, adjustable black blade rear sight, frame mounted magazine release, thumb safety, loaded chamber indicator and it is drilled and tapped for optical sight base. The pistol includes a factory hard case that is correctly end-labeled and numbered to the gun, a pair of factory magazines, Weaver style scope base, a pair of internal lock keys, padlock with a pair of keys, manual and paperwork. A great gun for training, practice, target shooting or hunting. (1X88816-11) {MODERN} (175/275)
1948. **RUGER MARK I SEMI-AUTO PISTOL** serial #17-52876, .22 LR, 5 1/2" bull barrel with a bright excellent bore. The metal surfaces retain 95% original blue finish with some loss to scratches, silvering along high edges and near the muzzle with some light operational wear. The pistol has a Patridge front sight with adjustable rear sight and the checkered black plastic grips silver phoenix medallion rate excellent. Included are a single 10 round factory magazine and two-piece yellow and black factory box that is in fair condition with multiple tape repairs and split seams but is complete. A nice Mark I that likely still shoots well. (1X108806-37) {MODERN} (150/350)
1949. **SAVAGE ARMS MODEL 101 SINGLE SHOT PISTOL** serial #44256, 22 LR, 5 1/2" barrel with a very good plus to excellent bore. The metal surfaces retain perhaps 50% original blue and enamel finishes, the balance an oxidized patina with some scattered light pitting, the gun clearly having been exposed to or been in a fire. The smooth impressed Savage logo grips rate fair and poor, the left side grip moderately to heavily scorched, the right side less-so. The gun seems to function mechanically. (1X38829-47) {C&R} (10/20)
1950. **BROWNING CHALLENGER II SEMI-AUTO PISTOL** serial #655RR07127, .22 LR, 6 3/4" barrel with a bright excellent bore. The metal surfaces retain 95% original finish with the barrel remaining a bright blue, the slide and grip frame toning more to a plum brown patina and the trigger retains near all of its gold plate. The pistol has standard sights and the smooth walnut grips with gold colored Browning medallions rate excellent. (1X108807-3) {MODERN} (175/275)
1951. **TROCAOLA Y ARANZABAL & CO. DOUBLE ACTION HAND EJECTOR REVOLVER** serial #182250, 38 CF (the left side of the barrel reads "For 38 Special and U.S. Service Cartridge"), 4 1/2" round barrel with a very good bore. The metal surfaces retain about 98% later hard chrome or bright nickel plate showing flaking along the butt and a bit on the backstrap. The checkered walnut grips rate good with their checkering worn to flat-top showing minor dings and dents. A couple of screw heads show some damage, the cylinder stop is a homemade replacement but the gun seems to function loosely mechanically. (1X38831-11) {C&R} (20/40)
1952. **HARRINGTON & RICHARDSON MODEL 632 DOUBLE ACTION REVOLVER** serial #M988, 32 S&W, 2 1/2" barrel with a very good lightly frosted bore. The metal surfaces retain 95% original blue finish with some light silvering at the muzzle, turn ring along the cylinder and scattered light oxidation staining near overall. The revolver has a blade front sight, square notch rear, pull pin cylinder release and the checkered plastic grips with H&R logos rate excellent. A salty little revolver that still seems to function well mechanically. (1X108826-21S21238) {C&R} (25/75)
1953. **PHOENIX ARMS CO. SEMI-AUTO POCKET PISTOL** serial #502, 25 ACP, 2 1/8" barrel with a very good bore showing small spots of very light oxidation and strong rifling throughout. The metal surfaces of this early 1900s Belgian-made pistol retain perhaps 60% original matte blue toning to smooth dark gray patina throughout with high edge wear, gripstraps worn to gray, some moderate freckling and oxidation staining mostly on the right side, scratches and handling marks. The left side of the recoil spring housing is marked "-PHEONIX- / LOWELL.MASS.U.S.A. / -PATENT-". The black checkered hard rubber grips with pistol cartridge logo remain in near excellent condition showing some light scuffs and handling marks. The frame and recoil spring housing are matching but the breechblock is numbered 369. One unmarked magazine is included and the pistol seems to function well mechanically. A very good example of these rather hard-to-find pocket guns. (1X138794-7) {C&R} (175/275)
1954. **UNMARKED BELGIAN DOUBLE ACTION TOP BREAK REVOLVER** serial #44, 44 CF, 6" ribbed round barrel with an oxidized bore showing evident rifling. The metal surfaces of this revolver retain about 88% original blue with some high edge wear, a few spots of moderate oxidation staining, light pitting and small dings. The trigger, hammer, barrel latch and lanyard retain some clouded nickel finish with moderate flaking and oxidation staining. The smooth walnut grips remain in about very good condition showing some dings, small chips, scratches, handling marks and fit a little loosely to the frame. The extractor mechanism works well but barrel-to-frame fit is quite loose and timing and lockup will require mechanical attention. (1X138753-16) {C&R} (50/100)
1955. **BELGIAN BULLDOG DOUBLE ACTION REVOLVER** serial #8791, .320 CF, 1 7/8" barrel with a lightly oxidized bore showing faint rifling. The metal surfaces of this revolver retain about 90% original nickel finish showing light staining, small flakes to gray patina and overall clouding of the finish. The hammer retains some streaks of nice fire blue while the trigger and ejector rod assembly have mostly toned to dark gray patina. The topstrap is stamped "BELGIAN BULLDOG". The checkered walnut grips remain in very good condition retaining a healthy amount of varnish and showing a few scuffs, small dings and handling marks throughout. This little revolver is equipped with a lanyard ring and the mechanism will require some attention, as single action is not functional, and the double action hammer fly spring is lost causing the sear to not catch the hammer. When pointed down the mechanism functions very well with excellent timing and lockup. (1X138753-54) {C&R} (75/150)

1956. **IMEZ PM/IJ70-18A SEMI-AUTO PISTOL** serial #ACP9708, 380 ACP, 3 5/8" barrel with an excellent bore. The metal surfaces of this Makarov style pistol retain 98% original blue with some fading and slivering along the high edges. The thumbrest grips rate very good plus with some scattered handling marks. There is a Century Arms import marking on the right side of the slide and a single 8-round magazine is included. The pistol is equipped with adjustable sights, no firing pin or firing pin spring are present. (2X208658-134D33602) {MODERN} (50/150)
1957. **PHOENIX ARMS MODEL HP22A SEMI-AUTO PISTOL** serial #4256482, 22 LR, 3" barrel with an excellent bore. The metal surfaces retain about 99% matte black finish with a few light handling marks. The checkered black synthetic factory grips rate about excellent. The pistol features a ventilated rib, windage adjustable rear sight, serrated ramp, frame mounted safety and slide mounted safety. The pistol includes a factory box that is correctly end-labeled and numbered to the gun, single magazine, cable lock with a pair of keys and a manual. The pistol appears to have seen minimal use. (1X88794-14) {MODERN} (50/100)
1958. **STERLING MODEL 302 SEMI-AUTO PISTOL** serial #A103900, 22LR, 2 1/4" barrel with an excellent bore. The metal surfaces retain about 99% original blue with some slight edge wear. The synthetic factory grips with Sterling logo rate excellent. The pistol includes a single magazine. (1X88445-31) {MODERN} (75/150)
1959. **F.I.E. OVER UNDER DERINGER** serial #029735, 38 Special, 3" over under barrel cluster with excellent bores. The barrels retain about 99% original chrome plate but the original black finish on the frame has worn to a mottled mix of gray and pewter with darker black color still visible in the protected areas. The checkered white synthetic grips rate near excellent with a few minor handling marks and light soiling. The selector on the hammer is in need of mechanical attention as it does not align with either firing pin. (1X88736-9) {MODERN} (10/20)
1960. **H&R TRAPPER MODEL DOUBLE ACTION REVOLVER** serial #169845, 22 RF, 4" professionally shortened barrel with a bright very good plus bore which shows only one small pit and a bit of oxidation. The metal surfaces retain about 90% original blue with some scattered dings and handling marks here and there and a bit of light surface oxidation. The checkered two-piece walnut grips rate about very good with numerous dings and handling marks. There has been no front sight re-affixed and the arm will need mechanical attention as occasionally the cylinder rotates rearward after indexing. (1X38753-19) {MODERN} (25/75)
1961. **NEW ORLEANS ACE SINGLE SHOT PERCUSSION PISTOL BY CLASSIC ARMS** serial #1151AK, .44 cal. percussion, 3 1/2" round barrel with a lightly oxidized bore. Barrel, ramrod, hammer and trigger are all polished bright and exhibit just a bit of light oxidation here and there. The brass frame is an ochre patina. The one piece walnut grip rates very good with some light flaking of the finish. The arm seems to function well mechanically however the hammer spring is a bit light. (1X38753-11) {ANTIQUE} (50/100)
1962. **HARRINGTON & RICHARDSON TOP BREAK DOUBLE ACTION REVOLVER** serial #8419, 32 S&W, 2" barrel with a fair bore that shows oxidation and pitting throughout but evident rifling. The metal surfaces retain 95% original nickel with a few light dings, scattered freckling and flaking. The mother of pearl grips rate very good plus with some dirt staining. The cylinder will not retract properly when the gun is opened and will require mechanical attention to fix. (1X208753-21) {C&R} (20/40)
1963. **SMITH & WESSON MODEL NO. 1 THIRD ISSUE REVOLVER** serial #129369, 22 RF, 3 3/16" barrel with a fair-good bore showing moderate oxidation and good rifling throughout. The metal surfaces of this revolver retain about 80% original nickel finish with some moderate flaking to gray patina on the left side frame and along the cylinder, some further smaller flakes, bubbling and light staining scattered throughout. The barrel marking is crisp and clear and most of the screw heads show some light slot damage. The trigger and hammer are mostly a smooth gray patina with some very faint remnants of case-hardened colors on the hammer. The smooth rosewood grips remain in very good plus condition retaining a healthy amount of old varnish with scattered light flaking, small dings and handling marks. Barrel-to-frame fit is excellent, the mechanism functions well with solid timing and lockup, the barrel and cylinder are matching the frame by assembly number. (1X138812-12) {ANTIQUE} (100/200)
1964. **EGYPTIAN HELWAN SEMI-AUTO PISTOL** serial #1050634, 9mm, 4 3/4" barrel with a very good plus bore that shows a couple small pits. The metal surfaces retain 98% arsenal blue finish. The grooved black plastic grips rate very good plus with some scattered handling marks. The slide is matching to the frame and there is an Interarms import marking on the frame. No magazine is included with this pistol. An excellent example of this Egyptian Beretta clone. (1X208825-26D33288) {MODERN} (100/200)
1965. **HAWES 21S SINGLE ACTION REVOLVER** serial #557338, 22 LR, 5 1/2" barrel with an excellent bore. The metal surfaces of this West German made revolver retain 90% original blue with some silvering on barrel, a turn-ring on cylinder and scattered fading. The smooth hardwood grips display a loose fit and rate very good as-refinished with an added varnish and a few light chips. (1X208735-10) {MODERN} (100/200)
1966. **WALTHER P99 AS SEMI-AUTO PISTOL** serial #FAM5349, 40 S&W, 4 1/8" barrel with an excellent bore. The metal surfaces retain about 99% original black finish and the polymer frame rates excellent. The pistol features three dot windage adjustable rear sight, ambidextrous paddle style magazine release and frame mounted de-cocker. The pistol includes a Plano hard gun case and a single ten round Mec-Gar magazine. A fine gun for home defense. (88736-11) {MODERN} (300/500)
1967. **SAVAGE AXIS STAINLESS BOLT ACTION RIFLE** serial #J134667, 7mm-08, 22" barrel with a bright excellent bore. The stainless steel surfaces rate excellent with only a couple minor rub marks. The Realtree Xtra synthetic pistolgrip stock rates excellent as well. The barrel is not equipped with sights, included is a set of Weaver two-piece rings and bases and two detachable factory magazines. An excellent all-weather flat shooting rifle. (58803-3) {MODERN} (400/600)



1968

1968. **CUSTOM SMITH CORONA MODEL 03-A3 INTERNATIONAL TARGET RIFLE BY WAYNE TREW** serial #3676753, 30-06, 26 1/2" heavy target weight barrel with a bright excellent bore. The metal surfaces retain about 97% later, good quality maker hot immersion blue. The rifle has been stocked international thumbhole style with a laminated fingergrooved stock with generous flat-bottomed forend. The laminated walnut stock rates very good plus to excellent and the quality of the craftsmanship is fairly good. The arm has been stocked blind with no floorplate, there being a blued-over triggerguard in place and a blued-over steel escutcheon for the front action screw. The rifle is sighted with a Lyman 77 globe front sight and a long tang Lyman rear receiver sight. The bolt handle has been nicely swept and there is a low scope safety installed, with the bolt body and extractor being nicely engine turned. An interesting open-sight off hand international match rifle appears to be well-made. Barrel is maker marked on its underside. Trew was a gunsmith from Baldwinsville New York and ran Trew's Gun Shop. (38476-105) {MODERN} (400/600)

1969. **BELGIAN DOUBLE HAMMERGUN MARKED T BARKER** 12 ga., 30" damascus barrels with about very good bores which show light oxidation. The barrels are an overall soft brown and lightly oxidized patina and are marked on their rib "Belgium Damascus Steel". The frame and lockplates are similar, the triggerguard with moderate oxidation and pitting. Each plate is marked "D Barker", the right showing some moderate pitting, the left with a leaping rabbit. The checkered round knob European walnut buttstock rates about very good with the expected overall minor dings and handling marks, the forend showing more wear. Gun features rebounding locks which seem to operate properly, although loosely, and the top lever is at the end of its travel. (38864-48) {C&R} (200/400)
1970. **MARLIN GLENFIELD MODEL 75 SEMI-AUTO RIFLE** serial #27287588, 22 LR, 18" barrel with a very good to excellent bore. The blued-over surfaces retain about 95% original factory finish with light oxidation, the enameled surfaces rate very good showing light flaking and handling marks. The birch Monte Carlo stock rates very good with overall light handling marks or scratches. The factory open sights are intact and there is a BSA 3-7x20 telescopic sight mounted to the factory grooved receiver. Scope rates very good with slightly cloudy optics. (38852-28) {MODERN} (50/150)
1971. **SAVAGE MODEL 11 BOLT ACTION RIFLE** serial #G177782, 308 Win, 22" barrel with a bright excellent bore. Metal surfaces retain about 99% original blue showing very light muzzle wear and a few very minor handling marks with a bright bolt body etched with the Savage trademark. The black injection molded synthetic stock rates very good with the expected minor dings and handling marks that come with a hunted arm showing a prominent scratch on left side at the rear of the checkering panel with a few adjacent handling marks. The rifle comes mounted with a Simmons 8 point 3x9x40 telescopic sight with duplex reticle and bright excellent optics. The set of QD sling swivels and black nylon sling are included. Field-ready. (38863-39) {MODERN} (250/400)



1972. **NEW YORK STATE PERCUSSION HALFSTOCK FOWLER BY GEORGE HERBERT**

About 8 bore, 30 1/4" part octagon part round P&S Remington barrel with an oxidized bore. The barrel is an overall dull gunmetal gray and softer brown patina showing remnants of damascus twist its full-length and with overall moderate pitting. The top flat is maker marked "GH Herbert/Albany" and there is a simple brass bead affixed, likely once a much longer barrel given its bore size, Philo and Samuel Remington provided barrels to the trade much as their father did, quality-makers trusting their steel. The lockplate as well is a dull gunmetal gray and brown patina with overall pitting and is marked "Warren/Albany" and shows the light open flowing scroll often seen on many Warren locks. Warren & Steele were a large hardware concern in Albany during the 1840s-50s and also supplied locks to the trade, as Remington did barrels. The halfstock appears to be of cherry, the grain structure not quite American black walnut. It rates about good showing an old refinish with a coarsely checkered wrist. There is a chip missing at the toe, the buttplate has been rounded-over in an attempt to protect the balance of the toe. There are long slivers missing left and right at the forestock and a good deal of scorching on the right side of the tang adjacent to the nipple barrel. There is what is likely a pewter noscap, German silver tailpipe, silver plated long tang brass triggerguard and simple food chopper style sideplate. There is an oval monogram plate atop the wrist which is un-engraved. The barrel is retained with a single wedge through oval German silver escutcheons, the left escutcheon is loose. There are the remnants of an antique ramrod in place. George Herbert was an active Albany maker from roughly 1838-1850. Overall and attractive large bore New York State fowler for over the mantel. (38629-1) {ANTIQUÉ} (300/500)

1973. **UNMARKED BELGIAN PINFIRE DOUBLE ACTION REVOLVER** About 7.5 mm pinfire, 3 1/4" round barrel with an oxidized bore. The metal surfaces are an overall oxidized brown patina with some pewter gray base gunmetal showing through. The smooth walnut grips rate good with trace original varnish and some oxidation staining. The mechanism seems to function properly double action, there is no single action feature, the ejector rod is slightly bent. (37708-1) {ANTIQUÉ} (15/40)
1974. **WINCHESTER MODEL 41 BOLT ACTION SHOTGUN** .410 bore, 24" plain barrel choked full with a bright excellent bore. The metal surfaces are an overall dull gray patina with toning to pewter on the sharp edges and contact points and overall light handling dings, the triggerguard with plum brown oxidation. The gumwood stock rates about good with trace original varnish and overall light dings and handling marks from the years, the original checkered hard rubber Winchester buttplate intact but showing a good deal of wear. (36520-1049) {C&R} [Richard "Stretch" Kennedy Collection] (200/400)
1975. **BELGIAN SIDE LEVER DOUBLE HAMMERGUN MARKED W RICHARDS** 12 ga., 30" barrels, loosely choked improved cylinder, with oxidized about good bores. The metal surfaces are an overall soft brown lightly oxidized patina mixing with plum and dark gunmetal gray undertones. The round knob European walnut buttstock and splinter forend show coarse checkering and rate good and fair respectively, the forend showing more wear with tiny chips all along its periphery. The barrels are off-face and very loose on the frame. The locks do function mechanically, hammers are mismatched and one firing pin is missing. (37875-3) {ANTIQUÉ} (40/80)

1976



1976. **CANADIAN MARKED U.S. MODEL 1917 BOLT ACTION RIFLE BY EDDYSTONE**

serial #147225, 30-06, 26" unmarked barrel with a good bore that shows a few patches of oxidation toward muzzle. The metal surfaces retain 97% gray arsenal parkerized finish with some light silvering on the exposed edges. The walnut stock rates very good with an armory oil finish, a strong "C (Broad Arrow)" marking on the right side of butt, some added red paint on front of handguard, scattered dings and handling marks. The stock is of Winchester manufacture, the rear sight Remington but most of the other parts are of Eddystone manufacture. The stock is numbered matching to the receiver on the toe, the bolt is numbered to a different gun, both of which are Canadian practices and there is a CDI import marking on the barrel. A very fine Canadian used 1917 Enfield rifle. (208852-25) {C&R} (500/700)

1977. **PIETTA PPS-50 SEMI AUTO CARBINE** serial #SA731, 22 LR, 16" barrel with an excellent bore. The metal surfaces of this PPSH-41 style carbine retain 98% original parkerized finish with a couple tiny spots of light oxidation on heatsield, a couple small spots of light flaking and some light silvering. The hardwood stock rates near excellent with a few light handling marks. This carbine includes a single drum magazine that is numbered "SA928". An excellent condition rimfire carbine for the World War Two enthusiast on a budget. (208873-640) {MODERN} (150/250)
1978. **WINCHESTER MODEL 77 SEMI AUTO RIFLE** serial #174126 22 LR, 21" barrel with a very good bore that shows a couple light pits. The metal surfaces of this tube fed rifle are drifting to a dull brown patina with a couple minor dings on top of receiver and the magazine tube retaining much original blue. The hardwood stock rates excellent as lightly cleaned with a few light handling marks. A solid Winchester 77 that may be a fun plinker. (208873-571) {C&R} (100/200)
1979. **REMINGTON 513T TARGETMASTER BOLT ACTION RIFLE** serial #120894, 22 LR, 27" barrel with an excellent bore. The metal surfaces retain 50% original blue with the bottom metal being a gray patina, a patch of staining on barrel, scattered fading, freckling and oxidation staining. The walnut stock rates good with a strong boxed "SA/R" cartouche on the left side, a large chip missing at heel, a few dings and scattered handling marks. There are four added holes on the left side of the receiver, the rifle has a globed front sight, no rear sight or magazine are present. An interesting Remington rimfire rifle that was likely used to train American servicemen. (208873-643) {MODERN} (100/200)
1980. **CZECH VZ-52 SEMI AUTO RIFLE** serial #K60581, 7.62x45, 21" barrel with an about very good bore that shows some light pitting and frosting but strong rifling. The metal surfaces of this "she 55"-coded rifle retain 97% arsenal parkerized finish with some light silvering on the exposed edges. The hardwood stock rates good with an added black enamel finish, a couple chips, a large patch of flaking on left side of handguard, further light flaking and handling marks. There is a Century Arms import marking on the barrel, the mechanism is working sluggishly and requires professional attention to clean. (208852-30) {C&R} (200/300)
1981. **SPANISH FR-8 BOLT ACTION CARBINE** serial #24209, 7.62 NATO, 17" barrel with a very good bore that shows some light pitting and frosting but strong rifling. The metal surfaces of this 1954 dated carbine show a fading gray parkerized finish with a few small spots of oxidation staining and some scattered silvering. The hardwood stock rates about very good with scattered dings and handling marks. The bolt is numbered matching to the receiver and there is a Century import mark on the barrel. A very good example of these late Spanish Mauser style carbines. (208852-9) {C&R} (200/400)
1982. **MAVERICK 88 SLIDE ACTION SHOTGUN** serial #MV57590H, 12 Ga, 20" plain barrel choked cylinder with an excellent bore. The metal surfaces retain 93% original blue with some silvering and moderate dings on the left side of receiver, some light flaking to brown and a few minor spots of light oxidation. The black synthetic stock and grooved forend have had their sling hardware removed and rate very good plus with a few handling marks. A fine shotgun that will likely be great for home defense. (20883-622) {MODERN} (100/200)
1983. **WINCHESTER MODEL 77 SEMI AUTO RIFLE** serial #67678, 22 LR, 22" barrel that has a ring about halfway down but otherwise rates very good with a couple spots of oxidation. The metal surfaces of this tube fed rifle retain 97% original blue with some light flaking to brown at the front end, a small patch of light dings at rear of receiver, a minor ding at bottom of muzzle and a couple tiny spots of light oxidation. The walnut stock rates excellent with a few handling marks. There is some white staining on the buttplate and the front triggerguard screw is missing. A very good Winchester Model 77 rifle overall. (208873-566) {C&R} (125/250)
1984. **WINCHESTER MODEL 290 SEMI AUTO RIFLE** serial #520239, 22 S,L,LR, 20" barrel with an excellent bore. The metal surfaces retain 99% original blue and black enamel finishes. The checkered pistolgrip stock and forend rate excellent with a couple tiny handling marks. This rifle includes its original factory box correctly end-labeled to the gun. An excellent condition Winchester 290 that may be a fun shooter. (208873-721) {MODERN} (150/300)
1985. **WINCHESTER MODEL 270 SLIDE ACTION RIFLE** serial #B837593, 22 LR, 21" barrel with an excellent bore. The metal surfaces retain 98% original blue and enamel with some light scratches and minor flaking on the receiver. The checkered pistolgrip stock and forend rate very good plus with an added oil finish, a few light dings and scattered handling marks. The rifle is equipped with factory sights and an unmarked Chinese made 4x40 scope that has a duplex crosshair reticle and optics that are a bit tinted. A very fine Winchester slide action rifle. (208873-587) {MODERN} (150/200)
1986. **COLT COURIER SEMI AUTO RIFLE** serial #SC32629, 22 LR, 19" barrel with an excellent bore. The metal surfaces retain 98% original blue and enamel finishes the loss mostly due to light flaking on the receiver. The hardwood stock rates near excellent with a couple handling marks on the left side of the forend. The rifle retains its sight hood, also included are the original box correctly end-labeled to the gun, manual and other factory paperwork. A very fine Colt Courier rifle for the rimfire enthusiast. (208873-722) {MODERN} (200/400)
1987. **WINCHESTER MODEL 1894 LEVER ACTION CARBINE** serial #2499421, 30 WCF, 20" barrel with an excellent bore. The metal surfaces retain 98% reapplied blue with some light flaking on the top of frame and "FO-271" lightly etched behind the serial number on frame. The walnut stock rates about excellent as lightly refinished with an added varnish and some scattered handling marks. The rifle is equipped with an adjustable semi buckhorn rear sight and a silver bead front sight. A solid Pre-64 1894 carbine that will likely be a good brush gun. (208873-565) {C&R} (300/400)
1988. **WINCHESTER MODEL 1894 RANGER LEVER ACTION CARBINE** serial #6182737, 30 WCF, 20" barrel with an excellent bore. The metal surfaces retain 98% original blue with some minor freckling on the receiver. The hardwood stock rates excellent with a couple light handling marks. The rifle is equipped with an adjustable semi buckhorn rear sight and a bead front sight. An excellent economy grade 94 Winchester carbine. (208873-603) {MODERN} (200/400)
1989. **GERMAN K98K BOLT ACTION RIFLE BY STEYR (SPORTERIZED)** serial #9035r, 8mm Mauser, 24" barrel with a very good bore that shows some light pits near muzzle. The barreled action of this bnz 45 coded rifle retains 70% reapplied blue with overall fading, a few light dings and a couple spots of light oxidation. The floorplate is turning to a gray patina with traces of original phosphate and some light freckling. The Monte Carlo stock rates very good as lightly refinished with an added varnish, some flaking and handling marks. The rifle is equipped with an aftermarket rear sight and a Stoeger recoil pad giving it a 13 1/2" length of pull. There are two added holes at the right rear of receiver and one of the small triggerguard screws is missing. An about very good sporterized K98k rifle. (206519-597) {MODERN} [Richard "Stretch" Kennedy Collection] (200/300)
1990. **ARMSCOR AK-22 SEMI AUTO RIFLE** serial #A813673, 22 LR, 18" barrel with an excellent bore. The metal surfaces retain 99% original matte finish with a few spots of dried grease. The faux wood stock rates excellent with a few light handling marks. Included with this rifle are magazine, a nylon sling, the original factory box correctly end-labeled to the gun, hang tags, manual and paperwork. A very fine Filipino AK style rifle. (208873-647) {MODERN} (150/200)

1991. **HIGH STANDARD SENTINEL MK IV REVOLVER** serial #S61131, 22 Magnum, 4" full lug barrel with an excellent bore. The metal surfaces retain about 95% original blue with some light wear above the knuckle, high edge wear, light scratches and a light grind mark on the right side of the frame. The smooth hardwood factory grips rate very good to excellent with light handling marks. This revolver features a ramp front sight and adjustable rear sight. The cylinder release is a heavily serrated button on the ejector rod and easily accessible from either side. The frame shows light tool marks and a re-bluing attempt over the serial number but they are still fully legible. This gun should make a good field gun. (88873-146) {MODERN} (250/350)
1992. **HIGH STANDARD SPORT KING SEMI-AUTO PISTOL** serial #360197, 22 LR, 6 3/4" barrel with an excellent bore. This early lever series, without the slide stop, retains about 96% original blue with scattered oxidation stains, edge wear, scratches and the slide toning to plum. The checkered synthetic thumb rest factory grips with High Standard logos rate near excellent with a few handling marks. The gun features a Patridge front sight and drift adjustable rear sight. The gun includes a single two-tone factory magazine. (88873-511) {C&R} (200/400)
1993. **HIGH STANDARD MODEL GB SEMI-AUTO PISTOL** serial #314956, 22 LR, 4 1/2" barrel with an excellent bore. This pistol retains about 85% original blue with the grip frame toned to pewter and brown with edge wear, freckling and handling wear. The checkered synthetic factory grips with High Standard logo rate very good with scattered light dings. The pistol features a serrated ramp front sight and drift adjustable rear sight. It includes a two-tone factory magazine. It should make a fine plinker or camp gun. (88873-462) {C&R} (200/300)
1994. **HIGH STANDARD SPORT KING SEMI-AUTO PISTOL** serial #340797, 22 LR, 4 1/2" barrel with an excellent bore. This early lever series, without the slide stop, is an overall brown patina with oxidation stains, fine pitting and other handling marks. The replacement grips are smooth faux mother-of-pearl semi-target grips by Sanen that rate very good and show light scratches and handling marks. There is a Sanen medallion on the left panel but the one on the right is missing. The pistol features a serrated ramp front sight and drift adjustable rear sight. It includes a factory magazine. (88873-134) {MODERN} (50/150)
1995. **HIGH STANDARD SPORT KING MODEL SEMI-AUTO PISTOL** serial #2454344, 22 LR, 4 1/2" barrel with an excellent bore. This slant grip late 1960's - early 1970's made gun retains about 97% original blue with scattered light freckling and a few handling marks. The checkered synthetic factory grips with High Standard medallions rate about excellent. The pistol features a serrated ramp front sight, drift adjustable rear sight and it includes a factory magazine. This gun has seen only light use and should make a great shooter. (88873-497) {MODERN} (250/350)
1996. **SAVAGE MODEL 1912 SEMI-AUTO RIFLE** serial #9394, 22 LR, 20" barrel with a bright near excellent bore. The barrel of this rifle retains about 75% original blue thinning to gray patina throughout showing light scratches, moderate freckling and some small spots of oxidation staining. The frame retains about 85% original bright blue with high edge wear, spots flaking to gray-brown patina, light freckling and oxidation staining. The smooth straight grip walnut buttstock and forend remain in good-very good condition showing thin 3" cracks at either side of the toe, a couple thin cracks forming at the right side rear of the forend, some further light staining, scratches and small dings. The rifle is sighted with a tang-mounted Lyman peep sight, original flat-top sporting rear and a Marble's Improved front sight. One original magazine is included that shows some moderate dings and damage around the base and feed lips. A very nice example overall of these interesting Savage semi-autos. (136520-1831) {C&R} [Richard "Stretch" Kennedy Collection] (300/500)
1997. **FABRIQUE NATIONALE ATD 22 SEMI-AUTO RIFLE** serial #75910, 22 LR, 19 1/2" barrel with a bright bore unfortunately showing two bulges. The barrel of this early top-loading rifle is mostly a blue-gray patina showing patches toning to more of a gray-brown, scattered dings, light oxidation staining and some remnants of blue. The frame is a gray-brown patina showing moderate oxidation staining and all of the markings are still quite clear. The smooth round knob pistolgrip walnut buttstock and forend remain in fair condition, the buttstock is very loose and will require some professional attention. There are a number of small chips around the edges at the rear of the forend, the buttstock shows moderate cracks and chips all around the frame junction along with further scattered dings, scratches and handling marks. The rifle is sighted with a simple leaf rear sight, brass blade front and the magazine tube is present. (136520-1399) {C&R} [Richard "Stretch" Kennedy Collection] (100/200)
1998. **STEVENS FAVORITE SINGLE SHOT RIFLE** serial #S876, 32 Long RF, 22" part round part octagon barrel with a mostly bright very good bore showing some spots of light pitting and strong rifling throughout. The barrel retains about 95% original blue showing some light scratches, small dings and some light oxidation near the muzzle. The frame retains some strong case-hardened colors throughout, the left side mostly cleaned to silvery patina showing scattered light oxidation staining and freckling. The straight grip walnut buttstock and forend remain in very good plus condition showing some light dings, scratches and handling marks throughout, along with a stretch of solvent or oil soaking the length of the right side buttstock. The original hard rubber buttplate is intact showing some scattered scuffs and small chips. The rifle is sighted with a large flip-up rear v-notch and German silver blade front. The ring on the takedown screw is missing and the mechanism seems to function well. Overall a rather attractive example. (136520-534) {C&R} [Richard "Stretch" Kennedy Collection] (200/400)
1999. **WALTHER SPORTMODELL BOLT ACTION RIFLE** serial #23069, 22 LR, 25 3/4" barrel with a bright excellent bore. The metal surfaces of this rifle are mostly a mottled light gray and blue-gray patina showing remnants of older reapplied blue scattered about and remnants of cleaned moderate pitting throughout. The barrel bands and triggerguard retain about 90% of a reapplied heavy black paint showing some flaking throughout. Most of the markings are still quite clear with visible "(Crown) / N / B / U" proofs and the bolt is numbered "433". The smooth round knob pistolgrip walnut stock and handguard remain in very good plus condition as lightly cleaned showing some spots of oil soaking scattered about, a few tiny chips, dings and a thin 3" crack on the top of the handguard. The handguard may be an older replacement, the barrel band has what appears to be a replacement nut and the original sights are intact. Also included are a rather crude replacement false cleaning rod and a leather sling that may be original but shows a 1' long added rubber backing, small scuffs and light staining. While not the prettiest-looking example it will probably still be a fine shooter. (136520-2278) {C&R} [Richard "Stretch" Kennedy Collection] (200/400)
2000. **BRITISH NO. 4 MKI* BOLT ACTION RIFLE BY SAVAGE** serial #40C1543, 303 British, 25" barrel with an about very good two-groove bore showing a patch of moderate oxidation nearer the breech but strong rifling throughout. The metal surfaces of this 1943-dated rifle are mostly a medium gray patina showing light freckling, scratches and minor oxidation staining here and there. The hardwood stocks and grooved handguard may be arsenal replacements with a large "FR" visible on the right side butt and remain in good condition showing a 1" shallow chip and crack at the heel, some small chips and moderate dings in the grooves of the handguard, a few smaller hairline cracks here and there, staining, dents and scratches. There is a painted "20" rack number on the stock, British export proofs are present on the right side of the muzzle, the bolt is matching and the rear sight is the correct two position flip-up aperture. The forward sling swivel is a little loose in its retainer and no magazine is present. A rather well-used example that will probably still be a fine shooter after locating a magazine. (136520-3432) {C&R} [Richard "Stretch" Kennedy Collection] (200/400)

2001. **BRITISH NO. 5 MKI BOLT ACTION "JUNGLE" CARBINE BY ROF FAZAKERLEY** serial #T983, 303 British, 20 1/2" barrel with flash hider and a very good plus bore showing some light frosting. The metal surfaces of this November 1945-made rifle are mostly a dark gray patina showing some pinprick pitting along the barrel, scattered freckling, minor dings and some remnants of black Suncorite finish here and there. The hardwood stocks and handguard remain in about very good condition as refinished showing a heavy coat of added varnish, scattered light dings, scratches and light staining. The hard rubber buttplate shows some small chips and scuffs and there are British export proofs on the barrel and small "ENGLAND" stamped on the socket. The stock and bolt are numbered to the gun and no magazine is present. (136520-2711) {C&R} [Richard "Stretch" Kennedy Collection] (250/450)
2002. **ZASTAVA M59/66 SKS SEMI-AUTO RIFLE** serial #G-180727, 7.62x39, 24" barrel with a bright excellent bore. The metal surfaces of this Cherry's-imported rifle retain about 97% factory phosphate and blue finishes showing some light high edge wear, scattered light scratches and handling marks. The bolt and bayonet are still mostly bright showing some light scratches and handling marks. The smooth hardwood stock and forend remain in near excellent condition showing some light scratches and handling marks and the buttstock is equipped with a black rubber buttplate. All of the original hardware is intact, the serialized parts are matching and there is an import mark on the right side barrel. An excellent example overall that appears to have seen little if any use. (136520-2704) {C&R} [Richard "Stretch" Kennedy Collection] (250/450)
2003. **MAUSER MODEL ES340B SINGLE SHOT BOLT ACTION RIFLE** serial #144248, 22 LR, 26 3/4" barrel with a bright excellent bore. The barrel and triggerguard of this rifle retain perhaps 65-70% original blue showing moderate oxidation staining throughout, a little heavier on the underside of the barrel additionally showing some light pinprick pitting and freckling. The receiver retains about 85% original blue showing light oxidation staining and freckling. Curiously the original Mauser buttplate is nickel-plated retaining about 85% nickel with flaking and light oxidation. The smooth round knob pistolgrip walnut buttstock remains in about very good condition showing mostly worn finish with scattered small chips around the buttplate, moderate dings, scratches and handling marks throughout. The Mauser cartouche on the right side butt has softened a little but is still clearly visible and the sling swivels are intact. The original sights are intact minus the front sight hood and the bolt appears to match but is covered in heavy cosmoline so will need a good cleaning. Although a little salty this rifle will probably still be a fine shooter. (136520-750) {C&R} [Richard "Stretch" Kennedy Collection] (350/550)
2004. **BRITISH DOUBLE HAMMERMUN WITH J. GURD & SON RETAILER MARKINGS** serial #9019, 10 ga, 31 3/8" barrels with fair bores showing spots of moderate pitting throughout although heavier nearer the breech. The barrels of this shotgun show strong remnants of damascus pattern throughout having toned mostly to gunmetal-gray patina showing spots of light oxidation staining, small dings and light pitting. The barrel rib shows one more moderate ding and is starting to separate for about 2" at the breech; it is neatly inscribed "J. GURD & SON LONDON ONT"; the markings softened a little but completely legible. The frame and hammers are embellished with simple but tasteful foliate scrollwork, geometric motifs and borders. The frame is a similar gray patina as the barrels, showing spots of light oxidation staining scattered about and both sides marked "J. GURD & SON". The checked straight grip walnut buttstock and splinter-style forend remain in about good-very good condition the forend showing more wear overall with worn finish, scattered dings, scratches and a few tiny chips. There is a blank German silver monogram plate along the toe line. The forend shows overall smoothing, a number of long splinters and chips along the edges and is a little loosely fitted; the horn tip insert is still intact showing some small chips at the edge and minor crackling. The barrels exhibit some play and lockup will require some mechanical attention as the tension in the lever is gone. The shotgun is sighted with a single silver bead, the hammers are rebounding and both still function very crisply. A rather well-used hammergun shipped to Canada that would look great above the mantel. (138365-5) {ANTIQUÉ} (300/500)
2005. **GERMAN M71/84 BOLT ACTION RIFLE BY SPANDAU** serial #6416, 11mm Mauser, 31 1/2" barrel with a mostly bright very good bore showing some light frosting. The metal surfaces of this 1888-dated rifle are mostly a dark brown patina showing some spots of light pitting and oxidation staining throughout but all of the markings are still quite clear. The walnut stock remains in good-very good condition showing overall smoothing, dings, shallow old chips, a tiny crack at the upper tang and soft but visible cartouches. The band spring screw is a more modern replacement and the bolt is mismatched numbered "6532". The remaining parts appear to be matching, the magazine cutoff switch is a little stiff but the mechanism seems to function well mechanically. (138852-16) {ANTIQUÉ} (300/500)
2006. **CZECH VZ-52 SEMI-AUTO PISTOL** serial #D11949, 7.62x25mm, 4 3/4" barrel with a bright excellent bore. The metal surfaces of this 1954 military-accepted pistol retain about 95% likely importer-reapplied blue showing some scattered scratches and high edge wear. The frame retains about 98% arsenal-quality phosphate finish showing some light high edge wear and minor scratches. The grooved dark brown Bakelite grips remain in excellent condition showing some light handling marks. The right side of the frame shows a refurbishment date of 1982, a small Century import mark and what may be a re-proof date of 1996. This pistol includes a factory 4 3/4" 9mm barrel with a bright excellent bore also numbered to the gun, importer box, manual, cleaning rod and two magazines, one of which shows a little more moderate operational wear and light staining. The slide and 7.65 barrel are also numbered to the frame and the pistol seems to function well mechanically. An excellent example overall with a desirable spare factory 9mm barrel. (138852-55) {C&R} (300/500)
2007. **NORINCO MODEL 213 SEMI-AUTO PISTOL** serial #428014, 9mm, 4 1/2" barrel with a bright excellent bore. The metal surfaces of this commercial Chinese Tokarev clone retain about 96% original blue showing some light high edge wear, scattered minor scratches and light freckling on the gripstraps. The black grooved plastic grips remain in near excellent condition showing just a few tiny chips on the right panel. There is a Sportarms import mark on the right side slide and the pistol seems to function well mechanically. One magazine numbered to the gun and the original box are included. A very nice example overall that will probably be a fun shooter. (138873-67) {MODERN} (200/300)
2008. **EMF NEW DAKOTA SINGLE ACTION ARMY REVOLVER** serial #SA12157, 44-40, 7 1/2" barrel with a bright near excellent bore. The barrel and cylinder of this Italian reproduction retain about 98% original blue showing some very light high edge wear, a few scratches and the ejector rod and cylinder starting to tone to plum under bright light. The ejector rod housing screw head shows some light slot damage. The frame retains mostly bold case-hardened colors showing a few tiny spots of oxidation staining and some very light freckling. The top and sides of the hammer have mostly toned to a pale gray patina with strong colors remaining along the back. The backstrap and triggerguard retain about 98% silver finish that remains mostly bright with some very light high edge wear and small areas showing a pleasant tarnish. The smooth walnut one piece grip remains in near excellent condition with just a handling mark or two. The action functions very well with solid timing and lockup and this revolver appears to have seen just a little bit of use. The original box showing some scuffs and tape repairs and manual are included. (138850-5) {MODERN} (300/500)
2009. **ITHACA MODEL 49 SINGLE SHOT LEVER ACTION CARBINE** serial #150874, 22 S,L,LR, 18 1/4" barrel with a bright near excellent bore. The metal surfaces of this Martini-style lever action retain about 98% original blue and black paint finishes showing some light flaking along the high edges of the frame and lever, a few small handling marks and minor freckling. The smooth straight grip walnut buttstock and forend remain in near excellent condition showing a few light handling marks. The original sights are intact. An excellent example overall that seems to have seen little or no use. (138865-2) {MODERN} (100/200)

2010. **HARRINGTON & RICHARDSON TOPPER MODEL 88 SINGLE BARREL SHOTGUN** serial #AY4413920, 20 ga, 26 1/4" barrel choked improved modified with a bright excellent bore. The metal surfaces of the barrel retain about 80-85% original blue thinning throughout along with scattered moderate oxidation staining. The frame retains most of its case-hardened colors although they are rather unremarkable and show some scattered light oxidation staining and freckling. The smooth hardwood pistolgrip buttstock and forend remain in very good plus condition the forend showing a small chip and scuffs at the left edge and some further smaller dings and handling marks. A nice example that seems to function well mechanically. (138873-621) {MODERN} (75/150)
2011. **SAVAGE 101 SINGLE ACTION PISTOL** serial #49033, .22 LR, 5 1/2" barrel with a bright excellent bore. The metal surfaces retain 90% of their original blue finish with some moderate oxidation staining and active oxidation at the muzzle and along the bottom of the barrel. The pistol has a blade front sight and drift adjustable rear sight and the smooth grips with Indian Head medallions rate excellent. Included with the pistol is an original hinged factory box that shows some light edge wear and ingrained dirt staining but remains in near excellent condition. (108865-88) {MODERN} (75/150)
2012. **WINCHESTER MODEL 1300 DEFENDER SLIDE ACTION SHOTGUN** serial #L2467853, 12 ga., 18" plain barrel choked cylinder with a poor dark oxidized and pitted bore. The metal surfaces retain 97% of their original matte and anodized finishes with scattered light scratches and spots of operational wear along the extended magazine tube. The shot gun features an eight round magazine tube, single brass bead sight and the stippled pistolgrip synthetic stock and grooved forend rate near excellent with scattered light handling marks. (106520-1099) {MODERN} [Richard "Stretch" Kennedy Collection] (75/150)
2013. **REMINGTON MODEL 742 WOODSMaster SEMI-AUTO CARBINE** serial #71794, .30-06, 18 1/2" barrel with a bright excellent bore. The metal surfaces retain 95% original blue finish with scattered light scratches, spots of freckling, silvering along some of the high edges. The rifle has a beaded ramp front sight with adjustable sporting rear sight and a Simmons 3-9x40mm 8 Point scope with duplex reticle and crisp clear optics has been added. The smooth pistolgrip stock and finger grooved forend rate very good with added finish over scattered light handling marks and has added swivel studs. (108806-1) {C&R} (200/400)
2014. **TAURUS MODEL 172 SLIDE ACTION RIFLE** serial #WB2397, .17 HMR, 16 1/2" barrel with a bright excellent bore. The stainless surfaces rate excellent aside from a few light scratches and some peen marks along the right side at the dovetail for the magazine tube. The carbine has a fixed blade front sight with adjustable sporting rear and smooth straight grip stock and grooved forend rate excellent. (106520-948) {MODERN} [Richard "Stretch" Kennedy Collection] (150/250)
2015. **WINCHESTER MODEL 74 SEMI-AUTO RIFLE** serial #346168A, 22 LR, 22" barrel with a bright excellent bore. The metal surfaces retain 95% original blue with scattered light freckling, spots of wear that are toning to brown on the contact and working parts with some silvering along the high edges. The rifle has a raised bead front sight and adjustable sporting rear and the smooth pistolgrip stock rates near excellent having had a light cleaning and some added finish. (108873-709) {C&R} (175/275)
2016. **REMINGTON MODEL 572 FIELDMASTER SLIDE ACTION RIFLE** serial #1637785, 22 LR, 21" barrel with a bright excellent bore. The metal surfaces retain 98% of their original blue and anodized finishes with a few scattered light scratches, spots of flaking and some silvering along select high edges. The rifle has a raised silver bead front sight and adjustable sporting rear right. The smooth walnut pistolgrip stock and grooved forend rate near excellent with scattered light handling marks. (108873-592) {MODERN} (200/300)
2017. **REMINGTON MODEL 788 BOLT ACTION RIFLE** serial #A6125247, .308 Win., 21 1/2" barrel with a bright excellent bore. The metal surfaces retain 98% original blue with some scattered light scratches, spots of fine oxidation staining and some silvering along select high edges. The rifle has no sights but has a set of two-piece Weaver bases installed on the receiver. The smooth hardwood Monte Carlo stock rates about very good with several light impressions rear of the wrist under which appears to be a light cleaning and added finish. Included is a single detachable box magazine. (106520-912) {MODERN} [Richard "Stretch" Kennedy Collection] (200/400)
2018. **J.C. HIGGINS MODEL 31 SEMI-AUTO RIFLE** 22 LR, 24" barrel with a bright excellent bore. The metal surfaces retain 90% plus original blue, toning to brown, with scattered spots of light oxidation, scratches, freckling and silvering along the high edges and working parts. The rifle has standard sights and an added Weaver B4 scope with crosshair reticle and cloudy optics. The smooth pistolgrip walnut stock and beavertail style forend rate near excellent with scattered light handling marks and the retractable sling remains intact and is in excellent condition. (108873-698) {C&R} (75/150)
2019. **LLAMA MODEL IX-A SEMI-AUTO PISTOL** serial #A16803, .45 ACP, 5" barrel with an excellent bore. This pistol retains about 98% factory blued-over finish with several disassembly/assembly marks on the slide release and slide, handling marks and signs of operational use. The smooth hardwood grips with silver Llama medallions are about very good with handling marks throughout. The front sight is a small blade and the rear is drift adjustable. Included is an orange factory hard case and a single magazine. (228873-379) {MODERN} (150/250)
2020. **RUGER MARK II TARGET 50TH ANNIVERSARY SEMI-AUTO PISTOL** serial #222-85298, .22 LR, 4 3/4" barrel with an excellent bore. The metal surfaces of this gun still hold about 99% factory blue with a small mark on the top of the barrel, handling marks and some slight signs of freckling near the 50th Anniversary Ruger crest on the top of the frame. The grips are black checkered plastic and rate about excellent. This target shooter features standard Ruger Mark series fixed sights and the trigger and bolt are stainless steel. Included is an extra magazine, Ruger padlock and a red factory hard case with matching serial number. (228873-267) {MODERN} (250/350)
2021. **BURGO DOUBLE ACTION REVOLVER** serial #113142, .38 Special, 4" barrel with an excellent bore. The metal surfaces of this revolver retain about 95% factory finish with handling marks throughout, a turn ring on the cylinder and some finish missing on the frame. The checkered Burgo grips are excellent and show little signs of use. The rear sight is integral to the frame and the front sight is a serrated ramp. The cylinder latch is partially missing but the revolver seems to operate correctly. (228873-153) {MODERN} (75/150)
2022. **SMITH & WESSON MODEL 10-6 DOUBLE ACTION REVOLVER** serial 2D92510, .38 Special, 4" heavy barrel with an excellent bore. This revolver retains about 98% original factory blue with handling marks, a slight turn ring and small signs of wear at the muzzle. The checkered black rubber combat grips are about excellent and show very minimal signs of handling. This gun is equipped with a serrated ramp front sight, an integral rear sight and case hardened hammer and trigger. (228873-471) {MODERN} (300/500)
2023. **GLOCK MODEL 21C GEN 3 SEMI-AUTO PISTOL** serial #HBA820, .45 ACP, 4 1/2" ported barrel with an excellent bore. The pistol's ported slide retains about 97% Tenifer finish with most of the loss on the right of the slide, most likely due to holster wear. There is also some curious spotting near the muzzle on both sides of the slide as well as scattered high edge wear. The polymer frame is excellent and sports an accessory rail. The sights are standard Glock with a single white dot on the front and a white outline rear. Included is a single factory magazine. (228873-332) {MODERN} (350/550)

2024. **SIG SAUER MODEL P226 SEMI-AUTO PISTOL** serial #U360020, 9mm, 4 1/2" barrel with an excellent bore. The slide retains about 90% factory finish with an impact mark on the hammer, some finish missing at the ejection port and signs of oxidation and handling marks throughout. The alloy frame has fared much better over the years and rates about excellent with small signs of handling. The checkered black factory grips also rate excellent with minor signs of use and screws that show some oxidation. The sights are standard with a single dot front and a single post rear. (228873-503) {MODERN} (350/550)
2025. **COLT MODEL 1903 POCKET HAMMERLESS SEMI-AUTO PISTOL** serial #87368, .32 ACP, 3 3/4" barrel with a frosted bore. The pistol retains about 90% after market nickel finish with most of the loss coming at the muzzle and ejection port with signs of flaking scattered about. There are also signs of flaking at the slide serrations and on the frame. The checkered hard rubber factory grips have been worn down to rounded points but are crack free and still display the Rampant Colt proudly. A magazine showing slight signs of flaking is included. (228873-52) {MODERN} (200/300)
2026. **GLOCK MODEL 32 GEN 2 SEMI-AUTO PISTOL** serial #CEA691US, .357 SIG, 4" barrel with an excellent bore. This pistol retains about 99% factory finish with very minimal signs of handling; the same can be said for the 2nd generation polymer frame. The sights are standard with a white dot front and white outline rear. Accompanying this gun is a Glock Tupperware containing cleaning tools, extra factory magazine, speed loader and paperwork. (228911-13) {MODERN} (300/500)
2027. **GLOCK MODEL 31 GEN 3 SEMI-AUTO PISTOL** serial #HBM549, .357 SIG, 4 1/2" barrel with an excellent bore. This gun retains about 99% factory finish and appears to be in like-new condition. The factory sights are a single white dot front and a drift adjustable white outline rear. Included is a matching number factory hard case with related paperwork, a gun lock, speed loader and three extra magazines. (228911-12) {MODERN} (300/500)
2028. **BERETTA PX4 STORM SEMI-AUTO PISTOL** serial #PY08888, .40 S&W, 4" barrel with an excellent bore. The slide holds about 99% factory finish with very scarce signs of handling. The polymer frame with interchangeable backstraps and accessory rail rates excellent. Affixed to the slide are Super Luminova three dot sights as well as an ambidextrous decocker/safety. This pistol comes in a Beretta hard case with three extra magazines, two different backstraps, a gun lock, manual and shipping sleeve. (228911-14) {MODERN} (300/500)
2029. **HIGH STANDARD MODEL R-101 DOUBLE ACTION REVOLVER** serial #722179, .22 RF, 2 3/8" barrel with a shiny excellent bore. The pistol still retains about 95% factory nickel finish that has dulled over the years with signs of flaking and freckling throughout. The faux ivory grips are about good with a crack radiating from the butt screw to the frontstrap. The cylinder shows slight movement but when the bobbed hammer is pulled back it locks up well and appears to function as it should. (228873-429) {C&R} (75/150)
2030. **SMITH & WESSON MODEL 5904 SEMI-AUTO PISTOL** serial #TCD9755, 9mm, 4" barrel with an excellent bore. The alloy frame and steel slide retain about 90% factory finish with handling marks, high edge wear and slight signs of oxidation throughout. The checkered black grips are about good with some handling marks and dings. The rear sight is adjustable and the front is a blade with a white dot. The dust cover is marked "E.M.P. 90-36" on the right side and has a C.A.I. import mark on the left. This gun comes with a single magazine. (228873-439) {MODERN} (200/300)
2031. **RAVEN ARMS MODEL MP-25 SEMI-AUTO PISTOL** serial #1117097, .25 ACP, 2 1/2" barrel with an about excellent bore. This chrome pistol retains 99% factory finish with slight signs of handling. The ivory colored grips rate about good and have turned to a yellow color. This made in the USA pistol comes in a two piece factory box with a single magazine. (228873-4) {MODERN} (25/50)
2032. **REMINGTON MODEL APACHE 77 SEMI-AUTO RIFLE** serial #A2326998, .22 LR, 19 5/8" barrel with an excellent bore. The black metal surfaces retain about 98% factory finish with handling marks and slight freckling that becomes more prominent as you reach the muzzle. The green nylon stock rates about very good with the majority of handling marks on the forend. This rifle's sight system is an adjustable rear and large blade white dot front. These guns were manufactured for K-Mart in the late 80s and comes with a single factory magazine. (228873-633) {MODERN} (100/200)
2033. **REMINGTON MODEL 597 SEMI-AUTO RIFLE** serial #2621600, .22 LR, 20" barrel with an excellent bore. This rifle's black metal surfaces retain about 96% factory finish with signs of oxidation scattered about the carbon steel barrel. The grey synthetic stock rates about excellent with signs of handling and operational use. This rifle sports an adjustable rear sight, a fixed white dot front sight and comes with a single magazine. (228873-655) {MODERN} (100/200)
2034. **REMINGTON MODEL 550-1 SEMI-AUTO RIFLE** .22 LR, 24" barrel with an excellent bore. The metal surfaces retain about 50% factory blue with many spots thinning to brown and signs of freckling toward the muzzle. The hardwood stock is about good with scattered signs of use and a large discolored section on the left hand side. A great trap-line or varmint rifle. (228873-617) {MODERN} (50/150)



2035

2035. **WINCHESTER MODEL 1893 SLIDE ACTION SHOTGUN** serial #29748, 12 ga., 21" open choke barrel with an oxidized bore. The metal surfaces hold about 50% original finish with several areas thinning to plum color and the majority of the finish loss coming from the receiver. The walnut forend rates excellent and the round pistolgrip buttstock is about good and still has the original steel buttplate attached. The stock also shows a badge indicating that this gun belonged to the Illinois Central Railroad. The badge is tarnished and the shotgun shows its age but this is still an interesting piece of history. (228873-691) {ANTIQUE} (200/400)
2036. **WINCHESTER MODEL 190 SEMI-AUTO CARBINE** serial #B1334526, .22 LR, 20 1/2" barrel with an excellent bore. The metal surfaces hold about 90% factory finish with light freckling on the barrel and the lion's share of the loss coming off the top of the receiver. The hardwood stock and forend are about good with signs of handling, dings and some areas with loss of finish. (228873-675) {MODERN} (75/150)

Edged Weapons

2037. **U. S. MODEL 1902 OFFICER'S SWORD** Lot consists of one regulation 1902 officer's sword by Ira Green, 29 3/4" curved blade with unstopped fullers, measures 36" total length. Blade retains 99% original nickel finish and is etched with scroll, U.S., and is marked "proved" within the Star of David on the obverse side and the eagle and "E Pluribus Unum" legend, and "Ira Green/Spain stainless" on the reverse. The hilt retains 98% of the nickel finish with one small flake on the loop guard. The steel scabbard retains 97% of the original nickel, while it does have a chip around the throat opening. It also includes the original cloth storage sleeve. (3A8935-8A)
2038. **IMPERIAL GERMAN MODEL 89 INFANTRY DEGEN WITH ETCHED BLADE** This Imperial German sword has a 31 3/4" blade, 37 1/4" overall length with stopped fullers. Blade etching features an open flowing scroll and martial panoplies. This Grosse Patern Model 89 Infantry Degen has a fine, pierced stationary basket hilt. The basket features the crowned Prussian Eagle clutching an orb and scepter in his talons; the breast of the eagle bears the crest of the Hohenzollern family. The pommel of the sword is the standard flat type, with a spanner nut to retain it. The Bakelite grip is in good condition with only a small amount of wear. The sword has a sword knot also attached to the pommel, the leather is slightly dried and flaked but the woven acorn remains intact and in near perfect condition with only a small amount of staining. The scabbard has an older leather strap attached. The sword shows light to moderate oxidization, while the scabbard shows heavy oxidization. (3A8935-8B)
2039. **GERMAN 1884/98 BAYONET LOT** This lot consists of a German 1884/98 bayonet and scabbard. The blade is marked "DURKOPP" and "38", it shows scattered flaking silvering and a few spots of oxidation staining. The crossguard shows some light silvering and minor oxidation. The pommel retains much original blue with scattered freckling to brown and oxidation. The brown bakelite handles show some light handling marks. The F. Horster marked scabbard dated 1938 and numbered to a different bayonet shows scattered light pitting and flaking. (208882-21)
2040. **GERMAN 1884/98 BAYONET LOT** This lot consists of a German 1884/98 bayonet and scabbard. The blade is marked "41 asw", it may have been refinished at some point and shows a couple tiny specks of light oxidation. The crossguard shows some silvering and oxidation spots, while the pommel shows a few minor dings and scattered oxidation. The grooved bakelite handles show some handling marks from the years. The scabbard is matching to the bayonet, it shows some silvering and scattered oxidation spots. (208882-21B)
2041. **GERMAN 1884/98 BAYONET LOT** This lot consists of a German 1884/98 bayonet and scabbard. The blade is marked "S/176", it appears arsenal refinished and shows some light silvering. The crossguard shows some light silvering while the pommel shows some scattered light freckling. The bakelite handles show scattered handling marks and light scratches. The scabbard is numbered to a different bayonet and it shows scattered fading and light oxidation. (208882-21E)
2042. **GERMAN 1884/98 BAYONET LOT** This lot consists of a German 1884/98 bayonet and scabbard. The blade is marked "43 fnj" and shows some silvering on the high edges. The crossguard and pommel are mostly a gray patina with scattered light oxidation. The brown bakelite handles show a couple dings and some handling marks. The scabbard is numbered to a different bayonet and is mostly a gray patina with scattered light oxidation. (208882-21D)
2043. **GERMAN 1884/98 BAYONET LOT** This lot consists of a German 1884/98 bayonet, frog and scabbard. The blade is marked "41 asw", it shows a balance between a gray patina and bluing with some oxidations stain spots. The crossguard and pommel are a dull gray patina with scattered oxidation staining. The brown bakelite handles show scattered handling marks. The scabbard is matching to the bayonet, it is mostly a dull gray patina with some light oxidation. The leather frog shows scattered flaking and is dated 1939. (208882-21C)
2044. **GERMAN 1884/98 BAYONET LOT** This lot consists of a German 1884/98 bayonet and scabbard. The blade is marked "41 crs", it shows some light silvering and minor oxidation staining. The crossguard and pommel show some light silvering and flaking to brown. The bakelite grips show some handling marks and light scratches. The scabbard, numbered to a different bayonet shows some silvering, light scratches and scattered oxidation. (208882-21A)
2045. **GERMAN 1884/98 BAYONET LOT** This lot consists of a German 1884/98 bayonet, frog and scabbard. The blade is maker marked ""S/176G", it shows silvering at the tip, scattered freckling and oxidation staining. The pommel is mostly a silver pewter with scattered oxidation staining. The pommel is a gray patina with scattered oxidation staining. The hardwood handles have the letters "EB" lightly etched on the right side and show scattered dings and handling marks. The leather frog has an indiscernible maker's mark and shows scattered crazing, flaking and dust staining. (208882-21F)
2046. **GERMAN 1884/98 BAYONET BY ENST PACK** This lot consists of a third pattern German 1884/98 bayonet and scabbard. The bayonet measures 15 1/4" overall with a 10" blade. The blade is numbered "8337" and coded "42 cul" for Enst Pack. The blade retains 90% original blue with the loss due to scattered scabbard wear. The guard, pommel and flashguard are mostly a dull gray patina with some light oxidation and scattered traces of original blue. The hardwood handles show scattered handling marks. The scabbard is numbered matching to the blade and is a pale patina with overall oxidation staining and freckling. The leather frog shows crazing throughout and scattered flaking. (208842-2)
2047. **SCARCE GERMAN KS-98 SAWBACK BAYONET** This lot consists of a German KS-98 sawback bayonet and scabbard. The bayonet measures 15" overall with a 10" blade. The in-the-white blade and crossguard remain mostly bright with a couple small spots of light pitting on the crossguard and some scattered spots of oxidation staining. The pommel remains partially bright with a couple patches of moderate pitting and oxidation staining. The checkered plastic handles have a couple small cracks, some flattened points and dings. The blade is maker marked by Erfurt and dated 1906. There is a Schutztruppe marking on the crossguard that reads "K.S.2084.". The scabbard has the same unit marking, it has a dent on one side, some freckling and oxidation staining. A very interesting and neat bayonet for the military collector. (207884-20BA) [Craig Brown Collection]
2048. **CHILEAN BAYONET LOT** This lot consists of bayonet and scabbard for the Chilean 1912 rifle. The blade and crossguard remain mostly bright with some scattered light oxidation staining and crisp markings. The pommel appears lightly cleaned with some small spots of light pitting and oxidation staining. The hardwood handles show a few handling marks and minor dings. The scabbard is numbered differently than the bayonet and appears chrome plated with a few minor dings and scattered scratches. (208917-1A)

2049. **SCARCE GERMAN KS-98 SAWBACK BAYONET** This lot consists of a German KS-98 sawback bayonet, scabbard and frog with knot. The metal surfaces of the bayonet have been nickel plated and they show scattered freckling and oxidation. The checkered plastic grips rate about good with a chip, a few areas of missing panels and scattered flattening points. The blade is dated 1903 and is maker marked by Erfurt. The crossguard is marked with a Schutztruppe marking that reads "KS3390". The scabbard shows overall light oxidation and freckling. The leather frog shows dust staining, light flaking, crazing, crackling and some scuffing. The attached knot shows some dust staining from the years. Mr. Brown's notes state that this was a "Walking out" bayonet for either a reenlisted man or an NCO serving on the Schutztruppe. A great bayonet for the German or military collector. (207884-20BB) [Craig Brown Collection]



2049

2050. **JAPANESE BAYONET LOT** This lot consists of a Japanese Type 30 bayonet made by an unknown subcontractor of Kokura arsenal and a proper scabbard. The blade, hooked crossguard and pommel are a dull gray oxidized patina with scattered light pitting. The Asian hardwood handles have a darkend oiled appearance and show a couple light cracks, some small chips and dings. The scabbard is a dull gray patina with a couple dents, scattered flaking and oxidation. (208868-5A)
2051. **U.S. M1 BAYONET** This lot consists of a U.S. M1 bayonet and scabbard. The blade is maker marked by Utica Cutlery and has an armory reapplied parkerized finish with some silvering and parkerized over pitting. The crossguard shows some silvering and light dings, while the parkerized pommel shows light silvering over pitting. The grooved plastic handles show scattered dings and handling marks. The E-US marked scabbard shows some flaking, silvering and dings. (28898-22D34275A)
2052. **U.S. M1 BAYONET** This lot consists of a U.S. M1 bayonet and a Danish scabbard. The blade is maker marked by American Fork & Hoe, it shows scattered silvering and some oxidation staining. The crossguard appears bent at one end with a fading to gray patina and scattered silvering. The pommel shows thinning, oxidation staining and silvering. The grooved plastic handles show scattered dings, light chips and handling marks. The scabbard is marked with a Danish "(Crown)/HTK" marking and shows some dings and silvering. (208864-58A)
2053. **RARE ITALIAN M1871 SWORD BAYONET** serial #KC5117, 25 1/2" overall length with a 20 1/4" Terni-made blade. This is a rare un-modified M1871 bayonet for the 10.4mm Italian Vetterli with full-length blade, hooked quillion and bird's beak pommel. The metal surfaces are mostly a mix of silvery gunmetal and dark gray patina with light oxidation staining and some small dings and nicks along both sides of the blade. The black composite grip panels remain in very good plus condition with some minor discol-



2053

oration, a few small dings and handling marks. The spring button is intact and the bayonet just needs a scabbard to be complete. Most of these were extensively modified when the Italians updated their Vetterli rifles to 6.5mm, making original examples quite desirable. (138789-19K)

2054. **ITALIAN M1938 FOLDING KNIFE BAYONET** 11 3/4" overall length with blade extended, 8 1/2" with blade folded and a 7" blade. The metal surfaces of this bayonet retain about 90% arsenal blue with some toning to brown-gray patina on the pommel and muzzle ring, some light high edge wear, small dings and spots of pinprick pitting underneath the blue. The hardwood grip panels remain in very good plus condition showing a tiny repaired chip around one of the escutcheons, some small scratches, dings and handling marks. The tang is marked with a "(CG)" along with number 4560. The folding mechanism works very well and the blade latches securely when both extended and folded. This example was probably arsenal-refurbished at some point but remains an excellent example of these interesting Italian bayonets. (138789-19N)
2055. **ITALIAN M1891 BAYONET** 16 1/4" overall length, 11 3/4" fullered blade. The metal surfaces of this bayonet retain about 80% arsenal blue with moderate high edge wear and toning to plum patina along the blade, some light oxidation staining and thinning along the pommel and crosspiece. The smooth hardwood grip panels remain in very good plus condition showing mostly worn finish, a few small dings and handling marks. The crosspiece is marked "C.GNUTTI.1942" and there is no scabbard present. Also included is a conical tin oil bottle for an Italian Carcano rifle in very good plus condition showing some light scratches, dings and overall toning to dark gray patina. (138789-19L)
2056. **DUTCH M1895 BAYONET** serial #7851W, 19" overall length, 14" "HEMBRUG"-marked blade. The metal surfaces of this bayonet retain perhaps 65-70% arsenal blue with moderate scabbard wear along the blade, scattered light oxidation staining, a few moderate dings and areas toning to gray-brown patina. The smooth walnut grip panels remain in very good condition with a thin 7/8" crack on the left panel, some small scattered chips, dings and handling marks. The blade is stamped with a small "(Crown) / O" inspector mark and included is an original leather scabbard with frog. The back of the frog is marked "4132 / AA / 71085 / Z". The metal scabbard tip is present and the leather remains in about good overall condition showing some moderate cracking along the length of the frog, about 6 1/2" of separating stitching on the scabbard, scattered scuffs, scratches and handling marks. The strap is present although one end has broken off. Overall a very solid example for the military collector. (138789-19M)
2057. **REMINGTON MODEL 1863 SABER BAYONET** 25" overall length, 20" single edge blade. The blade is stamped with an "H" inspector mark and is mostly bright overall with moderate spots of gray freckling, pinprick pitting and light oxidation staining. The edge of the blade has been sharpened at some point. The all brass handle is stamped with a "C" inspector mark on the crosspiece, "B.H." on the handle and is a nice light ocher patina overall with spots toning more to reddish-brown, scattered small dings and scratches. There is no scabbard present. Overall a solid bayonet for your Remington Zouave rifle. (138764-1A)

2058. **BRITISH PATTERN 1907 BAYONET** 22" overall length, 17" blade. The maker markings are quite soft but appear to read "SAND-ERSON". The crown stamp is also quite faint but "1907 / 11 18" is quite visible. The blade is an overall gray-pewter patina showing spots of light pitting and moderate dings throughout the edge. The walnut grip panels remain in very good condition showing a couple tiny hairline cracks, small dings and handling marks. The scabbard remains in very good condition the metal surfaces an overall gray-pewter patina showing moderate dings and dents throughout and the leather body shows some light staining and handling marks. The scabbard features a round frog stud. (138888-14A)
2059. **JAPANESE 1935 PATTERN ARMY NCO SWORD** 26 1/4" to the brass sleeve, 36 1/4" overall length. The blade remains overall bright with scattered light scabbard marks and has been coated with a clear urethane protective covering. The blade is numbered "126059". The pierced brass tsuba has a pleasing tarnished patina. The aluminum handle has a brown painted collar, spine mounted spring-clip and simulated linen wrapping, the tassel ring is present and intact. The brown paint shows light high spot and edge wear and the brass grip screw and locking nut are free-spinning, prohibiting the grip from being removed. The steel scabbard retains about 80% flaking OD enamel flaking to brown and is numbered to another sword. A very good Type 95 sword overall. (58793-5) (350/550)
2060. **ITALIAN MODEL 1938 CARCANO FOLDING BAYONET** This is a folding bayonet with scabbard for the Model 1938 Carcano rifle equipped with a muzzle ring and push-button release on the guard. The bayonet measures 11 3/8" overall with a 7" single stopped fuller folding steel blade. The metal surfaces retain about 90% original blue evenly toning to brown, loss due to contact and edge wear. The hardwood grips rate very good plus with light handling marks. The spine of the hilt is marked with a small "R" below triangle and is numbered "L16876". The smooth steel scabbard retains about 75% original black enamel flaking to gray with scattered light scratches and oxidation. (58793-2)
2061. **RANDALL MODEL 9 PRO-THROWER KNIFE** This knife measures 10" overall and is constructed of 1/8" solid stainless steel. The knife remains unsharpened and bright with a couple specks of freckling and tiny storage scratches and familiar Randall double foot scimitar maker mark on the obverse side. The knife includes a Johnson roughback 9-10 leather sheath with Randall Made "football" logo on the back of the belt loop. An excellent Randall thrower. (58873-737) (175/275)
2062. **U.S. KRAG BAYONET LOT** This lot consists of a U.S. Model 1892 Krag bayonet and scabbard. The bayonet measures 16-1/4" long with a 11-1/2" blade dated "1900". The metal is a mottled gray with areas of light pitting and other minor handling marks, the blade has a couple of small nicks and cut marks. The wood grip panels have been sanded and partially reshaped. The scabbard has moderate to heavy flaking with much of its black finish missing and a few minor dents. The metal frog has been separated from its base and is no longer present. The bayonet in mounted to a unique, oak base with a small brass plaque that reads "1898 KRAG". A very good example overall. (47094-3)
2063. **BRITISH BAYONET LOT** This lot consists of a British L1A3 bayonet with scabbard. The bayonet measures 12" long with an 8" fullered blade that has been sharpened. Both the bayonet and the all steel scabbard rate excellent. (47094-2)
2064. **BUCK KNIFE LOT** This lot consists of a Buck #102 Woodsman fixed blade knife with sheath. The knife measures 7-3/4" overall with a bright steel 3-1/2" blade. Included is the original black leather sheath. The knife appears to have a factory edge and is in excellent overall condition. (47524-9)
2065. **U.S. BAYONET LOT** This lot consists of a U.S. M7 bayonet with M8A1 scabbard. The bayonet measures about 12" long and has a 6-3/4" blade. An excellent example overall. (47524-10B)
2066. **KNIFE LOT** This lot consists of a Spanish made decorative knife measuring 13-3/4" long with an almost 9" double "edged" blade that has not been sharpened. The metal has areas of gray and brown patinas and specks of light surface oxidation. The hardwood grip rates excellent. The knife has a medieval appearance and would make a fine addition to an historic display or costume. (44260-3)
2067. **FINNISH KNIFE LOT** This lot consists of three Finnish made Mora style knives. The first two measure 10-3/4" long with 5-3/4" blades that are etched with maker's mark in the fuller and have "Made In Finland" along the side of the blade. The steel has areas of light surface oxidation scattered about. The grips feature a brass guard with traditional design, a yellowish orange resin grip and brass horse head pommel. The brass has varying amounts of light tarnish. Each have identical leather sheaths with tarnish and brass throat and tip with similar pattern designs as the guards. The third appears to be an earlier vintage that measures 10-3/4" long with a 5-3/4" blade that has a more moderate gray patina and heavier etched designs that are very similar to the two described above. The grip has a tarnished brass guard and washer style hardwood grip that has the Finnish crest label on one side that is fading. The included leather sheath is more ornate and features tooled designs. All three are in very good to near excellent condition. (45872-25A)
2068. **KNIFE LOT** This lot consists of nine assorted collectible or decorative knives. First is a Case "The Rebel" folding knife that is in as-new condition in its original packaging and features the Confederate flag image on its grip. Second is a fixed blade trade souvenir knife that is 9-1/2" long with a 5-1/4" blade that is marked "GUATEMALA". The horn grip has been carved into a primitive Mayan type figure, the metal has some light oxidation and staining and the grip rates excellent. A leather sheath is included. Next is an Indonesian garab style knife with wood sheath that measures 14" long with a 9" hand forged blade. The metal has some oxidation and dark patina, the wood grip has a foliate shape and the two-piece scabbard is held with braided cord. Fourth is a miniature Japanese katana that measures 6-1/4" long and has a 3-1/2" blade and matching wood scabbard. The metal has a few light specks of surface oxidation. Fifth is a miniature German Army dagger that measures 7-1/4" overall and has light oxidation staining and flaking to the ivory enamel grip finish. Next are three miniature "bowie" style fixed blade knives, each with a leather sheath and are in varying conditions. Lastly is a single blade folding knife with red grip and a 2" blade that is simply marked "U.S.A." and has varying amounts of light oxidation. All are in about very good to very good condition unless described otherwise. (45872-25B)
2069. **KNIFE LOT** This lot consists of a vintage Ka-bar hunting knife that measures 11" long with a 6" high polish blade that appears to have the factory edge and is marked "Ka-bar" on the ricasso. The knife features a stag grip that shows signs of drying and age and has a tarnished brass guard and aluminum pommel which is angled on one side. Included is the original tan leather sheath. An excellent example of these vintage hunting knives. (45872-25C)
2070. **KNIFE LOT** This lot consists of a German made stag handle hunting knife with sheath made by Dale Products Corp.. The knife measures 8-3/8" long and has a 4-1/2" blade that has minor flaking and areas of light oxidation. The stag grip features a small brass guard and has an aluminum pommel. The original tan leather sheath is included. A very good condition example of these vintage hunting knives. (45872-25D)
2071. **KNIFE LOT** This lot consists of a theater made trench or fighting knife that was made from an M1 bayonet. The metal surfaces have been polished bright and have areas of light surface oxidation scattered about. The knife measures 11" long overall and has a 6-3/4" blade that has been sharpened and the markings removed from the ricasso. The guard has been reshaped and the lug retention system has been removed. The black composite grips rate excellent. Included is a brown leather sheath. (45872-25E)

2072. **KNIGHTS TEMPLAR FRATERNAL SWORD** This fraternal sword measures 34 1/2" overall with a 27 1/2" triangular tipped double edge blade. The blade has toned to a dark gray patina with scattered fine oxidation and pinprick pitting concentrating more so along the foible and with small patches on the forte. There is faint evidence of etching still visible, the maker mark however can no longer be seen. The hilt consists of a cast brass crossguard and knights head pommel, nickel silver tangs and dark brown hardwood grip with a red cross in a larger nickel silver cross inlay. The crossguard is decorated with twelve small stars in a triangle pattern on each quillion and a rearward facing eagle on the quillon blocks. The brass has a nicely tarnished patina with light oxidation forming in the protected edges, the grip rates very good with shallow light handling marks and the nickel silver inlay and tangs are mellowing to pewter with fine staining and traces of red still present in the cross. There is no scabbard present and the thin leather buffer washer is dried and cracking but remains mostly intact. A good older fraternal sword that has withstood the sands of time. (2X57338-1)
2073. **U.S. MODEL 1860 GAR OFFICERS SWORD WITH PRESENTATION BY J.A. JOEL CO.** 29 1/2" straight blade, 1860 Staff & Field pattern sword. The blade remains bright overall with a few spots of light staining, retaining much original gold wash. The blade is etched with scroll, panoplies of arms, U.S. and "Samuel H. Bailey" on the obverse side and "J.A. Joel / New York / N.Y."



maker mark on the reverse ricasso. The gold washed hilt has a floral decorated knucklebow, a single branch guard with floral shaped quillon, static guard with Federal Eagle on the obverse and a folding guard with shield and arms on the reverse and the grip is bright cast steel wrapped in simulated brass wire. The metal scabbard is nickel plated with fancy pierced brass mounts and is engraved "PRESENTED TO SAMUEL H. BAILEY / BY MEMBERS AND FRIENDS OF / JUDSON KILPATRICK POST No. 143 / DEPT NY GAR JAN 17th 1891" between the two hangers. Included with the sword are copies of musters and pension records for Samuel Bailey and a copy of the N.Y. Times Oct. 17, 1887 announcement by Samuel Bailey, commander of the Judson Kilpatrick Post 143 G.A.R. to assemble for the funeral of General Kilpatrick. (1X58431-7)



(175/275)



2074. **U.S. SONS OF VETERANS SOCIETY SWORD BY WM READ & SONS** Presented to Capt. Charles H. Holmes 3 Rd. Mass. Regt. This is essentially an 1860 Staff & Field pattern sword with a 30" double edged blade and 36 1/2" overall length. The blade is nicely etched with a gold washed background and decorations including scroll, shields, soldiers and awards. The fancy gold washed hilt has a lovely scroll engraved silver grip wrapped in braided brass wire. The knuckle bow has a single branch guard with plain oval quillon, static guard with two gentleman holding shield in front of flags and eagle centered between "Filli Veteranorum" and "Gratii Dei Servatus" in ribands on the obverse and a folding counterguard with shield and panoply of arms on the reverse. The condition of the sword is excellent, the blade retaining perhaps 92-95% gold wash with the balance of the blade remaining bright with scattered fine staining and tiny scabbard marks along the foible, the hilt retaining 95% original gold wash with the exposed brass having a pleasing soft patina. The obverse side of the blade is etched "Presented To / Capt. Charles H. Holmes / By Theodore Winthrop Camp No. 81 / S. of V" while the reverse is etched "Chelsea / Mass. / January 15, 1890" in riband and "WM READ / & Sons / Boston Mass" on the ricasso. The metal scabbard retains nearly all its nickel plate with only some sparse fine staining and storage marks and is decorated with fancy pierced brass fittings retaining much original gold wash. A great looking Sons Of Veterans presentation sword with highly sought after retailer markings. (1X58674-20)



(200/400)

2075. **UNMARKED U.S. 1860 STAFF & FIELD OFFICERS SWORD** 29 3/4" diamond shaped double edged blade with extra long ricasso. The blade has toned to a bright silver patina showing an old light cleaning with scattered fine oxidation staining and tiny nicks along the edges. The cast brass hilt has a floral decorated knucklebow with single branch guard and plain oval quillon single static guard with Federal eagle in front of flags, foliate decorated pommel with eagle and shield on the sides and a shagreen-like grip wrapped with braided wire. The brass has a lightly mellowed patina with scattered patches of oxidation, the grip having fading applied black enamel to simulate leather. The leather buffer washer and tang shims are missing, leaving the hilt loose fitting to the blade. The tubular steel scabbard has toned to a brown patina with patches of gray. The brass mounts have a tarnished patina with light oxidation. The collar retention screw is missing. (1X58740-35)
2076. **FRENCH M1866 SWORD BAYONET** serial #R53426, 27 1/2" overall length with a 22 3/4" Tulle-made blade dated 1873. The blade is mostly toning to a light gray patina showing some spots of minor oxidation staining, darker freckling, small nicks along the blade and some small patches of applied heavy enamel. The maker marking on the spine is still clearly visible. The hooked quillon is a similar light gray patina with light oxidation staining throughout. The grooved brass grip is mostly a pale goldenrod patina with some small dings, spots of light staining and handling marks throughout. No scabbard is present. (1X138735-34C)
2077. **LOT OF REPRODUCTION GERMAN BLADES** Three total: (1) 2nd Pattern Reichsluftscutzbund dagger The double edge blade on this subordinate's dagger measures 7 1/8" with an 11 3/4" overall length from the tip of the blade to the end of the central rib pommel. The center line equipped blade remains overall bright with a small spot of staining and tiny scratches on the obverse side and "XL 1207 / Stainless Steel / Handcrafted in China" at the rear reverse side of the blade. The rudimentary party eagle with swastika crossguard and pommel remain bright with numerous tiny casting marks and the black plastic grip with crude sunburst swastika inlay rates excellent. The black plastic scabbard with aluminum tip rates excellent as well; (1) German S.S. 1936 pattern dagger The straight double edged blade measures 8 1/2" with an overall length of 13 5/8" from the tip to the top of the capstan nut. The blade remains bright with photo etched "Meine Ehre heist Treue" logo on the obverse side and RZM "M7/14 / CHINA" on the reverse side. The crossguard and pommel retain all their bright chrome finish with some minor light storage scratches. The black plastic grip rates very good with a crude party eagle inlay, the SS emblem is no longer present. The black plastic scabbard with chromed mounts and death head swastika hanger rates excellent; (1) Hitler Youth Knife This knife measures 10 1/2" overall with a 6 1/8" blade. The blade remains bright and the obverse side is etched with facsimile "Blut und Ehre" motto and RZM logo above "M7/38" Paul Seilhelmer code on the ricasso while the reverse side is stamped "STAINLESS / CHINA" on the ricasso. The aluminum hilt retains all its bright nickel and the checkered black plastic grips rate excellent with intact swastika emblem on the obverse panel. Included is a steel scabbard with leather hanger retaining nearly all of its black enamel with only light storage marks from the years. (58445-29A,B,C)
2078. **BERG & CO. MACHETE WITH U.S. MARKING** 18" blade, 23 1/2" overall. The blade is a mix of bright metal and mottled gray patina showing spots of light pitting, staining and small dings throughout. The smooth black synthetic grips remain in very good plus condition showing some scuffs, scratches and handling marks throughout. The left side of the blade is marked "BERG & CO. / SOLINGEN-OHLIGS / 1958" and "U.S.". A green leather sheath with metal reinforcement and spring retainer is included. It remains in about good overall condition showing moderate cracking, staining, a tape repair at the tip and a few small areas torn away. The stitching is solid and the sheath is structurally sound overall. An interesting example for the collector of American militaria. (1X138714-2)
2079. **SMITH & WESSON COMMEMORATIVE KNIFE LOT** This lot consists of a single Smith & Wesson Texas Ranger commemorative knife and accessories. The knife has a 1/4" thick, 5 5/8" long clipped or bowie style blade that rates excellent. The fixed blade knife has an overall length of 10" and features a brass pommel, double brass hand guard and a Texas Ranger Star of Texas Commemorative medallion inset into the handle. The back of the blade is serialized "TR4701" and the right side is marked "TEXAS RANGERS 1823-1973". The handle is laminated hardwood and rates excellent. The knife includes a wood presentation case with the Texas Ranger Commemorative Seal and the S&W logo burnt into the wood on the cover with a deep blue crushed velvet interior. Also included is a leather sheath in an unopened package and is provided with a blue factory two-piece box with reinforced corners. The overall rating of the lot is excellent. (88903-65)
2080. **IMPERIAL GERMAN NCO SWORD BY EICKHORN** 31 1/2" plain, stopped fuller blade with Eickhorn circle maker mark on the reverse ricasso. The blade remains overall bright with scattered patches of fine oxidation staining and tiny light scratches. The edges of the ricasso are marked with a large "2" on the main edge and an imperial proof on the opposite side. The brass hilt has a P-shaped guard with dual langets, single circular quillon, ferrule, dove head pommel with wraparound ears and a black Bakelite grip wrapped with double braided brass wire and a leather finger strap. The brass surfaces have a nice mellowed patina, the front of the guard is marked with imperial proofs and "9870" and "C.E./G" on either side of the leather buffer washer. The grip rates excellent with tight wrappings and the finger loop shows light scuffs but remains fully intact. The steel scabbard is nicely toning to brown still retaining much original blue with scattered fine oxidation and flaking lacquer. The throat is marked "C.E./G" on one side and is numbered "9870", matching that of the sword. (58865-81) (200/400)
2081. **GERMAN OFFICERS PARADE SWORD BY PUMA** 30 1/2" plain, unstopped fuller blade with Puma over Solingen maker mark on the reverse ricasso and "No 9" on the obverse ricasso. The blade retains all its bright polished finish with only some tiny marks from scabbard removal. The aluminum hilt has a P-shaped guard with dual langets, single circular quillon and a dove head shaped pommel with wraparound ears and ferrule and a black plastic covered wood grip wrapped in double braided aluminum wire. The bright metal surfaces have mellowed lightly with scattered fine staining and flaking, the grip has a large crack on either side of the guard at the pommel. The steel scabbard retains about 90% flaking black enamel with some sparse fine oxidation. (58585-143) (100/200)
2082. **GERMAN SECOND WORLD WAR OFFICERS SWORD BY ALCOSCO** 32 1/4" slightly curved unstopped fuller blade with Alexander Coppel GmbH Solingen balance of scales insignia on the reverse ricasso. The blade remains mostly bright with scattered fine staining, tiny scratches and light nicks along the main edge. The hilt has a cast brass P-shaped guard with dual langets, single circular quillon, dove head pommel with wraparound ears and ferrule and a black Bakelite grip wrapped with double bordered braided brass wire. The guard is decorated with oak leaves, the obverse langet has National Party eagle clutching swastika, the reverse langet plain. The metal surfaces have a tarnished ocher patina with generous traces of original gold wash in the protected areas. The grip rates very good plus showing minimal wear and the wrappings have loosened slightly but remain fully intact. The steel scabbard retains about 85% flaking black enamel with scattered light scratches, a small dent and specks of oxidation staining. (58585-142) (200/400)
2083. **GERMAN SECOND WORLD WAR OFFICERS SWORD BY EICKHORN** 31 3/4" slightly curved unstopped fuller blade with Carl Eickhorn standing squirrel maker mark on the reverse ricasso. The blade retains nearly all its mirror polish with a few sparse spots of fine oxidation and very light scabbard scuffs along the foible. The hilt has a brass P-shaped guard with dual langets, single spiraled quillon, dove head pommel with wraparound ears and ferrule and a black Bakelite grip wrapped with double bordered braided aluminum wire. The guard is decorated with oak leaves, the obverse langet has National Party eagle clutching swastika, the reverse langet has raised monogram plate. The metal surfaces have a tarnished ocher patina along the high edges with much original gold wash in the protected areas and inside of guard. The grip rates near excellent with a couple light handling marks, the wrappings tight and intact. The steel scabbard retains about 80% black enamel flaking to brown with scattered light oxidation. (58585-141) (300/500)

2084. **BAVARIAN OFFICERS SABER 33"** slightly curved unstopped fuller blade with no maker marks. The blade is fading to pale silver with scattered fine oxidation and is etched on both sides "IN TREUE FEST!" in riband surrounded by floral scroll with the addition of crown of monogram on the obverse side. The hilt has an iron B-shaped guard with downward round quillon, dove head pommel and ferrule and a brown celluloid grip wrapped with double bordered braided steel wire. The guard is double slotted for knot attachment and the metal surfaces retain about 70% black enamel toning to brown with scattered fine oxidation. The grip rates near excellent with a couple minor blemishes and the wrappings remain tight and intact. The steel scabbard retains about 75% flaking black enamel with scattered light oxidation, becoming slightly more active along the hanger, tip and drag. (58563-12) (100/200)
2085. **U.S. MODEL 1860 LIGHT CALVARY SABER 34 3/4"** slightly curved blade with wide and narrow fullers, 41 1/4" overall length. The blade is a pale gray patina with scattered light oxidation and patches of modest oxidation along the forte, the only visible marking is a light "U.S." on the obverse ricasso. The hilt has a brass triple branch guard, Phrygian pommel and remnants of a brown leather covered wood grip. The brass has a dark tarnished patina with spots of verdigris and tiny impact marks and the leather shows moderate crazing and flaking. The steel scabbard has toned to brown overall with scattered oxidation, pitting and a few light dents. (58545-1) (150/250)
2086. **U.S. MODEL 1860 LIGHT CALVARY SABER** by Ames 34 3/4" slightly curved blade with wide and narrow fullers, 40 7/8" overall length. The blade is lightly mellowing to a bright silvery patina with scattered fine staining and very light scratches from scabbard storage. The reverse ricasso is marked with "Made by / AMES MFg Co. / CHICOPEE / MASS." in scroll while the obverse ricasso is marked U.S. / J.F. / 1866". The hilt has a brass triple branch guard, Phrygian pommel and traces of a black leather covered wood grip wrapped in braided brass wire. The brass is a lightly mellowed goldenrod with tiny impact marks and specks of tarnish. The exposed wood has darkened with age and there is a large chip where the guard contacts the pommel. The wire wrapping has loosened slightly from the deteriorating covering but remains intact. The steel scabbard retains about 60% flaking black enamel toning to brown and gray with scattered light oxidation. (58315-205LTS550) [Lewis T. Steadman Collection] (300/500)
2087. **U.S. MODEL 1860 STAFF & FIELD OFFICER'S SWORD BY RIDABOCK 29 3/4"** plain double edge blade with angular Ridabock maker mark on the reverse ricasso. The blade is fading to bright silver with scattered patches of light oxidation and more moderate oxidation along the foible and ricassos, the maker mark partially lost to the oxidation. The hilt has a brass fixed counterguard and is decorated with typical cast eagles, shields, stand of flags, floral decor and a wood grip covered in black leather. The brass has a tarnished ochre patina with light ingrained dirt and oxidation staining; there is no wire wrapping and the leather has flaked in areas exposing the wood grip. The leather buffer washer is missing, leaving the guard loose fitting to the grip and pommel. The steel scabbard has toned to brown and gray with scattered light to moderate oxidation and areas of pitting. (58865-83)(100/200)
2088. **U.S. MODEL 1860 STAFF & FIELD OFFICER'S SWORD WITH CRANE RETAILER'S MARKINGS 30 1/8"** diamond shaped double edge blade marked "HAROLD / L. / CRANE. / NEW / YORK" on the reverse ricasso. The sides of the blade are nicely etched with "U.S."; Federal eagle, stands of flags and loose scroll and remain overall bright with some scattered fine oxidation staining and a patch of slightly more prominent oxidation on the reverse foible. The cast obverse counterguard shows eagle over flags while the folding kidney shaped reverse guard shows shield over a panoply of arms, the knucklebow shows typical floral center and the inverted cone shaped pommel is decorated with eagle on one side and shield on the other. The dark rayskin covered grip is wrapped in braided brass wire and rates excellent remaining tight and intact. The brass retains much original gold wash fading to a bright ochre along the edges. The scabbard remains mostly bright with scattered light staining and fine oxidation and the brass mounts have mellowed slightly, still retaining much original gold wash. Included is a soft leather sleeve remaining mainly intact with a couple tiny holes. (58865-82) (200/400)
2089. **U.S. MODEL 1840 LIGHT ARTILLERY SABER 31 3/8"** unmarked curved blade equipped with single wide unstopped fullers and narrow ricassos. The blade remains mostly bright with light brush marks the last 2" of the fullers, scattered fine staining and patches of light freckling along the foible. The blade has a slightly rounded tip, a few light nicks along the main edge and light scabbard scratches between the tip and beginning of the fuller, the leather buffer washer is no longer present. The hilt has a brass guard that ends with a round quillon and a domed pommel, the grip is covered in brown leather and wrapped in braided brass wire. The brass is a slightly mellowed goldenrod with scattered tiny scratches, impact marks and spots of tarnish. The center of the guard is stamped "94" behind a slanted scratch engraved "JH". The leather shows moderate cracking and flaking, exposing the wood grip and the brass wire has loosened slightly but remains intact. The steel scabbard is mellowing to bright silver with scattered light staining and sparse spots of more active oxidation. A good to very good 1840 saber, possibly imported. (58735-46) (200/400)
2090. **BRITISH PATTERN 1821(50) ARTILLERY SWORD 35 1/4"** unmarked slightly curved blade equipped with a single wide stopped fuller. The blade has been lightly sharpened and is toning to pale smoky gray patina with scattered light oxidation and a couple tiny nicks along the main edge. The hilt has a brass triple branch guard with round crosshatched counterguard that ends with a round quillon, is slotted for knot attachment, a stepped rounded head pommel with flattened finger button on tang and a brown leather covered grip, wrapped in decorative brass wire. The brass has a mellow patina with tiny impact marks and spots of tarnish. The leather covering shows a few light chips and wear and the wire wrapping is tight and intact. The leather buffer washer is in place, there is however, no scabbard present. (58315-206LTS551) [Lewis T. Steadman Collection] (200/400)
2091. **UNMARKED U.S. MODEL 1860 STAFF & FIELD OFFICER'S SWORD 29 1/2"** plain double edge blade fading to pale gray with scattered fine oxidation and a couple spots of more modest oxidation toward the guard. The hilt has a brass fixed counterguard and is decorated with typical cast eagles, stands of flags, shields, panoply of arms and a wood grip covered in black leather and wrapped in braided brass wire. The brass has a tarnished patina with traces of original silver plate on the back side of the guard and pommel. The leather covering is dry and flaking at the pommel, exposing the wood grip; the wire wrapping has loosened slightly but remains intact. The leather buffer washer is no longer present causing the guard to be loose fitting. The steel scabbard retains about 85% flaking original nickel and is equipped with brass mounts. The brass is toning to pale silver and the exposed steel surfaces, pale brown. (58621-25) (100/200)
2092. **U.S. MODEL 1840 MUSICIANS SWORD 28"** single edged blade equipped with a single nearly full length unstopped fuller, 34 1/4" overall length. The blade has a dark smoky gray patina with overall scattered pitting and oxidation. The ricasso is marked "U.S. / 1863", there are no markings on the reverse ricasso which may be due to the pitting and oxidation. The brass hilt has a lightly tarnished patina, the relief-cast wire wrap rates excellent with only some minor flattening and very light verdigris forming in the grooves. There is no scabbard present. (58621-22) (100/200)
2093. **U.S. MODEL 1840 MUSICIANS SWORD BY AMES** This is a very nice example of a U.S. Model 1840 musician sword. The blade measures 28 1/4" with a 34 1/2" overall length. The blade features a single stopped fuller nearly its full length and retains some very lovely bright original polish showing some very sparsely scattered fine staining any tiny scratches from scabbard storage. The obverse ricasso shows appropriate "U.S. / ADK / 1862" inspectors marking and date while the reverse ricasso shows lightly fading Ames scroll trademark. The brass hilt rates excellent and is a lightly tarnished goldenrod, the obverse bow is also inspector marked "AHC". The relief cast wire wrap rates excellent as well with only some light flattening on each side. There is a leather scabbard and hanger included. The scabbard rates excellent, the tip chape being stamped "AHC" on the drag. The brown leather frog is marked "ROCK ISLAND / ARSENAL / 1903" and has inspector initials "HEK". The frog rates very good plus with light flaking primarily at the front of the suspension tab. (58802-18) (200/400)

2094. **U.S. MODEL 1852 NAVAL OFFICER'S SWORD BY HORSTMANN** 32" single stopped fuller blade marked with lightly etched WM. H. Horstmann circular maker mark on one ricasso and lightly etched star of damascus on the opposite ricasso. The blade retains nearly all of its mirror polish with some sparse fine staining and tiny scabbard marks along the foible. The blade is etched with panoplies of scroll, flags, anchors, Federal eagle, stars and "U.S.N." in riband, the rear of the spine is vertically numbered "17". The felt buffer washer is present and the hilt has a brass guard and basket with "U.S.N." cast amongst leaves and nuts, a serpent quillon and a pommel decorated with leaves, eagle and thirteen stars and a shagreen covered wood grip wrapped with double bordered braided brass wire. The brass retains much original gold wash with the exposed brass surfaces a pleasing goldenrod. The shagreen grip rates excellent with a couple light scuffs and the wire wrapping tight and intact, attached to the guard is a braided brass knot and tassel. The steel scabbard has brass intertwined rope mounts and a serpent drag with remnants of the black leather covering behind the mounts and are numbered to the sword. The steel body has toned to brown and gray with light oxidation staining. The brass remains bright with light staining and impact marks and verdigris forming along the edges of the drag. Also included is a Harding Uniform Co. fabric sword sleeve with scattered stains and holes but remaining fully intact. (58585-140) (200/400)
2095. **JAPANESE PATTERN 1875 PARADE SABER** 27" narrow single fuller blade, 32 1/4" overall length. The blade retains about 95% original chrome plate with acid etched temper line, loss due to flaking at the tip and some sparse specks of oxidation. The pierced brass hilt is decorated with a stippled pommel and cherry blossoms on the ears and backstrap. The brass has a tarnished ochre patina and the black plastic grip shows a few light nicks and the braided brass has started to unravel and is missing in spots. The tubular steel scabbard retains about 80% original flaking nickel with scattered fine oxidation and a couple small dents, the majority of loss toward the top and drag. (58621-27) (200/400)
2096. **UNMARKED ITALIAN MODEL 1873 CAVALRY SWORD** 33 3/4" single edge unstopped fuller blade, 39" overall length. The thin lightly etched blade retains about 95% dull fading nickel with scattered fine oxidation staining and sparsely scattered spots of flaking and more active oxidation; the ricassos are unmarked. The hilt has an iron semi-bowl guard with thumb rest and rolled quillon, nickel pommel with partially checkered backstrap and a wood finger groove grip. The guard retains 95-98% flaking nickel with scattered fine oxidation and light flaking. The pommel shows scattered fine staining and the grip rates excellent showing minimal wear. The tubular steel scabbard retains 95% flaking nickel with scattered fine oxidation. The suspension rings are missing and the flared collar is no longer attached to the interior of the scabbard. (58621-23) (100/200)
2097. **U.S. MODEL 1840 HEAVY CALVARY SABER BY CLEMEN & JUNG** 35 1/2" blade with wide and narrow fullers 41 1/8" overall length. The blade has toned to a dull pewter with scattered oxidation staining and fine pitting at the tip. The reverse ricasso is marked with Clemen & Jung's "C&J" logo, the obverse ricasso is not marked. The hilt has a brass triple branch guard, Phrygian pommel and a wood grip covered in brown leather and wrapped in braided brass wire. The leather buffer washer is in place. The brass a mellowed patina with spots of light tarnish and impact marks, the leather is dried and flaking, exposing the wood and sections of the wire wrap are no longer present. The steel scabbard has toned to a smoky gray and brown patina with scattered fine oxidation, light dents and pitting along the drag. (58621-20) (300/500)
2098. **JAPANESE PATTERN 1875 PARADE SABER** 34" narrow, non-fuller blade, 39 1/4" overall length. The blade retains 95-98% original chrome plate with acid etched temper line, loss due to light scabbard scratches and specks of flaking at the tip. The pierced brass hilt is decorated with a stippled pommel and backstrap with cherry blossoms on the ears and has a nicely mellowed patina with traces of original gold wash in protected areas. The black plastic grip shows a couple light handling marks and is wrapped in smooth brass wire. The tubular steel scabbard retains about 90% flaking original nickel with scattered fine oxidation, a couple small dents, a tiny hole at the tip on one side with the majority of loss on the drag. (58621-28) (200/400)

Ammunition

2099. **LOT OF AMMUNITION AND BRASS** This lot consists of 20 factory-loaded rounds of Norma 9.3x72R ammunition with a round nose soft point projectile. The brass is mostly bright, some of the projectiles show a bit of staining. They rate excellent overall and are in an unmarked white box. Also included with the lot are 20 once-fired rounds of 9.3x72R from what is likely the same brass-ammunition lot. They rate very good plus overall. (38518-3)
2100. **GERMAN COLLECTIBLE AMMUNITION LOT** This lot consists of two full 15 round boxes of Nazi 8mm Mauser, 4 rounds of 7.62x54 Russian and 5 rounds of 6.5 Dutch. The two 15 round boxes include 3 stripper clips, they are marked "S.S." indicating heavy ball and they are brass cased. The rounds rate excellent overall and remain mostly bright. The four rounds of 7.62x54 appear to be of prewar or wartime Soviet. The rounds show scattered moderate tarnish, one is black tipped, another green and the other two appear plain. These rounds include a tender envelope that states that they were found on the Normandy beaches on June 7th, 1944. The 6.5 Dutch ammunition is steel cased and of Nazi manufacture. All rounds are headstamped "am/st/22/43". A great lot for the military or cartridge collector. (207884-59C) [Craig Brown Collection]
2101. **7.92X33 KURZ LOT** This lot consists of approximately 50 rounds of 7.92x33 Kurz. The ammunition is all steel cased, most of it appears to be of wartime manufacture and the rounds exhibit light to moderate tarnishing. (207884-59D) [Craig Brown Collection]
2102. **7.92X33 KURZ LOT** This lot consists of approximately 50 rounds of 7.92x33 Kurz. The ammunition is all steel cased and most of it appears to be of wartime manufacture. Some of the rounds exhibit flaking and tarnish. (207884-59E) [Craig Brown Collection]
2103. **7.92X33 KURZ LOT** This lot consists of approximately 36 rounds of 7.92x33 Kurz and a 5 round stripper clip. The ammunition appears to be steel cased, most of it appears to be wartime and headstamped "oxo". Some of the rounds exhibit varying degrees of tarnish and flaking. The stripper clip appears unmarked and shows scattered light oxidation. (207884-59F) [Craig Brown Collection]
2104. **8MM MAUSER LOT** This lot consists of 14 full 15 round boxes of Nazi produced 8mm Mauser. Four boxes are of the S.M.E. iron core variety and are all dated 1944. The other 10 boxes are of the S.S. heavy pointed bullet variety. The boxes show some moderate soiling and staining from the years. The ammo is housed in a US 30 caliber can. (207884-59G) [Craig Brown Collection]
2105. **30 MAUSER LOT** This lot consists of approximately 360 rounds of 7.63mm/30 Mauser ammunition on stripper clips. The ammo appears to be mostly of DWM manufacture and the rounds exhibit varying degrees of tarnish. The stripper clips are gray and some exhibit oxidation. The ammo is housed in a USGI style 30 caliber ammo can. (207884-59H) [Craig Brown Collection]

2106. **11MM MAUSER LOT** This lot consists of two boxes of 11mm Mauser ammunition. The first is a 10 round box of blank rounds that are housed in a standard 11mm ball ammunition box that has been opened. The rounds show light to moderate tarnish and the box shows some crazing and flaking. The second box is a partial 20 round box that contains 9 rounds of lead round nose ammo that exhibit varying degrees of tarnish, the top of the box is missing, the box shows crazing, a few small tears at the edges and some flaking. (207884-59I) [Craig Brown Collection]
2107. **8MM MAUSER AMMO LOT** This lot consists of 12 full 15 round boxes of German 8mm Mauser ammunition. Eight of the boxes have labels indicating that they are 1944 production S.M.E. iron core. Four of the boxes have partial indiscernible labels or are missing their labels. The boxes show varying degrees of wear from the years, light soiling and flaking. The ammo is housed in a USGI 30 caliber ammo can. (207884-59J) [Craig Brown Collection]
2108. **11MM MAUSER AMMO LOT** This lot consists of a full 20 round box of Dominion 11mm Mauser ammunition. The box shows some small tears and flaking from the years. The ammunition has a 385 grain lead bullet and it shows light tarnish from the years. (207884-59K) [Craig Brown Collection]
2109. **11MM MAUSER AMMO LOT** This lot consists of a full 20 round box of Dominion 11mm Mauser ammunition. The box shows some tearing on the edges, creasing and flaking. The ammunition has a 385 grain lead bullet and the rounds show varying degrees of tarnish. (207884-59L) [Craig Brown Collection]
2110. **11MM MAUSER AMMO LOT** This lot consists of a full 20 round box of Dominion 11mm Mauser ammunition. The box shows some light flaking and some small tears. The ammunition has a 385 grain lead bullet and some of the rounds show light tarnishing. (207884-59M) [Craig Brown Collection]
2111. **11MM MAUSER AMMO LOT** This lot consists of a full 20 round box of Dominion 11mm Mauser ammunition. The box shows some tearing, creasing and light flaking. The ammunition has a 385 grain lead bullet and some of the rounds show light tarnishing. (207884-59N) [Craig Brown Collection]
2112. **8MM MAUSER WOODEN BULLET LOT** This lot consists of approximately 380 rounds of German 8mm Mauser wooden bullet ammunition. The ammo has mixed headstamps with some being Weimar era and others Nazi era. The rounds show light to moderate tarnish and some of the wooden bullets exhibit dings and wear. The ammunition is housed in USGI 30 caliber ammo can. (207884-59O) [Craig Brown Collection]
2113. **9MM CANADIAN AMMO LOT** This lot consists of 15 full 64 round boxes of Canadian made 9mm MK1 ammunition. The ammunition appears to be of 1980's production by IVI, the rounds appear to be in very good condition or better and the boxes are housed in a 30 caliber ammo can. (207884-59P) [Craig Brown Collection]
2114. **MIXED SURPLUS AMMO LOT** This lot consists of 9 boxes of European surplus ammunition and four Berthier clips of ammo. There are five boxes of French 7.5 ammunition that are packed in French boxes marked "CALIBRE .30 M2" instead of 7.5. One of the boxes has been opened, the boxes show creasing and the rounds may show light tarnishing. The next box is a full 20 round box of Hansen Cartridge 6.5x55 Swedish 139 grain FMJ ammo. Some of the rounds show light tarnishing. The seventh is a full 20 round box of Hungarian 7.62x54 short range training ammunition. The eighth is a full 32 round box of French 7.65 Longue pistol ammunition. This ammo shows tarnishing, the box is held by tape, there are tears and one end is opening. The last box is a full 8 round, 1940 dated packet of French 8mm Lebel balle "D" ammunition, the packet has been opened on both sides and it shows some soiling. Three of the clips are 3-shot Berthier clips with ammo, both the clips and ammo show varying degrees of tarnish. The last clip is a 5-shot Berthier clip with ammo, both the clip and ammo show tarnishing. (207884-59Q) [Craig Brown Collection]
2115. **7.62X45 AMMUNITION LOT** This lot consists of a mostly full tin of Czech 7.62x45 surplus ammunition. The tin is open at one end and it appears that most but not all of the packets of ammunition are present. The exterior of the tin shows scattered light oxidation and dings. (208878-2A)
2116. **6.5X54 MANNLICHER AMMO LOT** This lot consists of three full 15 round boxes of FN made 6.5x54 Mannlicher for the Greek Mannlicher Schonauer rifle. Some of the ammunition shows minor tarnishing, one of the boxes is sealed, another opened and the last is missing its top. (207884-59R) [Craig Brown Collection]
2117. **8MM MAUSER COLLECTIBLE AMMO LOT** This lot consists of 16 full 15 round boxes of German 8mm Mauser. All of the boxes are of the S.S. patrone variety, the boxes show varying degrees of soiling staining and worn labels. A couple of the boxes have torn bottom flaps and one is missing most of its label. The ammo is housed in a USGI 30 caliber ammo can. (207884-59S) [Craig Brown Collection]
2118. **9MM LARGO AMMO LOT** This lot consists of four full 50 round boxes of Blazer 9mm Largo/Bergmann-Bayard ammunition. The rounds are the 124 grain TMJ variety and remain in excellent condition. (208879-22A)
2119. **6.5 JAPANESE AMMO LOT** This lot consists of 59 assorted rounds of 6.5 Japanese ammunition. 19 rounds are Norma 139 grain softpoint and they show light tarnish. The other 40 rounds are military surplus on 5 round stripper clips, including three enclosed in a box with some rounds showing oxidation and tarnish. The box appears is in tender condition, it is dated 1949 and the ammunition may be of Chinese manufacture. (208879-25)
2120. **9MM STEYR AMMO LOT** This lot consists of two full 50 round boxes of PCI 9mm Steyr 115 grain brass cased FMJ ammunition in excellent condition. (208879-22C)
2121. **7.62X54 AMMO LOT** This lot consists of six boxes of various 7.62x54 ammunition in 20 round boxes. 40 rounds are brass FMJ surplus of unknown origin, 19 rounds are Seller & Belliot brass softpoint and 59 rounds are surplus steel FMJ. (208879-26)
2122. **7.5 FRENCH AMMO LOT** This lot consists of nine, 15 round boxes of surplus 7.5 French ammunition. Four boxes are French 1950's surplus and they have 3 stripper clips per box. The other five boxes are Syrian surplus and some of both varieties have opened boxes, revealing a few rounds with light tarnish. (208879-23)
2123. **9MM BERGMANN AMMO LOT** This lot consists of two full 50 round boxes of Midway 9mm Bergmann/Largo ammunition. The ammunition is brass 124 grain FMJ and the rounds exhibit light tarnish. (208879-22B)
2124. **9MM STEYR AMMO LOT** This lot consists of 75 assorted rounds of 9mm Steyr ammunition for the 1912 pistol. 50 rounds of the ammunition is Geco brass FMJ and the other 25 rounds appear to be mixed FMJ brass ammunition. Also included are three empty five rd. stripper clips rating very good plus. (208879-22)
2125. **7.62X54 AMMO LOT** This lot consists of five 20 round boxes of Czech surplus 7.62x54 steel cased FMJ with silver tips rating very good plus. (208879-26A)

2126. **7.65 ARGENTINE AMMO LOT** This lot consists of 85 assorted rounds of 7.65 Argentine. The first 20 rounds are Norma 150 grain softpoints and they exhibit some light tarnish. The other 65 rounds are Argentine FMJ surplus, including 10 full, 5 .rd stripper clips. The rounds show varying degrees of tarnish with one round showing a large area of tarnish. The surplus ammo is housed in three open 15 round boxes and one large blue Interarms box. (208879-24)
2127. **LOT OF 41 SWISS CARTRIDGES** This lot consists of seven vintage Remington UMC 41 Swiss rimfire cartridges. The cartridges are loaded with lead round nose bullets in copper cases, one round has been lightly cleaned while the remainder show some light oxidation and staining scattered about. All are marked with Remington UMC "U" stamps and three cartridges show firing pin impact marks from attempted firing. A very nice condition lot overall for the military collector. (138900-1S21489A)
2128. **COLLECTIBLE AMMUNITION LOT** This lot consists of two items. First is a two-piece box of UMC 32 S&R 88 grain lead round nose black powder cartridges. The box contains 49 rounds and has pale green labels with nearly all the original label portions remaining. The box has some minor foxing and flaking and is in very good condition. Next is a box of Peters "RUSTLESS" 32 S&W lead round nose (3262). The box is yellow with blue labels and contains 50 rounds of mixed ammunition. The box has some light fraying and foxing and a small tear on one end flap but is in very good condition overall. (46504-53)
2129. **COLLECTIBLE AMMUNITION LOT** This lot consists of three boxes of 32 S&W 88 grain lead round nose ammunition, two partial and one full. The full box of 50 is a two-piece UMC box that has blue labels. Most of the labels remain intact with the loss being around the sides of the box. The box has some minor foxing but is in otherwise near excellent condition. Next is a two-piece Peters box with about 44 rounds of mixed manufacturer. The box has green labels that have some light fraying and minor foxing, the included cartridges have minor oxidation. Lastly is a two piece box of Peters ammunition that contains 35 rounds of Peters cartridges. The box has a pale colored label that has minor flaking and light foxing. The latter two boxes are in very good condition. (47613-7C)
2130. **8MM LEBEL AMMUNITION LOT** This lot consists of an assortment of surplus 8mm Lebel FMJ ammunition. Included are 290 loose rounds and ten rounds loaded into two en-bloc stripper clips. All shows signs of tarnish and some have minor oxidation, but are in very good to near excellent overall condition. The ammunition comes in a green U.S. military ammo can. (46557-6)
2131. **8X50R AMMUNITION LOT** This lot consists of a U.S. military ammo can containing 235 rounds of surplus 8x50R assorted military ammunition. 200 or the rounds are sealed in ten round paper packs, the remaining rounds are loaded into stripper clips. There is one additional stripper clip included. All are in excellent condition and most are dated 1936. (46557-5)
2132. **LOT OF AMMUNITION** This lot consists of eight full 50 rd. boxes of PMC Bronze 9mm, 115 gr., FMJ in bright excellent condition. (78900-35S21355A1)
2133. **LOT OF AMMUNITION** This is a lot of eight full 50 rd. boxes of PMC Bronze 9mm, 115 gr., FMJ in bright excellent condition. (78900-35S21355A2)
2134. **LOT OF AMMUNITION** This lot consists of eight boxes of 9mm: (4) full 50 rd. and (1) containing 30 rds. of Blazer 124 gr. FMJ; (1) full 50 rd. of Federal 115 gr. FMJ RN; (1) full 50 rd. of PMC Bronze 115 gr., FMJ; (1) full 25 rd. of Hornady Zombie Max 115 gr., Z-Max. The overall condition of the lot is excellent. (78900-35S21355A3)
2135. **LOT OF SHOTSHELLS** This lot consists of two full 25 rd. size boxes of Remington 12 ga., 2 3/4", 8 shot, Gun Club Target Loads in excellent condition. (78900-35S21355A4)
2136. **LOT OF SHOTSHELLS** This lot consists of seven, 25 rd. size boxes of Remington 12 ga., 2 3/4", 5 shot, Duck/Pheasant Load: (6) full; (1) containing 18 rds. The condition is excellent and two of the boxes have labels affixed that read "Slightly Imperfect/Not For Resale" and consist of a few shells that have a slightly concave crimp. (77891-1A)
2137. **LOT OF SHOTSHELLS** This lot consists of eight full 25 rd. size boxes of Remington Express 12 ga., 2 3/4": (6) of 6 shot; (2) of 5 shot. Also included are 19 mixed, loose rds. of Remington Most of the shells in this rate excellent with a few showing mild tarnish to the brass. (77891-1B)
2138. **LOT OF SHOTSHELLS** This lot consists of ten full 25 rd. size boxes of Remington 12 ga. including the first nine that are 2 3/4": (2) of Express Magnum 4 shot; (2) of Mohawk Long Range 4 shot; (1) of Shur Shot 6 shot; (2) of Express Extra Long Range 4 shot; (2) of Express Extra Long Range 6 shot; (1) Remington UMC 3", 5 shot. The lot rates very good to excellent overall. (77891-1C)
2139. **LOT OF SHOTSHELLS** This lot consists of eleven full 25 rd. boxes of Peters 12 ga., 2 3/4": (5) of Victor 5 shot; (5) of Long Range Game Loads 4 shot; (1) of High Velocity 5 shot. This is an excellent condition lot. (77891-1D)
2140. **LOT OF SHOTSHELLS** This lot consists of seven full 25 rd. boxes of Remington 12 ga., 2 3/4": (6) of Duck/Pheasant Load 4 shot; (1) containing 24 rds. of Express 4 shot and one rd. of Express 6 shot. One of the Duck/Pheasant Load boxes has an affixed label that reads "Slightly Imperfect/Not For Resale" due to some shells exhibiting slightly concave crimps and a couple of the boxes show moderate tarnish to some of the shells but otherwise the lot rates excellent. (77891-1E)
2141. **LOT OF SHOTSHELLS** This lot consists of nine full 25 rd. boxes of Remington 16 ga. Duck/Pheasant Load, 2 3/4", 6 shot in excellent condition. (77891-2A)
2142. **LOT OF SHOTSHELLS** This is a lot of ten full 25 rd. boxes of Remington Express 16 ga., 2 3/4": (4) 5 shot; (4) 6 shot; (2) 4 shot. Five of the boxes in this lot are stamped "Slightly Imperfect" (four on inside flap, one on exterior) presumably due to the mild tarnish that is observed. The balance is in excellent condition. (77891-2B)
2143. **LOT OF SHOTSHELLS** This lot consists of eleven full 25 rd. boxes and one bag of 16 ga., 2 3/4": (3) of Remington Mohawk Long Range 6 shot; (2) of Remington Express Magnum 6 shot; (2) of Peters Long Range Game Loads 6 shot; (1) of Peters High Velocity 6 shot; (1) of Peters Victor 5 shot; (1) of CIL Imperial Special Long Range 4 shot; (1) of mixed Remington. The bag contains 60 rds. of mixed Remington and one rd. of Canuck. The overall condition of the lot is very good to excellent. (77891-2C)
2144. **LOT OF AMMUNITION AND ACCESSORIES** This lot consists of eight boxes of ammunition: (1) 100 rd. value pack that has been opened and is currently housing possibly slightly more than the original amount of Federal 223 Rem. 55 gr., FMJ; (1) full 20 rd. and (1) containing nine rds. of American Eagle 223 Rem. 55 gr., FMJ; (1) full 50 rd. of Russian manufactured Tul Ammo 40 S&W 180 gr., FMJ; (1) containing 19 rds. of Liberty Civil Defense 40 S&W 60 gr., 2000 fps.; (1) containing 29 rds. of Russian manufactured Tul Ammo 9mm 115 gr., FMJ.; (1) apparently full and (1) nearly full 50 rd. box of Winchester Super-X 22 short, high velocity. The ammunition is in excellent condition. Also included in this lot are two magazines beginning with a translucent smoke plastic example for an air pistol and containing about 60 rds. of 6mm airsoft bb's. The other one is an Italian manufactured Beretta PX4 Storm subcompact 40 S&W ten rd. with a blued-over steel body. There is also a Sony PL Filter Kit VF-37PK S camera lens two filter kit containing two polarizing lenses and there is an additional cased clear lens. All of the accessories rate excellent and the lot comes in a padded black camera bag by Case Logic that has a shoulder strap and several accessories pockets and would serve as an ideal shooter's bag. (78900-12S21341A)

2145. **LOT OF AMMUNITION** This lot consists of six full 50 rd. boxes of Blazer Brass 9mm, 115 gr. FMJ and 12 loose rds. of mixed 9mm. The lot is in excellent condition and contained in the original Blazer Brass factory green plastic carry case. (78900-28S21458D)
2146. **LOT OF AMMUNITION** This lot consists of 17 boxes of 22 LR: (1) Remington Golden Bullet Value Pack containing approximately 300 rds. of brass-plated HP; (1) factory sealed 325 rd. and (1) opened containing approximately 300 rds. of Federal Target Grade Performance 40 gr. solid; (3) factory sealed 100 rd. plastic cases of Remington 22 Target standard velocity; (2) factory sealed 100 rd. plastic cases of Winchester Super X 40 gr., Super Speed round nose, copper plated; (1) factory sealed 100 rd. and (1) containing 44 rds. of CCI Mini-Mag 40 gr., copper plated round nose; (2) full 50 rd. of CCI standard velocity lead round nose 40 gr.; (2) full 50 rd. and (2) containing a total of approximately 90 rds. of Remington Kleanbore standard velocity; (1) full 50 rd. of American Eagle high velocity 38 gr., copper-plated HP. Also included is a 22 LR Winchester model 77 factory magazine with strong spring and retaining about 97% original blue. The lot is in excellent condition and comes in a U.S. issued .50 cal. metal ammo can. (78900-28S21458C)
2147. **LOT OF AMMUNITION** This lot consists of (6) 50 rd. size boxes: (1) full and (1) containing 44 rds. of American Eagle 38 Special 130 gr., FMJ; (1) full of Winchester USA Target Pack 38 Special 130 gr., FMJ; (1) full of Remington UMC 38 Special 130 gr., FMJ; (1) full and (1) containing 32 rds. of American Eagle 357 Magnum 158 gr., JSP. The conditions range from very good with mild tarnish to excellent and the lot includes a large (19"x6"x10") and excellent condition U.S. issued metal can that originally held 40 mm cartridges. (78900-2821458BA)
2148. **LOT OF AMMUNITION** This lot consists of four full 50 rd. boxes of Winchester USA Target Pack 380 Auto 95 gr., FMJ in excellent condition. (78900-281458BB)
2149. **LOT OF AMMUNITION** This is a lot of five boxes of 45 Auto 230 gr., FMJ: (1) Winchester 100 rd. Made in USA Value Pack containing 90 rds.; (2) full 50 rd. of Winchester USA Target Pack; (1) full 50 rd. and (1) containing 47 rds. of Remington UMC. This is an excellent condition lot. (78900-281458BC)
2150. **LOT OF SHOTSHELLS** This lot consists of four boxes: (2) full 25 rd. of Remington Game Loads 16 ga., 2 3/4", 6 shot; (1) full five rd. of Remington Slugger 16 ga., 2 3/4", HP rifled slug; (1) containing 21 rds. of Remington Premier STS Target Load .410 bore, 2 1/2", 9 shot. Also included is one loose rd. of Winchester-Western 12 ga., 2 3/4", AA Skeet, 9 shot. The overall condition of the lot is excellent. (78900-281458BD)
2151. **LOT OF AMMUNITION** This is a lot of three boxes: (1) tattered box containing 40 rds. of S&W 38 Special + P, 158 gr., semi-wad-cutter; (1) containing 17 rds. of Speer Gold Dot 40 S&W 180 gr., GDHP; (1) containing nine rds. of Winchester Ranger 40 S&W 180 gr., Talon. Also included are five rds. of Remington 38 special, two rds. of 1988 dated Winchester 9mm HP and one rd. of Speer 40 S&W FMJ. The overall condition is very good to excellent and the ammunition is house in an excellent condition Sentry Safe model 100 measuring 14"x10"x6" with carry handle and without key. (78900-49S21540B)
2152. **LOT OF AMMUNITION** This lot consists of three full 20 rd. boxes of Winchester Super-X 308 Win., 150 gr., Silvertip in very good to excellent condition overall. (78001-13C)
2153. **LOT OF AMMUNITION** This lot consists of four 20 rd. size boxes and three stripper clips: (1) containing 16 rds. and 4 fired casings of Norma .243 Win., 100 gr., semi pointed SP; (1) containing 14 rds. and 5 fired casings of Norma .243 Win., 75 gr., HP; (1) full of Western Super X Silvertip, 30-06, 180 gr., expanding bullet; (1) full of 1942 dated Eau Claire Ordnance Plant 30-06 Ball in the original tan box stamped lot 28185. There are also three full ten rd. stripper clips and 13 loose rds. of U.S. issued and mostly 1970 dated Frankford Arsenal .223 Rem. FMJ, one rd. of 1946 dated Fabrique Nationale 7x57 Mauser FMJ, 4 rds. of Remington .410 bore, 2 1/2" slugs and one rd. of Remington 12 ga: 2 3/4", slug. Rounding out this excellent condition lot are three .223 Rem. stripper clip guides. (78001-13B,G, 17A)
2154. **LOT OF AMMUNITION** This is a lot of four 50 rd. size boxes of 41 Rem. Mag.: (1) full and (1) containing 38 rds. and 12 fired casings of Remington high velocity, 210 gr., SP; (1) full of Winchester Super-X, 175 gr., HP; (1) full of PMC, 210 gr., JHP. The ammunition rates very good to excellent. (78001-18)
2155. **LOT OF AMMUNITION** This lot consists of four boxes: (1) full 20 rd. of Remington High Velocity 44 Rem. Mag., 240 gr., semi-jacketed HP; (1) containing 18 rds. and two fired casings of Remington High Velocity 44 Rem. Mag., 240 gr., SP; (1) containing 19 rds. and one fired casing of Federal Hi-Power, 44 Rem. Mag., 240 gr., hollow SP; (1) containing 47 rds. of Fiocchi 763 Mauser, 88 gr., FMJ. Also included are nine loose rds. of 40 S&W. The ammunition rates near excellent. (78001-7A, 13D, 13IA)
2156. **LOT OF AMMUNITION** This lot consists of two 50 rd. size boxes of 44 Magnum: (1) full of Norma 240 gr., SP flat lead nose; (1) containing 36 rds. and 14 fired casings of Western Super X, 240 gr., Lubaloy. The condition rating is very good to excellent. (78001-13IB)
2157. **LOT OF AMMUNITION** This is a lot of three boxes of 357 magnum: (2) full 50 rds. of Winchester Super-X, 145 gr., Silvertip HP; (1) containing 39 rds. of Western Super-X, 158 gr., metal piercing. This is an excellent condition lot. (78001-19)
2158. **LOT OF AMMUNITION** This lot consists of four, 50 rd. size boxes of 45 auto: (1) full of Western Super Match, 185 gr., FMJ; (1) containing approximately 42 rds. of Western Super Match, 210 gr., lead; (2) full of U.S. issued 1966 dated Western from the Olin Mathieson plant in East Alton IL. The lot rates excellent. (78001-13H)
2159. **LOT OF AMMUNITION** This is a lot of five, 50 rd. size boxes: (1) full of Federal 25 auto, 50 gr., FMJ; (1) containing about 48 rds. of Western-X 25 auto, 50 gr., FMJHP; (1) full of Remington 32 auto, 71 gr., FMJ; (1) full of Norma 32 auto, 77 gr., FMJ; (1) full of U.S. issued military surplus 1957 dated 38 special ball, by Federal. Also included are nine mixed rds. of commercial 38 special and one rd. of Remington 25 auto FMJ. The lot rates excellent overall. (78001-13E, F, K)
2160. **LOT OF AMMUNITION** This is a lot of four full 50 rd. boxes of collectible .22 LR: (1) Remington box 1522 with red backdrop to green stripe that reads "Hi-Speed Kleanbore"; (1) Remington R21 that includes "Kleanbore" in red with "Hi-Speed" below it; (1) Remington R19 that includes "New and Improved"; (1) Winchester LD22LR that exhibits "Leader" over the trademark "W". The lot rates excellent with crisp edges, bold graphics and clean, bright cartridges. (78001-13AA)
2161. **LOT OF AMMUNITION** This is a lot of five full 50 rd. boxes of collectible .22 LR: (1) Remington R21 that includes "Kleanbore" in red with "Hi-Speed" below it; (1) Remington R19 that includes "New and Improved"; (1) Winchester LD22LR that exhibits "Leader" over the trademark "W"; (1) Western K1222R featuring the target image at the upper right of the main panel; (1) Western SX22L that includes a large "Super-X" above "long range". The lot rates excellent with crisp edges, bold graphics and clean, bright cartridges. (78001-13AB)
2162. **LOT OF AMMUNITION** This lot consists of four full 50 rd. boxes of collectible .22 LR: (1) Remington R21 that includes "Kleanbore" in red with "Hi-Speed" below it; (1) Remington R19 that includes "New and Improved"; (1) Winchester LD22LR that exhibits "Leader" over the trademark "W"; (1) Western SX22L that includes a large "Super-X" above "long range". The lot rates excellent with the Winchester box showing a crease that is folding back and the R21 box showing light isolated edge wear but otherwise the boxes are crisp with bold graphics and all of the ammunition is clean and bright. (78001-13AC)

2163. **LOT OF AMMUNITION** This is a lot of five full 50 rd. boxes of collectible .22 LR: (1) Remington R21 that includes "Kleanbore" in red with "Hi-Speed" below it; (1) Remington R19 that includes "New and Improved"; (2) Winchester LD22LR that exhibit "Leader" over the trademark "W"; (1) Western K1222R featuring the target image at the upper right of the main panel. The lot rates excellent with crisp edges overall, bold graphics and clean, bright cartridges. (78001-13AD)
2164. **LOT OF AMMUNITION** This lot consists of five full 70 rd. boxes of 7.62 x 25mm Tokarev FMJ. The buff boxes bear white labels with blue print that includes "104 70 KOM/METAKA TT-762mm". Four of the boxes remain factory sealed and one was opened at the time of this inspection to reveal excellent condition cartridges with 1955 dated headstamps. The boxes come in a U.S. issued metal military ammunition can that originally held .30 cal. linked blanks. (78001-16A, 20A)
2165. **LOT OF AMMUNITION** This lot consists of five 70 rd. size boxes of 7.62 x 25mm Tokarev FMJ with 1955 dated headstamps and in excellent condition: (3) factory sealed; (1) full and opened at the time of this inspection; (1) containing 43 rds. The buff boxes have white labels with blue print that includes "104 70 Kom./Metaka TT-762mm". (78001-16B)
2166. **LOT OF AMMUNITION** This lot consists of one box of and some loose 8mm Nambu: the box containing approximately (42) rds. of B. & E. Cartridge FMJ; (29) loose rds. of FMJ with unmarked headstamps and gilding metal jackets; (12) loose rds. of FMJ with cupronickel steel tips; (10) rds. of Midway lead bullet. The overall condition is very good to excellent. (78001-9A)
2167. **COLLECTIBLE SHOTSHELL AMMUNITION LOT** This lot consists of one bag containing one Remington Shurshot 2 1/4" 12 gauge shotshell, one partial box of 18 Federal Hi-Power 16 gauge 1 1/8 ounce #4 shotshells with the shells looking a bit swollen and compressed and the box being in good condition, one partial box of 18 Sears and Roebuck Xtra-Range Sportload 20 gauge shotshells also with shells in swollen/compressed condition and box in good condition and one JC Higgins Sportload box with 8 Sears, Roebuck and Co. 2 1/4" Sportload 20 gauge #6 shot shotshells, three Winchester Super Skeet 2 1/4" "Red Dot" shotshells, six Winchester Super X 2 1/4" "Short Shot String" 20 gauge shotshells, three Nitro Long Range Express 2 1/4" 20 gauge shotshells and five Western Super X long range load shotshells. (1X8825-167B)
2168. **AMMUNITION LOT** This lot consists of three full boxes of Prvi Partizan (PPU) 25-06 90 grain HP. Each box contains 20 rounds and all are in excellent condition. (1X47696-1A)
2169. **AMMUNITION LOT** This lot consists of three full boxes of Winchester 25-06 120 grain Positive Expanding point (X25062). Each box contains 30 rounds and all are in excellent condition. (1X47696-1B)
2170. **AMMUNITION LOT** This lot consists of three full boxes of 25-60 ammunition. Included are one box of Federal 117 grain Hi-Shok Soft Point (2506B) and two boxes of Remington 100 grain Core-Lokt Pointed Soft Point (R25062). Each box contains 20 rounds and all are in excellent condition. (1X47696-1C)
2171. **AMMUNITION LOT** This lot consists of six boxes of PMP 243 Win 100 grain Soft Point ammunition. Each box contains 20 rounds and all are in excellent condition. (1X47696-4A)
2172. **LOT OF SHOTSHELLS** This lot consists of eight full five rd. boxes including the first seven of 12 ga.: (1) of Hornady Heavy Mag H2K, 2 3/4", 300 gr. XTP Mag; (1) of Federal 3", Magnum Buckshot, 00 buckshot; (1) of Federal 3" Magnum Hi-Shok slug; (1) of Winchester Supreme 2 3/4" copper plated lead shot, 00 buck, 12 pellets; (1) of Rottweil Brenneke 2 3/4", rifled slug, magnum load; (2) of Rottweil Brenneke, 3" magnum, rifled slug; (1) of Federal Classic .410 bore, 2 1/2", rifled slug, 88 gr. HP. The overall condition is near excellent and the shotgun shells come in a metal military ammunition can. (1X76654-19Q)
2173. **LOT OF AMMUNITION** This is a full 20 rd. box of Hornady Lever Revolution 444 Marlin 265 gr. FTX in excellent condition. (1X76654-19M)
2174. **LOT OF 10MM AMMUNITION** This lot consists of (2) boxes of reloaded 10mm ammunition totaling approximately 99 rounds. The ammunition is remanufactured by Williams Reloads of Marlborough, Connecticut. One box of ammunition is 185 JHP and the second box is 185 plated JHP, all in excellent condition. (1X88641-6G) [William "Wild Bill" Ziegler Collection]
2175. **MIXED LOT OF RIMFIRE AND SHOTSHELL AMMUNITION** This lot consists of (7) assorted boxes or bags of rimfire and shotshell ammunition. Included are (2) boxes (one full and one partial) of CCI 22 LR 36 gr. hollow point high speed ammunition totaling approximately 182 rounds. (1) partial box of CCI 22 Short 29 gr. high speed solid ammunition totaling 95 rounds. (1) partial box of CCI 22 Winchester Magnum Rimfire hollow point ammunition of unknown bullet weight totaling 30 rounds. (2) boxes (one full and one partial) of Winchester 12 gauge 2 3/4" 1-ounce hollow point rifled slugs totaling 9 rounds and (1) bag of nine loose rounds of Federal 12 gauge 2 3/4" 1 1/8-ounce of #7 1/2 shotshells. All rate excellent. (2X88641-6I) [William "Wild Bill" Ziegler Collection]
2176. **LOT OF 7.62X39 AMMUNITION** This lot is 15 full boxes of Yugoslavian made "7.62mm Koma M67". These rounds have corrosive berdan primers and show slight signs of oxidation and are in very good condition. (1X228825-168D)
2177. **LOT OF TOKAREV PISTOL AMMUNITION** This lot contains two 70 round boxes of 7.62x25mm Tokarev ammunition in excellent condition. This ammo contains corrosive Berdan primers (1X228825-168E)
2178. **LOT OF AMMUNITION** This is a lot of nine full 15 rd. boxes of Syrian manufactured 7.5 French. Five of the boxes remain factory sealed and the opened ones reveal slight darkening to the brass, bringing the condition rating to near excellent. (1X76557-4B)
2179. **LOT OF AMMUNITION** This lot consists of nine full 15 rd. boxes of Syrian manufactured 7.5 French in near excellent condition with some minor darkening occurring to the brass. (1X76557-4C)
2180. **COLLECTIBLE AMMUNITION LOT** This lot consists of two boxes total: one partial box of (16) 405 Winchester cartridges and one partial box of mixed cartridges including (6) Remington UMC 405 Winchester and (13) Peter's 30-06. The 405 Winchester cartridges are brass-cased with 300 grain cupro-nickel soft points and all remain in good-very good condition with some mild to moderate tarnishing. The Peter's ammo is brass-cased with 220 grain soft points and remains in very good condition showing some light tarnishing and oxidation staining. The Winchester cartridges are housed in a red and yellow Winchester box that remains in fair-good condition with one missing end flap, a separated bottom, moderate tears, scuffs and some tape repairs. The Remington UMC ammo is housed with the Peter's cartridges in the original Peter's .30 Gov't '06 blue and yellow box in fair-good condition missing both end flaps and showing some small sections torn off, moderate scuffs, tape repairs and staining. The color and text on both boxes still remains quite bold. (1X137761-2C)
2181. **LOT OF AMMUNITION** This is a lot of three 20 rd. boxes of Federal 7-30 Waters 120 gr., boat-tail SP., one of which contains only 17 rds. The ammunition is in excellent condition overall. (1X76654-19J)
2182. **LOT OF DAISY VL CASELESS AMMUNITION** This lot consists of one full and two partial boxes of Daisy Caseless VL 22 caliber ammunition. There are 25 plastic tubes, the full box rating about very good with lightly scuffed corners. An additional box has eight full tubes, its edges are mouse chewed. The third box has five partial tubes and one which appears to be full, it is scuffed and missing its end flaps on one side. (1X38735-36)

2183. **AMMUNITION LOT** This lot contains 3 boxes of ammunition, the first being a partial box of 50 gr. Remington .25 Auto pistol holding 49 total rounds with half looking bright and clean and half looking slightly tarnished and dull and the box in very good condition. The remaining 2 boxes are 40 gr. Western .22 Winchester Magnum JHPs, one is a full 50 rounds and one is partial with 16 rounds. All rounds are in very good condition with one very good condition box and one missing an end flap. (1X228825-167H)
2184. **LOT OF COLLECTIBLE AMMUNITION** This lot contains two boxes. First is an empty two-piece natural colored box with green and orange affixed labels that read: "Winchester .32 Caliber Cartridges". The box is in near very good condition with some light scuffing and a small tear along the top edge and two seam separations at the corners. Second is a two-piece box of Peters .32 S&W cartridges containing 41 mixed manufacture cartridges ranging in condition from good to very good, showing varying levels of discoloration and oxidation. The natural color box rates poor having been crudely tape repaired with several small tears, missing sections and split seams. (1X108825-167L)
2185. **COLLECTIBLE REMINGTON AMMUNITION** This lot contains two items. First is a full 50 round box of .32 Automatic that is of mixed manufacture. The cartridges range in condition from good to very good with varying levels of oxidation. The two-piece plaid pattern box rates about very good with scattered scuffing, light ingrained dirt staining, and the labels are mostly complete. Second is a two-piece black box with red label of .38 Colt Police Positive. The cartridges are of mixed manufacture and they range in condition from good to very good with varying levels of discoloration and oxidation. The box has scuffing along its edges and flats, with separated seam along the top half corner. The red labels are mostly complete with one missing a 2" section on the top half and it has started to separate from the box. (1X108825-167M)
2186. **VINTAGE 405 WINCHESTER AMMUNITION** This lot consists of two boxes total: one full 20-round box and one empty box. The cartridges are brass-cased with 300 grain cupro-nickel soft points remaining in very good plus condition, showing some light tarnishing and oxidation staining throughout. The buff box with orange Winchester label rates about good showing some tears and blow-outs on the bottom surface, light staining, scuffs and a few torn labels. Most of the labels are still intact and entirely visible. The empty buff box with orange labels appears to have a mismatched lid but remains in about very good condition showing some old tape residue, minor scuffs, a few small tears and light staining. The labels on the lid and body are still mostly clear. (1X137761-2A)
2187. **LOT OF COLLECTIBLE AMMUNITION** This lot consists of some partial and full boxes of ammunition as well as some loose cartridges. One box Winchester Lubaloy Marksman 22 long rifle, appears full, box is about very good with some fading and ingrained soiling on the top, the cartridges within have copper cases with diamond headstamps. One box Winchester 22 Short Spotlight, box is full and rates good to very good with some light ingrained soiling, Winchester's number "K2261R". Two partial boxes CIL 22 short, overall very good. Partial two-piece box of Union Metallic Cartridge Company 38 S&W, blackpowder loaded. Good overall. Western Lubaloy 32-20 Win, partial box with loaded rounds and fired brass, box is not full, the box rates poor. 15 rounds of 45-70 Govt. 2 are Benet primed, 7 are government, lead round nose with no headstamp (likely Frankford Arsenal), 6 rounds commercial JSPs. 3 rounds of 45 Colt with early scant rim and lead flat nose projectiles. Some of the 45-70 Govt. ammunition shows light oxidation and verdigris. (1X37040-3)
2188. **30-40 KRAG COLLECTIBLE AMMUNITION LOT** This lot consists of a full 20 round box of 30-40 Krag ammunition made by Frankford Arsenal. The box was opened at some point, the lid has added cellophane tape and scattered dirt staining. The label shows a few tears with some added tape, a missing piece on the left side and light dirt staining. The front of the box is marked "20 CALIBER 30/BALL CARTRIDGES/For U.S. Magazine Rifle./MODEL 1898.". The rounds are dated 1908 and some show light to moderate tarnishing. A neat lot for the military or cartridge collector. (208878-1)
2189. **30 CARBINE LOT** This lot consists of approximately 60 rounds of surplus 30 Carbine on stripper clips, two bandoliers and a single 30 round magazine. The ammunition appears to be mainly 1972 Lake City FMJ, some of the rounds show tarnish and oxidation. The bandoliers show light wear and five cardboard inserts are also present in one of the bandoliers. The 30 round magazine rates very good plus and has a "J" marking indicating manufacture by B. Jahn. (208864-61A)
2190. **45 COLT LOT** Consists of fifty (50) 45 Colt cartridges in a red plastic ammo tray. All are brass-cased with lead bullets likely in the typical 225-250 grain range. All of the cartridges remain in very good plus condition showing some light tarnishing throughout and most have Remington-UMC headstamps, a few have later Remington R-P headstamps and one is a Western cartridge. (138903-62A)
2191. **HORNADY AMMUNITION** This lot includes two full 20 round boxes of Hornady Custom 300 RCM, 165 gr., SST (Super Shock Tip) cartridges. The brass remains bright and the bullets have red tips with the boxes remaining in excellent condition. (108912-2)
2192. **HORNADY AMMUNITION** This lot includes two full 20 round boxes of Hornady Custom 338 RCM, 225 gr., SST (Super Shock Tip) cartridges. The brass remains bright and the bullets have red tips with the boxes remaining in excellent condition. (108912-3)
2193. **NOSLER CUSTOM AMMUNITION** This lot includes two full 20 round boxes of Trophy Grade 6.25x284 Norma. The first box contains 130 gr., AccuBond cartridges with bright brass and white tipped bullets. The second box contains 120 gr., Ballistic tip cartridges with overall bright brass and brown tipped bullets. The cartridges in this lot are in excellent condition. (108912-4)
2194. **HORNADY AMMUNITION** This lot contains three full and/or partial boxes of Superformance Varmint 17 Hornet, 20 gr., V-Max cartridges. There are two full 25 round boxes with overall bright brass and red tipped bullets and a partial containing 18 cartridges and six fired casings, all in excellent condition. (108912-1)

Magazines

2195. **GERMAN MAGAZINE LOT** This lot consists of two items. The first is a 25 round MG13 magazine dated 1938 and made by BSW. It shows scattered silvering and a few minor oxidation spots. The second is stamped "BYF" on the floorplate and triggerguard that has been modified to accept an MG13 magazine. The triggerguard is a silver pewter with a few spots of light pitting and some oxidation staining. There is a 1938 dated BSW body present but no spring or follower and the magazine body retains much of its blue with a spot of minor pitting and some silvering. (207884-12A) [Craig Brown Collection]
2196. **GERMAN MAGAZINE LOT** This lot consists of two items. The first is an original German Gew 98 Trench magazine marked "N/B" on the rear. The magazine retains about 70% of its black enamel finish with the floorplate being gray with scattered flaking and oxidation. The second item is a G/K43 magazine body coded "gcb", retaining less than 50% finish and the floorplate is a Danish made replacement. There is no follower or magazine spring present. (207884-59N) [Craig Brown Collection]
2197. **G43 MAGAZINE LOT** This lot consists of a Danish made 10 round magazine for the G/43 family of rifles. It has a black enamel finish that shows scattered flaking. (208882-2A)

2198. **COLT 38 SPECIAL MID-RANGE WADCUTTER MAGAZINE LOT** This lot consists of a single magazine for a Colt Government Model Mid-Range Match 38 Special semi-auto pistol. The magazine is in excellent condition with light handling marks and the base is marked "COLT .38 SPEC.". (88903-44A)
2199. **COLT 38 SPECIAL MID-RANGE WADCUTTER MAGAZINE LOT** This lot consists of a single magazine for a Colt Government Model Mid-Range Match 38 Special semi-auto pistol. The magazine is in excellent condition with light handling marks and the base is marked "COLT .38 SPEC.". (88903-44B)
2200. **COLT 38 SPECIAL MID-RANGE WADCUTTER MAGAZINE LOT** This lot consists of a single magazine for a Colt Government Model Mid-Range Match 38 Special semi-auto pistol. The magazine is in excellent condition with light handling marks and the base is marked "COLT .38 SPEC.". (88903-44C)
2201. **GERMAN P.640 (B) MAGAZINE LOT** This lot consists of one original split base magazine with appropriate "(Eagle) / WaA140" stamp at the bottom of the spine along with a small "B" stamp. The magazine shows some light operational wear and retains about 90% original blue with minor thinning, freckling, scratches and minor oxidation staining on the base. The follower is mostly bright and the spring is still strong. Overall a very nice magazine to accompany your Nazi-issued Hi-Power pistol. (138877-10A)
2202. **RUGER MAGAZINE LOT** This lot consists of five extended magazines for the Ruger 10/22 Carbine. Included are four Champion, clear 25 round magazines with metal heads, three of which are sealed in their original packaging. The fifth is a smoke colored magazine by Ram-Line, also in a 25 round capacity. (47524-11)
2203. **RUGER MAGAZINE LOT** This lot consists of a factory rotary magazine for the Ruger 99/44 semi-auto rifle. The magazine is still in the original factory packaging. Also included is a set of Ruger 1" scope rings (S100RH). These high rings will fit the No.1, 77/22, Mini-14/30, Carbine and Redhawk and other models. The original packaging is included but the rings are not sealed. (47524-11A)
2204. **PROMAG AR MAGAZINE LOT** This lot consists of six black polymer 42 round ProMag magazines for the Ar-15 and similar in 5.56/223. All are in excellent condition. (47524-12A)
2205. **AR MAGAZINE LOT** This lot consists of five Tapco 5.56 AR 30 round magazines and two Thermold AR 30 round magazines. All are black polymer and are in excellent condition. (47524-12B)
2206. **COLT AR MAGAZINE LOT** This lot consists of three metal magazines for AR 15 5.56/223 rifles and pistols. Included are: one Colt 30 round magazine, one Colt ten round magazine and one NHMTG 30 round magazine. All are in excellent condition. (47524-12C)
2207. **MAGAZINE LOT** This lot consists of five assorted pistol magazines. Included are: two Triple K 1911 magazines in their original packaging, one extended 22 round Glock 40 caliber magazine, and two Mossberg 702 Plinkster magazines, including one in its original packaging. All are in excellent condition. (47524-14)
2208. **LOT OF M1A/M14 MAGAZINES** This lot consists of six assorted magazines for the M1a and M14 series rifles. Included are: four unmarked Tapco steel 30 round magazines, one Springfield Armory 20 round magazine, and one Springfield Armory ten round magazine. All are in excellent to as-new condition. (47524-13)
2209. **LOT OF LAHTI MAGAZINES** This lot consists of three surplus magazines for the Swedish M40 and Finish M35 Lahti pistols. The unmarked magazines are blued-over and in near excellent condition. Included is a factory loading tool. (48579-1A)
2210. **LOT OF LAHTI MAGAZINES** This lot consists of two surplus magazines for the Swedish M40 and Finish M35 Lahti pistols. The magazines are blued-over and in near excellent condition. One is unmarked, the other is stamped with the Swedish crown along the spine and has the notched body for removing the floorplate. Also included is a factory loading tool. (48579-1B)
2211. **LOT OF LUGER MAGAZINES** This lot consists two unmarked magazines for the Luger P08 and similar pistols. The magazines each have a black polymer base and are likely newer reproductions that are in excellent condition. An unmarked combination tool is included. (48579-2)
2212. **LOT OF ERMA MAGAZINES** This lot consists of three unmarked steel magazines for the Erma EP-ET-LA series pistols. Two have black polymer bases, the third has an aluminum base. All three are in near excellent condition. (48579-3)
2213. **ERMA MAGAZINE LOT** This lot consists of a single Erma 22 caliber magazine for the KGP-69 and Beeman series pistols. The magazine has a bronzed appearance and a black polymer base and is marked along the base of the spine. An excellent example overall. (48579-4)
2214. **LOT OF UZI MAGAZINES** This lot consists of five, 25 round factory Uzi magazines. The magazines are in as-new condition and are in their original packaging. (48579-5A)
2215. **LOT OF UZI MAGAZINES** This lot consists of four, 32 round factory Uzi Magazines. The magazines are in as-new condition and are in their original packaging. Also included is a factory loading tool, also in its original box. (48579-5B)
2216. **AUTO-ORDNANCE DRUM LOT** This lot consists of a 40 round drum magazine by Auto-Ordnance for the Thompson 45 ACP "tommy gun" carbines. The magazine is in as-new condition and is in its original box. (48579-6)
2217. **COLT MAGAZINE LOT** This lot consists of two Colt factory 32 round AR-15/SMG 9mm magazines. The parkerized steel magazines are in excellent condition. (48579-7A)
2218. **COLT MAGAZINE LOT** This lot consists of two Colt factory 32 round AR-15/SMG 9mm magazines. The parkerized steel magazines are in excellent condition. (48579-7B)
2219. **COLT MAGAZINE LOT** This lot consists of two Colt factory 32 round AR-15/SMG 9mm magazines. The parkerized steel magazines are in excellent condition. (48579-7C)
2220. **COLT MAGAZINE LOT** This lot consists of two Colt factory 32 round AR-15/SMG 9mm magazines. The parkerized steel magazines are in excellent condition. (48579-7D)
2221. **COLT MAGAZINE LOT** This lot consists of two Colt factory 32 round AR-15/SMG 9mm magazines. The parkerized steel magazines are in excellent condition. (48579-7E)
2222. **COLT MAGAZINE LOT** This lot consists of two Colt factory 32 round AR-15/SMG 9mm magazines. The parkerized steel magazines are in excellent condition. (48579-7F)
2223. **COLT MAGAZINE LOT** This lot consists of two Colt factory 32 round AR-15/SMG 9mm magazines. The parkerized steel magazines are in excellent condition. (48579-7G)
2224. **AK MAGAZINE LOT** This lot consists of a Russian made 90 round drum magazine for the AK style rifles. The magazine is marked with a (star) inside a circle and numbered "H8081" and is in excellent overall condition. (48579-8A)

2225. **AK MAGAZINE LOT** This lot consists of a Russian made 90 round drum magazine for the AK style rifles. The magazine is marked with a (star) inside a circle and numbered "L1262" and is in excellent overall condition. (48579-8B)
2226. **AK MAGAZINE LOT** This lot consists of a Russian made 90 round drum magazine for the AK style rifles. The magazine is marked with a (star) inside a circle and is comprised of non-matching numbered parts. It has some light wear and minor oxidation and is in very good overall condition. (48579-8C)
2227. **AK MAGAZINE LOT** This lot consists of four steel 30 round magazines for AK style rifles. The blued-over magazines are in excellent condition, three are unmarked, one is in a Mitchell Arms package. (48579-8D)
2228. **AK MAGAZINE LOT** This lot consists of two steel 20 round AK style magazines. The magazines are blued-over and unmarked with some light wear but remain in excellent condition. Also included are three stripper clips and a loading tool. (48579-8E)
2229. **AK MAGAZINE LOT** This lot consists of four East German ribbed back AK magazines. The magazines are unmarked and are in excellent condition. They are housed in an East German canvas military magazine pouch. (48579-9A)
2230. **AK MAGAZINE LOT** This lot consists of four East German ribbed back AK magazines. The magazines are unmarked and are in excellent condition. They are housed in an East German canvas military magazine pouch. (48579-9B)
2231. **AK MAGAZINE LOT** This lot consists of four East German ribbed back AK magazines. The magazines are unmarked and are in excellent condition. They are housed in an East German canvas military magazine pouch. (48579-9C)
2232. **FAL MAGAZINE LOT** This lot consists of six surplus 20 round metric magazines for the FAL, L1A1 and similar 308/7.62 rifles. The magazines have varying amounts of finish and range from very good to excellent condition. (48579-10)
2233. **AK-47 M90 MAGAZINE LOT** This lot consists of five Mitchell Arms 20 round 308/7.62mm magazines for the Yugo AK-47 M90 series rifles. The magazines are in as-new condition and are in their original packaging. (48579-11)
2234. **MINI-30 MAGAZINE LOT** This lot consists of three aftermarket magazines for the Ruger Mini-30 rifles. Two are unmarked steel "AK" style 30 magazines, the third is an Eagle polymer 15 round magazine #3015. All are in excellent condition. (48579-12A)
2235. **RUGER MAGAZINE LOT** This lot consists of two Ruger Mini-14 five round magazines. Both are factory magazines and are in excellent condition. (48579-12B)
2236. **MARLIN MAGAZINE LOT** This lot consists of four magazines for the Marlin Camp 9 carbine. Included are one 20 round magazine and three 12 round magazines. The blued-over magazines all have Marlin marked bases and are in excellent condition. (48579-13A)
2237. **S&W MAGAZINE LOT** This lot consists of two Smith & Wesson blued-over steel 14 round magazines for the Model 59 series and similar pistols. The magazines are in excellent condition. These magazines can also be used in the Marlin Camp 9 carbines. (48579-13B)
2238. **H&K MAGAZINE LOT** This lot consists of five 20 round magazines for the H&K 91 and similar 308/7.62 rifles. The steel magazines are unmarked and all are in excellent condition. (48579-14A)
2239. **H&K MAGAZINE LOT** This lot consists of five 20 round magazines for the H&K 91 and similar 308/7.62 rifles. The steel magazines are unmarked and all are in excellent condition. (48579-14B)
2240. **H&K MAGAZINE LOT** This lot consists of five 20 round magazines for the H&K 91 and similar 308/7.62 rifles. The steel magazines are unmarked and all are in excellent condition. (48579-14C)
2241. **RUGER MAGAZINE LOT** This lot consists of a single Ruger factory ten round magazine for the P series 9mm pistols. The magazine will fit the later P89 through the P95 series pistols and will also fit the PC9 Carbine. An excellent condition example overall. (48627-3B)
2242. **SAVAGE MAGAZINE LOT** This lot consists of a factory magazine for the Savage Model 99C rifle. The magazine is marked for 243 Win, 308 Win and 250-300 calibers. There is a protective label on the bottom and the magazine is in excellent condition. (46758-52I)
2243. **SAVAGE MAGAZINE LOT** This lot consists of a new-in-package factory magazine for the Model 25 rifle. The magazine for 222 Rem, 223 Rem, 204 Ruger and 5.45x39. (46758-52J)
2244. **CZ MAGAZINE LOT** This lot consists of a factory CZ model 527 detachable magazine for 22 Hornet. The magazine is in excellent condition. (46758-52K)
2245. **AR-15 MAGAZINE LOT** This lot consists of four 30 round magazines for the AR-15 and similar rifles. Included are three Colt magazines, the fourth is by Adventure Line MFG.. All four have been used but are still in very good, useable condition. (48903-3A)
2246. **CZ MAGAZINE LOT** This lot consists of five CZ Scorpion EVO 9mm magazines. All are factory 30 round magazines in excellent to as-new condition. (48913-8A)
2247. **COLT MAGAZINE LOT** This lot consists of three Colt factory 20 round magazines for the AR-15 and similar rifles. The magazines are all in excellent condition and have Colt marked floorplates. (48903-12A)
2248. **COLT MAGAZINE LOT** This lot consists of three Colt factory 20 round magazines for the AR-15 and similar rifles. The magazines are in very good to excellent condition with varying amounts of finish remaining. All three have Colt marked floorplates. (48903-12B)
2249. **AR-15 MAGAZINE LOT** This lot consists of three magazines for the AR-15 and similar rifles. Included are one, 30 round by Circle K, and two, 20 round magazines by Universal and Adventure Lines. All are in very good condition. (48903-6A)
2250. **AR-15 LOT** This lot consists of three items. The first two are Colt 20 round magazines for the AR-15 and similar rifles. The magazines retain little, if any of their original finish but are still functional and retain the Colt floorplates. The third item is a USMC technical manual for the M16A2 5.56 rifle dated 1984. (48873-650A)
2251. **MAGAZINE LOT** This is a rare and tiny Erika 4.25mm caliber magazine measuring only 1 3/4" in length and in excellent condition with fully functioning spring and retaining about 98% original blue. (78001-8)
2252. **SMITH & WESSON MAGAZINES** This lot includes two single stack seven round factory magazines for the M&P 40 Shield. The magazines are bright body with extended bases and one is used the other remains in its original sealed factory packaging, both remain in excellent condition. (108900-45S21538A)
2253. **CALICO MAGAZINE** This lot includes a 50 round 9mm rotary magazine for the M900 semi-auto carbine. The magazine has a couple of light handling marks and remains in excellent condition. (108903-11A)

2254. **CALICO MAGAZINE** This lot includes a 50 round 9mm rotary magazine for the M900 / 950 carbine in its original factory box. The magazine appears to have seen little if any use and remains in excellent condition. (108903-11B)
2255. **CALICO MAGAZINE** This Lot includes a 100 round 9mm rotary magazine for the M900 / 950 carbine in its original factory box. The magazine has a few scattered light handling marks and remains in near excellent condition. (108903-11C)
2256. **AR-10 MAGAZINES** This lot includes three PMAG 25, Gen M3, LR/SR, polymer 25 round magazines. These items are in factory sealed packages and remain in near-new condition. (108717-116C) [John W. Young Collection]
2257. **HECKLER & KOCH MAGAZINE LOT** Six total: (4) 20 round alloy magazines for the H&K G3 and similar 308 Win caliber rifles. One is marked "G3 HK/5/76", the others are unmarked; (2) 20 round steel magazines for the H&K 91 and similar 308 Win caliber rifles. One is marked "7.62x51/1A", the other is marked "7.62x51/1B". Both are in excellent condition. (2X46850-9L)
2258. **MAGAZINE LOT** Eight total: (4) HK aluminum 20 round magazines for the HK 91 and similar rifles. All are in excellent condition and are dated "4/67"; (4) unmarked steel bodied 20 round magazines for the HK G3 or Spanish Cetme rifle. They are two G3 style magazines with parkerized finish and two Cetme style with parkerized finish, all in very good to excellent condition. (2X106247-49B)
2259. **PRECISION MAG INDUSTRIES LOT** This lot includes four items. First are three 30 round steel body blued-over magazines for the Mini-14 rifle, two are still sealed in their factory blister packs and the third shows some light wear consistent with use. Second is a steel body 40 round blued-over magazine for the Mini-14 rifle, sealed in its original factory packaging. (1X108821-145C)
2260. **SIG P228 MAGAZINE LOT** This lot consists of four 13 round Sig Sauer P228 magazines in their original packaging; (2) are Pro Mag "High Capacity", (1) is a USA marked magazine and (1) is a Mec-Gar. The entire lot is in excellent condition. (1X228821-145M) [Stuart Floam Collection]
2261. **LOT OF HK MAGAZINES** This lot includes two 30 round polymer UMP 40 magazines. These are factory magazines dated 10-94 that are in as new condition. (2X108543-25C)
2262. **WALTHER MAGAZINE LOT** This lot consists of one stainless 6 round Walther PPK 380 ACP / 9mm Kurz magazine. This magazine has an extended black plastic finger-rest floorplate and is marked with the Walther banner and is in excellent condition. (228821-145V) [Stuart Floam Collection]
2263. **LOT OF TEC 9 MAGAZINES** This lot includes two steel bodied blue finished unmarked double stack magazines for the Intratec Tec 9 semi-auto pistol with 30 and 32 round capacities and in overall excellent condition. (108543-29)
2264. **LOT OF TEC 9 MAGAZINES** This lot includes two steel bodied blue finished unmarked double stack magazines for the Intratec Tec 9 semi-auto pistol with 30 and 32 round capacities and in overall excellent condition. (1X108543-29)
2265. **SAVAGE MODEL 340 MAGAZINE LOT** This lot consists of one, 4 round capacity, Cal .222 Rem magazine. This magazine is in excellent condition with strong remaining blue finish and only minor operational wear. (1X218803-24A)
2266. **SAVAGE MODEL 340 MAGAZINE LOT** This lot consists of one, 4 round capacity, Cal .222 Rem magazine. This magazine is in excellent condition with strong remaining blue finish and only minor operational wear. (1X218803-24B)
2267. **SAVAGE MODEL 340 MAGAZINE LOT** This lot consists of one, 4 round capacity, Cal .222 Rem magazine. This magazine is in excellent condition with strong remaining blue finish and only minor operational wear. (1X218803-24C)

Optics

2268. **WEAVER K4 SCOPE LOT** This lot consists of a Weaver K4 scope and a set of 1" Weaver rings. The scope tube retains 99% original blue, it has a fine crosshair reticle and the optics have a slight green tint. (208865-21A)
2269. **BURRIS SCOPE LOT** This lot consists of a single Burris 4-12X 32mm "Mini" variable rifle scope with parallax adjustment, 99% black gloss finish and duplex reticle. The scope has clear optics and light scratches and scuffs on the tube from rings. A nice small compact scope to keep your favorite sporter light and trim. (88821-116A)
2270. **BRITISH ARTILLERY SCOPE** The scope measures 11 1/4" overall with a 1" tube and is equipped with a brass covered objective. The steel retains about 90% thinning original blue toning to brown with a few scattered nicks, sparse very fine oxidation staining and a tiny ding along the edge of the ocular bell. The scope is marked "TEL. STG. No. 42 MK 1 / H.H.S. O.S. 817. G.A. / REGd No. 5260" and is equipped with a fine crosshair reticle, the optics are mainly clear with a couple tiny nicks, scratches and specks of dirt. An original three placement leather scope cover is included. (57118-15)
2271. **VINTAGE KAHLES SCOPE** This older Kahles Helia Super 2S2 Nr.64121 scope measures 9 3/8" overall with a 1" tube, integral claw mounts and is equipped with a German #1 post and crosshair reticle and clear optics. The steel body retains about 95% original blue with scattered light nicks, scratches and fine oxidation with a few larger spots on the front mount. Included is a set of bases with oxidation matching that of the scope and a period two-piece leather carry case with red felt interior. The leather shows some light scuffs and stains, there is active oxidation on the carry strap hardware and the lining is pulling away from the leather. (57118-14)
2272. **SPRINGFIELD SCOPE** This lot consists of a Springfield 6X40 Government Model 7.62mm Rifle scope. The scope features a range-finding reticle and has excellent optics. It is mounted to an Springfield M-1 series mount for the M1A and M14 rifles. The original case for the mount is included. An excellent example overall. (47524-6A)
2273. **AR SCOPE** This lot consists of a NcStar 4X22 scope to fit the carry handle of an AR platform rifle. The scope features a mil-dot style tactical reticle and has very good optics. Lens covers are included. (47524-6C)
2274. **LEUPOLD SCOPE** This lot consists of a Leupold M8 4X riflescope. This gloss finish scope features a duplex reticle and has excellent optics. Included is a Paul Jaeger side mount set of rings and a set of Bulter Creek flip-up lens covers. An excellent example overall. (48821-147A)
2275. **BURRIS SCOPE** This lot consists of a Burris Fullfield 6-18X40 adjustable objective riflescope. This matte finish scope features a fine target dot reticle and has excellent optics. A set of Millett tip-off rings to fit grooved receiver mounts and a set of factory lens covers are included. The scope has a few light handling marks but remains in overall excellent condition. (48821-147B)
2276. **WEAVER SCOPE** This lot consists of a Weaver CV16 silver 4-16X42 adjustable objective riflescope. The scope features a fine target dot reticle and has bright excellent optics. A set of nickel finish Millett tip-off rings to fit a grooved receiver are included. An excellent example overall. (48821-147C)

2277. **LEUPOLD SCOPE** This lot consists of a Leupold Vari-XII 1-4X shotgun scope. This matte finished scope features a heavy duplex reticle and has excellent optics. There are a few light ring marks visible from mounting but scope remains in excellent condition. (48821-147D)
2278. **WEAVER SCOPE** This lot consists of a Weaver CV16 4-16X42 adjustable objective riflescope. This matte finish scope features a fine target dot reticle and has excellent optics. The elevation knob is missing its cover and there are a few light ring marks from mounting but the scope is in otherwise excellent condition. A set of factory lens covers are included. (48821-147E)
2279. **BUSHNELL SCOPE** This lot consists of a Bushnell ScopeChief VI 2.5-8X32 riflescope. The scope features a duplex reticle with excellent optics. The scope includes a set of Weaver rings and is in near excellent overall condition. (48821-147F)
2280. **UNERTL SCOPE** This lot consists of a J.Unertl 12X adjustable objective riflescope. The scope features a crosshair reticle and has excellent optics. Designed to be used with target blocks, the ring mounts are included. A set of threaded lens covers are also included. This vintage scope is in excellent overall condition. (48821-147G)
2281. **LYMAN SCOPE** This lot consists of a Lyman 10X All-American riflescope with adjustable objective. The scope features a crosshair reticle and has excellent optics. The scope has light ring marks and other handling marks from mounting and use, and has what appears to be a treaded extension to the body just ahead of the eye lens. A very good example overall. (48821-147H)
2282. **SCOPE LOT** This lot consists of two riflescopes. First is a Bushnell Banner 4X riflescope with a crosshair reticle and excellent optics. Scope has a few light ring marks from mounting and a set of lens covers are included. Second is a Tasco RF 3-7X20 rimfire riflescope. This 7/8" tube scope features a "TV-view" duplex reticle and has very good optics. A set of factory tip-off rings and a set of lens covers are included. (48821-147I)
2283. **SCOPE LOT** This lot consists of two riflescopes. First is a Bushnell Banner 4-12X40 riflescope with adjustable objective. The scope features a duplex reticle and has excellent optics. The elevation turret is missing the adjustment knob and the body has some light ring and handling marks. Second is a Simmons 8 Point 2.5X20 rifle/shotgun scope with a duplex reticle and excellent optics. This matte finish scope has light ring marks from mounting but remains in otherwise excellent condition. (48221-147J)
2284. **UNERTL SCOPE** This lot consists of a Unertl 10X riflescope. This parkerized finish scope features a mil-dot reticle and has bright excellent optics. The scope is housed in its original slide-top wood box and is in excellent overall condition. (47467-3D)
2285. **BUSHNELL SCOPE** This lot consists of a Bushnell Scopechief VI 2.5-8X32 riflescope. The scope features a duplex reticle and has excellent optics. The scope is in overall excellent condition and includes a set of Weaver style generic rings. (46758-53B)
2286. **BROWNING SCOPE** This lot consists of a Browning 4X 7/8" rimfire riflescope. The scope features a crosshair reticle and has excellent optics. A set of rings to fit a grooved receiver are included. An excellent accessory for your rimfire sporting rifle. (46758-53C)
2287. **REDFIELD SCOPE** This lot consists of a vintage Redfield 1-4X riflescope. This scope was made in Denver, CO and features a crosshair reticle with excellent optics. There are a few light ring marks from the scope having been mounted but the scope remains in otherwise excellent condition. (46758-53D)
2288. **REDFIELD SCOPE** This lot consists of a vintage Redfield 1-3/4 to 5X Widefield low-profile riflescope. The scope features the wide duplex reticle and has excellent optics. There are a few light ring marks from the scope having been mounted but the scope remains in otherwise excellent condition. (46758-53E)
2289. **REDFIELD SCOPE** This lot consists of a vintage Redfield 2-3/4X fixed power riflescope. The scope features a duplex reticle with excellent optics. There are a few light ring marks from the scope having been mounted but the scope remains in otherwise excellent condition. (46758-53F)
2290. **REDFIELD SCOPE** This lot consists of a vintage Redfield 4X Widefield lo-profile riflescope. The scope features the wide duplex reticle and has excellent optics. There are a few light ring marks from the scope having been mounted but the scope remains in otherwise excellent condition. (46758-53G)
2291. **REDFIELD SCOPE** This lot consists of a vintage Redfield 2-7X Widefield riflescope. The scope features the wide duplex reticle and has excellent optics. There are a few light ring marks from the scope having been mounted but the scope remains in otherwise excellent condition. (46758-53H)
2292. **WEAVER SCOPE** This lot consists of a Weaver CH2 2X28 handgun scope. This blued-over long eye relief scope features a duplex reticle and has excellent optics. There are a few light handling marks noted but the scope appears to not have been mounted. An excellent example overall. (46758-53I)
2293. **BAUSCH & LOMB SCOPE** This lot consists of a Bausch & Lomb 3000 Elite series 2-7X32 riflescope. The scope features a duplex reticle and has excellent optics. The tube has a few light ring marks from mounting but the scope remains in overall excellent condition. (46758-53J)
2294. **BURRIS SCOPE** This lot consists of a Burris 2-8X Signature series riflescope. This matte finished scope features a duplex reticle and has excellent optics. A set of rings to fit a Weaver style base are included and the scope is in excellent overall condition. (46758-53K)
2295. **BURRIS SCOPE** This lot consists of a Burris 6X Fullfield series riflescope. This matte finish fixed power scope features a duplex reticle and has excellent optics. The scope has a few very light ring marks from mounting but is in excellent overall condition. (46758-53L)
2296. **MOSSBERG SCOPE** This lot consists of a Mossberg 4X No. M4D riflescope. The scope features a fine crosshair reticle and has very good optics. The grooved receiver rings for mounting to a grooved receiver are included. The scope has some light handling marks and is in very good overall condition. (46758-53M)
2297. **WEAVER SCOPE** This lot consists of a Weaver KV 2-3/4-5X riflescope. The scope features a crosshair with bullet drop reticle and has very good optics. There are a few light ring marks and handling marks present and the scope is in near excellent condition overall. (46758-53N)
2298. **BAUSCH & LOMB SCOPE** This lot consists of a Bausch & Lomb Balfor B series 4X32 riflescope. The scope features a tapered crosshair reticle and has excellent, bright optics. There are a few light ring marks from mounting but the scope remains in excellent condition. A blue terry cloth wrap is included. (46758-53O)
2299. **BAUSCH & LOMB SCOPE** This lot consists of a Bausch & Lomb Baltur A series 2.5X32 riflescope. The scope features a crosshair reticle and has excellent, bright optics. There are a few light handling marks but the scope remains in excellent condition. (46758-53P)

2300. **BAUSCH & LOMB SCOPE** This lot consists of a Bausch & Lomb Baltur A series 2.5X32 riflescope. The scope features a crosshair reticle and has excellent, bright optics. There are a few light handling marks but the scope remains in excellent condition. (46758-53Q)
2301. **SWIFT SCOPE** This lot consists of a Swift 4-12X40 adjustable objective riflescope. This silver finish scope features a duplex reticle and has excellent optics. There are few light ring marks from mounting but the scope is in excellent condition minus the rubber outer ring around the eye lens which is missing. (46758-53R)
2302. **SIMMONS SCOPE** This lot consists of a Simmons 3-9X32 riflescope. The scope features a duplex reticle and has excellent optics. A set of Weaver rings are included. (46758-53S)
2303. **WEAVER SCOPE** This lot consists of a Weaver V9 3-9X40 adjustable objective riflescope. The scope features a post and crosshair reticle and has very good optics. There are some light ring marks from mounting but overall the scope remains in excellent condition. A set of lens covers is included. (48737-289A)
2304. **TACTICAL SCOPE** This lot consists of an NcStar 3-9X42RE armored riflescope. The scope features a mil-dot reticle and has excellent optics. A set of flip-up lens covers and a pair of high see-thru rings are included. An excellent compact scope for your tactical carbine. (48873-577A)
2305. **BSA SCOPE** This lot consists of a BSA Contender 6-24X40SP target riflescope. This matte finish target scope features target reticle, side focus knob, 1/8 MOA turrets and has excellent optics. Included are the manual, a sunshade, metal lens caps and a set of Weaver base rings. An excellent example of these quality optics. (48852-1A)
2306. **LEUPOLD SCOPE** This lot consists of a Leupold Vari-XIII 2.5-8X riflescope. The scope features a duplex reticle with excellent optics. There are a few light ring marks from mounting but the scope remains in excellent condition. A set of bikini lens covers are included. (47757-6)
2307. **NIKON SCOPE** This lot consists of a Nikon Monarch 5-20X44 SF series riflescope. The matte finish scope features a duplex reticle and has bright, excellent optics. Scope also features a side focus knob and includes a sunshade and additional turret adjustment knobs. Also included are the original box and a set of factory lens covers. There are a few light ring marks from mounting but the scope is in otherwise excellent condition. (48898-9D34272A)
2308. **LEUPOLD SCOPE** This lot consists of a Leupold 12X series riflescope. The scope features an adjustable objective and has a duplex reticle with excellent optics. Included are a sunshade and a set of Butler Creek flip-up lens covers. There are light ring marks from mounting but the scope remains in excellent overall condition. (48889-6A)
2309. **REDFIELD SCOPE** This lot consists of a vintage Redfield Widefield Lo-Pro fixed 4X riflescope. The scope features Redfield's wide duplex reticle and has excellent optics. The scope has some light ring marks from mounting but remains in overall excellent condition. (48806-27A)
2310. **WEATHERBY SCOPE** This lot consists of a Weatherby Premier 3-9X40 riflescope. The scope features a duplex reticle with excellent optics and has a adjustable focus eye piece. There are light ring marks from mounting, but overall the scope remains in excellent condition. (48873-701A)
2311. **LEUPOLD SCOPE** This lot consists of a Leupold Vari-XII 2-7X riflescope. This gloss blue scope features a duplex reticle and has excellent optics. There are light ring marks from mounting but overall the scope remains in excellent condition. (48865-15A)
2312. **WEAVER SCOPE** This lot consists of a Weaver CV9 3-9X40 Micro-Trac riflescope. The scope features a duplex reticle with clear optics. There are a few light ring marks from mounting, but the scope remains in excellent condition overall. (46520-1654A)
2313. **LEUPOLD SCOPE** This lot consists of a Leupold M8 4X shotgun series scope. The gloss finish scope features a heavy duplex reticle and has excellent optics. There are light ring marks from mounting but overall the scope remains in excellent condition. (48806-8A)
2314. **LEUPOLD SCOPE** This lot consists of a Leupold VX-II 1-4X20 riflescope. This matte finished scope features a duplex reticle and has excellent optics. There are a few light ring marks from mounting but the scope remains in excellent overall condition. A set of factory bikini lens covers are included. (48852-4A)
2315. **REDFIELD SCOPE** This lot consists of a vintage Redfield 2-7X Low-Profile Widefield riflescope. The scope features a duplex "tv-view" reticle and has excellent optics. There are light ring marks from mounting, but scope remains in excellent condition overall. (48879-10A)
2316. **LYMAN SCOPE** This lot consists of a Lyman All-American 4X riflescope. The scope features a crosshair reticle and has excellent optics. A set of rings to fit a Weaver type base are included. An excellent example of these popular vintage scopes. (48841-22A)
2317. **NIKON SCOPE** This lot includes a Prostaff 3-9X40mm rifle scope with BDC Long Range Hunting Reticle and crisp, clear optics. The scope has a matte black finish measuring 12" overall in length with a 1" diameter tube that has a set of unknown rings and bases designed for a 1/2" dovetail. One of the hold-down rings is missing a screw and the scope remains in excellent condition. (8900-25S21457A)
2318. **TASCO SCOPE** This lot consists of a Tasco Pronghorn series 3-9X40 riflescope. This matte finished scope features a duplex reticle and has excellent optics. There are a few light ring marks from mounting but the scope remains in excellent overall condition. (1X46520-528A)
2319. **TRUGLO RED DOT SIGHT** This sight has a matte black finish with integral Weaver style base. The fixed 1X sight with 5 MOA dot and 11 brightness settings measures 5 3/8" overall and remains in excellent working condition. (1X108805-22A)
2320. **WEATHERBY SCOPE** This lot consists of a Weatherby Supreme 3-9x44 riflescope. The scope features a fine duplex reticle with clear optics and eye lens focus. There are some minor ring marks but the scope remains in excellent condition overall. (3X8521-4A)
2321. **TASCO 10-40 X 50MM DS TARGET SCOPE.** The scope features a rubberized all-weather finish, multi coated lenses and is weatherproof, shockproof and fog proof. This scope includes sun shield and lens covers, does not appear to have ever been mounted and comes in its original box with instruction booklet and shows crisp optics. (28193-1)
2322. **TASCO WORLD CLASS 36 X 44MM TARGET SILHOUETTE RIFLESCOPE.** The scope comes in its original box and packaging and appears to retain 99% of its all black finish with very few minor scratches. The scope also comes with two wrapped sun shields brand new, never assembled and shows crisp optics. (28193-1A)
2323. **TASCO WORLD CLASS 36 X 44MM TARGET SILHOUETTE RIFLESCOPE.** The scope comes in its original box and packaging and appears to retain all of its original black finish. The scope comes with 3 sun shields that are as new and do not appear to have ever been mounted and shows crisp optics. (28193-1B)

2324. **TASCO WORLD CLASS 36 X 44MM TARGET SILHOUETTE RIFLESCOPE.** The scope comes in its original box and packaging and appears to retain all of its black finish. The scope comes with 2 sun shields in 2 different lengths with a cleaning cloth and a scope cover. All accessories come in new packaging and do not appear to have been used and the scope shows crisp optics. (28193-1C)
2325. **TASCO WORLD CLASS 36 X 44MM TARGET SILHOUETTE RIFLESCOPE.** The scope comes in its original box and packaging and appears to retain 99% of all of its black finish. The scope comes with one sun shield and a cleaning cloth and an instruction manual as well which are all removed from their original packaging and the scope shows crisp optics. (28193-1D)
2326. **TASCO WORLD CLASS 8X-32X44MM TARGET SILHOUETTE RIFLESCOPE.** The scope comes in its original box and packaging and does show some mounting marks on it. The scope comes with 2 sun shields with a cleaning cloth and some other very small accessories. The sun shields appear to have been used with some minor marks on them and the scope shows crisp optics. (28193-1E)
2327. **TASCO WORLD CLASS 8X-32X44MM TARGET SILHOUETTE RIFLESCOPE.** The scope comes in its original box and packaging and does show some minor scratches that are not ring shaped from mounting. The scope comes with an instruction manual and two sun shields in packaging with a cleaning cloth and some other small accessories and the scope shows crisp optics. (28193-1F)
2328. **TASCO 36 X 44MM TARGET SILHOUETTE RIFLESCOPE.** The scope comes with lens covers and does show some minor mounting ring marks. The scope has a 1/8 min Target Dot Reticle and shows crisp optics. (28193-1G)
2329. **TASCO 36 X 44MM TARGET SILHOUETTE RIFLESCOPE.** The scope comes with lens covers and does sustain some minor mounting scratches but overall retains 98% of its all black finish. The scope has a 1/8 min Target Dot Reticle and shows crisp optics. (28193-1H)
2330. **TASCO WORLD CLASS PLUS 36 X 50 TARGET SILHOUETTE RIFLESCOPE.** The scope comes with lens caps and does sustain some minor scratches from mounting but overall retains 97% of its all black finish. The scope has a 1/8 min Target Dot Reticle and shows crisp optics. (28193-1I)
2331. **TASCO 36 X 44MM TARGET SILHOUETTE RIFLESCOPE.** The scope comes with lens covers and shows some minor and faded mounting marks but overall retains 98% of its all black finish. The scope has a 1/8 min Target Dot Reticles and shows crisp optics. (28193-1J)
2332. **NIKON 2-7X32 RIFLESCOPE.** The scope shows some mounting rings but overall retains 98% of its all black finish. The scope has a duplex reticle and shows crisp optics. (28893-1A)
2333. **LEUPOLD VARI-X 3X9 COMPACT TARGET RIFLESCOPE.** The scope does show some minor mounting ring marks but overall retains 98% of its all black finish. The scope has a duplex reticle and shows crisp optics. (28893-2A)
2334. **LEUPOLD VARI-X III 2.5 X 8 RIFLESCOPE.** The scope does show some very minor and faded mounting ring marks but overall retains 98% of its all black finish. The scope has a duplex reticle and shows crisp optics. (28893-4A)
2335. **BURRIS 2X – 7X RIFLESCOPE.** The scope does show some very minor and faded mounting ring marks but overall retains 98% of its all black finish. The scope has a duplex reticle and shows crisp optics. (28854-6A)
2336. **REDFIELD 3X – 9X RIFLESCOPE.** The scope comes with snap-on lens covers and shows some very minor and faded mounting ring marks but overall retains 99% of its all black finish. The scope has a duplex reticle and shows crisp optics. (28902-5A)
2337. **BURRIS 6X – 18X FULLFIELD RIFLESCOPE.** The scope shows minor mounting ring marks and overall retains 98% of its all black finish. The scope has a duplex reticle and shows crisp optics. (28821-62A)
2338. **LYMAN SUPER TARGETSPOT SCOPE** serial #24080. The scope has 15 power and is equipped with adjustable target rings and lens covers. The scope shows minor scratches but overall retains 98% of its all black finish. The scope has a 1/8 min Target Dot Reticle and shows crisp optics. (28865-98)
2339. **REDFIELD 3X – 12X ILLUMINATOR RIFLESCOPE** serial #05242. The scope shows some marks from stickers but overall retains 97% of its all black finish. The scope has Crossbones Ballistic Reticles and shows crisp optics. (26519-263A)
2340. **BSA PLATINUM 8-32X44 RIFLESCOPE.** The scope comes with lens covers and shows some minor scratches and mounting ring marks but overall retains 97% of its all black finish. The scope has a 1/8 min Target Dot Reticle with crisp optics. (26519-263B)
2341. **THOMPSON CENTER ARMS RP 4 X 32 RIFLESCOPE.** The scope shows some very minor scratches and mounting rings but overall retains 98% of its all black finish. The scope has an Electra Dot T Reticle with crisp optics. (26519-263C)
2342. **WEAVER K6-1 MICRO-TRAC RIFLESCOPE.** The scope shows very minimal scratches and retains 99% of its all black finish. The scope has an Duplex reticle with crisp optics. (26519-263D)
2343. **SIMMONS WHITETAIL CLASSIC 3.5-10X50 RIFLESCOPE.** The scope shows some mounting ring marks and retains 98% of its all black finish. The scope has a duplex reticle and shows crisp optics. (26519-263E)
2344. **BURRIS 4X – 12X RIFLESCOPE** serial# 084069. The scope does show some mounting ring marks but overall retains 97% of its all black finish. The scope has a duplex reticle and shows crisp optics. (26519-263F)
2345. **WEAVER 1.5 – 6X32 RIFLESCOPE.** The scope comes with one lens cover and does not show mounting ring marks but does show some minor scratches and overall retains 98% of its all black finish. The scope has a Boone & Croquette Reticle with crisp optics. (26519-263G)
2346. **NCSTAR 3-9X44 RIFLESCOPE.** The scope shows some very minor chipped finish but overall retains 98% of its all black finish. The scope has an Illuminated Rangefinding Reticle and shows crisp optics. (26519-263H)
2347. **BSA CASTEYE 1.5-4.5X32 RIFLESCOPE.** The scope shows some minor scratches/mark on the finish but overall retains 98% of its all black finish. The scope has an Illuminated Firedot Reticle and shows crisp optics. (26519-263I)
2348. **REDFIELD 6X RIFLESCOPE.** The scope shows minor scratches and chipped finish but overall retains 98% of its all black finish. The scope has a target crosshair reticle ad shows crisp optics. (26519-263J)
2349. **TASCO SILVER ANTLER SA4X40 RIFLESCOPE.** The scope includes a set of 1" Weaver rings and does show some minor chipped finish and mounting ring marks but overall retains 98% of its all black finish. The scope has a duplex reticle and shows crisp optics. (26519-263K)
2350. **MARLIN 3X-9X40 MODEL 900A RIFLESCOPE.** The scope has some dings and scratches on the all black finish but overall retains 97% of its all black finish. The scope has a post crosshair German reticle and shows crisp optics. (26519-263L)

- 2351. **BALTUR 2 1/2X RIFLESCOPE.** The scope comes with two lens caps and does show some minor scratches and chipped finish, but overall retains 98% of its all black finish. The scope has a center dot reticle and shows decent crisp optics. (26519-263M)
- 2352. **GERMANY PECAR BERLIN 2 3/4 X 64 RIFLESCOPE.** The scope comes with two detachable 7/8" Weaver rings and retains about 98% of its all black finish just showing some minor scratches. The scope has a target crosshair reticle and shows crisp optics. (26519-263N)
- 2353. **REDFIELD 2 3/4X RIFLESCOPE** serial #E55514. The scope shows some very minor and faded marks obtaining about 99% of its all black finish. The scope has a thick post thin crosshair reticle and shows crisp optics. (26519-263O)
- 2354. **UNMARKED CHINESE MANUFACTURED 4X28 RIFLESCOPE.** The scope does not show any marks from being mounted or any other miscellaneous scratches, overall the scope retains around 99-100% of its all black finish. The scope has a Firedot duplex reticle with crisp optics. (26519-263P)
- 2355. **EUROLUX 4X25 RIFLESCOPE.** The scope shows some very minor scratches/marks but overall the scope retains 99% of its all black finish. The scope has a Firedot duplex reticle with crisp optics. 926519-263Q)
- 2356. **LYMAN ALL WEATHER 2 1/2 POWER RIFLESCOPE.** The scope shows minor marks but overall retains 98% of its all black finish. The scope has a center dot reticle with crisp optics. (26519-263R)
- 2357. **BALVAR 4X20 RIFLESCOPE** The scope shows some very minor chipped finish and retains 99% of its all black finish. The scope has a Thick Post Thin Crosshair Reticle and shows crisp optics. (26519-263S)

Sights

- 2358. **WEAVER SIGHT** This lot consists of a Weaver Qwik-Point fiber optic close range sight. The sight mounts to a Weaver or picatinny style base and uses available light to generate the red dot. The sight is house din its original box which has some crush damage, the sight itself remains in as-new condition. (43638-46)
- 2359. **SIGHT MARK RED DOT SIGHT** This lot consists of a Sight Mark tactical series red dot sight. The sight has a mount included that attaches to a picatinny style base and a set of factory lens covers. It appears to operate correctly and includes a manual. (47524-6B)
- 2360. **BUSHNELL RED DOT SIGHT** This lot consists of a Bushnell Trophy red dot sight. This matte black sight features an adjustable red dot aperture and has clear optics. A sunshade extension and a set of Weaver style split rings are included and the sight is operational. (46520-758A)
- 2361. **SIMMONS RED DOT SIGHT** This lot consists of a Simmons 42mm red dot sight with mounting bracket. The sight is in excellent condition and functions correctly. The integral bracket is adjustable to fit Weaver style bases and picatinny rails. Included is a set of factory lens covers. (48871-16A)
- 2362. **THOMPSON REAR SIGHT LOT** This lot consists of a modern Lyman adjustable rear sight for the 1927 Thompson rifles. The sight retains much of its finish but shows scattered light silvering. (1X208585-136C)

Miscellaneous

- 2363. **ANTIQUE HORN AND FLASK LOT** This lot consists of a fixed common top shell-bush pattern powder flask with adjustable spout. The flask is copper-toned and likely brass construction and is embossed on both front and back with dual hangers on each side and tight seams. The fixed common top has a four position adjustable charging spout from 3 to 4 drams, in quarter dram increments, the positioning screw is no longer present. The spout seems to work well however the cutoff spring is broken. There appears to be remnants of some good lacquer beneath a coating of light grime and dust and an original green-toned hanger cord is included. The powder horn has a 12 1/2" body which is reduced its full-length to form a simple medial at the spout. It features a slightly convex softwood plug retained by four tiny iron brads with a very small staple at its center as hanger provision. It is an overall translucent yellow-gray; no stopper is present. The third item is a leather pancake-style shot pouch roughly 4 1/2" in diameter. It has a hand sewn seam which is intact around its periphery and a cast lead spout, no stopper is present. The leather is primarily rather dry and lightly flaked with a tiny pinprick hole on one side of the pouch. Overall a nice accessory lot for a shotgun case or hunting pouch display. (38619-5)
- 2364. **LOT OF 1911 GRIPS** This lot consists of two grips for Colt 1911 Government Model-style pistols. First are a pair of Colt factory checkered walnut grips with gold Rampant Colt medallions. Grips are as-new. Second is a pair of Pachmayr Signature Model wrap-around grips. Stock number GM-45 and are new in original box. (3A8935-5B)
- 2365. **LOT OF S&W GRIPS** This lot consists of two grips for Smith & Wesson N-Frame revolvers. The first are a factory pair of checkered target walnut grips with silver Smith & Wesson medallions. These feature the left side relief for extractor but are not cut for speed loader. Grips are date August 26, 1983 and are as-new. The second are a pair of Pachmayr Gripper finger groove grips showing light use but rating very good plus. (3A8935-5A)



2363

2366. **FRAMED WATERFOWL PRINT** This lot consists of a framed waterfowl print entitled "SUNSET AND CANADA GEESE". This print was done by Liz Mitten Ryan in 1989 and it show three Canada geese on a lake shore with hues of light and dark purple and a light section depicting the rays of the sun on the water. The frame measures 15 1/4" by 12 1/4" and the viewing area measures 7 3/4" by 5 1/2". The frame shows some marks with separation on the bottom of the frame, and the back framers paper has been torn at the top and down one side. The sticker indicates it was framed by The Framers Market in Bedford, NH. Over all a lovely and warm print for any bird enthusiast. (3A8935-27)



2367. **FRAMED WATERFOWL PRINT** This lot consists of a framed waterfowl print that depicts two Redhead ducks on salt water next to a piling and is titled "SPLASH OF RED". The print was created by Terry Isaac in 1990 and is marked C.E. 160/250. This does include the 1991 New York Migratory Bird Stamp depicting the print. The frame measures 20" by 18 1/2" and the viewing area measures 10 1/2" by 8" and is double matted. The frame is in good condition and the back shows two minor holes in the paper and includes a plaque about both Mr. Isaac, the program and the painting itself. It is signed and numbered by the artist on its lower edge. This is a lovely print with great detail and shows two lovely ducks. This would be a great piece to add to any collection or as a stand-alone. (3A8935-29)



2368. **LOT OF COLT GRIPS** This lot consists of a pair of a genuine mother-of-pearl grips with silver Rampant Colt medallions. The grips will fit the square butt New Model Army 1895-1901 series of frames as well as the Official Police square butt series of frame. The grips rate very good plus with tiny chips on a couple of the bottom corner edges and a small occlusion or crack at the rear lower edge of the left grip, it is tight and nearly un-noticed at first glance. No grip screw is included. (37762-79)



2369. **U.S. GI HOLSTER**

This is a leather "U.S." marked holster from Graton & Knight and is so-marked on its rear with U.S. inspector's initials and 1917 date. The holster rates very good overall, with minor scuffing and light flaking on the suspension billet on rear of holster, with light verdigris at the rivets. (38904-27A)

2370. **COLLECTIBLE HOLSTER LOT** This lot consists of two holsters, first is a regulation U.S. G.I. holster for a Government Model pistol. The brown leather holster rates about good with overall flaking and light crackling. It is maker-marked on its rear but it is no longer discernible, nor is the date. The flap has "F13-33" stamped at the flex point and there is a crossed saber hat device affixed to the flap itself which is stamped "13F12". The wire suspension hanger has been removed from the rear and it currently rides on a 1" antique leather cartridge belt which is commercial in nature. The seam stitching is intact around its periphery but for the bottom muzzle billet which was purposefully removed. The second item is an unmarked but quality-made "Mexican jockstrap" dual-loop holster of top grain leather. It has a closed muzzle and cut away for trigger finger, it is left-hand or right-handed "twist draw" and will accommodate a Colt Single Action Army-size revolver with a 5 1/2" barrel. This holster rates very good plus. (8864-35,31A)

2371. **ANTIQUE SLIM JIM HOLSTER** This is an antique leather holster which will accommodate a Colt 1860 Army or similar-sized revolver. The leather slightly dry but still supple and shows mild crazing overall with fraying along the very top edges of the holster's throat. The seam stitching is mostly intact showing old restored stitching and a section along the rear edge which has separated. There are light stamped decorations around the periphery of the face of the holster. There is a single suspension billet attached to the rear which is a later replacement from the period of use, it is attached with iron rivets. This is a very nice vintage percussion revolver-era holster. (38864-30A)

2372. **ANTIQUE BELT AND HOLSTER LOT** This lot consists of a regulation pattern U.S. model 1863-1865 late war holster for Colt and Remington percussion revolvers. The holster is about very good with overall crackling and light drying but remaining supple and pliable for the most part. The seam stitching shows some light repairs which are well-done and the muzzle billet is a replacement from the period of use, the flap closure billet is a later replacement. The suspension billet in the rear has torn and broken through and has been re-stitched, also during the period of use. The holster is not marked. Included is a Civil War-era cap pouch which is un-marked, has intact inner flap, the dual rear suspension billets are sewn, rather than riveted. The pouch itself rates very good plus to fine with only light crackling or flaking, primarily on the closure tab portion of the outer flap. The seam stitching is intact around its periphery, one of the rear suspension billets has been repaired as it had worn-through. These are both attached to a regulation leather belt. The belt rates about good with overall flaking and light drying, it however remains supple and flexible, attached to it is a brass "U.S." buckle which rates very good to very good plus as well. A nice civil war holster-belt-rig to accompany your percussion revolver. (38864-62)
2373. **U.S. MODEL 1922 RIFLE MAGAZINE** This lot consists of a single original blued-over "M2"-marked five-round magazine. The magazine shows light wear with the marking just slightly light but appears to be original blue. (38893-3A)
2374. **U.S. MODEL 1922 RIFLE MAGAZINE** This lot consists of a single original parkerized "M2"-marked five-round magazine. The magazine shows light wear with the baseplate blued-over rather than parkerized. (38893-3B)
2375. **U.S. MODEL 1922 MAGAZINE AND SIGHT** This lot consists of a single blued-over "M2" marked magazine. The magazine rates very good and is overall blued-over showing remnants of some light oxidation speckling. Also included is a Lyman No. 10 globe sight which fits on a sporting ramp (it may accommodate a 1903-style front sight base). It rates about very good with minor wear and some light dings. Only one insert is included. (38809-47A)
2376. **RARE EARLY RUGER NO. 1 RINGS** This is a pair of it vertically-split Ruger factory 1" rings. These rings are of identical height and are therefore for a Ruger No. 1 rifle or any Ruger quarter rib. They rate very good plus to excellent with only some very scant to very light handling marks, a couple of the screw slots showing some light damage (one ring screw is actually missing). The main attaching thumb-pieces are undamaged. A nice set of rare early rings. (38821-146D)
2377. **GUN STOCK LOT** This lot consists of 2 semi-inletted gunstocks for a 98 Mauser. The first is a Bishop Imperial stock for a Mauser 98 large ring action, Monte Carlo style with a flared left side cheekpiece and showing very light water staining but is otherwise very good. This stock has 90% inletting and has 95% shaping. The second is an unmarked classic style flared left side cheekpiece with shadow line. It has a rough semi-inletting for a 98 Mauser, showing nice grain figure with some drying checks and filled knots. It has 70% inletting and 95% shaping and rates about excellent. (3A8935-7A)
2378. **GUN STOCK LOT** This lot consists of a 41" long by 6 1/2" at widest point piece of rough stock blank. This Goby Walnut Products, Oregon Black Walnut stock shows a very nice feather crotche grain in butt and fiddleback throughout the piece. A very nice piece of walnut will make a beautiful one-piece rifle stock. (3A8935-7B)
2379. **RELOADING LOT** This lot consists of (1) full 100 round box of Hornady full jacketed 44 CAL. 240 GR. .430 in very good condition, (1) full 100 round box of Hornady full jacketed 38 CAL. 160 GR. .357 unopened, likely very good condition, (1) box of 17 rounds of 30 CAL. 165 GR. .308 B.T.S.P. and (3) boxes of various amounts (1) full appx. 100 rounds, 1 box appx. half full, and 1 box with 7) of Hornady full jacketed 9mm CAL. 124 GR. .355. Also included is a bag of cast lead .355 for 9mm CAL. appx. 90 (3A8935-4)
2380. **RELOADING LOT** This lot consists of (2) appx. full boxes of Sierra Tournament Master 44 CAL. .4295 DIA 220 GR FPJ Silhouette in very good condition (3A8935-3A)
2381. **RELOADING LOT** This lot consists of 2 full boxes of Sierra Tournament Master 44 CAL. .4295 DIA 220 GR FPJ Silhouette in very good condition (3A8935-3B)
2382. **RELOADING LOT** This lot consists of (3) boxes appx. full of Sierra Pro-Hunter Spitzer 7mm CAL. .284 DIA 140 GR. very good overall. (3A8935-2A)
2383. **RELOADING LOT** This lot consists of (1) box of appx. 40 Sierra Game King Spitzer Boat Tail 7mm .284 DIA 140 GR in very good condition, (1) box of appx. 20 Sierra Pro-Hunter Spitzer 7mm CAL. .284 DIA 140 GR in very good condition, and (2) boxes of full Sierra Pro-Hunter Spitzer 7mm CAL. .284 DIA 140 GR in very good condition. (3A8935-2B)



2384

2384. **GERMAN MG08/15 PARTS LOT** This lot consists of a water jacket, feed block assembly, topcover, sights and sideplate. The topcover is maker marked by J.P. Sauer and is dated 1918, the rear sight is numbered matching to it. The barrel jacket shows a few light dents and the metal surfaces are primarily a dull gray and lightly oxidized patina, with some heavier oxidation on the front left of water jacket. A great lot for the owner of a "Devil's Paintbrush" or for that display build you have been wanting to construct. (38829-42)
2385. **11MM MAUSER BRASS LOT** This lot consists of three full 20 round boxes of Bertram unprimed 11mm/.43 Mauser brass. Some of the rounds show minor tarnish but they rate about excellent overall. (208878-4)
2386. **M1 CARBINE MAGAZINE POUCH** This lot consists of an original tan canvas M1 Carbine magazine pouch. The back of the pouch is marked "Mid-West Duck & Canvas Co./1942". The pouch shows some minor dust staining. (208873-673A)

2387. **AK-47 RUBBER TRAINING RIFLE** This lot consists of a black rubber AK-47 dummy training rifle. The rifle resembles a milled AK-47 and it has a dummy rubber bayonet affixed. The gun shows scattered scuffing and handling marks from the years. An interesting item for the military collector. (208909-46) (NON-GUN)



2387

2388. **GERMAN ZF-41 SCOPE ADJUSTMENT TOOL** This lot consists of an original ZF-41 scope adjustment tool. The metal surfaces retain 30% of a black enamel finish with overall flaking and some small spots of oxidation. The tool is marked "cxn/89948/V-2x" and the optics are dirty and cloudy. A neat item for the military or sniper collector. (207884-14J) [Craig Brown Collection]

2389. **GERMAN CZ-39 HOLSTER LOT** This lot consists of a black leather German holster for CZ-38/39 style pistols and a single magazine. The holster is marked "TOPH NEÜNER/GENUR" and "(Eagle)/(Swastika)/WaA757" on the rear. The interior is marked "P.39 (T)" and there is some illegible writing on the inside flap. The holster shows some moderate flaking, scattered scuffing and crazing. The magazine appears unmarked and shows scattered dings. (207884-47A) [Craig Brown Collection]



2388



2390



2392

2390. **P08 LUGER HOLSTER LOT** This lot consists of a black leather P08 Luger holster that was converted from a Steyr 1912 holster. The rear of the holster is marked with an "(Eagle)/(Swastika)/Wg1" and there is a faint boxed marking on the inside flap. The holster shows some moderate flaking, soiling and scuffing from the years. (207884-47B) [Craig Brown Collection]
2391. **REICHSREVOLVER HOLSTER LOT** This lot consists of a brown leather M/79 Reichsrevolver style holster. The holster appears unmarked and the construction does not appear consistent with known military examples but it does not appear modern. The holster shows some scuffs, crazing and light dings. (207884-47C) [Craig Brown Collection]
2392. **P08 LUGER HOLSTER** This lot consists of a brown leather P08 Luger holster and a Luger magazine. The holster appears unmarked except for a handwritten number "3" on the rear. The holster does not appear to be a reproduction and it shows scattered scuffs, light flaking and crazing. The bright body magazine has a brown baseplate that shows some chipping and it is numbered "5483e". The magazine body shows some light oxidation and dried grease from the years. (207884-47D) [Craig Brown Collection]
2393. **GERMAN RADOM HOLSTER LOT** This lot consists of a tan leather holster for the P.35/VIS 35 Radom pistol. The inside of the holster is marked "bnz 1944/P35 (b)" indicating manufacture by Steyr and there do not appear to be any other markings. The holster shows some light scuffing, handling marks and minor flaking from the years. (207884-47E) [Craig Brown Collection]
2394. **AUSTRIAN HOLSTER LOT** This lot consists of a dark brown leather Austrian Gendarmerie Steyr 1912 holster. The holster appears unmarked, it shows overall crazing, some crackling and flaking. (207884-47F) [Craig Brown Collection]
2395. **REICHSREVOLVER HOLSTER LOT** This lot consists of a brown leather 1904 for the Model 1883 Reichsrevolver. The rear of the holster has a maker's mark that appears to read "LUDEWIG/BERLIN/1913" and there is a unit marking on the inside flap of the ammunition pouch that reads in part "1912FAB 10". The holster shows some scuffs, crazing and light flaking from the years. (207884-47G) [Craig Brown Collection]



2396



2401



2403



2404



2405

2396. **BAVARIAN HOLSTER LOT** This lot consists of a pigskin Bavarian Steyr 1912 holster. There are no discernable markings on this holster and it features a double magazine pouch. There is the onset of a tear on front of flap, scattered crazing, scuffing and flaking. (207884-47H) [Craig Brown Collection]

2397. **U.S. M1911 HOLSTER LOT** This lot consists of an M1916 belt holster and a 7 round magazine for the M1911 pistol. The holster is tan leather and it is marked "BOYT/44" on the rear. The holster shows scattered scuffs, a few dings and some crazing. The blued-over magazine is marked "S" on the toe indicating manufacture by Scoville and it shows scattered silvering. (207884-47I) [Craig Brown Collection]

2398. **STEYR M1912 HOLSTER LOT** This lot consists of a black leather interwar era Steyr M1912 holster. The holster appears to be unmarked and only one strap is present on the rear with the other appearing to have broken. The holster shows scattered crazing, flaking and some scuffing. (207884-47J) [Craig Brown Collection]

2399. **GERMAN P08 LUGER HOLSTER** This lot consists of a pre-World War One brown leather P08 Luger holster. The back appears unmarked and the inside of the flap has a stamped maker mark that appears to be H.C. Clemen over a date of 1911. The flap has an ink marking that appears to read "F.s.A.R.9/1912" and another ink marking that appears to read "I.B.". The holster shows scattered crazing, moderate flaking and scuffs. A neat item for the military or Luger collector. (207884-47K) [Craig Brown Collection]

2400. **GERMAN HOLSTER LOT** This lot consists of two reproduction German military holsters. The first is a modified brown leather Navy Luger holster. Part of the flap has been removed to allow for an 1879 Reichsrevolver. The holster shows some light crazing and handling wear. The second is an M79 Reichsrevolver holster that appears to be older but non-military. It is unmarked and it shows some light staining, scattered scuffing, crazing and some light flaking. (207884-47L) [Craig Brown Collection]

2401. **GERMAN P08 LUGER HOLSTER LOT** This lot consists of a brown leather P08 Luger holster and a magazine. The back of the holster appears unmarked, the front of the flap is marked "JzPf.6/15" and there is a maker's mark on the front of the body that is mostly indiscernible and it appears to read in part "JOHANNES/VIENS". The holster shows scattered scuffing, light flaking and crazing. The magazine is numbered "8166m", it is of the bright bodied variety and it has a red baseplate. The magazine is a dull gray patina with scattered oxidation staining. (207884-47M) [Craig Brown Collection]

2402. **REICHSREVOLVER HOLSTER LOT** This lot consists of two holsters for the 1879 Reichsrevolver. The first is an M/79 holster dated 1903, maker marked "J.ARNADÉ/METZ" on the rear and "12 FAR/1908" on the inside. The holster is brown, it shows some scuffing, crazing and flaking on the flap. The second holster is a 1904 model that appears to be a reproduction. It is unmarked and has an ammunition pouch on the front. The holster shows some light scuffing and crazing. (207884-47N) [Craig Brown Collection]

2403. **ROTH STEYR M1907 HOLSTER** This lot consists of a Austrian M1907 Roth Steyr tan sheepskin holster. The holster is dated 1918, there is some staining on the backside, scattered scuffing, dirt staining, light flaking and crazing. (207884-47O) [Craig Brown Collection]

2404. **STEYR M1912 HOLSTER** This lot consists of a German issue Steyr M1912 black holster. There is a maker's mark on the back that reads "BURGHARD/PASING/1916" and it has a dual stripper clip pouch on the front. The holster shows scattered light flaking, scuffing and dirt staining. (207884-47P) [Craig Brown Collection]

2405. **REICHSREVOLVER HOLSTER LOT** This lot consists of a black leather 1904 style holster for the Model 1883 Reichsrevolver. The front of the holster is marked "L.G.06"

and there do not appear to be any other markings. The holster shows overall crazing, some flaking and crackling. (207879-47Q) [Craig Brown Collection]

2406. **GERMAN NAVY LUGER HOLSTER LOT** This lot consists of a black leather holster that appears to be for the Navy model Luger pistol. The front of the holster is marked in part "JUL. RICHTER/DRESDEN/1916". The holster appears to have been modified with the bottom being flat and there are a few areas of empty stitching holes. The holster shows scattered crazing, light flaking and scuffing. (207884-47R) [Craig Brown Collection]

2407. **STEYR M1912 HOLSTER LOT** This lot consists of an original dark brown leather holster for the Steyr M1912 pistol. The holster appears unmarked and there is an indiscernible written name on the back. The holster has a pouch on the front for stripper clips and it shows scattered scuffing and some light flaking. (207884-47S) [Craig Brown Collection]

2408. **GERMAN CZ-27 HOLSTER** This lot consists of a brown sheepskin holster for a German P.27/CZ-27 pistol. The holster appears unmarked and it has a magazine pouch on the front. There is scattered light flaking and some minor dirt staining. (207884-47T) [Craig Brown Collection]

2409. **C96 BROOMHANDLE HOLSTER LOT** This lot consists of a brown leather C96 Broomhandle holster. The holster appears unmarked, it has a dual stripper clip pouch near the flap and a cleaning rod pouch on the front. One of the belt loops has come loose, the holster shows scattered scuffing, some crazing and minor soiling. (207884-47U) [Craig Brown Collection]

2410. **STEYR M1912 HOLSTER LOT** This lot consists of a brown leather Steyr M1912 holster. The holster appears unmarked and it has a stripper clip pouch on the front. The holster shows some moderate flaking, scuffing and crazing. (207884-47V) [Craig Brown Collection]

2411. **STEYR M1912 HOLSTER LOT** This lot consists of a brown sheepskin German issue Steyr M1912 holster. The holster is dated 1918, it has an indiscernible maker's marking and it has a dual stripper clip pouch near the flap. The holster shows scattered light flaking and some minor soiling from the years. (207884-47W) [Craig Brown Collection]

2412. **GERMAN P.35 RADOM HOLSTER LOT** This lot consists of a tan leather German holster for the Vis. 35/P.35 Radom pistol. The inside is marked "gag5", "P.35 (p)" and has an added name that appears to read in part "R. RAMSEY". The holster shows scattered crazing, moderate flaking, light crackling and some scuffing. (207884-47X) [Craig Brown Collection]

2413. **MAUSER HSC HOLSTER LOT** This lot consists of a black cowhide holster for the HSC pistol. The rear is marked "fkx4" and the holster shows minor scuffing and a few spots of dirt staining from the years. (207884-47Y) [Craig Brown Collection]

2414. **REICHSREVOLVER HOLSTER LOT** This lot consists of an original leather German M/85 holster for the 1883 Reichsrevolver. The holster is marked "AWM/4/35", it is in about good condition overall with one of the belt straps having come undone at one end and the bottom tip missing. The holster shows overall crazing, some minor scuffing and scattered dirt staining. (207884-47Z) [Craig Brown Collection]

2415. **NORWEGIAN M1914 HOLSTER LOT** This lot consists of a Norwegian M1914 Kongsberg softshell holster. The holster appears unmarked and it has an overall darkened tan appearance. The holster shows scattered scuffing, crazing and some minor flaking. (207884-47AA) [Craig Brown Collection]

2416. **NORWEGIAN M1914 HOLSTER LOT** This lot consists of a Norwegian M1914 Kongsberg softshell holster. The holster appears unmarked and it shows scattered scuffing, some light flaking and crazing. (207884-47AB) [Craig Brown Collection]

2417. **STEYR 1912 ACCESSORY LOT** This lot consists of a reproduction Steyr 1912 holster, six stripper clips and a dual pouch. The holster is tan leather, it is marked "STEYR/1914" on the rear and shows some light wear. One of the clips is unmarked, the other five are marked "50" and some show some tiny specks of light oxidation. The black leather two-pocket pouch appears period and unmarked; there is an indiscernible name on the inside and the pouch shows scattered crazing and flaking. (208879-21)

2418. **U.S. M1 HELMET LOT** This lot consists of a front seam M1 helmet. The exterior of the helmet has a dark textured OD green paint. The exterior shows some flaking particularly around the rim, some minor scuffs and oxidation. The interior of the rim shows a few dented areas and some flaking. The interior of the dome shows some minor oxidation, scuffing and light flaking. The Firestone made liner has a "49" marking on the top, it shows some scuffing and a 1" crack at the rear. The helmet has swivel bales and blackened steel parts. A good example of an M1 helmet overall. (208842-1)



2407



2409



2410



2414



2415

2420



2419. **GERMAN CANTEEN LOT** This lot consists of a World War Two German canteen, cup, cover and bread bag. The brightly finished canteen is marked "W.A.L. 43" and it shows some tiny spots of light oxidation. The green cover shows some minor soiling and staining from the years. The black cup shows some moderate flaking of the enamel finish and dust staining. The breadbag shows some soiling from the years and light flaking. (207884-32C) [Craig Brown Collection]

2420. **LUFTSCHUTZ HELMET LOT** This lot consists of a dark blue Luftschutz helmet. The exterior shows scattered scuffing, some flaking and oxidation with a large patch of oxidation at front. The interior shows scattered light oxidation, dust staining and light flaking. The rear is stamped "R.L.239" and the top of the dome is marked "20" in white paint. The original liner shows scattered staining and soiling from the years and there is what appears to be an indiscernible name on one side. The clear plastic chinstrap shows some oxidation on the metal parts, a few cracks and scattered staining. The front exterior of the helmet is marked with a large orange paint "05/7", likely a Volksstrum marking. An interesting helmet overall. (207879-440CA) [Craig Brown Collection]

2421



2421. **LUFTSCHUTZ HELMET LOT** This lot consists of a dark blue Luftschutz helmet. The exterior shows a couple spots of light oxidation, some scuffing and light scratches from the years. The interior shows flaking throughout the dome giving way to oxidation, further scattered flaking, oxidation, scuffing and dirt staining. The liner is a bit loose, it shows some dirt staining from the years as does the clear plastic chinstrap. A good addition to your militaria collection. (207879-440CH) [Craig Brown Collection]

2422. **LUFTSCHUTZ HELMET LOT** This lot consists of a Luftschutz helmet with a field reapplied apfelgrun paint. The exterior shows scattered flaking with the two largest spots on top, some scuffing and light oxidation. The rim and the skirts have the same apfelgrun over blue paint with some scattered light scuffing and minor flaking. The dome has a dark blue paint with a few spots of oxidation, scattered scuffing and flaking. The liner shows some scattered light staining and soiling. The right side of the chinstrap is missing but the left half is present and it shows some dirt staining. A good affordable helmet for the World War Two collector. (207879-440CI) [Craig Brown Collection]

2423. **CZECH M32 HELMET LOT** This lot consists of a Czech M32 helmet with a dark blue over green paint. The paint shows overall flaking, oxidation on the base metal and paint staining. The interior has a green paint that shows oxidation around the rim with further scattered small spots of oxidation on the dome. The rear appears to be marked "BrahG & B Brno/-38/8" and there do not appear to be any other markings. One of the sweat pads has a large tear, all pads show scattered crazing, dirt staining and flaking. The chinstrap shows scattered flaking, crazing and dust staining. It is known that these Czech helmets were used by German second line and auxiliary units so it is probable that this helmet was used by such an organization. (207879-440CK) [Craig Brown Collection]

2423



2424. **LUFTSCHUTZ ADRIAN HELMET** This lot consists of a French M26 Adrian helmet that has an apfelgrun paint. The paint is fading to a brown patina, the paint shows some light oxidation, scuffs and minor flaking. The interior has the same apfelgrun paint with scattered light oxidation, scuffing and some runs in the paint. The liner is mostly separate from the helmet, it shows some crazing and dust staining. There is no chinstrap present on this helmet. The front has a white paint eagle over swastika Luftschutz insignia and it shows some light flaking. An interesting helmet that may benefit from further research. (207879-440CL) [Craig Brown Collection]

2424



2425. **GERMAN LUFTSCHUTZ HELMET** This lot consists of a German beaded Luftschutz helmet. The helmet has a gray Feldgrau paint that is turning to a gray oxidized patina with scattered dust staining and some light flaking. The interior has the same dark gray Feldgrau that is an overall oxidized patina with some heavy flaking at the top of dome giving way to oxidation underneath and scattered dust staining. The left side is marked "Q64" and there do not appear to be any other stampings inside the helmet. The liner is coming loose on the sides, it shows scattered crazing and dirt staining. There is no chinstrap present. The front of the helmet has a white Luftschutz decal with scattered light flaking and dirt staining. (1X208621-39)

2425



2426. **FRENCH M26 ADRIAN HELMET** This lot consists of a French M26 Adrian helmet that has a dark gray paint. The exterior shows some scattered light scuffing, flaking and a few spots of oxidation on the base metal. The interior has a sandy tan paint that is turning to a brown patina with some flaking, oxidation and scuffs. The liner is loose, it shows a couple torn sections, some dirt staining and crazing. The liner has two sets of black marker initials that appear to read "AES", the chinstrap shows scattered soiling and staining from the years. There is no badge or insignia on the helmet and it is possible that it may have been German used. A great helmet for the militaria collector. (207879-440CN) [Craig Brown Collection]

2427. **GERMAN GRENADE LOT** This lot consists of an inert Type 2 German 61mm anti-tank grenade. The grenade is marked "dot 44 (Eagle)/63" indicating manufacture by Brunn, it shows some pitting and oxidation staining. The grenade is mounted on a clear plastic display stand with a description. This type of grenade had a round nose, it was developed by the SS and it has an effective range of 75 to 100 meters. An interesting lot for the military collector. (207884-46W) [Craig Brown Collection]

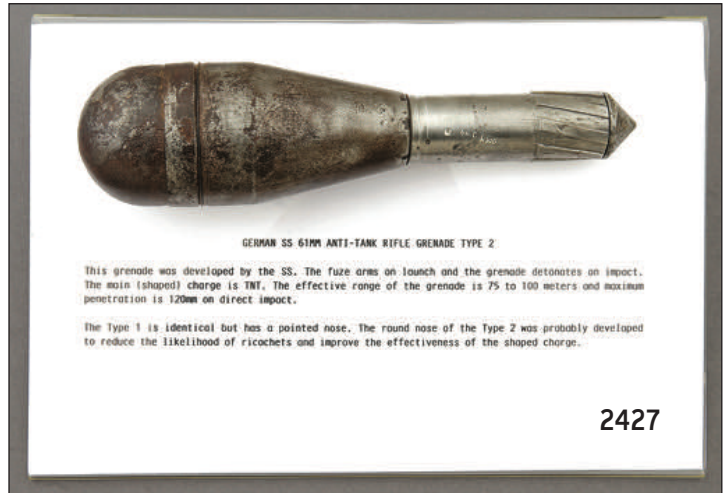

2428. **GERMAN GRENADE LOT** This lot consists of an inert Type 1 German 61mm anti-tank grenade. The grenade is marked "dot 1b 44 (Eagle)/63" indicating manufacture by Brunn, it shows some pitting, flaking and oxidation staining. The grenade is mounted on a clear plastic display stand with a short description. This type of grenade had a pointed nose, it was developed by the SS and had an effect range of 75 to 100 meters. A neat item for the ordnance collector. (207884-46X) [Craig Brown Collection]



2429. **GERMAN GRENADE LOT** This lot consists of a World War Two German 30mm combination grenade. The grenade has a black tip, yellow body and brown bakelite base. The paint shows scattered flaking and some freckling on the tip. The tip is coded "wa 43 489e", this grenade was designed to be used both as a hand and rifle grenade. An interesting piece of ordnance overall. (207884-46AA) [Craig Brown Collection]

2430. **GERMAN GRENADE LOT** This lot consists of a World War Two German 30mm combination grenade. The grenade has black base, yellow body and a silvery gray tip. The paint finish has mostly worn off with some moderate pitting on the body and scattered oxidation staining. The tip is coded "43 auz 438 (Eagle/Swastika)". A neat item for the ordnance collector. (207884-46AB) [Craig Brown Collection]



2431. **GERMAN GRENADE LOT** This lot consists of a World War Two German 40mm anti-tank grenade. The projectile is mostly a dull brown patina with scattered oxidation. The body shows scattered oxidation staining on the metal parts and some dings on the bakelite part. The grenade appears unmarked, this type of grenade used a TNT charge and had an effective range of up to 100 yards on an immobile tank. A neat item for the military collector. (207884-46AC) [Craig Brown Collection]



2432



2433



2434



2435



2432. **GERMAN GRENADE LOT** This lot consists of a World War Two German 46mm anti-tank rifle grenade. The grenade shows some scattered flaking of its black enamel paint that appears reapplied, a couple chips, some light pitting, crackling and silvering. There is a marking that appears to read in part "5a 42". This type of grenade was developed by the SS and had a TNT charge that was effective to 200 meters. A neat item for the cartridge or ordnance collector. (207884-46AD) [Craig Brown Collection]

2433. **GERMAN GRENADE LOT** This lot consists of a World War Two German 30mm anti-personnel rifle grenade. The body is green, the cap and fuse are black. The grenade shows some scattered flaking and small spots of oxidation. The cap is coded "wa 42 21ba", this type of grenade had a maximum effective range of 250 meters and a 25 meter fragmentation radius. A fine example of a hard-to-find grenade. (207884-46AE) [Craig Brown Collection]

2434. **GERMAN GRENADE LOT** This lot consists of a World War Two German 30mm anti-personnel rifle grenade. The body is yellow, the cap is brown metal and the fuse brown bakelite. The yellow paint shows overall flaking with oxidation on the base metal, oxidation throughout the cap and some flaking and dirt staining on the fuse. The cap is marked "AZ5071St 44 nho 28" and the body appears to be marked "44wa846i". A very good example of these interesting grenades. (207884-46AF) [Craig Brown Collection]

2435. **GERMAN GRENADE LOT** This lot consists of a World War Two German 30mm rifle grenade. The body was yellow, the cap brown and the fuse black bakelite. The body is mostly a brown patina with remnants of yellow paint, oxidation and some light pitting, the fuse shows some flaking, the cap shows scattered flaking and oxidation. The cap is marked "AZ 50/1 ST 44" indicating a steel fuse. An interesting rifle grenade. (207884-46AG) [Craig Brown Collection]

2436. **GERMAN GRENADE CRATE LOT** This lot consists of an empty 40mm German anti-tank grenade crate. The crate was made to hold 20 grenades, there are a few cracks in the wood, some dings and the wood has a dark blue paint that shows scattered flaking. The top and the left side of the crate are marked "gr.G.Pzgr" and the front has a Heer label in white paint that is partially illegible. The top of the lid on the inside has a label that is mostly torn away but it reads "20 Gewehr Panzergr" and it is dated 1943". A neat lot for the military collector. (207884-46AH) [Craig Brown Collection]

2436



2437. **GERMAN GRENADE CRATE LOT** This lot consists of an empty German 30mm anti-personnel rifle grenade crate. The exterior of the crate is marked "G.Sprgr." in two places in white paint and the interior label is marked "30/Gewehr-Sprenggranaten" and dated 1944. The interior label shows crazing and some torn sections. There are lengthwise cracks on the top and bottom of box, a few other cracks and some flaking paint. A great item for the World War Two collector. (207884-46AI) [Craig Brown Collection]

2438. **SS GRENADE CRATE LOT**

This lot consists of an empty SS 61mm anti-tank grenade crate that holds 14 rounds. The top of the box is marked "14/SS Gewehr Panzer-Granate61/SS-G.-Pz-Gr.61", there are the remnants of two labels, one on the top and one the left side. The inside of the box retains its label, it appears to be dated 1945 and is intact but crumpled. The crate shows a few cracks, some chips, scuffing, flaking feldgrau paint and dirt staining. An interesting crate for the German collector. (207884-46AJ) [Craig Brown Collection]

2439. **LEE 11MM MAUSER RELOADING DIE SET** This lot consists of a boxed Lee two-die set for the 11mm/.43 Mauser cartridge. The dies also include an instruction sheet, shell holder and a powder dipper. The unit appears used but has seen very light use and remains in excellent condition. (208877-15A)

2440. **LYMAN 50-70 GOVT RELOADING DIE SET** This lot consists of a boxed Lyman four die-set for the 50-70 Government cartridge. The dies remain in very good condition with some showing oxidation staining. An Allen wrench is also included. (208877-4A)
2441. **LEE 8X56R MANNLICHER RELOADING DIE SET** This lot consists of a boxed Lee two die-set for the 8x56 Mannlicher cartridge. The dies appear to have seen little use and included are an instruction sheet and a shell holder. (208877-23A)
2442. **LEE 8X57 MAUSER RELOADING DIE SET** This lot consists of a boxed Lee three die set for the 8x57 Mauser cartridge. The dies appear to be in very good plus condition, included are an instruction sheet, shell holder and powder dipper. (208877-11A)
2443. **LEE 303 BRITISH RELOADING DIE SET** This lot consists of a boxed Lee three die-set for the 303 British cartridge. The dies appear to be in very good plus condition, included are an instruction sheet, shell holder and a powder dipper. (208877-12A)
2444. **LEE 375 WINCHESTER RELOADING DIE SET** This lot consists of a boxed Lee four-die set for the 375 Winchester cartridge. The dies appear to be in very good plus condition with some minor tarnishing. Included with this die set are an instruction sheet, shell holder and powder dipper. (208877-6A)
2445. **JAPANESE TYPE 99 MUZZLE COVER** This lot consists of a Type 99 Arisaka brown plastic muzzle cover that appears original. The cover has a small crack, some dings and dirt staining. (208913-6A)
2446. **SMITH & WESSON K-38 MASTERPIECE BOX LOT** This lot consists of a single gold colored two-piece factory box from the 1946-1965 era with steel reinforced corners, blue printing on cover, slightly embossed image of a K-38 and a series of bullets on the gun's features. The end label is for a 6" barreled "K-38 Heavy Masterpiece" and the grease pencil number appears to be "K224602". The box rates about excellent with some soiling, strong intact corners but two drops of white paint on the cover. The paint should be able to be removed with some slow careful work but it may damage the cover. Overall, a nice find for the collector. (88903-32A)
2447. **IMPERIAL GERMAN HOLSTER LOT** This lot consists of an Imperial-era Luger holster, loading tool and magazine. The holster is brown leather, 1918-dated with a crisp "SCHWARZENBERGER / & CO / NURNBERG" stamp on the interior flap along with a black ink unit stamp "B.A. XI" and a faint "(Crown) / III" on the back side of the body. The holster remains in very good condition showing some small older glue repairs to the belt loops, some light scuffs, scratches and minor staining. The strap shows some minor cracking and the buckle is intact. The loading tool is mostly worn to gunmetal gray patina and shows rather heavy use with some older cleaned pitting and a crisp German Imperial acceptance stamp. The included magazine appears to be un-numbered and retains about 50% original nickel finish with spots flaking to gray-brown patina throughout, scratches and handling marks. The wood base shows rather heavy wear around the high edges and a thin hairline crack forming. A nice assortment of accessories for your Great War Luger. (138873-154A)
2448. **U.S. CIVIL WAR HOLSTER LOT** This lot consists of an original black leather flap holster for a Colt or Remington percussion revolver. This holster remains in about good overall condition considering its age. The body shows some moderate scuffing and flaking throughout while the flap is mostly a dark brown color. The back seam of the body has lost its stitching for about 2 1/2" at the bottom and top with a few other spots showing lost stitching. The holster body is nevertheless structurally sound and the bottom plug is intact. The flap shows a few small cracks and tears, there is a three hole strap present although it appears to have been re-attached long ago with a brass rivet, the belt loop and all of the brass hardware is intact. A very nice holster to accompany your Civil War revolver. (138735-4A)
2449. **FRENCH WORLD WAR ONE I.D. DISC LOT** This lot consists of three French World War One identity discs. The first is dated 1917 and bears the name "MAXIME HOAREAU" with the back stamped "MADAGASCAR / 3". The second is dated 1911 and bears the name "PIERRE DIDIER-LAURENT" with the back stamped "EPINAL / 1092". The final disc is dated 1917 and bears the name "Raoul SIMON" with the back stamped "Seine / 3e Bureau / 1135". All of the discs remain in very good condition showing some scattered small dents and light staining. French soldiers would wear these discs as bracelets in addition to their official dog tags in order to make identification a little easier if necessary. An interesting lot for the collector of Great War militaria. (138852-29A)
2450. **C96 REPRODUCTION STOCK LOT** This lot consists of one reproduction wooden shoulder stock for a German C96 pistol. The body and lid rate near excellent with a dark applied stain, some small scattered dings and handling marks. The lid closes securely and the stock attachment hardware is present. A very nice accessory overall that seems to be well-made. (138903-34A)



2451. **UNMARKED MILITARY SHOULDER HOLSTER** This lot consists of one military-style shoulder holster that appears reminiscent of those produced by German craftsmen immediately post-war for the occupying American GIs. The holster is light brown leather showing moderate scuffs, flaking and light staining throughout. The shoulder strap, retention strap and belt loop are all present, the shoulder strap showing some small tears forming. The retention strap and belt loop are both secured by large brass turn catches that have toned to an ocher patina with scattered light verdigris staining. The holster seems to fit a P.38 or Luger equally well. (138897-8D34228A)

2452. **41 SWISS RELOADER'S LOT** This lot consists of 65 previously fired and de-primed cases of converted 41 Swiss (centerfire), 16 have been converted from 348 Win and the remaining from 8mm Lebel. They all remain in very good plus condition showing some mild tarnishing. Also included are 49 flat point lead bullets about .43", weighing 300 grains and 3 dummy cartridges. (138877-16A)

2453. **POWDER FLASK BY DIXON** Plain bag shaped brass bodied flask measuring 6" and equipped with an exterior spring patent top and four position adjustable charger. The body shows a few small dents and light staining, still retaining much original lacquer and tight seams. The screw-off top is maker marked and part of the spring is missing, prohibiting the thumbpiece from operating properly. (57118-18A)

2454. **UNMARKED POWDER FLASK** French style bag shaped brass bodied flask with dual sided paneled beads, panoply of arms and floral motifs, measuring 5 1/2" and equipped with single hangers and a fixed common top and cup style charger. The seams remain tight, hangers are present and intact and the body shows a couple tiny dings and light oxidation, retaining much original brown lacquer. The brass top has a nicely tarnished patina with light wear along the edges; the charger cup is present and intact. A nicely decorated European manufactured flask. (57118-18B)



2456

2455. **LEATHER SHOT POUCH BY DIXON** 2 lb. plain bodied

leather flask equipped with a maker marked sterling silver adjustable charger graduated from 1 1/4 oz.- 1 1/2 oz. The body is in excellent condition with expected scuffs and crazing from the years, the seams remain tight and the hanger intact. The charger is equipped with a hallmark and has a nicely mellowed patina. The spring remains strong and the plunger operates properly. (57118-18C)

2456. **ANTIQUE FRENCH POWDER FLASK BY FARQUE FILS** This rather unique brass rectangular plain bodied flask measures 6 1/2" from the tip of the sloping charger to the edge of the lanyard ring. The flask also features a fingergroove cross-spring pump charger, threaded removable plug and a butter knife shaped iron belt hook and lanyard ring that is mounted to the base with small iron screws. The cylindrical shaped throat is maker marked "Farque Fils / a Paris" on the reverse side. Both the brass and iron clip have a nicely tarnished patina. A nice imported powder flask. (57118-16A)

2457. **UNKNOWN CONICAL BALL BULLET MOULD** This is a single cavity .485 dual groove conical ball mold, the markings are fading but what appears to be "RENSON" along the top shoulder of the left handle. The mould has toned to a brown and gray patina with scattered light oxidation and tiny impact marks. The mould is equipped with a butter knife shaped sprue cutter with a raised circular spout in the center. The cavity shows some light staining but clean edges. (57118-17B)

2458. **JAPANESE TSUBA** This is a semi-round copper Tsuba equipped with a single Hitsu-ana (auxiliary blade hole). The front is engraved with cherry blossoms, a silver inlaid flower on the side and a gold inlaid horse along the bottom while the rear has a single cherry blossom at the bottom. The Tsuba has a nice dark patina and perhaps one or two small dings along the outer edges. (57118-10A)

2459. **JAPANESE TSUBA** This is a highly decorative circular copper Tsuba equipped with a single Hitsu-ana (auxiliary blade hole). Both sides are engraved with flowing foliate scroll on a fine punch dot background which continues along the edges, the front is further decorated with a Samurai warrior. The copper has acquired a dark reddish-brown patina with thin verdigris staining along the background and traces of original gold wash is present on the Samurai and some of the scroll. (57118-10B)

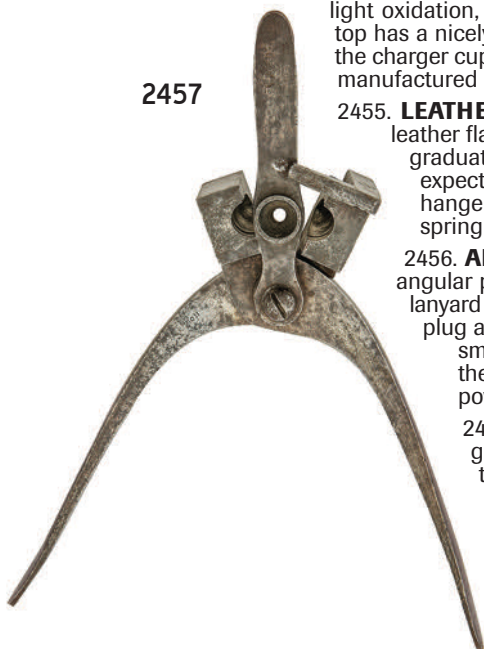

2457



2458



2459

2460. **JAPANESE TSUBA** This is a circular copper Tsuba equipped with a single Hitsu-ana (auxiliary blade hole and a Nakago-ana (center hole) that has been partially filled with copper for a shorter thinner tang leaving the edges a bit misshapen. The front of the Tsuba is decorated with four silver inlaid insects and the back has three simple inlaid silver chrysanthemums. The Tsuba has a dark patina which enhances the brightness of the inlays with exception of the later added filler. (57118-10C)



2460



2461



2461. **JAPANESE TSUBA** This is a circular iron Tsuba equipped with two Hitsu-anas (auxiliary holes) and a pierced iron gate design. The front of the Tsuba is engraved with a large flowering cherry blossom limb decorated with sporadic gold highlights while the rear has a much smaller branch with fewer gold highlights. The iron has toned to dark brown with scattered oxidation staining and pinprick pitting. (57118-10D)

2462. **JAPANESE TSUBA** This is an attractive Mokku shaped iron Tsuba with flying birds, flowing waves, a structured dam, pierced clouds and sky decorations and is signed along the Nakago-ana (center hole) on the rear side. The iron has toned to an even brown patina with some sparse fine oxidation staining. A nice, decorative signed Tsuba. (57118-10E)



2463. **GERMAN WEIMAR MILITARY FIFE WITH CARRYING CASE**

This is an unmarked rosewood fife measuring 15" overall and equipped with German silver ends. The body appears to be in very good plus condition showing no cracks and minimal wear from years of play. Accompanying the fife is a leather carrying case showing moderate flaking and scuffs and a faint 1931 dated Fischer maker mark on the back of the belt loop. Attached to the belt loop is an original Heeresbekleidungsamt "Nachprobe" (resample) tag dated "4 Juni (June) 1931" with perhaps 75% of the red wax inspection stamp still present. The seal shows cracks and light chips and the tag shows folds, age staining and worn edges from age. An interesting collectible for the music or military enthusiast. (57118-13)



2462

2464. **VOLQUARTSEN RUGER 10/22 CONVERSION UNIT** Enabling 22 Shorts to be shot from a Ruger 10/22 rifle, this kit consists of a Teflon coated alloy bolt with removable bolt handle, titanium firing pin, EDM extractor and reduced hammer spring. The recoil rod, rod spring and modified magazine are not included. The bolt is in excellent condition with only the handle retention screw showing slot wear. (57575-5)

2465. **UNKNOWN COLT STYLE BULLET MOULD** This is a two cavity .44 caliber bullet mould closely resembling a Colt mould for their cap and ball revolvers. The mould measures 5" from the hinge to the edge of the outward swept brass handles and is equipped with a rectangular steel sprue cutter. The only marking is an uneven "No 56" on the top of the cutter. The brass handles have a mellowed patina with scattered tiny impact marks and spots of oxidation and verdigris particularly at the bottom of the hinge. The pins and cutter have toned to brown and gray with scattered light surface oxidation. The round and conical ball cavities show some very light staining but the edges remain sharp and clean. (57118-19A)

2466. **UNKNOWN COLT STYLE BULLET MOULD** This is a two cavity .44 caliber bullet mould closely resembling a Colt mould for their cap and ball revolvers. The mould measures 4 7/8" from the hinge to the edge of the inward curved brass handles and is equipped with a rectangular steel sprue cutter. The bottom of the left handle flat is marked with scratch engraved letters that are undecipherable while the top is numbered "7864". The brass has a tarnished patina with some tiny nicks and scratches along the edges. The cutter retains about 60% flaking applied black enamel with light surface oxidation along the edges. The round and conical ball cavities show some light staining and old lead residue, the edges remain clean and uniform. (57118-19B)

2467. **ADAMS BULLET MOULD** This is a two cavity .44 caliber bullet mould for Adams .44 cal. revolvers. The mould measures 7" from the tip of the iron sprue cutter to the end of the brass handles. The right side of the handle flat is stamped with the Adams registered seal above "5180". The brass has a pleasing untouched patina that has mellowed nicely with age showing scattered spots of light tarnish and the cutter retains 85-90% original fire temper finish toning to brown with some sparse fine oxidation staining, the colors crisp and brilliant. The round and conical ball cavities remain clean with nice sharp edges. An excellent maker marked Adams bullet mould. (57118-19C)
2468. **BULGARIAN MODEL 1911 LUGER HOLSTER** This is a reddish-brown leather flap holster for a Bulgarian Luger pistol equipped with a side magazine pouch and single belt loop. The leather shows cracking, scuffs and staining from the years but remains soft, the stitching strong and the brass strap retention ring and plate intact. There are no maker markings visible. A very good Bulgarian holster overall. (57118-11A)
2469. **BULGARIAN MODEL 1911 LUGER HOLSTER** This is an unmarked brown leather flap holster for a Bulgarian Luger pistol equipped with a side magazine pouch and double belt loops, brass strap ring and plate. The belt loops are attached with different hardware and are slightly off-center, possibly field replacements. The leather shows modest scuffs, worn edges and dirt staining. The tip of the retention strap is missing, the stitching however is tight and intact. (57118-11B)
2470. **BULGARIAN MODEL 1911 LUGER HOLSTER** This is an unmarked brown leather flap holster for a Bulgarian Luger pistol equipped with a side magazine pouch, double belt loops, brass strap ring and plate. The leather shows light staining and scuffing, the front flap showing modest crackling and a small pinhole about 2" above the retention strap where a rivet and longer strap may have once been present. The leather remains soft and the stitching tight and intact. (57118-11C)
2471. **UNMARKED LEATHER FLAP HOLSTER** This is an unmarked brown leather flap holster for a High Power pistol equipped with a front magazine pocket and retention strap. The holster shows light edge wear, handling marks and age staining. The leather remains soft and pliable and the stitching tight and intact. A very good leather holster appearing to be original or at least a high-quality reproduction. (57118-11D)
2472. **BRITISH FLAP HOLSTER** This is a brown leather flap holster for a Webley RIC or Service pattern revolver. The holster features a wrap-around flap retention strap and two suspension straps equipped with brass spring hooks. The leather shows some light crazing along the top of the flap and some scattered very light scuffs. The stitching remains tight and there is a fading but still visible Wilkinson Pall Mall maker mark on the rear interior of the holster. A very good plus Wilkinson holster. (57118-11E)
2473. **BRITISH OPEN-TOP HOLSTER** This is a WWI era brown leather open top holster for a MKVI or similar Webley revolver. The holster is equipped with a wrap-over retention strap, dual brass wire belt hooks and a cleaning rod sleeve. The leather shows some scattered light scuffs and stains, a 2 1/2" area of tiny light scratches between the belt hooks and a small tear in one side of the stud hole on the retention strap and the other side starting to separate. There is no cleaning rod present. (57118-11F)
2474. **COMMERCIAL LUGER HOLSTER** This is an unmarked commercial brown leather flap holster for a luger pistol equipped with a single flap covered side magazine and cleaning rod pouch. The leather shows numerous scuffs, crazing and worn folded edges, the stitching is separating along the rear right edge leaving the covering loose. The flaps are equipped with cream colored Lucite snaps and there is no visible maker mark, the upper left corner of the front flap is numbered "4243". (57118-11G)
2475. **LOT OF BULGARIAN FLAP HOLSTERS** Two total: (1) brown leather flap holster quite possibly for a CZ27 or a Walther PP semi-auto pistol. The holster measures 7 1/4" x 5 1/2" wide and features a side magazine pouch, double belt loops, brass strap ring and plate. The leather shows some light scuffs with scattered stains and ingrained dirt and the stitching remains intact with a small repair along the bottom rear tip; (1) brown leather flap holster most likely for a CZ38 semi-auto pistol. The holster measures 8 2/5" x 5 29/32" wide and features a side magazine pouch, double belt loops and a brass strap plate, the retention ring is no longer present. The leather shows moderate fading, scuffing and rolled cracked edges. The retention strap shows light crazing and a large crack across the center that does not penetrate all the way through. (57118-11H)
2476. **UNMARKED BRITISH FLAP HOLSTER** This is a brown leather flap holster for a medium size Victorian pattern revolver. The holster features a wrap around flap retention strap and two suspension straps equipped with brass spring hooks. There is no visible maker mark and the leather shows overall crazing with modest scuffing along the corners and sides. The stitching remains tight and intact. (57118-11I)
2477. **BRITISH OPEN-TOP HOLSTER** This is a post-war era brown leather holster for a MKVI or similar Webley revolver. The holster is equipped with a wrap-over retention strap, dual adjustable strap belt loops and a cleaning rod sleeve. The leather shows light scuffs, handling marks, a small hole in the upper right front corner and verdigris on the brass hardware. There is a Hobson & Son 1949 dated maker mark between the belt loops and there is no cleaning rod present. (57118-11J)
2478. **UNMARKED LUGER HOLSTER** This is an unmarked tan leather flap holster for a P.08 Luger pistol. The holster is equipped with an adjustable flap retention strap, dual strap belt loops, side magazine pouch and a dual front tool pouch. The leather shows some light stains and scuffs, the stitching remains tight and intact. (57118-11K)
2479. **UNMARKED SWEDISH FLAP HOLSTER** This is an unmarked brown leather flap holster for a Swedish Model 1887 revolver. The holster is equipped with a retention strap, dual leather belt loops and a six-round cartridge holder on the front of the holster. The leather shows scattered scuffs, rub marks and crazing. The short left side belt loop is equipped with an iron ring and a longer newer strap has been added with two large bright steel rivets. The remaining stitching remains tight and intact. An about very good Swedish Nagant style holster. (57118-11L)
2480. **UNMARKED SAME BROWNE HOLSTER** This is a black leather flap holster for Webley & Enfield .455 caliber service revolvers with no visible maker mark or date. The holster is equipped with a brass stud and retention strap for the flap and a large rear belt loop with original brass bar and hook attachment to Same Browne belt rigs. The leather shows light crazing and handling marks, the retention and hook straps have rolled tips, the stitching remains tight and intact. A very good plus holster overall. (57118-11M)
2481. **U.S. G.I. FLAP HOLSTER AND WEB BELT** This lot consists of an O.D. web belt, magazine pouch and leather flap holster for the 1911 series of pistol. The web belt has no visible markings and rates very good plus with expected age staining, fading finish on the connectors and light verdigris on the brass hardware. Attached is a L-F Co. 1951-dated dual magazine pouch which rates very good plus as well showing light scuffs, handling marks and verdigris on the hardware. The leather flap holster is from Enger-Kress but is not dated, "CPT GAFF" is written in black ink below the maker mark. The holster is in about very good condition overall with scattered handling marks some light flaking and cracking. The stitching remains intact and there is light verdigris on the hardware. (57118-11N)

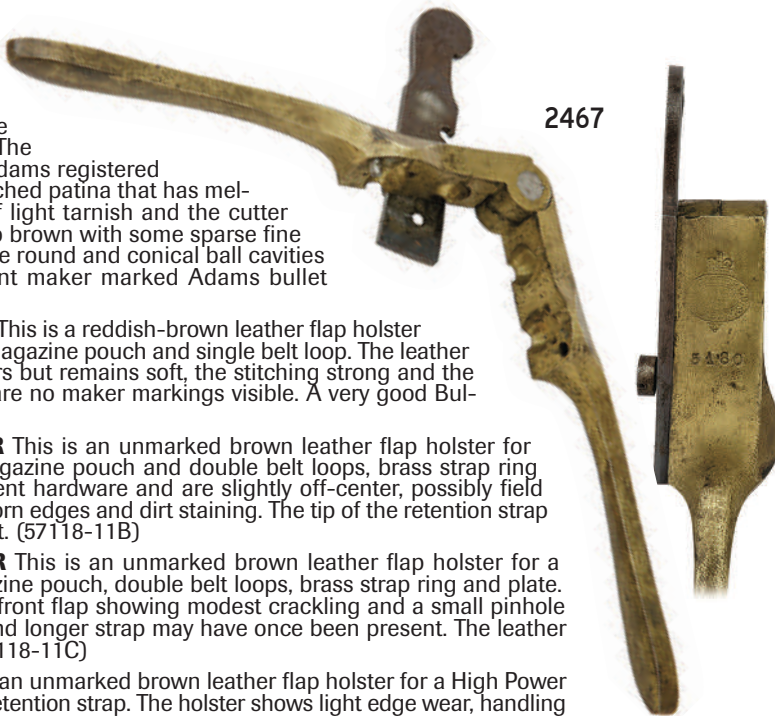

2482. **LOT OF REPLICA BRITISH SAM BROWNE AMMO POUCHES** This lot consists of two replica brown leather ammo pouches that go on the Sam Browne belt rig, one more darker then the other. The pouches measure 4" x 5 3/8" and feature a flap with a single brass stud and retention strap, the lighter of the two having a much wider belt loop. Both pouches rate near excellent appearing to be modern with sparse light storage marks and light verdigris forming on the studs, the stitching remains tight around the peripheries. (57118-11P)

2483. **ANTIQUE POWDER MEASURE** This is a rather neat and interesting powder measure by John Wilkinson of Plattsburg, N.Y. The measure is composed of a gray cast iron frame and spout and a copper drum centered between a brass lid and base. The drum rotates via a large and small folded brass handle and the top is equipped with a single plain pourer. The frame is shaped for mounting to a bench and is secured by a large thumbscrew, additionally there is an iron arm that mounts to the top of the drum and is height adjustable via a small thumbscrew possibly for different size drums. The arm is fastened to the lid with a small screw and pin, the pin appears to be frozen in place preventing the arm from sliding upward. The top of the base is marked "J.D. WILKINSON / PLATTSBURG NY / PATD JULY 1877". A measure similar to this one is pictured on pg. 109 of Kelder's book RELOADING TOOLS, SIGHTS AND TELESCOPES for Single Shot Rifles. There is no funnel or canister present. A wonderful antique measure by a maker of fine N.Y. percussion rifles. (57118-16B)



2483

2484. **REMINGTON 870 BARREL** 12 ga., 28" single bead ventilated rib Rem-choke barrel with a bright excellent bore. The barrel retains 98% plus original graphite black Cerakote finish with some light silvering around the bead and some sparse fine oxidation along the rib. Included is a full choke tube. (58916-3A)

2485. **REMINGTON 870 BARREL** 12 ga., 20" slug barrel with a bright excellent bore choked improved cylinder. The barrel retains 98% plus original graphite black Cerakote finish with a couple light rub marks and specks of very fine oxidation. Barrel is equipped with an orange post front sight and an adjustable green fiber optic rear sight. (58916-3B)

2486. **RWS DIANA MODEL 48/52 SIDE COCKING AIR RIFLE** serial #02060639, 22 cal. pellet, 17 1/4" barrel with an excellent bore. The metal surfaces retain 99% original blue with some light storage marks along the edges. The plain hardwood pistolgrip stock rates excellent with a couple tiny handling marks. The factory sights are in place and mounted to the factory rail is an RWS Model 400 2-7 x 32mm scope with a duplex reticle and clear optics. An excellent precision German air rifle. (58893-7) {NON-GUN} (200/300)

2487. **SHERIDAN BLUE C SERIES AIR RIFLE** serial #489724, 20 cal. pellet, 19 1/4" barrel with a bright excellent bore. The metal surfaces retain 98-99% original blue with a couple minor rub marks from storage. The plain pistolgrip hardwood stock and forearm rate very good with light scuffs and handling marks. (58752-2)

2488. **IMPERIAL GERMAN FLIGHT BADGE** This lot consists of a boxed WWI Imperial German flight or pilot's badge that is housed in its original case. This Weimar vintage collectible is cast from silver and was made by C.E. Juncker in Berlin. The badge features the Imperial crown with non-outlined cross on top and has a wreath bordered flight scene with single wing plane aloft over the German countryside. The badge is marked "C.E. JUNCKER" on the back and has the crescent moon and "800" as was correct for pieces of this era. The clasp is a simple hinged pin with hoop, the hinge is properly recessed. The silver has a light tarnish but is still mostly bright. The black case has a purple lining and rates near excellent. A special and unique accessory of the Imperial German Empire that appears to be original. (48235-2A)

2489. **IMPERIAL GERMAN OBSERVER'S BADGE** This lot consists of a boxed WWI Imperial German observation badge that is housed in its original case. This Weimar vintage collectible is cast from silver and was made by C.E. Juncker in Berlin. The badge features the Imperial crown with non-outlined cross on top and has a wreath border with enameled square single shield in center that has the black and white checkerboard pattern in center with red border. The background has the ray pattern. The badge is unmarked and has the ray pattern back that is worn mostly smooth. The clasp is a simple hinged pin with hoop, the hinge is properly recessed. The silver has a light tarnish but is still mostly bright. The black case has a purple lining and rates near excellent. A unique accessory of the Imperial German Empire that appears to be original. (48235-2B)

2490. **IMPERIAL GERMAN AIRSHIP BADGE** This lot consists of a German Imperial Navy Commemorative Airship Badge or "Navy Zeppelin Badge". This horizontal series badge was issued post World War I in the 1920's and is one of the more prized flight award badges. It features a Zeppelin airship in center of a wreath with the Imperial Prussian crown on top. The badge is silver plated with some light wear and abrasions on the front. The back is marked "C.E. JUNCKER / Berlin" and has the correct style clasp and stabilizing hook. The silver has a mild tarnish but overall the badge appears to be original. (48235-2C)



2488



2489



2490



2491



2492



2493

2491. IMPERIAL GERMAN PILOT'S BADGE This lot consists of a German Imperial commemorative silver pilot's badge that is not maker marked but appears to be original. The badge features an Imperial style crown and has a wreath with flying eagle in center of a landscape. The back has what appears to be three hall marks, one is a cross the other two are not discernable. The reverse side of the eagle is marked "800". The pin is copper or brass and is likely a later replacement. The silver has some mild tarnish but is overall in near excellent condition. (48235-2D)

2492. IMPERIAL GERMAN PILOT'S BADGE This lot consists of an unmarked silver plated Imperial German pilot's badge. The badge features an Imperial style crown with detailed cross on top and has a wreath with single wing plane flight scene in center. The reverse side is flat with no visible markings but has a correct styled pin. The silver has a mild tarnish and the badge is in very good condition. (48235-2E)

2493. IMPERIAL GERMAN PIN This lot consists of an Imperial German Pour le Merite pin, better known as the Blue Max. The Kingdom of Prussia's highest military decoration. The pin is in very good condition with some minor loss to the blue enamel on the front. Established as a Prussian military merit award in 1667 by Elector Frederick of Prussia and revised in 1810 by King Frederick William III for outstanding bravery

on the battlefield. This order of merit was generally awarded to high-ranking officers. In World War I, the decoration became famous because it was awarded to German aviators. One of the early recipients during the war was flying ace Max Immelmann also awarded to famous aviators such as "the Red Baron" and Herman Goering and has not been awarded again since 1918. The name of the medal is in French because that was the language of the Prussian court when the medal was created and the medal's color and Immelmann's fame led to the British calling the medal the Blue Max. An incorrect ribbon is included, but the pin is likely an original example. (48235-2F)

2494. VINTAGE BOX LOT This lot consists of two vintage factory pistol boxes. First is a red and black two-piece box for a Ruger Standard Pistol. Marked for 4-3/4" barrel No.RST4 the box has some fraying and wear along the edges and corners. One corner is separated at the seam. The second is a blue and silver Bangor Punta box for a Smith & Wesson Model 15 revolver. The box has some tears and oxidation to the corner braces. It contains the instruction sheet and end label for a Model 15 revolver. Both are in about very good condition overall. Also included are a folded pamphlet "The Evolution Of The Colt: From the year 1836", a Remington Model 700 Varmint Special hang tag, A Winchester information booklet on the NEW 12 gauge 2-3/4" magnum and an instruction card for setting Poly Choke sleeves. (47613-7A)

- 2495. LOT OF ASSORTED GRIPS** This lot consists of an assortment of nine sets of assorted grips. Included are eight grips for Colt firearms and one set of laminate wood grips for a Galesi pistol. The Colt grips include: one set of reproduction hard rubber grips for the 1903/1908 Hammerless pistol, one set of checkered wood grips for the 1903/1908 Hammerless pistol, one set of wood lined synthetic stag grips of the 1903/1908 Hammerless pistol, three right side grip panels for the 1903/1908 hammerless pistols that are broken or repaired, one Pachmayr Gripper for the Colt I frame revolvers, one set of factory checkered walnut grips for the Police Positive, one set of factory checkered walnut grips for the Official Police and Officers model revolvers, and one set of checkered walnut target grips for the Officer's model revolver. The condition ratings of the grips range from very good to excellent. Also included is an excellent condition 10" long nylon zippered pistol rug. (47613-6,7B)
- 2496. CLAY THROWER LOT** This lot consists of a Remington Automatic Hand Trap clay thrower. The hand thrower trap is in excellent condition and included is the original box. The box has some minor foxing and staining. (46054-52)
- 2497. LOT OF 6.5 MS BRASS** This lot consists of ten boxes of 6.5x54 Mannlicher Schoenauer rifle brass. First are three Midway boxes of fired brass, two boxes with 20 pieces, the third with 18 and one piece of primed brass. Second are seven white handwritten boxes with 94 pieces of unprimed Midway brass and 40 pieces of fired brass. All are in excellent condition. (46054-27)
- 2498. HOLSTER LOT** This lot consists of two Hunter brand holsters in their original boxes. First is a style 1100 size #14 right hand belt holster for a large frame revolver with barrel up to 6". Next is a style 1100 size #10 right hand belt holster for a medium frame revolver with up to 6" barrel length. Both are unused brown leather and are in need of touching up due to storage. The boxes have crush damage and tears at the edges and corners. (43638-42)
- 2499. HOLSTER LOT** This lot consists of a vintage Lawrence brown leather holster for a 5-1/2" Single Action Army or similar revolver and cartridge belt. The holster rates near excellent and has some light scuffs and other handling marks. The belt is unmarked and appears to be a size small. The leather is faded and flaking heavily, the loops fit a 38 caliber cartridge. A very good vintage western style rig that could have some use left. (47094-4)
- 2500. BROOMHANDLE MAUSER LOT** This lot consists of a reproduction wood shoulder stock/holster for the Mauser C96 Broom-handle pistols. The wood stock is unmarked but is in excellent condition. The brown leather holster system is also unmarked and in excellent condition. It contains a spare magazine spring and cleaning tool. (47094-7)
- 2501. HUNGARIAN HELMET LOT** This lot consists of a Hungarian M38 steel helmet. The helmet is unmarked and painted a dull battleship gray with areas of minor to moderate flaking. The chinstrap and most of the interior are intact. A very good example overall. (47094-5)

2502. **U.S. WEB GEAR LOT** This lot consists of a U.S. web belt with 1911 flap holster, canteen, magazine pouch, first aid kit and lanyard. The holster appears to be a newer reproduction and all are in excellent overall condition. (47094-6)
2503. **LOT OF GUN RUGS** This lot consists of three items. First are two zippered pistol rugs, one 14" the other 17". Next is a 48" long fleece long gun sleeve with Velcro closure. All are in excellent condition. (47094-8)
2504. **PEWTER GUN PIN LOT** This lot consists of six firearm shaped pewter pins. Included are three M60 style pins (M60S), two H&K Mk 23 pistol pins with silencer (S45S) and one M16 rifle pin with the M203 grenade launcher and a banner that reads "I DON'T DIAL 911" (911S). All are in excellent condition and in their original packaging. One of the H&K pins is missing the internal backing card. (47524-9A)
2505. **SHOOTER'S LOT** This lot consists of 12 sporting related items. First is a full bag of Southern Bloomer .223 Cal cleaning patches #122. Next is an NcStar 308 caliber laser boresighter that is sealed in its original packaging. Third is an NcStar 30-06 caliber laser boresighter that is missing its batteries. Fourth is a Springfield Armory cable lock. Fifth is an Outdoor Connection black nylon Express2 sporting sling. Sixth is an Uncle Mike's #8602 size 2 black nylon pancake style ambidextrous holster for 4" medium frame revolvers. Seventh are two Duluth Trading Co. black nylon pouches with belt clips for cell phones, magazines or other accessories. Next is a gray pouch with Velcro flap by Norelco. Tenth is a U.S. military cleaning kit for the M16/AR-15 series rifles in an OD green nylon carry pouch. Eleventh is a set of Uncle Mikes QD 1-1/4" sling swivels (1403-3) in their original packaging. Lastly are a set of swivel studs that have wood screw threads. The lot rates excellent. (47524-10)
2506. **CROSSBOW LOT** This lot consists of a Cobra System self-cocking crossbow pistol. The crossbow is sealed in its original packaging with operating and assembly instructions printed on the backside of the outer sleeve. Three brass bolts are included. Also included is a Omer Tempest 2000 harpoon pistol. No parts or accessories are included, just the base of the pistol. (47524-4)
2507. **FLARE PISTOL LOT** This lot consists of a 12 gauge marine flare launcher. The launcher is designed after a Deringer style pistol and has a bright orange grip. It is housed in the original box and includes three flares and the instruction sheet. An excellent accessory for the boat or any survival situation. (47524-7)
2508. **LOT OF LEAD PROJECTILES** This lot consists of two boxes of lead muzzleloader projectiles. First is a full box of 100 Hornady .451 round balls. Next is a box with 20 .54 caliber sabot rounds, each with a .45 caliber lead hollow point projectile. All are in excellent condition. (47524-10C)
2509. **CIVIL WAR BELT LOT** This lot consists of a reproduction black leather gun belt with "US" bronze buckle. The belt holds a Cabela's black flap holster to fit an Army style percussion revolver and has two Triple K musket cap pouches. The belt is unmarked but appear to be a size medium. All are in excellent condition. (47524-16)
2510. **DECORATIVE PISTOL LOT** This lot consists of a decorative reproduction non-working percussion center hammer style pistol. This is a Spanish made replica and comes in its original box. The pistol is ornate and has a wood grip that has some light dings and other handling marks. The action functions correctly. This is a cast metal pistol that cannot be loaded or fired. (48795-3A)
2511. **SCOPE BASE LOT** This lot consists of an assortment of scope bases and rings with about 15 items in total. Included are: one Weaver #402M base, one Weaver #55 base, one Weaver #20A base, one Weaver #47 base, two Weaver #15 bases, two Weaver #46M bases, one Weaver #93 base, one Weaver #1 sideplate base with no screws, two sets of Weaver 1" rings, two sets of aftermarket rings (one is missing the top screws), one Bausch & Lomb L.S.A.-55 base, and a set of Uncle Mike swivels screws. The Weaver bases are all in as-new condition and in their original packaging with the exception of the #1 sideplate. All the remaining items are in excellent condition. (46758-52L)
2512. **GUN CARE LOT** This lot consists of an assortment of gun cleaning and refinishing items. Included are: on Birchwood Casey Perma Blue liquid gun blue kit, one Hoppe's #9 .22 caliber rifle cleaning kit, one Outers all-gauge shotgun cleaning kit, one Outers 20 gauge shotgun cleaning kit, and three Hoppe's #9 stock refinishing kits. All appear unused and are in their original packaging. (46758-52M)
2513. **BORE SIGHTING LOT** This lot consists of a BSA bore sighting kit. The kit contains the bore sighter and 15 arbors ranging from .177 caliber to .50 caliber and the kit is housed in its original container. An excellent example overall. (46758-52N)
2514. **RELOADING LOT** This lot consists of seven items. First is a Lyman single stage reloading press. Second is an RCBS Uniflow powder measure with stand, and two disassembled tumblers. Third is an RCBS loading block. Next are a scale tray and RCBS neck brush with handle. Next are two copies of the Hornady Third Edition Handbook of Cartridge Reloading. Lastly is a Lee Powder Measure kit in the original box. All are in very good condition. (46758-52O)
2515. **RELOADING LOT** This lot consists of three sets of reloading dies. Included are: a set of RCBS 38/357 dies, one set of Herter's 244 Rem dies, and one set of Lee 222 Rem dies. All are in excellent condition. (46758-52P)
2516. **HARD CASE LOT** This lot consists of a wood hard case for pistols or other accessories. The case measures 25" wide by 17" high and is 4-1/2" deep. There are a few minor chips and light handling marks on the exterior and the interior is lined with foam that has some light staining. The case is secured with two simple, non-locking latches and the handle is becoming separated on one end. A very good example that would likely hold a number of small handguns. (45105-6)
2517. **SHOOTER'S LOT** This lot consists of an assortment of recoil pads and other accessory items with about 20 items in total. Included are: one replacement timer switch for an RCBS tumbler; one Beeman basic airgun maintenance kit; one ITC cheekrest kit; one Pachmayr small black slip one recoil pad; two Pachmayr White Line rifle pads in their original boxes - one black, one brown; one leather rifle rest bag; one box with parts for a Freeland scope stand and other target swivels; two leather comb risers; one 45 caliber GI cleaning kit; one checkered steel GI buttplate; and nine assorted solid and vented recoil pads, some with screws. All are in very good to excellent condition. (44457-4F)
2518. **FISHING CREEL LOT** This lot consists of two whicker fishing creels. The first measures 13" x 9" x 7" and has leather reinforced edges and bracing and a leather shoulder strap. The whicker remains intact, the leather is drying but still mostly supple, the buckle that secures the lid is becoming detached. The second is a more basic model and measures 12" x 7" x 5-1/2". It too has a leather shoulder strap that is becoming stiff the lid latch is a simple wood slide, the hoop portion has become detached but the remainder of the creel is still intact. Also included is a small worm tin that is painted green. A nice vintage fishing lot for your rustic décor. (45872-29A)
2519. **FRENCH ILLUMINATOR LOT** This lot consists of a French "Projecteur Lumineux Type Campana" rifle illuminator training device by Andre Losfeld in its original case. The case is marked "appareil d'entrainement au tir de jour et de nuit" which translated to "day and night shooting training apparatus". The case holds the illuminator, leather attachment straps, bulbs, battery pack, bulbs and connecting parts and appears to be complete. The instruction manual is also included. Designed to be utilized on a variety of French military arms, this device was to be used to train soldiers and correct deficiencies without the use of ammunition during times when post war ammunition shortages were prevalent. The kit appears to be in as-new condition and would make an interesting addition to a French Military collection. (45354-8A)

2520. **FRENCH ILLUMINATOR LOT** This lot consists of a French "Projecteur Lumineux Type Campana" rifle illuminator training device by Andre Losfeld in its original case. The case is marked "appareil d'entrainement au tir de jour et de nuit" which translated to "day and night shooting training apparatus". The case holds the illuminator, leather attachment straps, bulbs, battery pack, bulbs and connecting parts and appears to be complete. The instruction manual is not included. Designed to be utilized on a variety of French military arms, this device was to be used to train soldiers and correct deficiencies without the use of ammunition during times when post war ammunition shortages were prevalent. The kit appears to be in as-new condition and would make an interesting addition to a French Military collection. (45354-8B)
2521. **MILITARY FLAG LOT** This lot consists of a U.S. Army signal flag kit in the original canvas holster. Included are four signal flags: red over white, white over red, red with white square and white with red square; and three poles, one with an extension section. The flags have minor staining but appear to be intact. The canvas holster has some minor staining as well and all are in very good condition. (45872-16A)
2522. **AR-15 LOT** This lot consists of a two items for the AR-15 platform rifles. First is an unmarked aluminum alloy foregrip that mounts to a picatinny rail and secures by turning the screw base. Second is an unmarked scope base to fit the A2 style carry handle or detachable carry handle for A3 style rifles. Both are in excellent condition. (48873-577B)
2523. **TACTICAL LOT** This lot consists of a Condor nylon tactical gun case. This padded desert tan colored case measures 36" long and features exterior pockets and MOLLE style attachment loops. Also included is a M16/AR-15 military style cleaning kit. An excellent accessory for your tactical carbine. (48871-16B)
2524. **AR-15 LOT** This lot consists of an adjustable carry handle mount by Midwest Industries. The mount attaches to the carry handle and has a picatinny type forward rail that can be adjusted for height. An excellent example of these milled accessories. (48916-11A)
2525. **AR-15 CONVERSION LOT** This lot consists of a Colt AR-15 22 LR conversion kit. Included are the bolt carrier group assembly with chamber insert and two Colt factory 22 LR magazines. These kits are designed to be drop-in, and use the existing charging handle. No additional fitting or parts are required for use. An excellent example that will turn your quality 223 or 5.56 AR rifle or pistol into a fun and economical plinker. (48882-11A)
2526. **STACK-ON GUN SAFE** This lot consists of a Stack-On GS-212 heavy gauge steel gun safe. This hunter green finished safe measures 59" tall x 21" wide and is 19.5" deep and weighs between 200-250 lbs.. It features a mechanical combination lock and has rack storage for up to 12 long guns with a single shelf for additional storage. There is no additional fire protection or fire rating for this model. There are a few minor scratches from installation but overall this basic utility safe is in near excellent overall condition. The original scope spacers and mounting hardware are included and the factory label is still attached to the door. Please note that due to its size and weight this item cannot be shipped. (48884-3)
2527. **GRANITE SECURITY GUN SAFE** This lot consists of a Granite Security R-19 "Ranger" series gun safe. This vintage matte black, heavy duty gun safe measures 60" tall x 24" wide x 18" deep and weighs about 525 lbs.. The gray interior will hold up to nine long guns and has shelves for additional storage. The safe features a 10 gauge steel body with a 1/4" thick door which has an LG Safeguard electronic lock that appears to function correctly. There are minor scratches and handling marks from previous moving and installation but this quality American made safe is in near excellent condition overall. The original product catalog and lock instruction sheet, as well as a small bottle of touch up paint, are included. Please note that due to its size and weight this item cannot be shipped. (48872-12)
2528. **LOT OF BRASS** This is a lot of approximately 500 rds. of unprimed 8mm Nambu brass from fired casings including about 75 that are reformed. Nice clean and excellent condition lot. (78001-9B)
2529. **LOT OF BULLETS** This lot consists of about 300 rds. of loose 8mm Nambu, 102 gr., bullets in excellent condition. (78001-9C)
2530. **LOT OF DIES** This is an RCBS three die set for 8mm Nambu. The group H set comes with shell holder, de-capping pin, instructions booklet, data sheet and original plastic case. This is an excellent condition set. (78001-14A)
2531. **LOT OF BULLETS** This lot consists of three boxes of 38 cal. (.357"), 158 Gr. bullets: (1) containing approximately 200 rds. of Berry's Preferred Plated; (1) virtually full 100 rd. and (1) containing approximately 80 rds. of Hornady HP/XTP. The bullets are in excellent condition. (78001-12A)
2532. **LOT OF BULLETS** This lot consists of four 100 rd. boxes of Hornady XTP, 41 cal. (.410"), 210 gr., HP/XTP: (3) full and still factory sealed; (1) containing approximately 28 rds. This is an excellent condition Lot of Bullets that come in a metal military ammunition can. (78001-12B, 20B)
2533. **LOT OF BULLETS** This is an apparently full 250 rd. box of Nosler Sporting Handgun, 44 cal., (.429"), 240 gr., HP in excellent condition. (78001-12C)
2534. **LOT OF BULLETS** This lot consists of approximately 320 loose rds. of 8mm Nambu by an unknown maker and in excellent condition. (78001-9D)
2535. **LOT OF BULLETS** This lot consists of five packages: (1) full 100 rd. box and (1) containing approximately 60 rds. of Sierra 6mm. (.243 dia.), 75 gr., HP; (1) virtually full 100 rd. box of Sierra 6mm. (.243 dia.), 100 gr., semi-pointed; (1) box containing approximately 50 rds. of Speer 6mm (.243 dia.), 80 gr., Spitzer SP. (1) bag containing approximately 100 rds. of Winchester 30 cal. (.308 dia.), 150 gr., Silvertip. The overall condition of the lot is very good to excellent with some showing isolated faint dark spots. (78001-12D)
2536. **LOT OF BULLETS** This lot consists of two boxes of 45 cal.: (1) containing approximately 110 rds. of Berry's Preferred Plated, 230 gr., FMJ; (1) containing approximately 180 rds. of 230 gr., semi-wadcutter, FMJ by an unknown maker. The condition rating of this lot is excellent. (78001-12E)
2537. **LOT OF BRASS** This lot consists of six zip-lock bags including the first five which are 100 rd. size of Winchester: (1) factory sealed and (1) apparently full of 41 Rem. Mag.; (1) apparently full of 44 S&W; (1) nearly full and (1) containing about 60 rds. of 38 Special. The first five are new and the final bag which contains about 100 rds. of 38 Special has been fired and cleaned. The brass is unprimed and in excellent overall condition. (78001-11)
2538. **LOT OF PRIMERS** This lot consists of three full 1000 pc. boxes of CCI 500 small pistol primers contained in 100 pc. trays and in excellent condition. (78001-10A)
2539. **LOT OF PRIMERS** This is a lot of two full 1000 pc. boxes of CCI 500 small pistol primers contained in 100 pc. trays and in excellent condition. (78001-10B)
2540. **LOT OF PRIMERS** This lot consists of three packages: (2) full 1000 pc. boxes of Sellier & Bellot 4,4 SP Boxer small pistol primers contained in 100 pc. trays and in excellent condition; (1) zip-lock bag with 383 small rifle primers by CCI, contained in 100 rd. trays and showing the onset of verdigris. (78801-10C)
2541. **LOT OF DIES** This is a lot of three sets of dies, each consisting of three dies housed in RCBS plastic cases: (1) RCBS carbide for .44 magnum/.44 special with shell holder, two de-capping pins, seating stem, spacer ring, instruction manual and unused data sheet and rating excellent; (1) excellent condition RCBS steel for .41 magnum with bullet seating stem, instruction manual and unused data sheet; (1) Herters steel for .44 magnum/.44 special with instructions and applicable cartridge listing card and rating very good to excellent. (78001-14A)

2542. **LOT OF DIES** This lot consists of three sets of dies in original plastic cases: (1) Bonanza 2 die for .223 Rem. with Lee shell holder and trim assembly, instruction manual and "Trouble Shooting" instruction label; (1) RCBS 2 die for .243 Win. with instruction manual and unused data sheet; (1) RCBS 2 die for .308 Win. with instructions and unused data sheet. The overall condition of the lot is very good to excellent. (78001-14B)
2543. **RELOADERS LOT** This is a lot of components for .223 Rem.: (3) full 50 rd. Herters plastic cases and (4) 50 rd. zip-lock bags of cleaned and reprimed 1981 dated Lake City casings; (1) zip-lock bag containing 21 rds. of cleaned and reprimed 1970 dated Frankford Arsenal casings; (1) zip-lock bag containing about 100 cleaned, unprimed Federal casings; (1) zip-lock bag containing 23 rds. of 2011 dated Lake City cleaned and unprimed casings; (1) apparently full box of Sierra .22 cal., .224 diam., high velocity 55 gr., FMJ BT bullets; (1) apparently full 100 rd. box of Hornady .22 cal., 55 gr., .224 diam. FMJ BT bullets (1) bag of approximately 200 rds. of maker unknown 224 dia., FMJ BT bullets; (4) full 100 pc. trays and (1) containing 15 pcs. of CCI 400 small rifle primers and housed in original box. The lot rates excellent and comes in a U.S. military metal ammunition can. (78001-17, 20C)
2544. **LOT OF CLEANING SUPPLIES** This is a lot of two items beginning with an excellent condition Hoppe's cleaning kit for long guns, in original plastic case and consisting of three piece aluminum rod of 11" each, unused small caliber brush, plastic slotted tip, about 20 patches, a virtually full 3 oz. can of lubricating oil and a nearly full 2 oz. bottle of No. 9 solvent. The other item is a three piece aluminum cleaning rod #2010 by Allison-Faulkner with wood handle, measuring 34" when assembled and accompanied by a brass bristled brush and swab, each showing some use and metal slotted tip. Included is the original two piece factory box. (78001-13L)
2545. **HOLSTER LOT** This is a remarkable U.S.M.C. M7 shoulder holster with straps and showing little indication of use. The brown leather body remains supple and virtually free of scuffs on the exterior, there are a couple of minor contact marks along the interior. The oval U.S. marking is bold and crisp as is the stamp on the back which reads "USMC/Boyt/45". The brass hardware is fully intact and there is some verdigris in contact areas. Overall an excellent condition Marine Corps. holster for the .45 caliber pistol. (78001-6BA)
2546. **LOT OF HOLSTERS** This lot consists of six items including four right handed belt holsters for revolvers and beginning with one from the renowned Denver maker, Heiser, this one, a 436 with nice black leather and crisp company logo on brass snap. It rates excellent as does the next one which is a 623 by Challenger in russet brown and also with all hardware and stitching intact. Next is a Lawrence 540 that is suitable for a Colt Chief .38 or similar revolver. This brown leather holster also rates excellent. The last holster is a black nylon Uncle Mike's Size 3 rating excellent. The last two items in the lot are black leather magazine carriers, each with loops for belt attachment and both with dual single stack magazine capacity. One is a Bianchi suitable for medium caliber and the other is a Safariland for larger magazines. Both show some light handling marks. (78001-6BB,BC, 2B)
2547. **BAYONET LOT** This is an excellent condition U.S. M7 bayonet by Conetta with all metal retaining nearly all of its original finish and grips showing sharp checkering. The correct OD green U.S. M8A1 scabbard marked "PWH" also rates excellent with canvas belt hanger showing mild contact wear. Included is original lanyard. (78001-4A)
2548. **LOT OF SPEEDLOADERS** This lot consists of four HKS speedloaders in excellent condition: (2) of model 29, suitable for 44 mag. and 44 special; (2) of model 57, suitable for .41 magnum. (78001-2A)
2549. **MISCELLANEOUS LOT** This lot consists of two items beginning with a Colt manufactured 20 rd. AR15 magazine with strong spring, retaining perhaps half of its original phosphate finish and exhibiting a few scattered scratches and some adhesive residue. The other item is a U.S. practice grenade marked "RFX55" and "N3". The "egg" style inert grenade rates excellent, retaining nearly all of its original OD green finish and the lever, pull ring and safety pin remain intact. (78001-4B,5)
2550. **LOT OF SCOPE RINGS** This lot consists of a pair of Sako 1" Split Ring (currently marketed as Optilock) scope mounts. These blued-over rings are the high variation (15/32") and appear as new in factory box. (78001-6A)
2551. **LOT OF DISPLAY CASES** This is a lot of four S&W factory display cases fitted for N-frame revolvers and constructed of finger jointed mahogany. The first two measure 11 1/2"x 7 3/4"x 3" and are French fitted to hold a single four inch barrel revolver and feature individual compartments for a cleaning rod with brush, bore mop and screwdriver sight adjustment tool. The wood exhibits a few scattered scratches and the interior blue flocking shows contact wear and fading, particularly on one. The other two measure 14" x 7 3/4"x 3" and are formed to hold revolvers with six inch barrels. Their interiors feature black plastic molding with a single compartment for accessories; only one retains the compartment lid. The upper section consists of protective foam and the wood exteriors show a few scratches particularly on the lighter finished one that has a somewhat compromised front latch, the other rates about excellent. All in all a nice opportunity to upgrade your S&W N-frame display capability with factory presentation cases. (76819-14A)
2552. **FACTORY BOX LOT** This is a single S&W two-piece gold box with metal reinforced corners that was produced from 1946-1965. The blue graphics indicate that it originally held a 357 magnum revolver with a 6 1/2" barrel and with a blue finish. One side of this box is hand numbered in large black writing as being serial #74646. The top has a notation written in pencil and there are a few small scuffs and the bottom has some areas of mild dirt but overall this is a near excellent condition box and included is an unopened cleaning kit that is correct for the period and consists of rod, bristle brush, mop and sight adjustment tool. (76819-14B)
2553. **LOT OF FACTORY BOXES** This lot consists of a total of 12 factory handgun boxes including ten that are S&W, of which six are of the two piece variety with metal reinforced corners with end labels for the following models: 22/32 Kit Gun with 4" barrel, 67 with 4" barrel, 14-2 with 6", 66-1 with 4", 28-2 with 4" and the sixth is missing the label but enclosed is an instruction sheet for a K-38 Masterpiece stainless revolver model 67. The one piece boxes have end labels of the following: 52-2 with 5" barrel, 560 with 6", 211 with 6" and one with missing label but with paperwork for a model 29 with 6" barrel. The last two in the lot are Browning starting with a hard plastic case for a BuckMark with 4" barrel, and a one pc. box with Styrofoam insert and excellent correct magazine for a Buck Mark Plus with a 5 1/2" barrel. The overall condition is about very good plus with some handling marks and soiling here and there and few still retain their original manuals/papers. (76816- 14C)
2554. **LOT OF NEWS RELEASES** This is a lot of five original WWI era news photo posters issued for the Connecticut State Council of Defense. Each of the 18 1/2"x16" posters is highlighted by a large 15"x9 1/2" black and white photo or drawing of an interesting and pertinent occurrence or theme of the period. Four of the dramatic releases include headers that read "Fighting in France for Freedom!—Are YOU Helping at Home?"; while the other states "Remember the Boys in France!—Write Them Often" and are identified as News Photo Posters Nos. 20, 21, 25, 26 and 34; Illustrated Current News, New Haven, Conn. The respective scenes consist of a photo of soldiers hustling to long ranged guns to take down oncoming airplanes, a drawing by London Sphere artist F. Matania depicting an interrogation of a captured and brave "Britisher", a drawing for the "Herald" depicting an American mother offering her son to the draft board as part of a request for citizens to contribute to the Liberty Loan Campaign, a photo of a group of Marines who were apparently injured in battle assigned by the War Dept. to speed up the Liberty Loan Campaign and a photo of German soldiers attempting to save one of their balloons by forcing the air to escape as they are in retreat mode toward the end of the war. The posters have been folded in quarters, contributing to the onset of separation at the edges of three; also evident are other minor isolated tears and soiling but overall a well-cared for grouping of documents from that important era in our history. Included is a plastic cover over a cardboard backing that would serve as a protective housing. (77541-7)

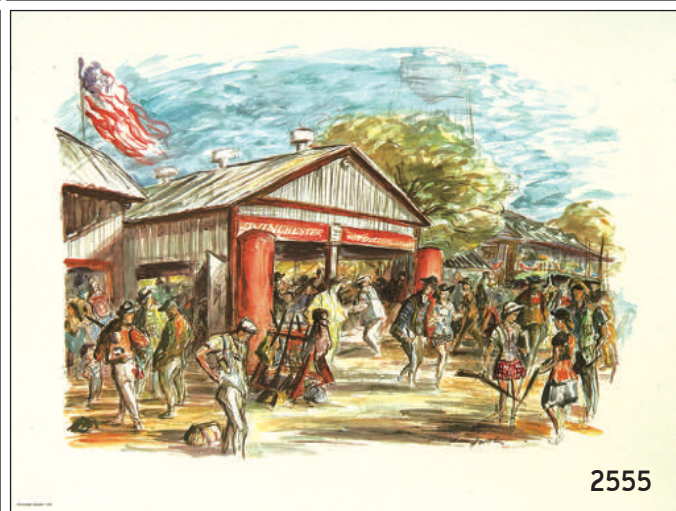

2555

2555. **LOT OF PRINTS** This is a lot of four lithographic prints of scenes from the 1961 Grand American World Trapshooting Championship held in Vandalia, Ohio. These are prints from original watercolors and signed by American artist John Groth (1902-1988) who was commissioned by Winchester-Western to attend and paint scenes at the event. This is a complete set of a limited edition that was issued to the company's primary dealers. The Vandalia location was used from 1924-2005 and the artist's themes are Trader Camp, Scoreboard, Firing Range and Western Pavilion. Examples of Groth's work are displayed at prominent museums such as The National Art Museum of Sport, Inc., The U.S. Dept. of the Interior Museum and The National Portrait Gallery. The 14"x10 1/2" prints with 12"x8 1/2" full color scenes are enclosed in individual clear plastic covers affixed to cardboard backings and remain in excellent condition. (77541-5A, B, C, D)

2556. **LOT OF PRINTS** This is a lot of two Spanish American War based examples by Truth Magazine and printed by The American Lithograph Co., beginning with one that reads "This Picture is Issued with TRUTH No. 587, July 20 1898." The 35"x11" piece is titled A Yard of Heroes and consists of an unidentified artist's drawing of the faces of eleven important U.S. figures from the war with Admiral of the Navy George Dewey serving as the centerpiece. The heroes are identified by their last name depicted below their respective images that are wonderfully presented in color and accented by a decorative red, white and blue border. The piece has been carefully preserved showing a 1" tear at the left edge, a 4" tear at the top and a couple of areas showing some mild contact marks. The other piece is identified as "...No. 500, August 10 1898," a watercolor by Truth's special artist, H. Reuterdahl, after a sketch by an officer of the U.S.S. America. It is titled "Defence of Camp McCalla," subtitled "Holding their Own. U.S. Marines Defending their Position at Guantanamo Against A Spanish Column", and consists of a dramatic and tense scene with about a dozen Marines in the act of firing their rifles, aided by artillery fire just beside them and a fallen Marine serves as a focal point at the lower center of the full color presentation measuring 25 1/2"x11" and showing a 1" piece missing at the lower right corner, a few small tears, a uniform crease at the center, presumably at the time it was originally distributed and a couple of other creases from having been folded. Both of the pieces in this lot are currently covered in clear plastic and resting against a protective cardboard backing. (77541-6A,B)

2557. **LOT OF PRINTS** This is a lot of two period prints by Truth Magazine commemorating U.S. efforts in the Spanish American War. The first one is another copy of "Defence of Camp McCalla" that is also described in the lot above, this one has a series of small pieces that are missing at the lower right, another small section missing at the left edge and a couple of small tears at the far right. The scene depicts Marines valiantly holding their ground, aided by nearby artillery fire and there are ships evident in the background behind a plume of smoke. The other item is titled "First Attack by Admiral Sampson on San Juan, Puerto Rico, May 12th" with very small print at the top stating "This Picture is Issued with Truth No. 586, July 13, 1898" and depicts sailors aboard the U.S.S. Iowa firing at the enemy and alongside them are the U.S. ships Indiana, New York and Amphitrite, a dramatic scene with Spanish gunfire exploding violently in the waters nearby. A small section of the lower right corner has separated but is present but otherwise there are only insignificant blemishes. The 25 1/2"x11" lithographs are covered in clear plastic taped to a cardboard backing. (77541-6C,D)

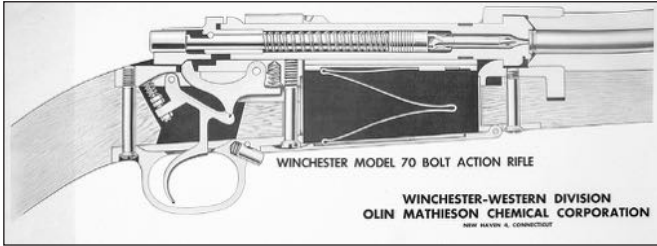
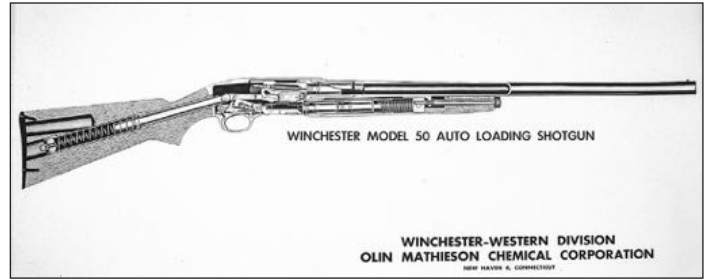
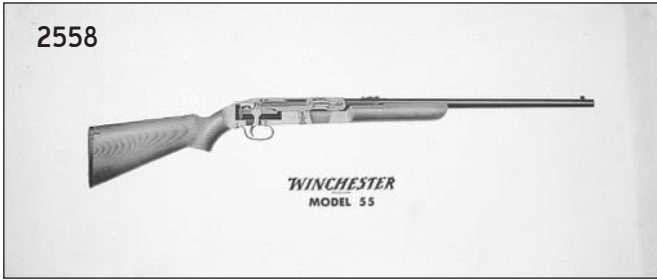

2558. **LOT OF DISPLAYS** This is a lot of three cut away drawings, each based on a particular Winchester model with the first two measuring 35"x15" and depicting a model 70 bolt action rifle and a model 50 semi-auto shotgun. Both contain the company name at the bottom displayed as follows: "Winchester-Western Division/Olin Nathieson Chemical Corporation/ New Haven 4, Connecticut". The first one is a close-up of the action area only and is captioned "Winchester Model 70 Bolt Action Rifle" whereas the one with the caption "Winchester Model 50 Auto Loading Shotgun" depicts the entire length of the gun and includes a cutaway of the buttstock area as well as that of the action. The last one is of a model 55 and is a bit larger, measuring 40"x17", the drawing, of the entire gun, a small section of the buttstock allowing for viewing the placement

with the cutaway effect focusing on the middle/action portion and of the screw. The identification simply reads "Winchester/Trademark/Model 55". The posters rate excellent overall with uniform folding creases at their centers. (77541-3F,G,H)

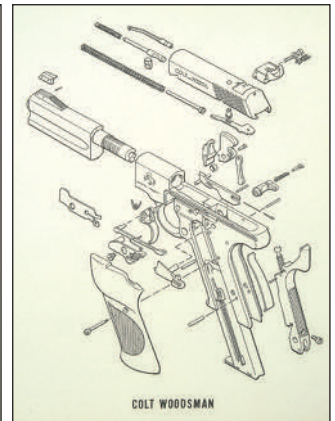
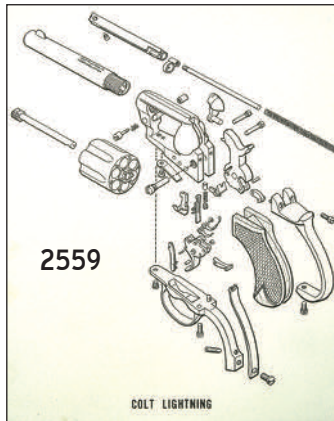
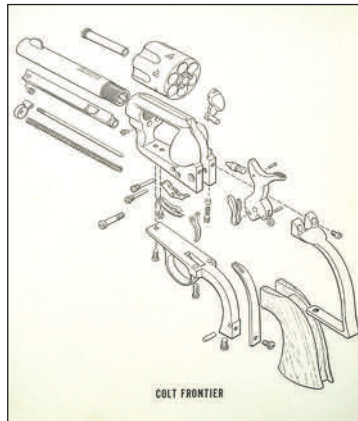
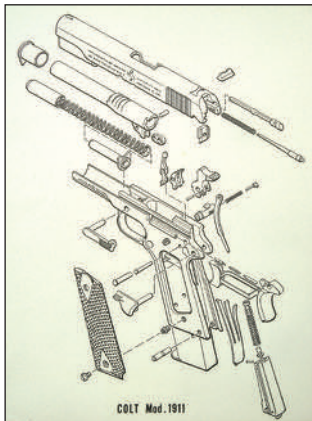

2559. **LOT OF PRINTS** This is a lot of four exploded-view drawings of Colt handguns consisting of Lightning, 1911, Woodsman and Frontier. The 17 1/2"x 14" black and white sheets contain up-close and crisp presentations of the various parts with no numbers or identification tables, each covered in clear plastic adhered to a cardboard backing and rate excellent overall. (77541-11G,H,I,J)



2560. **LOT OF PRINTS** This lot consists of three retail display advertisements for Winchester products. The 1970's era posters each measure 30"x15", making use of a vertical and color presentation with the majority of their surfaces promoting the respective firearm(s) making use of pictures by unidentified artists and the lower section informing the prospective buyer that they should always use Winchester ammunition. The first one has a header that reads "Winchester Shotguns Sold Here" and the illustration is of a close-up of a hunter taking aim. The second one reads "Winchester 22 Rim Fire Rifles Sold Here" and the picture is an extreme close-up of a woodchuck in the act of eating some form of vegetation. The last one reads "Winchester Center Fire Rifles Sold Here" and shows a black bear in an upright position superimposed over a larger scale view of a hunter peering through optics and with text below it that reads "Choose from a wide selection of Model 70s for big and medium game and varmints or select the famous Model 94 lever action rifle". The sheets remain in excellent condition and are currently sleeved in clear plastic with a cardboard backing. (77541-11AA, AB, AC)

2560



"Worked Over"
by Charles M. Russell



2562



2561



2561. **LOT OF PRINTS** This lot of two prints, each measuring 23"x17 1/2", with a wild west theme begins with one showing a young Buffalo Bill riding a white horse on the frontier with rifle in hand and scouting ahead of a line of soldiers behind him. Depicted underfoot is "The Scout Buffalo Bill Hon. W.F. Cody". The print is not signed but "The Scout" is the 1888 work of American/French artist Paul Frenzeny (1840-1892). This is a clean poster with a vertical presentation with a 1/2" wide white border and small print at the bottom left that reads "C. Carl Wray Card Co., 1966/This is an Authentic Reproduction of an Actual "Buffalo Bill" Show Bill." The other print makes use of a horizontal layout with a wider white border that measures 1 3/4" wide and within it resides the scene titled "Worked Over" by Charles M. Russell, an illustration of two cowboys on horseback looking down where there are livestock settled in around a water hole with a mountain range and calm sky serving as a backdrop in this serene and full color illustration produced in 1925. Charles Russell nicknamed "the cowboy artist" is renowned as a great artist that completed over 2000 paintings based on the Western United States and was also a sculptor and author. This print rates about excellent with some minor isolated soiling and there is small print at the lower right that includes "Reprinted by permission of the National Cowboy Hall of Fame by Winchester-Western". The prints in this lot are individually sleeved in clear plastic that is taped to cardboard backings. (77541-11P, S)
2562. **LOT OF PRINTS** This is a lot of two prints with large bold headers that read "Buffalo Bill's Wild West" and with 1966 copyright dates by Carl Wray Card Company and each of the 23"x17 1/2" posters stating that "This is an authentic reproduction of a Buffalo Bill Show bill used in the 1890's". The first one is set up vertically to exhibit a close-up drawing of an older Buffalo Bill, depicted with white hair and beard and with a gleam in his eye, producing the impression that he is on an important scouting expedition, atop a proud white stallion, a jagged and rugged mountain range serving as a backdrop. The other poster makes use of a horizontal layout with a younger Cody, illustrated with dark and streaming hair taking shot at colorful targets, apparently of clay, being tossed midair by his companion, an Indian who like Buffalo Bill is riding at full gallop upon horses expressing some concern over the festivities. A playful and colorful piece of art work that like the other one in this lot is not signed by its creator and rates about near excellent with only minor handling marks. (77541-11Q,R)



2563

2563. **WWI RED CROSS POSTER** This is an original poster promoting the joint efforts of the American Red Cross and the Departments of War and Labor in their pursuit to encourage employers to hire veterans. An impressive illustration by Dan Smith (1865-1934) serves as a means to do so with its captivating, full color imagery of a U.S. Marine regiment charging into battle in France with bayonets fixed, U.S and Regiment flags raised boldly and with air support overhead. Displayed over the smoky-gray sky is a large golden badge listing the battle names Cantigny, Chateau Thierry, St. Mihiel, Argonne and Marne. The message below the fiery illustration reads: "Put Fighting Blood in Your Business-Here's his record! Does he get a job?" and accredited to Arthur Woods, Assistant to the Secretary of War. The poster measures 28"x19" with the Dan Smith illustration comprising 26 1/2"x14" including its effective 1/2" wide olive green border. The surface is quite clean, displaying a few very small sections outside of the illustration that are missing. An impressive and rare piece of WWI era memorabilia designed and printed by Thomsen Ellis Co. of Baltimore and New York. Included is a clear plastic protective sleeve adhered to a cardboard backing. (77541-11M)
2564. **WINCHESTER PROMOTIONAL LOT** This is a lot of two items beginning with a print with a colorful tom turkey presented in the foreground of a forest environment encompassed by a natural toned and flowing border, all above a turquoise colored backdrop to the caption "The Cock of the Woods". Below that is a promotion to use Winchester shotgun shells with several displayed in a colorful arrangement. The entire sheet measures 20"x16" including the 3 1/2" wide white border. Excellent condition, very clean Winchester poster. The other item is a newspaper style layout serving as a means for store owners to select ad mats amongst a wide range of offerings presented by Winchester-Western in this "four page newspaper". The "front page headline" reads in bold font "Advertising In Your Local Newspaper Builds Sales". The 1963 dated paper shows no tears and is essentially free of soiling, has been folded in quarters and retains the creasing that reflects this storage method. Much of the perimeter and the areas at the creases exhibit a darker or tan tone to the paper that measures 22 1/2"x 15 1/2". Included with each item in this lot is a plastic cover/cardboard backing combination. (77541-11T,U)
2565. **LOT OF PRINTS** This lot consists of two posters commissioned by Winchester-Western, each measuring 28"x14" including illustrations measuring 24"x8" and presented in a horizontal configuration beginning with the one titled "Texas-Frontier of Freedom" by Bernie Fuchs (1932-2009), a colorful abstract style arrangement of historical people, concepts and events that characterize the frontier period of Texas. It is easily recognizable as it is the illustration used on the picture sleeve of the Winchester '94 Lone Star Commemorative factory box. Bernie Fuchs was an illustrator for major national publications such as McCall's, Redbook and Sports Illustrated, drew portraits of world renowned personalities and was also commissioned to do illustrations for U.S. postage stamps. The other poster is titled "East meets West" and is an illustration celebrating the accomplishment of May 10, 1869 in Promontory, Utah where the completion of the meeting of the Central Pacific and Union Pacific Railroads occurred. It captures the moment with flair and grace as many individuals who have travelled from afar to witness this unique moment in history are presented in this painting by an unknown artist along with the steam engines and fuel cars of each railroad as they are settled within mere feet of each other. This illustration is also very recognizable in that it is used for the picture sleeve for the factory box of the Winchester '94 Golden Spike Commemorative. Each poster in this lot rates about near excellent with minor isolated creasing and soiling evident in areas and included are plastic covers and cardboard backings for each. (77541-11AE,AG)

2566. LOT OF FIREARMS MEMORABILIA This lot consists of two original items with a Winchester theme beginning with a 12"x9 1/2" document that was originally generated to announce that The New Haven Arms Company had obtained the rights to manufacture "Volcanic Repeating Fire-Arms" and apparently distributed this information sheet, or advertisement if you will, to prospective purchasers. The company information reads: "New Haven Arms Company, New Haven Conn. Office and Depot of Sales, 267 Broadway, New York. Joseph Merwin, Agent. New York, May 1, 1859." The other item is not dated, but is a document generated by Winchester announcing the manufacture of "The Winchester Repeating Rifle" and stating that it is capable of "two shots a second". The two different variations of what eventually would be identified as the Model 1866 are exhibited in the form of illustrations facing in opposite directions, one above the other. The announcement includes several paragraphs of text detailing the advantages that it possesses over all competitors and goes on to provide an itemized breakdown of options and their respective prices. The bottom section is remarkable in that one can truly recognize how long ago this sheet was produced as it reads "O. P. Davis, Sec'y." and "O.F. Winchester, Pres't." Each document rates excellent with no blemishes worth mentioning. (77541-11V, AF)

2567. MEMORABILIA LOT This is a lot of two vintage calendars and a print. The calendars are for the years 1939 and 1941 and were issued by industrial giant Dupont to be distributed to its many facilities. Each measures 19 1/2"x16" with plastic binding and each includes a cover page discussing the overall theme. That of the 1939 issue exhibits aerial photographs of 14 of the company's plants bordering a signed message from the company president at the time, Lammot du Pont to its employees discussing its impressive safety record and declaring that this calendar is dedicated to efforts for continued safety in the workplace. The pages of each calendar month include colorful works of art of historical American events and with captions that provide a connection with the benefits of being safety oriented. This is a 14 page publication (the page of the month of February has been removed) with the back two pages serving as instructions in the case of a workplace emergency. Examples of events presented by way of the impressive and classic paintings are The Oath of Allegiance-Valley Forge-1778, The Battle of Lake Erie-1813 and The Pilgrims First Feast of Thanksgiving-1621. The condition has been retained quite nicely with a little soiling on the cover page and some small tears on the last page. The 1941 issue has a cover that features a photograph of and signed message by then company president Walter S. Carpenter, Jr. and like the one described above and all Dupont annual company calendars of that period, it is dedicated to safety. Carpenter relates how this concept extends further and goes on to state that in 1941 "a major part of our national security effort is based on industry and on production". Each monthly page consists of a scene of early America portrayed by impressive artwork in vibrant colors intended to inspire all to perform their national duty. Examples include scenes involving historical figures such

as George Washington, Abraham Lincoln and William Penn. The calendar is complete with the top center of each page bearing a hole that resulted from having been hung, but otherwise it rates about excellent. The last item in the lot is a print measuring 12"x9" of an illustration titled "Widgeon", by Ducks Unlimited artist John W. Taylor, with captions consisting of "Winchester News Bureau" and "Christmas 1968" and depicting a male and female pairing of American Wigeon ducks in a weedy, aquatic setting as they observe the approach of two others nearby. It rates excellent and, like the calendars, is protected by a clear plastic sleeve attached to a cardboard backing. (77541-4A, B, 11W)

2568. PRINT LOT This is a large poster measuring 40"x26" produced in 1955 as part of a four poster series by Olin Matheison Chemical Corp., each depicting a different animal to be hunted and used to promote Western-Winchester products. This one shows a large close-up of a darting rabbit in full stride with remnants of snow flying off its paws as it is about to be shot at by a hunter that is shown in the background along with a grouping of trees, all in a snowy winter setting. The cold but exciting moment is captioned by the Western and Winchester trademark names presented in large, bold red graphics just below the rabbit. The painting is by American artist Weimer Purcell (1906-1974), a graduate of the Chicago Art Institute and a noted poster artist who did work for the travel and advertisement industries. This poster, enclosed in a protective clear plastic sleeve that is attached to a cardboard backing, is free of creases with little indication of any soiling, with only a couple of small pieces missing from the lower left corner area. (77541-11C)

2569. LOT OF PRINTS This is a lot of four with a Civil War theme beginning with two black and white prints of paintings with similar styles but are not signed and with each measuring 14"x11". The first one exemplifies the exploits of Union General Philip Sheridan, in this case he is portrayed on horseback in the heat of battle, hurtling over the enemy's barrier while boldly exhibiting the flag of the Army of the Shenandoah, a battle in which he defeated Confederate General Jubal Early to take control of the Shenandoah Valley. The other one depicts a Union officer as a focal point of a dramatic and violent scene of Union soldiers in their quest to advance beyond a barricade against strong Confederate firepower. This could easily be interpreted as General Ulysses S. Grant in his capturing of Fort Donelson in the heart of Tennessee in February, 1862. The third print measures 24"x16" with an oval shaped layout of 40 carbines with corresponding identifications. The center of the oval, which measures 19 1/2" at its widest point, reads in a variety of period fonts: "Breech Loading/Carbines/submitted by inventors to a board of officers convened/ by order of the/Secretary of War at the National Armory/ Springfield, Mass. U. S. A./ on the Fourth of January 1865.". The last item is quite large, a 41"x28" full color display, dated 1960, exhibiting a ribbon



2568

identifying the piece with "Civil War Centennial". The print shows multiple and diverse graphics arranged in an entertaining yet informative layout. Included is an upper section with the images of ten prominent individuals of the period, five from each warring faction and arranged on their respective side of the crossed flag display at the center and bordered by larger images of Generals Grant and Lee at their respective ends. Also included is a large map with chronological legend identifying important battles and presented on a drape with images of representative soldiers on either side. The entire display has a 1 1/4" gold border containing the names of 25 different battles, several of which are represented by dramatic illustrations within and surrounding the map. The prints in this lot have been meticulously cared for and rate excellent showing only the slightest of blemishes, if any, and each is protected with a plastic sleeve and cardboard backing. (77541-11A, N, X, Y)

2570. **ADVERTISEMENT LOT** This is a store advertisement for Lefever guns and measures 25 1/2"x22" and shows striking, actual size and vibrant color illustrations of the center portion of three models and includes their prices in bold red: Nitro Special Double, Long Range Single Barrel Field and Trap Gun and New Single Barrel Trap Gun The poster also shows "Lefever Guns" in red above the images and below them resides "Lefever Arms Company, Incorporated/1929 Ithaca, New York 1929". There is also a small cut-away diagram for the double and the sheet is equipped with reinforced corners. There is minor soiling evident in isolated areas and there are creases from having been folded. (77541-11K)
2571. **LOT OF ADVERTISEMENTS** This is a lot of two store advertisements for Winchester-Western Components, each with upper and lower plastic bindings and exhibiting the rider-on-horse logo and bold red company names displayed at the upper left corner. The first one measures 29 1/2"x23" and the top shows in large blue font "Components" and below that is "A complete line of quality-matched components... from a single source". Below that is the main body with three separate vertically arranged sections including the two on the sides that have a royal blue background to their respective displays: one with the header "Rifle, Pistol and Revolver Cartridge Cases" and the other with "Jacketed and Lead Bullets". These sections include actual size images with identifications of a total of 57 cartridge cases and 61 bullets and the middle row consists of the following categories of products and photos: Ball Powder Propellant, Wads and Primers. There is also a standard shot chart at the bottom. The second ad is larger, measuring 36"x30 1/2" and it displays the term "components" in the same red as the company names and is just below it. To the side of that and at the top in large blue font is "Ball Powder for the Reloader" and below that in black is "available in 6 Convenient Sizes". The main body consists of four actual size photos of example products, one for each size available and with the respective codes for the products available in that size and above them are detailed explanations for each component. These ads remain crisp and vibrant, in excellent condition, showing no negatives worth mentioning. (77541-11B, D)
2572. **LOT OF ADVERTISEMENTS** This lot consists of the oversized reproductions of two black and white ads that ostensibly originally appeared in The Saturday Evening Post magazine. The first one measures 31"x11" and bears the date April 29, 1922 under the periodical name at the top. Within the bordered ad is the header in large font: "Winchester Tools" and below that is an illustration that consumes about half of the ad surface of someone working on the wheel hub of a period automobile with a tool kit laid out in the foreground and below the picture is an extensive explanation of the many rewards for choosing Winchester Tools. This is an excellent condition memorabilia item. The other poster in this lot has a less vertical configuration as it measures 31"x22" but has similar characteristics as the first with the large header again announcing boldly: "Winchester Tools" below the top section that informs: "The Saturday Evening Post" and in this instance, "March 4, 1922". The illustration in this ad consists of a close-up view with a Winchester marked hammer lying on a front porch along with a screwdriver and pliers nearby with the pleasant view of the front yard in a fairly upscale appearing neighborhood. Below it are several paragraphs pronouncing the unequalled qualities and also enticements to purchase the items available from the legendary manufacturer. The poster has folding creases and some minor tears along them, with a few others, mainly at the edges but overall a clean and interesting item that like the first one is marked in small print at the bottom left "National Process Co., Inc. N. Y. City". Both are also covered in clear plastic along with a cardboard backing. (77541-11F, AD)
2573. **LOT OF RETAIL ADS** This is a lot of two advertisements issued by Winchester for store owners to display on their walls. The first poster which measures 34"x15 1/2" was produced to announce the introduction of the Big Bore 94, 375 Winchester in 1978 for the XTR and the full color poster features at its center, a close-up view of the rifle along with text that includes in red at the upper left: "See It Now" and below that in white: "An American classic in a brand new caliber...". To the right of all that resides the new trademark logo: "Winchester XTR/Big Bore 94/375 Winchester. Below the photo of the gun resides in black print: and New 375 Winchester caliber ammunition... with a photo to its right of the box and a couple of cartridges displayed as well. The second one measures 34"x22" with a black backdrop to light gray text serving as the top section that reads "Winchester Announces The New Model 23 XTR/Pigeon Grade Double Shotgun" (with the model name cleverly set within a straight-on view of its muzzle end) and "in the tradition of Model 21 elegance and excellence". The photo of the gun, which was introduced in 1979, is presented against a bright blue backdrop forming the lower portion of the layout. This is an excellent condition lot with each poster protected by a clear plastic sleeve that is taped to a cardboard backing. (77541-11E, Z)

2574. **LOT OF DISPLAYS** This is a lot of three Winchester black and white cutaway drawing display posters with the first two of these black and white prints measuring 35"x15" and each with their lower right sections bearing text in bold black print that reads: "Winchester-Western Division/Olin Mathieson Chemical Corporation/New Haven 4, Connecticut. The first one has identification that reads: "Winchester Model 12 Repeating Shotgun" which lies just under the up-close cutaway image of the action area of the model including the view of two shells, one of which is presented at an angle as it is in the process of being chambered. The next one is identified as "Winchester Model 88 Lever Action Rifle" with the drawing above, in this case, being of the entire length of the arm and includes cut-away views of not only the action area which includes loaded cartridges but also those of screws at the forend and buttstock. The first two posters in this lot rate excellent with minor darkening along the edge of the Model 12 example. The last one in this lot measures 40"x17" with the text consisting of



the Winchester trademark name above "Model 55". The drawing above it is centered leaving an abundance of the white background visible and consists of the entire length of the gun to include cutaway views of the action as well as the screw near the heel of the buttstock. There are several moderate creases and some water stains at the left side of the sheet but it is otherwise clean with no tears. All three of the displays have protective clear plastic covers taped to cardboard backings. (77541-3C, D, E)



2574



2575. **LOT OF DISPLAYS** This is a lot of three Winchester black and white cutaway drawing display posters bearing text that includes in bold black print: "Winchester-Western Division/Olin Mathieson Chemical Corporation/New Haven 4, Connecticut" and with the first two that measure 35"x15". The first one has identification that reads: "Winchester Model 12 Repeating Shotgun" which lies just under the up-close cutaway image of the action area including the view of two shells, including one in the process of chambering. The next one is identified as "Winchester Model 88 Lever Action Rifle" with the drawing consisting of the entire length of the gun and includes cutaway views of the loaded action area, forend and buttstock. The first two posters in this lot rate excellent with the left edge area of the second one showing some darkening from storage. The last one in this lot is based on ammunition and measures 22"x21 1/2" and consists of up-close cutaway drawings of three items beginning with one titled "30-06 Springfield Super-Speed/180 Gr. Silvertip Center Fire Cartridge". The next one, "12 Ga. Super-Speed Shotshell" and the last one is "22 Long Rifle Super-Speed Rim Fire Cartridge". The drawings are augmented by parts identification including the shotshell diagram which is identified as having a paper tube which provides insight into the period in which the poster was produced. This poster shows some light tan areas to the white paper and some creasing and an area of the right corner that shows some chafing with a very small amount missing and a section of the upper right that may have been cut inadequately at the factory. (77541-3DA, EA, 11LA)

2576. **LOT OF DISPLAYS** This lot consists of three Winchester black and white cutaway drawing display posters measuring 35"x15", with bold text at the lower right section that exhibits "Winchester-Western Division/Olin Mathieson Chemical Corporation/New Haven 4, Connecticut". The first one has identification that reads "Winchester Model 12 Repeating Shotgun" which lies just below the up-close image of the cutaway action area, including the views of two shells, one of which is being chambered. The second one is identified as "Winchester Model 88 Lever Action Rifle" with the drawing consisting of the entire length of the gun with cutaway views of the action area as well as that of the forend and buttstock. The last one reads "Winchester Model 77 Automatic (Self-Loading) Clip Magazine" and shows a cutaway of the action area including eight rds. in the magazine. The posters rate excellent with a darker tone showing at the left edge of the second one. (77541-3EB, 3DB, 3BA)

2577. **LOT OF DISPLAYS** This lot consists of two Winchester black and white cutaway drawing display posters with bold text that reads "Winchester Western Division/Olin Mathieson Chemical Corporation/ New Haven 4, Connecticut". The first one measures 35"x15" and is identified as "Winchester Model 77 Automatic (Self-Loading) Clip Magazine" and shows a cutaway of the action area including eight rds. in the magazine and one in the chamber. The condition rating is excellent. The other poster in this lot is based on ammunition and measures 22"x21 1/2" and consists of up-close cutaway drawings of three items beginning with one with the caption "30-06 Springfield Super-Speed/180 Gr. Silvertip Center Fire Cartridge". The next one reads "12 Ga. Super Speed Shotshell" and the last one "22 Long Rifle Super-Speed/ Rim Fire Cartridge". The drawings are augmented by parts identifications with the shotshell identified as having a paper tube which provides insight as to the period of production of the drawings. The poster rates about very good plus exhibiting isolated spotting and edge chafing and the lower right corner shows some small holes, apparently due to contact with a strip of adhesive tape that left a darkened spot on the back of the sheet. (77541-3B, 11L)

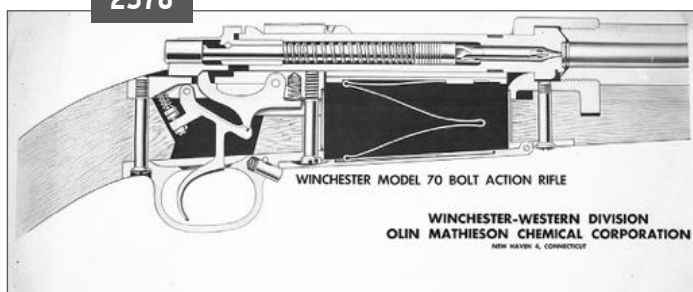

2578. **LOT OF DISPLAYS** This is a lot of two Winchester black and white cutaway drawing display posters that measure 35"x15" with bold text at the lower right side that reads "Winchester-Western Division/Olin Mathieson Chemical Corporation/New Haven 4, Connecticut". The first one bears the identification "Winchester Model 77 Automatic (Self-Loading) Clip Magazine" and shows a cutaway of the action area including eight cartridges in the magazine and one in the chamber. The poster sheet is crisp and clean with the exception of the left edge and lower corner showing a somewhat darker tone. The other one reads "Winchester Model 70 Bolt Action Rifle" and provides an extreme close-up of the action area and the poster has some areas along the edge that are a bit darker, isolated very small spots of dirt and a small tear. (77541-3BB, 3FA)

2586



2579. **LOT OF BULLET MOULDS** This lot includes three .36 caliber dual cavity Manhattan Firearms bullet moulds. They range in condition from fair to about very good having scattered light to moderate pitting near overall, oxidized cavities, replacement sprue cutter screws, and the wing missing from the sprue cutter. (106229-42,34,23)
2580. **MANHATTAN FIREARMS BULLET MOULD** This .36 caliber dual cavity round and conical shaped bullet mould remains in very good condition. The mould has been cleaned and is now a mostly brown color patina with overall scattered pitting and light impact marks consistent with use. The cavities remain clean and the logo is still legible along the front face. (106229-78)
2581. **MANHATTAN FIREARMS BULLET MOULD** This .36 caliber dual cavity round and conical shaped bullet mould remains in very good condition. The mould has been cleaned and is now a mostly brown color patina with spots of dark gray blending showing overall scattered pitting and light impact marks consistent with use. The cavities are oxidized with no deformities and the logo is still legible along the front face. (106229-82)
2582. **MANHATTAN FIREARMS BULLET MOULD** This .36 caliber dual cavity round and conical shaped bullet mould remains in very good condition. The mould has been cleaned and is now mostly a pewter color patina with overall scattered pitting and light impact marks consistent with use. The cavities remain clean and the logo is still legible along the front face. (106229-6)
2583. **SENTRY MODEL 1100 SAFE** This lot includes a compact lockable fire safe measuring roughly 14"x10"x6". The personal safe is a sand color with keyed lock and carry handle and would be suitable for most semi-auto pistols, jewelry or documents. (108900-30S21534A)
2584. **FRAMED MEMORIAL** This lot includes a framed colleague of military medals, and patches with dog tags and a black and white photo of Orval S. Johnson. The framed display measures roughly 17 1/2"x13 1/2" and contains 4 patches, 17 badges, two pins and several ribbons. There is a small placard that reads U.S. Army / 1946-1972 with all contents likely a collection of Johnson's military achievements. The majority of the medals are from during the Korean War with some during the Vietnam War and includes an Armed Forces Retired Badge. A nice tribute to one of Americas finest. (108724-1)
2585. **LOT OF TACTICAL GUN SLEEVES** This lot includes six black nylon padded and zippered cases by makers like Bagmaster and Gallat Int., varying in length from 30" to 47", all in very good to excellent condition. (108903-70)
2586. **WATER FOWL PRINT** This framed print titled "Winter Snows" by Terry Redlin measures 29"x24" with a viewing area of roughly 22"x17". The print depicts a flock of geese gliding in for a landing over a snow covered corn field with farm house and barn in the background. It is depicting a cold stormy wintery day with heavy dark cloud cover and is signed by the artist. A handsome print that would look nice hanging in any décor. (108506-3B) [please note: extra shipping will apply]



2587

2587. **DUCKS UNLIMITED PRINT** This framed print titled "Closing Minutes" by Scot Stotyn is signed and numbered 2422 / 4800. The contemporary wood grained frame measures 33"x27 1/2" with a viewing area of 25"x19". This lovely print depicts an open water marsh scene viewed from the reeds looking out at a flock of ducks making a final descent to the water below with a cloudy sky backdrop at what appears to be the start of sunset. A handsome print that is nicely framed and sure to enhance any décor. (108506-3) [please note: extra shipping will apply]



2588

2588. **DUCKS UNLIMITED PRINT** This framed print titled "On the Wing" by Andrew Kiss (2002 Artist of the year, Ducks Unlimited-Canada) is signed and numbered 4022 / 5050. The contemporary wood grain frame has a distressed look and measures 35"x25" with a viewing area of 26"x16 1/2". The print depicts three ducks gliding into a landing in a remote back woods pond in early fall. A splendid scene that would display nicely with any of the other prints available in this auction. (108506-3A) [please note: extra shipping will apply]



2589

2589. **DUCKS UNLIMITED PRINT** This framed untitled print by conservationists and artist Jim Killen is signed and numbered 1329/3200. The decorative wood frame measures 27 1/2"x36 1/4" with a viewing area of 28"x19". The picture depicts a lovely fall day with rolling mountains along the sky line with cloudy overcast skies and ducks flying in all directions over a reed-filled marsh. The detail is lovely and you can almost feel the bite in the air. (108056-3C) [please note: extra shipping will apply]



2590

2590. **FRAMED PRINT** This lot includes a framed print titled "Chownings Tavern" by Bob Howard that is signed and numbered 58 / 500 by the artist. The frame measures 29"x36" with a viewing area of 21"x29". It depicts an old colonial tavern set in Williamsburg, with fancy buggy and two white horses parked out front with the tender standing at ready. A lovely rendition fashioned after a local colonial tavern named Josiah Chownings that is located in historic colonial Williamsburg Va. A very lovely print suitable for any décor. (108506-3D) [please note: extra shipping will apply]
2591. **FRAMED PRINT** This lot includes a framed reproduction of a 1939 copyright dated print of historical events from 1585-1781 in Virginia showing Jamestown, Williamsburg, and Yorktown. The frame measures 30"x24" with a viewing area of 24"x17" and this would make a great addition to any colonial or rustic décor. (108506-3E) [please note: extra shipping will apply]
2592. **MOSSBERG 500 BARREL** This 12 ga., 28" ventilated rib Accu-choked barrel has a bright excellent bore that retains 95% original blue finish, with scattered light oxidation staining and a couple of minor spots of flaking near the barrel lug. The barrel has a single brass bead front sight and includes a screw in choke that is modified. (108898-118G)
2593. **MOSSBERG 500 BARREL** This 12 ga., 28" ventilated rib Accu-choked barrel has a bright excellent bore that retains 90% original blue finish with spots toning to plum at the breech end, tooling marks at the barrel lug, scattered fine oxidation staining with numerous light scratches. The rear bead is missing and the white front bead remains in place. Included is a single screw in choke that is Improved Cylinder. (108898-118F)
2594. **MOSSBERG 500 BARREL** This 12 ga., 28" ventilated rib Accu-choked barrel has a bright excellent bore that retains 95% original blue with scattered light scratches, silvering at the muzzle and along some of the high edges with spots of oxidation under the rib at the vent posts. The barrel has dual beads, white in the front and brass at the rear and the included screw in choke is Improved Cylinder. (108898-118E)
2595. **SAVAGE MODEL 30 BARREL** This 12 ga., 21" slug barrel with bright excellent smooth bore retains 97% original blue with light freckling, scattered light scratches and has some silvering along the high edges of the rifle sights that include a raised front brass bead and folding rear leaf. (108898-118D)
2596. **MOSSBERG 500 BARREL** This 12 ga., 24" Slugster barrel with bright excellent smooth bore retains 98% original blue with scattered light scratches, spots of light fine oxidation staining and a few spots of oxidation at the muzzle. The barrel has rifle style sights and barrel screw with swivel stud. (108898-118B)
2597. **REMINGTON 1100 BARREL** This 12 ga., 30" ventilated rib barrel with bright excellent bore is choked full, and retains 90% plus of its original blue finish with scattered scratches, spots of freckling and silvering along some of the high edges. The barrel has dual beads, white in the front and brass in the rear and has a small dent in the rib just forward of the rear bead and has been marked in electric pencil with a previous owner's last name and serial number. (108898-118C)
2598. **MOSSBERG 500 BARRELS** This lot includes two. First is a 12 ga., 28" ventilated rib barrel with a bright excellent bore, choked modified and retains 95% original blue with scattered light oxidation staining and is toning to plum at the breech end. It is missing the front bead sight and has light tooling marks on the barrel retention screw. The second barrel is a 12 ga., 30" ventilated rib barrel with a bright excellent bore that retains 85% blue finish under a very heavy coating of clear varnish. Likely applied to keep the flaking and spots of oxidation from expanding. Barrels are in good to about very good condition. (108898-118)

2599. **ITHACA 37 BARREL** This Featherweight 12 ga., 30" ventilated rib barrel with bright excellent bore is choked full and retains 85% thinning original blue. There is scattered light scratches, spots of wear, oxidation and light fine oxidation staining near throughout the evenly thinning blue. A single high visibility bead sits at the front of the barrel and the rib is slightly dented 7" back from the muzzle. (108898-118A)
2600. **REMINGTON 11-87 BARREL** This 12 ga., Light Contour 28" ventilated rib barrel with bright excellent bore is Rem-choked and retains 98% of its original matte finish with a few minor scratches and spots of fine oxidation staining. The barrel has dual beads, white front and silver rear and the included screw-in choke is Improved Cylinder. (108898-118G)
2601. **MOSSBERG 500 BARREL** This 12 ga., 24" Slugster barrel with bright excellent smooth bore retains 98% original blue with some scattered light oxidation staining. The barrel has rifle style sights and remains in excellent condition. (108898-118H)
2602. **ITHACA 37 BARREL** This 12 ga., 26" Featherlight Deer Slayer barrel with a bright excellent smooth bore retains 85% thinning blue with some scattered light scratches, spots of oxidation staining and is evenly thinning along its length. The barrel has a high visibility front sight with traditional sporting rear. (108898-118I)
2603. **REMINGTON 870 BARREL** This 12 ga., 28" ventilated rib barrel is choked modified and retains 95% original evenly thinning blue that is toning to brown when under bright light and with scattered light scratches and spots of fine oxidation staining. A single silver bead sight is affixed. (108898-118J)
2604. **REMINGTON 870 BARREL** This 12 ga., 28" ventilated rib, Rem-Choke barrel with a bright excellent bore retains 98% of its matte finish with scattered light scratches, and a couple of tiny dings along the rib. The included screw-in choke is Modified. (108898-118K)
2605. **MOSSBERG 500 BARREL** This 12 ga., 28" plain barrel with bright excellent bore is choked Modified and retains 95% original blue with scattered scratches, oxidation staining, and spots of very light pinprick pitting near the barrel retention screw. The barrel has a single brass bead sight. (108898-118L)
2606. **MOSSBERG 500 BARREL** This 12 ga., 24" ventilated rib, Accu-Choked barrel with bright excellent bore retains 98% original blue with scattered light scratches, spots of freckling and has a couple light wear marks and dings along the rib. The barrel has a single brass bead sight and the included screw in choke is modified. (108898-118M)
2607. **REMINGTON 870 BARREL** This 12 ga., 18" plain barrel with a bright about excellent bore is choked cylinder and retains 95% original blue with overall light scratches, spots of freckling, and has some light wear marks along the sides and at the breech end. The barrel lug has toned to a plum color and has a single silver bead sight. (108898-118N)
2608. **MAVERICK 88 BARREL** This 12 ga., 18 1/2" plain barrel with bright about excellent bore is choked cylinder and retains 98% original blue finish with some scattered superficial scratches and spots of light fine oxidation staining. The barrel is sighted by a single brass bead. (108898-118P)
2609. **MOSSBERG MODEL 500 BARREL** This 12 ga., 18 1/2" plain barrel with an about very good bore is choked cylinder and retains 95% original blue finish that shows minor spots of wear, freckling, and some scattered light scratches. The barrel has a single brass bead sight. (108898-118Q)
2610. **MOSSBERG MODEL 500 BARREL** This 20 ga., 24" slug barrel with a bright excellent smooth bore. The barrel has a fixed front sight and folding rear leaf sight and retains 95% original blue with scattered oxidation and fine oxidation staining, light scratches, and tooling marks just forward of the rear sight. (108898-118R)
2611. **MOSSBERG 500 BARRELS** This lot includes a 12 ga., 24" slug barrel and an 18 1/2" plain barrel. The slug barrel with rifle sights retains about 95% original blue with scattered oxidation and oxidation staining, with silvering along high edges and numerous light scratches and has a dark, about good bore with active oxidation. The second barrel has a bright, about very good bore that is choked cylinder with some scattered oxidation near the breech end. It retains 95% of its original blue finish and has a single brass bead sight. (108898-118S)

2612. **BRITISH OAK BRASS BOUND TAKEDOWN CASE** This case measures 33" x 9 1/2" and is 3 1/2" tall when closed and features brass reinforced corners on lid and base along with a round British style carrying handle in middle of outer lid which folds flush. The case features external rotating brass locking clasps. The interior of the case is partitioned to accept a double with 30" barrels and includes four compartments for accessories in addition to the compartments for the barrel and butt-stock. There are some cleaning accessories included. The condition of the case is very good with the exterior showing what looks to be an old quality refinish, the lid has a crack running almost entirely across the top but seems sound, the interior is very good with green felt lining and some partitions are loose; they should be easy to rectify. The front face of the lid has an applied brass plaque which measures 4" x 1" and is engraved "B.GUIDONE". Overall a nice period British oak case awaiting your British double gun. (27147-154)



2613. **LEATHER TRIMMED CANVAS COVERED TAKEDOWN SHOTGUN PRESENTATION CASE** This case measures 32 1/2" x 8" and is 3" tall when closed and has leather reinforced corners with two leather closing straps and a leather carrying handle. This case features a brass combination lock on the front and is currently set up to accept up to 30" barrels and has a compartment for accessories and a pair of 12 ga. snap caps. Overall condition is excellent with a couple of minor scuffs on the exterior. (27147-162)
2614. **LEATHER TRIMMED CANVAS COVERED TAKEDOWN SHOTGUN PRESENTATION CASE** This case measures 34" x 12" and is 3 1/2" tall when closed and has leather reinforced corners. This case features two brass combination locks on both the left and right front face side and also has the Beretta logo embroidered on exterior. The interior of this case is currently set up to accept two sets of 32 1/2" barrels and is entirely lined with blue felt with the Beretta logo embroidered in yellow/gold on the interior of the lid and has compartments for accessories. The overall condition of this case is excellent. (27147-196)
2615. **LEATHER TRIMMED CANVAS COVERED TAKEDOWN SHOTGUN PRESENTATION CASE** This case measures 30 1/2" x 7 3/4" and is 3" high when closed and has leather reinforced corners with two leather closing straps and a leather carrying handle. This case features a brass combination lock on the front face of the case and is currently set up to accept up to 29" barrels and has compartments for accessories and is completely lined with green felt. Overall excellent condition with some minor dirt stains on the top and bottom face of this case. (27147-167)
2616. **LEATHER TRIMMED CANVAS COVERED TAKEDOWN SHOTGUN PRESENTATION CASE** This case measures 30" x 8" and is 3 1/4" high when closed and has leather reinforced corners with two leather closing straps and a leather carrying handle. This case features a brass key lock on the front face of the case and is currently set up to accept up to 28 1/2" barrels and has other compartments for accessories and is entirely lined with nice green felt. Overall the condition of this case is very good with some minor fading to the green canvas on the top and sides of case. (27147-194)
2617. **LEATHER COVERED TAKEDOWN SHOTGUN PRESENTATION CASE** This case measures 30" x 8" and is 3 1/4" high when closed and has leather reinforced corners with two leather closing straps and a leather carrying handle. This case features a brass key lock on the front face of the case and is currently set up to accept up to 27 1/2" barrels and has other compartments for accessories and is lined entirely with nice green felt. There is a black embossed leather Francotte maker's label affixed to the interior of the lid. Overall excellent condition with a 2 1/4" partial tear in the leather on the bottom side of the case. (27147-192)
2618. **LEATHER COVERED TAKEDOWN SHOTGUN PRESENTATION CASE** This case measures 31 1/2" x 14 3/4" and is 3" tall when closed and has leather reinforced corners with two leather closing straps and a leather carrying handle along with a brass key lock on the front face. The interior of this case is currently set up to accept two sets of barrels up to 30 1/4" and is partitioned allowing for multiple accessories and is lined entirely with nice green felt. Overall this case is in great condition with some very minor scratches on the bottom of the back side of the case. (27147-178/179)
2619. **LEATHER COVERED TAKEDOWN SHOTGUN PRESENTATION CASE** This case measures 30" x 8" and is 3 1/4" when closed and has leather reinforced corners with two leather closing straps and a leather carrying handle. This case features a brass key lock on the front face and is currently set up to accept up to 28 1/2" barrels and is partitioned for multiple accessories to be stored and is lined entirely with nice green felt. The interior of the lid bears a maker's label which reads "JAMES PURDEY & SONS LTD. INCORPORATING JAMES WOODWARD & SONS. GUN, RIFLE AND CARTRIDGE MAKERS. REGISTERED OFFICE, AUDLEY HOUSE 57-58 SOUTH AUDLEY STREET LONDON W1Y 6ED. TELEPHONE: 01---499 180 1/2. TELEGRAMS: PURDEY-LONDON WI". The overall condition of this case is excellent with minor marks on the bottom side of the case. (27147-163)
2620. **LEATHER COVERED TAKEDOWN SHOTGUN PRESENTATION CASE** This case measures 30" x 8 1/2" and is 3 1/4" tall when closed and has leather reinforced corners with two leather closing straps and a leather carrying handle. This case features a brass key lock on the front face and is currently assembled to accept up to 28 1/2" barrels and is partitioned for multiple accessories to be stored with nice woodwork and is lined entirely with very nice red felt. Overall the condition of this case is very good with some marks on the top face cover. (27147-195)
2621. **LOT OF VINTAGE TOY "TRAINING" RIFLES** This lot consists of two "Kadet Trainerifle" diminutive toy rifles from Parris Manufacturing Co. of Savannah Tennessee. These nice examples are long before the "orange muzzled" examples that Parris is turning out today. These rifles feature genuine wooden stocks with blued-over steel or enameled hardware and nicked muzzle pieces. When the "bolt" is drawn back, there is a golden painted wooden bullet that is spring-loaded in the interior. One of these examples has the blued-over aluminum bolt handle, the other has the nickel plated cast iron bolt handle. The clicker works on only one gun. Both come with the appropriate green web slings, the black painted "bands" are flaking to some degree, both "rifles" show minor splits at the muzzle and are encircled there with black electrical tape. Both rate about very good, one with a sticker on both sides of the butt. (1X38808-6)



2621



2622

2622. **VINTAGE KADET TRAINER RIFLE** This lot consists of a nice vintage "Kadet Trainer rifle" from the Parris Manufacturing Co. of Savannah Tennessee. The stock on this example is hardwood with a black enameled steel "action" and nickel plated muzzle and swivels. The cast-iron handle is nickel plated which shows some flaking. The dovetailed rear sight plate actually has a genuine M1 carbine adjustable rear sight attached. This example also has the wooden gold bullet inside the "action". The rifle rates overall very good with some minor oxidation on the nickeled muzzle piece. The clicker works and the right side of butt has an intact gold toned with red and black print Kadet Trainer rifle decal showing only a small scratch at its center, the Army-Navy E-Award wartime production flag shown in the logo. A single green M1 Garand-style sling is included. (1X38808-8A)



2623

2623. **MARK I U.S. NAVY 1903 SPRINGFIELD-STYLE TRAINING RIFLE FROM PARRIS MANUFACTURING** This is a full-size version training rifle patterned after the U.S. 1903 Springfield rifle. The metal surfaces retain a fading plum-brown, blued-over finish, with some sparsely scattered light oxidation staining. The hardwood stock rates about very good with overall flaking varnish and small dings and handling marks. These examples cock on opening, a small "hammer" being actuated by the bolt knob when it is manipulated upward. The buttplate is marked "Dummy Training Rifle / Mark1-USN / Parris Dunn Corp. / Clarinda Iowa". Included is a green web military rifle sling. (1X38808-8B)

2624. **DIANAWERK MODEL 26 AIR RIFLE** .177 cal., 16" barrel. This air rifle retains 60% original blue finish with oxidation stains, pitting and scratches. The wood stock rates very good with scratches and handling marks. The trigger and trigger guard are lightly oxidized with slight slot damage on the head screws. (2X98446-11)

2625. **DAISY MODEL 1894 CARBINE AIR RIFLE** serial #1020942, BB Gun, 19 1/2" barrel. This 1894 Commemorative Winchester-style carbine's receiver and barrel band retain 95% of its original gold paint with scratches, high edge wear and oxidation stains. The octagon barrel and cylinder retain 95% of their original black paint with scratches and light oxidation staining. The plastic stock rates near excellent with scratches and handling marks but the forend is loose and separated at the seam. A piece of tape is currently keeping it together. The model numbers and etchings are visible. This is a great find for the air rifle collector. (2X8657-68S20920A)

2626. **PARRIS-DUNN DUMMY TRAINING RIFLE** 24" barrel. This Mark 1 U.S. Navy training rifle retains 60% black finish with expected scratches and oxidation staining. The wood stock rates very good with scratches and handling marks. The barrel band is intact but slightly loose and the fixed front and flip-up rear sights are still with the trainer. (2X98585-148)

2627. **CRIMSON TRACE GRIPS** This lot includes a set of LG-320 laser grips for all Sig Sauer P220 model pistols. The grips are complete with correctly labeled factory box, batteries, manual, warranty card, and tools for adjustment. The grips remain in excellent condition. (1X108551-3)

2628. **ARTILLERY LOT** This lot consists of a single 75mm artillery brass shell casing. The shell measures 13 3/4" long and has is marked "AM.LOT 75mmG. SCOVILL LOT" on the base. It is in very good condition with light oxidation and ochre patina throughout. (1X47921-2)

2629. **PACT CHRONOGRAPH PRINTER** This is a printer to be used in conjunction with your chronograph screens, acting as a ballistic computer. Manufacturer of bullet, caliber, bullet weight can be set, velocity can be set and the computer will calculate drop or holdover at given ranges as well as giving you the velocity data. No sky screens are included however the cables etc. for hooking the instrument up to your sky screens are all present. An owner's manual is included that walks you through setting up the printer and your sky screens. A black cordura carry case is included. (1X37494-20)

2630. **LOT OF BRASS** This lot includes a 50 count mixture of brass and nickel brass fired casings and 47 primed assorted commercial brass casings, all remaining in very good condition. (1X108345-24)

2631. **RING LOT** This lot consists of three sets of blued-over 1" scope rings. First is a set of Weaver low height rings that include a set of bases numbered #26 and #20A. Next is a set of Leupold style medium height rings. Last are a set of Holden Boresighter see-thru ring mounts that are not model marked but are for round top receivers and do not include the mounting screws. The Holden rings are covered in a black residue, possibly resulting from black powder shooting, the other items are in excellent condition. (2X48189-1D)

2632. **M14/M1A SCOPE MOUNT** This lot consists of a scope mount for the M14 and M1A family of rifles. It is marked "M14/M1A SCOPE MOUNT"; there are two mounting holes and screws present but no mounting block is included. (1X208802-1A)
2633. **AMMUNITION POUCH LOT** This lot includes two ammunition pouches for carrying 8x50R/8x56R rifle cartridges attached to en bloc clips. The first pouch is light green canvas with leather straps, one of the straps has a broken back rivet, this pouch shows light stains and signs of wear. The second pouch is brown leather in excellent condition and with cosmetic signs of use. (1X228789-19T,U)
2634. **AO SIGHT** This lot consists of an AO Sight Systems AO Lever Scout Mount for the Marlin 1894 rifles. The mount is in its original packaging and is in like new condition. (3X46850-10C)
2635. **U.S. ARMORY SHOULDER KNOT LOT** This lot consists of two U.S. Army gold shoulder knots and a black tin. The shoulder knots show some light dirt and dust staining from the years. The black tin shows scattered flaking, oxidation and some dirt staining. (1X208357-13)
2636. **BOX LOT** This lot consists of box for a Bull's Eye Pistol Co. Sharpshooter rubber band pistol. The two-piece box measures 4 1/4" x 8" and includes the instruction manual. The lettering is mostly faded and there are some small scuffs, tears and light foxing. The manual additionally has similar issues. A very good example for the toy gun collector. (1X47921-7C)
2637. **LOT OF AMMUNITION AND BOXES** This lot consists of (8) boxes. Included are: (1) empty and (1) partial box of fourteen rounds of Western Expert 22 LR 40 gr. solid in yellow and blue boxes with red writing. The boxes rate excellent and the ammunition exhibits light oxidation on the bullets. Also included are (3) boxes of Western 38 Special Mid-Range wadcutter in blue and yellow boxes with red writing. Two of the boxes are empty and one has (50) empty cartridge cases. They rate very good to excellent. Included is (1) box of Remington Targetmaster 38 Special wadcutter in a green box with 30 mixed empty cartridge cases. Also, one full box of (50) rounds of excellent condition Remington Kleanbore standard velocity 22 LR 40 gr. solid ammunition. Finally, one box of Western Super-X 22 W.R.F. ammunition in blue and yellow box containing (30) rounds of 22 W.R.F. ammunition in near excellent condition. (3X108511-8)
2638. **MISCELLANEOUS LOT** This lot consists of two items. First is a black nylon right hand Uncle Mike's Sidekick size 3 belt holster for medium double action revolvers with 5-6 1/2" barrel length. It features a retention strap with snap and is in excellent condition. Second is a 14 1/2" hardwood club that has some light dings and handling marks. It is in very good condition and was likely used as a fish whomper to control large aggressive game fish. (2X48541-27S20937A)
2639. **SCOPE RINGS AND BASES** This lot includes four packages of Weaver top mount bases, other various mounting parts, one brand new package of Leupold Remington 700 scope mounts and one brand new package of Leupold super high scope rings. (1X228821-146E) [Stuart Floam Collection]
2640. **LOT OF M1 CARBINE ACCESSORIES** This lot includes four items. First is an M15 grenade sight without mounting disc that is wrapped in cosmoline, in excellent condition and includes a range chart and instruction sheet. Second is an unmarked carry case for the aforementioned item that has light mildew staining and in good overall condition. Third are two OD green canvas magazine pouches, one U.S. marked, both with light to perhaps moderate mildew staining and in overall good condition. (2X108570-10B)
2641. **STOCK LOT** This lot consists of two stocks, one a semi-inlet, the other a take-off. The semi-inletted stock is for the 1917 Enfield series of rifles. Currently it features a blind magazine but obviously could be inletted for full bottom metal if one wished. The inletting is perhaps 70% completed with a similar amount of shaping done. The stock is American black walnut, Monte Carlo style with a flared left side cheekpiece and rates about very good overall. The take-off stock is from a Czech VZ-24 and shows overall built up grime, oil and grease from the years with handling marks and dings consistent with a field-used arm. The noseclip is present as is the band spring and the side-mounted sling swivel, rear sling swivel and steel buttplate. No handguard is included. An about good example overall. (1X38832-13)
2642. **COMMERCIAL M1 CARBINE TELESCOPING BUTTSTOCK** This is a nice quality walnut and blued-over steel buttstock, inletted for an M1 carbine. It is one piece with a shaped pistolgrip and has a blued-over steel telescoping buttstock with steel rods that run the left and right of the body of the stock, affixed with flat blued-over steel plates just above the pistolgrip proper, tightening with a knurled thumb nut. The stock includes a band spring and stock iron attaching screw, they are not installed, and it appears very much as though some final fitting or inletting may need to be done to the stock itself. It is unused, as-new. No handguard is included. (1X38832-8)
2643. **SPRINGFIELD MODEL 944 SERIES A BREAK ACTION SHOTGUN PARTS LOT** This lot consists of frame serial #P824405, .410 bore, 26" plain barrel with a very good bore. The barrel retains about 65% original thinning blue with scattered areas of pinprick pitting and oxidation staining. The frame has a 2" crack at the bottom and the gun has been disassembled and is being sold as parts only. The smooth straight grip hardwood buttstock and forend rate near very good with the buttstock having a moderate amount of finish missing and includes a ventilated rubber recoil pad. The barrel is fitted with a silver bead front sight. (1X218563-7) (MODERN)
2644. **RAM-LINE FOLDING STOCK** This lot includes a black colored polymer folding stock and handguard for a Ruger 10/22 rifle. The stock rates very good with a weak latch on the shoulder piece that allows it to fall forward when shouldering the stock and a torn end on the barrel strap. (2X108570-6A) [Calhoun L.H. Howard Collection]
2645. **H&R TOPPER STOCK** This lot includes a hardwood pistolgrip buttstock for a Topper single barrel shotgun. The stock has a red russet color with scattered light handling marks and a ventilated red rubber recoil pad with company logo and it remains in excellent condition. (2X108570-6E) [Calhoun L.H. Howard Collection]
2646. **LEG-O-MUTTON CASE** This lot consists of a brown leather case by Wm Read & Sons Boston, MASS. The case measures 33 1/2" x 5 3/4" x 2 3/4". The surface displays moderate scuffs and crazing, mostly on the corners. There are openings on both ends and the lids are present with the bottom hinge worn almost completely through. The leather strap, handle and brass buckles are still intact as is the seam stitching around its periphery. There are remnants of a leather barrel protector being held in place with some old newspaper on the interior. (1X218588-2)
2647. **VINTAGE ALUMINUM TREESTAND** Looks like an old Baker "Death Trap" climber constructed of an aluminum frame with plywood platform, the climber/seat has an aluminum frame with a simple fabric seat. The stand measures 47 1/2" x 20 1/2" and together with the climbing aid weighs just over 22 lbs. The stand has an added classic green and black spray painted finish that has faded and flaked with time especially along the edges and adjustment holes and a piece of carpet has been added to the base. The olive drab fabric seat has dried and faded over the years but remains intact as do the black fabric carry straps which may be a later addition. In the early days of modern bow hunting these types of stands got their nickname because they had the tendency of sliding down the tree at the slightest movement causing the hunter to fall or become stranded leading to serious injury or fatality and should be only used for collectible purposes only. (1X58600-6)

2648. **WING ARCHERY THUNDERBIRD RECURVE BOW** This is an older recurve bow measuring 54", the draw weight is unknown due to the added "camo" spray paint and ingrained dirt from the years. The colors have flaked and faded with time leaving a riser made of what looks to be rock maple. The wood has become dried with numerous drying cracks along the rear of the grip, some of which may be deeper than the finish. An older quiver and what looks to be a homemade two-pin sight has been installed on the front of the bow. A short homemade stabilizer has been installed in the front of the riser. Included are (5) old broadhead tipped aluminum arrows also with ingrained dirt staining and wrinkled plastic fletching, two of which are bare. There is an old dried Dacron string which is currently unstrung and because of the age and condition should remain as such. (1X58600-7)
2649. **COMPOUND BOW** This lot consists of a Martin Cougar 11 MT-6 vintage compound bow. The bow is equipped with pin sights and a quiver mount and is in very good overall condition. (1X48020-7)
2650. **COMPOUND BOW** This lot consists of a Darton Viper compound bow. The bow features a gray camo finish and has an adjustable draw weight of 65-70 lbs with a 65% let off at full draw. A pin sight, quiver, wrist strap, counter weight and trigger release are all included. A near excellent example that should perform quite well after being looked at and evaluated by a qualified pro-shop. (1X48020-6)
2651. **LOT OF GUN CASES** This lot consists of five hard plastic cases for long arms, each with all latches and handles fully intact and functional and with foam interiors. The first one is by Gun Guard, measuring 52" in length and with a sloped contour, molded hunting scenes and carry handles. The black exterior has an area of tape residue and some handling marks, the interior showing very light wear. The next one is also by Gun Guard and of the same length with a width of 11 1/2" and the tan outer shell is of a higher density plastic, the foam showing mild wear and soiling. The next two are dark green with no maker name with lengths of 48" and 52" and with indication of only light usage to the exteriors and interiors. The last one is also unmarked with a few cracks and small sections missing from the dark brown shell that is also showing areas of sticker remnants but should be still serviceable; it features a 4" depth and the interior is equipped with five layers of foam inserts. (1X77558-17B)
2652. **GUN CASE LOT** This is a custom wood case measuring 54"x11"x7" and suitable for displaying and transporting a long arm. This impressively constructed maple case is marked "Handcrafted by Gerald Jones, Hartford, NY" and exhibits a thin application of light brown stain and is accented with brass hardware in the form of two closure latches, reinforced corners and three rear hinges along with four protective plastic feet. The interior shows a less even finish and would benefit from a fabric insert that could enhance the presentation aspect. The case rates excellent with very minor contact marks and features two fully intact carry handles. (1X74764-5)
2653. **GUN CASE LOT** This is a long gun case with a metal exterior measuring 52"x14"x4 1/2" with surfaces showing areas of discoloration and a few dirt spots. The fully intact case by Aluminum Box Mfg. features two lockable metal latches, sturdy carry handle and thick foam interior showing little wear and a few small stains. (2X77759-3B)
2654. **GUN CASE LOT** This is a hard plastic case by Gun Guard measuring 26"x13"x5" with three layers of interior foam making it ideal for multiple hand guns or a take-down long arm and showing minimal wear and a couple of minor stains. The tan exterior shows minor scratches, metal reinforced edges, dual carry handles and metal latches. (2X76031-15B)
2655. **GUN CASE LOT** This lot consists of very good plus Aries Custom metal aluminum case measuring 36" x 9 1/2" x 4" with red felt that looks to be configured for two shotguns. The exterior has scratches and dents and is secured with two turn style clasps and a lock with key included and metal handle. (2X95464-2A)
2656. **RIFLE HARD CASES LOT OF FIVE HARD CASES** Three are 48" and the remaining two are 53". All five cases are black and range from fair to good condition. [extra shipping cost applies] (1X227023-26)
2657. **RIFLE HARD CASE LOT OF TWO HARD CASES** Both are 53" x 13.5". Exterior and interiors are in very good condition. (1X227342-2,3)
2658. **RIFLE HARD CASE BLACK HARD CASE** 53" x 13". Interior and exterior of case are in excellent condition. The latches are lockable and the keys are present. (1X224040-1)
2659. **LOT OF GUN CASES** This lot consists of six long gun cases with hard outer shells with five being of hard plastic with foam interiors and from various manufacturers. The lengths range from 48" to 52", the widths from 7 1/2" to 13". The last one is by Gunest which is of compressed wood with a vinyl shell and a fabric interior that is fitted to hold a scoped gun and has a compartment for accessories. The overall condition of the lot is very good with all components intact and functional and with minor wear and abrasions. (2X76019-31F)
2660. **LOT OF GUN CASES** This is a lot of four cases for long guns, all with hard plastic outer shells and foam interiors. The first one is by Gun Guard, capable of holding two guns and features four metal latches and dual carry handles. The next two are by Flambeau Outdoors beginning with one that retains its original label identifying it as model 6470SE from the Safe Shot line and is contoured to fit a scoped gun and the other is an oversized single gun case. The last one is a Doskosport that like the Flambeau examples features a molded carry handle and four plastic closure latches; it is a bit shorter than the others in this lot, as it measures 48", the others about 54". This is an excellent condition lot with the exteriors showing very minor spots of dirt and a few scratches and the convoluted foam strips showing little indication of use. (2X76019-31D)
2661. **LOT OF GUN CASES** This lot consists of two hard cases. The first case is a very good plus brown Protecto Kaddy measuring 32 1/2" x 14 1/2" x 3" with a gray foam interior. The exterior has light scratches and handling marks and secured with three clasps and it has two plastic handles. The second case is a very good plus brown Gun Guard case measuring 47" x 8 3/4" x 4" with gray foam interior. The exterior has light scratches and handling marks and secured with four clasps with two plastic handles. (2X95464-2C)
2662. **RIFLE HARD CASES** Lot of four black 52" hard plastic cases. All are in very good condition (1X228048-14A)
2663. **RIFLE HARD CASE** Orange hard case, size is 52" x 13.5". Case and padding are in good condition, one of four latches is missing. (1X226292-6)
2664. **RIFLE HARD CASE** Black hard case, exterior shows minor signs of use and the interior padding is excellent. This is a Plano Gun Guard typically accompanying a Bushmaster rifle, 42" overall length. (1X228297-4)
2665. **SCOPED RIFLE HARD CASE** 50" Plano AirGlide scoped rifle hard case in brand new condition, the exterior shows modes dust from storage. Comes with booklet and foam blocks for vertical rifle travel. [extra shipping cost applies] (1X227467-1)
2666. **RIFLE HARD CASE PLANO PROTECTOR SERIES RIFLE HARD CASE** in very good condition. Padding is very good with slight staining throughout. (1X224318-16A)
2667. **SCOPED RIFLE HARD CASE** 50" Plano AirGlide scoped rifle hard case in good condition. Comes with foam blocks for vertical rifle travel. Case also includes a small Plano accessory tray. [extra shipping cost applies] (1X226070-54)
2668. **GUN CASE AND SLEEVE LOT** This lot contains 2 hard cases and four zippered padded gun sleeves. The hard cases are 48" x 9" and are in excellent condition inside and out. Three of the gun sleeves are nylon and measure 40", 48" and 50" with the last sleeve being leather and measuring 52", all four sleeves are in excellent condition. (1X228821-148B)

2669. **GUN SLEEVE/HARD CASE LOT** This lot contains seven gun sleeves and two hard cases. The sleeves are approx. 52" in length and the sleeve materials are nylon and leather. The first hard case is 48" x 9", the second is 53" x 11". All sleeves and hard cases are in very good condition. [extra shipping cost applies] (1X227152-1)
2670. **GUN SLEEVES/HARD CASE** This lot consists of 12 gun sleeves approx. 52" in length. Seven sleeves are padded and zippered while the remaining five are open-ended. Sleeve materials are leather and nylon. This lot also includes a 49" x 9" hard case and a zippered leather case of the same size. The overall condition of the lot is very good with slight cosmetic damage on 2 of the sleeves. [extra shipping cost applies] (1X228726-37)
2671. **LOT OF GUN CASES** This lot consists of three cases for long guns beginning with a Gun Guard with a black hard plastic outer shell measuring 52"x11"x4 1/2" and featuring a molded wildlife scene on each side, metal frame and four latches. The exterior rates excellent with very minor wear and dirt and the foam interior is in a somewhat lesser state retaining the impression of a previously stored gun and showing some mild staining. The other case is a fully functional zippered soft sleeve by Field & Stream with a tan fabric exterior and brown vinyl trim, equipped with dual handles and an auxiliary snap pouch having some light staining and a small tear in the trim. Also included is a thin brown vinyl zippered case with carry handles. (2X78331-5)
2672. **GUN SLEEVES** Lot of four gun sleeves, two are 40", two are 44". All are canvas and nylon material and are in good condition (1X223667-8A)
2673. **GUN SLEEVES** Four zippered padded gun sleeves, three at 48", one at 45". Sleeve materials are leather and canvas, this lot is in very good condition. (1X226519-535)
2674. **LOT OF GUN CASES** This lot consists of six padded soft cases for long guns beginning with two by Allen in excellent condition with zippered nylon shells with lengths of 53" and followed by two 46" long vinyl examples by Red Head that are capable of holding scoped guns and with zippers at the butt end, including one that does not fully close. The next one is also configured for a scoped gun, a Featherweight that is 45" long with a full length zipper, reinforced muzzle end and moderate mildew staining. The last one is a Lyan & Coulson with strap and buckle closure, a 48" long vinyl shell, leather sling and faux fur interior and rating near very good with wear, soiling and some cracking and seam separation occurring at the leather reinforcement areas. (2X78491-9)
2675. **GUN SLEEVES** Lot of five zippered and padded gun sleeves. All sleeves are 52" long, sleeve materials are leather and nylon. Entire lot is in very good condition. (1X227704-9)
2676. **GUN SLEEVES LOT** of four gun sleeves all approx. 52". Three nylon sleeves are zippered and padded and one leather sleeve is open ended. (1X224299-64AA)
2677. **GUN SLEEVES** Four vinyl zippered gun sleeves in good condition with light stains and separations at some of the seams. (1X224005-1B)
2678. **GUN SLEEVES** This lot contains four gun sleeves, three are padded and zippered and one is canvas. The padded sleeves are in good condition, the canvas sleeve has a small tear at the barrel end. (1X223391-8B)
2679. **GUN SLEEVES** This lot contains seven zippered and padded gun sleeves and one gun sock. Sleeve materials are vinyl and nylon and measure approx. 52" in length. (1X227904-30)
2680. **GUN SLEEVES** Lot of 6 zippered and padded gun sleeves constructed of vinyl, canvas and nylon ranging in length from 48" - 54". (1X226292-7B)
2681. **GUN SLEEVES** Lot consists of 10 zippered padded sleeves varying in size from 69" to 41" in good condition made from leather, canvas and nylon material. Also included is one tooled leather rifle scabbard in fair condition. (1X227390-7)
2682. **GUN SLEEVES** This lot consists of 13 zippered gun sleeves varying in length from 40" - 56". Sleeve materials are leather, canvas and nylon. All sleeves are in good to very good condition showing varying degrees of wear. (1X226679-41AA)
2683. **GUN SLEEVES** This lot consists of 10 padded zippered sleeves of various lengths. Sleeve materials are canvas, leather and nylon. Some of the sleeves have small tears and signs of wear. (1X226679-49AB)
2684. **FRAMED A.B. FROST PRINT LOT** This lot consists of a framed and matted brown and white copy of A.B Frost's "A Tempting Shot". The view measures 13 1/2" x 10 1/4", with a salmon colored border and the external dimensions of the wooden frame are 15 1/2" x 19 1/2". The back of the frame is labeled "A Tempting Shot / Hunting Shooting Waterfowl Ducks / By A. B. Frost / Indian Canoe, Rice Lake, Minnesota / Published in Harper Weekly / October 24, 1885". The condition rating is excellent. (2X218474-1)
2685. **SNIPER MEMORABILIA LOT** This lot consists of a framed patch lot and a framed motivational sniper poster. The framed patch lot consists of three Marine patches that may be reproductions. The first has the Grim Reaper over a prone sniper with the words "THE DECISION IS MINE", the second shows a Ghille covered skull over spotting scopes with the words "NO PLACE TO HIDE" and the third shows a skull with two crossed rifles in front of the words "SCOUT SNIPER/DEATH FROM AFAR". The case measures 12" in width and 15" in length. The motivational poster shows an Army sniper and spotter team over the words "PATIENCE/IF YOU HAVE ONE SHOT AT AN OPPORTUNITY MAKE IT COUNT". The frame measures 24" in width and 30" in length. (1X204343-63A,D)
2686. **REMINGTON 870 BARREL** This 12 ga., 28" ventilated rib Rem-Choked barrel with bright excellent bore retains 90% of its original matte finish with overall light scratches, oxidation staining and active oxidation. The barrel has a single silver bead sight and the included screw-in choke is modified. (108898-118W)
2687. **BRASS TRANTER BULLET MOULD** This is a single cavity bullet mould for a 54 bore (44 caliber) Tranter revolver, the projectile widely belted and the mould cavity very clean. The mould is 5 1/4" overall length with a fairly long blued-over steel sprue cutter which is marked "54". The mould shows a number of dings and tiny impact marks on its base, no doubt from being "tapped" over the years as it was being used. The brass surfaces are a dull tarnished ochre patina and the sprue cutoff is a mix of blue-dull pewter and brown oxidation, showing some light pitting, it does not affect the function of the sprue cutter or mould. An excellent accessory for your cased Tranter revolver. (1X37575-2)
2688. **CLEANING KIT LOT** This lot consists of two Pro-Shot pistol competition cleaning kits. Each features an 8" stainless steel rod and has jags and patch holders for the calibers listed. One kit is for 22 cal. the other will accommodate 9mm - 45 cal. pistol. Both are in "as-new" condition. (1X44113-15B,C)



2689. **DAISY AIR RIFLE LOT** This lot includes two air rifles. First is a Daisy Model 95 that retains about 95% original black paint finish showing some flaking along the lever, minor operational wear and remnants of a factory sticker on the barrel. The checkered brown plastic forend remains in excellent condition showing a few minor scratches and the hardwood buttstock rates very good plus with minor scratches and scuffs throughout. Next is a special edition Daisy Model 95B "Pony Express" that retains about 98% original gold-tone anodized finish showing a few small dings and minor oxidation around the rear sight. The smooth walnut forend and buttstock remain in excellent condition and the right side of the butt is laser-engraved with a galloping horseman and "PONY EXPRESS / 906 of 1860 Collector Edition". Both appear to have seen little use and include their original boxes, the plain Model 95 box shows some more moderate scuffs and tears. (138783-62, 63)
2690. **REMINGTON 870 BARREL** This 12 ga., 28" ventilated rib barrel with a bright about excellent bore is choked modified and retains 90% plus original blue with scattered freckling, spots of active oxidation, light scratches and silvery along some of the high edges and contact points. The barrel has a single silver bead sight. (108898-118T)
2691. **MOSSBERG MODEL 500 BARREL** This 12 ga., 24" slug barrel with bright excellent smooth bore is choked cylinder and retains perhaps 50% original blue finish that shows a heavy cleaning with fine scratches and bare metal throughout its length. It has traditional rifle style sights and would make a great candidate for a re-blue. (108898-118U)
2692. **MOSSBERG 500 BARREL** This 12 ga., 18 1/2" plain barrel with bright excellent bore is choked cylinder and retains 98% original blue finish with a few scattered light scratches and spots of fine oxidation staining. It has a single brass bead sight and remains in excellent condition. (108898-118V)
2693. **KUDU HORN LOT** This lot consists of a set of Kudu horns that are mounted on a wooden plaque. The horns measure about 31" in length and 20" in width. The horns are a bit loose from the plaque, they show some crackling, flaking and dirt staining. Please note extra shipping may apply. (1X206663-1)
2694. **UNMARKED SADDLE** This lot includes an unmarked gaited western style saddle with 6" gullet, 15" seat, high cantle and wrapped pommel without horn. The leather is somewhat dry but still supple and the stitching remains tight with most of the attaching metal showing either oxidation or oxidation staining. The fender, stirrups, and tread covers are all complete showing some light ingrained staining and spots of light crazing. The skirt is fleece lined and this is a lovely rustic looking saddle that would look fantastic hanging in any western décor or could be freshened up for riding. (107785-35) [please note: extra shipping will apply]
2695. **DAISY AIR RIFLES** This lot includes two Model 25, .177 caliber slide action air rifles. The first one is an older variation that has worn smooth, showing very little original finish and is now mostly a dark pewter color. The sights are intact and the plastic checkered wood grain stock and forend remain in very good condition. The second air rifle is of new production and still retains near all of its original finish with some of the gold stenciled decorative designs. The fold-down rear leaf sight is present and the plastic wood grain stocks rate near excellent and both items come with a factory box and/or shipping sleeve. (108783-59, 60) {NON-GUN}
2696. **SEARS ROEBUCK & COMPANY MODEL 9052 LEVER ACTION AIR RIFLE** This .177 caliber lever action air rifle is fashioned after the beloved Model 94. It has a brass colored receiver and buttplate with fixed blade front sight and adjustable sporting rear sight. The wood grain straight grip plastic stocks rate excellent. Included is the original factory picture box that has slightly tattered ends with scuffs along the seams and a couple of small tears. It does remain in overall very good condition. (108783-57) {NON-GUN}
2697. **DAISY MODEL 1894 "SPITTING IMAGE" LEVER ACTION .177 CALIBER AIR RIFLE** has numerous light scratches and spots of flaking in its enamel finish. The plastic wood grain stocks rate about excellent with some light spots of staining and included is an original factory box that has tattered and torn edges with ingrained dirt staining and evidence of light foxing. (108783-61)



2698. **DAISY MODEL 1938B LEVER ACTION AIR RIFLE** This Limited Edition Christmas 1999 is numbered 840 of 1500 and remains in excellent condition aside from a few very light handling marks. The air rifle comes with its original factory box, ornament, certificate of authenticity and some other related papers. The box has some liquid staining, light scuffs and remains in overall very good condition. (108783-64)
2699. **DAISY GOLD RUSH COMMEMORATIVE AIR RIFLE** This limited edition gold colored lever action air rifle is numbered 1296 / 2500 and remains in excellent condition. There are a couple of very minor handling marks and the inlaid Gold Rush medallion remains in excellent condition. Included with the air rifle are the original factory box, certificate of authenticity, two full tubes of BB's and related papers. The box has some overall light scuffing but remains in near excellent condition. (108783-58)

Books

2700. **LOT OF BOOKS** 7 total - The Foxes of the Desert, By Paul Carell, translated from German by Mervyn Savill; first published in the German language as Die Wüstenfüchse by Henry Nannen Verlag 1958, this version published by Bantam in 1962. 355 pages paperback, with tearing at the bottom of the binding and yellowing of the pages. Moltke on the Art of War, edited by Daniel J. Hughes, translated by Harry Bell and Daniel J. Hughes; C. 1993 by Daniel J. Hughes. 269 pages, hardcover with dust jacket in near excellent condition and appears to be unused. No Margin for Error The Making of the Israeli Air Force by Ehud Yonay; C. 1993 by Ehud Yonay. 395 page, hardcover with dust jacket in excellent condition and appears to have never been used. Daring to Win, Special Forces at War by David Eshel; C. 1992 by David Eshel. 210 pages, hardcover with dust jacket in near excellent condition with only slight signs of use. Lost Victories, The Military Genius of Stonewall Jackson by Bevin Alexander; C. 1992 by Bevin Alexander. 336 pages hardcover with dust jacket in near excellent condition with only slight signs of use. Chairman John J. McCloy The Making of the American Establishment By Kai Bird; C. 1992 by Kai Bird. 776 pages hardcover with dust jacket in near excellent condition with slight signs of use. Napoleon's Soldiers The Grande Armée of 1807 as Depicted in the Paintings of the Otto Manuscript, By Guy C. Dempsey, Jr.; C. 1994 by Guy C. Dempsey, Jr. 250 pages hardcover with dust jacket in near excellent condition with slight signs of use on the bottom of binding and jacket. This book contains paintings of French soldiers with detailed descriptions and thoughts from the author on each painting. (3A8935-26)
2701. **BOOK LOT** Total of Two Kriegsmoell 412 Pgs. and Karabiner 98k 588 Pgs., both by Michael Steves and Bruce Karem. Both books are hardcover, their dustcovers show scattered creasing and wear from use. Both are autographed by the authors with Kreisgmoell having a written note to Craig Brown. (207884-16IA) [Craig Brown Collection]
2702. **BOOK LOT** This lot consists of two items. First is the 28-th Edition Blue Book Of Gun Values by S.P. Fjestad. 2080 pages soft cover in very good condition with some folds to the covers. Next is Clark's New Hampshire Fishing Guide '03 Edition by Gary L. Clark. This softcover guide contains maps, county and access listings, species information and definitions and is in as-new condition. (44003-3)
2703. **LOT OF BOOKS** Complete four volume hardcover set with jackets, of Bayonets of the World by Paul Kiesling; c. Military Collectors Service and covering a total of 1049 different bayonets. Vol. 1, no date provided approximately 110 pages. Vol. 2, Acknowledgements section dated April, 1974, 131 pages. Vol. 3, dated Oct. 1974, 136 pages. Vol. 4, dated Dec. 1976, 187 pages. Standard reference work for serious collectors and these volumes show crisp edges and jackets with a few tiny tears and spots of soiling. The top edges have some very mild foxing, the inside covers have a previous owner's ID label attached and they and the front end papers exhibit additional mild foxing. (77813-1)
2704. **BOOK LOT** British Military Pistols 1603- 1888, by R.E. Booker, Jr.; c. 1978 Robert E. Booker Jr. 139 pages dark blue pebble grained hardcover featuring gilt title and drawing of a flintlock example and would serve as an excellent tool for identification purposes and includes an appendix on proof marks. Excellent condition with a small scuff on the top cover edge and a previous owner's ID label on the inside cover. (77813-2)
2705. **LOT OF BOOKS** Total of four. British Military Flintlock Rifles: 1740-1840, by De Witt Bailey, Ph.D.; c. 2002 De Witt Bailey. 264 pages hardcover rating excellent, showing very little, if any use. Don Troiani's Soldiers in America 1754-1865; Art by Don Troiani, text by Earl J. Coates and James L. Kochan; c. 1998 Don Troiani. 242 pages hardcover with jacket and with title page showing a 1998 dated note of gifting and includes nearly 200 photos of equipment and uniforms and full color scenes of important characters and action. Armies of the American Revolution, by Ian V. Hogg and John H. Batchelor; c. 1975 Bison Books, LTD. 160 pages hardcover with jacket showing mild soiling and the back showing residue from contact with a strip of tape, some spots of foxing around the illustrated inside cover but otherwise excellent. Americans and their Guns: The National Rifle Association story-through nearly a century of service to the nation., compiled by James B. Trefethen, edited by James E. Servern; c. 1967 The National Rifle Association. 320 pages hardcover with jacket showing creasing and edge wear and some spots of dirt on page edges. (77813-3)
2706. **LOT OF BOOKS** Total of six. Complete Book of Firearms: The origin, design and development of the gun, By Sergio Masini and Gian Rodolfo Rotasso; c. 1987 Arnoldo Mondadori Editore. 287 pages hardcover with jacket. The Great Century of Guns by Branko Bogdanovic and Ivan Valencak; c. 1986 Motovun. 280 pages hardcover with jacket and covering the period between the Napoleonic and World War I. An Illustrated History of Guns and Small Arms, by Joseph G. Rosa and Robin May; c. 1974 Octopus Books Limited, this edition published 1976. 96 pages hardcover. Antique Guns, by Hank Wieand Bowman; c. 1953 Fawcett Publications, Inc., this edition published 1960. 144 pages hardcover with tape repaired jacket. The Gun and its Development, by W.W. Greener; undated facsimile of the 9th edition of 1910. 804 pages hardcover with jacket. Antique Guns in Colour 1250-1865, by Robert Wilkinson-Latham; c. 1977 Blandford Press. 215 pages hardcover with jacket. The overall condition is very good plus with each book having some combination of light soiling, small jacket tears and/or edge wear. (77813-4)
2707. **LOT OF BOOKS** Total of six hardcovers. The Handgun, By Geoffrey Boothroyd; c. 1970 Geoffrey Boothroyd. 577 pages and with jacket. The Lure of Antique Arms, by Merrill Lindsay; c. 1976 Merrill Lindsay. 146 pages. The Gun Collector's Handbook of Values, c. 1940, 1947, 1951, 1955, 1958, 1960, 1963 Charles Edward Chappel. 398 pages and with jacket. Antique Weapons: for pleasure and investment, by Richard Akehurst; c. 1969 Richard Akehurst. 174 pages and with jacket. Antique Pistols: An illustrated Reference Guide for Collectors, by F. Wilkinson; 1985 F. Wilkinson. 84 pages and with jacket. Small Arms by Frederick Wilkinson; c. 1965 Frederick Wilkinson. 256 pages and with jacket. The overall condition of the lot is very good plus with examples of dirt stains, edge wear and jacket fading and small tears. (77813-5)

2708. **LOT OF BOOKS** Eight total. Japanese Arms and Armour, introduction by H. Russell Robinson; c. 1969 Arms and Armour Press. Approximately 150 pages hardcover with jacket affixed to inside back cover and ID label attached to inside front cover. British and Foreign Arms and Armour by Charles Henry Ashdown; published 1909 T. C. & E. C. Jack. 384 pages hardcover depicting armoured soldier on horseback and with gilt top edge and deckled front and bottom edges and the front and rear covers are separating at the spine. The Journal of the Arms and Armour Society, Vol. I, 1953-1955, second edition c. 1970 Lionel Leventhal Ltd., 400 copies. 230 pages near excellent condition hardcover with jacket and showing light edge wear. Arms and Armour, by Stephen V. Grancsay; c. 1964 Odyssey Press, Inc. 46 pages small sized hardcover rating near excellent. The Armoury Hall Guide to the Royal Danish Arsenal Museum, Copenhagen 1953. First edition 200 copies. 124 pages softcover. Arms and Armour, by Howard L. Blackmore; c. 1965 Howard L. Blackmore. 160 pages softcover. European Armour, by J. F. Hayward; published 1951. 58 pages illustrated softcover booklet sold at the Victoria & Albert Museum. Exhibition of Spanish Royal Armour in H. M. Tower of London; published 1960. 26 pages illustrated softcover booklet. The last four items in the lot rate very good with instances of foxing, soiling and wear. (78313-6)
2709. **LOT OF BOOKS** Total of three hardcovers with jackets. Frederic Remington, by Sophia Craze; c. 2004 World Publications Group, Inc. 112 pages and excellent condition. The Charles M. Russell Book, by Harold McCracken; c. 1957 Harold McCracken. 236 pages with some areas of light foxing and dirt and jacket showing a few small tears. There are four related vintage postage stamps attached to the front end paper also showing some 1960 dated hand written captions. Frederic Remington: The Masterworks, by Michael Edward Shapiro and Peter H. Hassrick; c. 1988 The St. Louis Art Museum. 271 pages and with some ID notes on the front end paper and some minor foxing and fading in isolated areas. These are large, illustration based offerings depicting the work of the artists. (78313-7)
2710. **LOT OF BOOKS** Total of five hardcovers. U.S. Military Knives, Bayonets & Machetes, Book IV, by M. H. Cole; c. 1990, this second printing 1991. 211 pages and with jacket and serving as a source of information on specimens that have turned up since Book III was published in 1979. Near excellent with some very light foxing along the top edge, a small jacket tear and a little wear to one corner. Swords and Daggers of Indonesia, text by Till Gottheiner, (no. c. info. provided). 67 pages and with a small plastic sword serving as a clasp. The Bayonet: A history of knife and sword bayonets 1850-1970, by Anthony Carter and John Walter; c. 1974 Anthony Carter and John Walter. 128 pages and with jacket. Near excellent with some foxing on top edge. The Collector's Pictorial Book of Bayonets, by Frederick J. Stephens; c. 1971 Frederick J. Stephens, Lionel Leventhal Limited. 127 pages, with jacket and in excellent condition. The Sword and the Centuries, by Alfred Hutton, published 1901. 367 deckled edge pages. There is separation occurring at the interior spine where it meets the front and back covers, some white liquid spots on the front cover which depicts a gilt sword over a maroon backdrop. Also evident is some sun fading at the spine and some corner wear and foxing mainly at the front and rear inside covers. (78313-8)
2711. **LOT OF BOOKS** Four total. The History of Remington Firearms, by Roy Marcot; c. 2005 Colin Gower Enterprises Ltd. 128 pages hardcover with jacket. Standard Catalog of Remington Firearms, by Dan Shideler; c. 2008 Krause Publications. 288 pages and showing little indication of use. Remington Arms: An American History, by Alden Hatch; c. 1956 Remington Arms Co., Inc. 359 pages and with jacket covered by a clear plastic sheet with tape having transposed to front and back end covers. There is mild fading and dirt evident but the book has held up quite nicely. The Remington Historical Treasury of American Guns, by Harold L. Peterson; c. 1966 Specialized Publishing Co. 159 pages and with jacket showing some small tears and a tape repair and there is isolated edge wear. (78313-9)
2712. **LOT OF BOOKS** Total of six. The Rifle in America, by Philip B. Sharpe; c. 1938 William Morrow and Co., Inc. (first edition). 641 pages pebble grained hardcover with gilt title and image of crossed rifles. The book was evidently once owned by famous shooter and author Bill Jordan as the inside front cover is stamped "William H. Jordan/NRA Representative/626 Ashburne Drive/Shreveport, La. 71106" and in larger font: "W. H. Jordan". Additionally the font end paper is dedicated by the author with: "Greetings Mr. Shooter". The book remains in very good plus condition with light foxing and soiling and very light wear. Included is the original cardboard sleeve in a lesser state with fading, edge wear and a tape repair to separated sections. Encyclopedia of American Hand Arms, by George Morgan Chinn, Jr. and Bayless Evans Hardin; c. 1942 Standard Printing and Publishing Company (first edition). 349 pages hardcover with tri-fold pullout illustrated frontispiece depicting a Civil War battle and the inside cover showing a 1942 dated note of gifting to a Capt. W. R. Hizar. American Small Arms, by Edward S. Farrow; c. 1904 Edward S. Farrow. 408 pages hardcover. Report of the Board of Officers on Magazine Arms 1892. Approximately 250 pages U. S. issued hardcover with a little loosening of the spine area. Firearms in American History Volume Two The Revolver, by Charles Winthrop Sawyer; c. 1939 Charles Winthrop Sawyer. 219 pages hardcover that is identified as copy no. 582 of 1000 issued. U.S. Martial and Semi-Martial Single-Shot Pistols, by Charles Edward Chapel; c. 1962 Charles Edward Chapel (first edition). 386 pages hardcover with jacket. Unless otherwise noted the books rate very good with some incidents of mild soiling, wear and fading. (78313-10)
2713. **BOOK LOT** Two total. A History of the Colt Revolver: and the Other Arms Made by Colt's Patent Fire Arms Manufacturing Company from 1836 to 1940, by Charles T. Haven & Frank A. Belden; c. 1940 Charles T. Haven and Frank A. Belden; c. 1940 by the authors. 711 pages with jacket showing sun fading at spine and a few small tears. Also evident on the book are some scattered areas of dirt, light wear, particularly at the corners and mild foxing at the top edge; the back end paper is missing. America's Premier Gunmakers Colt, by K.D. Kirkland; c. 1988 Bison Books Corp. 109 pages hardcover with jacket adhered to inside back cover and embossed ID and original sales receipt on back end paper. There is also a decorative ID label with a previous owner's name on inside front cover and a penciled in ID on front end paper. The illustration based book rates excellent. (78313-11)
2714. **LOT OF BOOKS** Total of four. The Standard Directory of Proof Marks: With WW II German Ordnance Codes, by Gerhard Wirnsburger, translated by R.A. Steindler. The Crossbow: Mediaeval and Modern Military and Sporting Its Construction, History and Management, by Sir Ralph Payne-Gallwey; c. 1958 The Holland Press. 328 pages plus a 24 page appendix and a 23 page section on the Turkish bow. Included is the jacket with protective sleeve and the inside cover has an ID label. Islamic Arms, by Anthony North; c. 1985 Anthony North. 48 pages hardcover from the Victoria & Albert Museum Series. The French Trade Gun in North America 1662-1759: A complete guide to identifying and understanding Military, Naval and Commercial Weapons manufactured at Saint-Etienne for New France and its fur trade, by Kevin Gladysz; c. 2011 Kevin Gladysz 183 pages softcover. The conditions of the books range from near excellent with minor blemishes to excellent. (78313-12)
2715. **LOT OF BOOKS** Total of six. The Illustrated Book of Guns and Rifles, edited by Frederick Wilkinson; c. 1979 The Hamlyn Publishing Group Limited. 191 pages hardcover with jacket and clear plastic covering. The front end paper has a note of gifting written in black ink and there is foxing evident in isolated pages. The World of Guns, by Richard Akehurst; c. 1972 Hamlyn Publishing Group Limited. 127 pages hardcover with clear plastic sleeve, an ID label attached to the front end paper and foxing evident in isolated areas. The Collecting of Guns, edited by James E. Severn; c. 1964 The Stackpole Co. 272 pages hardcover with jacket and protective sleeve and evidence of removed labels on inside cover and front end paper. Pictorial History of the Rifle, by G.W.P. Swenson; c. 1972 G.W.P. Swenson. 184 pages excellent condition hardcover with jacket. Modern Breech-Loaders, Sporting and Military, by W. W. Greener. Second edition. No c. info. provided. 273 pages hardcover with pull-out section intact and moderate foxing in areas. Also evident is sun fading at the spine and an embossed ID on front end paper. Rifles and Rifle Shooting, by Charles Askins; c. 1912 The McMillan Co. This edition published 1928. 244 pages hardcover with jacket. Unless otherwise referenced, the books rate about very good overall with wear, soiling and fading commensurate with books of this age. (78313-13)

2716. **LOT OF BOOKS** Total of ten. Antique Guns and Gun Collecting, by Frederick Wilkinson; c. 1974 Hamlyn Publishing Group Limited. 96 pages hardcover. A Century of Guns, by H. J. Blanch; published 1909 John Blanch & Son. 160 pages hardcover with separation occurring at spine, moderate foxing particularly at inside covers and end papers, an ID label on inside front cover and handling marks at the corners. Firearms, by Howard Ricketts; c. 1962 Howard Ricketts. 128 pages hardcover from the Pleasures and Treasures series and housed in its original cardboard sleeve with matching graphics. Gun: A Visual History, edited by Dr. Chris McNab; c. 2007 Dorling Kindersley Limited. 360 pages excellent condition hardcover with jacket. The Miniature Firearms of David Kucer, by K. Corey Keeble. 64 pages hardcover rating excellent with an ID label affixed to inside cover, a cut-out attached to the inside back cover and a previous owner's name written in ink on front end paper. Famous Guns that Won the West, by James Wyckoff; c. 1967 Fawcett Publications. 112 pages softcover. Collectors' Guns, by Don Myrus; c. 1961 Maco Magazine Corp. 128 pages softcover. Hand Guns of the World, by Hy Hunter; c. 1956 Trend Books Inc. 128 pages softcover. Complete Guide to Handguns, by Charles M. Heard; c. 1960 Trend Books. 128 pages softcover. Famous Guns From the Harolds Club Collection, by Hank Wieand Bowman; c. 1962 Fawcett Publications. The last five books rate very good with minor fading, creasing and wear. (78313-14)
2717. **LOT OF BOOKS** Total of ten. Famous Guns from the Harolds Club Collection, by Hank Wieand Bowman; c. 1962 Fawcett Publications Inc. 144 pages hardcover with jacket and protective clear cover. Famous Guns From the Winchester Collection, by Hank Wieand Bowman; c. 1958 Fawcett Publications. 144 pages softcover. Famous Guns from the Smithsonian Collection: The story of firearms patents between the years 1836 and 1880, by Hank Wieand Bowman; c. 1966 Fawcett Publications. 112 pages softcover. Famous Guns From Famous Collections, by Hank Wieand Bowman; c. 1957 Fawcett Publications. 144 pages softcover. How-To's For the Black Powder Cartridge Rifle Shooter, by Paul A. Mathews; c. 1995 Wolfe Publishing Co. 134 pages softcover. Muzzle Loading "...to begin with", by Don Davis; c. 1982 Friendship Publishing Co., Inc. 75 pages softcover. Modern Gunsmithing, by Clyde Baker; c. 1933. Second edition. 528 pages hardcover with jacket, protective sleeve and illustrated frontispiece. The Gunsmith's Manual, by J. P. Stelle and Wm. B. Harrison; republished 1945 Thomas Samworth. 376 pages hardcover with jacket, protective sleeve and illustrated frontispiece. Advanced Gunsmithing, by W. F. Vickery; c. 1940 Thomas Samworth. 429 pages hardcover with tattered jacket, protective sleeve, separation at spine and several ink notations on front end paper. The overall condition is very good with most exhibiting mild fading and wear. (78313-15)
2718. **LOT OF BOOKS** Total of four. Lugers at Random, by Charles Kenyon, Jr.; c. 1969 Charles Kenyon, Jr. 416 pages hardcover serving as an ideal identification tool for the collector that includes extensive break-downs on proof marks. Near excellent condition with a few dark spots on the cover and minor fading to page edges. Deutsche Plattnerkunst, by Von Bruno Thomas; c. 1944 F. Bruckman Verlag KG. 124 pages hardcover on armour, written in German with extensive captioned photography. Cover separation occurring at the spine but otherwise very good with some fading and minimal wear. Gamle Danske Militaervaben: II sampling, by Th. Moller; c. 1968 Host & Sons Forlag. 64 pages heavy grade softcover written in Danish on Danish historical military weaponry with helpful identification oriented drawings. Near excellent condition with handling marks at the upper corners and sun fading at the spine. Technical Dictionary for Weapons Enthusiasts, Shooters and Hunters, by Gustav Sybertz; c. 1969 Verlag J. Neuman. 164 pages excellent condition vinyl cover English/German dictionary on firearms related terms. (78313-16)
2719. **LOT OF BOOKS** This is a lot of approximately 100 items consisting of vintage auction catalogs, gun and cartridge related publications, price reference guides and other useful and interesting literature. Some examples are the fourteenth and fifteenth editions of the Blue Book of Gun Values, by S.P. Fjestad, the 1986 edition of Gun Trader's Guide, the 1989 Modern Gun Values, 1994 annual edition of Gun Digest and the 6th edition of Modern Guns Identification and Values. Examples of catalogs are the 1994 and 1999 editions of Dixie Gun Works, several by Martin B. Retting, a couple of 1964 dated Museum of Historical Arms and a 1942 Abercrombie & Fitch. There are approximately 30 catalogs by N. Flayderman & Co., Inc. and examples by Jack Brickell's, Robert Abels, James Tillinghast, Skinner, Ricard A. Bourne and other period catalogs. Also included in this diverse lot are vintage editions of the Western Ammunition Handbook, several issues of The National Cartridge Collector's Association and twelve issues of The Gun Report circa 1969/1970. Rounding out the lot are dozens of issues of the Shotgun Research Newsletter circa 1987-1994. The overall condition is about very good plus. (78313-17)
2720. **LOT OF BOOKS** Total of two. Japanese Military Cartridge Handguns 1893-1945: A Revised and Expanded Edition of "Hand Cannons of Imperial Japan", by Harry L. Derby III & James D. Brown; c. 2003 by the authors. 383 pages hardcover with jacket that retains the format of the original edition which is available in the following lot but with coverage on signal pistols, foreign procured military hand guns, ammunition, holsters and accessories. Japanese Hand Guns, by Frederick E. Leithe; c. 1968 Frederick E. Leithe, this second printing 1985. Approximately 225 pages hardcover with jacket showing a minor smudge and serving as an identification guide. This is an excellent condition lot with the books showing virtually no wear. (78001-15A)
2721. **LOT OF BOOKS** Two total. The Hand Cannons of Imperial Japan, by Harry Derby; c. 1981 Harry Derby, III. 283 pages hardcover signed by the author. Great source for identification while incorporating the history and evolution behind the arms. Military Pistols of Japan, by Fred L. Honeycutt, Jr.; third edition c. 1991, this fourth printing 1994. 168 pages hardcover with jacket showing a few minor stains and handling marks. Outstanding resource for the collector with full page photography contributing to easy identification characteristics. The condition rating of the two books is excellent. (78001-15B)
2722. **LOT OF BOOKS** Total of five. America's Premier Gunmakers Winchester, by K.D. Kirkland; c. 1989 Brompton Books Corp. 112 pages hardcover with jacket. America's Premier Gunmakers, by K.D. Kirkland; c. 1989 Brompton Books Corp. 112 pages hardcover with jacket. The Winchester Handbook, by George Madis; this first edition c. 1981 George Madis. 287 pages hardcover that is 1 of 1000 and signed by the author. Matt Eastman's Guide to Browning's Sporting Firearms' serial Numbers 1924 to Present by Matt Eastman; c. 1985 Matt Eastman. 11 pages staple-bound softcover signed by the author. The last book in this lot is a Wolfe Publishing Company reproduction of the Winchester Catalogue of 1899. 157 pages softcover. Overall this is an excellent condition lot showing very little in the way of wear; there are a couple of price stickers affixed and a scuff or handling mark here and there but they have clearly been well cared for. (78001-15C)
2723. **LOT OF BOOKS** Total of five. Walther Pistols and Rifles, by W. H. B. Smith; second edition c. 1962 The Stackpole Company. 198 pages hardcover. Book of Pistols and Revolvers, by W. H. B. Smith, completely updated by Kent Bellah; c. 1965 The Stackpole Company. 752 pages hardcover. History of Smith & Wesson, by Roy G. Jinks; c. 1977 Beinfeld Publishing. 290 pages hardcover with jacket. Handguns of the World: Military Revolvers and Self-Loaders from 1870 to 1945, by Edward C. Ezell; c. 1981 Edward C. Ezell. 704 pages hardcover with jacket. Das grosse Buch der Sig-Pistolen, by Lorenz Vetter; c. 1995 Verlag Stocker-Schmid AG. 240 pages excellent condition identification based hardcover with jacket and written entirely in German. The overall condition of the first four books in this lot is very good with foxing, fading, soiling and mild wear evident. (78001-15D)
2724. **LOT OF BOOKS** Total of four. Military Holsters of World War II, by Eugene Bender; c. 1998 Tom Rowe (reprint edition, first published 1984). 208 pages hardcover in excellent condition. The Encyclopedia of Infantry Weapons of World War II, by Ian V. Hogg; c. 1977 Bison Books, this fourth printing 1979. 192 pages hardcover with jacket showing an ink marking on the front but otherwise this is an excellent condition book packed with battlefield photography. The Crossbow, by Sir Ralph Payne-Gallwey; c. 1996 Barnes & Noble, Inc., originally published in 1903. 328 pages hardcover with jacket and rating about very good plus with some creased pages, isolated small stains to page edges and storage marks to jacket. The Book of Rifles, by W. H. B. Smith and Joseph E. Smith; c. 1948 N.R.A., this third edition, second printing 1965. 656 pages hardcover with a small tear at upper spine, moderate fading and a previous owner's name written on the front end paper but with overall only light wear. (78001-15E)

2725. **LOT OF BOOKS** Total of seven. The Ruger 10/22, by Wm. E. Workman; c. 1994 Krause Publications. 320 pages softcover. Savage & Stevens Arms Collector's History, by Jay Kimmel; c. 1990 Jay Kimmel, this second printing 1991. 224 pages softcover. The Nine-ty-Nine: A History of the Savage Model 99 Rifle, by Douglas P. Murray; c. 1985 Douglas P. Murray. 153 pages softcover. 10 Shots Quick: The Fascinating Story of the Savage Pocket Automatics, by Daniel K. Stern; c. 1967 Daniel K. Stern. 153 pages hardcover with jacket and moderate foxing on top edge. Savage Automatic Pistols, by James R. Carr; (no c. info. provided) 131 pages hardcover with jacket. Matt Eastman's Guide to Browning's Sporting Firearms 1924- 1985, by Matt Eastman; c. 1985 Matt Eastman; 32 pages staple-bound softcover signed by the author. The last item in the lot is a photocopied version of the B-92 Field Service Manual, produced by Browning and consisting of a total of nine full size pages. The overall condition of the lot is very good to excellent with some incidents of soiling and wear. (78001-15F)
2726. **LOT OF BOOKS** Total of two. The Guns of Boston Harbor: (From the Bay Colony through the Present), by Gerald W. Butler, S.F.H.; c. 2001 Gerald W. Butler. 398 pages softcover covering defense systems in place and included is coverage of enemy sneak ships penetrating the harbor shortly after the attack on Pearl Harbor. Nice crisp edges with a few dirt spots here and there. Small Arms of the Sea Services: A history of the firearms and edged weapons of the U.S. Navy, Marine Corps and Coast Guard from the Revolution to the present, by Colonel Robert H. Rankin, USMC (Ret); c. 1972 N. Flayderman & Co., Inc. 227 pages hardcover with jacket showing minor edge wear but no other negatives worth mentioning. The overall condition of the lot is excellent. (1X78334-8S)
2727. **LOT OF BOOKS** Total of six hardcovers. The Gun-Founders of England: With a List of English and Continental Gun-Founders from the XIV to the XIX Centuries, by Charles Ffoulkes; c. 1937, 1969 Charles Ffoulkes; 133 pages. The Crossbow, by Sir Ralph Payne-Gallway, c. 1953 Holland Press. 375 pages. European Firearms European, by J.F. Hayward; c. 1955 Philosophical Library, Inc. 53 pages text with extensive photo plate section. The first four books in this lot include the original jackets affixed to the back covers and rate near excellent with a previous owner's name written and embossed. Gun Collecting, by Charles Edward Chapel; c. 1939, by Coward-McCann, Inc. 232 pages with separated jacket that is missing a large section of the front and extensive white staining to the back cover. An Introduction to European Swords, by Anthony North; c. 1982 Anthony North. 48 pages and rating near excellent. (1X73762-1B)
2728. **LOT OF BOOKS** Three total. American Military and Related Equipments, by R. Stephen Dorsey; c. 1984 Pioneer Press. 129 pages softcover and excellent tool for identification purposes. Arms & Equipment of the Civil War, by Jack Coggins; c. 1972 Jack Coggins. 160 pages hardcover with jacket and utilizing more than 500 illustrations produced by the author. Guns of the American West, by Joseph G. Rosa; c. 1985 Joseph G. Rosa, Lionel Leventhal Ltd. 192 pages hardcover with jacket covering flintlocks through the introduction of the semi-auto pistol of the late nineteenth century. This is an excellent condition lot with some minor isolated dirt and the inside cover of the first book showing a tan section from storage contact with a periodical clipping. (1X78334-8Y)
2729. **LOT OF BOOKS** Total of nine and all from The Old West Series from Time Life Books. These are well constructed leather bound volumes featuring raised western motif covers, gilt titles and accents at the spines and each with a colorful and dramatic illustration representing its respective topic. The series consists of a total of 27 volumes published between 1973 and 1980 and the nine in this lot have the following titles: The Indians, The Gunfighters, The Trailblazers, The Expressmen, The Townsmen, The Soldiers, The Great Chiefs, The Cowboys and The Forty-Niners. The books are in excellent condition. (1X78334-8X)
2730. **LOT OF BOOKS** Total of four. Ethan Allen and Allen & Wheelock: their guns and their legacy, by Paul Henry; c. 2006 Paul Henry. 230 pages hardcover with a personalized and signed dedication sticker by the author affixed to the front end paper. The Deringer in America. Vol. Two: The Cartridge Period, by L.D. Eberhart & R. L. Wilson; c. 1993 by the authors. 280 pages hardcover with jacket. by the authors. 280 pages hardcover with jacket. All About Southerners: The history and details of the .41 Caliber Rim Fire Southerner derringer. Vol. One, Limited Edition book no. 231 of 1000 and signed by the author. 114 pages hardcover with jacket and like the first two books in this lot rates excellent with virtually no blemishes. The last item is a 24 page staple bound booklet with a blue softcover that reads "Illustrated Catalogue/of/"Brown" Military Gun,/Ballard Sporting Rifles./Southerner Pistols, &c./ Manufactured/By The/Brown Manufacturing Co./1869". The booklet shows light wear with the first two pages showing a name written in ink. (1X78334-8R)
2731. **LOT OF BOOKLETS** Total of eight beginning with a copied version of Fifty Years of Gunmaking: The Story of the Hopkins & Allen Arms Company 1867 to 1917, by Joseph T. Vorisek; c. 1992 Armsco Press. 149 pages contained in a binder with a clear plastic cover. The remaining items in this lot are vintage catalogs and price lists, all but one being staple bound and likely reproductions. They are from various manufacturers starting with a Hopkins & Allen catalog of the 1908 era with the image of the horse drawn sleigh being pursued by a pack of wolves. The staple bound 34 page booklet measures 10"x7 1/2". There is also a catalog by Forehand & Wadsworth of about the same size and with blue graphics on white stock with an inside cover informing that this is a Fortress Publications reproduction of a catalog circa 1880. There is also a 15 page example dated 1879 and from The Lee Arms Company exhibiting the image of the Bridgeport, Conn. facility over the light blue cover. The last four are pocket size and consist of a Harrington & Richardson Arms Co. Catalog No. 21 and a U.S. Cartridge Co. example dated 1881 and consisting of 113 pages. The last two are price lists starting with a Sept. 1923 Harrington & Richardson by Info-Arm and the other is a pull-out folder of Remington guns. This is an excellent condition lot. (1X78334-8W)

Gun Parts

2732. **L.C. SMITH BARREL LOT** This is a set of L.C. Smith Field Grade 12 ga. ejectorgun barrels from the Hunter Arms Company of Fulton New York. The barrels are 30" choked modified and a light modified with bright excellent bores. They retain about 95%, likely original blue, showing light muzzle wear, even toning overall and a few light handling marks. Rib is equipped with dual brass beads. serial number is 191931, they are armor steel, ejector barrels with 2 3/4" chambers. (38855-1A)
2733. **K98K HANDGUARD LOT** This lot consists of three German K98k style handguards. One is solid walnut and it appears to be Weimar era. The second is laminated and shows the beginnings of a laminate separation along its length. The third is solid walnut and it appears unmarked. All handguards are numbered, they show minor dings, handling marks and dirt staining. (207884-14A) [Craig Brown Collection]
2734. **K98K HANDGUARD LOT** This lot consists of three German K98k style handguards. All three appear to be solid walnut. One handguard is un-numbered, it is marked with a "(Weimar Eagle?0WaA26" and "S/237". The other two appear unmarked and are numbered. The handguards show minor dings and handling marks from the years. (207884-14B) [Craig Brown Collection]

2735. **K98K BAND LOT** This lot consists of four un-numbered K98k front bands. The first band is the earlier "H" type. The next band is a midwar smooth stamped type and the other two are the late-war ribbed stamped type. The bands show some light oxidation, silvering and a few minor dings. (207884-14C) [Craig Brown Collection]
2736. **GEW 98 PARTS LOT** This lot consists of four Gew 98 front bands and a Lange Vizier rear sight assembly. One of the bands is un-numbered and the other three are serialized. The bands all retain much of their arsenal blue finish with varying degrees of oxidation, minor dings, silvering and one band having light pitting. The Lange Vizier rear sight is the earlier 200 meter type that has been modified to only go back to 400 meters. The base is numbered matching to the sight, the assembly is an overall silver pewter with scattered oxidation and oxidation staining. (207884-14D) [Craig Brown Collection]
2737. **K98K PARTS LOT** This lot consists of four items for the K98k rifle. The first is an un-numbered front band that is the "H" type showing silvering and some freckling. The next item is a Mauser made floorplate, follower and follower spring. The floorplate is un-numbered, it is marked with a "(Eagle)/655" Waffenamt and the follower is numbered "92". This assembly retains much of its blue finish with some light oxidation here and there. The next part is a triggerguard that includes a magazine box, floorplate and follower. The numbered parts are matching, the bottom metal is a dull gray patina, with oxidation staining and there is some freckling on the other parts. The last part is a rear sight assembly, the rear sight base is the only serialized part and the base shows scattered silvering. (207884-14E) [Craig Brown Collection]
2738. **K98K PARTS LOT** This lot consists of five K98k parts. Four of the parts are cupped buttplates, all of the buttplates show oxidation with two of them showing oxidation and freckling throughout. The last item is a rear sight assembly. The rear sight elevator and base are mismatched, the rear sight retains much of its blue finish with scattered light oxidation. (207884-14EF) [Craig Brown Collection]
2739. **GEW 98 PARTS LOT** This lot consists of 10 Gew 98 front bands. All of the bands are numbered, they show varying degrees of oxidation, silvering and finish wear. Some of the bands are worn to a silver pewter, some show dings and another some moderate pitting. (207884-14G) [Craig Brown Collection]
2740. **K98K BAND LOT** This lot consists of six assorted K98k bands. Two are the front bands and four are rear. One of the front bands is a midwar type that lacks reinforcing ribs, it is un-numbered and shows scattered freckling. The other front band is an un-numbered late war ribbed type, it is worn to a silver pewter with freckling. Two of the rear bands are the earlier milled type, they are numbered, have a few dings, light oxidation and silvering. The other two rear bands are the late war stamped type, they are un-numbered, have a few dings and oxidation. (207884-14H) [Craig Brown Collection]
2741. **GEW 98 PARTS LOT** This lot consists of eight assorted Gew 98 parts. There are three bayonet lugs, one has been cleaned to a silver pewter, one is a dull gray patina and the other retains much of an arsenal blue finish with silvering and oxidation staining. The next two parts are buttplates, one is numbered, it shows freckling and light oxidation throughout. The other buttplate is numbered "7g", it shows heavier oxidation throughout. The next part is a triggerguard assembly with magazine box, without follower, trigger or associated parts are present. The bottom metal shows silvering and fading around its edges. The last two parts are floorplates, both are numbered, one shows moderate oxidation and the other some light oxidation. (207884-14I) [Craig Brown Collection]
2742. **GEW 88 BOLT PARTS LOT** This lot consists of a Gew 88 bolt body numbered "1532m", firing pin and cocking pin. There is no bolt head or safety are present. The cocking piece is non-matching to the bolt body and the bolt shows scattered oxidation staining. (207884-14K) [Craig Brown Collection]
2743. **MAUSER RIFLE PARTS LOT** This lot consists of 8 various Mauser rifle parts. The first part is a VZ-24 rear band with sling swivel, it retains much arsenal blue with an area of dings, overall thinning and freckling. The next item is a Gew 98 narrow rear band and sling swivel numbered "71" with an overall dull gray patina and scattered oxidation. The next item is an un-numbered K98k style floorplate and it retains nearly all of its reapplied blue finish. The fourth item is a K98k rear sight, it shows some minor oxidation staining and is numbered "86". The next item is 98 bayonet lug numbered "1", it shows some light pitting and scattered oxidation. The sixth item is a rear sight base barrel sleeve for a K98k, it appears reblued, has a small crack at the end and scattered oxidation. The seventh item is a folding muzzle cover for a Gew 98 that is numbered "1420", it is an overall gray patina with some oxidation staining. The last item is a Gew 98 bolt sleeve numbered "38" and it is a silvery gray patina. (207884-14L) [Craig Brown Collection]
2744. **VIS 35 RADOM BARREL** This lot consists of a Steyr made barrel for the P.35/Vis 35 Radom pistol. The barrel appears un-numbered, it is marked with a "(Eagle)/623" Waffenamt, it has a dull gray patina with overall oxidation staining. The bore rates very good plus with a few light pits and minor oxidation. (207884-14M) [Craig Brown Collection]
2745. **MAUSER 98 PARTS LOT** This lot consists of 7 various Mauser 98 military items. The first two are folding muzzle covers. The Nazi marked cover is blued-over and the other is Imperial marked and finished brightly. The next two items are K98k rear sights and they show some light oxidation. The next two items are 98 Mauser bolt sleeves, both appear un-numbered, one appears to have been polished brightly and the other is blued-over. The last item is a Gew 98 buttplate, it appears un-numbered and shows overall oxidation. (207884-14N) [Craig Brown Collection]
2746. **WALTHER P.38 PARTS LOT** This lot consists of a Walther-made P.38 barrel and right grip panel. The barrel is numbered "8076a", it retains about 70% original blue with a couple minor dings on top, some silvering on the sides and overall flaking to brown. The bore shows some light pitting and frosting and there is no locking block or front sight present. The grip panel is the brown grooved type and it shows some wear from handling. (207884-14O) [Craig Brown Collection]
2747. **MAUSER 98 PARTS LOT** This lot consists of nine assorted Mauser 98 parts. The first is a tangent rear sight for a Kar 98b or Gew 98M style rifle. It is a silvery gray patina and is missing its adjustment bar. The next three items are K98k style rear sights, they show oxidation staining and have their adjustment bars. The next two items are Gew 98 roller coaster sight ramps. One shows oxidation throughout and the other retains much of its original blue finish. The next two items are Mauser 98 style safeties. One has been cleaned bright with light pitting and the other appears reblued with light freckling. The last item is a Gew 98 bolt sleeve that appears partially bright with some light pitting and oxidation staining. (207884-14P) [Craig Brown Collection]
2748. **MAUSER 98 PARTS LOT** This lot consists of six assorted Mauser 98 parts. The first part appears to be a G33/40 rear sight barrel sleeve. It shows some flaking and light oxidation. The next part is a K98k follower marked "lxi" and it shows some light oxidation. The next item is a Gew 98 rear band that had its swivel hardware removed. The next item is a folding muzzle cover for a Gew 98. The last two items are Gew 98 rear bands with sling swivels. One retains much of its blue finish the other is a dull brown oxidized patina. (207884-14Q) [Craig Brown Collection]
2749. **ASSORTED MILITARY PARTS LOT** This lot consists of six assorted military parts. The first two are K/G43 dustcovers, they are blued-over, unmarked, show scattered oxidation and are either well made reproductions or original. The next two items are 98 Mauser extractors, one is numbered "562", the other un-numbered, one has worn to a silvery gray patina with oxidation and the other is blued-over with some scattered oxidation. The next item is a black Mauser 98 folding muzzle cap that shows some light oxidation. The last item appears to be the nose cap and bayonet lug assembly from an 89/36 Belgian Mauser. It lacks sling hardware and shows some light oxidation. (207884-14R) [Craig Brown Collection]

2750. **ASSORTED ANTIQUE MILITARY PARTS LOT** This lot consists of seven antique military musket parts. The first part is a brass 1809 Potsdam buttplate that is dated 1834, it is an overall dull brown patina with oxidation throughout and some heavy pitting. The next item appears to be a hammer for a Potsdam 1809 percussion converted musket, it is an overall dull gray patina with oxidation staining. The next two items are two identical percussion hammers of unknown make and model, they are finished brightly and show light oxidation staining. The next two items are brass triggerguards that appear to be Prussian or Imperial German possibly for a needle gun. They are an overall dull yellow patina with some oxidation staining and one having a front mounted swivel hole and the other lacking such a hole. The last item is a brass triggerguard that appears to be Bavarian as there is a crown proof marking, it is an overall dull brown patina with a few dings and some oxidation staining. (207884-14S) [Craig Brown Collection]
2751. **ASSORTED MAUSER 98 PARTS LOT** This lot consists of 11 Mauser 98 parts. The first two parts are firing pins, they are numbered, they appear to be Imperial era and show some oxidation staining. The next three parts are extractors, one is blued-over, the other two are in-the-white and all show oxidation staining. The next two items are stock discs, one is unmarked, the other is for a VZ33 carbine, it is marked "CETN/5114B" and both show oxidation. The next two items are Gew 98 floorplates, one is numbered "63", the other un-numbered and they show scattered oxidation. The tenth item is a Gew 98 safety numbered "83" and it shows some light oxidation staining. The last item is a K98k rear sight base marked "WaA280" and there is no barrel sleeve present. (207884-14T) [Craig Brown Collection]
2752. **ASSORTED GERMAN PISTOL PARTS LOT** This lot consists of four items. The first is an aluminum-base Luger magazine that is marked with "(Eagle)/63" and numbered "52b". The Luger magazine spring lever does not appear to function, there are scattered pitting and oxidation spots on the body. The next item is a right grip panel for an FN 1922 pistol, no screw is present, the panel rates fair to good with overall dirt staining, scuffing and some flattened points. The third item is a J.P. Sauer 1913 right grip panel with a screw. This grip panel rates very good showing some dirt staining and flattening points. The last item is a Waffenamts-marked Unique Model 17 barrel, it is numbered 11, the exterior shows some oxidation staining and the bore rates very good plus showing a couple spots of light pitting. (207884-14U) [Craig Brown Collection]
2753. **1911 SHOULDER STOCK LOT** This lot consists of a wooden 1911 shoulder stock. The stock shows a couple minor handling marks and the metal parts show light silvering. The consignor refers to this stock as a "Rhodesian" style and a 1911A1 style main-spring housing is included. (208903-67)
2754. **LOT OF S&W PRE-MODEL 10 PARTS** This lot consists of parts from a Smith & Wesson Military and Police pre-model 10 five-screw hand ejector revolver in 38 Special serial number C17968. The parts rate good to very good overall and include a cylinder assembly, 2" barrel assembly with an excellent bore, crane, sideplate, all internal parts plus the stock pin and barrel pin. The frame is not present. The side plate has been non-factory re-blued, the barrel is original blue finish with moderate edge wear and the hammer has had the spur removed and reapplied blue finish added. The cylinder and crane also appear to be original finish. The standard trigger has thinning original case-hardened colors on the right side and edges. A set of Pachmayr K-frame round but Compac grips in excellent condition are included. (86520-2925)
2755. **SAKO L61R RIGHT HAND LONG ACTION** serial #614490 (action only). This action is sized to accommodate the .300 / .338 Winchester Magnum family of cartridges or similar. The metal surfaces are in-the-white and rate about excellent with a few scattered light scratches. The top of the action is checkered as is the bolt cover. The safety lever, lock mechanism, magazine body and recoil lug are blue finished and rate excellent. The left side of the action is marked with the serial number and the right side is laser-etched with the importer's information. The action is complete and needs only a barrel, stock, associated hardware and finish of choice to transform it into a beautiful rifle for your next hunt. The action includes the original factory box that is correctly end-labeled and numbered to the gun. (86519-494) {FIREARM}
2756. **U.S. MODEL 1903 ACTION BY SPRINGFIELD ARMORY** serial #1256268 (action only). Included with this is a complete bolt assembly, magazine cutoff and complete triggerguard-magazine assembly. No trigger assembly, barrel or other parts are provided. The metal surfaces have about 95% re-applied Parkerized finish, with the exception of the magazine floorplate which is in-the-white, showing a few areas of oxidized pitting on the front receiver ring, high edge wear, operational wear and light handling marks. (86519-504) {FIREARM}
2757. **U.S. MODEL 1911 SEMI-AUTO PISTOL PARTS BY SPRINGFIELD ARMORY (FRAME AND SLIDE ONLY)** serial #76046. This gun includes the frame, (4) grip screw bushings, (4) grip screws, plunger tube and ejector. The slide includes the front and rear sights only. The metal surfaces retain about 40% original blue with the slide, front strap and portions of the triggerguard toned to brown, scattered oxidation blemishes and a few handling marks. It appears attempts were made to start accurizing the pistol as there are tool impact marks on the sides of the forward section of the slide, impact marks on the front and rear of the slides from driving it on and off the frame but no tool marks on the frame. The slide is now showing slight bulging on the right side of the muzzle section and all the markings on the slide and frame remain strong to crisp. (86519-655) {MODERN}
2758. **U.S. MODEL 1903 ACTION BY SPRINGFIELD ARMORY** serial #101742 (action only). Included with this is a complete bolt assembly, magazine cutoff and trigger assembly. No magazine assembly, barrel or other parts are provided. The metal surfaces of the action are gray with a few streaks of darker blue visible in the protected areas. The bolt is polished and left in the white. The cocking piece and safety lock have been polished bright with reapplied blue finish toning to purple. This action is in the serial number range for non-double heat-treated receivers. A nice representative sample action for the student of U.S. Model 1903s or military turn bolt rifles in general. (86519-275) {FIREARM}
2759. **GERMAN SCHUETZEN MARTINI STYLE CENTER FIRE ACTION** serial #8249 (action only). Overall the metal retains about 50% robust case-hardened colors, mostly on the side of the action, with most of the loss due to oxidation blemishes, scratches and a small impact mark above the serial number. This is a complete action with double set triggers, trigger mechanism, breech block and other associated parts. The mechanism is fully operational and there are provisions for a diopter rear sight on the tang. The metal needs a little t-l-c but overall this is a great start toward building your next Schuetzen rifle. (86519-563) {FIREARM}
2760. **DWM P.08 LUGER PARTS LOT** This lot consists of an almost complete set of Luger parts minus the frame, mainspring and mainspring guide. The metal surfaces retain about 90% likely Russian arsenal-reapplied dull blue showing some light high edge wear, scratches, a few spots of light oxidation staining and some fine pinprick pitting underneath the blue. The receiver is dated 1915 with a Russian capture "X" over the date and the 4" 9mm barrel has an oxidized bore showing some faint rifling throughout. The DWM toggle with grooved firing pin is numbered "91" while the barrel and receiver are "3980". The other parts are an assortment of numbers some having been punched-out. The black checkered plastic grips are likely Russian replacements remaining in very good plus condition showing a few lightly chipped points, dings and handling marks. The right panel is noticeably coarser than the left. Also included is an un-numbered bright-bodied aluminum base magazine that shows some small dings, a few spots of light flaking and has a replacement polymer follower. (138050-9A)

2761. **MAUSER CODE 42 P.08 LUGER PARTS LOT** This lot consists of a complete set of Luger parts minus the frame. The metal surfaces retain about 85% original blue with some overall thinning to gray patina along the receiver and toggle train and the extractor is a nice plum patina. The receiver is dated 1940 and the 4" 9mm barrel has an about good bore with some moderate spots of oxidation and strong rifling throughout. Most of the serialized parts are matching to the barrel and receiver numbered "9357", the sideplate may have been re-numbered to match at some point, the grooved firing pin is numbered "34" and the hold open is "43". The checkered walnut grips are un-numbered but stamped with "(Eagle) / 655" Waffenamts and remain in very good condition showing a few scattered tiny chips, some more prominent dings on the right panel and scattered handling marks. If you are looking to restore your Luger pistol or just like to have extra original parts on hand this lot is for you. (138050-52A)
2762. **MAUSER S/42 P.08 LUGER PARTS LOT** This lot consists of an almost complete set of Luger parts minus the frame, grips and grip screws. The metal surfaces retain about 95% arsenal quality reappplied blue showing some scattered light freckling, handling marks and small spots of lightly cleaned pinprick pits underneath the blue. The ejector is polished bright, the extractor is a dark plum color and the magazine release spring still retains some fire blue. The receiver is dated 1936 and the 4" 9mm barrel has an about good bore showing some moderate oxidation but strong rifling throughout. All of the serialized parts including the grooved firing pin are matching the barrel and receiver numbered "2310". (138050-329A)
2763. **MAUSER S/42 P.08 LUGER PARTS LOT** This lot consists of an almost complete set of Luger parts minus the frame, grips and grip screws. The metal surfaces retain perhaps 75% older reappplied blue mostly toning to a dark blue-gray patina and showing moderate oxidation staining and freckling along the barrel and spots of fine pinprick pitting underneath the blue. The receiver is dated 1939 and the 4" 9mm barrel has a fair oxidized bore still showing good rifling throughout. All of the serialized parts including the grooved firing pin are matching the barrel and receiver are numbered "2601". (138050-376A)
2764. **COLT 22/45 CONVERSION UNIT LOT** This lot consists of a single Colt 22/45 Conversion Unit. The unit includes a factory slide complete with firing pin assembly, extractor, serrated semi-ramp front sight and Coltmaster adjustable rear sight. The slide retains about 98% original blue with high edge wear, scratches and operational marks. Slide address is "COLT'S MFG. HARTFORD CT. U.S.A." which indicates the unit was made between 1947 and 1955. Also included are a 5" Colt barrel with a bright excellent bore in 22 LR featuring a Williams floating chamber, ejector, slide stop, recoil spring, recoil spring guide and factory magazine. All rate very good to excellent. It also includes an original brown factory hinged box correctly labeled for a 22/45 conversion unit. The cover has separated from the base and the two left side corners are torn. There is scattered light scuffing and handling marks for an overall rating of good on the box. (88893-24)
2765. **HARRINGTON & RICHARDSON HANDY GUN FRAME** serial #205. The metal surfaces retain about 80% original blue with scattered patches of moderate to heavy oxidation staining and light pitting. The hammer retains some faint hints of case-hardened colors mostly obscured by oxidation staining. The checkered walnut grip remains in about fair-good condition with a large 1 1/2" chip out of the top edge exposing the frame, a couple thin 1" cracks running from the chip, a couple further chips at the heel, dings and handling marks. The lever seems to function normally and the hammer is robust. (138895-22) {FIREARM}
2766. **GERMAN P.38 SEMI-AUTO PISTOL BY SPREWERK PARTS LOT** serial #3361e, 9mm, 5" barrel with a bright near excellent bore showing a few tiny spots of light oxidation. The metal surfaces of this cyq-coded pistol are mostly a blue-gray patina showing scattered patches of both original and older reappplied blue throughout, spots of cleaned light to moderate pitting and high edge wear. The black grooved synthetic grips remain in near excellent condition showing some very small dings and light handling marks. All of the markings are still quite clear, the serialized parts are matching the frame and appropriately stamped with "(Eagle) / 88" Waffenamts. Also included is one original magazine with "(Eagle) / 359" on the spine showing some moderate scratches throughout and spots of light pitting on the floorplate. The frame of this pistol is stripped and all of the parts appear to be present although some of the springs seem a little bent out of shape. (138897-8D34228) {FIREARM}
2767. **LOT OF COLT CYLINDERS** This lot consists of three Colt Official Police 38 caliber cylinders. The blued-over cylinders retain nearly all of their original blue with a few light handling and some light edge marks. All are in excellent condition. (47613-2)
2768. **LOT OF COLT PARTS** This lot consists of parts for Colt 1903 Pocket Hammerless pistols. Included are a slide, three grip straps and three safeties. All are mostly a mottled gray but are in very good overall condition. (47613-4)
2769. **LOT OF S&W PARTS** This lot consists of a back strap and two sight assemblies for the earlier S&W Model 39 series pistols. One of the sights is broken. Also included are two instruction sheets on the Model 39. (47613-5)
2770. **MOSSBERG BARREL LOT** This lot consists of a single Mossberg 500 28" plain field barrel choked modified. The barrel has an excellent bore, there are a few areas of light surface oxidation and pitting along with some minor abrasions and tools marks on the exterior. A decent replacement field barrel. (77094-1)
2771. **AR-15 PARTS LOT** This lot consists of a Rock River Arms AR-15 Lower receiver parts kit. The kit appears to be complete and includes a black checkered pistolgrip, collapsible stock, buffer spring and piston. (47524-10A)
2772. **HK MOUNT LOT** This lot consists of a Heckler & Koch claw mount for the 91, 93, G3 and MP5 series. The matte parkerized mount is marked "SchuBrichtung" on the underside and is in excellent overall condition. A set of 30mm to 1" adapters is included. (48821-147K)
2773. **THOMPSON/CENTER CONTENDER BARREL** This lot consists of a 10" blued-over 9mm barrel for the Thompson/Center Contender pistol. The barrel is in its original box and is in as-new original condition. (48579-15)



2774. **LUGER BARREL LOT** This lot consists of a Luger artillery barrel and receiver for the P08 series pistols. The barrel has an excellent bore and has 99% of a commercial blue finish. There are a few handling marks and a few small pits visible. The receiver is stripped and is dated "1916". The barrel is equipped with proper sights and is serial numbered to the receiver (3442). An excellent accessory or replacement barrel assembly for your P08 series Luger pistol. (48578-20A)
2775. **WINCHESTER BARREL LOT** This lot consists of a Winchester Model 1300 20 gauge shotgun barrel. The barrel measures 22 1/2" and features a ventilated rib and screw-in improved cylinder choke. The barrel has some light handling wear along with a few specks of light surface oxidation but remains in near excellent condition overall. (46758-58B)
2776. **SAVAGE BARREL LOT** This lot consists of a Savage Model 110 22" rifle barrel. The barrel is chambered in 243 Win and has an excellent bore. The barrel has been stripped of its sights, but the collar remains. There are light handling and wear marks overall but this would make a terrific replacement or barrel for your custom build. (46758-58C)
2777. **WINCHESTER BARREL LOT** This lot consists of a Winchester Model 70 Featherweight barrel in 30-06. The barrel measures 22" in length and has an excellent bore. The front sight base and hood remain, the blade has been removed and a folding rear sight fitted in the rear dovetail. A terrific replacement or addition to your custom build. (46758-58D)
2778. **WINCHESTER BARREL LOT** This lot consists of a Winchester Model 70 Pre-64 style barrel in 30-06. The barrel measures 24" in length and has a presumably excellent bore that has been plugged with grease. There are a few specks of light surface oxidation and some light handling wear scattered about. The underside of the barrel is marked "1906 52". The front sight base remains, the blade and rear sight have been removed and the dovetails remain empty. A terrific replacement barrel or addition to your custom build. (46758-58E)
2779. **LOT OF ASSORTED GUN PARTS** This lot consists of about 19 items. Included are: one small brown Uncle Mikes slip-on recoil pad; one medium brown Uncle Mikes slip-on recoil pad; three Pachmayr solid recoil pads of varying thicknesses; one Winchester solid rifle pad; one Brownell's Marlin trigger safety pivot screw (new in package); one 3/16 x 3/4 tension roll pin; one Remington 700 ADL small action magazine box; three bolt action rifle magazine boxes (one marked "KFC"); one bottom metal assembly with triggerguard, follower and spring and hinged floorplate; one fixed floorplate with triggerguard; one metal triggerguard; and four assorted hard rubber buttplates (one is Marlin, two are Ithaca). Some have areas of light surface oxidation and most are in excellent condition. (46758-52H)
2780. **WINCHESTER STOCK LOT** This lot consists of a checkered factory walnut stock for a Winchester Model 70 Featherweight long action rifle. The swivel studs and grip cap are missing but the original solid rubber red rifle pad remains. The schnabel tipped stock appears to have added finish and a few light handling marks but is in near excellent condition overall. (46758-59A)
2781. **BROWNING STOCK LOT** This lot consists of two items. First is a factory checkered walnut stock for a Browning High Power Safari long action rifle. The stock appears sound and has swivel studs, the crossbolt and a Pachmayr recoil pad. The stock has several cosmetic blemishes, moderate flaking, scratches and light dings to the lacquer but there are no visible cracks or chips. The second item is a gray fiberglass stock blank which also appears to be for the Browning High Power rifles. It is lightweight and is not marked, but does include swivel studs. Both are in very good condition. (46758-59B)
2782. **REMINGTON STOCK LOT** This lot consists of two items. First is a factory checkered walnut stock for a long action Model 700 series rifle. The stock features the black forend tip and gripcap and has several dings and light handling marks but appears to be otherwise sound with no visible cracks. A rear swivel stud is included but there is no other hardware or a buttplate present. The second item is a factory black composite short action stock for Model 700 ADL rifles. It is in excellent condition and features a solid recoil pad. (46758-59C)
2783. **REMINGTON STOCK LOT** This lot consists of two items. The first appears to be a walnut stock for a Remington Model 721 rifle. The stock has added lacquer, light dings and handling marks. There is no hardware present but the original buttplate is intact. Second is a walnut stock for a Remington Model 722 rifle. The stock has a satin oil finish with light dings and handling marks throughout. It includes a set of swivel studs but no other hardware is included. Both are in very good condition. (46758-59D)
2784. **MARLIN STOCK LOT** This lot consists of a factory Marlin Model 781 checkered walnut stock. The stock has been sanded and is unfinished but has crisp "deluxe" pattern checkering along the forend and sides of the wrist. The "bullseye" is intact but there is no hardware or other parts present. An excellent replacement stock for your vintage Marlin 781. (46758-59E)
2785. **MAUSER STOCK LOT** This lot consists of two items. First is a CoreLite black composite stock that appears to fit the Mauser 98 series actions. A set of swivel studs are installed, no other hardware is present. The stock is in excellent condition and has the original solid recoil pad. Second is an unmarked checkered walnut stock that also appears to fit the Mauser 98 actions. The stock is unfinished and has been lightly sanded, the checkering on the wrist remains crisp. No hardware is present. A couple of great options for your custom build. (46758-59F)
2786. **SAKO STOCK LOT** This lot consists of an unfinished walnut stock for the Sako Finnbear rifle. The pistolgrip stock is not maker-marked but would make a great project for your custom build. No hardware is included. (46758-59G)
2787. **SAVAGE STOCK LOT** This lot consists of three items for a Savage 99 rifle. Included are two smooth walnut buttstocks and a schnabel forearm. One stock is straight-gripped and includes a single rear swivel stud. The other is the pistolgrip variation and includes a hard rubber buttplate. There are some light dings and other small handling marks present, no additional hardware is included. (46758-59H)
2788. **ITHACA STOCK LOT** This lot consists of two Ithaca Model 37 checkered walnut buttstocks. The first is an earlier vintage for the smaller framed action and includes an unmarked gripcap but no buttplate. It has a few light handling marks and some minor chipping along the top of the wrist where it would meet the receiver. The second is a newer variation and has a few light handling marks, fancier checkering and an "ITHACA"-marked grip cap. It appears to be for the 12 gauge models and includes a factory vented recoil pad. (46758-59I)
2789. **1911 BARREL LOT** This lot consists of a U.S. GI 1911 5" barrel with a near excellent bore that has some light frosting along the edges of the grooves. The barrel is marked "HS" on the right side and has some light exterior wear but appears to still be quite serviceable. (44457-4D)
2790. **1903 FOLLOWER LOT** This lot consists of a sealed GI replacement follower for the 1903, 1903-A3 and similar rifles. The package is marked "1005-554-5029" and contains one follower. (44457-4E)
2791. **AR-15 PARTS LOT** This lot consists of parts and accessories for AR-15 and similar rifles. First is a DPMS AR fire control group that is in its original packaging. Next is a four-piece cleaning rod that could be stored in the butt trap of a fixed A2 buttstock. Lastly is a universal magazine loader for AR-15 magazines. All are in excellent condition. (48903-7A)

2792. **SIG STOCK LOT** This lot consists of a SIG folding buttstock for the 556 series rifles. The stock is black polymer and features a raised comb piece with textured sides. The pivot pin is included and the stock is in excellent condition. (48913-7C)
2793. **MARBLE'S GAME GETTER ACTION** serial #1637. The metal surfaces retain 90% plus original blue with some high edge wear, spots of scattered light fine oxidation staining and minor finish loss at the top of the frame. The action seems to function properly and the original peep sight remains intact. The checkered hard rubber logo grips rate about excellent with light ingrained dirt staining in the grooves, minor handling marks and light wear along some of the points and contact edges. The screws show very light slot wear and this action contains many serviceable parts. (108545-6) {FIREARM}
2794. **B.C. MIROKU ACTION** This lot contains an engraved Model 101 receiver serial #6381776. The metal surfaces retain 98% blue finish with geometric borders and foliate pattern engraving. The action is missing the trigger and possibly other small parts but appears mostly complete and is in excellent condition. (10889-73) {FIREARM}
2795. **LOT OF ERMA ET-22 LUGER CARBINE PARTS** This lot contains a barrel and toggle breach with about 85% black finish remaining. The barrel features a fixed blade front sight and an adjustable artillery style rear sight. Also included in this lot is an unmarked magazine and hardwood grips and forend in excellent condition with all corresponding screws included.
2796. **1911 GOVERNMENT MODEL GRIP LOT** This lot consists of a single set of checkered walnut factory grips by Colt with gold Rampant Colt medallions for a Government model semi-auto pistol. The grips rate very good with no diamond point wear or handling marks but the right panel has a 3/16" long shallow dent. (1X88805-9A)
2797. **GERMAN G.43 SEMI-AUTO RIFLE PARTS LOT** This lot consists of a G43 barreled action, sights, buttplate, handguard, bolt, trigger, trigger parts, trigger guard, magazine, sling and cleaning rod. The metal surfaces show light oxidation and oxidation staining throughout with generous traces of the original phosphate. The laminated stock is broken at the wrist, there is a large section missing on the left side, a couple other large chunks missing, a crack along the handguard, a couple other cracks, scattered handling marks and dings. The left side of the rear sight base is marked "G.43 duv 44", the bolt is matching to the receiver but it is stuck and we are unable to open it. There is no dustcover, lower buttplate screw or safety assembly present but all of the trigger parts appear to be present. A good source of parts or perhaps a restoration candidate. (206519-587) {MODERN}
2798. **HARRINGTON & RICHARDSON 1873 OFFICER'S MODEL TRAPDOOR BARRELED ACTION** serial #SA81, 45-70, 22" barrel with a mostly bright near excellent bore showing some light frosting throughout. The metal surfaces retain perhaps 90% silver finish showing some high edge wear, a few small spots of flaking, small dings and scratches. The silver is rather heavily tarnished throughout and shows a few areas of moderate verdigris staining particularly around the front sight. The action is embellished with small wedges of foliate scrollwork and the breechblock seems to close securely. No rear sight assembly is present and the front is a plain blade. (138899-20) {FIREARM}

End of Silent Auction - Thank you

All Silent Auction Bids are due by 3:00 pm on August 25th 2018

Results will be available on Wednesday, August 29, 2018.

NOTES

ABSENTEE BIDDING FORM

AMOSKEAG
AUCTION COMPANY, INC.

250 Commercial Street, Unit No. 3011 • Manchester, NH 03101
603/627-7383 • Fax 603/627-7384 • www.amoskeagauction.com



OFFICE USE ONLY

DATE RECEIVED: _____ ENTERED: _____ FIRST TIME BIDDER

NOTE: To make one additional bid on your behalf in the event of a tie, please place a “ + ” after your bid amount.

ITEM #	ITEM DESCRIPTION	BID AMOUNT
_____	_____	_____
_____	_____	_____
_____	_____	_____
_____	_____	_____
_____	_____	_____
_____	_____	_____
_____	_____	_____
_____	_____	_____
_____	_____	_____
_____	_____	_____
_____	_____	_____
_____	_____	_____
_____	_____	_____
_____	_____	_____
_____	_____	_____
_____	_____	_____
_____	_____	_____
_____	_____	_____
_____	_____	_____
_____	_____	_____
_____	_____	_____

SILENT AUCTION BIDS ARE DUE BY 3:00PM ON THE DAY OF THE SALE

Name: _____ Email: _____

Address: _____

City: _____ State: _____ Zip: _____

Home #: _____ Cell #: _____ Fax #: _____

Bidders without prior credit approval are required to submit a 20% deposit prior to bids being accepted. You may do this by check or credit card authorization. If your bids are unsuccessful a refund check will be issued.

DEPOSIT: Check# _____ Bid Total: _____ Deposit Amount: _____

Credit Card: _____ Exp: _____ CVV #: _____

**VISA MC
AMEX DISC**

PAYMENT IS DUE UPON RECEIPT. If in the event my bids are successful on the above items and I do not contact Amoskeag Auction Co., Inc. or make payment arrangements within 15 days, Amoskeag Auction Co., Inc. is hereby authorized to charge my credit card for the total purchase price together with the applicable Buyer's Premium (**17.5%**).

I authorize Amoskeag Auction Co., Inc. to place the above bids on my behalf in accordance with the Terms and Conditions of Sale. I have read, fully understand and agree to the Terms and Conditions of Sale and the Firearms Warning for this auction (printed and online).

Signature: _____ Date: _____



ITEM #

ITEM DESCRIPTION

BID AMOUNT

BRING TOTAL TO THE FRONT



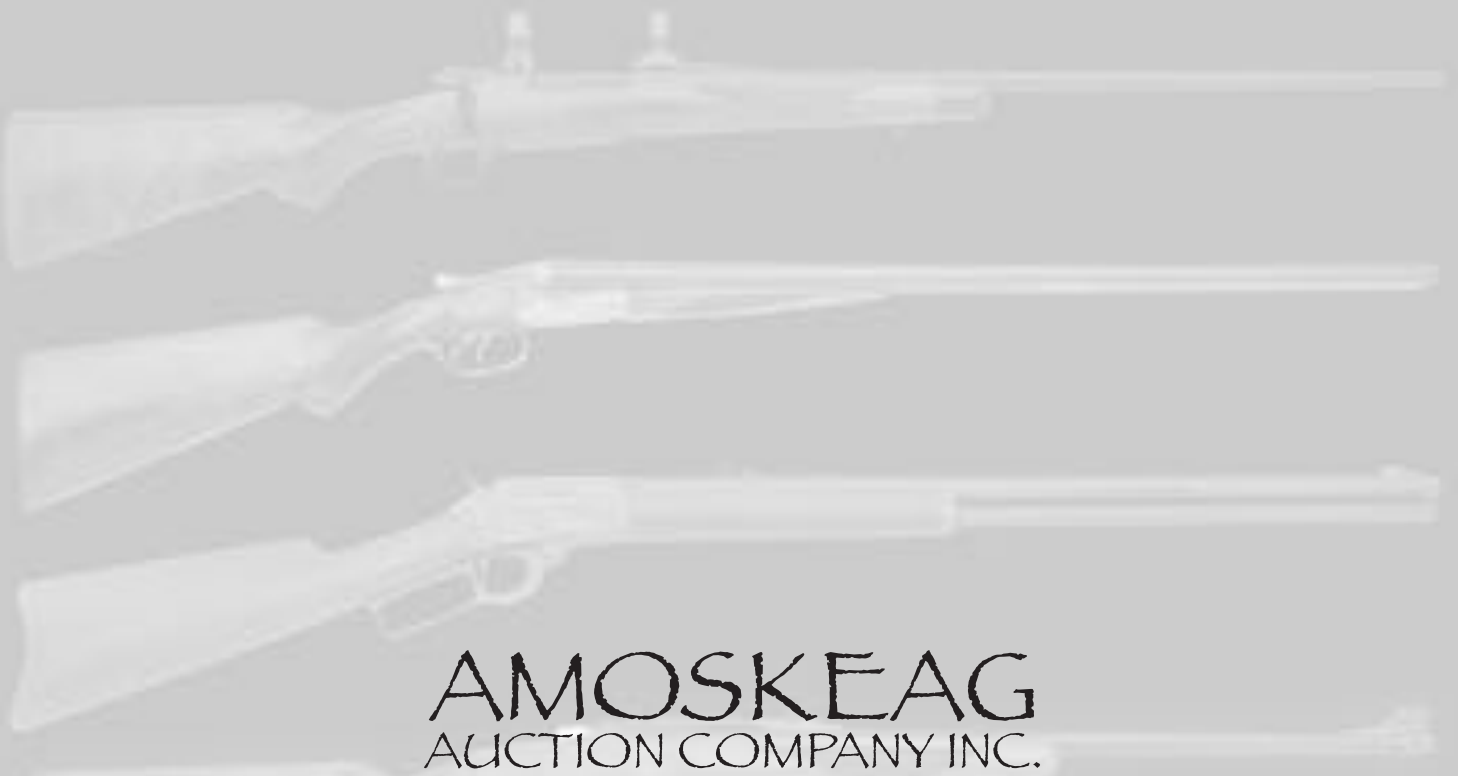

AMOSKEAG AUCTION COMPANY INC.

250 Commercial Street • Suite 3011 • Manchester, New Hampshire 03101
Phone (603) 627-7383 Fax (603) 627-7384 • www.amoskeagauction.com
Jason & Melissa Devine • NH License No. 2555