

CASE II
AGRICULTURE

MAGNUM

250 – 380HP TRACTORS



1987



1993



1998



2004



2007



THE SUCCESS STORY

30 years of Magnum tractor leadership

The success of Case IH is based upon a strong past. As a result of continuous growth and development, today we are one of the largest manufacturers of agricultural machinery in the world.

Thanks to continuous development and expansion of our range, Case IH now offers the widest ever portfolio of products to our clients.

1987

The first Magnum tractor series is launched, with horsepower ranging from 160 to 240 hp.

1993

The Magnum 7200 Series is launched and sets a new industry standard in farm power, technology, innovative-oriented customer convenience, quality and value.

1998

Launch of the MX Magnum tractors featuring higher traction due to better weight distribution, a smoother ride and much better visibility all the way around.

2004

Acting as trendsetter once again, Case IH is first to introduce a factory installed guidance system on MX Magnum.

2007

Launch of Magnum models 215, 235, 275 and 305 with the first touchscreen display AFS® Pro 600 and enhanced field and road auto-shift functions.

2009



2012



2014



2015



2009

APM - Automatic Productivity Management feature is launched in the Magnum Series for best fuel efficiency.

2012

The Magnum celebrates its 25th anniversary.

2014

Case IH launches Magnum CVT models ranging from 250 hp to 380 hp and celebrates the milestone of 150,000 Magnums built.

2015

The Magnum Rowtrac is launched. Magnum CVT receives “Tractor of the Year” award at EIMA in Bologna and “Machine of the Year 2015” at SIMA in Paris.

SUPREME COMFORT

Look after yourself and minimise fatigue with the low noise levels, climate control and excellent visibility on your front and rear implements. The new split wide angle mirrors dramatically reduce blind spots for safer and easier driving. The 360-degree LED lighting package will enable you to carry on working after dark without slowing down. The 5-point suspension system (cab, seat, axle and rear linkage) provides a remarkably smooth ride.

INTUITIVE OPERATION PUTS YOU IN CONTROL

You have a perfect overview of all your Magnum's functions: the Integrated Control Panel gives you all the key information at a glance and the AFS® Pro 700 screen integrates the data from the tractor and implement. The new multi-function handle makes operation even easier, with more pronounced and backlit buttons for a greater feel and operator experience. Your Magnum's controls are all at your fingertips.

PRODUCTIVITY DRIVES HIGH RETURNS

The Magnum Range.

Big on power and efficiency, comfort and intuitive operation, the new Magnum drives productivity to new heights and slashes ownership costs. The new Magnum brings reliable technology to your business and a high return on your investment.

EVERYTHING YOU WANT YOUR TRACTOR TO BE – AND MORE.

MODELS	RATED POWER ECE R120 ³⁾ @ 2,000 RPM (KW/HP(CV))	MAXIMUM POWER ECE R120 ³⁾ POWER MANAGEMENT @ 1,800 RPM (KW/HP(CV))	CAPACITY (CM ³)	NUMBER OF CYLINDERS
Magnum 250 FPS / CVT	184 / 250	235 / 320	8,700	6
Magnum 280 FPS / CVT	206 / 280	258 / 351		
Magnum 310 FPS / CVT	229 / 311	281 / 382		
Magnum 340 FPS / CVT	250 / 340	301 / 409		
Magnum 380 CVT	279 / 379	320 / 435		

³⁾ECE R120 correspond to ISO 14396 and 97 / 68 / EC or 2000 / 25 / EC





POWERFUL EFFICIENCY UNDER THE BONNET

The powerful 8.7 litre, 6-cylinder engine is designed to generate power and optimise fuel efficiency. The flatter torque curve of the new Magnum delivers maximum torque at greater range of engine speeds.

POWERFUL IN THE FIELD AND ON THE ROAD

You can choose the proven Full Powershift transmission with Automatic Productivity Management (APM) that automatically reduces engine speed to match power requirements. Or you can opt for the Continuously Variable Transmission that makes the Magnum CVT the perfect all-rounder on the road and in the field, with the CVT speed range from 0 to 50 kph.

BORN TO BE STRONG

With the new Magnum, you can count on a massive lift capacity of 10,580 kg. If you need to operate big implements with your Magnum that require high hydraulic flow, you can opt for the twin-flow 282 litre pump. You can have up to six electro-hydraulic remote valves to enable a high number of functions without the need to reconnect hydraulic hoses.

POWER TO THE IMPLEMENT

The heavy-duty PTO meets the greater requirements of the higher engine power. The 1000 PTO speed is achieved at 1,803 rpm, where there is a huge power growth. Dual speed 540/100 is standard equipment.

AFS: MAXIMISE RETURNS WITH PRECISION FARMING

The integrated AFS Pro 700 touchscreen gives you all the key data, from fuel consumption to engine and PTO power, at a glance. It also enables you to adjust easily and quickly the settings for different implements and working conditions. The Magnum is ISOBUS ready to control compatible implements. To maximise your efficiency, you can choose from a full range of guidance solutions, offering accuracy levels of up to 2.0 cm.



COMFORTABLE AND QUIET

For long days.

Everything is easily adjustable to customise your own workstation

Supreme comfort offered by Semi-Active red leather seat with positive response, heated and ventilated cushion and automatic seat suspension

If you were to describe the cab of your dreams, we have no doubt that the Magnum Surveyor cab would fit the bill to perfection. As you step into the cab, prepare to be delighted: the luxurious feel of the quality leather upholstery, the ergonomic suspended seat, and the controls strategically placed within easy reach. The Surveyor cab has been designed to give you supreme comfort while behind the wheel. Put yourself first; choose the Magnum.

A WORKSTATION TAILORED TO THE OPERATOR

Every element – from the steering wheel, seat and multicontroller armrest – is easily adjustable so you can customise your workstation perfectly to give you the best and healthiest driving position.

THE IDEAL WORKING ENVIRONMENT

The exceptionally low noise levels of just 67 dB(A) and automatic climate control create your ideal environment and internal climate. The removable carpeted floor in the Luxury cab adds to the feeling of comfort and further reduces noise levels. You are working hard, why not be comfortable?

SUPREME COMFORT

The Semi-Active heated and ventilated leather seat with adjustable cushion gives you the luxurious ride you would only expect from a luxury car. The automatic seat suspension reacts to the individual driver's weight to provide an optimally smooth ride on a rough drive. The instructor will also ride in comfort on their own red leather seat, featuring a backrest and homologated safety belt. The red leather seat is standard in the Surveyor cab while the Deluxe cab is supplied with cloth seating.



- A** Left-hand cab storage area
- B** Instructional seat
- C** Luxury carpeted floor reduces noise levels from transmission/drivetrain
- D** Heated and ventilated seat with extendable/retractable lower seat cushion

- E** AFS® Pro 700 touchscreen
- F** Multicontroller armrest
- G** Air filtration and auto climate control (not shown)

WORK LONGER AND STAY FRESHER

24/7 efficiency in any conditions.

FOR WHEN YOU NEED TO WORK AT NIGHT

The Luxury cab's panoramic view provides excellent visibility from all aspects. For those days when you need to carry on working after dark, illumination is king and with the 360 degree LED lighting package Case IH drive to turn night into day. Giving you solid visibility on your implements – even to the outermost tine of your largest planter. With 34,400 lumen lighting power, you will be working in bright light conditions – what you need to get the job done efficiently.

SMOOTH RIDE – 5-POINT SUSPENSION SYSTEM

The Magnum has pulled out all the stops with its full suspension package; the combination of the suspension within the seat, cab, axle, and front and rear linkage are adjustable to provide a comfortable work environment for the operator. The suspended front axle design on the Magnum tractor isolates the driver from shock.

TYRES TO THE GROUND

The Magnum's front axle suspension keeps all your wheels on the ground, so that you enjoy the best stability, traction and control over rough terrain. Whether you are working uneven ground or travelling at high speeds, this simple design ensures you don't have a bouncing or jarring ride and assists delivering your required power to the ground. It also has the added advantage of requiring less maintenance than other systems because of its solid construction.







1

INTUITIVE OPERATION

puts you in control with ease.

1 All information on the tractor's performance at a glance

We know how busy you and your operators are, so we make sure you don't waste time getting used to a new control layout when you switch tractors. Case IH is driving its innovation from one tractor to another, from a Magnum to a Steiger Quadtrac, you will find the same control layout. From the moment you sit in the cab, you know where everything is and have all the information you need at a glance on either the A-Post or the AFS® Pro 700. The multicontroller armrest was the finishing touch to make our machines more user friendly.

Comfort and control – no time wasting.

CONTROL STATION

The multicontroller featuring drive logic, the ICP (Intuitive Control Panel) and the AFS Pro 700 touchscreen monitor integrate all the tractor's functions into the armrest, putting all the controls at your fingertips: speed selection, direction changes, throttle, AccuGuide engage, Headland Management Control, electronic remote valves, rear hitch controls, PTO and joystick. Everything is in one place and within easy reach.

OPTIMISE YOUR PERFORMANCE

The AFS Pro 700 gives you all the information you need on the tractor's performance; from fuel consumption to engine and PTO power. The touchscreen interface is easy to use and you can quickly adjust the settings for different implements and working conditions. To make it even more intuitive, you can customise the different screens to display the information most important to you.

EVERYTHING UNDER CONTROL

The performance instrumentation cluster on the A-Post tells you everything you need to know about the tractor – engine speed, transmission target speeds, actual ground speed, brake position and drive direction. Everything is clearly displayed in one place so you have it all under control.

- A** AFS Pro 700 touchscreen
- B** Multicontroller
- C** Remote valve controls incl. joystick (optional)
- D** ICP - intuitive control panel
- E** Rear PTO on/off
- F** Hydraulic controls





Perfect integration of engine and transmission –
FPT engines

FIELD LEADING POWER AND PERFORMANCE

At the wheel of a Magnum tractor, you'll enjoy the full benefit of high efficiency, low emissions engine technology. This is driven from the know-how of our engine specialist at FPT. They bring to bear the experience of developing millions of engines running around the world in on and off-road applications in the development and production of engines that meet the specific requirements of agricultural tractors worldwide.

POWERFUL IN ALL OPERATIONS

The Magnum's 8.7 litre, 6 cylinder common rail turbocharged intercooled engines are designed to deliver massive power efficiently. Engine power management gives you the power you need when you need it – with frugal fuel consumption: 10% power growth at 1,800 engine rpm and, when under load engine rpm drop, Engine Power Management unleashes up to 38 more horsepower, giving you the boost you need to deal with the most difficult conditions.

POWER BOOST TO MATCH THE CONDITIONS

The Magnum 340 and 380 features an electronically controlled variable geometry turbocharger, which adjusts the aspect ratio, optimising it according to the changing conditions. The variable geometry turbocharger adapts, reducing the aspect ratio at low engine speeds so that it is able to produce a boost at lower speeds, and increasing the aspect ratio at high speeds, so that the turbo doesn't choke and power output is delivered efficiently.

POWERFUL FUEL EFFICIENCY

The Magnum 380 delivers best-in-class 1,850 Nm maximum torque. The flatter torque curves mean that the new Magnum delivers maximum torque at a wider range of engine speeds, from 1,300 to 1,400 rpm. This results in further fuel economy, as the engine delivers more power on lower engine rpms – and optimal transmission of power is produced.

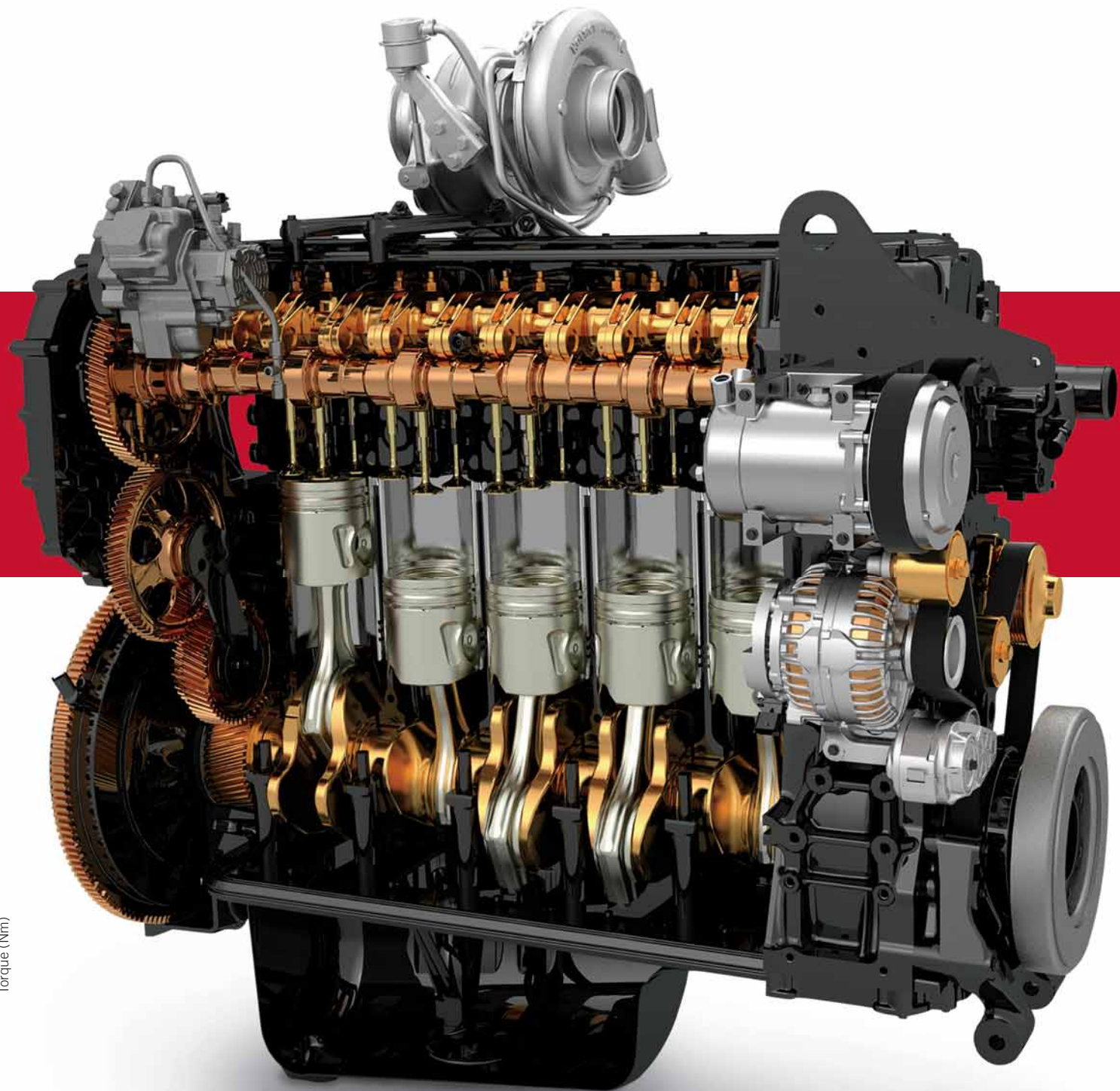

MAGNUM 380 CVT

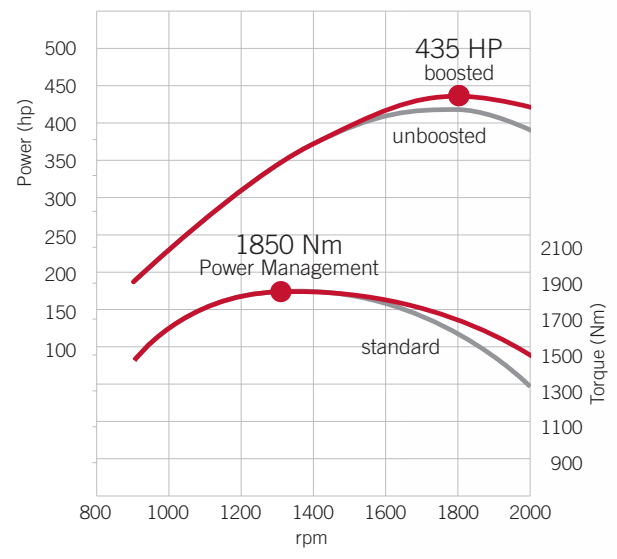

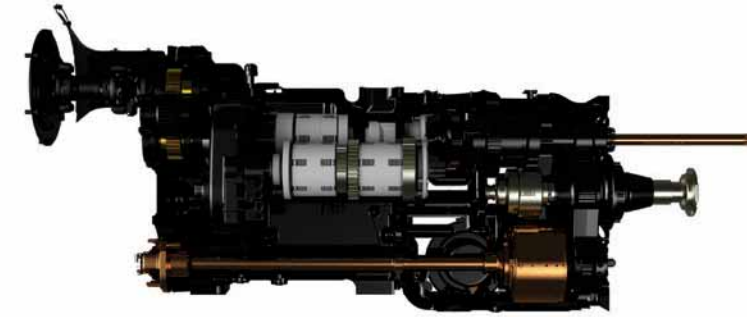
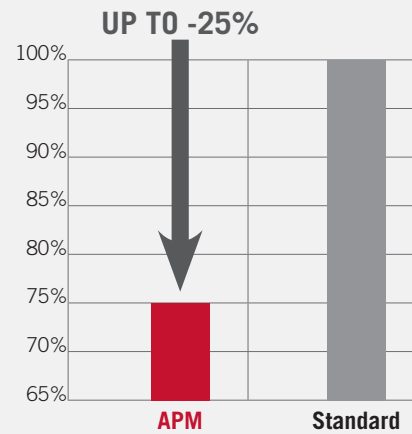
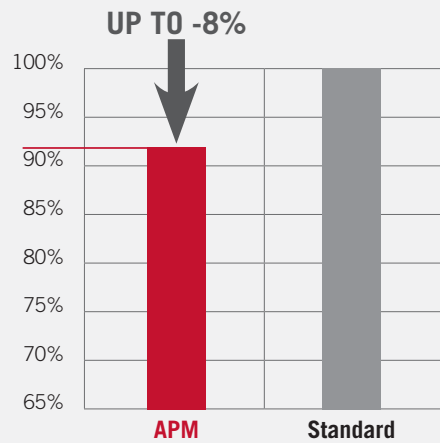

FULL POWERSHIFT TRANSMISSION

Transmit efficient power in your fields.

- 1 Auto Road: reduced fuel consumption by using this mode
- 2 Auto Field: perfect fit for your productivity
- 3 23x6 Full Powershift transmission with creeper (optional)

The automatic shift of the Magnum's Full Powershift transmission ensures you shift seamlessly from zero to 40 or 50 kph. When you have jobs to do at slow speed, you can choose the optional creeper transmission with five forward and two reverse speeds. It does it with exceptional fuel efficiency, as the Diesel Saver™ Automatic Productivity Management (APM) system automatically adjusts gear setting and engine speed to the most fuel efficient mode.

OPTIMAL EFFICIENCY – THANKS TO APM

On a Magnum tractor, you can keep your focus on your work while the APM takes care of optimising efficiency by shifting up and throttling back automatically to minimise fuel consumption. You can select Road or Field mode, so that the APM will continuously optimise the tractor's efficiency according to the conditions. When working in the field, you can set a fixed speed at up to 23 kph with the throttle lever and APM will shift up or down and change engine speed, continuously adjusting according to the job and terrain.

On the road, you can set a variable forward speed within a range (1.2 kph to 40 kph or 1.2 kph to 50 kph depending on the transmission) and the Auto Road function will adjust engine speed and change gears to maintain the best fuel efficiency at all times.

19x4 Full Powershift transmission 50 kph

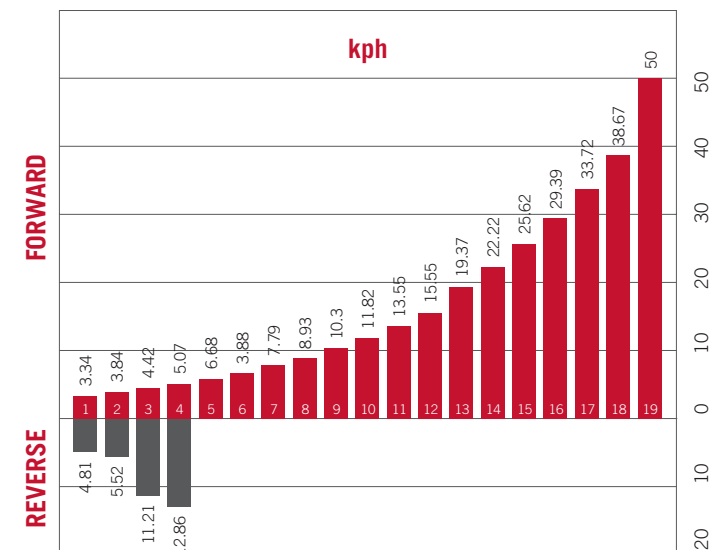



CVT TRANSMISSION

Full power to the ground.

- 1** CVT transmission – stepless drive between 0-50 kph
- 2** Outstanding performance. Choose your speed between 0 to 50 kph with just one lever or foot pedal.

Step into the world of supreme efficiency with the Magnum's CVT (Continuously Variable Transmission). Available on all models throughout the range, and standard on the Magnum 380, this transmission offers a max speed of 50 kph and includes Active Hold Control.

SUPREME FUEL EFFICIENCY AT ALL TIMES

The Magnum CVT is designed to operate with extreme fuel efficiency in all applications and conditions, and to ensure you never waste fuel. On the road, it reaches 50 kph at just 1,400 rpm, so you save fuel for every tonne you transport. In the field, in specialist applications at low speed, the integrated creeper, independent of engine speed, ensures economical performance.

FULL POWER TRANSFER

The Magnum CVT's transmission transfers power from the engine to the transmission mechanically, ensuring the full power is transferred to the ground without dispersion.

ACTIVE HOLD CONTROL ON SLOPES

The Magnum CVT makes it easy and safe for operators to work in all conditions, even on steep slopes, with the Active Hold Control, standard on all CVT models, which prevents the tractor from rolling back when you stop on an incline and enables you to pull away again without having to use the clutch or brakes.



MASSIVE PTO POWER

at low engine rpm.





The higher engine power of the new Magnum comes with a PTO to match, as the heavy-duty 1,000 rpm PTO delivers its best performance on full engine power. Alternatively, you can opt for the 540/1,000 rpm with interchangeable shafts.

QUIETLY POWERFUL

The rear PTO delivers 1,000 or 540 rpm at peak engine power at 1,803 engine rpm, which cuts down fuel consumption and noise. In addition, the positioning of the PTO clutch on the top shaft results in even quieter operation. Both the 1,000 and 540/1,000 PTOs will easily run any implement you may be pulling. The hydraulically activated and electronically controlled system allows for smooth modulation and protects the components.

EASILY EFFICIENT OPERATION

When you need to change implements, the PTO shaft is easy to rotate for quick coupling. With PTO Management, you can make sure that the PTO and implements run most efficiently by selecting 'Auto' or, if you are running heavy implements such as wood chippers or large balers, 'Heavy' mode.

OUTSTANDING FRONT PTO

The 1,000 rpm front PTO runs on equally excellent engine speed of 1,804 rpm and delivers a maximum power of 230 hp with its 1.3/8-inch shaft and 6 splines. Clockwise (CW) or Anticlockwise (ACW) rotation can be selected at the time of ordering.





VERSATILE CONNECTION

for any kind of implement.

- 1 Seamlessly integrated front linkage with a lifting power of 5,000 kg
- 2 No limits of operation with six electronic-hydraulic rear remotes
- 3 Easy and safe operation with the external controls
- 4 Control your remote valves with the AFS 700 Pro Monitor

With a maximum lift capacity of 10,580 kg, the hydraulic system is designed to give you all the lifting power you need, optimising fuel consumption. Powered by a standard high flow 228 l/min pump or, for the biggest implements, a 282 l/min twin flow with two variable displacement pumps, the Magnum's hydraulics have all the lift power you may need.

A load sensing power beyond system is standard, providing the possibility to operate additional auxiliary functions. The automatic flow compensation reduces fuel consumption, so you get the full benefit of the Magnum's lift power and economy.

EFFICIENT VERSATILITY

The Magnum's advanced hydraulics system with Pressure Flow Compensating (PFC) design and the ability to operate up to six electro-hydraulic remote valves enables you to control a wide variety of implements to cover off numerous applications without having to stop and reconnect hydraulic hoses. Made at our plant in Racine, USA, the remote valves deliver the power you need with 140 l/min per valve.

EASY OPERATION

The remote valves are easy to operate, by manually adjusting it in the armrest or using the

AFS® Pro 700 touchscreen. From the driver's seat you can set six function remote lever controls – for orbital motor, loader, full function, no float and lock – and with the programmable valve timer you can set repeatable engagement times without leaving the cab. A power beyond supply is standard for hydraulic power supply, return, load sense and case drain, for easy hook-up to pull-type sprayers.

HEAVY-DUTY HITCH AND DRAWBAR FOR BIG IMPLEMENTS

The Magnum's versatility is further extended by the heavy-duty hitch and drawbar with standard electronic draft control, which provide up to 10,580 kg lift capacity so that you can also work with wider and heavier implements. You can adjust the maximum slip according to your application with Slip Limit Control and minimise bouncing during transport with a mounted implement with Hitch Ride Control.

INTEGRATED FRONT LINKAGE

You can give a further boost to your productivity with the fully integrated front linkage, which delivers a power lift up to 5,000 kg and offers a PTO option and external hydraulic couplers to enable you to connect a front implement with separate hydraulic components.





CASE IH ADVANCED FARMING SYSTEMS

Success with precision.

- 1** AFS AccuGuide: GPS and GLONASS based guidance for ultimate precision independent of crop conditions. Accuracy levels down to 2.5 cm available.
- 2** xFill bridges RTK signal gaps up to 20 minutes.
- 3** Accurately pinpoint all machines with AFS Connect.

Case IH Advanced Farming Systems® (AFS) have been at the forefront of precision farming for more than a decade, giving farmers the ability to control the entire crop production cycle. Case IH AFS® tools include everything you need to achieve repeatable accuracy down to 2.5 cm, reduce overlaps and cut input costs – and maximise your yield potential.

ADVANCED VEHICLE CONTROL.

If it's interactive vehicle set-up and control you need then look no further than the AFS Pro touchscreens: monitor yield, fuel usage and work rates, connect external cameras, keep job records and manage ISOBUS implements. AFS Pro touchscreens are interactive, fully customisable and portable between your Case IH fleet.

VEHICLE GUIDANCE SOLUTIONS.

If it's a guidance system you are looking for, we have simple 'plug and play' lightbar steering kits through to fully automated and integrated solutions (AccuGuide). The accuracy you need depends on your requirements. With the range topping RTK systems we can make you pass perfect down to 2.5 cm. The xFill option can bridge RTK signal gaps up to 20 minutes.

AFS FARM MANAGEMENT SOFTWARE.

Many variables apply in farming; it is key to understand what is happening and why. It's time to manage your farming operation on a new level by making decisions based on facts. With the AFS Farm Management software package from Case IH you can see, field by field, the tasks performed, the work rates achieved, the fuel used during each task and, most importantly, your yield. Plan for the future today.

AFS CONNECT™ TELEMATICS.

The Case IH AFS Connect telematics system allows farm owners and managers to monitor and manage their machinery from the farm office, tracking machines in real time on the farm computer to observe how they are performing, through the use of precision guidance GPS signals and wireless data networks. Analysing the data it provides helps to improve logistics, minimise fuel consumption and maximise performance.

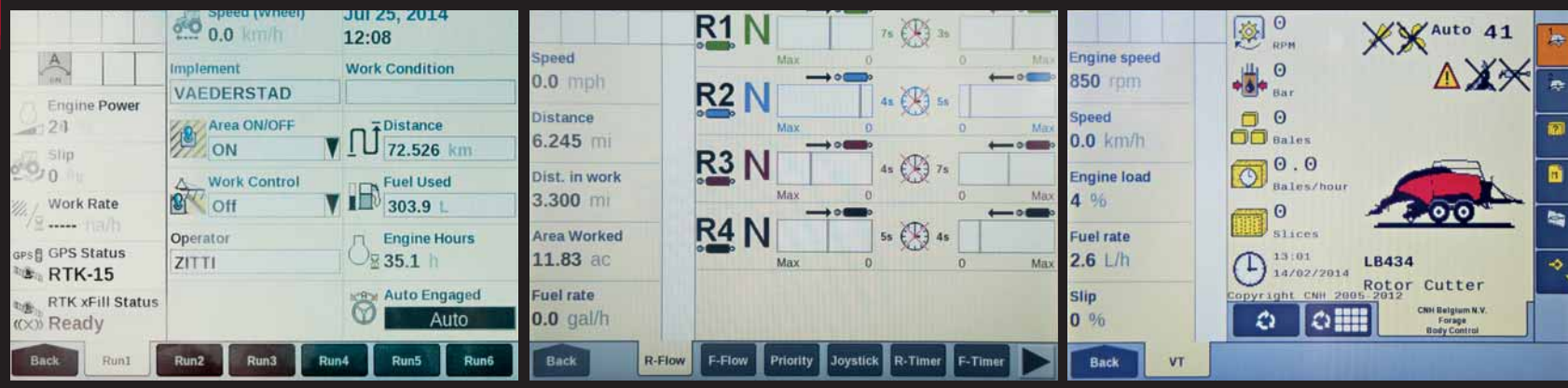

INTEGRATED PRECISION

for maximum production.

Case IH Advanced Farming Systems are within easy reach on the AFS Pro 700 touchscreen monitor, integrated into the armrest of the Magnum and Magnum CVT models.

In addition, to complete automation of all the tractor's key functions, including the sequencing of up to 30 headland functions, the AFS screen also keeps track of the work done, fuel consumption, operating costs and much more.

KEY FEATURES INCLUDE:

- Performance monitoring: record overall performance, performance for each day and performance for each job. All data from the AFS monitors can be saved to a USB for analysis back at the office if required.
- Vehicle settings: a series of AFS screens allow you to fine-tune the tractor's settings. It is easy to set the flow rates and timers for each of the remote valves, giving you an excellent overview of the whole setup.
- Hitch notebook: this screen allows you to save the settings for each implement according to the working conditions. Next time you attach the implement, for example, you just need to open the notebook, choose the right set-up and away you go.
- Full ISOBUS compatibility: hook up any compatible machine to display the user interface for the machine on the AFS monitor. Now you are able to operate the machine easily and interactively by pressing the control buttons on the AFS monitor screen. You do not need a separate control pendant or cables inside the cab.
- Video input: you can display a live video feed from a camera positioned at the rear end of a loader wagon or baler. This means you can monitor what is going on behind you without having to take your eyes off the work area in front of you.
- A variety of vehicle guidance solutions are available to match your needs for precision. A fully automated and integrated solution, which is factory installed, gives you the pinpoint accuracy you need for high value crops. Alternatively, a simple plug and play lightbar steering kit can be installed.



1



2



3

YOUR MAGNUM — just the way you want it.

- 1 Transfer massive power to the ground
- 2 Wide offering of tyres and ballasting packages
- 3 Unbeatable turning radius of 4.8m

The Magnum delivers a massive performance: you want to be sure you have the right driveline that will bring all this power to the ground in your field. Power is nothing if you don't have the correct tyres, axles and ballasting - all factory fitted.

TYRES

You can choose from a wide offering of tyres that will provide the best traction and least slippage in your farming operation. You can choose tyres up to IF 900/60R42 to transfer the Magnum's massive power to the ground or narrow the width but continue to hold the power to the ground with the Magnum Rowtrac undercarriage on 18 inch Camso belts.

BALLASTING

Select just the right ballasting package for your Magnum and consider the rear wheel ballast with integrated wheel weights, which brings even more power to the ground.

FRONT AXLE

The Magnum 250 hp feature a Class 4.75 front axle. Models above 250 hp are available with a Class 5 axle manufactured at our plant in Racine, USA, which has a significantly higher suspended load capacity and further reduces cab bounce, improving the driver's comfort. It also delivers better traction in fieldwork and better handling performance in high-speed operation.

REAR AXLE

All Magnum models feature a standard 3 metre/120 inch bar axle. The heavy-duty rear axle is standard on the Magnum 340 and 380 in both Full Powershift and CVT models, giving you more lift capacity; 75mm more hitch lift height.



SIMPLE AND EASY SERVICE TO SAVE YOU TIME AND MONEY

KEEP DRIVING!

When you run a Magnum tractor, daily checks and regular maintenance are easy and quick. For example, the radiator package is easy to clean and the air filter is conveniently located for quick inspection. Just make your quick checks and drive off!

MAXIMUM UPTIME, MINIMUM SERVICE COSTS

The Magnum with Efficient Power technology keeps you working, reducing maintenance and costly downtime to a minimum. The long 600 hour service intervals are just one of the many features that drive down your maintenance and service costs.

1 CONVENIENT ACCESS

New steps and handrails on right hand side for stability when accessing windows, mirrors and AFS receiver.

2 QUICK AND EASY CLEANING

Radiators can be folded out for cleaning purposes.

3 EASY ACCESS TO SERVICE POINTS

The one-piece engine bonnet is lifted by two gas-filled struts and can be set in two positions (45 and 90 degrees), even with a mounted front implement.

4 EASY TO FILL UP

The fuel tank is accessible from ground level and the fuel-cap is lockable.

MODELS	MAGNUM 250	MAGNUM 280	MAGNUM 310	MAGNUM 340
ENGINE	FPT	FPT	FPT	FPT
Number of cylinders	6	6	6	6
Type	Electronic high pressure common rail - turbocharged (wastegate), aftercooled			VGT (Variable Geometry Turbo)
Emission level	Tier 2			
Capacity (cm ³)	8.700			
Maximum power ECE R1203) Power Management ⁴⁾ (kW/hp)	235 / 320	258 / 351	281 / 382	301 / 409
Maximum power ECE R1203) (kW/hp)	209 / 284	232 / 315	255 / 347	275 / 374
...at engine speed (rpm)	1.800			
Rated power ECE R1203) Power Management ⁴⁾ (kW/hp)	210 / 286	232 / 315	255 / 347	276 / 375
Rated power ECE R1203) (kW/hp)	184 / 250	206 / 280	229 / 311	250 / 340
...at engine speed (rpm)	2.000			
Maximum torque Power Management ⁴⁾ (Nm @ 1,400-1,600 rpm)	1.407	1.558	1.708	1.800
Maximum torque (Nm @ 1,500-1,600 rpm)	1.229	1.381	1.531	1.671
Torque rise Standard / Power Management ⁴⁾ (%)	40 / 40	40 / 41	40 / 40	40 / 37
Fuel tank capacity diesel	765			
TRANSMISSION				
19x4 Full Powershift 40 kph Eco or 50 kph - 19Fx4R	•	•	•	•
23x6 Full Powershift with creeper 40 kph - 23Fx6R	◦	◦	◦	◦
Powershuttle	•	•	•	•
Rear axle diff-lock type	Electro-hydraulic with auto control			
Service brake	Hydraulically operated multiple wet disc brake, self adjusting			
POWER TAKE OFF				
Engagement type	Electro-hydraulic			
Speeds Standard (RPM)	540/1000			
Engine speeds Standard (RPM)	1,592/1803			
Shaft type Standard	Three interchangeable shafts - 540 (6 spline - 13/8 inch), 1000 (21 spline -1 3/8 inch), 1000 (20 spline - 1 3/4 inch)			
FRONT HITCH AND PTO				
Front PTO 1,000 speed @ 1,804 rpm	◦	◦	◦	◦
Direction of turn (CW - CCW)	◦	◦	◦	◦
Front hitch lift capacity (kg)	5.000			
FOUR-WHEEL DRIVE AND STEERING (DRIVELINE)				
Front axle category Standard	Class 4.75 MFD w. diff lock	Class 5 MFD w. diff lock		
Front axle suspension	Optional on Classic / Standard on Ultimate			
Steering angle (°)	56°			
Min. turning radius (1) track setting 1,800 mm (m)	4,8	5,3		
HYDRAULIC SYSTEM				
System type	Variable displacement, pressure flow compensated pump			
Max. pump flow rate Standard / Twin Flow (l/min)	221 / 282			
System pressure (kPa)	21000			
Control type	Electronic Hitch Control (EHC) with hitch ride control, Optional hydraulic top link			
Max. lift capacity (kg)	8.550	9.130	10.200	
OECD lift capacity through range @ 610 mm (kg)	6.337	6.706		7.416
Max. number of rear remote valves	Four electronic remote valves standard, 5th and 6th optional - power beyond or low pressure return connection with individual remote valve timer and flow controls			
Remote valve timer control	0-30 seconds on all models			
Category type	Cat. III/IIIN	Cat IVN/III		Cat IV HD

¹⁾ With standard tyres

²⁾ Other tyres on request

³⁾ ECE R120 correspond to ISO 14396 and 97/68/EC

⁴⁾ Power Management is only available during mobile PTO and haulage applications

• Standard ◦ Optional

MODELS	MAGNUM 250 CVT	MAGNUM 280 CVT	MAGNUM 310 CVT	MAGNUM 340 CVT	MAGNUM 380 CVT
ENGINE	FPT	FPT	FPT	FPT	FPT
Number of cylinders	6	6	6	6	6
Type	Electronic high pressure common rail turbocharged (wastegate), aftercooled			VGT (Variable Geometry Turbo)	
Emission level	Tier 2				
Capacity (cm³)	8.700				
Maximum power ECE R1203) Power Management4) (kW/hp)	235 / 320	258 / 351	281 / 382	301 / 409	320 / 435
Maximum power ECE R1203) (kW/hp)	209 / 284	232 / 315	255 / 347	275 / 374	307 / 417
...at engine speed (rpm)	1.800				
Rated power ECE R1203) Power Management4) (kW/hp)	210 / 286	232 / 315	255 / 347	276 / 375	305 / 415
Rated power ECE R1203) (kW/hp)	184 / 250	206 / 280	229 / 311	250 / 340	279 / 379
...at engine speed (rpm)	2.000				
Maximum torque Power Management4) (Nm @ 1,400-1,600 rpm)	1.407	1.558	1.708	1.800	1.850
Maximum torque (Nm @ 1,500-1,600 rpm)	1.229	1.381	1.531	1.671	1.850
Torque rise Standard / Power Management4) (%)	40 / 40	40 / 41	40 / 40	40 / 37	39 / 27
Fuel tank capacity diesel	765				
TRANSMISSION					
Continuously variable transmission 50 kph Eco or 40 kph Eco Powershuttle	•	•	•	•	•
Rear axle diff-lock type	Electro-hydraulic with auto control				
Service brake	Hydraulically operated multiple wet disc brake, self adjusting				
POWER TAKE OFF					
Engagement type	Electro-hydraulic				
Speeds Standard (RPM)	540/1000				
Engine speeds Standard (RPM)	1,592/1803				
Shaft type Standard	Three interchangeable shafts - 540 (6 spline - 13/8 inch), 1000 (21 spline -1 3/8 inch), 1000 (20 spline - 1 3/4 inch)				
FRONT HITCH AND PTO					
Front PTO 1,000 speed @ 1,804 rpm	○	○	○	○	○
Direction of turn (CW - CCW)	○	○	○	○	○
Front hitch lift capacity (kg)	5,000				
FOUR-WHEEL DRIVE AND STEERING (DRIVELINE)					
Front axle category Standard	Class 4.75 MFD w. diff lock	Class 5 MFD w. diff lock			
Front axle suspension	Optional on Classic / Standard on Ultimate				
Steering angle (°)	56°				
Min. turning radius (1) track setting 1,800 mm (m)	4,8				5,3
HYDRAULIC SYSTEM					
System type	Variable displacement, pressure flow compensated pump				
Max. pump flow rate Standard / Twin Flow (l/min)	221 / 282				
System pressure (kPa)	21000				
Control type	Electronic Hitch Control (EHC) with hitch ride control, Optional hydraulic top link				
Max. lift capacity (kg)	8.550	9.130		10.200	
OECD lift capacity through range @ 610 mm (kg)	6.337	6.706		7.416	
Max. number of rear remote valves	Four electronic remote valves standard, 5th and 6th optional - power beyond or low pressure return connection with individual remote valve timer and flow controls				
Remote valve timer control	0-30 seconds on all models				
Category type	Cat. III/IIIN	Cat IVN/III		Cat IV HD	

¹⁾ With standard tyres

²⁾ Other tyres on request

³⁾ ECE R120 correspond to ISO 14396 and 97/68/EC

⁴⁾ Power Management is only available during mobile PTO and haulage applications

● Standard ○ Optional

MODELS	MAGNUM ROWTRAC 340 P/S	MAGNUM ROWTRAC 340 CVT	MAGNUM ROWTRAC 380 CVT
ENGINE	FPT	FPT	FPT
Number of cylinders	6	6	
Type	Electronic high pressure common rail VGT (Variable Geometry Turbo)		
Emission level		Tier 2	
Capacity (cm ³)		8.700	
Maximum power ECE R1203) Power Management ⁴) (kW/hp)	301 / 409	301 / 409	320 / 435
Maximum power ECE R1203) (kW/hp)	275 / 374	275 / 374	307 / 417
...at engine speed (rpm)		1.800	
Rated power ECE R1203) Power Management ⁴) (kW/hp)	276 / 375	276 / 375	305 / 415
Rated power ECE R1203) (kW/hp)	250 / 340	250 / 340	279 / 379
...at engine speed (rpm)		2.000	
Maximum torque Power Management ⁴) (Nm @ 1,400-1,600 rpm)	1.800	1.800	1.850
Maximum torque (Nm @ 1,500-1,600 rpm)	1.671	1.671	1.850
Torque rise Standard / Power Management (4) (%)	40 / 40	40 / 37	39 / 27
Fuel tank capacity diesel		765	
TRANSMISSION			
Continuously variable transmission 40 kph Eco or 30 kph Eco		•	•
19x4 Full Powershift 40 kph Eco or 30 kph - 19Fx4R	•		
* ROAD SPEED DEPENDING ON UNDERCARRIAGE CONF.			
Powershuttle	•	•	•
Rear axle diff-lock type		Electro-hydraulic with auto control	
Service brake		Hydraulically operated multiple wet disc brake, self adjusting	
POWER TAKE OFF			
Engagement type		Electro-hydraulic	
Speeds Standard (RPM)		540/1000	
Engine speeds Standard (RPM)		1,592/1803	
Shaft type Standard		Three interchangeable shafts - 540 (6 spline - 13/8 inch), 1000 (21 spline - 1 3/8 inch), 1000 (20 spline - 1 3/4 inch)	
FRONT HITCH AND PTO			
Front PTO 1,000 speed @ 1,804 rpm	•	•	•
Direction of turn (CW - CCW)	•	•	•
Front hitch lift capacity (kg)		5.000	
FOUR-WHEEL DRIVE AND STEERING (DRIVELINE)			
Front axle category Standard		Wide MFD w/diff lock 12 bolt - rigid or suspended	
Front axle suspension		Suspended axle 3 mtrs and below/ rigid axle over 3 mtr spacings	
Steering angle (°)		56°	
Min. turning radius (1) track setting 1,800 mm (m)		5,3	
HYDRAULIC SYSTEM			
System type		Variable displacement, pressure flow compensated pump	
Max. pump flow rate Standard / Twin Flow (l/min)		221 / 282	
System pressure (kPa)		21000	
Control type		Electronic Hitch Control (EHC) with hitch ride control, Optional hydraulic top link	
Max. lift capacity (kg)		10.200	
OECD lift capacity through range @ 610 mm (kg)		7.416	
Max. number of rear remote valves		Four electronic remote valves standard, 5th and 6th optional - power beyond or low pressure return connection with individual remote valve timer and flow controls	
Remote valve timer control		0-30 seconds on all models	
Category type		Cat IV HD	

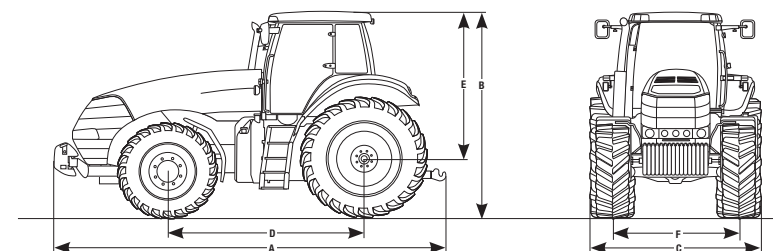

¹⁾ With standard tyres
²⁾ Other tyres on request
³⁾ ECE R120 correspond to ISO 14396 and 97/68/EC
⁴⁾ Power Management is only available during mobile PTO and haulage applications
• Standard • Optional

MODELS	MAGNUM 250	MAGNUM 280	MAGNUM 310	MAGNUM 340
WEIGHT				
Approximate shipping weight standard / suspended front axle (kg)	10,830 / 11,290	10,910 / 11,415	10,910 / 11,415	11,730 / 12,190
Class 5 (option) / Class 5 suspended front axle (kg)	- / -	10,985 / 11,450	10,985 / 11,450	- / -
Magnum 340 with heavy-duty rear axle (kg)	- / -	- / -	- / -	12,395 / 12,850
Permissible total weight Class 4.75 / Class 5 front axle (kg)	17,530 / -	17,530 / 17,850	17,530 / 17,850	- / 18,000
Max. permissible weight front Class 4.75 / Class 5 front axle (kg)	6,030 / -	6,030 / 6,350	6,030 / 6,350	- / 7,760
Max. permissible weight rear (kg)	11,500	11,500	11,500	11,500
DIMENSIONS ¹⁾				
A: Total length only carrier / front hitch / front weights (mm)	6,015 / 6,295 / 6,225	6,015 / 6,295 / 6,225	6,015 / 6,295 / 6,225	- / - / -
with heavy-duty rear axle	- / - / -	- / - / -	- / - / -	6,299 / 6,575 / 6,505
B: Total height (mm)	3,105	3,375	3,375	3,375
C: Total width (across rear fenders extension) (mm)	2,550	2,550	2,550	2,550
D: Wheelbase standard / heavy-duty rear axle (mm)	3,105 / -	3,105 / -	3,105 / -	- / 3,155
E: Height at centre of rear axle to highest point (mm)	2,488	2,488	2,488	2,488
F: Track setting front (mm)	1,560 - 2,256	1,560 - 2,256	1,560 - 2,256	1,560 - 2,256
rear (mm)	1,470 - 2,294	1,470 - 2,294	1,470 - 2,294	1,470 - 2,294
STANDARD TYRES ²⁾				
Front	480 / 70R34	480 / 70R34	480 / 70R34	480 / 70R34
Rear	Dual 480 / 80R50	Dual 480 / 80R50	Dual 480 / 80R50	Dual 480 / 80R50

MODELS	MAGNUM 250 CVT	MAGNUM 280 CVT	MAGNUM 310 CVT	MAGNUM 340 CVT	MAGNUM 380 CVT
WEIGHT					
Approximate shipping weight standard / suspended front axle (kg)	10,830 / 11,290	10,910 / 11,415	10,910 / 11,415	11,730 / 12,190	11,730 / 12,190
Class 5 (option) / Class 5 suspended front axle (kg)	- / -	10,985 / 11,450	10,985 / 11,450	- / -	- / -
Magnum 340 with heavy-duty rear axle (kg)	- / -	- / -	- / -	12,395 / 12,850	12,395 / 12,850
Permissible total weight Class 4.75 / Class 5 front axle (kg)	17,530 / -	17,530 / 17,850	17,530 / 17,850	- / 18,000	- / 18,000
Max. permissible weight front Class 4.75 / Class 5 front axle (kg)	6,030 / -	6,030 / 6,350	6,030 / 6,350	- / 7,760	- / 7,760
Max. permissible weight rear (kg)	11,500	11,500	11,500	11,500	11,500
DIMENSIONS ¹⁾					
A: Total length only carrier / front hitch / front weights (mm)	6,015 / 6,295 / 6,225	6,015 / 6,295 / 6,225	6,015 / 6,295 / 6,225	- / - / -	- / - / -
with heavy-duty rear axle	- / - / -	- / - / -	- / - / -	6,299 / 6,575 / 6,505	6,299 / 6,575 / 6,505
B: Total height (mm)	3105	3375	3375	3375	3375
C: Total width (across rear fenders extension) (mm)	2550	2550	2550	2550	2550
D: Wheelbase standard / heavy-duty rear axle (mm)	3,105 / -	3,105 / -	3,105 / -	- / 3,155	- / 3,155
E: Height at centre of rear axle to highest point (mm)	2,488	2,488	2,488	2,488	2,488
F: Track setting front (mm)	1,560 - 2,256	1,560 - 2,256	1,560 - 2,256	1,560 - 2,256	1,560 - 2,256
rear (mm)	1,470 - 2,294	1,470 - 2,294	1,470 - 2,294	1,470 - 2,294	1,470 - 2,294
STANDARD TYRES ²⁾					
Front	480 / 70R34	480 / 70R34	480 / 70R34	480 / 70R34	480 / 70R34
Rear	Dual 480 / 80R50	Dual 480 / 80R50	Dual 480 / 80R50	Dual 480 / 80R50	Dual 480 / 80R50

MODELS	MAGNUM ROWTRAC 340	MAGNUM ROWTRAC 340 CVT	MAGNUM ROWTRAC 380 CVT
WEIGHT			
Approximate shipping weight standard / suspended front axle (kg)	- / -	- / -	- / -
Class 5 Wide suspended front axle (kg)	- / -	- / -	- / -
with heavy-duty rear axle (kg)	- / 16,332	- / 17,113	- / 17,113
Permissible total weight Class 5 front axle (kg)	18,700	18,700	18,700
Max. permissible weight front Class 5 front axle (kg)	7,760	7,760	7,760
Max. permissible weight rear (kg)	11,500	11,500	11,500
DIMENSIONS ¹⁾			
A: Total length only carrier / front hitch / front weights (mm)	- / - / -	- / - / -	- / - / -
with heavy-duty rear axle	6,120 / 6,402 / 6,332	6,120 / 6,402 / 6,332	6,120 / 6,402 / 6,332
B: Total height (mm)	3,450	3,450	3,450
C: Total width (across rear fenders extension) (mm)	2,540	2,540	2,540
D: Wheelbase standard / heavy-duty rear axle (mm)	- / 3,155	- / 3,155	- / 3,155
E: Height at centre of rear axle to highest point (mm)	2,207	2,207	2,207
F: Track setting front (mm)	1,828 - 2,235	1,828 - 2,235	1,828 - 2,235
rear (mm) *requires spacer kit over 2,032 mm	2,032 - 3,860*	2,032 - 3,860*	2,032 - 3,860*
STANDARD TYRES ²⁾			
Front	IF420 / 85R38	IF420 / 85R38	IF420 / 85R38
Rear	24 inch Camso	24 inch Camso	24 inch Camso



caseih.co.nz

SAFETY NEVER HURTS![™] Always read the Operator's Manual before working with any equipment. Inspect equipment before using it, and be sure it is operating properly. Follow the product safety signs, and use any safety features provided. This literature has been published for worldwide circulation. The standard and optional equipment and the availability of individual models may vary from one country to the next. Case IH reserves the right to undertake modifications without prior notice to the design and technical equipment at all times without this resulting in any obligation whatsoever to make such modifications to units already sold. Whilst every effort is made to ensure that the specifications, descriptions and illustrations in this brochure are correct at the time of going to press, these are also subject to change without prior notice. Illustrations may show optional equipment or may not show all standard equipment. Case IH recommends **AKCELA** lubricants. 19CIH012 – 05/2019

CASE IH
AGRICULTURE