

# 1931



# Convertible Coupe

History, Restoration and Photos.  
One of Six Examples



# For Sale

**\$37,777 obo**

Timothy Cox  
Docfirewall@gmail.com  
209-321-1454  
Lodi, California



# 1931 Buick Vehicle Identification Numbers

**VIN: 2730796**

The Vehicle Identification Number on the registration slip suggests that this vehicle was manufactured in late February or March of 1931.



**Cowl ID Plates**



**Chassis ID Plate 258686**

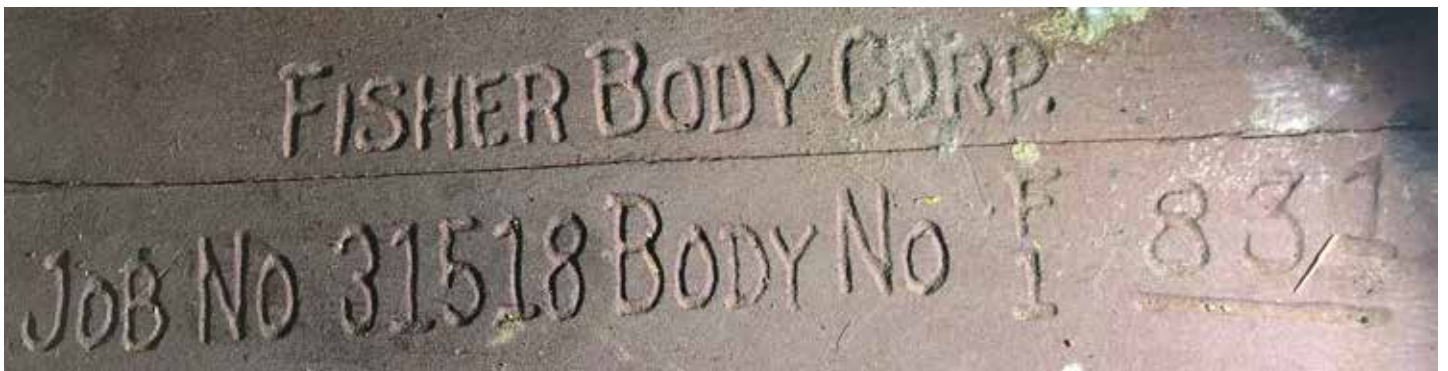

**Wood Sill Plate**

THE



*A full color reproduction of this painting by George Ford Norris, suitable for framing, will be sent free on request, Dept. L. D., Buick Motor Co., Flint, Mich.*

E I C H T  
 A S B U I C K  
 B U I L D S I T

## Repeated triumphs alone make the winner

A stalwart three-year-old thoroughbred wins a great race—the Preakness. Excellent! This record alone, however, does not place him among the racing idols. But he repeats! He wins the Kentucky Derby—he wins the Lawrence Realization—he wins the Dwyer Stakes. This makes him an undisputed champion. The *extra margin* of quality is there, and a winner must have this extra margin.

Pre-eminence in golf has been accorded, not to the winner of one or two titles, but to the man whose prowess enabled him to win

four major championships during 1930. And here is still another repeat winner with a record in which over two million thinking people have played a part:

There are 14 builders of straight eight motor cars in the Buick field, and yet Buick alone sells more than all the 13 others combined. Buick alone with its new Eight sells four times as many as the next company in its field. Buick alone has 750,000 more cars in operation than the second company.

And now, do you think that Buick could

have won this pre-eminent position more than ten years ago and could actually repeat every single year since, if Buick did not build that extra margin of quality into Buick cars?

The repeat winner on the turf—the repeat winner in golf—the repeat winner in business capture the interest of the world, and the world is quick to respond, because everybody loves a winner.

*The new Buick Straight Eights, in four series and four price ranges, are offered in 22 luxurious models, from \$1025 to \$2035, f. o. b. Flint, Michigan.*

*Consider the delivered price as well as the list price when comparing motor car values.*

A GENERAL MOTORS VALUE



WHEN BETTER AUTOMOBILES ARE BUILT, BUICK WILL BUILD THEM



# 2 New Convertible Coupes

## BUICK VIII

### BUICK FOUR-PASSENGER CONVERTIBLE COUPE

*Model 8-56C on 114-inch wheel base*

Closed car convenience and all the advantages of open models are combined in this new Convertible Coupe. The smartly tailored top of double-texture material is quickly and easily raised and lowered. Windshield folds forward. The interior is complete in every detail. The low, luxurious seats are trimmed in genuine leather.

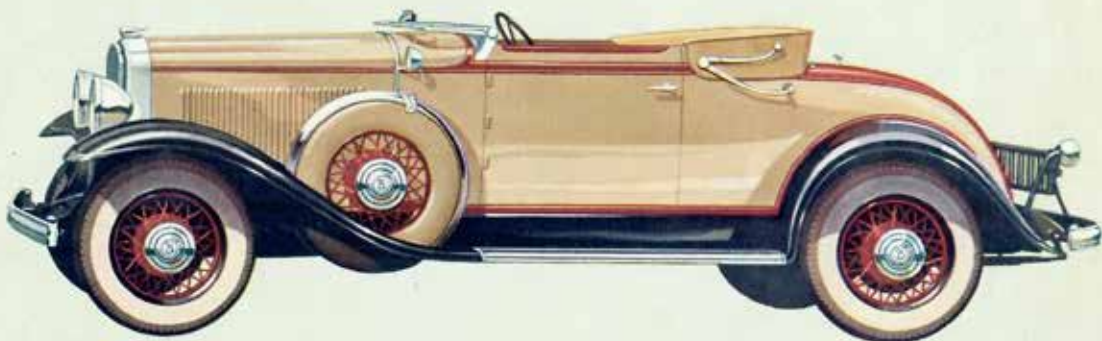



*A reproduction of this painting, in full color, suitable for framing, will be mailed upon request—Dept. F, Buick Motor Company, Flint, Michigan*

## It's blue blood that wins blue ribbons

Champions are not champions through training alone. Leadership requires more than the will to accomplish. Skill may be developed—strength and speed increased—but *natural* ability remains the deciding requisite. When all is said and done, it's blue blood that wins blue ribbons.

True of dogs and of horses—true of men—and true of the triumphs men achieve with mind and hand.

A large part of Buick's success in building fine motor cars can be traced to the natural ability among Buick craftsmen. Years of training as an organization have given direction to originality and genius, of course, but it is the innate caliber of the men themselves that you find reflected in Buick cars.

That, we feel, is why Buick leadership has become so outstanding—why three people buy Buick Straight Eights for every one who chooses the second most popular eight. More and more each year, the American public recognizes in this car of swift pace and distinguished bearing, the extra quality that comes of inborn talent applied at the

drafting board, in the laboratory, on the proving ground and at the factory.

And how much this extra quality means in genuine satisfaction is clearly revealed by Buick owners. For 89 out of every 100 Buick owners buy Buicks again and again.

*The new Buick Straight Eights, in four series and four price ranges, are offered in 22 luxurious models, priced from \$1025 to \$2935, J. O. B. Flint, Mich. . . . Convenient terms can be arranged on the liberal G. M. A. C. time payment plan.*

A G E N E R A L M O T O R S V A L U E



WHEN BETTER AUTOMOBILES ARE BUILT, BUICK WILL BUILD THEM

# THE EIGHT AS BUICK BUILDS IT

**From Marquette to Buick:**

# **Tracing the lineage of Buick's First True Convertible Coupe**

**A year of "Firsts" for the Buick Motor Division:**

- First---Buick Convertible**
- First---Straight 8 Engine**
- First---Syncro-mesh Transmission**

**MSRP: \$1,055**

The Model 56C Convertible Coupe is a relative rarity among Buick's early Depression-era offerings: Its lineage stemmed from the division's attempt at offering an entry level companion called the **Marquette** in 1929, which ceased production shortly after its debut.

Not all was lost with the "baby Buick's" demise.

Flint engineers took the Marquette's 114-inch-wheelbase chassis and designated it as the Series 50—the division's new-for-1931 entry-level level car, joining the larger 60, 80 and 90 Series offerings.

The series 50 chassis was refitted with a 77-hp version of the newly developed 220-cu. in. straight-eight engine and syncro-mesh transmission.

Initially offered in six body styles, the line was expanded to a seventh body style with the mid-year addition of the Model 56C--Buick's first true Convertible Coupe.



## **Limited Production**

As a result, just 1,531 were made for the American market and another nine were assembled for export. At the

same time, Buick also introduced a large series version of the new Convertible Coupe designated as the 96C with production of just 1,066 cars for the American market and four designated for export.

## GM COLLECTORS



GENERAL MOTORS CALENDAR FOR 1985

# A story spanning 50 plus years

**1964**

In the summer of my junior-senior year in high school I was confronted with the option of buying descent running 1930 Ford Model A Coupe for \$125 or a 1928 Buick Model 26S Coupe (barn find) that I had located on a Patterson, California ranch for only \$100. I “wagged home” the Buick with help of my uncle and so began a life-long Buick odyssey.

It didn't take long to get it cleaned up and running, but the Fisher Body roof was a “jig-saw puzzle” of wood pieces which were half missing and/or falling to the garage floor with every movement of the car.



## 1928-26s Country Club Coupe Trade-In



My solution was to find a roadster body.





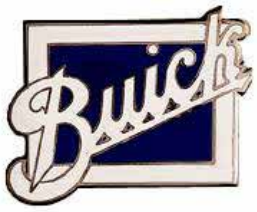

# 1931 Buick Convertible Coupe Original Photos



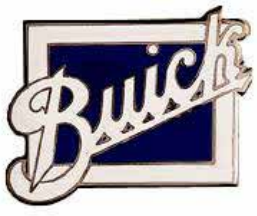

# 1931 Buick Convertible Coupe Original Photos





# 1931 Buick Convertible Coupe Original Photos



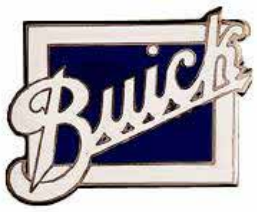

# 1931 Buick Convertible Coupe Original Photos





# 1931 Buick Convertible Coupe Exterior Detail



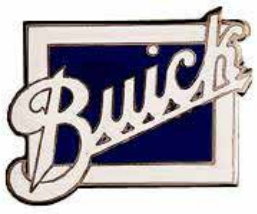

# 1931 Buick Convertible Coupe Exterior Detail





# 1931 Buick Convertible Coupe Exterior Detail



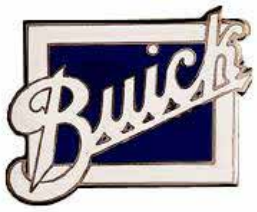

# 1931 Buick Convertible Coupe Lighting Detail







## 1931 Convertible Coupe Missing Parts Re-Manufactured

**1966**

In late 1966 my search for a Buick roaster body lead to another open field in Sacramento, California leading to a Buick roadster body, but it turned out to be a 1927 model. With disappointment I followed the owner back to his house and in the driveway stood a 1931 Buick 56C Convertible. He said this would be a better car to work with since it had minimal wood and virtually all of the parts were still on the car—right down to the dipstick. He offered to take





## 1931 Convertible Coupe Exterior Detail



the 1928 Buick and plus some cash, this transaction did not sit well with Mom, since I was starting my freshman year of college. Reluctantly, she relented, since I had saved up the money!

### 1967

On Easter weekend 1967, the 1928 Buick was loaded on a trailer and transported to its new home in Sacramento, and the 1931 Buick came back the same day. That started a 20-plus year restoration process that progressed slowly as I worked my way through college and my first few jobs.



In the early years, the body was removed and the engine was sent out for a complete rebuild. The chassis was stripped, and all components were refurbished and painted. All the while I searched local swap meets and wrecking yards for parts and meeting a number of Buick guys through phone calls and "SSAE mail" back then.

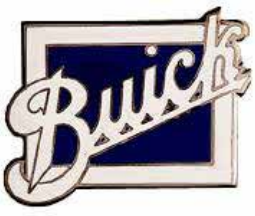

## 1931 Convertible Coupe Rumble Seat and Golf Bag Door



Like all car guys, I amassed a small collection of the parts that I would need to finish the car, but I was missing both the front and rear bumpers. At one point in my third year of college, a friend found a 1932 Buick 50 series coupe in Bakersfield, California, which I did not need, except for those bumpers. I bought the car for \$100, took the bumpers and immediately sold it before Mom got wind of it.

Parts were being moved in and out of my college apartment to a local chrome shop as spare money became available.



# 1931 Convertible Coupe Interior and Upholstery





# 1931 Convertible Coupe Convertible Top





## 1931 Convertible Coupe Interior and Upholstery

### 1970

In 1970, the engine returned as a “short block” from the rebuilder with new Babbitt main bearings rods, pistons and rings. The cylinder head had been rebuilt and the transmission cleaned and inspected. All of the mechanical components were re-installed in the chassis which sat then took up residence in Mom’s garage waiting to be reunited with the body. While I worked my day job, my attention at night focused on the wood frame of the body. All of the sheet metal came off the Fisher Body frame and was replaced using a borrowed band saw and hand tools.



### 1972-74

Along the way, I took some machining and fabrication courses at the local community college for “shop projects,” I duplicated parts I needed for my car that I would borrow from other Buick owners. This included the metal wind wing channels and brack-

ets and some small convertible bow parts. In all of my years of swap meet searching, I had acquired only one fairly “descent” 50 series Buick wire wheel hubcap. As a shop project, I turned that one hub cap into a mold and cast enough nine-pound solid aluminum hubcap blanks

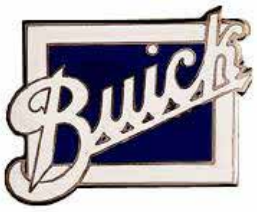

## 1931 Convertible Coupe Top Boot



to make a complete set for the Buick. The castings were machined down to fit the wire wheel hubs and holding pins and retaining clips were fabricated. They were buffed and polished and are on the car today.



### 1975

The body was reunited with the chassis in 1975 and sent out for paint. I was able to find samples of the original tan and maroon body colors under several

layers of black and gray paint and made exact paint matches to a couple of early 1960s BMW 3-series cars. While the chassis and body were out of my own one-car garage, I sand blasted



# 1931 Convertible Coupe Chassis Detail

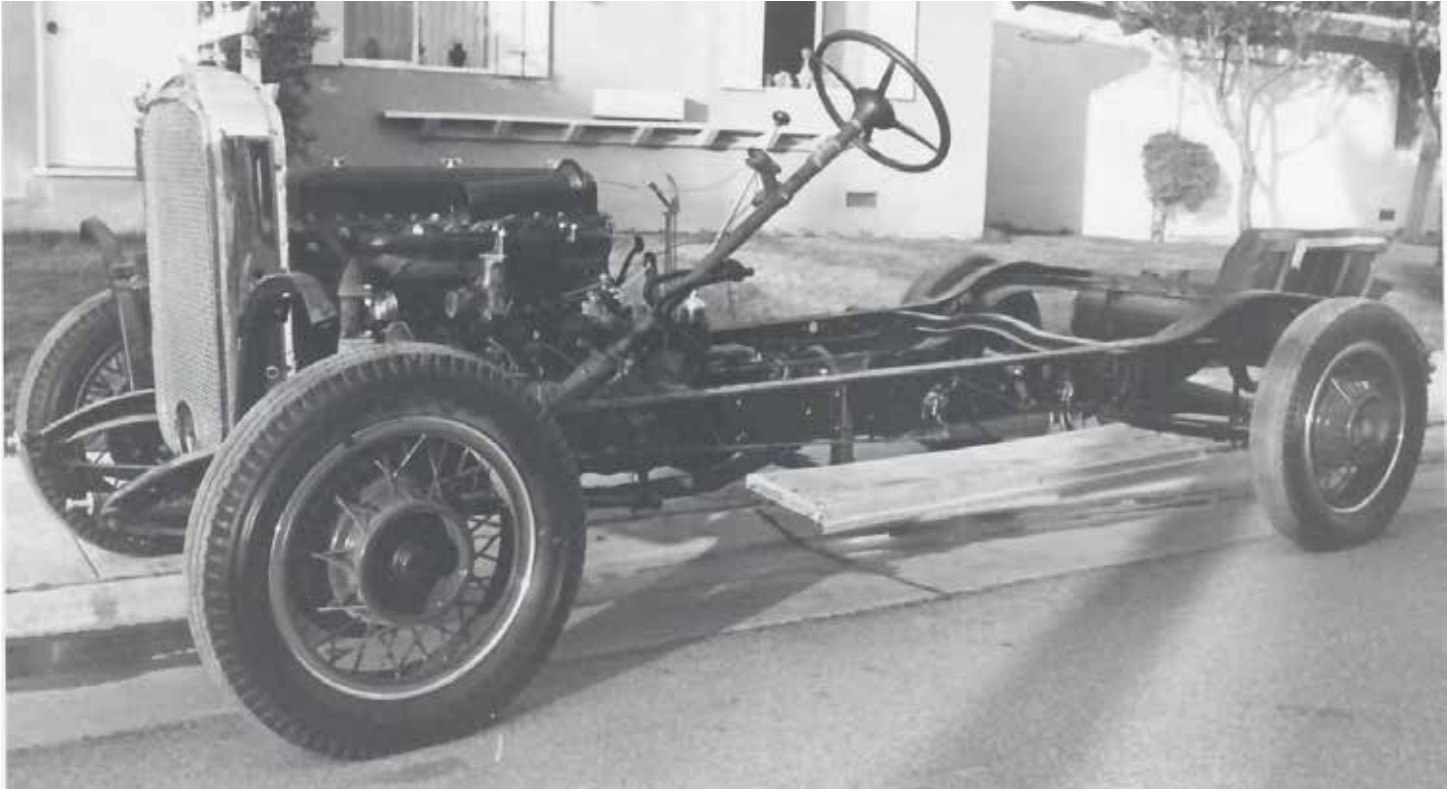





# 1931 Convertible Coupe Body and Wood Detail



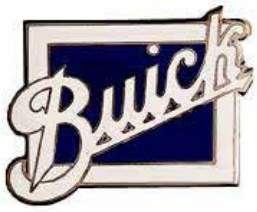

## 1931 Convertible Coupe Body and Chassis Reunited



**1975**

**The chassis had been in storage from 1968 while life and career moved on. Rebuilding the Body by Fisher wood frame, sandblasting the body, and reassembly began in earnest in 1972.**

**About 50 percent of the original wood had to be replaced.**

**On a spring weekend in 1975 we drove to Turlock, CA with a car trailer in tow and brought the Buick Chassis back to Pacific Grove. Once we got the chassis on the ground we had neighborhood helpers move the body off of its construction cradle on to the chassis. It was starting to look like a car again after eight years of sitting in various locations as “parts.”**



## 1931 Convertible Coupe Dash and Driver Controls



and prepared the fenders and aprons and painted them black.

### 1976

With the return of the body and its fresh two-tone paint, the fenders and aprons were mounted and the 1931 Buick began to look more like a real car again. I found an experienced upholstery shop and sent the car out to have the convertible top fabricated along with the side mount covers, trunk cover and the driver compartment leather seat—projects that required



## 1931 Convertible Coupe Dash and Driver Controls



someone with automotive upholstery experience. Not one to shirk from a challenge, I whipped out the home sewing machine and bought enough Naugahyde to cover my mistakes. I learned how to fabricate door, cowl and rear body panels and recovered the rumble seat cushions.



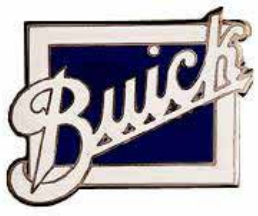

# 1931 Convertible Coupe Engine Detail





## 1931 Convertible Coupe Carburetor Conversion

The car is completely original with one exception. Anyone who has had one of these early Buick cars is well aware of the follies of the Marvel updraft carburetors which notoriously leak all over the exhaust pipe. After 50 years of fighting this problem, I turned the intake manifold up-side-down and machined adapter plates to mount an early 1950s GM down draft carburetor.





## 1931 Convertible Coupe Firewall Insulator



### Hobby Turned into Manufacturing Business

Here is where the story took me in another direction.

#### 1977

It is now 1977 and the Buick was virtually complete except for the worn out and damaged tar paper insulator that was still clinging to the passenger side of the firewall bulkhead. I carefully removed it and talked to some local boat

repair shop people and learned their techniques for working with fiberglass. I was able to build a mold using plywood and wood dough to replicate the same shape as the steel firewall in the Buick. From this mold I could pull off a fiberglass "cap," trim it to size, and drill the holes needed to duplicate the original firewall insulator. I hand stitched



## 1931 Convertible Coupe Hobby Turned Business



a welt on the sides and bottom and attached a rubber carpet skirt to the bottom, like the original.

That first firewall panel is still in the Buick and it turned a hobby project into a new industry—Tim Cox Firewall Insulators and later--QuietRide Solutions.

Buick Club members John and Barbara Gerstkemper wanted a firewall insulator for their 1931 Buick which now is owned by Buick Club member Steve Fisher.

As word got out, and with some HMN advertising, more Buick guys wanted firewall covers for different year cars and they started sending me old tattered and beat up insulation panels to

be duplicated. Then non-Buick guys wanted firewalls for their cars and trucks and more patterns came pouring in.

The company manufactures 75 firewall insulator products for Buick cars, dating from 1927 through 1988, as well as hundreds of firewall insulator panels other GM, Ford and Chrysler cars and trucks.



QuietRide also manufactures complete vehicle insulation kits, truck headliners and under hood covers for later model Buick A-body cars as well as Rivieras and hundreds of other cars and trucks.





# 1931 Convertible Coupe Restoration Projects Continue

**2015-20**

In the last several years I have continued to refine or make parts for the 1931 Buick. I had the shop make an AcoustiShield Thermal Acoustic Insulation Kit for the interior of the vehicle which made a complete change in the interior noise—yes, even on a convertible.

## Convertible Coupe Trunk Floor Kit



**Dynamat Xtreme Damper Pads** stop floor panel vibration.



**HeatShield Thermal Acoustic Barrier Insulation** contains the noise and stops heat penetration.

## Convertible Coupe Body Panel Kit



**Dynamat Xtreme Damper Pads** stop trunk deck and body panel vibration.



**HeatShield Thermal Acoustic Barrier Insulation** contains the noise and stops heat penetration.



## 1931 Convertible Coupe Restoration Projects Continue



I made a better steering column floor board brake and clutch peddle hole cover that really keeps the fumes from coming into the car. In my "Buick parts boxes" I rediscovered an old mock-up pattern from a 1931 Buick Roadster top boot that I had borrowed one January weekend at a local swap meet in 1971. Between the patterns and photos of 1931 Buick cars, I was able to fabricat-ed a new top boot to for the car. Still to be restored is the early 1930s Philco radio I acquired from another Buick friend.

I have about 4,500 miles on the car. My longest trip was to the Buick Club West Coast Regional meet in Morrow Bay about 1978--it was a long weekend drive at 45 MPH, but a lot of fun. The car still looks great, and draws a lot of attention, but it could use a cosmetic refresh to take it into the future!



**Automotive Thermal Acoustic Insulation Pre-Cut Kits Ready to Install**

# 1931 Buick Catalog

**Roof to Road Solutions to Control Passenger Caabin Noise, Vibration and Heat**



Introducing a multi-stage, automotive insulation and sound damping system to give Buick cars the “quiet riding comfort” found in today’s new cars. AcoustiSHIELD kits are designed on current “state-of-the-art” auto acoustic technology, to insulate and control the noise, vibration and heat in the passenger cabin. Kits are pre-cut and come with easy-to-follow installation instructions-----everything you need to do the job right.

## Turn Your Buick into “Quiet Riding Comfort”

### Stage 1 Sound Damper Pads



The first stage consists of pre-trimmed, self-adhesive, Sound Damper Pads, bonded to strategically located trouble spots on the floor pan and roof of the vehicle to control body panel vibration and noise. These spots are mapped and labeled in detailed instructions which are included in the kit.

### Stage 2 HeatShield-Barrier Panels



The second stage uses a high-tech absorber/barrier material, bonded to the body panels, to both sound deaden and insulate the vehicle from radiant heat penetration from the engine and road. Each absorber panel is cut to the correct shape and contour and is mapped and labeled in the detailed instructions.

#### Kits Include:

- Stage 1 Pre-Sized Sound Damper Pads
- Stage 2 Pre-Cut HeatShield/Insulation Panels
- ° Spray Adhesive and Sealing Tape
- Complete Illustrated Installation Instruction

Dealer program available. For more information contact us at [info@quietride.com](mailto:info@quietride.com)

©2003-19 Quiet Ride Solutions Prices Subject to Change Without Notice



Order Line: 888-777-3410

Tech Line: 209-942-4777

Fax: 209-942-4476

6507 Pacific Ave. Ste. #334 Stockton, CA 95207

# 1931 Buick Series 56 Convertible Complete AcoustiShield Insulation Kit

BCK 3156-CVAK

**Cowl Kit**

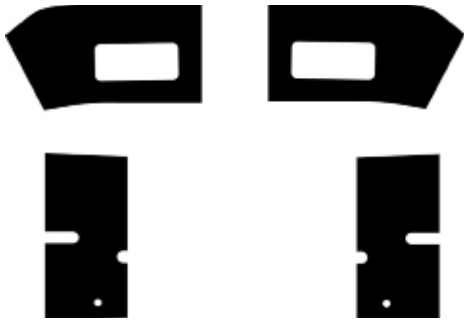

**Floor Kit**

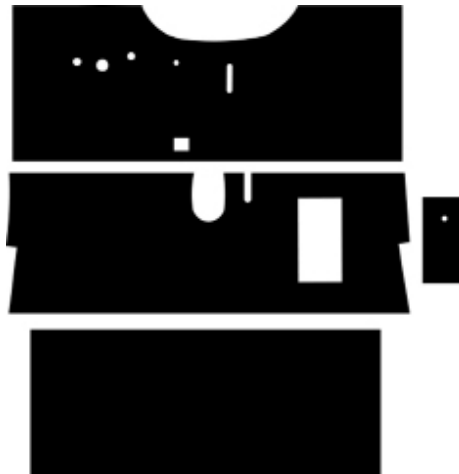

**Trunk Floor Kit**



**Body Panel Kit**



**Door Kit**

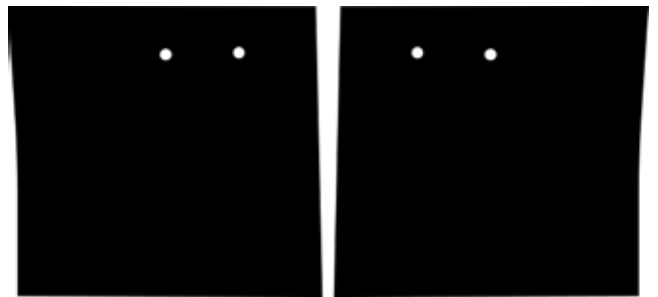

**The components of this AcoustiShield Insulation Kit are a direct fit for the following 1931 Buick Models:**

- 54 4-Pass Sport Roadster
- 56 2-Pass Business Coupe
- 56S 4-Pass Special Coupe

The Front Floor Kit, Cowl Kit, Door Kit and Firewall Insulator will fit all Series 50 Buicks for this year and can be ordered separately.



**ASU-DDBIK-4 Universal 4-Door Damper/Barrier Insulation Kit**

For Coupes, Convertibles, Trucks with upholstered door panels. Includes Dynamat Xtreme damper pads, Weather-Barrier Insulation, double-sided foam tape and Instructions. Easy to Install.

Part #	Description	MSRP
<b>BCK 3156-CVAK</b>	<b>1931 Buick 56C Series Convertible Complete Insulation Kit</b>	
BCK 3156-CVBPK	1931 Buick 56C Series Convertible Body Panel Insulation. Kit	
BCK 3156-CVCK	1931 Buick 56C Series Convertible Cowl Insulation Kit	
BCK 3156-CVFK	1931 Buick 56C Series Convertible Floor Insulation Kit	
BCK 3156-CVTK	1931 Buick 56C Series Convertible Trunk Floor Insulation Kit	
BCK 3156-DDBIK-2	1931 Buick Series 56C 2-Door Damper/Barrier Insulation Kit	

**Other Related Parts For This Vehicle (Sold Separately)**

BCK 3100-50-C	1931 Buick Series 50 Firewall Insulator Panel	
---------------	---	--

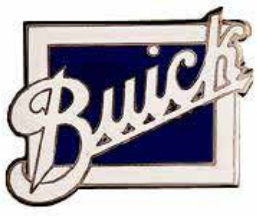

# 1931 Buick Sales and Marketing Specifications

# BUICK

## VALVE-IN-HEAD STRAIGHT



## SYNCHRO-MESH TRANSMISSION

TORQUE TUBE DRIVE · SERIES 8-50 · 114" WHEELBASE



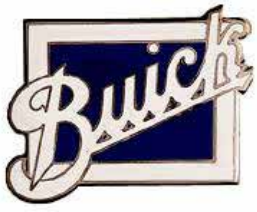

# 1931 Buick Sales and Marketing Specifications



## *A New Buick Series at New Low Prices*

SERIES 8-50—114 INCH WHEELBASE

**T**HE NEW BUICK SERIES 8-50, like Buick's other three series, offers Valve-in-Head Straight Eight engine, ultra-luxurious Insulated Bodies by Fisher, silent Syncro-Mesh Transmission and Torque Tube Drive. There is no compromise throughout the entire line. Moreover, Series 8-50 is priced so as to be within easy reach of new thousands who have long looked forward to Buick ownership. The Buick Series 8-50 is the world's lowest priced Valve-in-Head Straight Eight with silent Syncro-Mesh Transmission and Torque Tube Drive.

This Series combines proven Valve-in-Head power and efficiency with remarkable smoothness that results from Buick's advanced Straight-Eight design. These brilliant Buick Eights accelerate in high gear from 10 to 60 miles per hour in only 28 seconds. They climb grades of 11.6% in high gear from a start of five miles per hour, and speed over the crest at 28 miles per hour. A consistent speed of 75 miles per hour can be maintained hour after hour.



# 1931 Buick Sales and Marketing Specifications

## *Buick Valve-in-Head Straight Eight Engine*

The Series 8-50 Valve-in-Head Straight Eight engine for 1931 has a bore of  $2\frac{7}{8}$  inches, with a stroke of  $4\frac{1}{4}$  inches, and a displacement of 220.7 cubic inches. The S. A. E. rating is 26.45 horsepower. It develops

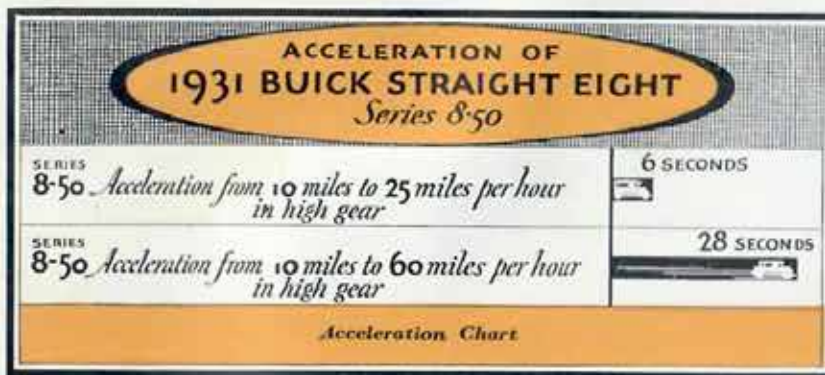

77 horsepower and is mounted at four points on flexible rubber mountings. The cylinder block and upper crankcase

are cast integral to provide maximum rigidity with minimum weight.

The cylinder head is a single casting of alloy iron. The combustion chambers are machined to provide uniform compression in all cylinders, and the valve seats are water cooled for the entire circumference.

### FIVE-BEARING CRANKSHAFT

This remarkable engine is equipped with a five-bearing crankshaft. The bearings are stepped in size for extreme rigidity without excessive weight. The crankshaft is fully counterweighted with eight counterweights, and has a torsion balancer of the new ring type. This rigid fully balanced crankshaft supported in Buick's new type crankcase



# 1931 Buick Sales and Marketing Specifications

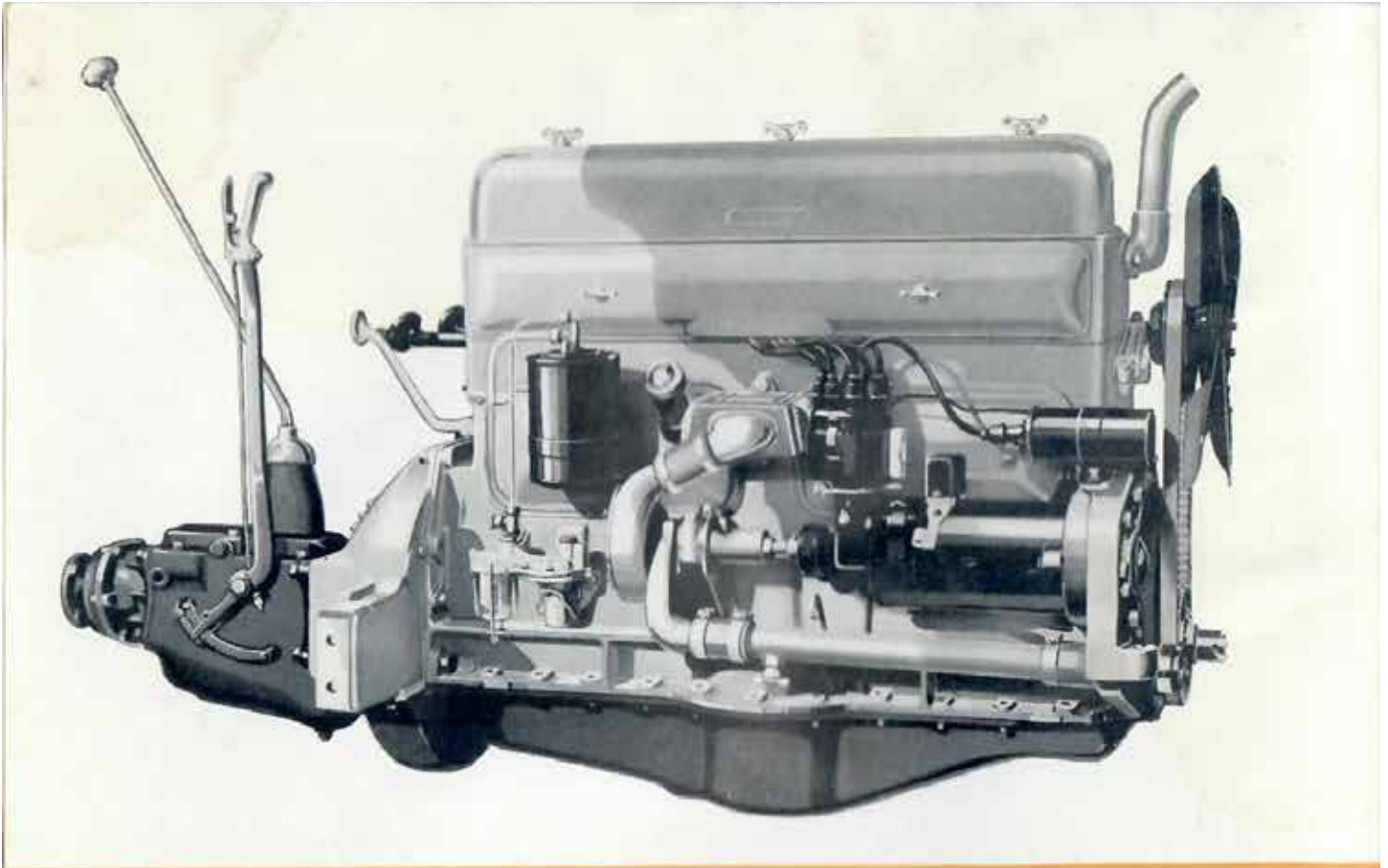

*Series 4-50 Buick Valve-in-Head Straight Eight Engine—Right Side—Story Page 3*

results in quietness and a smooth flow of power that reaches its highest peak in Buick valve-in-head construction. The crankshaft and torsion balancer are balanced separately, both statically and dynamically. Complete with counterweights and balancer this shaft weighs 99 pounds.

## CAMSHAFT AND TIMING GEARS

The camshaft is a drop forging, hardened and ground, with cams





# 1931 Buick Sales and Marketing Specifications

carefully formed for accuracy of contour. They are heat treated for extra long life and are ground to a brilliant smoothness. The shaft is rigidly mounted in five bearings, all of which are lubricated under pressure. The timing gear train consists of three helical cut gears. The camshaft and generator shaft gears are steel in mesh with a Textolite camshaft gear between the two. This type of drive insures quietness and accuracy without the necessity of adjustment.

## PISTONS

The Buick pistons are cast-iron of the same specification as the cylinder block. Because of this fact the pistons are fitted more closely for quietness and long life than would be possible if any other type of piston material were used. This is due to the fact that the cast-iron in the pistons has the same co-efficient of expansion as the cylinder block.

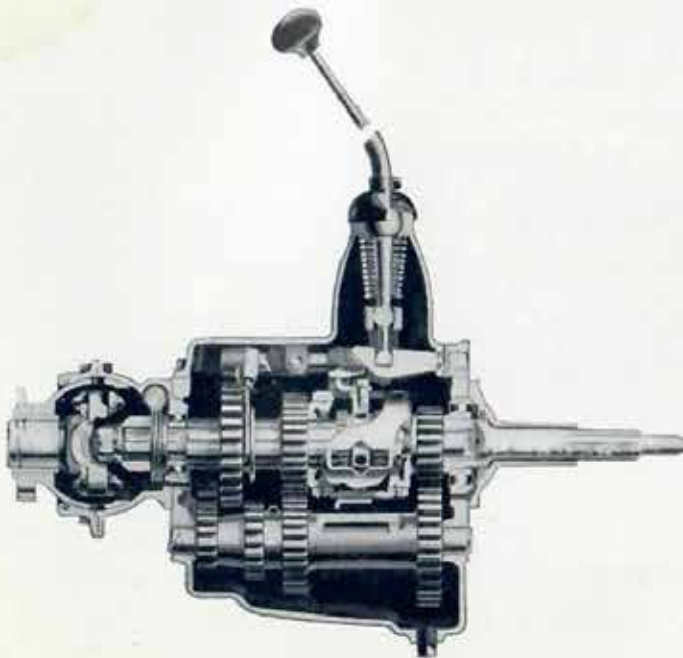

## CONNECTING RODS

Heat treated, drop forged steel is used in making the connecting rods which are of special Buick design having an I-beam section. The bearings are manufactured of finest quality bab-bitt bonded directly to the connecting rod and cap. The wrist pins are hardened and ground and

Page Five



# 1931 Buick Sales and Marketing Specifications

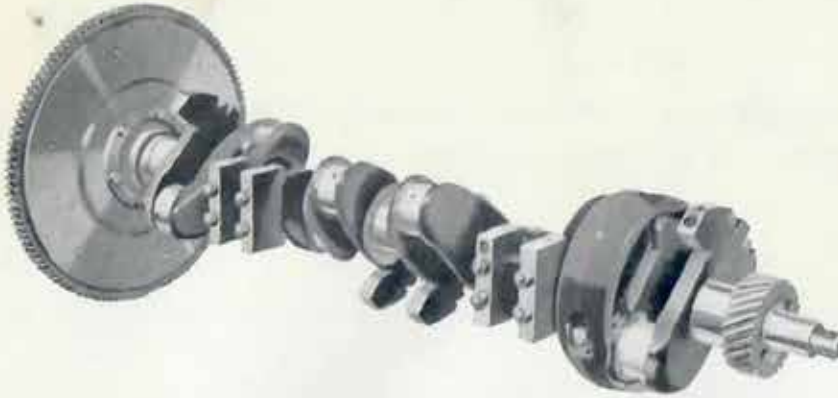

*Counterweighted Crankshaft*



*Ring Type Torsion Balancer*

operate in bronze bushings fitted in the pistons. All pistons and rods are carefully selected for uniformity of weight before being assembled as units. The result is a perfectly balanced assembly, and is one of the chief reasons why the 1931 Series 8-50 Buick Valve-in-Head Straight Eight is so quiet and smooth in operation.

## VALVES

The valves are of one-piece construction. The inlet valves are made of chrome nickel steel, and the exhaust valves of silchrome No. 1 steel, which has remarkable heat resisting properties. These silchrome exhaust valves will withstand without distortion the excessive heat to which they are constantly exposed. Buick Valve-in-Head Straight Eight engines are so designed and constructed as to provide an unusual supply of water in the jackets which surround the valve seats. This extra large quantity of water better dissipates heat at this particular point, thus assuring longer life for the valves. The entire valve mech-



# 1931 Buick Sales and Marketing Specifications

anism, rocker arms, push rods, etc., are automatically lubricated, and the over-head mechanism is completely enclosed from dust and dirt.

## VALVE MECHANISM

Two springs are used on each valve to provide quick action and positive closing of valves at all engine speeds. The valve lifters are hollow to reduce weight. Rollers and pins are case hardened and ground. Pins are hollow also, to reduce weight and to insure lubrication.

## FUEL SYSTEM

Heat controlled carburetion with positive feed by means of camshaft operated fuel pump equipped with gasoline strainer. Air cleaner and intake silencer. Sixteen gallon gasoline tank.

## *Air Cleaner and Silencer*

Freedom from intake noises will be noticed immediately when you drive

Page Seven

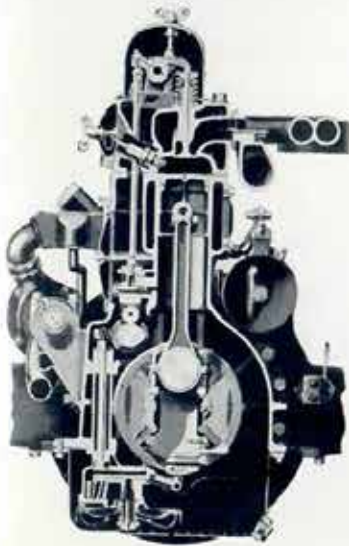

End Sectional View Engine

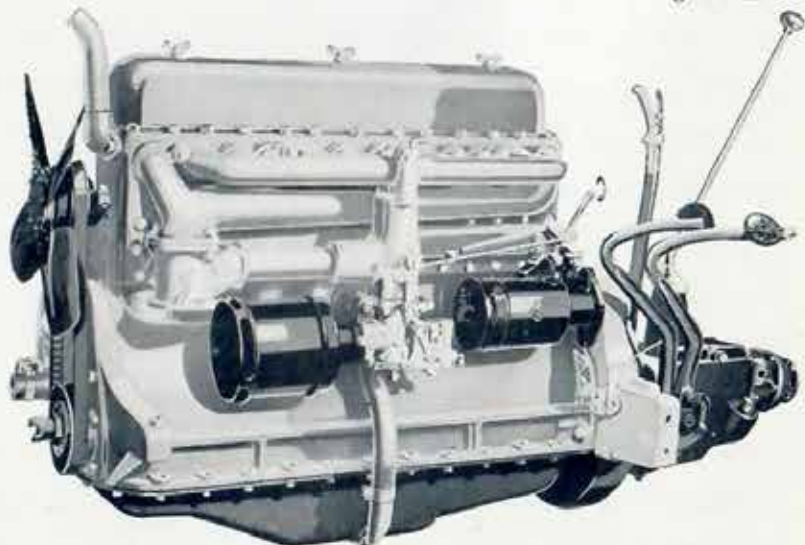

Series 8-50 Valve-in-Head Straight Eight Engine—Left Side—Story Page 5

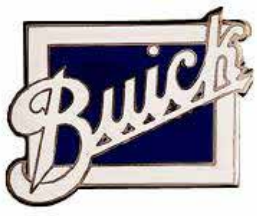

# 1931 Buick Sales and Marketing Specifications

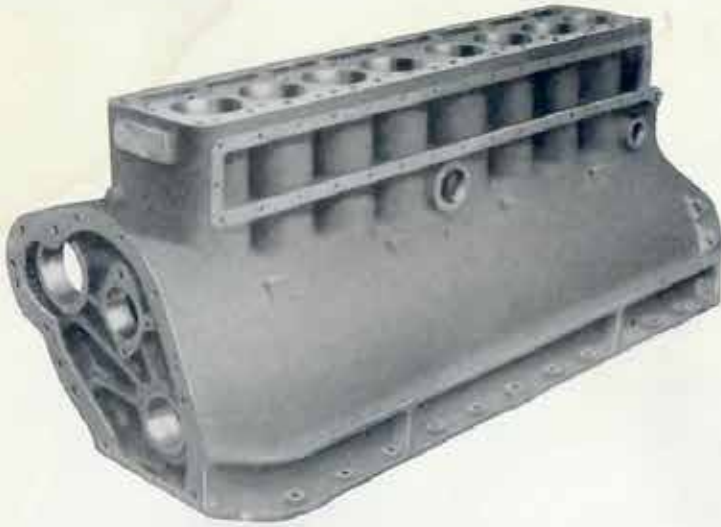

*Unit-Cast Cylinder Block and Crankcase*

these new Buick Valve-in-Head Straight Eights. The reason is Buick's new air cleaner and silencer that muffle noises, giving a pleasant feeling of smoothness and quietness throughout the entire speed range.

## *Lubricating System*

The Buick 1931 Valve-in-Head Straight Eight engine is assured of proper lubrication because of the forced feed type of system. Oil under pressure of 35 pounds per square inch is supplied by the oil pump which is submerged in the crankcase to main, connecting rod, and camshaft bearings. A second line from the oil pump delivers oil to the oil filter, and from there to the rocker arm shaft and valve mechanism. Cylinder walls, pistons, and piston pin bearings are lubricated by the oil mist thrown from the crankshaft main bearings and the lower connecting rod bearings. Additional oil is also supplied through a hole drilled into the lower connecting rod bearing which meters with



*Steel-Backed Babbitt Bearing and Cap*



# 1931 Buick Sales and Marketing Specifications

the oil distributing hole in the crankshaft at every revolution. The timing gears and the generator shaft front bearings are lubricated by oil from the rocker arm shaft. The oil capacity of the Buick Series 8-50 engine is 9 quarts, and to refill—7 quarts.

## OIL TEMPERATURE REGULATOR

An exclusive Buick feature, the Oil Temperature Regulator, keeps engine oil at a normal operating temperature under all driving conditions. When travelling at high speeds it acts as an oil cooler to prevent rise in temperature, to a point where the lubricating quality of the oil would be considerably reduced. It also acts as an oil heater when the engine is started in cold weather. The water temperature, under

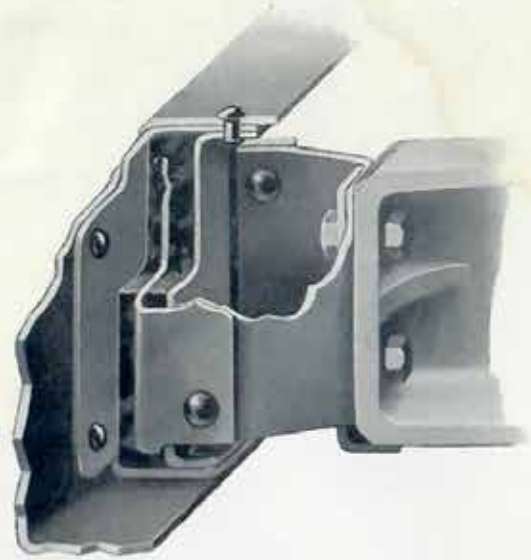

*Rubber Engine Mounting*

control of the radiator shutter, is raised more quickly than the temperature of the oil in the sump and this hot water passing through the Oil Temperature Regulator warms the oil quickly. The Regulator tends to

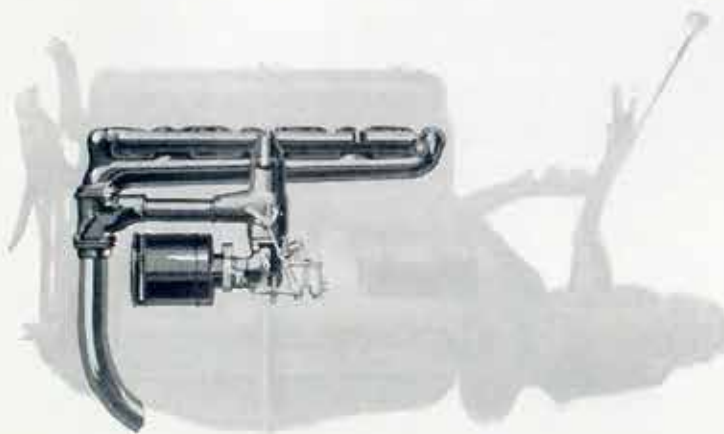

*Carburetor Manifold System and Heat Control*



# 1931 Buick Sales and Marketing Specifications



*Oil Filter*

equalize the temperature of the engine oil and cooling water, thereby providing a more uniform temperature of engine parts and a consequent uniformity of heat throughout the engine. The Buick Oil Temperature Regulator without any working parts to require the attention of the owner, is one of the greatest inventions applied to motor cars since the adoption of four-wheel brakes. It not only prolongs the ordinary life of the Buick engine but also assures better, smoother, and more brilliant performance whether driving in tropic or frigid zones.



*Combined Air Cleaner and Intake Silencer*

This Regulator consists of a radiative core enclosed in a steel jacket and bolted to the side of the cylinder block, directly above the water pump. Water from the cooling system flows through the core passages, while oil under pressure circulates around these passages.

## OIL PUMP

The oil pump is located in the lowest point in the lower crankcase and is driven by the camshaft through spiral gears. It is provided with a relief valve to control the oil pressure and a by-pass valve to protect the oil temperature regulator in cold weather. Both of



*Gasoline Pump and Strainer*



# 1931 Buick Sales and Marketing Specifications

these valves are non-adjustable. Oil is drawn through a fine mesh screen under a dome shaped cover, the design of which insures a supply of oil to the pump under all driving conditions.

## OIL FILTER

An AC oil filter that has a surface of 600 square inches in the filtering element is used on this engine. One quart of oil per minute passes through the filter at a car speed of 25 miles per hour. It functions automatically and requires no attention from the owner other than replacement after 10,000 miles of driving. This will insure maximum results. The oil filter removes from the oil all grit and foreign matter which are so destructive to bearing surfaces.

## CRANKCASE VENTILATING SYSTEM

Buick protects its lubricating system further by equipping all its Valve-in-Head Straight Eight engines with crankcase ventilation. The crankcase ventilator prevents harmful dilution of the engine oil by removing water and fuel vapors. The ventilator will prevent accumulation of water in the crankcase, and holds the fuel dilution to a minimum. It operates auto-

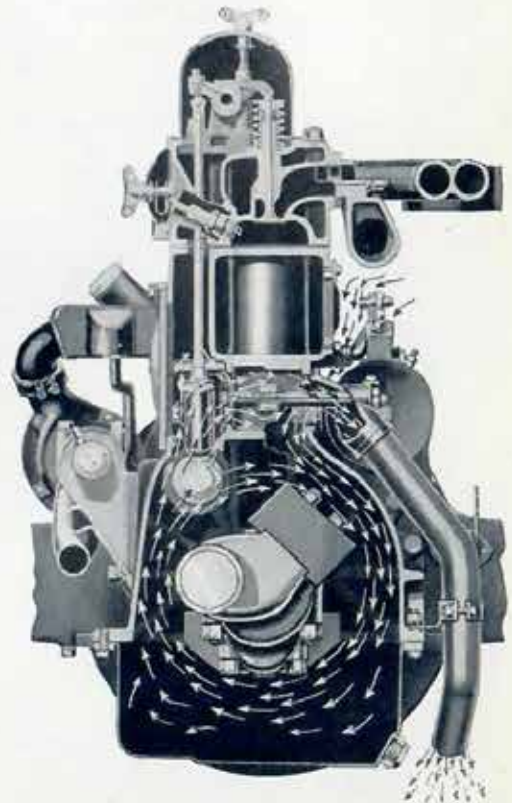

Page Eleven

*Crankcase Ventilation*

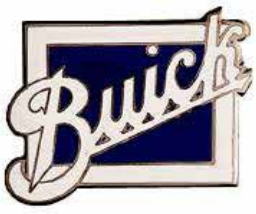

# 1931 Buick Sales and Marketing Specifications

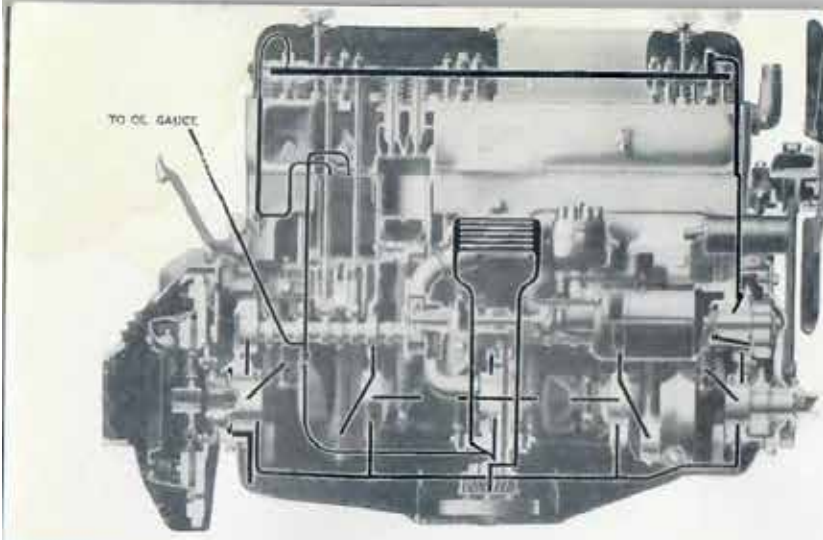

*Lubricating System*

matically and is of the vacuum type without any moving parts to require attention.

## CHASSIS

### LUBRICATION

The Zerk chassis lubrication system is used and every point to be lubricated is reached positively and easily.

## *Cooling System*

Buick has made ample provisions to insure the proper cooling of its Valve-in-Head Straight Eight engines. Water is circulated by a centrifugal pump gear driven by the generator shaft, and rotates one and one-half times as fast as the crankshaft.

## RADIATOR

The radiator has the cellular type water passages and copper cooling

Page Twelve



*Exclusive Buick Engine Oil Temperature Regulator—Story Page 9*

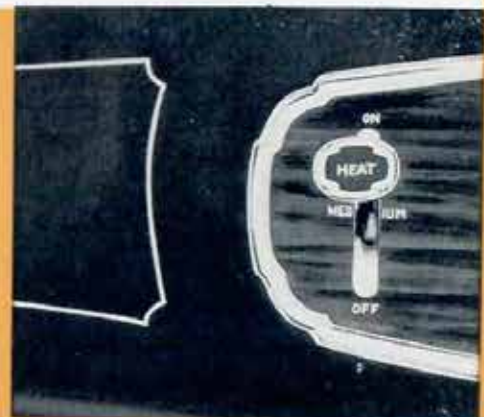

*Carburetor Heat Control*





# 1931 Buick Sales and Marketing Specifications



*Radiator Shutter Thermostat*

fins. A pressed steel shell encloses the core and supports it on a frame cross member. It has a frontal area of  $398\frac{1}{2}$  square inches.

The water capacity of cooling system is three gallons. A water temperature gauge on the instrument panel tells at a glance the temperature of water in the engine.

## AUTOMATIC THERMOSTATICALLY CONTROLLED RADIATOR SHUTTER

The radiator is equipped with a vertical shutter that is automatically controlled by a new type thermostat, placed directly in the water in the top tank of the radiator. The shutter prevents circulation of air through the radiator core when the engine is cold, thereby permitting the engine to warm up quickly to an efficient operating temperature. At which time the shutter automatically opens and permits just enough cool air to pass through to maintain an efficient operating temperature. The shutters are so controlled by the operation of the thermostat that an average minimum temperature of 130 to 140 degrees Fahrenheit is constantly maintained to insure the most economical operation.



*Automatic Radiator Shutter*



# 1931 Buick Sales and Marketing Specifications

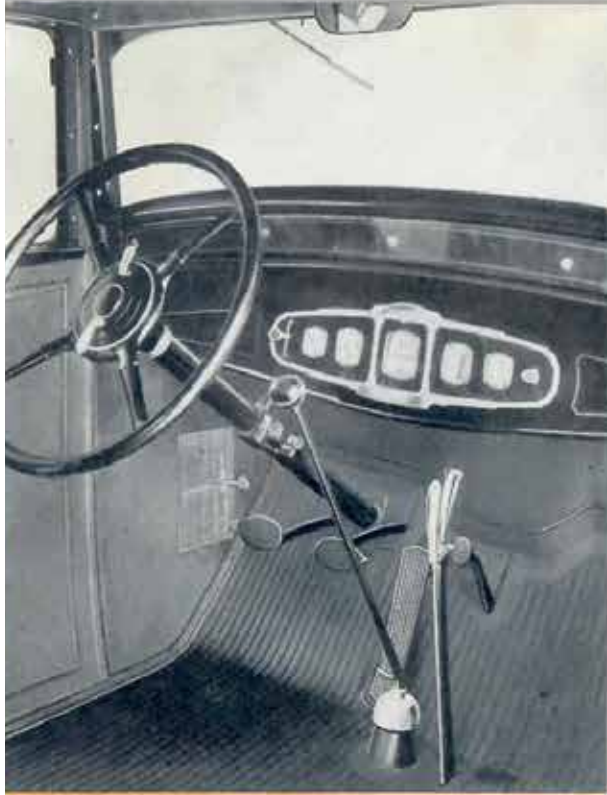

*Front Driving Compartment*

## WATER PUMP

The centrifugal type water pump, driven by the generator shaft, is mounted on a bracket attached to the upper crankcase. The shaft is case hardened and supported in the pump body in two bronze bushings.

## FAN

An efficient four-blade fan is mounted on an adjustable bracket attached to the cylinder block, and driven by a  $\frac{5}{8}$  inch V-belt. The fan operates on a plain bearing which is lubricated under pressure by a gear driven pump, self-contained in the fan hub shell.

## *Electrical System*

The Buick 1931 Valve-in-Head Straight Eight Series 8-50 engine has a Delco-Remy 6-volt electrical system of the 2-unit type, using separate generator and starter. A double breaker arm distributor insures positive firing of all cylinders. AC spark plugs and a single coil are used.

### GENERATOR

A Delco-Remy generator is used. Controlling the electrical output of the generator is a thermostat which automatically regulates the



# 1931 Buick Sales and Marketing Specifications

charging rate to meet varying requirements. A cut-out relay prevents excessive battery discharge.

## STARTING MOTOR

The starting motor has a manually controlled gear drive which permits the starting gears to mesh before the revolving action of the starter takes place. This prevents clashing or burring of the starter gears.

## BATTERY

Delco-Remy or Exide battery, 13-plate, 85 amp. hour, assures the perfect operation of the entire electrical system.

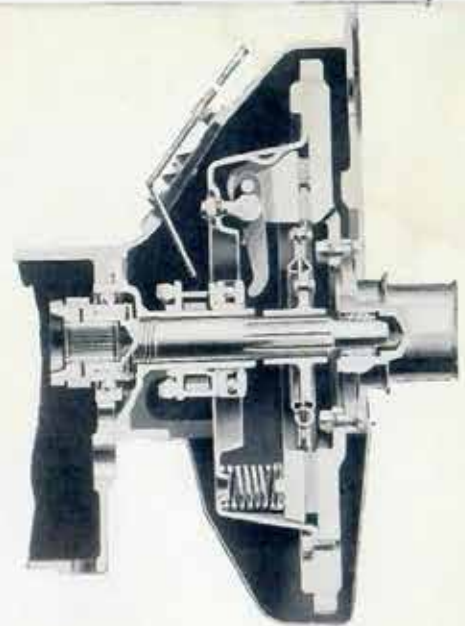

*Clutch*

## *Clutch*

The Buick clutch assures the fine car driving ease especially evident in the Series 8-50 Valve-in-Head Straight Eight, due to the responsiveness of the clutch to the slightest pedal pressure. The clutch is the single plate type, self-contained and enclosed in a pressed steel cover bolted to the flywheel. It has ten coil springs that flexibly connect the driven disc to the hub. Simple in construction, no adjustments are necessary. The friction surface area is 80.4 square inches.

Page Fifteen

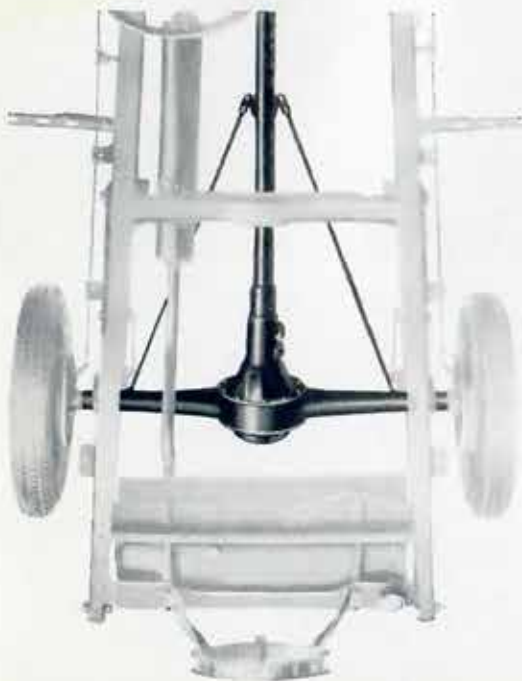



# 1931 Buick Sales and Marketing Specifications

## *Synco-Mesh Transmission*

The famous silent-shift Synco-Mesh transmission is provided in Series 8-50. It is of the selective sliding type with three speeds forward and one reverse. All gears except low and reverse are in constant mesh. A synchronizing mechanism—two friction cones and a gear clutch—is provided to connect the drive shaft with either the second-speed or high-speed gears. In shifting, the conical member engages a corresponding member on the second or high-speed gear before the teeth on the gear

and the gear-clutch actually meet. This causes the rotating parts to travel at the same speed, enabling complete engagement to be effected readily and without clashing. With Synco-Mesh, you can shift gears at any speed smoothly and silently, and without pausing in neutral. The gears and shafts are alloy steel heat treated for strength.



*Rear Wheel Brake*



*Front Wheel Brake*

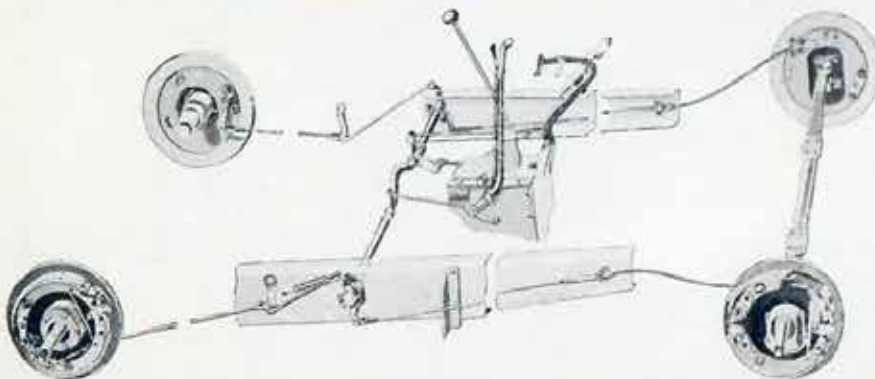

*Brake Hook Up*



# 1931 Buick Sales and Marketing Specifications



# 1931 Buick Sales and Marketing Specifications

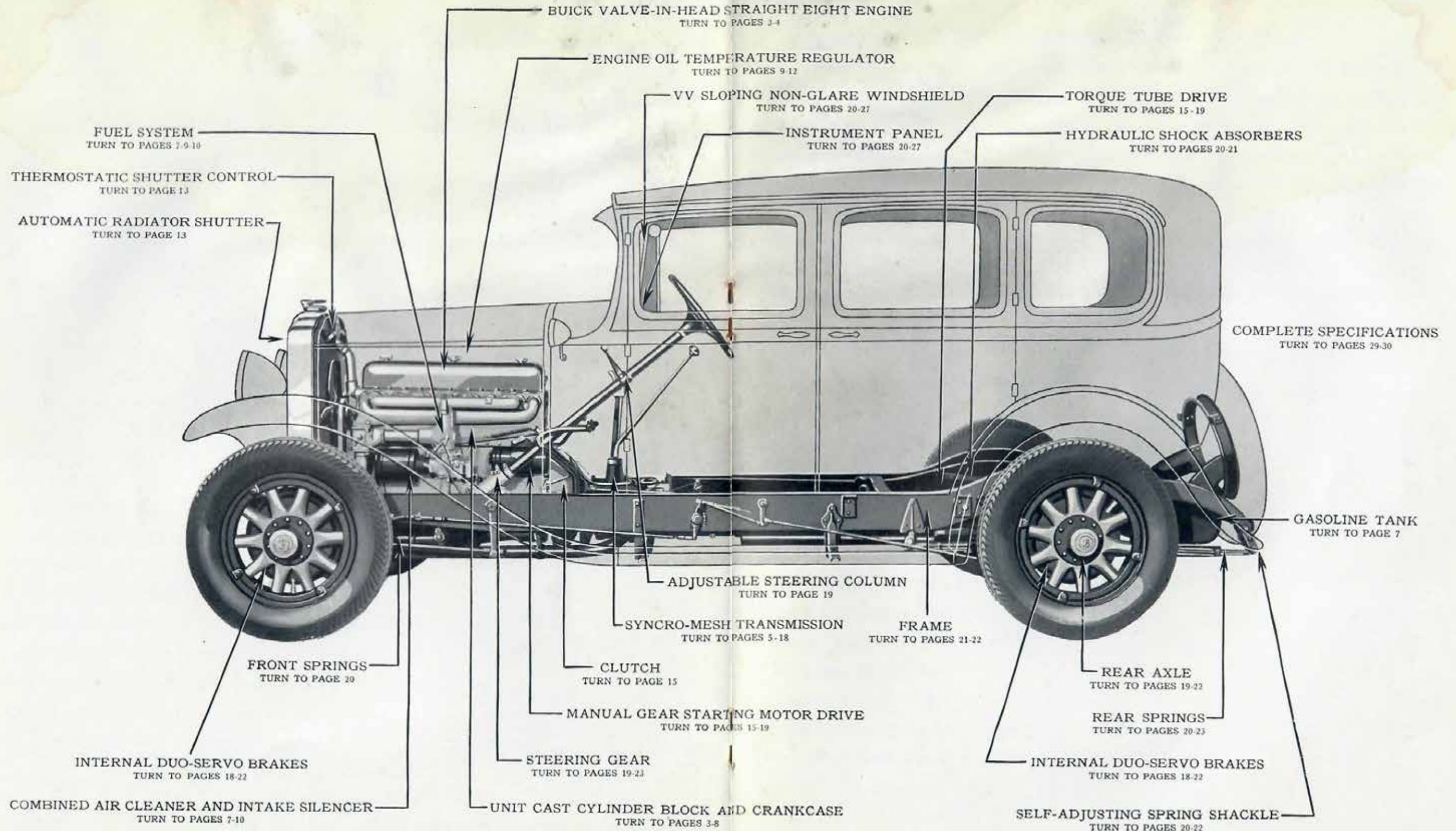

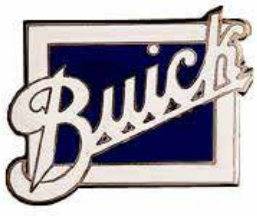

# 1931 Buick Sales and Marketing Specifications



*Steering Gear*



*Steering Wheel*

## *Rear Axle and Torque Tube*

The Semi-Floating type rear axle with Torque Tube drive—built to Buick's precise manufacturing limits—is employed in Buick Series 8-50. The torque tube transmits the driving torque from the rear axle to the frame, serves to keep the rear axle in perfect alignment, and also prevents any dirt or water from coming in contact with moving parts. A single universal joint, located at the front end of the torque tube—completely enclosed and automatically lubricated from the transmission—is another important advantage with this type of construction. Rear axle differential is of the two pinion type, with pinion and bevel gears mounted in ball bearings. They are fully adjustable for proper gear mesh. Axle shafts are of manganese steel, heat treated,

Page Nineteen



*Manual Gear Starting Motor*

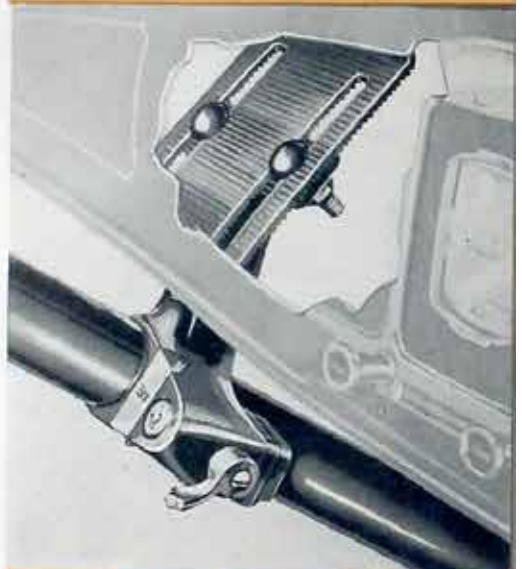

*Adjustable Steering Column*

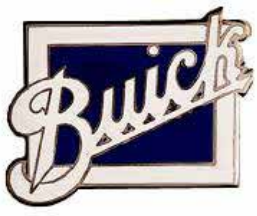

# 1931 Buick Sales and Marketing Specifications



*Instrument Panel*

and tapered from inner to outer ends which prevent centralization of strains.

## *Front Axle*

A strong and rugged front axle of I-beam section and the reverse Elliott type is used. The exceptionally heavy section of drop forged steel in the axle gives it an ample safety factor to withstand the road shocks and braking strains of high road speeds. The tie rod is located behind the axle for safety and protection. King bolts and steering spindles are of generous size, and ball thrust bearings are a major factor of the easy steering built into the axle.

## *Springs and Shock Absorbers*

The rear springs are the semi-elliptic type, under-slung, 54½ inches in length and 2 inches in width, and

Page Twenty

*Fisher FF Non-Glare Sloping Windshield*



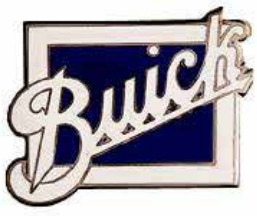

# 1931 Buick Sales and Marketing Specifications

together with Lovejoy hydraulic shock absorbers assure maximum riding comfort. The springs are mounted at the rear in self-adjusting spring shackles that are rattle-proof.

The front springs are the semi-elliptic type, overlung, 35 inches long and 2 inches wide, and like rear springs, are equipped with Lovejoy hydraulic shock absorbers. These springs are also mounted at the rear end of the spring in self-adjusting spring shackles that are rattle-proof and eliminate shackle stiffness.



*Hydraulic Shock Absorber*

## *Chassis*

The chassis of the 8-50 Series, Buick Valve-in-Head Straight Eight, is rugged and strong, built to withstand the hardest use on all types of roads. The wheel base is 114 inches. The chassis units—frame, axles,

*Sturdy, Rugged Frame*

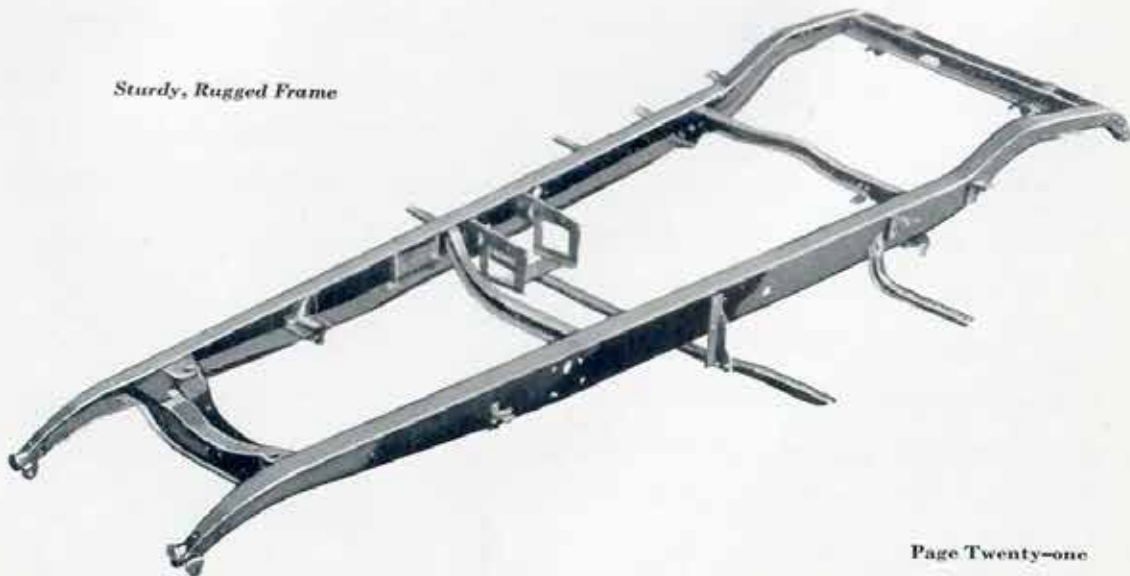





# 1931 Buick Sales and Marketing Specifications

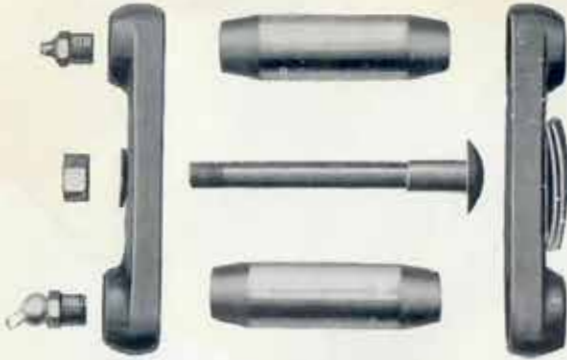

*Self-Adjusting Spring Shackle*

wheels, steering mechanism and springs — are in perfect balance, part for part. The result is a chassis of extra long life and excellent roadability.

## *Frame*

The frame is tapered to permit a short turning circle of only 39 feet, right or left. The side rails of the

frame are made of one-eighth inch stock,  $5\frac{1}{2}$  inches deep with wide top and bottom flanges. It has five large cross members and is well reinforced. Bumper mountings are integral with the frame at both the front and rear.

## *Brakes*

The Series 8-50 Buick Valve-in-Head Straight Eight has the Duo-Servo internal mechanical brakes on both front and rear wheels. Buick uses the same brakes for service and emergency, controlled through a single shaft hook-up. At the front wheel brake, a cable control is used which makes a very neat and safe installation. The cable control is fully enclosed in a dirt proof housing and only requires periodic lubrication. The brakes are smooth, positive, and quick acting with the slightest pedal pressure,

Page Twenty-two



*One-Piece Rear Axle Housing*



# 1931 Buick Sales and Marketing Specifications

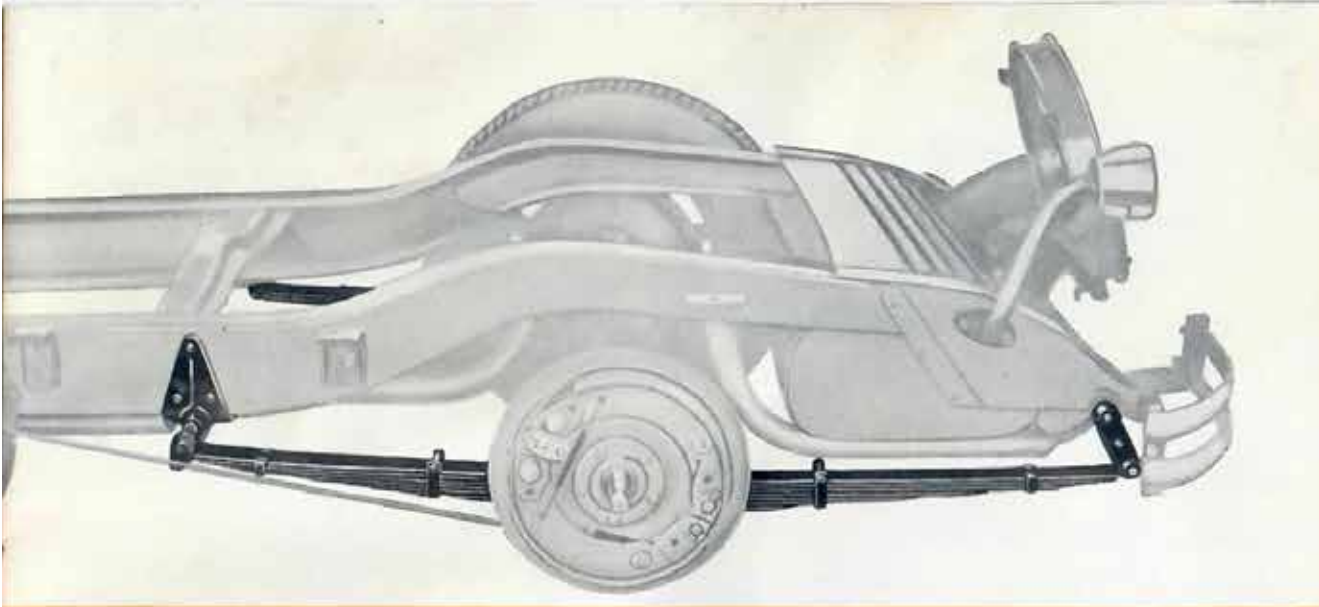

*Rear Spring*

and have total braking area of 182 square inches. Both front and rear brakes are completely sealed against mud and water, insuring positive braking efficiency in all weather.

## *Steering Gear*

A thrilling new experience in driving ease is assured in the Series 8-50 Buick Valve-in-Head Straight Eight. The steering gear is of the worm and sector type, providing a reduction of 16 to 1. Tapered roller bearings are provided for thrust loads. The entire mechanism is enclosed in an oil tight housing and firmly mounted to the frame.

## *Body*

The closed Bodies by Fisher and the Fisher designed open bodies of the Buick Series 8-50 Valve-in-Head Straight Eight, are smartly and beautifully styled. The long racy curves of the fenders blend harmoniously



# 1931 Buick Sales and Marketing Specifications

with the soft curves of the body to definitely establish these cars among the most beautiful in America.

Constructed of wood and steel, great care has been taken to eliminate all possible squeaks and rattles from the body. Floor and toe boards in the front compartments are of ply-wood, insulated from draft, dirt, and noises by a heavy felt bonded to the rubber floor mat. Against the dash is installed an insulating board which is composed of three layers of material cemented together, each having an important function to perform. Next to the dash is a thick insulating board primarily used to shut off the heat of the engine; then a layer of felt three-quarters of an inch in thickness, which eliminates noise. Over this felt pad is a layer of water proof board, extending from the top of the dash to within three inches of the bottom. The bottom three inches is covered with black rubber. This board is finished in hand crushed Spanish grain with a color that harmonizes with the interior of the car.

The openings in the floor boards, through which the control pedals and levers enter the driving compartment, are completely sealed by a tight fitting rubber mat which makes this compartment draftproof.

Page Twenty-four



*Muffler*

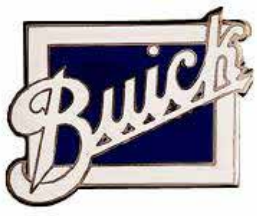

# 1931 Buick Sales and Marketing Specifications

All closed bodies have an adjustable front seat which can be easily adjusted to suit the individual driver's exact position. This seat can be moved a total of four inches—two inches back-

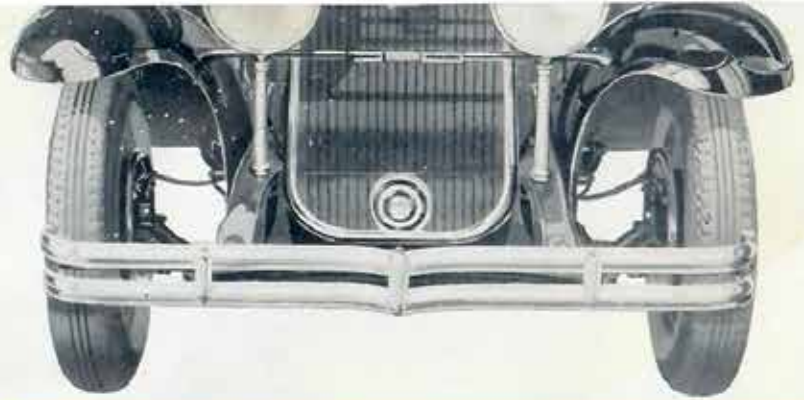

*Clean Frontal Appearance, Bumper Brackets Integral with Frame*

ward and two inches forward from neutral position. The big, roomy rear compartments are made more comfortable and free from noise by having an insulated floor board—a heavy jute pad  $\frac{1}{4}$  inch thick—over which is placed a velvet pile carpet.

The sedan models and the phaeton are provided with comfortable arm rests. In addition, the sedan models have assist cords for convenience when getting in or out of the car. An attractive dome light for entering and leaving the car, or for reading. It is controlled by a switch on the center pillar post. Vanity cases are also mounted on the side panels in convenient location for the occupants of the rear compartment. Rear compartment windows have silk curtains that harmonize in color with the upholstery.

## *Upholstery and Cushions*

Cushions of exceptionally easy riding qualities, constructed with special type springs, upholstered in genuine mohair, insures complete comfort. The backs of the cushions are built at just the cor-



# 1931 Buick Sales and Marketing Specifications



*Fisher Body Construction—Story Page 23*

rect angle giving the maximum riding comfort, even on long drives.

## *Roof Construction*

The roof on the Bodies by Fisher used on the Series 8-50 Valve-in-Head Straight Eight closed cars, is a unit by itself. The roof is fastened securely onto the body pillars and roof side rails. Horizontal slats form the frame work of the roof. This construction is the strongest type known to the body building industry. The roof structure is thoroughly padded to prevent drumming and is then covered with a high grade roof material. This material consists of two layers of fabric,



*Adjustable Front Seat*

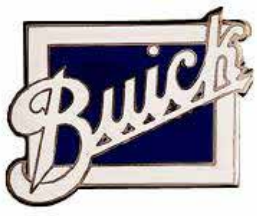

# 1931 Buick Sales and Marketing Specifications

joined together by a layer of rubber. These are covered with a pyroxalin finish and treated with aluminum acetate, which makes the material not only waterproof but water repellent.

## *Sun Visor and Non-Glare Sloping Wind Shield*

A military sun visor specially designed to be in harmony with the roof line helps to make the front end appearance of the Series 3-50 Valve-in-Head Straight Eight Buick one of outstanding beauty. The absence of the sun visor brackets gives the visor an ultra smart appearance. The closed cars are equipped with the non-glare Fisher VV sloping wind shield that makes night driving a pleasure, as all light reflections are deflected from the driver's eyes. An automatic wind shield wiper is standard equipment on all models.

## *Instrument Panel*

The instrument panel is complete in every detail and is lighted both directly and indirectly. All gauges are conveniently placed so that the driver can see each one at a glance, either at day or night. On the instrument panel is the

Page Twenty-seven



*Front Corner Roof Brace*

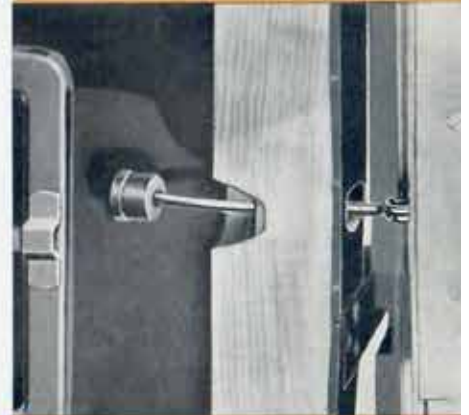

*Rubber-Cushioned Door Check*



*Screened Side Cowl Ventilator*



# 1931 Buick Sales and Marketing Specifications



*Interior Hardware*



*Rear View Mirror—Windshield Wiper Control  
Fisher VV Non-glare Sloping Windshield*

oil gauge, water temperature gauge, speedometer, hydrostatic gasoline gauge, ammeter, and also the manual carburetor heat control. The light switch, choke and spark buttons are also located on the instrument panel within easy reach of the driver.

It is obvious that Buick supplies in the 1931 Series 8-50 Valve-in-Head Straight Eight cars, fine car engineering, spaciousness and comfort. Thousands who always desired a Buick can now own one of these fine eights—the lowest priced valve-in-head straight eight in the world.

## TAKE THE WHEEL AND MARVEL

You have read the story of the new Buicks; the only way to know the car is to get behind the wheel. Your local Buick dealer will be glad to place a car at your disposal. Better take that ride soon—the new Buick Valve-in-Head Eight will please you.

Page Twenty-eight



*Insulated Dash and Front  
Compartment Floor*



*Insulated Rear Compartment  
Floor—Story Page 23*

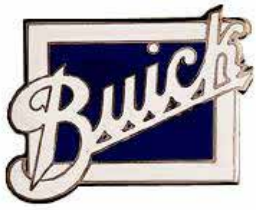

# 1931 Buick

## Sales and Marketing Specifications

### SPECIFICATIONS

1931 Buick Valve-in-Head Straight Eight Series 8-50 on 114-inch wheelbase



#### ENGINE

*The Buick Valve-in-Head Straight Eight engine in all Buick models for 1931 is the culmination of 27 years' experience in developing the Valve-in-Head principle. It carries that principle forward to new triumphs. Making possible a consistent speed of 75 miles an hour, in the Series 8-50, it is amazingly smooth and responsive—without question the greatest engine that Buick has ever built.*

**TYPE:** Buick Valve-in-Head, eight cylinders in line, cast as unit with upper half of crankcase. Four-point suspension with flexible rubber mountings.

**BORE AND STROKE:**  $2\frac{7}{8}'' \times 4\frac{1}{4}''$ .

**DISPLACEMENT:** 220.7 cu. inches.

**HORSEPOWER:** 77; quick acceleration, amazing hill climbing ability and speed of 75 miles an hour.

**S. A. E. RATING:** 26.45.

**PISTONS:** Cast iron, of Buick design. Two compression rings and one oil ring.

**CONNECTING RODS:** Drop forged steel, heat treated. Improved I-beam type.

**VALVES:** Inlet: Nickel chromium steel. Exhaust: Silchrome No. 1 steel.

**CRANKSHAFT:** Drop forged, heat treated. Fully counterweighted and balanced with latest ring-type torsion balancer. Practically vibrationless. Weight with counterweights and balancer, 99 pounds.

**MAIN BEARINGS:** 5 steel backed babbitt bearings, stepped in size.

**TIMING GEARS:** Positive drive. Silent. Require no adjustment.

**FUEL SYSTEM:** Marvel carburetor. Automatic heat control, and manual control on instrument panel. Dual manifold. AC fuel pump and gas-line strainer. Combined intake silencer and air cleaner. Gas tank capacity, 16 gallons.

**WATER COOLING SYSTEM:** Cellular type radiator with rigid mounting. Shutters automatically controlled by new-type thermostat and mounted in rigid frame, eliminating binding or

distortion from road strain. Centrifugal pump, gear driven by generator shaft. Four-blade fan, driven by  $\frac{5}{8}''$  V-belt. Fan lubricated by self-contained oil pump.

**EXHAUST SYSTEM:** Special design. Quiet without excessive back pressure. Tightly-sealed joints. Special mountings to give proper support and eliminate noise.

#### ENGINE OIL TEMPERATURE REGULATOR

*Because of the remarkable high speeds at which the Buick Valve-in-Head Straight Eights can be driven hour after hour, cooling of the engine oil is just as important as cooling of the water. Buick, therefore, has perfected an Engine Oil Temperature Regulator that prevents the oil from over-heating. The Regulator also warms the oil quickly in cold weather, assuring efficient engine performance immediately after starting the motor.*

**OIL TEMPERATURE REGULATOR:** Consists of a radiative core enclosed in shell, bolted to engine directly above water pump. Oil under pressure circulates between passages of core. Regulation is controlled by water from cooling system passing through the core. Assures efficient lubrication—increases life of bearings. No moving parts. No attention required from owner.

#### LUBRICATION SYSTEM

*The efficiency of Buick's forced feed lubrication system is made certain by a large capacity gear-driven pump, an oil filter and a crankcase ventilator.*

**FEED:** 35-lb. pressure from gear pump to main, connecting rod and camshaft bearings, rocker arm shaft. Valve stems, timing gears, and generator front bearing by overflow from rocker arm shaft. Capacity, 9 quarts, (7-quart refill).

**OIL FILTER:** AC. Removes impurities from oil and protects working parts against abrasive action of dust and other matter.

**CRANKCASE VENTILATION:** Counterweights,





# 1931 Buick

## Sales and Marketing Specifications

balancer and crankshaft act as blower forcing all fumes and vapor out of engine and entirely clear of car, preventing dilution of oil in crankcase. Only four oil changes a year needed, with oil added as required between changes.

**CHASSIS:** Zerk lubrication system, reaching every point positively and easily.

### POWER TRANSMISSION SYSTEM

*Buick, and only Buick, in its price class, can offer such a remarkable power transmission system. The silent-shift synchro-mesh transmission, Buick's famous torque tube drive, a positive release clutch, and the reliable Buick rear axle, all developed with characteristic Buick thoroughness that gives the greatest automobile dollar for dollar value.*

**TRANSMISSION:** New silent Synchro-Mesh, selective gear type, eliminating gear clashing and promoting quick getaway. Three speeds forward and one reverse. Chrome nickel steel gears, hardened and ground, insuring quietness and long life. Shaft mounted in ball bearings.

**CLUTCH:** Positive release, single plate type with 80.4 sq. inches surface area.

**TORQUE TUBE:** Fully enclosed propeller shaft, protecting it from dust, dirt and water. Insures perfect alignment between propeller shaft and rear axle. Relieves springs of all driving strain. Has only one universal joint automatically lubricated from transmission.

**REAR AXLE:** Semi-floating; axle ratio 4.545 to 1; two pinion differential; bevel ring and pinion supported by ball bearings. Improved, one-piece housing, exceptionally rigid and oil-tight.

### CHASSIS

*Into the foundation of the car—the chassis—Buick puts all the skill and knowledge acquired in 27 years of honest manufacturing. The frames of the 1931 Buicks are stronger and more rugged than ever. Similar extra strength and efficiency is found in all the other units which make up the chassis. The result is perfect coordination with the Buick Valve-in-Head Straight Eight engine, making for smooth dependable performance, and unusually long life.*

**FRAME:** Single drop type; constructed of heavy steel side channel  $5\frac{1}{2}$  inches deep with five sturdy cross members. Whole construction is exceptionally rugged.

**STEERING GEAR:** Worm and sector type,

mounted in roller bearings fully adjustable for wear. Easily operated. Adjustable column.

**FRONT AXLE:** Reverse Elliott type with drop forged I-beam section, plain bronze knuckle bearings, vertical thrust ball bearings. Tie rod provided with automatic take up for wear at the ball sockets.

**FRONT SPRINGS:** Semi-elliptic overslung type 35 inches long, 2 inches wide. Bronze bushings.

**REAR SPRINGS:** Semi-elliptic underslung type  $54\frac{1}{2}$  inches long, 2 inches wide. Bronze bushings.

**SHOCK ABSORBERS:** Hydraulic type, front and rear. So designed with the long springs to produce an exceedingly easy ride.

**FOUR-WHEEL BRAKES:** Buick Duo-Servo internal mechanical type controlled by pedal and hand lever, operating independently of each other. This hookup eliminates duplication of brake parts and permits easy and quick adjustment. Cable control for front brakes enclosed in dirt proof housing. Braking surface 182 square inches.

**HAND BRAKES:** Operates on all four wheels. **TIRES:** 18 x 5.25 (four ply).

**WHEELS:** 10-spoke artillery type, with demountable rims.

### ELECTRICAL SYSTEM

*In its electrical system, as in other parts of the car, Buick has worked successfully toward the goal of simplicity and dependability.*

**EQUIPMENT:** Delco-Remy 2-unit 6-volt system. 13-plate, 35 amp. hour Delco-Remy or Exide battery. Manual gear starter drive. Thermostatic generator control. Double breaker arm distributor, single coil and AC spark plugs. Double filament tilt-ray fixed focus chromium plated headlamps, 21-21 c. p., with cowl lamps to match. Combination tail (3 c. p.) and stop light (15 c. p.). Direct and indirect lighting for instrument panel.

### EQUIPMENT

**INSTRUMENT PANEL:** Mahogany finish, complete with speedometer, ammeter, oil pressure and gasoline gauges, water temperature indicator (all directly or indirectly lighted). Heat control, light switch, choke and spark buttons, within easy reach of the driver, are also on the panel.

*Following is special equipment at small additional cost:* Special demountable wire, wood or disc wheels, fender wells, trunk rack, trunk, bumpers, fabric or metal tire covers, gravel deflectors, tire locks, heaters and clocks.

*In addition to the Series 8-50 on 114-inch wheelbase, the complete Buick line also includes the Series 8-60 on 118-inch wheelbase; Series 8-80 on 124-inch wheelbase, and Series 8-90 on 132-inch wheelbase.*

**BUICK MOTOR COMPANY, FLINT, MICHIGAN**

Division of General Motors Corporation

*All facts in this book have been checked but are subject to correction.*

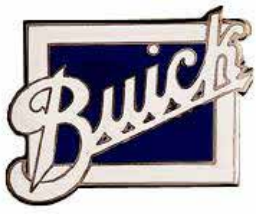

# 1931 Buick Sales and Marketing Specifications



## Service Policy

- 1** A Written Warranty, covering the first 90 days of ownership, or the first 4000 miles, whichever shall occur first, guarantees to every purchaser of a new Buick a more than liberal Service Policy.
- 2** Should Buick parts or workmanship prove defective at any time during the Warranty period, Buick dealers will supply the parts and perform the necessary labor free of charge.
- 3** Before delivery of new cars to purchasers every Buick dealer will determine that all pre-delivery conditioning operations, as shown in the current Buick Flat Rate Manual have been completed.
- 4** During the initial driving period, new cars will receive two major inspections without cost—one after 500 miles and another after 1,500 miles of driving. The owner is also entitled to receive a free inspection every 30 days or 1000 miles thereafter from the selling dealer.
- 5** The Buick owner can change his residence or tour any part of the United States or Canada, and still receive the full benefit of the Parts and Labor Warranty, from the nearest Buick dealer.
- 6** At the termination of the Warranty period, the owner is offered the facilities of one of the most efficient service organizations in the world, providing genuine Buick parts at uniform list prices and service labor, based on current flat rate prices.

*The complete facts regarding Buick Owner Service Policy may now be had in a brief, compact form. We have a copy reserved for you.*