

*the Beautiful Chrysler*  
**new yorker**





**180**

HORSEPOWER



...AND

MORE!

***Fire  
Power***

*the Sensation  
of the Century!*

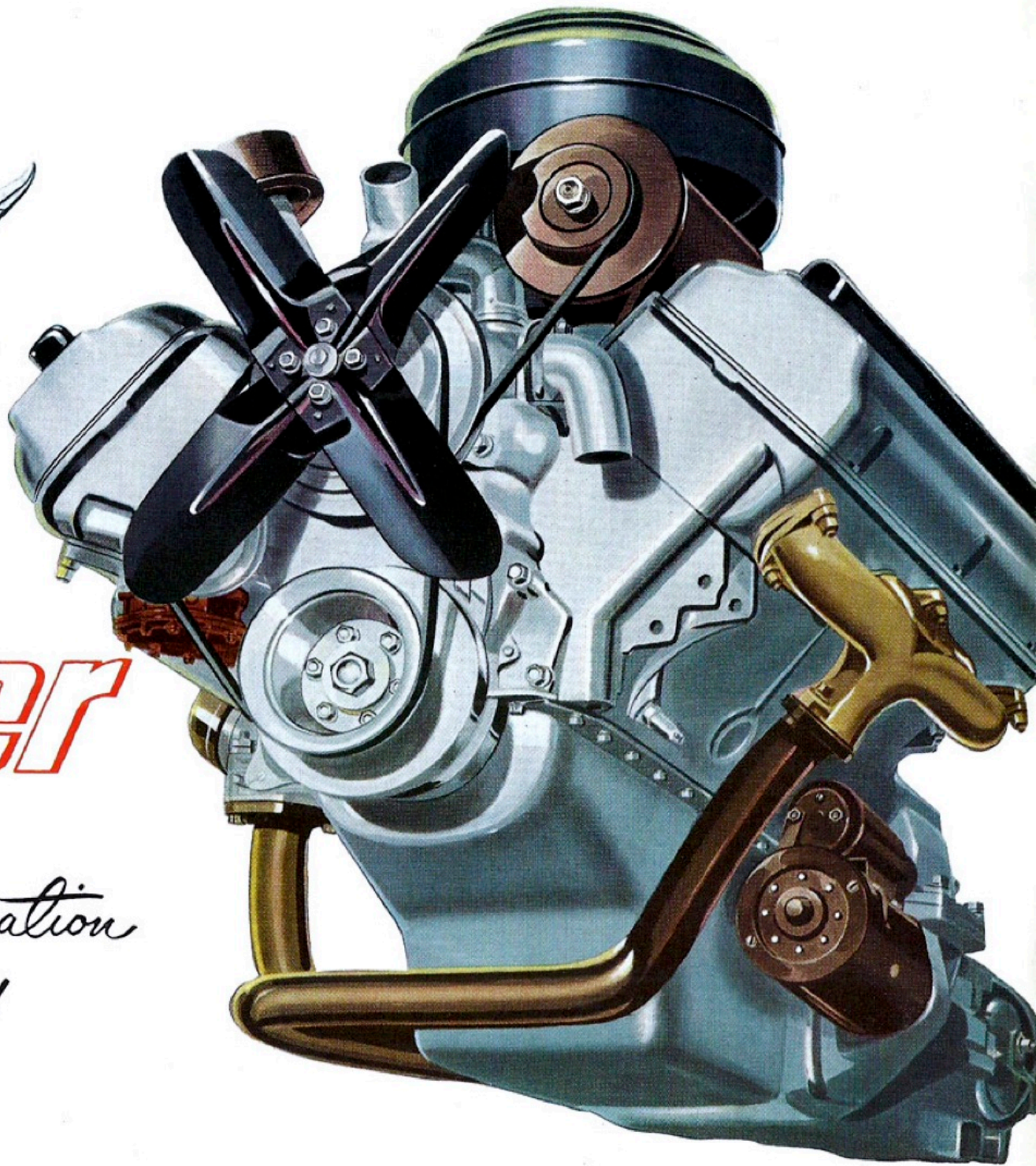



# *The Beautiful Chrysler New Yorker...*

## *Foremost in the Fine Car Field*

**BELOW** is illustrated the Hemispherical Combustion Chamber with lateral valve arrangement and the spark plug located in the center. This ideal design gives almost perfect combustion; gets more power out of the fuels; is practically free from carbon; and results in smoother, quieter, more economical performance throughout the entire power range.

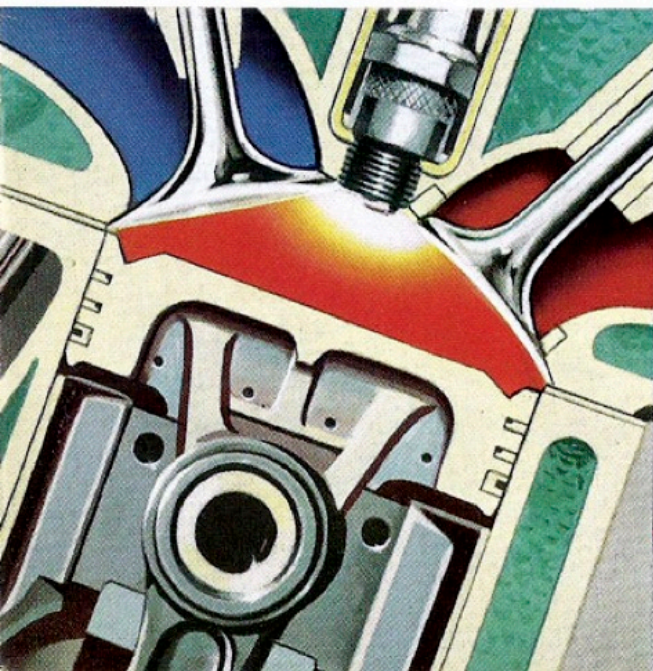

On the opposite page is an illustration of the most remarkable engine in the automobile industry today. On this page is an illustration showing the source of the power and efficiency of this great engine. And on the following pages are illustrations of three of the smartest, most beautiful automobiles Chrysler has ever designed. And it is this combination that makes the 1952 New Yorker just about the most desirable car you will find anywhere in the land—the foremost car in the fine car field—in the opinion of long experienced, old Chrysler owners and many thousands of new Chrysler owners, who have always driven fine cars of other makes and last year switched to Chrysler.

Regarding the FirePower Engine, it is rated at 180 horsepower, and it *delivers* 180 horsepower—and MORE! These engines are coming off the test blocks every day showing 182 horsepower—185—and even as high as 187 horsepower. So, you can be absolutely certain you are actually getting 180 horsepower—and MORE, when you buy a Chrysler FirePower engine.

Another interesting point is the fact that

FirePower, with 7.5 to 1 Compression Ratio, delivers an actual 180 horsepower—and MORE, on *non-premium* grade fuel. The more expensive *premium* fuel is *not required*, as is the case in some engines of comparable compression ratio—a good point to check up on with the possibility of premium fuel becoming a scarce item because of the defense program.

Still another interesting point is FirePower *performance*—the equal of which, we believe, you will not find in any other car, regardless of horsepower. Talk with Chrysler owners about it, or, better still, *drive the car* and find out for yourself.

Another revolutionary Chrysler engineering development is Hydraguide Power Steering, which is considered by many owners as more important, even more desirable, if possible, than the FirePower engine. This great device does 80 percent of the work of parking and steering the car. Turning the wheel is little or no effort—child's play—and yet, you have much greater control of the car. On rough roads, in sand or gravel, or on soft shoulders, you steer the car easily, safely, and with complete confidence in yourself—and in the car.







OTHER IMPORTANT Chrysler engineering features are illustrated on pages nine and ten, but now, let's talk of beauty, style and comfort.

Most everyone will agree that the Sedan, shown on the right, is a beautiful car—a smart car, with distinctive, free-flowing lines of graceful symmetry. The front end is quite unlike any other car—distinctively different—easily recognizable as a Chrysler New Yorker. The massive bumper has the same graceful lines as the grille and fenders, enhancing the beauty of the front end and giving greater protection to the fenders.

The doors are unusually wide, as you can see, both on the exterior view and the interior shown on the left. Also, the doors open wide so you step into and out of the car without stooping or knocking your hat off.

And, inside the car, you have legroom, plenty of headroom, and perfect visibility in all directions. Comfort, too, you have, in great abundance, with the deep cushions and chair-height seats.



*The Four Door Sedan*

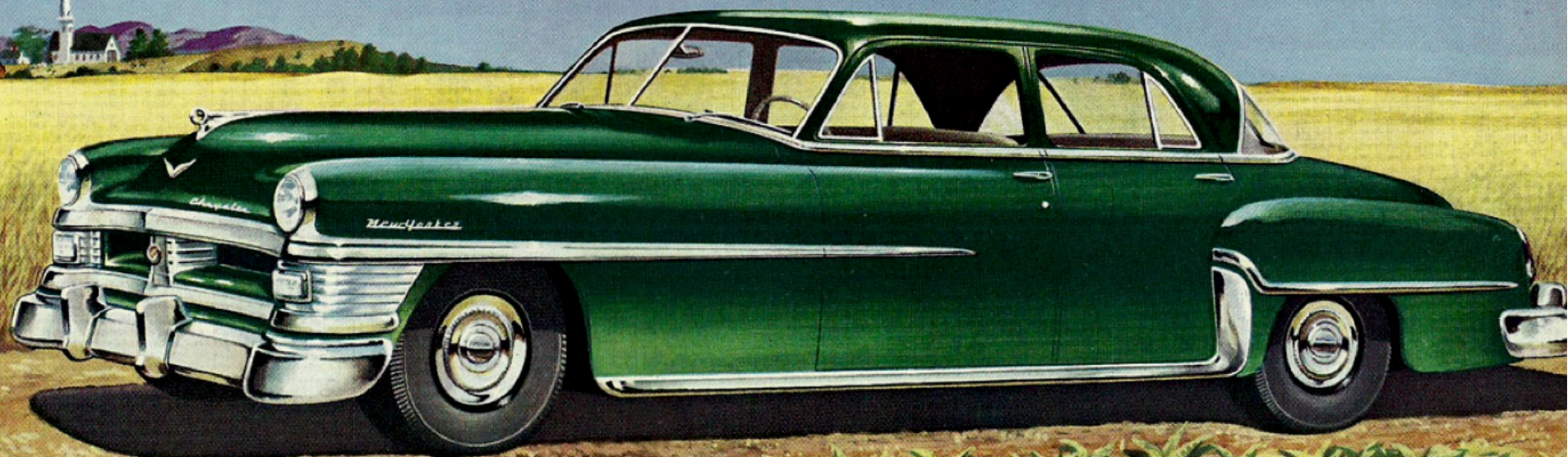

*McLennan's*

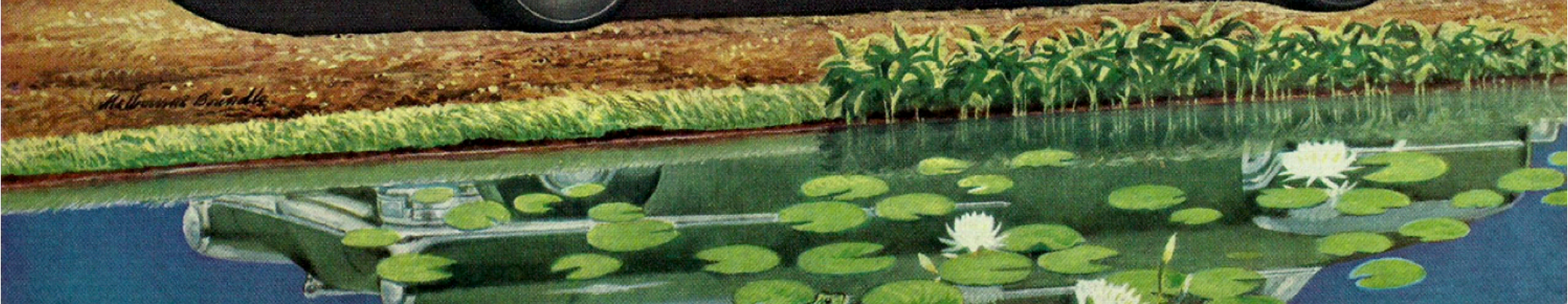



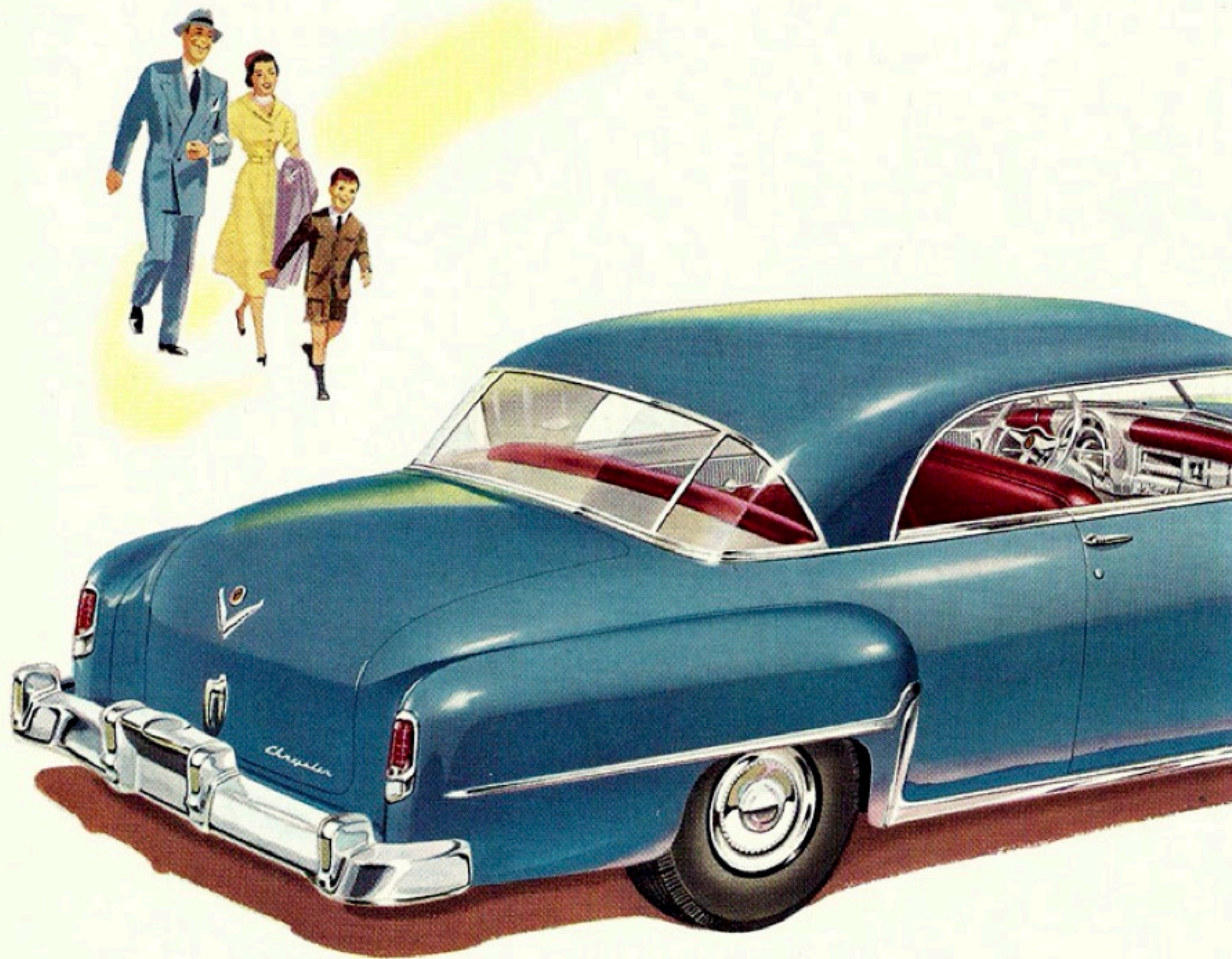

"THE MOST BEAUTIFUL CAR in America" is what many people say about the New Yorker Newport, and we proudly submit the three-quarter view on the right and the rear three-quarter view on the left for your consideration, hoping that you, too, will be of the same opinion.

The Newport has the same long, graceful lines of the Convertible Coupe, but the roof is all steel, giving this "open car" body type the strength, rigidity and safety of the Sedan.

The windows lower into the doors, and the rear three-quarter windows roll back into the body panels. If you prefer, electric window lifts may be had on all four windows at extra cost, each window with its own electric motor to insure trouble-free operation.

On the rear view, note the CLEARBAC Chrysler-designed rear window that permits full visibility to the rear, eliminating dangerous blind-spots. Note also, the graceful lines of the rear fenders and the rear deck, which houses a large storage compartment.





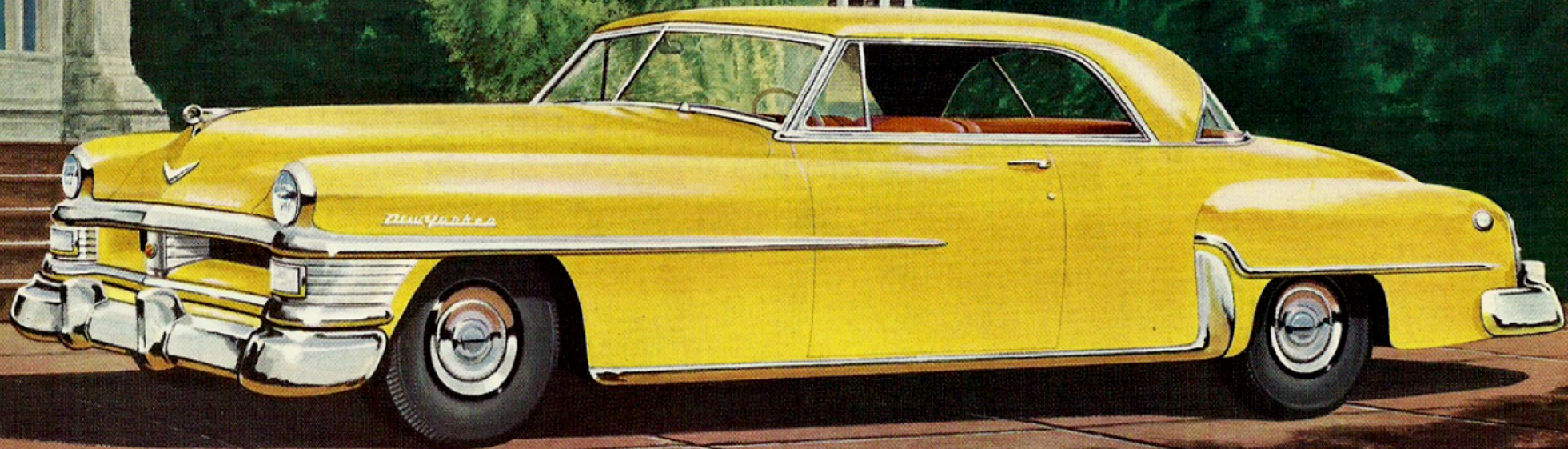

*The Newport*



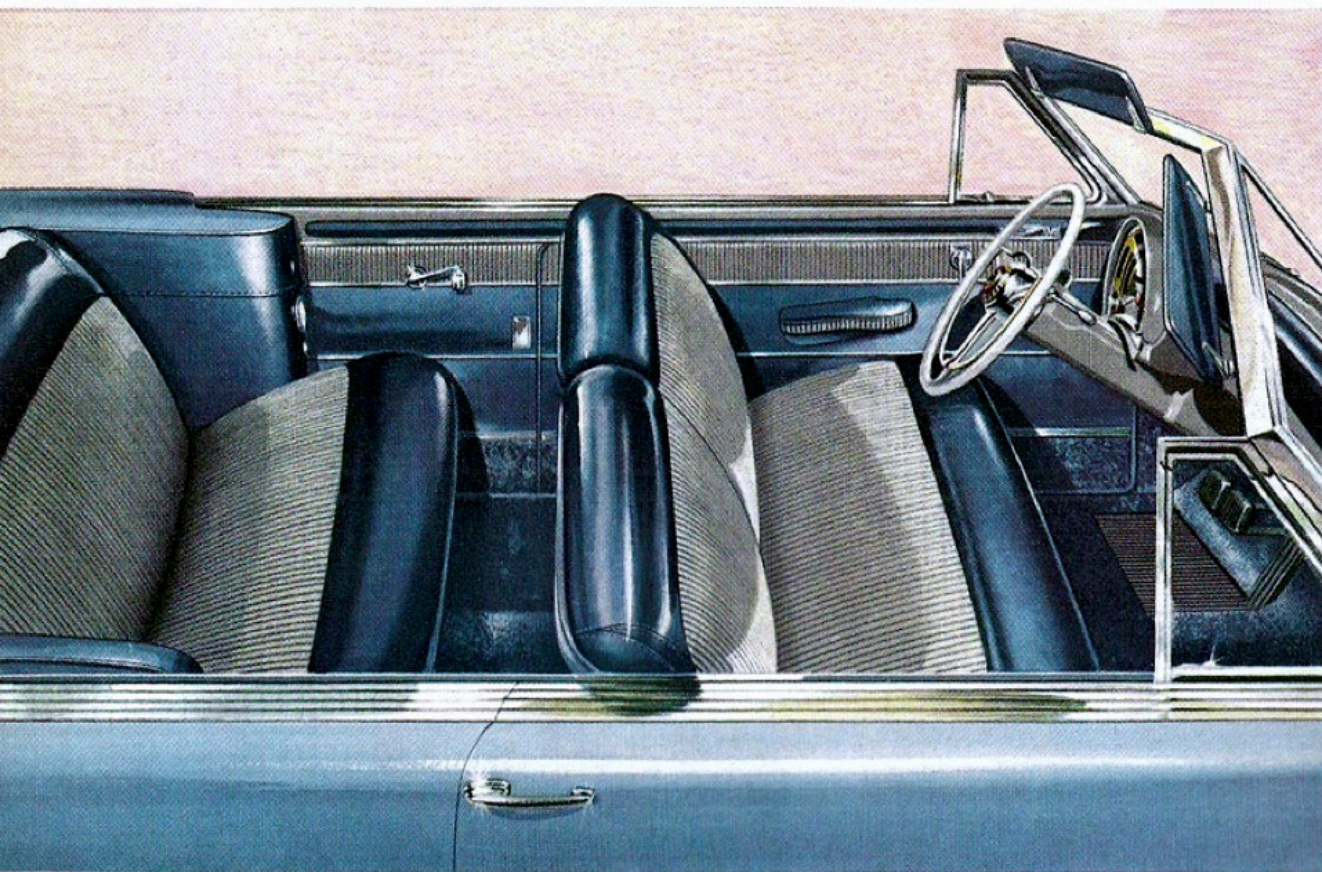

**T**HE NEW YORKER Convertible is a smart-looking car—beautifully proportioned—perfectly balanced—and just about the sweetest running and smoothest performing car anyone ever drove.

With the FirePower engine and Oriflow Shock Absorbers, it is the closest thing to flying you ever experienced. And, the reserve power under the hood, and the soft, sure action of Chrysler Power Brakes, give you a feeling of security, confidence, and safety that enhances your driving pleasure and your pride of ownership in your Chrysler New Yorker.

The top is electrically operated—up or down in a matter of seconds. The windows lower into the body, giving that out-in-the-open freedom that is so enjoyable in the Spring, Summer and Fall months.

The rear deck is a veritable store room, and the seats in both front and rear compartments are generously wide so that six can ride comfortably. The interiors have the charm and beauty of a finely appointed home.



*The Convertible Coupe*





### HYDRAGUIDE POWER STEERING

—another great Chrysler Engineering First that is now available as extra equipment on all Chrysler cars (standard on the Crown Imperial). Briefly, the unit is hydraulically operated by an oil pump driven off of the generator.

Hydraguide does 4/5 of the work of steering, which reduces driver fatigue and makes steering and parking the car practically effortless. It also gives greater control of the car under all driving conditions, which means greater safety, because of the resistance of the power steering unit to any deflection of the road wheels due to chuck holes, ruts, soft shoulders, or a tire blow-out. It is, by far, the greatest convenience and safety feature introduced in the past 25 years.

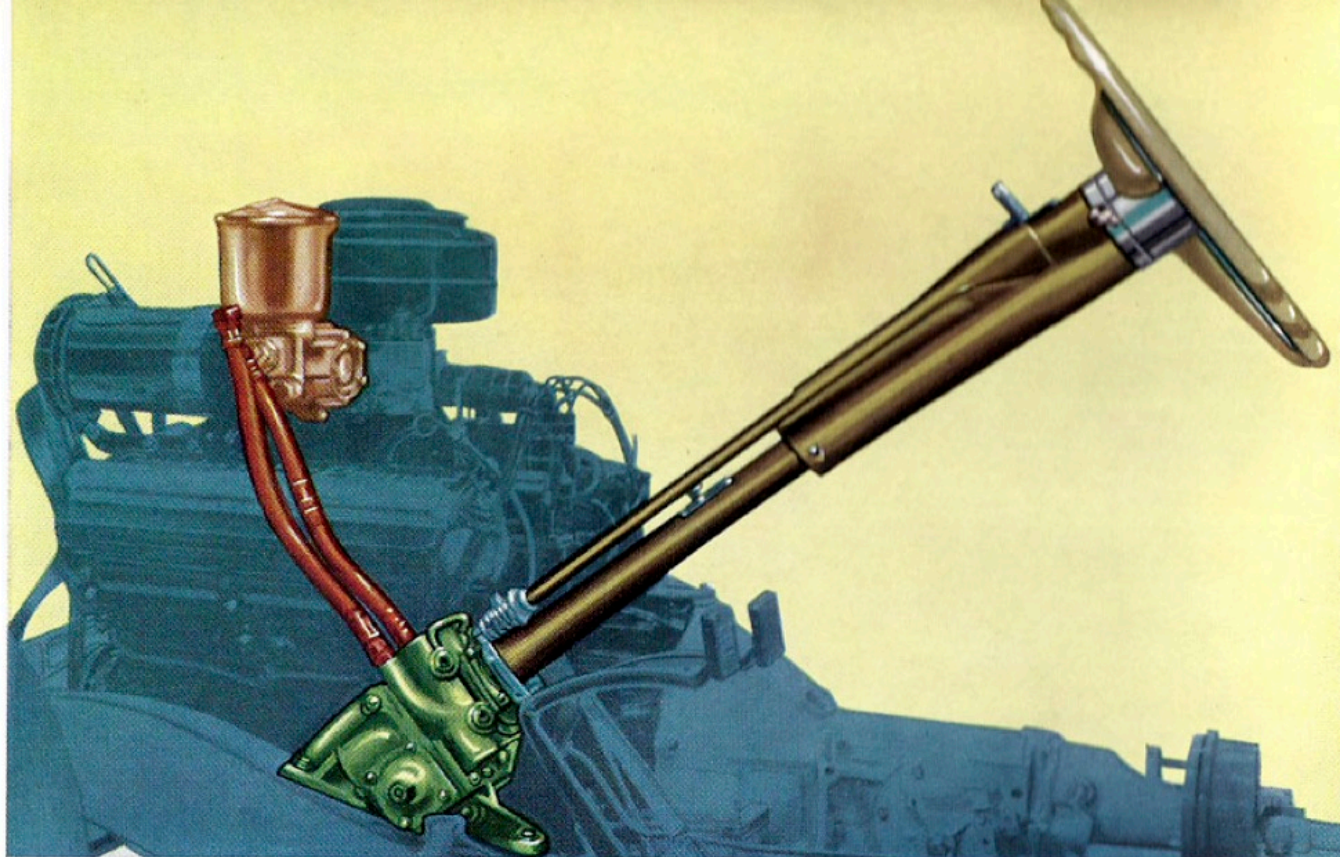

# Chrysler Engineering Features

**THAT MAKE**

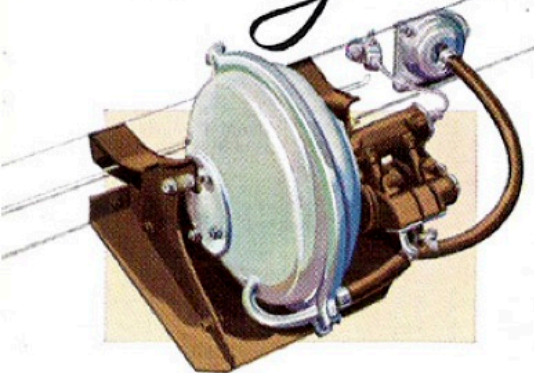

**POWER BRAKES**, long an outstanding Chrysler feature, give better, surer, easier, safer braking. Less pedal pressure required. Standard on the New Yorker.

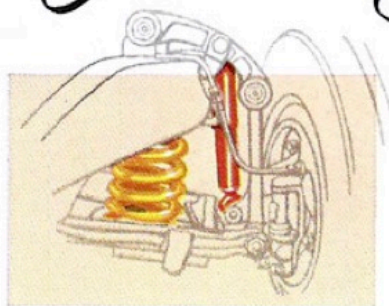

**ORIFLOW SHOCK ABSORBERS** enable you to take the rough roads smoothly, comfortably, safely. They are straddle mounted to give greater effectiveness.

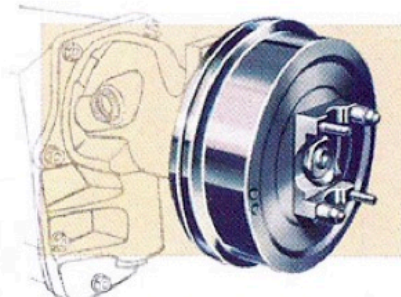

**THE CHRYSLER EASI-LOCK** Parking Brake holds the car safely and securely on any hill. It is internal-expanding and independent of the service brakes.

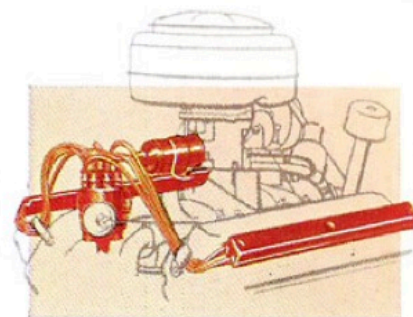

**THE WATERPROOF** Ignition System insures starting and smooth performance in rainy or damp weather. Prevents stalling of the engine in a heavy rain.



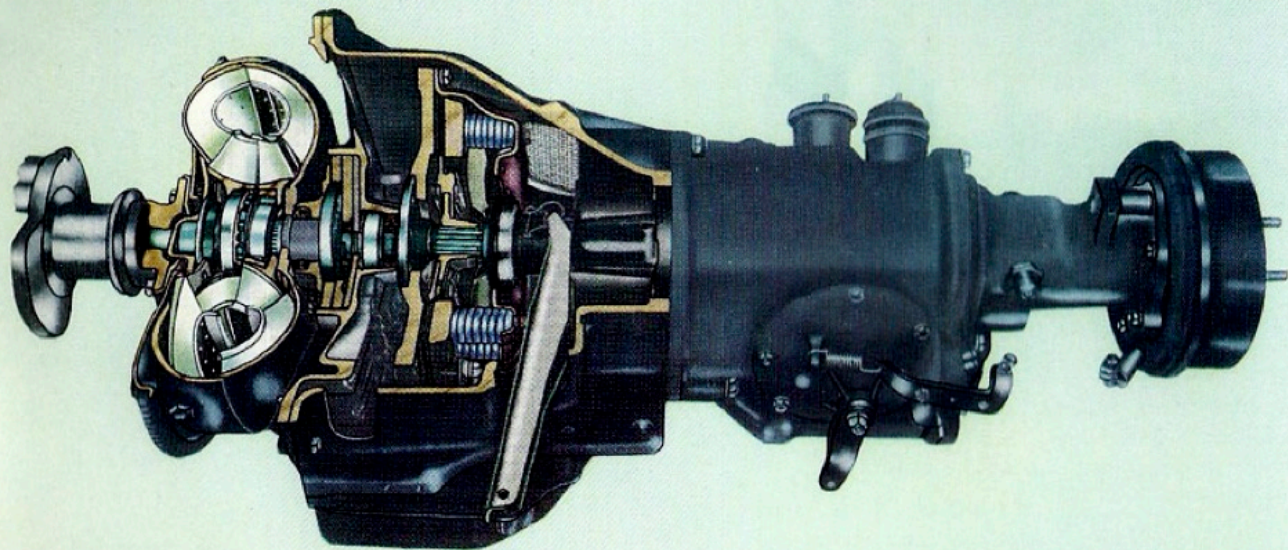

### THE OUTSTANDING PERFORMANCE

of the FirePower engine is made even more remarkable with the addition of the new Chrysler Fluid-Torque Drive, which is now available as extra equipment on the New Yorker, and also the Chrysler Saratoga and Imperial Models.

Fluid-Torque Drive is a combination of a torque converter and the hydraulically operated transmission. The illustration on the left shows, first, from the left, the torque converter; the clutch; the hydraulically operated transmission; and the Parking Brake on the propeller shaft.

Fluid-Torque Drive provides exceptionally smooth, fast acceleration from a standing start to cruising speeds. It also prevents stalling of the engine on hills; and gives finer performance throughout the entire power range.

## EVERY CHRYSLER SAFE, ECONOMICAL, COMFORTABLE

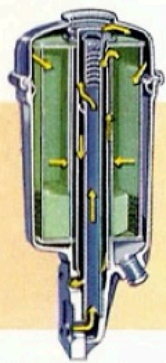

**FULL-FLOW Oil Filter** saves money on operating cost. Filters all the oil before it goes to the working parts of the engine.



**CHRYSLER SAFE-GUARD Hydraulic Brakes**—the finest brakes in the Industry. Front brakes have two cylinders per brake, one for each shoe.

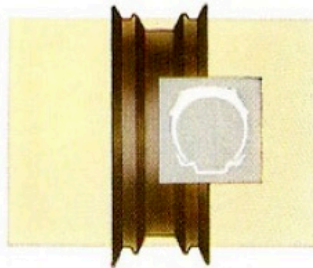

**THE EXCLUSIVE Safety-Rim Wheel** affords great protection in case of blow-out. Holds the tire on the wheel so that you can stop safely.

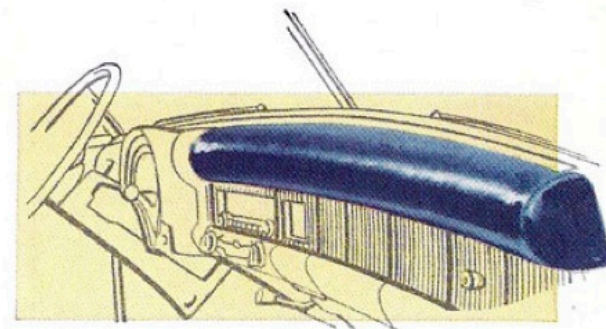

**ANOTHER IMPORTANT safety feature**—the Chrysler Safety Crash Pad, made of heavy sponge rubber. Standard on all Chrysler body styles.



# Specifications

**BODY STYLES**—6-Passenger Sedan; Convertible; and Newport.

**ENGINE**—FirePower High-Compression 90° V-8. Bore, 3-13/16 in. Stroke 3 3/8 in. Piston Displacement, 331 cu. in. Brake Horsepower, 180 at 4000 r.p.m. Torque, 312 ft.-lbs. at 2000 r.p.m. Hemispherical Combustion Chamber with lateral valve arrangement. 3 rings per piston. Full-Pressure Lubrication. Exhaust Valve Seat Inserts. Waterproof Ignition. Full-Flow Oil Filter. Full length Water Jacket Cooling. Twin Concentric Valve Springs. Resistor-type Spark Plugs. Crankcase Ventilation. Double Breaker Distributor. Dual-throated Carburetor with integral automatic choke.

**FUEL SYSTEM**—Dual-Throated Downdraft Carburetor with integral automatic choke and water-jacketed throttle body. Oilite fuel filter in gas tank. Tank capacity, 20 gal.

**COOLING SYSTEM**—Thermostatic by-pass control. Four-bladed fan. Fin and tube radiator core. Full-length water jackets. Pressure vent radiator cap. Capacity, 25 qts.

**CLUTCH**—Single-plate, dry, ventilated with two molded, woven asbestos facings, 9 1/2 in. dia.

**ELECTRICAL SYSTEM**—High-capacity generator, 50 amps. 19-plate, 6-volt battery, 135 amp.-hr. capacity. Waterproof Ignition. Resistor-type spark plugs. Back-up lights. Directional Signals. Ignition key starter switch. Solenoid-engaged starter. Sealed-Beam Headlights. Electric Window Lifts, individual motors for each window, available as extra equipment on all body styles.

**FLUID-MATIC DRIVE**—Hydraulically operated, controlled type automatic transmission with gýrol Fluid Drive. Four forward speeds and reverse. All forward gears are synchronized. Ratios: 3.57 to 1—2.04 to 1—1.75 to 1—1.00 to 1—with 3.99 to 1 for reverse. Capacity, 3 pints. Fluid Drive Unit permanently sealed at Factory.

**FLUID-TORQUE DRIVE**—New Chrysler Torque Converter with hydraulically operated, controlled type automatic transmission. Available at extra cost.

**DRIVE**—Hotchkiss type, through rear springs. Hypoid rear axle. Ratios 3.54 to 1.

**FRONT SUSPENSION**—Independent front wheel suspension with Amola steel helical coil springs. Oriflow Shock Absorbers. Four rubber limit bumpers. Rubber-bushed torsion rod stabilizer.

**REAR SUSPENSION**—Semi-elliptic springs with grooved and tapered leaves. Wax-impregnated permanently lubricated liners. Straddle-mounted Oriflow Shock Absorbers.

**STEERING**—Center-arm steering with equal length tie rods. Steering ratios 20.4 to 1. Hydraguide Power Steering unit is available at extra cost.

**BRAKES**—Chrysler Safe-Guard Hydraulic 12-in. diameter, internal expanding, with Cyclebond brake linings. Power Braking unit, vacuum operated. Parking Brake—Chrysler Easi-Lock, independent, internal-expanding, located on propeller shaft at rear of transmission.

**WHEELS AND TIRES**—Safety-Rim Wheels, 15 x 6.00, with 4-ply Super Cushion Tires, 8.20 x 15. Wheel covers standard all models.

**WHEELBASE**—131 1/2 inches.

**TREAD**—Front 57 1/8", Rear 58-9/32".

**OVER-ALL LENGTH**—213 1/4".

**OVER-ALL WIDTH**—75 1/8".

**SOLEX SAFETY GLASS**—heat-resisting and glare-reducing—available at slight extra cost.

*All Specifications and Prices Subject to Change Without Notice*

**CHRYSLER SALES DIVISION • DETROIT**