

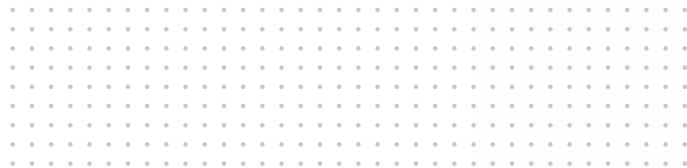

2011 GMC YUKON

GMC YUKON IS THE NO-EXCUSES FULL-SIZE SUV ENGINEERED FOR THOSE WHO REFUSE TO SACRIFICE CAPABILITY FOR REFINEMENT OR CAPACITY FOR EFFICIENCY. THIS UNCOMPROMISING APPROACH GIVES YUKON DENALI THE MOST POWER IN ITS CLASS. IT'S WHY YUKON HYBRID IS THE FIRST FULL-SIZE SUV WITH A TWO-MODE HYBRID SYSTEM FOR THE BEST FUEL ECONOMY IN ITS CLASS.¹ IT'S ALSO WHY YUKON XL OFFERS NINE-PASSENGER SEATING AND CARGO CAPACITY UNMATCHED BY ANY COMPETITOR. TOGETHER, THESE ACCOMPLISHMENTS AND MORE MAKE YUKON THE BENCHMARK FOR THE FULL-SIZE SUV AND EXEMPLIFY WHY OUR ENGINEERS NEVER SAY NEVER. GMC. WE ARE PROFESSIONAL GRADE.

OUR ENGINEERING ACCOMPLISHMENTS
YUKON DENALI HYBRID



¹EPA-est. mpg 20 city/23 hwy. Based on GM Large Utility segment.

ARE LEADING TO THE FUTURE.

YUKON HYBRID



YUKON DENALI HYBRID IN ONYX BLACK (L)
YUKON HYBRID IN PURE SILVER METALLIC (R)
BOTH SHOWN WITH AVAILABLE EQUIPMENT

HYBRID TECHNOLOGY

THE MOST SCIENCE IN ITS CLASS.

Yukon Hybrid is the first full-size SUV to offer two-mode hybrid drive. Together with Yukon Denali Hybrid, they use the breakthrough technology of the Power Control Management System that seamlessly transitions between fuel and electric power. The result is a 33 percent improvement in EPA-estimated fuel economy during city driving over the non-hybrid model.¹ Just as impressive is the 6200-lb trailering capacity,² along with undiminished interior cargo volume and passenger seating capacity.

FIGURE 1: THE FIRST FULL-SIZE HYBRID SUV



At low speeds and light loads, Yukon Hybrid can reduce fuel consumption by shutting off the engine and operating on electric power alone. It can also run on engine power alone, or a combination of both gas and electric. In the city, this technology offers an EPA-estimated 20 mpg, the best in its class.³

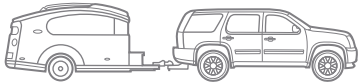

With the advanced technology of Active Fuel Management (see below) at highway speeds, Yukon can use its 6.0L V-8 VVT engine in either V-4 or V-8 operation—sometimes with an extra boost of electric power—as conditions warrant. Full V-8 power is available for trailer towing, passing or pulling on a long, steep grade. In other words, you have all the power you need, when you need it, while still maintaining excellent fuel economy—an EPA-estimated 23 mpg on the highway.

REGENERATIVE BRAKING

During normal stops, regenerative braking uses the motors in the hybrid transmission as generators to decelerate the vehicle by applying resistance in the motors rather than brake friction. At the same time, the motors are capturing that energy as electricity in the 300-volt battery pack, electricity that is available for the next acceleration cycle.

ACTIVE FUEL MANAGEMENT (AFM)

In situations where extra power isn't needed, such as cruising at highway speeds, AFM deactivates four of the eight cylinders to become a V-4. For passing, trailering or hilly terrain, pressing the accelerator can reactivate all eight cylinders in milliseconds. For even greater power when necessary, the electric drive system can automatically engage for extra torque.

VARIABLE VALVE TIMING (VVT)

To give you maximum power over the widest range of engine speeds, VVT changes the engine's performance profile to match the driving situation. In city driving, VVT gives you a smooth idle and quick response at low speeds. On the open road, VVT changes your engine to a bold, high-performance V-8 with horsepower to spare.

NiMH BATTERY POWER

Yukon Hybrid packs a lot of power in a small space, thanks to its 300-volt Nickel-Metal Hydride (NiMH) battery pack. Its technology stores power so efficiently that the complete battery pack fits under the second-row seat between the strong steel frame rails, leaving your passenger and cargo volume unaffected.

¹EPA-estimated city mpg—Yukon Hybrid 20 compared to 15 non-Hybrid Yukon with standard 5.3L V-8. ²Maximum trailer weight ratings are calculated assuming a base vehicle, except for any option(s) necessary to achieve the rating, plus driver. The weight of other optional equipment, passengers and cargo will reduce the maximum trailer weight your vehicle can tow. See your GMC dealer for additional details. ³Based on 2010 GM Large Utility segment.

POWERTRAIN CONTROLLER



6.0L V-8 VVT WITH ACTIVE FUEL MANAGEMENT (AFM)

ELECTRONICALLY VARIABLE TRANSMISSION
WITH INTEGRAL ELECTRONIC MOTORS

300-VOLT NICKEL-METAL
HYDRIDE BATTERY

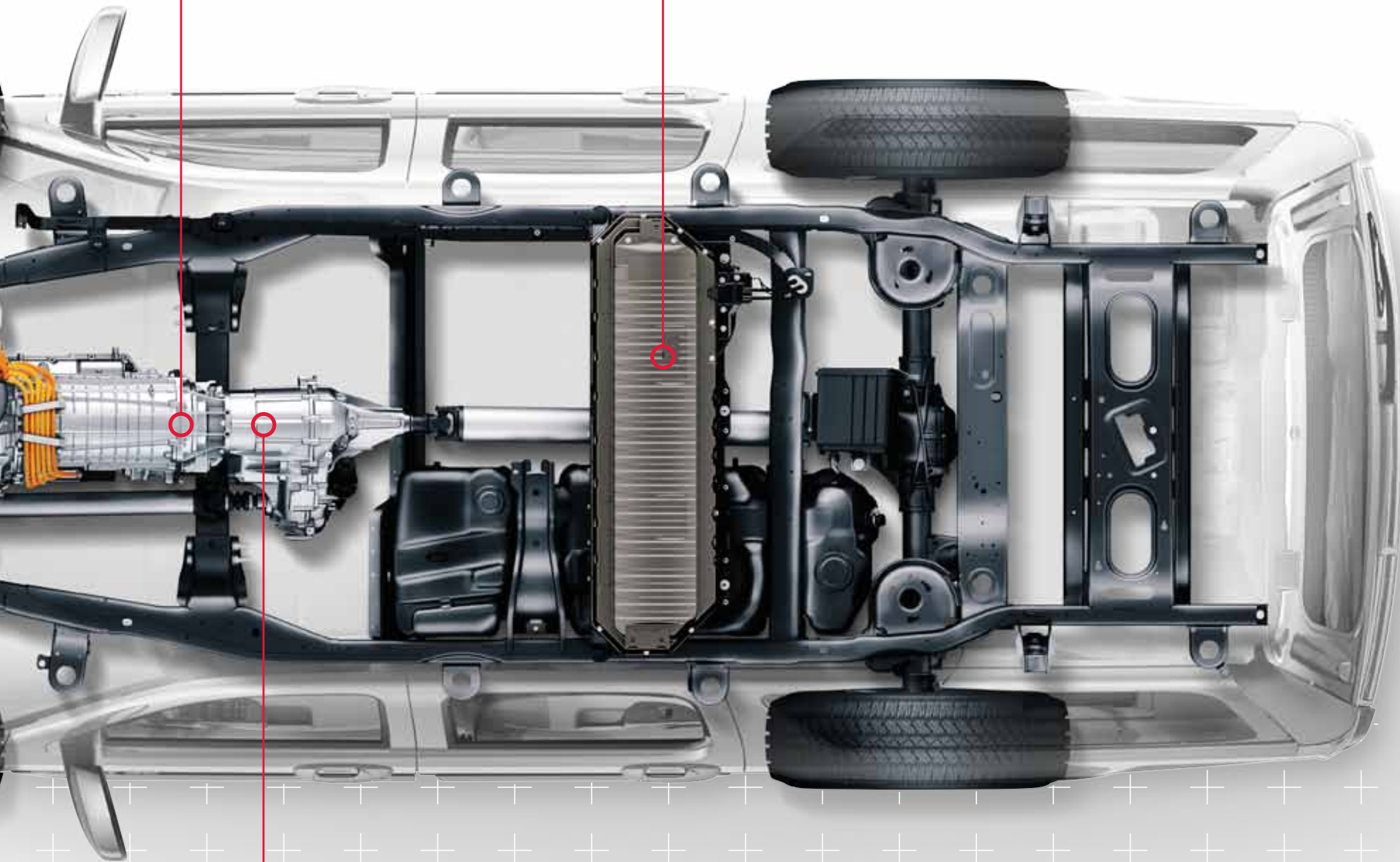

REGENERATING BRAKING
POWER FLOW

VORTEC V-8 POWER/6-SPEED AUTO

ENGINEERED TO EXCEL.

The Vortec V-8 engine family is designed to deliver power without compromise. Each engine uses premium materials and advanced technology that give you impressive overall refinement and efficiency.¹ In fact, when Yukon is equipped with the 5.3L V-8 VVT, it offers an EPA-estimated highway mpg rating of 21, better than any competitor in its class.²

FIGURE 2: POWER WITHOUT SACRIFICE TO ECONOMY



At 403 horsepower and 417 lb-ft of torque, the Vortec 6.2L V-8 VVT engine that is standard in Yukon Denali and Yukon XL Denali offers the most horsepower and torque in its class. Thanks to this engine's uncompromised engineering, its bold acceleration and passing capability are also matched with a smooth idle and progressive low-speed response rarely found in V-8s of similar performance.

ONSTAR VEHICLE DIAGNOSTICS (OVD)

To keep your engine performing at its best, you can monitor its operation and many of your Yukon's other vital functions with OnStar³ Vehicle Diagnostics (OVD). With OVD, your vehicle can run through a series of checks for your engine, transmission, antilock brakes and more, then e-mail you a summary of the results every month. If you choose, you can press the OnStar button and ask your Advisor to perform a complete system check as you drive.

FIGURE 3: RESPONSE AT ANY SPEED

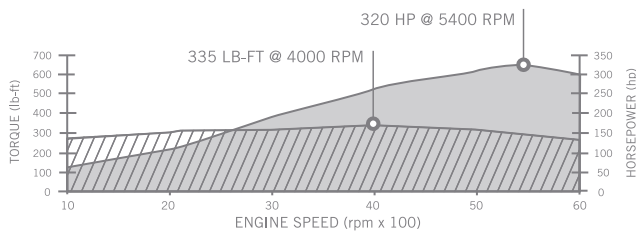

To give you immediate acceleration with strong reserve response at almost any speed, the standard Vortec 5.3L V-8 VVT with Active Fuel Management (AFM) is tuned to deliver its power across a wide RPM range. This engine also offers the best highway fuel economy of any conventional gas V-8 in its class, an EPA-estimated 21 mpg hwy.

¹EPA-estimated city/hwy mpg: Yukon with Vortec 5.3L V-8, 15/21; Yukon XL with Vortec 5.3L V-8, 15/21; Yukon Hybrid with Vortec 6.0L V-8, 20/23; Yukon Denali with Vortec 6.2L V-8, 14/18. ²Based on 2010 GM Large Utility segment. ³Visit onstar.com for details and system limitations. ⁴E85 is 85 percent ethanol and 15 percent gasoline. Visit gm.com/e85 to see if there is an E85 station near you.

6-SPEED AUTOMATIC

All 5.3L and 6.2L Yukon models are equipped with a 6-speed automatic transmission engineered to extract optimum performance from the Vortec engine. Standard with all 6-speed automatics is Driver Shift Control (DSC), which lets you manually shift gears to suit driving conditions. Shift to the "M" position and DSC will also allow you to shift gears up and down with the +/- tap shift selector. All Yukon models also feature Tow/Haul mode and automatic Grade Braking (see page 14 for details).

E85 FLEXFUEL CAPABILITY

To reduce emissions and give you more choices when you fill up, all Yukon models except Yukon ¾-ton, Yukon Hybrid and Yukon Denali Hybrid are FlexFuel capable. This means they can use E85 ethanol,⁴ a blend of 85 percent ethanol produced from mostly domestic renewable resources, and 15 percent regular unleaded gasoline. E85's high-octane rating can also help improve your engine performance, increasing both power and torque.



VORTEC 5.3L V-8 VVT ENGINE



YUKON DENALI HYBRID IN ONYX BLACK SHOWN WITH AVAILABLE EQUIPMENT

YUKON DENALI INTERIOR

THE INSIDE CONNECTION.

In a world that is increasingly defined by communication technology, staying connected is vital to everything you do. To this goal, Yukon Denali is engineered to keep you safely in touch, informed and on the right path to your destination.

FIGURE 4: BOSE® CENTERPOINT® SURROUND SOUND SYSTEM

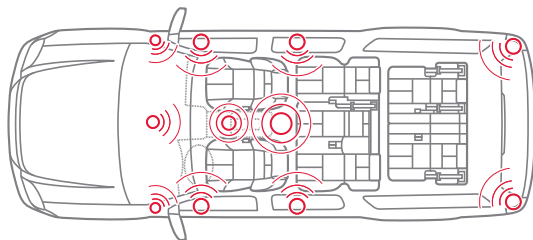

For a surround-sound experience from stereo CD recordings, just press play. The Denali's standard 10-speaker Bose Centerpoint surround sound system uses digital amplification to make music sound full, detailed and free of distortion. SurroundStage™ signal processing circuitry puts you in the center of the performance, while Bose AudioPilot® noise-compensation technology continuously monitors ambient cabin noise and adjusts continually to hold the sound at a consistent level without resetting the volume controls.

STANDARD ON DENALI: DVD TOUCH-SCREEN NAVIGATION

The DVD-based Touch-Screen Navigation System¹ combines superb audio performance with mapping capabilities from a variety of sources. Featuring a 6.5-inch diagonal display with touch-screen control, it allows you to choose either 2-D or 3-D views. This advanced system can also incorporate driving directions from OnStar Directions & Connections. Included with the system is a 3-month trial subscription to XM NavTraffic (3 years standard on Yukon Hybrid and Yukon Denali Hybrid).²

CONNECT WITH BLUETOOTH® AND USB

Yukon makes it easy to stay in the touch thanks to built-in Bluetooth technology. Simply activate your Bluetooth-enabled phone, and you can synchronize its functions with the vehicle's built-in hands-free calling system.³ You can also monitor and operate MP3 music players with the audio system controls by using the built-in USB connection.⁴

TRI-ZONE CLIMATE CONTROL

Yukon takes an uncompromised approach to individual comfort. Tri-zone climate control is standard in all models to give the driver, front-seat passenger and second-row occupants the option of their own individual temperature adjustments.

HELP WHEN YOU NEED IT

Every Yukon has a six-month trial subscription to OnStar⁵ Directions & Connections plan, which includes Turn-By-Turn Navigation. Just push the OnStar button to tell the Advisor where you want to go, and turn-by-turn directions are downloaded to your vehicle. OnStar eNav lets you plan destinations on Mapquest.com and Google™ Maps® and store them in your vehicle so you can call them up with a simple voice command. OnStar Destination Download lets you contact your Advisor and then download directions to your screen-based navigation system. OnStar can even use GPS technology to locate your vehicle if you report it stolen, and help police recover it quickly.⁵

¹Map coverage for Puerto Rico and the Virgin Islands available on separate disc. Coverage not available for portions of Canada. ²Required XM Radio and XM NavTraffic monthly subscriptions sold separately by XM after the trial period. XM NavTraffic only available in select markets. For more information, visit xmradio.com/navtraffic. ³Go to gm.com/bluetooth to find out which Bluetooth phones are compatible with the vehicle. ⁴Not compatible with all devices. ⁵Go to onstar.com for coverage maps, details and system limitations. Services vary with conditions.









YUKON DENALI EBONY INTERIOR SHOWN WITH AVAILABLE EQUIPMENT

FIGURE 5: 12- AND 10-WAY POWER SEATING

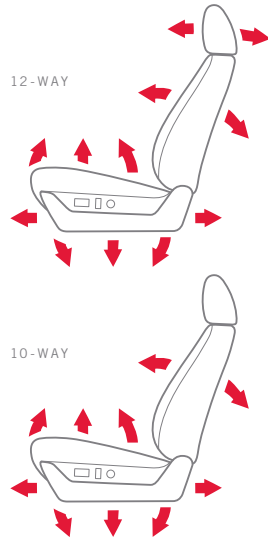

All Yukon Denali models come standard with leather-appointed 12-way power heated and cooled front bucket seats, featuring perforated inserts that circulate cooled air between you and the seating surface in warm weather. On all SLT models, in addition to the standard leather-appointed 10-way power heated front bucket seats, 10-way power heated and cooled seats are also available for added comfort. (Ten-way power seats are not available on Yukon Hybrid.)

YUKON INTERIOR/FLEXIBILITY

EASY TO ENJOY. COMFORTABLE TO USE.

Yukon is designed to give you impressive space and easy access to help you use it. With easily configured luxury seating, beautifully crafted touches and premium-quality materials, Yukon's interior combines attention to detail with a practical, organized layout that makes it a refined traveling companion for your busy life.

SEATING CONFIGURATIONS

Standard on Yukon Denali are perforated leather-appointed seating surfaces for the first and second rows. Shown at left is the Denali's standard seven-passenger seating configuration, with full-feature front buckets and luxurious second-row captain's chairs. For added capacity, a three-passenger second row is available to bring total seating capacity to eight passengers.

FIGURE 6: EASY THIRD-ROW ACCESS

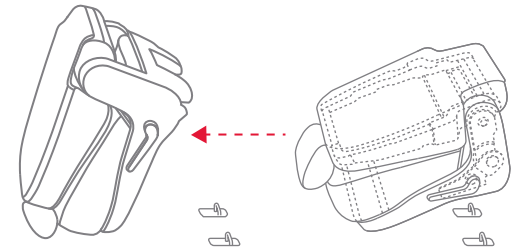

Using the extra passenger capacity of the third-row seating is easy, thanks to a GM-exclusive power fold-and-tumble second-row seat. This feature is available for second-row captain's chairs or the available three-passenger second-row bench seat. Each seat automatically unlatches, folds and tumbles out of the way with an easy one-hand operation.

DVD REAR-SEAT ENTERTAINMENT SYSTEM

The available DVD Rear-Seat Entertainment System features an 8-inch diagonal LCD screen that drops down from the headliner behind the front-row passengers for a vibrant picture. In Yukon XL and Yukon XL Denali models, an optional second screen can bring third-row passengers closer to the action. This system is also designed to be compatible with most video gaming systems for long-distance entertainment.





YUKON XL SLT EBONY INTERIOR SHOWN WITH AVAILABLE EQUIPMENT

YUKON FLEXIBILITY AND FUNCTIONALITY

THE CAPACITY FOR CHANGE.

Life has many dimensions. So does GMC Yukon. From the spacious Yukon, to Yukon XL that offers the most cargo room of any SUV, their most impressive feature is their flexibility. They are engineered to anticipate your changing demands and accommodate whatever combination of cargo and passengers the situation demands or you desire.

FIGURE 7: SPACE FOR EVERYTHING

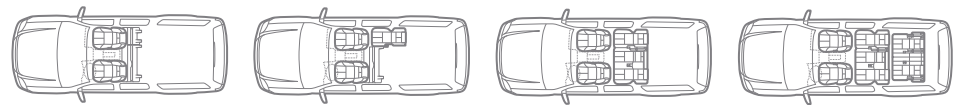

Yukon and Yukon XL can open up a number of possibilities for you and your passengers. By folding all the seats behind the driver's row, you can access class-leading cargo capacity that rises to 108.9 cu. ft. for Yukon and 137.4 cu. ft. for Yukon XL,¹ unmatched by any competitor.

 FIGURE 8: SEVEN, EIGHT OR NINE PASSENGERS

Yukon Denali models feature standard second-row captain's chairs to accommodate up to seven passengers. For eight-passenger seating, a 60/40 second-row split-folding bench seat is standard in SLE and SLT models, and available in Denali. For nine-passenger capacity, SLE models are standard with a 40/20/40 front bench seat.

STARTS WITH A TOUCH

Before you leave, your Yukon can be ready to go. With the Remote Start feature, one touch of your electronic key fob can start the engine and begin heating or cooling your cabin. It's standard on Denali, SLT models and all Hybrids, and available on SLE models.

FIGURE 9: POWER LIFTGATE

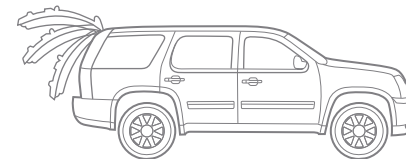

In addition to its impressive passenger and cargo capacity, Yukon is also easy to load. With the available power liftgate, you can open and close it with the touch of a button. It's great for those times when you need another hand.

¹Cargo and load capacity limited by weight and distribution.

RIDE AND HANDLING

EVERY RESPONSE IS CAREFULLY REFINED.

Yukon's poise shows the moment you take it on the road. With its strong frame and rigid body structure, it can easily soak up and shake off the jolts and bumps. With advanced safety and ride technology, it offers you the confidence to match its capabilities.

TUNED FOR A QUALITY RIDE

For a smooth, stable ride under a variety of conditions, the Yukon is engineered with coil-over-shock front and five-link coil spring rear suspensions. Premium Smooth Ride Tuning keeps road harshness out while preserving responsive handling under both light-load and heavy-load conditions.

REAL-TIME CONTROL

The AutoRide real-time damping system is engineered to eliminate the compromise between a smooth ride and precise control. It is standard in Yukon Denali and Yukon XL Denali and available on SLT models. This system varies shock absorber settings in real time to respond to changing driving conditions.

ULTRA-LUXURY RIDE

The Yukon Denali Hybrid features the remarkable capability of Magnetic Ride Control. Its sensors monitor and measure the road surface up to 1000 times per second, instantly adjusting for maximum comfort and control. The result is premium ride smoothness without sacrifice to Denali Hybrid's agility.

THE CONTROL OF STABILITRAK

StabiliTrak helps to heighten your safety on most road conditions, even during emergency maneuvers. The system uses sensors that feed real-time data on the position of your steering wheel, brake pressure, lateral acceleration and turning rate to an onboard computer. If your Yukon is not responding adequately to your steering input, the computer adjusts engine torque and/or brake pressure to any individual wheel to help you stay on track. StabiliTrak can also help to mitigate the chance of a rollover.

FIGURE 10:
EXTRA BRAKING
ASSISTANCE

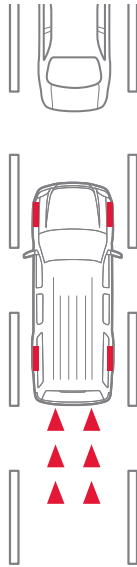

Large, high-capacity four-wheel disc brakes with ABS are engineered into every Yukon model for confident stops, time after time. For extra assistance, the system offers brake assist that can sense a sudden stop and apply full-pedal pressure to help stop or slow your Yukon as quickly as possible for the conditions.





YUKON XL DENALI IN ONYX BLACK SHOWN WITH AVAILABLE EQUIPMENT

YUKON TRAILERING

THE TRAILERING LEADER.

The challenges of real life bring out the best in Yukon. For work, recreation or somewhere in between, we went beyond the sheer capacity to not only help you shoulder the load but to enjoy the experience. From the confident power of the Vortec engine family to the advanced stability control systems, Yukon is engineered from the ground up for trailering, ready for any challenge and comfortable in any situation.

FIGURE 11: MAXIMUM TRAILERING CAPACITY¹

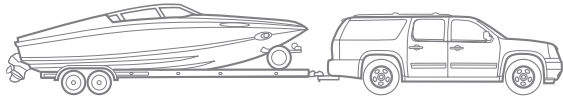

With available seating for up to nine or best-in-class 137.4 cu. ft. of cargo volume,² Yukon XL is the choice for maximum passenger and cargo capacity. The Yukon XL features a $\frac{3}{4}$ -ton model not offered by any competitor. This provides a trailer weight rating of 9600 lbs¹ and a best-in-class maximum payload of up to 2454 lbs.³

EXTRA CONTROL FOR TRAILERING

Because using Yukon's capacity shouldn't test your limits, the 6-speed automatic has two standard assists. First is the Tow/Haul mode, which works to reduce excess shifting when towing or carrying a heavy load. It also automatically engages the second feature, called Grade Braking. This changes the timing of gear shifts to use the engine and the transmission to slow the vehicle, to reduce demand on the brakes and help to produce confident descents.

INTEGRATED TRAILER BRAKE CONTROLLER

No other competitor offers the confidence of Yukon's available trailer brake controller. It is completely integrated with the Yukon's electrical and ABS systems, allowing your trailer brakes to operate simultaneously with your vehicle brakes. To suit changing conditions, this system also allows you to adjust the trailer brake force (or "gain") from the controller switch located on your lower left instrument panel.

¹Maximum trailer weight ratings are calculated assuming a base vehicle, except for any option(s) necessary to achieve the rating, plus driver. The weight of other optional equipment, passengers and cargo will reduce the maximum trailer weight your vehicle can tow. See your GMC dealer for more information. ²Cargo and load capacity limited by weight and distribution. ³Maximum payload capacity includes weight of driver, passengers, optional equipment and cargo.

FIGURE 12: EATON® LOCKING REAR DIFFERENTIAL

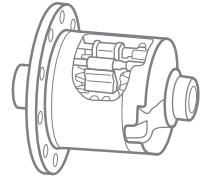

For greater traction on poor or uneven road surfaces, Yukon is equipped with the fully automatic Eaton Locking Rear Differential. When it senses one wheel slipping more than another, it locks both to turn at the same speed for extra traction. No other competitor in its class offers this type of traction-enhancing technology.

FIGURE 13: SEE WHAT'S BEHIND YOU

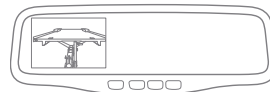

Yukon's available Rearview Camera System includes a built-in camera mounted near the license plate. When you shift into reverse, the image is displayed in your rearview mirror or the available 6.5-inch NAV screen, just the thing for backing up to a trailer or negotiating a tight parking situation.





YUKON XL ¾-TON SLT IN PURE SILVER METALLIC SHOWN WITH AVAILABLE EQUIPMENT





YUKON SLT IN PURE SILVER METALLIC SHOWN WITH AVAILABLE EQUIPMENT

YUKON SECURITY AND SAFETY

CONFIDENCE COMES FROM WITHIN.

From your first drive, you can tell Yukon is solidly in your corner. It is engineered with multiple safety features that help you before, during and, thanks to OnStar, even after a collision. Yukon's active safety systems help you avoid trouble, while its passive systems protect you if a crash occurs. It all works together to give you the security you need to use its capabilities to the fullest.

SIDE BLIND ZONE ALERT

In addition to standard safety systems such as StabiliTrak and antilock brakes, Yukon is available with Side Blind Zone Alert (SBZA). It uses alternating radar beams to sweep adjacent traffic lanes, covering a zone approximately one lane over from each side of the vehicle.¹ A dedicated amber icon next to the outside rearview mirror's turn-signal display lights up any time there is a vehicle in the blind spot and flashes if you activate the turn signal.

FIGURE 14: YUKON AIR BAG DEPLOYMENT²

Yukon is engineered with dual-stage front air bags that feature the Passenger Sensing System. The system uses a sensor within the front passenger seat to detect the weight and position of an occupant. Depending on its readings, it can automatically deactivate the air bag, or choose the proper low- or high-level deployment to help reduce the risk of air-bag-induced injury.

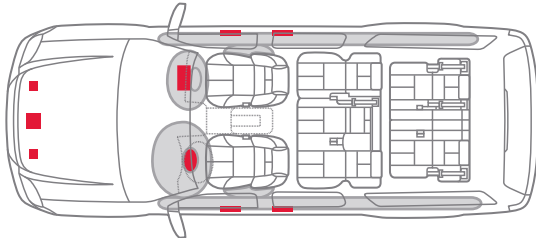

To help protect you in a rollover or side-impact crash, Yukon has head curtain side-impact air bags with rollover protection. They function like a protective curtain, unfolding from the roof rail on each side. Activated by side-impact and rollover sensors, each curtain includes air bag sections for all outboard passengers. All models except Yukon Hybrid (but including the Yukon Denali Hybrid) also include side-impact air bags to provide thorax (chest) and pelvic (hip) protection for both the driver and front seat passenger.

AUTOMATIC CRASH RESPONSE³

Now, you can get the help you need even if you can't ask for it. In the event of a crash, sensors around your vehicle can automatically send an alert to OnStar. An OnStar Advisor is immediately connected to your vehicle to see if you need help. If you are unable to respond, the Advisor will use GPS technology to pinpoint your exact location to direct emergency help—even in areas of limited cellular reception. The Advisor can also relay critical crash information to emergency responders, such as the severity and type of crash, so the responders are better equipped to treat you at the scene.

¹Before making a lane change, always check the SBZA display. Check the side and inside rear mirrors, look over your shoulder for vehicles and hazards and start the turn signal. ²Air bag inflation can cause severe injury or death to anyone too close to the air bag when it deploys. Always use safety belts and the correct restraint for your child's age and size. Even in vehicles equipped with the Passenger Sensing System, children are safer when properly secured in a rear seat in the appropriate infant, child or booster seat. Never place a rear-facing infant restraint in the front seat of any vehicle equipped with a passenger air bag. See the Owner's Manual and child safety seat instructions for more safety information. ³Visit onstar.com for details and system limitations.





STANDARD AND AVAILABLE FEATURES/YUKON

TRIM LEVELS	SLE	SLT	DENALI	HYBRID	DENALI HYBRID
MECHANICAL					
ALTERNATOR 160-amp. Requires Snow Plow Prep Package on ¾-ton XL models.	S	S	S	—	—
145-amp, ¾-ton XL models	S	S	—	—	—
BATTERY Heavy-duty maintenance-free with 730 cold-cranking amps and rundown protection	—	—	S	S	S
BATTERY PACK 300-volt hybrid, located under second-row seat cushion	—	—	—	S	S
BRAKES 4-wheel Antilock Brake System (ABS), 4-wheel disc	S	S	S	S	S
DRIVETRAIN 2WD	S	S	S	S	S
4WD. Single-speed active transfer case	S	S	—	—	—
4WD. Active 2-speed transfer case with rotary controls. Included with Heavy-Duty Trailing Package.	A	A	—	S	S
All-Wheel Drive (AWD). Electronic automatic system; includes AWD transfer case.	—	—	A	—	—
ENGINES Vortec 5.3L V-8 VVT FlexFuel with Active Fuel Management (AFM), E85 capable	S	S	—	—	—
Vortec 6.0L V-8 VVT Hybrid with AFM	—	—	—	S	S
Vortec 6.0L V-8 VVT, requires ¾-ton models	S	S	—	—	—
Vortec 6.2L V-8 VVT with AFM, E85 capable	—	—	S	—	—
ENGINE BLOCK HEATER	A	A	A	—	—
EXTERNAL ENGINE OIL COOLER Heavy-duty air-to-oil, integral to radiator. Requires Heavy-Duty Trailing Package on ½-ton Yukon and XL models. Standard on ¾-ton XL models.	A	A	S	—	—
HEAVY-DUTY AUTOMATIC LOCKING REAR DIFFERENTIAL	S	S	S	S	S
HIGH-VOLTAGE MANAGEMENT Power electronics module	—	—	—	S	S
REGENERATIVE BRAKING	—	—	—	S	S
STABILITRAK Stability control system and traction control	S	S	S	S	S
STEERING Power. On Hybrid models, includes 42-volt electric power.	S	S	S	S	S
SUSPENSION Front independent coil-over-shock with stabilizer bar. ½-ton models only.	S	S	S	S	S
Front independent with torsion bar. ¾-ton XL models only.	S	S	—	—	—
Rear multilink with coil springs. Leaf springs on ¾-ton XL models.	S	S	S	S	S
Automatic Rear Level Control, air. ½-ton models only.	—	A	S	—	S
Magnetic Ride Control, road sensing, electronically controlled shock absorbers	—	—	—	—	S
Premium Smooth Ride Suspension Package	S	S	—	S	—

A-Available S-Standard — -Not Available

TRIM LEVELS	SLE	SLT	DENALI	HYBRID	DENALI HYBRID
AutoRide Suspension Package. Bi-state variable shock dampening and rear air-assisted load-leveling, includes automatic air-level control. Not available on ¾-ton models.	—	A	S	—	—
Z71 Off-Road Suspension Package. Available only on Yukon SLE and SLT 4WD and ½-ton XL 4WD models. Includes Skid Plate Package, P265/70R17 on-/off-road, blackwall tires and high-capacity air cleaner on all models. Not available with SLT Chrome Package.	A	A	—	—	—
TRANSMISSION 6-speed automatic, heavy-duty, electronically controlled with overdrive, Tow/Haul mode and tap up/tap down shifting	S	S	S	—	—
2-mode strong hybrid automatic electronic with Tow/Haul mode built in to the software	—	—	—	S	S
TRAILERING Trailer Brake Controller, integrated. On SLE and SLT, requires Heavy-Duty Trailing Package.	A	A	A	—	—
Trailing Equipment. Includes hitch platform with 2" trailing receiver and 7-wire harness with independent fused trailing circuits mated to a 7-way sealed connector.	S	S	S	S	S

PACKAGES

CONVENIENCE PACKAGE Includes power-adjustable pedals, remote vehicle start, Rear Parking Assist, inside rearview mirror with rear camera display and Rearview Camera System	A	—	—	—	—
HEAVY-DUTY TRAILERING PACKAGE Includes trailer brake controller, auxiliary external transmission oil cooler and external engine oil cooler. Includes 3.42 rear axle ratio and requires Vortec 5.3L V-8 FlexFuel engine with AFM. Not available on ¾-ton XL models. Includes 2-speed AutoTrac on 4WD models.	A	A	—	—	—
HEAVY-DUTY HANDLING/TRAILERING SUSPENSION PACKAGE. ¾-ton XL models only.	S	S	—	—	—
REGIONAL VALUE PACKAGE Includes outside heated power-adjustable, power-folding and driver-side auto-dimming mirrors, 1 year of XM Radio service, ¹ 20" polished-aluminum wheels, Trailing Package and SLT Chrome Edition. Not available with Sun, Entertainment and Destinations Package, SLT Chrome Edition or 20" chrome-clad wheels.	—	A	—	—	—
SKID PLATE PACKAGE Includes front underbody shield. Requires 4WD models and Off-Road Suspension Package. Standard on ¾-ton XL models.	A	A	—	—	—
SLE EXTERIOR APPEARANCE PACKAGE Includes front fog lamps, front recovery hooks and luggage rack center rails	A	—	—	—	—

TRIM LEVELS	SLE	SLT	DENALI	HYBRID	DENALI HYBRID
SLT CHROME PACKAGE Includes chrome door handles, chrome mirror caps, polished exhaust tips, chrome recovery hooks, chrome grille, outside heated power-adjustable, power-folding and driver-side auto-dimming body-color mirrors and 20" polished aluminum wheels. Not available with Off-Road Suspension Package.	—	A	—	—	—
SLT-2 EQUIPMENT PACKAGE Includes 10-way power leather-appointed heated front bucket seats, heated second-row seats, second-row power seat release, rear power liftgate and outside heated power-adjustable, power-folding mirrors and memory feature	—	A	—	—	—
SNOW PLOW PREP PACKAGE Includes instrument panel switch, roof beacon wiring, forward lamp wiring and torsion bar (¾-ton XL models only)	A	A	—	—	—
SUN, ENTERTAINMENT & DESTINATION PACKAGE Includes power sunroof, inside rearview auto-dimming mirror, audio system with Rear-Seat Entertainment and navigation and rear-seat DVD entertainment system. On SLT models, not available with AM/FM stereo with CD player and MP3 playback, audio system with Rear-Seat Entertainment or audio system with navigation. On SLE models, not available with the audio system with navigation.	—	A	A	—	—
TEXAS EDITION Includes Regional Value Package features plus Texas Edition badge	—	A	—	—	—

SEATING

SEATS 40/20/40 front split-bench, 3-passenger with Premium Cloth. Includes 6-way power driver seat adjuster, driver and front passenger manual reclining, center fold-down armrest with storage, lockable storage compartments in seat cushion (includes auxiliary power outlet), outboard adjustable head restraints and storage pockets.	A	—	—	—	—
Front buckets. Includes 6-way power driver and passenger seat adjuster, outboard adjustable head restraints, floor console and rear storage pockets. Leather-appointed seats on SLT and Hybrid.	S	S	—	S	—
Leather-appointed seats on the first and second rows. Includes front bucket seats with 10-way power driver and front-passenger seat adjusters, including power lumbar control, heated seat cushion and seatbacks, 2-position driver memory, adjustable head restraints, storage pockets and floor console.	—	A	—	—	—
Heated and cooled perforated leather-appointed seats on first and second rows. Includes front bucket seats with 10-way power driver and front-passenger seat adjusters (12-way on Denali models), including power lumbar control, heated and cooled seat cushion and seatbacks, 2-position driver memory, adjustable head restraints, storage pockets and floor console.	—	A	S	—	S

STANDARD AND AVAILABLE FEATURES/YUKON

TRIM LEVELS	SLE	SLT	DENALI	HYBRID	DENALI HYBRID
60/40 second-row split-folding 3-passenger bench in Premium Cloth, with center armrest and storage tray	S	—	—	—	—
60/40 second-row split-folding 3-passenger leather-appointed bench with center armrest and storage tray	—	S	A	S	S
Leather-appointed second-row reclining captain's chairs. On Denali, includes heated cushions.	—	A	S	—	—
Heated second-row seat cushions. Outboard positions only with bench seats.	—	A	S	—	S
Flip and fold power second-row seat release for captain's chairs or bench seat. Requires front bucket seats with leather-appointed seating surfaces.	—	A	S	—	—
50/50 third-row split-bench seats with Premium Cloth, 3-passenger, removable, all belts-to-seat	S	—	—	—	—
50/50 third-row split-bench seats, 3-passenger, removable, all belts-to-seat	—	S	S	S	S

INSTRUMENTATION AND CONTROLS

INSTRUMENTATION Analog cluster with speedometer, odometer/trip odometer, fuel level, voltmeter, engine temperature, oil pressure and tachometer. Full-function Driver Information Center including temperature and compass. Hybrid models include efficiency gauge.	S	S	S	S	S
POWER-ADJUSTABLE PEDALS On SLE models, included and only available with Convenience Package	A	S	S	S	S
REARVIEW CAMERA With auto-dimming inside rearview mirror display	A	S	—	—	—
With NAV-screen display. Requires Touch-Screen Navigation.	—	A	S	S	S
STEERING WHEEL Leather-wrapped, with controls for audio, cruise control and Driver Information Center located on instrument panel, plus tilt-adjustable column with brake/transmission shift interlock. Heated steering wheel with power-tilt on Denali. Deluxe leather-wrapped with power-tilt on Denali Hybrid.	S	S	S	S	S
TOW/HAUL MODE SELECTOR Built-in automatic on Hybrid models	S	S	S	S	S
ULTRASONIC REAR PARKING ASSIST With audible warning. On SLE models, included and only available with Convenience Package.	A	S	S	S	S

INTERIOR DETAILS AND CONVENIENCE FEATURES

CARPET Color-keyed with removable carpeted floor mats for first and second rows	S	S	S	S	S
CLIMATE CONTROL Tri-zone manual air conditioning. Available on SLE models with bench seat.	A	—	—	—	—

	SLE	SLT	DENALI	HYBRID	DENALI HYBRID
Tri-zone automatic air conditioning, includes individual climate settings for driver and right-front passenger. On SLE, not available with optional 40/20/40 front split-bench seating.	S	S	S	S	S
Rear auxiliary heater and air conditioner with rear-passenger heating and air ducts	S	S	S	S	S
Defogger, rear-window electric	S	S	S	S	S
CONSOLES Overhead mini with map lights	S	S	S	S	S
Floor with storage area, cupholders and integrated second-row audio and HVAC controls. Included and only available with front bucket seats.	S	S	S	S	S
Storage bin behind driver-side rear quarter panel	S	S	S	S	S
CUP HOLDERS Front seating area, rear floor console, third-row outboard side trim	S	S	S	S	S
MIRROR Auto-dimming rearview	A	A	S	S	S
OUTLETS 12-volt power, 5	S	S	S	S	S
PADDED VISORS AND ARRESTS	S	S	S	S	S
POWER PROGRAMMABLE DOOR LOCKS	S	S	S	S	S
POWER WINDOWS With driver express-down and lockout protection	S	S	S	S	S
REMOTE STARTER SYSTEM With keyless entry. On SLE, requires Convenience Package.	A	S	S	S	S
SUNROOF Power, tilt-sliding with express-open and -close and wind deflector	A	A	A	A	A
UNIVERSAL HOME REMOTE Includes garage door opener, programmable. Deleted on XL models when Snow Plow Prep Package is ordered.	—	S	S	S	S

ENTERTAINMENT/COMMUNICATION/NAVIGATION

AUDIO SYSTEM AM/FM stereo with CD player and MP3 playback, seek-and-scan, digital clock, auto-tone control, Radio Data System (RDS), ² speed-compensated volume, TheftLock, auxiliary input jack and USB port ³	S	S	—	—	—
AUDIO SYSTEM WITH REAR-SEAT ENTERTAINMENT AM/FM stereo with MP3 compatible CD/DVD player, seek-and-scan, digital clock, auto-tone control, RDS, ² speed-compensated volume, TheftLock and USB port ³	A	A	—	—	—
AUDIO SYSTEM WITH NAVIGATION⁴ AM/FM stereo with MP3-compatible CD player and Touch-Screen Navigation, auxiliary input jack, seek-and-scan, digital clock, auto-tone control, RDS, ² speed-compensated volume, TheftLock, USB port ³ and voice recognition. On Yukon Hybrid and Yukon Denali Hybrid, includes Hybrid power flow display.	—	A	S	S	S
AUDIO SYSTEM WITH REAR-SEAT ENTERTAINMENT AND NAVIGATION⁴ AM/FM stereo with MP3-compatible CD/DVD player and DVD-based Touch-Screen Navigation, seek-and-scan, digital clock, auto-tone control, RDS, ² speed-compensated volume, TheftLock, USB port ³ and voice recognition.	—	A	A	A	A

	SLE	SLT	DENALI	HYBRID	DENALI HYBRID
On Yukon Hybrid and Yukon Denali Hybrid, includes Hybrid power flow display.					
REAR-SEAT ENTERTAINMENT SYSTEM Includes DVD player with remote control, overhead display, 2 sets of 2-channel wireless infrared headphones and auxiliary audio/video input jacks. Requires AM/FM stereo with MP3-compatible CD/DVD player or AM/FM stereo with MP3-compatible CD/DVD player and DVD-based Navigation. ⁴	A	A	A	A	A
REAR AUDIO SYSTEM CONTROLS With 2 headphone jacks (headphones not included), power outlet and controls for volume, station selection and media	S	S	S	S	S
AUDIO 6-speaker system included with bench seat	A	—	—	—	—
10-speaker Bose® sound system with subwoofer in center console. Not available with optional bench seat.	S	S	—	S	—
10-speaker Bose Centerpoint® surround sound system	—	—	S	—	S
PREMIUM ACOUSTICAL INSULATION PACKAGE	—	—	S	—	S
DUAL-SCREEN ENTERTAINMENT SYSTEM Adds second screen for third-row passengers. Includes 2 additional sets of headphones. Available on XL models only.	A	A	A	—	—
ONSTAR Six months of Directions & Connections plan. ⁵ See page 25 for details.	S	S	S	S	S
XM RADIO¹ 3 trial months included. See page 25 for details.	S	S	S	S	S
XM NAVTRAFFIC⁶ 3 trial months included. 3 years included on Hybrid models. Included and only available with Touch-Screen Navigation. See page 25 for details.	—	A	S	S	S
BLUETOOTH® FOR PHONE⁷ Personal cell-phone connectivity	S	S	S	S	S

EXTERIOR STYLING AND FUNCTIONALITY

ASSIST STEPS Black	S	S	—	S	—
Body-color with chrome inserts	—	—	S	—	S
Power-retractable. Requires AutoRide Suspension Package. On SLT models, requires SLT-2 Equipment Package. Not available on ¾-ton XL models or Hybrid.	—	A	A	—	—
GLASS Solar-Ray deep-tinted. All windows except light-tinted glass on windshield and driver- and front-passenger-side glass.	S	S	S	S	S

¹XM Radio requires a subscription, sold separately by XM after the first 90 days. XM Radio U.S. service only available in the 48 contiguous United States and the District of Columbia. For more information, visit xmradio.com. ²RDS functions only where stations broadcast RDS information. ³Not compatible with all devices. ⁴Map coverage for Puerto Rico and the Virgin Islands available on separate disc. Coverage not available for portions of Canada. ⁵Visit onstar.com for details and system limitations. ⁶Required XM Radio and XM NavTraffic monthly subscriptions sold separately by XM after trial period. XM NavTraffic only available in select markets. For more information, visit xmradio.com/navtraffic. ⁷Go to gm.com/bluetooth to find out which Bluetooth phones are compatible with the vehicle.

STANDARD AND AVAILABLE FEATURES/YUKON

	SLE	SLT	DENALI	HYBRID	DENALI HYBRID
--	-----	-----	--------	--------	---------------

EXTERIOR STYLING AND FUNCTIONALITY CONT'D

LIGHTS Dual halogen composite headlamps with automatic exterior lamp control and flash-to-pass	S	S	S	S	S
Halogen front fog lamps, round	A	S	S	S	S
LUGGAGE RACK Roof-mounted side rails, black; bright accent on Yukon Denali and Denali Hybrid models	S	S	S	—	S
Luggage rack center rails. On SLE, requires Exterior Appearance Package.	A	S	S	—	S
OUTSIDE MIRRORS Heated, power-adjustable, manual-folding, body-color	S	S	—	—	—
Heated power-folding, power-adjustable, driver-side auto-dimming, body-color mirrors with integrated turn-signal indicators, ground illumination and curb-tilt. On SLT models, requires SLT-2 Equipment Package.	—	A	S	S	S
Vertical camper, heated, power-adjustable, manual-folding, includes integrated turn-signal indicators (¾-ton XL models only)	A	A	—	—	—
POWER LIFTGATE On SLT, requires SLT-2 Equipment Package. Not available with Snow Plow Prep Package on XL models.	—	A	S	—	S
RECOVERY HOOKS 2 front, frame-mounted. Standard on all 4WD models, ¾-ton XL models and on all Yukon Denali models. On 2WD and ½-ton 2WD XL models, included and only available with Exterior Appearance Package.	A	S	S	—	S
WIPERS Front intermittent wet-arm with flat blade and pulse washers	S	S	S	S	S
Rear intermittent with washer	S	S	S	S	S

SAFETY AND SECURITY

AIR BAGS¹ Dual-stage frontal with Passenger Sensing System	S	S	S	S	S
Front and rear head curtain side-impact air bags for first- and second-row outboard seating positions with rollover sensor. Includes third-row seating positions with 3-passenger third-row 50/50 split-bench seat.	S	S	S	S	S
Front-seat-mounted side-impact air bags	S	S	S	—	S
SIDE BLIND ZONE ALERT On SLT models, requires SLT-2 Equipment Package	—	A	A	—	A
TIRE PRESSURE MONITORING SYSTEM (Does not monitor spare)	S	S	S	S	S
VEHICLE THEFT-DETERRENT SYSTEM PASS-Key III	S	S	S	S	S

YUKON/YUKON XL/YUKON DENALI/YUKON XL DENALI/SPECIFICATIONS

	LMG VORTEC 5.3L V-8 VVT	LC9 VORTEC 5.3L V-8 VVT	L96 VORTEC 6.0L V-8 VVT	L94 VORTEC 6.2L V-8 VVT	LZ1 HYBRID VORTEC 6.0L V-8
ENGINE					
HP @ RPM	SWB: 320@5400 LWB: 320@5400	— LWB: 320@5400	— LWB: 352@5400	SWB: 403@5700 LWB: 403@5700	SWB: 332@5100 —
LB-FT TORQUE @ RPM	SWB: 335@4000 LWB: 335@4000	— LWB: 335@4000	— LWB: 382@4200	SWB: 417@4300 LWB: 417@4300	SWB: 367@4100 —
ACTIVE FUEL MANAGEMENT	Included	Included	—	Included	Included
E85-CAPABLE	Included	Included	—	Included	—
EPA-ESTIMATED CITY/HWY MPG	15/21 GAS 11/16 E85	15/21 GAS 11/16 E85	10/16 GAS (2WD) 10/15 GAS (4WD)	14/18 GAS (2WD) 10/15 E85 (2WD) 13/18 GAS (AWD) 9/14 E85 (AWD)	20/23 GAS
STANDARD	YUKON YUKON XL 2WD	YUKON XL 4WD	YUKON XL ¾-TON	YUKON DENALI YUKON XL DENALI	YUKON HYBRID YUKON DENALI HYBRID

MODEL	DRIVETRAIN/TRANSMISSION
YUKON/YUKON XL ½ - TON	2WD or 4WD/ Hydra-Matic 6-speed electronically controlled automatic with Driver Shift Control and Tow/Haul mode
YUKON/YUKON XL ¾ - TON	2WD or 4WD/ Hydra-Matic 6-speed electronically controlled automatic with Driver Shift Control and Tow/Haul mode
YUKON DENALI	2WD or 4WD/ Hydra-Matic 6-speed electronically controlled automatic with Driver Shift Control and Tow/Haul mode
YUKON HYBRID	2WD or 4WD/ Electronically controlled automatic with built-in Tow/Haul mode
YUKON DENALI HYBRID	2WD or 4WD/ Electronically controlled automatic with built-in Tow/Haul mode

	2WD YUKON	4WD YUKON	2WD YUKON XL	4WD YUKON XL ½-TON / ¾-TON	YUKON DENALI	YUKON XL DENALI
MEASUREMENTS/CAPACITIES						
TURNING DIAMETER curb to curb, ft.	39.0	39.0	43.0 / 45.3	43.0 / 45.3	39.0	43.0
WHEELBASE in.	116.0	116.0	130.0	130.0	116.0	130.0
MAXIMUM CARGO VOLUME² cu. ft.	108.9	108.9	137.4	137.4	108.9	137.4
OVERALL LENGTH in.	202.0	202.0	222.4	222.4	202.0	222.4
OVERALL WIDTH in.	79.0	79.0	79.1	79.1	79.0	79.1
HEIGHT in.	76.9	76.9	76.8	76.8	77.0	77.1
FUEL TANK CAPACITY approx. gallons	26.0 (25.0 Hybrid)	26.0 (25.0 Hybrid)	31.0/39.0	31.0/39.0	26.0 (25.0 Hybrid)	31.0

MODEL	YUKON VORTEC 5.3L		YUKON XL VORTEC 5.3L		YUKON XL VORTEC 6.0L		YUKON DENALI/ YUKON XL DENALI VORTEC 6.2L		YUKON HYBRID/ YUKON DENALI HYBRID VORTEC 6.0L HYBRID	
	AXLE RATIO	MAX. TRAILER WEIGHT LBS	AXLE RATIO	MAX. TRAILER WEIGHT LBS	AXLE RATIO	MAX. TRAILER WEIGHT LBS	AXLE RATIO	MAX. TRAILER WEIGHT LBS	AXLE RATIO	MAX. TRAILER WEIGHT LBS
1500 2WD	3.08 / 3.42	5500 / 8500	3.08 / 3.42	5100 / 8100						
1500 4WD	3.08 / 3.42	5200 / 8200	3.08 / 3.42	5000 / 8000						
2500 2WD					3.73	9600				
2500 4WD					3.73	9400				
DENALI 2WD							3.42	8300 / 7900		
DENALI AWD							3.42	8100 / 7800		
YUKON HYBRID 2WD/4WD									3.08/3.08	6200 / 5900
YUKON DENALI HYBRID 2WD/4WD									3.08/3.08	6000 / 5700

A-Available S-Standard — -Not Available

For Yukon Hybrid and Yukon Denali Hybrid trailering specifications, see page 8.

GMC YUKON
GMC
ACCESSORIES

YUKON/WHEELS⁴



N88
 17"
 POLISHED
 ALUMINUM
 STANDARD:
 SLE AND SLT
 1500 MODELS
 ONLY



S86
 20"
 CHROME-CLAD
 AVAILABLE:
 SLE AND SLT
 1500 MODELS
 ONLY



RDP
 20"
 POLISHED
 ALUMINUM
 AVAILABLE:
 SLE AND SLT
 1500 MODELS
 ONLY

YUKON ¾-TON/WHEEL⁴



P25
 17" WITH
 8 LUGS
 MACHINED
 ALUMINUM
 STANDARD:
 YUKON XL
 2500 MODELS
 ONLY



P41
 20"
 CHROME WHEEL
 STANDARD:
 YUKON DENALI
 AND YUKON
 XL DENALI

YUKON HYBRID/WHEELS⁴



P71
 18"
 POLISHED
 ALUMINUM
 STANDARD
 AND ONLY
 AVAILABLE ON
 YUKON HYBRID



RVA
 22" WITH 8
 SPOKES
 CHROME
 STANDARD ON
 YUKON DENALI
 HYBRID

Express yourself. Genuine GMC Accessories are the only accessories engineered and tested to meet the standards of your Yukon. They are available individually, or as a part of a complete package that's ready to enjoy the moment you take delivery. It's the easiest way to make Yukon all yours, while still keeping it all Professional Grade. To see how easy it is to personalize your new Yukon, just ask.

FIGURE 1: CHROME GRILLE



This chrome grille is specifically designed and engineered for your vehicle. It has a chrome surround and features the GMC logo.

FIGURE 2: SPLASH GUARDS



These custom-molded splash guards provide protection from tire splashes and mud. Front guards are not compatible with articulating running boards or Hybrid models. Rear guards feature the GMC logo.

FIGURE 3: TRAILER HITCH CLOSEOUT



This custom-molded cover hides the trailer hitch receiver when not in use. Available in select body colors. Not available for Yukon Denali or Yukon XL Denali.

FIGURE 4: 20" AND 22" CAST ALUMINUM WHEELS⁴

Roll with the best. These custom wheels feature a brilliant, durable chrome finish and are available with matching lugs and GMC center caps.



**CK951 20"
 CHROME (VSA)**



**CK916 22"
 CHROME (VSK)**



**CK945 20"
 CHROME**



**CK375 22"
 CHROME (VSJ)**



**CK948 20"
 CHROME (VSB)**



**CK910 22"
 CHROME**



**CK370 20"
 CHROME (VZK)**



**CK366 22"
 CHROME (VS4)**



**CK997 20"
 CHROME (VSF)**



**CK798 22"
 BLACK
 POLISHED
 (VSN)**

¹Always use safety belts and the correct restraint for your child's age and size. Even in vehicles equipped with the Passenger Sensing System, children are safer when properly secured in a rear seat in the appropriate infant, child or booster seat. Never place a rear-facing infant restraint in the front seat of any vehicle equipped with a passenger air bag. See the Owner's Manual and child safety seat instructions for more safety information. ²Cargo and load capacity limited by weight and distribution. ³Maximum trailer weight ratings are calculated assuming a base vehicle, except for any option(s) necessary to achieve the rating, plus driver. The weight of optional equipment, passengers, cargo and required trailering equipment will reduce the maximum trailer weight your vehicle can tow. See your dealer for details. ⁴Use only GM-approved wheel and tire combinations. Unapproved combinations may change the vehicle's performance characteristics. For approved wheel and tire combinations and other important information, go to gmaccessorieszone.com or see your dealer for details.

GMC YUKON
COLORS

WHITE DIAMOND¹ EXTRA-COST COLOR



ONYX BLACK



GOLD MIST METALLIC



SUMMIT WHITE



MOCHA STEEL METALLIC



STORM GRAY METALLIC



RED JEWEL TRICOAT EXTRA-COST COLOR



PURE SILVER METALLIC



CARBON BLACK METALLIC EXTRA-COST COLOR



PREMIUM CLOTH

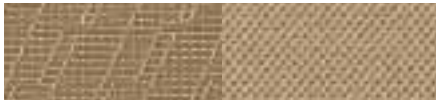

LIGHT TAN



EBONY

ULTRASOFT LEATHER-APPOINTED



LIGHT TAN



EBONY

YUKON DENALI/YUKON XL DENALI



COCOA/LIGHT CASHMERE



EBONY

All colors are basecoat/clearcoat for high-gloss and durable finish. See dealer for more details on paint and color availability.
¹Available on Yukon, Yukon XL and Denali models only.



AT GMC, MORE IS WHAT WE DO. OUR DEDICATION TO ENGINEERING EXCELLENCE LEADS US TO CONSTANTLY EXAMINE AND REFINE THE IDEAS THAT HELP GIVE YOU MORE CAPABILITY, POWER AND CONTROL.

FOR 2011, WE ARE PROUD TO INTRODUCE THE REDESIGNED GMC SIERRA HD, INCLUDING THE FIRST-EVER DENALI HD, OUR STRONGEST, SMARTEST AND MOST POWERFUL SIERRA PICKUPS EVER, AS WELL AS THE FIRST-EVER GMC ACADIA DENALI.

THESE NEW VEHICLES JOIN THE LEGENDARY GMC SIERRA AND YUKON THAT OFFER THE WIDEST ARRAY OF FULL-SIZE HYBRIDS AVAILABLE, AND THE GMC TERRAIN, WITH BEST-IN-CLASS HIGHWAY FUEL ECONOMY.¹

TOGETHER, THEY SHOW HOW EXPERIENCE AND INNOVATION CAN OVERCOME COMPROMISE. IT'S WHY WE NEVER SAY NEVER.

GMC. WE ARE PROFESSIONAL GRADE.

¹EPA-estimated mpg 32 hwy. Based on 2010 GM Compact SUV-Crossover segment.



ONSTAR

OnStar is a core asset of your Yukon. Benefiting from more than a decade of innovative development, it is both a highly advanced technology—fully integrated within the vehicle—and a warm human service. Standard on all Yukon models are six months of the OnStar Directions & Connections plan, including the convenience of Hands-Free Calling. It also includes Automatic Crash Response (see page 18), Stolen Vehicle Assistance, link to Emergency Services, Roadside Assistance, Remote Door Unlock, OnStar Vehicle Diagnostics, Crisis Assist and Remote Horn and Lights. OnStar services require vehicle electrical system (including battery), wireless service and GPS satellite signals to be available and operating for features to function properly. OnStar acts as a link to existing emergency service providers. Visit onstar.com for coverage maps, details and system limitations. Services vary with conditions.

HANDS-FREE CALLING

OnStar Hands-Free Calling capability is built into your OnStar-equipped Yukon. It's there when your cell phone is unavailable, its battery is low, you can't reach it easily or you left it home or in the office. Your Hands-Free Calling system is the right choice whenever you need an easy way to make and receive calls—at the touch of the phone icon on the rearview mirror or the steering-wheel-mounted controls shown on page 6. Voice-activated dialing is convenient because you don't have to dial when you are at the wheel. And Hands-Free Calling is reliable because it's specially designed for better reception and fewer dropped calls in areas of limited cellular reception. You are invited to experience the benefits yourself with 30 Hands-Free Calling minutes—on OnStar—during the first two months you drive your Yukon, with no strings attached.

ONSTAR TURN-BY-TURN NAVIGATION

Standard on all Yukon, Denali and Yukon Hybrid models are six months of the OnStar Directions & Connections plan that adds innovative, easy-to-use Turn-by-Turn Navigation plus Information and Convenience Services and Driving Directions. With Turn-by-Turn Navigation, you simply tell the OnStar Advisor your intended destination, and directions will automatically be sent to your Yukon. If you drive off-course, the system can reroute you to your intended destination. An automated voice then guides you turn-by-turn until you arrive at your destination. Turn-by-Turn Navigation is further enhanced with eNAV, allowing you to send Google™ Maps® and MapQuest® destinations directly to your vehicle. No need to print out directions; just call them up with simple voice commands.



XM RADIO

XM Radio¹ is standard with 3 trial months of service on all Yukon models. XM turns your drive on with commercial-free music channels from virtually every genre, artist-dedicated channels, live performances and more. Tune in to live play-by-play from the biggest sports, exclusive entertainment from top personalities, compelling talk, hilarious comedy, world-class news, local traffic and weather and family-friendly programming. Everything worth listening to is now on XM. Visit xmradio.com for details.

XM NAVTRAFFIC



Included with the available Touch-Screen Navigation System, 3 trial months of XM NavTraffic² (3 years on Hybrid models) enhances Yukon's GPS navigation system by showing real-time traffic data—while you're driving. Available in over 80 markets, XM NavTraffic displays construction, road closures and accidents so that you can get to your destination faster, plus average traffic speed and estimated drive time in select markets. For more information, visit xmradio.com/navtraffic. (Three years of XM NavTraffic are standard on all Yukon Hybrid models.)

GOODWRENCH SERVICE



To help your Yukon live up to its performance promise, GMC Goodwrench Service—found exclusively at your GMC dealer—is there. With all the engineering excellence in Yukon, GM-trained Goodwrench technicians have the expertise to care for all of it.

¹XM Radio requires a subscription, sold separately by XM after the first 90 days. XM Radio U.S. service only available in the 48 contiguous United States and the District of Columbia. For more information, visit xmradio.com.

²Required XM Radio and NavTraffic monthly subscriptions sold separately by XM after trial period. XM NavTraffic only available in select markets. For more information, visit xmradio.com/navtraffic.



COMMITMENT PLUS

From the owner orientation—and full tank of gas—you receive when you take possession of your Yukon to the **24-Hour Roadside Assistance, Courtesy Transportation and Travel Benefits**, Commitment Plus is a portfolio of owner privileges that lasts throughout your warranty. For expert product information, Roadside Assistance or other services, call 1-800-GMC-8782.

TRAVEL BENEFITS AND ROADSIDE ASSISTANCE Available around the clock: trip routing service, a program for reimbursement for trip interruption due to necessary warranty repairs, towing, flat tire change, jump-starts and more for 5 years or 100,000 miles (whichever comes first).

COURTESY TRANSPORTATION Available at participating dealers: shuttle service, reimbursement of certain public transportation or fuel expenses for overnight warranty repairs, and courtesy rental for overnight work repairs. See your dealer for details.

GMC OWNER CENTER A complimentary, one-stop resource to enhance your GMC ownership experience. It's easy to sign up. Just go to gm.com/gmownercenter/gmc.

CONFIDENCE IS STANDARD Yukon offers a comprehensive consumer confidence package that is among the best in the industry. It means you get all the benefits of Commitment Plus, including Roadside Assistance and Courtesy Transportation, along with the GM 5-Year/100,000-Mile Transferable Powertrain Limited Warranty (whichever comes first). Ask your GMC dealer for all the details.

A NOTE ON CHILD SAFETY Always use safety belts and the correct restraint for your child's age and size. Even in vehicles equipped with the Passenger Sensing System, children are safer when properly secured in a rear seat in the appropriate infant, child or booster seat. Never place a rear-facing infant restraint in the front seat of any vehicle equipped with a passenger air bag. See the Owner's Manual and child safety seat instructions for more safety information.

TRAILERING AND OFF-ROAD INFORMATION Please carefully review the Owner's Manual for important safety information about trailering or off-road driving in your vehicle.

IMPORTANT WORDS ABOUT THIS CATALOG We have tried to make this catalog comprehensive and factual. We reserve the right, however, to make changes at any time, without notice, in prices, colors, materials, equipment, specifications, models and availability. Specifications, dimensions, measurements, ratings and other numbers in this catalog and other printed materials provided at the dealership or affixed to vehicles are approximates based upon design and engineering drawings and prototypes and laboratory tests. Your vehicle may differ due to variations in manufacture and equipment. Since some information may have been updated since the time of printing, please check with your GMC dealer for complete details. GMC reserves the right to lengthen or shorten the model year for any product for any reason, or to start and end model years at different times.

ENGINES GMC products are equipped with engines produced by GM Powertrain or other suppliers to GM worldwide. The engines in GMC products may also be used in other GM makes and models.

FLEET ORDERS Some standard content may be deleted with fleet orders. See dealer for details.

GMC.COM See more of Yukon on our Web site: gmc.com/yukon. More photos and information; hot links to related subjects; convenient dealer locator; pricing guide, spec out your own vehicle. Or call 1-800-GMC-8782.

AN IMPORTANT NOTE ABOUT ALTERATIONS AND WARRANTIES Installations or alterations to the original equipment vehicle (or chassis) as distributed by General Motors are not covered by the General Motors New-Vehicle Limited Warranty. The special body company, assembler, equipment installer or upfitter is solely responsible for warranties on the body or equipment and any alterations (or any effect of the alterations) to any of the parts, components, systems or assemblies installed by GM. General Motors is not responsible for the safety or quality of design features, materials or workmanship of any alterations by such suppliers.

NEW-VEHICLE LIMITED WARRANTY All GMC light-duty vehicles come with a fully transferable, no-deductible 5-year/100,000-mile (whichever comes first) Powertrain Limited Warranty. GM vehicles registered in the U.S.A. are also covered for 3 years or 36,000 miles (whichever comes first). Coverage includes tires and towing to your nearest GMC dealership. Repairs will be made to correct any vehicle defect and most warranty repairs will be made at no charge. In addition, rust-through corrosion will be covered for 6 years or 100,000 miles (whichever comes first). See dealer for details.

HYBRID WARRANTY In addition to the transferable GMC 3-year/36,000-mile (whichever comes first) New-Vehicle Limited Warranty and the 5-year/100,000-mile (whichever comes first) Powertrain Limited Warranty, GM will also warrant certain hybrid components on Yukon Hybrid models for 8 years/100,000 miles (whichever comes first). No deductibles are associated with the Yukon Hybrid limited warranty, which is transferable to any subsequent persons assuming ownership of the vehicle during the 8-year/100,000-mile warranty period. See your GMC dealer for details.

ASSEMBLY GMC vehicles and their components are assembled or produced by different operating units of General Motors, its subsidiaries or suppliers to GM worldwide. We sometimes find it necessary to produce GMC vehicles with different or differently sourced components than originally scheduled. Since some options may be unavailable when your vehicle is assembled, we suggest that you verify that your vehicle includes the equipment you ordered or, if there are changes, that they are acceptable to you.

GMMOBILITY.COM (1-800-323-9935) GM Mobility offers financial assistance for eligible adaptive equipment to make automotive travel easier for persons with disabilities or special transportation needs. To learn more about special GM Mobility offers, visit gmmobility.com.

GMCARDMEMBERSERVICES.COM Did you know about the family of reward credit cards that can help you get a great deal on a new GM car, light-duty truck, SUV or crossover? With a GM reward card, you accrue earnings on every credit card purchase to use toward the purchase or lease of an eligible new GM vehicle. With three cards to choose from, you're sure to find one that suits you.

©2010 General Motors. All rights reserved. GM, the GM logo, GMC, the slogans, emblems, vehicle model names, vehicle body designs and other marks appearing in this catalog are the trademarks and/or service marks of General Motors, its subsidiaries, affiliates or licensors. Bose, Centerpoint, AudioPilot and SurroundStage are registered trademarks of the Bose Corporation. Facebook is a registered trademark of Facebook, Inc.



GMC.COM | LEARN MORE ABOUT GMC, AND JOIN THE DIALOGUE ON FACEBOOK (FACEBOOK.COM/GMC)

11GMCYUKRC-25

