



MP4-12C
E-BROCHURE

North American Edition
Spring 2011



'LIFE IS MEASURED IN ACHIEVEMENT, NOT IN YEARS ALONE' BRUCE McLAREN

**MOTOR RACING VICTORIES
IN FIA FORMULA ONE™,
CANADIAN-AMERICAN
CHALLENGE CUP,
LE MANS 24 HOUR
& INDIANAPOLIS 500**
DRIVER / CAR / RACE

KEY



FIA FORMULA ONE™
CONSTRUCTORS' CHAMPION



FIA FORMULA ONE™
DRIVERS' CHAMPION

1967

D. HULME / M6A / ROAD AMERICA
D. HULME / M6A / BRIDGEHAMPTON
D. HULME / M6A / MOSPORT PARK
B. McLAREN / M6A / LAGUNA SECA
B. McLAREN / M6A / RIVERSIDE

1968

B. McLAREN / M7A / BELGIAN GP
D. HULME / M7A / ITALIAN GP
D. HULME / M7A / CANADIAN GP
D. HULME / M8A / ROAD AMERICA
D. HULME / M8A / EDMONTON
B. McLAREN / M8A / RIVERSIDE
D. HULME / M8A / LAS VEGAS

The story of the MP4-12C is one of revolution. Free from the constraints of convention and empowered by the skills gained from decades spent at the pinnacle of Formula One™, we knew that to create the world's first no-compromise sports car we had to form a visionary new sports car company. McLaren Automotive was born.

The first and most important decision we made was to equip our team of designers and engineers with the ultimate creative resource: a clean sheet of paper. Underpinned by considerable investment, some of the brightest and bravest minds in the automotive industry set to work on creating a sports car like no other.

Four years later, the result is what we've come to refer to as the 'AND' car. It's a small word, but one that carries huge significance. We passionately believe that our commitment to innovation, our obsessive attention to detail and our exacting standards have resulted in a car that surpasses the highs you have experienced in previous sports cars. And convincingly addresses the compromises and limitations that you have come to accept.

Designed from scratch around the driver, with nothing carried over from an existing car, the 12C has a unique breadth of ability. Carbon fiber construction ensures it is both light 'AND' strong. A bespoke, small-capacity, twin-turbo V8 engine delivers tremendous power 'AND' outstanding efficiency. Radical thinking and intelligent design have minimized exterior dimensions 'AND' maximized interior space, while a revolutionary suspension system delivers exhilarating dynamism 'AND' exceptional ride comfort. We feel this car is 'Pure McLaren.'

I firmly believe the 12C is the best available in the core sports car segment, but don't take my word for it. I urge you to drive it, for only then can you truly appreciate how we've rewritten the rules of sports car design.

Antony Sheriff

Managing Director, McLaren Automotive

1969

D. HULME / M7A / MEXICAN GP
B. McLAREN / MBB / MOSPORT PARK
D. HULME / MBB / ST JOVITE
B. McLAREN / MBB / WATKINS GLEN
D. HULME / MBB / EDMONTON
D. HULME / MBB / MID-OHIO

B. McLAREN / MBB / ROAD AMERICA
D. HULME / MBB / BRIDGEHAMPTON
B. McLAREN / MBB / MICHIGAN
B. McLAREN / MBB / LAGUNA SECA
D. HULME / MBB / RIVERSIDE
B. McLAREN / MBB / TEXAS SPEEDWAY

1970

D. GURNEY / MBD / MOSPORT PARK
D. GURNEY / MBD / ST JOVITE
D. HULME / MBD / WATKINS GLEN
D. HULME / MBD / EDMONTON
D. HULME / MBD / MID-OHIO
P. GETHIN / MBD / ROAD AMERICA
D. HULME / MBD / DONNYBROOKE
D. HULME / MBD / LAGUNA SECA
D. HULME / MBD / RIVERSIDE

1971

D. HULME / MBF / MOSPORT PARK
P. REVSON / MBF / ROAD ATLANTA
P. REVSON / MBF / WATKINS GLEN
P. REVSON / MBF / ROAD AMERICA
P. REVSON / MBF / DONNYBROOKE
D. HULME / MBF / EDMONTON
P. REVSON / MBF / LAGUNA SECA
D. HULME / MBF / RIVERSIDE

1972

D. HULME / M19A / SOUTH AFRICAN GP
D. HULME / M20 / MOSPORT PARK
D. HULME / M20 / WATKINS GLEN
M. DONOHUE / M16B / INDY 500

1.0	Introduction
1.1	We are McLaren
1.2	The MP4-12C

2.0	The 'AND' car
2.1	Lightweight 'AND' Strong
2.2	Powerful 'AND' Efficient
2.3	Compact 'AND' Spacious
2.4	Comfortable 'AND' Exhilarating

3.0	Features & Content
3.1	MP4-12C Highlights
3.2	Body Structure
3.3	Powertrain
3.4	ProActive Chassis Control (PCC)
3.5	Vehicle Dynamics
3.6	Exterior
3.7	Interior
3.8	Color & Trim
3.9	Options
3.10	Features Table
3.11	Technical Specification

1973
 D. HULME / M23 / SWEDISH GP
 P. REVSON / M23 / BRITISH GP
 P. REVSON / M23 / CANADIAN GP

   (FITTIPALDI)
1974
 D. HULME / M23 / ARGENTINE GP
 E. FITTIPALDI / M23 / BRAZILIAN GP
 E. FITTIPALDI / M23 / BELGIAN GP
 E. FITTIPALDI / M23 / CANADIAN GP
 J. RUTHERFORD / M16C/D / INDY 500

1975
 E. FITTIPALDI / M23 / ARGENTINE GP
 J. MASS / M23 / SPANISH GP
 E. FITTIPALDI / M23 / BRITISH GP

 (HUNT)
1976
 J. HUNT / M23 / SPANISH GP
 J. HUNT / M23 / FRENCH GP
 J. HUNT / M23 / GERMAN GP
 J. HUNT / M23 / DUTCH GP
 J. HUNT / M23 / CANADIAN GP
 J. HUNT / M23 / USA (EAST) GP
 J. RUTHERFORD / M16E / INDY 500

1977
 J. HUNT / M26 / BRITISH GP
 J. HUNT / M26 / US (EAST) GP
 J. HUNT / M26 / JAPANESE GP

1

INTRODUCTION

1.1 We are McLaren

1.2 The MP4-12C

1981

J. WATSON / MP4/1 / BRITISH GP

1982

N. LAUDA / MP4/1B / USA (WEST) GP
J. WATSON / MP4/1B / BELGIAN GP
J. WATSON / MP4/1B / USA GP
N. LAUDA / MP4/1B / BRITISH GP

1983

J. WATSON / MP4/1C / USA (WEST) GP

🏆 🏆 🏆 (LAUDA)

1984

A. PROST / MP4/2 / BRAZILIAN GP
N. LAUDA / MP4/2 / SOUTH AFRICAN GP
A. PROST / MP4/2 / SAN MARINO GP
N. LAUDA / MP4/2 / FRENCH GP
A. PROST / MP4/2 / MONACO GP
N. LAUDA / MP4/2 / BRITISH GP

A. PROST / MP4/2 / GERMAN GP
N. LAUDA / MP4/2 / AUSTRIAN GP
A. PROST / MP4/2 / DUTCH GP
N. LAUDA / MP4/2 / ITALIAN GP
A. PROST / MP4/2 / EUROPEAN GP
A. PROST / MP4/2 / PORTUGUESE GP

WE ARE McLAREN

At McLaren we respect our heritage without being slaves to it. Innovating to win and challenging convention are in our DNA. Everything we do is governed by the belief that 'good enough is not good,' which is why where we lead, others inevitably follow. Pioneers in the use of carbon fiber, we were the first race team to construct a Formula One™ car from what was then a material reserved for the aerospace industry. It's this approach that has won us no fewer than 12 FIA Formula One™ Constructors' titles and eight FIA Formula One™ World Drivers' Championships. Likewise our first road car – the groundbreaking McLaren F1 supercar – introduced carbon fiber chassis construction to the road car realm and set standards that remain unbeaten to this day.

Today the 12C employs unprecedented one-piece molding techniques to bring the weight and strength benefits of carbon fiber to a segment previously denied such an exotic and advanced material. In road car design, as in our Formula One™ efforts, the McLaren name stands for a unique brand of excellence: joined-up thinking, fearless commitment, fanatical attention to detail and peerless execution. All channelled into the creation of a car that only we could build.

Over 30 years of being carbon fiber pioneers on road and track. *Below:* McLaren F1 road car and MP4/1

1966
1981
169

Formula One™ debut

First ever carbon fiber chassis in Formula One™

Formula One™ victories and counting...



[CLICK HERE TO INDEX](#) ▶

🏆🏆🏆 (PROST)

- 1985**
 A. PROST / MP4/2B / BRAZILIAN GP
 A. PROST / MP4/2B / MONACO GP
 A. PROST / MP4/2B / BRITISH GP
 A. PROST / MP4/2B / AUSTRIAN GP
 N. LAUDA / MP4/2B / DUTCH GP
 A. PROST / MP4/2B / ITALIAN GP

🏆🏆 (PROST)

- 1986**
 A. PROST / MP4/2C / SAN MARINO GP
 A. PROST / MP4/2C / MONACO GP
 A. PROST / MP4/2C / AUSTRIAN GP
 A. PROST / MP4/2C / AUSTRALIAN GP

- 1987**
 A. PROST / MP4/3 / BRAZILIAN GP
 A. PROST / MP4/3 / BELGIAN GP
 A. PROST / MP4/3 / PORTUGUESE GP

🏆🏆🏆 (SENNA)

- 1988**
 A. PROST / MP4/4 / BRAZILIAN GP
 A. SENNA / MP4/4 / SAN MARINO GP
 A. PROST / MP4/4 / MONACO GP
 A. PROST / MP4/4 / MEXICAN GP
 A. SENNA / MP4/4 / CANADIAN GP
 A. SENNA / MP4/4 / USA GP
 A. PROST / MP4/4 / FRENCH GP
 A. SENNA / MP4/4 / BRITISH GP

- A. SENNA / MP4/4 / GERMAN GP
 A. SENNA / MP4/4 / HUNGARIAN GP
 A. SENNA / MP4/4 / BELGIAN GP
 A. PROST / MP4/4 / PORTUGUESE GP
 A. PROST / MP4/4 / SPANISH GP
 A. SENNA / MP4/4 / JAPANESE GP
 A. PROST / MP4/4 / AUSTRALIAN GP

Imagine a car that adapts to its environment and molds itself to your mood. A 592hp sports car with a level of readily accessible performance so far beyond your realm of experience it redefines your notion of ultimate speed and agility. A car that will transport you to work with the ease and comfort of a luxury sedan, yet lap the world's most demanding race track faster than all but the most specialized racing cars.

The 12C is all these cars and more. The product of uninhibited engineering, constructed from the most advanced materials and production techniques, rigorously engineered and obsessively honed to deliver levels of performance, refinement, comfort and practicality previously believed to be impossible. A car that's 'Pure McLaren.' A car called the MP4-12C.

[CLICK HERE TO INDEX](#) ▶

The MP4-12C – phenomenal performance yet refined and usable

592
3

hp

Drive modes

Normal
Sport
Track

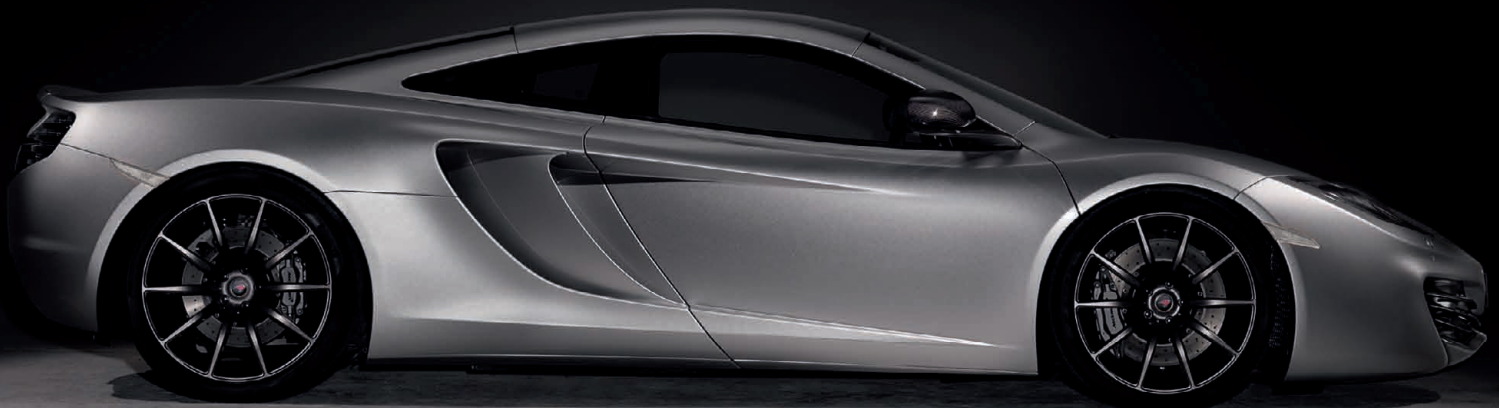

🏆 🏆 🏆 (PROST)

1989

A. SENNA / MP4/5 / SAN MARINO GP
A. SENNA / MP4/5 / MONACO GP
A. SENNA / MP4/5 / MEXICAN GP
A. PROST / MP4/5 / USA GP
A. PROST / MP4/5 / FRENCH GP
A. PROST / MP4/5 / BRITISH GP
A. SENNA / MP4/5 / GERMAN GP
A. SENNA / MP4/5 / BELGIAN GP
A. PROST / MP4/5 / ITALIAN GP
A. SENNA / MP4/5 / SPANISH GP

🏆 🏆 🏆 (SENNA)

1990

A. SENNA / MP4/5B / USA GP
A. SENNA / MP4/5B / MONACO GP
A. SENNA / MP4/5B / CANADIAN GP
A. SENNA / MP4/5B / GERMAN GP
A. SENNA / MP4/5B / BELGIAN GP
A. SENNA / MP4/5B / ITALIAN GP

🏆 🏆 🏆 (SENNA)

1991

A. SENNA / MP4/6 / USA GP
A. SENNA / MP4/6 / BRAZILIAN GP
A. SENNA / MP4/6 / SAN MARINO GP
A. SENNA / MP4/6 / MONACO GP
A. SENNA / MP4/6 / HUNGARIAN GP
A. SENNA / MP4/6 / BELGIAN GP
G. BERGER / MP4/6 / JAPANESE GP
A. SENNA / MP4/6 / AUSTRALIAN GP

1992

A. SENNA / MP4/7 / MONACO GP
G. BERGER / MP4/7 / CANADIAN GP
A. SENNA / MP4/7 / HUNGARIAN GP
A. SENNA / MP4/7 / ITALIAN GP
G. BERGER / MP4/7 / AUSTRALIAN GP

1993

A. SENNA / MP4/8 / BRAZILIAN GP
A. SENNA / MP4/8 / EUROPEAN GP
A. SENNA / MP4/8 / MONACO GP
A. SENNA / MP4/8 / JAPANESE GP
A. SENNA / MP4/8 / AUSTRALIAN GP



1995

J.J. LEHTO / Y. DALMAS / M. SEKIYA /
F1 GTR / LE MANS

1997

D. COULTHARD / MP4-12 / AUSTRALIAN GP
D. COULTHARD / MP4-12 / ITALIAN GP
M. HAKKINEN / MP4-12 / EUROPEAN GP

🏆 🏆 🏆 [HAKKINEN]

1998

M. HAKKINEN / MP4-13 / AUSTRALIAN GP
M. HAKKINEN / MP4-13 / BRAZILIAN GP
D. COULTHARD / MP4-13 / SAN MARINO GP
M. HAKKINEN / MP4-13 / SPANISH GP
M. HAKKINEN / MP4-13 / MONACO GP
M. HAKKINEN / MP4-13 / AUSTRIAN GP
M. HAKKINEN / MP4-13 / GERMAN GP
M. HAKKINEN / MP4-13 / EUROPEAN GP
M. HAKKINEN / MP4-13 / JAPANESE GP

🏆 🏆 [HAKKINEN]

1999

M. HAKKINEN / MP4-14 / BRAZILIAN GP
M. HAKKINEN / MP4-14 / SPANISH GP
M. HAKKINEN / MP4-14 / CANADIAN GP
D. COULTHARD / MP4-14 / BRITISH GP
M. HAKKINEN / MP4-14 / HUNGARIAN GP
D. COULTHARD / MP4-14 / BELGIAN GP
M. HAKKINEN / MP4-14 / JAPANESE GP

2000

D. COULTHARD / MP4-15 / BRITISH GP
M. HAKKINEN / MP4-15 / SPANISH GP
D. COULTHARD / MP4-15 / MONACO GP
D. COULTHARD / MP4-15 / FRENCH GP
M. HAKKINEN / MP4-15 / AUSTRIAN GP
M. HAKKINEN / MP4-15 / HUNGARIAN GP
M. HAKKINEN / MP4-15 / BELGIAN GP



2001

D. COULTHARD / MP4-16 / BRAZILIAN GP
D. COULTHARD / MP4-16 / AUSTRIAN GP
M. HAKKINEN / MP4-16 / BRITISH GP
M. HAKKINEN / MP4-16 / USA GP

2002

D. COULTHARD / MP4-17A / MONACO GP

2003

D. COULTHARD / MP4-17D / AUSTRALIAN GP
K. RAIKKONEN / MP4-17D / MALAYSIAN GP

2004

K. RAIKKONEN / MP4-19B / BELGIAN GP

2005

K. RAIKKONEN / MP4-20A / SPANISH GP
K. RAIKKONEN / MP4-20A / MONACO GP
K. RAIKKONEN / MP4-20A / CANADIAN GP
J. P. MONTOYA / MP4-20A / BRITISH GP
K. RAIKKONEN / MP4-20A / HUNGARIAN GP
K. RAIKKONEN / MP4-20A / TURKISH GP
J. P. MONTOYA / MP4-20A / ITALIAN GP
K. RAIKKONEN / MP4-20A / BELGIAN GP
J. P. MONTOYA / MP4-20A / BRAZILIAN GP
K. RAIKKONEN / MP4-20A / JAPANESE GP

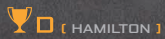

2007

F. ALONSO / MP4-22A / MALAYSIAN GP
F. ALONSO / MP4-22A / MONACO GP
L. HAMILTON / MP4-22A / CANADIAN GP
L. HAMILTON / MP4-22A / USA GP
F. ALONSO / MP4-22A / EUROPEAN GP
L. HAMILTON / MP4-22A / HUNGARIAN GP
F. ALONSO / MP4-22A / ITALIAN GP
L. HAMILTON / MP4-22A / JAPANESE GP

2008

L. HAMILTON / MP4-23A / AUSTRALIAN GP
L. HAMILTON / MP4-23A / MONACO GP
L. HAMILTON / MP4-23A / BRITISH GP
L. HAMILTON / MP4-23A / GERMAN GP
H. KOVALAINEN / MP4-23A / HUNGARIAN GP
L. HAMILTON / MP4-23A / CHINESE GP

2009

L. HAMILTON / MP4-24 / HUNGARIAN GP
L. HAMILTON / MP4-24 / SINGAPORE GP

2010

J. BUTTON / MP4-25 / AUSTRALIAN GP
J. BUTTON / MP4-25 / CHINESE GP
L. HAMILTON / MP4-25 / TURKISH GP
L. HAMILTON / MP4-25 / CANADIAN GP
L. HAMILTON / MP4-25 / BELGIAN GP

2

THE 'AND' CAR

- 2.1 Lightweight 'AND' Strong
- 2.2 Powerful 'AND' Efficient
- 2.3 Compact 'AND' Spacious
- 2.4 Comfortable 'AND' Exhilarating

2.1

LIGHTWEIGHT 'AND' STRONG

Why make a heavy car when you can make a light one? It's a simple question, but finding the answer requires the unflinching embrace of fresh ideas, technologies and processes. We call it 'pushing the edge.' Achieving a dry weight of just 2,868lbs* and a power-to-weight ratio of 455hp per ton requires an absolute commitment to innovation and unrivalled expertise in the use of lightweight materials. In short, it requires carbon fiber. What else would we use? After all, we haven't made a car from anything else for over 30 years.

Not only were we the first team to construct and race a carbon fiber Formula One™ car, but our legendary F1 road car was also the first to be made from this low-mass, high-strength material. Now, with the 12C, we have introduced carbon fiber to an entirely new sector of the market.

Called the MonoCell, the 12C's central chassis 'tub' weighs just 165lbs, yet thanks to the remarkable properties of carbon fiber, this unique one-piece molded structure is three times as stiff as the aluminum equivalent. Such strength and integrity bring tremendous advantages, not only in terms of weight reduction and therefore performance, but also in the precision and control of the steering and suspension, and in exceptional occupant safety in the event of an accident.

[CLICK HERE TO INDEX](#) ▶

Thirty years of carbon fiber innovation

165 3

lbs
MonoCell
weight

x stiffer
than aluminum



* All data supplied by European specification vehicles using European measuring methodology

By capitalizing on the weight-saving advantages of its carbon fiber MonoCell, the 12C pushes the boundaries of total performance. With 592hp and 443lbs ft of torque, the 12C is one of the fastest accelerating road cars available in the world today. Fitted with Corsa tires it will reach 60mph from rest in just 3.0sec. Top speed? 205mph.

It's an exemplary lesson in achieving the most by using the least, and the product of our obsessive quest to rewrite the rules of sports car design.

[CLICK HERE TO INDEX](#) ▶

The McLaren M838T

205

mph

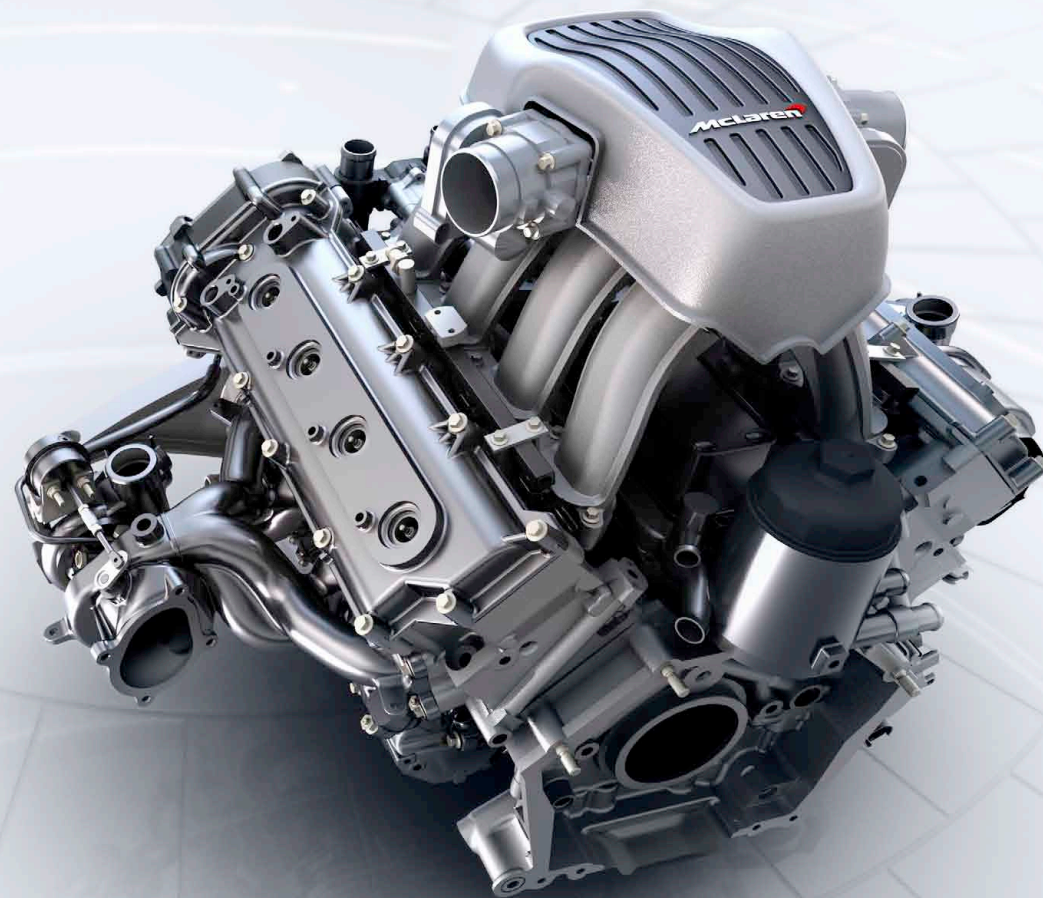

2.3

To create the perfect driver's car you need to design it around the driver. This inside-out approach is central to the 12C concept, for it informed all the critical packaging decisions we made to create a spacious interior within a compact exterior. Building a sports car that occupies the smallest possible area on the road yet accommodates two adults (from the 98th percentile) and their luggage was a major challenge, but our Formula One™ experience means we've turned packaging into an art form.

Witness the 12C's slim sides. Where convention dictates a mid-engined car's cooling radiators are mounted at right angles to the airflow, we tucked them in-line, using carefully sculpted turning vanes to deflect the airflow through 90 degrees onto the face of the radiator. Not only does this make the 12C narrower and therefore easier to drive in traffic, but it also makes the car smaller, which in turn saves weight.

We found a similarly virtuous solution when positioning the driver and passenger. By placing the occupants as close to the center of the car as possible, not only have we created an interior with a greater sense of space, but we've also optimised the 12C's polar moment of inertia for increased agility and dynamism.

[CLICK HERE TO INDEX](#) ▶

COMPACT 'AND' SPACIOUS



2.4

For a little over a century, automotive engineers have tried – and failed – to reconcile the requirements for dynamic handling and a comfortable ride. Traditional thinking suggests it's the eternal engineering dilemma. At McLaren, we think differently. Innovation is our oxygen. We refute compromise and relish finding solutions to age-old problems. In this case, the solutions are ProActive Chassis Control (PCC) and the Active Dynamics Panel (ADP). The genius of PCC is its unique linked hydraulic system, which allows us to dispense with the antiquated and heavy anti-roll bar to give handling and ride equal priority.

The 12C delivers exceptional levels of roll control; up to 1.7g of transient lateral cornering force was achieved during testing. Thanks to the hydraulic system's ability to decouple the suspension at each corner, it also ensures almost total isolation from road imperfections. Seamless integration between the PCC system and the ADP enables you to precisely and independently tailor the handling and powertrain settings to suit different driving conditions via Normal, Sport and Track modes. Smooth and supple in urban driving, firm and ultra-responsive for the ultimate on-track adrenalin rush, the 12C is the complete sports car.

[CLICK HERE TO INDEX](#) ▶

COMFORTABLE 'AND' EXHILARATING

Active Dynamics Panel (ADP) – Normal, Sport & Track modes



Normal

Low-speed ride quality is a match for the best executive sedans, not just sports cars.

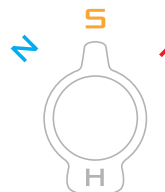

Sport

Switch the ADP from Normal to Sport and feel the MP4-12C seamlessly sharpen handling and gearchange responses.

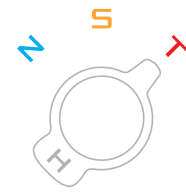

Track

Track mode fully exploits near-instantaneous gearshifts and the fast agility of the chassis.

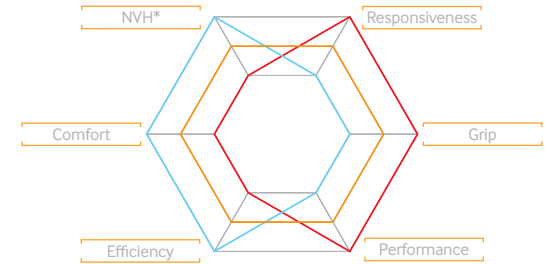

* Noise, Vibration & Harshness



3

FEATURES & CONTENT

3.1 MP4-12C Highlights

3.2 Body Structure

3.3 Powertrain

3.4 ProActive Chassis Control (PCC)

3.5 Vehicle Dynamics

3.6 Exterior

3.7 Interior

3.8 Color & Trim

3.9 Options

3.10 Features Table

3.11 Technical Specification

Body Structure

We have been pioneers in carbon fiber technology for more than three decades. The 12C is the product of this unrivalled expertise, having our groundbreaking carbon MonoCell at its heart.

[CLICK HERE TO READ MORE](#) ▶

ProActive Chassis Control (PCC)

PCC is the most radical rethink of sports car suspension design in half a century. By separating the conflicting objectives of dynamic handling and pliant ride, it sets new standards in both.

[CLICK HERE TO READ MORE](#) ▶

Powertrain

A sports car like no other deserves an engine and gearbox like no other. That's why the 12C features a bespoke powertrain that heralds a new era in performance, efficiency, response and tractability.

[CLICK HERE TO READ MORE](#) ▶

**Vehicle Dynamics**

Thanks to the benefits of lightweight construction and a fully integrated array of innovative, aerodynamic and electronic aids, the 12C brings supercar performance and dynamics to the sports car segment.

[CLICK HERE TO READ MORE](#) ▶

Exterior

The 12C's distinctive form follows function. Shaped by the demands of aerodynamics and refined with the same rigour we apply to designing our Formula One™ cars, every feature you see on the 12C is there for a reason.

[CLICK HERE TO READ MORE](#) ▶

Interior

Designed around the driver to create a comfortable, functional driving environment, the 12C's interior is a real step forward in packaging and a truly great place to be.

[CLICK HERE TO READ MORE](#) ▶

We have been pioneers in carbon fiber technology for more than three decades. The 12C is the product of our unrivalled expertise and another world-first for McLaren.

- We were the first constructor to build and race a carbon fiber chassis in Formula One™ – the MP4/1 in 1981 – and followed this 12 years later with the world's first carbon fiber road car, the iconic McLaren F1.
- The 12C continues this tradition by bringing the benefits of carbon fiber construction to the core sports car segment.
- The groundbreaking carbon MonoCell structure makes the 12C lighter than any car in its class.
- The MonoCell weighs only 165lbs and takes just four hours to manufacture thanks to its unique, one-piece molding process.
- High-strength, low-mass properties and exceptionally low levels of torsional flex create the ideal platform for optimized suspension design.
- The MonoCell acts as a super-strong safety cell, as in a Formula One™ car.
- Easily replaceable sacrificial extruded aluminum front and rear structures are designed to absorb high-energy impacts, protecting occupants from harm and the MonoCell from damage.

[CLICK HERE TO RETURN TO HIGHLIGHTS](#) ▶

30+
165

years of carbon fiber
pioneering

lbs
MonoCell
weight



3.3

POWERTRAIN

A sports car like no other deserves an engine and gearbox like no other. That's why the 12C features a bespoke powertrain that heralds a new era in performance, efficiency, response and tractability.

- M838T engine is a bespoke 3.8-litre, twin-turbocharged, 90-degree V8, developing 592hp and 443lbs ft of torque.
- Created using our philosophy of intelligent design to maximise performance and efficiency.
- Revs to a thrilling 8,500rpm, yet has 80% of peak torque still available below 2,000rpm.
- Features a dry-sump oil system to cope with extreme cornering forces, and to enable the engine to be mounted as low as possible in the chassis.
- One of the most efficient high-performance engines ever built when judged on power output versus CO₂ emissions.
- Seamless Shift Gearbox is a dual-clutch, seven-speed transmission with fully automatic and manual modes.
- Controlled via a push-pull rockershift mounted on the back of the steering wheel, just as in our Formula One™ cars.
- Three drive modes – Normal, Sport and Track – perfectly match shift characteristics to driving conditions.
- Pre-Cog facility eliminates latency by priming the transmission for your next up or downshift to deliver an almost instantaneous gearchange.
- Launch Control system gives access to the 12C's blistering standing-start acceleration.
- Lubricated clutches allow full performance to be enjoyed without compromising reliability.

[CLICK HERE TO RETURN TO HIGHLIGHTS](#) ►



3.4

PROACTIVE CHASSIS CONTROL (PCC)

PCC is the most radical rethink of sports car suspension design in half a century. By separating the conflicting objectives of dynamic handling and comfortable ride, it sets new standards in both.

- The 12C's chassis features two principal systems – adaptive damping and hydraulic roll control – linked via a unique interconnected hydraulic system.
- Adaptive damping system uses electronically adjustable actuator valves to continuously vary damping force according to road conditions and handling mode selected by the driver.
- The system responds to individual wheel damping inputs in real time for immediate control and enhanced handling response and agility.
- By harnessing the natural dynamics of fluid under pressure – flowing from an area of high pressure to one of low pressure – the 12C's interconnected hydraulic system increases roll stiffness during cornering.
- When roll stiffness isn't required – when travelling in a straight line – PCC effectively decouples the individual wheels, allowing them to absorb road imperfections far more effectively.
- The driver can choose between three suspension modes – Normal, Sport and Track. Changing from N to S to T increases the pressure in the hydraulic system for a greater base level of damping and roll stiffness.
- The result is a unique combination of uncanny ride comfort and extraordinary handling.

[CLICK HERE TO RETURN TO HIGHLIGHTS](#) ►



3.5

VEHICLE DYNAMICS

Thanks to the benefits of lightweight construction and a fully integrated array of innovative, aerodynamic and electronic aids, the 12C brings supercar performance and dynamics to the core sports car segment.

- When fitted with optional Pirelli Corsa tires, the 12C is capable of accelerating from a standstill to 60mph in 3.0sec, covering a standing quarter mile in 10.9sec and achieving a top speed of 205mph.
- The 12C's dynamic characteristics are controlled by the Active Dynamics Panel: an intuitive array of two rotary switches and four push buttons that effectively gives you three cars in one.
- Normal mode is ideal for everyday urban driving conditions; Sport delivers a set-up optimized for driver enjoyment; Track prioritizes outright performance over comfort for a driving experience aimed specifically at circuit driving.
- The McLaren Airbrake is an active aerodynamic device that rises under heavy braking to reduce stopping distances by increasing drag and maintaining rear downforce to increase stability.
- First seen on the McLaren F1 and later on the Mercedes-Benz SLR McLaren, the Airbrake can also be manually deployed to function as a rear spoiler for increased downforce at all times.
- Brake Steer cleverly uses the brakes to manage traction, minimize mid-corner understeer and control slip angle (oversteer) in fast driving conditions. The result is remarkably stable and incisive cornering ability.
- By braking the inside rear wheel when turning, Brake Steer mimics the action of a torque vectoring differential, but retains an open differential, saving on weight and complexity.

[CLICK HERE TO RETURN TO HIGHLIGHTS](#) ►



3.6

EXTERIOR

The 12C's distinctive form follows function. Shaped by the demands of aerodynamics and refined with the same rigour we apply to designing our Formula One™ cars, every feature you see on the 12C is there for a reason.

- Extensive use of advanced wind tunnel modelling and Computational Fluid Dynamics optimized the 12C's aerodynamic performance and efficiency.
- The intelligent use of airflow enabled us to create the turning vane in the 12C's sides. Designed to turn the airflow through 90 degrees, this allowed us to move the cooling radiators back and in-line with the car for perfect packaging.
- The 12C's rear haunches are shaped perfectly to feed air over the Airbrake for maximum effectiveness.
- The high-mounted exhaust looks dramatic but has genuine benefits: it takes the direct route to minimize piping and therefore weight; allows fitment of a flat floor and rear diffuser to reduce lift and increase handling stability.
- Dihedral door design pioneered in the McLaren F1. Undeniably spectacular, the doors are also practical, improving the leg swing area, requiring less room to fully open and reducing the width of sill you have to negotiate when getting in and out.
- Latest LED light technology used to create a distinctive identity for the 12C.
- Bright white light diffused through gill-shaped apertures, which echo the McLaren speed-mark and soften the glare that's associated with traditional daytime driving lights.
- Rear lights 'hidden' by embedding thin strips of LEDs in the black horizontal bars. Spectacular when lit, stealthy when not, they are unique to the 12C.

[CLICK HERE TO RETURN TO HIGHLIGHTS](#) ►



Designed around the driver to create a comfortable, functional driving environment, the 12C's interior is a real step forward in packaging and a truly great place to be.

- Perfect alignment of seat, steering wheel and pedals, with no offset, gives the perfect driving position.
- Interior is designed to provide sufficient head, leg and shoulder room to accommodate two adults (from the 98th percentile) in comfort.
- A low windscreen cowl increases forward visibility.
- High point of the front wings is directly above the centerline of the front wheels to help the driver place the car more accurately on a bend.
- Devoid of distracting switches and fiddly buttons, the 12C's steering wheel is an exercise in ergonomic simplicity and satisfying tactility. Its grip was modelled using data from Lewis Hamilton's Formula One™ wheel, incorporating an additional 2mm to compensate for glove thickness.
- The rockershift moves with the wheel and operates in a push-pull manner, so you can change up or down with either the left- or right-hand paddle for ultimate control. Just as in our Formula One™ cars.
- Mid-engined configuration and radical packaging of cooling radiators create room for a generous luggage space.

[CLICK HERE TO RETURN TO HIGHLIGHTS](#) ►



COLOR & TRIM

STANDARD EXTERIOR COLORS

The MP4-12C's distinctive spectrum of colors and finishes is 'Pure McLaren.' Our highly skilled technicians use their unrivalled experience and eye for detail to meticulously hand-prime and paint each 12C.

[CLICK HERE TO INDEX](#) ▶

White

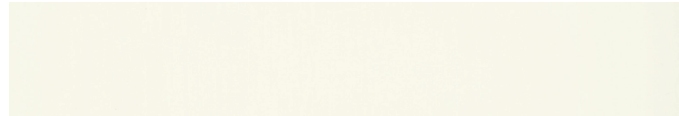

Blue



Silver

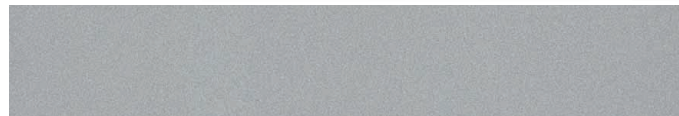

The Special paint options have been created by our technicians using the very latest pigments and effects to achieve a greater depth of finish and to highlight every aerodynamic contour of the 12C.

Orange first appeared on our M6A race car in 1967 and was later resurrected for the McLaren F1 LM, built to celebrate our 1995 Le Mans victory. The 12C's paint range includes a McLaren Orange in commemoration of the original color.

[CLICK HERE TO CONFIGURE YOUR MP4-12C](#) ▶

[CLICK HERE TO INDEX](#) ▶

COLOR & TRIM

SPECIAL EXTERIOR COLORS

Titanium Silver



Graphite Grey

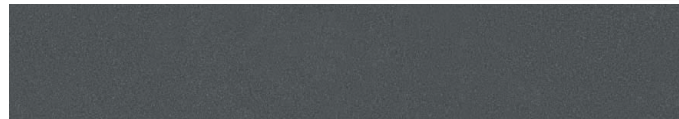

Carbon Black

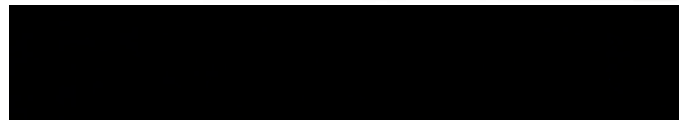

Sapphire Black



McLaren Orange



Mercury Red



Azure Blue



Racing Green



For the Elite paint options, the technicians combine artistry with expertise. Using exclusive pigments and an intensive, three-stage paint process, they reveal an even greater depth of pearlescent or metallic effect, and a mirror-like finish.

The Elite Volcano Orange option was developed to closely match the color of the last McLaren F1 ever built. This unique color uses a special silver metallic base and an orange lacquer to achieve an unmistakable tone and iridescence.

[CLICK HERE TO INDEX](#) ▶

COLOR & TRIM

ELITE EXTERIOR COLORS

Pearl White



Supernova Silver



Ice Silver



Fire Black



Volcano Orange



Volcano Red



COLOR & TRIM

SPORT

Leather Sport Interior (standard)

The standard interior offers a balance between performance and luxury by combining Napa leather with a lightweight Space Fabric. This gives you grip, support, and better air circulation – ideal for road or track driving. The dashboard, doors, seat outers and trim area behind the driver and passenger are all trimmed in Carbon Black leather, while the seat inners and door inserts are trimmed in one of four Space Fabric colors. The headlining is trimmed in Carbon Black Alcantara®.



Alcantara® & Leather Interior

Alcantara® is renowned for its lightweight, high-grip properties, making it an ideal material for performance driving. The Alcantara® interior option combines this tactile fabric with leather for a distinctive look. The cabin's headlining, door inserts, seat inners and dashboard inner surfaces are upgraded to Carbon Black Alcantara®, and you can choose from six leather colors for the surrounding dashboard and seat surfaces.



[CLICK HERE TO INDEX](#) ▶

COLOR & TRIM LEATHER

Full Leather Interior

If you choose the Full Leather Interior option, the seat inners and door inserts are upgraded to leather, creating a highly luxurious environment.

You can choose either a single leather color from six available, or select two colors from the full pallet of eight to form a contrast between the seats and door inserts and the dashboard.

[1] Single Color

[2] Dual Color

[CLICK HERE TO INDEX](#) ▶



3.8

COLOR & TRIM CUSTOM

Custom Zoned Interior

The cabin is upgraded with Leather Seats & Surfaces but, to make your 12C truly individual, we've developed a unique Custom Zoned Interior option.* The interior is divided into distinct areas that can be contrasted using 28 dual-color combinations.

* Color Co-ordinated Steering Wheel is an additional option



Driver Zone Interior

Take our unique zoning to the next level by choosing our Driver Zone option.* This distinctive, asymmetrical interior allows you to highlight the driver's space in your desired combination of up to two leather colors and Alcantara®.

* Color Co-ordinated Steering Wheel is an additional option

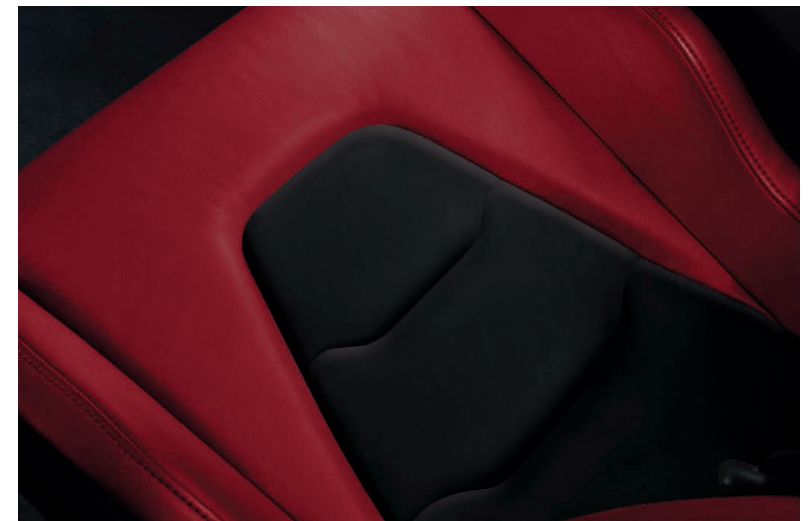

[CLICK HERE TO INDEX](#) ▶

COLOR & TRIM

INTERIOR FABRIC OPTIONS

Space Fabric

Silver



Blue

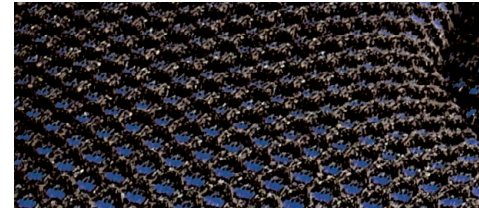

Orange

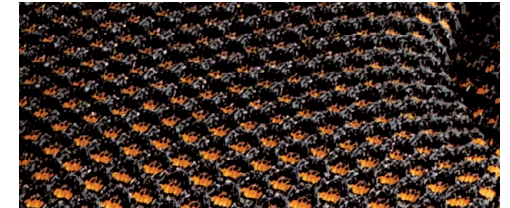

Red



COLOR & TRIM

INTERIOR LEATHER & ALCANTARA® OPTIONS

Fine Napa Leather

Carbon Black



Stone Grey

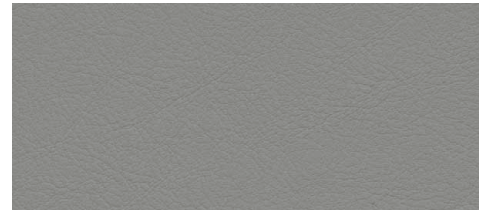

Midnight Blue

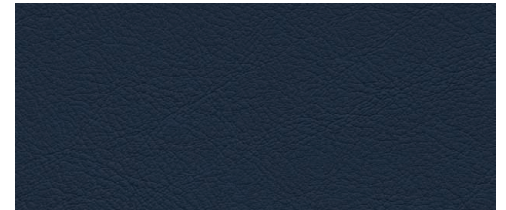

Harissa Red

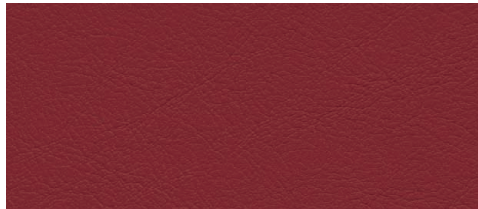

McLaren Orange



Natural Tan

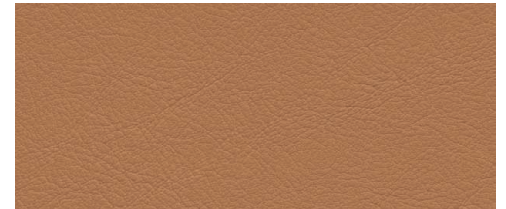

Saddle Tan

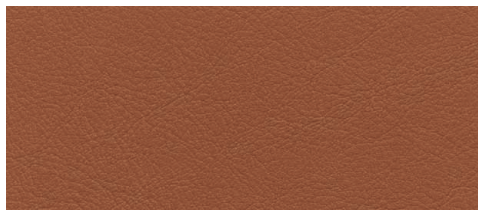

Arabica Brown

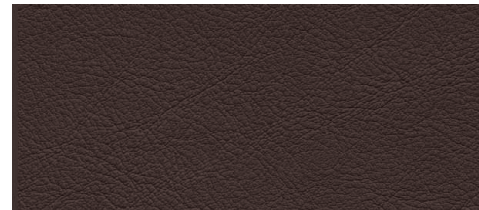

Almond White

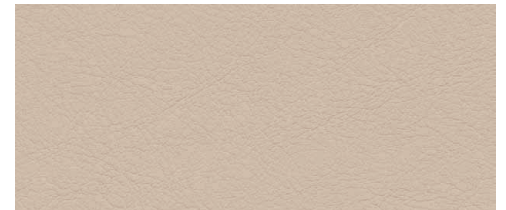

Alcantara®

Carbon Black



3.8

COLOR & TRIM INTERIOR DETAILING

Color Co-ordinated Steering Wheel

With this option you can color-match your steering wheel [1] to your interior. Colored leather is applied to the upper and lower part of the rim.

Contrast Stitching on Dashboard

You can complete your interior design by adding contrast stitching [2] to the dashboard in one of up to nine colors, depending on your chosen interior specification.

[CLICK HERE TO INDEX](#) ▶



The 12C offers an enormous choice of interior trims, not all of which can be illustrated effectively in this issue. To see the full range, please consult with your McLaren retailer or [click here](#) to go to our online MP4-12C configurator. All information is correct at the time of publishing. McLaren Automotive reserves the right to alter specifications and other product information without prior notice. For individual and bespoke options please consult with your McLaren retailer.

3.9

OPTIONS

EXTERIOR CARBON FIBER

Carbon fiber is at the heart of the MP4-12C. The unique, lightweight MonoCell at its core helped us achieve the optimum balance of weight, power and fuel efficiency. You can choose to upgrade your 12C's turning vanes, diffuser, splitter and mirrors to stunning lacquered carbon fiber, to highlight the advanced carbon technology under the skin of your 12C.

[1] Carbon Fiber Mirror Casings

Exterior mirror casings finished in carbon fiber.

[2] Carbon Fiber Turning Vanes

Turning vane panels finished in carbon fiber.

[3] Carbon Fiber Diffuser

Single-piece carbon fiber rear diffuser.

[4] Stealth Pack

Exhaust finishers and Airbrake mechanism finished in gunmetal.

[5] Carbon Fiber Splitter

Front splitter in carbon fiber.

Body-Color Splitter

Front splitter in body color.

Contrast-Color Splitter

Front splitter in contrast color from exterior paint shade.

Carbon Fiber Engine Bay Panels & Covers

The highly efficient McLaren M838T engine is framed by the 12C's glass cover. You can accentuate this area further by specifying the engine's plenum, header tank covers and surrounding engine panels in carbon fiber.

[6] Carbon Fiber Engine Covers

[7] Carbon Fiber Engine Bay Panels

Carbon Fiber Mirror Casings, Turning Vanes & Rear Diffuser



Carbon Fiber Splitter



Carbon Fiber Engine Bay Panels & Covers



OPTIONS

WHEELS & CALIPERS

The optional Lightweight and Super-Lightweight Forged Wheels offer significant weight savings for owners wanting to save precious kilograms and increase performance even further. By using forged alloy, our engineers have stripped out the mass, while maintaining strength. The five-spoke Lightweight Forged Wheels have a technical look and save 13lbs or 12%, when compared with the standard cast wheels. The 10-spoke Super-Lightweight Forged Wheels offer a pure performance look and are 22lbs or 20% lighter.

Standard Wheels

Lightweight Forged Wheels

Super-Lightweight Forged Wheels

Stealth Wheel Finish

The standard silver wheel finish can be changed to a satin gunmetal finish, giving your 12C a striking, more aggressive presence.

Special Color Brake Calipers

You can complete your own personal wheel design by changing the brake calipers from the standard black [1] to red [2], McLaren Orange [3] or silver [4]. If you specify the Carbon Ceramic Brakes, it is also possible to upgrade to a polished finish caliper.

[CLICK HERE TO INDEX](#) ▶

Standard Wheel



● Silver ● Stealth

Lightweight Forged Wheel



● Silver ● Stealth

Super-Lightweight Forged Wheel



● Silver ● Stealth



Brake Calipers

- Black (standard)
- Silver
- Red
- McLaren Orange
- Polished finish
(Carbon Ceramics only)

3.9

[1] Carbon Ceramic Brakes

For the driver who seeks the ultimate in braking performance, durability and reliability on the track, the standard cast iron brakes can be upgraded to the 12C's Carbon Ceramic Brakes, derived from Formula One™. The significantly larger 394mm diameter front rotors and 380mm rear rotors, combined with the unique, heat-resistant properties of the carbon ceramic material, make them more resistant to brake fade and ensure that they perform consistently even when under pressure from repeated, heavy braking. The 12C's carbon ceramic rotors are also matched with larger six-piston front and four-piston rear calipers. These can be personalized in several ways, including a polished finish inspired by the FIA Formula One™ Championship winning car, the MP4-23.

Please note: the service life of even the most durable brake pads and rotors can be reduced by performance driving. As with any braking system, we recommend that they are inspected by a professional after every track event.

Sport Exhaust

For the MP4-12C's stainless steel exhaust system, we designed an innovative mixing box to avoid the use of a conventional, heavy silencer box. By using Inconel, a tough material also found on our Formula One™ cars, we've been able to create a thinner, lighter Sport Exhaust. We've also altered the Sport Exhaust's geometry to deliver a more intense, amplified sound. Its distinctive, rhythmic low rumble is punctuated by powerful acoustics every time you step on the 12C's accelerator and take it up through the gears. Louder and more exhilarating, it creates an unmistakable McLaren sound.

Additional Super-Lightweight Forged Wheels with Corsa Tires

When you're on the track, a specialist tire helps you get the most out of your 12C's performance. We've developed our Corsa tires with Pirelli to offer superior dry-weather grip. Special compound and tread, combined with a unique construction, will help you maximize your lap times when performance driving. This option gives you an extra set of Super-Lightweight Forged Wheels, fitted with Corsa Tires.

Additional Wheels with Winter Tires

For more control in extreme wet or low-grip conditions, Winter Tires are specially developed to deliver increased grip. This option gives you an extra set of standard wheels, fitted with Winter Tires.

[CLICK HERE TO INDEX](#) ▶

OPTIONS

PERFORMANCE OPTIONS



3.9

OPTIONS INTERIOR

Carbon Fiber Interior Upgrade

By choosing the Carbon Fiber Interior Upgrade, you can highlight the 12C's advanced carbon fiber technology in the cabin of your car. The door switch packs [1], steering wheel spokes [2] and center console [3] are all finished in lacquered carbon fiber, replacing the standard metallic components.

Audio & Communications

Like every critical element of the 12C, its onboard entertainment, media and communication systems have been specially designed to our exacting requirements. The result – whether you select the standard system or optional IRIS system – is a bespoke, innovative and truly exceptional multi-media experience.

- Standard seven-inch, portrait touch-screen gives fingertip access to the car's on-board entertainment, media and communication systems.
- Meridian two-channel, four-speaker sound system complete with hard drive media player, AM/FM radio, USB port and integrated support for iPod™ and Microsoft Zune.
- 32GB hard drive; 512MB flash memory.
- Bluetooth connectivity.

IRIS

The IRIS option gives you a significant upgrade to the 12C's media system:

- Satellite navigation.
- Meridian seven-speaker DSP surround sound hi-fi system.
- 64GB hard drive; 1GB flash memory.

Carbon Fiber Interior Upgrade



OPTIONS INTERIOR

[1] Carbon Fiber Sill Panels

[2] Carbon Fiber Wheel Arches

[3] Carbon Fiber Seat Backs

Electric & Heated Memory Seats

The MP4-12C's Electric and Heated Memory Seats offer the ultimate in comfort and control for you and your passenger. The fully electric seats offer two heat settings as well as a three-position memory, while a sophisticated six-way electrical adjust and four-way lumbar adjust mean that you can tailor your seat position for maximum support and comfort on long journeys. When you turn the 12C's engine off and open its distinctive dihedral door, this option's 'easy-entry' feature can automatically move the driver's seat back and down, allowing you to step out of, and back into, the car with greater ease.

[CLICK HERE TO INDEX](#) ▶

Carbon Fiber Sill Panels & Wheel Arches



Carbon Fiber Seat Backs

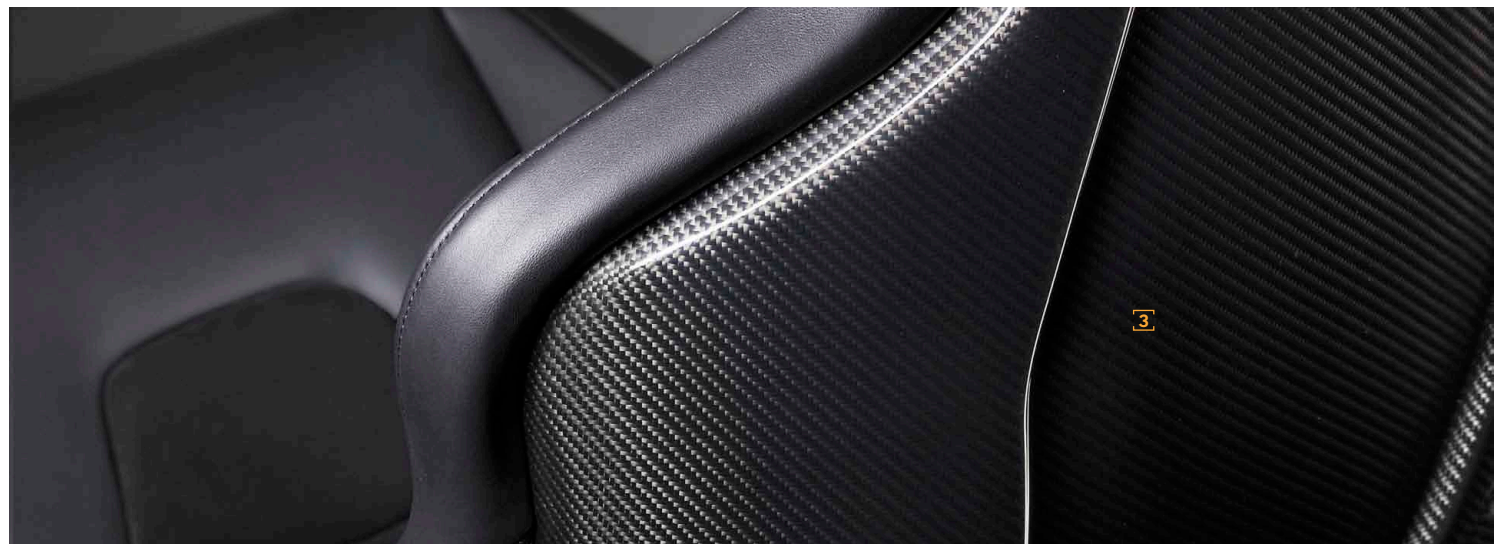

OPTIONS

SAFETY & SECURITY

Parking Sensors (front & rear)

Flush-mounted Parking Sensors on the 12C's front and rear bumpers activate a warning sound within the cabin to make parking easier and safer.

OPTIONS

PRACTICAL

Branded Floor Mats

Driver and passenger Floor Mats featuring MP4-12C branding (edged in high quality leather). A protective matt is also provided in the front luggage cell.

Coin Tray / Ashtray

A Coin Tray / Ashtray can be supplied in the cupholder.

Branded Car Cover

The Branded Car Cover protects your 12C when indoors.

Fire Extinguisher

You can equip your 12C with a Fire Extinguisher, which is securely housed in the luggage cell.

Warning Triangle & First Aid Kit

Lithium Battery Charger

FEATURES TABLE

Body Structure	Single-piece carbon fiber MonoCell Front extruded aluminum impact structure Rear aluminum engine frame and impact structure	Wheels & Tires	Silver finish, cast aluminum, five-spoke design wheels 8.5" x 19" (front) Silver finish, cast aluminum, five-spoke design wheels 11" x 20" (rear) Pirelli P Zero McLaren specification tires 235/35 R19 (front) Pirelli P Zero McLaren specification tires 305/30 R20 (rear) Tire Pressure Monitoring System (TPMS)
Engine	M838T 3.8L V8 turbo engine Power: 592hp @7000rpm Torque: 443lbs ft @ 3000-7000rpm Aluminum block and cylinder heads Aluminum nikasil lined cylinders Dual Variable Valve Timing (VVT) Port Fuel Injection (PFI) Water cooling Four valves per cylinder Twin turbochargers Individual ignition coils Two catalytic converters Stainless steel exhaust system with mixing box	Brakes	McLaren Airbrake Four-piston monobloc aluminum calipers (front & rear) 370mm cast iron brake rotors with forged aluminum bell (front) 350mm cast iron brake rotors with forged aluminum bell (rear) Calipers in black finish with silver McLaren logo
Transmission & Differential	Seven-speed + R Seamless Shift Gearbox (SSG) Pre-Cog gear priming feature Three powertrain & transmission modes (Normal, Sport, Track) Twin multi-plate clutches Compact twin output shaft design Open differential McLaren Brake Steer	Body	Single hinge mounted dihedral doors Standard paint colors (White, Silver, Blue) Front splitter finished in satin dark grey Polypropylene body-color bumpers Aluminum roof, front bonnet & fenders Composite body panels Single pantograph wiper Rear diffuser finished in satin dark grey
Suspension	ProActive Chassis Control (PCC) with hydraulic roll control and adaptive damping Three roll and damping modes (Normal, Sport, Track) Rear Z-bar for additional heave stiffness	Lighting	Bi-xenon headlights with headlight cleaning system LED daytime driving lights Automatic lights Follow me home headlights Rear LED lights Central High-Mounted Stop Lamp Rear dual-function fog/reverse LED lamp Illuminated side markers

Interior

Manual adjustable steering column
 Center console stowage
 Stowage in seat pockets
 Cup holders (x2)
 Sun visors
 Manual seats (with electric height adjust on driver side)
 Black Alcantara® headlining
 Part leather seats with Space Fabric inserts
 Leather steering wheel
 Metal interior components
 (switch-pack surrounds & steering wheel spokes)
 Rocker-mounted branding plate

Telematics

Seven-inch, portrait, touch-screen monitor
 Audio media player
 Picture viewer
 AM/FM radio
 Bluetooth telephony
 USB – Audio in
 iPod™ integration
 32GB hard drive; 512MB flash memory
 Meridian four-speaker sound system

Electrical Features

Lithium-ion battery
 Two keys with unlock/lock/luggage open & mechanical key function
 Touch entry door system
 Keyless entry
 Keyless start
 Dual-zone climate control
 Electric park brake

Practical

Lithium-ion battery charger
 Towing hook
 Tire inflation kit
 Fuel funnel adapter

Interior Controls & Displays

Steering-wheel-mounted rocker shift with Pre-Cog function for gearchanges
 Active Dynamics Panel with Powertrain & Handling switches (Normal, Sport, Track)
 Start/Stop button
 Launch control button
 Winter mode button
 Downforce mode button
 Auto/Manual mode button
 Hazard lights button
 Transmission controls (RND)
 Manual door lock button
 Luggage compartment open button
 Tilt sensor deactivation button
 Engine cover release button
 Cruise control
 One-touch electric windows
 Electrically adjustable and folding heated mirrors (with dip in reverse functionality)
 Trip computer
 Rain sensor
 Rear window de-fogger
 Up-shift indicator
 Battery level indicator
 Oil level measurement via instrument cluster
 Service indicator
 External temperature indicator
 12V accessory socket (x2)

Safety & Security

Exterior & interior secondary mechanical door releases
 Alarm (doors, engine cover, luggage compartment)
 Tilt sensors
 Electronic immobiliser
 Driver & passenger front airbags
 Driver & passenger side head airbags
 Driver & passenger knee airbags
 Passenger Occupant Classification System (OCS)
 Emergency fuel shut-off device
 Traction Control (TC)
 Electronic Stability Control (ESC)
 Hill hold
 Brake pad wear sensor
 Anti-Lock Braking System (ABS)
 Brake rotor wipe technology
 Brake assist technology
 Brake pre-fill technology

FEATURES TABLE

OPTIONS

Exterior	Special Paint	Wheels & Brakes	Lightweight Forged Wheels	
	Elite Paint		Super-Lightweight Forged Wheels	
	Body-Color Splitter		Stealth Wheel Finish	
	Contrast-Color Splitter		Carbon Ceramic Brakes	
	Carbon Fiber Splitter		Special Color Brake Calipers	
	Carbon Fiber Mirror Casings			
	Carbon Fiber Turning Vanes		Entertainment	IRIS upgrade with satellite navigation & upgraded Meridian surround sound system
	Carbon Fiber Diffuser			
	Carbon Fiber Engine Covers			
	Carbon Fiber Engine Bay Panels		Safety & Security	Parking Sensors (front & rear)
	Sport Exhaust			Vehicle Tracking System *
Stealth Pack				
Interior	Full Leather Interior	Practical	Branded Floor Mat Set	
	Alcantara® & Leather Interior		Coin tray / Ashtray	
	Custom Zoned Interior		Branded Car Cover	
	Driver Zone Interior		Fire Extinguisher	
	Color Co-ordinated Steering Wheel		Warning Triangle & First Aid kit**	
	Contrast Stitching on Dashboard			
	Carbon Fiber Interior Upgrade		Additional Wheels & Tires	Additional Super-Lightweight Forged Wheels with Corsa Tires
	Electric & Heated Memory Seats			Additional Wheels with Winter Tires
	Carbon Fiber Seat Backs			
	Carbon Fiber Sill Panels			
	Carbon Fiber Wheel Arches			

* Service may vary by market – please consult with your McLaren retailer

** Standard equipment in specific markets – please consult with your McLaren retailer

McLaren reserves the right to change product specifications at any time without notice or incurring obligation. Rotorussions and images in this communication may describe or depict equipment that may not be available in all markets around the world or may be optional equipment. All information presented herein is based on data available at the time of printing and is subject to change without notice. All performance figures are based on European specification public relations cars as presented in 2011. Fuel economy and CO₂ emissions data are based on EU testing methodology and are taken from 2011 performance data. High performance vehicle usage must only be conducted under controlled track conditions, following the correct driver training, appropriate vehicle inspection and modification, and using the appropriate safety equipment. Always obey all driving laws, drive in accordance with road conditions, and use the McLaren MP4-12C in a responsible and safe manner.

TECHNICAL SPECIFICATION

Engine

Type	M838T
Engine capacity (cc)	3,798
Type	90° V8
Technology	Twin-turbo, Dry sump
Valvetrain	32-valve, DOHC, VVT
Bore x Stroke	93mm x 69.9mm
Compression ratio	8.7:1
Max rpm	8,500
Power	592hp @ 7,000rpm
Torque	443lbs ft @ 3,000-7,000rpm

Transmission

Type	7- speed McLaren Seamless Shift dual clutch gearbox (SSG) with Pre-Cog functionality
Gear ratio (1st)	4.0
Gear ratio (2nd)	2.6
Gear ratio (3rd)	1.9
Gear ratio (4th)	1.5
Gear ratio (5th)	1.2
Gear ratio (6th)	0.9
Gear ratio (7th)	0.7
Final-drive ratio	3.3
1st (mph / 1,000rpm)	6.0
2nd (mph / 1,000rpm)	9.1
3rd (mph / 1,000rpm)	12.5
4th (mph / 1,000rpm)	16.2
5th (mph / 1,000rpm)	20.6
6th (mph / 1,000rpm)	26.4
7th (mph / 1,000rpm)	34.8

Suspension

Type	McLaren ProActive Chassis Control Double wishbone independent suspension
Damping & Roll Modes	Normal / Sport / Track

Wheels & Brakes

Wheel Size (F/R)	8.5" x 19" / 11" x 20"
Tire Type	McLaren spec Pirelli P_Zero
Tire Size (F/R)	235/35 R19 / 305/30 R20
Standard Brakes	Cast iron rotors with forged aluminum hubs
Standard Brake Size (F/R)	370mm / 350mm
Standard Brake Calipers (F/R)	4 piston / 4 piston
Optional Brakes Carbon	Ceramic Rotor
Optional Brake Size (F/R)	394mm / 380mm
Optional Brake Calipers (F/R)	6 piston / 4 piston

Vehicle Dynamics

Differential	Open differential with Formula One™ Brake Steer
Stability control modes	Winter / Normal / Sport / Track
Driver aids	ABS, traction control, ESC, launch control

Body

Type	McLaren Carbon Fiber MonoCell with aluminum front and rear structures
Aerodynamics	Active Airbrake
Wheelbase	2,670mm (105.12")
Length	4,509mm (177.52")
Width	1,908mm (75.12")
Height	1,199mm (47.2")
Track (F/R)	1,656mm / 1,583mm (65.2" / 62.3")

Efficiency

Power to weight*	455hp/ton
------------------	-----------

* with lightweight options

Performance

Maximum speed	205mph
0-60mph	3.0s (with Corsa tires)
0-402m (¼ mile)	10.9s @ 134mph

Braking

124-0mph	404ft
62-0mph	100ft

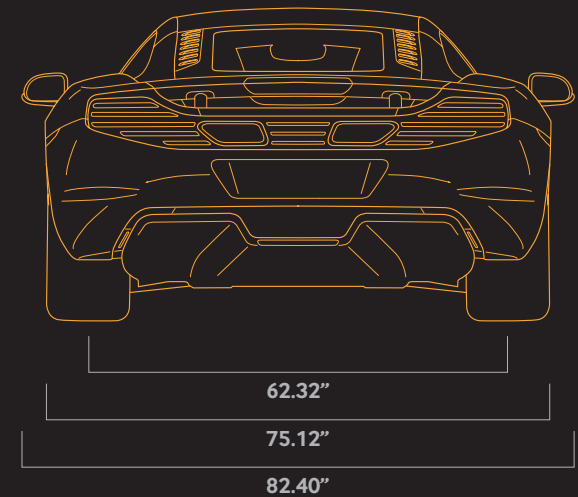
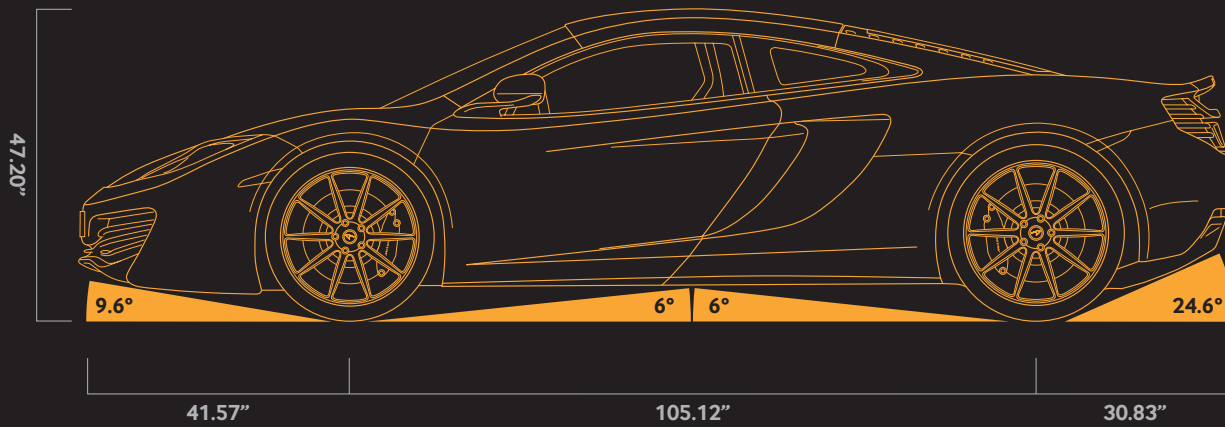
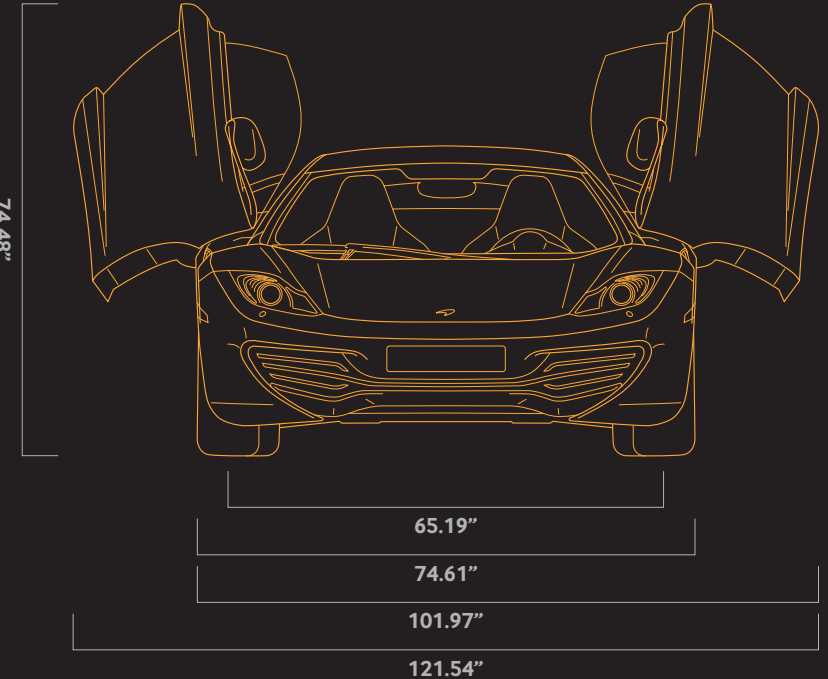
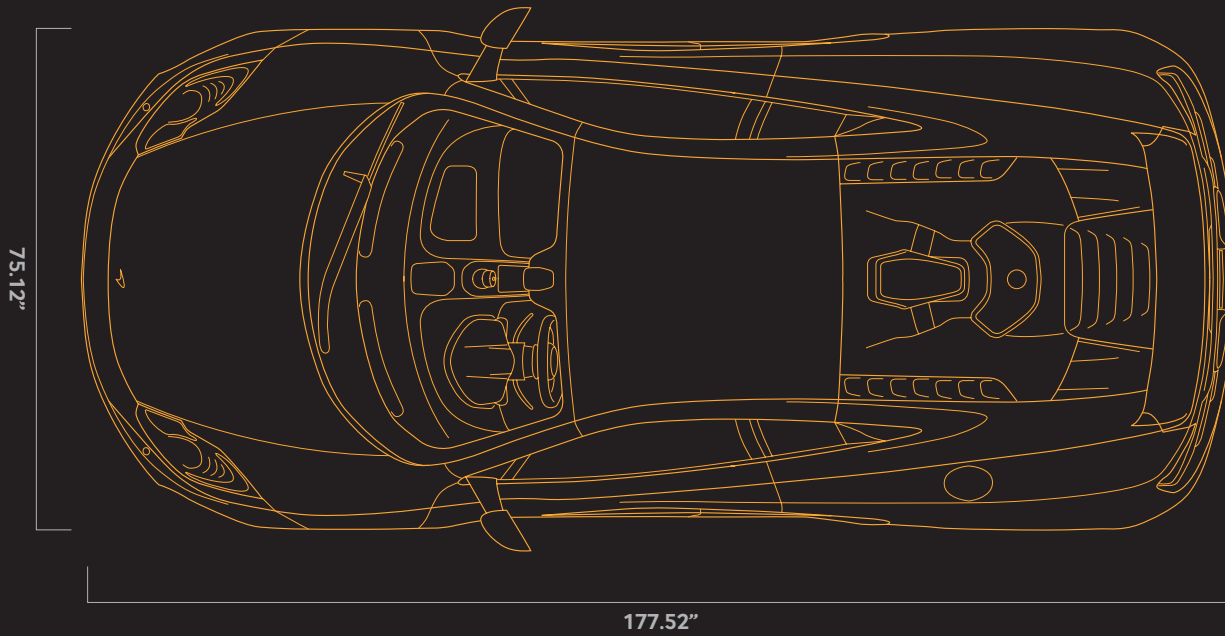

OVER TO YOU...

The MP4-12C is a new kind of sports car built to satisfy the diverse demands of 21st century driving. From crowded city streets to inter-continental highways. From sinuous mountain passes to wide-open race tracks. Night or day. Rain or shine. Hugely powerful yet highly efficient. Blisteringly fast but wholly accessible. Compact and spacious. Light and strong. Understated yet unmistakable. MP4-12C: 'Pure McLaren,' designed for you.



[CLICK HERE TO INDEX](#) ▶