



MASERATI

GHIBLI



Ghibli



TARGA FLORIO: PROVING GROUNDS FOR THOSE WITH SOMETHING TO PROVE.

In the early 1900s, sleepy villages and rural, rutted trails in the mountains of Sicily were suddenly overrun with roaring, speeding cars, all vying to win the title of an automobile race called Targa Florio. Dreamed up by Vincenzo Florio, a wealthy Italian businessman, this treacherous, winding endurance course was as popular with race fans as it was with local villagers, who walked for miles to catch a glimpse of the glorious machines and their drivers. Maserati has always had a huge presence at Targa Florio. Maserati drivers and their cars were famous: from Alfieri Maserati in the Tipo 26 to Maria Teresa de Filippis in her Maserati A6GCS. For decades, the race was among the most important in the world until it was deemed too dangerous to run. Now, the Rally Targa Florio is a noncompetitive event for vintage automobiles, and it is no coincidence that historic cars bearing the Trident inspire fans even today.





MASERATI A6GCS/53 AT THE 1955 TARGA FLORIO,
DRIVEN BY MARIA TERESA DE FILIPPIS AND LUIGI BELLUCCI.



MASERATI GHIBLI ON THE ROUTE OF THE TARGA FLORIO.
THE TIMES HAVE CHANGED, THE ROUTE AND INSPIRATION REMAIN.





*Ghibli shown in Rosso Energia with 20-inch Urano machine-polished wheels.
In the background, the original Maserati 3500 GT Touring.*





Ghibli S shown with Maserati Tipo 63 classiche.







GHIBLI: THE LATEST FRUIT OF ITALIAN INNOVATION.

While the Targa Florio has been transformed into a showcase event for vintage and classic cars, its lessons of sheer determination, resilience and the rewards of hard work are a reflection of its Sicilian hosts. In just the past two decades, entrepreneurs have turned Sicily into Italy's most prolific wine-producing region. It's the same kind of ingenuity and pursuit of quality

that has long established Maserati as one of the world's finest automakers. So, while there is great pride in the historical accomplishments of the brand, the focus is always forward. The Maserati Ghibli is the proud product of both the collective knowledge and the latest, most inventive thinking of this legendary marque.





Maserati

Ghibli

Ghibli



THE BEAUTY THAT LIES WITHIN IS,
AT ONCE, SIMPLE AND COMPLEX.

For aficionados of both fine wine and motorcars, quality and character are things that are ascertained through sight, smell, touch—not by simply relying on a name or a label. Opening the door of a Ghibli is much like appreciating and evaluating an excellent vintage ... its opulent materials and handcrafted quality speak to all the senses. Proof that what is on the inside is what counts most of all.







European model shown.

EXTERIOR DESIGN

SCULPTED BY MASTERS. INSPIRED BY NATURE.

The Maserati Ghibli is a masterpiece of design, emphasizing both elegance and sportiness. What makes the Ghibli's sleek and flowing lines so dramatic are the front and rear wheel arches, which merge into a single central form to create a breathtakingly beautiful silhouette, its gleaming metal making a solid statement, much like a wind-carved stone peak. The front of the Ghibli is dominated by the distinctive Maserati grille, with concave vertical fillets inspired by the current GranTurismo and

the A6GCS Berlinetta, a classic Maserati of the past. The grille's traditional oval shape narrows at the top, where it meets the aggressive headlights that make skillful use of LED daytime running lights to emphasize the car's powerful persona. Continuing along the side, two curved lines merge together before giving way to the muscular rear end. Here, the tapered design of the rear deck is the natural continuation of the cabin, while the two LED taillights provide continuity with the wheel arches. The triangular C-pillar and the frameless door windows give the Ghibli the appearance of a sleek and agile sports coupé, even though its length and wheelbase are among the longest in its class.

OUR HIGH STANDARDS
CAN BE DISTILLED TO ONE
VITAL INGREDIENT: PASSION.

The process and precision that go into every Maserati cannot be overstated. State-of-the-art engineering is apparent throughout the car: from the chassis to the transmission, through to the suspension and brakes, every component plays a part in delivering levels of comfort and performance that only Maserati drivers can enjoy. This passion for quality enhances reliability, for which the Maserati Ghibli is renowned. As part of the car's exhaustive development program, Ghibli prototypes were driven in the most extreme weather conditions across South Africa, Morocco, Sweden and New Zealand. Such thorough action is the key to Maserati's continued success. Perhaps it is no coincidence that so many of our drivers share this trait themselves.





ff
ARGA
LORIO

104

1906 - 1956

CINQUANTE MARIO









*Ghibli shown with 21-inch Titanio forged wheels.
Polished calipers not available in the North American market.*





European model shown.





THE CRAFT COMES FROM THE HANDS. THE KNOWLEDGE THAT DELIVERS IT IS A GIFT.

The Maserati Ghibli's unique personality is also expressed in its luxurious cabin. The seats are upholstered in soft leather, which can also be specified for the dashboard and doors in dual color combinations for either a sporty or more elegant interior look. Exquisite leather stitching reflects the very finest traditions of Italian craftsmanship.



European model Ghibli with Nero leather interior.



MASERATI
TOUCH CONTROL

GranTurismo

R
N
D
M
+



Cuoio premium leather, with Zegna dark gray silk with light gray contrast stitching.

THE ERMENEGILDO ZEGNA-DRESSED MASERATI

CONNECT WITH THE HAND, AND YOU WILL REACH THE HEART.

Dedicated craftspeople choose to work with only the finest materials available. It is fitting, then, that Maserati has commissioned Ermenegildo Zegna, one of the world's foremost fashion houses and producer of fine fabrics. The company, still in family ownership after more than 100 years, has much in common with Maserati, with its Italian tradition of excellence and innovation. The partnership will produce new, exclusive Zegna Edition interiors, creating a dynamic, contemporary look for the Ghibli. The models stand out from the current Ghibli range thanks to special color finishes, materials and trims. They are a tribute to the harmony of opposites, a stylistic synthesis

between sophisticated design and the latest technology. This exclusive new interpretation targets the most discerning drivers and passengers. They know luxury through a tactile sense, and will no doubt feel fully indulged, surrounded by the truly exquisite materials chosen for the Zegna interiors. The finest leather is combined with natural-fiber Zegna Mulberry Silk inserts on the seats, embellished with a hand-stitched micro-chevron. Seating features a central silk insert with a macro-chevron weave. Door panels, roof lining and sunshades are covered with Zegna Jersey Silk. Three different color combinations of leather, silk and contrasting stitching will be offered. In all, the Zegna Edition Ghibli marks the first milestone toward the renewed future product line-up for Maserati, further enhancing the character and aesthetic value of this iconic marque.



GHIBLI ZEGNA PACKAGES



Cuoio Premium Leather / Dark Gray Zegna Silk with Light Gray Contrast Stitching



Rosso Premium Leather / Dark Gray Zegna Silk with Light Gray Contrast Stitching



Nero Premium Leather / Dark Gray Zegna Silk with Light Gray Contrast Stitching



ON BOARD

DELIGHT IN DETAILS FOCUSED ON PERFECTION.

The smooth lines of the dashboard surround the Ghibli's occupants with an atmosphere of opulence: two side panels converge in the center, drawing in the top section that features the traditional Maserati clock and aluminum detailing. The precision of the Trident logo that is embossed on the headrests is a clear indication of the immense care given to the seats. Their wraparound form enhances the interior's sporty look while still delivering the highest levels of comfort. The soft

leather used for the upholstery has a natural texture that makes it particularly pleasant to the touch. The electric front seat adjustment system on the Ghibli makes it easy to achieve the perfect driving position. The Maserati Ghibli is equipped with the very latest information and entertainment system that makes life on board either relaxing or invigorating, depending on your mood.



COMFORT FEATURES

The Maserati Ghibli features several available comfort features. These include the standard exterior electrochromic rearview mirrors that darken progressively as light intensity increases and an optional rear windscreen sunshade to enhance privacy and screen occupants from sunlight. For greater thermal insulation and quieter journeys, the Ghibli features double-laminated, acoustic front side glass windows (optional for rear side glass).

CLIMATE CONTROL SYSTEM

The automatic dual-zone climate control automatically adjusts the intensity of the ventilation in relation to the outdoor temperature, and allows those onboard to select their own individual heat settings. With 13 ventilation outlets, the system is able to cool or heat the car extremely rapidly and maintains the temperature by means of the Maserati touch control display or the control panel beneath it. The system is fitted with a humidity sensor that is automatically programmed to reduce the moisture content of the air as soon as the windows start to fog up. Standard for all Ghibli models.

KEYLESS GO / KEYLESS ENTRY

In the world of Maserati, small details are everything—right down to the design of the remote aluminum key fob, which reflects the style of the Ghibli and incorporates Keyless Go technology. The standard keyless entry function enables the driver to open the doors or trunk without ever touching the key fob. Once inside the car, the driver needs only to press the ignition button to start the engine. Standard for all Ghibli models.

STORAGE COMPARTMENTS

The interior of the Maserati Ghibli features numerous storage compartments. Along with the spacious, illuminated, climate-controlled glove box, there are two concealed cupholders in the central tunnel and a handy cubbyhole with AUX-IN and USB docks for the connection of remote devices. Underneath the front armrests, there is another illuminated, climate-controlled compartment, with two more cupholders and a 12V power outlet. In the rear, the bench seat is divided by a fold-down central armrest that can be equipped with a 12V power source and a USB port.

EASY TRUNK ACCESS

The Maserati Ghibli features a trunk that is designed to provide the very best in space and versatility. Its generous capacity of almost 18 cubic feet accommodates large suitcases with ease, while providing convenient features such as trunk interior light, a handy 12V power outlet and chromed tie-down rings to connect the luggage net. The rear bench seatback can also be folded down asymmetrically for transportation of particularly large items.

The Power Trunk Lid feature enables several ways of automatically opening and closing the trunk: by using the key fob, by pressing a button on the interior door panel or the buttons of the trunk lid itself, or by simulating a kick under the rear bumper. Optional for all Ghibli models.

SIRI VOICE COMMANDS

For Ghibli drivers with an iPhone® 5 or 6, the Siri system acts as their personal assistant, allowing them to perform numerous tasks using voice commands. Through simple voice commands, without taking your eyes off the road, it is possible to make a call or access music, messages, reminders, emails, information services—and much more—in eight languages. Standard for all Ghibli models.

HARMAN KARDON PREMIUM SOUND SYSTEM

For music connoisseurs seeking more power, more dynamism, and an extra dimension of emotional realism, the optional Harman Kardon Premium Sound System brings new levels of audio refinement to the Maserati Ghibli. Utilizing the very latest in digital technology, at the heart of the system there is a state-of-the-art 900-watt amplifier delivering excellent sound quality, whatever the source: radio, CD, iPhone® or any other similar device. Twelve independent channels are employed, providing a truly inspirational experience that releases all the subtle nuances of the original recording. With ten high-powered speakers carefully positioned throughout the cabin, the system produces 360 degrees of sublime sound reproduction irrespective of where the listener is seated. A special high-performance subwoofer handles the low-end frequencies with ease, while the mid-range drivers and tweeters ensure that every instrument makes its presence felt on this virtual concert platform. Optional for all Ghibli models.



Carbon Fiber trim.

Bowers & Wilkins

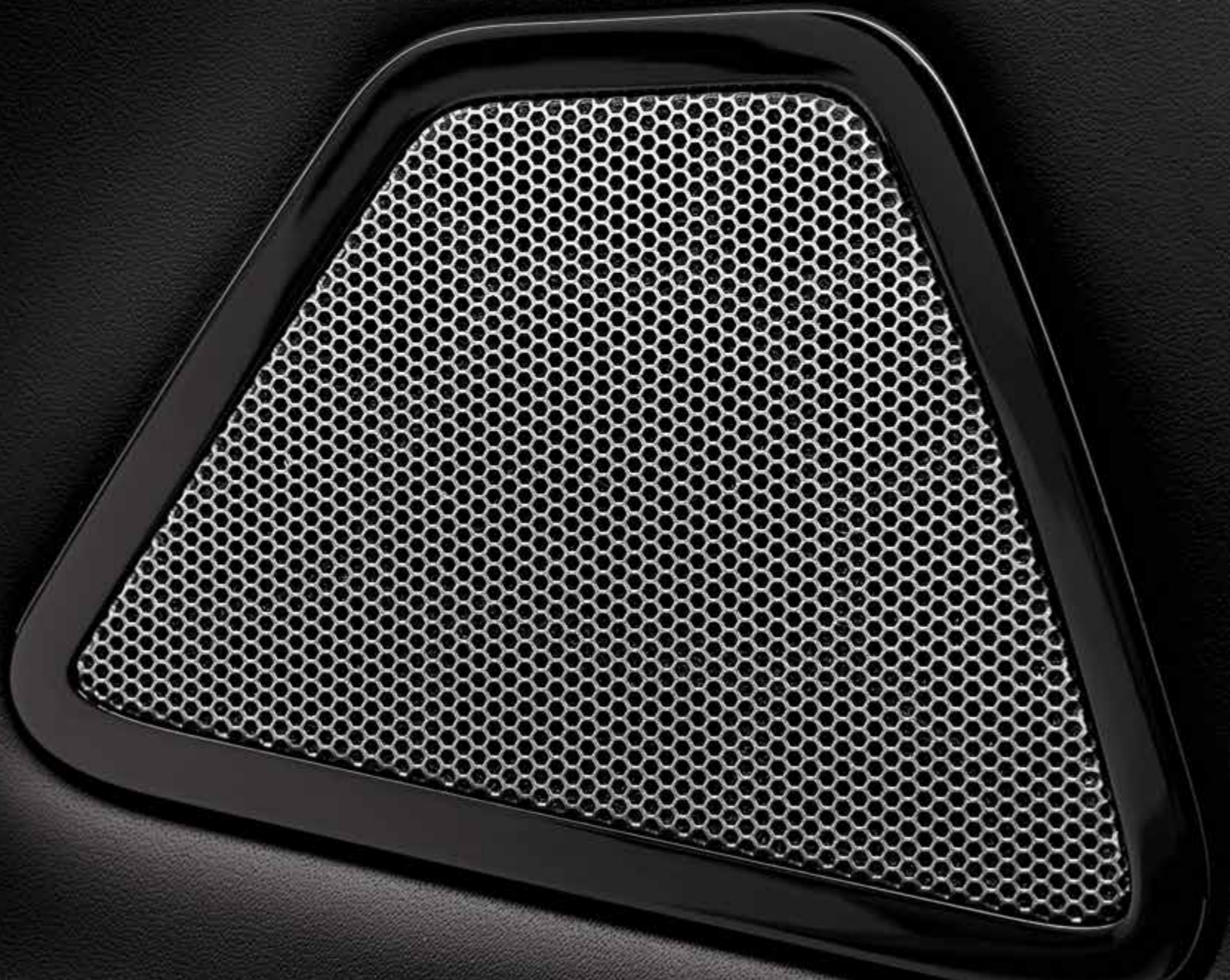

BOWERS & WILKINS

EACH NOTE IS DELIVERED THE WAY THE MUSICIAN INTENDED.

Uncompromising automotive excellence is a Maserati promise that extends to every aspect of the driving experience, including providing immersive concert-hall acoustics in the Maserati Ghibli. Its new-generation premium surround system, created in association with high-end sound specialists Bowers & Wilkins, offers a sound experience that is just as thrilling as Ghibli's distinctive, throaty exhaust note. This optional hi-fi system reproduces every subtle note to perfection, with

unparalleled dynamic purity. The system is architecturally designed and enhanced with digital features to ensure a rich sound experience in every position of the interior, so everyone in the car reaps the audio benefits. It is stunning sound for an astounding car.



INNOVATIVE MATERIALS

The speakers installed in the Ghibli benefit from the very latest technology and materials, such as Kevlar® and aluminum. These provide the ideal combination of lightness and rigidity, and extend the resulting sound to the very limits of human hearing. For the very best bass sounds, the speaker cones are made of Rohacell®, a material normally used in the aeronautics industry.

INTEGRATED ACOUSTICS

The Bowers & Wilkins Premium Surround Sound System includes a 16-channel, 1,280-watt amplifier that blends perfectly into the car's interior design, thanks to painstaking work on the layout of the sound sources. Fifteen speakers are located in the dashboard, doors and rear shelf to deliver the ultimate in acoustics without compromising the elegance of the cabin.

CONFIGURED TO PERFECTION

The tuning of a sound system is a sophisticated art, requiring countless hours of listening by the most highly trained ears. The Ghibli's Premium Surround Sound System has been configured by the engineers responsible for the Bowers & Wilkins 800 Series Diamond speakers—the ones used in London's famous Abbey Road Studios.

SURROUNDED BY SOUND

The HARMAN QuantumLogic™ Surround Sound processing system recognizes and isolates the various elements in an audio track—for instance, the musical instruments, the voices and the internal reverb. These are separated and processed to provide crystal-clear sounds with the highest possible definition.

TRUE SOUND RESTORED BY CLARI-FI

When music is played on a digital device, it is digitally compressed, which inevitably removes many of the subtle audio details that were originally recorded. To rectify this, the Bowers & Wilkins System features a special music restoration process called Clari-Fi, which instantly scans all types of compressed audio files and intelligently corrects any deficiencies detected. As a result, the missing highs and lows are recaptured, vocals are restored to their natural tone, and distortions are removed.



European model shown.

THE MASERATI GIBLI RANGE

UNDER EVERY HOOD, A RICH RACING HERITAGE.

During the development of the Ghibli, one of the main aims of its designers and engineers was to capture the passion and excitement of Maserati's competition past. Under the hood of each Ghibli is an engine specifically designed to deliver the power needed to reach that goal—and to go beyond. The Ghibli is powered by a versatile 345 HP, 3.0-liter twin-turbocharged V6 engine. The 404 HP V6 engine of the Ghibli S and Ghibli S Q4 delivers thrills with every mile and through

every turn. Its driver connects to the Maserati racing heritage simply by stepping on the accelerator. Driving has never been more rewarding—even for the most demanding of automotive enthusiasts.

THE UNMISTAKABLE GHIBLI

POWER AND EFFICIENCY.

The Maserati Ghibli's twin-turbocharged V6 engine has been designed to achieve the lowest possible fuel consumption and CO₂ emissions, while at the same time delivering extremely high performance. The numbers are a clear indication of Ghibli's sporting prowess: 345 HP and a top speed of 163 mph. From a standstill, the Maserati Ghibli accelerates to 60 mph in 5.5 seconds. The Sport button on the transmission tunnel activates the overboost function, allowing the engine's torque to soar. This six-cylinder engine features modifications that cut fuel consumption, while

sacrificing little in the way the car responds to the accelerator. The twin-turbo system has two intercoolers, while the engine's aluminum alloy crankcase and cylinder heads keep the weight of the car low and ensure the best possible responsiveness and handling. A compact, lightweight exhaust system includes an air-valve system capable of adding extra drama to the Ghibli's stirring exhaust hole. In ICE and Normal modes, the valves remain closed, keeping the engine noise discreet and understated. However, when the Sport button is pressed, the bypass valves open up to release a formidable roar.





THE RESPONSIVE GIBLI S

A POWERFUL DRIVING EXPERIENCE.

At the wheel of the Ghibli S, the driver enters a whole new dimension of luxury, refinement, power and exhilaration. According to one's mood, the car delivers calm and relaxation or excitement and adrenaline in equal measure. With its 3.0-liter V6 engine generating 404 HP, and two parallel-mounted, low-inertia turbochargers that help prevent turbo lag, Ghibli S responds instantly to every command and produces the kind of performance for which Maserati is world renowned.

In addition, the engine features highly innovative engineering solutions, including a high-pressure direct-injection system, to help improve fuel efficiency. The driver can choose from three different engine modes: Normal, Sport and the new ICE (Increased Control & Efficiency). This mode, developed to reduce fuel consumption, emissions and noise, delivers a more measured throttle response, for smoother driving. The Ghibli S accelerates from 0 to 60 mph in 4.9 seconds with a top speed of 177 mph. USA model only, not available in Canada.



THE VERSATILE GIBLI S Q4

SPLIT-SECOND RESPONSE TIMES WHEN THEY ARE NEEDED MOST.

The Ghibli S Q4 is equipped with an innovative on-demand intelligent all-wheel-drive system capable of combining exhilarating driving pleasure with utmost safety on all road surfaces. Normally, it is up to the rear-wheel-drive system to transfer the Ghibli S Q4's 404 HP to the terrain, but if the road surface becomes slippery or the wheels lose grip, the system instantaneously (in just 150 milliseconds) transfers the necessary drive force to the front wheels. In terms of handling, the

adoption of front double-wishbone and rear five-arm multilink suspension combines comfort with sporty handling, while the eight-speed ZF automatic transmission is controlled by auto-adaptive software able to switch from the smooth gearshifts of Auto Normal mode to the Manual Sport mode, which gives the driver full control over all gear changes. The Ghibli S Q4 delivers impressive acceleration, going from 0 to 60 mph in just 4.7 seconds and with a top speed of 176 mph.



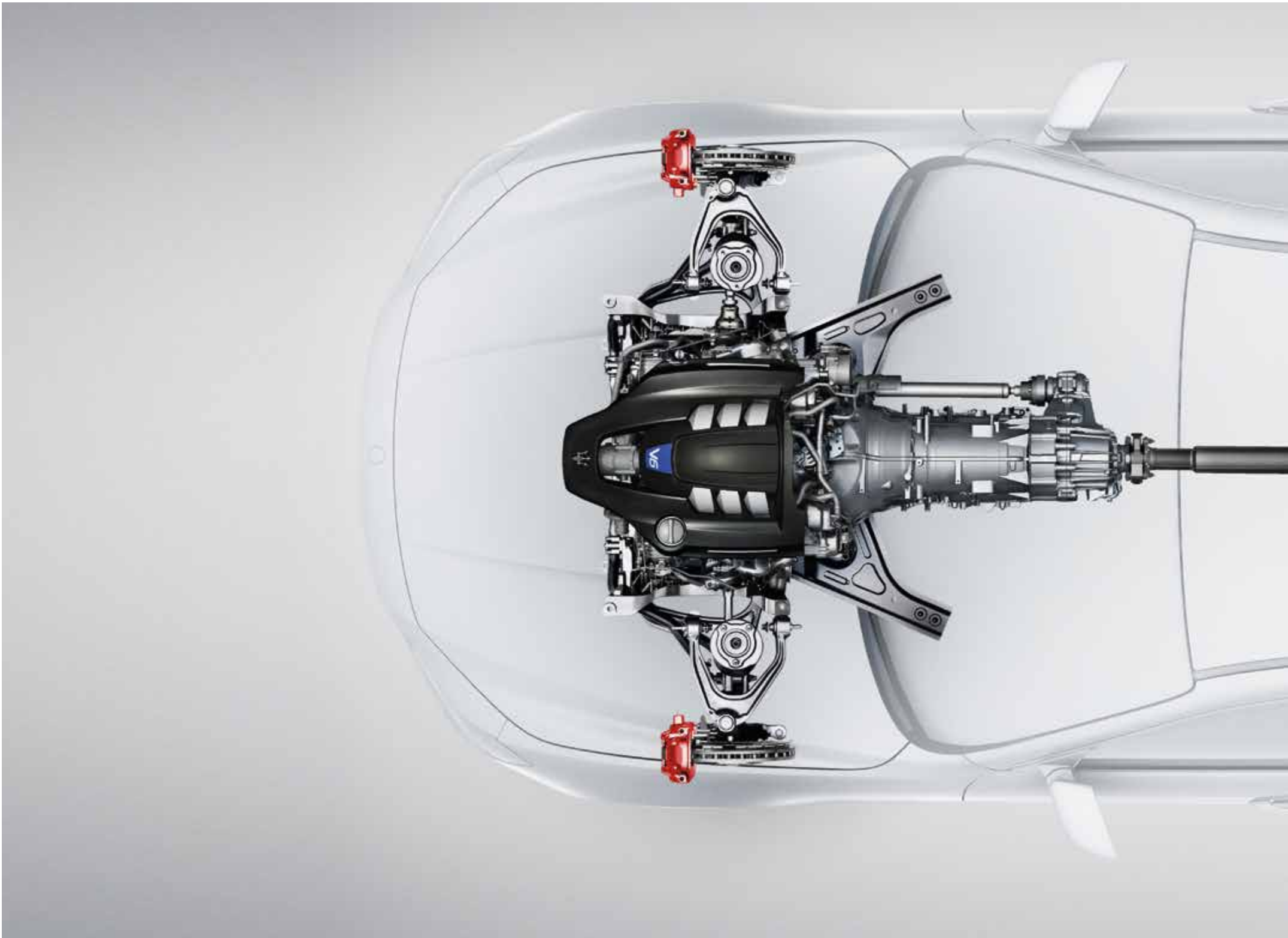

THE GHIBLI S Q4 FEATURES AN ALL-WHEEL DRIVE SYSTEM THAT SUPPLIES TRACTION SEAMLESSLY ON DEMAND.



TECHNOLOGY AND SAFETY

THE TRANSMISSION IS NOT A PIECE OF ART: IT IS A GALLERY.

The Maserati Ghibli benefits from the sophistication and refinement of the latest-generation eight-speed ZF automatic transmission. Lightweight, precise and easily capable of coping with the car's high-performance engines, it uses auto-adaptive software to recognize the driving style and road conditions, and then alters the gear-changing mode accordingly. The last two gears, seventh and eighth, have been specially calibrated to reduce fuel consumption and increase comfort on long, high-speed journeys.

On the Maserati Ghibli, the front-mounted gearbox transmits the drive to the rear wheels by means of a dual-section articulated driveshaft. This is coupled to a limited-slip mechanical differential, with an asymmetric locking function that allows locking of 35 percent during traction and 45 percent during release. There are five operating modes, selected using the buttons by the gear lever: Auto Normal, Auto Sport, Manual Normal, Manual Sport and ICE (Increased Control & Efficiency).





AUTO NORMAL MODE

This preset mode provides smooth gearshifts at low revs to maximize ride comfort and minimize fuel consumption. When a more sporty style of driving is recognized, upshifts automatically take place at higher engine speeds.

AUTO SPORT MODE

The gearshifts are faster and occur at higher revs for a much more sporty driving style.



MANUAL NORMAL MODE

The driver can change gear using the optional paddles behind the steering wheel or the lever on the central tunnel. The system automatically shifts up a gear as the maximum engine speed approaches, and shifts down in the same manner.

MANUAL SPORT MODE

The driver takes full control of the transmission: gearshifts are quicker and sharper, and the engine can be pushed right to the limit without the system intervening. The only automatic feature is downshifting if the revs drop too low.



ICE (INCREASED CONTROL & EFFICIENCY) MODE

Developed not only for use in icy conditions, this mode is intended to ensure an even quieter, smoother ride, and also a reduction in fuel consumption. In ICE mode, gearshifts take place automatically and are almost unnoticeable, for unrivaled ride comfort.



SUSPENSION AND BRAKING

For a car with the longest wheelbase in its class, the Ghibli's roadholding and handling are outstanding. Meanwhile, its occupants enjoy the highest levels of safety. A combination of aluminum and steel ensures that the car's weight distribution is ideally balanced, while special stiffening crossmembers deliver exceptional torsional rigidity.

In keeping with Maserati traditions, the Ghibli features a highly sophisticated suspension setup. The aluminum arms of the double-wishbone front suspension are higher up for more precise handling, while the five-arm multilink system at the rear provides the perfect blend of comfort and agility. Particular attention has been focused on weight reduction: a large number of suspension components are made of lightweight aluminum, and the front stabilizer bar is hollow.

The Ghibli can also be equipped with the optional Skyhook suspension, with new shock absorbers featuring continuous variable damping. The basic setting gives priority to ride comfort, but if more dynamic handling is required, the driver presses the Suspension button on the central tunnel and the shock absorbers immediately stiffen, significantly reducing load transfer during fast cornering.

All Ghibli models are equipped with dual-cast discs that combine the strength of cast iron with the lightness of aluminum to help reduce the unsprung mass. Braking power is provided by efficient monobloc calipers, with six pistons at the front and four at the rear acting on ventilated, cross-drilled discs: 360 mm x 32 mm (front) and 350 mm x 28 mm (rear).



These brakes not only deliver extremely short stopping distances, but are highly resistant to brake fade when the car is driven hard and fast over long distances. The servo-assisted hydraulic steering system ensures that the driver receives the very best feedback from the steering wheel, with no annoying feel of artificial assistance when cornering at high speeds. Specifically designed to make driving as enjoyable as possible, the Ghibli's steering system is light and responsive, even when parking. This precision is further enhanced by an aluminum steering box, specifically developed to suit the front suspension layout.

MASERATI STABILITY PROGRAM (MSP)

The Maserati Stability Program (MSP) is an advanced electronic stability control system that reduces torque from the engine and activates the brakes if the vehicle begins to deviate from its normal trajectory or if a skid is detected. All this happens in just a few milliseconds.

The system combines a number of devices including Anti-Slip Regulation (ASR), which reduces wheelspin and improves traction, and Motor Spin Regulation (MSR), which prevents wheels from locking up when changing down suddenly. The Antilock Braking System (ABS) and Electronic Brake-force Distribution (EBD) monitor the car's braking, stopping the wheels from locking and distributing the braking force between the front and rear axles. A Brake Assistance System (BAS) then recognizes emergency stops and boosts the pressure in the hydraulic circuit for the ultimate in stopping power.

TIRE PRESSURE MONITORING SYSTEM (TPMS)

The Tire Pressure Monitoring System (TPMS) is a device that continuously monitors tire pressures by means of sensors fitted inside the wheel rims. The tire pressure is shown on the display at the center of the dashboard, and a beeper and warning light alert the driver if this drops below the optimal level or in the event of a puncture.

CRUISE CONTROL

The Maserati Ghibli comes equipped with Cruise Control, operated from the steering wheel. The set speed is shown on the display at the middle of the instrument panel and is maintained even when the road climbs or descends—the system makes the car accelerate or decelerate accordingly.

PARKING SENSORS AND REVERSING CAMERA

To assist with maneuvering in tight spaces, the Maserati Ghibli comes equipped with parking sensors housed in the front and rear bumpers. Beeping noises increase in frequency as the obstacle approaches, while the TFT display at the center of the instrument panel shows the car surrounded by symbols which light up in green, yellow or red, depending upon the remaining distance. In addition, there is a rearview camera, fitted close to the trunk lock that shows a view of what is behind the car on the Maserati Touch Control display.

ADAPTIVE FRONT LIGHTING SYSTEM (AFS)

The outstanding lighting provided by the bi-Xenon headlights is further enhanced by the AFS, which automatically adjusts the width and depth of the beam. This is made possible by a camera mounted in the rearview mirror and sensors that monitor several different parameters, including the lights of other road users, the car's speed and the way it is being driven. If the road ahead is empty, the beam expands to its maximum width and depth for the best visibility, with no need to switch manually to full-beam mode.

The advantages offered by the AFS system are perceived especially in case of bad weather and for motorway or town driving. In these conditions the system adjusts automatically to increase visibility and driving safety.

ELECTRONIC PARKING BRAKE (EPB)

The Ghibli is equipped with an Electronic Parking Brake (EPB) that is engaged via a control on the gear lever surround instead of a conventional mechanical lever. If necessary, it can be used when the car is moving: the system communicates with the MSP and acts on all four wheels to obtain an immediate braking action (a deceleration of 0.5 g), without any loss of stability, until the control is released.

HILL HOLDER

To help the driver when starting off on an uphill slope, the Ghibli comes with the Hill Holder system. On a gradient, this device keeps the car braked for a short time, thus allowing the driver's foot to move from the brake to the accelerator pedal without the car rolling backwards.

BLIND SPOT ALERT (BSA) AND REAR CROSS PATH (RCP)

As its name suggests, the Blind Spot Alert (BSA) system monitors the zones around the driver that cannot be seen in the door mirrors. When a vehicle enters one of these areas, a warning triangle appears in the door mirror; should the driver then activate the indicator to change lane, a warning is sounded. The Rear Cross Path (RCP) works in a similar way, emitting the same warning when an unseen vehicle is detected approaching from the right or the left as the car reverses out of a parking space.



BI AHEAD
10

RES+
CRUISE
SET-
ON/OFF

PHONE
MEDIA
NAVIGATION
CLIMATE

200
180
160
140
120
100
80
60
40
20
0

5
4
3
2
1
0



The Supplemental Restraint System (SRS) consists of seven air bags designed to provide added protection along with the seat belt system.

Maserati made passive safety a top priority when designing the Ghibli. To provide the best possible protection for its occupants and help it achieve its aim of a 5-Star Safety Rating by EURO NCAP and US NCAP, it features the latest-generation air bag system and a special front-end crumple structure.

AIR BAGS

The Maserati Ghibli comes equipped with seven air bags. Two front air bags, both dual-stage, shield the driver and front passenger in the event of collision, while their torsos and hips are further protected by two side air bags located in the front seats. There are also two window air bags fitted in the roof next to the central pillar that cushion the heads of the front and rear passengers if the car is struck from the side. Finally, a seventh air bag protects the driver's legs.

SEAT BELT PRETENSIONERS AND ACTIVE HEADRESTS

The front seat belts are fitted with electronically controlled pyrotechnic pretensioners and the latest-generation load limiters. The system communicates with a sensor to determine the seriousness of a collision, and then activates with precisely the right amount of force to reel in the optimum length of belt. If the car is hit from behind, the active headrests of the two front seats automatically move in closer to the occupants' heads to reduce the risk of whiplash injury. Both side seats at the rear are fitted with ISOFIX fasteners for child seats, ensuring that the youngest passengers are properly protected as well.



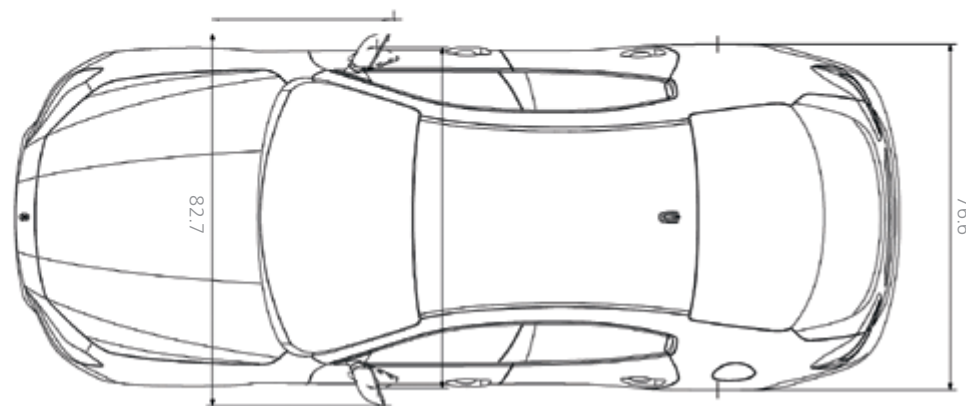
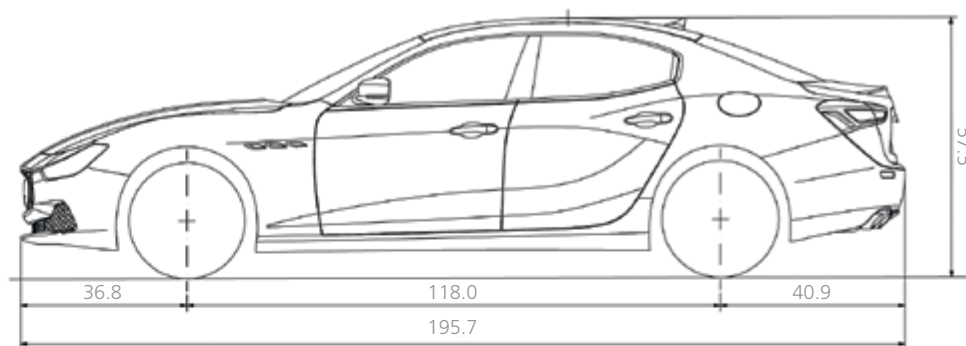
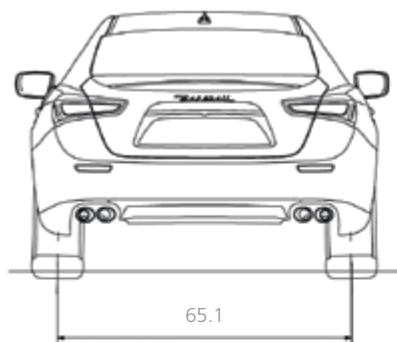

DIMENSIONS AND WEIGHTS	GHIBLI	GHIBLI S*	GHIBLI S Q4
Length	195.7 in (4971 mm)	195.7 in (4971 mm)	195.7 in (4971 mm)
Width (with side mirrors)	82.7 in (2100 mm)	82.7 in (2100 mm)	82.7 in (2100 mm)
Width (without side mirrors)	76.6 in (1945 mm)	76.6 in (1945 mm)	76.6 in (1945 mm)
Height	57.5 in (1461 mm)	57.5 in (1461 mm)	57.5 in (1461 mm)
Wheelbase	118.0 in (2998 mm)	118.0 in (2998 mm)	118.0 in (2998 mm)
Front track	64.4 in (1635 mm)	64.4 in (1635 mm)	64.4 in (1635 mm)
Rear track	65.1 in (1652 mm)	65.1 in (1652 mm)	65.1 in (1652 mm)
Front overhang	36.8 in (935 mm)	36.8 in (935 mm)	36.8 in (935 mm)
Rear overhang	40.9 in (1038 mm)	40.9 in (1038 mm)	40.9 in (1038 mm)
Turning circle	38.4 ft (11.7 m)	38.4 ft (11.7 m)	38.4 ft (11.7 m)
Trunk capacity	17.7 cu ft (500 L)	17.7 cu ft (500 L)	17.7 cu ft (500 L)
Fuel tank capacity	21.1 gal (80 L)	21.1 gal (80 L)	21.1 gal (80 L)
Curb weight	3,990 lbs (1810 kg)	3,990 lbs (1810 kg)	4,122 lbs (1870 kg)

ENGINE

	V6 60°	V6 60°	V6 60°
Number of cylinders and layout	V6 60°	V6 60°	V6 60°
Displacement	182 cu in (2979 cm ³)	182 cu in (2979 cm ³)	182 cu in (2979 cm ³)
Transmission	8-speed automatic	8-speed automatic	8-speed automatic
Compression ratio	9.7:1	9.7:1	9.7:1
Max power output	345 HP (330 CV / 243 kW)	404 HP (410 CV / 302 kW)	404 HP (410 CV / 302 kW)
Engine speed at max power output	5,000 rpm	5,000 rpm	5,000 rpm
Peak torque	369 ft lb (500 Nm)	405 ft lb (550 Nm)	405 ft lb (550 Nm)
Engine speed at peak torque	4,500 rpm	5,000 rpm	5,000 rpm
Overboost torque	369 ft lb (500 Nm)	406 ft lb (550 Nm)	406 ft lb (550 Nm)
Engine speed at overboost torque	1,750 – 4,500 rpm	1,750 – 5,000 rpm	1,750 – 5,000 rpm

PERFORMANCE

Maximum speed	163 mph (263 km/h)	177 mph (285 km/h)	176 mph (284 km/h)
Acceleration from 0 to 60 mph (0 to 100 km/h)	5.5 sec (5.6 sec)	4.9 sec (5.0 sec)	4.7 sec (4.8 sec)
Stopping distance from 60 mph (100 to 0 km/h)	118 ft (36 m)	114 ft (35 m)	114 ft (35 m)
Fuel consumption – combined fuel	19 mpg	19 mpg	19 mpg
Fuel consumption – highway fuel	24 mpg	24 mpg	24 mpg
Fuel consumption – city fuel	17 mpg	16 mpg	16 mpg

* USA model only, not available in Canada.

SOLID PAINTS

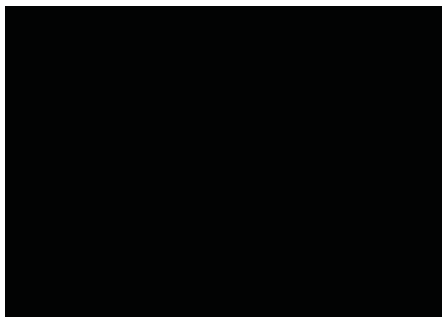

Nero

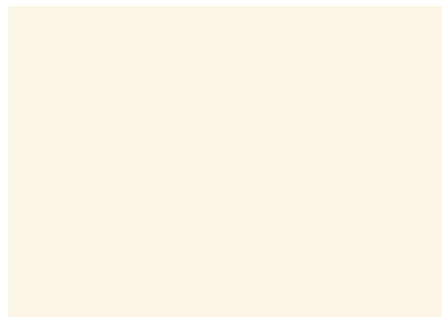

Bianco

METALLIC PAINTS



Grigio



Grigio Metallo

MICA PAINTS

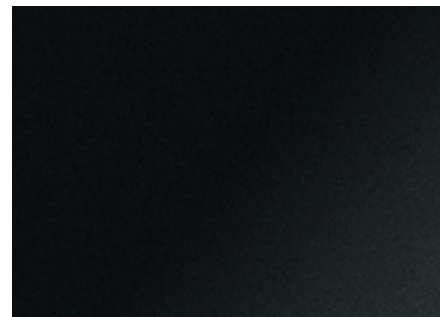

Nero Ribelle



Blu Emozione



Blu Passione



Rosso Folgore

METALLESCECENT PAINTS



Bronzo Siena



Champagne



Grigio Maratea

PEARLESCENT PAINTS

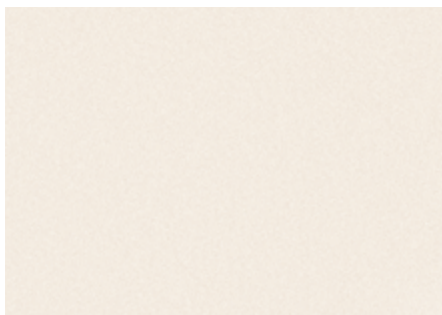

Bianco Alpi



Rosso Energia

INTERIOR TRIM



Dark Mirror (high-gloss)



Ebano (high-gloss)



Radica (open-pore)



Rovere Chiaro (open-pore)



Carbon Fiber (high-gloss)

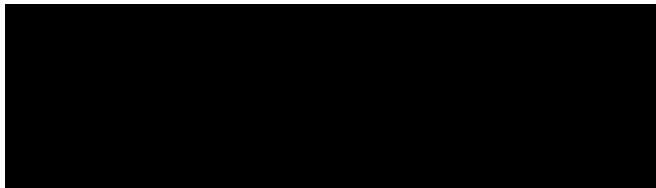

Black Piano (high-gloss)

LOWER DASHBOARD / CARPET / SEAT BELTS



Nero*



Sabbia

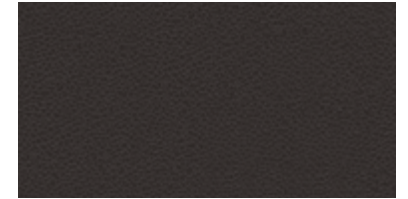

Marrone

STEERING WHEEL



Nero*

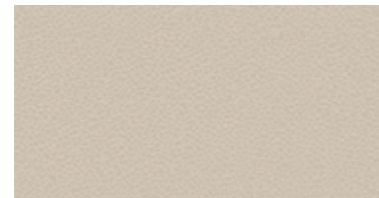

Sabbia

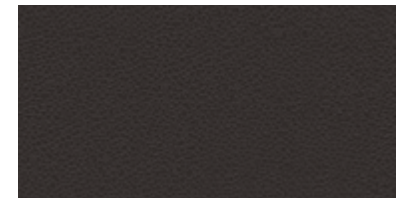

Marrone

HEAD LINING



Nero



Sabbia

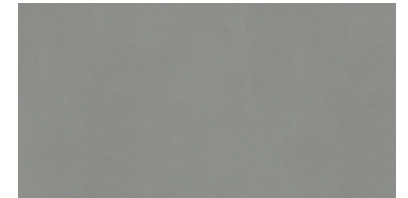

Grigio

SEATS



Nero*



Cuoio*

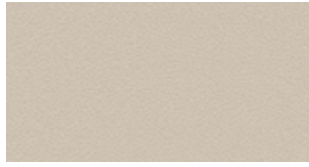

Sabbia*



Marrone



Rosso



Blu

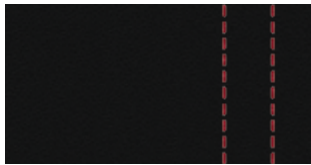

Nero with Rosso Stitching



Nero with Grigio Stitching



Nero with Cuoio Stitching

UPPER DASHBOARD



Nero*



Nero / Cuoio



Marrone



Nero / Rosso



Marrone / Blu

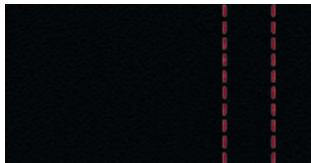

Nero with Rosso Stitching



Nero with Grigio Stitching

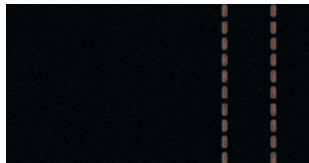

Nero with Cuoio Stitching

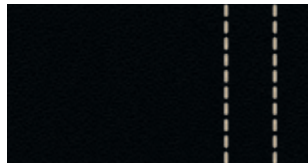

Nero with Sabbia Stitching



Marrone with Sabbia Stitching

HEADREST STITCHING

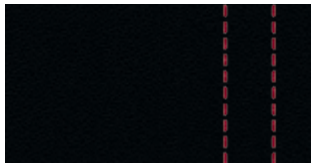

Nero with Rosso Stitching



Nero with Grigio Stitching



Nero with Cuoio Stitching



Rosso with Nero Stitching

* Standard contents



POSEIDONE

- * Dimensions: 19-in
- * Front tire: 245/45 R19
- * Rear tire: 275/40 R19
- * Standard on full range



PROTEO

- * Dimensions: 19-in
- * Front tire: 245/45 R19
- * Rear tire: 275/40 R19



APOLLO

- * Dimensions: 19-in
- * Front tire: 245/45 R19
- * Rear tire: 275/40 R19



URANO

- * Dimensions: 20-in
- * Front tire: 245/40 R20
- * Rear tire: 285/35 R20



URANO (POLISHED)

- * Dimensions: 20-in
- * Front tire: 245/40 R20
- * Rear tire: 285/35 R20



GTS ANTRACITE (FORGED)

- * Dimensions: 20-in
- * Front tire: 245/40 R20
- * Rear tire: 285/35 R20



TITANO (FORGED)

- * Dimensions: 21-in
- * Front tire: 245/35 R21
- * Rear tire: 285/30 R21

STANDARD



Nero Opaco (S and S Q4)



Grigio (Ghibli)

OPTIONAL



Rosso



Nero



Blu



Argento

	GHIBLI	GHIBLI S*	GHIBLI S Q4
WHEELS & CHASSIS			
19-inch machine-painted Poseidone design alloy wheels (245/45 R19 front; 275/40 R19 rear)	●	●	●
19-inch machine-polished Proteo design alloy wheels (245/45 R19 front; 275/40 R19 rear)	○/p	○/p	○/p
19-inch sport Apollo alloy wheels (245/45 R19 front; 275/40 R19 rear)	○	○	○
20-inch Urano design alloy wheels (245/40 R20 front; 285/35 R20 rear)	○	○	○
20-inch machine-polished Urano design alloy wheels (245/40 R20 front; 285/35 R20 rear)	○/p	○/p	○/p
20-inch forged machine-polished GTS Antracite alloy wheels (245/40 R20 front; 285/35 R20 rear)	○	○	○
21-inch forged matte Titano design alloy wheels (245/35 R21 front; 285/30 R21 rear)	○/p	○/p	○/p
18-inch space-saver spare wheel	●	●	●
Brake calipers, matte Black	–	●	●
Brake calipers, Gray	●	–	–
Brake calipers, painted Black	p	○/p	○/p
Brake calipers, painted Red	p	○/p	○/p
Brake calipers, painted Blue	p	○/p	○/p
Brake calipers, painted Silver	p	○/p	○/p
Limited-slip differential	●	●	●
8-speed ZF automatic transmission with tip up/down function from gear knob and fully manual mode (activation by specific button)	●	●	●
Braking system – Front Brakes: 4-piston aluminum monobloc fixed calipers with ventilated discs (345 mm x 28 mm) Rear Brakes: Floating calipers with ventilated discs (320 mm x 22 mm)	●	–	–
Braking system – Front Brakes: 6-piston aluminum monobloc fixed calipers with dual-cast ventilated drilled discs (360 mm x 32 mm) Rear Brakes: 4-piston aluminum monobloc fixed calipers with ventilated discs (350 mm x 28 mm)	–	●	●
Power-assisted steering with speed-sensitive feature	●	●	●
Sport suspension	–	○	○
Skyhook – electronically variable active-damping suspension system (manually adjustable with two stiffness levels and dedicated control button)	○	○	○
ICE (Increased Control & Efficiency) – specific software for the vehicle dynamic management in all conditions and for reduced consumptions	●	●	●
Start & Stop function	●	●	●
SAFETY			
Blind Spot Alert	○	○	○
Bi-xenon front headlamps	●	–	–
Bi-xenon front headlamps with Adaptive Front Lighting System (AFS) and high-pressure front headlamp washing system	○	●	●
High-pressure front headlamp washing system	○	○	○
Daytime Running Lights (DRL)	●	●	●
LED taillamps and third stop light integrated into the rear window	●	●	●

	GHIBLI	GHIBLI S*	GHIBLI S Q4
Automatic headlamp activation	●	●	●
Air bag system – dual-stage front air bags (driver and passenger), side air bags, head air bags and driver knee air bag	●	●	●
Front seat belts with pretensioners and load limiters; rear seat belts	●	●	●
Maserati Stability Program (MSP) includes: – acceleration slip regulation (ASR) – antilock braking system (ABS) – electronic brake distribution (EBD) – Maserati drag torque control (MSR)	●	●	●
Brake Assistance System (BAS)	●	●	●
Hill Holder	●	●	●
Electronic Parking Brake (EPB)	●	●	●
Tire Pressure Monitoring System (TPMS) with pressure displayed on central digital cluster	●	●	●
Tire sealing compound and electric air compressor	●	●	●
Cruise Control	●	●	●
EXTERIOR EQUIPMENT			
Solid paint	●	●	●
Metallic paint	○	○	○
Metallescent paint	○	○	○
Mica paint	○	○	○
Pearlescent paint (Tricoat)	○	○	○
Electric sunroof, with tilting and sliding regulations	●	●	●
Chromeline exterior trim	●	●	●
Heated windscreen washer nozzles	○	○	○
Front and rear parking sensors with graphic display on central digital cluster	p	p	p
Rearview camera with imaging displayed on central Maserati Touch Control (MTC) display	●	●	●
Electrically adjustable, foldable and heated exterior mirrors with integrated LED turn lights	●	●	●
Automatically dimming exterior mirrors with integrated LED turn lights	●	●	●
Twin dual-pipe exhaust system in chrome-plated stainless steel	●	●	●
Ghibli badge on rear deck lid	●	●	●
Q4 badge on rear deck lid	–	–	●
20-inch all-season tires	○	○	○

	GHIBLI	GHIBLI S*	GHIBLI S Q4
INTERIOR EQUIPMENT			
Fabric headlining	●	●	●
Alcantara® headlining	○	○	○
Leather interior upholstery for seats	●	●	●
Extended leather interior upholstery for instrument cowl, individual upper dashboard sections and door armrests	○ / p	●	●
Fine-grain extended leather interior upholstery for seats, upper and lower dashboard, armrests, and upper and central door panels (some combinations are available with contrast stitching)	○ / p	○ / p	○ / p
Fine-grain extended and perforated leather interior upholstery for seats (with perforated seat squab and backrest centers), upper and lower dashboard, armrests, and upper and central door panels (some combinations are available also with contrast stitching)	○ / p	○ / p	○ / p
Zegna Edition interiors: combines leather interiors with Zegna silk inserts for seats, door panels, roofline and sun visors. Available in three leather color choices: Black, Tan or Red	○	○	○
Trident stitched on the headrests (requires Premium leather with contrast stitching)	○	○	○
Metallic-effect dark mirror trim for interior details	●	○	○
Open-pore Radica wood trim for interior details	○ / p	●	●
Open-pore Rovere Chiaro wood trim for interior details	○ / p	○	○
High-gloss Ebano wood trim for interior details	○ / p	○	○
Black Piano trimming for selected interior details (lower console, door panels)	○ / p	○	○
High-gloss carbon-fiber trim for interior details	○ / p	○	○
Multifunction three-spoke steering wheel	●	●	●
Steering wheel and gear knob in fine leather (Nero or Marrone)	●	●	●
Steering wheel and gear knob in fine Sabbia leather with matching insert	○	○	○
Steering wheel and gear knob in fine colored leather (Nero or Marrone) with wood insert	○	○	○
Steering wheel and gear knob in fine Sabbia leather with wood insert	○	○	○
Steering wheel and gear knob in fine Nero leather with carbon fiber insert	○	○	○
Sport pedals in brushed stainless steel	p	p	p
Maserati Active Shifting aluminum gearshift paddles mounted on the steering column	○ / p	○ / p	○ / p
High thermal and noise-insulated laminated glass (front windows)	●	●	●
High thermal and noise-insulated laminated glass (rear windows)	○	○	○
Heated front seats	●	●	●
Heated rear seats	○	○	○
Split-folding rear seats (60/40)	●	●	●
Front tunnel with hidden Media Box (includes: USB and AUX-IN connection), two cupholders and cigarette lighter	●	●	●
Front armrest with twin mechanical opening, illuminated storage compartment, air conditioning, two cupholders and 12V outlet	●	●	●
Rear armrest with covered cupholders, illuminated storage compartment, USB charger and 12V power outlet	p	p	p
Rear armrest with storage compartment and cupholders	●	●	●

	GHIBLI	GHIBLI S*	GHIBLI S Q4
Dashboard-mounted, Maserati design clock	●	●	●
Storage compartments: driver glove box; passenger glove box; front and rear armrest, map pocket on front and rear doors, seatback net pockets	●	●	●
12V socket into trunk	●	●	●
Velour carpet mats	●	●	●
COMFORT AND FUNCTIONALITY			
Maserati Touch Control (MTC) unit. 8.4-inch touchscreen display, including radio, DAB radio, CD/DVD audio/video player, SD card reader, USB and AUX-in (into dedicated compartment on front tunnel), Apple® chip, Bluetooth® for audio streaming and phone functions, climate controls, car setup, etc.	●	●	●
7-inch color cluster display with onboard computer/driver information	●	●	●
Satellite navigation system	●	●	●
External temperature sensor	●	●	●
Dual-zone automatic climate control	●	●	●
Rain sensor for automatic windscreen wiper function	●	●	●
Power rear sunshade	o / p	o / p	o / p
Front seat ventilation	o / p	o / p	o / p
Heated steering wheel in fine colored leather (Nero or Marrone) with wood insert	o	o	o
Heated steering wheel in fine Sabbia leather with matching color and wood inserts	o	o	o
Steering column with power height and reach adjustments	●	●	●
Power foot pedals	o	o	o
Front seats electrically adjustable (8 ways + 4 ways for lumbar adjustments), with two memories for driver's side	●	●	●
Easy entry – exit system for steering column and driver's seat	●	●	●
Standard audio system with 8 speakers (280W)	●	●	●
Harman Kardon Sound System with 10 speakers (900W)	o / p	o / p	o / p
Bowers & Wilkins Premium Surround System with 15 speakers (1,280W) with Clari-Fi music restoration function	o / p	o / p	o / p
SIRI (Apple® function) Smart Personal Assistant	●	●	●
Aluminum key fob, with keyless entry and keyless go functions (includes lock/unlock buttons, trunk opening, exterior light on)	●	●	●
Power Trunk Lid – hands-free function	o	o	o
Alarm system (perimeter and volumetric sensing, antilift device, electronic immobilizer)	●	●	●
Wi-Fi vehicle hot spot	o	o	o
HomeLink® (garage door opener)	●	●	●
Smoking kit (lighter and ashtray for cup-holder)	o	o	o
Quick user guide and DVD interactive user guide, browsable via MTC	●	●	●

GHIBLI PACKAGES

Exclusivity, versatility and performance. With its distinct Maserati DNA, the Ghibli combines the sportiness of a coupé with the luxury and comfort of an executive saloon. It is designed to make inspirational motoring an everyday experience. To adapt the Maserati Ghibli to your own needs and preferences, you might like to consider the special packages that have been individually created for this exceptional car. Not only do they enhance the car's practicality and exclusivity, but they represent fantastic value for money, as well.

PREMIUM PACKAGE

This package enhances driving comfort and improves visibility, which makes touring in the Maserati Ghibli even more enjoyable.

	GHIBLI	GHIBLI S	GHIBLI S Q4
Remote start	●	●	●
Front and rear parking sensors	●	●	●
Rear armrest with illuminated compartment, USB charger, 12V socket and two cup holders	●	●	●
Upgraded sound system required (900 watt or 1,280 watt)	●	●	●

LUXURY AND LUXURY PLUS PACKAGES

For those who require an even more elegant and luxurious interior, the Luxury Package is the obvious choice. Along with exclusive upholstery in natural-grain, premium leather with contrast stitching, the package also features extended leather. In addition, the Luxury Plus Package also includes ventilated front seats.

	GHIBLI	GHIBLI S	GHIBLI S Q4
LUXURY PACKAGE			
Extended leather (upper dashboard & door panels)	●	–	–
Contrast stitching	●	–	–
Premium leather	●	●	●
Wood trim required with package	●	–	–
LUXURY PLUS PACKAGE			
Extended leather (upper dashboard & door panels)	●	–	–
Contrast stitching	●	–	–
Premium drilled leather	●	●	●
Front seat ventilation	●	●	●
Wood trim required with package	●	–	–

SPORT PACKAGE 19-INCH, SPORT PACKAGE 20-INCH AND SPORT PACKAGE 21-INCH

With colored brake calipers and racing-style brushed steel pedals, these packages take the sporty appearance of the Ghibli to new heights. For an even more dynamic driving experience, aluminum Maserati Active Shifting gearshift paddles are incorporated in the steering column. The package is available in three different versions: with 19-inch machine-polished Proteo wheels, 20-inch machine-polished Urano wheels, or 21-inch forged matte Titano wheels.

SPORT PACKAGE 19-inch	GHIBLI	GHIBLI S	GHIBLI S Q4
19-inch machine-polished Proteo design alloy wheels	●	●	●
Painted brake calipers in Nero, Rosso, Blu or Argento	●	●	●
Maserati "active shifting" aluminum gearshift paddles	●	●	●
Inox sport pedals in brushed stainless steel	●	●	●
Extended leather interior upholstery required with package	●	–	–
SPORT PACKAGE 20-inch	GHIBLI	GHIBLI S	GHIBLI S Q4
20-inch machine-polished Urano design alloy wheels	●	●	●
Painted brake calipers in Nero, Rosso, Blu or Argento	●	●	●
Maserati "active shifting" aluminum gearshift paddles	●	●	●
Inox sport pedals in brushed stainless steel	●	●	●
Extended leather interior upholstery required with package	●	–	–
SPORT PACKAGE 21-inch	GHIBLI	GHIBLI S	GHIBLI S Q4
21-inch matte Titano design forged wheels	●	●	●
Painted brake calipers in Nero, Rosso, Blu or Argento	●	●	●
Maserati "active shifting" aluminum gearshift paddles	●	●	●
Inox sport pedals in brushed stainless steel	●	●	●
Extended leather interior upholstery required with package	●	–	–



WORLD OF MASERATI

THE MASERATI LEGEND: NEVER RE-CREATED. RARELY CAUGHT.

Maserati was founded as a racing car constructor, and its deepest roots are in the world of competition. After the impressive records set by the MC12, the racing spirit lives on today in the Maserati Trofeo MC, the international single-marque championship for drivers who wish to compete in the GT class.

TROFEO MC WORLD SERIES: STYLISH TRACK EXCITEMENT

The Maserati Trofeo MC is one of the most successful international GT racing series, with events in Europe, the United States, Japan and China. For more information, visit maseraticorse.com or send an email to TrofeoMaserati@maserati.com

MASTER MASERATI DRIVING COURSES

It is perhaps the ultimate driving experience: taking to the racetrack in a race-tuned Maserati. A Master Maserati Driving Course places you behind the wheel of all Maserati range models so that you can learn about performance driving and other techniques.

WARM-UP

The Maserati Master Warm-Up offers Maserati enthusiasts training in the techniques of race-circuit driving in high-performance cars, with the support of a qualified, expert staff. It is an opportunity to enter the Maserati world as a privileged guest, starting with a morning visit to the Factory where the brand's unmistakable cars are built and moving on to the Varano de' Melegari circuit, home of the Master Maserati courses. It is a whole afternoon of dynamic activities, including several on-circuit driving sessions combined with a car-handling exercise that tests students' driving abilities, which can then be perfected in subsequent course levels.



MASTER GT 1 DAY

The one-day Master GT course is designed to improve personal driving techniques at the wheel of different Maseratis. This intensive training program comprises a number of exciting and dynamic sessions in high-performance cars, and is run by a highly trained specialist staff whose aim is to improve every participant's personal driving skills in an environment that is enjoyable and challenging for all.

MASTER GT 2 DAYS

An intensive two-day course that focuses on advanced GT driving techniques and safe yet sporty driving. In a sequence of sessions on the circuit, the driver is taught how to control the car in different simulated road conditions such as quick direction changes, controlled skids and braking techniques. The ultimate aim is to use the lessons learned to maximize the enjoyment of driving a high-performance Maserati.

MASTER HIGH PERFORMANCE

The Master High Performance program includes advanced high-speed driving and more technically complex exercises that build upon the fundamental skills acquired in the earlier Master GT courses. The teaching and structure of this course are adapted



to the individual needs of the participants, who can improve their driving proficiency through the analysis of Formula 1-type telemetry data.

MASTER ITALIAN LIFESTYLE EXPERIENCE

This exclusive, five-star event allows Maserati enthusiasts and their companions to experience the very best that Italy has to offer. Along with a series of Maserati racetrack sessions for the driver, both participants enjoy a program of first-class activities and excursions in two cities steeped in history and culture: Florence and Parma.

MASTER MASERATI INCENTIVE

The incentive courses last either a half day or a whole day, and include a series of highly stimulating activities. Aside from the thrilling driving sessions on the track, there are practice exercises and competitions that foster team spirit—hence they provide the perfect context for corporate incentive and team-building events.

TO REGISTER, CONTACT MASTER MASERATI:

Telephone: +39 0525 551138 Fax: +39 0525 551140

Email: info@mastertgt.it

For more information, visit www.maseratiusa.com

FACTORY TOUR*

See where and how the Maserati myth is born. Maserati offers you the opportunity of finding out about its secrets from the inside, through a guided tour of the Modena production plant. Discover how the cars are made, learn their secrets, fully understand their engineering and really feel part of the Maserati family.

MASERATI EXPERIENCE

For those wishing to combine their factory visit with a little more insight into the company's home city of Modena, Maserati has the perfect solution. Lasting one or more days, the Maserati Experience enables you to get to know the world of Maserati firsthand via a guided tour that allows you to discover Modena, its culture, its history and its fine food. For more information, please contact us by writing to maseratiexperience@maserati.com

*Tours are arranged by appointment and can be booked through your Authorized Maserati Dealer.

You can tailor your Maserati experience to your own personal tastes and interests by combining these and a variety of other activities:

- Visit the Panini Museum and/or Stanguellini Museum (famous motor museums)
- Guided tour of the town
- Guided tour of a traditional balsamic vinegar manufacturer, with tasting
- Guided tour of a winery, with tasting of local wines
- Cookery school
- Day at the Modena Golf & Country Club

MASERATI COLLECTION

The Maserati Collection of leisurewear, goods and branded merchandise has been specially created for those who share the Maserati passion and who seek to associate with the illustrious marque. Maserati Collection items are available from all Maserati dealers and from the Maserati Store at the Maserati showroom in Modena. Alternatively, all the articles in the collection can be purchased online at www.maseratistore.com

MASERATI CLUB

Joining the exclusive Maserati Club means sharing thrills and experiences with other Maserati owners, and being invited to take part in special motoring events all over the world. Drivers of cars from every era can enjoy the pleasure of driving their Maseratis in a calendar of events created especially for Maserati Club members. The Maserati Club provides the link between the past, present and future of the company. For more information, visit www.themaseraticlub.com

MASERATI GENUINE ACCESSORIES

Specially conceived to satisfy our customers' needs, Maserati genuine accessories are a perfect combination of design and functionality. The attention to detail, style and quality of each individual accessory reveals the very essence of the Maserati brand, always searching for the perfect balance between comfort and performance. The car covers and car-care products are just a few examples of the Cleaning and Care line, designed to preserve the charm of Maserati cars over time. The Safety line includes child seats and a water-repellent windscreen treatment. The range is completed by the Travel line accessories, which include winter tires and a luggage compartment net, to make the most out of your car. These are just some examples of the items available that make the Maserati driving experience unique for our customers.

MASERATI CLASSICHE

Created for enthusiasts and owners of vintage Maserati cars, Maserati Classiche is an organization that is dedicated to those who wish to engage with the marque's glorious past. The Maserati Classiche range of products includes items that celebrate the company's 99-year history: paintings of glorious events, pictures of classic Maseratis, original reproductions of parts catalogs, owners' handbooks and old brochures, clothing, scale models and much, much more. All the latest items can be found on maserati.com in the Maserati—Maserati Classic section. Or for more information, email maserati.classiche@maserati.com





MANUFACTURING

A GLORIOUS COLLABORATION OF MAN AND MACHINE.

While Maserati headquarters and manufacturing have long been based in Modena, Italy, production of the Ghibli is located at a recently opened Maserati plant in Grugliasco, Italy—outside of Turin. The plant is named after company patriarch Giovanni “Gianni” Agnelli, honoring Gianni’s strong connection with the Turin area. One billion euros were invested in renewing this plant, anticipating growing global sales. While the latest technology is utilized to help with fitting parts, skilled technicians man each station, keeping the assembly a handcrafted affair. Utilizing proven practices developed through the company’s World-Class Manufacturing (WCM) system, the plant has a strong culture dedicated to producing the highest quality cars possible. Each car is built to order—and with literally millions of combinations of mechanical and interior specifications possible, a document goes with each car and is signed at each station to ensure that the exact car is built to each customer’s personal requirements.

After completion, the Ghibli is subjected to all manner of quality-control tests, looking at everything from the integrity of its weatherproofing to its handling on different road surfaces. Each car is tested on a wide mix of different local roads, including mountains, motorways and city streets. Each one goes through a series of checkpoints before it is checked again by an independent contractor, who double-checks the vehicle one more time. Finally, senior Maserati inspectors go over the vehicle with a white-glove treatment, wrapping it in a protective covering before it makes its way to the importer—then to the dealer and, ultimately, to the customer. It is this kind of care and pride-in-presentation that is second to none.



©2016 Maserati North America, Inc. All rights reserved. Maserati and the Trident logo are registered trademarks of Maserati SpA. Maserati urges you to obey all posted speed limits. The illustrations and text contained in this brochure are based on the information available at the time of printing and do not contain a description of specific characteristics of the car by the manufacturer. Some models, equipment and accessories may not be available or may only become available after the car's launch on the market. Maserati reserves the right to modify colors, designs and technical features at any time and without prior notice. Contact your authorized Maserati Dealer for further details.

WWW.MASERATIUSA.COM

1-877-MY MASERATI / DRIVEMASERATI@MASERATIUSA.COM

MASERATI NORTH AMERICA, INC. / 250 SYLVAN AVENUE / ENGLEWOOD CLIFFS, NJ 07632