

KYRON

BEAST IN CLASS



SSANGYONG

Experts In 4x4



A black and white photograph of the front left corner of a SsangYong Kyron SUV. The car is parked on a gravel surface, and the background shows a vast, open landscape under a cloudy sky. The car's grille, headlight, and a license plate reading 'KYRON' are visible.

Welcome to SsangYong, your experts in 4x4's.

Founded in 1954, SsangYong have been making off road vehicles in Korea for more than five decades and is forging a growing international reputation with its vehicles.

SsangYong is a specialist 4x4 manufacturer that thinks BIG!

That is BIG on the ability of its 4x4's, BIG on the latest, leading 4x4 technology and BIG on value for its customers - you!



A Real Sports Utility Vehicle

Kyron, the SUV all 'soft-roaders' want to be when they grow up. Designed to be stylish without compromising off-road ability, Kyron redefines the Sports Utility Vehicle market.

The Kyron design reflects the muscularity of the engineering. Standing still it looks like it could pull the chrome off a Harley Davidson, unlike some in its peer group who would struggle to pull the skin off a rice pudding.

Clear lens headlamps and LED stop lights hint at the quality that is in the DNA of this real SUV.





* See page 22 for In Car Entertainment options

Quality You Can Feel

Compromise, not a concept we're familiar with. With Kyrón you sense and feel the quality, elegant finishing materials and an inner space more likely found in a big sports coupe. Unique switch clusters, high-fidelity audio system and an Air Quality Control System (AQS) all contribute to making the Kyrón driving experience second to none.

Electronically adjustable seats and power folding door mirrors* further demonstrate the attention to detail and enhance the practicality of use.



* SX model only

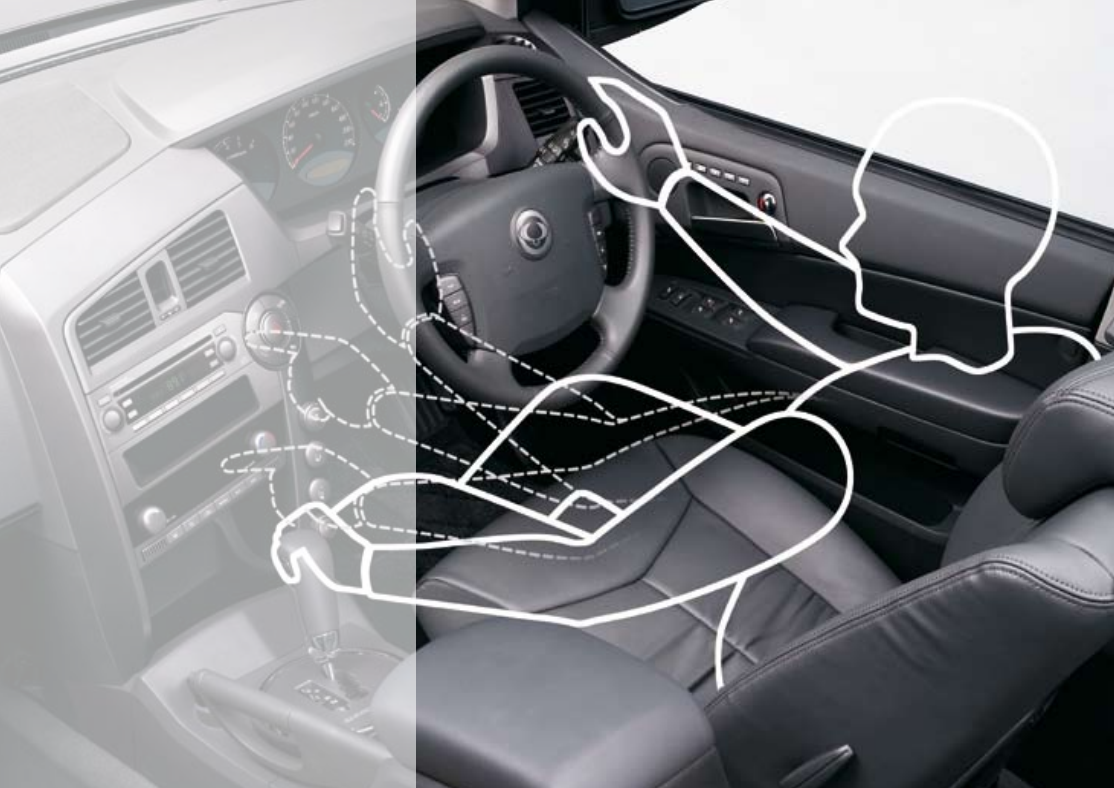

Driving is Believing

When the journey becomes more important than the destination, you know you're driving the Kyron. The driving position is ergonomically designed to allow all controls to fall readily to hand. The centre fascia is orientated towards the driver where the driving position can be further enhanced via the 8 way adjustable seat.

However, what may not be immediately apparent are the features that come into their own when you need them, such as Safety Windows that stop and reverse for a short distance if they encounter resistance, such as a child's hand. Wiper De-icer, Fluidic Washer Nozzles and Heated Seats are just a few of the hidden secrets of Kyron.



Seat Variations



5 luxury adult seats and room for luggage.



2nd row folding flat 60%, long objects can be transported along with 3 passengers.



2nd row folded flat turns Kyron into a load lugging vehicle with endless possibilities for use.

Kyron will get you and your family to places other SUV's only dream of.
Make your dreams reality with the confidence and daring that is Kyron.





KYRON



What Is Your Next Adventure?

Ever heard the kids say “I wish we had a 4 door saloon”? No we didn’t think so! With Kyron we have combined the practicality of ownership with a sense of adventure where the next horizon is the next challenge. We at SsangYong have pushed the boundaries of what you can expect of an SUV. Kyron allows you to push your own personal boundaries in whatever direction you want to go, and who knows, when you discover that new road the new you is probably somewhere down it.

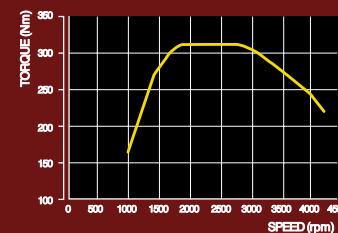
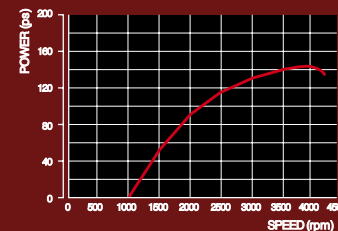

Engine and Transmission

The new 3rd generation common rail Xdi 2.0 Diesel power plant generates a maximum output of 141ps and a class topping 310N/m of torque over an extremely wide range. Better acceleration from standstill and when passing, and quietness and economy have all been designed into this engine's DNA.

Power is nothing without control, and the first link in getting that power down to the wheels is through the Mercedes-Benz T-Tronic automatic transmission, with five forward gears and two reverse, all controlled by an intelligent programme that adjusts shifting points for optimal smoothness and economy.

Alternatively, opt for the 5-Speed manual transmission with dual-mass flywheel that dampens transmission noise and vibration.





Chassis and Suspension

When driving off road any SUV without the correct credentials will soon be found out. Kyron with double-wishbone suspension in front and five link suspension in the rear plays at the high end of the gene pool.

Double wishbone suspension means the wheels stay perpendicular to the road surface for secure footing on irregular or slippery surfaces. This combined with anti-roll bar and coil springs produces a saloon quality ride.

5-link suspension disperses the road shock better than the dual-link system favoured by less focused competing models. Our system provides greater traction, comfort and durability while reducing component wear and tear.





Tow With Confidence

While one would expect most of your driving will be in 2WD high gear mode for greater fuel economy and lower rolling resistance, it's comforting to know that when the going gets tough Kyron can move into 4WD high 'on the move' giving reassuringly positive traction on unpaved roads or icy surfaces*.

Should the conditions dictate, Kyron can engage 4WD low gear mode to bring maximum power at slow speeds to show Kyron's real off-road pedigree.

This plethora of gear options, combined with Kyron's steel frame chassis creates a class leading towing vehicle, which outperforms its monocoque bodied competitors.

*Please note that the Kyron S model is available in 2WD or 4WD.

The Latest Electronic Safety Systems

Electronic Stability Programme (ESP)

Constantly monitoring the vehicle status ESP will instantly take control should the system detect danger, controlling engine output and braking to ensure the vehicle stays on course. The system includes Active Roll Protection (ARP) which intervenes should lateral forces prove excessive (such as veering too sharply to make a U-turn). Brake Assist System (BAS) can determine the driver's intention to brake in an emergency and increases the braking force to the maximum.

Hill Decent Control (HDC)

Allows the vehicle to descend steep gradients taking control of each individual wheel's braking forces to maintain a walking pace speed so enabling the driver to fully concentrate on steering.

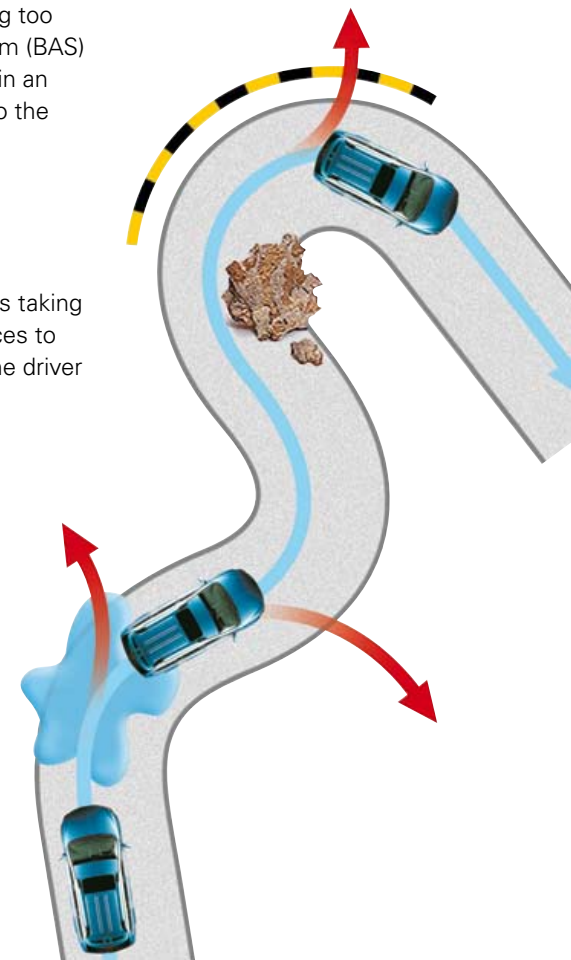



Protect Your Most Valuable Possessions

Should the unthinkable happen it's reassuring to know that Kyron is built to keep your loved ones safe.

The ultra-ridged steel frame with triple layer construction will not intrude into the cabin and extra reinforcements have been included to further enhance the overall rigidity and crash resistance of this tough SUV.



Air Bags Front And Rear

The driver and front passenger are both protected by front and side curtain airbags*, which extend on both sides to give protection to rear passengers.

In the event of an accident, the curtain airbags are designed to give side impact protection to all occupants whilst shielding them from broken glass and also keeping them inside the safety cell for the duration of the crash. All seats are equipped with three-point safety belts for maximum safety.

* Curtain airbags only on SE and SX models

Each front seat is further protected by a safety belt pretensioner and load limiter. At the moment of impact the belt will tighten momentarily, keeping the occupant secure before the airbag fully deploys. As the occupant moves forward into the airbag, the restraining force of the safety belt lessens gradually.

Kyron is fitted with Door Impact Beams and Automatic door locks as standard.





BEAST IN CLASS

Kyrón Is Distinctive







We have added many of the 'must have' accessories as standard, such as roof bars, clear fog lamps and electronically adjustable door mirrors to name a few, but you can make Kyrón truly yours by enhancing it with the option of 18" wheels (unheard of in this class), Privacy glass, Satellite navigation and leather trim.

If Kyrón floats your boat (or more probably tows it), why not make it the SUV to help you re-discover why you've got a driving licence, a family and a life.

SPECIFICATIONS/OPTIONS

Equipment

Luggage Cover	Sun Visors With Mirror And Lamp	Twin Power Outlets	Centre Storage Console	Tilting Headrests	Door Trim Pockets
					

Door Scuff Plate	Folding Centre Armrest	Drivers Lumbar Support	Roomy Glove Box	2nd Row Seat Adjustment Lever	Safety Windows
					

ICE (In-Car Entertainment)

Ice Pack 1 (S Model)	Ice Pack 2 (SE Model)	Ice Pack 3 (SX Model)	Ice Pack 4 (Optional Upgrade)
			

Dimensions

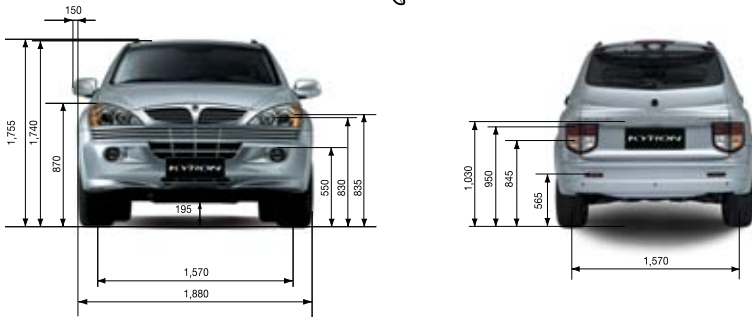
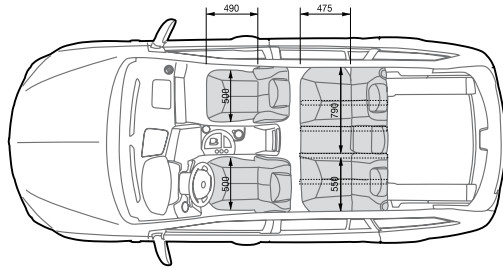
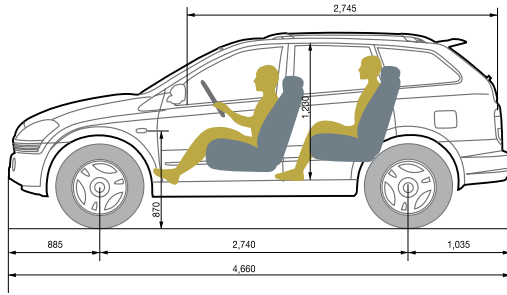

Wheels

**16" Alloy Wheels
(S and SE Model)**



18" Alloy Wheels (SX Model)



Trim

Luxurious Beige Leather*



Luxurious Grey Leather



Flat Woven Beige Fabric*



Flat Woven Grey Fabric



* Beige only available in Premier Wine and Sahara Beige paint colour options.

Paint

These colours are intended to serve primarily as a guide, and whilst they approximate closely to the actual colours used, they should not be utilised for paint matching or any other purpose where complete accuracy is essential. We reserve the right to alter or withdraw any colour finish or seat trim without notice. Please note actual colours may vary from those shown owing to printing variances.

Grand White



Paradise Blue



Premier Wine



Sahara Beige



Space Black



Fine Silver



Cyber Grey



SsangYong Support

Warranties

Three year mechanical warranty.

A warranty covering the vehicle for three years or 60,000 miles, whichever occurs first against a fault which is attributable to a manufacturing or material defect. Contact your local SsangYong dealership for further details.

Six Year Anti-Corrosion Warranty

A six year unlimited mileage warranty which covers the vehicle against rust perforation through any sheet metal body panel occurring as a result of a manufacturing or assembly defect in the vehicle. Contact your local SsangYong dealership for further details.

SsangYong Assist

Free breakdown assistance is included when you purchase your new Rexton. Contact your local SsangYong dealership for further details.

SsangYong Financial Services

SsangYong Financial Services offer a range of quality finance products to meet your needs.

Your local SsangYong dealer can provide full details of options available. Alternatively visit www.syukcars.co.uk. Written quotations are available on request. Indemnities may be required and credit is subject to status to over 18s only.

SsangYong Contract Hire

Contract Hire is a convenient, cost effective way to purchase and run business vehicles. As SsangYong Financial Services can recover the VAT in the purchase price of new vehicles this saving can be passed on in lower monthly Contract Hire rentals. Fixed monthly costs allow you to budget more accurately, particularly with the 'full maintenance' option which covers routine servicing and maintenance, emergency service, a relief vehicle in the unlikely event of a breakdown as well as road fund licence renewal. All vehicle administration including disposal at the end of the contract is taken care of by SsangYong Contract Hire. Written quotations are available on request. Indemnities may be required and credit is subject to status to over 18s only.

SsangYong Personal Contract Purchase

The SsangYong Personal Contract Purchase is a flexible and affordable way to drive a new SsangYong every two or three years. We will guarantee the minimum future value of the vehicle at the end of the agreed period, based on the mileage specified, giving you complete confidence and flexibility to choose one of three alternatives at the end of the agreement. On payment of the purchase fee you can either part exchange your current SsangYong for a new one, pay the final payment and keep the car, or – provided the vehicle is in good conditions and the specific mileage has not been exceeded – return it with nothing further to pay. Written quotations are available on request. Indemnities may be required and credit is subject to status to over 18s only.

Kyron range economy figures: Urban 26.7-28.5mpg (9.9-10.6l/100km), Extra urban 39.8-44.8mpg (6.3-7.1l/100km), Combined 33.6-36.7mpg (7.7-8.4l/100km) CO₂ emissions 197-217 g/km

Every effort has been made to ensure that the content of this publication is correct at the time of going to press January 2006. While we have attempted to reproduce accurate information, we reserve the right to change specifications, equipment and availability without prior notice. The brochure cannot be regarded as infallible (some of the vehicles shown may not be to exact UK specification), and as such does not constitute an offer for sale of any particular vehicle or specification. For the latest specification and availability we ask that you contact your local SsangYong dealer.

SsangYong UK Central House, 2 Kings Road, Fleet, Hampshire, GU51 3AD
Tel: 0845 456 4056 Website: www.syukcars.co.uk



SSANGYONG

Experts In 4x4