



S1

 Audi S1 | S1 Sportback

Vorsprung durch Technik 



	Page
Fascination	
	4 Audi S1/Audi S1 Sportback
Technology	
26	Innovations
28	Audi ultra
30	Audi connect
32	quattro®
	34 Intelligent performance
	36 Dynamics
	38 Assistance systems
	40 Simplicity
Equipment	
44	quattro styling package
46	Audi exclusive
48	Paint finishes/roof line/roof dome
50	Wheels/tyres
52	Seats/seat upholstery
55	Leather packages/headlinings
56	Air vent sleeves
58	Technology
58	Lights
	59 Design
	61 Control elements
	62 Comfort
	63 Transport
	64 Safety
	64 Assistance systems
	65 Infotainment
	67 Audi Extended Warranty
Other	
68	Audi Genuine Accessories
70	Technical data
72	Dimensions
	74 Index
	80 The fascination of Audi

Dialogue: Audi QR codes

Experience Audi even more directly: download a QR app to your smartphone and then scan the QR code or follow the given link in your browser. Connection costs depend on mobile phone contract.



The equipment for the vehicles illustrated in the Fascination section can be found on page 79.
The fuel consumption and CO₂ emission figures as well as the efficiency class can be found on page 70.

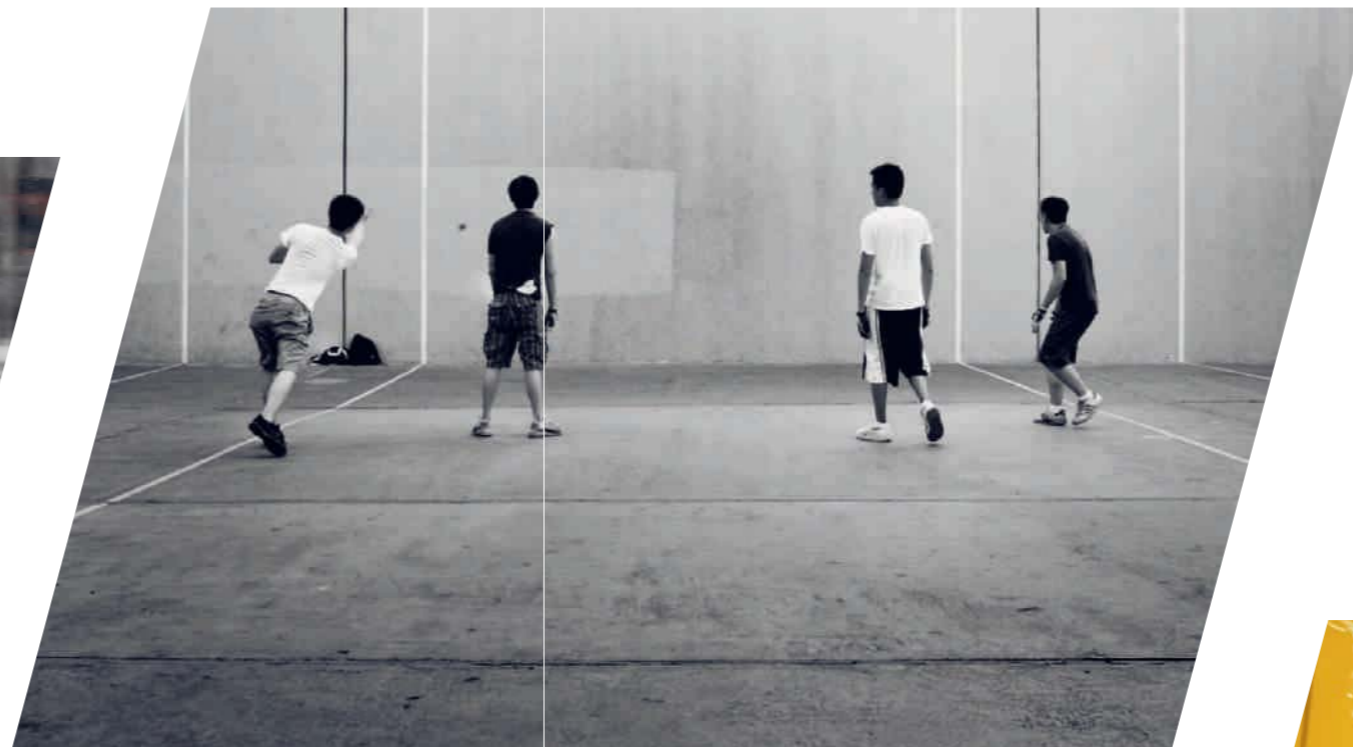

Great sport /

Take the city by storm every day.

The road is under control. With quattro® permanent all-wheel drive. Force of attraction as standard. Pioneering agility. A performance that sets benchmarks. Coupled with a design that will capture your heart. Sporty. S-specific. Progressive. The Audi S1 and Audi S1 Sportback. The city is yours.

The fuel consumption and CO₂ emission figures as well as the efficiency class can be found on page 70.



The fuel consumption and CO₂ emission figures as well as the efficiency class can be found on page 70.



Great drive /

Use every wheel.

Power that grips. Permanently. With all four wheels. Thanks to quattro® all-wheel drive. For perceptibly more traction. Excellent cornering and vehicle stability. A good feeling. Outstanding dynamics. Mastered with confidence. Inspirational. Standard.

The fuel consumption and CO₂ emission figures as well as the efficiency class can be found on page 70.





To see the Audi S1 and Audi S1 Sportback in action, just scan this QR code using your smartphone (connection costs depend on mobile phone contract). Or follow this link in your browser: www.audi.com/s1film

The fuel consumption and CO₂ emission figures as well as the efficiency class can be found on page 70.



Great fun /

**Enjoy every
sprint.**

170 kW that will quickly impress. From 0 to 100 km/h in 5.8 seconds. With S-specific engine sound. A maximum torque of 370 Nm. And a top speed of 250 km/h. Impressive performance. A fascinating driving experience. Supported by S sport suspension with switchable dampers. And individual vehicle adjustment with Audi drive select.

The fuel consumption and CO₂ emission figures as well as the efficiency class can be found on page 70.



Great appearance /

Attracts all the attention.

Power and performance made visible. At first sight. An S model through and through. Exterior mirror housings in aluminium look. Brake callipers in black. Or optionally in red. With S1 badge at the front. Exuding pure dynamics. Highlighted by the S bumper at the front with air inlets. And by typical S side sills. A classic S look.

The fuel consumption and CO₂ emission figures as well as the efficiency class can be found on page 70.

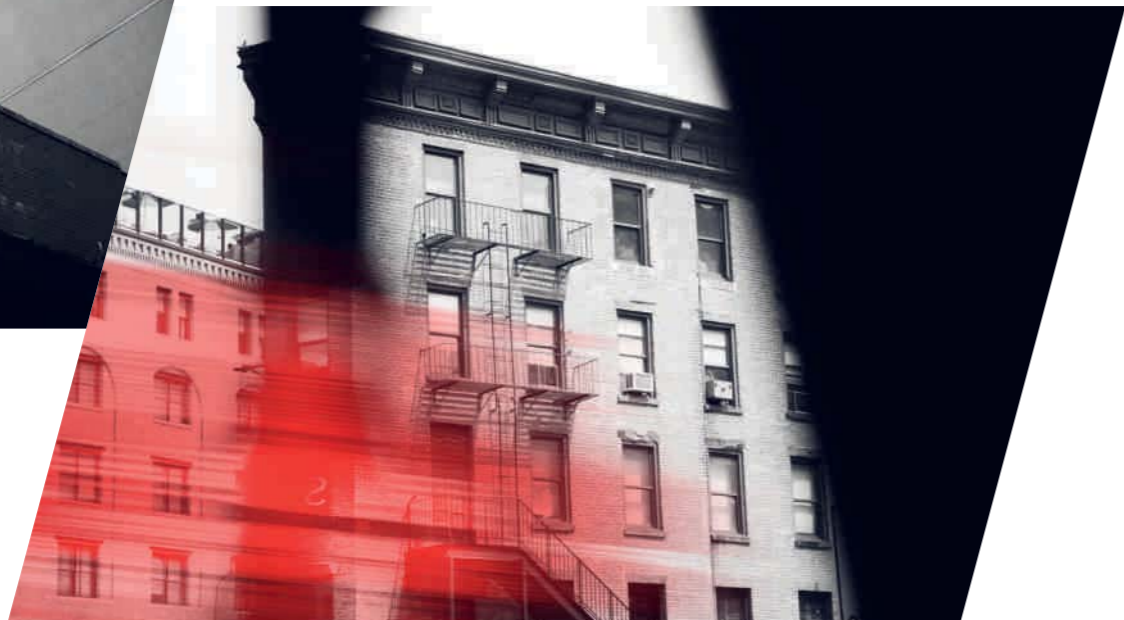



This is how it is seen by others. S diffuser insert. S-specific dual-branch exhaust system with two oval trims each. S roof edge spoiler. Sporty features wherever you look.

The fuel consumption and CO₂ emission figures as well as the efficiency class can be found on page 70.





Great standard /

Every part inspires.





A fascinating interior. Consistently sporty. Convincingly high-quality. Optionally with MMI® navigation plus and high-resolution 6.5-inch colour display. With an option to integrate services supported by Audi connect. Infotainment on a high level. Fast information. Top entertainment. With Bose Surround Sound upon request. Through 14 loudspeakers.

The fuel consumption and CO₂ emission figures as well as the efficiency class can be found on page 70.

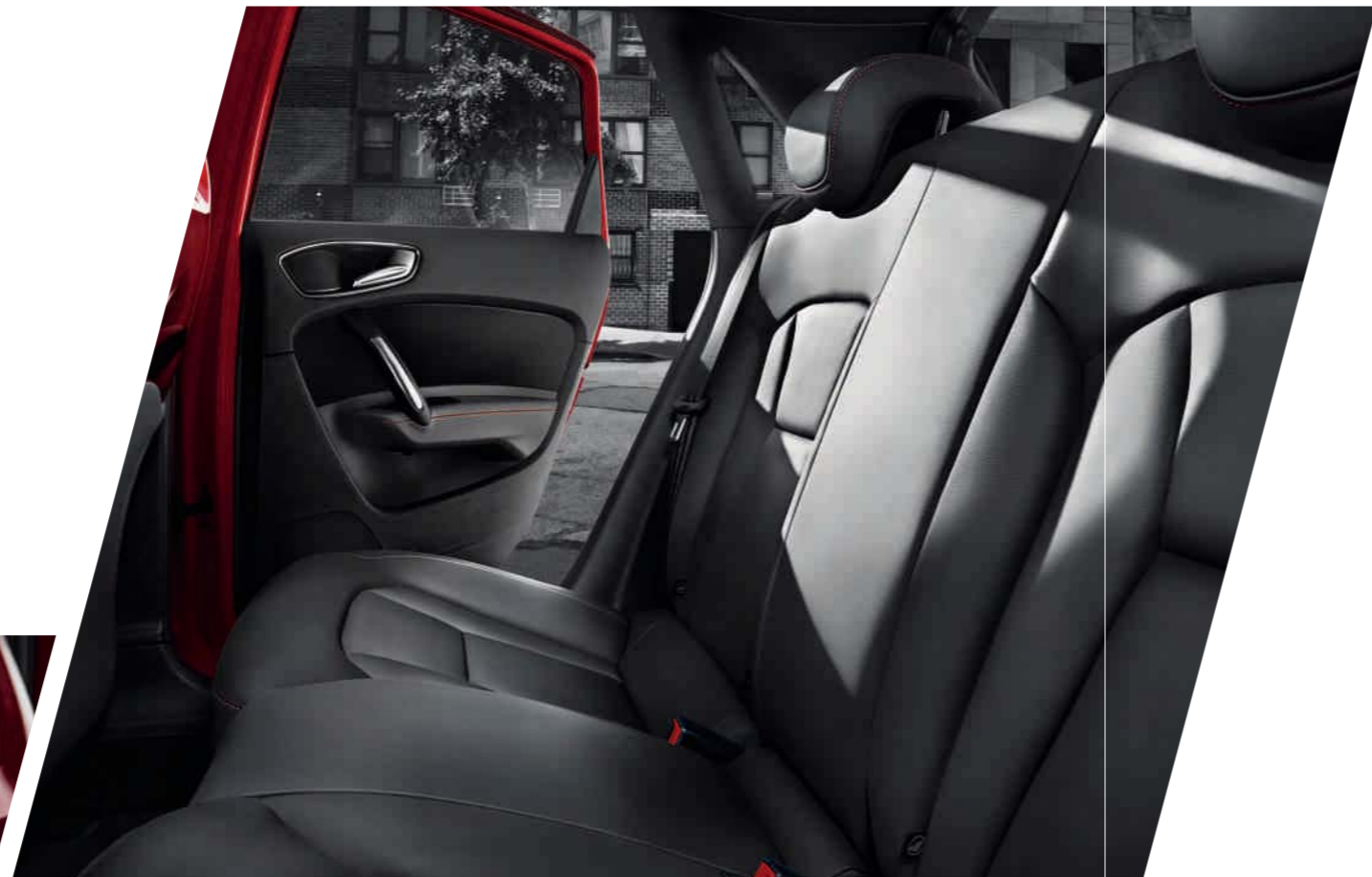

Your very own start line. Take pole position on the optional S sport seats in the front. S1 embossing on the front-seat backrests. The rear side of the front-seat backrests in red. Place your feet on the stainless steel pedal caps. And your hands on the optional multifunction sport leather steering wheel. Now hold your breath. The countdown has begun.

The fuel consumption and CO₂ emission figures as well as the efficiency class can be found on page 70.



Enthusiasm right from the word go. Dynamics with outstanding traction. quattro®. More than just an innovative technology. An attitude to life. A mission. A new city experience. And you at the centre. With the Audi S1 and the Audi S1 Sportback.

The fuel consumption and CO₂ emission figures as well as the efficiency class can be found on page 70.





>>> Audi connect
The future of connected mobility.

>>> Audi tron
The future of CO₂-reduced mobility.

>>> quattro®
The future of all-wheel drive.

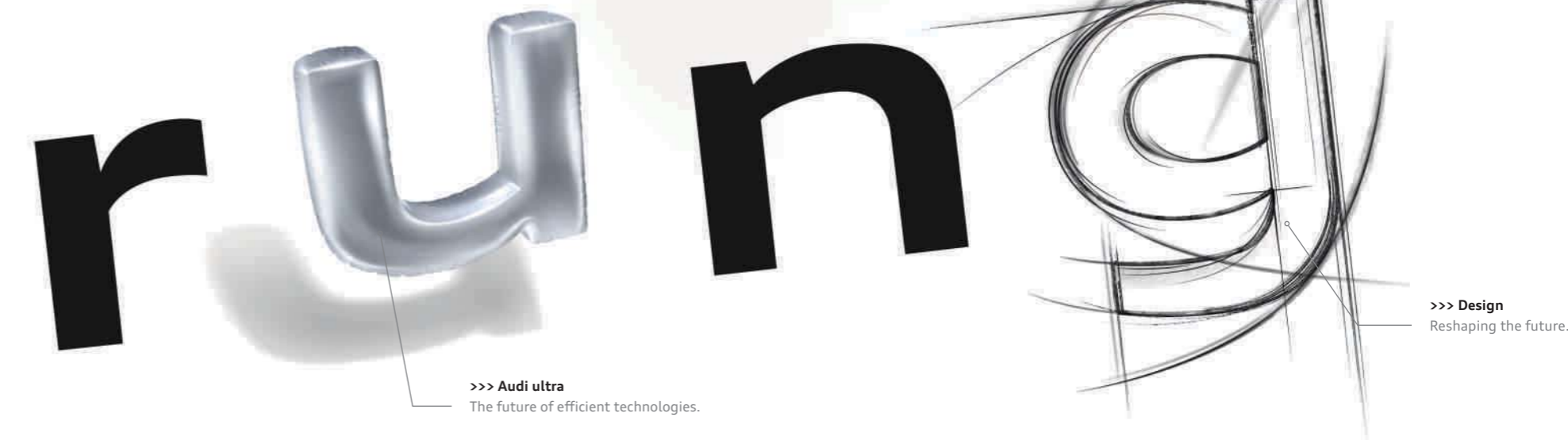

>>> Audi ultra
The future of efficient technologies.

>>> Design
Reshaping the future.

... durch Technik.

The world is constantly changing. Technology is advancing at an ever faster pace. And in the process, more and more opportunities are opening up to you – nowhere more so than in the field of mobility. We are playing an instrumental role in shaping this progress with Vorsprung durch Technik. Striving to provide you with technology that enriches your life. Making sure that we don't just satisfy your expectations of mobility both today and in the future, but continue to surpass them.

Audi ultra

Perfectly combined.

The future of efficient technologies.

Building an Audi is an extremely complicated business. And yet a simple principle applies for all models: all vehicle components interlock precisely in order to produce emission-reducing synergies. What started in accordance with this principle at the end of the 1980s with Audi lightweight construction and the revolutionary Audi Space Frame (ASF®) is now known as the reversal of the weight spiral: every lightweight component has an impact on other components, which can in turn be made smaller. In this way, existing forms and materials are continuously being improved with regard to their functionality, the lowest possible weight and their production process. With the goal of building vehicles that are even more efficient and make more sparing use of resources. At the same time, more and more efficiency technologies are being built into an Audi. These include recuperation and the start-stop system. Not to mention progressive, efficient high-tech engines. For greater driving dynamics, high compression, more efficient combustion and lower CO₂ emissions. All this is known as Audi ultra. Today and in the future – towards CO₂-reduced mobility.

>>> Aerodynamics

Less drag, more efficiency. Thanks to the consistently aerodynamic styling of the vehicle's lines, its underbody and spoiler edges - in order to achieve the best possible form for aerodynamic efficiency. Not forgetting the tyres with reduced rolling resistance. All tested in the Audi wind tunnel at up to 300 km/h.

>>> Lightweight expertise

Less weight. More savings, power and endurance. Audi lightweight technology. What started with lightweight body construction has now made its way into nearly all areas, combining innovative materials such as aluminium, carbon fibre and magnesium, intelligent design principles and resource-saving manufacturing processes into an overall concept.

>>> Transmission expertise

Improved efficiency values thanks to improved gear ratio. Increased torque enables the transmission ratio to be made longer, particularly in the higher gears. For powerful torque in the low engine speed range, which reduces consumption – yet has no adverse effects on driving performance and sportiness.

>>> Recuperation

Braking for even more efficient driving. With brake energy recovery (recuperation). Part of the kinetic energy produced during braking and coasting is stored in the vehicle battery and then used in acceleration phases – enabling up to 3 % of fuel to be saved depending on the driving cycle.

>>> Engine expertise

Powerfully and efficiently driven. By Audi ultra with the efficiency technologies in the engine sector

Mobility & navigation



Point-of-interest (POI) search with voice control
in the Google™* database



Traffic information online
complements the dynamic route guidance with real-time traffic flow information for individual stretches of road



Fuel prices
The cheapest petrol stations at your destination or in the vicinity



Parking information
Help with looking for car parks and multi-storeys incl. details of available prices. And – if available – display of currently vacant spaces



Country information
Country-specific regulations such as the obligatory wearing of high-visibility vests and maximum speed limits can be requested at the push of a button at any time in the MMI.



Navigation with Google Earth™* and Google Street View™*
uses high-resolution aerial and satellite images, photos and address information to guide you to your destination even more easily



myAudi

Destination entry via myAudi or Google Maps*
Set your personal destinations from the comfort of your home. If required, you can plan your navigation destinations from your home computer. myAudi and Google Maps* allow individual navigation destinations to be sent to the vehicle. When you start your journey, these are loaded into the MMI® navigation plus.

Communication



Wi-Fi hotspot
connects your mobile devices to the internet

Audi connect.

Audi connect

The future of connected mobility.

The world presents you with countless possibilities. Audi connect enables you to make the most of many of them in digital form directly from your Audi. At the press of a button. Tailored to you. Thanks to myAudi and the services supported by Audi connect in your vehicle. In places all over the world. Intuitively, easily and conveniently.

Infotainment



Weather
Forecasts and maps for the required destination



Audi music stream
Access to global radio stations via smartphone app and Wi-Fi, plus access to your smartphone's media library



News online
Text and images about current world events



City events
provides you with up-to-date information about events – e. g. at your destination



Travel information
offers you sightseeing information – with function for importing destination to navigation system

* Google and the Google logo are registered trademarks of Google Inc.

Availability, screen display and the cost of services vary depending on the country, model, device and tariff. More legal information and usage information can be found on page 66 and at www.audi.com/connect. The fuel consumption and CO₂ emission figures as well as the efficiency class can be found on page 70.

The Audi S1 and Audi S1 Sportback – equipped with quattro as standard. Have the road completely under control, thanks to permanent distribution of the drive force to all four wheels. Variably dosed by the hydraulically controlled multi-plate clutch. Always depending on the situation. Experience handling stability, dynamism and agility as never before and combat the effects of over- and understeer with quattro. For increased traction and superior propulsive power. Tame any road. And always keep your eyes set on where you're heading. In bends. On straights. Over any surface. For a fascinating experience that sticks. To the road – and in your mind.



quattro®
**Stick to
the road.**

With quattro®.

Maximum power. Put to maximum use.

Every movement originates from something. Something that sets it off, an idea. The engine in your Audi S1 and S1 Sportback can also be traced back to an initial spark of inspiration: higher power with lower fuel consumption. These apparently conflicting aims are reconciled in the revolutionary drive technology TFSI®. Get acquainted with the drive that will move you in impressive style.



TFSI®

Audi TFSI engines attain a particularly high compression rate. The result: outstanding efficiency combined with optimum performance. Substituting supercharging for cubic capacity has the effect of considerably reducing engine size and weight – while performance remains as impressively dynamic as ever. For power delivery that will win you over from the word go.

>>> 5 sport suspension including switchable dampers
Increase in driving dynamics through selection between 2 damper settings

>>> Track widening
for high vehicle stability, agile handling and impressive dynamism when cornering

>>> 4-link rear axle
with separate spring/damper arrangement

>>> S-specific steering
for a superior driving experience thanks to electro-mechanical power steering assistance adapted to the driving dynamics

>>> Audi drive select
Audi drive select lets you adapt the driving characteristics of your Audi to your requirements. At the press of a button. Sportier, more balanced or more economical. It's entirely up to you.

>>> 6-speed manual transmission
for powerful acceleration in the low gears and efficient driving at reduced engine speed in the high gears

>>> quattro®
The permanent all-wheel-drive system distributes the drive forces to each individual wheel according to the driving situation for extra traction and dynamic performance.

Dynamics

Dynamics

that will take a hold of you.

Get in. Buckle up. Start the engine. Wherever you're heading, enthralling driving dynamics will power you there. For as you know, the world is your oyster once you get behind the wheel of your Audi. You decide the direction. The driving style. The pace. And you enjoy the satisfaction of knowing you have plenty in reserve. More than enough to get the very best from every drive.

The fuel consumption and CO₂ emission figures as well as the efficiency class can be found on page 70. You can find out which equipment features are standard or optional in your model by referring to the index starting on page 74.

Assistance systems

Wherever you're heading, peace of mind will be your constant companion.

With the assistance systems in your Audi.

Each drive is different. Yet they all have one thing in common – the feeling of being protected that you get from every Audi. All driver assistance systems in your Audi help you during your journey and guarantee even greater comfort when you're on the road. Get to know the most important driver assistance systems.

>>> **Hill hold assist**
allows you to drive away smoothly on almost any gradient

>>> **Cruise control**
keeps any speed set over 30 km/h more or less constant and thus supports a safe and relaxed driving

>>> **Secondary collision brake assist**
prevents the vehicle rolling away uncontrolled after an accident in certain situations and can prevent secondary collisions in these cases.

>>> **ESC with wheel-selective torque control**
improves traction and dynamics in bends, guarantees more precise driving behaviour and provides more agile steering

>>> **Parking system, rear**
provides assistance during reverse parking. Warns drivers of obstacles they cannot see by means of acoustic signals.

>>> **Parking system plus**
provides a better overview for parking and manoeuvring by showing visual displays of the entire vehicle. Measurement is carried out by ultrasonic sensors integrated discreetly in the bumpers.

>>> Audi connect

With the MMI navigation plus use all the optional services supported by Audi connect – quickly and comfortably. The intuitive operation of the MMI makes accessing many internet-based functions remarkably straightforward.

>>> Navigation

With MMI navigation plus, you can let yourself be guided to your destinations with even greater ease with 3D map views and a three-dimensional display of places of interest and landmark buildings.

>>> Car

Control and alter driver assistance systems, vehicle settings as well as climate control and service functions quickly and easily from concert radio onwards.

>>> Phone

Make phone calls safely and easily using the hands-free facility: simply select the number to dial from your contacts in the MMI.

>>> Media

Browse through the covers of your music collection on all available media sources, such as a jukebox, inserted SD cards, Audi music interface or CDs, as well as – in conjunction with MMI navigation plus – DVDs.

y



u

**Simplicity****The MMI® – intelligent, individual, intuitive.**

Streamlined. Simple. Logical. The world of mobile infotainment completely redefined: the optional Multi Media Interface (MMI). Phoning, navigating or surfing the internet via Audi connect available on request: all highly intuitive, highly functional and convenient – not least thanks to the voice control function. With the optional concert radio or MMI navigation plus, everything will be child's play for you when you're in your Audi.



As unique as you are.
The equipment options.

Sportiness, comfort, design, functionality – whatever you demand of your Audi, it offers you a wealth of custom options. Audi equipment versions are varied and high-quality and you can tailor them entirely to your needs.

You have the road – and everyone's attention. The quattro exterior and interior styling package for the Audi S1 and Audi S1 Sportback.

Unconditional sportiness made visible. From afar: through the striking roof spoilers and headlights with red trims. From close up: through the 18-inch cast aluminium wheels in 5-arm facet design with red brake callipers. On the interior: through numerous striking details. The quattro exterior and interior styling package for your Audi S1 and Audi S1 Sportback – dynamism wherever you look.

quattro exterior styling package

Available in 8 different exterior colours

Xenon plus headlights with red trim

Brake callipers, painted red, with S1 badge

Cast aluminium wheels in 5-arm facet design (S design), black matt, partly polished^{1, 2}

Striking roof spoiler

quattro logo on the side

Bumper with front spoiler lip in aluminium look



The fuel consumption and CO₂ emission figures as well as the efficiency class can be found on page 70.



quattro interior styling package

Centre console in high-gloss black, red or yellow

S sport seats in fine Nappa leather with backrest cover in high-gloss black, red or yellow with quattro logo

Armrest in the door in fine Nappa leather in same colour as seat with contrasting stitching

Multifunction sport leather steering wheel in 3-spoke design, flattened at the bottom, with S-specific stitching

Air vent sleeves in high-gloss black with red inner ring; optionally in aluminium look with red inner ring

Floor mats in black with double piping

The illustrations show the Audi S1 Sportback with quattro exterior and interior styling package in red.



¹You will find specifications on the technical characteristics of tyres on page 71. ²Please note the special information about the rim on page 70.

You have an exclusive character. So why shouldn't your Audi have one too?

That the Audi exclusive range aspires to exclusivity is already evident from its name. Here coloured leather can be combined with customised paint finishes from the large selection of Audi exclusive colours to suit your own personal preferences. So you can highlight your car's exceptional character to even better advantage. Your Audi partner and the Audi exclusive Studio of the Audi Forum Neckarsulm await your wishes.



Audi S1 Sportback in green customised paint finish

Black gloss package

Cast aluminium wheels in 5-arm facet design (S design), in contrasting grey, partly polished^{2, 3}

Leather upholstery and trim (package 1) in Audi exclusive fine Nappa leather in cloudy grey and jet grey with contrasting stitching

Extended coloured interior elements in Audi exclusive leather

Audi exclusive leather controls

Air vent sleeves in Audi exclusive aluminium look



Your Audi is not just painted once. But four times.

When you choose a paint colour, choose one that best reflects your own personality. But regardless of which colour you opt for, you can count on the outstanding quality of our painting process. Though no thicker than a human hair, the layer of paint on an Audi is actually made up of four different coats. So not only do you look radiant, your Audi is also optimally protected from environmental influences and wear. For its entire lifetime.



| Roof line/roof dome

Roof line in contrasting colour

Brilliant black								
Glacier white, metallic								
Floret silver, metallic								
Daytona grey, pearl effect								
Body paint finish	Vegas yellow	Glacier white, metallic	Floret silver, metallic	Scuba blue, metallic	Mythos black, metallic	Daytona grey, pearl effect	Sepang blue, pearl effect	Misano red, pearl effect

Roof dome in contrasting colour

Brilliant black								
Floret silver, metallic								
Daytona grey, pearl effect								
Body paint finish	Vegas yellow	Glacier white, metallic	Floret silver, metallic	Scuba blue, metallic	Mythos black, metallic	Daytona grey, pearl effect	Sepang blue, pearl effect	Misano red, pearl effect



The illustration shows the Audi S1 in glacier white, metallic, with roof line in Daytona grey, pearl effect.



The illustration shows the Audi S1 Sportback in Sepang blue, pearl effect, with roof dome in brilliant black.
The model-specific standard and optional equipment can be found in the index from page 74 onwards.

| Solid paint finishes

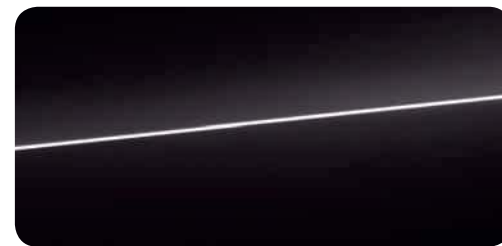

Brilliant black



Vegas yellow

| Metallic paint finishes

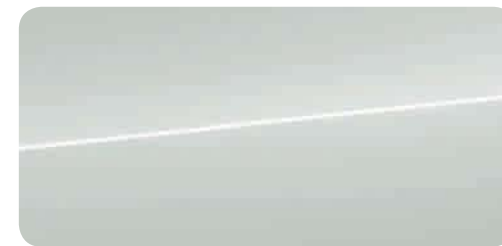

Glacier white, metallic



Floret silver, metallic

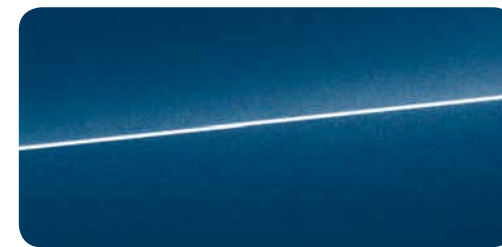

Scuba blue, metallic

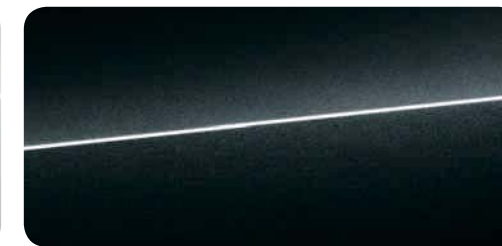

Mythos black, metallic

| Pearl effect paint finishes

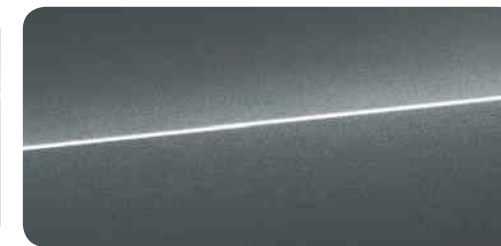

Daytona grey, pearl effect



Sepang blue, pearl effect



Misano red, pearl effect

| Audi exclusive



Audi exclusive customised paint finishes*
From quattro GmbH

* For information on when this feature will be available, please contact your Audi partner.



The perfect connection between an Audi and the road: Audi wheels and tyres.

Audi tests its wheels and tyres especially carefully to be sure you have a good feel for the road from the outset. Before a tyre can become an Audi tyre, it has to undergo a series of tests. This is the only way of guaranteeing that each tyre meets Audi's high quality standards and is perfectly tailored to each specific vehicle. It means you can be sure that both tyre and wheel offer maximum quality, service life and safety. Whichever design you choose.

|Wheels



Cast aluminium wheels in 5-parallel-spoke design (S design) size 7.5 J x 17 with 215/40 R 17 tyres¹



Cast aluminium wheels in 5-arm facet design (S design) contrasting grey, partly polished², size 7.5 J x 18 with 225/35 R 18 tyres¹



Cast aluminium wheels in 5-arm facet design (S design) black matt, partly polished², size 7.5 J x 18 with 225/35 R 18 tyres¹. Only available in conjunction with quattro exterior styling package

|Winter wheels



Cast aluminium winter wheels in 7-arm dynamic design size 6 J x 16 with 195/50 R 16 tyres¹, permissible top speed 210 km/h, can be fitted with snow chains



Cast aluminium winter wheels in 5-parallel-spoke design (S design) size 7.5 J x 17 with 215/40 R 17 tyres¹, permissible top speed 240 km/h, cannot be fitted with snow chains



Cast aluminium winter wheels in 5-arm design with decorative elements in high-gloss black, size 7.5 J x 17 with 215/40 R 17 tyres¹, permissible top speed 240 km/h, cannot be fitted with snow chains

The model-specific standard and optional equipment can be found in the index from page 74 onwards.

¹You will find specifications on the technical characteristics of tyres on page 71.

²Please note the special information about the rim on page 70.

Premium quality you can rely on.

You have a special place in your Audi. Exclusive comfort can be felt on the front and back seats: thanks to high-quality materials and first-class workmanship. No matter which seat upholstery you choose for your seats and whether you prefer sport seats or S sport seats for dynamic driving: you're sitting in the right place.



Sport seats, front 1

The image shows sport seat, front, in sector cloth/leather, black.

S sport seats, front 2

The image shows S sport seat, front, in fine Nappa leather, black.

| Cloth/Leather



Sector cloth/leather, black

| Leather



1 Fine Nappa leather, black

| Audi exclusive

1 2 Audi exclusive leather upholstery and trim¹
Individual choice of colour for leather/stitching.
From quattro GmbH

| Seat options

- 1 Sport seats, front
- 2 S sport seats, front

| Seat upholstery

Sector cloth/leather

seat centre panel in sector cloth, black, seat side bolsters in leather, black, design elements on the seat in mono.pur, black, contrasting stitching in red, door trim inserts in mono.pur, black, centre armrest (if ordered) in mono.pur, black

Fine Nappa leather

high-quality supple leather with a balanced lacquer coat. It has air-permeable properties thanks to its natural surface, thereby contributing to a pleasant seating climate. The leather is extremely hard-wearing, durable and resistant to fading. Its fine embossing underlines its exclusive character.

For sport seats, front: seat centre panel, seat side bolsters and head restraint centre panel in fine Nappa leather, black (contrasting stitching in silver) or steel grey (contrasting stitching in red), door/side panel trim inserts in mono.pur, black, centre armrest, front (if ordered) in mono.pur, black, with S embossing on the front-seat backrests

For S sport seats, front: seat centre panel, seat side bolsters and head restraint centre panel in fine Nappa leather, black (contrasting stitching in silver) or steel grey (contrasting stitching in red), backrest cover in high-gloss black, door/side panel trim inserts in mono.pur, black, centre armrest, front (if ordered) in mono.pur, black, with S embossing on the front-seat backrests

| Leather packages

Audi exclusive fine Nappa leather upholstery and trim (package 1)^{1,2}

seat upholstery, head restraints and door trim inserts in fine Nappa leather. Floor mats black with coloured leather piping. Individual choice of colour for the leather and the stitching from the range of Audi exclusive colours.

| Headlinings

Headlinings in cloth black

attachments in black

titanium grey

depending on the interior equipment colour chosen

Highlights on the interior. For maximum charisma.

Details determine individualism. They bring fascination alive. They determine a vehicle's character. And they highlight the driver's demands. Decide for yourself which colour the air vent sleeves of your Audi S1 or Audi S1 Sportback are to have – and give your vehicle even more charisma.



The model-specific standard and optional equipment can be found in the index from page 74 onwards.

| Air vent sleeves



High-gloss black



High-gloss black with red inner ring¹



Audi exclusive aluminium look²



Aluminium look with red inner ring¹

¹Only available in conjunction with the quattro interior styling package. ²From quattro GmbH.

| Technology

**Audi drive select**

allows vehicle characteristics to be set in the available modes auto, dynamic, efficiency by adjusting the accelerator characteristics, the engine sound and the S sport suspension with switchable dampers. The efficiency mode shifts specially selected systems (e. g. engine, air conditioning) to a consumption-improved basic setting.

Start-stop system

helps to reduce fuel consumption and CO₂ emissions by automatically switching off the engine when standing, e. g. at traffic lights. The start process is initiated as soon as the clutch is pressed (manual transmission). May be deactivated using a switch at any time

Recuperation

economises on fuel through brake energy recovery. Kinetic energy is converted into usable electrical energy by increasing the generator voltage when the vehicle is coasting or braking and reducing the voltage during a subsequent acceleration

6-speed manual transmission

all-synchromesh 6-speed manual transmission with hydraulically activated single-disc dry clutch with asbestos-free linings and dual-mass flywheel

quattro®

impressive traction and driving safety through the distribution of the drive forces to each individual wheel according to the driving situation. With wheel-selective torque control. The drive force is distributed by means of the electronically controlled multi-plate clutch on the rear axle and targeted braking actions on the part of the Electronic Differential Lock (EDL).

S sport suspension including switchable dampers

S-specific dynamic spring/damper setting. Improved driving comfort and driving dynamics thanks to 2 individual damping characteristics (auto/dynamic)

4-link rear axle

with independent wheel suspension and separate spring/damper arrangement

Power steering

set to a particularly sporty, direct style with electro-mechanical speed-sensitive steering assistance and energy-saving mode. Track stabilising steering scrub radius

**Brake callipers, painted black**

with S1 logo at the front, support the dynamic character of the vehicle by giving the brake system a sportier appearance

**Brake callipers, painted red**

| Lights

**Xenon plus including headlight cleaning system**

intensive road illumination, good uniformity and range thanks to headlights with durable gas discharge technology for dipped and high beam. Automatic dynamic headlight range control that prevents oncoming traffic from being dazzled. Integrated homogeneous LED daytime running light strip and headlight cleaning system. Also includes a red trim in conjunction with the quattro exterior styling package.

Light/rain sensor

automatic control of lights-on function, windscreen wipers and the coming home/leaving home function. Delayed switch-off/automatic switch-on of headlights, rear and number plate lights and with xenon plus the LED daytime running lights when parking/opening the vehicle. Windscreen with grey strip along the top edge

High-beam assist¹

Depending on the traffic situation, the high beam automatically adjusts to dipped beam and vice versa. Working within system limits, automatically detects the headlights of oncoming traffic, the rear lights of other road users and built-up areas

**LED rear lights**

earlier recognition by the driver behind due to the faster activation of brake lights, tail lights, rear number plate lights and indicators using LED technology with low power consumption. With reversing lights and rear fog lights. New design language with homogeneous, 3-dimensional floating effect for the light guide

Adaptive brake light

Brake light flashes in case of emergency stop to warn following traffic. In addition, the hazard warning light is automatically activated when the vehicle comes to a stop.

Technology Light Design Control elements Comfort Transport Safety Assistance systems Infotainment Audi Extended Warranty

| Design

**Audi Singleframe**

radiator grille in platinum grey with horizontal chrome struts. With chrome-plated, centred Audi rings

Exterior mirror housings in aluminium look

optionally:

painted in body colour
in roof line colour
in roof dome colour

S bumpers

in a striking sporty design with highlighted side air inlets and flaps in aluminium look, side sill trims and S diffuser at the rear

S roof edge spoiler

in a striking sporty design, painted in body colour

Exhaust tailpipes

dual-branch exhaust system each with 2 oval, chrome-plated tailpipes to the left and right

Model name

model name S1 on the luggage compartment lid and in the radiator grille. Can also be supplied without the model name on the rear on request. Model name S1 in the rev counter and MMI display. quattro logo on the dashboard on the passenger side

Audi exclusive black gloss package²

frame of the radiator grille, horizontal struts in the radiator grille and flaps in the side air inlets in high-gloss black, number plate holder and radiator grille in black matt

S door sill trims

on the door sills with aluminium inlay and S1 logo

**Pedals and footrest in stainless steel**

underline the sporty character



Aluminium look in the interior
elements in aluminium look on inside door handles, door pull handles, glove compartment, air conditioning control panel and rotary light switch, includes door sill trims with aluminium inlay

Extended coloured interior elements in mono.pur
armrests in the doors and lower centre console in mono.pur

Extended coloured interior elements in Audi exclusive leather^{1, 2}
armrests in the doors in the doors and lower centre console in leather. The colours of the leather and the stitching can be selected from the entire range of Audi exclusive colours.



competition kit film kit in contrasting colour³
makes your Audi S1 or Audi S1 Sportback quite unique. Comprising a film kit for the tailgate and film kit with dynamic strip for the shoulder line and one exterior mirror housing, all in contrasting colour (Amalfi white, Daytona grey, pearl effect or floret silver, metallic)

competition kit R18³
On the path of a champion: the competition kit R18 grey, consists of matt decorative film kits in ice silver and Daytona grey for the roof line, shoulder line and rear mirror. Also available as competition kit R18 red: with decorative film kits in ice silver and Misano red



Roof spoiler competition kit³
its athletic design rounds off the rear of the car with a striking touch – in vehicle colour or contrasting paint finish. Specially tailored to the design of the Audi S1 or Audi S1 Sportback

Roof line and rear film kit⁴
Give the roof of your Audi S1 Sportback a more customised appearance. The film kit in the glossy contrasting colours Amalfi white, Daytona grey, pearl effect, or floret silver, metallic, emphasises the roof line in a unique way. And the colouring of the rear provides additional contrast.

Roof line film kit³
Emphasise the sporty character of your Audi S1 or Audi S1 Sportback with a matt film kit in contrasting colour. Available in brilliant black matt or Daytona grey matt

Rear film kit³
sets dynamic highlights all round. With the film kit in contrasting colour for the rear mirror you will give your Audi S1 or Audi S1 Sportback an individual touch. Only available in combination with the quattro exterior styling package (colour-matched to the quattro logo in brilliant black or floret silver) or the roof line film kit (brilliant black matt or Daytona grey matt)

| Control elements



Multifunction sport leather steering wheel in 3-spoke design
with S1 emblem and S-specific contrasting stitching. Multifunction operating concept for operation of the available infotainment features. With full-size airbag, adjustable for height and reach, and gear lever knob in leather.



Multifunction sport leather steering wheel in 3-spoke design, flattened at the bottom

Sport leather steering wheel in 3-spoke design
with full-size airbag, adjustable for height and reach

Audi exclusive leather steering wheel rim^{1, 2}
Leather covering of steering wheel rim available in all Audi exclusive colours. Individual choice of colour for stitching in various Audi exclusive colours with specific Audi exclusive seam detail

Audi exclusive leather controls^{1, 2}
leather-covered steering wheel rim, gear lever and gear lever gaiter available in all Audi exclusive colours. Individual choice of colour for stitching in various Audi exclusive colours. Stitching on the steering wheel rim with special Audi exclusive seam detail

Audi exclusive controls in black suede^{1, 2}
steering wheel rim, gear lever knob and handbrake grip available in suede. The grip areas may show signs of use over time.



S-specific gear lever knob
in leather with red ring



Audi exclusive aluminium gear lever knob²



Convenience key
Access and drive authorisation system in which the key only needs to be carried with you. The engine is started and stopped using the engine start-stop button with red ring on the dashboard. The vehicle is locked and unlocked from outside via sensors on the driver and front-passenger door handles. Opening of the luggage compartment lid is possible even when the vehicle is locked.

Remote control key
unlocks and locks doors, luggage compartment lid and tank flap. With convenience closing/opening of the windows and the optional panoramic glass sunroof

¹ For information on when this feature will be available, please contact your Audi partner. ² From quattro GmbH. ³ From Audi Genuine Accessories: available as factory-fitted optional equipment or as a retrofit from your Audi partner. See the Audi configurator at www.audi.com for information on combination possibilities. ⁴ From Audi Genuine Accessories: available as factory-fitted optional equipment exclusively for the Audi S1 Sportback or as a retrofit from your Audi partner for the Audi S1 and Audi S1 Sportback. See the Audi configurator at www.audi.com for information on combination possibilities.

| Comfort

**Rear seat system**

2 seats and visually matched to the front seats. 2 L-shaped rear head restraints, height manually adjustable, for better rearward visibility. Rear seat backrest can be split and folded 40:60 or fully

**Centre armrest, front**

with fold-open storage compartment, adjustable angle

**Automatic air conditioning system**

electronically controls air temperature, volume and distribution, with sunlight-dependent control and automatic recirculation mode. 4 air vents in the dashboard as well as footwell vents at the front and rear. Separate defroster button for faster defrosting of front and side windows. Including combined filter, air intake control and light/rain and humidity sensor

Front seats with height adjustment including convenience entry

in addition to the driver seat the height of the front-passenger seat can be manually adjusted. In the Audi S1 easy access to the rear compartment thanks to enhanced folding function of the front seats

2-way lumbar support for the front seats

manually adjustable horizontally

Seat heating, front

heats the seat and backrest centre panels as well as the seat side bolsters. For driver and front-passenger seat individually adjustable in 2 stages

Windscreen with grey strip

along the top edge. Heat-insulating glass, tinted green

Dark-tinted windows (privacy glazing)

dark-tinted rear window, rear door windows and rear side windows

**Panoramic glass sunroof***

electrical activation to raise and open the glass section, opens and closes automatically. With tinted glass insert and infinitely adjustable sun shield as well as convenience closing from outside via the vehicle key. Creates a pleasant bright ambience thanks to the extra-large glass area. Good acoustics when the roof is raised or fully opened, integrated wind deflector reduces wind noise when the roof is opened.

**Panoramic glass sunroof with blackened roof***

including roof edge spoiler in black as well as without roof line in contrasting colour

| Transport

Storage compartments

storage compartment in the door/side panel trims and in the centre console

Storage package

comprising storage bag on the back of the front-seat backrests, storage compartment under the driver seat and storage net in the footwell on the front-passenger side. 2 multi-fastening points in the rear left and right, lockable glove compartment as well as storage tray including 3 cup holders between the rear seats

Luggage compartment package

comprising a luggage compartment net for securing to the lashing points on the luggage compartment floor, storage compartments under the loading floor, side tightening strap, additional multi-fastening point, additional luggage compartment light, 12V socket

Storage package with luggage compartment package

flexible transport of objects and convenient for travel. Combines the features of the storage package and the luggage compartment package

Ski/snowboard bag

for the practical transportation of long items, e. g. up to 4 pairs of skis or 2 snowboards. Removable and secured by a strap

| Safety

Exterior mirrors with integrated LED indicator
electrically adjustable with aspherical mirror glass on the left, convex on the right. Housings in aluminium look

additional options:

heated

including heated windscreen washer

heated and electrically folding

including heated windscreen washer jets and automatic kerb-side function for the exterior mirror on the passenger side

The automatic kerb-side function tilts the exterior mirror on the passenger side downwards when reverse gear is engaged, giving the driver a better view of the kerb.

Interior mirror, dimming

in same colour as headlining

optionally:

automatically dimming

with light/rain sensor and windscreen with grey strip

Anti-theft alarm

monitors doors, bonnet and luggage compartment lid and interior. Interior monitoring system which can be switched off and signal horn which is independent of the vehicle electrical system. With tow-away protection through tilt angle sensor

Airbags

full-size airbags for driver and front passenger. Optional deactivation switch for front-passenger airbag

Side airbags, front, and head airbag system

protect front and outer rear seats in the event of a side impact. Side airbags at the front integrated into the backrests and additional head airbag system which unfolds over the side window area

Integrated head restraint system

increases safety and reduces the danger of whiplash. In the event of a rear-end collision, the design of the front seat better restrains the upper torso and provides stronger support for the head than conventional systems.

ISOFIX child seat mounting and Top Tether¹ for the outer rear seats

standard mounting for practical attachment of ISOFIX child seats. Including additional attachment point (Top Tether). You can obtain the recommended child seats from your Audi partner.

| Assistance systems

Parking system, rear²

makes reverse parking easier within system limits by indicating acoustically how far away the vehicle is from an object detected behind the vehicle. Measured by ultrasonic sensors integrated discreetly in the bumpers



Secondary collision brake assist²

Following an accident, uncontrolled continued vehicle motion is prevented in certain situations. In these cases secondary collisions can be avoided.

Hill hold assist²

makes it more convenient to drive away on almost any gradient thanks to automatic braking intervention. After the foot brake has been pressed for a while with the vehicle stationary, the brake pressure that is built up is maintained for a short time after the brake is released.

Cruise control²

At speeds of 30 km/h and above, the system keeps the set speed constant, provided that engine power and engine braking effect permit it. Operated via separate steering column stalk. Set speed displayed in driver information system

Parking system plus²

acoustic and visual front and rear parking system assists with parking and manoeuvring. With optical indication in the display

| Infotainment



Driver information system

displays a variety of useful vehicle information on a 3.5-inch monochrome display in the direct field of vision of the driver. An integrated efficiency program provides consumption data overviews.

Instrument cluster

with grey dials, adjustable lighting, rev counter and speedometer with disproportionate display



chorus radio

- monochrome 3-inch display
- CD drive (MP3-capable)
- 24 station memory, FM (VHF) and AM (MW) reception range and speed-sensitive volume adjustment
- 4 passive loudspeakers at front, total output 40 watts

Digital Audio Broadcasting

better sound quality according to DAB standard, includes DAB+ and DMB audio through the reception of digitally broadcast radio stations³, display of additional information accompanying the programme e.g. artist, title and cover (depending on provision by the respective radio station) in the form of a slide show and other programme-independent data services (e.g. weather, traffic and news). In conjunction with MMI navigation plus permanent search for alternative reception frequencies of the set radio station by a 2nd DAB tuner. At the same time the station list is updated.



concert radio

- integrated MMI control concept with offset 6.5-inch colour display and car menu
- CD drive and SDHC memory card reader (up to 32 GB), each MP3-, WMA- and AAC-capable, as well as AUX-IN connection
- 50 station memory with dynamic station list, FM (VHF) and AM (MW) reception range including phase diversity and speed-sensitive volume adjustment
- TP memo function whilst driving
- 8 passive loudspeakers at the front and rear, total output 80 watts

Audi sound system

impressive sound thanks to 6-channel amplifier with a total output of 180 watts and 10 loudspeakers including centre speaker and subwoofer



Bose Surround Sound

impressive surround sound reproduction thanks to 10-channel amplifier with a total output of 465 watts and 14 loudspeakers including centre speaker and subwoofer. Noise-dependent volume adjustment thanks to AudioPilot® and reproduction of 5.1 surround sound (in conjunction with MMI navigation plus). Powerful and precise bass reproduction. A special design feature is the floating effect of the front loudspeaker created by indirect lighting using LED technology.

CD changer

supports CDs (MP3- and WMA-capable). 6 CDs can be changed individually. Files with digital rights management (DRM) cannot be played. Shock-resistant location in the glove compartment

¹The model-specific standard and optional equipment can be found in the index from page 74 onwards.

²For information on when this feature will be available, please contact your Audi partner. ³Please note: the systems can only work within system limits. They support the driver in driving tasks. The responsibility and attentiveness required for mastering driving tasks remains with the driver. ⁴Reception depends on digital network availability.

Audi music interface¹

Portable media players such as Apple iPod, Apple iPhone (music functionality) as well as USB storage media and MP3 players may be connected with special adapter cables available from Audi Genuine Accessories. Located in the glove compartment. Operation via the MMI or radio control or multifunction sport leather steering wheel. Part of the connectivity package and MMI navigation plus

**Audi music interface online¹**

The Audi music interface online extends the functionalities of the Audi music interface. Internet radio stations and podcasts can be recorded via your Wi-Fi home network and played back in the vehicle. Internet radio stations can be listened to live in the vehicle. The Audi music interface online makes it possible to create a Wi-Fi hotspot in the vehicle. Visit www.audi.com/mp3 for information on compatibility. From quattro GmbH

Adapter cable set for Audi music interface

comprising 2 connection cables for connection of Apple iPod/iPhone with dock connection (e.g. iPhone 4) as well as data storage devices/media players¹ with USB connection (type A). Other adapter cables are available from Audi Genuine Accessories

Adapter cable set plus for Audi music interface

Depending on the device used, the representation of cover arts and videos is possible as an added function in conjunction with Apple iPhone and more recent Apple iPod generations¹.

MMI® navigation plus

- with navigation data² (hard drive)
- high-resolution 6.5-inch colour display with high-quality map display and topographical map colouring, shows a lot of sightseeing information and 3D city models, choice of 3 alternative routes provided
- split-screen mode for route information (manoeuvring points, points of interest on motorways, TMCpro on route), detailed junction map and lane recommendations
- dynamic route guidance with TMCpro and spoken traffic information
- voice control system (whole-word entry of address in one sentence)
- additional arrow display in the driver information system
- radio with 3-way tuner and phase diversity
- hard drive can also be used to store music (20 GB)
- DVD drive (MP3-, WMA-, AAC- and MPEG-4-capable), can be used for music and video DVDs
- 2 SDHC card readers (up to 32 GB)
- Audi music interface
- Bluetooth interface with Bluetooth audio streaming
- 8 passive loudspeakers with a total output of 80 watts
- use of the services supported by Audi connect³

Audi connect including car phone

convenient connection of your vehicle to the internet for the use of Audi connect via an integrated data module. There is a reader for your SIM card in the surround of the MMI navigation plus.

The following services supported by Audi connect are currently available in your model:

Communication

- Wi-Fi hotspot

Mobility & navigation

- point-of-interest (POI) search with voice control
- traffic information online
- navigation with Google Earth™⁴ and Google Street View™⁴
- destination entry via myAudi or Google Maps™⁴
- country information
- fuel prices
- parking information

Infotainment

- Audi music stream
- weather
- news online
- city events
- travel information

Use of the services supported by Audi connect is possible only with the optional MMI navigation plus equipment and with Audi connect including car phone. You also require a SIM card with data option – with car phone a SIM card with phone and data option or a Bluetooth-capable smartphone with remote SIM Access Profile (rSAP). The services are available only with an existing or separate mobile phone contract and only within the range of the respective mobile phone network. Additional costs may be incurred when receiving data packets from the internet, depending on the terms of your mobile phone contract, particularly when used abroad. Because of the high data volumes involved, a data flat rate is strongly recommended.

The availability of the services supported by Audi connect varies from country to country. The services are provided for at least one year from vehicle delivery. The traffic information online service requires initial activation in the vehicle. From that point onwards, this service is subject to a 36-month usage limit (in as far as activation takes place within 6 months of vehicle delivery; otherwise corresponding shortening of the usage rights).

Please visit www.audi.com/connect or contact your Audi partner for more detailed information about Audi connect; contact your mobile services provider for information about contract conditions

Audi eInfo

everything at a glance – have selected information for vehicle control displayed directly on your smartphone with Audi connect. Audi eInfo uses the camera built into the smartphone to detect objects in the vehicle: just place the phone in the bracket behind the steering wheel, start the app and focus the camera on different controls in the driver area. If the element is recognised, operating instructions related to the function can be displayed on request. Audi eInfo for the Audi S1 and Audi S1 Sportback: specific information – clear, fast and no page turning!

Audi MMI connect app

The Audi MMI connect app is available for some smartphones and supports the following connect services:

- Audi music stream
- point-of-interest search
- destination entry via myAudi or Google Maps⁴
- city events
- traffic information online

Bluetooth interface⁵

allows hands-free calls to be made in the vehicle using the microphone and – depending on the mobile phone compatibility – Bluetooth audio streaming. Bluetooth-capable mobile phones can be connected to the vehicle via the interface.

**Audi phone box⁵**

allows phoning in the vehicle by placing the mobile phone in the mobile phone holder in the front centre armrest; includes an integrated coupling aerial for connection of the mobile phone with the external aerial, thus reducing radiation inside the vehicle and improving signal quality; includes a hands-free facility and voice control for the telephone functions; operation via the radio/navigation systems or the multifunction sport leather steering wheel. USB charging adapters which are available separately for many popular mobile phone models from Audi Genuine Accessories permit the simple charging of mobile phone batteries.

Connectivity package

combines the following features:

- Audi music interface
- Bluetooth interface for connecting Bluetooth-capable mobile phones with Bluetooth audio streaming
- preparation for navigation system (navigation function and map data available as retrofit solution from Audi Genuine Accessories)
- additional SDHC card reader (up to 32 GB)

In conjunction with the Audi music interface, the separate AUX-IN connection is omitted.

| Audi Extended Warranty**Audi Extended Warranty**

The Audi Extended Warranty offers longer-term protection against risk and allows you to control servicing costs even after the first 2 years of the manufacturer's guarantee. It can only be ordered directly and on purchase of a new car. 9 combinations of service life and mileage can be selected. Ask your Audi partner for more detailed information.

Navigation package

contains the features of the connectivity package as well as the navigation function and data on SD card². Maps shown on 6.5-inch colour display. Operation via concert radio, multifunction sport leather steering wheel or voice control

¹ Please contact your Audi partner and visit www.audi.com/mp3 for information on compatible media players. If Audi music interface is ordered the separate AUX-IN connection is omitted. ² Navigation data are not available for all countries and regions. For more detailed information, please contact your Audi partner. ³ Requires the optional equipment Audi connect. ⁴ Google and the Google logo are registered trademarks of Google Inc.

⁵ Please contact your Audi partner or visit www.audi.com/bluetooth for information on compatible mobile phones.

Audi Genuine Accessories. As individual as you are.

Enjoy getting from A to B. And then, inspired, just keep on driving. In the Audi S1 and Audi S1 Sportback, it's almost a given. Not least because they are thoroughly prepared for a multitude of individual requirements. Thanks to Audi Genuine Accessories: products that will inspire you to new destinations time and again. And keep our quality promise day in, day out. Benefit from customised solutions with convincing design and functionality. Because creativity in development and high production standards alongside numerous testing procedures are just as decisive for Audi Genuine Accessories as for the Audi vehicles themselves. Discover which tailor-made ideas Audi Genuine Accessories has to offer you. A few highlights are illustrated here – please contact your Audi partner for more information on the complete range.



Carrier unit with ski and snowboard rack

For the convenient transport of up to 6 pairs of skis or 4 snowboards. Can only be used in conjunction with the carrier unit, which is also suitable for the luggage box (370 l). The carrier unit is made of anodised aluminium, is easy to fit and can be locked. Maximum permissible total weight of carrier, modules and load: 75 kg.



Cast aluminium wheel in 5-arm polygon design, gloss turned finish¹, matt black

Unusual design for your Audi S1 or Audi S1 Sportback in the size 7.5 J x 18 for tyres of the size 225/35 R 18². Sophisticated casting procedure, classy multi-layer paint finishes and a comprehensive range of tests guarantee that the high quality demands we place on the cast aluminium wheel as well as the combination of attractive design and functionality are fulfilled.

Audi wireless internet access (not illustrated)

For setting up a free internet connection in the vehicle via Wi-Fi. Serves as a hotspot for up to 8 mobile devices such as tablets, laptops or smartphones – even up to a radius of 100 m outside the vehicle. Independent of battery run times thanks to router integrated in the vehicle. With roaming function, including for prepaid cards.

Adapter cables for Audi music interface

Enable connection of various iPod models and other portable media players. Operation via the MMI system if this function is supported by the media player. For more information, please contact your Audi partner.



Painted key trim

High-quality painted plastic trim for the remote control key. Available in the colours Samoa orange, metallic, Misano red, pearl effect, Amalfi white, ice silver, metallic, and glacier white, metallic. Also available: key trims made of leather in a range of different colours.



The fuel consumption and CO₂ emission figures as well as the efficiency class can be found on page 70.

¹Please note the special information about the rim on page 70. ²You will find specifications on the technical characteristics of tyres on page 71.

Model	S1 2.0 TFSI (170 kW)			
Engine type	4-cylinder inline petrol engine with direct fuel injection, turbocharging and intercooling			
Displacement in cc (valves per cylinder)	1,984 (4)			
Max. output ¹ in kW at rpm	170/6,000			
Max. torque in Nm at rpm	370/1,600–3,000			
Power transmission/wheels				
Drive type	quattro® permanent all-wheel drive			
Transmission type	6-speed manual transmission			
Wheels	Cast aluminium wheels, 7.5] x 17 [Cast aluminium wheels, 7.5] x 18]			
Tyres	215/40 R 17 ² [225/35 R 18 ²]			
Weights/capacities	S1	S1 Sportback		
Unladen weight ³ in kg	1,390	1,415		
Gross vehicle weight in kg	1,765	1,790		
Permissible roof load	75	75		
Fuel tank capacity, approx. in l	45	45		
Performance/consumption ⁴				
Top speed in km/h	250	250		
Acceleration 0–100 km/h in s	5.8	5.9		
Fuel grade	Sulphur-free super 95 RON ⁵			
Fuel consumption ⁶ in l/100 km				
urban	9.1	[9.2]	9.2	[9.3]
extra-urban	5.8	[5.9]	5.9	[6.0]
combined	7.0	[7.2]	7.1	[7.3]
CO ₂ emissions ⁶ in g/km				
urban	210	[214]	214	[216]
extra-urban	134	[138]	137	[140]
combined	162	[166]	166	[168]
Efficiency class/emission standard	E/EU6			

Explanatory notes

¹ The figure given was calculated using the specified measuring procedure (current version of Directive 80/1269/EEC).

² You will find specifications on the technical characteristics of tyres in the adjacent table.

³ Unladen vehicle weight includes driver (68 kg), luggage (7 kg) and fuel tank 90 % full, calculated in accordance with the current version of EC Directive 92/21/EEC. Optional equipment may increase the car's unladen weight and drag coefficient, whereupon the possible payload limit and the top speed will be reduced accordingly.

⁴ A vehicle's fuel consumption and CO₂ emissions do not just depend on how efficiently the vehicle uses the fuel, but are also influenced by driving behaviour and other non-technical factors. CO₂ is the greenhouse gas primarily responsible for global warming.

⁵ We recommend using sulphur-free super unleaded RON 95 fuel complying with DIN EN 228. If this is not available, use sulphur-free regular unleaded RON 91 fuel complying with DIN EN 228; power output will be slightly reduced. Unleaded RON 95 fuel with a maximum ethanol content of 10 % (E10) can generally be used. Fuel consumption details refer to operation with RON 95 fuel complying with 692/2008/EC.

⁶ The figures given were calculated using the specified measuring procedures. The figures do not refer to one individual vehicle and do not form part of any offer, but rather should be used purely for purposes of comparison between the different vehicle models.







Important note

Inspections are due as shown by the service display.

Special information about the rim: gloss turned finish, polished or galvanically chrome-plated rims must not be used in wintry road conditions. The surface of the rim does not have sufficient corrosion protection for manufacturing reasons and can be damaged permanently by road salt or similar.

Classifications of tyre parameters

The table shows the range of fuel efficiency, wet grip and exterior noise emission classes for the different tyre sizes of the Audi S1 and Audi S1 Sportback.

	Tyre size	Fuel efficiency class	Wet grip class	Exterior noise emission class
Summer tyres	215/40 R 17	F-E	C-B	72–71 
	225/35 R 18	F	C-B	73–68  – 
Winter tyres	195/50 R 16	F-E	E-C	72–67  – 
	215/40 R 17	F	E	67 

It is not possible to order a specific tyre. Ask your Audi partner about the range of tyres available in your country.

Audi S1

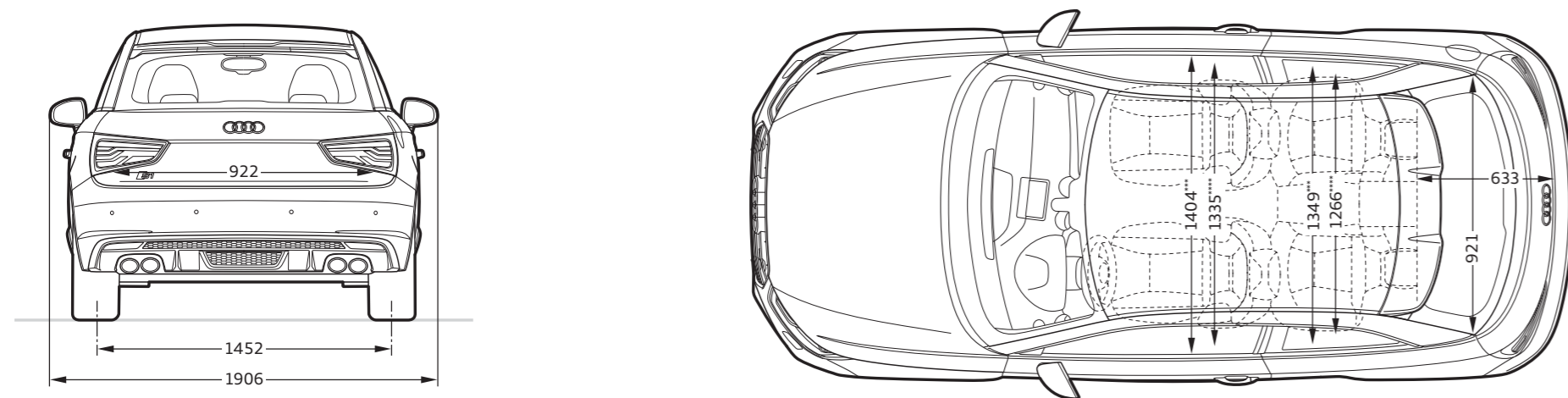
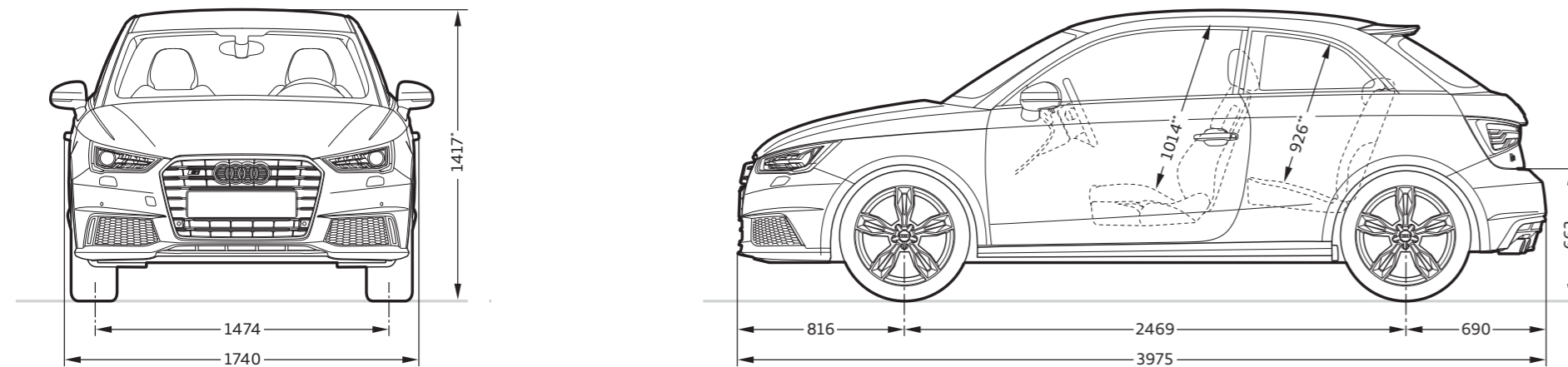
**Dimensions in millimetres.**

Dimensions are for unladen vehicle weight.

Luggage compartment volume 210/860 l (measured by the VDA method using 200 x 100 x 50 mm blocks; 2nd value is with the rear seat backrest folded down and the vehicle loaded up to roof height).

Turning circle approx. 10.6 m.

*With roof aerial the height of the vehicle is 1,409 mm. **Maximum headroom. ***Elbow room width.

****Shoulder room width.

Audi S1 Sportback

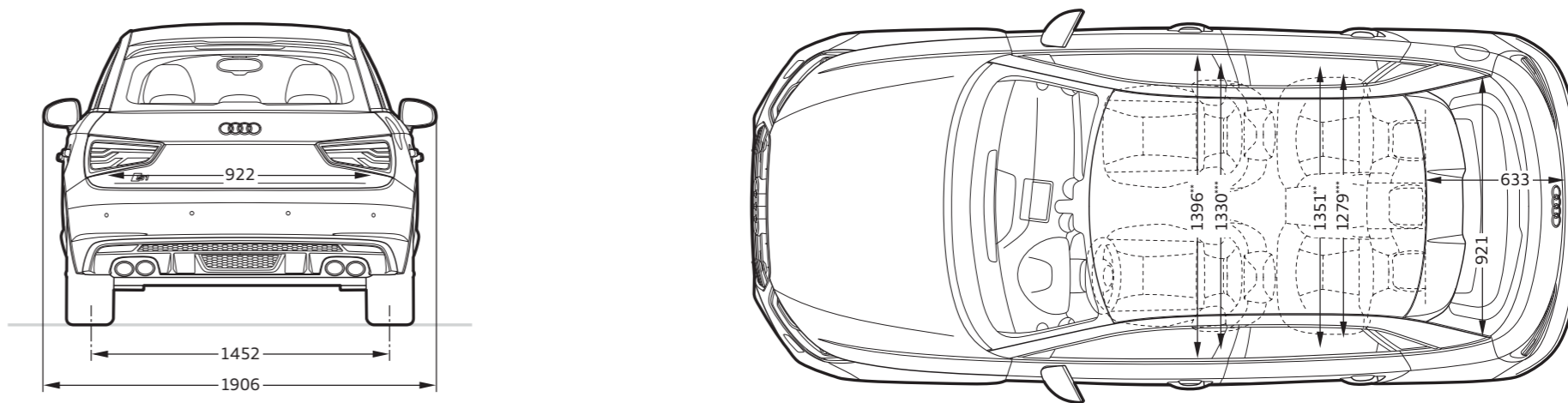
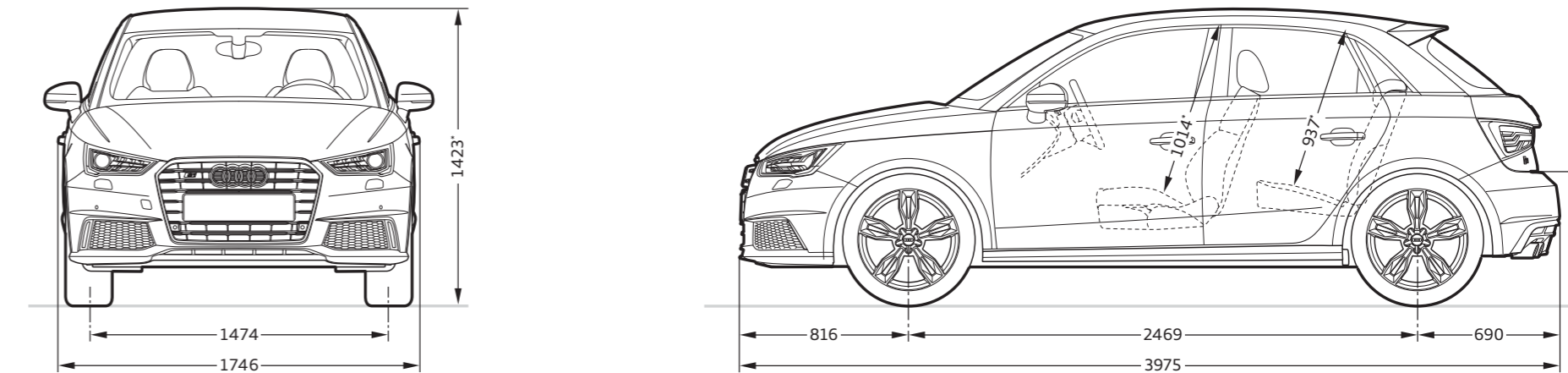
**Dimensions in millimetres.**











Dimensions are for unladen vehicle weight.







Luggage compartment volume 210/860 l (measured by the VDA method using 200 x 100 x 50 mm blocks; 2nd value is with the rear seat backrest folded down and the vehicle loaded up to roof height).







Turning circle approx. 10.6 m.

*With roof aerial the height of the vehicle is 1,414 mm. **Maximum headroom. ***Elbow room width.

****Shoulder room width.

	Page	S1	S1 Sportback
Equipment packages	44		
quattro exterior styling package		■	■
quattro interior styling package		■	■
Solid paint finishes	48		
 Brilliant black		□	□
 Vegas yellow		■	■
Metallic paint finishes	49		
 Glacier white, metallic		■	■
 Floret silver, metallic		■	■
 Scuba blue, metallic		■	■
 Mythos black, metallic		■	■
Pearl effect paint finishes	49		
 Daytona grey, pearl effect		■	■
 Sepang blue, pearl effect		■	■
 Misano red, pearl effect		■	■
Customised paint finishes	49		
 Audi exclusive customised paint finishes ¹		■	■
Roof line/roof dome in contrasting colour	48		
Roof line in contrasting colour		■	—
Roof dome in contrasting colour		—	■

	Page	S1	S1 Sportback
Wheels/tyres	50		
 17" cast aluminium wheels in 5-parallel-spoke design (S design)		□	□
 18" cast aluminium wheels in 5-arm facet design (S design), contrasting grey, partly polished ²		■	■
 18" cast aluminium wheels in 5-arm facet design (S design), black matt, partly polished ^{2, 3}		■	■
 16" cast aluminium winter wheels in 7-arm dynamic design		■	■
 17" cast aluminium winter wheels in 5-parallel-spoke design (S design)		■	■
 17" cast aluminium winter wheels in 5-arm design with decorative elements in high-gloss black		■	■
Anti-theft wheel bolts		■	■
Tyre repair kit		□	□
Tyre pressure loss indicator		□	□
Vehicle tool kit		□	□
Vehicle jack		■	■

	Page	S1	S1 Sportback
Seats	52		
Sport seats, front		□	□
S sport seats, front		■	■
Seat upholstery for sport seats, front	54		
 Sector cloth/leather, black		□	□
 Fine Nappa leather, black		■	■
 Fine Nappa leather, steel grey		■	■
 Audi exclusive fine Nappa leather upholstery and trim (package 1) ¹		■	■
Seat upholstery for S sport seats, front	54		
 Fine Nappa leather, black		■	■
 Fine Nappa leather, steel grey		■	■
 Audi exclusive fine Nappa leather upholstery and trim (package 1) ¹		■	■
Headlinings	55		
Headlining in cloth, black		□	□
Headlining in cloth, titanium grey		■	■
Air vent sleeves	56		
High-gloss black		□	□
High-gloss black with red inner ring ⁴		■	■
Audi exclusive aluminium look		■	■
Aluminium look with red inner ring ⁴		■	■

	Page	S1	S1 Sportback
Technology	58		
Audi drive select		□	□
Body		□	□
Start-stop system		□	□
Recuperation		□	□
6-speed manual transmission		□	□
quattro®		□	□
S sport suspension including switchable dampers		□	□
4-link rear axle		□	□
Power steering		□	□
Brake callipers, painted black		□	□
Brake callipers, painted red		■	■
Anti-Slip Regulation (ASR)		□	□
Electronic Differential Lock (EDL)		□	□
Electronic Stabilisation Control (ESC)		□	□
Lights	58		
Xenon plus including headlight cleaning system		□	□
Light/rain sensor		□	□
High-beam assist ⁵		■	■
LED rear lights		□	□

□ Standard equipment ■ Optional equipment — not available

Country-specific variations possible. Please find out from your local Audi partner which equipment is standard and what optional equipment is available in your country.

¹For information on when this feature will be available, please contact your Audi partner. ²Please note the special information about the rim on page 70. ³Only in conjunction with the quattro exterior style package.

⁴Only in conjunction with the quattro interior style package. ⁵Only in conjunction with interior mirror, automatically dimming with light/rain sensor.

	Page	S1	S1 Sportback
Lights (continued)	58		
Adaptive brake light		<input type="checkbox"/>	<input type="checkbox"/>
LED interior lighting package		<input type="checkbox"/>	<input type="checkbox"/>
Design	59		
Audi Singleframe		<input type="checkbox"/>	<input type="checkbox"/>
Exterior mirror housings in aluminium look		<input type="checkbox"/>	<input type="checkbox"/>
Exterior mirror housings painted in body colour		<input checked="" type="checkbox"/>	<input checked="" type="checkbox"/>
Exterior mirror housings in roof line colour		<input checked="" type="checkbox"/>	–
Exterior mirror housings in roof dome colour		–	<input checked="" type="checkbox"/>
S bumpers		<input type="checkbox"/>	<input type="checkbox"/>
S roof edge spoiler		<input type="checkbox"/>	<input type="checkbox"/>
Exhaust tailpipes		<input type="checkbox"/>	<input type="checkbox"/>
Model name		<input type="checkbox"/>	<input type="checkbox"/>
Without model name		<input checked="" type="checkbox"/>	<input checked="" type="checkbox"/>
Audi exclusive black gloss package		<input checked="" type="checkbox"/>	<input checked="" type="checkbox"/>
S door sill trims		<input type="checkbox"/>	<input type="checkbox"/>
Footwell trim		<input type="checkbox"/>	<input type="checkbox"/>
Pedals and footrest in stainless steel		<input type="checkbox"/>	<input type="checkbox"/>
Aluminium look in the interior		<input type="checkbox"/>	<input type="checkbox"/>
Extended coloured interior elements in mono.pur		<input type="checkbox"/>	<input type="checkbox"/>
Extended coloured interior elements in Audi exclusive leather ¹		<input checked="" type="checkbox"/>	<input checked="" type="checkbox"/>

	Page	S1	S1 Sportback
competition kit film kit in contrasting colour ²		<input checked="" type="checkbox"/>	<input checked="" type="checkbox"/>
competition kit R18 ²		<input checked="" type="checkbox"/>	<input checked="" type="checkbox"/>
Roof spoiler competition kit ²		<input checked="" type="checkbox"/>	<input checked="" type="checkbox"/>
Roof line and rear film kit ²		–	<input checked="" type="checkbox"/>
Roof line film kit ²		<input checked="" type="checkbox"/>	<input checked="" type="checkbox"/>
Rear film kit ²		<input checked="" type="checkbox"/>	<input checked="" type="checkbox"/>
Control elements	61		
Sport leather steering wheel in 3-spoke design		<input type="checkbox"/>	<input type="checkbox"/>
Multifunction sport leather steering wheel in 3-spoke design		<input checked="" type="checkbox"/>	<input checked="" type="checkbox"/>
Multifunction sport leather steering wheel in 3-spoke design, flattened at the bottom		<input checked="" type="checkbox"/>	<input checked="" type="checkbox"/>
Audi exclusive leather steering wheel rim ¹		<input checked="" type="checkbox"/>	<input checked="" type="checkbox"/>
Audi exclusive leather controls ¹		<input checked="" type="checkbox"/>	<input checked="" type="checkbox"/>
Audi exclusive controls in black suede ¹		<input checked="" type="checkbox"/>	<input checked="" type="checkbox"/>
S-specific gear lever knob		<input type="checkbox"/>	<input type="checkbox"/>
Audi exclusive aluminium gear lever knob		<input checked="" type="checkbox"/>	<input checked="" type="checkbox"/>
Convenience key		<input checked="" type="checkbox"/>	<input checked="" type="checkbox"/>
Remote control key		<input type="checkbox"/>	<input type="checkbox"/>
Window controls		<input type="checkbox"/>	<input type="checkbox"/>
Comfort	62		
Rear seat system, folding		<input type="checkbox"/>	<input type="checkbox"/>
Centre armrest, front		<input checked="" type="checkbox"/>	<input checked="" type="checkbox"/>
Centre console with storage compartment		<input type="checkbox"/>	<input type="checkbox"/>
Cigarette lighter and ashtrays		<input checked="" type="checkbox"/>	<input checked="" type="checkbox"/>

	Page	S1	S1 Sportback
12V socket		<input type="checkbox"/>	<input type="checkbox"/>
Floor mats, front and rear		<input type="checkbox"/>	<input type="checkbox"/>
Automatic air conditioning system		<input type="checkbox"/>	<input type="checkbox"/>
Front seats with height adjustment		<input type="checkbox"/>	<input type="checkbox"/>
Front seats with convenience entry		<input type="checkbox"/>	–
2-way lumbar support for the front seats		<input type="checkbox"/>	<input type="checkbox"/>
Seat heating, front		<input checked="" type="checkbox"/>	<input checked="" type="checkbox"/>
Sun visors		<input type="checkbox"/>	<input type="checkbox"/>
Grab handles		<input type="checkbox"/>	<input type="checkbox"/>
Windscreen with grey strip		<input type="checkbox"/>	<input type="checkbox"/>
Windscreen cleaning system		<input type="checkbox"/>	<input type="checkbox"/>
Heat-insulating glass		<input type="checkbox"/>	<input type="checkbox"/>
Heated rear window		<input type="checkbox"/>	<input type="checkbox"/>
Dark-tinted windows (privacy glazing)		<input checked="" type="checkbox"/>	<input checked="" type="checkbox"/>
Panoramic glass sunroof		<input checked="" type="checkbox"/>	–
Panoramic glass sunroof with blackened roof ³		<input checked="" type="checkbox"/>	–
Transport	63		
Glove compartment lighting		<input type="checkbox"/>	<input type="checkbox"/>
Storage compartments		<input type="checkbox"/>	<input type="checkbox"/>
Storage package		<input checked="" type="checkbox"/>	<input checked="" type="checkbox"/>
Luggage compartment package		<input checked="" type="checkbox"/>	<input checked="" type="checkbox"/>

	Page	S1	S1 Sportback
Storage package with luggage compartment package		<input checked="" type="checkbox"/>	<input checked="" type="checkbox"/>
Ski/snowboard bag		<input checked="" type="checkbox"/>	<input checked="" type="checkbox"/>
Lashing points in the luggage compartment		<input type="checkbox"/>	<input type="checkbox"/>
Safety	64		
Exterior mirrors with integrated LED indicator		<input type="checkbox"/>	<input type="checkbox"/>
Exterior mirrors, heated		<input checked="" type="checkbox"/>	<input checked="" type="checkbox"/>
Exterior mirrors, heated and electrically folding		<input checked="" type="checkbox"/>	<input checked="" type="checkbox"/>
Interior mirror, dimming		<input type="checkbox"/>	<input type="checkbox"/>
Interior mirror, automatically dimming		<input checked="" type="checkbox"/>	<input checked="" type="checkbox"/>
Electronic immobiliser		<input type="checkbox"/>	<input type="checkbox"/>
Anti-theft alarm		<input checked="" type="checkbox"/>	<input checked="" type="checkbox"/>
Preparation for tracking system		<input checked="" type="checkbox"/>	<input checked="" type="checkbox"/>
Airbags		<input type="checkbox"/>	<input type="checkbox"/>
Side airbags, front, and head airbag system		<input type="checkbox"/>	<input type="checkbox"/>
Side impact protection		<input type="checkbox"/>	<input type="checkbox"/>
Safety steering column		<input type="checkbox"/>	<input type="checkbox"/>
Head restraints, front		<input type="checkbox"/>	<input type="checkbox"/>
Head restraints, rear		<input type="checkbox"/>	<input type="checkbox"/>
Integrated head restraint system		<input type="checkbox"/>	<input type="checkbox"/>
Seat belts		<input type="checkbox"/>	<input type="checkbox"/>
Seat belt height adjustment		<input type="checkbox"/>	<input type="checkbox"/>
Seat belt reminder		<input type="checkbox"/>	<input type="checkbox"/>

Standard equipment Optional equipment – not available

Country-specific variations possible. Please find out from your local Audi partner which equipment is standard and what optional equipment is available in your country.

¹ For information on when this feature will be available, please contact your Audi partner. ² From Audi Genuine Accessories: available as factory-fitted optional equipment or as a retrofit from your Audi partner.

See the Audi configurator at www.audi.com for information on combination possibilities. ³ Can only be ordered with roof line in vehicle colour.

	Page	S1	S1 Sportback
Safety (continued)	64		
ISOFIX child seat mounting and Top Tether ¹ for the outer rear seats		<input type="checkbox"/>	<input type="checkbox"/>
Deactivation switch for front-passenger airbag		<input checked="" type="checkbox"/>	<input checked="" type="checkbox"/>
Warning and control lights		<input type="checkbox"/>	<input type="checkbox"/>
First-aid kit and warning triangle		<input checked="" type="checkbox"/>	<input checked="" type="checkbox"/>
Assistance systems	64		
Parking system, rear		<input checked="" type="checkbox"/>	<input checked="" type="checkbox"/>
Parking system plus		<input checked="" type="checkbox"/>	<input checked="" type="checkbox"/>
Secondary collision brake assist		<input type="checkbox"/>	<input type="checkbox"/>
Hill hold assist		<input checked="" type="checkbox"/>	<input checked="" type="checkbox"/>
Cruise control		<input checked="" type="checkbox"/>	<input checked="" type="checkbox"/>
Infotainment	65		
Driver information system		<input type="checkbox"/>	<input type="checkbox"/>
Instrument cluster		<input type="checkbox"/>	<input type="checkbox"/>
Centre display		<input type="checkbox"/>	<input type="checkbox"/>
chorus radio		<input type="checkbox"/>	<input type="checkbox"/>
Digital Audio Broadcasting		<input checked="" type="checkbox"/>	<input checked="" type="checkbox"/>
concert radio		<input checked="" type="checkbox"/>	<input checked="" type="checkbox"/>
Audi sound system		<input checked="" type="checkbox"/>	<input checked="" type="checkbox"/>
Bose Surround Sound		<input checked="" type="checkbox"/>	<input checked="" type="checkbox"/>
CD changer		<input checked="" type="checkbox"/>	<input checked="" type="checkbox"/>
Audi music interface		<input checked="" type="checkbox"/>	<input checked="" type="checkbox"/>
Audi music interface online		<input checked="" type="checkbox"/>	<input checked="" type="checkbox"/>

	Page	S1	S1 Sportback
Adapter cable set for Audi music interface		<input checked="" type="checkbox"/>	<input checked="" type="checkbox"/>
Adapter cable set plus for Audi music interface		<input checked="" type="checkbox"/>	<input checked="" type="checkbox"/>
MMI® navigation plus		<input checked="" type="checkbox"/>	<input checked="" type="checkbox"/>
Audi connect including car phone		<input checked="" type="checkbox"/>	<input checked="" type="checkbox"/>
Audi eInfo		<input checked="" type="checkbox"/>	<input checked="" type="checkbox"/>
Audi MMI connect app		<input checked="" type="checkbox"/>	<input checked="" type="checkbox"/>
Bluetooth interface		<input checked="" type="checkbox"/>	<input checked="" type="checkbox"/>
Audi phone box		<input checked="" type="checkbox"/>	<input checked="" type="checkbox"/>
Connectivity package		<input checked="" type="checkbox"/>	<input checked="" type="checkbox"/>
Navigation package		<input checked="" type="checkbox"/>	<input checked="" type="checkbox"/>
Audi Extended Warranty	67		
Extended Warranty		<input checked="" type="checkbox"/>	<input checked="" type="checkbox"/>

Equipment for the Audi S1 illustrated (p. 4–25):

Paint finish: Vegas yellow with roof line in brilliant black

Wheels/tyres: cast aluminium wheels in 5-arm facet design (S design) contrasting grey, partly polished²

Seats/seat upholstery: sport seats in fine Nappa leather, black, with silver contrasting stitching and S1 embossing

Air vent sleeves: Audi exclusive aluminium look

Equipment for the Audi S1 Sportback illustrated (p. 4–25):

Paint finish: Misano red, pearl effect, with roof dome in brilliant black

Wheels/tyres: cast aluminium wheels in 5-arm facet design (S design) black matt, partly polished²

Seats/seat upholstery: S sport seats in fine Nappa leather, steel grey with red contrasting stitching and backrest cover in high-gloss red as well as S1 embossing

Air vent sleeves: high-gloss black with red inner ring

Standard equipment Optional equipment — not available

Country-specific variations possible. Please find out from your local Audi partner which equipment is standard and what optional equipment is available in your country.

¹For information on when this feature will be available, please contact your Audi partner. ²Please note the special information about the rim on page 70.

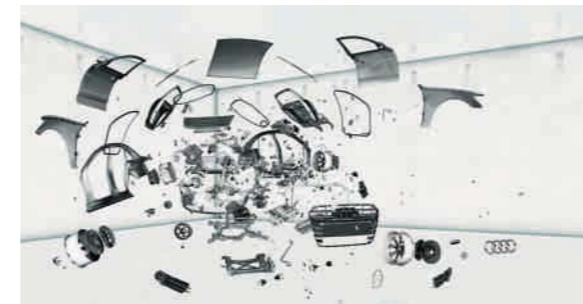

Responsibility

Living up to our responsibilities is a principle that is firmly anchored in Audi strategy. Alongside commercial success and international competitiveness, our responsibility toward company employees and society as a whole is a key consideration, as is protecting the environment and conserving resources. And what is true in the details – our catalogues are printed on FSC-certified paper – also holds in general: Audi develops cars that are not only sporty and emotive but also ever more efficient. In the long run, Audi wants its products

to allow CO₂-neutral mobility. Seeing to it that production in Audi plants gradually becomes CO₂-neutral is another aspect of our comprehensive approach. Audi is also committed to society – particularly in the fields of education, technology and social projects. At Audi, sustainability is closely linked with how we see the future: the Audi Urban Future Initiative sees Audi working with international experts to get to the root of future urban challenges and trends in mobility.

Discover the world of Audi.



Choosing an Audi means choosing a brand that offers more. More individuality. More exclusivity. More fascination.



Team spirit

Motorsport is a driving force behind the brand. For years Audi has been among the champions in various racing series, for instance the 24 Hours of Le Mans or the DTM German Touring Car Masters. The values that are crucial in many different areas of sports are also central ones for Audi: precision, passion and technology. No coincidence then that Audi has been sponsoring sporting events for

many years. In the world of winter sports, for example, Audi has been the main sponsor of the German Ski Association (DSV) for almost three decades and has also partnered 14 other national alpine teams. In football, we support national and international teams. And Audi is also a partner for the German Olympic Sports Confederation.

www.audi.com

Information on all the topics mentioned above can be found on our website: www.audi.com.

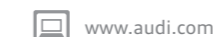

www.audi.com



configurator.audi.com



www.audi.com/vorsprung-durch-technik



www.audi.com/driving



www.audi.com/cr

Audi S1/S1 Sportback equipment

12V socket	77	Brake callipers, painted red	58
2-way lumbar support for the front seats	62	CD changer	65
4-link rear axle	58	Centre armrest, front	62
6-speed manual transmission	58	Centre console with storage compartment	76
Adapter cable set for Audi music interface	66	Centre display	78
Adapter cable set plus for Audi music interface	66	chorus radio	65
Adaptive brake light	59	Cigarette lighter and ashtray	76
Air vent sleeves	56	Cloth/leather upholstery and trim	54
Airbags	64	competition kit film kit in contrasting colour	60
Aluminium look in the interior	60	competition kit R18	60
Anti-Slip Regulation (ASR)	75	concert radio	65
Anti-theft alarm	64	Connectivity package	67
Anti-theft wheel bolts	74	Convenience key	61
Audi connect including car phone	66	Cruise control	64
Audi drive select	58	Dark-tinted windows (privacy glazing)	62
Audi eInfo	66	Deactivation switch for front-passenger airbag	78
Audi exclusive	46	Digital Audio Broadcasting	65
Audi exclusive aluminium gear lever knob	61	Driver information system	65
Audi exclusive black gloss package	59	Electronic Differential Lock (EDL)	75
Audi exclusive controls	61	Electronic immobiliser	77
Audi exclusive fine Nappa leather upholstery and trim (package 1)	55	Electronic Stabilisation Control (ESC)	75
Audi exclusive leather steering wheel rim	61	Exhaust tailpipes	59
Audi Extended Warranty	67	Extended coloured interior elements in Audi exclusive leather	60
Audi Genuine Accessories	68	Extended coloured interior elements in mono.pur	60
Audi MMI connect app	66	Exterior mirrors	64
Audi music interface	66	Exterior mirror housings	59
Audi music interface online	66	Film kit for roof lines and rear in contrasting colour	60
Audi phone box	67	First-aid kit and warning triangle	78
Audi Singleframe	59	Floor mats, front and rear	77
Audi sound system	65	Footwell trim	76
Automatic air conditioning	62	Front seats with height adjustment	62
Bluetooth interface	66	including convenience entry	62
Body	75	Glove compartment lighting	77
BOSE Surround Sound	65	Grab handles	77
Brake callipers, painted black	58		

Audi S1/S1 Sportback equipment

Head restraints	77	Roof line film kit	60
Headlinings	55	Roof line in contrasting colour	48
Heat-insulating glass	77	Roof spoiler competition kit	60
Heated rear window	77	S bumpers	59
High-beam assist	58	S door sill trims	59
Hill hold assist	64	S roof edge spoiler	59
Instrument cluster	65	S sport seats, front	53
Integrated head restraint system	64	S sport suspension	
Interior mirror	64	including switchable dampers	58
ISOFIX child seat mounting and Top Tether for the outer rear seats	64	S-specific gear lever knob	61
Lashing points in the luggage compartment	77	Safety steering column	77
LED interior lighting package	59	Seat belts	77
LED rear lights	59	Seat belt height adjustment	77
Light/rain sensor	58	Seat belt reminder	77
Luggage compartment package	63	Seat heating, front	62
MMI® navigation plus	66	Secondary collision brake assist	64
Model name	59	Side airbags, front, and head airbag system	64
Multifunction sport leather steering wheel		Side impact protection	77
in 3-spoke design	61	Ski/snowboard bag	63
Multifunction sport leather steering wheel		Sport leather steering wheel	
in 3-spoke design, flattened at the bottom	61	in 3-spoke design	61
Navigation package	67	Sport seats, front	53
Paint finishes	48	Start-stop system	58
Panoramic glass sunroof	63	Storage compartments	63
Panoramic glass sunroof with blackened roof	63	Storage package	63
Parking system plus	64	Storage package	
Parking system, rear	64	with luggage compartment package	63
Pedals and footrest in stainless steel	59	Sun visors	77
Power steering	58	Tyre pressure loss indicator	74
Preparation for tracking system	77	Tyre repair kit	74
quattro®	58	Vehicle jack	74
quattro exterior styling package	44	Vehicle tool kit	74
quattro interior styling package	44	Warning and control lights	78
Rear film kit	60	Wheels/tyres	50
Rear seat system	62	Window controls	76
Recuperation	58	Windscreen cleaning system	77
Remote control key	61	Windscreen with grey strip	62
Roof dome in contrasting colour	48	Xenon plus	
		including headlight cleaning system	58



AUDI AG
85045 Ingolstadt
www.audi.com
Valid from February 2014

Printed in Germany
433/1133.18.18

The models and equipment versions illustrated and described in this brochure and some of the services listed are not available in all countries. Some of the cars illustrated are equipped with optional features for which an extra charge is made. Details concerning the delivery specifications, appearance, performance, dimensions and weights, fuel consumption and running costs of the vehicles were correct to the best of our knowledge at the time of going to press. Deviations from the colours and shapes shown in the illustrations may occur. No liability is accepted for errors and printing errors. The right to introduce modifications is reserved. Not to be reproduced, including in part, without the written approval of AUDI AG.

This brochure is printed on paper made from pulp bleached without the use of chlorine.

