

JAGUAR F-TYPE 2020



THE ART OF PERFORMANCE





BY APPOINTMENT TO
HM THE QUEEN
MANUFACTURERS OF
MOTOR VEHICLES
JAGUAR LAND ROVER LIMITED
COVENTRY



BY APPOINTMENT TO
HRH THE DUKE OF EDINBURGH
MANUFACTURERS OF
MOTOR VEHICLES
JAGUAR LAND ROVER LIMITED
COVENTRY



BY APPOINTMENT TO
HRH THE PRINCE OF WALES
MANUFACTURERS OF
MOTOR VEHICLES
JAGUAR LAND ROVER LIMITED
COVENTRY



JAGUAR

THE ART OF PERFORMANCE

Every day we push performance to its limit. Our performance. Our cars' performance.
We innovate, we engineer, we design. We master rules and then break them.
Only to push further. Past the limits of convention. This is when performance becomes art.

Jaguar. The Art of Performance.



CONTENTS

INTRODUCTION

The Concept of the F-TYPE	06
The F-TYPE - The Facts	08

DESIGN

Exterior Principles	11
Exterior Detail	12
LED Headlights	14
Interior Connection	17
An Exclusive Space	19
Lightweight Seats	20
Luggage Space	23

PERFORMANCE

Engines Overview	24
i4 Engine	25
V6 Engines	26
V8 Engines	28
Lightweight Aluminum Architecture	30
Chassis and Suspension	32
Advanced Aerodynamics	34
Tested to the Extreme	37

DRIVING TECHNOLOGY

Advanced Driving Dynamics	38
Intensified Performance	40
Advanced Drivetrain Technology	43
Torque Vectoring	44
Stability and Control	46
Performance Braking Systems	49

TECHNOLOGY

Infotainment	51
Connectivity	52
Audio	56

DRIVER ASSISTANCE

	58
F-TYPE SVR	
Special Vehicle Operations	61
The Concept of the F-TYPE SVR	63
F-TYPE SVR Aerodynamics	64
F-TYPE SVR	
Lightweight Technologies	67
F-TYPE SVR Interior	69

PERSONALIZATION

F-TYPE - Your Choice	70
Choose your Engine	72
New F-TYPE Checkered Flag	74
Choose your Model	76
Choose your Options	78
Choose your Color	88
Choose your Wheels & Braking System	92
Choose your Interior	94
Choose your Jaguar Gear - Accessories	108
Technical Specifications	112
Dimensions	114

THE WORLD OF JAGUAR

AT YOUR SERVICE

INTRODUCTION

THE CONCEPT OF THE F-TYPE

The New Jaguar F-TYPE is the latest in a distinguished bloodline of powerful, agile and distinctive sports cars. Combining exhilarating performance, accomplished handling and cutting-edge technology, it delivers an exceptional driver-focused experience.

The advanced technology of the F-TYPE makes it as up-to-date as it is special. The range features a 2.0 liter 296HP Turbocharged Ingenium Gas engine – Jaguar’s most advanced and efficient engine ever found in an F-TYPE. While Jaguar’s most powerful infotainment system, Touch Pro, part of Jaguar InControl® technologies, is standard with a highly responsive 10" Touchscreen*. A range of driver assistance features are also available, helping to provide assistance on every drive.

LED headlights help make driving at night less tiring as they provide a quality of beam that is closer to daylight. Inside, slim seats save weight and provide more space and comfort, while interior finisher details allow even more personalization.

Checkered Flag enhances the racing heritage-inspired design of the F-TYPE. Exclusive exterior features accentuate the sport styling, while the interior is both contemporary and beautifully realized. This is a car that exudes confidence and one you'll simply relish driving.

*Driving while distracted can result in loss of vehicle control. Do not operate, adjust or view the navigation or multimedia systems under conditions that will affect your safety or the safety of others. Only use mobile phones and other devices, even with voice commands, when it is safe to do so.

VEHICLE SHOWN: JAGUAR F-TYPE CHECKERED FLAG 2.0 LITER i4 RWD GAS IN CARPATHIAN GREY WITH OPTIONAL EQUIPMENT





THE F-TYPE - THE FACTS

Stunning design, exhilarating performance, instant response, agile handling and advanced technology. The F-TYPE is created to deliver breathtaking driving experiences.

ALL WHEEL DRIVE

Instinctive All Wheel Drive® (AWD) combines the agility and character of Rear Wheel Drive (RWD) with the increased assistance and traction provided by AWD. In normal driving, the F-TYPE is predominantly RWD to deliver handling purity, feel and balance. But when needed, the system rapidly redistributes torque to the front axle, enabling the F-TYPE to maintain optimum traction in various conditions*.

TECHNOLOGY

The F-TYPE advanced technologies keep you entertained and connected. Park Assist¹ makes parking in a tight spot easier than ever*. Our 10" Touch Pro Jaguar InControl® infotainment system[†], with its tablet-style Touchscreen, offers intuitive swipe and pinch-to-zoom navigation**. And, with Remote, you have the ability to remotely connect to and monitor your F-TYPE.

INTERIOR

Weight reduction and driver focus find their balance in the F-TYPE. Standard slimline seats feature a lightweight magnesium construction and offer excellent lateral support. The F-TYPE looks as meticulously honed and sporty on the inside as it does on the outside.

*These features are not a substitute for driving safely with due care and attention and will not function under all circumstances, speeds, weather and road conditions, etc. Driver should not assume that these features will correct errors of judgment in driving. Please consult the owner's manual or your local authorized Jaguar Retailer for more details. **Driving while distracted can result in loss of vehicle control. Do not operate, adjust or view the navigation or multimedia systems under conditions that will affect your safety or the safety of others. Only use mobile phones and other devices, even with voice commands, when it is safe to do so. †Do not use Jaguar InControl® features under conditions that will affect your safety or the safety of others. Driving while distracted can result in loss of vehicle control.

¹Not available on F-TYPE. Optional on F-TYPE R-Dynamic, F-TYPE R and F-TYPE SVR.

²Engine dependent. ³Only available on F-TYPE R and F-TYPE SVR.

VEHICLE SHOWN: JAGUAR F-TYPE R-DYNAMIC IN YULONG WHITE WITH OPTIONAL EQUIPMENT

INGENIUM

The Ingenium 2.0 liter 4-cylinder 296HP Turbocharged Gas engine offers impressive levels of power. Its low inertia twin-scroll turbocharger features low-friction ball bearings and a mixed flow turbine wheel. Underpinned by the turbocharger's increased aerodynamic efficiency, the engine delivers rapid acceleration and maximum torque of 295 lb-ft between 1,500-4,500 rpm.

SUPERCHARGED PERFORMANCE

V6 and V8 engines use a twin vortex supercharger to reduce acceleration lag. Throttle response is instantaneous, with seamless power delivery and high levels of torque at all engine speeds.



DESIGN

Developed with advanced aerodynamics, the purposeful front end of the F-TYPE features a bumper framed by LED headlights. These elegant headlights adapt the width and depth of their beam to your speed and offer a superb quality of light - so you always have the best possible illumination whatever your surroundings. The F-TYPE has an exclusive range of 18 bespoke paints available in two finishes: these are in addition to the core F-TYPE color palette.

HANDLING AND AGILITY

To optimize handling and agility, a range of driving technologies are available on the F-TYPE. These include Torque Vectoring by Braking, Adaptive Dynamics² and an Electronic Active Differential³. Each feature works to enhance the driving experience through increased control, traction and feel*.





DESIGN EXTERIOR PRINCIPLES

DRAMATIC DESIGN

"A piece of design should tell a story. The F-TYPE lines have a start, a direction and a conclusion. Make every line individual and aesthetically correct, with the right dimensions, and a design will stand the test of time."

Ian Callum, Jaguar Design Director

Those bold proportions. Those instinctive curves. Timeless, evocative and progressive in a way that could only be Jaguar.

Some say great design is subjective, but for us there's no debate: F-TYPE beauty is the ultimate expression of the Art of Performance.

VEHICLE SHOWN: JAGUAR F-TYPE R-DYNAMIC AWD IN SILICON SILVER WITH OPTIONAL EQUIPMENT



EXTERIOR DETAIL

POWERFUL FORM

Rising vertically from the front spoiler and running up through elongated headlights, the beautifully flowing body line of the F-TYPE begins to take shape. The line arcs over the front wheel, descending elegantly as it runs across the door, before culminating in a pronounced muscular rear haunch. Whether you choose Coupe or Convertible, the F-TYPE leaves you under no illusion – this is a performance sports car, the latest in a distinguished bloodline.

VEHICLE SHOWN (LEFT): JAGUAR F-TYPE R-DYNAMIC AWD IN SILICON SILVER WITH OPTIONAL EQUIPMENT
VEHICLE SHOWN (RIGHT): JAGUAR F-TYPE IN INDUS SILVER WITH OPTIONAL EQUIPMENT



It is, in part, sculpted by the wind itself, formed by the Jaguar state-of-the-art Computational Fluid Dynamics design methods. A front splitter beneath the grille and rear venturi manage airflow along the underside, while a deployable rear spoiler¹ automatically rises at higher speeds to increase downforce and reduce drag. Even the door handles retract when not required; their flush design creates uninterrupted airflow along the F-TYPE flanks.

¹Optional on Jaguar F-TYPE SVR.

LED HEADLIGHTS



SIGNATURE DESIGN

ENHANCED ILLUMINATION



Even at night, the F-TYPE stands out. The LED headlights featuring LED 'J' blade Daytime Running Lights are as powerful as they look. These headlights reach further into the darkness than Xenon headlights, producing a highly focused beam of light with a quality closer to daylight, helping your eyes distinguish objects more easily.

Optional Auto High Beam Assist provides added convenience by automatically lowering the beam when other vehicles are detected*. 'J' blades complete the dramatic headlight design. These crisp bars of light wrap around each light's outer edge, giving the F-TYPE an instantly recognizable visual signature that adds to its assertive presence and distinctive style.

*These features are not a substitute for driving safely with due care and attention and will not function under all circumstances, speeds, weather and road conditions, etc. Driver should not assume that these features will correct errors of judgment in driving. Please consult the owner's manual or your local authorized Jaguar Retailer for more details.

VEHICLE SHOWN: JAGUAR F-TYPE R-DYNAMIC AWD IN SILICON SILVER WITH OPTIONAL EQUIPMENT





Instrument cluster featuring three analog gauges: a speedometer (0-190 mph), a tachometer (0-8,000 RPM), and a central digital display showing 2:56 PM and 79°F.

Steering wheel with the Jaguar logo in the center and 'XFR' branding at the bottom. The wheel is equipped with multiple control buttons for navigation, media, and phone functions.

Infotainment screen displaying a 'HOME' menu with the following options:

- Navigation: Arlington Avenue, Leamington Spa, 65 m, 4:55 min
- Media: Bluetooth audio, Young Before Your Time, Corvidae
- Phone: My iPhone

Climate control panel with three circular dials, each set to 70°F. Below the dials are buttons for AUTO, A/C, and other climate functions.

Center console featuring a gear shifter, a 'START ENGINE STOP' button, and various control buttons for driving modes and vehicle settings.

INTERIOR CONNECTION



DRIVER FOCUS

CLARITY OF DESIGN

In the F-TYPE, you and the car become one. Every aspect of its 1+1 configuration is designed to create a bond. It wraps around you, taking your driving experience to greater heights.

The cockpit provides increased visibility, minimal distractions, and close-to-the-center-of-gravity seating for a complete connection with the car. The low dashboard is free from clutter to increase the view ahead. The active central air vent, part of the advanced climate control system, hides the two central air vents, which automatically rise from the dashboard when required and retract after use.

The easy-to-use 10" color Touchscreen is your primary interaction point with the Touch Pro infotainment system. The system responds directly to touch and swipe gestures, providing effortless control over navigation, music, phone, climate and driver assistance features*.

*Do not use Jaguar InControl® features under conditions that will affect your safety or the safety of others. Driving while distracted can result in loss of vehicle control.

VEHICLE SHOWN: F-TYPE R-DYNAMIC AWD FEATURING EBONY WINDSOR LEATHER PERFORMANCE SEATS WITH IVORY CONTRAST STITCH WITH OPTIONAL FEATURES FITTED





AN EXCLUSIVE SPACE



SUPERIOR CRAFTSMANSHIP

A TAILORED SPACE

We design our interiors so that nothing detracts from the outstanding driving experience. You'll always feel comfortably cocooned in the exquisitely crafted F-TYPE cockpit. The cabin's styling expresses exclusivity and refinement while always maintaining driver focus. Every element of the interior is carefully considered, with even the smallest details deepening the sense of luxury - for instance, the Chrome finishes on the doors and steering wheel.

The F-TYPE interior starts with Jaguar's quintessential British character, but its unique personality is up to you. Tailor your interior styling with a variety of stitches and materials including Windsor leather and suedecloth, as well as Ebony, Pimento, Ivory and Sienna Tan color combinations. It's easy to make the F-TYPE feel truly personal, to make your perfect sports car.

VEHICLE SHOWN: F-TYPE R-DYNAMIC AWD FEATURING EBONY WINDSOR LEATHER PERFORMANCE SEATS WITH IVORY CONTRAST STITCH WITH OPTIONAL FEATURES FITTED



LIGHTWEIGHT SEATS



WEIGHT SAVING

COMFORT AND SUPPORT

The F-TYPE sport and Performance seats have been engineered with sports cars in mind. The magnesium construction of the seats reduces vehicle weight. The streamlined form takes up less space, enabling a greater range of seating positions. Performance seats provide increased lateral support during dynamic driving and the option of cooling for greater comfort.

VEHICLE SHOWN ABOVE AND RIGHT: JAGUAR F-TYPE R-DYNAMIC AWD FEATURING EBONY WINDSOR LEATHER PERFORMANCE SEATS WITH IVORY CONTRAST STITCH WITH OPTIONAL EQUIPMENT







LUGGAGE SPACE

> 14.4 CU.FT. | OPTIONAL POWERED TAILGATE¹

We have designed the cargo space of the F-TYPE Coupe to create a sports car that fits every lifestyle. With up to 14.4 cu.ft (and up to 7.3 cu.ft in the F-TYPE Convertible), the F-TYPE Coupe certainly has the space to accommodate two generously sized suitcases for a weekend away. For added ease of access, the tailgate can be opened or closed at the touch of a button with the optional powered function.

¹Coupe only.

VEHICLES SHOWN: JAGUAR F-TYPE IN INDUS SILVER AND F-TYPE R-DYNAMIC AWD IN SILICON SILVER WITH OPTIONAL EQUIPMENT

PERFORMANCE ENGINES OVERVIEW



HIGH PERFORMANCE ENGINES

RESPONSIVE POWER

All of the F-TYPE engines deliver high levels of torque and a near instantaneous response to your demand for power.

Making the dynamic performance more accessible is a 2.0 liter 4-cylinder 296HP Turbocharged Gas engine from our Ingenium range. It is the newest addition to our range of outstanding engines alongside the Supercharged 3.0 liter V6 340HP, the Supercharged 3.0 liter V6 380HP, the Supercharged 5.0 liter V8 550HP and the Supercharged 5.0 liter V8 575HP.

Every F-TYPE is fitted with an Active Sports Exhaust that creates a race-car inspired crescendo. The exhaust system reacts to throttle position, speed and engine revs by opening active valves. When open, these valves allow exhaust gases to take a more direct, less restrictive route through the rear silencer producing a much richer, more exhilarating sound. The Switchable Active Exhaust¹ allows you to manually open the exhaust valves so you can enjoy the stirring soundtrack of the F-TYPE at all engine speeds.



i4 ENGINE

0-60 mph from 5.4 seconds*

2.0 LITER i4		296HP
Model Availability		F-TYPE
Cylinders/Valves per Cylinder		4/4
Bore/Stroke	inches	3.27/3.64
Capacity	cc	1,997
Maximum Power	HP	296
Maximum Torque	lb-ft	295
Compression	ratio:1	9.5

*Always follow local speed limits. ¹Optional on F-TYPE, standard on F-TYPE R-Dynamic, F-TYPE R and F-TYPE SVR.

i4 ENGINE

 2.0 LITER 4-CYLINDER 296HP

The high-performance Ingenium 2.0 liter 296HP 4-cylinder Turbocharged Gas engine produces 295 lb-ft of torque and delivers outstanding driveability.

- The intelligent Continuously Variable Valve Lift (CVVL) system varies the extent to which inlet valves are opened, reducing engine pumping losses. This lets the engine 'breathe' with maximum efficiency, optimizing power and torque.
- CVVL works in combination with dual independent variable cam timing for ultimate operating flexibility, resulting in excellent power across the rev range.
- The twin-scroll Turbocharger is fed by an integrated exhaust manifold which increases the transfer of energy to the turbine - significantly reducing turbo lag and improving engine response.
- The twin-scroll Turbocharger features ceramic ball-bearings which reduce friction and improve transient response.

SINGLE CENTER MOUNTED EXHAUST

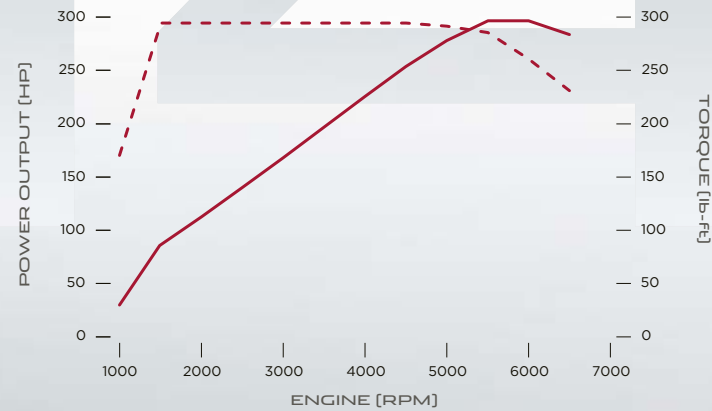

POWER [HP] ——— 296HP
TORQUE [lb-ft] - - - - -

VEHICLE SHOWN: JAGUAR F-TYPE IN YULONG WHITE WITH OPTIONAL EQUIPMENT

V6 ENGINES



3.0 LITER V6 340HP

3.0 LITER V6 380HP

The 3.0 liter V6 Supercharged Gas engines produce up to 339 lb-ft of torque for powerful and responsive performance.

- The Roots-type twin vortex supercharger provides linear power delivery and enhances responsiveness.
- A spray guided direct injection system carefully manages the air-fuel mixture in the combustion chamber for improved combustion, extracting more energy from the fuel injected - resulting in excellent power.



V6 ENGINES

0-60 mph from 4.8 seconds*

3.0 LITER V6 SUPERCHARGED	340HP	380HP
Model Availability	F-TYPE	F-TYPE R-Dynamic
Cylinders/Valves per Cylinder	6/4	6/4
Bore/Stroke	inches 3.33/3.50	3.33/3.50
Capacity	cc 2,995	2,995
Maximum Power	HP 340	380
Maximum Torque	lb-ft 332	339
Compression	ratio:1 10.5	10.5

*Always follow local speed limits.

- The engine also features dual independent variable cam timing to vary inlet and exhaust valve operation, working alongside lightweight pistons with ultra-low friction piston rings, for increased performance.
- A twin, contra-rotating balancer shaft system is employed to maximize refinement, resulting in an engine that delivers power smoothly.

CENTER MOUNTED TWIN EXHAUSTS

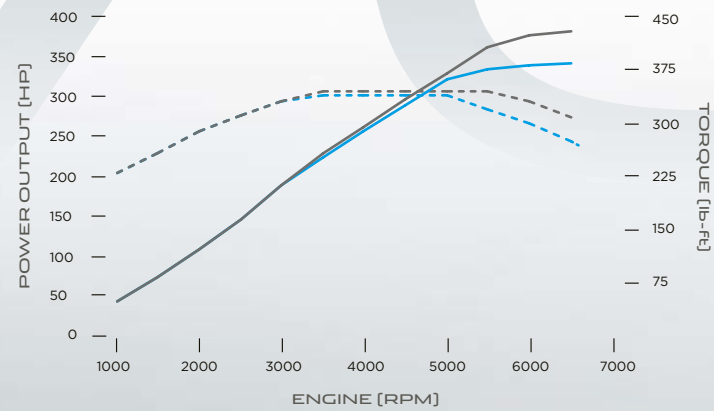

POWER [HP] 340HP 380HP
 TORQUE [lb-ft] - - - - - - - - - -

VEHICLE SHOWN: JAGUAR F-TYPE R-DYNAMIC AWD IN YULONG WHITE WITH OPTIONAL EQUIPMENT

V8 ENGINES



5.0 LITER V8 550HP

5.0 LITER V8 575HP

The 5.0 liter V8 Supercharged Gas engines produce up to 516 lb-ft of torque for top-of-the-range performance.

- The V8 has a compact and lightweight all-aluminum design, with impressively low levels of internal friction.
- The engine has been optimized around a state-of-the-art Bosch engine management system. This features high-pressure direct injection with a centrally mounted, multi-hole, spray-guided injection system.



V8 ENGINES

0-60 mph from 3.5 seconds*

5.0 LITER V8 SUPERCHARGED	550HP	575HP
Model Availability	F-TYPE R	F-TYPE SVR
Cylinders/Valves per Cylinder	8/4	8/4
Bore/Stroke	inches 3.64/3.66	3.64/3.66
Capacity	cc 5,000	5,000
Maximum Power	HP 550	575
Maximum Torque	lb-ft 502	516
Compression	ratio:1 9.5	9.5

*Always follow local speed limits.

- Fitted with a sixth-generation Twin Vortex System (TVS) supercharger, the engine offers thermodynamic efficiency and extremely refined noise levels. The supercharger fully utilizes the additional capacity of the 5.0 liter engine, generating a torque profile that delivers outstanding levels of power in a linear and engaging manner.

OUTBOARD MOUNTED QUAD EXHAUSTS

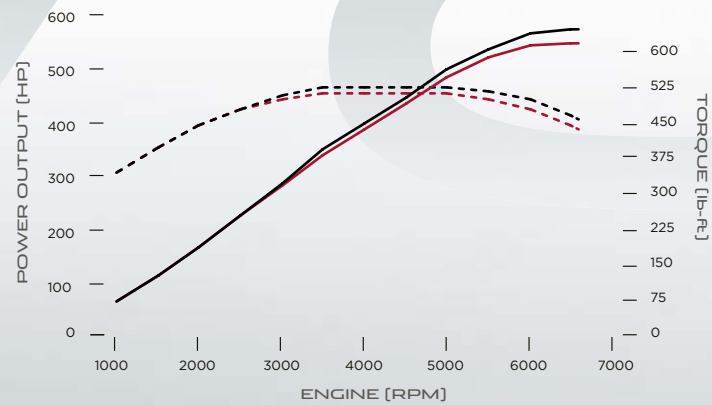

POWER [HP] 550HP 575HP
 TORQUE [lb-ft] - - - - - - - -

VEHICLE SHOWN: JAGUAR F-TYPE R IN YULONG WHITE WITH OPTIONAL EQUIPMENT

LIGHTWEIGHT ALUMINUM ARCHITECTURE



STRONG AND RIGID

HIGH POWER-TO-WEIGHT AND TORQUE-TO-WEIGHT RATIOS



A lightweight aluminum body with a strong, stiff structure is the perfect platform for a sports car. Jaguar pioneered this technology over a decade ago and continues to push the boundaries today. It informs every aspect of how the F-TYPE performs, handles and feels. The structure provides a platform for precise, agile handling and allows the finely-tuned suspension system to deliver connectivity and driver feedback. Lightweight aluminum panels are bonded together with a super-strong adhesive, then punched with zinc-coated, boron steel rivets that compress the adhesive to form an airtight bond for phenomenal strength and rigidity. The F-TYPE body is the perfect complement to its high-performance engine range. Together they produce the exceptional power-to-weight and torque-to-weight ratios that deliver the real-world measures of performance in a sports car.

The exterior panels are made from specially developed alloys. They combine robustness with greater formability, which gives clarity and tightness to curves and feature lines. On Coupe models, the side pressing is among the most technically advanced. It allows for cleaner lines with an extraordinarily beautiful, uninterrupted sweep from the front pillar to the trailing edge. This combination of advanced materials and innovative techniques has two advantages. It allows us to reproduce the crisp, crafted lines of the F-TYPE, exactly as the designers intended.

VEHICLE SHOWN: JAGUAR F-TYPE IN INDUS SILVER WITH OPTIONAL EQUIPMENT



F-TYPE

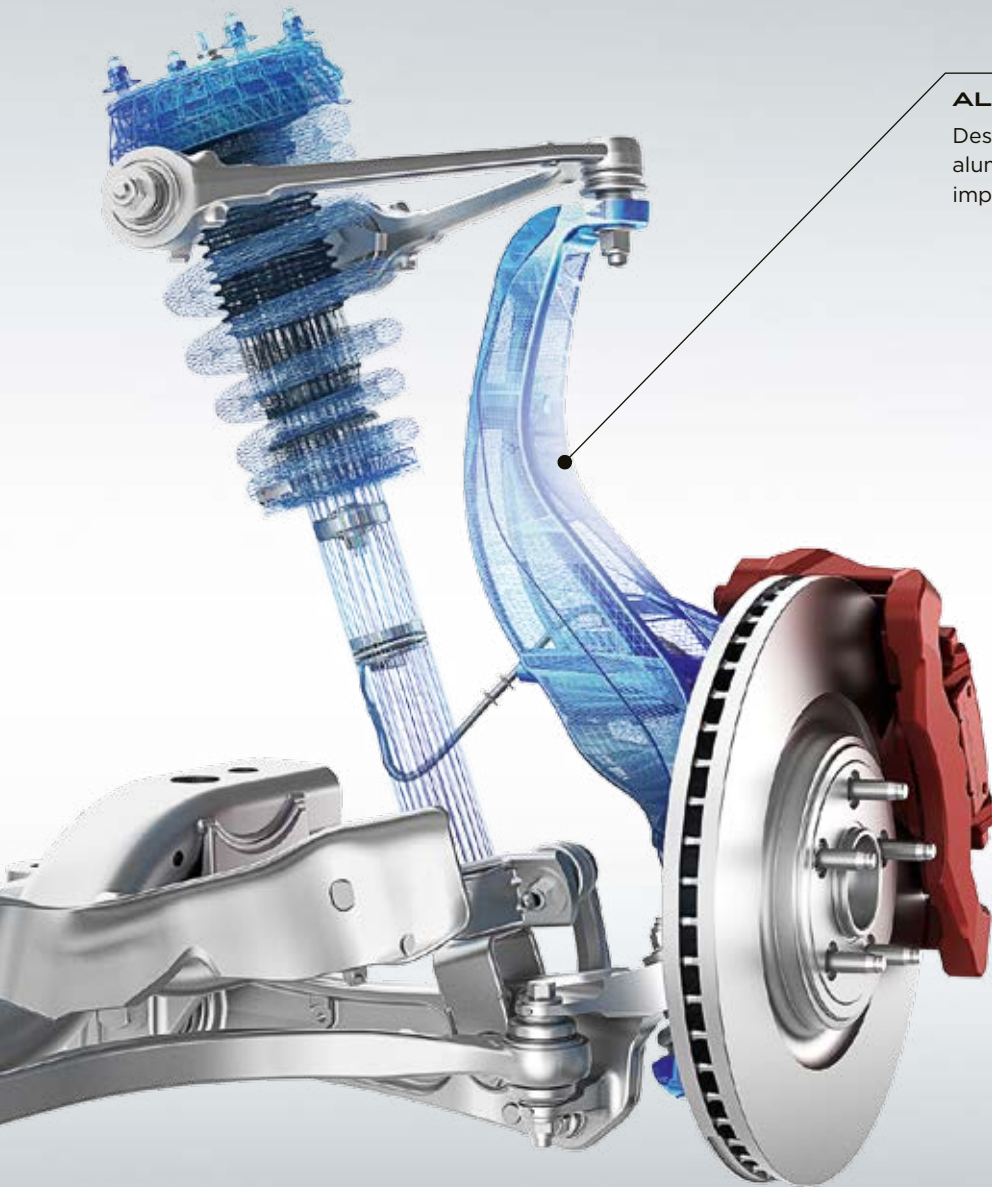

ALUMINUM SUSPENSION KNUCKLES

Designed to improve stiffness and strength, the lightweight aluminum front and rear suspension knuckles help to improve the agility and responsiveness of the F-TYPE.

CHASSIS AND SUSPENSION



CONTROL AND COMFORT

DYNAMIC AND REFINED

The Lightweight Aluminum Architecture of the F-TYPE creates a stable platform from which the forged aluminum double wishbone suspension can control the car. With the damping set-up optimized for the best partnership between dynamics and refinement, it gives the perfect combination of control, agility and feedback.

ADAPTIVE DYNAMICS

Standard on the 3.0 liter V6 380HP and 5.0 liter V8 engines, Adaptive Dynamics delivers composed dynamics and a compliant ride. The system assesses body motion and pitch rates 100 times per second. The steering wheel position is also measured 500 times a second, enabling the system to predict movements of the F-TYPE. The stiffness of each damper is then adjusted to help maintain body control and agility*.

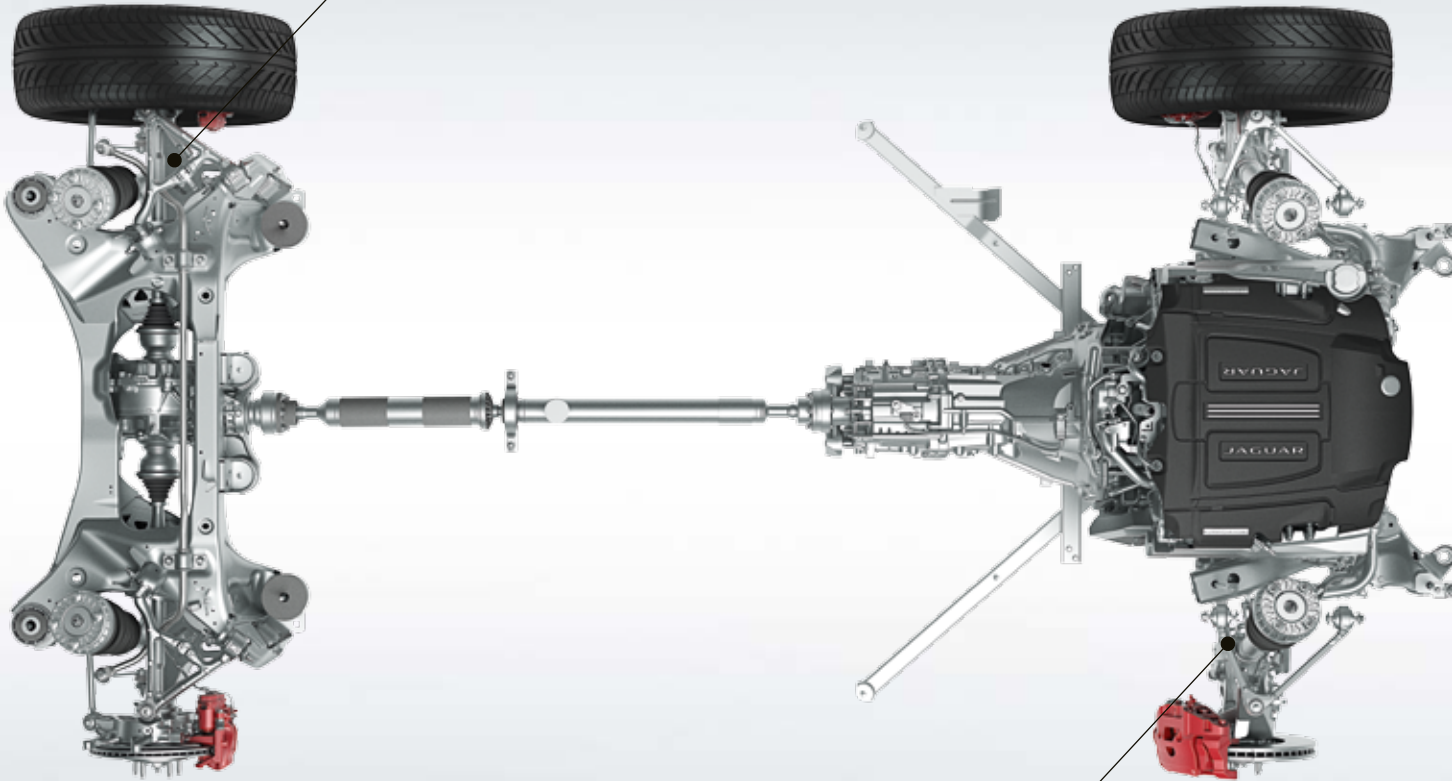

SUSPENSION

Considered by Jaguar as the best configuration for a suspension system, the F-TYPE forged aluminum double wishbone design offers precise handling and control.

*These features are not a substitute for driving safely with due care and attention and will not function under all circumstances, speeds, weather and road conditions, etc. Driver should not assume that these features will correct errors of judgment in driving. Please consult the owner's manual or your local authorized Jaguar Retailer for more details.

ADVANCED AERODYNAMICS



LOW DRAG AND HIGH STABILITY

DEPLOYABLE REAR SPOILER

Aerodynamic performance is at the heart of the F-TYPE design. It is seamlessly integrated into the body for low levels of lift and excellent stability at high speed. Even the door handles retract to create an uninterrupted airflow along its flanks. The deployable rear spoiler¹ automatically rises at higher speeds to reduce lift by up to 264 lbs. A front splitter beneath the grille manages airflow along the vehicle's underside, with the sharply defined tail helping to separate air cleanly at lower speeds. The result is improved handling and stability.

¹Optional on F-TYPE SVR.

VEHICLE SHOWN: JAGUAR F-TYPE R IN YULONG WHITE WITH OPTIONAL EQUIPMENT



373 GALLONS

OF RECYCLED WATER PER MINUTE
BLASTED AT EVERY CAR TO ENSURE
THE F-TYPE IS MONSOON PROOF

10,000,000 HOURS

OF VIRTUAL TESTING, REDUCING OUR IMPACT ON THE
ENVIRONMENT WITH SIGNIFICANT SAVINGS IN RESOURCE,
WASTE, POWER AND FUEL

792,000

VIRTUAL VEHICLES CREATED
TO PERFECT THE F-TYPE

12,000 MILES

OF EXTREME TRACK TESTING ON GERMANY'S
INFAMOUS NÜRBURGRING RACE TRACK -
EQUIVALENT TO DRIVING HALF WAY AROUND THE WORLD



162°F

DIFFERENCE BETWEEN THE HOTTEST (+122°F)
AND COLDEST (-40°F) EXTREME CLIMATE
TESTING ENVIRONMENTS

300 TERABYTES

OF PERFORMANCE DATA GATHERED TO REFINE
EVERY INCH OF THE F-TYPE

TESTED TO THE EXTREME



VIRTUAL ANALYSIS

REAL-WORLD TRIALS

The F-TYPE first took to the road in the virtual world of Computer Aided Engineering (CAE) systems, ensuring that all components underwent extensive development and testing before being committed to the physical testing process. Engineers produced a series of virtual prototypes to realistically simulate the behavior of complex mechanical systems, allowing them to analyze multiple variations until the optimum design was achieved. For example, using a technique first used in the aerospace industry, aerodynamic testing took place in a virtual wind tunnel with Computational Fluid Dynamics running on high-speed supercomputers. During its virtual life, the F-TYPE completed half a million tests, requiring 10 million computer processor hours and creating 300TB of data. The CAE development process was one of the key contributing factors in delivering the exhilarating performance and responsiveness of the F-TYPE.

The real-world testing to fine-tune the setup took place in specialized facilities and some of the harshest environments across the globe in temperatures ranging from - 40°F to +122°F, and at altitudes of up to 13,123 ft. The Nordschleife circuit at the Nürburgring in Germany was the perfect location to prove out handling, braking, cooling and durability. Known as the "Green Hell", and featuring 12.94 miles of track with 73 turns, it is renowned as the most demanding circuit in the world and the ultimate test of both car and driver.

VEHICLE SHOWN: JAGUAR F-TYPE R IN YULONG WHITE WITH OPTIONAL EQUIPMENT

DRIVING TECHNOLOGY ADVANCED DRIVING DYNAMICS



ENHANCING AGILITY

CONTINUOUSLY ADAPTING

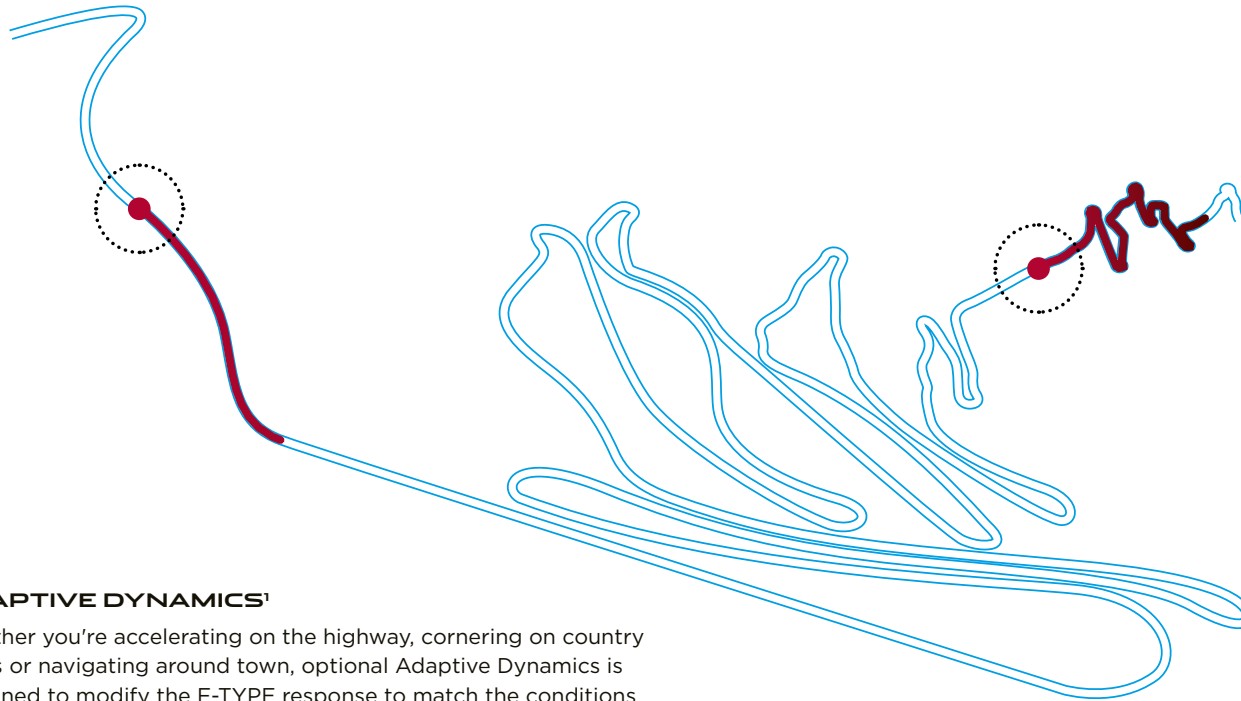

ADAPTIVE DYNAMICS¹

Whether you're accelerating on the highway, cornering on country roads or navigating around town, optional Adaptive Dynamics is designed to modify the F-TYPE response to match the conditions and your driving style. It analyzes acceleration, cornering, throttle and brake pedal activity as well as kick-down activation. Steering movement is analyzed up to 500 times a second, and body movement up to 100 times a second. Electronically controlled dampers then constantly adjust to optimize the suspension settings and maintain the F-TYPE dynamism and comfort*.

*These features are not a substitute for driving safely with due care and attention and will not function under all circumstances, speeds, weather and road conditions, etc. Driver should not assume that these features will correct errors of judgment in driving. Please consult the owner's manual or your local authorized Jaguar Retailer for more details.

¹Only available with the 3.0 liter V6 380HP engine and 5.0 liter V8 engines.

ELECTRIC POWER ASSISTED STEERING

Electric Power Assisted Steering (EPAS) offers outstanding feedback, control and is active on demand – saving power for where you really need it. This steering system delivers the immediate response and connected feel expected from a Jaguar sports car. Sophisticated computer management varies steering assistance as appropriate – increasing assistance for low-speed maneuvering and improving feel at higher speeds*.



INTENSIFIED PERFORMANCE

> DYNAMIC MODE | CONFIGURABLE DYNAMICS



Engaging Dynamic Mode amplifies the sporting character of the F-TYPE. Gearshifts are faster and at higher engine speeds with automatic upshifts prevented if in Manual Mode, throttle response is sharpened, the dampers are stiffened¹ and steering weighting is increased. Dynamic Mode also opens the Active Sports Exhaust for a more thrilling soundtrack and brings visual drama to the cabin – the F-TYPE instrument cluster and Configurable Ambient Interior Lighting² instantly take on a Red glow.

The Configurable Dynamics system¹ allows you to personalize the Dynamic Mode to create your perfect dynamic setup. Via the Touchscreen, four driving characteristics can be changed to Dynamic or left as normal. So whatever combination of throttle sensitivity, transmission shift points, steering weighting or damper stiffness you want, Configurable Dynamics allows you to set up Dynamic Mode to suit your driving needs.

¹Standard on F-TYPE R and F-TYPE SVR. Optional on F-TYPE R-Dynamic. Not available on F-TYPE.

²Standard on F-TYPE R and F-TYPE SVR. Optional on F-TYPE and F-TYPE R-Dynamic.



DRY ROAD CONDITIONS

In normal conditions, All Wheel Drive (AWD) models distribute torque to the rear wheels, delivering acclaimed Jaguar agility and handling*.

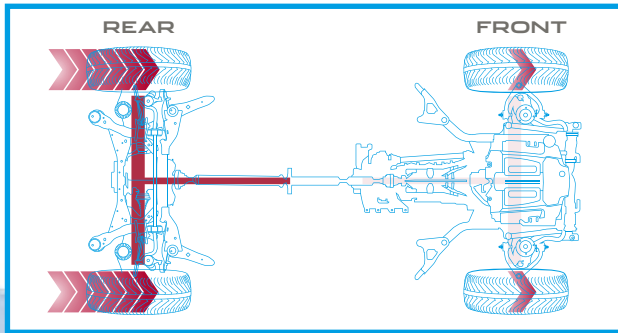

LOW TRACTION CONDITIONS

On slippery surfaces, such as grass and snow, torque can be balanced between the front and rear wheels to improve traction on All Wheel Drive (AWD) models. In extreme conditions where only the front wheels have traction, up to 100 percent of engine torque can be distributed to the front wheels for a more optimal grip*.

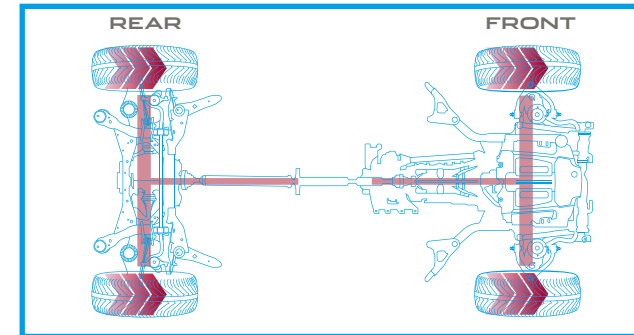

ADVANCED DRIVETRAIN TECHNOLOGY



ALL WHEEL DRIVE

INTELLIGENT DRIVELINE DYNAMICS

The All Wheel Drive (AWD) system combines the agility and character of Rear Wheel Drive (RWD) with the increased traction provided by AWD. In normal driving, the F-TYPE is predominantly RWD to deliver handling purity, feel and balance. But when roads become more challenging, or when you accelerate on low-grip surfaces, the system subtly channels power forwards, enabling the F-TYPE to maintain improved traction for comfortable progress in most conditions*.

The F-TYPE AWD uses a transfer case at the back of the 8-speed Automatic Transmission to manage the appropriate distribution of torque to the front and rear wheels. Engineered to ensure that the F-TYPE retains the dynamic behavior appropriate for a sports car, the transfer case contains an electro-mechanically activated multi-plate clutch with a smart actuator. Torque is delivered quickly and accurately, via a sophisticated ball ramp mechanism that develops the required force at the clutch, to transfer the optimal amount of torque to the front wheels.

Unlike other systems that react to wheel slip, the Jaguar Intelligent Driveline Dynamics (IDD) software is predictive and uses sensors measuring throttle and steering inputs to anticipate wheel slip. IDD seamlessly coordinates these inputs and compares them with responses from the engine, transmission and traction control systems to calculate the traction available and distribute torque accordingly, even before grip is lost. From a standstill, the F-TYPE can transition from RWD to AWD in as little as 165 milliseconds, or just 100 milliseconds when the car is moving**.

The result is a drive which blends the character of RWD with the capability of AWD, providing outstanding levels of performance in various conditions.

*This feature is not a substitute for safe and attentive driving, nor can it overcome all extreme circumstances. Please consult the owner's manual or your local authorized Jaguar Retailer for more details. **These features are not a substitute for driving safely with due care and attention and will not function under all circumstances, speeds, weather and road conditions, etc. Driver should not assume that these features will correct errors of judgment in driving. Please consult the owner's manual or your local authorized Jaguar Retailer for more details.

TORQUE VECTORING



**INCREASED STEERING
PERFORMANCE**

**ENHANCED
CORNERING CAPABILITY**

The F-TYPE Torque Vectoring improves capability through even the tightest corners. Torque Vectoring technology provides controlled independent braking of the individual inside front and rear wheels to add to the turning forces acting on the car. In most conditions, more braking pressure is applied to the rear inside wheel as this supports the most increased cornering capability, while the front inside wheel is braked for greater effectiveness and refinement. The result is reduced understeer for sharper turning and more consistent road holding*.

Torque Vectoring delivers increased agility and handling. On the F-TYPE R and the F-TYPE SVR, Torque Vectoring works together with the Electronic Active Differential system (see page 46), complementing each other to enhance traction and cornering ability as well as enhancing steering feel and agility*.

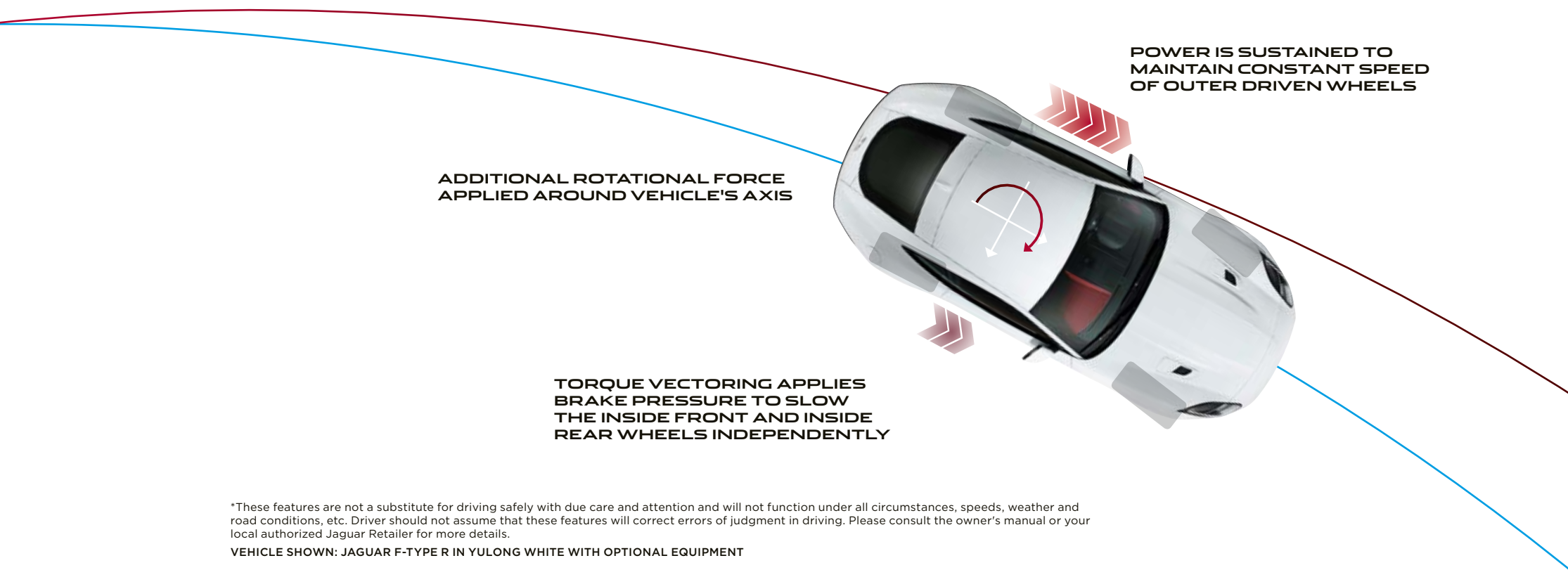

**POWER IS SUSTAINED TO
MAINTAIN CONSTANT SPEED
OF OUTER DRIVEN WHEELS**

**ADDITIONAL ROTATIONAL FORCE
APPLIED AROUND VEHICLE'S AXIS**

**TORQUE VECTORING APPLIES
BRAKE PRESSURE TO SLOW
THE INSIDE FRONT AND INSIDE
REAR WHEELS INDEPENDENTLY**

*These features are not a substitute for driving safely with due care and attention and will not function under all circumstances, speeds, weather and road conditions, etc. Driver should not assume that these features will correct errors of judgment in driving. Please consult the owner's manual or your local authorized Jaguar Retailer for more details.

VEHICLE SHOWN: JAGUAR F-TYPE R IN YULONG WHITE WITH OPTIONAL EQUIPMENT



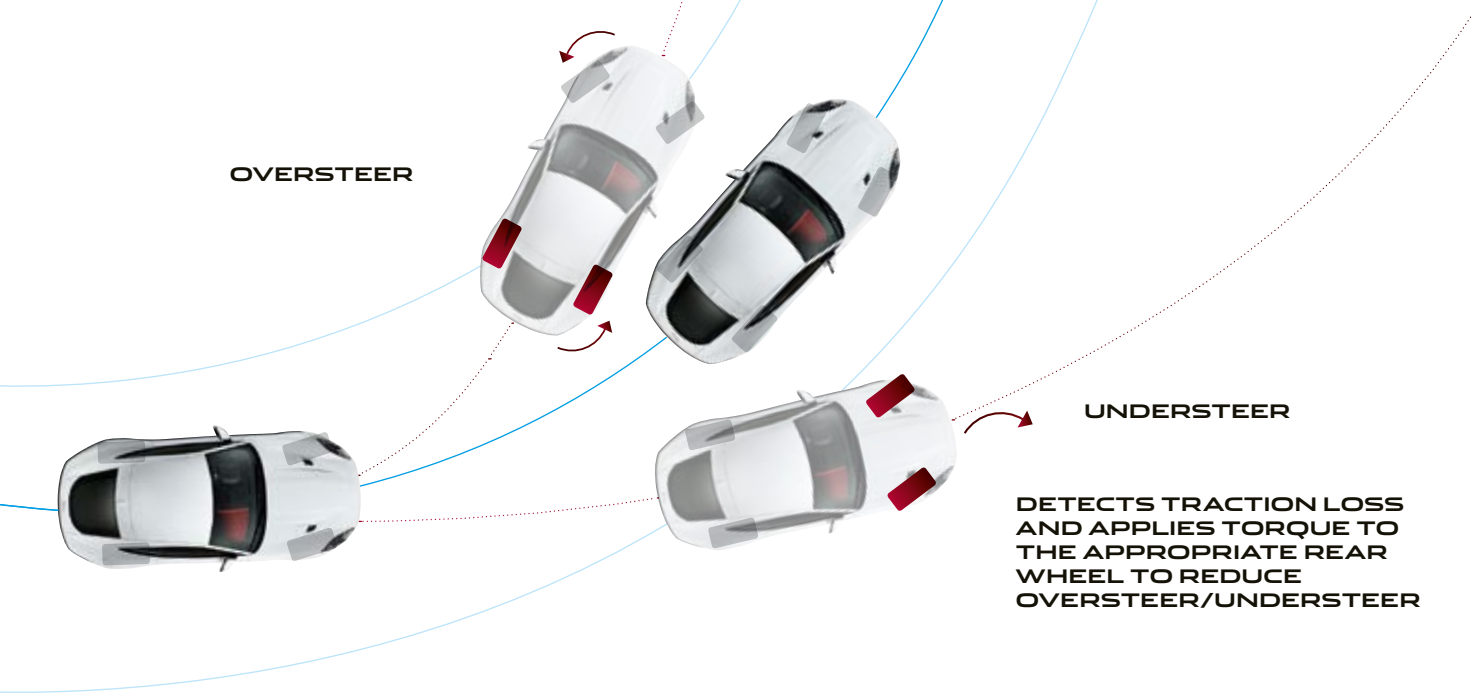

STABILITY AND CONTROL

> OUTSTANDING TRACTION | ELECTRONIC ACTIVE DIFFERENTIAL

Jaguar's stability systems are designed to help keep the F-TYPE well balanced whether you're driving enthusiastically or simply require assurance when driving in challenging conditions. To fully harness their performance potential, and for greater control and traction, a Limited Slip Differential is fitted with the 3.0L V6 380HP engine and an Electronic Active Differential is fitted with the 5.0L V8 550HP and 575HP engines*.

Limited Slip Differential: When a rear wheel has low grip, the Limited Slip Differential is designed to transfer torque through a mechanically activated clutch package to the wheel that has more grip. This limits slip across the axle, improving control and traction for faster, more precise cornering*.

Electronic Active Differential: Has a higher locking torque capacity to exploit the increased power and torque of the V8 engines. This differential works with the AWD system and Intelligent Driveline Dynamics (IDD) software, as well as the traction and stability systems, to improve traction and cornering control. Variable electronic control allows this differential to continually adjust locking torque between the wheels - this gives sharper turn-in when entering corners and the ability to accelerate sooner when leaving corners because the torque at each wheel is more controllable*.

*These features are not a substitute for driving safely with due care and attention and will not function under all circumstances, speeds, weather and road conditions, etc. Driver should not assume that these features will correct errors of judgment in driving. Please consult the owner's manual or your local authorized Jaguar Retailer for more details.

VEHICLE SHOWN: JAGUAR F-TYPE R IN YULONG WHITE WITH OPTIONAL EQUIPMENT





JAGUAR
CARBON CERAMIC

PERFORMANCE BRAKING SYSTEMS

> LIGHTWEIGHT | POWERFUL | DURABLE

A range of braking systems are available, each one engineered to deliver a confident, progressive feel and consistent high performance. The calipers use aluminum to reduce the unsprung mass of the car, benefiting both handling and ride refinement. Each system features large, ventilated brake discs – up to 398mm in diameter on the carbon ceramic system. This large swept area improves braking force as well as providing greater capacity for the discs to absorb and dissipate the heat energy generated during braking.

Jaguar's Carbon Ceramic Braking System¹, with its striking Yellow monobloc calipers, is the most powerful braking system fitted to a Jaguar road car. It offers up to 46 lbs of weight saving, further reducing unsprung mass. With greater resistance to fade and wear, it is designed to deliver sustained performance in demanding conditions.

355MM FRONT AND
325MM REAR BRAKES



STANDARD ON F-TYPE
CALIPERS: SILVER

380MM FRONT AND
325MM REAR BRAKES



STANDARD ON F-TYPE R-DYNAMIC¹
CALIPERS: BLACK OR RED

380MM FRONT AND
376MM REAR BRAKES



STANDARD ON F-TYPE R AND F-TYPE SVR
OPTIONAL ON F-TYPE R-DYNAMIC¹
CALIPERS: BLACK OR RED

398MM FRONT AND
380MM REAR CARBON
CERAMIC BRAKES



OPTIONAL ON F-TYPE R-DYNAMIC,
F-TYPE R AND F-TYPE SVR¹
CALIPERS: YELLOW

¹Not available on F-TYPE.

For more details on brake availability refer to pages 92-93 or configure your vehicle at jaguarusa.com





TECHNOLOGY INFOTAINMENT

Delivering a wealth of information and entertainment, every F-TYPE is equipped with our Jaguar InControl® infotainment system, Touch Pro. It features intuitive and advanced integrated technologies to ensure everyone can make the most of their trip*.

TOUCH PRO 10" SCREEN

The standard 10" Touchscreen at the heart of the center console supports swipe and pinch gestures and delivers our richest audio-visual entertainment. To enhance the in-car experience, Touch Pro offers customizable homescreens and fast response times. Multi-tasking is also made easy thanks to the Interactive Side Panel*.

*Do not use Jaguar InControl® features under conditions that will affect your safety or the safety of others. Driving while distracted can result in loss of vehicle control.

INTERIOR SHOWN: JAGUAR F-TYPE SVR FEATURING EBONY WINDSOR LEATHER PERFORMANCE SEATS WITH IVORY CONTRAST STITCH

CONNECTIVITY

Jaguar InControl® is our suite of standard and optional features that connects you to your vehicle and links you seamlessly with the outside world. There are a range of packages and options available to choose from. With a selection of apps, even when you're away from your car, some of the InControl features stay with you, making sure the Jaguar experience is more enjoyable than ever*.

STANDARD FEATURES

NAVIGATION PRO

Navigation Pro allows you to save your favorite places, use swipe and pinch-to-zoom gestures for simple map exploration and display a choice of either 2D or 3D crystal clear map graphics*. You can also keep maps up-to-date with the latest release with Map Care¹. Navigation Pro functionality is further enhanced by Connect Pro.

CONNECT PRO PACKAGE²

Connect Pro consists of InControl Apps and Pro Services. It's designed to enhance your in-car and out-of-car experience, ensuring you and your passengers enjoy the journey while remaining connected to the world*.

SMARTPHONE PACKAGE³

By screen sharing with the F-TYPE infotainment system, the Smartphone Package helps you stay connected to your smartphone even while in the car. Featuring Jaguar InControl® Apps technology, the Smartphone Package allows vehicle-optimized apps on your Android™ or Apple® smartphone to be controlled through the Touchscreen*, including your contacts, calendar and music player, via a USB cable. You can also download third-party apps offering a vast range of services.

INCONTROL APPS

Features a range of Jaguar approved apps that can be connected to F-TYPE from your smartphone. It ensures convenient use of apps optimized to enhance aspects of your in-car experience. You can also download third-party apps offering a vast range of services. Applications include:

- **Spotify³** – Access a library of more than 30 million songs with this seamlessly integrated app. Featuring all the same intuitive functionality as the Spotify smartphone app, you can search songs, stations and recommendations, create playlists and access your music in offline mode. Simply log in using your existing Spotify Free or Spotify Premium account.
- **Tile⁴** – Helps you find lost or misplaced items in seconds. Attach a tiny Bluetooth™ tracker Tile to your keys, wallet or bag. The easy-to-use Tile app can then help you find these items should they be misplaced. The app is accessible any time through your vehicle's Touchscreen, allowing you to make sure you have everything you need with you before you set out on your journey*.

*Do not use Jaguar InControl® features under conditions that will affect your safety or the safety of others. Driving while distracted can result in loss of vehicle control.

¹Free map updates for the period of the warranty. ²Certain features require an appropriate micro SIM with a suitable data contract, which will require further subscription after the initial term as advised by your Jaguar Retailer. ³Please check App Store and Google Play for availability. ⁴Bluetooth tracker tiles must be purchased separately. 2016 Tile Inc. and the Tile design are trademarks of Tile, Inc.

InControl Apps will need to be downloaded from the Apple App/Google Play Store.

iPhone® is a registered trademark of Apple Inc., registered in the US and other countries. Please ensure iPhone compatibility is reviewed with your local Jaguar Retailer.



PROTECT

Jaguar Optimized Assistance – If you break down, you can make a direct call to the Jaguar Assistance team by pressing the button on the overhead console or from the Assistance screen within the Remote smartphone app.

SOS Emergency Call – In a more serious incident, if the airbags are deployed, SOS Emergency Call will automatically connect you to the emergency response team who will notify the emergency services to your location. For peace of mind, this service is provided for the first ten years from date of registration.

Remote – Remote smartphone app provides information on your vehicle and enables you to interact with it remotely. Compatible with most smartphones, Android Wear™ or the Apple Watch®, this service includes:

- **Journeys** – This opt-in feature can automatically record your trip history including your route and mileage statistics. This information can be exported by email to use for expense reporting and can be imported to a spreadsheet.
- **Vehicle Status Check** – Check current fuel level and range, and status of door and window position and locks. See the last parked location of the vehicle and find your way back to it with on-foot directions.

Remote contains subscription services that can be extended after the initial term advised by your Jaguar Retailer. InControl features, options and their availability may vary – check with your Jaguar Retailer for availability and full terms. Information and images displayed in relation to the InControl technology, including screens or sequences, are subject to software updates, version control and other system/visual changes depending on options selected. Mobile network connectivity cannot be guaranteed in all locations. InControl Apps and Remote App will need to be downloaded from the Apple/Play Store. All in-car features should be used by drivers only when safe for them to do so. Drivers must ensure they are in full control of the vehicle at all times.

Jaguar Optimized Assistance is a subscription service that can be extended after the initial term advised by your Jaguar Retailer.

REMOTE

Allows you to monitor as well as interact with your F-TYPE from your smartphone. Remote start F-TYPE to pre-condition the climate, lock and unlock the car, locate your F-TYPE on a map or using the beep and flash function, and track your journeys.

- **Remote Lock/Unlock** – Lock or unlock your doors remotely. Simply press the 'lock' button on the Vehicle Security screen of the Remote smartphone app to single lock the doors and fold in the side mirrors¹. Press the 'unlock' button to open your vehicle, unfold the side mirrors, turn on the headlights and cause the hazard lights to flash twice to help you locate your vehicle.
- **Remote Climate** – Prepare your F-TYPE in advance by pre-heating or pre-cooling the cabin, so that you and your passengers are comfortable from the moment you step inside.
- **Beep/Flash** – This feature turns on your Jaguar's hazard lights and headlights, and sounds an audible alert to help you locate your vehicle.

PRO SERVICES

Offers a number of enhanced capabilities designed to help you reach your destination easily:

- **Real Time Traffic Information** – Uses live traffic data feeds to give you the most accurate picture of what the traffic is like on the way to your destination*.
- **One-Box Search** – Wherever you are, you can search the surrounding area for places of interest. The system can access expert destination information, travel tips and inspiration as well as online travel reviews of the local area*.
- **Planning Routes and Door-to-Door Routing** – Before setting off, use the Route Planner app or search online, save locations or set your destination. The app uses the Cloud to send your destination automatically to your vehicle's navigation screen. Once you've parked, the Route Planner app will guide you to your destination – a true door-to-door experience which includes public transportation options*.
- **Share ETA** – You can share your estimated time of arrival so your selected contact(s) will know exactly when you will arrive, as calculated by the navigation guidance system. If you're running late, Share ETA can then send automatic updates via text messages or email, without any further action from you*.

- **Satellite View** – When you want to get the context of your surroundings from overhead, simply switch to satellite view*.
- **Commute Mode** – Allows the system to learn your commutes and automatically advises you of the expected travel time based on live and historical traffic movements without you having to input a destination. The system learns the routes you take for a given destination and then advises which of those is the quickest. The feature can be turned on and off dependent on driver preference.
- **Parking Service** – As you approach your destination, you can see where parking is available. Simply tap on the parking and the navigation system updates to direct you to it.
- **Online Routing** – While you're on your way to a destination the system monitors live traffic conditions and takes into account typical traffic patterns for that time of day, keeping you on the optimum route.
- **Fuel Prices** – When you're going to fill up, the Fuel Price service not only finds gas stations along your route, it also enables you to compare fuel prices so you can keep your costs down.

*Do not use Jaguar InControl® features under conditions that will affect your safety or the safety of others. Driving while distracted can result in loss of vehicle control.

¹When power fold mirrors are specified.

Remote contains subscription services that can be extended after the initial term advised by your Jaguar Retailer. InControl features, options and their availability remain may vary – check with your Jaguar Retailer for availability and full terms. Information and images displayed in relation to the InControl technology, including screens or sequences, are subject to software updates, version control and other system/visual changes depending on options selected.

Mobile network connectivity cannot be guaranteed in all locations. InControl Apps and Remote App will need to be downloaded from the Apple/Play Store. All in-car features should be used by drivers only when safe for them to do so. Drivers must ensure they are in full control of the vehicle at all times.

Recently Played



Revision Ballads Playlist



Composer Weekly: Playlist

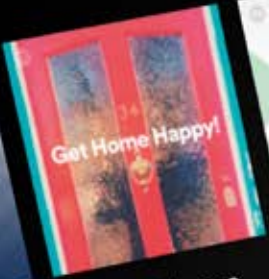

Get Home Happy! Playlist



Today's Top Hits Playlist



Happy Pop Hits Playlist



The Pop List Playlist



AUDIO

A vehicle's cabin is the ideal place within which to experience your personal choice of music and the Jaguar F-TYPE has the option of two different audio systems to bring your music to life:



MERIDIAN™ SOUND SYSTEM - 380W¹

Great definition, crystal clear highs and full, deep bass - delivered through the careful arrangement of 8 speakers and 2 subwoofers.

MERIDIAN SURROUND SOUND SYSTEM - 770W²

All the fullness and clarity of a live performance delivered through an arrangement of 10 speakers and 2 subwoofers - seamlessly brought together using Trifield™ technology. Exclusive to Meridian, Trifield perfectly blends the center and surround channels with left and right channels ensuring an optimum, consistent sound experience for each passenger.

SIRIUSXM® SATELLITE RADIO AND HD RADIO™¹

Standard on all F-TYPE models, SiriusXM® radio and HD radio technology offers improved sound quality, and a wide choice of stations and entertainment*.

*A three-month trial subscription to the Sirius All Access package is included with the vehicle, which gives you access to 150+ channels of premium programming. Plus you can stream SiriusXM on your computer, smartphone or tablet - it's included in your trial. If you decide to continue service after your trial, the subscription plan you choose will automatically renew thereafter and you will be charged according to your chosen payment method at then-current rates. Fees and taxes apply. To cancel you must call SiriusXM at 1-866-635-2349. See the SiriusXM Customer Agreement for complete terms at siriusxm.com. All fees and programming are subject to change. SiriusXM satellite radio is not available in Alaska or Hawaii.

¹Standard on all models. ²Optional.

Image is representative of Meridian Surround Sound System.

MERIDIAN™

Formed in 1977 in Cambridgeshire, England, Jaguar’s audio partner Meridian has pioneered many firsts including active speakers and the world’s first digital surround sound processor. Meridian’s audio technology input has helped ensure that the F-TYPE is a superb space to experience sound. Meridian Cabin Correction technology was utilized to analyze cabin shape, acoustics and resonance characteristics in order to help remove unwanted sounds. The advanced algorithm ensures that the rhythm, punch and timing of any piece of music are heard precisely how the artist intended, providing a consistently exceptional quality audio experience for all passengers in the vehicle.



DIGITAL SIGNAL PROCESSING

Brings all elements of the audio system together as one, for performance that would otherwise require significantly larger speakers.



MERIDIAN CABIN CORRECTION

The advanced algorithm of Meridian’s Cabin Correction tailors the sound experience to the precise acoustics of the F-TYPE interior.









MERIDIAN DIGITAL DITHER SHAPING

To maintain the quality of musical recordings, they are converted into a common digital format. Meridian Digital Dither Shaping ensures that digital signal conversions are made smoothly and seamlessly, preserving the finest details of the audio performance. The result is authentic musical conversion, evoking the emotions of the original recording.



TRIFIELD

Exclusive to Meridian, Trifield™ blends the center and surround channels seamlessly with left and right channels, delivering a consistent, concert-like experience for all occupants.

	UNIQUE MERIDIAN™ TECHNOLOGY	SPEAKERS + SUBWOOFERS	WATTS
MERIDIAN™ SOUND	  	8 + 2	380
MERIDIAN™ SURROUND SOUND	   	10 + 2	770

Meridian is a trademark of Meridian Audio Ltd.
Trifield and the "three fields" device is a trademark of Trifield Productions Ltd.
Features and their availability may differ by vehicle specification and market.

DRIVER ASSISTANCE

The technology in the F-TYPE is designed to take the stress out of driving. It can help with everything from reducing the chance of a highway collision to avoiding minor bumps in a parking lot. This range of driver assistance systems give you the reassurance, information and control to focus on the pleasure of the drive.



PARKING AIDS

Our standard Front and Rear Parking Aids help make maneuvering even easier. When you select Reverse, or choose to activate them manually, sensors located in the front and rear bumpers are triggered. As you park, the Touch Pro display and audio feedback indicate how close you are to obstacles*.



PARK ASSIST

The optional Park Assist system is designed to make parallel parking in a tight spot easier than ever by steering your car into a suitable space. You just have to select the appropriate gear and control the car's speed. Park Assist will also steer you out of a space, taking the stress out of parking. Graphics and notifications guide you through both maneuvers*.



REAR CAMERA

Our standard Rear Camera provides improved visibility when reversing. Guiding lines representing the vehicle's outer perimeter and predicted path are superimposed onto the rearward image displayed*.

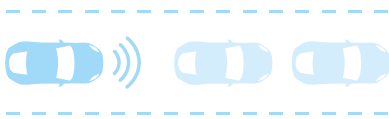

EMERGENCY BRAKING

Our standard Emergency Braking can help detect frontal collisions with other vehicles or pedestrians. If a potential frontal collision is detected, a warning is displayed, to alert you to take action. A camera at the front of the vehicle monitors at speeds from 3 to 50 mph for frontal collisions and 3 to 37 mph for pedestrians. If a collision is still anticipated and you have taken no action**, this system can assist with applying the brakes to help reduce the severity of the possible impact*.



EMERGENCY BRAKE ASSIST

If the brakes are applied rapidly, this standard system boosts braking force to the maximum to help reduce stopping distances. It can also help retain greater steering control in unexpected situations*.

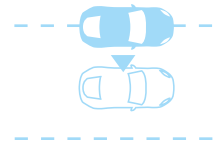

LANE KEEP ASSIST

Lane Keep Assist is designed to detect when the vehicle is unintentionally drifting out of the lane, and to apply corrective torque to the steering wheel, encouraging you to guide your vehicle back*.

*These features are not a substitute for driving safely with due care and attention and will not function under all circumstances, speeds, weather and road conditions, etc. Driver should not assume that these features will correct errors of judgment in driving. Please consult the owner's manual or your local authorized Jaguar Retailer for more details. **Please note that if any action is taken, the Emergency Braking system will assume the driver resumed control of the vehicle and the system will automatically disengage.

For more details on feature availability and information on airbags, refer to page 80.

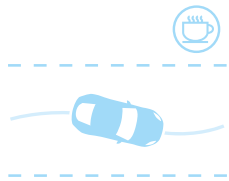

DRIVER CONDITION MONITOR

Our standard Driver Condition Monitor monitors driver inputs to establish if you're starting to feel drowsy or fatigued - giving you an early warning when you need to take a break*.



TRAFFIC SIGN RECOGNITION AND ADAPTIVE SPEED LIMITER

Our standard Traffic Sign Recognition system keeps you fully informed and aware on the road, by displaying speed limits and 'no passing' signs in the instrument cluster where they can easily be seen. When activated, our Adaptive Speed Limiter uses Traffic Sign Recognition information to adjust your car's speed accordingly*.



BLIND SPOT ASSIST AND REAR TRAFFIC MONITOR

If your car detects another car in your blind spot when you begin to change lanes, a small warning light illuminates in the corresponding side mirror. Corrective torque is also applied to the steering wheel, encouraging you to guide your vehicle away from the approaching vehicle. Rear Traffic Monitor warns you of hazards approaching from either side of your vehicle, through both audible and visual warnings even when the view is obstructed*.

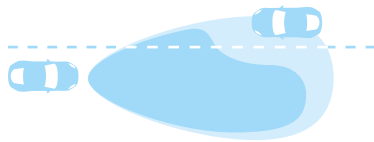

AUTO HIGH BEAM ASSIST

The optional Auto High Beam Assist system automatically switches between low and high beam when necessary, using a sensor mounted at the front of the rear view mirror*.

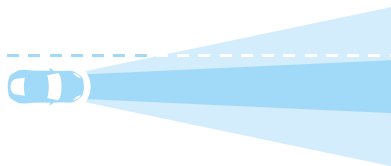

LED FRONT LIGHTING SYSTEM

This standard system is designed to provide better illumination in a variety of situations by adjusting the headlight beam to your speed and the weather conditions. At slower speeds it widens the low beam to illuminate your peripheral vision, helping you to see pedestrians and intersections. At higher speeds the system raises and narrows the low beam for extended visibility*.



THE THEATRE OF DREAMS

SPECIAL VEHICLE OPERATIONS

JAGUAR'S CENTER OF EXCELLENCE

Special Vehicle Operations (SVO) assembles and hand finishes halo models and limited run collector's editions, including the F-TYPE SVR. Each one showcases the best of Jaguar with stunning performance, exceptional luxury and cutting-edge technology. With a dedicated team of designers, engineers and technicians, SVO takes precision engineering to new heights and offers the opportunity for more individuality, choice and personalization. A car from SVO is the ultimate expression of Jaguar.

SVO is based at a brand new Technical Center in Warwickshire, England. This 215,000 sq ft speciality manufacturing facility has been established to enable our most discerning clients to indulge their passion for Jaguar. Our state-of-the-art facility features over 40 engineering inspection station, a commissioning suite and an environmentally sustainable world-class paint facility.

The F-TYPE is now available with an optional range of specially formulated, ultra metallic premium palette of 18 colors and finishes. These latest high-technology colors and finishes are applied at our state-of-the-art SVO facility. All Ultra Metallic colors come in a Gloss finish or, as an additional option, Satin Matte finish (See pages 90-91).





THE CONCEPT OF THE F-TYPE SVR



STATE-OF-THE-ART MATERIALS

ADVANCED AERODYNAMICS

The F-TYPE SVR is designed and engineered at Special Vehicle Operations, where our highly skilled engineers and aerodynamics experts have scrutinized every possible component to maximize performance. In both Coupe and Convertible form, it is the ultimate F-TYPE. State-of-the-art materials and advanced aerodynamic design push F-TYPE beyond the extraordinary with an exceptional powertrain. Delivering supreme performance, ride and handling, the F-TYPE SVR creates once-in-a-lifetime driving experiences - every day.

The F-TYPE SVR lightweight All Wheel Drive system, with Intelligent Driveline Dynamics (IDD), delivers the engine's power with efficiency and control*. The 5.0 liter V8 engine has been recalibrated to produce 575HP and 516 lb-ft of torque, with a power-to-weight ratio of 6.5 lbs/HP¹. It will take you from 0-60 mph in just 3.5 seconds** and on to a top speed of 200 mph¹. But it is about more than numbers, more than just a machine. Jaguar makes performance an art. The F-TYPE SVR is our masterpiece.

*These features are not a substitute for driving safely with due care and attention and will not function under all circumstances, speeds, weather and road conditions, etc. Driver should not assume that these features will correct errors of judgment in driving. Please consult the owner's manual or your local authorized Jaguar Retailer for more details. **Always follow local speed limits. ¹Coupe only.





F-TYPE SVR AERODYNAMICS



**MAXIMIZED
CAPABILITY**

**ADJUSTABLE
DOWNFORCE**

The performance of the F-TYPE SVR is not expressed by its exterior design: it is created by it. Form follows function in every swooping curve and finely drawn line. Each unique styling element, down to the smallest, subtle detail, improves the F-TYPE SVR. Its advanced aerodynamic design offers less drag and higher levels of downforce. As a result, F-TYPE SVR slices cleanly through the air, achieving rapid acceleration and effortlessly efficient cruising. Strong downforce improves stability and handling, road holding and dynamic capability.

FRONT INTAKES AND SPLITTER

Unique large lower bumper intakes maximize airflow for cooling of both the engine and brakes for improved performance. A precision splitter designed specially for the F-TYPE SVR directs airflow into the car for optimum cooling. It also creates downforce at the front of the car to balance the rear spoiler.

HOOD LOUVERS AND SIDE POWER VENTS

Uniquely shaped louvers maximize airflow through the engine bay. This aids cooling, so the engine can operate at the highest level. Air from the wheel housing is released through side power vents which manage airflow around the wheel arch to minimize drag.

ENHANCED COOLING

The cooling system has been enhanced with significant improvements to airflow. To achieve this, the auxiliary radiator has been relocated, while the bumper beam profile and inlet trumpet size have been reduced. This increases the full performance envelope on the F-TYPE SVR for greater endurance in extreme driving situations.

VEHICLES SHOWN ABOVE AND PREVIOUS PAGES: JAGUAR F-TYPE SVR IN CALDERA RED WITH OPTIONAL EQUIPMENT



AERODYNAMIC SPOILER

The aerodynamic spoiler is integral to the enhanced performance of the F-TYPE SVR. Compared with the standard F-TYPE Coupe rear spoiler, the F-TYPE SVR produces more downforce but crucially less drag. The active spoiler is more elevated and wider than the standard F-TYPE Coupe spoiler, enabling it to act over the whole width of the car.

Air passes both over and under the spoiler, allowing Bernoulli's principle to act in the car's favor, faster moving air underneath the spoiler is at a lower pressure than that passing over the top, resulting in additional downforce.

The F-TYPE SVR spoiler operates in two different positions: on the Coupe the aerodynamic spoiler deploys at 70 mph and stores at 50 mph*. On the Convertible, the aerodynamic spoiler deploys at 60 mph and stores at 40 mph*.

DEPLOYED SPOILER

When the F-TYPE SVR spoiler is deployed, it increases downforce for greater stability and improved handling at top speed. In this position the spoiler gives a drag coefficient reduction of 2.5 percent and a lift coefficient reduction of 15 percent.

STORED SPOILER

For maximum top speed (V-Max), the spoiler is stored to reduce drag. It works in conjunction with the front spoiler and other aerodynamic enhancements to bring a drag coefficient improvement of 7.5 percent and lift coefficient reduction of 45 percent.

V-MAX

In order to achieve 200 mph* you must consciously prepare your F-TYPE SVR Coupe. Select 'Dynamic Mode' and press the deployable aerodynamic spoiler switch for three seconds to enable V-Max Mode. While active, a permanent symbol appears on the instrument cluster. In this mode the spoiler remains stored at all speeds, keeping drag to a minimum.

REAR UNDERFLOOR AND DIFFUSER

The smooth rear underfloor reduces drag, while the rear diffuser works with the rear underfloor to manage airflow, adding to the stability of the F-TYPE SVR.

*Always follow local speed limits. F-TYPE SVR Coupe top speed is 200 mph. F-TYPE SVR Convertible top speed is 195 mph.



108 SOM

F-TYPE

F-TYPE SVR LIGHTWEIGHT TECHNOLOGIES



WEIGHT SAVING

INNOVATIVE DESIGN

Weight is the enemy of performance. So we designed the F-TYPE SVR to be as lean as possible. Every pound has a reason to be there. Every ounce saved gives you more rapid acceleration, more agile handling and sharper braking. Yet the interior still offers comfort and luxury in equal measures. The F-TYPE SVR has the capability to make performance effortlessly enjoyable.

FORGED ALLOY WHEELS

The bespoke forged alloy wheels of the F-TYPE SVR are fitted with unique Pirelli P ZERO™ tires. Its tires are 10mm wider than standard F-TYPE tires, for improved handling and grip. While the striking forged alloys offer a 30.4 lbs overall weight saving.

CERAMIC BRAKES

The optional CCM brakes on the F-TYPE SVR save up to 46 lbs of weight compared with non-ceramic alternatives.

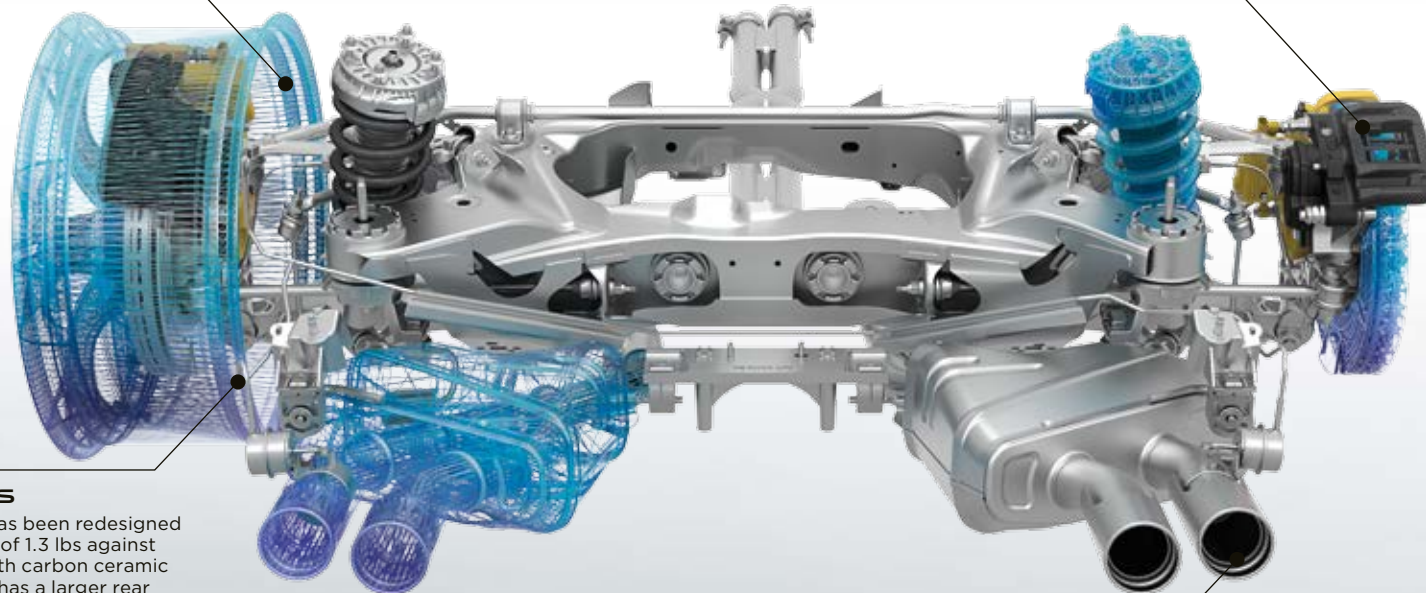

REAR KNUCKLES

The suspension system has been redesigned enabling a weight saving of 1.3 lbs against conventional knuckles with carbon ceramic brakes. The F-TYPE SVR has a larger rear bearing that contributes towards an increased stiffness of up to 37 percent over the standard F-TYPE knuckles. This enables the car to handle even higher lateral G-forces.

TITANIUM EXHAUST

The lightweight Titanium and Inconel® exhaust system saves 35.2 lbs. With its SVR badged tailpipes, it not only looks unique, it sounds unique - F-TYPE SVR is recognizable by the distinctive rumble of its exhaust.





F-TYPE SVR INTERIOR

> UNIQUE DETAILS | SPORTING CRAFTSMANSHIP

Just as no detail of the engineering and exterior design of the F-TYPE SVR has been overlooked, its interior is testament to the SVO division's attention to detail. The moment you open the door, the SVR treadplate shows that you are entering a special space.

Exclusive materials are everywhere you look, from fine contrast stitching to ultra-modern finishes that create a sense of total luxury. The SVR badged steering wheel with larger aluminum anodized gearshift paddles offers the perfect connection to the road, and the quilted Performance seats offer comfort and support while you enjoy the dynamic drive.

VEHICLE SHOWN: JAGUAR F-TYPE SVR FEATURING EBONY QUILTED LEATHER PERFORMANCE SEATS WITH CIRRUS STITCH AND MICROPIPING AND OPTIONAL EQUIPMENT

PERSONALIZATION F-TYPE - YOUR CHOICE

 Configure your vehicle at jaguarusa.com



CHOOSE YOUR ENGINE

Page 72

Select a powerful F-TYPE engine to suit your driving style.

CHOOSE YOUR MODEL & OPTIONS

Page 76

Compare the wealth of standard features and options on F-TYPE models.

CHOOSE YOUR COLOR

Page 88

Express your individuality with one of the F-TYPE stunning exterior colors.

CHOOSE YOUR

WHEELS & BRAKING SYSTEM

Page 92

Complement the stunning style of the F-TYPE with a set of beautifully designed alloy wheels.

CHOOSE YOUR

INTERIOR

Page 94

There's a wide selection of Premium materials, leathers and finishes for every personal taste.

CHOOSE YOUR

JAGUAR GEAR - ACCESSORIES

Page 108

Really make it yours by adding style, practicality and versatility with official F-TYPE Gear Accessories from your local Jaguar Retailer.

1 CHOOSE YOUR ENGINE

 Configure your vehicle at jaguarusa.com

> i4 ENGINE

2.0 LITER i4

TURBOCHARGED GAS [296HP] RWD
AUTOMATIC

MAXIMUM POWER 296HP

MAXIMUM TORQUE 295 lb-ft

ACCELERATION 0-60 mph* 5.4 seconds*

TOP SPEED 155 mph*

F-TYPE, F-TYPE CHECKERED FLAG EDITION



0-60 MPH

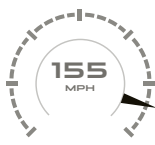

TOP SPEED MPH

> V6 ENGINES

3.0 LITER V6

SUPERCHARGED GAS [340HP] RWD
AUTOMATIC

MAXIMUM POWER 340HP

MAXIMUM TORQUE 332 lb-ft

ACCELERATION 0-60 mph* Auto 5.1 seconds*

TOP SPEED 161 mph*

F-TYPE



AUTO
0-60 MPH

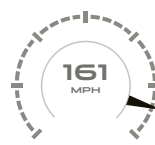

AUTO
TOP SPEED MPH

3.0 LITER V6

SUPERCHARGED GAS [380HP] RWD
AUTOMATIC

MAXIMUM POWER 380HP

MAXIMUM TORQUE 339 lb-ft

ACCELERATION 0-60 mph* Auto 4.8 seconds*

TOP SPEED 171 mph*

F-TYPE R-DYNAMIC



AUTO
0-60 MPH

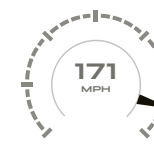

AUTO
TOP SPEED MPH

*Always follow local speed limits.

> V8 ENGINES

3.0 LITER V6

SUPERCHARGED GAS [380HP] AWD
AUTOMATIC

MAXIMUM POWER 380HP

MAXIMUM TORQUE 339 lb-ft

ACCELERATION 0-60 mph* 4.9 seconds*

TOP SPEED 171 mph*

F-TYPE R-DYNAMIC, F-TYPE CHECKERED FLAG EDITION



0-60 MPH

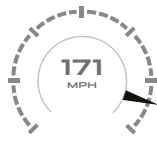

TOP SPEED MPH

5.0 LITER V8

SUPERCHARGED GAS [550HP] AWD
AUTOMATIC

MAXIMUM POWER 550HP

MAXIMUM TORQUE 502 lb-ft

ACCELERATION 0-60 mph* 3.9 seconds*

TOP SPEED 186 mph*

F-TYPE R



0-60 MPH

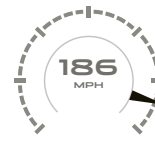

TOP SPEED MPH

5.0 LITER V8

SUPERCHARGED GAS [575HP] AWD
AUTOMATIC

MAXIMUM POWER 575HP

MAXIMUM TORQUE 516 lb-ft

ACCELERATION 0-60 mph* 3.5 seconds*

TOP SPEED 200 mph* (Coupe) 195 mph* (Convertible)

F-TYPE SVR



0-60 MPH

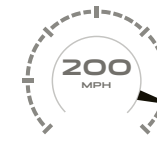

COUPE
TOP SPEED MPH



0-60 MPH

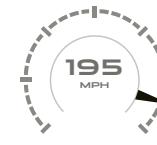

CONVERTIBLE
TOP SPEED MPH



NEW F-TYPE CHECKERED FLAG

Slip into the driving seat of Jaguar F-TYPE Checkered Flag and feel its power. This car is the embodiment of pure excitement. Pure engineering. Pure performance. Just like the years of racing heritage that inspired its design, F-TYPE Checkered Flag is a compelling achievement. Under the sculpted hood is the familiar, raw power of F-TYPE. Such design details as unique badging, body-colored sport side sills and Black contrast roof add to the car's dynamic appearance. While inside, 'Checkered Flag' embossed seats, a race-inspired red top center steering wheel marker and an uncompromising attention to detail all help to reinforce Jaguar's pedigree. Go ahead, put your foot down, make some noise. This is a car that relishes being out on the road.

F-TYPE CHECKERED FLAG EDITION STANDARD FEATURES

• A choice of i4 Ingenium and V6 Supercharged Gas engines. Coupe or Convertible. Rear Wheel Drive (RWD) or All Wheel Drive (AWD).

Exterior:

• Available in Caldera Red, Fuji White or Carpathian Grey • Exterior Black Design Package with extended side sills
• Checkered Flag has extended side sills vs 'Exterior Black Design Package' • Black contrast roof • 20" 6 split-spoke 'Style 6003' with Gloss Black finish • Red brake calipers • 'Checkered Flag' badge, front and rear.

Interior:

• Ebony Windsor leather interior with Pimento Red or Cirrus stitching • Ebony suedecloth headlining
• 'Checkered Flag' embossed Performance seats • Red seatbelts • 'Checkered Flag' heated steering wheel with Red top center marker • 'Checkered Flag' embroidered mats • Black Brushed Aluminum center console
• Red illuminated metal treadplates.



2 CHOOSE YOUR MODEL

 Configure your vehicle at jaguarusa.com



F-TYPE

KEY FEATURES

Active Sports Exhaust
Dynamic Mode[†]
Emergency Braking^{††}
Deployable trunk lid spoiler
LED headlights with signature DRL
LED tail lights
Infrared reflective windshield
Sport seats with leather and
suedecloth facings
12-way electric front seats with memory
Leather steering wheel with
Silver gearshift paddles
Knurled Aluminum center console
10" Touchscreen*
Meridian™ Sound System

Navigation Pro*
SiriusXM® radio** and HD radio™
Rear Camera[†]
Front and Rear Parking Aids[†]
Passive suspension
Open Differential with Torque Vectoring[†]
18" alloy wheels
355mm front and 325mm rear brakes
with Silver brake calipers



F-TYPE R-DYNAMIC

KEY FEATURES (IN ADDITION TO F-TYPE)

380HP

Switchable Active Exhaust
Design Package in Gloss Black
Delta Aluminum center console
R-Dynamic treadplates
Adaptive Dynamics[†]
Limited Slip Differential
with Torque Vectoring[†]
20" alloy wheels
380mm front and 325mm
rear brakes with Black brake calipers
All Wheel Drive (optional)^{††}

*Do not use Jaguar InControl® features under conditions that will affect your safety or the safety of others. Driving while distracted can result in loss of vehicle control. **A 3-month trial subscription to the SiriusXM All Access package is included with the vehicle, which gives you access to 175+ channels of premium programming. Plus you can stream SiriusXM on your computer, smartphone or tablet – it's included in your trial. If you decide to continue service after your trial, the subscription plan you choose will automatically renew thereafter and you will be charged according to your chosen payment method at then-current rates. Fees and taxes apply. To cancel you must call SiriusXM at 1-866-635-2349. See the SiriusXM Customer Agreement for complete terms at siriusxm.com. All fees and programming are subject to change. SiriusXM satellite radio is not available in Alaska, Hawaii, or Puerto Rico. Please consult the owner's manual or your local authorized Jaguar Retailer for more details.



F-TYPE R

KEY FEATURES (IN ADDITION TO R-DYNAMIC)

550HP

All Wheel Drive**

380mm front and 376mm rear brakes with Red brake calipers

Electronic Active Differential with Torque Vectoring†

Configurable Dynamic Mode

20" alloy wheels

Bright metal pedals

Windsor leather interior

R Performance seats

12-way electric front seats with memory

R branded leather steering wheel with Silver gearshift paddles

Linear Vee Aluminum center console with R branding

Configurable Ambient Interior Lighting

Wind deflector (Convertible only)

Keyless Entry



F-TYPE SVR

KEY FEATURES (IN ADDITION TO F-TYPE R)

575HP

Lightweight Titanium and Inconel® exhaust

20" forged alloy wheels

Redesigned aerodynamics

Carbon Fiber rear aerodynamic wing

SVR Performance seats

Suedecloth headlining

Heated SVR branded leather steering wheel
with aluminum gearshift paddles

Dark Brushed Aluminum center console with SVR branding

†These features are not a substitute for driving safely with due care and attention and will not function under all circumstances, speeds, weather and road conditions, etc. Driver should not assume that these features will correct errors of judgment in driving. Please consult the owner's manual or your local authorized Jaguar Retailer for more details. **This feature is not a substitute for safe and attentive driving, nor can it overcome all extreme circumstances. ‡Please note that if any action is taken, even minimal steering, the Emergency Braking system will assume the driver resumed control of the vehicle and the system will automatically disengage.

Vehicles shown are for illustrative purposes and may have optional features fitted. Options and availability should be verified with your local Jaguar Retailer.

2 CHOOSE YOUR OPTIONS

 Configure your vehicle at jaguarusa.com

ROOF STYLES

F-TYPE offers a range of different roofs to suit your own personal style. Each delivering their own distinctive characteristics, they provide a powerful expression of individual flair both inside the cabin and to the outside world.



ALUMINUM ROOF

For the pure Coupe look, the aluminum roof is as strong and lightweight as the rest of the vehicle. It provides the ideal complement in color, style and line to the powerful F-TYPE profile. The aluminum roof expresses F-TYPE in its clearest sports car form.



PANORAMIC GLASS ROOF

Introducing even more natural light and airiness to the interior, a full width panoramic glass roof is optional on F-TYPE Coupe models. For increased seclusion, should it be required, the roof features a manually sliding 'black-out' blind, which can screen the occupants from up to 99 percent of the incoming light.



CARBON FIBER ROOF*

With Carbon Fiber outer and inner panels bonded together to create a strong yet light roof structure, the optional Carbon Fiber roof is 20 percent lighter than the standard aluminum roof. It features Carbon Fiber weave visible through a deep, high-grade lacquered finish.



CONVERTIBLE ROOF

The Convertible's lightweight fabric roof is available in a choice of four colors. Acoustically enhanced with composite fabric to reduce noise, it features a flush fitting heated glass rear window. The roof can be raised or lowered in just 12 seconds and operated fully automatically at speeds of up to 30 mph.

*Please consult your local Jaguar Retailer for availability.

VEHICLES SHOWN: JAGUAR F-TYPE R IN YULONG WHITE WITH OPTIONAL EQUIPMENT

CONVERTIBLE ROOF COLORS

STANDARD OPTIONAL

Black

Grey

Red

Beige

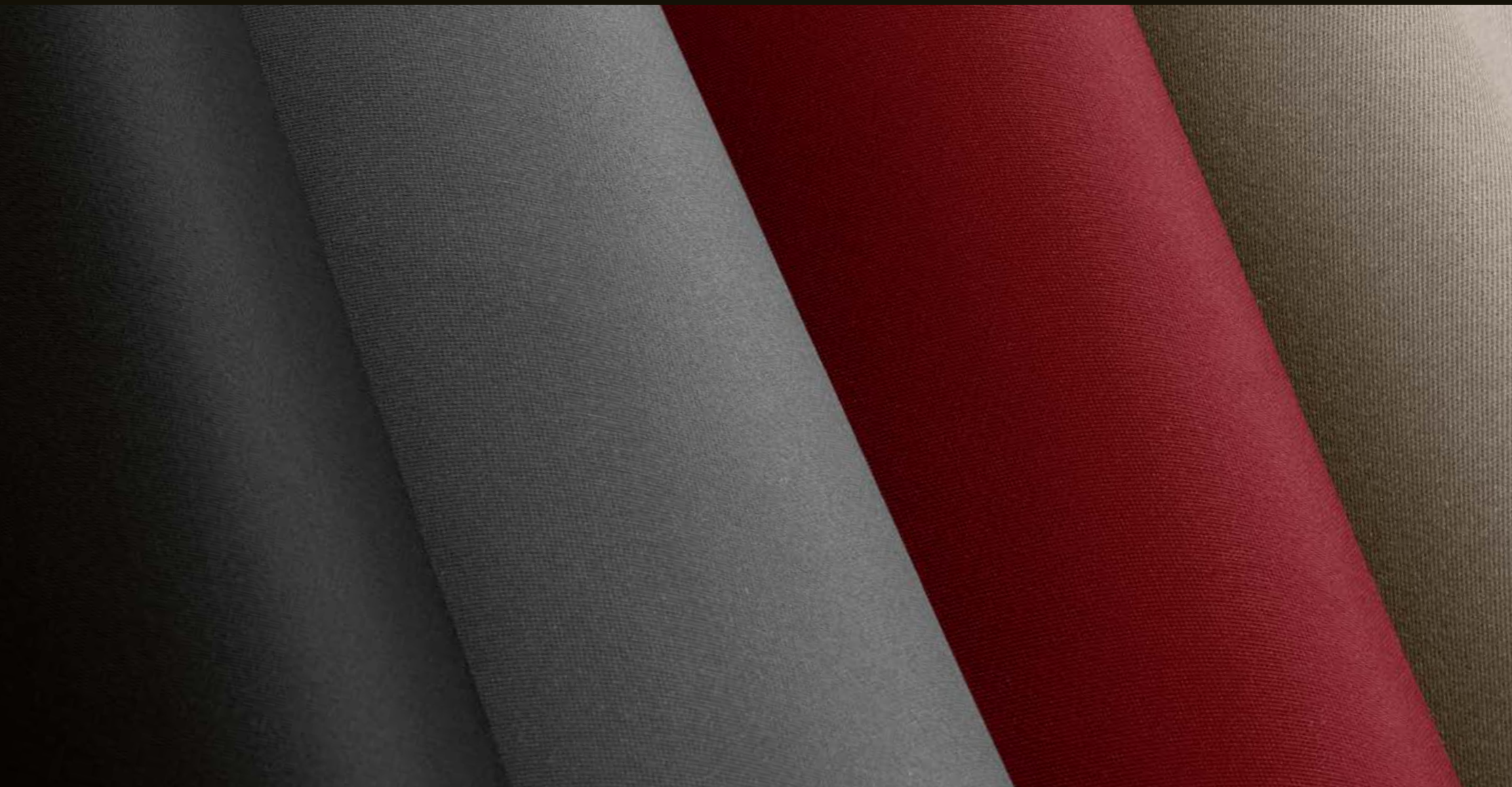

2 CHOOSE YOUR OPTIONS

 Configure your vehicle at jaguarusa.com

KEY STANDARD FEATURES

	F-TYPE	F-TYPE R-DYNAMIC	F-TYPE R	F-TYPE SVR	DESCRIPTION
Rain, Ice, Snow Mode*	●	●	●	●	
Dynamic Stability Control (DSC)*	●	●	●	●	
Airbags**	●	●	●	●	4 airbags in Convertible, 6 airbags in Coupe
Electric Parking Brake (EPB)*	●	●	●	●	
Emergency Braking*††	●	●	●	●	
Emergency Brake Assist*	●	●	●	●	
Anti-lock Braking System (ABS)*	●	●	●	●	
Electronic Brake-force Distribution (EBD)*	●	●	●	●	
Flush exterior door handles	●	●	●	●	
Body-colored door mirror caps	●	●	●	●	
Rain sensing windshield wipers	●	●	●	●	
LED headlights with signature DRL	●	●	●	●	
LED tail lights	●	●	●	●	
Deployable front air vents	●	●	●	●	
Auto-dimming interior rear view mirror	●	●	●	●	
Overhead lighting console	●	●	●	●	
Twin front cupholders	●	●	●	●	
10" Touch Pro†	●	●	●	●	
Power socket	●	●	●	●	
USB and 12V socket in center console	●	●	●	●	
Remote central locking with deadlocks and drive-away locking	●	●	●	●	
Perimetric alarm and immobilizer	●	●	●	●	
Trunk entrapment release lever	●	●	●	●	
Push Button Start	●	●	●	●	
Valet Mode	●	●	●	●	
Lane Keep Assist*	●	●	●	●	See pages 58-59
Driver Condition Monitor*	●	●	●	●	See pages 58-59
Traffic Sign Recognition and Adaptive Speed Limiter*	●	●	●	●	See pages 58-59
Front and Rear Parking Aids*	●	●	●	●	See pages 58-59
Rear Camera*	●	●	●	●	See pages 58-59

● Standard ○ Option — Not available ■ Part of Package

*These features are not a substitute for driving safely with due care and attention and will not function under all circumstances, speeds, weather and road conditions, etc. Driver should not assume that these features will correct errors of judgment in driving. Please consult the owner's manual or your local authorized Jaguar Retailer for more details. **Please remember that the safety belts in a vehicle constitute the primary protection system for driver and passengers in collisions. Airbags are not designed to deploy in all collisions. The airbag Supplemental Restraint System (SRS) is a supplement to the safety belts and is designed to work as a system with the safety belts. Although airbags provide additional protection, airbags without safety belts do not provide optimal protection in a crash. Always wear your safety belts. Children younger than 13 years old should always be properly restrained in a back seat, away from airbags. Never place an infant seat in the front seat. †Driving while distracted can result in loss of vehicle control. Do not operate, adjust or view the navigation or multimedia systems under conditions that will affect your safety or the safety of others. Only use mobile phones and other devices, even with voice commands, when it is safe to do so. ††Please note that if any action is taken, even minimal steering, the Emergency Braking system will assume the driver resumed control of the vehicle and the system will automatically disengage.

KEY OPTIONAL FEATURES

		F-TYPE (296HP & 340HP)	F-TYPE R-DYNAMIC (380HP)	F-TYPE R (550HP)	F-TYPE SVR (575HP)	
TRANSMISSION AND DYNAMIC FEATURES		CODE				DESCRIPTION
Silver gearshift paddles	078CN	●	●	●	—	
Aluminum gearshift paddles	078CP	—	—	—	●	
Adaptive Dynamics*	027CW	—	●	●	●	
Passive suspension	027CZ	●	—	—	—	
Dynamic Mode*	088IL	●	●	●	●	
Configurable Dynamics*	184AB	—	○	●	●	
Open Differential with Torque Vectoring*	027DH	●	—	—	—	
Limited Slip Differential with Torque Vectoring*	027DJ	—	●	—	—	
Electronic Active Differential with Torque Vectoring*	027DC	—	—	●	●	
Active Sports Exhaust	037AX	●	—	—	—	
Switchable Active Exhaust	037CF	○	●	●	●	
BRAKES						
Silver brake calipers	020BJ	●	—	—	—	
Red brake calipers	020BE	—	○	●	●	Only available as an option with 380mm front and 325mm rear brakes or 380mm front and 376mm rear brakes
Black brake calipers	020BK	—	●	○	○	Only available as an option with 380mm front and 325mm rear brakes or 380mm front and 376mm rear brakes
Yellow brake calipers	020BL	—	■	■	■	Part of Carbon Ceramic Brake Package
355mm front and 325mm rear brakes	020DV	●	—	—	—	
380mm front and 325mm rear brakes	020JC	—	●	—	—	Only available with Red brake calipers or Black brake calipers. Not available with 18" alloy wheels
380mm front and 376mm rear brakes	020JB	—	○	●	●	Only available with Red brake calipers or Black brake calipers. Not available with 18" alloy wheels
398mm front and 380mm rear carbon ceramic brakes	020JD	—	■	■	■	Part of Carbon Ceramic Brake Package

Please consult your local Jaguar Retailer for details.

For a complete list of optional features and packages refer to the F-TYPE Specification and Price Guide or configure your vehicle at jaguarusa.com

2 CHOOSE YOUR OPTIONS

 Configure your vehicle at jaguarusa.com

EXTERIOR FEATURES AND FINISHERS		F-TYPE	F-TYPE R-DYNAMIC	F-TYPE R	F-TYPE SVR	
EXTERIOR FEATURES AND FINISHERS		CODE				DESCRIPTION
Black fully electric convertible roof	041CM	●	●	●	●	Only available on Convertible
Grey fully electric convertible roof	041DF	○	○	○	○	Only available on Convertible
Red fully electric convertible roof	041DG	○	○	○	○	Only available on Convertible
Beige fully electric convertible roof	041DK	○	○	○	○	Only available on Convertible
Gloss Black roll over protection bars	027BU	■	■	■	●	Only available on Convertible. Part of Black Exterior Package
Satin Chrome roll over protection bars	027BV	●	●	●	—	Only available on Convertible
Carbon Fiber roof	041CO	○	○	○	○	Only available on Coupe
Panoramic glass roof	041CX	○	○	○	○	Only available on Coupe
Powered tailgate	070AV	○	○	○	○	Only available on Coupe
Deployable rear spoiler	070CA/070CB	●	●	●	○	Reduces top speed of F-TYPE SVR to 186 mph when selected
Carbon Fiber rear aerodynamic wing	070CC/070CH	—	—	—	●	
GLASS AND EXTERIOR MIRRORS						
Heated windshield	040AK	○	○	○	○	Also available as part of Climate Package
Power fold, heated door mirrors with memory	030RF	●	●	—	—	
Auto-dimming, power fold, heated door mirrors with memory	030PC	○	○	●	●	
Solar attenuating windscreen	047EB	●	●	●	●	
HEADLIGHTS AND LIGHTING						
LED headlights with signature DRL	064GK	●	●	●	●	
Auto High Beam Assist (AHBA)*	030NT	○	○	○	○	
EXTERIOR COLORS						
Solid paint		●	●	●	●	
Metallic paint		○	○	○	○	
Premium Metallic paint		○	○	○	—	
SVO Ultra Metallic paint		○	○	○	○	
SVO Special Effect paint		○	○	○	○	
WHEELS						
Tire Repair System	029SJ	●	●	●	●	

*These features are not a substitute for driving safely with due care and attention and will not function under all circumstances, speeds, weather and road conditions, etc. Driver should not assume that these features will correct errors of judgment in driving. Please consult the owner's manual or your local authorized Jaguar Retailer for more details.

INTERIOR SEATING

		F-TYPE	F-TYPE R-DYNAMIC	F-TYPE R	F-TYPE SVR	
SEATING		CODE				DESCRIPTION
Sport seats	033MC	●	●	—	—	
Performance seats	033MT	○	○	●	●	Linked to Windsor Leather Interior Package, Suedecloth Interior Package or Extended Windsor Leather Interior Package on F-TYPE R-Dynamic. R embossing is removed on F-TYPE R with Suedecloth Interior Package and Extended Windsor Leather Interior Package
R Performance seats	033MU	—	—	●	—	
SVR Performance seats	033MW	—	—	—	●	
Grained leather and suedecloth seats	033JC	●	●	—	—	
Windsor leather seats	033HJ	■	■	●	—	Part of Windsor Leather Interior Package
Suedecloth and Windsor leather seats with contrast stitching	033AL	—	■	■	—	Part of Suedecloth Interior Package
Lozenge quilted Windsor leather	033YQ	—	—	—	●	
Red seat belts	032HC	○	○	○	○	Red seat belts can be fitted to Ebony seats with Ebony stitching, Pimento contrast stitching or Pimento seats
12-way electric front seats with memory	300JD	●	●	●	●	
12-way heated electric front seats with memory	300JE	○	○	○	—	Not available with leather Performance seats
12-way heated and cooled electric front seats with memory	300JF	○	○	○	○	Only available with Performance seats

HEADLINING

HEADLINING		Refer to Page 94-95 for full details on interior color availability				
Leather headlining	088FE	■	■	■	■	Part of Windsor Leather Headlining Package
Suedecloth headlining	088HE	—	■	■	●	Part of Suedecloth Upper Environment Package
Morzine headlining	088HH	●	●	●	—	
Ebony headlining	032BU	●	●	●	●	
Grey headlining	032FG	○	○	○	—	Morzine only
Pimento headlining	032FH	○	○	○	○	Not available on Coupe. Leather only
Ivory headlining	032CV	○	○	○	—	Not available with panoramic glass roof. Leather only

● Standard ○ Option — Not available ■ Part of Package

Please consult your local Jaguar Retailer for details.

For a complete list of optional features and packages refer to the F-TYPE Specification and Price Guide or configure your vehicle at jaguarusa.com

Refer to pages 92-93 for full details on interior color availability.

2 CHOOSE YOUR OPTIONS

 Configure your vehicle at jaguarusa.com

INTERIOR FEATURES

INTERIOR FEATURES	CODE	F-TYPE	F-TYPE R-DYNAMIC	F-TYPE R	F-TYPE SVR	DESCRIPTION
Sunvisors with vanity mirrors	115AQ	●	●	●	—	Only available in Ebony or Grey
Suede cloth sunvisors with vanity mirrors	115AT	—	■	■	●	Part of Suede cloth Upper Environment Package
Leather sunvisors with vanity mirrors	115AS	■	■	■	■	Part of Windsor Leather Headlining Package
Bright metal pedals	051AJ	—	■	●	●	Only available as part of the Carbon Ceramic Brake Package unless standard
Wind deflector	041EB	—	—	●	●	Only available on Convertible
Electrically adjustable steering column with memory	049AE	○	○	●	●	
Leather steering wheel	032BV	●	●	—	—	
Flat-bottom leather steering wheel	032LF	○	○	—	—	
Flat-bottom leather steering wheel with Black spokes	032LA	■	■	—	—	Part of Interior Black Package
R branded leather steering wheel	032FL	—	—	●	—	
R branded flat-bottom leather steering wheel	032FQ	—	—	○	—	
R branded flat-bottom leather steering wheel with Black spokes	032LE	—	—	■	—	Part of Interior Black Package
SVR branded leather steering wheel	032FO	—	—	—	●	
SVR branded suede cloth steering wheel	032FI	—	—	—	○	Not available with heated steering wheel
Heated steering wheel	032DV	○	○	○	●	Also available as part of Climate Package
Premium carpet mats	079CA	●	●	■	—	Part of Suede cloth Interior Pack unless standard
Nubuck edged carpet mats	079DG	—	—	—	●	
Contrast carpet mats	079BT	—	■	●	—	Part of Full Windsor Leather Interior Package

● Standard ○ Option — Not available ■ Part of Package

Please consult your local Jaguar Retailer for details.

For a complete list of optional features and packages refer to the F-TYPE Specification and Price Guide or configure your vehicle at jaguarusa.com

		F-TYPE	F-TYPE R-DYNAMIC	F-TYPE R	F-TYPE SVR	
INTERIOR FEATURES (CONTINUED)						
Single-zone Climate Control	022AX	●	●	●	●	
Two-zone Climate Control	022AY	○	○	○	○	Also available as part of Climate Package
Air Quality Sensor	022FA	○	○	○	○	
Configurable Ambient Interior Lighting	064FM	○	○	●	●	
Illuminated metal treadplates with Jaguar script	048BD	○	○	○	○	

DRIVER ASSISTANCE AND SECURITY

DRIVER ASSISTANCE AND SECURITY						
Garage Door Opener (HomeLink*)	025CT	○	○	○	○	
Keyless Entry	066AC	○	○	●	●	
Tire Pressure Monitoring System (TPMS)	062AD	●	●	●	●	
Rear Camera*	086FA	●	●	●	●	
Cruise Control and Speed Limiter*	065AB	●	●	●	●	
Front Parking Aid*	086EG	●	●	●	●	
Rear Parking Aid*	086EH	●	●	●	●	
Emergency Braking**	065EA	●	●	●	●	
Park Assist*	086GZ	—	○	○	○	
Blind Spot Assist with Rear Traffic Monitor*	086GM/086KB	○	○	○	○	Requires auto-dimming, power fold, heated door mirrors
Lane Keep Assist*	086BG	●	●	●	●	
Driver Condition Monitor*	086DH	●	●	●	●	
Traffic Sign Recognition and Adaptive Speed Limiter*	086DC	●	●	●	●	

*These features are not a substitute for driving safely with due care and attention and will not function under all circumstances, speeds, weather and road conditions, etc.

Driver should not assume that these features will correct errors of judgment in driving. Please consult the owner's manual or your local authorized Jaguar Retailer for more details.

†Please note that if any action is taken, even minimal steering, the Emergency Braking system will assume the driver resumed control of the vehicle and the system will automatically disengage.

2 CHOOSE YOUR OPTIONS

 Configure your vehicle at jaguarusa.com

INFORMATION, COMMUNICATION AND ENTERTAINMENT

INFORMATION AND COMMUNICATION		F-TYPE	F-TYPE R-DYNAMIC	F-TYPE R	F-TYPE SVR	DESCRIPTION
Protect*	011BE	●	●	●	●	
Remote*	011DA	●	●	●	●	
InControl Apps*	025PA	●	●	●	●	
10" Touch Pro*	025NE	●	●	●	●	
Navigation Pro*	087AU	●	●	●	●	
Pro Services*	025RK	●	●	●	●	
Bluetooth® connectivity**	025MA	●	●	●	●	
Smartphone Package		●	●	●	●	
5" central TFT display with instrument panel – 190 mph	038IE	●	●	—	—	
5" central TFT display with instrument panel – 210 mph	038IF	—	—	●	●	

AUDIO		F-TYPE	F-TYPE R-DYNAMIC	F-TYPE R	F-TYPE SVR	DESCRIPTION
SiriusXM® satellite radio+ and HD radio™	025LA	●	●	●	●	
Meridian™ Sound System (380W)	025LM	●	●	●	●	
Meridian™ Surround Sound System (770W)	025LN	○	○	○	○	

● Standard ○ Option — Not available ■ Part of Package

*Do not use Jaguar InControl® features under conditions that will affect your safety or the safety of others. Driving while distracted can result in loss of vehicle control. **Driving while distracted can result in loss of vehicle control. Do not operate, adjust or view the navigation or multimedia systems under conditions that will affect your safety or the safety of others. Only use mobile phones and other devices, even with voice commands, when it is safe to do so. +A 3-month trial subscription to the SiriusXM All Access package is included with the vehicle, which gives you access to 175+ channels of premium programming. Plus you can stream SiriusXM on your computer, smartphone or tablet – it's included in your trial. If you decide to continue service after your trial, the subscription plan you choose will automatically renew thereafter and you will be charged according to your chosen payment method at then-current rates. Fees and taxes apply. To cancel you must call SiriusXM at 1-866-635-2349. See the SiriusXM Customer Agreement for complete terms at siriusxm.com. All fees and programming are subject to change. SiriusXM satellite radio is not available in Alaska, Hawaii, or Puerto Rico.

Jaguar Optimized Assistance is a subscription service that can be extended after the initial term advised by your Jaguar Retailer.

Remote contains subscription services that can be extended after the initial term advised by your Jaguar Retailer. InControl features, options and their availability may vary – check with your Jaguar Retailer for availability and full terms. Information and images displayed in relation to the InControl technology, including screens or sequences, are subject to software updates, version control and other system/visual changes depending on options selected. Mobile network connectivity cannot be guaranteed in all locations. InControl Apps and Remote App will need to be downloaded from the Apple/Play Store. All in-car features should be used by drivers only when safe for them to do so. Drivers must ensure they are in full control of the vehicle at all times.

OPTION PACKAGES

	CODE	F-TYPE	F-TYPE R-DYNAMIC	F-TYPE R	F-TYPE SVR	DESCRIPTION
Black Exterior Design Package	032EI	○	○	○	—	Gloss Black finish to side window surrounds (Coupe only), front bumper splitter, front grille surround, side power vents, hood vents, rear valance and roll over protection bars (Convertible only, standard on R-Dynamic and R) ¹
Black Exterior Design Package	032GK	—	○	○	—	Body-coloured front bumper splitter, side sills and rear venturi. Gloss Black finish to side window surrounds (Coupe only), front grille surround, side power vents, hood louvers and roll over protection bars (Convertible only) ¹
Carbon Fiber Exterior Package	032IT	—	○	○	—	Body-colored front bumper splitter, side sills and rear venturi. Gloss Black finish to side window surrounds (Coupe only) and front grille surround. Carbon Fiber side power vents, hood vents, mirror caps and roll over protection bars (Convertible only) ¹
SVR Carbon Fiber Exterior Package	032IA	—	—	—	○	Carbon Fiber side power vents, hood vents, mirror caps, front bumper splitter, rear venturi and roll over protection bars (Convertible only)
Carbon Ceramic Brake Package	095MA	—	○	○	—	Yellow brake calipers, 20" 5 split-spoke 'Style 5040' alloy wheels with metallic Black finish, 398mm front and 380mm rear carbon ceramic brakes, Bright metal pedals (standard on R)
SVR Carbon Ceramic Brake Package	095MC	—	—	—	○	Yellow brake calipers, 20" 10 spoke 'Style 1041' forged alloy wheels with Satin Black Diamond Turned finish, 398mm front and 380mm carbon ceramic brakes
Windsor Leather Headlining Package	021BS	○	○	○	○	Leather sunvisors with vanity mirrors, leather headlining ²
Suedecloth Headlining Package	021BT	○	○	○	—	Suedecloth sunvisors with vanity mirrors, suedecloth headlining
Climate Package	017DL	○	○	○	—	Two-zone Climate Control, heated windshield, heated steering wheel
Windsor Leather Interior Package	017FD	○	○	—	—	Windsor leather seats, Windsor leather door trim, Windsor leather console, Windsor leather wrapped instrument panel topper
Extended Windsor Leather Interior Package	017FZ	—	○	○	○	Exclusive to Sienna Tan and Pimento. Extended color Windsor leather interior with contrast carpet mats
Suedecloth Interior Package	SDF	—	○	○	—	Suedecloth door trim, suedecloth and Windsor leather seats with contrast stitching, Performance seats, suedecloth sunvisors with vanity mirrors, suedecloth headlining, Windsor leather console with twin stitching (standard on R) suedecloth wrapped instrument panel topper with contrast stitching. Includes Premium carpet mats on F-TYPE R

¹Package content varies between models. ²Vehicle must have Windsor Leather Interior Package or Full Windsor Leather Interior Package.

Refer to pages 94-95 for full details on interior color availability when selecting an Interior Package.

Please consult your local Jaguar Retailer for details.

For a complete list of optional features and packages refer to the F-TYPE Specification and Price Guide or configure your vehicle at jaguarusa.com

3 CHOOSE YOUR COLOR

 Configure your vehicle at jaguarusa.com

SOLID

Narvik Black

Fuji White

Caldera Red

METALLIC

Santorini Black

Yulong White

Eiger Grey*

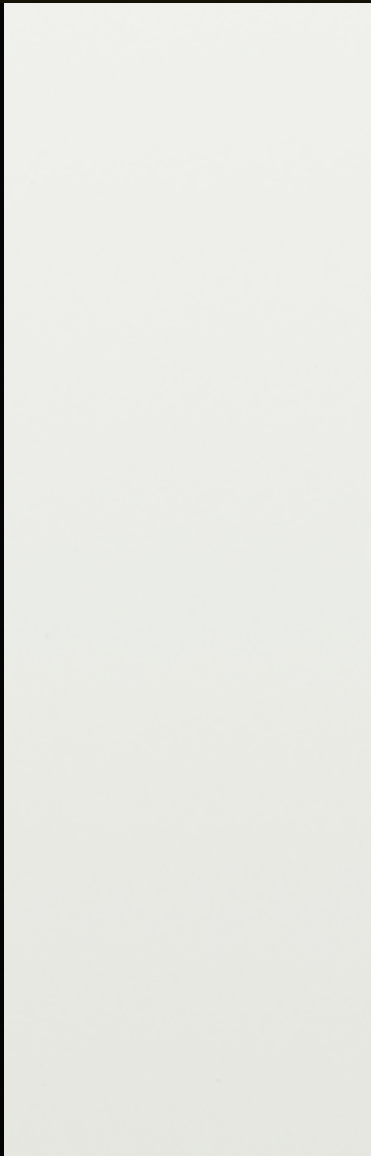
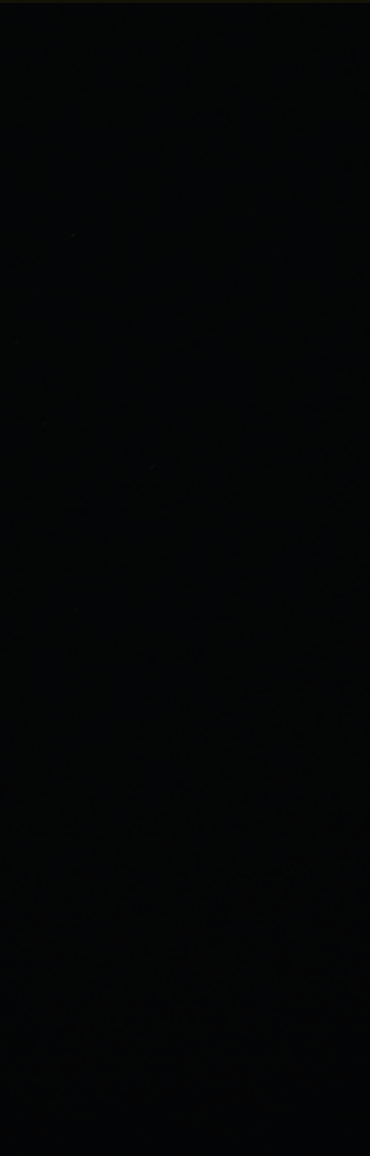

*Not available until March 2019.

Indus Silver

British Racing Green

Portofino Blue*

Ultra Blue

PREMIUM

Carpathian Grey

Silicon Silver

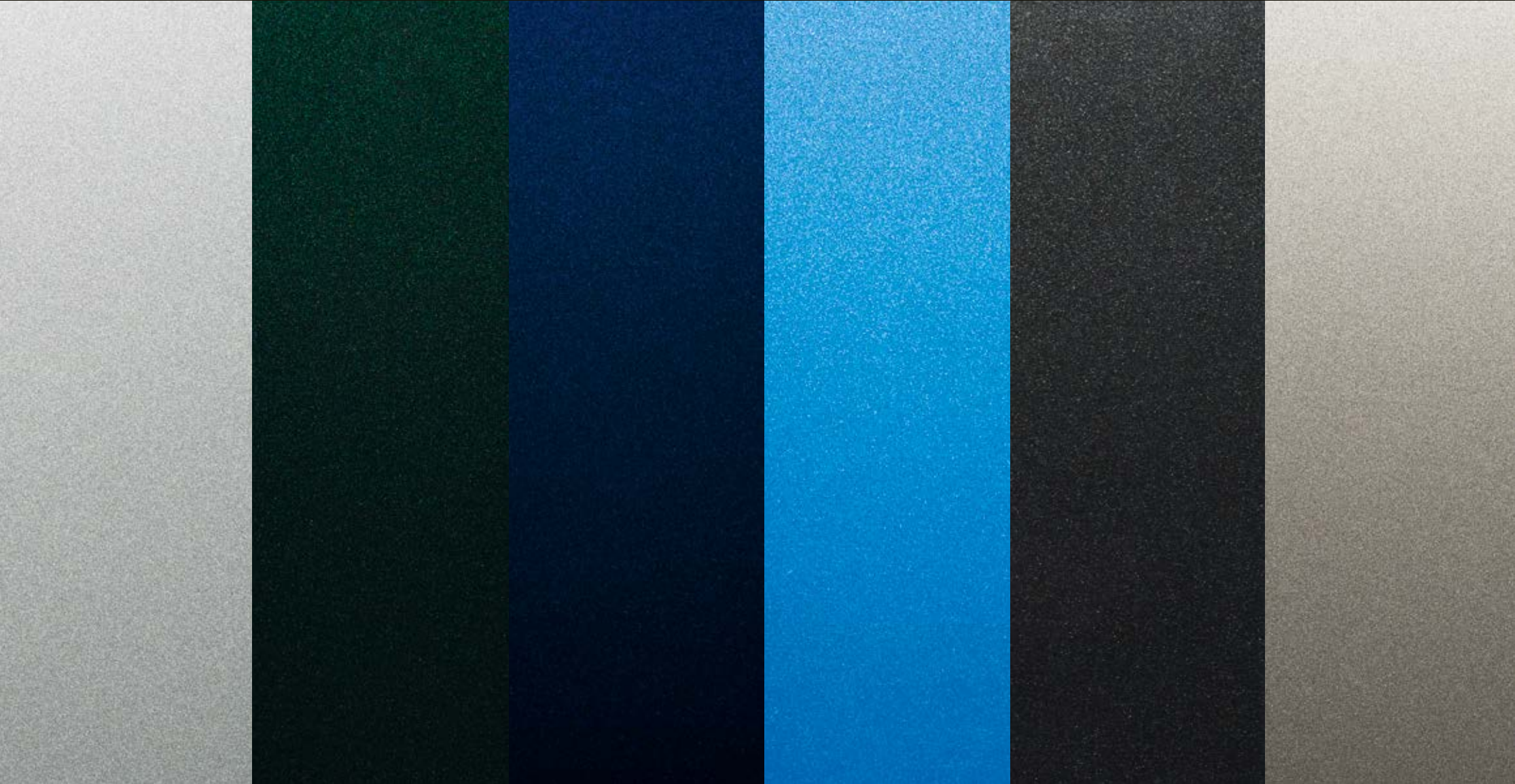

3 CHOOSE YOUR COLOR

 Configure your vehicle at jaguarusa.com

SPECIAL EFFECT

Valloire
White Pearl

Meribel
White Pearl

Spectral Racing Red

ULTRA METALLIC

Velocity

Ligurian Black

Mescalito Black

Borealis Black

Bosphorus Grey

Windward Grey

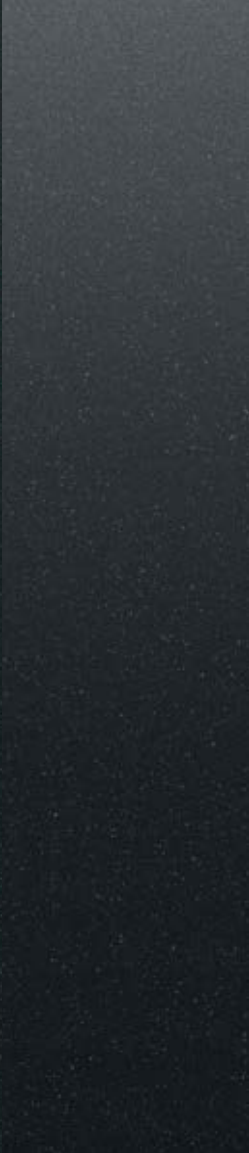
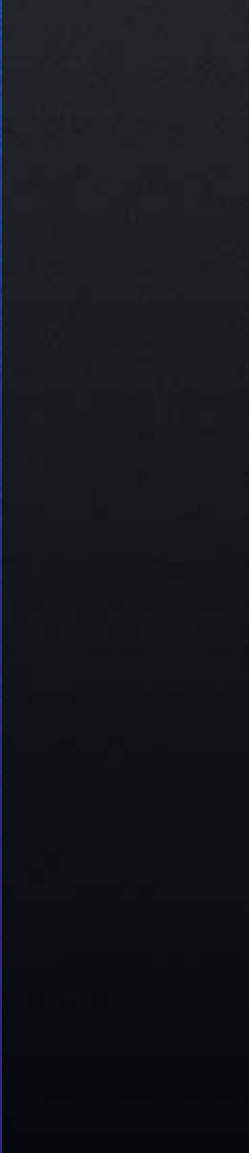



SPECIAL VEHICLE
OPERATIONS

Scafell Grey

British Racing Green

Balmoral Blue

Desire

Madagascar Orange

Flux

Rio Gold

Verbier Silver

Ethereal



4 CHOOSE YOUR WHEELS & BRAKING SYSTEM

 Configure your vehicle at jaguarusa.com



18" 10 SPOKE
'STYLE 1036'



18" 10 SPOKE
'STYLE 1024'



19" 10 SPOKE
'STYLE 1023'



19" 7 SPLIT-SPOKE
'STYLE 7013'



19" 5 SPLIT-SPOKE
'STYLE 5058'

ALLOY WHEEL FINISH	Silver	Silver	Silver	Silver	Technical Grey and Diamond Turned
FRONT ALLOY WHEELS	8.5J x 18"	8.5J x 18"	8.5J x 19"	8.5J x 19"	8.5J x 19"
FRONT TIRES	245/45 R18	245/45 R18	245/40 R19	245/40 R19	245/40 R19
REAR ALLOY WHEELS	9.5J x 18"	9.5J x 18"	9.5J x 19"	9.5J x 19"	9.5J x 19"
REAR TIRES	275/40 R18	275/40 R18	275/35 R19	275/35 R19	275/35 R19
CODE	031FK	029ZG	029ZF	029ZK	029ZA
F-TYPE 296HP	●	—	○	○	○
F-TYPE 340HP	—	●	○	○	○
F-TYPE R-Dynamic 380HP	—	—	—	—	—
F-TYPE R	—	—	—	—	—
F-TYPE SVR	—	—	—	—	—



355MM FRONT AND
325MM REAR BRAKES



380MM FRONT AND
325MM REAR BRAKES



380MM FRONT AND
376MM REAR BRAKES



398MM FRONT AND
380MM REAR CARBON
CERAMIC BRAKES

● Standard ○ Option — Not Applicable ■ Part of Package

Please consult your local Jaguar Retailer for details. For a complete list of optional features and Packages refer to the F-TYPE Specification and Price Guide or configure your vehicle at jaguarusa.com



20" 6 SPLIT-SPOKE
'STYLE 6003'

20" 5 SPOKE
'STYLE 5060'

20" 5 SPOKE
'STYLE 5042'

20" 5 SPLIT-SPOKE
'STYLE 5039'

20" 5 SPLIT-SPOKE
'STYLE 5061'

20" 5 SPLIT-SPOKE
'STYLE 5040'

FORGED 20"
10 SPOKE 'STYLE
1041'

Dark Grey and
Diamond Turned

Silver

Carbon Fiber, Satin Grey
and Diamond Turned

Gloss Black

Satin Grey

Metallic Black

Satin Black and
Diamond Turned

9.0J x 20"

9.0J x 20"

9.0J x 20"

9.0J x 20"

9.0J x 20"

9.0J x 20"

9.0J x 20"

255/35 R20

255/35 R20

255/35 R20

255/35 R20

265/35 R20

255/35 R20

265/35 R20

10.5J x 20"

10.5J x 20"

10.5J x 20"

10.5J x 20"

11.0J x 20"

10.5J x 20"

11.0J x 20"

295/30 R20

295/30 R20

295/30 R20

295/30 R20

305/30 R20

295/30 R20

305/30 R20

029ZI

031FL

029ZS

029ZL

031JT

031FN

031JR

○

○

○

○

—

—

—

○

○

○

○

—

—

—

●

○

○

○

—

■

—

○

●

○

○

—

■

—

—

—

—

—

●

—

■

BRAKING SYSTEMS	CODE	F-TYPE (296HP & 340HP)	F-TYPE R-DYNAMIC (380HP)	F-TYPE R (550HP)	F-TYPE SVR (575HP)	DESCRIPTION
355mm front and 325mm rear brakes	020DV	●	—	—	—	
380mm front and 325mm rear brakes	020JC	—	●	—	—	Only available with Red brake calipers or Black brake calipers. Not available with 18" wheels
380mm front and 376mm rear brakes	020JB	—	○	●	●	Only available with Red brake calipers or Black brake calipers. Not available with 18" wheels
398mm front and 380mm rear carbon ceramic brakes	020JD	—	■	■	■	Part of Carbon Ceramic Brake Package with 20" alloy wheels and Carbon Ceramic Brake Package with SVR forged alloy wheels

5 CHOOSE YOUR INTERIOR

 Configure your vehicle at jaguarusa.com

F-TYPE AND F-TYPE R-DYNAMIC						
	SEAT WITH STITCH	UPPER FASCIA WITH STITCH	INTERIOR TRIM AND OPTION CODES	HEADLINING	CARPETS	SEAT BELTS
Standard						
Sport seats with leather and suedecloth facings	Ebony with Ebony	Ebony with Ebony	SDE	Ebony or Grey	Ebony	Ebony or Red
	Cirrus with Cirrus	Ebony with Ebony	SDH	Ebony or Grey	Ebony	Ebony
Optional						
Sport seats in Windsor leather and Windsor leather interior ¹	Ebony with Ebony	Ebony with Ebony	SDE + 017FD	Ebony, Grey or Ivory ³	Ebony	Ebony or Red
	Cirrus with Cirrus	Ebony with Ebony	SDH + 017FD	Ebony or Grey	Ebony	Ebony
Performance seats in Windsor leather and Windsor leather interior ¹	Ebony with Ebony	Ebony with Ebony	SDE + 033MT + 017FD	Ebony, Grey or Ivory ³	Ebony	Ebony or Red
	Ebony with Pimento	Ebony with Ebony	SDX + 033MT + 017FD	Ebony, Grey or Pimento ⁴	Ebony	Ebony or Red
	Ebony with Sienna Tan	Ebony with Ebony	SDY + 033MT + 017FD	Ebony or Grey	Ebony	Ebony
	Ebony with Ivory	Ebony with Ebony	SDG + 033MT + 017FD	Ebony, Grey or Ivory ³	Ebony	Ebony
	Sienna Tan with Cirrus	Ebony with Ebony	TJR + 033MT + 017FD	Ebony or Grey	Ebony	Ebony
	Brogue with Ivory	Ebony with Ebony	SDK + 033MT + 017FD	Ebony, Grey or Ivory ³	Ebony	Ebony
	Pimento with Ebony	Ebony with Ebony	SDL + 033MT + 017FD	Ebony, Grey or Pimento ⁴	Ebony	Ebony or Red
Ivory with Ebony	Ebony with Ebony	SDM + 033MT + 017FD	Ebony, Grey or Ivory ³	Ebony	Ebony	
Performance seats in Windsor leather and suedecloth and Windsor leather interior ^{1,5}	Ebony with Cirrus	Ebony with Cirrus	SDF	Ebony suedecloth	Ebony	Ebony
Performance seats in Windsor leather and extended colored Windsor leather interior and contrast edged carpet mat ^{2,5}	Pimento with Ebony	Pimento with Ebony	TSW + 033MT + 017FZ	Ebony or Pimento ⁴	Ebony	Ebony or Red
	Sienna Tan with Cirrus	Sienna Tan with Cirrus	SBH + 033MT + 017FZ	Ebony	Ebony	Ebony

¹Windsor leather interior adds Windsor leather to the upper fascia, center console and door casings.

²Includes colored Windsor leather passenger side upper fascia, upper door casings, center console and Ebony carpet mats with colored nubuck edging and Ebony contrast stitching.

³Ivory leather headlining not available with panoramic glass roof.

⁴Pimento leather headlining available on Convertible only.

⁵Only available on F-TYPE R-Dynamic.

Please consult your local Jaguar Retailer for details.

F-TYPE R						
	SEAT WITH STITCH	UPPER FASCIA WITH STITCH	INTERIOR TRIM AND OPTION CODES	HEADLINING	CARPETS	SEAT BELTS
Standard						
Performance seats in Windsor leather with R embossed headrests and Windsor leather interior	Ebony with Ebony	Ebony with Ebony	SDE	Ebony, Grey or Ivory ³	Ebony	Ebony or Red
	Ebony with Ivory	Ebony with Ivory	SDR	Ebony, Grey or Ivory ³	Ebony	Ebony
	Ebony with Pimento	Ebony with Pimento	SDQ	Ebony, Grey or Pimento ⁴	Ebony	Ebony or Red
	Ebony with Sienna Tan	Ebony with Sienna Tan	SDS	Ebony or Grey	Ebony	Ebony
	Sienna Tan and Ebony Duo Tone with Sienna Tan	Ebony with Sienna Tan	SDV	Ebony or Grey	Ebony	Ebony
	Ivory and Ebony Duo Tone with Ivory	Ebony with Ivory	SDU	Ebony, Grey or Ivory ³	Ebony	Ebony
	Pimento and Ebony Duo Tone with Pimento	Ebony with Pimento	SDT	Ebony, Grey or Pimento ⁴	Ebony	Ebony or Red
Optional						
Performance seats in Windsor leather and suedecloth and Windsor leather interior	Ebony with Cirrus	Ebony with Cirrus	SDF	Ebony suedecloth	Ebony	Ebony
	Performance seats in Windsor leather and extended colored Windsor leather interior ²	Pimento with Ebony	Pimento with Ebony	TSW + 017FZ	Ebony or Pimento ⁴	Ebony or Red
		Sienna Tan with Cirrus	Sienna Tan with Cirrus	SBH + 017FZ	Ebony	Ebony
F-TYPE SVR						
	SEAT WITH STITCH	UPPER FASCIA WITH STITCH	INTERIOR TRIM AND OPTION CODES	HEADLINING	CARPETS	SEAT BELTS
Standard						
Performance seats in quilted Windsor leather with SVR embossed headrests and suedecloth driver's instrument panel area	Ebony with Cirrus	Ebony with Cirrus	SDP	Ebony	Ebony	Ebony
	Ebony with Pimento	Ebony with Pimento	SDQ	Ebony or Pimento ⁴	Ebony	Ebony or Red
	Ebony with Reims Blue	Ebony with Reims Blue	SDW	Ebony	Ebony	Ebony
Optional						
Performance seats in quilted Windsor leather with SVR embossed headrests and extended colored Windsor leather interior ²	Pimento with Ebony	Pimento with Ebony	TSW + 017FZ	Ebony or Pimento ⁴	Ebony	Red
	Sienna Tan with Cirrus	Sienna Tan with Cirrus	SBH + 017FZ	Ebony	Ebony	Ebony

5 CHOOSE YOUR INTERIOR

Configure your vehicle at jaguarusa.com









Interior shown: F-TYPE R-Dynamic with optional Ebony Windsor leather Performance seats, Delta Aluminum trim finisher, Ebony Morzine headlining, Ebony upper fascia and Ebony carpets.

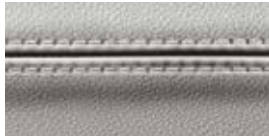

F-TYPE AND F-TYPE R-DYNAMIC

INTERIOR COLOR COMBINATIONS

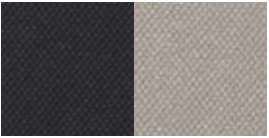
STANDARD SPORT SEATS WITH LEATHER AND SUEDECLOTH FACINGS
 OPTIONAL SPORT SEATS IN WINDSOR LEATHER AND WINDSOR LEATHER INTERIOR

①	②	③	④	⑤
SEAT WITH STITCH	FINISHER	HEADLINING ¹	UPPER FASCIA WITH STITCH	CARPET
				
Ebony with Ebony	Delta Aluminum ² , Knurled Aluminum ³ , Carbon Fiber	Ebony, Grey or Ivory ⁴	Ebony with Ebony	Ebony
				
Cirrus with Cirrus	Delta Aluminum ² , Knurled Aluminum ³ , Carbon Fiber	Ebony or Grey	Ebony with Ebony	Ebony

OPTIONAL PERFORMANCE SEATS IN WINDSOR LEATHER AND WINDSOR LEATHER INTERIOR

SEAT WITH STITCH	FINISHER	HEADLINING ¹	UPPER FASCIA WITH STITCH	CARPET
				
Ebony with Ebony	Delta Aluminum ² , Knurled Aluminum ³ , Carbon Fiber	Ebony, Grey or Ivory ⁴	Ebony with Ebony	Ebony
				
Ebony with Pimento	Delta Aluminum ² , Knurled Aluminum ³ , Carbon Fiber	Ebony, Grey or Pimento ⁵	Ebony with Ebony	Ebony

¹Ebony Morzine standard, Grey Morzine and Ebony suedecloth optional. Ebony, Pimento and Ivory leather optional.

²Delta Aluminum is standard on F-TYPE R-Dynamic and optional on F-TYPE.

³Knurled Aluminum is standard on F-TYPE and optional on F-TYPE R-Dynamic.

















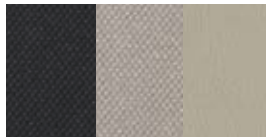

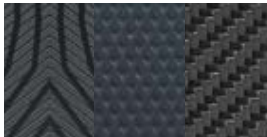
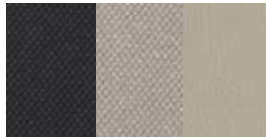

⁴Ivory leather headlining not available with panoramic glass roof.

⁵Pimento headlining available on Convertible only.

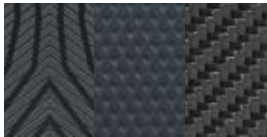
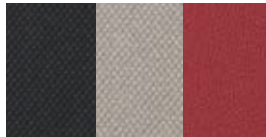
F-TYPE AND F-TYPE R-DYNAMIC

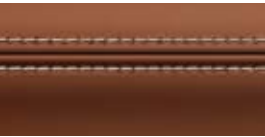
INTERIOR COLOR COMBINATIONS

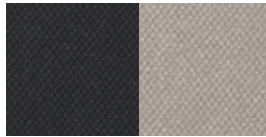
OPTIONAL PERFORMANCE SEATS IN WINDSOR LEATHER AND WINDSOR LEATHER INTERIOR [CONTINUED]

1	2	3	4	5
SEAT WITH STITCH	FINISHER	HEADLINING ¹	UPPER FASCIA WITH STITCH	CARPET
				
Ebony with Sienna Tan	Delta Aluminum ² , Knurled Aluminum ³ , Carbon Fiber	Ebony or Grey	Ebony with Ebony	Ebony
				
Ebony with Ivory	Delta Aluminum ² , Knurled Aluminum ³ , Carbon Fiber	Ebony, Grey or Ivory ⁴	Ebony with Ebony	Ebony
				
Brogue with Ivory	Delta Aluminum ² , Knurled Aluminum ³ , Carbon Fiber	Ebony, Grey or Ivory ⁴	Ebony with Ebony	Ebony
				
Pimento with Ebony	Delta Aluminum ² , Knurled Aluminum ³ , Carbon Fiber	Ebony, Grey or Pimento ⁵	Ebony with Ebony	Ebony
				
Sienna Tan with Cirrus	Delta Aluminum ² , Knurled Aluminum ³ , Carbon Fiber	Ebony or Grey	Ebony with Ebony	Ebony

¹Ebony Morzine standard, Grey Morzine and Ebony suedecloth optional. Ebony, Pimento and Ivory leather optional.

²Delta Aluminum is standard on F-TYPE R-Dynamic and optional on F-TYPE.





³Knurled Aluminum is standard on F-TYPE and optional on F-TYPE R-Dynamic.

⁴Ivory leather headlining not available with panoramic glass roof.

⁵Pimento headlining available on Convertible only.

⁶Only available on F-TYPE R-Dynamic.

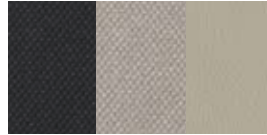



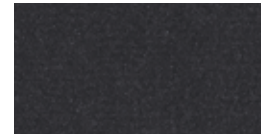

OPTIONAL PERFORMANCE SEATS IN WINDSOR LEATHER
AND WINDSOR LEATHER INTERIOR [CONTINUED]

①	②	③	④	⑤
SEAT WITH STITCH	FINISHER	HEADLINING ¹	UPPER FASCIA WITH STITCH	CARPET
				
Ivory with Ebony	Delta Aluminum ² , Knurled Aluminum ³ , Carbon Fiber	Ebony, Grey or Ivory ⁴	Ebony with Ebony	Ebony

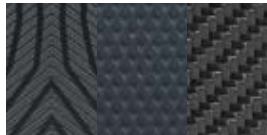
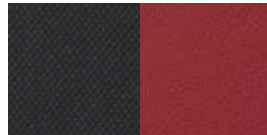
OPTIONAL PERFORMANCE SEATS IN WINDSOR LEATHER
AND EXTENDED WINDSOR LEATHER INTERIOR⁶

SEAT WITH STITCH	FINISHER	HEADLINING	UPPER FASCIA WITH STITCH	CARPET
				
Ebony with Cirrus	Delta Aluminum ² , Knurled Aluminum ³ , Carbon Fiber	Ebony suedecloth	Ebony with Cirrus	Ebony

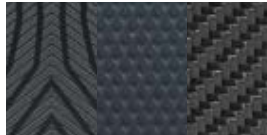
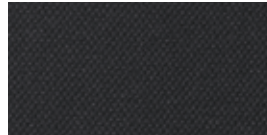
OPTIONAL PERFORMANCE SEATS IN WINDSOR LEATHER
AND EXTENDED WINDSOR LEATHER INTERIOR⁶

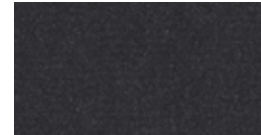
SEAT WITH STITCH	FINISHER	HEADLINING ¹	UPPER FASCIA WITH STITCH	CARPET
				
Pimento with Ebony	Delta Aluminum ² , Knurled Aluminum ³ , Carbon Fiber	Ebony or Pimento ⁵	Pimento with Ebony	Ebony
				
Sienna Tan with Cirrus	Delta Aluminum ² , Knurled Aluminum ³ , Carbon Fiber	Ebony	Sienna Tan with Cirrus	Ebony

5 CHOOSE YOUR INTERIOR

Configure your vehicle at jaguarusa.com













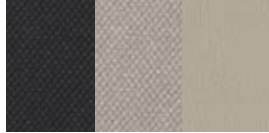

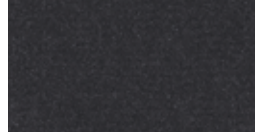

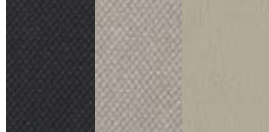
Interior shown: Optional Pimento Windsor leather Performance seats with Linear Vee Aluminum trim finisher, Ebony leather headlining, Pimento upper fascia and Ebony carpets.

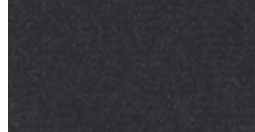

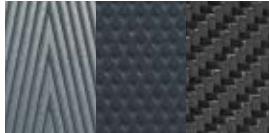
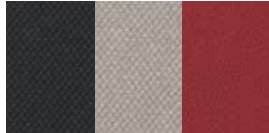
F-TYPE R

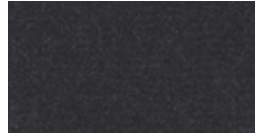
INTERIOR COLOR COMBINATIONS

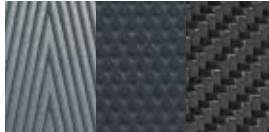
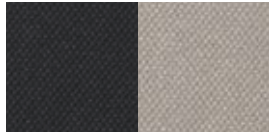
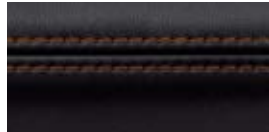
STANDARD R-PERFORMANCE SEATS IN WINDSOR LEATHER AND WINDSOR LEATHER INTERIOR

1	2	3	4	5
SEAT WITH STITCH	FINISHER	HEADLINING ¹	UPPER FASCIA WITH STITCH	CARPET
 Ebony with Ebony	 Linear Vee Aluminum ² , Knurled Aluminum, Carbon Fiber	 Ebony, Grey or Ivory ³	 Ebony with Ebony	 Ebony
 Ebony with Ivory	 Linear Vee Aluminum ² , Knurled Aluminum, Carbon Fiber	 Ebony, Grey or Ivory ³	 Ebony with Ivory	 Ebony
 Ebony with Pimento	 Linear Vee Aluminum ² , Knurled Aluminum, Carbon Fiber	 Ebony, Grey or Pimento ⁴	 Ebony with Pimento	 Ebony
 Ebony with Sienna Tan	 Linear Vee Aluminum ² , Knurled Aluminum, Carbon Fiber	 Ebony or Grey	 Ebony with Sienna Tan	 Ebony

¹Ebony Morzine standard, Grey Morzine and Ebony suedecloth optional. Ebony, Pimento and Ivory leather optional.

²Linear Vee Aluminum is standard.







³Ivory leather headlining not available with panoramic glass roof.

⁴Pimento headlining available on Convertible only.

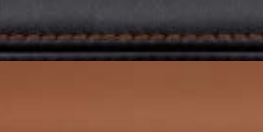
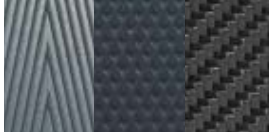
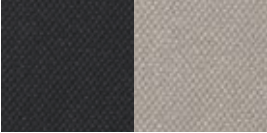
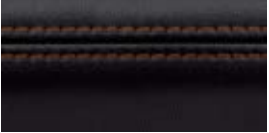
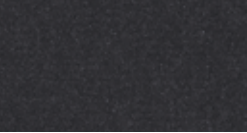
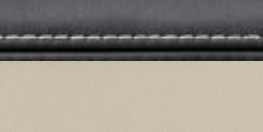
F-TYPE R

INTERIOR COLOR COMBINATIONS

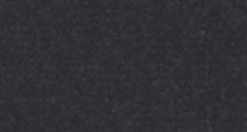
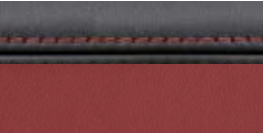
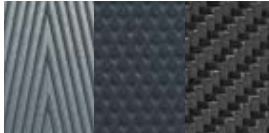
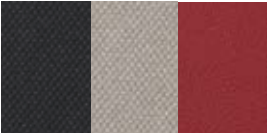
STANDARD R-PERFORMANCE SEATS IN WINDSOR LEATHER AND WINDSOR LEATHER INTERIOR [CONTINUED]

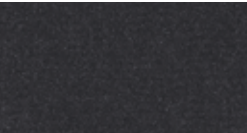
1	2	3	4	5
DUO TONE SEAT WITH STITCH	FINISHER	HEADLINING ¹	UPPER FASCIA WITH STITCH	CARPET
 Ebony with Sienna Tan	 Linear Vee Aluminum ² , Knurled Aluminum, Carbon Fiber	 Ebony or Grey	 Ebony with Sienna Tan	 Ebony
 Ebony with Ivory	 Linear Vee Aluminum ² , Knurled Aluminum, Carbon Fiber	 Ebony, Grey or Ivory ³	 Ebony with Ivory	 Ebony
 Ebony with Pimento	 Linear Vee Aluminum ² , Knurled Aluminum, Carbon Fiber	 Ebony, Grey or Pimento ⁴	 Ebony with Pimento	 Ebony

¹Ebony Morzine standard, Grey Morzine and Ebony suedecloth optional. Ebony, Pimento and Ivory leather optional.

²Linear Vee Aluminum is standard.







³Ivory leather headlining not available with panoramic glass roof.

⁴Pimento headlining available on Convertible only.

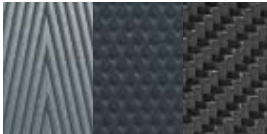
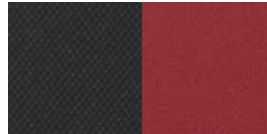
OPTIONAL R-PERFORMANCE SEATS IN WINDSOR LEATHER
AND SUEDECLOTH AND WINDSOR LEATHER INTERIOR

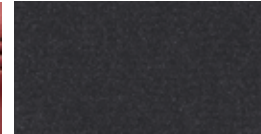
①	②	③	④	⑤
SEAT WITH STITCH	FINISHER	HEADLINING	UPPER FASCIA WITH STITCH	CARPET
				
Ebony with Cirrus	Linear Vee Aluminum ² , Knurled Aluminum, Carbon Fiber	Ebony suedecloth	Ebony with Cirrus	Ebony

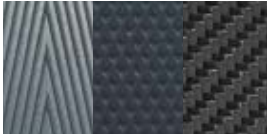
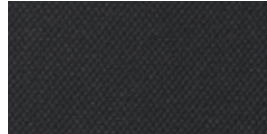
OPTIONAL R-PERFORMANCE SEATS IN WINDSOR LEATHER
AND EXTENDED WINDSOR LEATHER INTERIOR

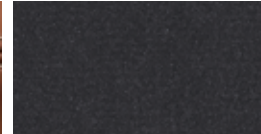
SEAT WITH STITCH	FINISHER	HEADLINING ³	UPPER FASCIA WITH STITCH	CARPET
				
Pimento with Ebony	Linear Vee Aluminum ² , Knurled Aluminum, Carbon Fiber	Ebony or Pimento ⁴	Pimento with Ebony	Ebony
				
Sienna Tan with Cirrus	Linear Vee Aluminum ² , Knurled Aluminum ³ , Carbon Fiber	Ebony	Sienna Tan with Cirrus	Ebony

5 CHOOSE YOUR INTERIOR

Configure your vehicle at jaguarusa.com











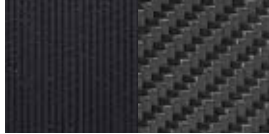

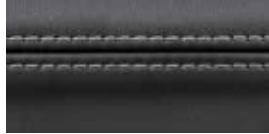
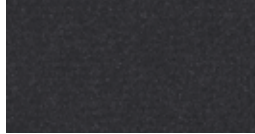
Interior shown: Ebony quilted Windsor leather Performance seats with Cirrus stitch and micropiping, Dark Brushed Aluminum trim finisher, Ebony headlining, Ebony upper fascia and Ebony carpets.

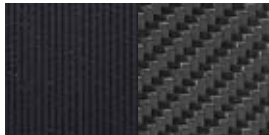



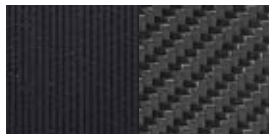



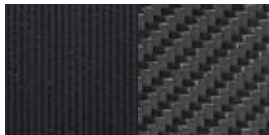

F-TYPE SVR

INTERIOR COLOR COMBINATIONS

STANDARD SVR QUILTED WINDSOR LEATHER PERFORMANCE SEATS WITH WINDSOR LEATHER AND SUEDECLOTH INTERIOR

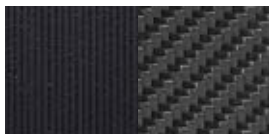
1	2	3	4	5
SEAT WITH STITCH	FINISHER	HEADLINING ¹	UPPER FASCIA WITH STITCH	CARPET
				
Ebony with Cirrus	Dark Brushed Aluminum ² or Carbon Fiber	Ebony	Ebony with Cirrus	Ebony
				
Ebony with Pimento	Dark Brushed Aluminum ² or Carbon Fiber	Ebony or Pimento ³	Ebony with Pimento	Ebony
				
Ebony with Reims Blue	Dark Brushed Aluminum ² or Carbon Fiber	Ebony	Ebony with Reims Blue	Ebony

OPTIONAL SVR QUILTED WINDSOR LEATHER PERFORMANCE SEATS WITH WINDSOR LEATHER INTERIOR

SEAT WITH STITCH	FINISHER	HEADLINING ¹	UPPER FASCIA WITH STITCH	CARPET
				
Pimento with Ebony	Dark Brushed Aluminum ² or Carbon Fiber	Ebony or Pimento ³	Pimento with Ebony	Ebony
				
Sienna Tan with Cirrus	Dark Brushed Aluminum ² or Carbon Fiber	Ebony	Sienna Tan with Cirrus	Ebony

¹Ebony suedecloth standard. Ebony and Pimento leather optional.

²Dark Brushed Aluminum is standard.

³Pimento leather headlining only available on Convertible.

5 CHOOSE YOUR INTERIOR

 Configure your vehicle at jaguarusa.com

Knurled Aluminum center console

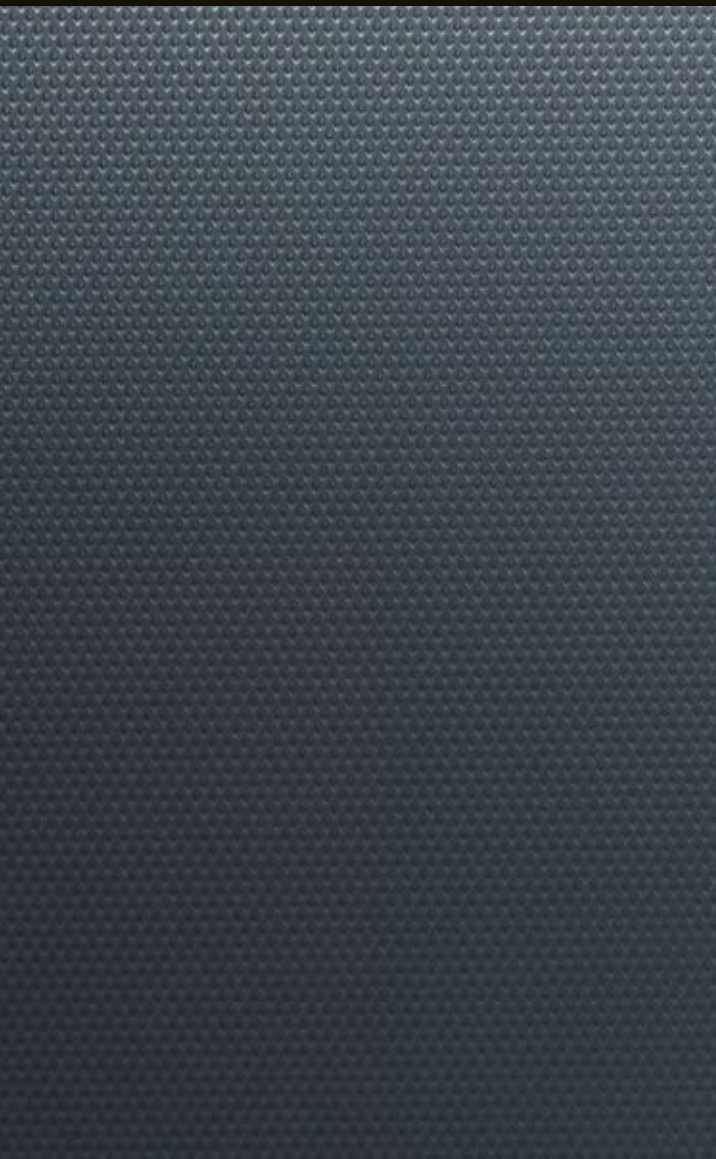

Delta Aluminum center console

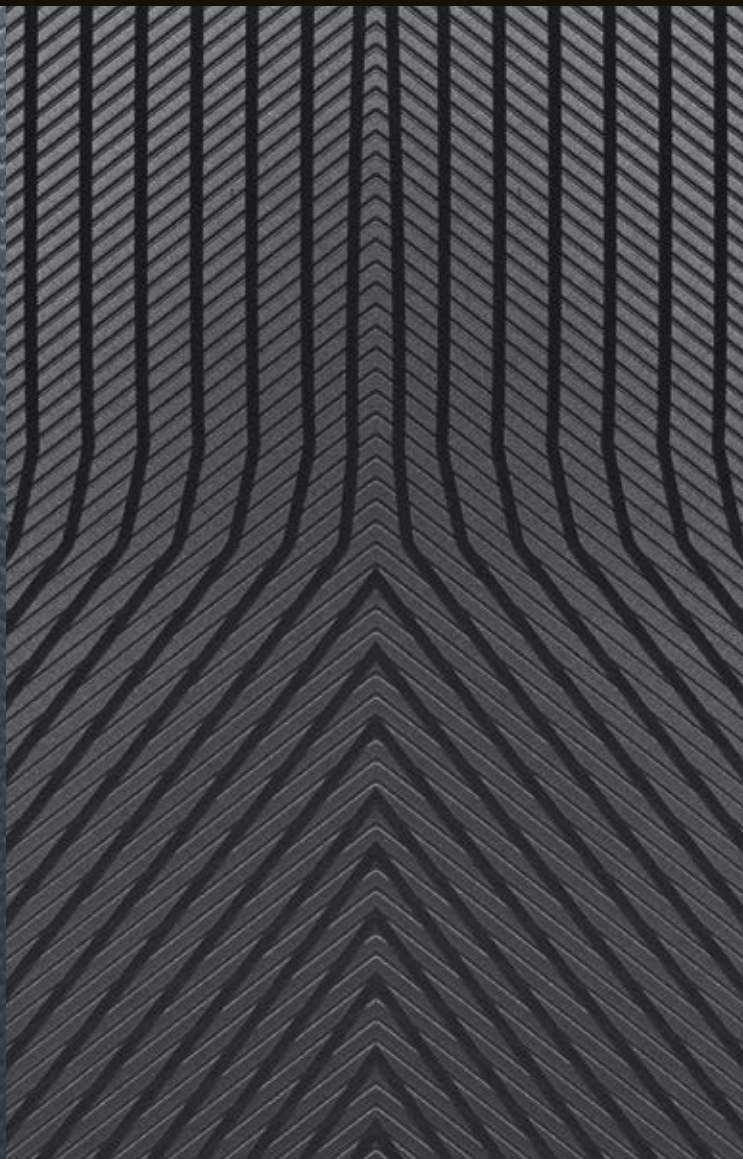

Linear Vee Aluminum center console with R branding



Carbon Fiber center console

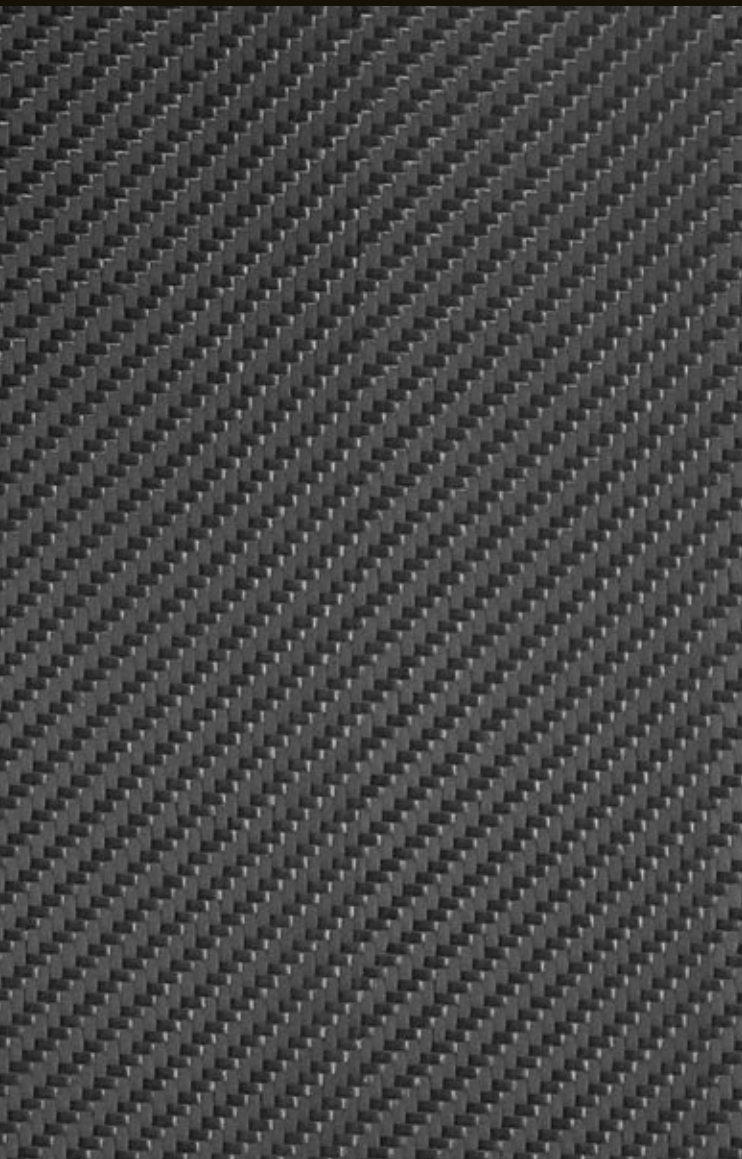

Dark Brushed Aluminum center console with SVR branding



Carbon Fiber center console with SVR branding

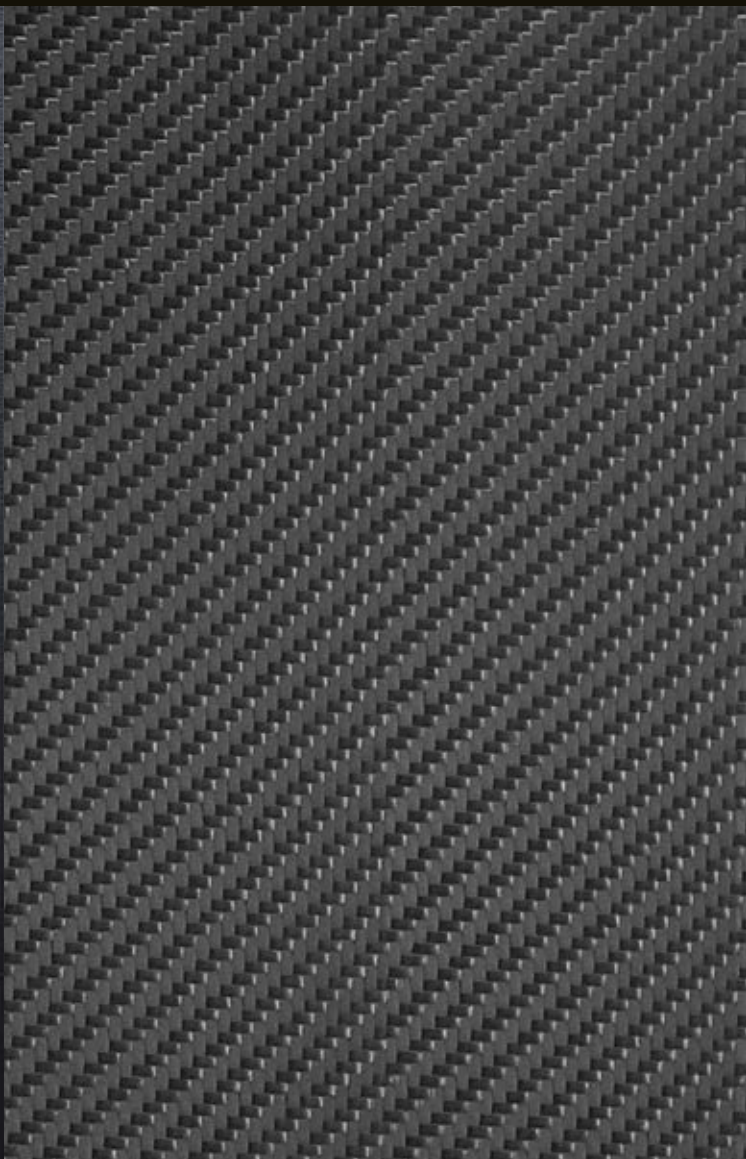

6 CHOOSE YOUR JAGUAR GEAR - ACCESSORIES

To find out more about the full range of retailer fit Jaguar Gear Accessories, please refer to your retailer or go to gear.landrover.com/us/en/



VEHICLE SHOWN: JAGUAR F-TYPE R IN YULONG WHITE
WITH SILVER WEAVE CARBON FIBER PACKAGE



**Personalized Illuminated Sill Treadplates
T2R6091**

Elegantly styled stainless steel sill treadplate finisher for driver or passenger doors. Illuminates when either the driver or passenger doors are opened. Highlighted by soft Phosphor Blue lighting. Allows you to specify a monochrome 'motif' in a choice of approved typefaces/scripts.



**Aluminum Gearshift Paddles¹
T2R6547MMU**

Replacement steering wheel gearshift paddles offered in a premium aluminum material providing a high quality finish to a key contact point in the vehicle. Manufactured from billet machined aluminum, the paddles are hand brushed for a premium finish and anodized to ensure they will not deteriorate with wear.



**Flexible Luggage Retainer
C2D49365**

Provides a neat storage solution to help secure luggage or other items within the luggage compartment.



**Luxury Carpet Mats
T2R16570PVJ - Left Hand Drive**

Luxurious, tailored 0.42lb/ft² pile front carpet mats with embossed Jaguar logo and nubuck edge binding. The luxury mats provide a well appointed finishing touch to the interior.



**Side Net²
T2R22934**

Side net provides additional enclosed storage in the luggage compartment and helps to secure loose items such as bags or small parcels.

¹Not applicable to SVR.

²Coupe only.

6 CHOOSE YOUR JAGUAR GEAR ACCESSORIES

 Configure your vehicle at jaguarusa.com



Silver Weave Carbon Fiber Side Power Vents¹
T2R25198 - Left Side T2R25197 - Right Side

High-grade Silver Weave Carbon Fiber side power vents provide a performance-inspired styling enhancement. Featuring a 2x2 twill weave with an eye-catching aluminum thread and a High Gloss lacquered finish.



Silver Weave Carbon Fiber Hood Vents¹
T2R25193 - Left Side RWD T2R25191 - Right Side RWD

High-grade Silver Weave Carbon Fiber hood vents featuring a 2x2 twill weave with aluminum thread and a High Gloss lacquered finish. Provides an eye-catching, performance-inspired styling enhancement coupled with the weight-saving benefits associated with carbon fiber.



Silver Weave Carbon Fiber Mirror Covers
T2R25196 - Left Side T2R25195 - Right Side

High-grade Silver Weave Carbon Fiber mirror covers provide a performance-inspired styling enhancement. Featuring a 2x2 twill weave with an eye-catching aluminum thread and a High Gloss lacquered finish.



Silver Weave Carbon Fiber Roll Hoops²
T2R23379 - Left Side T2R23378 - Right Side

High-grade Silver Weave Carbon Fiber roll hoops featuring a 2x2 twill weave with aluminum thread and a High Gloss lacquered finish. Provides an eye-catching, performance-inspired styling enhancement coupled with the weight-saving benefits associated with carbon fiber.



Wind Deflector³
T2R11321

Simple to fit and remove, the wind deflector reduces air draught and turbulence in the passenger compartment, even at high speeds. Supplied with a Jaguar branded storage bag.



Gloss Black Side Power Vents¹
T2R15226 - Left Side T2R15225 - Right Side

Jaguar branded Gloss Black side power vents provide a dynamic exterior styling enhancement.



Chrome Hood Vents⁴
T2R5277LML - Left Side T2R5276LML - Right Side

Bright finish accents highlight the F-TYPE exterior styling cues.



Chrome Mirror Covers
T2R5400 - Left Side T2R5399 - Right Side

Chrome mirror covers accentuate the stylish design of the exterior mirrors.



Chrome Roll Hoops²
T2R5402 - Left Side T2R5401 - Right Side

Bright finish accents highlight the F-TYPE exterior styling cues.



All-Weather Car Cover
T2R4364

All-weather tailored cover for the F-TYPE with the Jaguar logo. Protect your F-TYPE from the elements, including showers, frost and dust. Quick and easy to fit.



Rear Diffuser - Carbon Fiber
T2R5391

Statement exterior styling accessory to replace the standard rear valance with a performance diffuser featuring aero blades for optimized air flow. High grade Carbon Fiber featuring a 2x2 twill weave and a High Gloss lacquered finish. Provides weight benefits associated with carbon fiber. Applicable to V6 and i4 models only.



Gloss Black Grille
T2R13838 - Without Parking Aids
T2R13839 - With Parking Aids

Provides a High Gloss Black finish to the grille surround and bumper beam accentuating the F-TYPE's dynamic appearance.

¹Not Available with F-TYPE SVR.

²Available for F-TYPE Convertible only.

³Standard on F-TYPE R and F-TYPE SVR. Also available as a line fit option.

⁴Not applicable for AWD models.

TECHNICAL SPECIFICATIONS

 Configure your vehicle at jaguarusa.com

ENGINES		F-TYPE JAGUAR 2.0 LITER i4 296 TURBOCHARGED GAS		F-TYPE JAGUAR 3.0 LITER V6 340 SUPERCHARGED GAS	
Cylinders/Valves per Cylinder		4/4		6/4	
Bore/Stroke	inches	3.27/3.63		3.33/3.50	
Capacity	cc	1,997		2,995	
Maximum power	HP	296		340	
@rev/min		5,500		6,500	
Maximum torque	lb-ft	295		332	
@rev/min		1,500 - 4,500		3,500 - 5,000	
Compression	ratio:1	9.5		10.5	
Tank capacity (usable)	US gallons	13.9		15.4	
PERFORMANCE*		COUPE Auto	CONVERTIBLE Auto	COUPE Auto	CONVERTIBLE Auto
0-60 mph	seconds	5.4	5.4	5.1	5.1
Top speed	mph	155	155	161	161
DIMENSIONS					
Overall length	in	176.5	176.5	176.5	176.5
Overall width (inc. mirrors)	in	80.4	80.4	80.4	80.4
Overall width (without mirrors)	in	76	76	76	76
Overall height	in	51.6	51.5	51.6	51.5
Wheelbase	in	103.2	103.2	103.2	103.2
Front track	in	62.9**	62.9**	62.9**	62.9**
Rear track	in	64.9†	64.9†	64.9†	64.9†
Ground clearance	in	3.9	3.9	4.0	4.0
Turning circle diameter (curb-to-curb)	ft.	35.0	35.0	35.0	35.0
Convertible trunk volume	cu.ft.	—	7.3	—	7.3
Coupe trunk volume with cargo space cover	cu.ft.	10.9	—	10.9	—
Coupe trunk volume without cargo space cover	cu.ft.	14.4	—	14.4	—
WEIGHT**					
Weight from	lbs	3,360	3,405	3,477	3,521
Gross vehicle weight	lbs	4,244	4,244	4,520	4,520

*Always follow local speed limits. **62.4 inches on 20" wheels. †64.1 inches on 20" wheels. **Weights reflect vehicles to standard specifications. Optional extras increase weight.

DIMENSIONS

Dimensions shown are based upon F-TYPE R, Coupe and Convertible. For details of all derivatives please refer to the Technical Specifications on pages 112 and 113.

Overall Width (inc. mirrors) 80.4 inches

Overall Width (mirrors folded) 74.2 inches

Trunk Volume 14.4 cu.ft (Coupe) 7.3 cu.ft (Convertible)



Turning Circle

Curb-to-curb
35.0ft (RWD)
37.0ft (AWD)



Dimensions were measured with vehicle at unladen weight.
Figures shown are for F-TYPE R. See pages 112-113 for full details on Technical Specifications.
VEHICLE SHOWN: JAGUAR F-TYPE R IN YULONG WHITE WITH OPTIONAL EQUIPMENT

THE WORLD OF JAGUAR

Your Jaguar drives with an instinct for performance, refined through decades of innovative design and engineering. Power and agility are combined with elegance and grace to deliver a vehicle like no other. As a celebration of Jaguar, we've created a range of experiences, publications and the Jaguar Lifestyle Collection. To top it all, we've even returned to the track with Jaguar Racing. Welcome to a world where every aspect of performance is an art.

EXPERIENCE DRIVES



There's no better way of understanding the spirit of Jaguar than by getting behind the wheel. Jaguar Experience Drives are an opportunity to unleash the breathtaking performance of our incredible Jaguar range. Join us at one of our Experience Centers, or take part in the Art of Performance Tour. New sensations await.

jaguarusa.com/experience-jaguar

JAGUAR LAND ROVER ICE ACADEMY



Take your driving to the next level with Jaguar Land Rover Ice Academy. Located on one of the many frozen lakes in Arjeplog, Sweden, your driving skills will be tested through tackling some of the harshest, most challenging tracks on the planet. It's a rare chance to dance on ice and glide around awe-inspiring corners, all under the expert guidance of our instructors. Encounter the true exhilarating potential of the latest Jaguar and Land Rover vehicles in extreme conditions.

jaguarusa.com/experience-jaguar

Follow us on:



MANUFACTURING TOURS



Witness at first-hand a Jaguar being brought to life. Behind our award-winning craftsmanship lies an unrivaled harmony of skilled technicians and cybernetic production robots. Our expert tour guides will accompany you as you make your way through the hi-tech manufacturing process, from sheet metal to the finished creation.

jaguarusa.com

SPECIAL VEHICLE OPERATIONS



With outstanding performance, cutting-edge technology and incomparable luxury, Jaguar is a showcase for the finest in design and engineering. Special Vehicle Operations takes this even further. Adorned with the SV badge, halo models and limited-run collector's editions are the very pinnacle of the Jaguar range, offering a combination of the ultimate in power and dynamics.

jaguarusa.com

ABB FIA FORMULA E



Jaguar's reputation for performance, technology and design was forged at the world's most challenging circuits and championships. From Le Mans to Formula 1, and now Formula E, the grid is our test bed. Formula E provides the perfect proving ground for electric vehicle technology in a high-performance environment. The racing series accelerates the development of Jaguar's electric powertrains. With every race, Formula E helps Jaguar engineers to create better electric vehicles.

jaguarusa.com/jaguar-racing

JAGUAR I-PACE eTROPHY



We're making history. Again. Our latest development as leader in the global automotive race to electrification is I-PACE eTrophy - the world's first all-electric production-based international race series. Engineered and built by Special Vehicle Operations to compete on the zero emissions world stage, racers of the future will push electrification to thrilling heights.

jaguarusa.com/etrophy

Follow us on:



THE JAGUAR LIFESTYLE COLLECTION



Our latest range of apparel and lifestyle accessories is inspired by Jaguar's rich heritage, racing expertise, and iconic designs. This exclusive, impressively executed collection follows the performance-orientated style that is Jaguar.

jaguarusa.com

THE JAGUAR MAGAZINE



This is our own vibrant, cosmopolitan and contemporary magazine. Go behind the scenes at Jaguar and explore our dedication to performance, design and innovation – as well as catching an insight into the world of luxury, style and travel. You can enjoy The Jaguar magazine twice a year, completely free of charge for the first three years of ownership. Ask your local Jaguar Retailer to ensure that you receive your copy.

jaguarusa.com



UCB 358

AT YOUR SERVICE

As well as providing a range of exclusive services and lifestyle products, the World of Jaguar makes owning and driving carefree and easy.

JAGUAR ELITECARE

Enjoy your Jaguar with peace of mind. The F-TYPE is backed by Jaguar EliteCare, our coverage program including New Vehicle Limited Warranty, Complimentary Scheduled Maintenance, Roadside Assistance and Jaguar InControl Remote & Protect™.

GENUINE PARTS

Jaguar Genuine Parts are designed, tested and manufactured to our uncompromising standards for quality, fit and durability. Each part is engineered specifically for your F-TYPE to contribute to optimum performance and to help maximize its lifespan.

FLEET & BUSINESS

Jaguar vehicles are dynamic and distinctive cars that help companies express the unique character and personality of their business. We are committed to providing customer-focused aftersales services, ensuring that every Jaguar performs to the highest standard and in the most cost-efficient way for businesses.

Visit jaguarusa.com/fleet-and-business for more information.

JAGUAR ASSISTANCE

Jaguar Optimized Assistance provides assistance in motoring emergencies, from immobilization due to breakdown or accident to minor problems such as punctures. You can rely on our roadside assistance, whatever the situation, anywhere in North America during the vehicle's warranty period.

JAGUAR FINANCIAL SERVICES

New or used, for personal or business use, we have a finance option that puts you in complete control. Please speak to your local Jaguar Retailer to find out more.

IMPORTANT NOTICE

Jaguar Land Rover Limited is constantly seeking ways to improve the specification, design and production of its vehicles, parts and accessories and alterations take place continually. Whilst every effort is made to produce up to date literature, this brochure should not be regarded as an infallible guide to current specifications or availability, nor does it constitute an offer for the sale of any particular vehicle, part or accessory. Distributors and retailers are not agents of Jaguar Land Rover Limited by any express or implied undertaking or representation.

COLORS

The colors reproduced here are subject to the limitations of the printing process and may therefore vary slightly from the actual vehicle. The company reserves the right to alter or withdraw any color finish without notice. Some of these colors may not be obtainable in your country. Please check availability of colors and current specifications with your Jaguar Retailer. Distributors and Retailers are not agents of Jaguar Land Rover Limited and have absolutely no authority to bind Jaguar Land Rover Limited to any express or implied undertaking or representation.

ENVIRONMENTAL INNOVATION AT JAGUAR

Jaguar is committed to reducing dependency on fossil fuels, using fewer natural resources and creating less waste as part of our approach to responsible and sustainable business development.

Search 'Jaguar Environmental Innovation' for more details.

Castrol EDGE Professional recommended by Jaguar.

Meridian™ is the trademark of Meridian Audio Ltd.

HomeLink® is a registered trademark of Gentex Corporation.

The Bluetooth® word mark and logos are owned by the Bluetooth SIG, Inc. and any use of such marks by Jaguar Land Rover Limited is under license. iPhone is a trademark of Apple Inc., registered in the US and other countries.

**VEHICLE SHOWN LEFT: JAGUAR F-TYPE R-DYNAMIC AWD IN SILICON SILVER WITH
OPTIONAL EQUIPMENT
VEHICLE SHOWN BACK COVER: JAGUAR F-TYPE SVR IN CALDERA RED**

Jaguar Land Rover North America, LLC
100 Jaguar Land Rover Way
Mahwah, NJ 07495-1100

© 2019 Jaguar Land Rover North America, LLC

jaguarusa.com

1X1522010CCSBUSEN01P

