



TRIBECA | 2010



A close-up, low-angle shot of the front left corner of a blue Subaru. The image focuses on the headlight assembly, which includes a circular main lamp and a rectangular fog light section. To the right, the upper portion of the chrome grille is visible, showing horizontal slats. The car's body panels are smooth and reflect the ambient light. The overall composition is clean and emphasizes the vehicle's design details.

A SUBARU IS DIFFERENT.



Tribeca Premier Package

THE 2010 SUBARU TRIBECA.

FOR THOSE WHO WANT IT ALL.



THE LOVE OF THE DRIVE

FEELING IN CONTROL

FOR ALL THE RIGHT REASONS.

THOUGHTFUL ENGINEERING

FOUR DECADES OF ALL-WHEEL DRIVE

SUPERIOR TRACTION

NATURAL BALANCE

UNMATCHED STABILITY

SMOOTH POWER

UNBRIDLED FUN

RALLY-PROVEN PERFORMANCE

SURPRISING EFFICIENCY

TRUSTED JAPANESE RELIABILITY

PURPOSEFUL INNOVATION

THE SPIRIT OF ADVENTURE

REASSURING SAFETY

REAL-WORLD VERSATILITY

ACCOMMODATING COMFORT

A SENSE OF WELL-BEING

RESPECT FOR THE EARTH

LOGIC WITH PASSION

ALL-WEATHER CAPABILITY

CONFIDENCE ON ANY ROAD

THERE ARE MANY DIFFERENT REASONS TO CHOOSE A VEHICLE.

THE SUBARU DIFFERENCE MIGHT BE THE MOST COMPELLING REASON OF ALL.

The more you know about Subaru, the more you might ask, “Why aren’t all vehicles made this way?” Subaru drivers experience a unique feeling behind the wheel, an unsurpassed level of confidence that comes from a balance of virtues rarely found working together in such perfect harmony. Like surefooted all-wheel drive handling complemented by refined smoothness. Invigorating performance with reassuring safety. And thoughtful innovation with superior Japanese reliability. You don’t need to be an engineer to appreciate all the various qualities that make a Subaru stand apart from the crowd. You can feel it – the first time you get behind the wheel of the 2010 Subaru Tribeca and the ten-thousandth time. You might never fully comprehend all the reasons why a Subaru rewards you with such an unexpected, extraordinary and singular sense of enjoyment. But feeling it is all the reason you need.

DECIDEDLY PROGRESSIVE. INCREDIBLY REFINED.
COMPLETELY SUV.

The Subaru Tribeca is a study in contrasts. A mid-size SUV that's neither too big nor too small. A cabin flexible enough for seven passengers, yet luxurious enough to make everyone feel pampered. A vehicle loaded with technologically advanced features which nevertheless remains a tremendous value. An SUV with the go-anywhere capability of Subaru symmetrical full-time All-Wheel Drive and the refinement and handling of a sport sedan. A SUBARU BOXER engine that is both powerful and economical. All of this complexity is ready to be discovered as you embark on the complex adventure that is your life.





METICULOUS CRAFTSMANSHIP. SUPERIOR COMFORT.

Step inside the Subaru Tribeca and one thing becomes immediately clear: Attention has been paid. A spacious cabin with seating for seven. Carefully chosen materials that grace every surface. Well-structured seats covered in premium fabric or luxurious leather. Supportive second-row seats that recline and offer plenty of legroom. Rear-window privacy glass for increased security. Courtesy lights that create a serene and comforting glow. Beautifully appointed and exquisitely designed, the interior of the Tribeca has the power to melt away stress like snow in springtime.

Tribeca Premier Package



BEAUTIFUL FORM. BOUNTIFUL FUNCTION.

The Subaru Tribeca is perfectly situated at the intersection of form and function – and you are the beneficiary. A dramatic wing-shaped dashboard that places all necessary controls and dials within easy reach. Electroluminescent gauges for dramatic impact and enhanced legibility. Desirable features that soothe, entertain and keep you connected. High-end materials that convey a sense of luxury and make every kilometre a distinct pleasure. This is driving comfort and driving control as it was intended to be.

Tribeca Premier Package



THE SUV FOR EVERYONE AND EVERY DIVERSION.

Whether your interests veer towards the adventurous – such as whitewater rafting – or the more laid back – antiquing, for example – the Subaru Tribeca has the versatility to match. With a cavernous passenger cabin and no fewer than 64 different seating configurations, there's always room for a raft, a hidden treasure and the people interested in either or both.



ONE PERSONALITY. MULTIPLE OPTIONS.

A well-designed cabin has the capacity to be a true multi-tasker. The interior of the Tribeca fits the description with a 40/20/40-split flat-folding second-row seat, a 50/50-split flat-folding third-row seat and up to 2106 litres of storage volume. Also standard: roof rails and a cargo compartment with a 12-volt power outlet and six utility hooks. For everything from a weekend at the cottage to a weeknight soccer practice – the Tribeca fits it all in.

A PLACE FOR EVERY NEED.

Not only does the Tribeca have ample storage space, it also boasts a wealth of nooks and crannies to carry virtually every possible necessity. The evidence: front door compartments for drinks and maps. A centre console with space for CDs, a cell phone or a mobile music player. A plethora of front- and back-seat cup holders, rear seatback pockets and a sub-floor tray in the cargo area. If you can't find a place for it here, you probably don't really need it.

Tribeca Premier Package



NEXT-GENERATION FEATURES, OLD-SCHOOL COMFORT.

Driving is about more than just getting from point A to point B – much more. Particularly if you're driving the Subaru Tribeca, an SUV loaded with features designed to bring more comfort and joy to any road trip of any length. With a superior sound system, auxiliary audio input jack, SIRIUS Satellite Radio*, GPS DVD-based navigation system* and rear-seat DVD entertainment system*, this SUV is almost as much fun to ride in as it is to drive.

*Available features.



GPS NAVIGATION: STEP-BY-STEP INSTRUCTIONS, DEPENDABLE DIRECTIONS.

The Tribeca Premier Package comes equipped with GPS DVD-based navigation for faster, more accurate step-by-step instructions guiding you directly to your destination. The 7-inch high-resolution VGA touchscreen can play DVD movies while the vehicle is parked and features readouts for fuel consumption and maintenance information.

PREMIUM AUDIO SYSTEM: IMMERSE YOURSELF.

The 6-CD premium audio system is MP3-compatible with six speakers specifically tuned for the interior of the Tribeca. The system boasts crisp audio reproduction and superb acoustics overall. Steering wheel-integrated audio switches place control over the system at your fingertips at all times.

HARMAN KARDON® SPEAKERS: THE LEGEND ROLLS ON.

The available 10-speaker, 385-watt Harman Kardon® speaker system* is designed to take your listening pleasure to new heights. A powerful subwoofer provides rich, full bass, while a 7-channel amplifier ensures crystal clear sound overall.

*Tribeca Limited Package and Premier Package.

REAR-VIEW CAMERA: PICTURE PERFECT.

A clear view of the road ahead is a key safety consideration – and so too is a clear view of the road behind. The rear-view camera projects a full-colour image of what's behind the vehicle onto the centre screen, greatly increasing visibility, safety and ease of parking.

REAR-SEAT DVD ENTERTAINMENT SYSTEM: ENTERTAIN THE TROOPS.

Even the lengthiest driving adventure can prove endlessly entertaining with the available rear-seat DVD entertainment system* that includes a 9-inch LCD screen, two sets of wireless headphones, remote control and audio/video auxiliary input for video game consoles.

*Tribeca Limited Package and Premier Package.

BLUECONNECT®: THE FUTURE OF HANDS-FREE.

Utilizing Bluetooth® technology to bring superior clarity to your hands-free mobile phone calls, voice-activated blueconnect® represents the next generation in mobile communication. Available with both upgrade packages*, the system is simple to access: Select the hands-free profile on your compatible Bluetooth®-enabled mobile phone and you're good to go – and talk along the way with the fully voice-activated system.

*Tribeca Limited Package and Premier Package.

AUXILIARY AUDIO INPUT: CUE YOUR MUSIC.

With the Subaru Tribeca, you can take your digital music with you wherever you go. Simply connect your portable music player to the standard auxiliary input jack or slip your MP3 CD into the in-dash changer and listen in wonder as crystal clear sound pours forth from the audio system.

SIRIUS® SATELLITE RADIO: THE CHOICE IS YOURS.

The Tribeca comes pre-wired for SIRIUS® Satellite Radio, while upgrade packages* offer a free 3-month trial subscription to this fantastic service. With over 100 satellite radio channels on the dial, you're certain to find exactly what you're looking for – everything from music to news, sports and talk radio.

*Tribeca Limited Package and Premier Package.





INTERIOR AND EXTERIOR FEATURES



Courtesy Lights

Front- and rear-door courtesy lights illuminate when the door is open, creating a welcoming glow and guiding occupants when entering and exiting the cabin.



Automatic Climate Control

The driver and front-seat passenger can both select the perfect personalized temperature setting with the automatic dual-zone climate control system.



Rear Cooling Unit

The rear cooling unit provides separate fan control settings, bringing added comfort and convenience for backseat passengers.



Power Moonroof

Operated electronically and featuring a manual sunshade, the panoramic moonroof is perfect for maximizing vitamin D intake on a sunny day and magnifying the stars on a clear night.



Power-adjustable Front Seats

The power-adjustable front seats – 8-way for the driver, 4-way for the front passenger – ensure maximum comfort at all times. The Limited and Premier Packages bring added convenience: a 2-position memory feature on the driver's seat.



Heated Front Seats

Individually adjustable heated front seats are just what the doctor ordered for relieving the mid-winter chills.



Monitor System

Gain instant information – the time, outside temperature, current fuel consumption and average fuel consumption – via the convenient digital readout positioned atop the dashboard.



Cruise Control

Unmatched convenience for the open road and a great way to boost fuel efficiency, cruise control is quick and easy to activate using steering wheel stalk controls.



Door Mirror LED Turn Signals

LED turn signals incorporated into the door mirrors are a slick feature that also serve to boost road safety by giving other drivers a clear sense of your intended path.



Power-adjustable Door Mirrors

Generous door mirrors are aerodynamically sculpted for reduced wind noise, heated to defog or melt way frost, power-adjustable to create superior visibility, and foldable to better fit narrow parking spaces.



18-inch Aluminum Alloy Wheels

The Subaru Tribeca comes standard with ultra-light 5 double-spoke 18-inch alloy wheels that make a bold statement and deliver better handling response when cornering.



18-inch Aluminum Alloy Wheels

The 7-spoke 18-inch alloy wheels found on Limited and Premier Package models are elegantly designed and finished to enhance curb appeal even more.



HID Headlights

For greater illumination at night, High Intensity Discharge (HID) headlights are just the ticket, casting a brighter and whiter beam. Standard with Limited and Premier Packages.



Fog Lights

For those times when foggy weather threatens visibility, standard multi-reflector halogen fog lights answer back with a wide, flat beam for reduced glare and increased safety.



Roof Rails

Standard raised-profile roof rails set the stage for transporting all manner of sports equipment, camping gear or other necessities – just add the proper accessory crossbars and you're good to go. (Silver finish on Tribeca Limited and Premier Packages).



Roofline Rear Spoiler

Improved aerodynamics, a sporty look and a more visible integrated brake light are all part of the picture with the standard roofline rear spoiler.

SYMMETRY GIVES YOU BALANCE.

EVERY SUBARU HAS SOMETHING IN COMMON WITH NO OTHER VEHICLE.

To build a better car, start with a more perfect idea. The ideally balanced SUBARU BOXER engine and Subaru symmetrical full-time All-Wheel Drive (AWD) are at the core of Subaru technology – unique to the industry, this technology is also the very reason why a Subaru outperforms.

BALANCE

The layout of the SUBARU BOXER engine and Subaru symmetrical full-time AWD creates a drivetrain that is naturally balanced from side to side and, therefore, produces superbly balanced handling. This symmetrical system delivers power more smoothly and distributes it more evenly among all four wheels, generating the spirited driving confidence that defines a Subaru.

CONTROL

The SUBARU BOXER engine's flat configuration gives the vehicle a very low centre of gravity. Teamed with the superior grip of Subaru symmetrical full-time AWD, this combination provides more precise, responsive and satisfying handling and control in virtually any driving condition.

SAFETY

In adverse weather, or in the precious few seconds it takes to react to a sudden situation, the combination of the balanced SUBARU BOXER engine, surefooted Subaru symmetrical full-time AWD and fine-tuned suspension provide the razor-sharp response needed to help drivers avoid a collision.

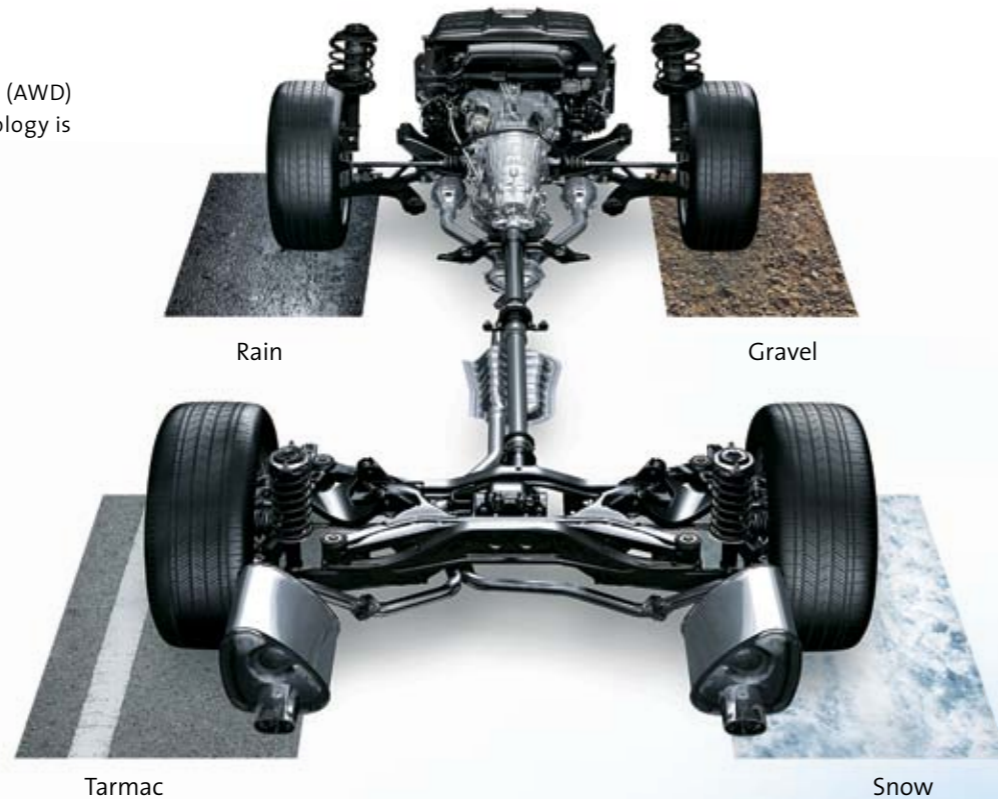

Rain

Gravel

Tarmac

Snow

SYMMETRICAL AWD

Throughout the past four decades, Subaru has diligently advanced its technology to meet the evolving needs of drivers around the world. As evidence, we submit the Subaru symmetrical full-time AWD system. With the engine and drivetrain organized in a symmetrical layout along the centreline of the vehicle, a Subaru is engineered from the ground up to deliver on the full promise of all-wheel drive – meaning, superior traction and stability. In this layout, power is able to be routed to all four wheels, creating naturally perfect balance and an innate sense of control.



BALANCE GIVES YOU CONTROL.

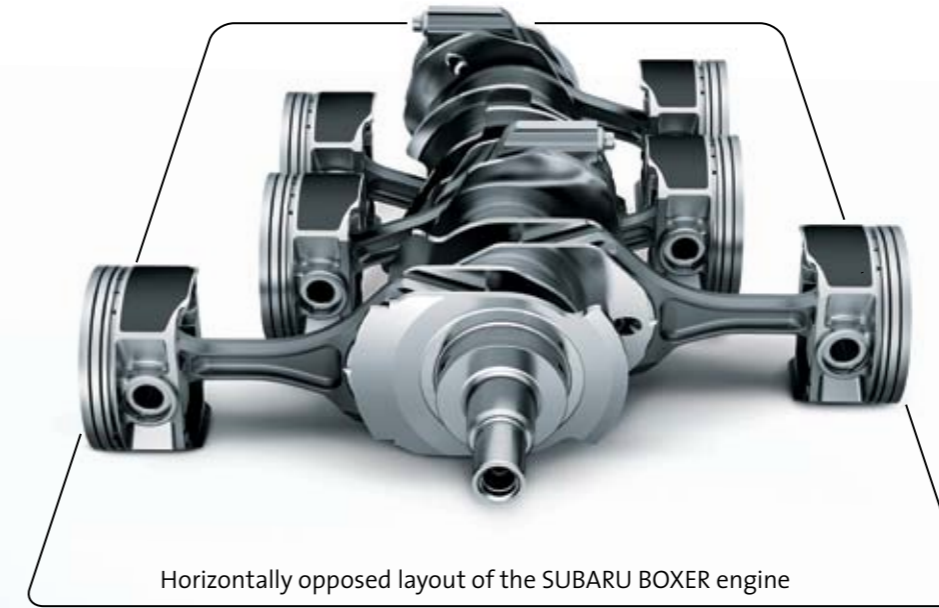

SUBARU BOXER

The horizontally opposed configuration of the SUBARU BOXER engine sees the pistons placed 180 degrees apart, creating a lower and flatter profile compared to other engine types. This gives the Subaru engine – thus, the entire vehicle – a lower centre of gravity and heightened sense of balance. Furthermore, the opposing movement of one bank of pistons inherently counteracts that of the other, helping to reduce engine vibration and boost driving comfort.

THREE DISTINCT ADVANTAGES OF THE SUBARU SYMMETRICAL FULL-TIME AWD SYSTEM

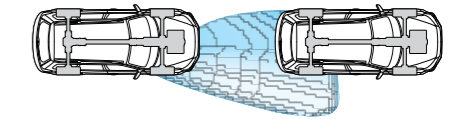

GREATER TRACTION

THE DIFFERENCE: When driving in bad weather or reacting to avoid a potential accident, Subaru symmetrical full-time AWD delivers exceptional traction – and therefore extraordinary confidence – because it can keep all four wheels engaged at all times.*
THE REASON: Traction generates control. Control inspires confidence.

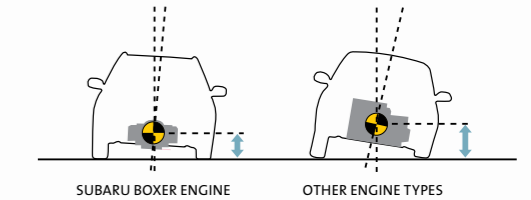

SUPERIOR STABILITY

THE DIFFERENCE: With its horizontally opposed configuration, the SUBARU BOXER engine lays flatter and can sit lower in the vehicle than other engine designs.
THE REASON: A lower centre of gravity for the entire vehicle means more balanced handling, flatter cornering capabilities and uncommon stability overall for an SUV.

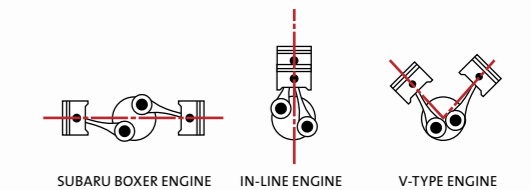

SMOOTHER OPERATION

THE DIFFERENCE: In the SUBARU BOXER engine, the pistons lay flat on each side of the crankshaft, so they thrust away from each other along the horizontal plane.
THE REASON: This "punch-counterpunch" action naturally suppresses engine vibration for inherently smoother running.

*When vehicle is in motion. Diagrams for illustrative purposes only.

Opposing forces, unifying result.

THE DIFFERENCE: The philosophy behind the SUBARU BOXER, its design and its construction create an inherently superior engine.

THE REASON: The punch-counterpunch action of the pistons – complemented by a highly sophisticated valvetrain – creates smooth, efficient and balanced power delivery, while advanced engineering delivers greater strength and durability for the road ahead.

HOW THE SUBARU BOXER ENGINE MAKES A BETTER SUV.

The SUBARU BOXER engine – with its low profile and inherent smoothness – is perfect for any type of vehicle, but a particularly inspired choice for an SUV. The placement of the engine gives the Tribeca an extremely low centre of gravity, which generates increased stability during cornering and a surprising level of handling prowess. The way the pistons fire in the engine promotes a stable and refined driving experience that is completely unexpected in a true SUV. And the engine itself is fine-tuned for greater torque, reduced emissions and heightened fuel efficiency. (That’s a powerful result.)

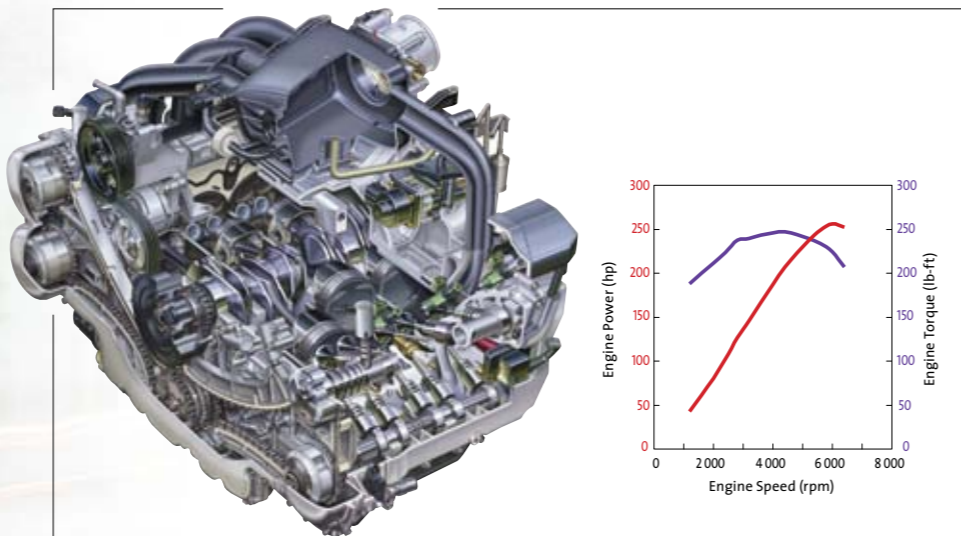

3.6-LITRE DOHC SUBARU BOXER
HORSEPOWER: 256 HP @ 6000 RPM
TORQUE: 247 LB-FT @ 4400 RPM
FUEL ECONOMY (L/100 KM): CITY 13.1 / HWY 9.4 (SEAT SS)

The largest engine in the Subaru fleet, the 3.6-litre DOHC 6-cylinder SUBARU BOXER offers an intoxicating blend of performance and efficiency. Benefiting from the highly advanced Dual Active Valve Control System, this mighty powerplant delivers excellent low- and mid-range torque, smooth acceleration throughout the rev range, robust fuel efficiency and surprisingly low emissions.

Shift to a higher level of performance.

THE DIFFERENCE: Subaru symmetrical full-time AWD is an advanced drive system in need of a similarly sophisticated means of delivering power to the ground – and the 5-speed automatic transmission in the Tribeca is precisely that.

THE REASON: The transmission is specifically designed to be able to deliver continuous, full-time power through the AWD system to all four wheels simultaneously* – this is not like on-demand systems used by some, this is a true full-time AWD system.

5-SPEED AUTOMATIC TRANSMISSION + VARIABLE TORQUE DISTRIBUTION

The 5-speed automatic transmission with SPORTSHIFT® (SEAT SS) employs advanced electronics and adaptive shifting logic to deliver smooth, quick and fuel-efficient performance – even when cornering or driving up and down hills. Two fully automatic shift modes (Normal for better fuel economy and Sport for better performance) and a manual shift mode allow the driver to choose optimum acceleration or fuel efficiency. The transmission also utilizes a Variable Torque Distribution AWD system that maintains a 45/55 front/rear torque split during normal driving conditions and automatically adjusts up to a 50/50 split under hard acceleration or when conditions warrant. This system is able to work in conjunction with the standard Vehicle Dynamics Control (VDC) to ensure power is distributed to all four wheels in a controlled fashion, creating superior levels of traction.



5-speed Electronic Direct Control Automatic Transmission with SPORTSHIFT® (SEAT SS)

*When vehicle is in motion.

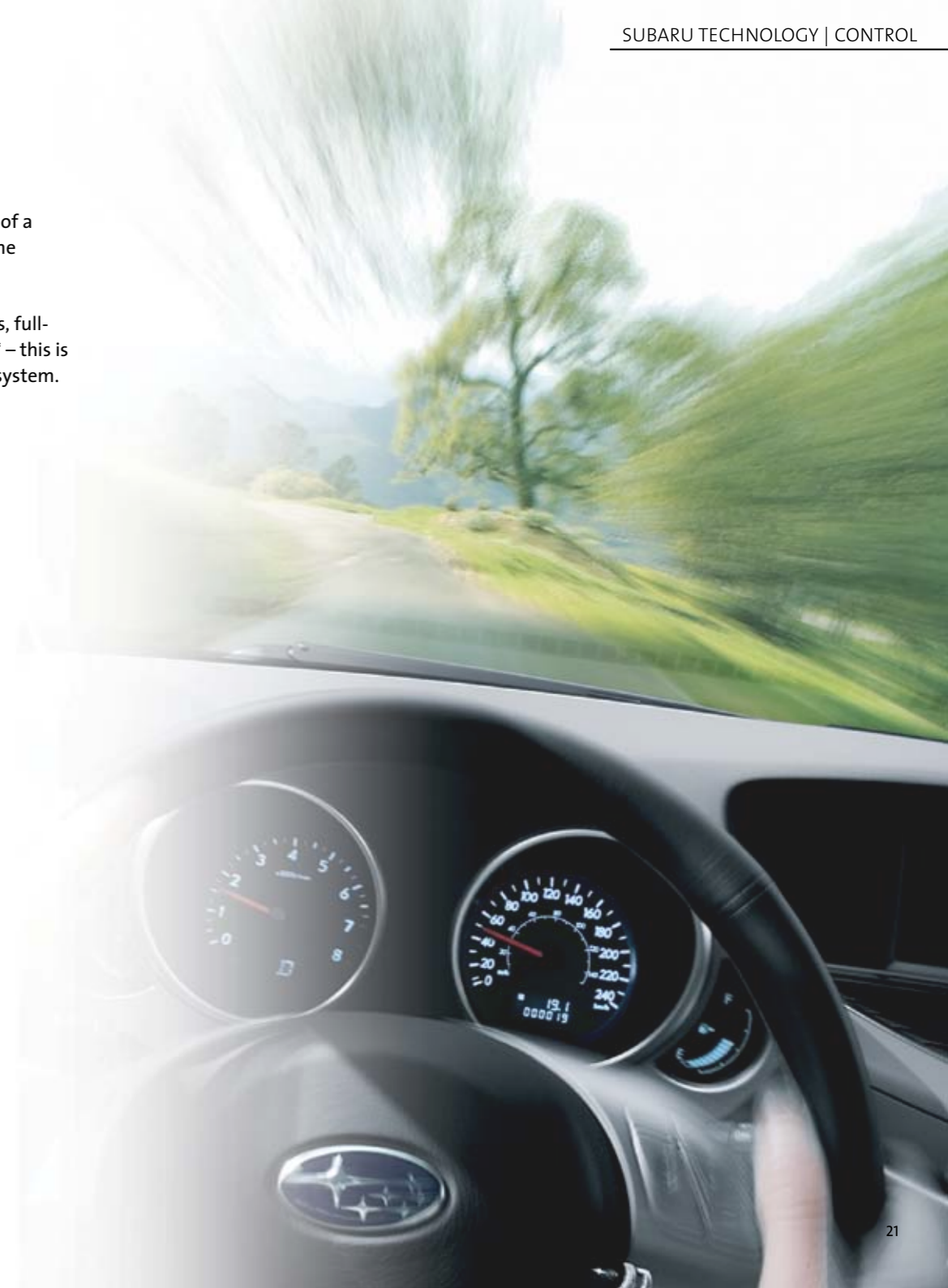



All four wheels, all in unison.

THE DIFFERENCE: The advanced chassis combined with Subaru symmetrical full-time AWD and sophisticated VDC are designed and engineered to work together to provide a safe and rewarding driving experience.

THE REASON: Supreme confidence behind the wheel – regardless of road or weather conditions – hinges on knowing your vehicle is designed to perform at incredibly high levels at every turn.

VEHICLE DYNAMICS CONTROL (VDC)[†]

Every Tribeca comes standard with VDC, a system that uses a network of sensors to monitor and analyze if the vehicle is following the driver's intended course. If the vehicle approaches the limits of stability, the torque distribution, engine output and brakes at each wheel are adjusted automatically to help keep the vehicle on the straight and narrow.

1. VDC monitors the driver's steering, braking and throttle input, along with the vehicle's lateral acceleration and yaw (rotation), to compare the intended and actual movements of the vehicle.
2. The system then adjusts torque distribution, braking at each individual wheel and engine output as needed to assist in keeping the vehicle as close as possible to the desired driving line.

[†]The Subaru Vehicle Dynamics Control system may also be known as Electronic Stability Control.

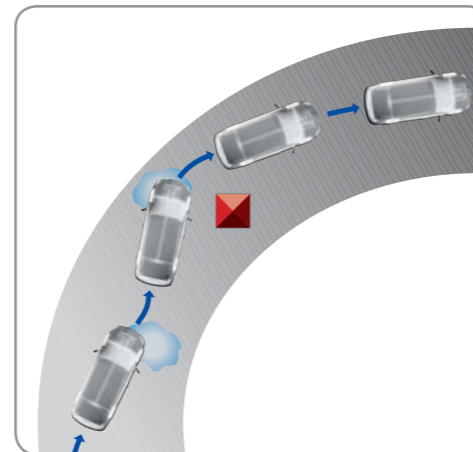

CORNERING
A super-strong chassis and a low centre of gravity set the stage for a finely tuned 4-wheel independent long-travel suspension system that soaks up imperfections, provides crisp cornering and opens up the lines of communication between the driver and the road.



OPEN HIGHWAY
An added benefit of using superior materials throughout the chassis and suspension system is that the added strength helps cut the amount of vibration and noise from the road to the cabin, creating a smoother and quieter ride.



FRONT SUSPENSION

A fine-tuned strut-type front suspension with long travel and a wide track give the Tribeca a level of handling, steering feel and ride quality completely unexpected in an SUV. Despite its generous ground clearance, this SUV corners with minimal body roll and tremendous stability.

ROUGH ROAD
Designed to provide generous wheel travel and optimize tire contact with the road at all times, the rugged yet compliant and refined long-travel suspension has been proven in the FIA World Rally Championship, the toughest motorsport competition known to man or machine.



CHANGING WEATHER
Subaru symmetrical full-time AWD, VDC and the independent suspension system work in concert to manage how the tire responds to the surface of the road, making the most out of available traction.

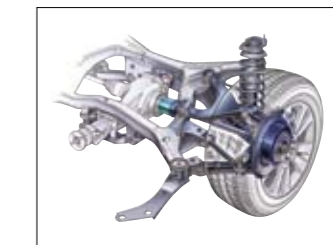

REAR SUSPENSION

Compact in design but big in real-world performance, the double-wishbone rear suspension system is calibrated to handle rough roads and sharp corners with equal composure. The end result is an SUV that fits the description: sporty with plenty of utility.

Drivetrain for illustrative purposes only.



Abundant safety features. More reasons to feel secure.

THE DIFFERENCE: A legendary symmetrical full-time AWD system, a surprising degree of agility and numerous active and passive safety features all come standard on the Tribeca.

THE REASON: The first rule of safety is to avoid a collision at all cost. The second is to be surrounded by superior protection systems should avoidance be impossible.

ACTIVE SAFETY, TO AVOID A COLLISION.

Many of the same features that make the Tribeca so pleasurable to drive contribute to its ability to protect occupants from unexpected hazards on the road. The stable, responsive handling of Subaru symmetrical full-time AWD. Superior agility courtesy of a low centre of gravity. Excellent evasive capabilities from the finely tuned suspension, powerful brakes, quick steering and standard VDC. Even the tremendous visibility afforded by a high seating position and generous glass area better equips the driver to avoid potential accidents.

PASSIVE SAFETY, TO PROTECT IN A COLLISION.

Even with the latest active safety systems standing guard, sometimes an accident is unavoidable. The Tribeca is engineered to protect occupants in the event of a collision with a series of class-leading passive safety systems. The story begins with an advanced ring-shaped reinforcement frame, designed to minimize impact energies by distributing it around the outside ring of the passenger cabin. Six airbags, whiplash-reducing active front-seat head restraints, collapsible brake pedal and 3-point seatbelts for all seating positions further contribute to the cause of passive safety. This is a core value of the Subaru philosophy: Peace of mind is crucial to fully experience true driving enjoyment.

VEHICLE DYNAMICS CONTROL (VDC) SYSTEM†

VDC is a very significant active safety feature – this is the reason why it’s standard on every Subaru. With a network of sensors constantly monitoring vehicle attitude, VDC helps to ensure that the vehicle is as stable and balanced as possible – and that it remains on the driver’s intended course.

BRAKING SYSTEM

The standard 4-channel Anti-lock Braking System (ABS) is equipped with Electronic Brake-force Distribution (EBD) to automatically adjust front/rear brake bias as passenger and cargo load changes. Electronic Brake Assist also provides greater braking force in panic situations.

RING-SHAPED REINFORCEMENT FRAME

The advanced ring-shaped reinforcement frame creates a uniform, interconnected safety cell comprised of the roof, door beams, side pillars and floor. This cell helps to divert impact energy away from the passenger cabin in the event of a collision. The Tribeca also features crumple zones (front and rear) engineered to dissipate impact energy gradually, while the front is also designed to allow the engine to slide under the passenger compartment in a severe front-end collision.

SEATBELTS, AIRBAGS AND HEAD RESTRAINTS

The Tribeca comes standard with front, front-side and side-curtain airbags with rollover sensors (first and second row). Also part of the picture are height-adjustable front seatbelts with pretensioners to hold passengers firmly in place and load limiters that ease peak forces to the chest area. Rear passengers are also secured with head restraints and 3-point seatbelts in all seating positions. Last but not least, whiplash-reducing active front-seat head restraints automatically move in a rear-end collision to better support the passenger’s head and minimize injury.

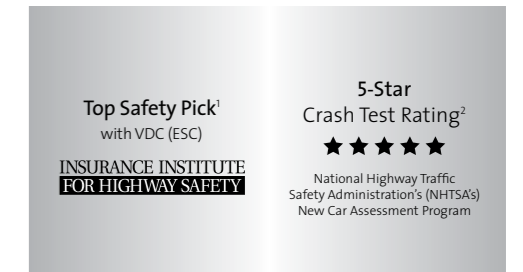
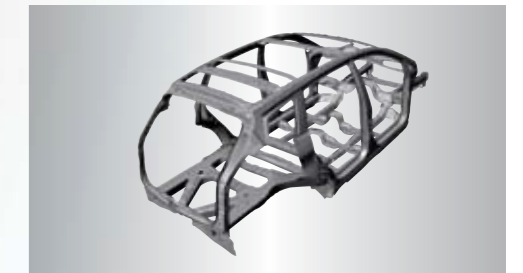
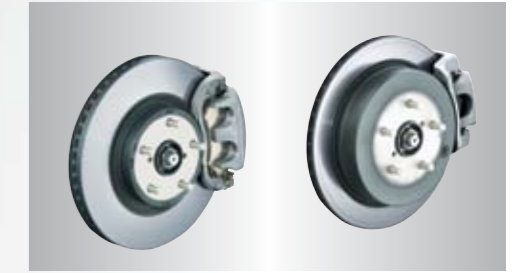

†The Subaru Vehicle Dynamics Control system may also be known as Electronic Stability Control.

Results for 2009 model year. †Ratings of “Good” are the highest rating awarded for 40-mph frontal offset, 31-mph side-impact and 20-mph rear-impact crash tests conducted by the Insurance Institute for Highway Safety (IIHS) (www.iihs.org). A “Good” rating obtained in all three crash tests and the availability of Electronic Stability Control (ESC) (Vehicle Dynamics Control) achieves a Top Safety Pick. †U.S. Government star crash-test ratings are part of the National Highway Traffic Safety Administration’s (NHTSA’s) New Car Assessment Program (www.safercar.gov). A 5-star crash-test rating is the highest government rating for a) Driver and right front seating positions in frontal crash tests and b) Front and rear seating positions in side-impact crash tests.

TRIBECA

A smooth SUBARU BOXER engine. The all-season capability of Subaru symmetrical full-time AWD. A luxurious interior filled with desirable attributes. A well-equipped base model and two available upgrade packages. Net result: An unexpected SUV completely unique to the SUV segment.



Selected standard features:

Horizontally opposed, 6-cylinder, 3.6L SUBARU BOXER engine with Dual Active Valve Control System

256 horsepower and 247 lb-ft of torque

5-speed Electronic Direct Control Automatic Transmission with SPORTSHIFT® (5EAT SS) and blipping control

Subaru symmetrical full-time All-Wheel Drive

Vehicle Dynamics Control system and Traction Control System

Anti-lock Braking System, Electronic Brake-force Distribution (EBD) and Brake Assist

Driver and front passenger front and side-impact airbags; side curtain airbags with rollover sensor (first and second row)

Rear-view camera

18-inch aluminum alloy wheels; 5 double-spoke design

Power tilting and sliding glass moonroof

Multi-reflector halogen fog lights

Power-adjustable, foldable and heated body-colour door mirrors with integrated LED turn signals

Raised-profile roof rails (black)

Premium AM/FM/6CD/MP3/WMA audio system with 6 speakers, auxiliary audio input, steering wheel-integrated controls and pre-wired for satellite radio[†]

Automatic dual-zone climate control

Rear-seat cooling unit

Heated, power-adjustable front seats with lumbar support

40/20/40-split, flat-folding, reclining and adjustable second-row seating

50/50-split, flat-folding third-row seats with driver and passenger side access

Premium cloth upholstery

LIMITED PACKAGE

Available for Tribeca:

18-inch aluminum alloy wheels, 7-spoke design

Body-colour rocker panels, wheel arches and lower bumpers

Raised-profile roof rails (silver)

Xenon High Intensity Discharge (HID) headlights (low beam) with manual levelizer

DVD entertainment system with 9-inch screen, audio/video auxiliary input, 2 wireless headphones and a remote control

DVD playback (front screen)

Harman Kardon® 10-speaker system with 385-watt amplifier

blueconnect® Bluetooth® hands-free system (voice-activated)

SIRIUS® Satellite Radio installed (free 3-month trial subscription included)

2-position memory function on driver's seat

Leather seating surfaces (Slate Grey or Desert Beige dependent on exterior colour)

PREMIER PACKAGE

Available for Tribeca:

18-inch aluminum alloy wheels, 7-spoke design

Body-colour rocker panels, wheel arches and lower bumpers

Raised-profile roof rails (silver)

Xenon High Intensity Discharge (HID) headlights (low beam) with manual levelizer

GPS DVD-based navigation (touchscreen)

DVD entertainment system with 9-inch screen, audio/video auxiliary input, 2 wireless headphones and a remote control

DVD playback (front screen)

Harman Kardon® 10-speaker system with 385-watt amplifier

blueconnect® Bluetooth® hands-free system (voice-activated)

SIRIUS® Satellite Radio installed (free 3-month trial subscription included)

2-position memory function on driver's seat

Leather seating surfaces (Slate Grey or Desert Beige dependent on exterior colour)

PERFECTIONIZE.

For those interested in giving your Tribeca a bit more functionality, personality or utility, nothing takes the place of genuine Subaru accessories. Engineered to the same high standards as your Subaru – and designed to fit and function as if they were original equipment – these add-ons can help you carry more necessities, do more things and appreciate your vehicle more overall.

- Battery warmer
- Bike carriers (trailer hitch-mounted and roof-mounted)
- Block heater
- blueconnect® Bluetooth® hands-free system
- Cargo area nets (rear, seatback)
- Cargo area tray
- Cargo area cover (retractable)
- Cargo basket
- Cargo organizer
- Compartment divider (dog guard)
- Crossbar set
- Hood deflector
- Kayak stacker
- Moonroof deflector
- Puddle lights
- Rearview mirror - auto-dimming with compass
- Rear bumper step pad
- Remote engine starter kit
- Reverse sensing system
- Roof cargo bin (several styles and sizes)
- Rubber floor mats
- Satellite radio kit (XM® or SIRIUS®)
- Security system upgrade (shock sensor)
- Side window deflectors
- Ski/snowboard carrier
- Subwoofer/amplifier
- Trailer hitch assembly
- Underguards (front)
- Wheel lock set



Side window deflectors



Puddle lights



Roof cargo bin (several sizes and styles available)



Cargo basket



Trailer hitch assembly (includes transmission cooler)



Hitch-mounted bike carrier



Retractable cargo area cover and cargo area tray (each sold separately)



Reverse sensing system

Visit www.subaru.ca or your local Subaru Dealer for more accessory options.

Fuel economy: 5EAT SS (L/100km): City 13.1 / Hwy 9.4



Exterior colours available: Azurite Blue Pearl, Crystal Black Silica, Deep Bronze Metallic, Graphite Grey Metallic, Ruby Red Pearl, Satin White Pearl (shown), Sky Blue Metallic, Steel Silver Metallic.

Interior colour: Slate Grey (shown).

See 2010 Subaru Tribeca specification insert for full details and colour samples. [†]Dealer accessory and subscription required.

SUBARU WARRANTIES

Every Subaru vehicle is designed and built to offer our customers the highest possible level of quality and reliability. We are proud of our vehicles and proud to stand behind them with a comprehensive warranty. For 2010 model year vehicles, the warranty on all Subaru vehicles consists of the following:

New Vehicle Limited Warranty (36 month/60,000 km) – Covers basic and major components for 36 months or 60,000 km.

Major Component Limited Warranty (60 month/100,000 km) – Extends coverage of major components (more than just powertrain) up to 60 months or 100,000 km.

Surface Corrosion Limited Warranty (36 month/60,000 km) – Covers surface corrosion to visible painted body panels for 36 months or 60,000 km.

Anti-Perforation Limited Warranty (60 month/unlimited km) – Covers perforation due to corrosion to body sheet metal panels for 60 months, regardless of kilometres.

Emission Control System Limited Warranty – Covers the majority of emissions components for 36 months or 60,000 km and the major parts of the emission control system for 96 months or 130,000 km.

Parts and Accessories Limited Warranty – Covers Subaru parts and accessories installed by the dealer prior to retail delivery of the vehicle for 36 months or 60,000 km, and Subaru parts and accessories installed by the dealer after the retail delivery of the vehicle for 12 months or 20,000 km from the date of the installation.

The above information is an overview of warranty coverage and is not a warranty statement. If you wish to see more details regarding Subaru warranties, please refer to your Subaru warranty booklet, contact your local Dealer or visit our Web site at subaru.ca.

SUBARU C.A.R.E. (CUSTOMER ASSISTANCE FOR ROADSIDE EMERGENCIES)

The Subaru C.A.R.E. program (which is backed by the Canadian Automobile Association [CAA]) is offered free of charge for the first three years from date of purchase on every new Subaru vehicle or as part of a Subaru Protection Plan. As a Subaru C.A.R.E. member, you can count on fast, courteous emergency roadside assistance 24 hours a day, 365 days a year. You will receive a membership card and have access to a dedicated toll-free telephone number (in English or French), allowing you to take advantage of over 20,000 roadside assistance contractors and 1,000 CAA and American Automobile Association (AAA) offices throughout Canada and the United States. Ask your Dealer for details or visit subaru.ca.

Subaru Canada, Inc. is proud to be the first vehicle manufacturer to have a direct relationship with CAA, giving our customers the benefit of CAA's unparalleled level of experience and service.

SUBARU PROTECTION PLAN

As a Subaru owner, you have expectations for a pleasurable, trouble-free ownership experience – now and into the future. Once your 36 month/60,000 km New Vehicle Limited Warranty period ends,* our Subaru Protection Plan can prolong your hassle-free ownership experience with three levels of extended service contract coverage tailored to your needs: Powertrain Protection; Major Protection; or Complete Protection (best level of coverage to complement the 60 month/100,000 km Major Component Limited Warranty). This extended service contract offers comprehensive mechanical and electrical coverage and a number of additional features and benefits. Be sure to ask your Dealer for details or visit subaru.ca.

*If you already own a Subaru vehicle and it is still within the 36 month/60,000 km New Vehicle Limited Warranty period, you are still eligible.



2010 SPECIFICATIONS



ENGINE

Tribeca (including packages)

Type	3.6L Dual Overhead Cam (DOHC), 24-valve, horizontally opposed, 6-cylinder SUBARU BOXER engine, Electronic Throttle Control and Dual Active Valve Control System
Power	256 hp @ 6000 rpm
Torque	247 lb-ft @ 4400 rpm

Tribeca models meet Low Emission Vehicle (LEV2) standards.

TRANSMISSION AND DRIVETRAIN

Tribeca (including packages)

Standard	5-speed Electronic Direct Control Automatic Transmission with SPORTSHIFT® (5EAT SS) Blipping control Variable Torque Distribution (VTD)
----------	---

All models are equipped with a Subaru symmetrical full-time All-Wheel Drive system.

FUEL ECONOMY

Tribeca (including packages)

5EAT SS	City 13.1 / Hwy 9.4 (L/100km)
---------	-------------------------------

Recommended minimum octane: 87

MEASUREMENTS (Measurements based on entry models)

	Tribeca
Curb weight: Automatic transmission (kg)	1914
Towing capacity: Maximum weight (kg) with trailer brakes and optional auxiliary transmission cooler†	1591
Length (mm)	4865
Width (mm) with mirrors	2256
Height (mm) with roof rails	1730
Roof rack: Maximum load (kg) (with optional crossbars)	68
Wheelbase (mm)	2745
Minimum ground clearance (at curb weight) (mm)	211
Steering: Turning circle radius (curb-to-curb) (m)	6.1
Headroom: Front / second row / third row (mm)	988 / 970 / 920
Legroom: Front / second row / third row (mm) (minimum)	1074 / 872 / 784
EPA interior volume (L)	4015
Cargo area: Cargo volume (seats up) - second row / third row (L)	1063 / 235
Cargo area: Cargo volume (seats folded flat) (L)	2106
Cargo area: Floor length (seats folded flat) (mm)	1886
Cargo area: Floor length (seats up) - second row / third row (mm)	1129 / 435
Cargo area: Height (mm)	837

†Please review Owner's Manual for details.

TRIBECA

Tribeca

CHASSIS

- Brakes: Anti-lock Braking System with Electronic Brake-force Distribution (EBD)
- Brakes: Brake Assist
- Brakes (front): Ventilated discs (316 x 30 mm), dual-piston calipers
- Brakes (rear): Ventilated discs (320 x 18 mm), single-piston calipers
- Structure: Advanced ring-shaped reinforcement frame
- Structure: Dual, side-impact door beams (front and rear)
- Suspension: 4-wheel fully independent
- Suspension (front): MacPherson strut
- Suspension (rear): Double-wishbone

INSTRUMENTS

- Gauges: Electroluminescent with red illuminated needles and full needle sweep on start-up
- Instrument panel: Coolant temperature gauge
- Instrument panel: Fuel gauge with low fuel warning light and fuel door location indicator
- Odometer: Digital, dual trip modes

Tribeca

SAFETY AND SECURITY

- Airbags (SRS): Driver dual-stage deployment with seat position sensor
- Airbags (SRS): Front passenger dual-stage deployment with occupant detection system
- Airbags (SRS): Front seat side-impact
- Airbags (SRS): Side curtain with rollover sensor (first and second row)
- Back-up sensor: Pre-wired (accessory kit required)
- Child safety: Rear door locking system
- Child safety: ISO-FIX/LATCH anchor system (second row)
- Head restraints (front): Height-adjustable, active
- Head restraints (rear): Height-adjustable
- Seatbelts (front): 3-point with pretensioners and load limiters (Driver - ELR / Passenger - ALR)
- Seatbelts (rear): 3-point, all seating positions (ALR)
- Seatbelts: Height-adjustable shoulder belt anchors, outboard seats (first and second row)
- Security: Anti-theft system and engine immobilizer system
- Security: Keyless entry system with panic alarm (separate door and cargo access controls)
- Tire Pressure Monitoring System (TPMS)
- Traction Control System
- Vehicle Dynamics Control system with lateral-g and yaw-rate sensor

Tribeca

EXTERIOR

- Body: Rocker panels, wheel arches and lower bumper (black)
- LP/PP Body: Rocker panels, wheel arches and lower bumper (body colour)
- Door mirrors: Power-adjustable, foldable and heated (body colour)
- Door mirrors: Integrated LED turn signals
- Door handles: Chrome
- Exhaust: Twin mufflers, stainless steel tips
- Fog lights: Multi-reflector halogen
- Headlights: Auto-off with ignition switch
- Headlights: Contoured multi-reflector halogen (high beam)
- Headlights: Projector beam halogen (low beam)
- LP/PP Headlights: Projector beam Xenon High Intensity Discharge (HID) (low beam) with manual levelizer
- Moonroof: Glass, power tilting and sliding with sunshade
- Roof rack: Raised-profile roof rails (black)
- LP/PP Roof rack: Raised-profile roof rails (silver)
- Spoiler: Roofline, integrated brake light
- Tires: 255/55 R18 104H Goodyear® Eagle® LS2 M+S All-Season
- Wheels: 18" x 8" aluminum alloy, 5 double-spoke design
- LP/PP Wheels: 18" x 8" aluminum alloy, 7-spoke design
- Windows: Privacy tinted glass (rear doors and cargo area)
- Windshield: Wiper de-icer
- Wiper (rear window): Intermittent and continuous mode with washer
- Wipers (windshield): Variable intermittent with washer

- standard
- LP Limited Package
- PP Premium Package

Tribeca

AUDIO AND TECHNOLOGY

	<ul style="list-style-type: none"> • Audio system: Premium AM/FM/6CD/MP3/WMA
LP/PP	Amplifier: 385-watt, 7-channel Harman Kardon® with Digital Signal Processing (DSP)
	<ul style="list-style-type: none"> • Antenna: In-glass integrated
	<ul style="list-style-type: none"> • Audio controls: Steering wheel integrated
	<ul style="list-style-type: none"> • Auxiliary input: Audio source in armrest console
LP/PP	Auxiliary input: Audio/video source (RCA type) (third row)
LP/PP	blueconnect® Bluetooth® hands-free system (voice-activated)
LP/PP	DVD entertainment system: Rear seat, 9-inch screen, roof-mounted
LP/PP	DVD playback (front screen*)
LP/PP	Headphones: Wireless (2) with remote control
	<ul style="list-style-type: none"> • HomeLink®
	<ul style="list-style-type: none"> • Monitor system: Colour, touchscreen with clock, ambient temperature, fuel information, driving record data, maintenance schedule, calculator
PP	Navigation system: GPS DVD-based
	<ul style="list-style-type: none"> • Rear-view camera (in monitor system) • Satellite radio: Pre-wired (dealer accessory required)
LP/PP	Satellite radio: SIRIUS® Satellite Radio installed (free 3-month trial subscription included)
	<ul style="list-style-type: none"> • Speakers: 6-speaker system
LP/PP	Speakers: 10-speaker Harman Kardon® system, including subwoofer

*Front display acts as a second monitor for DVD system when vehicles' transmission is in park.

Tribeca

SEATING AND TRIM

	<ul style="list-style-type: none"> • Accents/trim: Silver metallic finish
	<ul style="list-style-type: none"> • Floor mats: Carpet
	<ul style="list-style-type: none"> • Interior: Premium cloth upholstery
LP/PP	Interior: Leather seating surfaces
	<ul style="list-style-type: none"> • Gear selector: Leather-wrapped
	<ul style="list-style-type: none"> • Seating capacity: Seven
LP/PP	Seat (driver's): 2-position memory function
	<ul style="list-style-type: none"> • Seat (driver's): 8-way power-adjustable with manual lumbar support
	<ul style="list-style-type: none"> • Seat (passenger): 4-way power-adjustable with manual lumbar support
	<ul style="list-style-type: none"> • Seats (front): Heated with 3 level settings
	<ul style="list-style-type: none"> • Seats (second row): 40/20/40-split, flat-folding, reclining and adjustable
	<ul style="list-style-type: none"> • Seats (third row): 50/50-split, flat-folding
	<ul style="list-style-type: none"> • Seats: Driver and passenger side third-row access
	<ul style="list-style-type: none"> • Steering wheel: Leather-wrapped

CARGO AREA

	<ul style="list-style-type: none"> • Cargo tie-down hooks (4)
	<ul style="list-style-type: none"> • Light: Cargo area
	<ul style="list-style-type: none"> • Power outlet: 12V
	<ul style="list-style-type: none"> • Storage: Sub-floor compartment
	<ul style="list-style-type: none"> • Utility hooks (2)

Tribeca

COMFORT AND CONVENIENCE

	<ul style="list-style-type: none"> • Armrest (front): With console storage
	<ul style="list-style-type: none"> • Armrest (second row): Folding with integrated cup holders (2)
	<ul style="list-style-type: none"> • Climate control: Air conditioning with air filtration
	<ul style="list-style-type: none"> • Climate control: Automatic, dual-zone
	<ul style="list-style-type: none"> • Climate control: Rear-seat cooling unit with adjustable fan and 4 rear vents
	<ul style="list-style-type: none"> • Cruise control: Steering wheel stalk controls
	<ul style="list-style-type: none"> • Glove box: Lockable and illuminated
	<ul style="list-style-type: none"> • Ignition key ring: Illuminated
	<ul style="list-style-type: none"> • Light: Front and rear door courtesy lights, interior dome with off delay and map spotlights
	<ul style="list-style-type: none"> • Power outlet: 12V in armrest console (2) and rear quarter trim
	<ul style="list-style-type: none"> • Remote starter: Pre-wired (accessory kit required)
	<ul style="list-style-type: none"> • Steering wheel: Tilt-adjustable
	<ul style="list-style-type: none"> • Storage: Front door compartments with integrated cup holders
	<ul style="list-style-type: none"> • Storage: Driver and passenger seatback pockets
	<ul style="list-style-type: none"> • Storage: Enclosed front console with integrated cup holders (2)
	<ul style="list-style-type: none"> • Storage: Overhead compartment
	<ul style="list-style-type: none"> • Storage: Rear-facing centre console drawer
	<ul style="list-style-type: none"> • Storage: Rear quarter panel integrated cup holders
	<ul style="list-style-type: none"> • Visor: Dual, with illuminated mirrors
	<ul style="list-style-type: none"> • Windows (power): Driver's window auto down

UPGRADE PACKAGES

Limited Package

- 18-inch aluminum alloy wheels (7-spoke)
- Xenon High Intensity Discharge (HID) headlights (low beam) with manual levelizer
- Raised-profile roof rails (silver)
- Body-colour rocker panels, wheel arches and lower bumpers
- 2-position memory function on driver's seat
- Leather seating surfaces
- DVD entertainment system with 9-inch screen, audio/video auxiliary input, 2 wireless headphones and a remote control
- 10-speaker Harman Kardon® system including subwoofer
- 385-watt Harman Kardon® amplifier
- DVD playback
- Voice-activated blueconnect® Bluetooth® hands-free system
- SIRIUS® Satellite Radio installed (free 3-month trial subscription included)

Premier Package

- 18-inch aluminum alloy wheels (7-spoke)
- Xenon High Intensity Discharge (HID) headlights (low beam) with manual levelizer
- Raised-profile roof rails (silver)
- Body-colour rocker panels, wheel arches and lower bumpers
- 2-position memory function on driver's seat
- Leather seating surfaces
- DVD entertainment system with 9-inch screen, audio/video auxiliary input, 2 wireless headphones and a remote control
- GPS DVD-based navigation system
- 10-speaker Harman Kardon® system including subwoofer
- 385-watt Harman Kardon® amplifier
- DVD playback
- Voice-activated blueconnect® Bluetooth® hands-free system
- SIRIUS® Satellite Radio installed (free 3-month trial subscription included)

AVAILABLE COLOURS



	Tribeca	Limited Package	Premier Package
Azurite Blue Pearl	GC	GL	GL
Crystal Black Silica	GC	GL	GL
Deep Bronze Metallic	GC	BL	BL
Graphite Grey Metallic	GC	GL	GL
Ruby Red Pearl	GC	BL	BL
Satin White Pearl	GC	GL	GL
Sky Blue Metallic	GC	GL	GL
Steel Silver Metallic	GC	GL	GL

GC Slate Grey Cloth GL Slate Grey Leather BL Desert Beige Leather

The Supplemental Restraint System (SRS airbags) affords the driver and passenger additional protection in some collisions. This system provides supplemental protection only, and seatbelts must be worn in order to avoid injuries to out-of-position occupants upon airbag deployment. The combination of SRS and seatbelts provides the best protection in a serious accident. All illustrations, specifications, features and photographs contained in this brochure are based on product information available at the time of its printing, and may not be completely accurate following its publication. Colours shown may vary due to reproduction variations in the printing process, and some vehicle parts cannot be shown in certain photographs. Subaru Canada, Inc. reserves the right to discontinue or make changes at any time, without notice or incurring obligations, to colours, materials, equipment, accessories, features, specifications and models, or to change their prices. Please visit our Web site for the latest information and specifications. For complete details on product updates, warranties or the Subaru C.A.R.E. program, please contact your Subaru Dealer. Tribeca, Subaru, and SUBARU BOXER are registered trademarks. blueconnect is a registered trademark of Johnson Controls, Inc. Bluetooth is a registered trademark of Bluetooth SIG, Inc. Goodyear and Eagle are registered trademarks of the Goodyear Tire & Rubber Company. Harman Kardon is a registered trademark of Harman International Industries, Inc. HomeLink is a registered trademark of Johnson Controls, Inc. SIRIUS and related marks are trademarks of SIRIUS Satellite Radio Inc. SPORTSHIFT is a registered trademark of Prodrive Ltd. Printed in Canada. © 2009 Subaru Canada, Inc. 2010 model year.



Mixed Sources
Product group from well-managed
forests and other controlled sources
www.fsc.org Cert no. SW-COC-002233
© 1996 Forest Stewardship Council

Environmental Management System (EMS) ISO 14001:2004 certified by SGS.
Brochure is printed on 100% chlorine-free bleached pulp (TCF), contains up to
30% pre-consumer recycled fibre and uses UV cured inks that are VOC (Volatile
Organic Compound) free to be fully recyclable with no harmful residue.



SUBARU

www.subaru.ca

The Supplemental Restraint System (SRS airbags) affords the driver and passenger additional protection in some collisions. This system provides supplemental protection only, and seatbelts must be worn in order to avoid injuries to out-of-position occupants upon airbag deployment. The combination of SRS and seatbelts provides the best protection in a serious accident. All illustrations, specifications, features and photographs contained in this brochure are based on product information available at the time of its printing, and may not be completely accurate following its publication. Colours shown may vary due to reproduction variations in the printing process, and some vehicle parts cannot be shown in certain photographs. Subaru Canada, Inc. reserves the right to discontinue or make changes at any time, without notice or incurring obligations, to colours, materials, equipment, accessories, features, specifications and models, or to change their prices. Some models shown may be from international markets and are not available in Canada, or they may be shown with equipment or accessories which are optional (at extra cost) or only available in certain combinations, or they may be subject to product delays or not be available in Canada. Please visit our Web site for the latest information and specifications. For complete details on product updates, warranties or the Subaru C.A.R.E. program, please contact your Subaru Dealer. Tribeca, Subaru, SUBARU BOXER, Subaru C.A.R.E. and Subaru C.A.R.E. Customer Assistance for Roadside Emergencies are registered trademarks. blueconnect is a registered trademark of Johnson Controls, Inc. Bluetooth is a registered trademark of Bluetooth SIG, Inc. Harman Kardon is a registered trademark of Harman International Industries, Inc. iPod is a registered trademark of Apple, Inc. SIRIUS and related marks are trademarks of SIRIUS Satellite Radio Inc. SPORTSHIFT is a registered trademark of Prodrive Ltd. XM is a registered trademark of XM Satellite Radio Inc. Printed in Canada. © 2009 Subaru Canada, Inc. 2010 model year.

SBT10E



Environmental Management System (EMS)
ISO 14001:2004 certified by SGS
www.subaru-earth.com

This brochure is printed on 100% chlorine-free bleached pulp (TCF), contains up to 30% recycled fibre and 70% pre-consumer waste and uses vegetable-based inks to be fully recyclable with no harmful residue. Please recycle.

