

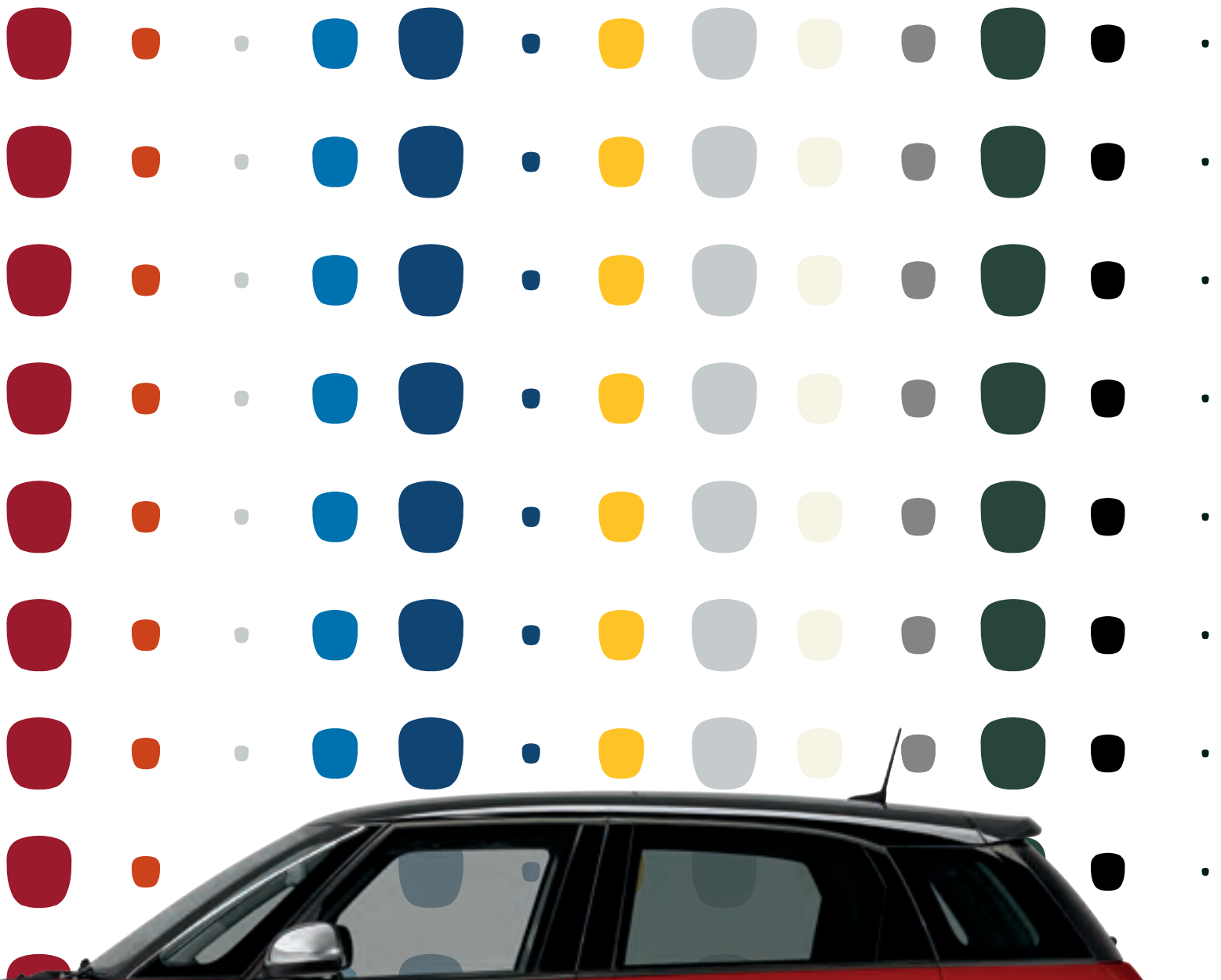

2020 CATALOG





2020 VISION

By design, FIAT® 500L provides drivers and passengers with an extraordinary view — it's just part of an even grander vision, one that has been shared by forward-thinking FIAT engineers for over a century. It's how FIAT 500L is able to infuse pure functionality into a brand personality that knows how to have fun. Efficiencies make the most of every aspect of driving: size, power, user experience — they all deliver what drivers need and want most.

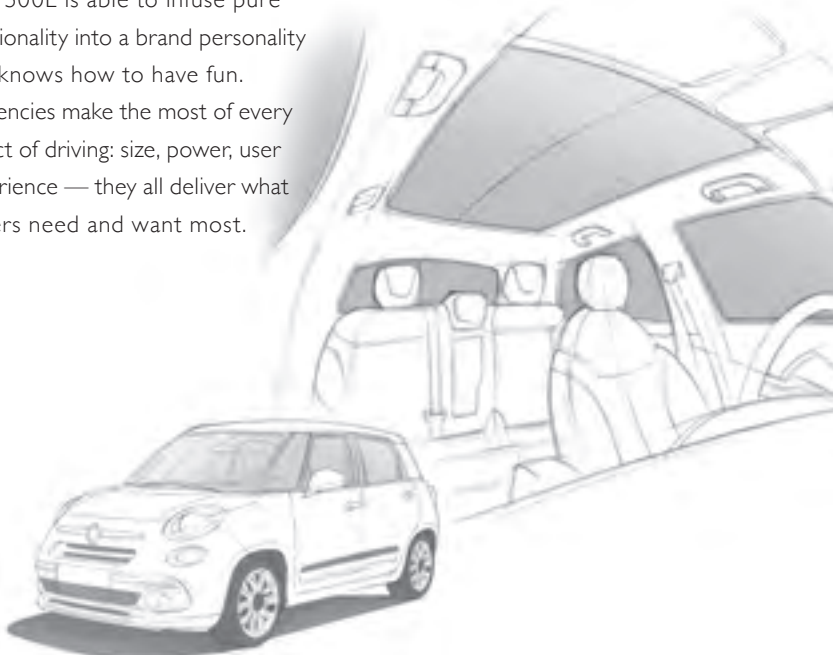

FIAT® 500L: space meets agility

TURNING UP THE VOLUME

FIAT 500L offers up to 68.0 cubic feet of maximum cargo volume (with the rear seats tumbled forward) and 121.1 cubic feet of total interior volume — so you can bring everything and everyone you want on your latest adventure. A unique floating-roof design helps create its signature spacious feeling. It's all packaged in a city-friendly, agile vehicle that maintains the flexibility to squeeze in and out of tight spaces. 500L expands on the Cinquecento efficient design philosophy, yet never loses sight of its nimble FIAT roots. *Bella!*

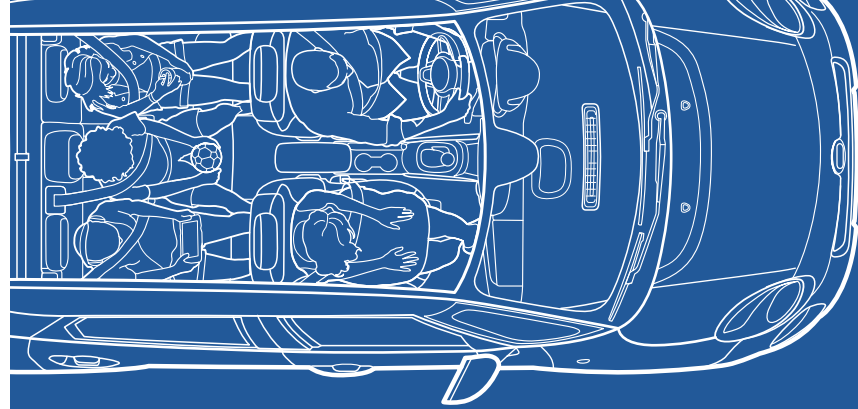

121.1 cu ft of total interior volume for your latest adventure.

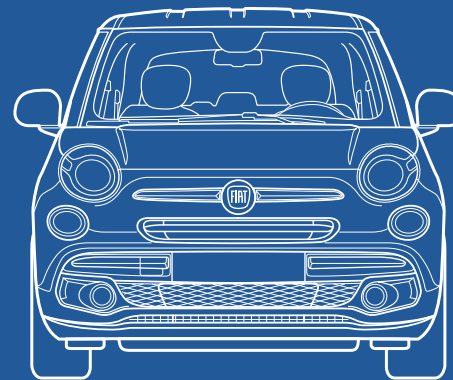

The FIAT 500L offers 68.0 cu ft of maximum cargo volume.

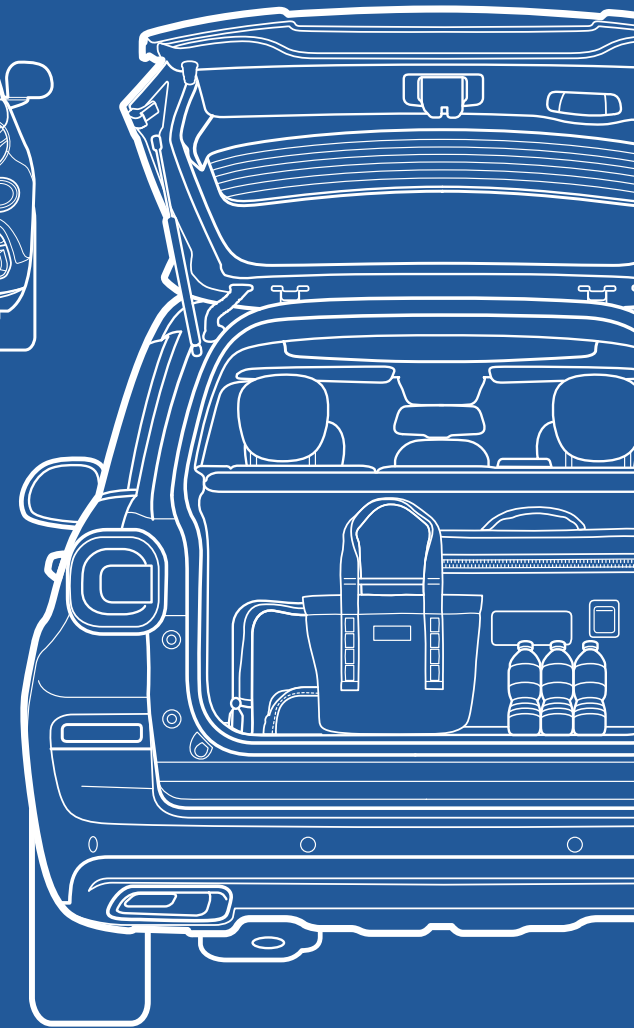

A CULTIVATED APPROACH Beyond a focus on comfort, it's the details that give the FIAT® 500L Lounge its urbane edge. Communication and audio partners, including Android Auto,^{TM1*} Apple CarPlay^{®2} and BeatsAudio,TM add new capabilities, while advanced safety and security features add driving confidence.

- 
- Chrome exterior accents
 - Dual-Zone Automatic Temperature Control (ATC)
 - Power 2-way driver lumbar adjust
 - Uconnect[®] 4 NAV with 7-inch touchscreen
 - BeatsAudio Premium Sound System
 - ParkSense[®] Rear Park Assist System³

LOUNGE

*A note about this brochure: all disclosures can be found on the back cover.

ADVENTURE'S INSTIGATOR

FIAT® 500L Trekking is loaded with features that cater to your outdoorsy side while spoiling you along the way. Rough-hewn details mark its exterior, while luxe heated front seating and wide views invite you in. Plus, with the advanced suspension and driving technologies of 500L, Trekking will become your favorite travel guide ever.



- Distinct Satin Silver exterior accents
- Rugged-design exterior cladding
- Unique 17-inch Trekking aluminum wheels
- Heated leather-trimmed front seats
- Available dual-pane power glass sunroof
- Available Black or White roof
(based on exterior color)

{ RARING TO GO: **FIAT 500L TREKKING** }

Properly secure all cargo.



POP: THE CULTURE OF FUN

The FIAT® 500L Pop takes “the more, the merrier” to the next level with contemporary Italian design that creates plenty of room for five. It has a wide range of amenities that keep both the driver and passengers happy — and it’s available in everyone’s favorite color. No wonder 500L Pop is all the rage.



- 160-horsepower 1.4L MultiAir® Turbo I-4 engine
- 6-speed automatic transmission with AutoStick
- 60/40 split-folding rear seats with Tilt, Tumble & Slide
- Apple CarPlay®2 iPhone® integration
- Android Auto™1 smartphone compatibility
- ParkView® Rear Back-Up Camera⁴



The largest dual-pane
sunroof in its class⁵



Over the top

FLOATING-ROOF DESIGN

The FIAT® 500L owes much of its roomy, open entertaining space to its unique floating-roof design, which includes the largest available dual-pane sunroof in its class⁵. This distinctive roof is offered in White, Black or body-color depending on chosen exterior color.



500L Lounge shown in Blue Tornado with Graphite Edition.

Don't miss a thing. Spectacular 360-degree views start with the traditional FIAT® small-wide architecture. This is the foundation for the vehicle's open, loft-like interior. Glass-framed pillars create its unique floating roof.

Broader horizons

360°



Best-in-class⁵ cargo room



Properly secure all cargo.

Super-flexible seating configurations — 54 in all — mean that your passengers get as much consideration as all your belongings. With 60/40 split-folding rear seats, Tilt, Tumble & Slide functionality, and over 121 cubic feet of total interior volume, packing is practically effortless and incredibly efficient. You can recline seatbacks to the preferred angle, create leg room by sliding seats and add cargo space with the tumbling action.



Configure it out

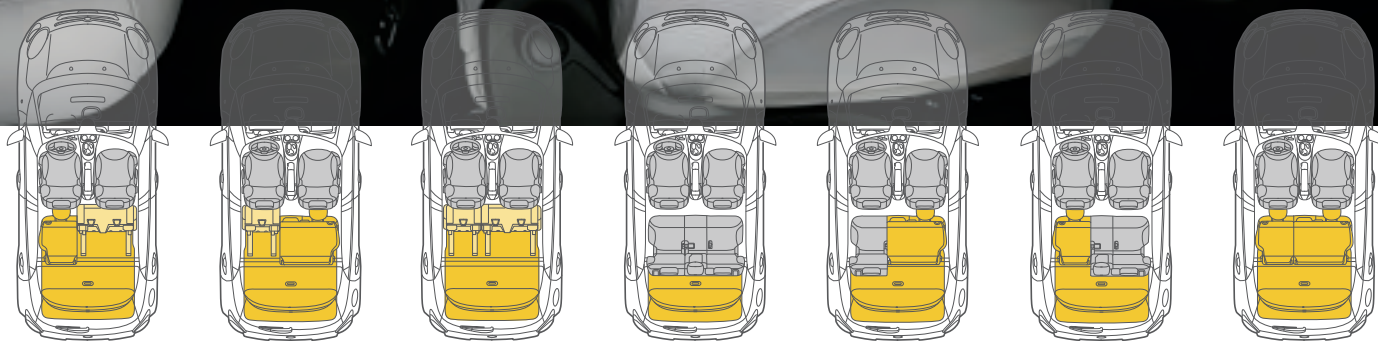

Lounge interior shown in premium leather-trimmed Carrera Gray.

Extraordinary measures



Electronic Stability Control (ESC)⁶
This feature assists drivers in maintaining control of their vehicle during extreme steering maneuvers. Standard.



ParkSense[®] Rear Park Assist System³
When the vehicle is in Reverse, these available sensors detect objects in the rear pathway, providing an audible and visual warning. Available.



7 Standard Air Bags⁷
Front-seat-mounted side, front and rear side, knee and advanced multistage front air bags⁷ all work together, providing protection.



Hill Start Assist
Maintains brake pressure during uphill stop/start moments to help prevent rollback — for a smooth start every time. Standard.



High-strength Steel
Innovative safety-cage body structure is made with high-strength steel to create energy-absorbing crumple zones. Standard.



ParkView[®] Rear Back-Up Camera⁴
Provides a wide-angle view with dynamic grid lines on a color touchscreen, aiding drivers when the vehicle is in Reverse. Standard.



Bifunction Halogen Projector Headlamps
Provide more controlled illumination for increased visibility. Standard.



Front-seat Active Head Restraints⁸
In the event of a rear collision, these restraints activate to help reduce injuries by minimizing the gap between the driver and front-passenger head restraints⁸ and the occupant's head. Standard.



Tire Pressure Monitoring System
Gives crucial, pinpointed information in the Electronic Vehicle Information Center (EVIC) at the moment any tire pressure falls below safe driving criteria. Standard.



Remote Keyless Entry
Affords easy access by remotely locking and unlocking doors and turning on interior lamps. For vehicles equipped with the standard security alarm,⁹ this device also arms and disarms that system. Standard.

A silver Fiat car is shown in motion, driving from left to right. The background features a modern building with curved glass facades, creating a sense of speed and urban environment. The car is positioned in the lower half of the frame, and the building's architecture is characterized by sweeping, curved lines and large glass panels. The overall scene is brightly lit, suggesting a clear day.

Power = Possibility

BEST-IN-CLASS⁵ STANDARD POWER AND TORQUE

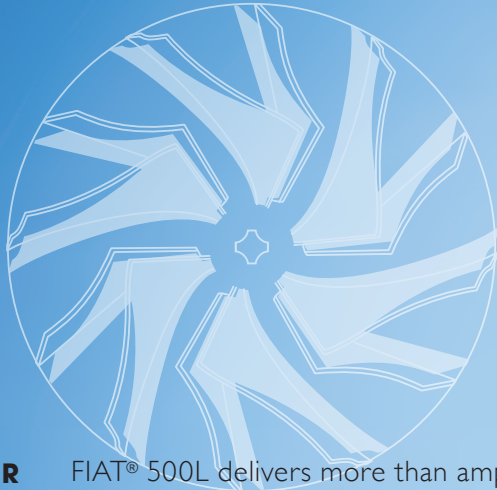

AIR FIAT® 500L delivers more than ample power to make the most of its expansive capacity. Its innovative 1.4L MultiAir® Turbo engine utilizes advanced cast and structural aluminum to reduce overall mass for great efficiency. The engine's turbocharger spins at up to 230,000 rpm to create impressive torque and power, while the innovative MultiAir Variable Valve System allows for optimized intake air control and efficiency. In short, every trip in the 500L offers huge potential.

TURBO



Step on it

In FIAT® 500L, the award-winning and innovative 1.4L MultiAir® Turbo engine delivers 160 horsepower and 184 lb-ft of torque. Its forceful performance is made all the more impressive thanks to a talented partner — a 6-speed automatic transmission that features AutoStick. It offers drivers an extra degree of control with the ability to downshift and upshift via the gear selector. Adding to the vehicle's nimble nature, MacPherson front struts and rear shock absorbers with KONI® Frequency Selective Damping (FSD) technology help make for handling that's truly responsive.

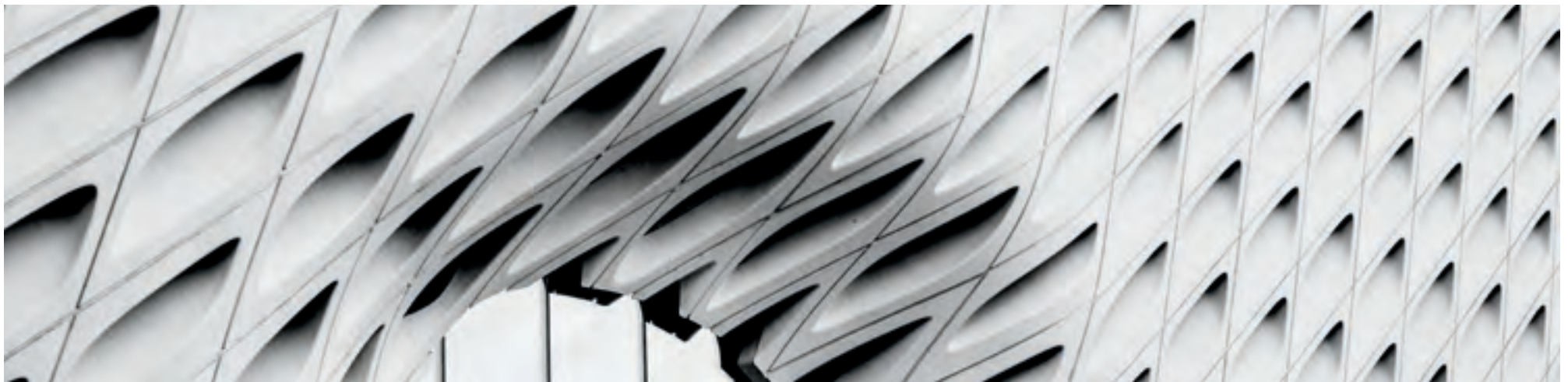



Technology that inspires

Designers approached the interior from a driver-centric standpoint, beginning with the FIAT® 500L instrument panel — a blend of simplicity and Italian refinement. The Electronic Vehicle Information Center (EVIC) clearly delivers trip and vehicle information, while other essentials are placed within reach.

FIAT 500L features Uconnect® 4 and Uconnect 4 NAV radio systems, both with:

- 7-inch full-color touchscreen display
- Integrated Voice Command with Bluetooth®
- Available SiriusXM® Radio¹⁰
- Apple CarPlay®² integration for iPhone®
- Android Auto™¹¹ smartphone compatibility
- Hands-free¹¹ calling and text delivery
- GPS Navigation with intuitive map graphics (on NAV radio system)
- Available BeatsAudio™ Premium Sound System





{ BIG SOUND GREAT MUSIC }

SIRIUSXM® RADIO⁹

Enjoy the perks of satellite radio, including commercial-free music, plus sports, news, talk and entertainment. The SiriusXM App⁹ lets you listen wherever you go on your portable devices (one-year trial subscription included). Available.

APPLE CARPLAY¹⁰

A smarter, safer way to use an iPhone[®] inside your vehicle, integrated with the Uconnect[®] touchscreen and Siri.¹¹ Make calls, access music, send and receive messages, get directions optimized for traffic conditions, and more. Standard.

ANDROID AUTOTM

Provides a safer way to use Android[™] while driving. Easily access Google Maps[™] with voice-guided navigation, search Play Music, place phone calls, send/receive messages and ask your Google Assistant any question by voice command. Standard.

Seamless Bluetooth[®] connectivity and standard Apple CarPlay² or Android Auto¹ give you uninterrupted access to your favorite sources of news, music, friends, work and family — all while your hands stay on the wheel.

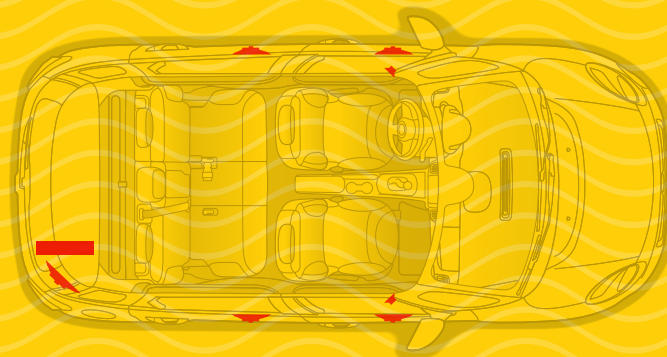

The available BeatsAudio[™] Premium Sound System brings its acoustic expertise to enhance the 500L experience.

Uconnect

SiriusXM



beatsaudio

Apple CarPlay screen shown.

Works with
Apple CarPlay

android
auto



POP

- 1.4L MultiAir® Turbo I-4 — 160 hp/184 lb-ft of torque with 6-speed automatic transmission and AutoStick
- Body-color door moldings with Black inserts
- Chrome exterior accents
- Projector headlamps
- 16-inch aluminum wheels
- Power, heated exterior mirrors in body-color
- Electronic Vehicle Information Center (EVIC)
- Body-color instrument-panel bezel
- Leather-wrapped steering wheel with audio and cruise controls
- Premium cloth bucket seats
- 60/40 split-folding rear seats with Tilt, Tumble & Slide function
- Multi-position cargo panel
- Uconnect® 4 with 7-inch touchscreen display
- Apple CarPlay^{®2} iPhone[®] integration
- Android Auto^{™1} smartphone compatibility
- Integrated Voice Command with Bluetooth[®]
- ParkView[®] Rear Back-Up Camera⁴
- Tire Pressure Monitoring System
- SiriusXM[®] Radio¹⁰ including one-year trial subscription — Available
- Power 2-way driver lumbar adjust — Available
- BeatsAudio[™] Premium Sound System — Available
- Dual-Zone Automatic Temperature Control (ATC) — Available
- Accent roof in Nero or Bianco — Available

TREKKING

- 1.4L MultiAir Turbo I-4 — 160 hp/184 lb-ft of torque with 6-speed automatic transmission and AutoStick
- Body-color side door moldings with Black inserts
- Rugged-design bottom cladding and wheel arches
- Satin Silver exterior accents
- Projector headlamps and front fog lamps
- Unique 17-inch Trekking aluminum wheels
- Electronic Vehicle Information Center (EVIC)
- Body-color instrument-panel bezel
- Ambient LED interior lighting
- Leather-wrapped steering wheel with audio and cruise controls
- Premium leather-trimmed seats
- Heated front seats
- 60/40 split-folding rear seats with Tilt, Tumble & Slide function
- Multi-position cargo panel
- Uconnect 4 NAV with 7-inch touchscreen display and GPS Navigation
- Apple CarPlay² iPhone integration
- Android Auto¹ smartphone compatibility
- Integrated Voice Command with Bluetooth
- BeatsAudio Premium Sound System
- SiriusXM Radio¹⁰ including one-year trial subscription
- ParkView Rear Back-Up Camera⁴
- Universal Garage Door Opener (UGDO)
- ParkSense[®] Rear Park Assist System³ — Available
- Dual-pane power sunroof — Available
- Power 2-way driver lumbar adjust — Available
- Dual-Zone Automatic Temperature Control (ATC) — Available
- Accent roof in Nero or Bianco — Available

LOUNGE

- 1.4L MultiAir Turbo I-4 — 160 hp/184 lb-ft of torque with 6-speed automatic transmission and AutoStick
- Body-color door molding with Chrome inserts
- Chrome exterior accents
- Projector headlamps and front fog lamps
- 17-inch aluminum wheels
- Power, heated exterior mirrors in Chrome
- Dual-Zone Automatic Temperature Control (ATC)
- Ambient LED interior lighting
- Rearview auto-dimming mirror
- Body-color instrument-panel bezel
- Leather-wrapped steering wheel with audio and cruise controls
- Power 2-way driver lumbar adjust
- Premium leather-trimmed seats
- Heated front seats
- 60/40 split-folding rear seats with Tilt, Tumble & Slide function
- Multi-position cargo panel
- Uconnect 4 NAV with 7-inch touchscreen display and GPS Navigation
- Apple CarPlay² iPhone integration
- Android Auto¹ smartphone compatibility
- Integrated Voice Command with Bluetooth
- BeatsAudio Premium Sound System
- SiriusXM Radio¹⁰ including one-year trial subscription
- ParkView Rear Back-Up Camera⁴
- ParkSense Rear Park Assist System³
- Universal Garage Door Opener (UGDO)
- Dual-pane power sunroof — Available
- Accent roof in Nero or Bianco — Available

FIAT® 500L materials

With an array of textures, patterns and colors, 500L is big on making good impressions.

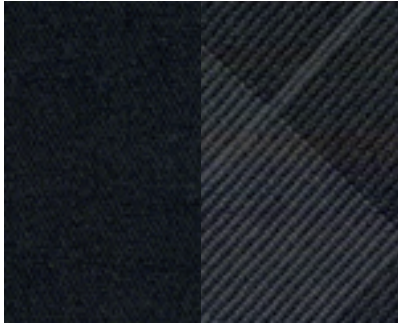

Dark Slate Gray Cloth
Standard on Pop

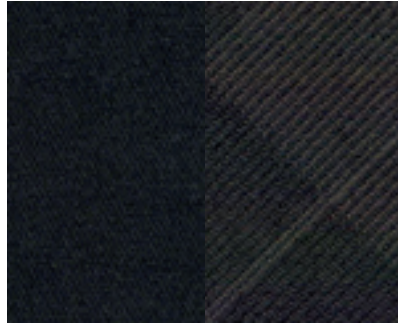

Warm Gray Cloth
Standard on Pop



Black Premium Leather Trim
Standard on Trekking and Lounge

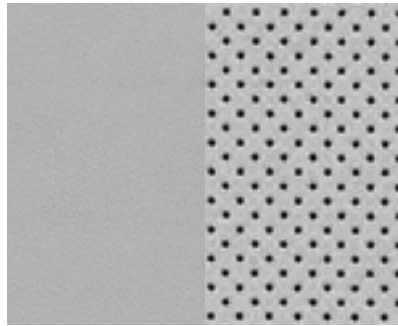

Carrera Gray Premium Leather Trim
Standard on Trekking and Lounge



FIAT® 500L colors*

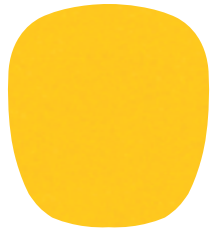

GIALLO
White, Black and
Body-Color Roof



GRIGIO CHIARO
Black and
Body-Color Roof

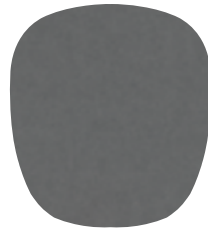

GRIGIO SCURO
White, Black^{1,2} and
Body-Color Roof



BIANCO
Black and
Body-Color Roof

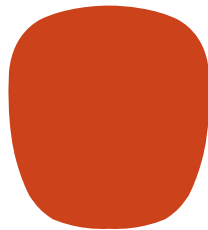

ARANCIA PASTELLO
White, Black and
Body-Color Roof



BLACK
White and
Body-Color Roof

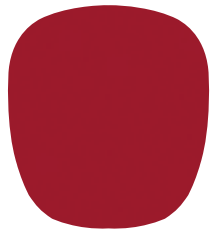

ROSSO
White, Black and
Body-Color Roof

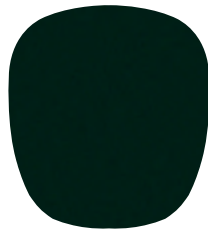

VERDE BOSCO PERLA
White, Black^{1,2} and
Body-Color Roof

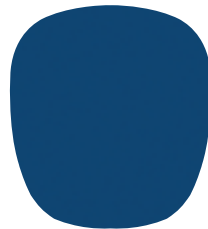

BLUE TORNADO
White, Black and
Body-Color Roof

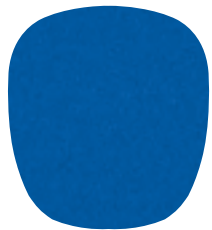

BLU DENIM
White, Black and
Body-Color Roof



BRONZO METALLIZATO
Black and
Body-Color Roof

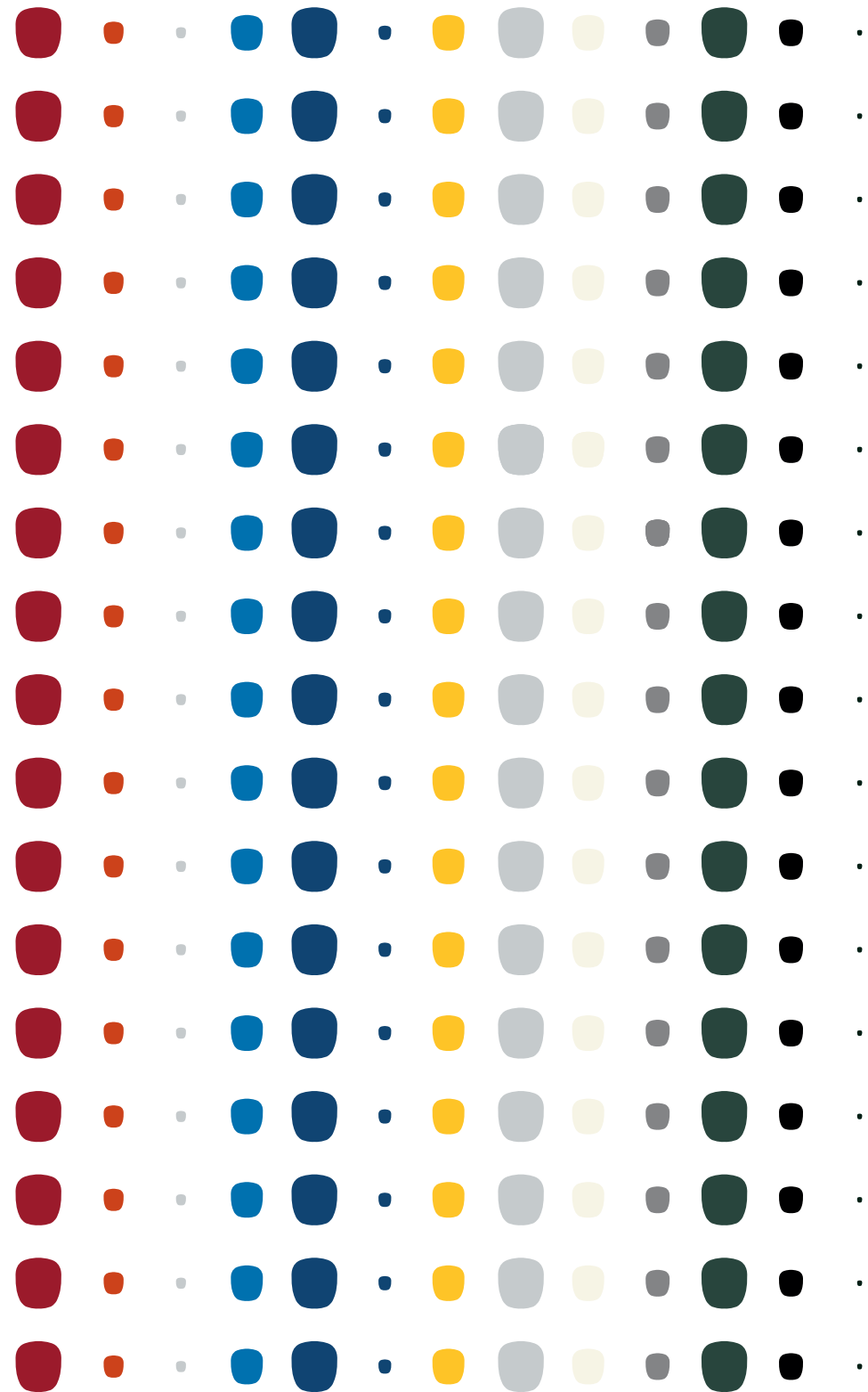

*Not all exterior colors are available on all trim models. Please consult your local FIAT dealer for complete details.

ZOOM IN: FIAT® 500L SPECS

THE CLOSER YOU LOOK AT THE FIAT 500L,
THE BIGGER THE IMPRESSION IT WILL MAKE.
STUDY THE CHARTS LINE BY LINE, FEATURE
BY FEATURE, AND IT WILL BECOME CLEAR
THAT THIS VEHICLE DELIVERS WAY BEYOND
YOUR "MUST HAVE" LIST.

OF COURSE, WHILE CHARTS CAN CONVINC
YOUR EYES, YOU OWE IT TO YOUR OTHER
SENSES TO DISCOVER THE REST OF THE STORY.
GET BEHIND THE WHEEL OF THE 500L AND
BECOME A TRUE BELIEVER.

20

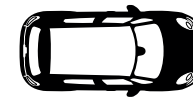
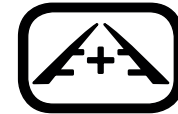

F I A T 5 0 0 L

FIAT® 500L specifications

	POP	TREKKING	LOUNGE
ENGINE			
1.4L MultiAir® Turbo I-4	•	•	•
TRANSMISSION			
6-speed automatic	•	•	•
MECHANICAL FEATURES			
Alternator — 150-amp	•	•	•
AutoStick Automatic Transmission	•	•	•
Battery — 500-amp, maintenance-free	•	•	•
Engine Block Heater	O	O	O
Front-Wheel Drive (FWD)	•	•	•
Fuel Door — Capless fuel-filler	•	•	•
Fuel Tank — 13.2-gallon capacity	•	•	•
Steering — Electric power, tilt/telescoping column	•	•	•
Suspension — Front MacPherson suspension with coil springs and twin-tube struts with KONI® Frequency Selective Damping (FSD) technology and stabilizer bar; rear twist-beam axle with coil springs and twin-tube shock absorbers with KONI FSD technology	•	•	•
EXTERIOR FEATURES			
Bodyside Molding — Body-color with Matte Black inserts	•	•	—
— With Chrome inserts	—	—	•
— Lower sill and wheel arch accent moldings in Nero (Black)	—	•	—
Door Handles — Chrome	•	—	•
— Satin	—	•	—
— Black (with Urbana Appearance Package)	—	P	—
Fascias (front) — Body-color	•	—	—
— Body-color with rugged design, Satin Gray accent	—	•	—
— Body-color with rugged design, Black accent (with Urbana Appearance Package)	—	P	—
— Body-color Bright Chrome accent (with Chrome Appearance Group)	P	—	•
Glass — Deep-tint sunscreen	•	•	•
License Plate Bracket — Front	O	O	O
Lighting — Bifunction halogen projector headlamps	•	•	•
— Daytime running lamps	•	•	•
— Cornering front fog lamps	—	•	•
— Chrome headlamp bezels	•	•	•
Mirrors — Power, heated, adjustable, foldaway with spotter mirrors in body-color	•	•	—
— Power, heated, adjustable, foldaway with spotter mirrors in Chrome	—	—	•
— Power, heated, adjustable foldaway with spotter mirrors in Black (with Urbana Appearance Package)	—	P	—
— Roof-color exterior mirror (Gray with Graphite Edition)	O	O	—/P
Roof — Body-color	•	•	•
— Nero (Black) includes roof-color exterior mirrors; mirrors remain Chrome on Lounge models (available in select colors; please see dealer for details)	O	O	O
— Bianco (White) includes roof-color exterior mirrors; mirrors remain Chrome on Lounge models (available in select colors; please see dealer for details)	O	O	O
— Gray (with Graphite Edition)	—	—	P
Sunroof — Power dual-pane panoramic glass with vent and one-touch express open; includes sun visors with illuminated mirrors	—	O	O
Tires — 205/55R16 BSW All-Season	•	—	—
— 225/45R17 BSW All-Season	—	•	•
— Tire Service Kit	•	•	•
— Compact spare	O	O	O
Wheels — 16-inch aluminum	•	—	—
— 17-inch machined aluminum with Black pockets (with Chrome Appearance Group)	P	—	—
— 17-inch aluminum	—	•	—

	POP	TREKKING	LOUNGE
EXTERIOR FEATURES (continued)			
— 17-inch Gloss Black aluminum (with Urbana Appearance Package)	—	P	—
— 17-inch aluminum painted Gray	—	—	•
— 17-inch machined aluminum with White-painted pockets (requires Bianco (White) exterior color or Bianco (White) roof)	—	—	O
— 17-inch aluminum (with Graphite Edition)	—	—	P
Windows — Power front and rear with one-touch up/down	•	•	•
— Rear window defroster	•	•	•
Wipers — Front wipers, variable/intermittent	•	•	•
— Rear wiper/washer, intermittent	•	•	•
INTERIOR FEATURES			
Armrest — Vinyl-wrapped with storage	•	•	•
— Fold-down rear armrest with cup holder (included with leather-trimmed seats)	—	•	•
Assist Handles — Front and rear with coat hooks	•	•	•
Cargo Area — Multi-position rear cargo shelf panel	•	•	•
— Rear lamp	•	•	•
Climate Control — Air conditioning	•	•	—
— Automatic Temperature Control (ATC) with Dual-Zone controls (with Premium Group and Popular Equipment Group)	P	P	•
Console — Front center floor with armrest, cup holders and parking brake	•	•	•
Door Locks — Power	•	•	•
Electronic Vehicle Information Center (EVIC) — Driver-selectable with trip computer, outside temperature, average fuel economy, distance-to-empty, low fuel, service interval and driving range	•	•	•
Floor Mats — Front and rear	•	•	•
Instrument Panel — Painted body-color	•	•	•
Lighting — Ambient LED	—	•	•
— Front reading/map lamps	•	•	•
Mirrors — Rear-passenger observation mirror (not available with sunroof)	•	•	•
— Sun visor with mirror	•	—	—
— Sun visor with illuminated mirror	—	•	•
— Rearview manual day/night adjust	•	•	—
— Rearview auto-dimming (with Premium Group and Popular Equipment Group)	P	P	•
Power Outlet — 12-volt	•	•	•
Seating — Premium cloth low-back bucket	•	—	—
— Premium leather-trimmed bucket	—	•	•
— Premium leather-trimmed bucket with Copper accents (with Urbana Appearance Package)	—	P	—
Seats (front) — Driver and front-passenger height adjuster	•	•	•
— Power 2-way driver lumbar adjust (with Premium Group and Popular Equipment Group)	P	P	•
— Manual 2-way front-passenger lumbar adjust (with Popular Equipment Group)	—	P	•
— Heated front seats	—	•	•
— Front-seatback map pockets	•	•	•
Seats (rear) — 60/40 split-folding with Tilt, Tumble & Slide function	•	•	•
— 3 headrests	•	•	•
— Armrest with cup holder	—	•	•
Shift Knob — Black, leather-wrapped with Chrome accent	•	•	•
Speedometer — 150-mph primary	•	•	•
Steering Wheel — Leather-wrapped with audio and cruise controls	•	•	•
Storage — Front-passenger instrument-panel cubby bin and concealed compartment	•	•	•
— Front-passenger glove box	•	•	•

• = Standard. O = Optional. P = Available within Package. — = Not available.

FIAT® 500L specifications (continued)

	POP	TREKKING	LOUNGE
UCONNECT®			
Apple CarPlay ^{®2} and Android Auto ^{™1} — Compatible with Uconnect 4 with 7-inch display and Uconnect 4 NAV with 7-inch display	•	•	•
Integrated Voice Command with Bluetooth [®] for Hands-Free ¹¹ Communications and Streaming Audio	•	•	•
Convenient USB Port	•	•	•
SiriusXM [®] Radio ¹⁰ — Includes one-year trial subscription (with Uconnect 4 NAV with 7-inch display; requires Popular Equipment Group or Premium Group on Pop models)	O/P	•	•
Speakers — 6	•	—	—
— BeatsAudio ^{™1} Premium Sound System — Includes 7 premium speakers, including 6.5-inch dual-voice coil subwoofer with trunk-mounted enclosure and 8-channel amplifier with BeatsAudio digital sound processing algorithm (with Premium Group)	O/P	•	•
Uconnect 4 with 7-inch Display — Includes 7-inch touchscreen display, Integrated Voice Command with Bluetooth, Bluetooth streaming audio, Apple CarPlay ² and Android Auto ¹ compatibility, and AM/FM radio	•	—	—
Uconnect 4 NAV with 7-inch Display — Includes 7-inch touchscreen display, GPS Navigation, Integrated Voice Command with Bluetooth, Bluetooth streaming audio, Apple CarPlay ² and Android Auto ¹ compatibility, AM/FM radio, and SiriusXM Radio ¹⁰ including one-year trial subscription (with Premium Group)	P	•	•

SAFETY AND SECURITY

Active Head Restraints ⁸ — Front seats	•	•	•
Air Bags ⁷ — Advanced multistage driver and front-passenger	•	•	•
— Supplemental front and rear side-curtain ⁷	•	•	•
— Supplemental front-seat-mounted side (pelvic-thorax) ⁷	•	•	•
— Driver-side knee bolster ⁷	•	•	•
BeltAlert — Passenger seat	•	•	•
Brake System — Antilock 4-wheel disc	•	•	•
Child Seat Anchor System — LATCH-ready	•	•	•
Cruise Control	•	•	•
Electronic Roll Mitigation	•	•	•
Electronic Stability Control (ESC) ⁶	•	•	•
Hill Start Assist	•	•	•
ParkSense [®] Rear Park Assist System ³ (with Premium Group and Popular Equipment Group)	P	P	•
ParkView [®] Rear Back-Up Camera ⁴ with Active Grid Lines	•	•	•
Remote Keyless Entry with 2 Key Fobs	•	•	•
Security Alarm ⁹	•	•	•
Sentry Key [®] Engine Immobilizer — Theft-deterrent system	•	•	•
Tire Pressure Monitoring System with Display	•	•	•
Universal Garage Door Opener (UGDO)	—	•	•

GROUPS / PACKAGES

Chrome Appearance Group — Includes Bright Chrome exterior accents on front fascia, rear reflector bezels and bodyside molding, 17-inch machined aluminum wheels with Black pockets and 225/45R17 All-Season tires	O	—	—
Graphite Edition — Includes Gray roof and matching exterior side mirrors, dual-pane power sunroof and 17-inch aluminum wheels (available in select colors; please see dealer for details)	—	—	O
Popular Equipment Group — Includes power 2-way driver lumbar adjust, rearview auto-dimming mirror, Dual-Zone Automatic Temperature Controls (ATC) and ParkSense Rear Park Assist System ³ ; additional for Trekking models include manual 2-way passenger lumbar adjust (requires SiriusXM Radio ¹⁰ on Pop models; not available with Premium Group)	O	O	—
Premium Group — Includes power 2-way driver lumbar adjust, rearview auto-dimming mirror, Dual-Zone ATC, ParkSense Rear Park Assist System ³ , BeatsAudio Premium Sound System including subwoofer, Uconnect 4 NAV with 7-inch touchscreen display plus GPS Navigation, Apple CarPlay ² and Android Auto ¹ compatibility, and SiriusXM Radio ¹⁰ including one-year trial subscription	O	—	—
Urbana Appearance Package — Includes Black exterior accents, Black door handles, Black exterior mirrors, 17-inch Gloss Black aluminum wheels, leather-trimmed bucket seats in Black with Copper accents and Gloss Black instrument panel (available in select colors; please see dealer for details)	—	O	—

• = Standard. O = Optional. P = Available within Package. — = Not available.

FIAT 500L wheels



16-INCH ALUMINUM

Standard on Pop

17-INCH ALUMINUM
PAINTED GRAY

Standard on Lounge

17-INCH ALUMINUM

Standard on Trekking

17-INCH MACHINED
ALUMINUM WITH
WHITE-PAINTED
POCKETS

Available on Lounge
in Bianco (White) or
with Bianco (White) roof



IT'S EVEN MORE "YOU"

The collection of authentic Mopar® Accessories will pack your FIAT® 500L vehicle with even more punch: featuring Roof Rack Kit and Upright Bike Carrier. See a full listing of other available accessories at mopar.com



JOIN US

Join fellow enthusiasts and tell your story by posting comments, participating in discussions and sharing your FIAT vehicle photos and videos. Connect with our community on Facebook (facebook.com/fiatusa), follow us on Twitter (twitter.com/fiatusa), and check us out on YouTube (youtube.com/fiatusa) and Instagram (instagram.com/fiatusa).

Standard coverage includes: Basic Limited Warranty¹³ — 4 Years/50,000 Miles, Anti-Corrosion Perforation Limited Warranty¹³ (outer panel) — 5 Years/100,000 Miles, Roadside Assistance — 4 Years/Unlimited Miles with services including: Flat-Tire Service, Out of Gas/Fuel Delivery (maximum two gallons), Battery Jump Assistance, Lockout Service and Towing Assistance.

Visit your FIAT dealer for additional details, eligibility and restrictions.



FIAT MERCHANDISE

Display your affection for striking style with merchandise that complements an active lifestyle. This collection includes everything from trend-setting apparel to distinctive conversation pieces for home, office and travel. Visit e-store.fiatusa.com

FIAT DRIVEPLUSSM MASTERCARD[®]

Apply today for a FIAT DrivePlus Mastercard and upon approval start earning 5% back on FIAT dealership purchases, 2% back on gas and travel purchases, and 1% back on purchases everywhere else!¹⁴ Redeem your rewards toward your next service or your next FIAT purchase. Visit drivepluscard.com or visit a participating dealer to learn more.



(1) To use Android Auto on your phone screen, you'll need an Android phone running 5.0 or higher and the Android Auto app. Google, Android, Android Auto, YouTube and other related marks and logos are trademarks of Google LLC. (2) Requires compatible iPhone. See dealer for phone compatibility. Data plan rates apply. Vehicle user interface is a product of Apple. Apple CarPlay is a trademark of Apple Inc. iPhone is a trademark of Apple Inc., registered in the US and other countries. Apple terms of use and privacy statements apply. (3) Always look before proceeding. An electronic drive aid is not a substitute for conscientious driving. Always be aware of your surroundings. (4) Always check entire surroundings visually before proceeding. (5) Based on FCA US LLC Compact MPV segment. (6) Always drive carefully, consistent with conditions. Always wear your seat belt and obey traffic laws. (7) Always sit properly in designated seating positions with seat belts securely fastened at all times. (8) Always sit properly with the head restraint properly adjusted. Never place anything in front of the head restraint. (9) Vehicle must be locked and system activated for alarm to sound. (10) SiriusXM Radio requires a subscription, sold separately, or as a package, by Sirius XM Radio Inc. **If you decide to continue service after your 12-month trial included with the new vehicle purchase, the subscription plan you choose will automatically renew thereafter and you will be charged according to your chosen payment method at then-current rates.** Trial service is not transferable. Fees and taxes apply. Please see the Customer Agreement at www.siriusxm.com for complete terms and how to cancel, which includes calling SiriusXM at 1-866-635-2349. All fees and programming are subject to change. Not all vehicles or devices are capable of receiving all services offered by SiriusXM. Data displays and individual product availability vary by vehicle hardware. Current information and features may not be available in all locations, or on all receivers. Weather Forecast, Current Conditions may not be available in all locations. (11) The Uconnect Phone requires a mobile phone equipped with the Bluetooth Hands-Free Profile. To check phone compatibility, please visit UconnectPhone.com. (12) Black roof on exterior colors with Urbana Edition. (13) Visit Mopar.com for complete details and a copy of the Basic Limited Warranty. (14) See the Reward Terms and Conditions in the Summary of Credit Terms provided at time of application for details, including earning, redemption, expiration or forfeiture. Percentage back is earned as points.

©2019 FCA US LLC. All Rights Reserved. FIAT is a registered trademark of FCA Group Marketing S.p.A., used under license by FCA US LLC. Mopar, ParkSense, ParkView, Sentry Key and Uconnect are registered trademarks of FCA US LLC. The 500L design is a registered trademark of FCA Italy S.p.A., used under license by FCA US LLC.

MultiAir is a registered trademark of C.R.F. Società Consortile per Azioni, used under license by FCA US LLC. Apple CarPlay is a trademark and iPhone and Siri are registered trademarks of Apple Inc. Dr. Dre, Beats, BeatsAudio and the b logo are trademarks of Beats Electronics, LLC. Bluetooth is a registered trademark of Bluetooth SIG, Inc. Facebook is a registered trademark of Facebook, Inc. Google, Android, Android Auto, Google Maps, YouTube and other related marks and logos are trademarks of Google LLC. Instagram is a registered trademark of Instagram, Inc. KONI is a registered trademark of KONI North America. Mastercard cards are issued by First Bankcard, a division of First National Bank of Omaha pursuant to a license from Mastercard International Incorporated. Mastercard is a registered trademark and the circles design is a trademark of Mastercard International Incorporated. SiriusXM Connected Vehicles Services Inc., Sirius, XM, SiriusXM and all related marks and logos are registered trademarks of SiriusXM Radio Inc. The Twitter name, logo, Twitter T, Tweet and the Twitter bird are trademarks of Twitter, Inc. in the United States and other countries.

This document is a publication of FCA US LLC. All product illustrations and specifications are based upon current information at the time of publication approval. FCA US LLC reserves the right to make changes from time to time, without notice or obligation, in prices, specifications, colors and materials, and to change or discontinue models which are considered necessary to the purpose of product improvement or for reasons of design and/or marketing.