



ABOVE & BEYOND

> FIND A DEALERSHIP

> BUILD YOUR OWN

OVERVIEW

SPECIFICATION

DEFENDER





ABOVE & BEYOND

> FIND A DEALERSHIP

> BUILD YOUR OWN

OVERVIEW

SPECIFICATION

LAND ROVER DEFENDER NEW FEATURES FOR 2015

EXTERIOR DESIGN CHANGES

Brand new editions feature the availability of two stylish packs including the purposeful Black Design Pack and a Silver Design Pack.

INTERIOR DESIGN CHANGES

With even higher levels of quality materials and craftsmanship, 2015 will see the introduction of contrast leather premium seats. With Windsor leather inserts, these seats will be available in a choice of three colours; Ebony/Pimento, Ebony/Tan or Ebony/Lunar. To complete the look, when these seats are selected, the front centre stowage compartment will feature contrast leather highlights.





ABOVE & BEYOND

> FIND A DEALERSHIP

> BUILD YOUR OWN

OVERVIEW

SPECIFICATION





ABOVE & BEYOND

> FIND A DEALERSHIP

> BUILD YOUR OWN

OVERVIEW

SPECIFICATION



Born of a lineage stretching back to the debut of the first Land Rover in 1948, today's Defender has capability at its heart and takes pride of place as the most capable and adaptable vehicle in the Land Rover range. Over six decades of experience in designing and building one of the world's most renowned four-wheel drive vehicles have shaped Defender.





ABOVE & BEYOND

> FIND A DEALERSHIP

> BUILD YOUR OWN

OVERVIEW

SPECIFICATION



Immensely strong, Defender's chassis is probably the single most important component in the vehicle's design and contributes to its strength, capability, versatility and durability. The box section, ladder frame design is far stronger than an open channel design and more adaptable than a unibody design.

Defender's simple body architecture lends itself perfectly to functionality and versatility. It is available in thirteen body styles including Station Wagon, Hard Top, Pick Up, Double Cab Pick Up and Chassis Cabs with a choice of three different wheelbases (90, 110 and 130).



ABOVE & BEYOND

> FIND A DEALERSHIP

> BUILD YOUR OWN

OVERVIEW

SPECIFICATION





ABOVE & BEYOND

> FIND A DEALERSHIP

> BUILD YOUR OWN

OVERVIEW

SPECIFICATION





ABOVE & BEYOND

> FIND A DEALERSHIP

> BUILD YOUR OWN

OVERVIEW

SPECIFICATION



The lightweight aluminium body* not only helps to improve fuel consumption, it also increases payload, the vehicle's renowned capability and gives an optimum trade-off between form and function. Indeed, the corrosion-resistant aluminium body panels have evolved directly from those on the original 1948 Land Rover. Even the cargo bed is made of aluminium so it won't rust.

*Doors and bonnet are made from corrosion-resistant steel.



ABOVE & BEYOND

> FIND A DEALERSHIP

> BUILD YOUR OWN

OVERVIEW

SPECIFICATION



Inspired by 21st century industrial design, the Defender fascia is simple, robust and practical but not without its creature comforts. Optional features include premium leather front seats, leather steering wheel and air conditioning. There is a choice of two entertainment systems, with the second system having the added benefit of Bluetooth® wireless connectivity with audio streaming. For a further enhanced in-car sound experience, an upgraded system with superior speakers and subwoofer (150W) is also available.

The legendary Land Rover Command Driving Position is now a central feature of every Land Rover vehicle. It gives greater visibility of the way ahead and the surrounding environment, adding to the driver's control and security.

The Bluetooth® word mark and logos are owned by the Bluetooth SIG, Inc. and any use of such marks by Land Rover is under license.



ABOVE & BEYOND

> FIND A DEALERSHIP

> BUILD YOUR OWN

OVERVIEW

SPECIFICATION





ABOVE & BEYOND

> FIND A DEALERSHIP

> BUILD YOUR OWN

OVERVIEW

SPECIFICATION





ABOVE & BEYOND

> FIND A DEALERSHIP

> BUILD YOUR OWN

OVERVIEW

SPECIFICATION



Superb towing power. And the power to help keep occupants out of trouble. With a state-of-the-art 2.2 litre diesel engine with an impressive 360Nm of torque. With 90 percent of peak power constantly on tap from as low as 2,200rpm to over 4,350rpm, it provides maximum muscle for tough working environments.





ABOVE & BEYOND

> FIND A DEALERSHIP

> BUILD YOUR OWN

OVERVIEW

SPECIFICATION

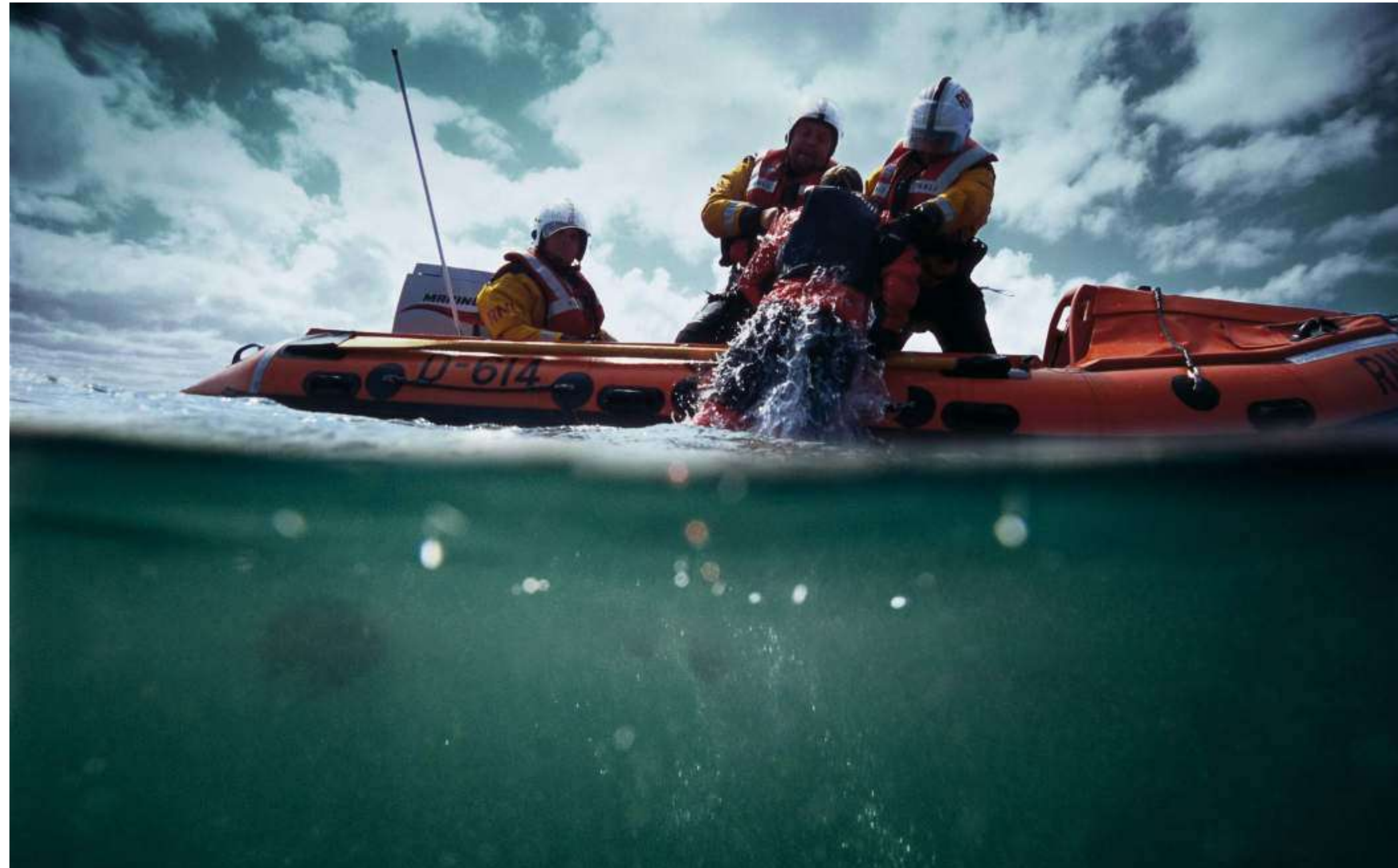

Specially developed for heavy-duty applications, Defender's six-speed transmission is light, strong and provides smooth on-road performance. With 12 forward gears across high and low ratios, whether towing, on-road or in rough terrain, you're always in command. Added to which, all Defenders have an impressive braked towing capacity of 3,500kg.

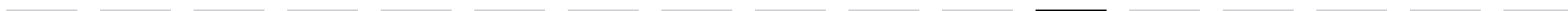



ABOVE & BEYOND

> FIND A DEALERSHIP

> BUILD YOUR OWN

OVERVIEW

SPECIFICATION





ABOVE & BEYOND

> FIND A DEALERSHIP

> BUILD YOUR OWN

OVERVIEW

SPECIFICATION





ABOVE & BEYOND

> FIND A DEALERSHIP

> BUILD YOUR OWN

OVERVIEW

SPECIFICATION

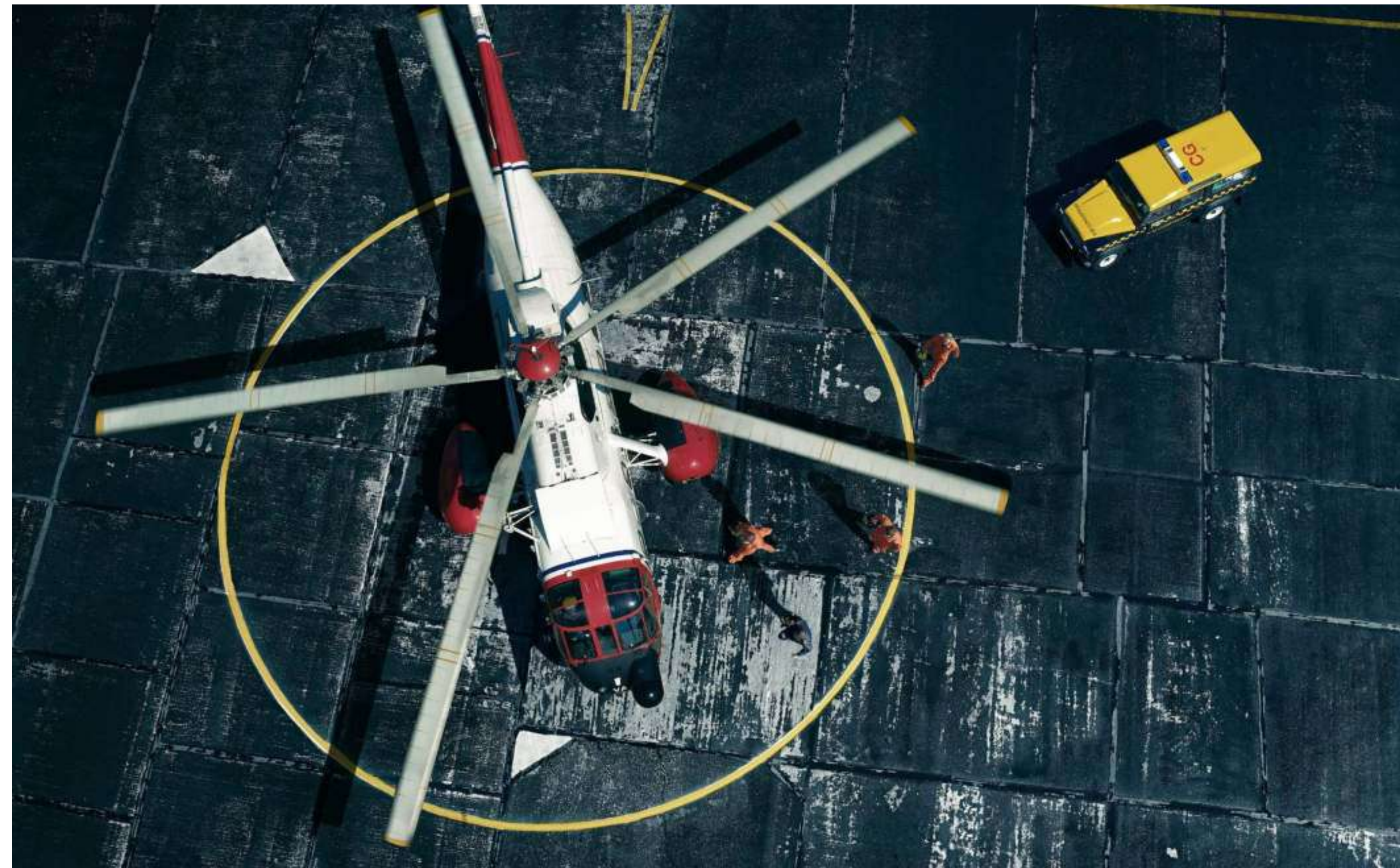

Defender has permanent four-wheel drive with the centre differential distributing torque evenly between front and rear axles to give optimum performance on all terrains. On tarmac, the vehicle's drive is composed and acceleration is assured. Defender comes with an ABS System featuring Electronic Traction Control and Dynamic Stability Control as standard.



ABOVE & BEYOND

> FIND A DEALERSHIP

> BUILD YOUR OWN

OVERVIEW

SPECIFICATION



Defender is designed to tackle extreme climbs and descents with ease. The engine's impressive 360Nm of torque can be fully utilised through the dual-range transfer box and six-speed gearbox. This provides an additional six forward and one reverse low-range gears for extreme conditions and gradients as steep as 45 degrees. What's more, the centre differential can be locked to help minimise wheel spin and maximise traction on slippery surfaces.



ABOVE & BEYOND

> FIND A DEALERSHIP

> BUILD YOUR OWN

OVERVIEW

SPECIFICATION





ABOVE & BEYOND

> FIND A DEALERSHIP

> BUILD YOUR OWN

OVERVIEW

SPECIFICATION



THE DEFENDER ENGINE



STEP 1 CHOOSE YOUR BODYSTYLE

A wide variety of bodystyles and wheelbases provide optimum capability to get the most from your Defender.

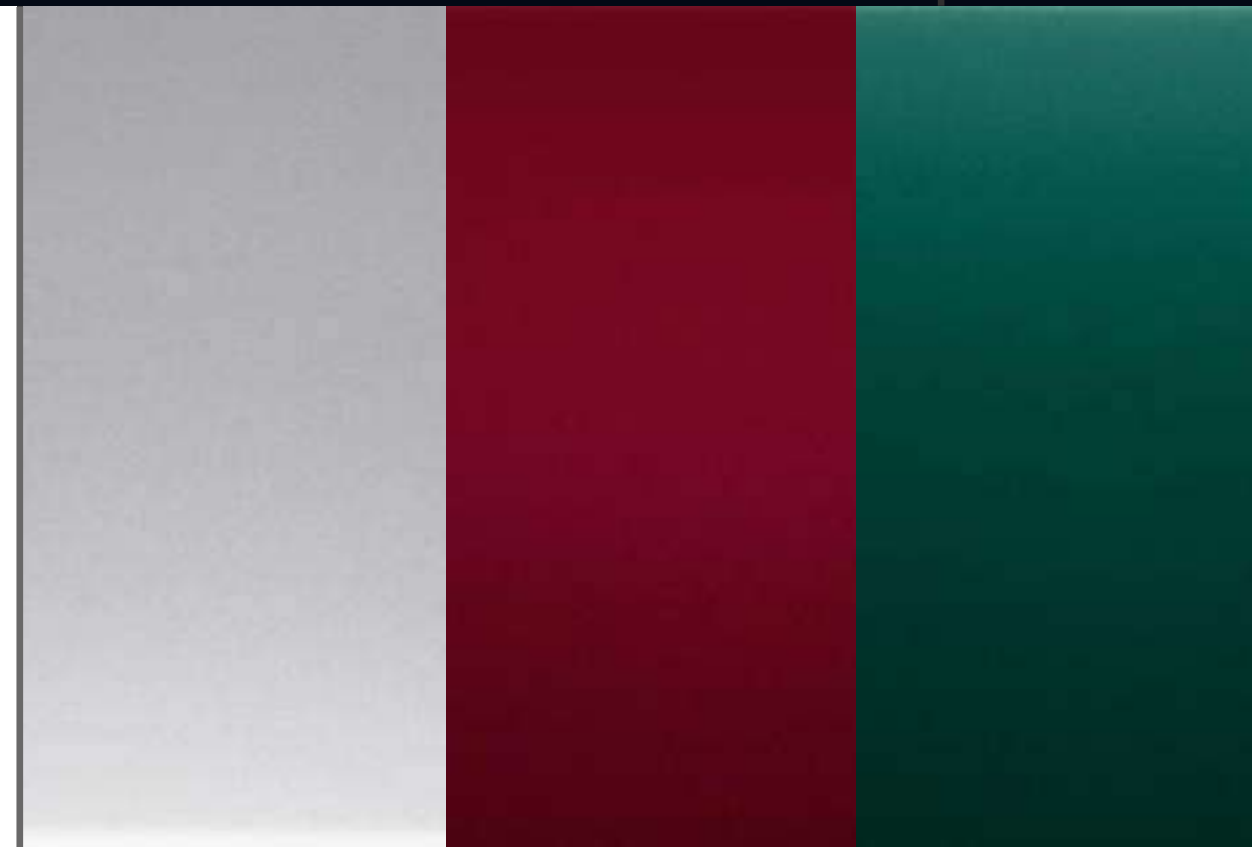

STEP 2 CHOOSE YOUR COLOUR

There's an extensive range of paints that provide durable coatings designed for the toughest working environments.



STEP 3 CHOOSE YOUR WHEELS

Defender's iconic looks can be complemented with a range of wheel options.

> VIEW ENGINES

> VIEW BODYSTYLES

> VIEW COLOURS

> VIEW WHEELS



STEP 4 CHOOSE YOUR INTERIOR

A selection of stylish, durable trim combinations are available for practicality, comfort and even a touch of luxury.

> VIEW INTERIORS



STEP 5 CHOOSE YOUR OPTIONS

Additional options can enhance and ensure optimum capability of your Defender.

> VIEW OPTIONS



TECHNICAL DETAILS

Technical information and data for dimensions, performance and specifications.

> TECHNICAL DETAILS



ACCESSORIES

A range of durable and practical accessories. You can tailor your vehicle to your specific needs.

> VIEW ACCESSORIES



ABOVE & BEYOND

> FIND A DEALERSHIP

> BUILD YOUR OWN

OVERVIEW

SPECIFICATION

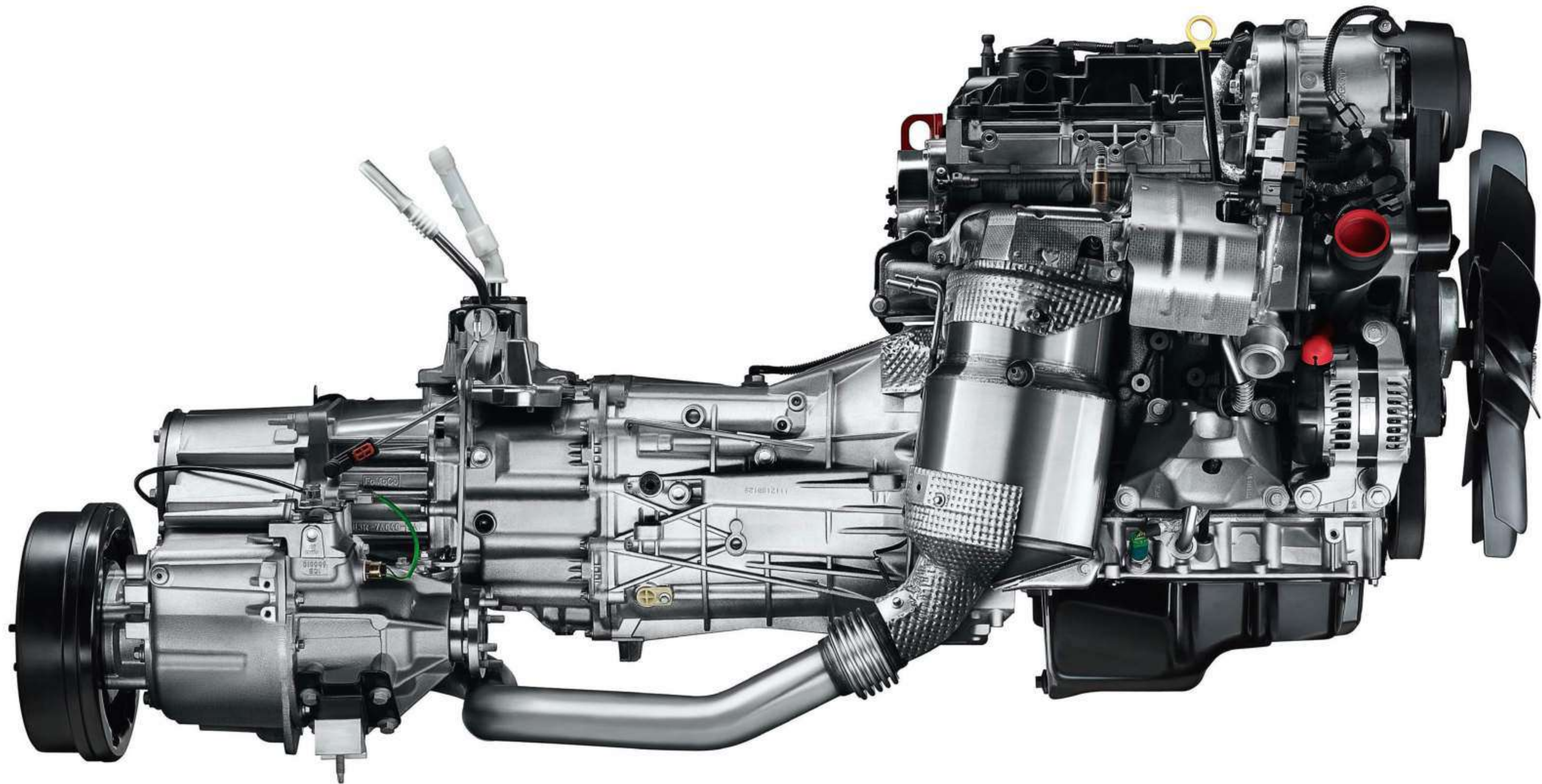

ENGINE

MODELS

COLOURS

WHEELS

INTERIORS

OPTIONS

TECHNICAL DETAILS

ACCESSORIES



ABOVE & BEYOND

> FIND A DEALERSHIP

> BUILD YOUR OWN

OVERVIEW

SPECIFICATION



ENGINE

MODELS

COLOURS

WHEELS

INTERIORS

OPTIONS

TECHNICAL DETAILS

ACCESSORIES



ABOVE & BEYOND

> FIND A DEALERSHIP

> BUILD YOUR OWN

OVERVIEW

SPECIFICATION



DEFENDER 110 CHASSIS CAB



DEFENDER 110 DOUBLE CAB PICK UP



DEFENDER 130 DOUBLE CAB HIGH CAPACITY PICK UP



DEFENDER 90 STATION WAGON



DEFENDER 110 STATION WAGON



DEFENDER 110 UTILITY WAGON



DEFENDER 130 DOUBLE CAB CHASSIS



DEFENDER 90 HARD TOP



DEFENDER 110 HARD TOP



DEFENDER 110 HIGH CAPACITY PICK UP



DEFENDER 130 CHASSIS CAB



DEFENDER 90 PICK UP



DEFENDER 110 PICK UP



ENGINE

MODELS

COLOURS

WHEELS

INTERIORS

OPTIONS

TECHNICAL DETAILS

ACCESSORIES



ABOVE & BEYOND

> FIND A DEALERSHIP

> BUILD YOUR OWN

OVERVIEW

SPECIFICATION

Defender is available in a wide variety of body styles and three wheelbases, all of which give optimum capability to a range of potential uses. Choosing the appropriate body type for your requirements will help you get the most from your Defender.

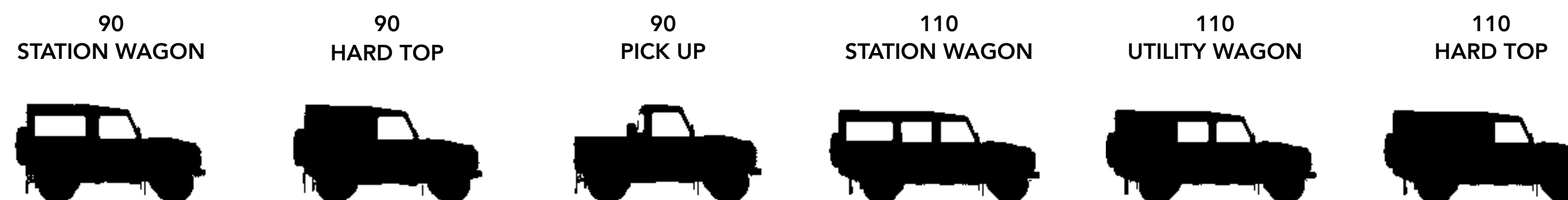

DESIRABLE CHARACTERISTICS

TOWING - short distance (e.g. agriculture)
Manoeuvrability, good rear visibility



TOWING - long distance (e.g. exhibition units)
Directional stability, fuel range



CARRYING EQUIPMENT (heavy, valuable, vulnerable)
Loadspace, payload, security, protection from the elements



CARRYING MATERIALS (loose, dirty, smelly, livestock)
Loadspace, payload, access, cab separation



CARRYING PEOPLE
Seating capacity, comfort, access



EXTREME OFF-ROAD
Manoeuvrability, all round visibility, good clearance angles



Key: ■■■■■■ - most desirable ■ - least desirable



ENGINE

MODELS

COLOURS

WHEELS

INTERIORS

OPTIONS

TECHNICAL DETAILS

ACCESSORIES



ABOVE & BEYOND

> FIND A DEALERSHIP

> BUILD YOUR OWN

OVERVIEW

SPECIFICATION

Defender is available in a wide variety of body styles and three wheelbases, all of which give optimum capability to a range of potential uses. Choosing the appropriate body type for your requirements will help you get the most from your Defender.



DESIRABLE CHARACTERISTICS

TOWING - short distance (e.g. agriculture)
Manoeuvrability, good rear visibility



TOWING - long distance (e.g. exhibition units)
Directional stability, fuel range



CARRYING EQUIPMENT (heavy, valuable, vulnerable)
Loadspace, payload, security, protection from the elements



CARRYING MATERIALS (loose, dirty, smelly, livestock)
Loadspace, payload, access, cab separation



CARRYING PEOPLE
Seating capacity, comfort, access



EXTREME OFF-ROAD
Manoeuvrability, all round visibility, good clearance angles



Key: ■■■■■■ - most desirable ■ - least desirable



ENGINE

MODELS

COLOURS

WHEELS

INTERIORS

OPTIONS

TECHNICAL DETAILS

ACCESSORIES



ABOVE & BEYOND

> FIND A DEALERSHIP

> BUILD YOUR OWN

OVERVIEW

SPECIFICATION



ENGINE

MODELS

COLOURS

WHEELS

INTERIORS

OPTIONS

TECHNICAL DETAILS

ACCESSORIES



ABOVE & BEYOND

> FIND A DEALERSHIP

> BUILD YOUR OWN

OVERVIEW

SPECIFICATION

Form follows function in the Defender interior. Tough working vehicles demand robust materials such as the scuff-resistant facia and durable seat coverings. The facia is a one-piece moulding for improved refinement, its distinctive lines providing Land Rover's traditional commanding view of the ground ahead.

The seats are arranged stadium style, their position maximising exterior vision and easing access. Designed to be comfortable and supportive whatever the task or terrain, each seat has a three-point safety harness, but can be folded to optimise the Defender's load-carrying versatility. There's space for smaller items too, in trays on the facia or between the front seats. The optional cubby box provides extra storage and includes two cup holders.



90 HT/PU* Two seats

Rear cabin line applicable to PU only



90 SW* Four seats



110 HT/PU/HCPU* Two seats

Rear cabin line applicable to PU only



110 SW/UW/DCPU* Five seats**

Rear cabin line applicable to DCPU only



110 SW* Seven seats** (optional extra)

Third row rear seats optional



130 DCHCPU* Five seats

HT = Hard Top PU = Pick Up HCPU = High Capacity Pick Up DCPU = Double Cab Pick Up SW = Station Wagon UW = Utility Wagon DCHCPU = Double Cab High Capacity Pick Up

*Optional Cubby Box shown.

**60:40 split folding middle bench seat (Station Wagon and Utility Wagon only).

Please note: Forward-facing seats can carry up to seven adults in comfort. A third row of seats is an optional extra on 110 SW derivatives, standard on 110 SW XS.



ENGINE

MODELS

COLOURS

WHEELS

INTERIORS

OPTIONS

TECHNICAL DETAILS

ACCESSORIES



ABOVE & BEYOND

> FIND A DEALERSHIP

> BUILD YOUR OWN

OVERVIEW

SPECIFICATION

	HARD TOP	PICK UP	STATION WAGON	UTILITY WAGON	CHASSIS CAB	DOUBLE CAB PICK UP	HIGH CAPACITY PICK UP
ENGINE TRANSMISSION, SUSPENSION AND DRIVING DYNAMICS							
Six-speed transmission with dual range transfer box	■	■	■	■	■	■	■
Permanent four-wheel drive	■	■	■	■	■	■	■
Front axle two-pin differential	■	■	■	■	■	■	■
Power Assisted Steering	■	■	■	■	■	■	■
Standard duty suspension	■	■	■	■	■	■	■
Underseat bottle jack	■	■	■	■	■	■	■
Diesel Particulate Filter (DPF)	■	■	■	■	■	■	■
Anti-lock Braking System (ABS), Electronic Traction Control (ETC) and Dynamic Stability Control	■	■	■	■	■	■	■
EXTERIOR FEATURES AND FINISHERS							
Roof and Exterior Styling							
Body coloured roof (1)	■	■	■	■		■	
Body coloured wheel arches (1)	■		■	■		■	
White roof (2)	■	■	■				■
Grille and headlamp surround – Brunel finish (1)	■		■	■		■	
Lower tailgate		■				■	■
Front mudflaps (1)			■	■		■	
Rear mudflaps	■	■	■	■	■	■	■
Rear folding step (3)	■		■				
Glass and Exterior Mirrors							
Heated rear windscreen	■		■	■			
Tinted front and side glass	■	■	■	■	■	■	■
Windscreen wash/wipe system with variable intermittent function	■	■	■	■	■	■	■
Manually adjustable exterior mirrors	■	■	■	■	■	■	■
Station Wagon roof (3)	■		■	■			
Plain metal side panel (no side window)	■			■			
Sliding side window			■				
Rear quarter windows (4)	■		■				
Rear wash wiper	■		■	■			

(1) County and XS models only (2) Standard on Base models only (3) Standard on HT XS only (4) Not available on 110 Hard Top.



ENGINE

MODELS

COLOURS

WHEELS

INTERIORS

OPTIONS

TECHNICAL DETAILS

ACCESSORIES



ABOVE & BEYOND

> FIND A DEALERSHIP

> BUILD YOUR OWN

OVERVIEW

SPECIFICATION

	HARD TOP	PICK UP	STATION WAGON	UTILITY WAGON	CHASSIS CAB	DOUBLE CAB PICK UP	HIGH CAPACITY PICK UP
EXTERIOR FEATURES AND FINISHERS (CONTINUED)							
Headlamps and Lighting							
Halogen headlamps	■	■	■	■	■	■	■
Paint							
Solid paint	■	■	■	■	■	■	■
Wheels and Wheel Options							
16 inch standard steel wheel with Michelin 'Latitude Cross' tubeless tyres (1) (2)	■	■	■	■	■	■	■
16 inch heavy duty steel wheel Continental 'ContiCrossContact AT' tyres (3)					■	■	■
Full size spare wheel	■	■	■	■	■	■	■
Locking wheel nuts (4)	■		■	■		■	
SEATING, INTERIOR FEATURES AND FINISHERS							
Seating							
Twill Vinyl (5)	■	■	■	■	■	■	■
Part leather (6)	■		■	■		■	
Two front seats only (1)	■	■			■		■
Two individual second row rear seats (7)			■				
Second row three-seat bench (8)				■		■	
Two Part leather third row seats (9)			■				
Interior finishers							
Graphite instrument panel insert	■	■	■	■	■	■	■
Rubber floor trim	■	■	■	■	■	■	■

(1) Not available on 130 models

(2) Not available on 110 with HD Suspension or XS and County models

(4) Standard on 130 models only

(3) County and XS models only

(5) Not available on XS and County models

(6) Standard on XS models only

(7) Standard on 90 Station Wagon only

(8) Not available on 90 models, 110 Pick Up, 110 High Capacity Pick Up and 130 Chassis Cab

(9) 110 XS Station Wagon only.



ABOVE & BEYOND

> FIND A DEALERSHIP

> BUILD YOUR OWN

OVERVIEW

SPECIFICATION

	HARD TOP	PICK UP	STATION WAGON	UTILITY WAGON	CHASSIS CAB	DOUBLE CAB PICK UP	HIGH CAPACITY PICK UP
SAFETY AND SECURITY							
Perimetric and volumetric alarm with engine immobilisation and battery back up sounder	■	■	■	■	■	■	■
CONVENIENCE AND LOADSPACE FEATURES							
Front centre console storage tray	■	■	■	■		■	
Front centre console storage compartment	■		■	■		■	
Low line stowage tray	■	■	■	■	■	■	■
Two front cup holders	■	■	■	■	■	■	■
Manual dipping interior mirror	■	■	■	■	■	■	■
Driver and passenger sunvisor	■	■	■	■	■	■	■
Driver and passenger map pocket (1)	■		■	■		■	
Rear loadspace net (2)	■		■	■			
Stowage net – rear door (3)	■		■	■			
INFOTAINMENT							
Audio system with single slot CD, radio, MP3/AUX (4)			■	■		■	
Audio system with single slot CD, radio, MP3/AUX and Bluetooth® (2)	■		■	■		■	
OPTION PACKS							
Convenience Pack – consists of electric front windows and remote central locking (5)	■		■	■		■	

(1) Standard with part leather and leather seats only

(2) Standard on XS models only

(3) XS Hard Top and Station Wagon models only

(4) Standard on County models only

(5) County and XS models only.

The Bluetooth® word mark and logos are owned by the Bluetooth SIG, Inc. and any use of such marks by Jaguar Land Rover Limited is under licence.

ENGINE

MODELS

COLOURS

WHEELS

INTERIORS

OPTIONS

TECHNICAL DETAILS

ACCESSORIES



ABOVE & BEYOND

> FIND A DEALERSHIP

> BUILD YOUR OWN

OVERVIEW

SPECIFICATION

Body Colour

Fuji White (Solid)



Indus Silver (Metallic)

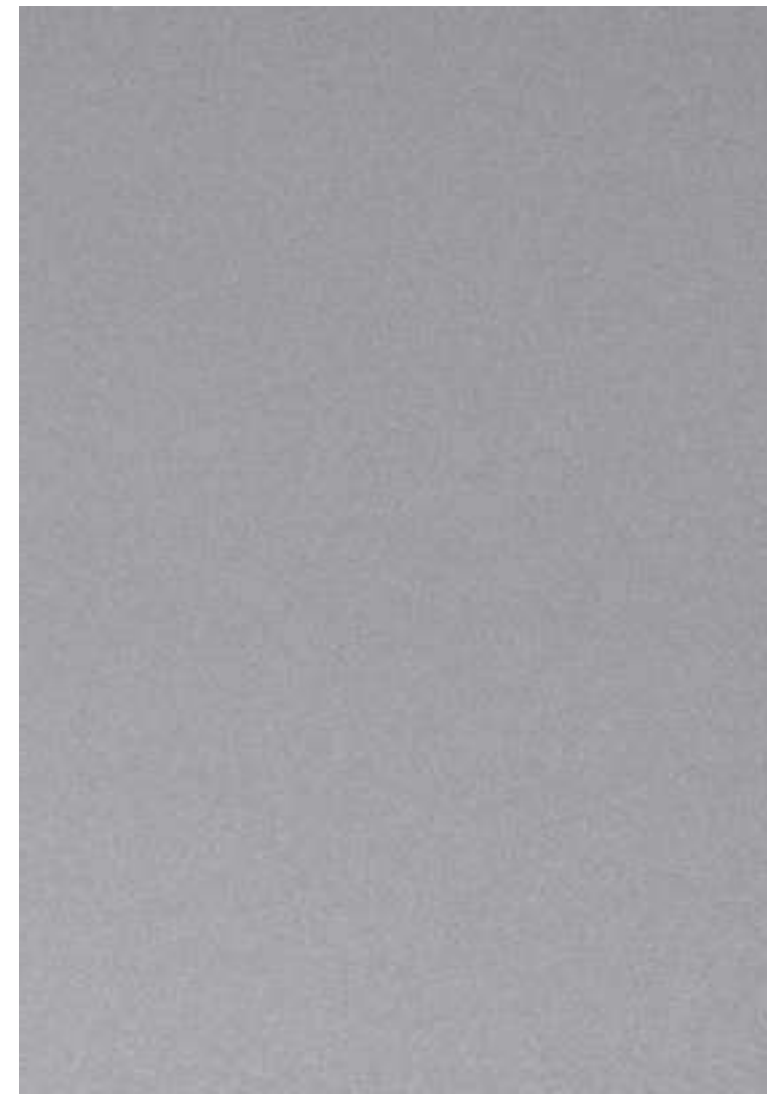

Corris Grey (Metallic)



Scotia Grey (Metallic)



Keswick Green (Solid)



Aintree Green (Metallic)



Optional Roof Colour*

Fuji White**

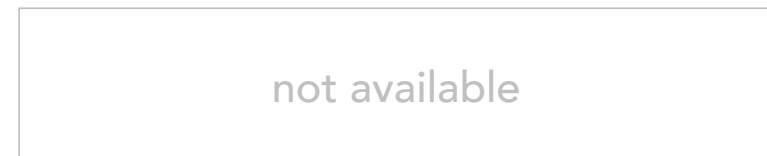
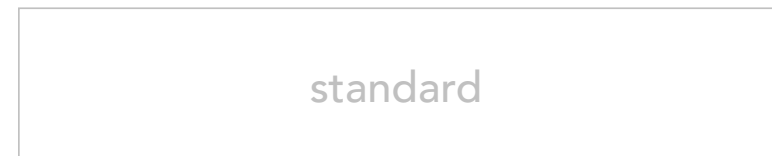

Contrast Santorini Black



Contrast Indus Silver

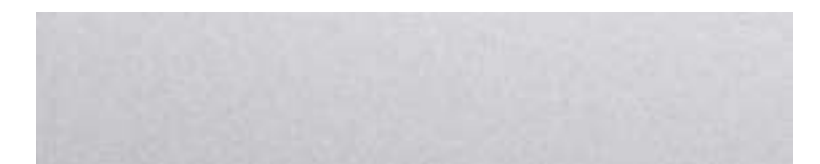
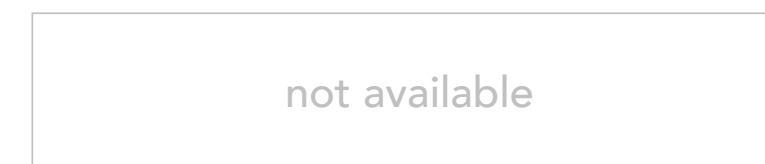
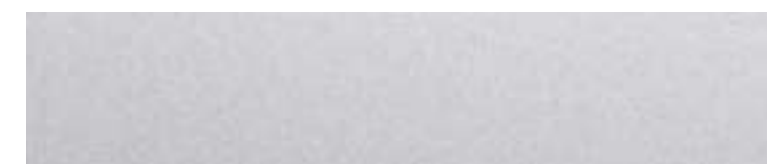
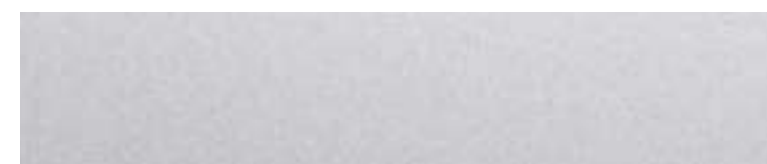
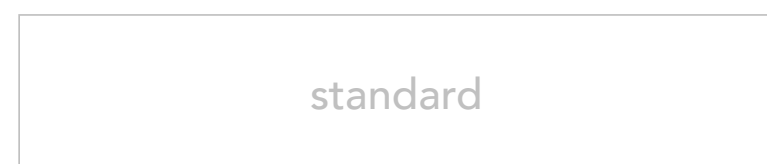
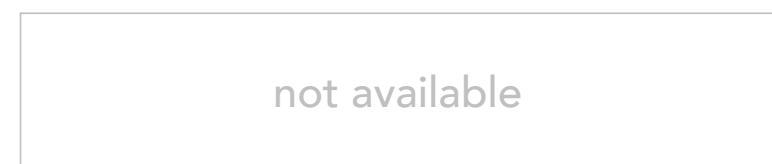

Contrast Corris Grey

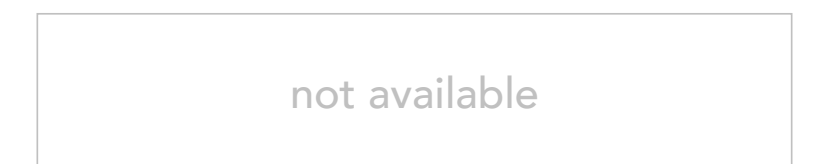
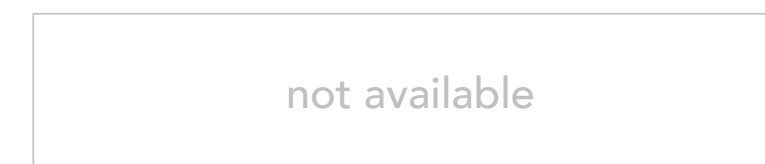
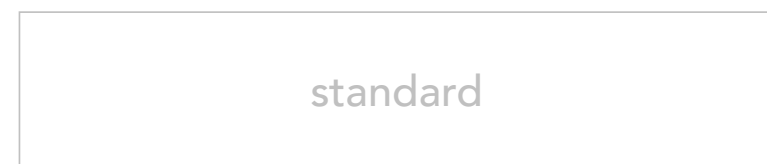

*Not available with 110 Hard Tops **Fuji White contrast roof not available on County or XS models (unless body colour is also Fuji White).

Visit landrover.co.uk for more information.

ENGINE

MODELS

COLOURS

WHEELS

INTERIORS

OPTIONS

TECHNICAL DETAILS

ACCESSORIES



ABOVE & BEYOND

> FIND A DEALERSHIP

> BUILD YOUR OWN

OVERVIEW

SPECIFICATION

Body Colour

Montalcino Red
(Metallic)

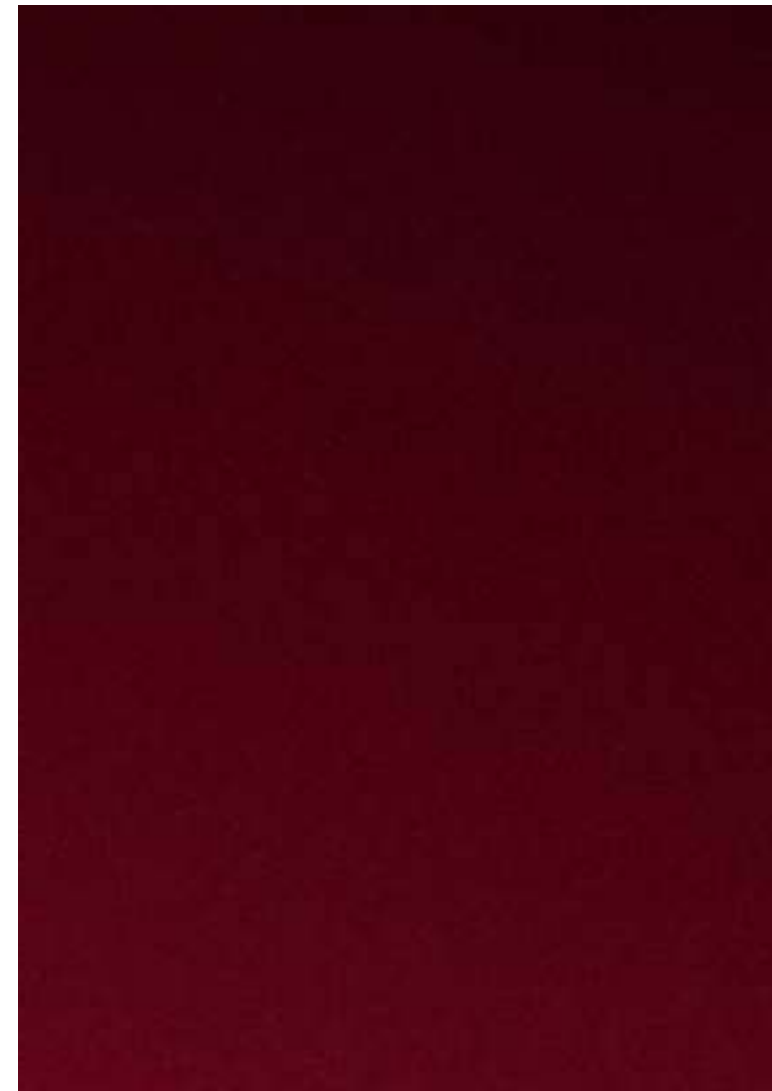

Havana
(Metallic)

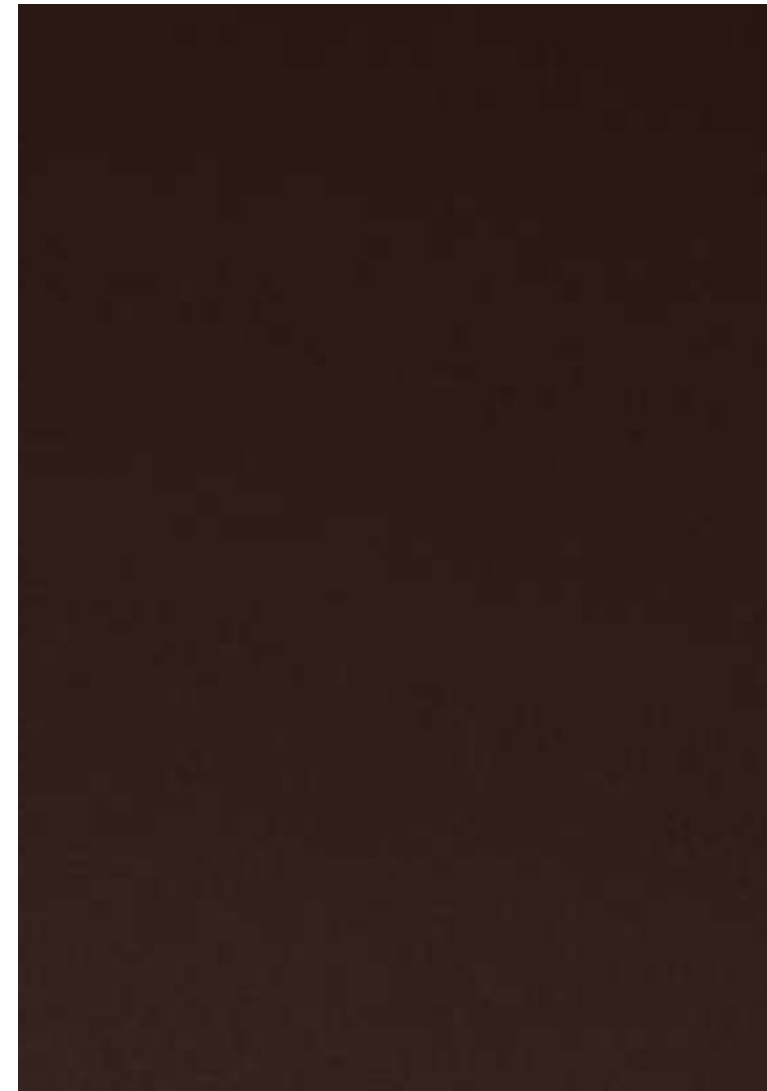

Barolo Black
(Metallic)



Santorini Black
(Metallic)



Optional Roof Colour*

Fuji White**



Contrast Santorini Black



not available

standard

Contrast Indus Silver

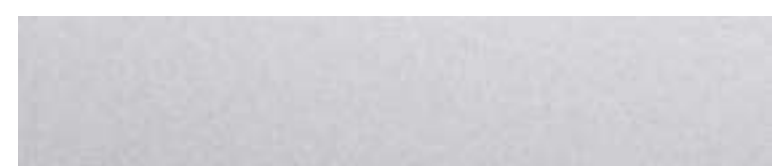

not available

not available



Contrast Corris Grey

not available

not available

not available



*Not available with 110 Hard Tops **Fuji White contrast roof not available on County or XS models (unless body colour is also Fuji White).

Visit landrover.co.uk for more information.

ENGINE

MODELS

COLOURS

WHEELS

INTERIORS

OPTIONS

TECHNICAL DETAILS

ACCESSORIES



ABOVE & BEYOND

> FIND A DEALERSHIP

> BUILD YOUR OWN

OVERVIEW

SPECIFICATION

Personalising the exterior

To distinctively style your vehicle, two bold side runners are available to create a dramatic impact to the Defender's exterior.

The new Silver Painted Side Runner enhances the vehicle's purposeful design, providing a perfect addition to customers opting to take the Silver Design Pack. Also available, the Black Side Runner brings a traditional element of elegance to the action-packed adventurer.



SILVER PAINTED SIDE RUNNER



BLACK PAINTED SIDE RUNNER

Visit landrover.co.uk for more information.

ENGINE

MODELS

COLOURS

WHEELS

INTERIORS

OPTIONS

TECHNICAL DETAILS

ACCESSORIES



ABOVE & BEYOND

> FIND A DEALERSHIP

> BUILD YOUR OWN

OVERVIEW

SPECIFICATION

Personalising the exterior

Showcasing distinctive style to match the Defender's bold character, the Black Design Pack* creates a dramatic impact on the overall image of the vehicle.

The Black Design Pack* includes the following: Santorini Black roof, grille, grille and headlamp surrounds, wheel arches, bonnet script, interior facia, Ebony headliner** and Gloss Black Sawtooth alloys wheels. To complete the look, the pack also includes privacy glass as a distinctive new feature.**



Santorini Black grille, grille and headlamp surrounds



Gloss Black Sawtooth alloy wheel



Santorini Black facia

Image shown with optional Black Painted Side Runner.

*Available on XS models only.

**Privacy glass and headliner not available on 110 Double Cab Pick Up models.

Visit landrover.co.uk for more information.

ENGINE

MODELS

COLOURS

WHEELS

INTERIORS

OPTIONS

TECHNICAL DETAILS

ACCESSORIES



ABOVE & BEYOND

> FIND A DEALERSHIP

> BUILD YOUR OWN

OVERVIEW

SPECIFICATION

Personalising the exterior

The new Silver Design Pack is a shining example of its cosmetic versatility.

The Silver Design Pack includes the following: Indus Silver contrast roof, grille, grille and headlamp surrounds, Silver side runners, interior facia and Dual finish alloy wheels. Also featured is a Bright Light Pack, consisting of white tail and indicator lights.



Indus Silver grille, grille and headlamp surrounds



Dual finish alloy wheel



Indus Silver facia

ENGINE

MODELS

COLOURS

WHEELS

INTERIORS

OPTIONS

TECHNICAL DETAILS

ACCESSORIES



ABOVE & BEYOND

> FIND A DEALERSHIP

> BUILD YOUR OWN

OVERVIEW

SPECIFICATION



STANDARD STEEL WHEEL 5.5F X 16



HEAVY DUTY STEEL WHEEL 6.5J X 16



BOOST ALLOY WHEEL 7J X 16

	90	110	130
WHEELS			
Standard steel wheel (1)	■	■	-
Boost alloy wheel (2)	□	□	-
Dual finish alloy wheel	□	□	-
Gloss Black Sawtooth alloy wheel*	□	□	-
Heavy duty steel wheel	□	□	■

■ Standard □ Optional - Not Available.

For further details on tyre efficiency as required by the EU legislation please speak to your local Land Rover Dealership. When choosing vehicles fitted with specific wheel and tyre combinations or optional wheels and tyres, your intended use of the vehicle should be considered. Alloy wheels may be more vulnerable to damage in some off-road conditions. Please discuss your requirements with your nearest Land Rover Dealership when selecting your vehicle and specification.

*Only available with MT/R tyre (not shown on image).

(1) Base models only (2) Boost alloy and Continental ContiCrossContact AT Tyres standard on 90 XS Hard Top, 90 County Station Wagon and 90 XS Station Wagon.

Visit landrover.co.uk for more information.

ENGINE

MODELS

COLOURS

WHEELS

INTERIORS

OPTIONS

TECHNICAL DETAILS

ACCESSORIES



ABOVE & BEYOND

> FIND A DEALERSHIP

> BUILD YOUR OWN

OVERVIEW

SPECIFICATION

As experts in off-road capability, Land Rover offer a wide range of tyres with differing performance characteristics allowing you to choose the tyre that best suits your requirements.



DUAL FINISH ALLOY WHEEL 7J X 16



BLACK SAWTOOTH ALLOY WHEEL 7J X 16

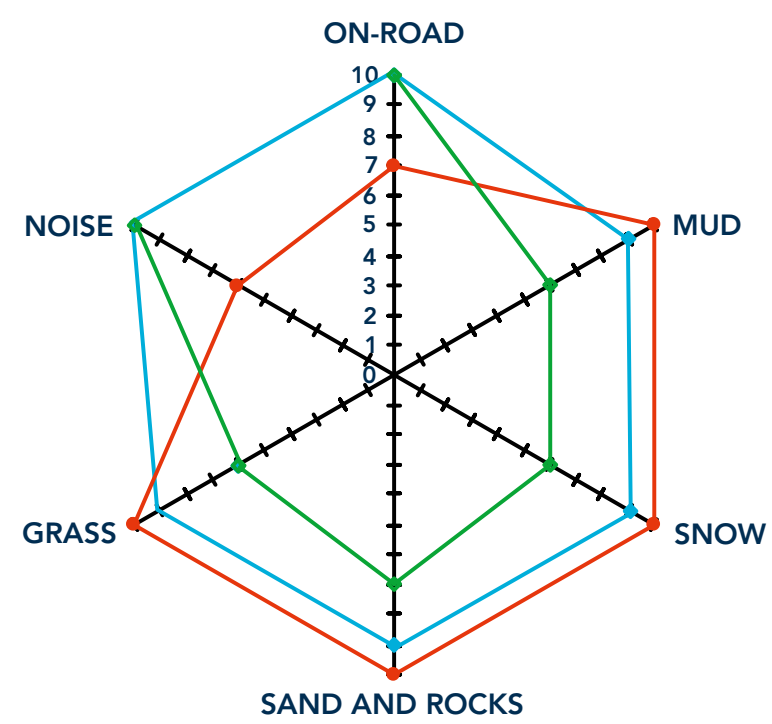

Distance from centre indicates level of performance 1 = Good 10 = Superior

TYRE	WHEEL	TYRE SIZE	90	110	130
MICHELIN LATITUDE CROSS (1)	Std Steel	7.50R16	■	■	-
GOODYEAR WRANGLER MT/R	HD Steel	235/85R16	□	□	□
CONTINENTAL CONTICROSS CONTACT AT	HD Steel	235/85R16	-	-	■
CONTINENTAL CONTICROSS CONTACT AT	Alloy	235/85R16	□	□	-
GOODYEAR WRANGLER MT/R	Alloy	235/85R16	□	□	-

■ Standard □ Optional - Not Available HD Heavy Duty

(1) Base models only.

ENGINE

MODELS

COLOURS

WHEELS

INTERIORS

OPTIONS

TECHNICAL DETAILS

ACCESSORIES



ABOVE & BEYOND

> FIND A DEALERSHIP

> BUILD YOUR OWN

OVERVIEW

SPECIFICATION



ENGINE

MODELS

COLOURS

WHEELS

INTERIORS

OPTIONS

TECHNICAL DETAILS

ACCESSORIES



ABOVE & BEYOND

> FIND A DEALERSHIP

> BUILD YOUR OWN

OVERVIEW

SPECIFICATION

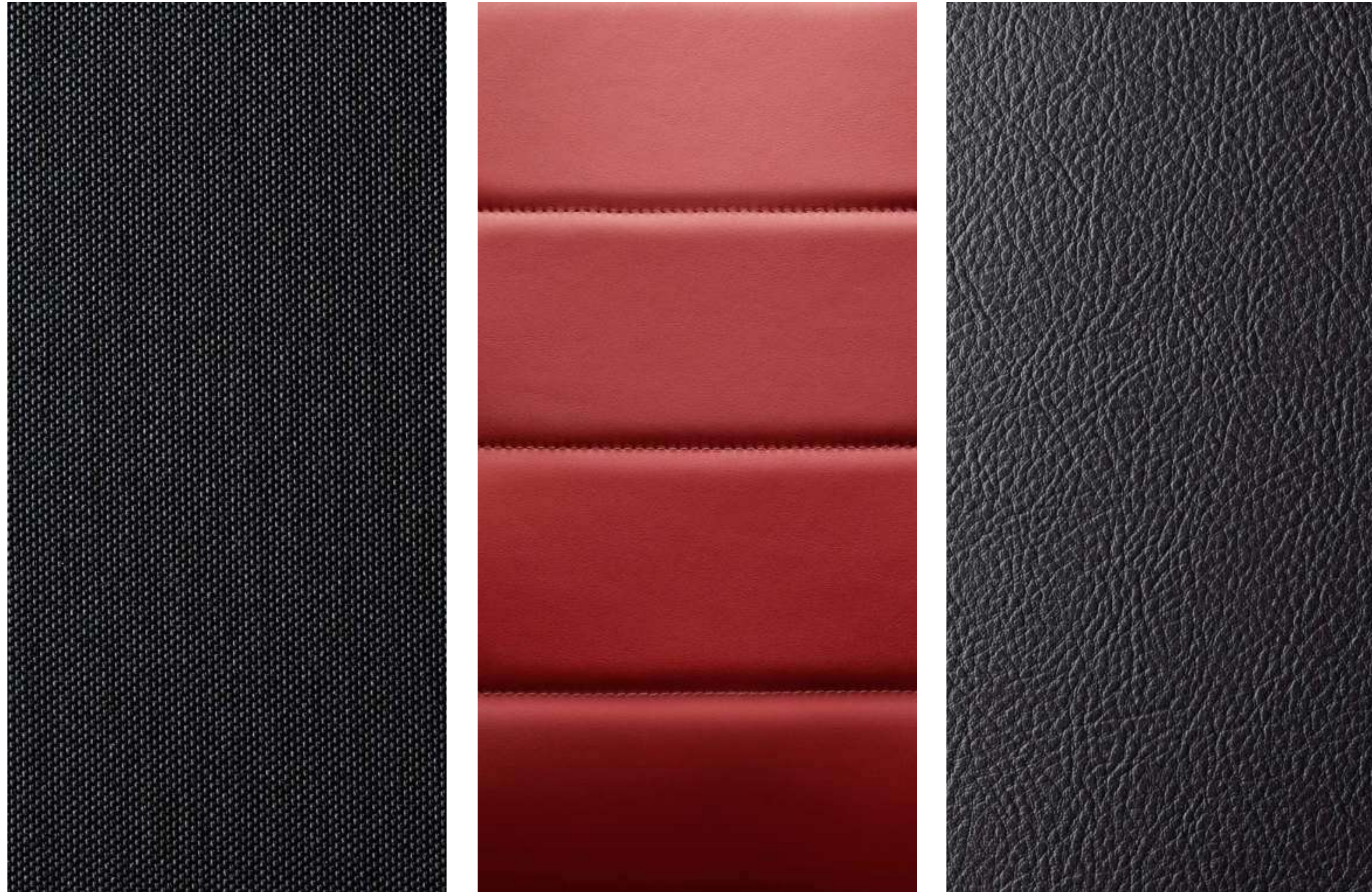

Right for the job and for making the right impression. A selection of stylish, durable trim combinations from the utility to the premium are available for practicality, comfort and even a touch of luxury.

ENGINE

MODELS

COLOURS

WHEELS

INTERIORS

OPTIONS

TECHNICAL DETAILS

ACCESSORIES



ABOVE & BEYOND

> FIND A DEALERSHIP

> BUILD YOUR OWN

OVERVIEW

SPECIFICATION



VINYL



CLOTH



PART LEATHER



EBONY/EBONY LEATHER
PREMIUM SEAT

ENGINE

MODELS

COLOURS

WHEELS

INTERIORS

OPTIONS

TECHNICAL DETAILS

ACCESSORIES



ABOVE & BEYOND

> FIND A DEALERSHIP

> BUILD YOUR OWN

OVERVIEW

SPECIFICATION



EBONY/PIMENTO CONTRAST
LEATHER PREMIUM SEAT



EBONY/TAN CONTRAST
LEATHER PREMIUM SEAT



EBONY/LUNAR CONTRAST
LEATHER PREMIUM SEAT

ENGINE

MODELS

COLOURS

WHEELS

INTERIORS

OPTIONS

TECHNICAL DETAILS

ACCESSORIES



ABOVE & BEYOND

> FIND A DEALERSHIP

> BUILD YOUR OWN

OVERVIEW

SPECIFICATION



ENGINE

MODELS

COLOURS

WHEELS

INTERIORS

OPTIONS

TECHNICAL DETAILS

ACCESSORIES



ABOVE & BEYOND

> FIND A DEALERSHIP

> BUILD YOUR OWN

OVERVIEW

SPECIFICATION



Departure angle

Ramp angle

Approach angle

MAXIMUM GRADIENT

	90	110	130
Maximum gradient	45°	45°	45°

GROUND CLEARANCE MM (inches)

	90	110	130
Tyre size	235/85R16	235/85R16	7.50R16
Axle ground clearance	250 (9.8)	250 (9.8)	250 (9.8)
Minimum underbody ground clearance, unladen	323 (12.72)	314 (12.36)	314 (12.36)

GRADIENTS AT KERB WEIGHT

	90	110	130
Departure angle	47.1°	35.6°	35.2°
Ramp break	147°	149.7°	152.5°
Approach angle	47°	48.7°	49°

ENGINE

MODELS

COLOURS

WHEELS

INTERIORS

OPTIONS

TECHNICAL DETAILS

ACCESSORIES



ABOVE & BEYOND

> FIND A DEALERSHIP

> BUILD YOUR OWN

OVERVIEW

SPECIFICATION



WADING DEPTH MM (inches)

	90	110	130
Maximum wading depth	500 (20)	500 (20)	500 (20)

TURNING CIRCLE Kerb-to-Kerb metres (feet)

	90		110		130
Tyre size	7.50R16	235/85R16	7.50R16	235/85R16	7.50R16
Minimum turning diameter	12.3 (40.4)	13.4 (43.8)	12.8 (42.0)	14.4 (47.3)	15.08 (49.4)

BRAKES

Servo assisted front and rear disc brakes on all models.

STEERING

All models have power assisted steering. Worm and roller.

ENGINE

MODELS

COLOURS

WHEELS

INTERIORS

OPTIONS

TECHNICAL DETAILS

ACCESSORIES



ABOVE & BEYOND

> FIND A DEALERSHIP

> BUILD YOUR OWN

OVERVIEW

SPECIFICATION



1,486mm (58.5) 130 DC/HCPU 1,511mm (59.5)
Vehicle height depends on tyre and suspension options



	90			110				130	
	Pick Up	Hard Top	Station Wagon	Pick Up	High Capacity Pick Up	Hard Top	Station Wagon	Double Cab	Double Cab HCPU
Track front/rear	1,486 (58.5) [†]	1,486 (58.5) [†]	1,486 (58.5) [†]	1,486 (58.5) [†]	1,486 (58.5) [†]	1,486 (58.5) [†]	1,486 (58.5) [†]	1,486 (58.5) [†]	1,511 (59.5)
Cargo bed length	983* (38.7)	1,144 (45.0)	1,144 (45.0)	1,740* (68.5)	1,986 (78.2)	1,900 (74.8)	1,900 (74.8)	1,020 (40.8)	1,680* (66.1)
Tailgate aperture width	878 (34.5)	878 (34.5)	878 (34.5)	878 (34.5)	1,362 (53.6)	878 (34.5)	878 (34.5)	878 (34.5)	1,362 (53.6)
Largest box length	830 (32.6)	1,030 (40.6)	1,005 (40)	1,570 (61.8)	1,980 (78)	1,750 (68.9)	1,100/1,470 (43.5/57.9)**	690 (27.2)	1,640 (64.6)
Largest box width	800 (31.5)	755 (29.7)	660 (26)	800 (31.5)	1,060 (41.7)	755 (29.7)	660 (26)	800 (31.5)	1,060 (41.7)
Largest box height	1,160 (45.7)	1,050 (41.3)	1,050 (41.3)	1,160 (45.7)	1,160 (45.7)	1,050 (41.3)	1,050 (41.3)	1,160 (45.7)	1,160 (45.7)

Dimensions mm (inches) *Add 161mm if spare wheel removed **2nd row seats up/2nd row seats folded [†]Due to greater wheel offset 1,511 (59.5) when HD Steel Wheel and Gloss Black Sawtooth alloy wheel is fitted.

ENGINE

MODELS

COLOURS

WHEELS

INTERIORS

OPTIONS

TECHNICAL DETAILS

ACCESSORIES



ABOVE & BEYOND

> FIND A DEALERSHIP

> BUILD YOUR OWN

OVERVIEW

SPECIFICATION

TECHNICAL SPECIFICATION, PERFORMANCE AND KEY DATA

Vehicle Loading

Incorrect vehicle and trailer loading can give poor vehicle handling and braking performance and a generally unstable and inefficient vehicle.

Payload and Weight Distribution

A correct weight distribution is achieved by considering several simple points:

- Payload is calculated by GVW – EEC kerb weight and must not be exceeded
- This payload should be distributed as evenly as possible along the vehicle's loadbed length
- The height of the payload should be kept to a minimum to keep the centre of gravity as low as possible
- Additional effects of a trailer should be taken into consideration (see towing section below).

Please refer to the Weights table opposite and the dimensions section to assess the most appropriate vehicle configuration for the loads you are likely to carry.

Towing

Choosing the correct equipment

Land Rover offers a range of towing equipment to suit different applications, both as optional original equipment and accessories. Multi-height tow bars enable the tow ball to be fitted in three different positions to suit different trailer towing requirements.

Adjustable tow bars enable the tow ball to be readily adjusted to different heights and are suitable for users who are likely to tow a variety of different trailers, or where the rear height of the vehicle may vary significantly with different payloads.

Roof Racks

Any load on the roof of the vehicle will affect vehicle handling and significant or tall loads should be avoided. Land Rover recommends a maximum of 150kg including the roof rack. Land Rover Accessories and Land Rover Professional Vehicles offer a range of roof rack systems to ensure roof loads are carried as safely as possible.

Please refer to the accessories section of this brochure or your Land Rover Dealership for more information.

Engine and Transmission

2.2 LITRE DIESEL

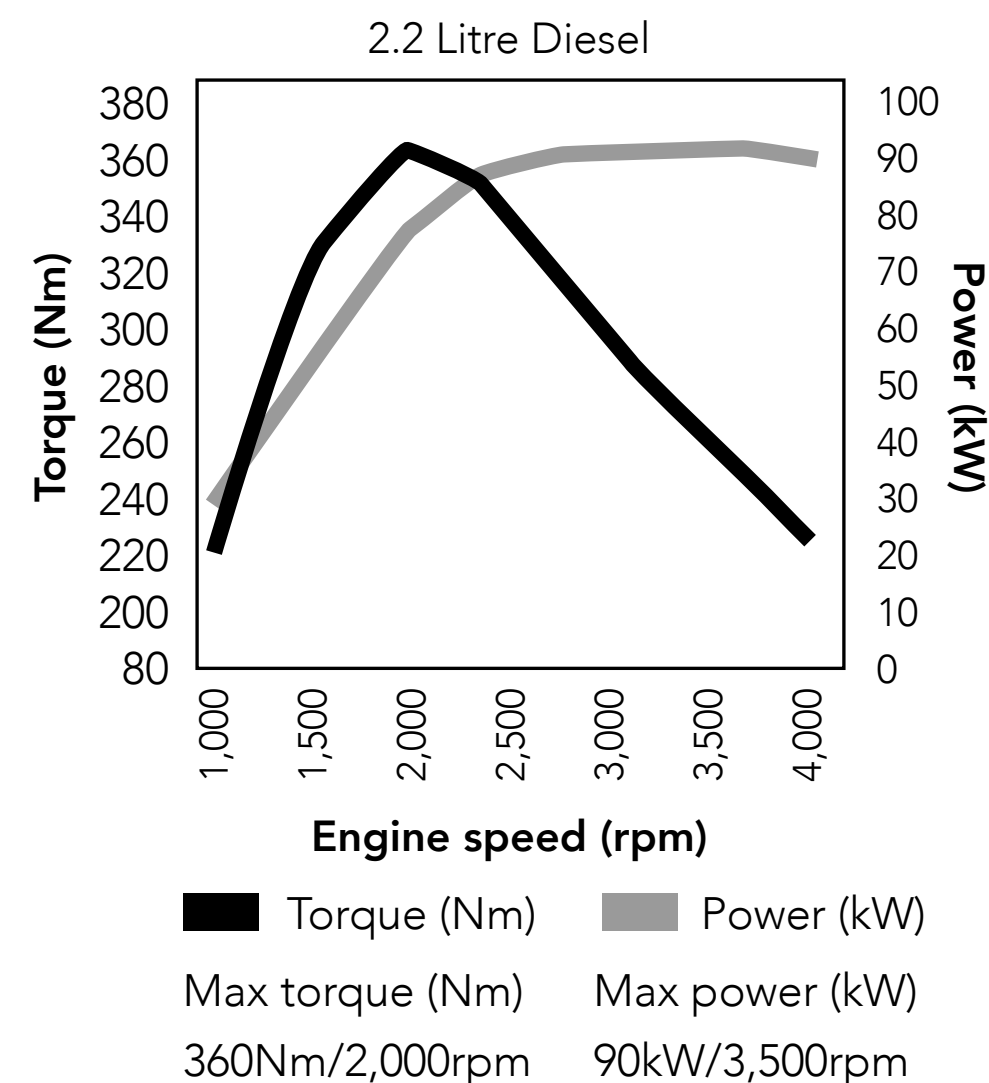

ENGINE DATA

Location	Longitudinal
Capacity (cc)	2,198
No. of cylinders	4
Valves per cylinder	4
Cylinder layout	North-South
Bore (mm)	86
Stroke (mm)	94.6
Compression ratio (:1)	15.64
Cylinder head material	Aluminium
Cylinder block material	Cast Iron
Maximum power kW (PS) @ rpm	90 (122) @ 3,500
Maximum torque Nm @ rpm	360 @ 2,000

FUEL TANK CAPACITY	90	90 SW	110	130
Litres	60	60	75	75

FUEL ECONOMY	90	90 SW	110	130
Urban mpg (L/100km)	24.6 (11.5)	24.1(11.7)	20.8 (13.6)	20.8 (13.6)
Extra Urban mpg (L/100km)	31.0 (9.1)	30.1 (9.4)	29.1 (9.7)	29.1 (9.7)
Combined mpg (L/100km)	28.3 (10.0)	27.7 (10.2)	25.5 (11.1)	25.5 (11.1)
Drive by noise	75dB (A)	75dB (A)	75dB (A)	75dB (A)
CO ₂ Combined emissions (g/km)	266	269	295	295
Certifiable emissions	EU5	EU5	EU5	EU5
Maximum speed mph (kph)	90 (145)	90 (145)	90 (145)	90 (145)
Acceleration 0-60mph in seconds	14.7	14.7	14.7	15.7
Acceleration 0-100kph in seconds	15.8	15.8	15.8	17

The figures provided are as a result of official manufacturer's tests in accordance with EU legislation. A vehicle's actual fuel consumption may differ from that achieved in such tests and these figures are for comparative purposes only. Vehicles are not individually tested, and there are inevitably differences between individual vehicles of the same model. Furthermore, the incorporation of particular modifications, the driver's style and road traffic conditions, as well as the extent to which the vehicle has been driven and the standard of maintenance will all affect its fuel consumption.

ENGINE

MODELS

COLOURS

WHEELS

INTERIORS

OPTIONS

TECHNICAL DETAILS

ACCESSORIES



ABOVE & BEYOND

> FIND A DEALERSHIP

> BUILD YOUR OWN

OVERVIEW

SPECIFICATION

TECHNICAL SPECIFICATION, PERFORMANCE AND KEY DATA

Load Capabilities

TOWING (KG)

	90	110	130
Braked trailer	3,500	3,500	3,500
Unbraked trailer	750	750	750
Recommended max. trailer nose weight	150	150	150
Effect on rear axle weight	201	204 (HCPU 215)	206

MAXIMUM AXLE (KG)

	90	110	130
Front axle	1,250	1,250	1,580
Rear axle	1,500	1,980	2,200
Gross vehicle weight	2,505	3,050	3,380

ROOF LOAD SYSTEM (KG)

	90/110/130
Roof rack	150
Ladder rack	150
Approved Land Rover Genuine Parts roof rack. Weight shown is maximum load, includes roof rack.	

Suspension

	90	110	130 HEAVY DUTY
Front	Live beam axle, linear rate coil springs, coaxial telescopic Nitrogen-charged hydraulic dampers. Panhard rod and Radius arms. Anti-roll bar.	Live beam axle, dual rate coil springs, coaxial telescopic Nitrogen-charged hydraulic dampers. Panhard rod and Radius arms. Anti-roll bar.	Live beam axle, linear rate coil springs, coaxial telescopic Nitrogen-charged hydraulic dampers. Panhard rod and Radius arms. Anti-roll bar.
Rear	Live beam axle, dual rate coil springs, telescopic Nitrogen-charged hydraulic dampers. 'A' frame and Trailing Links. Anti-roll bar.	Live beam axle, triple rate coil springs, telescopic Nitrogen-charged hydraulic dampers. 'A' frame and Trailing Links. Anti-roll bar.	Live beam axle, triple rate coil springs, coaxial linear rate helper springs, telescopic Nitrogen-charged hydraulic dampers. 'A' frame and Trailing Links. Anti-roll bar.

Weights (kg)

	90			110					130				
STANDARD	Pick Up	Hard Top	Station Wagon	Pick Up	High Capacity Pick Up	Hard Top	Station Wagon 5 seat/7 seat	Utility Wagon	Double Cab Pick Up	Chassis Cab	Double Cab HCPU	Chassis Cab	Double Cab Chassis
Gross vehicle	2,505	2,505	2,505	3,050	3,050	3,050	3,050/3,050	3,050	3,050	3,050	3,380	3,500	3,380
Minimum kerb weight*	1,765	1,786	1,902	1,921	1,942	1,969	2,064/2,125	2,064	2,046	1,791	2,153	1,862	2,028
Maximum payload**	740	719	603	1,129	1,108	1,081	986/925	986	1,004	1,259	1,227	1,638	1,352

*Minimum kerb weight = Unladen weight + full tank and 75kg allowance for driver **Maximum payload = GVW – Kerb weight

Visit landrover.co.uk for more information.

ENGINE

MODELS

COLOURS

WHEELS

INTERIORS

OPTIONS

TECHNICAL DETAILS

ACCESSORIES



ABOVE & BEYOND

> FIND A DEALERSHIP

> BUILD YOUR OWN

OVERVIEW

SPECIFICATION



ENGINE

MODELS

COLOURS

WHEELS

INTERIORS

OPTIONS

TECHNICAL DETAILS

ACCESSORIES



ABOVE & BEYOND

> FIND A DEALERSHIP

> BUILD YOUR OWN

OVERVIEW

SPECIFICATION

The Defender was born to explore. Add this collection of accessories to make the most of every moment, whether you're discovering the UK under canvas or driving across continents on a challenging off-road expedition.



Expedition Roof Rack System*

VPLDR0063 – 90 Hard Top/Station Wagon
VPLDR0064 – 110 Hard Top/Station Wagon (not shown)
VPLDR0065 – 110/130 Double Cab (not shown)

Heavy duty rack system secured by clamps to the roof gutter.



Two Part Rear Access Ladder
AGP710010

For use with Expedition Roof Racks VPLDR0063 and VPLDR0064.



Ribbed Aluminium Undershield
LR008247

Helps to provide under-engine protection when driving off-road.



Black Leather Hand Brake, Gear and Transfer Lever Gaiters
VPLDS0258

Grained Leather Gaiter covers detailing ebony coloured twin stitch features.



Moulded Wheel Cover
STC7889

Styled spare wheel cover fits most wheel sizes.



Cargo Barrier**

Designed to help prevent cargo and luggage from entering the passenger compartment. Manufactured in Black nylon coated steel and easy to remove when not required. Please note: ECE R17 compliant.

LR006785* – Cargo Barrier – 90/110HT (not shown)

LR006447 – Cargo Barrier – 110SW

LR006448* – Cargo Barrier – 90SW (not shown)

*Maximum permissible load capacity minus the weight of the roof mounted accessory.

**Sports Bar System (STC7582) is required for all Land Rover roof-mounted accessories.

ENGINE

MODELS

COLOURS

WHEELS

INTERIORS

OPTIONS

TECHNICAL DETAILS

ACCESSORIES



ABOVE & BEYOND

> FIND A DEALERSHIP

> BUILD YOUR OWN

OVERVIEW

SPECIFICATION

Whatever your sport, this collection of invaluable accessories converts your Defender to the ultimate sports vehicle and gives you all the extra storage space you need for your kit.



Side Protection Runners – Twin Tube*

VPLDP0006 – Stainless Steel – Defender 90

VPLDP0067 – Black Finish – Defender 110SW and Double Cab (not shown)

VPLDP0068 – Black Finish – Defender 90SW (not shown)



**Raised Air Intake
LR008383**

Ideal for dusty conditions, this raised air intake secures to the vehicle's 'A' post and also utilises the existing air intake vent fixings. Suitable for Td5, 2.4 and current 2.2 diesel engines.

Please note: Not compatible with SVX Soft Top model.



Sports Bar System
STC7582**

A high leg design which extends the carrying potential for a variety of equipment. The sports bars can accommodate a range of attachments, including roof boxes and special carriers for various sports equipment. Vehicle height when fitted 2,088mm (90SW) and 2,141mm (110SW). Maximum payload 75kg**.



Luggage Box
VPLVR0062**

Opens from both sides. Lockable for security. Volume 410 litres. Maximum payload 75kg**.



**Folding Side Step
STC7631**

Spring-loaded folding step helps makes access to the interior of your Defender easier. Supplied with fitting kit. For all Defender models.



Rear Step Bumper

Makes access to the loadspace easy as well as helping to provide added protection from minor knocks, and also incorporates a dual height tow bracket.

STC50269AA – Defender 90

STC50301 – Defender 110 (not shown)

*Maximum permissible load capacity minus the weight of the roof mounted accessory.

**Sports Bar System (STC7582) is required for all Land Rover roof-mounted accessories.

ENGINE

MODELS

COLOURS

WHEELS

INTERIORS

OPTIONS

TECHNICAL DETAILS

ACCESSORIES



ABOVE & BEYOND

> FIND A DEALERSHIP

> BUILD YOUR OWN

OVERVIEW

SPECIFICATION

If you need your Defender to be ready for the toughest tasks, you'd do well to order this collection of accessories which includes a powerful winch and essential floodlight.



**9.5CTI Electric Winch
VPLDP0113**

Rated capacity of 9,500lb/4,310kg. 38 metres x 8mm diameter wire rope. This powerful electric winch is designed to fit easily to the front of your Defender, even if the air conditioning option is fitted. Offering maximum reliability for all general winching and self recovery requirements, the winch is available as a complete vehicle kit, ensuring specification and installation are straightforward.



Chequer Plate Protection Kit

Features sill edge and rear corner protectors and two front bumper step plates.
STC50245 – Defender 90SW, Silver
STC50381 – Defender 110SW – except HCPU – Silver (not shown)
Please note: Front bumper step plates are not compatible with PIAA Driving Lamp Kit (LR006815).



Wing Top Protectors

Manufactured in an aluminium chequer plate design, these enable access to roof racks and a potential viewing height advantage.
LR005230 – Silver (2007 Model Year vehicles onwards)



**Worklight
RTC8921AA**

Enables your Defender to provide floodlight style illumination when working in reduced lighting conditions. Fits both 90 and 110 models. Switches, cables and brackets are supplied in the kit.



**A-Frame Protection Bar – Non winch version
VPLPP0060†**

**A-Frame Protection Bar – Winch version (not shown)
VPLPP0061†**

Manufactured from durable polymer, suitable for models with or without air conditioning.



**Front Mudflaps
RTC9479**

Heavy duty moulded Mudflaps reduce spray and help protect vehicle paintwork. Mudflaps, front pair for 90 and 110 models only.

†Compliant to EEC Directive 2005/66.

To view the full range of accessories and prices please ask your retailer for an accessory brochure. Alternatively visit accessories.landrover.com

ENGINE

MODELS

COLOURS

WHEELS

INTERIORS

OPTIONS

TECHNICAL DETAILS

ACCESSORIES



ABOVE & BEYOND

> FIND A DEALERSHIP

> BUILD YOUR OWN

OVERVIEW

SPECIFICATION

Choose this range of accessories to give your Defender a stylish, sporty finishing touch and add a little luxury to every trip and bike carrier.



Style Valve Caps

- LR027560 – Land Rover
- LR027664 – Union Jack
- LR027666 – Black Jack



Union Flag Bonnet and Side Decals
VPLDB0146LKH – Corris Grey

Union Flag Bonnet and Side Decals offer an exterior styling upgrade with a distinctively British twist. Tested to exacting Land Rover standards to ensure resistance to fading or peeling over time. Recommended exterior colour combinations: Corris Grey Decals with Santorini Black, Fuji White or Indus Silver body colours. Santorini Black Decals with Corris Grey body colour.



Union Flag Side Decal - Corris Grey



Side Protection Runners

- LR008379 – Black Finish – Defender 90
 - LR008375 – Black Finish – Defender 110 (not shown)
- The sturdy steel design enhances the appearance of your Defender as well as helping to ease entry and exit. The moulded rubber footgrips help to ensure non-slip stability.



Ebony Black Carpet Mat Set With Silver Land Rover Ingot*
VPLDS0240

Includes mats for the front and folding middle/rear seat footwells. The carpet mats have matching ebony suede effect piping and a silver Land Rover ingot. These durable mats come fitted with protective rubber backing.

Ebony Black Carpet Mats With Silver Land Rover Ingot – Front*
VPLDS0241

Ebony carpet mat for the front seat footwells only.



Recaro Front Seat Kit

- VPLDS0036PUY – Left-hand seat
 - VPLDS0035PUY – Right-hand seat (not shown)
- Heated seat with cloth seat facings and leather surround, featuring Land Rover and Recaro embossed logos. Installation kit included. Not compatible with vehicles fitted with a bulkhead or 90 bulkhead deleted vehicles with jack stowage brackets behind the front seats. Applicable VIN WA138480 110SW, 110 and 130 Double Cab and 9A773310 90 vehicles with bulkhead deleted. Compatible with vehicles fitted with heated seat option. Supplied individually.

*Only available with carpet flooring option.

ENGINE

MODELS

COLOURS

WHEELS

INTERIORS

OPTIONS

TECHNICAL DETAILS

ACCESSORIES



ABOVE & BEYOND

> FIND A DEALERSHIP

> BUILD YOUR OWN

OVERVIEW

SPECIFICATION



Tow Ball**
RTC8891AA
50mm Tow Ball.



Adjustable Tow Bar**
Copes with different trailer coupling heights without the need for any tools and comprises of a towing armature, sliding plate and security pin.
LR007221 – Defender 90
LR007222 – Defender 110 (not shown)
LR007223 – Defender 130 and 110 HCPU (not shown)



13 Pin Towing Electrics†
LR005919
European style towing electrics, capable of supplying all trailer rear lighting and interior equipment power, including fridge feed and battery charging.



Combination Tow Ball/Jaw Unit**
LR008244
50mm tow ball and jaw combination for increased towing versatility and a 3,500kg capacity.

*Only available with carpet flooring option.

For information go to **load capabilities.

†These accessories are not suitable for Caravans, Trailers or Lighting Boards fitted with rear mounted LED Lamps.

Visit landrover.co.uk for more information.



Multi-height Tow Bar**
This cost-effective design gives a range of towing heights to suit different trailers and contains a towing armature, multi-height face plate and 50mm tow ball.
VPLDT0084 – Defender 90
VPLDT0085 – Defender 110 (except HCPU) (not shown)
VPLDT0086 – Defender 130 and HCPU



'S' Type Towing Electrics†
LR005921 – (shown above, left-hand side)
For use when additional trailer power is required. Capable of supplying interior lighting and equipment power including fridge feed and battery charging. Please note: Not compatible with standard fitted 12N sockets. Must be used in conjunction with 'N' Type Towing Electrics LR005920.

'N' Type Towing Electrics†
LR005920 – (shown above, right-hand side)
Provides power for rear trailer lighting including rear lamps, brake lamps, direction indicators and high intensity fog lamp(s). Can also power a Lighting Board.

ENGINE

MODELS

COLOURS

WHEELS

INTERIORS

OPTIONS

TECHNICAL DETAILS

ACCESSORIES



ABOVE & BEYOND

> FIND A DEALERSHIP

> BUILD YOUR OWN

OVERVIEW

SPECIFICATION



ENGINE

MODELS

COLOURS

WHEELS

INTERIORS

OPTIONS

TECHNICAL DETAILS

ACCESSORIES



ABOVE & BEYOND

> FIND A DEALERSHIP

> BUILD YOUR OWN

OVERVIEW

SPECIFICATION



BY APPOINTMENT TO
HM THE QUEEN
MANUFACTURERS OF
MOTOR VEHICLES
JAGUAR LAND ROVER LIMITED
COVENTRY



BY APPOINTMENT TO
HRH THE DUKE OF EDINBURGH
MANUFACTURERS OF
MOTOR VEHICLES
JAGUAR LAND ROVER LIMITED
COVENTRY



BY APPOINTMENT TO
HRH THE PRINCE OF WALES
MANUFACTURERS OF
MOTOR VEHICLES
JAGUAR LAND ROVER LIMITED
COVENTRY

IMPORTANT NOTICE: Jaguar Land Rover Limited is constantly seeking ways to improve the specification, design and production of its vehicles and alterations take place continually. Whilst every effort is made to produce up to date literature, this brochure should not be regarded as an infallible guide to current specifications, nor does it constitute an offer for the sale of any particular vehicle. Distributors and retailers are not agents of Jaguar Land Rover Limited by any express or implied undertaking or representation.

All Land Rover Approved Accessories fitted by a Land Rover Retailer within one month or 1,600 kilometres/ 1,000 miles (whichever occurs first) of the handover of a new registered vehicle will benefit from the same warranty terms and period of cover as the vehicle warranty. Accessories purchased outside of these parameters will be subject to a 12 month unlimited mileage warranty. All Land Rover Approved Accessories are rigorously tested to the same exacting standards as those applied to our vehicles. Performance in extreme hot and cold temperatures, corrosion resistance, impact and airbag deployment highlight some of the exhaustive product testing carried out to ensure accessories are both durable and importantly, continue to comply with current legislation.

All our accessories are designed to be an integral part of Land Rover vehicles. While many items such as roof carriers are simple to fit, some products require specialist tools and diagnostic equipment to ensure correct integration with the vehicle structure and electrical systems. These products vary from market to market, please consult your Land Rover Retailer who will be pleased to advise you on current specifications and any query you may have.

The colours reproduced here are subject to the limitations of the printing process and may therefore vary slightly from the actual vehicle. The company reserves the right to alter or withdraw any colour finish without notice. Some of these colours may not be obtainable in your country. Please check availability of colours and current specifications with your Land Rover Retailer.

Castrol EDGE Professional exclusively recommended by Land Rover.

Jaguar Land Rover Limited Registered Office:

Abbey Road, Whitley, Coventry CV3 4LF

United Kingdom.

Registered in England and Wales: Number 1672070

landrover.co.uk

© Jaguar Land Rover Limited 2014.

Keep me informed



ENGINE

MODELS

COLOURS

WHEELS

INTERIORS

OPTIONS

TECHNICAL DETAILS

ACCESSORIES