



**IF IT DOESN'T SAY
BUSH HOG®
IT JUST WON'T CUT IT™**

MACHINE PRICE LIST & SPECIFICATIONS

PRICES F.O.B. FACTORY AND SUBJECT TO CHANGE WITHOUT NOTICE

Prices Effective January 1, 2021

Oklahoma Contract
SW0196 Effective 1-1-2021
Revised 10-1-2021

NOTEWORTHY UPDATES

NEW

Page 20 | SS3
BH210-2 SERIES
SINGLE SPINDLES

NEW

Page 24 | SS7
BH310-2 SERIES
SINGLE SPINDLES

NEW

Page 27 | SS10
BH416-1Z | BH417-1Z
GALVANIZED SINGLE SPINDLES

NEW

Page 29 | SS12
BH516-1Z GALVANIZED
SINGLE SPINDLES

NEW

Page 34 | MS3
2208 SERIES
ROTARY CUTTER

NEW

Page 43 | MS12
3510 LIFT AND SEMI-
MOUNT HD AXLE ARMS
(PAIR) WITH 20.5"
PNEUMATIC AIRCRAFT TIRES

NEW

HYDRAULIC HOSE SELECTION
ON 15' FLEX-WINGS

NEW

Page 157 | SB4
SBPT/PULL TYPE SERIES
NEW SNOW BLOWER MODELS

NEW

Page 161 | SB8
SBLM/LOADER MOUNTED
NEW SNOW BLOWER SERIES

Agriculture, Trees, and
Brush Maintenance
Equipment & Repair
Services

[GO TO IMPORTANT NOTICE](#)

[GO TO INDEX](#)



[RETURN TO INDEX](#)

IMPORTANT NOTICE

Prices shown in this book are list prices and do not include freight, setup, or handling unless specifically noted. Shipping weights listed in this book are approximate and include crating or skids where applicable. All prices are F.O.B. factory; freight shipments arranged by Bush Hog® will be per the published rate chart and subject to change. Bush Hog® reserves the right to ship items via motor freight collect at its discretion. Dealers should reference their whole good invoices and billing statements for freight amount and due dates.

Prices, terms, and discounts are subject to change without notice. Orders placed will be accepted based on the price in effect at the time of shipment unless otherwise specified. Prices shown in this book do not include any applicable federal, provincial, state, or local taxes, or levies.

Machines included in this price book conform to safety standards applicable to the products at the time of manufacture and may include safety devices such as shields, guards, or operator protective devices. Under no circumstances should machines be operated without the safety devices in place.

This document is confidential and is for use by authorized Bush Hog® dealership personnel only. It is not to be distributed for any purpose other than selling Bush Hog® branded products.

Bush Hog® reserves the right to make changes and/or improvements in design and construction of parts or machines shown herein without notice or obligation.

ROTARY CUTTER OR FLAIL MOWER THROWN OBJECT PROTECTION

Bush Hog offers three types of shielding to protect the operator, passersby, livestock, and property from mower thrown objects: deflectors, single chain guards, and double chain guards. Shielding should be selected based on the intended use of the mower. Double chain guards or deflectors should be used for highway, right-of-way, parks, or greenbelt mowing or other mowing where human dwellings, vehicles, or livestock could be within 300 feet of the mower. Chain guards are more durable, provide longer service life, and require less maintenance than deflectors. Single chain guards should be sufficient for agricultural and other mowing where passersby or property are not within 300 feet of the mower during operation.

No shielding is completely effective in preventing thrown objects. The possibility of injury or property damage from this hazard can be substantially reduced by selecting proper shielding, maintaining the mower and shielding in good operating condition, inspecting the area for foreign debris before mowing, operating the mower at a minimum cutting height of 4", and keeping people at least 300 feet from the mower at all times during operation.

BUSH HOG® GUARANTEES EACH PIECE OF EQUIPMENT AGAINST DEFECTIVE MATERIALS AND WORKMANSHIP FOR A PERIOD OF ONE YEAR FROM DATE OF DELIVERY UNLESS OTHERWISE NOTED.

INDEX OF PRODUCTS

FINISHING MOWERS

| | | |
|--|------------|----------|
| HDTH Series Rear Discharge Finishing Mower | FM1 | 4 |
| TDC Series Tri-Deck Finish Mower | FM3 | 6 |

ZERO TURN MOWERS

| | | |
|---|-----|----|
| HDE-4 Estate Series Zero Turn Mower | ZT1 | 10 |
| HDC-4 Commercial Series Zero Turn Mower | ZT3 | 12 |
| HDZ-4 Professional Series Zero Turn Mower | ZT5 | 14 |

DISCONTINUED

SINGLE-SPINDLE ROTARY CUTTERS

| | | |
|---|-------------|-----------|
| BH100 Series Rotary Cutter | SS1 | 18 |
| BH215-2 Series Rotary Cutter | SS3 | 20 |
| BH216-2 Series Rotary Cutter | SS3 | 20 |
| BH217-2 Series Rotary Cutter | SS5 | 22 |
| BH315-2 Series Rotary Cutter | SS7 | 24 |
| BH316-2 Series Rotary Cutter | SS7 | 24 |
| BH317-2 Series Rotary Cutter | SS7 | 24 |
| BH416 Series Rotary Cutter | SS10 | 27 |
| BH417 Series Rotary Cutter | SS10 | 27 |
| BH516 Series Rotary Cutter | SS12 | 29 |

MULTI-SPINDLE RIGID DECK ROTARY CUTTERS

| | | |
|--|------------|-----------|
| SQ84T Squealer Series Twin Spindle Rotary Cutter | MS1 | 32 |
| 2208 Series Rotary Cutter | MS3 | 34 |
| 2310 Series Rotary Cutter | MS5 | 36 |
| 3308-2 Series Rotary Cutter | MS7 | 38 |
| 3308SH-2 Series Rotary Cutter | MS9 | 40 |
| 3510 Series Rotary Cutter | MS11 | 42 |
| 3514 Series Rotary Cutter | MS13 | 44 |
| 14215 Series Rotary Cutter | MS15 | 46 |

FLEX-WING ROTARY CUTTERS

| | | |
|--|------|----|
| 1812 Series Flex-Wing Rotary Cutter | FW1 | 48 |
| 1815 Series Flex-Wing Rotary Cutter | FW3 | 50 |
| 2215 Series Flex-Wing Rotary Cutter | FW5 | 52 |
| 2810CD Contractor Series Flex-Wing Rotary Cutter | FW7 | 54 |
| 2815 Contractor Series Flex-Wing Rotary Cutter | FW9 | 56 |
| 3810HD Contractor Series Flex-Wing Rotary Cutter | FW11 | 58 |
| 3815 Contractor Series Flex-Wing Rotary Cutter | FW13 | 60 |
| 4815 Contractor Series Flex-Wing Rotary Cutter | FW15 | 62 |
| 2814 Series Flex-Wing Rotary Cutter | FW17 | 64 |
| 2820 Series Flex-Wing Rotary Cutter | FW19 | 66 |

FLAIL SHREDDERS

| | | |
|---|-----|----|
| BRC115 Series Row Crop Flail Shredder | FS1 | 70 |
| BRC118 Series Row Crop Flail Shredder | FS1 | 70 |
| BRC120 Series Row Crop Flail Shredder | FS3 | 72 |
| BRC125 Series Row Crop Flail Shredder | FS5 | 74 |

BOOM MOWERS

| | | |
|---|------------|-----------|
| Rear-Mounted Boom Mower Series | BM1 | 78 |
| Forward Reach Rear-Mounted Boom Mower Series | BM4 | 81 |

CONSTRUCTION

| | | |
|---|------|-----|
| DSP Series Pull Dirt Scraper | CS1 | 86 |
| PHD Series Post Hole Digger | CS3 | 88 |
| PHDHF Farm-Ranch Series Post Hole Digger | CS5 | 90 |
| PHDHC Construction-Contractor Series Post Hole Digger | CS7 | 92 |
| XD Series Backhoe | CS11 | 96 |
| AGR Series Ag Grapple | CS13 | 98 |
| BGR Series Bucket Grapple | CS14 | 99 |
| BRGR Series Brush Grapple | CS14 | 99 |
| PF48 Series Pallet Fork | CS15 | 100 |

LANDSCAPE

| | | |
|--|------|-----|
| CRB Series Compact Rear Blade | LS1 | 102 |
| CBX Series Compact Box Blade | LS1 | 102 |
| CLR Series Compact Landscape Rake | LS2 | 103 |
| CRG Series Compact Road Grader | LS2 | 103 |
| CPG CPA Series Compact Plugger and Aerator | LS3 | 104 |
| 35 Series Rear Mount Medium Blade | LS4 | 105 |
| 50 Series Rear Mount Medium Blade | LS5 | 106 |
| 70 Series Medium Duty Blade | LS6 | 107 |
| 91 Series Medium Duty Blade | LS7 | 108 |
| 100 Series Heavy Duty Blade | LS8 | 109 |
| 141 Series Heavy Duty Blade | LS9 | 110 |
| 160 Series Heavy Duty Blade | LS10 | 111 |
| 181 Series Heavy Duty Blade | LS11 | 112 |
| 225/300 Series Heavy Duty Blade | LS12 | 113 |
| LLR Series Economy Landscape Rake | LS13 | 114 |
| MLR Series Medium Duty Landscape Rake | LS13 | 114 |
| BBX Series Box Blade | LS14 | 115 |
| SBX Series Box Blade | LS15 | 116 |
| MBX Series Box Blade | LS16 | 117 |
| RBX Series Retractable Shank Box Blade | LS17 | 118 |
| RO Series Roll-Over Box Blade | LS17 | 118 |
| RG Series Road Grader | LS18 | 119 |
| HDRG Series Heavy Duty Road Grader | LS19 | 120 |
| PV Series Pulverizer | LS20 | 121 |
| PG & MPG Series Plugger Core Type Aerator | LS21 | 122 |
| FSP Series Fertilizer Spreader | LS22 | 123 |
| MS Manure Spreader | LS23 | 124 |
| CP Series Cultipacker | LS24 | 125 |
| Quick Hitches | LS25 | 126 |

TILLAGE

| | | |
|---|------|-----|
| RTC Series Rotary Tiller | TL1 | 128 |
| RTG Series Rotary Tiller | TL2 | 129 |
| RTX Heavy Duty Rotary Tiller | TL4 | 131 |
| Lift Disc Harrow Series | TL5 | 132 |
| DHP Series Pull Disc Harrow | TL11 | 138 |
| APP Series All Purpose Plow | TL13 | 140 |
| HDS5 Series Heavy Duty Subsoiler | TL14 | 141 |
| SS1 Series Subsoiler, LP Series Layoff Plow, IRCV Series Cultivator | TL15 | 142 |
| PA Series Pasture Aerator | TL16 | 143 |

HAY TOOLS

| | | |
|--|-----|-----|
| DHM Hay Mower | HT1 | 146 |
| HT Hay Tedder | HT2 | 147 |
| XLRR-I Series Pull-Type V-Rake | HT3 | 148 |
| EWR Series Pull Type Wheel V-Rake | HT4 | 149 |
| 3PB Series 3-PT Hay Spears | HT5 | 150 |
| 3PB Series 3-PT Bale Unroller | HT5 | 150 |
| BS Series Tractor-Mounted Bale Spear | HT6 | 151 |

SNOW BLOWERS

| | | |
|--|------------|------------|
| SBSA Series 54"-60" Single Auger Snow Blower | SB1 | 154 |
| SBSA Series 72"-97" Single Auger Snow Blower | SB2 | 155 |
| SBDA Series Double Auger Snow Blower | SB3 | 156 |
| SBPT Series Pull Type Snow Blower | SB4 | 157 |
| SBSS Series Skid Steer Snow Blower | SB6 | 159 |
| SBL Series Loader Mount Snow Blower | SB8 | 161 |

WHEEL & TIRE SELECTION GUIDE

| | | |
|--|--------------|------------|
| 294, 97708, 50050727, 50068834 | TIRE1 | 162 |
| 50072403, 50074504, 50074505, 50075401 | TIRE2 | 163 |
| 50078502, 500BH | TIRE3 | 164 |

*Limited Availability

Blue Text Denotes New Products



[RETURN TO INDEX](#)

FINISHING MOWERS

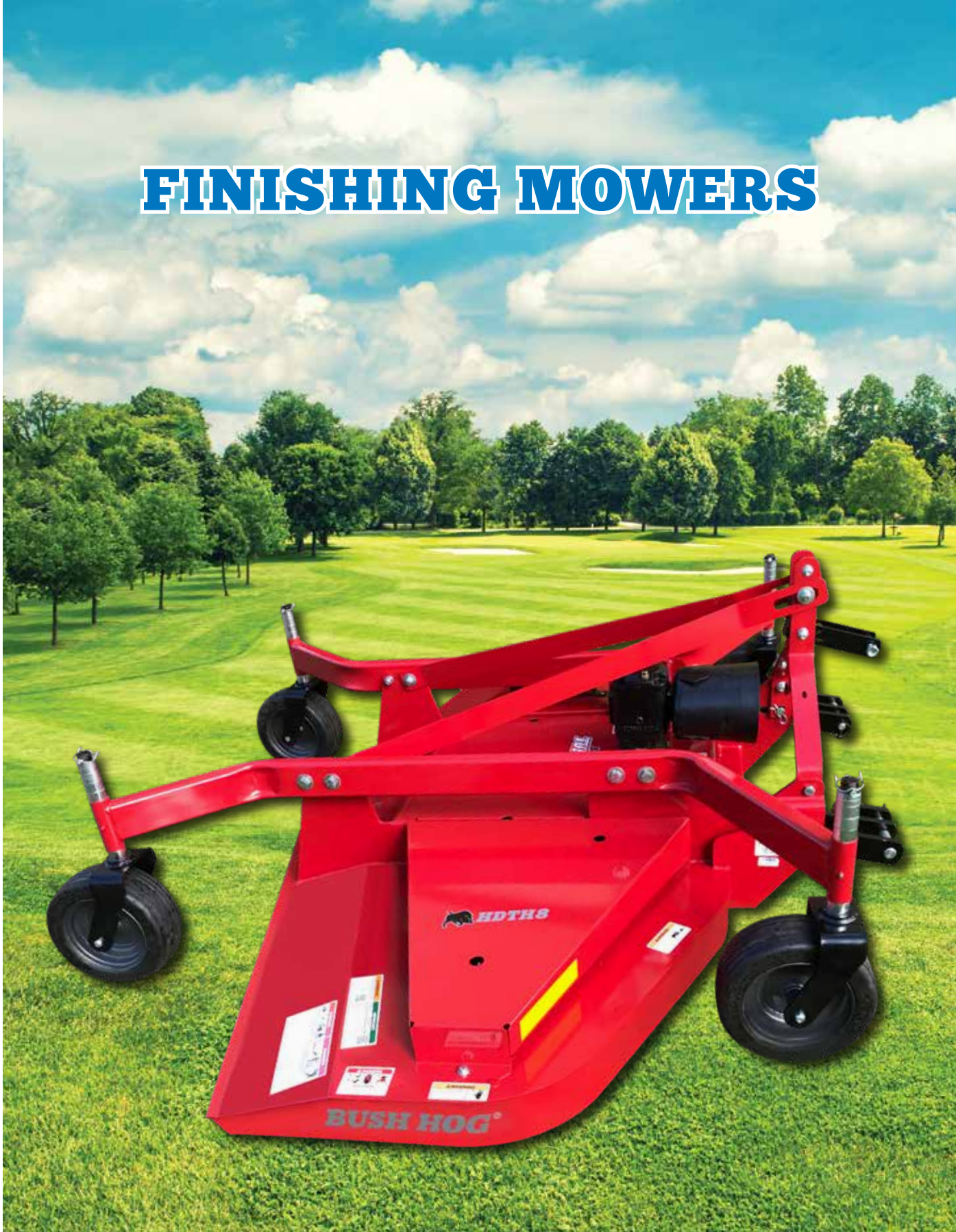

FINISHING MOWERS

RETURN TO INDEX



HDTH SERIES FINISHING MOWER

| MODEL | HDTH5 | HDTH6 | HDTH7 | HDTH8 |
|--|------------------------|------------------|--------------------|------------------------|
| Cutting Width | 60" | 72" | 84" | 99" |
| Cutting Height (1/2" incr.) | 1/2" - 6½" | 1½" - 6½" | | |
| Minimum Tractor PTO HP | 15 | 20 | 30 | 35 |
| Hitch | Cat 1 Std & QH | | Cat 1, 2, Std & QH | |
| Blade Size | 1/4" x 2½" x 21" | 1/4" x 2½" x 25" | 5/16" x 2½" x 29" | 1/4" x 2½" x 21" |
| Number of Blades | 3 | | | 5 |
| Blade Tip Speed | 18,231 FPM | 18,272 FPM | 18,266 FPM | 18,266 FPM |
| Blade Overlap | 1½" | | | |
| Blade Uplift | Parallel | | | |
| Driveline | ASAE Category 3 | | | |
| Front Roller (optional) | 3" x 5" | | | 3" x 13" |
| Discharge | Rear | | | |
| Deck Thickness | 7 Gauge | | | |
| Tire Size (solid) | 3¼ x 10 | | 4 x 10 | 5 x 13 |
| Belts | (1) B Size Aramid Cord | | | (2) B Size Aramid Cord |
| Belt Adjustment | Spring-Loaded Idler | | | |
| Gearbox | 45 HP | | 55 HP | |
| Approx. Weight | 672 lb. | 730 lb. | 954 lb. | 1,190 lb. |
| Five-Year Limited Gearbox Warranty. | | | | |

*Gearbox rating based on field performance.

HOW TO ORDER:

The Base Unit Selection for the HDTH Finish Mowers comes as a complete unit.

Freight NOT included in list price



RETURN TO INDEX

| All models are available in the colors below: | |
|---|------------------|
| Model Color Indicator | Unit Color |
| R | Bush Hog Red |
| G | John Deere Green |
| O | Kubota Orange |
| B | New Holland Blue |

HDTH SERIES FINISHING MOWER

BASE UNIT SELECTION

| Model Number | Description | Approx. Wt. | List Price (\$US) |
|--------------|--|-------------|-------------------|
| HDTH5R | HDTH Finishing Mower, Bush Hog Red, 5' | 672 lb. | \$3,408 |
| HDTH5G | HDTH Finishing Mower, John Deere Green, 5' | 672 lb. | \$3,408 |
| HDTH5O | HDTH Finishing Mower, Kubota Orange, 5' | 672 lb. | \$3,408 |
| HDTH5B | HDTH Finishing Mower, New Holland Blue, 5' | 672 lb. | \$3,408 |
| HDTH6R | HDTH Finishing Mower, Bush Hog Red, 6' | 730 lb. | \$3,911 |
| HDTH6G | HDTH Finishing Mower, John Deere Green, 6' | 730 lb. | \$3,911 |
| HDTH6O | HDTH Finishing Mower, Kubota Orange, 6' | 730 lb. | \$3,911 |
| HDTH6B | HDTH Finishing Mower, New Holland Blue, 6' | 730 lb. | \$3,911 |
| HDTH7R | HDTH Finishing Mower, Bush Hog Red, 7' | 954 lb. | \$4,887 |
| HDTH7G | HDTH Finishing Mower, John Deere Green, 7' | 954 lb. | \$4,887 |
| HDTH7O | HDTH Finishing Mower, Kubota Orange, 7' | 954 lb. | \$4,887 |
| HDTH7B | HDTH Finishing Mower, New Holland Blue, 7' | 954 lb. | \$4,887 |
| HDTH8R | HDTH Finishing Mower, Bush Hog Red, 8' | 1,190 lb. | \$6,687 |
| HDTH8G | HDTH Finishing Mower, John Deere Green, 8' | 1,190 lb. | \$6,687 |
| HDTH8O | HDTH Finishing Mower, Kubota Orange, 8' | 1,190 lb. | \$6,687 |
| HDTH8B | HDTH Finishing Mower, New Holland Blue, 8' | 1,190 lb. | \$6,687 |

OPTIONS

| Model Number | Description | List Price (\$US) |
|--------------|----------------------------------|-------------------|
| 50059787 | Front Roller Kit (HDTH5 & HDTH6) | \$73 |
| 50078559 | Front Roller Kit (HDTH7 & HDTH8) | \$104 |

RETURN TO INDEX

NEW
for
**Summer
2020**



TDC SERIES FINISHING MOWER

| MODEL | TDC-1200 | TDC-1500 | TDC-1700 |
|---------------------------------------|---|------------|------------|
| Cutting Width | 12' | 15' | 17' |
| Cutting Height (1/4" incr.) | 1" - 5" | | |
| Minimum Tractor PTO HP | 25 | 30 | 35 |
| Tractor PTO Speed | 540 | | |
| Hitch | Cat 1 & 2, Drawbar | | |
| Number of Blades Per Deck (Total) | 3 (9) | | |
| Blade Tip Speed | 15,747 FPM | 16,863 FPM | 16,732 FPM |
| Center Deck Cutting Width (ft.) | 5' | 6' | |
| Wing Deck Cutting Width (ft.) | 4' | 5' | 6' |
| Deck Overlap Adjustment (in.) | 6" | | |
| Degree of Cutting Attitude (Flex) | 30° Up / 15° Down | | |
| Deck Thickness | 8-Gauge Steel Plate | | |
| Splitter Gearbox HP | 80 HP | | |
| Mower Deck Gearbox HP | 50 HP | | |
| Deck Lift Cylinders (in.) | 2½" x 10" Single Acting | | |
| Main Driveline | Cat 6 Constant Velocity with Slip Clutch | | |
| Hydraulics | 3 - Single Action | | |
| Transport Width (ft.) | 7.6' | 8.1' | 8.3' |
| Transport Length (ft.) | 11.9' | 12.2' | 12.2' |
| Transport Height (ft.) | 6.2' | 7.7' | 8.7' |
| Overall Width (ft.) | 12.2' | 15.2' | 17.2' |
| Max. Overall Length (ft.) | 12.7' | 13' | 13' |
| Deflector Type | Rear Safety Chains Std | | |
| Transport Tires (2) / Deck Tires (12) | 20½ x 8 - 10 Highway Rated / 11 x 4.00 - 5NHS | | |

One-Year Limited Warranty.

HOW TO ORDER: The Base Unit Selection for the TDC Finish Mowers comes as a complete unit.

Freight NOT included in list price



RETURN TO INDEX

TDC SERIES FINISHING MOWER

BASE UNIT SELECTION

| Model Number | Description | Approx. Wt. | List Price (\$US) |
|--------------|-------------------------------|-------------|-------------------|
| TDC-1200 | TDC Series Rotary Cutter, 12' | 2,742 lb. | \$23,090 |
| TDC-1500 | TDC Series Rotary Cutter, 15' | 2,874 lb. | \$23,805 |
| TDC-1700 | TDC Series Rotary Cutter, 17' | 2,995 lb. | \$24,881 |

OPTIONS / SHIPPED SEPARATELY

| Model Number | Description | List Price (\$US) |
|--------------|---|-------------------|
| 50082150 | Mulching Kit TDC-1200, (Complete, 3 Units - Blades & Baffles) | \$1,239 |
| 50082151 | Mulching Kit TDC-1500, (Complete, 3 Units - Blades & Baffles) | \$1,357 |
| 50082152 | Mulching Kit TDC-1700, (Complete, 3 Units - Blades & Baffles) | \$1,478 |



RETURN TO INDEX



[RETURN TO INDEX](#)

ZERO-TURN MOWERS

DISCONTINUED



RETURN TO INDEX



ESTATE SERIES – 4

| | |
|-------------------------------|--|
| Deck Size | 49", 55" and 61" |
| Engine Options | Kohler 7000 Series, Kawasaki FS 651, Kohler 7000 Series+PRO Filtration |
| Drive System | Hydro-Gear® ZT3100™ Dual Hydrostats |
| Front Axle | Fixed |
| Brakes | Hydraulic Braking, Disc-Type Parking Brake |
| Steering Motor Control | Dampened Twin Levers, Adjustable, Lifted Vertically |
| Front Caster Tires | 13 x 6.5-6" Tubeless |
| Drive Tires | 23 x 10-10" Turf Tire Type |
| Speed | Infinitely Variable, 10 mph Forward, 0-4 mph Reverse |
| Blade Tip Speed | 18,000 fpm |
| Controls | Electronic Control Module with Access Start and System Monitoring and Soft-Start PTO Engage |
| Features | Molded-in Large Kohler and Storage Tray, Tethered Gas Tank Cap, Electronic Control Module |
| PTO | Electromagnetic Clutch Rated at 200 ft lb |
| Fuel Capacity | 8-Gallon Single-Center Mounted Tank |
| Standard Seat | Foam Padded Seat with Flip-Up Armrests and Seat Platform Elastic Isolators, Full-Suspension Seat Option Embroidered Bush Hog® Logo |
| Deck Construction | 7-Gauge Reinforced Steel |
| Deck Lift | Manual Foot Lift with Pin Out Height Selection |
| Blades | (3) 0.204 Inch Thick, Heat-Treated High Alloy Steel |
| Cutting Height | 1½" - 5", Adjustable in 1/4" Increments |
| Safety | Certified Operator Presence Controls, 2" Diamond Tube ROPS, and Seat Belt |
| Battery | 12 Volt, Rated 350 CCA |

DISCONTINUED

Three-Year Limited Residential Use Warranty (third year parts only). Lifetime Limited Warranty on deck weldment. See dealer for details. One-Year or 400 Hours Commercial Use Warranty.

*This model is designed to meet CARB exhaust emissions requirements.
 Full compliance with CARB requirements and availability to sell into California pending approval.
 **Engines are rated at 3600 RPM per SAE J1940 Gross
 ***Approved for use on US Forest Service Lands

HOW TO ORDER: The Bush Hog® HDE-4 Series Zero Turn Mower is available with a choice of 6 engine/deck combinations with 2 tire packages, and 2 seat selections. You must order from Group 1, Group 2 and Group 3 to receive a complete Zero Turn Mower. Add all prices for a total list price.

Freight IS included in list price



HDE-4 SERIES PRICES INCLUDE FREIGHT!

RETURN TO INDEX

HDE-4 SERIES ZERO TURN MOWER

BASE UNIT SELECTION

| Model Number | Description | Ship Wt. | List Price (\$US) |
|--------------|---|----------|-------------------|
| HDE2049KT4 | 20HP, Kohler, KT715, 49" Deck | 900 lb. | \$7,269 |
| HDE2249FS4 | 22HP, Kawasaki, FS615, 49" Deck | 900 lb. | \$7,409 |
| HDE2255FS4 | 22HP, Kawasaki, FS651, 55" Deck | 900 lb. | \$7,440 |
| HDE2555KP4 | 25HP, Kohler 7000 Series + Pro Filtration, 55" Deck | 900 lb. | \$7,560 |
| HDE2261FS4 | 22HP, Kawasaki, FS651, 61" Deck | 900 lb. | \$7,511 |
| HDE2561KP4 | 25HP, Kohler 7000 Series + Pro Filtration, 61" Deck | 900 lb. | \$7,648 |

GROUP 2 TIRE SELECTION

| Model Number | Description | List Price (\$US) |
|--------------|---------------------------|-------------------|
| 50077276 | Turf Tire 23 x 10.50 x 12 | \$226 |
| 50077277 | Bar Tire 23 x 10.50 x 12 | \$413 |

GROUP 3 SEAT SELECTION

| Model Number | Description | Ship Wt. | List Price (\$US) |
|--------------|--|----------|-------------------|
| 50081243 | Non-Suspension Seat with Iso. for Kit | 22 lb. | \$362 |
| 50081221 | Full-Suspension Seat with Iso. for Kit | 50 lb. | \$656 |

OPTIONS / SHIPPED SEPARATELY

| Model Number | Description | List Price (\$US) |
|--------------|--|-------------------|
| 50049014 | Mulching Kit for 49" Deck (Includes mulching blades) | \$230 |
| 50048625 | Mulching Kit for 55" Deck (Includes mulching blades) | \$265 |
| 50048626 | Mulching Kit for 61" Deck (Includes mulching blades) | \$301 |
| 50079750 | Seat Platform Isolator Kit (Below Serial Number 1HGLR1190700041) | \$77 |
| 50080566 | Assist Handle Kit (HDE-3 and earlier) | \$54 |
| 50081509 | Assist Handle Kit (HDE-4) | \$54 |
| 50080564 | Run Flat Front Tire Kit (2 wheels/tires) | \$206 |
| 50080572 | 5 Gallon Bucket Holder Kit (Bucket not included) | \$57 |
| 50080600 | String Trimmer Holder Kit (HDE-3 and earlier) | \$87 |
| 50081552 | String Trimmer Holder Kit (HDE-4) | \$87 |
| 50080783 | LED Light Kit | \$98 |
| 50081559 | Front Suspension Kit | \$254 |
| 50081545 | Jack and Mount Kit | \$91 |

Grass Collection System

Contact PECO at 1-800-438-5823 for pricing and availability information

RETURN TO INDEX



COMMERCIAL SERIES - 4

| | |
|-------------------------------|--|
| Deck Size | 61" |
| Engine Options | Kohler 7000 Series+PRO Filtration, Kawasaki FS691 |
| Drive System | Hydro-Gear® ZT3400™ Dual Hydrostats |
| Front Axle | Fixed |
| Brakes | Hydraulic Braking, Disc-Type Parking Brake |
| Steering Motor Control | Dampened Twin Levers, Adjustable Force, Aft and Vibrationally |
| Front Caster Tires | 13 x 6.5-6 - 4 Ply Tires |
| Drive Tires | 23 x 10.50 - 12 Ply Tires |
| Speed | Infinitely Variable 0-10 mph Forward, 0-4 mph Reverse |
| Blade Tip Speed | 8,000 fpm |
| Controls | Electronic Control Module, Mower Start and System Monitoring and Soft-Start PTO Engage |
| Features | Molded-in Lubrication, Beverage Holder and Storage Tray, Tethered Gas Tank Cap, Electronic Control Module, USB Port |
| PTO | Electromagnetic Clutch Rated at 200 ft lb |
| Fuel Capacity | 8-Gallon Single-Center Mounted Tank |
| Standard Seat | Deep Back, Vinyl Full-Suspension Seat with Flip-Up Armrests, Operator Weight Adjustment, Fore and Aft Adjustment, Embroidered Bush Hog® Logo |
| Deck Construction | 7-Gauge Reinforced Steel |
| Deck Lift | Rotary Dial Height Adjustment with Transport Lock |
| Blades | (3) 0.204 Inch Thick, Heat-Treated High Alloy Steel |
| Cutting Height | 1½" - 5", Adjustable in 1/4" Increments |
| Safety | Certified Operator Presence Controls, 2" Diamond Tube ROPS, and Seat Belt |
| Battery | 12 Volt, Rated 350 CCA |

DISCONTINUED

**Three-Year Limited Residential/Commercial Use Warranty (third year parts only).
Lifetime Limited Warranty on deck weldment. See dealer for details.**

*This model is designed to meet CARB exhaust emissions requirements.
Full compliance with CARB requirements and availability to sell into California pending approval.
**Engines are rated at 3600 RPM per SAE J1940 Gross
***Approved for use on US Forest Service Lands

HOW TO ORDER: The Bush Hog® HDC-4 Zero Turn Mower comes standard with a full-suspension seat and is available with a choice of 2 engine/deck combinations, and 2 tire packages. You must order from Group 1 and Group 2 to receive a complete Zero Turn Mower. Add all prices for a total list price.

Freight IS included in list price



HDC-4 SERIES PRICES INCLUDE FREIGHT!

RETURN TO INDEX

HDC-4 SERIES ZERO TURN MOWER

BASE UNIT SELECTION

| Model Number | Description | Ship Wt. | List Price (\$US) |
|--------------|---|-----------|-------------------|
| HDC2361FS4 | 23HP, Kawasaki, FS691, 61" Deck | 1,050 lb. | \$10,274 |
| HDC2561KP4 | 25HP, Kohler 7000 Series + Pro Filtration, 61" Deck | 1,050 lb. | \$9,864 |

GROUP 2 TIRE SELECTION

| Model Number | Description | List Price (\$US) |
|--------------|---------------------------|-------------------|
| 50077276 | Turf Tire 23 x 10.50 x 12 | \$226 |
| 50077277 | Bar Tire 23 x 10.50 x 12 | \$413 |

OPTIONS / SHIPMENTS SEPARATELY

| Model Number | Description | List Price (\$US) |
|--------------|--|-------------------|
| 50048626 | Mulching Kit for 61" Deck (includes mulching blades) | \$301 |
| 50079750 | Seat Platform Operator Kit (Below Serial Number 1HGGR1190570012) | \$77 |
| 50079748 | Light Kit | \$77 |
| 50080566 | Assist Handle Kit (HDC-3 and earlier) | \$54 |
| 50081509 | Assist Handle Kit (HDC-4) | \$54 |
| 50080564 | Run Flat Front Tire Kit (2 wheels/tires) | \$206 |
| 50080572 | 5 Gallon Bucket Holder Kit (Bucket not included) | \$57 |
| 50080600 | String Trimmer Holder Kit (HDC-3 and earlier) | \$87 |
| 50081552 | String Trimmer Holder Kit (HDC-4) | \$87 |
| 50081559 | Front Suspension Kit | \$254 |
| 50081545 | Jack and Mount Kit | \$91 |

Grass Collection System

Contact PECO at 1-800-438-5823 for pricing and availability information

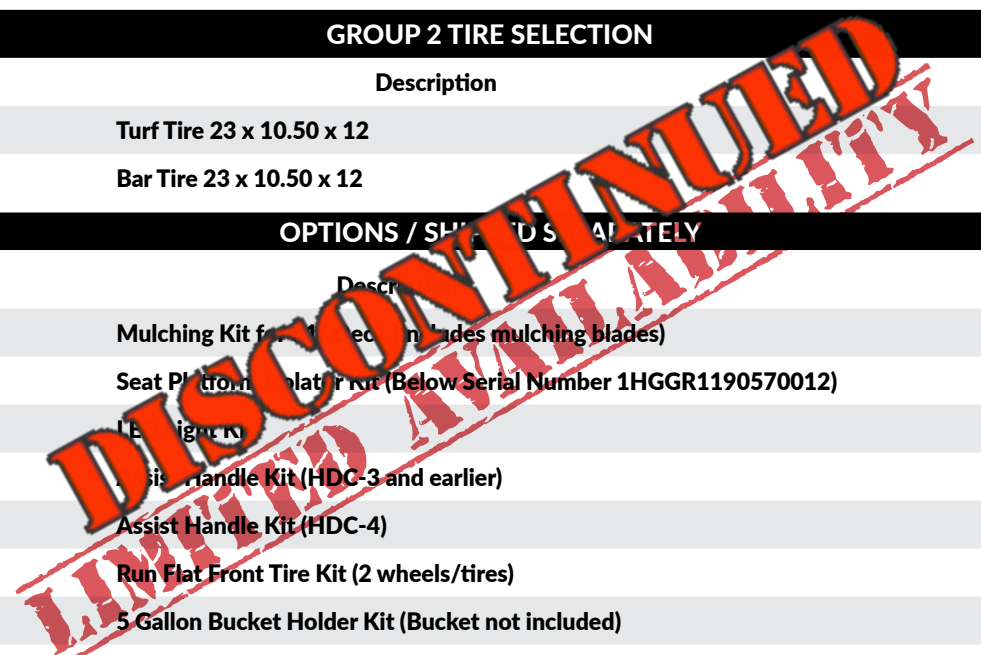

RETURN TO INDEX



PROFESSIONAL SERIES - 4

| | |
|-------------------------------|---|
| Deck Size | 55", 61" and 73" |
| Engine Options | Kawasaki FX921, Kohler EFI Command Pro |
| Drive System | Hydro-Gear® ZT5400™ Dual Hydrost |
| Front Axle | Fixed |
| Brakes | Hydraulic Braking, Disc-Type, Min |
| Steering Motor Control | Dampened Twin Levers, Adjustable Fore, Aft and Vertically |
| Front Caster Tires | 13 x 4.00-4-Pneum |
| Drive Tires | 12" Dual or Bar Type |
| Speed | Infinite Variable, 0-14 mph Forward, 0-4 mph Reverse |
| Blade Tip Speed | 18,000 fpm |
| Controls | Electronic Control Module/Keyless Start and System Monitoring and Soft-Start PTO Engage |
| Features | Molded-in Storage Beverage Holder and Storage Tray, Tethered Gas Tank Cap, USB Port, Electronic Control Module, LED Lights, Patent-Pending Front Suspension |
| PTO | Electromagnetic Clutch Rated at 200 ft lb |
| Fuel Capacity | 8-Gallon Single-Center Mounted Tank |
| Standard Seat | Deluxe High-Back, Vinyl Full-Suspension Seat with Flip-Up Armrests, Operator Weight Adjustment, Fore and Aft Adjustment, Embroidered Bush Hog® Logo |
| Deck Construction | 7-Gauge Reinforced Steel |
| Deck Lift | Rotary Dial Height Adjustment with Transport Lock |
| Blades | (3) 0.204 Inch Thick, Heat-Treated High Alloy Steel |
| Cutting Height | 1 1/2" - 5", Adjustable in 1/4" Increments |
| Safety | Certified Operator Presence Controls, 3" Diameter Round Tube ROPS, and Seat Belt |
| Battery | 12 Volt, Rated 350 CCA |

DISCONTINUED

**Three-Year Limited Residential/Commercial Use Warranty (third year parts only).
Lifetime Limited Warranty on deck weldment. See dealer for details.**

*This model does not meet CARB exhaust emissions requirements; Not available for sale in California
 **Engines are rated at 3600 RPM per SAE J1940 Gross
 ***Approved for use on US Forest Service Lands

HOW TO ORDER: The Bush Hog® HDZ-4 Zero Turn Mower comes standard with a full-suspension seat and is available with a choice of 9 engine/deck combinations and 2 tire packages. You must order from Group 1 and Group 2 to receive a complete Zero Turn Mower. Add all prices for a total list price.

Freight IS included in list price



HDZ-4 SERIES PRICES INCLUDE FREIGHT!

RETURN TO INDEX

HDZ-4 SERIES ZERO TURN MOWER

BASE UNIT SELECTION

| Model Number | Description | Ship Wt. | List Price (\$US) |
|--------------|--|-----------|-------------------|
| HDZ3155FX4 | 31HP, Kawasaki, FX921, 55" Deck LIMITED AVAILABILITY | 1,400 lb. | \$11,705 |
| HDZ3355ECV4 | 33HP, Kohler EFI Command Pro, 55" Deck LIMITED AVAILABILITY | 1,400 lb. | \$12,330 |
| HDZ3855ECV4 | 38HP, Kohler EFI Command Pro, 55" Deck LIMITED AVAILABILITY | 1,400 lb. | \$12,705 |
| HDZ3161FX4 | 31HP, Kawasaki, FX921, 61" Deck | 1,400 lb. | \$12,270 |
| HDZ3361ECV4 | 33HP, Kohler EFI Command Pro, 61" Deck | 1,400 lb. | \$12,900 |
| HDZ3861ECV4 | 38HP, Kohler EFI Command Pro, 61" Deck | 1,400 lb. | \$13,406 |
| HDZ3173FX4 | 31HP, Kawasaki, FX921, 73" Deck | 1,400 lb. | \$12,676 |
| HDZ3373ECV4 | 33HP, Kohler EFI Command Pro, 73" Deck | 1,400 lb. | \$13,306 |
| HDZ3873ECV4 | 38HP, Kohler EFI Command Pro, 73" Deck | 1,400 lb. | \$13,784 |

GROUP 2 SELECTION

| Model Number | Description | List Price (\$US) |
|--------------|-----------------------|-------------------|
| 50081550 | Radial Tire 24" x 12" | \$354 |
| 50077279 | Bar Tire 24" x 12" | \$464 |

OPTIONS / SHIPPED SEPARATELY

| Model Number | Description | List Price (\$US) |
|--------------|---|-------------------|
| 50048625 | Mulching Kit for 55" Deck (Includes mulching blades) | \$265 |
| 50048626 | Mulching Kit for 61" Deck (Includes mulching blades) | \$301 |
| 50052952 | Deck Caster Wheel Kit (61" deck only) | \$180 |
| 50080511 | Electric Actuator Kit (-2 and higher red models only) | \$544 |
| 50080566 | Assist Handle Kit (HDZ-3 and earlier) | \$54 |
| 50081509 | Assist Handle Kit (HDZ-4) | \$54 |
| 50080564 | Run Flat Front Tire Kit (2 wheels/tires) | \$206 |
| 50080573 | 5 Gallon Bucket Holder Kit (Bucket not included) | \$63 |
| 50080600 | String Trimmer Holder Kit | \$87 |
| 50081559 | Front Suspension Kit | \$254 |
| 50081545 | Jack and Mount Kit | \$91 |

Grass Collection System

Contact PECO at 1-800-438-5823 for pricing and availability information



[RETURN TO INDEX](#)



[RETURN TO INDEX](#)

SINGLE-SPINDLE ROTARY CUTTERS



SINGLE-SPINDLE ROTARY CUTTERS

RETURN TO INDEX



BH100 SERIES ROTARY CUTTER

| MODEL | BH114 | BH115 | BH116 |
|---|---|------------|------------|
| Cutting Width | 4' | 5' | 6' |
| Cutting Height | 2" - 11" | | |
| Cutting Capacity | 1" Diameter | | |
| Hitch | Cat. 1 Std; Quick Hitch Optional | | |
| Deck Thickness | 12 Gauge | | |
| Side Bands | "C" Channel, 10 Gauge x 8" | | |
| Gearbox Rating (HP) | 60* | | |
| Driveline | ASAE Category 3 | | |
| Driveline Protection | Slip Clutch or Shearpin | | |
| Blade Holder | Formed Pan | | |
| Blades | 1/2" x 3" Corner Uplift | | |
| Blade Tip Speed | 15,904 fpm | 15,472 fpm | 14,307 fpm |
| Wheels | 14 1/2" Laminated | | |
| Minimum Tractor PTO HP | 15 | 20 | 25 |
| Safety Shielding | Front Rubber Belt and Rear Metal Band Standard; Front Chains Optional | | |
| 10-Year Gearbox Limited Warranty and 1-Year Machine Limited Warranty | | | |

*Gearbox rating based on field performance.

WARNING:

A deflector kit or chain shielding must be used for all non-agricultural purposes or in areas where thrown objects could be hazardous to people, animals, or property.

HOW TO ORDER:

The BH100 Series Rotary Cutters are priced as a base unit including front belting and rear metal band. To receive a complete cutter, you must choose your base unit selection, including your choice of model color from the chart at the top of the next page, and indicate your choice of driveline from Group 2 Driveline Selection. **All units are sold in pairs. Each pair must be the same model and color.**

Freight NOT included in list price



RETURN TO INDEX

| All models are available in the colors below: | |
|---|-------------------------|
| Model Color Indicator | Unit Color |
| 1R | Bush Hog Red |
| 1G | John Deere Green |
| 1O | Kubota Orange |
| 1B | New Holland Blue |

BH100 SERIES ROTARY CUTTER

BASE UNIT SELECTION

| Model Number | Description | Approx. Wt. | List Price (\$US) |
|--------------|---|-------------|-------------------|
| BH114-1x | BH100 Series Rotary Cutter, 540 PTO, Lift Hitch, 4' | 393 lb. | \$1,384 |
| BH115-1x | BH100 Series Rotary Cutter, 540 PTO, Lift Hitch, 5' | 491 lb. | \$1,512 |
| BH116-1x | BH100 Series Rotary Cutter, 540 PTO, Lift Hitch, 6' | 577 lb. | \$1,779 |

GROUP 2 DRIVELINE SELECTION

| Model Number | Description | Approx. Wt. | List Price (\$US) |
|--------------|--|-------------|-------------------|
| 50075901 | Driveline, ASAE Category 3, with Shearpin (BH114 Model Only) | 25 lb. | \$125 |
| 50075919 | Driveline, ASAE Category 3, with Shearpin (BH115 and BH116 Models Only) | 25 lb. | \$144 |
| 50075900 | Driveline, ASAE Category 3, with Slip-Clutch (BH114 and BH115 Models Only) | 25 lb. | \$301 |
| 50076537 | Driveline, ASAE Category 3, with Slip-Clutch (BH116 Model Only) | 25 lb. | \$301 |

OPTIONS

| Model Number | Description | Approx. Wt. | List Price (\$US) |
|--------------|---------------------------|-------------|-------------------|
| 50081169 | Front Chain Bundle, BH114 | 35 lb. | \$109 |
| 50081170 | Front Chain Bundle, BH115 | 40 lb. | \$117 |
| 50081433 | Front Chain Bundle, BH116 | 45 lb. | \$125 |
| 50081027 | Quick Hitch Kit | 5 lb. | \$40 |

RETURN TO INDEX



BH215-2/BH216-2 SERIES ROTARY CUTTER

| MODEL | BH215-2 | BH216-2 |
|---|--|-----------------|
| Cutting Width | 60" | 72" |
| Cutting Height | 2" - 12" | |
| Cutting Capacity | 2" Diameter | |
| Hitch | Cat. 1 Std & Quick Hitch; Cat. 2 Compatible with Optional Bushings | |
| Deck Thickness | 11 Gauge | 10 Gauge |
| Side Bands | 11½" x 11 Gauge | 11½" x 10 Gauge |
| Driveline | ASAE Category 3 | |
| Driveline Protection | Slip Clutch or Shearbolt | |
| Gearbox Rating (HP) | 65* | |
| Tractor PTO Speed | 540 | |
| Minimum Tractor PTO HP | 25 | |
| Blade Holder | Oval Pan | |
| Blades | 1/2" x 4" Uplift | |
| Blade Tip Speed | 14,335 fpm | 14,963 fpm |
| Wheels | 15 ½" Laminated | |
| Safety Shielding | Front Rubber Belt or Single Row Chains Rear Metal Band Front and Rear Chains | |
| Approximate Weight | 650 lb. | 750 lb. |
| 10-Year Gearbox Limited Warranty and 1-Year Machine Limited Warranty | | |

*Gearbox rating based on field performance.

| | |
|----------------------|--|
| NOTICE: | PTO adapter must not be used in any application. |
| WARNING: | A deflector kit or chain shielding must be used for all non-agricultural purposes or in areas where thrown objects could be hazardous to people, animals, or property. |
| HOW TO ORDER: | To receive a complete cutter, you must order from each group listed for the model you have selected. |

Freight NOT included in list price



RETURN TO INDEX

| All models are available in the colors below: | |
|---|------------------|
| Model Color Indicator | Unit Color |
| 2R | Bush Hog Red |
| 2G | John Deere Green |
| 2O | Kubota Orange |
| 2B | New Holland Blue |

BH215-2 SERIES ROTARY CUTTER

BASE UNIT SELECTION

| Model Number | Description | Approx. Wt. | List Price (\$US) |
|--------------|--|-------------|-------------------|
| BH215-2R | BH215 Series Rotary Cutter, 5', Bush Hog Red | 650 lb. | \$1,917 |
| BH215-2G | BH215 Series Rotary Cutter, 5', John Deere Green | 650 lb. | \$1,917 |
| BH215-2O | BH215 Series Rotary Cutter, 5', Kubota Orange | 650 lb. | \$1,917 |
| BH215-2B | BH215 Series Rotary Cutter, 5', New Holland Blue | 650 lb. | \$1,917 |

GROUP 2 PTO SELECTION

| | | | |
|----------|---------------------------------------|--------|-------|
| 50053123 | ASAE Category 3 Shearbolt Driveline | 31 lb. | \$289 |
| 50053126 | ASAE Category 3 Slip-Clutch Driveline | 40 lb. | \$450 |

GROUP 3 ENCLOSURE SELECTION

| | | | |
|----------|-----------------|--------|-------|
| 50071036 | Front Deflector | 9 lb. | \$80 |
| 50080236 | Rear Band | 18 lb. | \$63 |
| 50074734 | Front Chains | 46 lb. | \$146 |
| 50080237 | Rear Chains | 58 lb. | \$277 |

GROUP 4 OPTIONS

| | | | |
|----------|-----------------------|-------|--------------------------|
| 50080070 | Cat. 2 Hitch Bushings | 1 lb. | Order Thru Service Parts |
|----------|-----------------------|-------|--------------------------|

BH216-2 SERIES ROTARY CUTTER

BASE UNIT SELECTION

| Model Number | Description | Approx. Wt. | List Price (\$US) |
|--------------|--|-------------|-------------------|
| BH216-2R | BH216 Series Rotary Cutter, 6', Bush Hog Red | 750 lb. | \$2,466 |
| BH216-2G | BH216 Series Rotary Cutter, 6', John Deere Green | 750 lb. | \$2,466 |
| BH216-2O | BH216 Series Rotary Cutter, 6', Kubota Orange | 750 lb. | \$2,466 |
| BH216-2B | BH216 Series Rotary Cutter, 6', New Holland Blue | 750 lb. | \$2,466 |

GROUP 2 PTO SELECTION

| | | | |
|----------|---------------------------------------|--------|-------|
| 50053131 | ASAE Category 3 Shearbolt Driveline | 32 lb. | \$289 |
| 50053125 | ASAE Category 3 Slip-Clutch Driveline | 40 lb. | \$450 |

GROUP 3 ENCLOSURE SELECTION

| | | | |
|----------|-----------------|--------|-------|
| 50070831 | Front Deflector | 10 lb. | \$89 |
| 50080241 | Rear Band | 28 lb. | \$76 |
| 50074732 | Front Chains | 54 lb. | \$185 |
| 50080242 | Rear Chains | 67 lb. | \$337 |

GROUP 4 OPTIONS

| | | | |
|----------|-----------------------|-------|--------------------------|
| 50080070 | Cat. 2 Hitch Bushings | 1 lb. | Order Thru Service Parts |
|----------|-----------------------|-------|--------------------------|

NOTE: Safety shieldings are non-returnable items for all models.

RETURN TO INDEX



BH217-2 SERIES ROTARY CUTTER

| MODEL | BH217-2 |
|---|---|
| Cutting Width | 84" |
| Cutting Height | 2" - 12" |
| Cutting Capacity | 2" Diameter |
| Hitch | Cat. 1 or 2 Std and Quick Hitch |
| Deck Thickness | 10 Gauge |
| Side Bands | 11 ³ / ₄ " x 10 Gauge |
| Driveline | ASAE Category 3 |
| Driveline Protection | Slip Clutch Standard |
| Gearbox Rating (HP) | 130* |
| Tractor PTO Speed | 540 |
| Minimum Tractor PTO HP | 50 |
| Blade Holder | Oval Pan |
| Blades | 1/2" x 4" Uplift |
| Blade Tip Speed | 14,963 fpm |
| Wheels | 15 1/2" Laminated |
| Safety Shielding | Front Rubber Belt Rear Metal Band Front and Rear Chains |
| Approximate Weight | 1,035 lb. |
| 10-Year Gearbox Limited Warranty and 1-Year Machine Limited Warranty | |

*Gearbox rating based on field performance.

NOTICE:

PTO adapter must not be used in any application.

WARNING:

A deflector kit or chain shielding must be used for all non-agricultural purposes or in areas where thrown objects could be hazardous to people, animals, or property.

HOW TO ORDER:

To receive a complete cutter, you must order Base Unit, and Front and Rear Safety Enclosures.

Freight NOT included in list price



RETURN TO INDEX

| All models are available in the colors below: | |
|---|-------------------------|
| Model Color Indicator | Unit Color |
| 2R | Bush Hog Red |
| 2G | John Deere Green |
| 2O | Kubota Orange |
| 2B | New Holland Blue |

BH217-2 SERIES ROTARY CUTTER

BASE UNIT SELECTION

| Model Number | Description | Approx. Wt. | List Price (\$US) |
|-----------------|---|-------------|-------------------|
| BH217-2R | BH217 Series Rotary Cutter, 7', Bush Hog Red | 1,035 lb. | \$4,411 |
| BH217-2G | BH217 Series Rotary Cutter, 7', John Deere Green | 1,035 lb. | \$4,411 |
| BH217-2O | BH217 Series Rotary Cutter, 7', Kubota Orange | 1,035 lb. | \$4,411 |
| BH217-2B | BH217 Series Rotary Cutter, 7', New Holland Blue | 1,035 lb. | \$4,411 |

GROUP 2 ENCLOSURE SELECTION

| Model Number | Description | Approx. Wt. | List Price (\$US) |
|-----------------|------------------------|-------------|-------------------|
| 50070944 | Front Deflector | 37 lb. | \$116 |
| 50080245 | Rear Band | 36 lb. | \$111 |
| 50074733 | Front Chains | 62 lb. | \$259 |
| 50080246 | Rear Chains | 75 lb. | \$415 |

NOTE: Safety shieldings are non-returnable items for all models.

RETURN TO INDEX



BH310-2 SERIES ROTARY CUTTERS

| MODEL | BH315-2 | BH316-2 | BH317-2 |
|---|--|------------|----------------------------------|
| Cutting Width | 60" | 72" | 84" |
| Cutting Height | 2" - 12" | | |
| Cutting Capacity | 3" | | |
| Hitch | Cat. 1 or 2 Std & Quick Hitch | | Cat. 2 or 3 Std & Quick Hitch |
| Deck Thickness (GA) | 10 | | |
| Side Bands | 11 1/2" x 1/4" | | 11 3/4" x 1/4" |
| Driveline | ASAE Category 4 | | |
| Driveline Protection | Slip Clutch | | |
| Gearbox Rating (HP) | 130* | | |
| Tractor PTO Speed | 540 | | |
| Minimum Tractor PTO HP | 35 | 45 | 55 |
| Blade Holder | Round Pan | | |
| Blades | 1/2" x 4" Uplift | | |
| Blade Tip Speed | 14,600 fpm | 15,000 fpm | 14,450 fpm |
| Wheels | 15 1/2" Laminated | | Single or Dual 15 1/2" Laminated |
| Safety Shielding | Front Rubber Belt Rear Metal Band Front and Rear Single or Double Row Chains | | |
| Approximate Weight | 890 lb. | 1,050 lb. | 1,250 lb. |
| 10-Year Gearbox Limited Warranty and 1-Year Machine Limited Warranty | | | |

*Gearbox rating based on field performance.

| | |
|----------------------|--|
| NOTICE: | PTO adapter must not be used in any application. |
| WARNING: | A deflector kit or chain shielding must be used for all non-agricultural purposes or in areas where thrown objects could be hazardous to people, animals, or property. |
| HOW TO ORDER: | To receive a complete cutter, you must order from each group listed for the model you have selected. |

Freight NOT included in list price



RETURN TO INDEX

BH315-2 SERIES ROTARY CUTTER

BASE UNIT SELECTION

| Model Number | Description | Approx. Wt. | List Price (\$US) |
|-----------------|---|-------------|-------------------|
| BH315-2R | BH315 Series Rotary Cutter, 5', Bush Hog Red | 890 lb. | \$3,607 |
| BH315-2G | BH315 Series Rotary Cutter, 5', John Deere Green | 890 lb. | \$3,607 |
| BH315-2O | BH315 Series Rotary Cutter, 5', Kubota Orange | 890 lb. | \$3,607 |
| BH315-2B | BH315 Series Rotary Cutter, 5', New Holland Blue | 890 lb. | \$3,607 |

GROUP 2 FRONT ENCLOSURE SELECTION

| Model Number | Description | Approx. Wt. | List Price (\$US) |
|--------------|-------------------------|-------------|-------------------|
| 50080400 | Front Deflector | 17 lb. | \$68 |
| 50074734 | Front Chains | 46 lb. | \$146 |
| 50080485 | Double Row Front Chains | 70 lb. | \$369 |

GROUP 3 REAR ENCLOSURE SELECTION

| Model Number | Description | Approx. Wt. | List Price (\$US) |
|--------------|------------------------|-------------|-------------------|
| 50080236 | Rear Band | 18 lb. | \$63 |
| 50080237 | Rear Chains | 58 lb. | \$277 |
| 50080384 | Double Row Rear Chains | 74 lb. | \$361 |

BH316-2 SERIES ROTARY CUTTER

BASE UNIT SELECTION

| Model Number | Description | Approx. Wt. | List Price (\$US) |
|-----------------|---|-------------|-------------------|
| BH316-2R | BH316 Series Rotary Cutter, 6', Bush Hog Red | 1,050 lb. | \$4,166 |
| BH316-2G | BH316 Series Rotary Cutter, 6', John Deere Green | 1,050 lb. | \$4,166 |
| BH316-2O | BH316 Series Rotary Cutter, 6', Kubota Orange | 1,050 lb. | \$4,166 |
| BH316-2B | BH316 Series Rotary Cutter, 6', New Holland Blue | 1,050 lb. | \$4,166 |

GROUP 2 FRONT ENCLOSURE SELECTION

| Model Number | Description | Approx. Wt. | List Price (\$US) |
|--------------|-------------------------|-------------|-------------------|
| 50080401 | Front Deflector | 28 lb. | \$75 |
| 50074732 | Front Chains | 54 lb. | \$185 |
| 50080486 | Double Row Front Chains | 80 lb. | \$426 |

GROUP 3 REAR ENCLOSURE SELECTION

| Model Number | Description | Approx. Wt. | List Price (\$US) |
|--------------|------------------------|-------------|-------------------|
| 50080241 | Rear Band | 28 lb. | \$76 |
| 50080242 | Rear Chains | 67 lb. | \$337 |
| 50080385 | Double Row Rear Chains | 88 lb. | \$425 |

NOTE: Safety shieldings are non-returnable items for all models.



RETURN TO INDEX

BH317-2 SERIES ROTARY CUTTER

BASE UNIT SELECTION

| Model Number | Description | Approx. Wt. | List Price (\$US) |
|-----------------|---|-------------|-------------------|
| BH317-2R | BH317 Series Rotary Cutter, 7', Bush Hog Red | 1,250 lb. | \$5,207 |
| BH317-2G | BH317 Series Rotary Cutter, 7', John Deere Green | 1,250 lb. | \$5,207 |
| BH317-2O | BH317 Series Rotary Cutter, 7', Kubota Orange | 1,250 lb. | \$5,207 |
| BH317-2B | BH317 Series Rotary Cutter, 7', New Holland Blue | 1,250 lb. | \$5,207 |

GROUP 2 TAILWHEEL SELECTION

| Model Number | Description | Approx. Wt. | List Price (\$US) |
|--------------|---------------------------|-------------|-------------------|
| 50080397 | Single Tailwheel Assembly | 63 lb. | \$283 |
| 50080395 | Dual Tailwheel Assembly | 130 lb. | \$796 |

GROUP 3 FRONT ENCLOSURE SELECTION

| Model Number | Description | Approx. Wt. | List Price (\$US) |
|--------------|-------------------------|-------------|-------------------|
| 50070944 | Front Deflector | 37 lb. | \$116 |
| 50074733 | Front Chains | 62 lb. | \$259 |
| 50080487 | Double Row Front Chains | 90 lb. | \$526 |

GROUP 4 REAR ENCLOSURE SELECTION

| Model Number | Description | Approx. Wt. | List Price (\$US) |
|--------------|------------------------|-------------|-------------------|
| 50080245 | Rear Band | 36 lb. | \$111 |
| 50080246 | Rear Chains | 75 lb. | \$415 |
| 50080386 | Double Row Rear Chains | 105 lb. | \$480 |

NOTE: Safety shieldings are non-returnable items for all models.

RETURN TO INDEX

**GALVANIZED MODEL AVAILABLE
FEBRUARY 2021**



BH400 SERIES ROTARY CUTTER

| MODEL | BH416 | BH417 |
|------------------------|-----------------------------|--------------------|
| Cutting Width | 72" | 84" |
| Cutting Height | 2" - 12" | |
| Cutting Capacity | 4" | |
| Hitch | Cat. 2 or 3 Std & QH | |
| Deck Thickness | 7 Gauge | |
| Side Bands | 13" x 1/4" | |
| Driveline | ASAE Category 5 | ASAE Category 6 |
| Driveline Protection | Slip Clutch | |
| Gearbox Rating (HP) | 210* | |
| Tractor PTO Speed | 540 | |
| Minimum Tractor PTO HP | 60 | 70 |
| Blade Holder | Round Pan | |
| Blades | 1/2" x 4" Uplift | |
| Blade Tip Speed (FPM) | 13,997 | 14,488 |
| Wheels | Single 21" Laminated | Dual 21" Laminated |
| Safety Shielding | Single or Double Row Chains | |
| Approximate Weight | 1,300 lb. | 2,000 lb. |

10-Year Gearbox Limited Warranty and 1-Year Machine Limited Warranty | 10-Year Deck Rust-Thru Limited Warranty on Galvanized Decks

*Gearbox rating based on field performance.

WARNING:

A deflector kit or chain shielding must be used for all non-agricultural purposes or in areas where thrown objects could be hazardous to people, animals, or property.

HOW TO ORDER:

To receive a complete cutter, you must order from each group listed for the model you have selected.

Freight NOT included in list price

RETURN TO INDEX

BH416 ROTARY CUTTER

BASE UNIT SELECTION

| Model Number | Description | Approx. Wt. | List Price (\$US) |
|--------------|---|-------------|-------------------|
| BH416-1R | BH416 Series Rotary Cutter, 6' | 1,114 lb. | \$6,464 |
| BH416-1Z | BH416 Series Rotary Cutter, 6', Galvanized <i>(available February 2021)</i> | 1,114 lb. | \$7,159 |

GROUP 2 FRONT ENCLOSURE SELECTION

| | | | |
|----------|-------------------------|---------|-------|
| 50080837 | Single Row Front Chains | 68 lb. | \$259 |
| 50080836 | Double Row Front Chains | 102 lb. | \$396 |

GROUP 3 REAR ENCLOSURE SELECTION

| | | | |
|----------|------------------------|---------|-------|
| 50080834 | Single Row Rear Chains | 86 lb. | \$366 |
| 50080833 | Double Row Rear Chains | 103 lb. | \$523 |

OPTIONS

| | | | |
|------------|--|-----------------------------|--|
| 50080466 | 1/2" x 5" x 22-1/4" Parallel Uplift Blades | Order Through Service Parts | |
| BH416 Spec | Special Paint Colors | Call for Quote | |

BH417 ROTARY CUTTER

BASE UNIT SELECTION

| Model Number | Description | Approx. Wt. | List Price (\$US) |
|--------------|---|-------------|-------------------|
| BH417-1R | BH417 Series Rotary Cutter, 7' | 1,817 lb. | \$8,724 |
| BH417-1Z | BH417 Series Rotary Cutter, 7', Galvanized <i>(available February 2021)</i> | 1,817 lb. | \$9,813 |

GROUP 2 HEIGHT ADJUSTMENT SELECTION

| | | | |
|-------|---------------------------|--------|-------|
| 1817 | Manual Ratchet Bundle | 15 lb. | \$164 |
| 64830 | Hydraulic Cylinder Bundle | 30 lb. | \$362 |

GROUP 3 FRONT ENCLOSURE SELECTION

| | | | |
|----------|-------------------------|---------|-------|
| 50080845 | Single Row Front Chains | 78 lb. | \$290 |
| 50080844 | Double Row Front Chains | 117 lb. | \$440 |

GROUP 4 REAR ENCLOSURE SELECTION

| | | | |
|----------|------------------------|---------|-------|
| 50080842 | Single Row Rear Chains | 94 lb. | \$449 |
| 50080841 | Double Row Rear Chains | 112 lb. | \$576 |

OPTIONS

| | | | |
|------------|----------------------|----------------|--|
| BH417 Spec | Special Paint Colors | Call for Quote | |
|------------|----------------------|----------------|--|



**GALVANIZED MODEL AVAILABLE
FEBRUARY 2021**

RETURN TO INDEX



**GALVANIZED MODEL AVAILABLE
FEBRUARY 2021**



BH500 SERIES ROTARY CUTTER

| MODEL | BH516 |
|------------------------|----------------------------|
| Cutting Width | 72" |
| Cutting Height | 2" - 12" |
| Cutting Capacity | 5" |
| Hitch | Cat. 2 or 3 Std & QH |
| Deck Thickness | 7 Gauge |
| Side Bands | 13" x 1/4" |
| Driveline | ASAE Category 6 |
| Driveline Protection | Slip Clutch |
| Gearbox Rating (HP) | 225* |
| Tractor PTO Speed | 540 |
| Minimum Tractor PTO HP | 70 |
| Blade Holder | Reinforced Round Pan |
| Blades | 1/2" x 5" Uplift |
| Blade Tip Speed (FPM) | 13,346 |
| Wheels | Single 21" Laminated |
| Safety Shielding | Double Row Chains Standard |
| Approximate Weight | 1,775 lb. |

10-Year Gearbox Limited Warranty and 1-Year Machine Limited Warranty | 10-Year Deck Rust-Thru Limited Warranty on Galvanized Decks

*Gearbox rating based on field performance.

WARNING:

A deflector kit or chain shielding must be used for all non-agricultural purposes or in areas where thrown objects could be hazardous to people, animals, or property.

HOW TO ORDER:

To receive a complete cutter, you must order from each group listed for the model you have selected. The BH516 comes equipped with lift-type hitch, driveline, and double row chains standard.

Freight NOT included in list price

BH516 ROTARY CUTTER

BASE UNIT SELECTION

| Model Number | Description | Approx. Wt. | List Price (\$US) |
|--------------|--|-------------|-------------------|
| BH516-1R | BH516 Series Rotary Cutter, 6' | 1,775 lb. | \$8,281 |
| BH516-1Z | BH516 Series Rotary Cutter, 6', Galvanized (available February 2021) | 1,775 lb. | \$9,089 |

OPTIONS

BH516 Spec

Special Paint Colors

Call for Quote

NOTE: Safety shieldings are non-returnable items for all models.



[RETURN TO INDEX](#)



[RETURN TO INDEX](#)

MULTI-SPINDLE RIGID DECK ROTARY CUTTERS

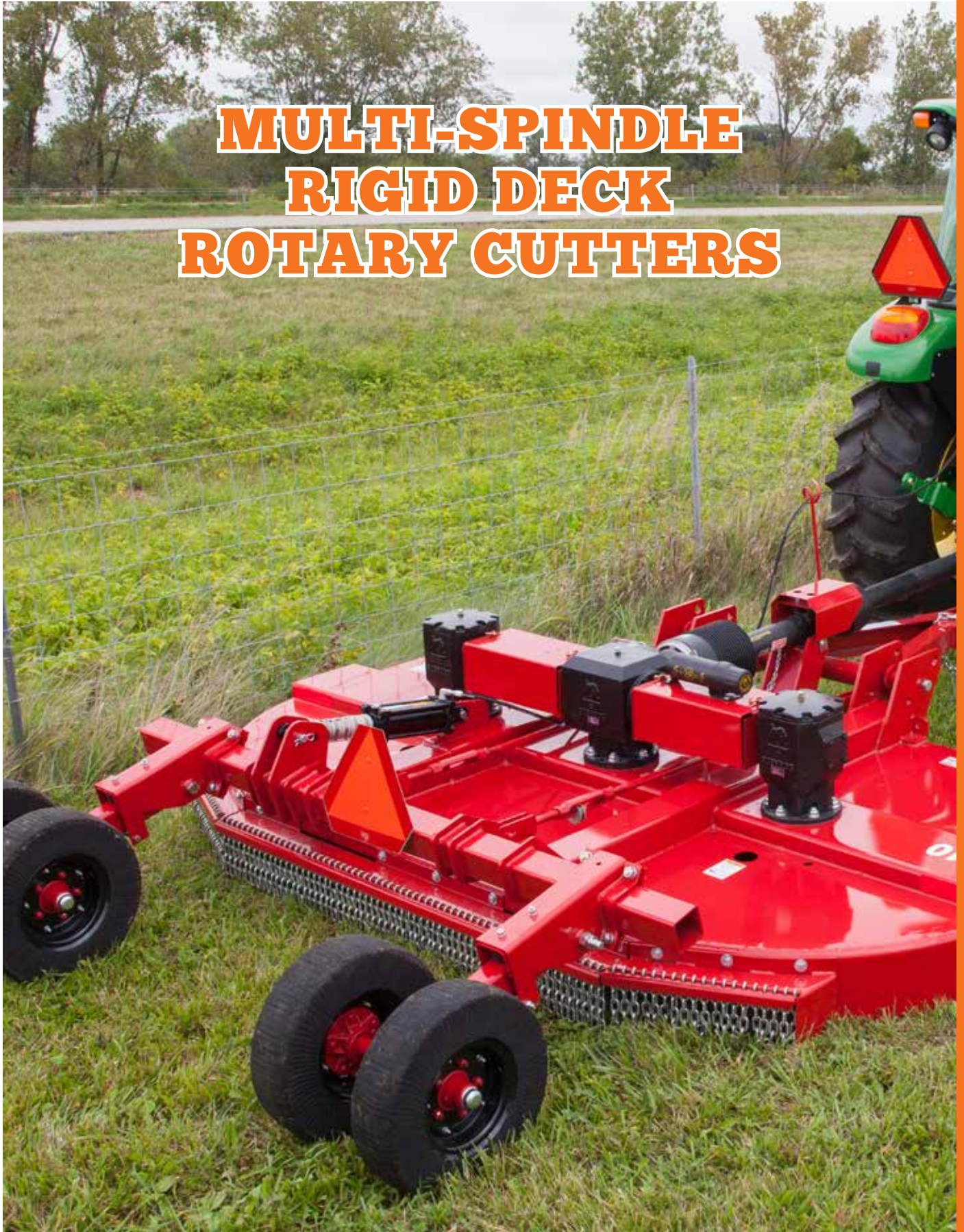

MULTI-SPINDLE RIGID DECK ROTARY CUTTERS

RETURN TO INDEX



SQ84T SQUEALER SERIES TWIN-SPINDLE 7' ROTARY CUTTER

| MODEL | SQ84T |
|------------------------|--|
| Cutting Width | 7' 1" |
| Overall Width | 7' 3" |
| Overall Length | 6' 3" |
| Cutting Height | 2" - 12" |
| Cutting Capacity | 1 ½" Diameter |
| Hitch | Cat 1 with 9" Offset |
| Deck Thickness | 11 Gauge |
| Side Bands | 7/8" x 11 Gauge |
| Driveline | ASAE Category 3 |
| Driveline Protection | Slip Clutch |
| Blade Holder | Oval Pans |
| Blades | 1/2" x 4" Uplift |
| Blade Tip Speed | 11,500 fpm |
| Wheels | 15 ½" Laminated |
| Minimum Tractor PTO HP | 35 |
| Safety Shielding | Front Rubber and Rear Metal Band Standard |
| Gearbox Rating (HP) | (1 ea.) 65* Center/Cutting and (1 ea.) 45* Cutting (540 rpm) |

| All models are available in the colors below: | |
|---|------------------|
| Model Color Indicator | Unit Color |
| 2R | Bush Hog Red |
| 2G | John Deere Green |
| 2O | Kubota Orange |
| 2B | New Holland Blue |

10-Year Gearbox Limited Warranty and 1-Year Machine Limited Warranty

*Gearbox rating based on field performance.

| | |
|----------------------|--|
| NOTICE: | PTO adapter must not be used in any application. |
| WARNING: | A deflector kit or chain shielding must be used for all non-agricultural purposes or in areas where thrown objects could be hazardous to people, animals, or property. |
| HOW TO ORDER: | To receive a complete cutter, you must order from each group listed for the model you have selected. |

Freight NOT included in list price



RETURN TO INDEX

SQ84T SQUEALER SERIES TWIN-SPINDLE 7' ROTARY CUTTER

BASE UNIT SELECTION

| Model Number | Description | Approx. Wt. | List Price (\$US) |
|----------------|---|-------------|-------------------|
| SQ84TRR | SQ84T Series Rotary Cutter, 7', Bush Hog Red | 720 lb. | \$5,569 |
| SQ84TRG | SQ84T Series Rotary Cutter, 7', John Deere Green | 720 lb. | \$5,569 |
| SQ84TRO | SQ84T Series Rotary Cutter, 7', Kubota Orange | 720 lb. | \$5,569 |
| SQ84TRB | SQ84T Series Rotary Cutter, 7', New Holland Blue | 720 lb. | \$5,569 |

Driveline and front and rear safety deflectors are included in above price.

GROUP 2 TIRE SELECTION

| | | |
|--------------|--------------------------------|--------------|
| 78868 | 15 1/2" Laminated Tires | \$395 |
|--------------|--------------------------------|--------------|

NOTE: Safety shieldings are non-returnable items for all models.

RETURN TO INDEX



2208 SERIES ROTARY CUTTER

| MODEL | 2208 |
|---|---|
| Cutting Width | 8' 3" |
| Transport Width | 8' 10" |
| Overall Length | 13' 4" (Pull) |
| Length | 8' 6" (Lift & Semi) 13' 4" (Pull) |
| Cutting Height | 2" - 13" |
| Tongue Weight | 880 lb. (Pull) |
| Cutting Capacity | 2" Diameter |
| Hitch | Cat. 1 or 2 Std & Quick Hitch Self-Leveling Pull-Type |
| Deck Thickness | 10 Gauge |
| Side Bands | 11 3/4" x 7 Gauge |
| Gearbox Rating (HP) | 140* (Transfer) 65* (Cutting) |
| Driveline | ASAE Category 4 |
| Driveline Protection | 2-Plate Slip-Clutch |
| Blade Holder | Oval Pans |
| Blades | 1/2" x 4" Uplift |
| Blade Overlap | 4 3/4" |
| Blade Tip Speed | 16,173 fpm |
| Wheels | 15 1/2" Laminated |
| Minimum Tractor PTO HP | 35 (Pull) 45 (Lift) |
| Safety Shielding | Chains (Front) Metal Band or Chains (Rear) |
| Safety Tow Chain | Standard (Pull) |
| 10-Year Gearbox Limited Warranty and 1-Year Machine Limited Warranty | |

*Gearbox rating based on field performance.

NOTICE:

PTO adapter must not be used in any application.

WARNING:

A deflector kit or chain shielding must be used for all non-agricultural purposes or in areas where thrown objects could be hazardous to people, animals, or property.

HOW TO ORDER:

To receive a complete cutter, you must order from each group listed for the model you have selected.

Freight NOT included in list price



RETURN TO INDEX

2208 SERIES ROTARY CUTTER

BASE UNIT SELECTION

| Model Number | Description | Approx. Wt. | List Price (\$US) |
|--------------|-------------|-------------|-------------------|
| 2208R | Base Unit | 1,240 lb. | \$5,259 |

GROUP 2 HITCH SELECTION

| Model Number | Description | Approx. Wt. | List Price (\$US) |
|--------------|---|-------------|-------------------|
| 50081054 | Lift Bundle with Cat. 4 Driveline, Twin Beam Axles, and 15 ½" Laminated Tires | 250 lb. | \$1,355 |
| 50076024 | Semi-Mount Bundle with Cat. 4 Driveline, Twin Beam Axles, and 15 ½" Laminated Tires | 175 lb. | \$1,114 |
| 50081053 | Pull Bundle with Cat. 4 Driveline, Cushioned Axles, and 21" Laminated Tires | 500 lb. | \$2,279 |

GROUP 3 HEIGHT ADJUSTMENT SELECTION (Pull Model Only)

| Model Number | Description | Approx. Wt. | List Price (\$US) |
|--------------|---------------------------|-------------|-------------------|
| 1817 | Manual Ratchet Bundle | 15 lb. | \$164 |
| 89045 | Hydraulic Cylinder Bundle | 45 lb. | \$380 |

GROUP 4 FRONT ENCLOSURE SELECTION

| Model Number | Description | Approx. Wt. | List Price (\$US) |
|--------------|-------------------------|-------------|-------------------|
| 50075423 | Front Single Row Chains | 83 lb. | \$285 |
| 50075424 | Front Double Row Chains | 110 lb. | \$471 |

GROUP 5 REAR ENCLOSURE SELECTION

| Model Number | Description | Approx. Wt. | List Price (\$US) |
|--------------|------------------------|-------------|-------------------|
| 50075503 | Rear Metal Band | 30 lb. | \$108 |
| 50075425 | Rear Single Row Chains | 72 lb. | \$232 |
| 50075426 | Rear Double Row Chains | 95 lb. | \$345 |

NOTE: Safety shieldings are non-returnable items for all models.

RETURN TO INDEX

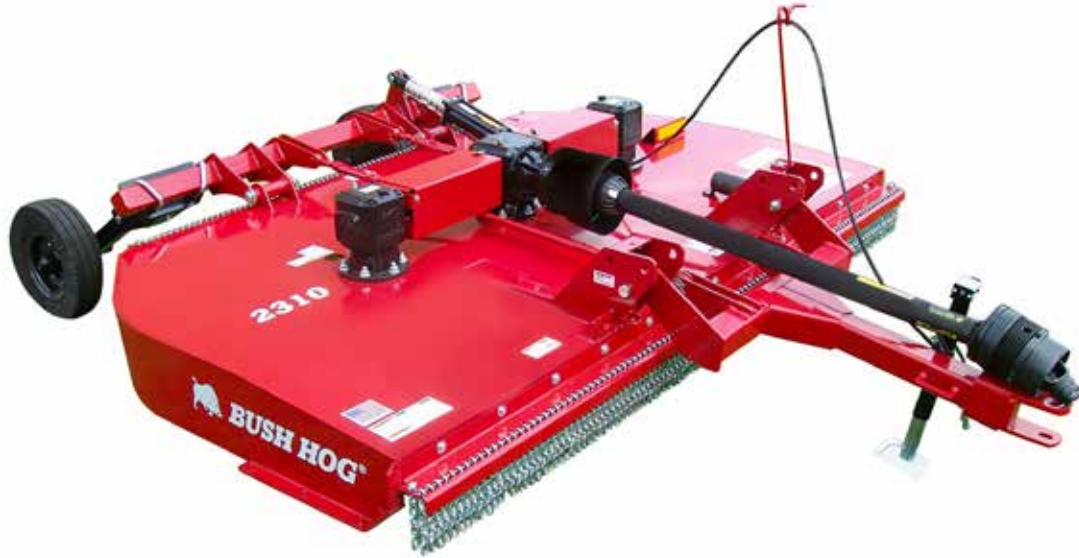

2310 SERIES ROTARY CUTTER

| MODEL | 2310 |
|---|--|
| Cutting Width | 9' 9" |
| Transport Width | 10' 3" |
| Overall Length | 12' 7" (Pull) |
| Cutting Height | 2" - 12" |
| Cutting Capacity | 2" Diameter |
| Hitch | Cat. 2 or 3 Std & Quick Hitch Self-Leveling Pull-Type |
| Deck Thickness | 10 Gauge |
| Side Bands | 10" x 7 Gauge |
| Driveline | ASAE Category 4 |
| Driveline Protection | Slip Clutch |
| Gearbox Rating (HP) | 140* (Transfer); 130* (Cutting) |
| Tractor PTO Speed | 540 |
| Minimum Tractor PTO HP | 50 (Pull), 70 (Lift) |
| Blade Holder | Round Pans |
| Blades | 1/2" x 4" Uplift |
| Blade Tip Speed | 15,828 fpm |
| Tires | Dual Laminated, Foam-Filled, or Pneumatic Aircraft |
| Safety Shielding | Front Single or Double Row Chains Rear Metal Band or Single or Double Row Chains |
| Approximate Weight | 2,280 lb |
| 10-Year Gearbox Limited Warranty and 1-Year Machine Limited Warranty | |

*Gearbox rating based on field performance.

| | |
|----------------------|--|
| NOTICE: | PTO adapter must not be used in any application. |
| WARNING: | A deflector kit or chain shielding must be used for all non-agricultural purposes or in areas where thrown objects could be hazardous to people, animals, or property. |
| HOW TO ORDER: | To receive a complete cutter, you must order from each group listed for the model you have selected. Group 4 Wheel Selection for Pull-Type Units Only. |

Freight NOT included in list price



RETURN TO INDEX

2310 SERIES ROTARY CUTTER

BASE UNIT SELECTION

| Model Number | Description | Approx. Wt. | List Price (\$US) |
|--------------|---|-------------|-------------------|
| 2310R | 2310 Series Rotary Cutter, Round Blade Pan, 540 PTO | 1,650 lb. | \$7,857 |

GROUP 2 HITCH SELECTION

| Model Number | Description | Approx. Wt. | List Price (\$US) |
|--------------|--|-------------|-------------------|
| 50080720 | Pull Bundle with CV Driveline | 325 lb. | \$2,323 |
| 50080721 | Lift Bundle with Driveline and 21" Laminated Tires | 275 lb. | \$1,548 |
| 50080722 | Semi-Mount Bundle with Driveline and 21" Laminated Tires | 170 lb. | \$1,289 |

GROUP 3 HEIGHT ADJUSTMENT SELECTION

| Model Number | Description | Approx. Wt. | List Price (\$US) |
|--------------|---------------------------|-------------|-------------------|
| 1817 | Manual Ratchet Bundle | 15 lb. | \$164 |
| 89045 | Hydraulic Cylinder Bundle | 45 lb. | \$380 |

GROUP 4 WHEEL SELECTION (Pull Models Only)

| Model Number | Description | Approx. Wt. | List Price (\$US) |
|--------------|-----------------------------|-------------|-------------------|
| 294 | 20" Laminated Tire | 72 lb. | each \$223 |
| 50050727 | Used Aircraft Tire, 29x9x15 | 75 lb. | each \$280 |

GROUP 5 FRONT ENCLOSURE SELECTION

| Model Number | Description | Approx. Wt. | List Price (\$US) |
|--------------|-------------------------|-------------|-------------------|
| 50080716 | Front Single Row Chains | 80 lb. | \$303 |
| 50080717 | Front Double Row Chains | 140 lb. | \$418 |

GROUP 6 REAR ENCLOSURE SELECTION

| Model Number | Description | Approx. Wt. | List Price (\$US) |
|--------------|------------------------|-------------|-------------------|
| 50081033 | Rear Metal Band | 50 lb. | \$170 |
| 50081043 | Rear Single Row Chains | 70 lb. | \$272 |
| 50081044 | Rear Double Row Chains | 120 lb. | \$375 |

NOTE: Safety shieldings are non-returnable items for all models.

RETURN TO INDEX



3308-2 SERIES ROTARY CUTTER

| MODEL | 3308-2 |
|---|--|
| Cutting Width | 8' 3" |
| Transport Width | 8' 10" |
| Overall Length | 8' 9" (Lift) |
| Axle Suspension | Heavy-Duty Axle with Rubber Cushions (Pull) |
| Cutting Height | 2" - 13" |
| Cutting Capacity | 3" Diameter |
| Hitch | Cat. 1 or 2 Std and Quick Hitch Self-Leveling Pull-Type |
| Deck Thickness | 10 Gauge |
| Side Bands | 1/4" x 12" |
| Gearbox Rating (HP) | 140* (Transfer); 130* (Cutting) Remove (540 rpm) |
| Driveline | ASAE Category 4 |
| Driveline Protection | 4-Plate Slip Clutch |
| Blade Holder | Round Pans |
| Blades | 1/2" x 4" Uplift |
| Blade Overlap | 5" |
| Blade Tip Speed | 16,121 fpm |
| Wheels | <i>See Wheel Selection</i> |
| Minimum Tractor PTO HP | 40 (Pull & Semi-Mount), 50 (Lift) |
| Safety Shielding | Front Single or Double Row Chains Rear Metal Band or Single or Double Row Chains |
| Safety Tow Chain | Standard (Pull) |
| Approximate Weight | 2050 lb. |
| 10-Year Gearbox Limited Warranty and 1-Year Machine Limited Warranty | |

*Gearbox rating based on field performance.

| | |
|----------------|--|
| NOTICE: | PTO adapter must not be used in any application. |
|----------------|--|

| | |
|-----------------|--|
| WARNING: | A deflector kit or chain shielding must be used for all non-agricultural purposes or in areas where thrown objects could be hazardous to people, animals, or property. |
|-----------------|--|

| | |
|----------------------|--|
| HOW TO ORDER: | To receive a complete cutter, you must order from each group listed for the model you have selected. |
|----------------------|--|

Freight NOT included in list price



RETURN TO INDEX

3308-2 SERIES ROTARY CUTTER

BASE UNIT SELECTION

| Model Number | Description | Approx. Wt. | List Price (\$US) |
|--------------|---|-------------|-------------------|
| 3308R-2 | 3308-2 Series Rotary Cutter, Round Pan, 540 PTO | 1,309 lb. | \$6,115 |

GROUP 2 HITCH SELECTION

| Model Number | Description | Approx. Wt. | List Price (\$US) |
|--------------|--------------------|-------------|-------------------|
| 50081004 | Lift Bundle* | 125 lb. | \$884 |
| 50081005 | Semi-Mount Bundle* | 87 lb. | \$625 |
| 50081006 | Pull Bundle* | 470 lb. | \$3,154 |

* Lift and Semi-Mount Bundles include Driveline with Slip-Clutch.
 ** Pull Bundle includes CV Driveline with Slip-Clutch and Heavy-Duty Axle.

GROUP 3 AXLE SELECTION (Lift and Semi-Mount Models Only)

| Model Number | Description | Approx. Wt. | List Price (\$US) |
|--------------|--|-------------|-------------------|
| 50075427 | Twin Beam Axle with 15 1/2" Laminated Tires | 177 lb. | \$665 |
| 50081013 | Lift and Semi-Mount HD Axle Arms (pair) with 21" Laminated Tires | 250 lb. | \$1,490 |

GROUP 4 HEIGHT ADJUSTMENT SELECTION

| Model Number | Description | Approx. Wt. | List Price (\$US) |
|--------------|---------------------------|-------------|-------------------|
| 1817 | Manual Ratchet Bundle | 15 lb. | \$164 |
| 89045 | Hydraulic Cylinder Bundle | 45 lb. | \$380 |

Note: Selection is for pull model and heavy duty axle on lift and semi-mount models

GROUP 5 WHEEL SELECTION (**Pull Models Only, 2 Tires Required)

| Model Number | Description | Approx. Wt. | List Price (\$US) |
|--------------|-----------------------------|-------------|-------------------|
| 294 | 20" Laminated Tire | 72 lb. | each \$223 |
| 50050727 | Used Aircraft Tire, 29x9x15 | 75 lb. | each \$280 |
| 50078502 | Foam-Filled Tire, 27 x 8-18 | 100 lb. | each \$475 |

GROUP 6 FRONT ENCLOSURE SELECTION

| Model Number | Description | Approx. Wt. | List Price (\$US) |
|--------------|-------------------------|-------------|-------------------|
| 50075423 | Front Single Row Chains | 83 lb. | \$285 |
| 50075424 | Front Double Row Chains | 110 lb. | \$471 |

GROUP 7 REAR ENCLOSURE SELECTION

| Model Number | Description | Approx. Wt. | List Price (\$US) |
|--------------|------------------------|-------------|-------------------|
| 50075503 | Rear Metal Band | 30 lb. | \$108 |
| 50075425 | Rear Single Row Chains | 72 lb. | \$232 |
| 50075426 | Rear Double Row Chains | 95 lb. | \$345 |

NOTE: Safety shieldings are non-returnable items for all models.

RETURN TO INDEX

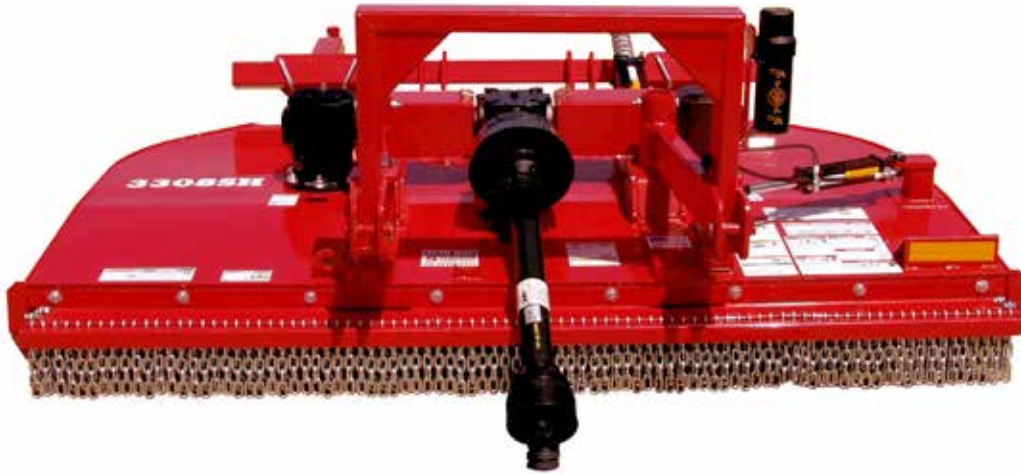

3308SH-2 SERIES MULTI-SPINDLE ROTARY CUTTER

| MODEL | 3308SH-2 |
|---|--|
| Cutting Width | 8' 3" |
| Transport Width | 8' 10" |
| Overall Length | 9' 7" (Semi-Mount) |
| Axle Suspension | Heavy Duty Axle with Rubber Suspension |
| Cutting Height | 2" - 13" |
| Cutting Capacity | 3" Diameter |
| Hitch | Cat. 1 or 2 (Semi-Mount Only With Variable Offset up to 13" to the Right of Tractor Center Line) |
| Deck Thickness | 10 Gauge |
| Side Bands | 1/4" x 12" |
| Gearbox Rating (HP) | 140* (Transfer); 130* (Cutting) |
| Driveline | ASAE Category 4 |
| Driveline Protection | 4-Plate Slip Clutch |
| Blade Holder | Round Pans |
| Blades | 1/2" x 3 1/2" Uplift |
| Blade Overlap | 5" |
| Blade Tip Speed | 16,121 fpm |
| Wheels | 21" Laminated Tires |
| Minimum Tractor PTO HP | 40 |
| Safety Shielding | Front Single or Double Row Chains Rear Metal Band or Single or Double Row Chains |
| 10-Year Gearbox Limited Warranty and 1-Year Machine Limited Warranty | |

*Gearbox rating based on field performance.

| | |
|----------------------|--|
| NOTICE: | PTO adapter must not be used in any application. |
| WARNING: | A deflector kit or chain shielding must be used for all non-agricultural purposes or in areas where thrown objects could be hazardous to people, animals, or property. |
| HOW TO ORDER: | To receive a cutter, you must choose a Selection from Groups 1-4. The Base 3308SH-2 comes equipped with Swing Hitch Bundle including Driveline and HD Axle. |

Freight NOT included in list price



RETURN TO INDEX

3308SH-2 SERIES MULTI-SPINDLE ROTARY CUTTER

BASE UNIT SELECTION

| Model Number | Description | Approx. Wt. | List Price (\$US) |
|--------------|--|-------------|-------------------|
| 3308SH-2 | 3308SH-2 Series Multi-Spindle Rotary Cutter, Round Pan Blade Carrier, 540 PTO, Swing Hitch Bundle Includes Driveline, HD Axle with 21" Laminated Tires | 1,750 lb. | \$9,324 |

GROUP 2 HEIGHT ADJUSTMENT SELECTION

| Model Number | Description | Approx. Wt. | List Price (\$US) |
|--------------|---------------------------|-------------|-------------------|
| 1817 | Manual Ratchet Bundle | 15 lb. | \$164 |
| 89045 | Hydraulic Cylinder Bundle | 45 lb. | \$380 |

GROUP 3 FRONT ENCLOSURE SELECTION

| Model Number | Description | Approx. Wt. | List Price (\$US) |
|--------------|-------------------------|-------------|-------------------|
| 50075423 | Front Single Row Chains | 83 lb. | \$285 |
| 50075424 | Front Double Row Chains | 110 lb. | \$471 |

GROUP 4 REAR ENCLOSURE SELECTION

| Model Number | Description | Approx. Wt. | List Price (\$US) |
|--------------|------------------------|-------------|-------------------|
| 50075503 | Rear Metal Band | 30 lb. | \$108 |
| 50075425 | Rear Single Row Chains | 72 lb. | \$232 |
| 50075426 | Rear Double Row Chains | 95 lb. | \$345 |

RETURN TO INDEX



3510 SERIES ROTARY CUTTER

| MODEL | 3510 |
|---|--|
| Cutting Width | 10' 6" |
| Cutting Height | 2" - 13" |
| Cutting Capacity | 3½" Diameter |
| Hitch | Cat. 2 or 3 Std and Quick Hitch Self-Leveling Pull-Type |
| Deck Thickness | 10 Gauge |
| Side Bands | 1/4" x 10" |
| Driveline | ASAE Category 5 |
| Driveline Protection | 4-Plate Slip Clutch |
| Gearbox Rating (HP) | 210* (Transfer); 210* (Cutting) |
| Tractor PTO Speed | 540 |
| Minimum Tractor PTO HP | 50 (Pull), 75 (Lift) |
| Blade Holder | Round Pans |
| Blades | 1/2" x 4" Uplift |
| Blade Tip Speed | 16,881 fpm |
| Wheels | <i>See Wheel Selection</i> |
| Safety Shielding | Front Single or Double Row Chains Rear Metal Band or Single or Double Row Chains |
| Approximate Weight | 2,900 lb. |
| 10-Year Gearbox Limited Warranty and 1-Year Machine Limited Warranty | |

*Gearbox rating based on field performance.

NOTICE:

PTO adapter must not be used in any application.

WARNING:

A deflector kit or chain shielding must be used for all non-agricultural purposes or in areas where thrown objects could be hazardous to people, animals, or property.

HOW TO ORDER:

To receive a complete cutter, you must order from each group listed for the model you have selected.

Freight NOT included in list price



RETURN TO INDEX

3510 SERIES ROTARY CUTTER

BASE UNIT SELECTION

| Model Number | Description | Approx. Wt. | List Price (\$US) |
|--------------|--|-------------|-------------------|
| 3510R | 3510 Series Rotary Cutter, Round Blade Holder, 540 PTO | 2,054 lb. | \$7,909 |

GROUP 2 HITCH SELECTION

| Model Number | Description | Approx. Wt. | List Price (\$US) |
|--------------|----------------------------|-------------|-------------------|
| 50076949 | Lift Hitch Bundle | 225 lb. | \$1,443 |
| 50068324 | Semi-Mount Bundle | 8 lb. | \$242 |
| 50036646 | Pull Bundle (540 PTO only) | 260 lb. | \$1,667 |

GROUP 3 DRIVELINE SELECTION

| Model Number | Description | Approx. Wt. | List Price (\$US) |
|--------------|---|-------------|-------------------|
| 76729 | Lift and Semi-Mount Driveline, 1-3/8-6, 540 PTO | 69 lb. | \$854 |
| 76625 | Pull, CV Driveline, 1-3/8-6, 540 PTO | 73 lb. | \$1,201 |

GROUP 4 AXLE SELECTION (For All Models)

| Model Number | Description | Approx. Wt. | List Price (\$US) |
|--------------|---|-------------|-------------------|
| 50068235 | Pull, Single Wheel Axle Arms (pair) | 162 lb. | \$1,000 |
| 50068236 | Pull, Dual Wheel Axle Arms (pair) | 194 lb. | \$1,268 |
| 50081078 | Lift and Semi-Mount HD Axle Arms (pair) with 20.5" Pneumatic Aircraft Tires | 200 lb. | \$1,662 |

GROUP 5 HEIGHT ADJUSTMENT SELECTION (For All Models)

| Model Number | Description | Approx. Wt. | List Price (\$US) |
|--------------|---------------------------|-------------|-------------------|
| 1817 | Manual Ratchet Bundle | 15 lb. | \$164 |
| 90492 | Hydraulic Cylinder Bundle | 45 lb. | \$420 |

GROUP 6 WHEEL SELECTION (Pull Models Only)

| Model Number | Description | Approx. Wt. | List Price (\$US) |
|--------------|-----------------------------|-------------|-------------------|
| 294 | 20" Laminated Tire | 72 lb. | each \$223 |
| 50075401 | 25" Laminated Tire | 85 lb. | each \$301 |
| 50050727 | Used Aircraft Tire, 29x9x15 | 75 lb. | each \$280 |
| 50078502 | Foam-Filled Tire, 27 x 8-18 | 100 lb. | each \$475 |

GROUP 7 FRONT ENCLOSURE SELECTION

| Model Number | Description | Approx. Wt. | List Price (\$US) |
|--------------|-------------------------|-------------|-------------------|
| 50076736 | Front Single Row Chains | 140 lb. | \$462 |
| 50076927 | Front Double Row Chains | 165 lb. | \$771 |

GROUP 8 REAR ENCLOSURE SELECTION

| Model Number | Description | Approx. Wt. | List Price (\$US) |
|--------------|------------------------|-------------|-------------------|
| 50076729 | Rear Metal Band | 40 lb. | \$122 |
| 50076939 | Rear Single Row Chains | 155 lb. | \$545 |
| 50076947 | Rear Double Row Chains | 180 lb. | \$847 |

NOTE: Safety shieldings are non-returnable items for all models.

RETURN TO INDEX



3514 SERIES ROTARY CUTTER

| MODEL | 3514 |
|---|---|
| Cutting Width | 14' |
| Transport Width | 14' 8" |
| Overall Length | 14' 7" (Pull) |
| Axle Suspension | Heavy-Duty Axle with Rubber Cushions |
| Cutting Height | 2½" - 13" |
| Cutting Capacity | 3½" Diameter |
| Hitch | Cat 2 and 3 Std and Quick Hitch & Self-Leveling Pull-Type |
| Deck Thickness | 10 Gauge |
| Side Bands | 1/4" x 10" |
| Gearbox Rating (HP) | (1 ea.) 210* Center and (2 ea.) 210* Cutting (540 rpm) |
| Driveline | ASAE Category 5 (540 PTO), ASAE Category 4 (1000 PTO Pull) |
| Cross Shafts | ASAE Category 5 Rubber Element with Category 4 Shearpin |
| Driveline Protection | 4-Plate Slip Clutch |
| Blade Holder | Round (540 PTO), Round or Bar (1000 PTO) |
| Blades | 1/2" x 4" Uplift |
| Blade Overlap | 3" |
| Blade Tip Speed | 15,242 fpm (540/1000 rpm) |
| Wheels | <i>See Wheel Selection</i> |
| Minimum Tractor PTO HP | 75 (Pull), 90 (Lift) |
| Safety Shielding | Front Rubber Belt or Single Row Chains Rear Rubber Belt Metal Band or Single Row Chains |
| Highway Light Kit | Standard |
| 10-Year Gearbox Limited Warranty and 1-Year Machine Limited Warranty | |

*Gearbox rating based on field performance.

NOTICE:

PTO adapter must not be used in any application.

WARNING:

A deflector kit or chain shielding must be used for all non-agricultural purposes or in areas where thrown objects could be hazardous to people, animals, or property.

HOW TO ORDER:

To receive a complete cutter, you must order a basic unit and then select one item from each of Groups 1 - 8 in the ordering section. Additional equipment may be added to your order by making your selection from the options list.

Freight NOT included in list price



RETURN TO INDEX

3514 SERIES ROTARY CUTTER

BASE UNIT SELECTION

| Model Number | Description | Approx. Wt. | List Price (\$US) |
|--------------|---|-------------|-------------------|
| 3514RS | 3514 Series Rotary Cutter, Round Blade Holder, 540 PTO with Shear Bolt Cross Shafts | 2,590 lb. | \$9,616 |
| 13514RS | 13514 Series Rotary Cutter, Round Blade Holder, 1000 PTO with Shear Bolt Cross Shafts | 2,590 lb. | \$10,206 |
| 13514SS | 13514 Series Rotary Cutter, Blade Bar, 1000 PTO with Shear Bolt Cross Shafts | 2,559 lb. | \$10,206 |

GROUP 2 HITCH SELECTION

| | | | |
|----------|--------------------------------------|---------|---------|
| 50076724 | Lift Bundle with 21" Laminated Tires | 530 lb. | \$4,287 |
| 50035727 | Pull Bundle | 281 lb. | \$3,020 |

GROUP 3 DRIVELINE SELECTION

| | | | |
|-------|---|--------|---------|
| 76729 | Lift and Semi-Mount Driveline, 1-3/8-6, 540 PTO | 69 lb. | \$854 |
| 76730 | Lift and Semi-Mount Driveline, 1-3/8-21, 1000 PTO | 69 lb. | \$854 |
| 76731 | Lift and Semi-Mount Driveline, 1-3/4-20, 1000 PTO | 70 lb. | \$854 |
| 76625 | Pull, CV Driveline, 1-3/8-6, 540 PTO | 73 lb. | \$1,201 |
| 76624 | Pull, CV Driveline, 1-3/8-21, 1000 PTO | 70 lb. | \$1,195 |

GROUP 4 AXLE SELECTION (Pull Models Only)

| | | | |
|----------|--------------------------------------|---------|---------|
| 50068369 | Pull, Single Wheel Axle Arms (pair)* | 162 lb. | \$1,071 |
| 50068370 | Pull, Dual Wheel Axle Arms (pair)** | 194 lb. | \$1,334 |

*If #50068369 axle is selected, you must select #294 tire from Group 6 Wheel Selection.

**If #50068370 is selected, you may select either tire from Group 6 Wheel Selection.

GROUP 5 HEIGHT ADJUSTMENT SELECTION (For All Models)

| | | | |
|-------|---------------------------|--------|-------|
| 1817 | Manual Ratchet Bundle | 15 lb. | \$164 |
| 90492 | Hydraulic Cylinder Bundle | 45 lb. | \$420 |

GROUP 6 WHEEL SELECTION (Pull Models Only)

| | | | |
|----------|-----------------------------|---------|------------|
| 294 | 20" Laminated Tire | 72 lb. | each \$223 |
| 50078502 | Foam-Filled Tire, 27 x 8-18 | 100 lb. | each \$475 |

GROUP 7 FRONT ENCLOSURE SELECTION

| | | | |
|----------|-------------------------|---------|-------|
| 50076813 | Front Single Row Chains | 160 lb. | \$606 |
| 50076807 | Front Rubber Belting | 65 lb. | \$466 |

GROUP 8 REAR ENCLOSURE SELECTION

| | | | |
|----------|------------------------|---------|-------|
| 50076817 | Rear Metal Band | 55 lb. | \$222 |
| 50076819 | Rear Single Row Chains | 170 lb. | \$652 |
| 50076818 | Rear Rubber Belting | 65 lb. | \$498 |

OPTIONS

| | | | |
|----------|---|---------|---------|
| 90604 | Shredder Kit for 38" and 40" | | \$481 |
| 90607 | Shredder Kit for 30" Rows | | \$481 |
| 50050192 | Lift, Single Tailwheel Bundle with 21" Tire | | \$850 |
| 50068369 | Pull, Single Wheel Axle Arms (pair)* *Must be used with #294 tire only. | 162 lb. | \$1,071 |

NOTE: Safety shieldings are non-returnable items for all models.

RETURN TO INDEX



14215 ROTARY CUTTER

| MODEL | 14215 | MODEL | 14215 |
|------------------------|---------------------------------|---------------------------------|---|
| Cutting Width | 15' | Outboard Driveline | ASAE Category 5 |
| Transport Width | 15' 7" | Driveline Protection (Outboard) | Multi-Plate Slip-Clutch |
| Cutting Height | 2" - 16" | Blade Holder | Round Pans |
| Cutting Capacity | 3 1/2" Diameter | Blades | 1/4" x 4" Uplift |
| Minimum Tractor PTO HP | 125 | Blade Overlap | 3" |
| Tractor PTO Speed | 1,000 RPM | Blade Tip Speed | 17,280 fpm (Center); 15,708 fpm (Outboard) |
| Hitch | Cat. 1 or 2 Std and Quick Hitch | Axle Suspension | Spring-Loaded |
| Deck Thickness | 7 Gauge | Wheels | 21" Laminated |
| Side Bands | 1/4" x 10" | Approximate Weight | 3,700 lb. |
| Gearbox Rating (HP) | 210* (Transfer); 210* (Cutting) | Safety Shielding | Front and Rear Rubber Belt Standard |
| Main Driveline | ASAE Category 5 | Highway Light Kit | Standard |

10-Year Gearbox Limited Warranty and 1-Year Machine Limited Warranty | 10-Year Deck Rust-Thru Limited Warranty on Galvanized Decks

*Gearbox rating based on field performance.

| | |
|----------------------|---|
| NOTICE: | PTO adapter must not be used in any application. |
| WARNING: | A deflector kit or chain shielding must be used for all non-agricultural purposes or in areas where thrown objects could be hazardous to people, animals, or property. |
| HOW TO ORDER: | To receive a complete cutter, you must order a Basic Unit and a Group 2 Height Adjustment Selection. The 14215R-2 comes equipped with Lift-Type Hitch, Round Blade Pans, ASAE Cat 5 Drivelines with Slip-Clutches, Front Belting and Rear Metal Band. |

Freight NOT included in list price

14215 ROTARY CUTTER

BASE UNIT SELECTION

| Model Number | Description | Approx. Wt. | List Price (\$US) |
|--------------|--|-------------|-------------------|
| 14215R-2 | 14215 Series Rotary Cutter, Round Blade Holder, 1000 PTO with Slip-Clutch Cross-Shafts | 3,700 lb. | \$24,072 |

GROUP 2 HEIGHT ADJUSTMENT SELECTION

| | | | |
|-------|---------------------------|--------|--------------|
| 1817 | Manual Ratchet Bundle | 15 lb. | \$164 |
| 90492 | Hydraulic Cylinder Bundle | 45 lb. | \$420 |



[RETURN TO INDEX](#)

FLEX-WING ROTARY CUTTERS



FLEX-WING ROTARY CUTTERS

RETURN TO INDEX



1812 SERIES FLEX-WING ROTARY CUTTER

| MODEL | 1812 |
|-----------------------|--|
| Transport Height* | 5' 8" |
| Transport Width** | 6' 8" |
| Overall Width | 12' 8" |
| Cutting Width | 12' |
| Length*** | 13' 3" |
| Axle Suspension | Cushioned Rubber Bumper on Each Center Axle Arm |
| Cutting Height | 2" - 14" |
| Cutting Capacity | 1 1/2" Diameter |
| Hitch | Cast Swivel Clevis |
| Approx. Tongue Weight | 1,100 lb. |
| Deck Thickness | 10 Gauge |
| Side Bands | 1/4" x 11 1/2" |
| Gearbox Rating (HP) | 160 [†] Transfer Gearbox, 65 [†] Cutting Gearboxes |
| Driveline | ASAE Category 4 (540 PTO) |
| Driveline Protection | (3) Multi-Plate Slip Clutch |

| MODEL | 1812 |
|------------------------|---|
| Blade Holder | Oval |
| Blades | 1/2" x 3" Parallel Uplift |
| Blade Overlap | 6" |
| Blade Tip Speed | 14,464 fpm Center (540 rpm); 13,930 fpm Wings (540 rpm) |
| Wing Cutting Angles | 22° Down to 45° Up |
| Center Hydraulic Lift | Standard |
| Wing Hydraulic Lift | Standard |
| Axle Tube Pivots | Greaseable Bushings |
| Wing Adjustment | Greaseable Turnbuckles |
| Wheels | See Wheel Selection |
| Minimum Tractor PTO HP | 50 |
| Jack Stand | Standard |
| Safety Tow Chain | Standard |
| Safety Shielding | Single or Double Row Chains |

10-Year Gearbox Limited Warranty and 1-Year Machine Limited Warranty

NOT FOR COMMERCIAL APPLICATION

*Measured at maximum transport height.

**Measured at outside of wing skirts, folded.

***Measured from hitch pin to axle spindle at transport height.

†Gearbox rating based on field performance.

WARNING:

A deflector kit or chain shielding must be used for all non-agricultural purposes or in areas where thrown objects could be hazardous to people, animals, or property.

HOW TO ORDER:

To receive a complete cutter, you must order a basic unit and then select one item from each of Groups 2 - 5 in the ordering section. Additional equipment may be added to your order by making your selection from the options list.

Freight NOT included in list price



RETURN TO INDEX

1812 SERIES FLEX-WING ROTARY CUTTER

BASE UNIT SELECTION

| Model Number | Description | Approx. Wt. | List Price (\$US) |
|--------------|--|-------------|-------------------|
| 1812R1 | 1812 Series Flex-Wing Rotary Cutter, Oval Blade Holder, 540 PTO, No Deck Rings | 2,554 lb. | \$13,898 |

Model Includes Center and Wing Hydraulic Cylinders and Hoses, Cast Swivel Hitch, Tow Chain, Wing Drivelines, and CV, ASAE Category 4 Driveline. Assembly Included in List Price.

GROUP 2 CENTER AXLE SELECTION

| Model Number | Description | Approx. Wt. | List Price (\$US) |
|--------------|----------------------------|-------------|-------------------|
| 50074514 | Dual Axle Arms (4 Tires) | 88 lb. | \$736 |
| 50074515 | Single Axle Arms (2 Tires) | 69 lb. | \$548 |

GROUP 3 WING AXLE SELECTION

| Model Number | Description | Approx. Wt. | List Price (\$US) |
|--------------|----------------------------|-------------|-------------------|
| 50072771 | Dual Axle Arms (4 Tires) | 38 lb. | \$378 |
| 50072772 | Single Axle Arms (2 Tires) | 19 lb. | \$191 |

GROUP 4 WHEEL SELECTION

| Model Number | Description | Approx. Wt. | List Price (\$US) |
|--------------|---|-----------------|-------------------|
| 294 | 20" Laminated Tire | 72 lb. | each \$223 |
| | | 4 Tires 288 lb. | \$892 |
| | | 6 Tires 432 lb. | \$1,338 |
| | | 8 Tires 576 lb. | \$1,784 |
| 50074504 | Used Aircraft Tire, 20.5x6.75-10 | 43 lb. | each \$185 |
| | | 4 Tires 172 lb. | \$740 |
| | | 6 Tires 258 lb. | \$1,110 |
| | | 8 Tires 344 lb. | \$1,480 |
| 50074505 | Used Aircraft Tire, Foam Filled, 20.5x6.75-10 | 60 lb. | each \$304 |
| | | 4 Tires 240 lb. | \$1,216 |
| | | 6 Tires 360 lb. | \$1,824 |
| | | 8 Tires 480 lb. | \$2,432 |

GROUP 5 ENCLOSURE SELECTION

| Model Number | Description | Approx. Wt. | List Price (\$US) |
|--------------|-----------------------------------|-------------|-------------------|
| 50074511 | Single Row Chains, Front and Rear | 197 lb. | \$653 |
| 50074512 | Double Row Chains, Front and Rear | 315 lb. | \$986 |

OPTIONS

| Model Number | Description | List Price (\$US) |
|--------------|--|-----------------------------|
| 50074762 | Hydraulic Hose Kit to Raise Wings Independent of Center Section (Requires Two Sets of Tractor Outlets) | \$40 |
| 1812 Spec | Special Paint Colors | Call for Quote |
| 50072725 | Field Conversion Kit, Center Single to Dual Axle. Order (2) Kits + Tires of Choice | Order Through Service Parts |
| 50073432 | Field Conversion Kit, Wing Single Axle to Dual Axle. Order (1) Kit Per Wing + Tires of Choice. | Order Through Service Parts |

NOTE: Safety shieldings are non-returnable items for all models.

RETURN TO INDEX



1815 SERIES FLEX-WING ROTARY CUTTER

| MODEL | 1815 | MODEL | 1815 |
|-----------------------|---|------------------------|---|
| Transport Height* | 7' | Blades | 1/2" x 4" Parallel Uplift |
| Transport Width** | 7' 7" | Blade Overlap | 6" |
| Cutting Width | 15' | Blade Tip Speed | 15,000 fpm (540 rpm); 15,600 fpm (1,000 rpm) |
| Length*** | 15' 2" | Wing Cutting Angles | 22° Down to 45° Up |
| Axle Suspension | Cushioned Rubber on Center Axle | Center Hydraulic Lift | Standard |
| Cutting Height | 2" - 14" | Wing Hydraulic Lift | Standard |
| Cutting Capacity | 2½" Diameter | Axle Tube Pivots | Greaseable Bushings |
| Hitch | See Hitch Selection | Wing Adjustment | Greaseable Turnbuckles |
| Approx. Tongue Weight | 1,700 lb. | Wheels | See Wheel Selection |
| Deck Thickness | 10 Gauge | Minimum Tractor PTO HP | 60 |
| Side Bands | 1/4" x 12" | Grass Baffles | Optional |
| Gearbox Rating (HP) | 160 hp† Transfer Gearbox, 130 hp† Cutting Gearboxes | Jack Stand | Standard |
| Driveline | Main: See Driveline Selection Wings: ASAE Category 4 | Safety Tow Chain | Standard |
| Driveline Protection | (3) Multi-Plate Slip Clutch | Safety Shielding | Single or Double Row Chains |
| Blade Holder | Round | | |

10-Year Gearbox Limited Warranty and 1-Year Machine Limited Warranty

NOT FOR COMMERCIAL APPLICATION

*Measured at maximum transport height.

**Measured at outside of wing skirts, folded.

***Measured from hitch pin to axle spindle at transport height.

†Gearbox rating based on field performance.

WARNING:

A deflector kit or chain shielding must be used for all non-agricultural purposes or in areas where thrown objects could be hazardous to people, animals, or property.

HOW TO ORDER:

To receive a complete cutter, you must order a basic unit and then select one item from each of Groups 2 - 6 in the ordering section. Additional equipment may be added to your order by making your selection from the options list.

Freight NOT included in list price



RETURN TO INDEX

1815 SERIES FLEX-WING ROTARY CUTTER

BASE UNIT SELECTION

| Model Number | Description | Approx. Wt. | List Price (\$US) |
|--------------|---|-------------|-------------------|
| 1815R1 | 1815 Flex-Wing Series Rotary Cutter, Round Blade Holder, 540 PTO, No Deck Rings | 3,421 lb. | \$16,097 |
| 1815RR1 | 1815 Flex-Wing Series Rotary Cutter, Round Blade Holder, 540 PTO, With Deck Rings | 3,630 lb. | \$16,659 |
| 11815R1 | 1815 Flex-Wing Series Rotary Cutter, Round Blade Holder, 1,000 PTO, No Deck Rings | 3,421 lb. | \$16,097 |
| 11815RR1 | 1815 Flex-Wing Series Rotary Cutter, Round Blade Holder, 1,000 PTO, With Deck Rings | 3,630 lb. | \$16,659 |

Model Includes Center and Wing Hydraulic Cylinders and Hoses, Tow Chain, and Wing Drivelines.
 Assembly Included in List Price.

GROUP 2 HITCH SELECTION

| | | | |
|----------|--------------------|--------|-------|
| 50054505 | Perma-Level® Hitch | 53 lb. | \$392 |
|----------|--------------------|--------|-------|

GROUP 3 DRIVELINE SELECTION

| | | | |
|----------|---|--------|---------|
| 50069764 | CV Driveline, 540 PTO, 1-3/8-6, ASAE Category 6 | 90 lb. | \$1,295 |
| 50069765 | CV Driveline, 1000 PTO, 1-3/8-21, ASAE Category 5 | 90 lb. | \$1,340 |

GROUP 4 WING AXLE SELECTION

| | | | |
|----------|----------------------------|--------|-------|
| 50072772 | Single Axle Arms (2 Tires) | 19 lb. | \$191 |
| 50072771 | Dual Axle Arms (4 Tires) | 38 lb. | \$378 |

GROUP 5 FRONT WHEEL SELECTION

| | | | |
|----------|------------------------------------|-----------------|------------|
| 294 | 20" Laminated Tire | 72 lb. | each \$223 |
| | | 6 Tires 432 lb. | \$1,338 |
| | | 8 Tires 576 lb. | \$1,784 |
| 50075401 | 25" Laminated Tire | 85 lb. | each \$301 |
| | | 6 Tires 510 lb. | \$1,806 |
| | | 8 Tires 680 lb. | \$2,408 |
| 97708 | Pneumatic Aircraft Tire, 24x7.7x10 | 75 lb. | each \$236 |
| | | 6 Tires 450 lb. | \$1,416 |
| | | 8 Tires 600 lb. | \$1,888 |

GROUP 6 ENCLOSURE SELECTION

| | | | |
|----------|-----------------------------------|---------|---------|
| 50072776 | Single Row Chains, Front and Rear | 269 lb. | \$1,272 |
| 50073433 | Double Row Chains, Front and Rear | 431 lb. | \$1,593 |

GROUP 7 HYDRAULIC HOSE SELECTION

| | | | |
|----------|------------------------------------|-------|-----|
| 50082034 | Independent Wing Control (3-Hoses) | 5 lb. | \$0 |
| 50082035 | Single Wing Control (2-Hoses) | 5 lb. | \$0 |

OPTIONS

| | | | |
|-----------|---|--------|-----------------------------|
| 50073353 | Grass Distribution Kit | 74 lb. | \$346 |
| 50077430 | EZ-Mount Driveline Holder (Please Contact Service Parts to Place Order) | 8 lb. | \$106 |
| 1815 Spec | Special Paint Colors | | Call for Quote |
| 50073432 | Field Conversion Kit, Wing Single Axle to Dual Axle. Order (1) Kit Per Wing + Tires of Choice. | | Order Through Service Parts |

NOTE: Safety shieldings are non-returnable items for all models.

RETURN TO INDEX

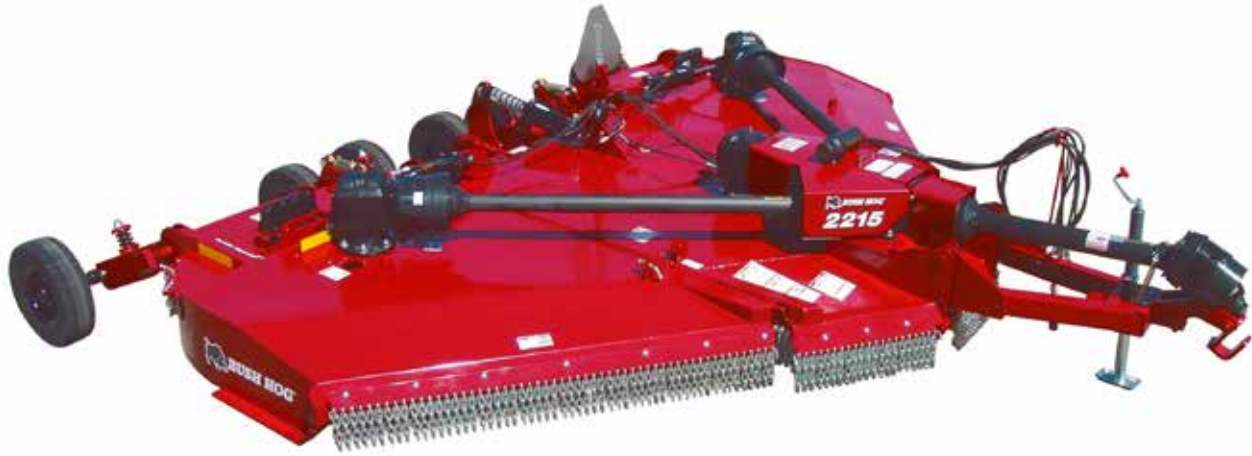

2215 SERIES FLEX-WING ROTARY CUTTER

| MODEL | 2215 | MODEL | 2215 |
|-----------------------|---|------------------------|--|
| Transport Height* | 7' 3" | Blade Overlap | 6" |
| Transport Width** | 8' 2" | Blade Tip Speed | 16,286 fpm (540 rpm); 16,000 fpm (1000 rpm) |
| Cutting Width | 15' | Wing Cutting Angles | 22° Down to 45° Up |
| Axle Suspension | Cushioned Springs at Each Wheel | Center Hydraulic Lift | Standard |
| Cutting Height | 2" - 14" | Wing Hydraulic Lift | Standard |
| Cutting Capacity | 3½" Diameter | Axle Tube Pivots | Greaseable Bushings |
| Hitch | See Hitch Selection | Axle Arm Pivots | Greaseable |
| Approx. Tongue Weight | 1,800 lb. | Wing Adjustment | Greaseable Turnbuckles |
| Deck Thickness | 10 Gauge | Wheels | See Wheel Selection |
| Side Bands | 1/4" x 13 ½" | Minimum Tractor PTO HP | 60 |
| Gearbox Rating (HP) | 250 hp† Transfer Gearbox, 210 hp† Cutting Gearboxes | Grass Baffles | Optional |
| Driveline | Main: See Driveline Selection Wings: ASAE Category 4 | Jack Stand | Standard |
| Driveline Protection | (3) Multi-Plate Slip Clutch | Safety Tow Chain | Standard |
| Blade Holder | Round | Safety Shielding | Single or Double Row Chains |
| Blades | 1/2" x 4" Parallel Uplift | | |

10-Year Gearbox Limited Warranty and 1-Year Machine Limited Warranty

*Measured at maximum transport height.

**Measured at outside of wing skirts.

†Gearbox rating based on field performance.

WARNING:

A deflector kit or chain shielding must be used for all non-agricultural purposes or in areas where thrown objects could be hazardous to people, animals, or property.

HOW TO ORDER:

To receive a complete cutter, you must order a basic unit and then select one item from each of Groups 2 - 6 in the ordering section. Additional equipment may be added to your order by making your selection from the options list.

Freight NOT included in list price



RETURN TO INDEX

2215 SERIES FLEX-WING ROTARY CUTTER

BASE UNIT SELECTION

| Model Number | Description | Approx. Wt. | List Price (\$US) |
|--------------|---|-------------|-------------------|
| 2215R1 | 2215 Flex-Wing Series Rotary Cutter, Round Blade Holder, 540 PTO, No Deck Rings | 3,565 lb. | \$16,982 |
| 2215RR1 | 2215 Flex-Wing Series Rotary Cutter, Round Blade Holder, 540 PTO, With Deck Rings | 3,774 lb. | \$17,542 |
| 12215R1 | 2215 Flex-Wing Series Rotary Cutter, Round Blade Holder, 1,000 PTO, No Deck Rings | 3,565 lb. | \$16,982 |
| 12215RR1 | 2215 Flex-Wing Series Rotary Cutter, Round Blade Holder, 1,000 PTO, With Deck Rings | 3,774 lb. | \$17,542 |

Model Includes Perma-Level Hitch and Tow Chain. Assembly Included in List Price.

GROUP 2 DRIVELINE SELECTION

| | | | |
|----------|--|--------|---------|
| 50069764 | CV Driveline, 540 PTO, 1-3/8-6, ASAE Category 6 | 90 lb. | \$1,295 |
| 50069765 | CV Driveline, 1,000 PTO, 1-3/8-21, ASAE Category 5 | 90 lb. | \$1,340 |
| 50074699 | CV Driveline, 1,000 PTO, 1-3/4-20, ASAE Category 6 | 90 lb. | \$1,340 |

GROUP 3 CENTER AXLE SELECTION

| | | | |
|----------|------------------------------------|---------|---------|
| 50070267 | Dual Axle Arms (4 Tires) | 126 lb. | \$1,343 |
| 50076588 | Tandem Walking Axle Arms (4 Tires) | 209 lb. | \$1,885 |

GROUP 4 WING AXLE SELECTION

| | | | |
|----------|------------------------------------|---------|---------|
| 50068188 | Single Axle Arms (2 Tires) | 98 lb. | \$1,042 |
| 50070267 | Dual Axle Arms (4 Tires) | 126 lb. | \$1,343 |
| 50076588 | Tandem Walking Axle Arms (4 Tires) | 209 lb. | \$1,885 |

GROUP 5 WHEEL SELECTION

| | | | | |
|----------|--------------------------------------|---------|---------|------------|
| 294 | 20" Laminated Tire | | 72 lb. | each \$223 |
| | | 6 Tires | 432 lb. | \$1,338 |
| | | 8 Tires | 576 lb. | \$1,784 |
| 50075401 | 25" Laminated Tire | | 85 lb. | each \$301 |
| | | 6 Tires | 510 lb. | \$1,806 |
| | | 8 Tires | 680 lb. | \$2,408 |
| 50050727 | Used Aircraft Tire, 29x9x15 | | 75 lb. | each \$280 |
| | | 6 Tires | 450 lb. | \$1,680 |
| | | 8 Tires | 600 lb. | \$2,240 |
| 50072403 | Used Aircraft Tire, 27.75x8.75-24PR | | 80 lb. | each \$305 |
| | | 6 Tires | 480 lb. | \$1,830 |
| | | 8 Tires | 640 lb. | \$2,440 |
| 50078502 | Foam-Filled Tire, 27 x 8-18 | | 100 lb. | each \$475 |
| | | 6 Tires | 600 lb. | \$2,850 |
| | | 8 Tires | 800 lb. | \$3,800 |
| 50068834 | Foam Filled Aircraft Tire, 26x6.6x14 | | 90 lb. | each \$465 |
| | | 6 Tires | 540 lb. | \$2,790 |
| | | 8 Tires | 720 lb. | \$3,720 |

GROUP 6 ENCLOSURE SELECTION

| | | | |
|----------|-----------------------------------|---------|---------|
| 50076835 | Single Row Chains, Front and Rear | 273 lb. | \$1,249 |
| 50076836 | Double Row Chains, Front and Rear | 439 lb. | \$1,562 |

GROUP 7 HYDRAULIC HOSE SELECTION

| | | | |
|----------|------------------------------------|-------|-----|
| 50082034 | Independent Wing Control (3-Hoses) | 5 lb. | \$0 |
| 50082035 | Single Wing Control (2-Hoses) | 5 lb. | \$0 |

OPTIONS

| | | | |
|-----------|---|--------|-----------------------------|
| 50076825 | Grass and Crop Baffles | 76 lb. | \$434 |
| 50077430 | EZ-Mount Driveline Holder (Please Contact Service Parts to Place Order) | 8 lb. | \$106 |
| 50073131 | Field Conversion Kit, Wing Single Axle to Dual Axle. Order (1) Kit Per Wing + Tires of Choice. | | Order Through Service Parts |
| 2215 Spec | Special Paint Colors | | Call for Quote |

NOTE: Safety shieldings are non-returnable items for all models.

RETURN TO INDEX



SEE WARRANTY SPECIFICATIONS BELOW



2810 SERIES FLEX-WING ROTARY CUTTER

| MODEL | 2810 | MODEL | 2810 |
|-----------------------|---|------------------------|--|
| Transport Height* | 7' 3" | Blade Holder | Round |
| Transport Width** | 8' 2" | Blades | 1/2" x 4" Parallel Uplift |
| Total Length | 15' 3" | Blade Overlap | 6" |
| Total Width | 12' | Blade Tip Speed | 16,286 fpm (540 rpm); 15,906 fpm (1000 rpm) |
| Cutting Width | 10' 6" | Wing Cutting Angles | 22° Down to 45° Up |
| Axle Suspension | Cushioned Springs at Each Wheel | Center Hydraulic Lift | Standard |
| Cutting Height | 2" - 14" | Wing Hydraulic Lift | Standard |
| Cutting Capacity | 4" Diameter | Axle Tube Pivots | Greaseable Bushings |
| Hitch | Self-Leveling Perma-Level® | Wing Adjustment | Greaseable Turnbuckles |
| Approx. Tongue Weight | 1,900 lb. | Wheels | See Wheel Selection |
| Deck Thickness | 11 Gauge (Center Top) 7 Gauge (Center Bottom) 7 Gauge (Wings) | Minimum Tractor PTO HP | 60 |
| Side Bands | 1/4" x 13 1/2" | Grass Baffles | Optional |
| Gearbox Rating (HP) | 250 hp† Transfer Gearbox, 225 hp† Cutting Gearboxes | Jack Stand | Standard |
| Driveline | Main: See Driveline Selection Wings: ASAE Category 4 | Safety Tow Chain | Standard |
| Driveline Protection | (2) Multi-Plate Slip Clutch | Safety Shielding | Double Row Chains" |

10-Year Gearbox Limited Warranty | 6-Month Machine Limited Warranty (Contractors) | 1-Year Machine Limited Warranty (Consumers)

*Measured at maximum transport height.

**Measured at outside of wing skids.

†Gearbox rating based on field performance.

WARNING: A deflector kit or chain shielding must be used for all non-agricultural purposes or in areas where thrown objects could be hazardous to people, animals, or property.

HOW TO ORDER: To receive a complete cutter, you must order a basic unit and then select one item from each of Groups 2 - 6 in the ordering section. Additional equipment may be added to your order by making your selection from the options list.

Freight NOT included in list price



RETURN TO INDEX

2810 SERIES FLEX-WING ROTARY CUTTER

RIGHT WING ONLY BASE UNIT SELECTION

| Model Number | Description | Approx. Wt. | List Price (\$US) |
|--------------|---|-------------|-------------------|
| 2810R4 | 2810 Flex-Wing Series Rotary Cutter, Round Blade Holder, 540 PTO, No Deck Rings | 4,324 lb. | \$18,337 |
| 2810RR4 | 2810 Flex-Wing Series Rotary Cutter, Round Blade Holder, 540 PTO, With Deck Rings | 4,533 lb. | \$18,787 |
| 12810R4 | 2810 Flex-Wing Series Rotary Cutter, Round Blade Holder, 1,000 PTO, No Deck Rings | 4,324 lb. | \$18,337 |
| 12810RR4 | 2810 Flex-Wing Series Rotary Cutter, Round Blade Holder, 1,000 PTO, With Deck Rings | 4,533 lb. | \$18,787 |

Model Includes Center and Wing Hydraulic Cylinders and Hoses, Perma-Level Hitch, Tow Chain, and Wing Drivelines. Assembly Included in List Price.

GROUP 2 DRIVELINE SELECTION

| | | | |
|----------|--|--------|----------------|
| 50069764 | CV Driveline, 540 PTO, 1-3/8-6, ASAE Category 6 | 90 lb. | \$1,295 |
| 50069765 | CV Driveline, 1,000 PTO, 1-3/8-21, ASAE Category 5 | 90 lb. | \$1,340 |
| 50074699 | CV Driveline, 1,000 PTO, 1-3/4-20, ASAE Category 6 | 90 lb. | \$1,340 |

GROUP 3 CENTER AXLE SELECTION

| | | | |
|----------|---|---------|----------------|
| 50074158 | Dual Axle Arms (4 Tires), Half Spindles | 171 lb. | \$1,376 |
| 50076586 | Tandem Walking Axle Arms (4 Tires) | 392 lb. | \$2,075 |

GROUP 4 WING AXLE SELECTION

| | | | |
|----------|-------------------------------|---------|--------------|
| 50070526 | Single Axle Arm (1 Tire) | 49 lb. | \$552 |
| 50070627 | Dual Axle Arm (2 Tires) | 63 lb. | \$659 |
| 50076589 | Tandem Walking Axle (4 Tires) | 104 lb. | \$999 |

GROUP 5 FRONT WHEEL SELECTION

| | | | | |
|----------|--------------------------------------|---------|---------|-------------------|
| 294 | 20" Laminated Tire | | 72 lb. | each \$223 |
| | | 5 Tires | 360 lb. | \$1,115 |
| | | 6 Tires | 432 lb. | \$1,338 |
| 50075401 | 25" Laminated Tire | | 85 lb. | each \$301 |
| | | 5 Tires | 425 lb. | \$1,505 |
| | | 6 Tires | 510 lb. | \$1,806 |
| 50050727 | Used Aircraft Tire, 29x9x15 | | 75 lb. | each \$280 |
| | | 5 Tires | 375 lb. | \$1,400 |
| | | 6 Tires | 450 lb. | \$1,680 |
| 50072403 | Used Aircraft Tire, 27.75x8.75-24PR | | 80 lb. | each \$305 |
| | | 5 Tires | 400 lb. | \$1,525 |
| | | 6 Tires | 480 lb. | \$1,830 |
| 50078502 | Foam-Filled Tire, 27 x 8-18 | | 100 lb. | each \$475 |
| | | 5 Tires | 500 lb. | \$2,375 |
| | | 6 Tires | 600 lb. | \$2,850 |
| 50068834 | Foam Filled Aircraft Tire, 26x6.6x14 | | 90 lb. | each \$465 |
| | | 5 Tires | 540 lb. | \$2,325 |
| | | 6 Tires | 720 lb. | \$2,790 |

GROUP 6 ENCLOSURE SELECTION

| | | | |
|----------|-----------------------------------|---------|--------------|
| 50070419 | Double Row Chains, Front and Rear | 310 lb. | \$852 |
|----------|-----------------------------------|---------|--------------|

OPTIONS

| | | | |
|-----------|---|-----------------------------|--------------|
| 50070395 | Grass and Crop Distribution Baffles | 59 lb. | \$318 |
| 50077430 | EZ-Mount Driveline Holder (Please Contact Service Parts to Place Order) | 8 lb. | \$106 |
| 50073131 | Field Conversion Kit, Wing Single Axle to Dual Axle. Order (1) Kit Per Wing + Tires of Choice. | Order Through Service Parts | |
| 2810 Spec | Special Paint Colors | Call for Quote | |

NOTE: Safety shieldings are non-returnable items for all models.

RETURN TO INDEX



SEE WARRANTY SPECIFICATIONS BELOW



2815 SERIES FLEX-WING ROTARY CUTTER

| MODEL | 2815 |
|-----------------------|---|
| Transport Height* | 7' 3" |
| Transport Width** | 8' 2" |
| Cutting Width | 15' |
| Axle Suspension | Cushioned Springs at Each Wheel |
| Cutting Height | 2" - 14" |
| Cutting Capacity | 4" Diameter |
| Hitch | Self-Leveling Perma-Level® |
| Approx. Tongue Weight | 1,900 lb. |
| Deck Thickness | 11 Gauge (Center Top) 7 Gauge (Center Bottom) 7 Gauge (Wings) |
| Side Bands | 1/4" x 13½" |
| Gearbox Rating (HP) | 250 hp† Splitter Gearbox, 225 hp† Cutting Gearboxes |
| Driveline | Main: See Driveline Selection Wings: ASAE Category 4 |
| Driveline Protection | (3) Multi-Plate Slip Clutch |
| Blade Holder | Round |
| Blades | 1/2" x 4" Parallel Uplift |

| MODEL | 2815 |
|------------------------|--|
| Blade Overlap | 6" |
| Blade Tip Speed | 16,286 fpm (540 rpm); 16,391 fpm (1000 rpm) |
| Wing Cutting Angles | 22° Down to 45° Up |
| Center Hydraulic Lift | Standard |
| Wing Hydraulic Lift | Standard |
| Axle Tube Pivots | Greaseable Bushings |
| Axle Arm Pivots | Greaseable |
| Wing Adjustment | Greaseable Turnbuckles |
| Wheels | See Wheel Selection |
| Minimum Tractor PTO HP | 60 |
| Grass Baffles | Optional |
| Jack Stand | Standard |
| Safety Tow Chain | Standard |
| Safety Shielding | Double Row Chains |

10-Year Gearbox Limited Warranty | 6-Month Machine Limited Warranty (Contractors) | 1-Year Machine Limited Warranty (Consumers)

*Measured at maximum transport height.

**Measured at outside of wing skids.

†Gearbox rating based on field performance.

WARNING:

A deflector kit or chain shielding must be used for all non-agricultural purposes or in areas where thrown objects could be hazardous to people, animals, or property.

HOW TO ORDER:

To receive a complete cutter, you must order a basic unit and then select one item from each of Groups 2 - 6 in the ordering section. Additional equipment may be added to your order by making your selection from the options list.

Freight NOT included in list price



RETURN TO INDEX

2815 SERIES FLEX-WING ROTARY CUTTER

BASE UNIT SELECTION

| Model Number | Description | Approx. Wt. | List Price (\$US) |
|--------------|---|-------------|-------------------|
| 2815R4 | 2815 Flex-Wing Series Rotary Cutter, Round Blade Holder, 540 PTO, No Deck Rings | 4,324 lb. | \$20,848 |
| 2815RR4 | 2815 Flex-Wing Series Rotary Cutter, Round Blade Holder, 540 PTO, With Deck Rings | 4,533 lb. | \$21,526 |
| 12815R4 | 2815 Flex-Wing Series Rotary Cutter, Round Blade Holder, 1,000 PTO, No Deck Rings | 4,324 lb. | \$20,848 |
| 12815RR4 | 2815 Flex-Wing Series Rotary Cutter, Round Blade Holder, 1,000 PTO, With Deck Rings | 4,533 lb. | \$21,526 |

Model Includes Center and Wing Hydraulic Cylinders and Hoses, Perma-Level Hitch, Tow Chain, and Wing Drivelines. Assembly Included in List Price.

GROUP 2 DRIVELINE SELECTION

| | | | |
|----------|--|--------|---------|
| 50069764 | CV Driveline, 540 PTO, 1-3/8-6, ASAE Category 6 | 90 lb. | \$1,295 |
| 50069765 | CV Driveline, 1,000 PTO, 1-3/8-21, ASAE Category 5 | 90 lb. | \$1,340 |
| 50074699 | CV Driveline, 1,000 PTO, 1-3/4-20, ASAE Category 6 | 90 lb. | \$1,340 |

GROUP 3 CENTER AXLE SELECTION

| | | | |
|----------|------------------------------------|---------|---------|
| 50074158 | Dual Axle Arms (4 Tires) | 126 lb. | \$1,376 |
| 50076586 | Tandem Walking Axle Arms (4 Tires) | 392 lb. | \$2,075 |

GROUP 4 WING AXLE SELECTION

| | | | |
|----------|------------------------------------|---------|---------|
| 50068188 | Single Axle Arms (2 Tires) | 98 lb. | \$1,042 |
| 50070267 | Dual Axle Arms (4 Tires) | 126 lb. | \$1,343 |
| 50076588 | Tandem Walking Axle Arms (4 Tires) | 209 lb. | \$1,885 |

GROUP 5 WHEEL SELECTION

| | | | | |
|----------|--------------------------------------|---------|---------|------------|
| 294 | 20" Laminated Tire | | 72 lb. | each \$223 |
| | | 6 Tires | 432 lb. | \$1,338 |
| | | 8 Tires | 576 lb. | \$1,784 |
| 50075401 | 25" Laminated Tire | | 85 lb. | each \$301 |
| | | 6 Tires | 510 lb. | \$1,806 |
| | | 8 Tires | 680 lb. | \$2,408 |
| 50050727 | Used Aircraft Tire, 29x9x15 | | 75 lb. | each \$280 |
| | | 6 Tires | 450 lb. | \$1,680 |
| | | 8 Tires | 600 lb. | \$2,240 |
| 50072403 | Used Aircraft Tire, 27.75x8.75-24PR | | 80 lb. | each \$305 |
| | | 6 Tires | 480 lb. | \$1,830 |
| | | 8 Tires | 640 lb. | \$2,440 |
| 50078502 | Foam-Filled Tire, 27 x 8-18 | | 100 lb. | each \$475 |
| | | 6 Tires | 600 lb. | \$2,850 |
| | | 8 Tires | 800 lb. | \$3,800 |
| 50068834 | Foam Filled Aircraft Tire, 26x6.6x14 | | 90 lb. | each \$465 |
| | | 6 Tires | 540 lb. | \$2,790 |
| | | 8 Tires | 720 lb. | \$3,720 |

GROUP 6 ENCLOSURE SELECTION

| | | | |
|----------|-----------------------------------|---------|---------|
| 50069458 | Double Row Chains, Front and Rear | 477 lb. | \$1,372 |
|----------|-----------------------------------|---------|---------|

GROUP 7 HYDRAULIC HOSE SELECTION

| | | | |
|----------|------------------------------------|-------|-----|
| 50082034 | Independent Wing Control (3-Hoses) | 5 lb. | \$0 |
| 50082035 | Single Wing Control (2-Hoses) | 5 lb. | \$0 |

OPTIONS

| | | | |
|-----------|---|--------|-----------------------------|
| 50069451 | Grass and Crop Distribution Baffles | 76 lb. | \$420 |
| 50077430 | EZ-Mount Driveline Holder (Please Contact Service Parts to Place Order) | 8 lb. | \$106 |
| 50073131 | Field Conversion Kit, Wing Single Axle to Dual Axle. Order (1) Kit Per Wing + Tires of Choice. | | Order Through Service Parts |
| 2815 Spec | Special Paint Colors | | Call for Quote |

NOTE: Safety shieldings are non-returnable items for all models.

RETURN TO INDEX



SEE WARRANTY SPECIFICATIONS BELOW

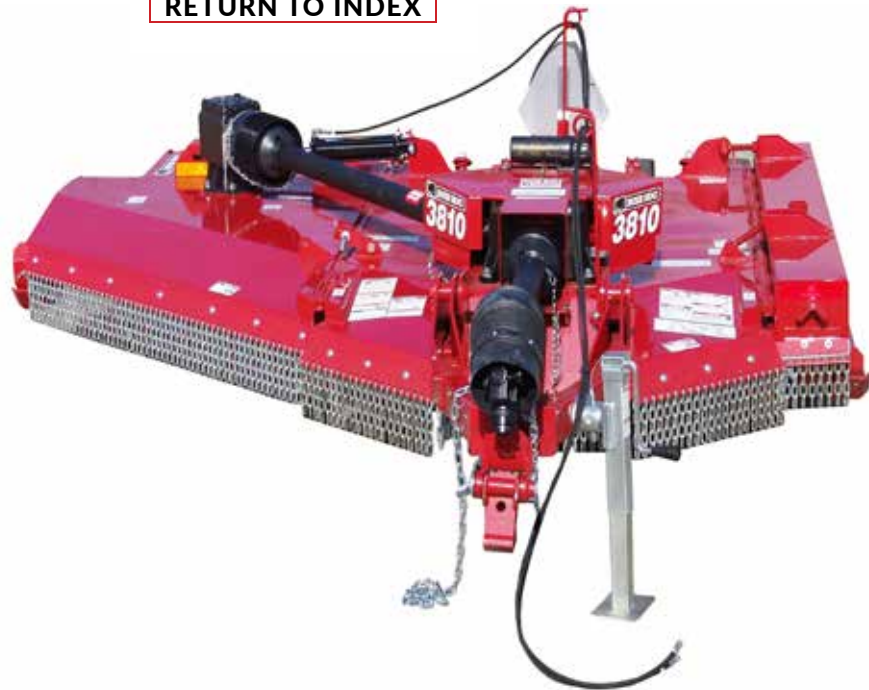

3810 SERIES FLEX-WING ROTARY CUTTER

| MODEL | 3810 |
|-----------------------|---|
| Transport Height* | 7' 3" |
| Transport Width** | 8' 2" |
| Cutting Width | 10' 6" |
| Axle Suspension | Cushioned Springs at Each Wheel |
| Cutting Height | 2" to 14" |
| Cutting Capacity | 4 1/2" Diameter |
| Hitch | See Hitch Selection |
| Approx. Tongue Weight | 2,200 lb. |
| Deck Thickness | 11 Gauge (Center Top) 7 Gauge (Center Bottom) 7 Gauge (Wings) |
| Side Bands | 1/4" x 13 1/2" |
| Gearbox Rating (HP) | 250 hp† Splitter Gearbox, 225 hp† Cutting Gearbox |
| Driveline | Main: See Driveline Selection Wings: ASAE Category 5 |
| Driveline Protection | (2) Multi-Plate Slip Clutch |
| Blade Holder | Round |
| Blade Bolts | Hex Shaped |

| MODEL | 3810 |
|------------------------|--|
| Blades | 1/2" x 4" Parallel Uplift |
| Blade Overlap | 6" |
| Blade Tip Speed | 16,286 fpm (540 rpm); 16,391 fpm (1000 rpm) |
| Wing Cutting Angles | 22° Down to 45° Up |
| Center Hydraulic Lift | Standard |
| Wing Hydraulic Lift | Standard |
| Axle Tube Pivots | Greaseable Bushings |
| Axle Arm Pivots | Greaseable |
| Wing Adjustment | Greaseable Turnbuckles |
| Wheels | See Wheel Selection |
| Minimum Tractor PTO HP | 60 |
| Grass Baffles | Optional |
| Jack Stand | Standard |
| Safety Tow Chain | Standard |
| Safety Shielding | Double Row Chains |

10-Year Gearbox Limited Warranty | 1-Year Machine Limited Warranty (Contractors) | 1-Year Machine Limited Warranty (Consumers)

*Measured at maximum transport height.

**Measured at outside of wing skids.

†Gearbox rating based on field performance.

WARNING:

A deflector kit or chain shielding must be used for all non-agricultural purposes or in areas where thrown objects could be hazardous to people, animals, or property.

HOW TO ORDER:

To receive a complete cutter, you must order a basic unit and then select one item from each of Groups 2 - 7 in the ordering section. Additional equipment may be added to your order by making your selection from the options list.

Freight NOT included in list price



RETURN TO INDEX

3810 SERIES FLEX-WING ROTARY CUTTER

BASE UNIT SELECTION

| Model Number | Description | Approx. Wt. | List Price (\$US) |
|--------------|---|-------------|-------------------|
| 3810RR3 | 3810 Flex-Wing Series Rotary Cutter, Round Blade Holder, 540 PTO, With Deck Rings | 4,708 lb. | \$20,450 |
| 13810RR3 | 3810 Flex-Wing Series Rotary Cutter, Round Blade Holder, 1,000 PTO, With Deck Rings | 4,708 lb. | \$20,450 |

Model Includes Center and Wing Hydraulic Cylinders and Hoses, Tow Chain, and Wing Drivelines. Assembly Included in List Price.

GROUP 2 HITCH SELECTION

| | | | |
|----------|---|--------|-------|
| 50072803 | Ball Hitch with 2 ⁵ / ₁₆ " Ball | 45 lb. | \$357 |
| 50054505 | Perma-Level® Hitch | 53 lb. | \$392 |

GROUP 3 DRIVELINE SELECTION

| | | | |
|----------|--|--------|---------|
| 50069764 | CV Driveline, 540 PTO, 1-3/8-6, ASAE Category 6 | 90 lb. | \$1,295 |
| 50069765 | CV Driveline, 1,000 PTO, 1-3/8-21, ASAE Category 5 | 90 lb. | \$1,340 |
| 50074699 | CV Driveline, 1,000 PTO, 1-3/4-20, ASAE Category 6 | 90 lb. | \$1,340 |

GROUP 4 CENTER AXLE SELECTION

| | | | |
|----------|---|---------|---------|
| 50074158 | Dual Axle Arms (4 Tires), Half Spindles | 171 lb. | \$1,376 |
| 50076586 | Tandem Walking Axle Arms (4 Tires) | 392 lb. | \$2,075 |

GROUP 5 WING AXLE SELECTION

| | | | |
|----------|--|---------|---------|
| 50075164 | Single Axle Arms (1 Tire), Half Spindles | 98 lb. | \$563 |
| 50075163 | Dual Axle Arms (2 Tires), Half Spindles | 126 lb. | \$697 |
| 50076587 | Tandem Walking Axle Arms (2 Tires) | 209 lb. | \$1,060 |

GROUP 6 WHEEL SELECTION

| | | | | |
|----------|--------------------------------------|---------|---------|------------|
| 294 | 20" Laminated Tire | | 72 lb. | each \$223 |
| | | 5 Tires | 360 lb. | \$1,115 |
| | | 6 Tires | 432 lb. | \$1,338 |
| 50075401 | 25" Laminated Tire | | 85 lb. | each \$301 |
| | | 5 Tires | 425 lb. | \$1,505 |
| | | 6 Tires | 510 lb. | \$1,806 |
| 50050727 | Used Aircraft Tire, 29x9x15 | | 75 lb. | each \$280 |
| | | 5 Tires | 375 lb. | \$1,400 |
| | | 6 Tires | 450 lb. | \$1,680 |
| 50072403 | Used Aircraft Tire, 27.75x8.75-24PR | | 80 lb. | each \$305 |
| | | 5 Tires | 400 lb. | \$1,525 |
| | | 6 Tires | 480 lb. | \$1,830 |
| 50078502 | Foam-Filled Tire, 27 x 8-18 | | 100 lb. | each \$475 |
| | | 5 Tires | 500 lb. | \$2,375 |
| | | 6 Tires | 600 lb. | \$2,850 |
| 50068834 | Foam Filled Aircraft Tire, 26x6.6x14 | | 90 lb. | each \$465 |
| | | 5 Tires | 540 lb. | \$2,325 |
| | | 6 Tires | 720 lb. | \$2,790 |

GROUP 7 ENCLOSURE SELECTION

| | | | |
|----------|-----------------------------------|---------|-------|
| 50070419 | Double Row Chains, Front and Rear | 310 lb. | \$852 |
|----------|-----------------------------------|---------|-------|

OPTIONS

| | | | |
|----------|---|--------|-----------------------------|
| 50070395 | Grass and Crop Distribution Baffles | 59 lb. | \$318 |
| 50077430 | EZ-Mount Driveline Holder (Please Contact Service Parts to Place Order) | 8 lb. | \$106 |
| 50073131 | Field Conversion Kit, Wing Single Axle to Dual Axle. Order (1) Kit Per Wing + Tires of Choice. | | Order Through Service Parts |

NOTE: Safety shieldings are non-returnable items for all models.

RETURN TO INDEX



SEE WARRANTY SPECIFICATIONS BELOW



3815 SERIES FLEX-WING ROTARY CUTTER

| MODEL | 3815 | MODEL | 3815 |
|-----------------------|---|------------------------|--|
| Transport Height* | 7' 3" | Blades | 1/2" x 4" Parallel Uplift |
| Transport Width** | 8' 2" | Blade Overlap | 6" |
| Cutting Width | 15' | Blade Tip Speed | 16,286 fpm (540 rpm); 16,391 fpm (1000 rpm) |
| Axle Suspension | Cushioned Springs at Each Wheel | Wing Cutting Angles | 22° Down to 45° Up |
| Cutting Height | 2" - 14" | Center Hydraulic Lift | Standard |
| Cutting Capacity | 4½" Diameter | Wing Hydraulic Lift | Standard |
| Hitch | See Hitch Selection | Axle Tube Pivots | Greaseable Bushings |
| Approx. Tongue Weight | 2,200 lb. | Axle Arm Pivots | Greaseable |
| Deck Thickness | 11 Gauge (Center Top) 7 Gauge (Center Bottom) 7 Gauge (Wings) | Wing Adjustment | Greaseable Turnbuckles |
| Side Bands | 1/4" x 13½" | Wheels | See Wheel Selection |
| Gearbox Rating (HP) | 250 hp† Splitter Gearbox, 225 hp† Cutting Gearbox | Minimum Tractor PTO HP | 60 |
| Driveline | Main: See Driveline Selection Wings: ASAE Category 5 | Grass Baffles | Optional |
| Driveline Protection | (3) Multi-Plate Slip Clutch | Jack Stand | Standard |
| Blade Holder | Round | Safety Tow Chain | Standard |
| Blade Bolts | Hex Shaped | Safety Shielding | Double Row Chains |

10-Year Gearbox Limited Warranty | 1-Year Machine Limited Warranty (Contractors) | 1-Year Machine Limited Warranty (Consumers)

*Measured at maximum transport height.

**Measured at outside of wing skirts.

†Gearbox rating based on field performance.

WARNING:

A deflector kit or chain shielding must be used for all non-agricultural purposes or in areas where thrown objects could be hazardous to people, animals, or property.

HOW TO ORDER:

To receive a complete cutter, you must order a basic unit and then select one item from each of Groups 2 - 7 in the ordering section. Additional equipment may be added to your order by making your selection from the options list.

Freight NOT included in list price



RETURN TO INDEX

3815 SERIES FLEX-WING ROTARY CUTTER

BASE UNIT SELECTION

| Model Number | Description | Approx. Wt. | List Price (\$US) |
|--------------|--|-------------|-------------------|
| 3815RR3 | 3815 Flex-Wing Series Rotary Cutter, Round Blade Holder, 540 PTO, With Deck Rings | 4,675 lb. | \$23,498 |
| 13815RR3 | 3815 Flex-Wing Series Rotary Cutter, Round Blade Holder, 1,000 PTO, With Deck Rings <small>Model Includes Center and Wing Hydraulic Cylinders and Hoses, Tow Chain, and Wing Drivelines. Assembly Included in List Price.</small> | 4,675 lb. | \$23,498 |

GROUP 2 HITCH SELECTION

| | | | |
|----------|---|--------|-------|
| 50072803 | Ball Hitch with 2 ⁵ / ₁₆ " Ball | 45 lb. | \$357 |
| 50054505 | Perma-Level® Hitch | 53 lb. | \$392 |

GROUP 3 DRIVELINE SELECTION

| | | | |
|----------|--|--------|---------|
| 50069764 | CV Driveline, 540 PTO, 1-3/8-6, ASAE Category 6 | 90 lb. | \$1,295 |
| 50069765 | CV Driveline, 1,000 PTO, 1-3/8-21, ASAE Category 5 | 90 lb. | \$1,340 |
| 50074699 | CV Driveline, 1,000 PTO, 1-3/4-20, ASAE Category 6 | 90 lb. | \$1,340 |

GROUP 4 CENTER AXLE SELECTION

| | | | |
|----------|---|---------|---------|
| 50074158 | Dual Axle Arms (4 Tires), Half Spindles | 171 lb. | \$1,376 |
| 50076586 | Tandem Walking Axle Arms (4 Tires) | 392 lb. | \$2,075 |

GROUP 5 WING AXLE SELECTION

| | | | |
|----------|---|---------|---------|
| 50074159 | Single Axle Arms (2 Tires), Half Spindles | 138 lb. | \$1,107 |
| 50074158 | Dual Axle Arms (4 Tires), Half Spindles | 171 lb. | \$1,376 |
| 50076586 | Tandem Walking Axle Arms (4 Tires) | 392 lb. | \$2,075 |

GROUP 6 WHEEL SELECTION

| | | | | |
|----------|--------------------------------------|---------|---------|------------|
| 294 | 20" Laminated Tire | | 72 lb. | each \$223 |
| | | 6 Tires | 432 lb. | \$1,338 |
| | | 8 Tires | 576 lb. | \$1,784 |
| 50075401 | 25" Laminated Tire | | 85 lb. | each \$301 |
| | | 6 Tires | 510 lb. | \$1,806 |
| | | 8 Tires | 680 lb. | \$2,408 |
| 50050727 | Used Aircraft Tire, 29x9x15 | | 75 lb. | each \$280 |
| | | 6 Tires | 450 lb. | \$1,680 |
| | | 8 Tires | 600 lb. | \$2,240 |
| 50072403 | Used Aircraft Tire, 27.75x8.75-24PR | | 80 lb. | each \$305 |
| | | 6 Tires | 480 lb. | \$1,830 |
| | | 8 Tires | 640 lb. | \$2,440 |
| 50078502 | Foam-Filled Tire, 27 x 8-18 | | 100 lb. | each \$475 |
| | | 6 Tires | 600 lb. | \$2,850 |
| | | 8 Tires | 800 lb. | \$3,800 |
| 50068834 | Foam Filled Aircraft Tire, 26x6.6x14 | | 90 lb. | each \$465 |
| | | 6 Tires | 540 lb. | \$2,790 |
| | | 8 Tires | 720 lb. | \$3,720 |

GROUP 7 ENCLOSURE SELECTION

| | | | |
|----------|-----------------------------------|---------|---------|
| 50069458 | Double Row Chains, Front and Rear | 477 lb. | \$1,372 |
|----------|-----------------------------------|---------|---------|

GROUP 8 HYDRAULIC HOSE SELECTION

| | | | |
|----------|------------------------------------|-------|-----|
| 50082034 | Independent Wing Control (3-Hoses) | 5 lb. | \$0 |
| 50082035 | Single Wing Control (2-Hoses) | 5 lb. | \$0 |

OPTIONS

| | | | |
|-----------|---|-----------------------------|-------|
| 50069451 | Grass and Crop Distribution Baffles | 76 lb. | \$420 |
| 50077430 | EZ-Mount Driveline Holder (Please Contact Service Parts to Place Order) | 8 lb. | \$106 |
| 50073131 | Field Conversion Kit, Wing Single Axle to Dual Axle. Order (1) Kit Per Wing + Tires of Choice. | Order Through Service Parts | |
| 3815 Spec | Special Paint Colors | Call for Quote | |

NOTE: Safety shieldings are non-returnable items for all models.

RETURN TO INDEX



SEE WARRANTY SPECIFICATIONS BELOW



4815 SERIES FLEX-WING ROTARY CUTTER

| MODEL | 4815 | MODEL | 4815 |
|-----------------------|---|------------------------|--|
| Transport Height* | 7' 3" | Blades | 1/2" x 4" Parallel Uplift |
| Transport Width** | 8' 2" | Blade Overlap | 6" |
| Cutting Width | 15' | Blade Tip Speed | 16,286 fpm (540 rpm); 16,391 fpm (1000 rpm) |
| Axle Suspension | Cushioned Springs at Each Wheel | Wing Cutting Angles | 22° Down to 45° Up |
| Cutting Height | 2" - 14" | Center Hydraulic Lift | Standard |
| Cutting Capacity | 4 1/2" Diameter | Wing Hydraulic Lift | Standard |
| Hitch | See Hitch Selection | Axle Tube Pivots | Greaseable Bushings |
| Approx. Tongue Weight | 2,200 lb. | Axle Arm Pivots | Greaseable |
| Deck Thickness | 11 Gauge (Center Top) 7 Gauge (Center Bottom) 7 Gauge (Wings) | Wing Adjustment | Greaseable Turnbuckles |
| Side Bands | 1/4" x 13 1/2" | Wheels | See Wheel Selection |
| Gearbox Rating (HP) | 250 hp† Splitter Gearbox, 225 hp† Cutting Gearboxes | Minimum Tractor PTO HP | 70 |
| Driveline | Main: See Driveline Selection Wings: ASAE Category 5 | Grass Baffles | Optional |
| Driveline Protection | (3) Multi-Plate Slip Clutch | Jack Stand | Standard |
| Blade Holder | Round | Safety Tow Chain | Standard |
| Blade Bolts | Hex Shaped | Safety Shielding | Double Row Chains |

10-Year Gearbox Limited Warranty | 1 1/2-Year Machine Limited Warranty (Contractors) | 1 1/2-Year Machine Limited Warranty (Consumers)

*Measured at maximum transport height.

**Measured at outside of wing skids.

†Gearbox rating based on field performance.

WARNING:

A deflector kit or chain shielding must be used for all non-agricultural purposes or in areas where thrown objects could be hazardous to people, animals, or property.

HOW TO ORDER:

To receive a complete cutter, you must order a basic unit and then select one item from each of Groups 2 - 7 in the ordering section. Additional equipment may be added to your order by making your selection from the options list.

Freight NOT included in list price



RETURN TO INDEX

4815 SERIES FLEX-WING ROTARY CUTTER

BASE UNIT SELECTION

| Model Number | Description | Approx. Wt. | List Price (\$US) |
|--------------|--|-------------|-------------------|
| 4815RR1 | 4815 Flex-Wing Series Rotary Cutter, Round Blade Holder, 540 PTO, With Deck Rings | 4,774 lb. | \$24,766 |
| 14815RR1 | 4815 Flex-Wing Series Rotary Cutter, Round Blade Holder, 1,000 PTO, With Deck Rings <small>Model Includes Center and Wing Hydraulic Cylinders and Hoses, Tow Chain, and Wing Drivelines. Assembly Included in List Price.</small> | 4,774 lb. | \$24,766 |

GROUP 2 HITCH SELECTION

| | | | |
|----------|---|--------|--------------|
| 50072803 | Ball Hitch with 2 ⁵ / ₁₆ " Ball | 45 lb. | \$357 |
| 50054505 | Perma-Level® Hitch | 53 lb. | \$392 |

GROUP 3 DRIVELINE SELECTION

| | | | |
|----------|--|--------|----------------|
| 50069764 | CV Driveline, 540 PTO, 1-3/8-6, ASAE Category 6 | 90 lb. | \$1,295 |
| 50069765 | CV Driveline, 1,000 PTO, 1-3/8-21, ASAE Category 5 | 90 lb. | \$1,340 |
| 50074699 | CV Driveline, 1,000 PTO, 1-3/4-20, ASAE Category 6 | 90 lb. | \$1,340 |

GROUP 4 CENTER AXLE SELECTION

| | | | |
|----------|---|---------|----------------|
| 50074158 | Dual Axle Arms (4 Tires), Half Spindles | 171 lb. | \$1,376 |
| 50076586 | Tandem Walking Axle Arms (4 Tires) | 392 lb. | \$2,075 |

GROUP 5 WING AXLE SELECTION

| | | | |
|----------|---|---------|----------------|
| 50074159 | Single Axle Arms (2 Tires), Half Spindles | 138 lb. | \$1,107 |
| 50074158 | Dual Axle Arms (4 Tires), Half Spindles | 171 lb. | \$1,376 |
| 50076586 | Tandem Walking Axle Arms (4 Tires) | 392 lb. | \$2,075 |

GROUP 6 WHEEL SELECTION

| | | | | |
|----------|--------------------------------------|---------|---------|-------------------|
| 294 | 20" Laminated Tire | | 72 lb. | each \$223 |
| | | 6 Tires | 432 lb. | \$1,338 |
| | | 8 Tires | 576 lb. | \$1,784 |
| 50075401 | 25" Laminated Tire | | 85 lb. | each \$301 |
| | | 6 Tires | 510 lb. | \$1,806 |
| | | 8 Tires | 680 lb. | \$2,408 |
| 50050727 | Used Aircraft Tire, 29x9x15 | | 75 lb. | each \$280 |
| | | 6 Tires | 450 lb. | \$1,680 |
| | | 8 Tires | 600 lb. | \$2,240 |
| 50072403 | Used Aircraft Tire, 27.75x8.75-24PR | | 80 lb. | each \$305 |
| | | 6 Tires | 480 lb. | \$1,830 |
| | | 8 Tires | 640 lb. | \$2,440 |
| 50078502 | Foam-Filled Tire, 27 x 8-18 | | 100 lb. | each \$475 |
| | | 6 Tires | 600 lb. | \$2,850 |
| | | 8 Tires | 800 lb. | \$3,800 |
| 50068834 | Foam Filled Aircraft Tire, 26x6.6x14 | | 90 lb. | each \$465 |
| | | 6 Tires | 540 lb. | \$2,790 |
| | | 8 Tires | 720 lb. | \$3,720 |

GROUP 7 ENCLOSURE SELECTION

| | | | |
|----------|-----------------------------------|---------|----------------|
| 50076494 | Double Row Chains, Front and Rear | 477 lb. | \$1,665 |
|----------|-----------------------------------|---------|----------------|

GROUP 8 HYDRAULIC HOSE SELECTION

| | | | |
|----------|------------------------------------|-------|------------|
| 50082034 | Independent Wing Control (3-Hoses) | 5 lb. | \$0 |
| 50082035 | Single Wing Control (2-Hoses) | 5 lb. | \$0 |

OPTIONS

| | | | |
|-----------|---|-----------------------------|--------------|
| 50069451 | Grass and Crop Distribution Baffles | 76 lb. | \$420 |
| 50077430 | EZ-Mount Driveline Holder (Please Contact Service Parts to Place Order) | 8 lb. | \$106 |
| 50073131 | Field Conversion Kit, Wing Single Axle to Dual Axle. Order (1) Kit Per Wing + Tires of Choice. | Order Through Service Parts | |
| 4815 Spec | Special Paint Colors | Call for Quote | |

NOTE: Safety shieldings are non-returnable items for all models.

[RETURN TO INDEX](#)

NEW
for
**Summer
2020**



2814 SERIES FLEX-WING ROTARY CUTTER

| MODEL | 2814 | MODEL | 2814 |
|-----------------------|---|------------------------|---|
| Transport Height* | 9' | Blades | 1/2" x 4" Parallel Uplift |
| Transport Width** | 9' | Blade Overlap | 6" |
| Cutting Width | 14' | Blade Tip Speed | 15,625 fpm (Center); 15,936 fpm (Wing) |
| Overall Width | 14' 6" | Wing Cutting Angles | 22° Down to 45° Up |
| Overall Length | 17' 2" | Center Hydraulic Lift | Standard |
| Axle Suspension | Cushioned Springs at Each Axle Arm | Wing Hydraulic Lift | Standard |
| Cutting Height | 2" - 14" | Axle Tube Pivots | Greaseable Bushings |
| Cutting Capacity | 3" Diameter | Axle Arm Pivots | Greaseable |
| Hitch | See Hitch Selection | Wing Adjustment | Greaseable Turnbuckles |
| Approx. Tongue Weight | 2,600 lb. | Wheels | See Wheel Selection |
| Deck Thickness | 11 Gauge (Center Top) 7 Gauge (Center Bottom) 7 Gauge (Wings) | Minimum Tractor PTO HP | 90 |
| Side Bands | 1/4" x 13 1/2" | Jack Stand | Standard |
| Gearbox Rating (HP) | 250 hp† Splitter Gearbox, 225 hp† Cutting Gearboxes | Safety Tow Chain | Standard |
| Driveline | Main: See Driveline Selection Wings: ASAE Category 5 | Safety Shielding | Double Row Chains |
| Blade Holder | Round | | |

10-Year Gearbox Limited Warranty and 1-Year Machine Limited Warranty

*Measured at maximum transport height.

**Measured at outside of wing skirts.

†Gearbox rating based on field performance.

WARNING:

A deflector kit or chain shielding must be used for all non-agricultural purposes or in areas where thrown objects could be hazardous to people, animals, or property.

HOW TO ORDER:

To receive a complete cutter, you must order a basic unit and then select one item from each of Groups 2 - 7 in the ordering section. Additional equipment may be added to your order by making your selection from the options list.

Freight NOT included in list price



RETURN TO INDEX

2814 SERIES FLEX-WING ROTARY CUTTER

BASE UNIT SELECTION

| Model Number | Description | Approx. Wt. | List Price (\$US) |
|--------------|--|-------------|-------------------|
| 2814RR1 | 2814 Flex-Wing Series Rotary Cutter, Pan Blade Carrier, 540 PTO, With Deck Rings and Double Row Chains | 5,100 lb. | \$22,394 |
| 12814RR1 | 12814 Flex-Wing Series Rotary Cutter, Pan Blade Carrier, 1000 PTO, With Deck Rings and Double Row Chains | 5,100 lb. | \$22,394 |

GROUP 2 HITCH SELECTION

| | | | |
|----------|---|--------|-------|
| 50072803 | Ball Hitch with 2 ⁵ / ₁₆ " Ball | 45 lb. | \$357 |
| 50054505 | Perma-Level® Hitch | 53 lb. | \$392 |

GROUP 3 DRIVELINE SELECTION

| | | | |
|----------|--|--------|---------|
| 50069764 | CV Driveline, 540 PTO, 1-3/8-6, ASAE Category 6 | 90 lb. | \$1,295 |
| 50069765 | CV Driveline, 1,000 PTO, 1-3/8-21, ASAE Category 5 | 90 lb. | \$1,340 |
| 50074699 | CV Driveline, 1,000 PTO, 1-3/4-20, ASAE Category 6 | 90 lb. | \$1,340 |

GROUP 4 CENTER AXLE SELECTION

| | | | |
|----------|---|---------|---------|
| 50074158 | Dual Axle Arms (4 Tires), Half Spindles | 171 lb. | \$1,376 |
|----------|---|---------|---------|

GROUP 5 WING AXLE SELECTION

| | | | |
|----------|---|---------|-------|
| 50075164 | Single Axle Arms (1 Tires), Half Spindles | 98 lb. | \$563 |
| 50075163 | Dual Axle Arms (2 Tires), Half Spindles | 126 lb. | \$697 |

GROUP 6 WHEEL SELECTION

| | | | | |
|----------|--------------------------------------|---------|---------|------------|
| 294 | 20" Laminated Tire | | 72 lb. | each \$223 |
| | | 5 Tires | 360 lb. | \$1,115 |
| | | 6 Tires | 432 lb. | \$1,338 |
| 50075401 | 25" Laminated Tire | | 85 lb. | each \$301 |
| | | 5 Tires | 425 lb. | \$1,505 |
| | | 6 Tires | 510 lb. | \$1,806 |
| 50050727 | Used Aircraft Tire, 29x9x15 | | 75 lb. | each \$280 |
| | | 5 Tires | 375 lb. | \$1,400 |
| | | 6 Tires | 450 lb. | \$1,680 |
| 50072403 | Used Aircraft Tire, 27.75x8.75-24PR | | 80 lb. | each \$305 |
| | | 5 Tires | 400 lb. | \$1,525 |
| | | 6 Tires | 480 lb. | \$1,830 |
| 50078502 | Foam-Filled Tire, 27 x 8-18 | | 100 lb. | each \$475 |
| | | 5 Tires | 500 lb. | \$2,375 |
| | | 6 Tires | 600 lb. | \$2,850 |
| 50068834 | Foam Filled Aircraft Tire, 26x6.6x14 | | 90 lb. | each \$465 |
| | | 5 Tires | 450 lb. | \$2,325 |
| | | 6 Tires | 540 lb. | \$2,790 |

OPTIONS

| | | | |
|----------|--|-----------------------------|-------|
| 50077430 | EZ-Mount Driveline Holder (Please Contact Service Parts to Place Order) | 8 lb. | \$106 |
| 50073131 | Field Conversion Kit, Wing Single Axle to Dual Axle. Order (1) Kit Per Wing + Tires of Choice. | Order Through Service Parts | |

RETURN TO INDEX



2820 SERIES FLEX-WING ROTARY CUTTER

| MODEL | 2820 | MODEL | 2820 |
|-----------------------|---|-------------------------------|---|
| Transport Height* | 9' | Blades | 1/2" x 4" Parallel Uplift |
| Transport Width** | 11' | Blade Overlap | 6" |
| Cutting Width | 20' | Blade Tip Speed | 15,625 fpm (Center); 15,936 fpm (Wing) |
| Overall Width | 21' | Wing Cutting Angles | 22° Down to 45° Up |
| Overall Length | 17' 2" | Center Hydraulic Lift | Standard |
| Axle Suspension | Cushioned Springs at Each Axle Arm | Wing Hydraulic Lift | Standard |
| Cutting Height | 2" - 14" | Axle Tube Pivots | Greaseable Bushings |
| Cutting Capacity | 3" Diameter | Axle Arm Pivots | Greaseable |
| Hitch | See Hitch Selection | Wing Adjustment | Greaseable Turnbuckles |
| Approx. Tongue Weight | 2,600 lb. | Wheels | See Wheel Selection |
| Deck Thickness | 11 Gauge (Center Top) 7 Gauge (Center Bottom) 7 Gauge (Wings) | Minimum Tractor PTO HP | 90 |
| Side Bands | 1/4" x 13½" | Grass Baffles | Optional |
| Gearbox Rating (HP) | 250 hp† Splitter Gearbox, 225 hp† Cutting Gearboxes | Jack Stand | Standard |
| Driveline | Main: See Driveline Selection Wings: ASAE Category 5 | Safety Tow Chain | Standard |
| Blade Holder | Round or Shredder Bar | Safety Shielding | Single or Double Row Chains |

10-Year Gearbox Limited Warranty and 1-Year Machine Limited Warranty

*Measured at maximum transport height.

**Measured at outside of wing skirts.

†Gearbox rating based on field performance.

WARNING:

A deflector kit or chain shielding must be used for all non-agricultural purposes or in areas where thrown objects could be hazardous to people, animals, or property.

HOW TO ORDER:

To receive a complete cutter, you must order a basic unit and then select one item from each of Groups 2 - 7 in the ordering section. Additional equipment may be added to your order by making your selection from the options list.

Freight NOT included in list price



RETURN TO INDEX

2820 SERIES FLEX-WING ROTARY CUTTER

BASE UNIT SELECTION

| Model Number | Description | Approx. Wt. | List Price (\$US) |
|--------------|--|-------------|-------------------|
| 2820RR1 | 2820 Flex-Wing Series Rotary Cutter, Pan Blade Carrier, 540 PTO, With Deck Rings | 5,851 lb. | \$26,294 |
| 12820RR1 | 2820 Flex-Wing Series Rotary Cutter, Pan Blade Carrier, 1,000 PTO, With Deck Rings | 5,851 lb. | \$26,294 |
| 12820SR1 | 2820 Flex-Wing Series Rotary Cutter, Bar Blade Carrier, 1,000 PTO, With Deck Rings | 5,851 lb. | \$26,502 |

Model Includes Center and Wing Hydraulic Cylinders and Hoses, Tow Chain, and Wing Drivelines.
Assembly Included in List Price.

GROUP 2 HITCH SELECTION

| | | | |
|----------|---|--------|-------|
| 50072803 | Ball Hitch with 2 ⁵ / ₁₆ " Ball | 45 lb. | \$357 |
| 50054505 | Perma-Level® Hitch | 53 lb. | \$392 |

GROUP 3 DRIVELINE SELECTION

| | | | |
|----------|--|--------|---------|
| 50069764 | CV Driveline, 540 PTO, 1-3/8-6, ASAE Category 6 | 90 lb. | \$1,295 |
| 50069765 | CV Driveline, 1,000 PTO, 1-3/8-21, ASAE Category 5 | 90 lb. | \$1,340 |
| 50054513 | CV Driveline, 1,000 PTO, 1-3/8-21, ASAE Category 6 | 90 lb. | \$1,601 |
| 50074699 | CV Driveline, 1,000 PTO, 1-3/4-20, ASAE Category 6 | 90 lb. | \$1,340 |

GROUP 4 CENTER AXLE SELECTION

| | | | |
|----------|---|---------|---------|
| 50074158 | Dual Axle Arms (4 Tires), Half Spindles | 171 lb. | \$1,376 |
| 50076586 | Tandem Walking Axle Arms (4 Tires) | 392 lb. | \$2,075 |

GROUP 5 WING AXLE SELECTION

| | | | |
|----------|---|---------|---------|
| 50074159 | Single Axle Arms (2 Tires), Half Spindles | 138 lb. | \$1,107 |
| 50074158 | Dual Axle Arms (4 Tires), Half Spindles | 171 lb. | \$1,376 |
| 50076586 | Tandem Walking Axle Arms (4 Tires) | 392 lb. | \$2,075 |

GROUP 6 WHEEL SELECTION

| | | | | |
|----------|--------------------------------------|---------|---------|------------|
| 294 | 20" Laminated Tire | | 72 lb. | each \$223 |
| | | 6 Tires | 432 lb. | \$1,338 |
| | | 8 Tires | 576 lb. | \$1,784 |
| 50075401 | 25" Laminated Tire | | 85 lb. | each \$301 |
| | | 6 Tires | 510 lb. | \$1,806 |
| | | 8 Tires | 680 lb. | \$2,408 |
| 50050727 | Used Aircraft Tire, 29x9x15 | | 75 lb. | each \$280 |
| | | 6 Tires | 450 lb. | \$1,680 |
| | | 8 Tires | 600 lb. | \$2,240 |
| 50072403 | Used Aircraft Tire, 27.75x8.75-24PR | | 80 lb. | each \$305 |
| | | 6 Tires | 480 lb. | \$1,830 |
| | | 8 Tires | 640 lb. | \$2,440 |
| 50078502 | Foam-Filled Tire, 27 x 8-18 | | 100 lb. | each \$475 |
| | | 6 Tires | 600 lb. | \$2,850 |
| | | 8 Tires | 800 lb. | \$3,800 |
| 50068834 | Foam Filled Aircraft Tire, 26x6.6x14 | | 90 lb. | each \$465 |
| | | 6 Tires | 540 lb. | \$2,790 |
| | | 8 Tires | 720 lb. | \$3,720 |

2820 Series Flex-Wing Rotary Cutter Continued on Next Page



RETURN TO INDEX

2820 SERIES FLEX-WING ROTARY CUTTER *Continued*

GROUP 7 ENCLOSURE SELECTION

| Model Number | Description | Approx. Wt. | List Price (\$US) |
|--|---|-------------|---|
| 50074153 | Single Row Chains, Front and Rear | 239 lb. | \$1,706 |
| 50074152 | Double Row Chains, Front and Rear | 395 lb. | \$2,346 |
| OPTIONS | | | |
| 50074156 | Grass Distribution Baffles | 170 lb. | \$408 |
| 50077430 | EZ-Mount Driveline Holder (Please Contact Service Parts to Place Order) | 8 lb. | \$106 |
| 50074155 | Shredder Kit for 2820 Flex-Wing Series Rotary Cutter, Model SR1 Adds second blade bar and (2) uplift blades to each cutting circle of SR1 model for finer shredding. | 288 lb. | \$1,353 |
| NOTE: SR1 base unit includes a straight blade bar with (2) uplift blades and (2) flat blades per cutting circle. | | | |
| 50074199 | 38" Row Crop Spacing Wheel Spindle Kit for Duals Kit places both center-section inside tires 3 inches toward the center of cutter to move tire off-center of row. Location is best with #294 laminated tire. (Please Contact Service Parts to Place Order) | | LIMITED AVAILABILITY Order Through Service Parts |
| 50073131 | Field Conversion Kit, Wing Single Axle to Dual Axle. Order (1) Kit Per Wing + Tires of Choice. | | Order Through Service Parts |
| 2820 Spec | Special Paint Colors | | Call for Quote |

NOTE: Safety shieldings are non-returnable items for all models.



[RETURN TO INDEX](#)

FLAIL SHREDDERS

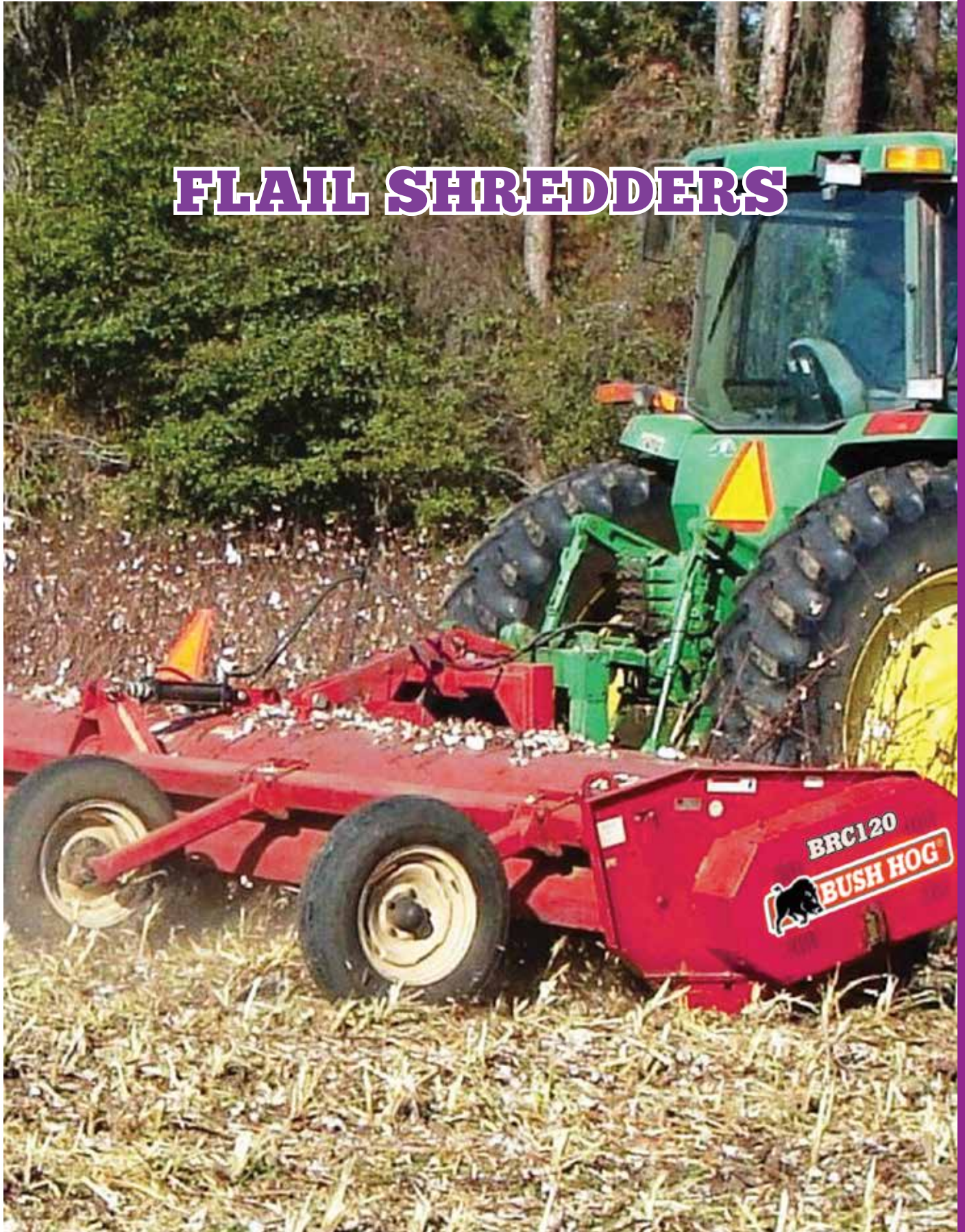

FLAIL SHREDDERS

[RETURN TO INDEX](#)

BRC115/BRC118 SERIES ROW CROP FLAIL SHREDDER

| MODEL | BRC115 | BRC118 |
|--|--|--|
| Cutting Width | 180" | 216" |
| Overall Width | 204" | 240" |
| Cutting Height | 1" - 18" | |
| Hitch | Cat 2 & 3 Quick Hitch Lift, Semi-Mount or Pull Type* | |
| Cutter Shaft | 10 3/4" Diameter | |
| Minimum Tractor PTO HP | 120 (Lift), 100 (Semi-Mount), 100 (Pull) | 130 (Lift), 110 (Semi-Mount), 110 (Pull) |
| Blades | Hard-Surfaced | |
| Tires | (4) 6.70x15 | |
| Wheel Hubs | 5-Bolt | |
| Gearbox Rating (1,000 rpm) | 207 hp | |
| Knife Tip Speed | 12,620 fpm | |
| Number of Blades | 168 | 200 |
| Driveline Size | Category 5 or 6 | |
| Driveline Protection | 5 x 5 V, Banded Belt | |
| Rotor Bearing Protection | Anti-Wrap Seal Protector | |
| Cutter Shaft Bearings | 2 9/16" Triple Sealed | |
| Hood Thickness | 3/16", With Wear Liner | |
| End Plate Thickness | 1/4" | |
| Safety Deflector - Lights | Standard | |
| Five-Year Limited Gearbox Warranty. | | |

*Tractor Quick Hitch must be used for Lift-Type and Semi-Mount units.

HOW TO ORDER:

To receive a complete machine, select the desired basic unit and order one item each from Groups 1 - 4. Red is the standard paint color for all units. If desired, special paint may be selected from Group 5.

Freight NOT included in list price



RETURN TO INDEX

BRC115/BRC118 SERIES ROW CROP FLAIL SHREDDER

BASE UNIT SELECTION

| Model Number | Description | Approx. Wt. | List Price (\$US) |
|--------------|---|-------------|-------------------|
| BRC115 | BRC Series Row Crop Flail Shredder, 15' Base Unit | 4,425 lb. | \$25,319 |
| BRC118 | BRC Series Row Crop Flail Shredder, 18' Base Unit | 4,785 lb. | \$27,558 |

GROUP 2 HITCH SELECTION

| Model Number | Description | Approx. Wt. | List Price (\$US) |
|--------------|---|-------------|-------------------|
| 00727125 | Hitch Bundle for BRC115, BRC118, Lift Type* | | \$4,766 |
| 00727126 | Hitch Bundle for BRC115, BRC118, Pull Type | 210 lb. | \$6,903 |
| 00727127 | Hitch Bundle for BRC115, BRC118, Semi-Mount Type* | | \$7,580 |

*Lift-Type and Semi-Mount units must be used on tractors equipped with Quick Hitches.

GROUP 3 DRIVELINE SELECTION

| Model Number | Description | Approx. Wt. | List Price (\$US) |
|--------------|---|-------------|-------------------|
| 00726673A | Driveline, Lift or Semi-Mount, Category 6 with 1 ³ / ₈ " PTO Yoke | 175 lb. | \$1,040 |
| 00726672A | Driveline, Lift or Semi-Mount, Category 6 with 1 ³ / ₄ " PTO Yoke | 185 lb. | \$1,254 |
| 00786844 | Driveline, Pull Type, Category 5 CV with 1 ³ / ₈ " PTO Yoke | 210 lb. | \$1,333 |
| 00786845 | Driveline, Pull Type, Category 5 CV with 1 ³ / ₄ " PTO Yoke | 240 lb. | \$1,333 |

GROUP 4 LIFT SELECTION

| Model Number | Description | Approx. Wt. | List Price (\$US) |
|--------------|------------------------------|------------------|-------------------|
| 00554600P | Ratchet Jack Manual Lift Kit | 12 lb. | \$144 |
| 00725933 | Hydraulic Cylinder Lift Kit | Included in Base | \$453 |

GROUP 5 SPECIAL PAINT COLOR SELECTION

| Model Number | Description | List Price (\$US) |
|--------------|-----------------------------------|-------------------|
| 00787653 | Custom Paint, John Deere Green | \$161 |
| 00787654 | Custom Paint, Kubota Orange | \$161 |
| 00787655 | Custom Paint, Case/IH Red | \$161 |
| 00787656 | Custom Paint, Massey Ferguson Red | \$161 |
| 00787657 | Custom Paint, New Holland Blue | \$161 |

CONTAINER FEES - International Shipments

| Model Number | Description | List Price (\$US) |
|--------------|--|-------------------|
| 00888891 | Container Processing Fee (Each Unit is Processed to Accommodate Loading) | net \$300 |
| 00888892 | Special Paint Colors | net \$300 |

[RETURN TO INDEX](#)

BRC120 SERIES ROW CROP FLAIL SHREDDER

| MODEL | BRC120 |
|--|--|
| Cutting Width | 240" |
| Overall Width | 264" |
| Cutting Height | 1" - 18" |
| Hitch | Cat 2 & 3 Quick Hitch Lift, Semi-Mount or Pull Type* |
| Cutter Shaft | 10 ³ / ₄ " Diameter |
| Minimum Tractor PTO HP | 130 (Lift), 120 (Semi-Mount), 120 (Pull) |
| Blades | Hard-Surfaced with Tungsten Carbide |
| Tires | 9.5L - 15" |
| Wheel Hubs | 6-Bolt |
| Gearbox Rating (1,000 rpm) | 207 hp |
| Knife Tip Speed | 12,620 fpm, Reverse Rotation |
| Number of Blades | 216 |
| Driveline Size | Category 5 or 6 |
| Driveline Protection | 5 x 5 V, Banded Belt |
| Rotor Bearing Protection | Anti-Wrap Seal Protector |
| Cutter Shaft Bearings | 2 ⁹ / ₁₆ " |
| Hood Thickness | 3/16", With 3/16" Wear Liner |
| End Plate Thickness | 1/4" |
| Safety Deflector - Lights | Standard |
| Five-Year Limited Gearbox Warranty. | |

*Tractor Quick Hitch must be used for Lift-Type and Semi-Mount units.

HOW TO ORDER:

To receive a complete machine, select the desired basic unit and order one item each from Groups 1 - 4. Red is the standard paint color for all units. If desired, special paint may be selected from Group 5. Extra equipment (dealer installed) may be selected from the Options listed in the ordering section.

Freight NOT included in list price



RETURN TO INDEX

BRC120 SERIES ROW CROP FLAIL SHREDDER

BASE UNIT SELECTION

| Model Number | Description | Approx. Wt. | List Price (\$US) |
|--------------|---|-------------|-------------------|
| BRC120 | BRC 120 Series Row Crop Flail Shredder, 20' Base Unit | 4,950 lb. | \$31,023 |

GROUP 2 HITCH SELECTION

| Model Number | Description | Approx. Wt. | List Price (\$US) |
|--------------|--|------------------|-------------------|
| 00727128 | Hitch Bundle for BRC120, BRC125, Lift Type* | Included in Base | \$4,851 |
| 00727129 | Hitch Bundle for BRC120, Lift Type with End Tow* | 660 lb. | \$8,807 |
| 00727130 | Hitch Bundle for BRC120, BRC125, Pull Type | 210 lb. | \$4,531 |
| 00727131 | Hitch Bundle for BRC120, Pull Type with End Tow | 870 lb. | \$7,601 |
| 00727132 | Hitch Bundle for BRC120, BRC125, Semi-Mount Type* | 100 lb. | \$7,814 |
| 00727133 | Hitch Bundle for BRC120, Semi-Mount Type with End Tow* | 870 lb. | \$10,245 |

*Lift-Type and Semi-Mount units must be used on tractors equipped with Quick Hitches.

GROUP 3 DRIVELINE SELECTION

| Model Number | Description | Approx. Wt. | List Price (\$US) |
|--------------|---|-------------|-------------------|
| 00726673A | Driveline, Lift or Semi-Mount, Category 6 with 1 ³ / ₈ " PTO Yoke | 175 lb. | \$1,040 |
| 00726672A | Driveline, Lift or Semi-Mount, Category 6 with 1 ³ / ₄ " PTO Yoke | 185 lb. | \$1,254 |
| 00786844 | Driveline, Pull Type, Category 5 CV with 1 ³ / ₈ " PTO Yoke | 210 lb. | \$1,333 |
| 00786845 | Driveline, Pull Type, Category 5 CV with 1 ³ / ₄ " PTO Yoke | 240 lb. | \$1,333 |

GROUP 4 LIFT SELECTION

| Model Number | Description | Approx. Wt. | List Price (\$US) |
|--------------|------------------------------|------------------|-------------------|
| 00554600P | Ratchet Jack Manual Lift Kit | 12 lb. | \$144 |
| 00725933 | Hydraulic Cylinder Lift Kit | Included in Base | \$453 |

GROUP 5 SPECIAL PAINT COLOR SELECTION

| Model Number | Description | List Price (\$US) |
|--------------|-----------------------------------|-------------------|
| 00787653 | Custom Paint, John Deere Green | \$161 |
| 00787654 | Custom Paint, Kubota Orange | \$161 |
| 00787655 | Custom Paint, Case/IH Red | \$161 |
| 00787656 | Custom Paint, Massey Ferguson Red | \$161 |
| 00787657 | Custom Paint, New Holland Blue | \$161 |

OPTIONS – Dealer Installed (Must Order Separately)

| Model Number | Description | Approx. Wt. | List Price (\$US) |
|--------------|--|-------------|-------------------|
| 00727009 | End Tow Kit for BRC120, Pull Type (Field Installation) | 660 lb. | \$7,319 |
| 00727010 | End Tow Kit for BRC120, Semi-Mount or Lift Type (Field Installation) | 500 lb. | \$7,322 |

CONTAINER FEES – International Shipments

| Model Number | Description | List Price (\$US) |
|--------------|--|-------------------|
| 00888891 | Container Processing Fee (Each Unit is Processed to Accommodate Loading) | net \$300 |
| 00888892 | Container Loading Fee (Single Charge Per Container Load) | net \$300 |

[RETURN TO INDEX](#)

BRC125 SERIES ROW CROP FLAIL SHREDDER

| MODEL | BRC125 |
|--|--|
| Cutting Width | 300" |
| Overall Width | 324" |
| Cutting Height | 1" - 18" |
| Hitch | Lift, Semi-Mount or Pull Type* |
| Cutter Shaft | 10¾" Diameter |
| Minimum Tractor PTO HP | 160 (Lift), 150 (Semi-Mount), 140 (Pull) |
| Blades | Hard-Surfaced |
| Tires | 9.5L - 15" |
| Wheel Hubs | 6-Bolt |
| Gearbox Rating (1,000 rpm) | 207 hp |
| Knife Tip Speed | 12,000 fpm, Reverse Rotation |
| Number of Blades | 272 |
| Driveline Size | Category 5 or 6 |
| Driveline Protection | 5 x 5 V, Banded Belt |
| Rotor Bearing Protection | Anti-Wrap Seal Protector |
| Cutter Shaft Bearings | 2 ⁹ / ₁₆ " |
| Hood Thickness | 3/16", With 3/16" Internal Wear Liner |
| End Plate Thickness | 1/4" |
| Safety Deflector - Lights | Standard |
| Five-Year Limited Gearbox Warranty. | |

*Tractor Quick Hitch must be used for Lift-Type and Semi-Mount units.

HOW TO ORDER:

To receive a complete machine, select the desired basic unit and order one item each from Groups 1 - 4. Red is the standard paint color for all units. If desired, special paint may be selected from Group 5. Extra equipment (dealer installed) may be selected from the Options listed in the ordering section.

Freight NOT included in list price



RETURN TO INDEX

BRC125 SERIES ROW CROP FLAIL SHREDDER

BASE UNIT SELECTION

| Model Number | Description | Approx. Wt. | List Price (\$US) |
|--------------|---|-------------|-------------------|
| BRC125 | BRC 125 Series Row Crop Flail Shredder, 25' Base Unit | 6,300 lb. | \$39,178 |

GROUP 2 HITCH SELECTION

| Model Number | Description | Approx. Wt. | List Price (\$US) |
|--------------|--|------------------|-------------------|
| 00727128 | Hitch Bundle for BRC120, BRC125, Lift Type* | Included in Base | \$4,851 |
| 00727134 | Hitch Bundle for BRC125, Lift Type with End Tow* | 450 lb. | \$8,822 |
| 00727130 | Hitch Bundle for BRC120, BRC125, Pull Type | 210 lb. | \$4,531 |
| 00727135 | Hitch Bundle for BRC125, Pull Type with End Tow | 780 lb. | \$7,607 |
| 00727132 | Hitch Bundle for BRC120, BRC125, Semi-Mount Type* | 100 lb. | \$7,814 |
| 00727136 | Hitch Bundle for BRC125, Semi-Mount Type with End Tow* | 450 lb. | \$10,251 |

*Lift-Type and Semi-Mount units must be used on tractors equipped with Quick Hitches.

GROUP 3 DRIVELINE SELECTION

| Model Number | Description | Approx. Wt. | List Price (\$US) |
|--------------|---|-------------|-------------------|
| 00726673A | Driveline, Lift or Semi-Mount, Category 6 with 1 ³ / ₈ " PTO Yoke | 175 lb. | \$1,040 |
| 00726672A | Driveline, Lift or Semi-Mount, Category 6 with 1 ³ / ₄ " PTO Yoke | 185 lb. | \$1,254 |
| 00786844 | Driveline, Pull Type, Category 5 CV with 1 ³ / ₈ " PTO Yoke | 210 lb. | \$1,333 |
| 00786845 | Driveline, Pull Type, Category 5 CV with 1 ³ / ₄ " PTO Yoke | 240 lb. | \$1,333 |

GROUP 4 LIFT SELECTION

| Model Number | Description | Approx. Wt. | List Price (\$US) |
|--------------|-----------------------------|------------------|-------------------|
| 00725933 | Hydraulic Cylinder Lift Kit | Included in Base | \$453 |

GROUP 5 SPECIAL PAINT COLOR SELECTION

| Model Number | Description | List Price (\$US) |
|--------------|-----------------------------------|-------------------|
| 00787653 | Custom Paint, John Deere Green | \$161 |
| 00787654 | Custom Paint, Kubota Orange | \$161 |
| 00787655 | Custom Paint, Case/IH Red | \$161 |
| 00787656 | Custom Paint, Massey Ferguson Red | \$161 |
| 00787657 | Custom Paint, New Holland Blue | \$161 |

OPTIONS – Dealer Installed (Must Order Separately)

| Model Number | Description | Approx. Wt. | List Price (\$US) |
|--------------|---|-------------|-------------------|
| 00727042 | Pair of Axle Arms, Pull & Lift Type with Tires & Wheels (May Not Fit All Row Spacings, Not Recommended with End Tow Kit) | 199 lb. | \$2,048 |
| 00727141 | Pair of Axle Arms, Semi-Mount Type with Tires & Wheels (May Not Fit All Row Spacings, Not Recommended with End Tow Kit) | 229 lb. | \$2,879 |
| 00726952 | End Tow Kit, Pull Type (For Field Installation, Order Separately from Machine) | 580 lb. | \$7,249 |
| 00726953 | End Tow Kit, Semi-Mount or Lift Type (For Field Installation, Order Separately from Machine) | 420 lb. | \$7,249 |

CONTAINER FEES – International Shipments

| Model Number | Description | List Price (\$US) |
|--------------|--|-------------------|
| 00888891 | Container Processing Fee (Each Unit is Processed to Accommodate Loading) | net \$300 |
| 00888892 | Container Loading Fee (Single Charge Per Container Load) | net \$300 |



[RETURN TO INDEX](#)



[RETURN TO INDEX](#)

BOOM MOWERS

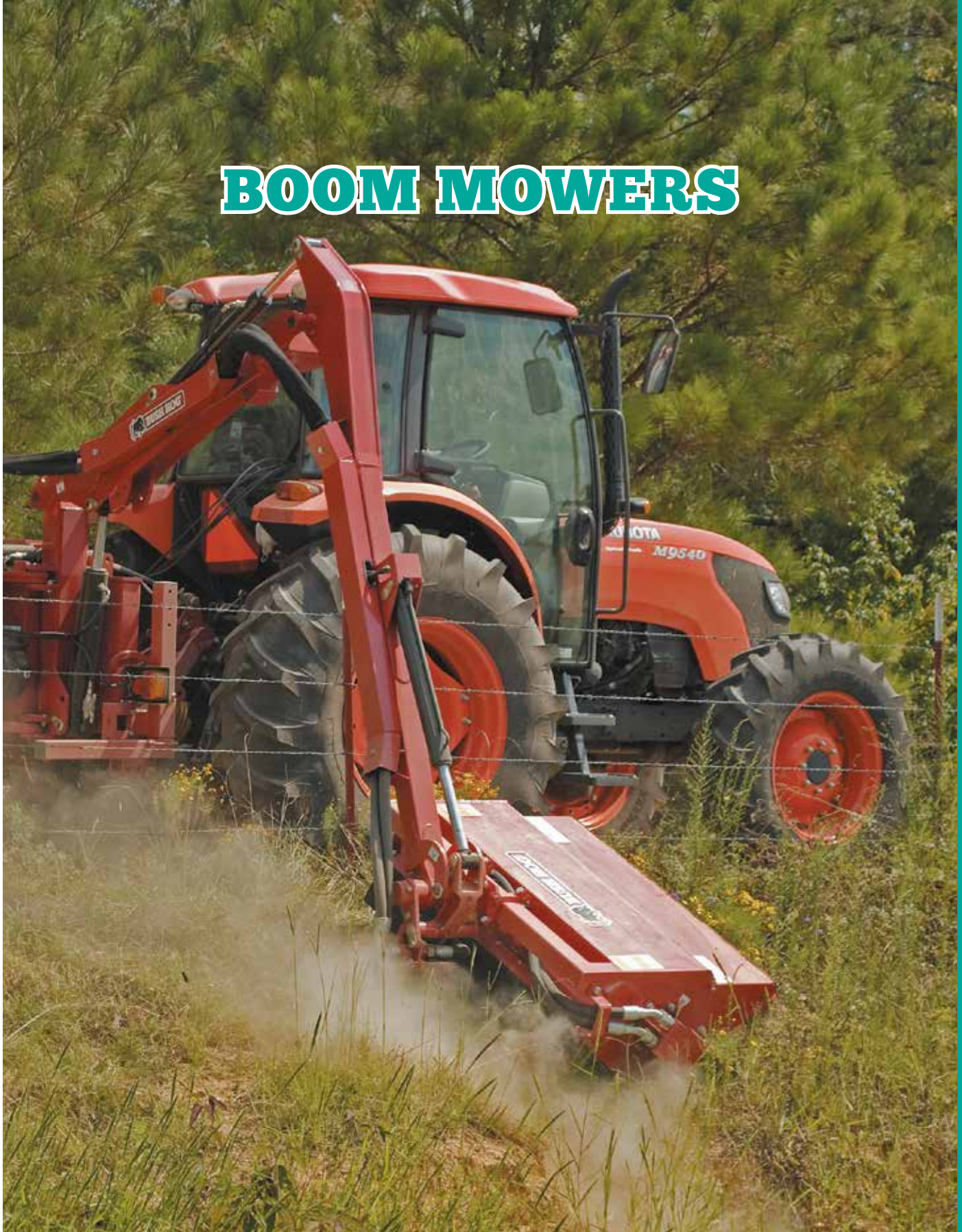

BOOM MOWERS

RETURN TO INDEX



REAR-MOUNTED BOOM MOWER SERIES

| MODEL | RMB1445-1 | RMB1660-1 | RMB1865-1 | PT5-2 POWERTRIM |
|---------------------------------------|--|-----------|--|--|
| Minimum Tractor PTO HP/Weight | See Head Selection Chart Next Page – Varies Based on Head Choice | | | |
| Tractor PTO | 540 | 540 | 540 | N/A |
| Machine Weight with Flail | 1,220 lb. | 2,403 lb. | 2,470 lb. | 415 lb. |
| Hydraulic System | Totally Independent | | | Open Center Hyd. System (Closed Center Kit Avail.), Tractor Remote Outlet, 3.7-5.6 GPM, Flow Control Valve Kit Std |
| Attachment Method | Cat 1/2, 3-Point Mount | | | Cat 1/2, 3-Point Mount |
| Controls | Cable-Controlled Quick Detach (QD) Standard | | Cable-Controlled Quick Detach (QD)/ Electronic Controls (XTC) Standard | Cable-Controlled Hydraulic Remotes Standard |
| Maximum Reach, Horizontal (A) | 14' 1" | 16' 5" | 18' 1" | 11' 5" |
| Maximum Height, Horizontal (B) | 13' 2" | 14' 6" | 16' 1" | 7' 2" |
| Maximum Height, Horizontal (C) | 13' 5" | 15' 9" | 17' 5" | 5' 7" |
| Maximum Height, Vertical (D) | 13' 9" | 20' 8" | 22' 4" | 10' 2" |
| Maximum Depth, 45° | 5' 4" | 7' 3" | 8' 2" | 4' 6" |
| Lightbar Kit | Standard | | | |

NOTICE: RMB Series mowers are to be used only on tractors equipped with cabs. For rotary mower heads, protective screen material must be installed.

HOW TO ORDER: To receive a complete cutter, for RMB models you must include a basic unit and the appropriate head option(s) from Group 2, 3 or 4 in the ordering section. For the PT5 model, make your base unit selection, which comes standard with a sickle bar head. No head selection is necessary. Additional equipment may be added to your order by making your selection from the Options list.

Freight NOT included in list price

RETURN TO INDEX

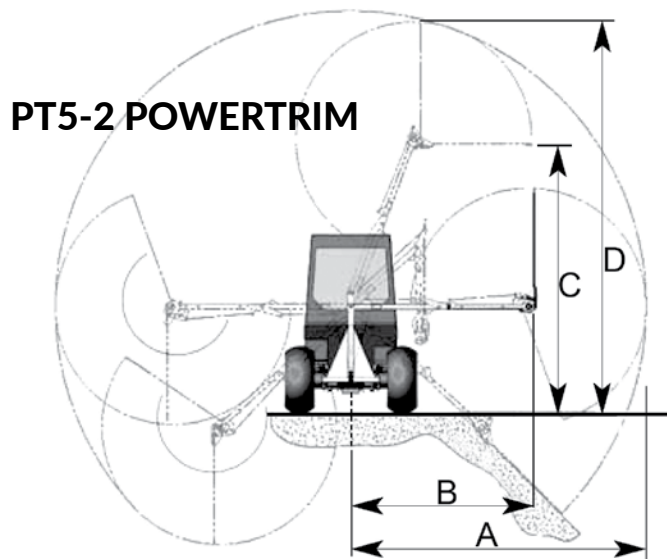
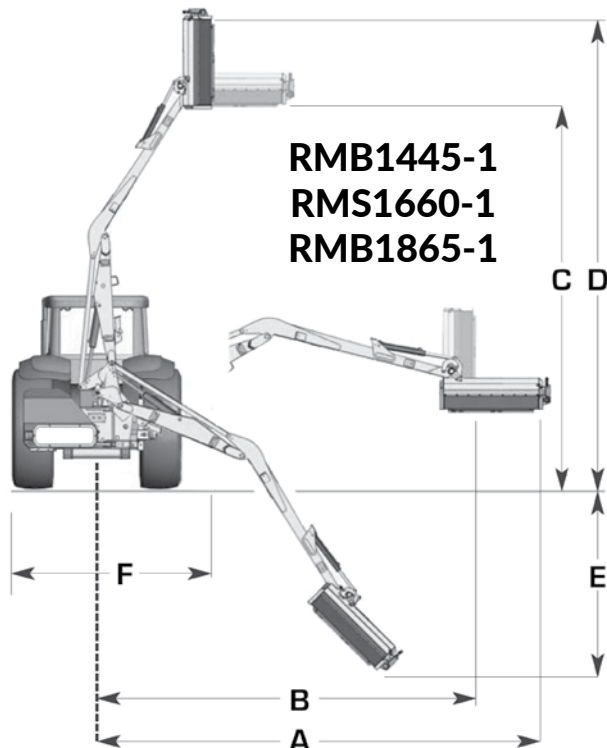

HEAD SELECTION CHART

| FLAIL HEAD | RMB1445-1 | RMB1660-1 | RMB1865-1 | PT5-2 POWERTRIM |
|-------------------------------|--|--|-------------------|--|
| Minimum Tractor PTO HP/Weight | 45 / 4,410 lb. | 60 / 6,614 lb. | 65 / 7,716 lb. | <i>Not Available For Use On This Model</i> |
| Rotor/Knife | Super Cut/Universal | Super Cut/F91 Competition or Multi-Cut Competition | | NA |
| Typical Application | Grass, Light Brush | Hedge Cutting, Grass | | NA |
| Cutting Capacity | 1" Diameter | 1½" Diameter | 2" Diameter | NA |
| Cutting Width | 39" | 47" | | NA |
| ROTARY HEAD | RMB1445-1 | RMB1660-1 | RMB1865-1 | PT5-2 POWERTRIM |
| Minimum Tractor PTO HP/Weight | <i>Not Available For Use On This Model</i> | 85 / 7,614 lb. | 85 / 8,716 lb. | <i>Not Available For Use On This Model</i> |
| Typical Application | NA | Grass/Brush | | NA |
| Cutting Capacity | NA | 4" Diameter | | NA |
| Cutting Width | NA | 60" | | NA |
| CUTTER BAR | RMB1445 (Only) | RMB1660 | RMB1865-1/1865E-1 | PT5-2 POWERTRIM (Sickle Bar Standard) |
| Minimum Tractor PTO HP/Weight | 45 / 4,410 lb. | 60 / 6,614 lb. | 65 / 7,716 lb. | 15 / 1,212 lb. |
| Cutter Type | Sickle Bar | | | |
| Cutting Capacity | 1¼" Diameter | | | ¾" Diameter |
| Cutting Width | 59" | | | |



RETURN TO INDEX

REAR-MOUNTED BOOM MOWER SERIES

BASE UNIT SELECTION

| Model Number | Description | Approx. Wt. Includes Flail Head | List Price (\$US) |
|--------------|--|------------------------------------|-------------------|
| RMB1445-1 | RMB 1445 Rear-Mounted Boom with Quick Detach Cable Controls and Light Kit | 1,220 lb. | \$17,102 |
| RMB1660-1 | RMB 1660 Rear-Mounted Boom with Quick Detach Cable Controls and Light Kit | 2,403 lb. | \$20,756 |
| RMB1865-1 | RMB 1865 Rear-Mounted Boom with Quick Detach Cable Controls and Light Kit | 2,470 lb. | \$22,617 |
| RMB1865E-1 | RMB 1865E (Electronic Controls) Rear-Mounted Boom with Quick Detach Cable Controls and Light Kit | 2,470 lb. | \$26,343 |
| PT5-2 | Powertrim Rear-Mounted Boom Series with Flow Control Valve Kit, Sickle Bar Head and One Set of Hydraulic Remotes | 415 lb. | \$11,877 |

GROUP 2 ROTARY HEAD SELECTION

| Model Number | Description | Approx. Wt. | List Price (\$US) |
|--|--|-------------|-------------------|
| <u>RMB1660-1, RMB1865-1, RMB1865E-1</u> | | | |
| 50071277 | Rotary Head, 5/8" x 6" Blades, 60" Wide Cut, 4" Capacity (Includes Buzzer Kit) | 915 lb. | \$10,664 |
| For rotary head, protective screen materials supplied must be installed. | | | |

GROUP 3 FLAIL HEAD SELECTION

| Model Number | Description | Approx. Wt. | List Price (\$US) |
|---|---|-------------|-------------------|
| <u>RMB1445-1</u> | | | |
| 50071904 | Supercut Compact Flailhead, Universal Knives, 39" Wide Cut, 1" Capacity | 309 lb. | \$5,667 |
| <u>RMB1660-1, RMB1865-1, RMB1865E-1</u> | | | |
| 50068497 | Supercut Flailhead, Competition Knives, 47" Wide Cut, 1.5" Capacity | 520 lb. | \$7,377 |
| 50068498 | Multicut Flailhead, Competition Knives, 47" Wide Cut, 2" Capacity | 712 lb. | \$8,812 |

GROUP 4 CUTTER BAR SELECTION

| Model Number | Description | Approx. Wt. | List Price (\$US) |
|---|--|-------------|-------------------|
| <u>RMB1445-1</u> | | | |
| 50068394 | Sheartrim Cutter Bar, 59" Wide Cut, 1.25" Capacity | 143 lb. | \$6,591 |
| <u>RMB1660-1, RMB1865-1, RMB1865E-1</u> | | | |
| 50068397 | Sheartrim Cutter Bar, 59" Wide Cut, 1.25" Capacity | 143 lb. | \$6,990 |

OPTIONS

| Model Number | Description | List Price (\$US) |
|---|---|-----------------------------|
| <u>PT5-2</u> | | |
| 8130059 | Closed Center Conversion Kit | Order Through Service Parts |
| <u>RMB1445-1</u> | | |
| 50081252 | Lift Float Kit | \$597 |
| <u>RMB1660-1, RMB1865-1, RMB1865E-1</u> | | |
| 50068500 | Lift Float Kit | \$621 |
| 50068502 | Skid Kit (Supercut Flailhead) | \$572 |
| 50068503 | Skid Kit (Multicut Flailhead) | \$470 |
| 21604.02 | Side Wheel Kit (For use with Rotary Head Only) | \$435 |
| 8402928 | Buzzer Kit (For use with Rotary Head only; Serial Number M175799 and lower) | Order Through Service Parts |

RETURN TO INDEX



FORWARD REACH REAR-MOUNTED BOOM MOWER

| MODEL | RMB1880F | RMB2080F |
|---------------------------------------|---|----------|
| Minimum Tractor PTO HP | 80 | |
| Tractor Minimum Weight (lb.) | 8,818 | |
| Tractor PTO | 540 | |
| Machine Weight (lb.)* | 2,469 | 2,540 |
| Hydraulic System | Totally Independent | |
| Attachment Method | Cat 2 & 3, 3-Point Mount | |
| Controls | Two-Way Rotor Engagement - Electric Control (ERC) | |
| Maximum Reach, Horizontal (A) | 18' 1" | 19' 8" |
| Maximum Height, Horizontal (B) | 16' 1" | 17' 9" |
| Maximum Height, Horizontal (C) | 17' 5" | 18' 8" |
| Maximum Height, Vertical (D) | 22' 0" | 23' 4" |
| Maximum Depth, 45° | 7' 10" | 9' 2" |
| Lightbar Kit | Standard | |
| * Excluding attachment and oil | | |

NOTICE:

RMB Series mowers are to be used only on tractors equipped with cabs. For rotary mower heads, protective screen material must be installed.

HOW TO ORDER:

To receive a complete cutter, for RMB models you must include a basic unit above and the appropriate head option in the ordering section.

Freight NOT included in list price

RETURN TO INDEX

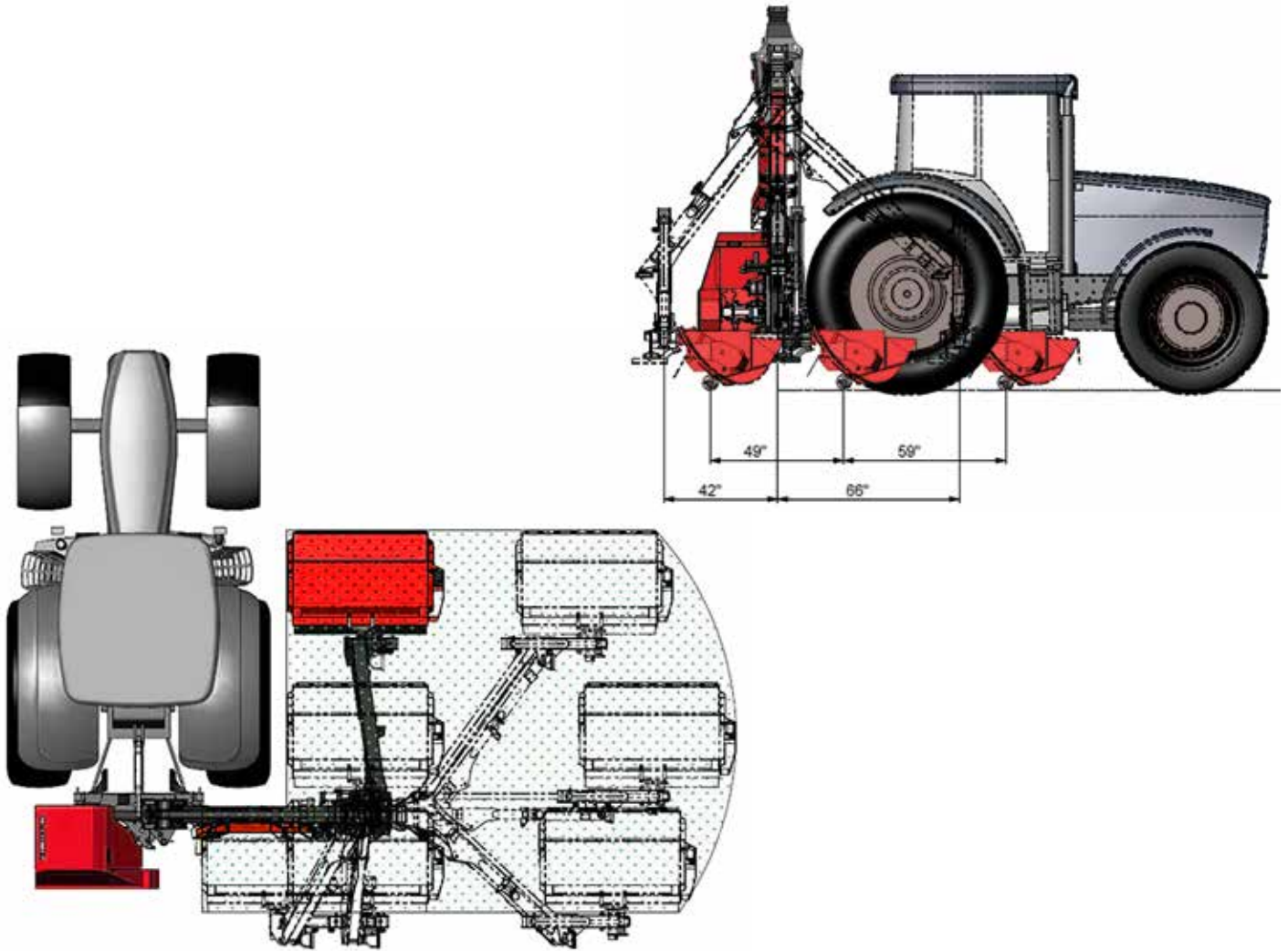

HEAD SELECTION CHART

| FLAIL HEAD | 50081485 | 50081486 | 50081487 |
|---------------------------------|----------------------|--------------|----------------|
| Minimum Tractor PTO HP / Weight | 80 / 8,818 lb. | | |
| Rotor / Knife | Uni-Boot Flail | Omega Flail | Uni-Boot Flail |
| Typical Application | Hedge Cutting, Grass | | |
| Cutting Capacity | 1" Diameter | 1½" Diameter | 1" Diameter |
| Cutting Width | 47" | 45" | 59" |

| ROTARY HEAD | 50081488 |
|---------------------------------|----------------|
| Minimum Tractor PTO HP / Weight | 80 / 8,818 lb. |
| Typical Application | Grass / Brush |
| Cutting Capacity | 4" Diameter |
| Cutting Width | 47" |

Freight NOT included in list price



RETURN TO INDEX

FORWARD REACH REAR-MOUNTED BOOM MOWER

BASE UNIT SELECTION

| Model Number | Description | Approx. Wt. | List Price (\$US) |
|--------------|---|-------------|-------------------|
| RMB1880F | RMB 1880F Rear Mounted Boom Series Mower with Two-Way Rotor Engagement - Electric Control and Light Kit | 2,469 lb. | \$35,797 |
| RMB2080F | RMB 2080F Rear Mounted Boom Series Mower with Two-Way Rotor Engagement - Electric Control and Light Kit | 2,540 lb. | \$37,930 |

*Base Unit weight excluding Cutting Head and Oil

GROUP 2 FLAIL HEAD SELECTION

| Model Number | Description | Approx. Wt. | List Price (\$US) |
|--------------|-------------------------------|-------------|-------------------|
| 50081485 | 120 Flail Head UNI-Boot Flail | 702 lb. | \$7,150 |
| 50081486 | 120 Head OMEGA Flail | 783 lb. | \$7,853 |
| 50081487 | 150 Head UNI-Boot Flail | 778 lb. | \$8,140 |

GROUP 3 ROTARY HEAD SELECTION

| Model Number | Description | Approx. Wt. | List Price (\$US) |
|--------------|--------------------------------|-------------|-------------------|
| 50081488 | 1.2 M HD Rotary Head Tri-Blade | 573 lb. | \$9,139 |



RETURN TO INDEX

[RETURN TO INDEX](#)

CONSTRUCTION

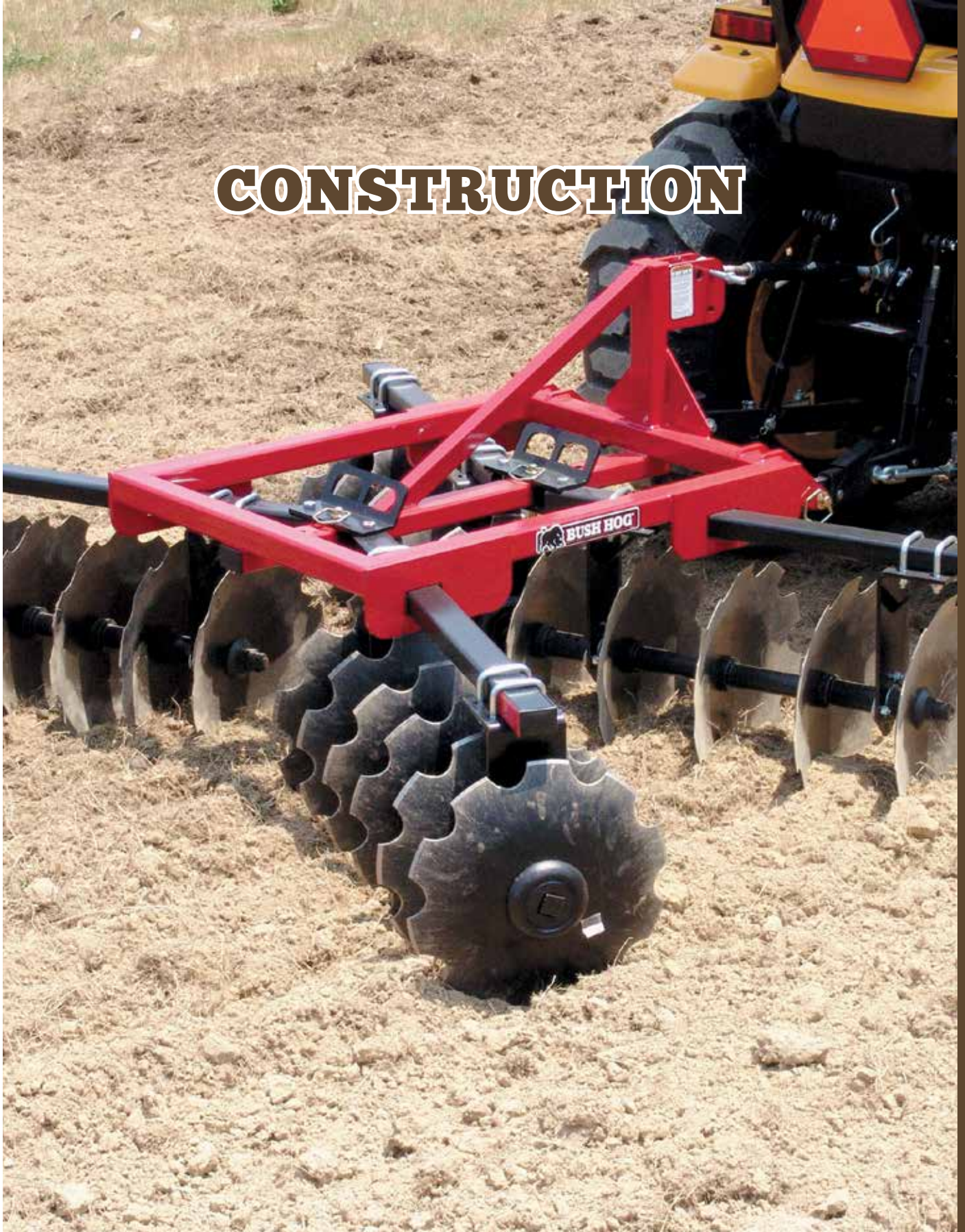

RETURN TO INDEX



DSP SERIES PULL DIRT SCRAPER

| MODEL | DSP8 | DSP10 | DSP12 |
|--|---|---|---|
| Horsepower Rating | 70 - 125 HP | | |
| Transport Width | 97" | 121" | 145" |
| Working Width | 96 ³ / ₁₆ " | 120 ³ / ₁₆ " | 144 ³ / ₁₆ " |
| Capacity | 1 ³ / ₄ Cu. Yds. | 2 ¹ / ₄ Cu. Yds. | 2 ³ / ₄ Cu. Yds. |
| Weight with Weight Box (Without Material in Weight Box) | 1,525 lb. (Tilt Axle) 1,405 lb. (No Tilt Axle) | 1,645 lb. (Tilt Axle) 1,525 lb. (No Tilt Axle) | 1,700 lb. (Tilt Axle) 1,580 lb. (No Tilt Axle) |
| Maximum Weight of Material in Weight Box | 760 lb. | | |
| Depth of Box | 39" | | |
| Dump Clearance | 5" Below Grade | | |
| Maximum Tilt Depth to the Right | 7" | 7 ⁵ / ₈ " | 8 ¹ / ₄ " |
| Maximum Tilt Angle | 3 ¹ / ₂ ° | | |
| Tongue Construction | 4" x 4" x 1/4" Tubing | | |
| Side Plate Construction | 3/8" x 24 ⁵ / ₁₆ " High x 39 ³ / ₄ " Deep | | |
| Moldboard Construction | 1/4" x 24 ³ / ₄ " High When Formed | | |
| Cutting Edge | 1/2" x 6" Reversible and Replaceable | | |
| Cutting Edge Reinforcement | 3" x 3" x 5/16" Angle Plus a 1/4" Moldboard = 9/16" at the Cutting Edge | | |
| Tires | New 9.5L x 15 8-Ply Rib TL on 5-Bolt Rim with 5.5" Bolt Center | | |
| Maximum Transport Speed | 20 mph | | |
| Lift Cylinder | 3 ¹ / ₂ " x 8" ASAE | | |
| Tilt Cylinder | 3 ¹ / ₂ " x 8" ASAE | | |

HOW TO ORDER:

The DSP Series Dirt Scraper is available as a pull-type implement only. To receive a complete unit, you must indicate your choice of basic unit, including your choice of model color from the chart above, and make a selection from Group 2 Tilt Preference Selection. Additional equipment may be selected from the Options Section at the bottom of the next page. Each unit selected from this ordering page is shipped in one crate with the tongue, tailwheels and options to be assembled by the dealer.

Freight NOT included in list price



RETURN TO INDEX

| All models are available in the colors below: | |
|---|--------------------|
| Model Color Indicator | Unit Color |
| 01 | Bush Hog Red |
| 03 | John Deere Green |
| 05 | Kubota Orange |
| 14 | New Holland Blue |
| 16 | Caterpillar Yellow |

DSP SERIES PULL DIRT SCRAPER

BASE UNIT SELECTION

| Model Number | Description | List Price (\$US) |
|--------------|---|-------------------|
| DSP8-01 | DSP Series Pull Dirt Scraper, Bush Hog Red, 8' | \$3,217 |
| DSP8-03 | DSP Series Pull Dirt Scraper, John Deere Green, 8' | \$3,217 |
| DSP8-05 | DSP Series Pull Dirt Scraper, Kubota Orange, 8' | \$3,217 |
| DSP8-14 | DSP Series Pull Dirt Scraper, New Holland Blue, 8' | \$3,217 |
| DSP8-16 | DSP Series Pull Dirt Scraper, Caterpillar Yellow, 8' | \$3,217 |
| DSP10-01 | DSP Series Pull Dirt Scraper, Bush Hog Red, 10' | \$3,738 |
| DSP10-03 | DSP Series Pull Dirt Scraper, John Deere Green, 10' | \$3,738 |
| DSP10-05 | DSP Series Pull Dirt Scraper, Kubota Orange, 10' | \$3,738 |
| DSP10-14 | DSP Series Pull Dirt Scraper, New Holland Blue, 10' | \$3,738 |
| DSP10-16 | DSP Series Pull Dirt Scraper, Caterpillar Yellow, 10' | \$3,738 |
| DSP12-01 | DSP Series Pull Dirt Scraper, Bush Hog Red, 12' | \$4,310 |
| DSP12-03 | DSP Series Pull Dirt Scraper, John Deere Green, 12' | \$4,310 |
| DSP12-05 | DSP Series Pull Dirt Scraper, Kubota Orange, 12' | \$4,310 |
| DSP12-14 | DSP Series Pull Dirt Scraper, New Holland Blue, 12' | \$4,310 |
| DSP12-16 | DSP Series Pull Dirt Scraper, Caterpillar Yellow, 12' | \$4,310 |

GROUP 2 TILT PREFERENCE SELECTION (Must Choose One)

| Model Number | Description | List Price (\$US) |
|--------------|--|-------------------|
| 50072337 | Fixed Gauge Wheel Bundle | \$1,964 |
| 50074713 | Hydraulic Tilt Bundle (DSP8 Series Only) | \$2,645 |
| 50072336 | Hydraulic Tilt Bundle (DSP10 Series, DSP12 Series) | \$2,425 |

OPTIONS

| Model Number | Description | List Price (\$US) |
|--------------|--|-------------------|
| 50074757 | Weight Box, No Weights Included (DSP8 Series Only) | \$339 |
| 50072350 | Weight Box, No Weights Included (DSP10 Series, DSP12 Series) | \$440 |

RETURN TO INDEX



PHD SERIES POST HOLE DIGGER

| MODEL | PHD2401 | PHD2402 | PHD2403 |
|--|----------------------|-----------------|--|
| Usage Type | Utility | Agricultural | Industrial |
| Input RPM | 540 | | |
| Auger RPM | 180 | 170 | 135 |
| Gear Ratio | 3.00:1 | 3.18:1 | 4.00:1 |
| Maximum Digging Depth | 42" Standard, 48" HD | | |
| Hitch | ASAE Cat 1 | ASAE Cat 1 & 2 | |
| Component Protection | Shear Bolt | | |
| Output Shaft | 2" Diameter | | |
| Driveshaft | ASAE Category 1 | ASAE Category 3 | |
| Yoke | 27/8" Tubing | | 3" Tubing |
| Boom | 27/8" Tubing | 3½" Tubing | 3½" Tubing With Reinforcing Hitch Rib |
| Maximum PTO HP | 45 | 65 | 95 |
| Five-Year Limited Gearbox Warranty. | | | |

NOTICE:

Category 2 conversion bushings are not supplied with PHD2402 and PHD2403 models.

HOW TO ORDER:

To receive a complete unit, select a model from the Base Unit section and an auger from Group 2 of the ordering section on the next page. Price of a complete unit is the list price for the base unit plus the list price for the auger selected. Optional desired equipment for these units may be selected from the Options list in the ordering section.

Freight NOT included in list price



RETURN TO INDEX

PHD2401, PHD2402, PHD2403 POST HOLE DIGGER

BASE UNIT SELECTION

| Model Number | Description | Approx. Wt. | List Price (\$US) |
|--------------|--|-------------|-------------------|
| PHD2401 | PHD Series Utility Post Hole Digger | 160 lb. | \$1,192 |
| PHD2402 | PHD Series Agricultural Post Hole Digger | 206 lb. | \$1,602 |
| PHD2403 | PHD Series Industrial Post Hole Digger | 210 lb. | \$2,060 |

GROUP 2 AUGER SELECTION

| Model Number | Description | Approx. Wt. | List Price (\$US) |
|---|---|-------------|-------------------|
| Standard Duty Augers – Fish Tail Point (Replaceable) | | | |
| 50072104 | 6" Semi-Double Flight Auger, Standard Duty, Fish Tail Point (Replaceable), With 42" Maximum Digging Depth | 22 lb. | \$272 |
| 50072105 | 9" Double Flight Auger, Standard Duty, Fish Tail Point (Replaceable), With 42" Maximum Digging Depth | 37 lb. | \$327 |
| 50072106 | 12" Double Flight Auger, Standard Duty, Fish Tail Point (Replaceable), With 42" Maximum Digging Depth | 46 lb. | \$340 |

Heavy Duty Augers – Aggressor Point (Replaceable)

| | | | |
|----------|---|---------|-------|
| 00780367 | 6" Semi-Double Flight Auger, Heavy Duty, Aggressor Point (Replaceable), With 48" Maximum Digging Depth | 42 lb. | \$320 |
| 00780368 | 9" Double Flight Auger, Heavy Duty, Aggressor Point (Replaceable), With 48" Maximum Digging Depth | 57 lb. | \$379 |
| 00780369 | 12" Double Flight Auger, Heavy Duty, Aggressor Point (Replaceable), With 48" Maximum Digging Depth | 64 lb. | \$401 |
| 00780371 | 18" Double Flight Auger, Heavy Duty, Aggressor Point (Replaceable), With 48" Maximum Digging Depth (May Not Be Used on PHD2401) | 82 lb. | \$565 |
| 00780372 | 24" Double Flight Auger, Heavy Duty, Aggressor Point (Replaceable), With 48" Maximum Digging Depth (May Not Be Used on PHD2401) | 109 lb. | \$661 |

OPTIONS

| Model Number | Description | Approx. Wt. | List Price (\$US) |
|--------------|--|-------------|-------------------|
| 50072108 | Parking Stand Kit for PHD 2401,PHD2402 | 12 lb. | \$175 |
| 50072111 | Parking Stand Kit for PHD2403 | 13 lb. | \$193 |
| 50072109 | Hydraulic Down Force Kit for PHD2401 | 39 lb. | \$700 |
| 50072110 | Hydraulic Down Force Kit for PHD2402 | 40 lb. | \$700 |
| 50072112 | Hydraulic Down Force Kit for PHD2403 | 42 lb. | \$684 |
| 50068115 | Bear Claw Auger Point Assembly, For Use on Standard Duty Augers Only | | \$137 |
| 50072107 | 12" Auger Extension, For Use on Standard Duty Augers Only | 16 lb. | \$259 |
| 01A01030 | 7" Auger Extension, For Use on Heavy Duty Augers Only | 4 lb. | \$262 |
| 01A01040 | 14" Auger Extension, For Use on Heavy Duty Augers Only | 7 lb. | \$331 |



RETURN TO INDEX



PHDHF FARM/RANCH SERIES POST HOLE DIGGER

| MODEL | PHDHF15-2 | PHDHF20-2 | PHDHF30-2 | PHDHF35 |
|-----------------------------------|--|-----------------|-----------------|-----------------|
| Drive Type | Planetary with Reversible Motor | | | |
| Shaft Output Size | 2" Hex | | | |
| Maximum Output Torque* | 1,512 ft. / lb. | 1,747 ft. / lb. | 2,511 ft. / lb. | 3,529 ft. / lb. |
| Recommended Hydraulic Flow | 6 - 15 gpm | 10 - 20 gpm | 15 - 30 gpm | 20 - 35 gpm |
| Maximum System Pressure | 3,000 psi | | | 3,500 psi |
| Drive Protection | Hydraulic Relief Valve | | | |
| Hydraulic Hoses | 1/2" x 8' with 10 MB Ends | | | |
| Type of Mounts | Loader Bucket, Skid Steer Universal, Euro Style Quick Attach | | | |
| Maximum Auger Diameter (Rock) | 18" | 24" | 36" | |
| Maximum Auger Diameter (Dirt) | 18" | 30" | 36" | |
| Standard Digging Depth | 48" | | | |
| Two-Year Limited Warranty. | | | | |

*All values are theoretical. Specifications and models are subject to change without notice.

| | |
|----------------|---|
| NOTICE: | PHDHF Series diggers are "Farm/Ranch" type, designed for use with tractor front end loaders or small skid steer loaders. Mounting brackets with frames offset to the right are designed for use on a tractor front end loader to provide visibility of the auger. |
|----------------|---|

| | |
|----------------------|---|
| HOW TO ORDER: | The PHDHF Series digger is priced as a basic unit with a choice of mounting kit bundle, auger, and options. In order to receive a complete unit, you must specify the basic unit, your selection of mounting kit from Group 2, and selection of auger from Group 3. Hydraulic hose is included. Additional equipment may be added to your order by making your selection from the Options list. |
|----------------------|---|

Freight NOT included in list price



RETURN TO INDEX

PHDHF FARM/RANCH SERIES POST HOLE DIGGER

BASE UNIT SELECTION

| Model Number | Description | Approx. Wt. | List Price (\$US) |
|--------------|--|-------------|-------------------|
| PHDHF15-2 | Planetary Drive Post Hole Digger for Systems Delivering 6 - 15 GPM Hydraulic Flow, 1,419 ft/lb Torque at Maximum System Pressure (3,000 psi) | 130 lb. | \$2,320 |
| PHDHF20-2 | Planetary Drive Post Hole Digger for Systems Delivering 10 - 20 GPM Hydraulic Flow, 1,777 ft/lb Torque at Maximum System Pressure (3,000 psi) | 135 lb. | \$2,431 |
| PHDHF30-2 | Planetary Drive Post Hole Digger for Systems Delivering 15 - 30 GPM Hydraulic Flow, 2,623 ft/lb Torque at Maximum System Pressure (3,000 psi) | 140 lb. | \$2,543 |
| PHDHF35 | Planetary Drive Post Hole Digger for Systems Delivering 20 - 30 GPM Hydraulic Flow, 3,500 ft/lb Torque at Maximum System Pressure (3,500 psi) | 145 lb. | \$2,656 |

GROUP 2 MOUNTING KIT SELECTION

| Model Number | Description | Approx. Wt. | List Price (\$US) |
|--------------|--|-------------|-------------------|
| 50077005 | Skid Steer Mount, Quick Attach, Center Hitch | 117 lb. | \$565 |
| 50077004 | Loader Bucket Mount* | 57 lb. | \$399 |
| 50077006 | Skid Steer Mount, Quick Attach, Right Offset (Offset to Right 15")** | 128 lb. | \$565 |
| 50077007 | Skid Steer Mount, Euro Quick Attach, Right Offset (Offset to Right 15")** | 140 lb. | \$632 |

* Requires drilling two holes in bucket. (Hoses not included.)

** Mounting brackets with frames offset to the right are designed for use on a tractor front end loader to provide visibility of the auger.

GROUP 3 AUGER SELECTION

| Model Number | Description | Approx. Wt. | List Price (\$US) |
|---|-------------------------------------|-------------|-------------------|
| HSDA Augers (Soil, Clay, Loose Rock), 48" Long | | | |
| 00789048 | 6" Auger | 68 lb. | \$342 |
| 00789049 | 9" Auger | 69 lb. | \$485 |
| 00789050 | 12" Auger | 108 lb. | \$552 |
| 00789051 | 18" Auger | 159 lb. | \$816 |
| 00789052 | 24" Auger (PHDHF30 Only) | 245 lb. | \$1,029 |
| 00789053 | 30" Auger (PHDHF30 Only) | 303 lb. | \$1,344 |
| 00789054 | 36" Auger (PHDHF30 Only) | 333 lb. | \$1,653 |
| 00789055 | 9" x 18" Tree Auger | 136 lb. | \$886 |
| 00789056 | 12" x 24" Tree Auger | 287 lb. | \$955 |
| 00789057 | 18" x 36" Tree Auger (PHDHF30 Only) | 322 lb. | \$1,621 |

Note: Augers 18" and greater will incur a separate freight charge of \$52.

T-Post Puff Auger (Soil, Clay, Compacted Soil)

| | | | |
|----------|----------|--------|-------|
| 00776653 | 2" Auger | 25 lb. | \$496 |
|----------|----------|--------|-------|

OPTIONS

| Model Number | Description | Approx. Wt. | List Price (\$US) |
|--------------|--|-------------|-------------------|
| 00776654 | 24" Variable Length Auger Extension | 33 lb. | \$320 |
| 00776655 | 48" Variable Length Auger Extension | 57 lb. | \$534 |
| 00785968 | Auger Adapter, 2" Hex (Female) to 2" Round (Male) (Bush Hog) | 15 lb. | \$267 |
| 00786085 | Auger Adapter, 2" Round (Female) to 2" Hex (Male) (3/4" Hole) | 14 lb. | \$267 |
| 00768105 | Hydraulic Hose Kit for Bolt-on Bucket Mount Kit (Hoses are 25' Long) (Dealer Installed) | 25 lb. | \$453 |

RETURN TO INDEX



PHDHC CONSTRUCTION/CONTRACTOR SERIES POST HOLE DIGGER

| MODEL | PHDHC20 | PHDHC30 | PHDHC35 |
|------------------------------------|---|-----------------|-----------------|
| Drive Type | Planetary with Reversible Motor | | |
| Shaft Output Size | 2" Hex | | |
| Maximum Output Torque* | 2,008 ft. / lb. | 2,937 ft. / lb. | 3,582 ft. / lb. |
| Recommended Hydraulic Flow | 10 - 20 gpm | 15 - 30 gpm | 20 - 35 gpm |
| Maximum System Pressure | 3,000 psi | | |
| Drive Protection | Hydraulic Relief Valve | | |
| Hydraulic Hoses | 1/2" x 8' with 10 MB Ends | | |
| Type of Mounts | Loader Bucket, Skid Steer Universal, Euro Style Quick Attach, Backhoe | | |
| Maximum Auger Diameter (Rock) | 24" | 36" | |
| Maximum Auger Diameter (Dirt) | 30" | 36" | |
| Standard Digging Depth | 48" | | |
| Five-Year Limited Warranty. | | | |

**All values are theoretical. Specifications and models are subject to change without notice.*

| | |
|---------------|---|
| NOTICE: | PHDHC Series diggers are "Construction/Contractor" type, designed for use with skid steer loaders, tractor loader backhoes, and mini-excavators. |
| HOW TO ORDER: | The PHDHC Series digger is priced as a basic unit with a choice of mounting kit bundle, auger, and options. In order to receive a complete unit, you must specify the basic unit, your selection of mounting kit from Group 2, and selection of auger from Group 3. Additional equipment may be added to your order by making your selection from the Options list. |

Freight NOT included in list price



RETURN TO INDEX

PHDHC CONSTRUCTION/CONTRACTOR SERIES POST HOLE DIGGER

BASE UNIT SELECTION

| Model Number | Description | Approx. Wt. | List Price (\$US) |
|--------------|--|-------------|-------------------|
| PHDHC20 | Planetary Drive Post Hole Digger for Systems Delivering 10 - 20 GPM Hydraulic Flow, 2,008 ft/lb Torque at Maximum System Pressure (3,000 psi) | 211 lb. | \$3,070 |
| PHDHC30 | Planetary Drive Post Hole Digger for Systems Delivering 15 - 30 GPM Hydraulic Flow, 2,937 ft/lb Torque at Maximum System Pressure (3,000 psi) | 211 lb. | \$3,236 |
| PHDHC35 | Planetary Drive Post Hole Digger for Systems Delivering 20 - 35 GPM Hydraulic Flow, 3,582 ft/lb Torque at Maximum System Pressure (3,000 psi) | 211 lb. | \$3,502 |

GROUP 2 MOUNTING KIT SELECTION

| Model Number | Description | Approx. Wt. | List Price (\$US) |
|---|--|-------------|-------------------|
| Skid Steer | | | |
| 50074571 | Universal Skid Steer Quick Attach Frame with Centered Hitch | 146 lb. | \$582 |
| 50074572 | Universal Skid Steer Quick Attach Frame (Offset to Right 15") | 146 lb. | \$582 |
| Backhoe and Mini-Excavator (See instructions at end of Ordering Section) | | | |
| 00776624 | Mounting Kit for Case 580, 580E, 580SE | 32 lb. | \$406 |
| 00776625 | Mounting Kit for Case 780 | 32 lb. | \$406 |
| 00776626 | Mounting Kit for Ford CL55, 555 Series; Deere 12, B, C; 410A, B, C, D; 9300, 9305, 210C, 300B, D; 310A, B, C, D, E; 500C, 510B, 510C | 32 lb. | \$406 |
| 00776627 | Mounting Kit for JCB 1400B, 1500, 215, 217, 214 | 32 lb. | \$406 |
| 00776628 | Mounting Kit for Deere 510; 710B, C, D | 32 lb. | \$406 |
| 00776629 | Mounting Kit for Deere 9450, 9550, 401C | 32 lb. | \$406 |
| 00776630 | Mounting Kit for Deere 310SE, 410E | 32 lb. | \$406 |
| 00776631 | Mounting Kit for Cat 410, 416, 426 | 32 lb. | \$406 |
| 00788379 | Mounting Kit for Kubota KX91 | 32 lb. | \$406 |

*Mounting brackets with frames offset to the right are designed for use on a tractor front end loader to provide visibility of the auger.

Case, Ford, JCB, John Deere, and CAT are trade names and/or registered trademarks which are the intellectual property of the entity listed or of the entity's successor(s). These names are used only to clarify the identification of skid steer loaders.

If mounting to a tractor front end loader, use mounting kits shown in PHDHF Series price sheets. Mounting kits for most backhoe and excavator models are available. See instructions at the end of this ordering section for backhoe or excavator models not listed above.

PHDHC Series Post Hole Diggers Continued on Next Page



RETURN TO INDEX

PHDHC SERIES POST HOLE DIGGER *Continued*

GROUP 3 AUGER SELECTION

| Model Number | Description | Approx. Wt. | List Price (\$US) |
|---|----------------------|-------------|-------------------|
| T-Post Puff Auger (Solid Rock) | | | |
| 00776653 | 2" Auger | 25 lb. | \$496 |
| HSDA AUGERS (Soil, Clay, Loose Rock) | | | |
| 00789048 | 6" Auger | 68 lb. | \$342 |
| 00789049 | 9" Auger | 69 lb. | \$485 |
| 00789050 | 12" Auger | 108 lb. | \$552 |
| 00789051 | 18" Auger | 159 lb. | \$816 |
| 00789052 | 24" Auger | 245 lb. | \$1,029 |
| 00789053 | 30" Auger | 303 lb. | \$1,344 |
| 00789054 | 36" Auger | 333 lb. | \$1,653 |
| 00789055 | 9" x 18" Tree Auger | 136 lb. | \$886 |
| 00789056 | 12" x 24" Tree Auger | 287 lb. | \$955 |
| 00789057 | 18" x 36" Tree Auger | 322 lb. | \$1,621 |
| HSRA AUGERS (Loose Rock, Solid Rock, Concrete) | | | |
| 00776632 | 4-½" Auger | 60 lb. | \$933 |
| 00776633 | 6" Auger | 53 lb. | \$1,301 |
| HRAD AUGERS (Soil, Hard Clay, Loose or Solid Rock, Concrete) | | | |
| 00776644 | 9" Auger | 102 lb. | \$1,541 |
| 00776645 | 12" Auger | 107 lb. | \$1,935 |
| 00776646 | 18" Auger | 201 lb. | \$2,484 |
| 00776647 | 24" Auger | 291 lb. | \$2,852 |
| 00776648 | 30" Auger | 340 lb. | \$3,278 |
| 00776649 | 36" Auger | 395 lb. | \$4,036 |

OPTIONS (DEALER INSTALLED)

| Model Number | Description | Approx. Wt. | List Price (\$US) |
|--------------|-------------------------------------|-------------|-------------------|
| 00776654 | 24" Variable Length Auger Extension | 33 lb. | \$320 |
| 00776655 | 48" Variable Length Auger Extension | 57 lb. | \$534 |
| 00776656 | 72" Variable Length Auger Extension | 80 lb. | \$629 |

BACKHOE & EXCAVATOR MOUNTING BRACKET INFORMATION

(See Group 2 Mounting Kit Selection for Weight and Price)

| | |
|---------------|---|
| STEP 1 | Choose PHDHC Series digger that matches the hydraulic flow and pressure of the backhoe or excavator. |
| STEP 2 | Measure the width of the backhoe or excavator dipper (outer boom section) at the connection point. |
| STEP 3 | Measure the pin diameter required to connect the digger to the backhoe or excavator. |
| STEP 4 | If the dipper width and pin diameter are the same as those listed in the chart below, order the part number that corresponds. If part number is not shown for the size you need, contact Bush Hog Customer Service Department with your dipper width and pin diameter information so they can determine availability. |

PHDHC Series Post Hole Diggers Continued on Next Page



RETURN TO INDEX

PHDHC SERIES POST HOLE DIGGER *Continued*

| DIPPER WIDTH & PIN DIAMETERS FOR MOUNT KITS LISTED IN GROUP 2 MOUNTING KIT SELECTION | | | |
|--|--------------|--------------|--|
| Part Number | Dipper Width | Pin Diameter | Typical Application |
| 00776624 | 10" | 1¾" | Case 580, 580E, 580SE |
| 00776625 | 8" | 2½" | Case 780 |
| 00776626 | 8" | 1¾" | Ford CL55, 555 Series; Deere 12, B, C; 410A, B, C, D; 9300, 9305 |
| 00776627 | 6¾" | 1¾" | JCB 1400B, 1500, 215, 217, 214 |
| 00776628 | 6½" | 1¾" | Deere 510, 710B, C, D |
| 00776629 | 8" | 1½" | Deere 9450, 9550, 401C |
| 00776630 | 8" | 2¾" | Deere 310SE, 410E |
| 00776631 | 10" | 2" | CAT 410, 416, 426 |
| 00788379 | 5½" | 1½" | Kubota KX91 |

AUGER SIZING CHART FOR PHDHF AND PHDHC SERIES POST HOLE DIGGERS

| | | Farm and Ranch | | | | | | Construction | | | | | |
|---|---------|----------------|------|---------|------|---------|------|--------------|------|---------|------|---------|------|
| | | PHDHF15 | | PHDHF20 | | PHDHF30 | | PHDHC20 | | PHDHC30 | | PHDHC35 | |
| | | Dirt | Rock | Dirt | Rock | Dirt | Rock | Dirt | Rock | Dirt | Rock | Dirt | Rock |
| Approx. Wt. | | | | | | | | | | | | | |
| T-POST PUFF AUGER (Solid Rock) | | | | | | | | | | | | | |
| 2" Auger | 25 lb. | X | X | X | X | X | X | X | X | X | X | X | X |
| HSDA AUGERS (Soil, Clay, Loose Rock) | | | | | | | | | | | | | |
| 6" Auger | 68 lb. | X | X | X | X | X | X | X | X | X | X | X | X |
| 9" Auger | 69 lb. | X | X | X | X | X | X | X | X | X | X | X | X |
| 12" Auger | 108 lb. | X | X | X | X | X | X | X | X | X | X | X | X |
| 18" Auger | 159 lb. | X | X | X | X | X | X | X | X | X | X | X | X |
| 24" Auger | 245 lb. | X | X | X | X | X | X | X | X | X | X | X | X |
| 30" Auger | 303 lb. | X | X | X | X | X | X | X | X | X | X | X | X |
| 36" Auger | 333 lb. | X | X | X | X | X | X | X | X | X | X | X | X |
| 9" x 18" Tree Auger | 136 lb. | X | X | X | X | X | X | X | X | X | X | X | X |
| 12" x 24" Tree Auger | 287 lb. | X | X | X | X | X | X | X | X | X | X | X | X |
| 18" x 36" Tree Auger | 322 lb. | X | X | X | X | X | X | X | X | X | X | X | X |
| HSRA AUGERS (Loose Rock, Solid Rock, Concrete) | | | | | | | | | | | | | |
| 4½" Auger | 60 lb. | X | X | X | X | X | X | X | X | X | X | X | X |
| 6" Auger | 53 lb. | X | X | X | X | X | X | X | X | X | X | X | X |
| HRAD AUGERS (Soil, Hard Clay, Loose or Solid Rock, Concrete) | | | | | | | | | | | | | |
| 9" Auger | 102 lb. | X | X | X | X | X | X | X | X | X | X | X | X |
| 12" Auger | 107 lb. | X | X | X | X | X | X | X | X | X | X | X | X |
| 18" Auger | 201 lb. | X | X | X | X | X | X | X | X | X | X | X | X |
| 24" Auger | 291 lb. | X | X | X | X | X | X | X | X | X | X | X | X |
| 30" Auger | 340 lb. | X | X | X | X | X | X | X | X | X | X | X | X |
| 36" Auger | 395 lb. | X | X | X | X | X | X | X | X | X | X | X | X |

RETURN TO INDEX

All models are available in the colors below:

| Model Color Indicator | Unit Color |
|-----------------------|------------------|
| 01 | Bush Hog Red |
| 02 | Bush Hog Black |
| 03 | John Deere Green |
| 05 | Kubota Orange |
| 14 | New Holland Blue |



***** THIS PRODUCT IS PRICED AT LIST LESS 25% *****

XD SERIES BACKHOE

BASE UNITS

**** BASE UNITS OPERATE ON OPEN CENTRE VALVES - SEE MISC ACCESSORIES ****

| Model Number | Description | Approx. Wt. | List Price (\$US) |
|---|--|-------------|-------------------|
| <small>** Please use Model Color Indicator behind product model number (ex. XD65C-02) **Please See P/N BFC501 under Hydraulic Accessories when ordering XD65C and XD65 model Backhoes**</small> | | | |
| XD65C | 6' 4" Backhoe Base Unit | 500 lb. | \$6,797 |
| XD65 | 6' 4" Backhoe Base Unit | 575 lb. | \$8,052 |
| XD75 | 7' 8" Backhoe Base Unit | 800 lb. | \$9,297 |
| XD95 | 9' 4" Backhoe Base Unit (5-7 GPM flow required for all XD models) | 850 lb. | \$10,978 |
| XD95EL | 11' 4" Backhoe Base Unit, extended reach Hydraulically retracted foot pedal control | 1,000 lb. | \$13,163 |
| XD600S | 6' Skid digger- std quick attach skidsteer mount Includes flat-faced couplers | 375 lb. | \$2,387 |

GROUP 1 TRACTOR MOUNTINGS

**** VISIT WEBSITE FOR CURRENT SUBFRAME AND SKIDSTEER MOUNTING LISTS ****

| Model Number | Description | List Price (\$US) |
|--------------|---|-------------------|
| PT300 | 3 Point Hitch Mount - Category 1 (Fits all models & includes turn buckle tie down except XD600S) | \$789 |
| PT322 | 3 Point Hitch Mount - Category 2 (Fits XD75, and XD95 includes tie down) | \$869 |
| SF100 | Subframe Mounting Kit (See www.bushhog.com for current subframe list in backhoe section) | \$1,476 |

NOTE: Some tractors may require wheel spacers after subframe installation.

Skidsteer Mountings

| | | |
|-------|---|---------|
| SQ400 | Universal Skidsteer Quick Attach Mount 35" Wide, Includes Flat Faced Couplers (Requires tie back kit) | \$1,035 |
| SQ500 | Universal Skidsteer Quick Attach Mount 44" Wide, Includes Flat Faced Couplers (Requires tie back) | \$1,274 |
| TB100 | Tie Back Kit FOR SQ400 and 500 Quick Attach (See www.bushhog.com for current mounting list) | \$474 |

HOW TO ORDER:

To order a complete unit you must select a base unit from the first section, select a subframe mount from Group 1, and a bucket from Group 2. Add color code to the end of selected model number.

Freight NOT included in list price



RETURN TO INDEX

XD SERIES BACKHOE

GROUP 2 BUCKETS

| Model Number | Description | List Price (\$US) |
|--------------------------------|---|-------------------|
| XD65 & XD65C | | |
| BK2609 | 9" Bucket - XD65 - 3 teeth / Bucket Volume = .5115 cubic ft or 884 cubic in. | \$508 |
| BK2612 | 12" Bucket - XD65 - 3 teeth / Bucket Volume = .6934 cubic ft or 1200 cubic in. | \$575 |
| BK2615 | 15" Bucket - XD65 - 4 teeth / Bucket Volume = .8749 cubic ft or 1512 cubic in. | \$602 |
| BK2618 | 18" Bucket - XD65 - 4 teeth / Bucket Volume = 1.0567 cubic ft or 1826 cubic in. | \$624 |
| XD75 & XD95, XD600S | | |
| BK2900 | 9" Bucket - XD65 - 3 teeth / Bucket Volume = .5115 cubic ft or 884 cubic in. | \$727 |
| BK2120 | 12" Bucket- XD75 & XD95, XD600S - 3 teeth / Bucket Volume = 1.1694 cubic ft or 2020 cubic in. | \$745 |
| BK2150 | 15" Bucket- XD75 & XD95, XD600S - 4 teeth / Bucket Volume = 1.4806 cubic ft or 2558 cubic in. | \$808 |
| BK2180 | 18" Bucket- XD75 & XD95, XD600S - 4 teeth / Bucket Volume = 1.7912 cubic ft or 3095 cubic in. | \$842 |
| BK2240 | 24" Bucket- XD75 & XD95, XD600S - 5 teeth / Bucket Volume = 2.413 cubic ft or 4169 cubic in. | \$974 |
| BK2240D | 24" Ditching Bucket (No Teeth) - XD75 & XD95, XD600S / Bucket Volume = same as above BK2240 | \$900 |

OPTIONS

| Model Number | Description | List Price (\$US) |
|----------------------------------|---|-------------------|
| Backhoe Thumbs | | |
| BT5280 | Clamp-on Mechanical Thumb for XD65 Backhoe | \$561 |
| BT5290 | Clamp-on Mechanical Thumb for XD75/XD95 Backhoe | \$665 |
| BT5300 | Hydraulic Thumb Kit - XD75 & XD95 - Factory installed option - foot pedal control | \$1,702 |
| BT5310 | Clamp-on Mechanical Thumb for XD600S | \$665 |
| BT5330 | Clamp-on Mechanical Thumb for XD95EL | \$685 |
| Miscellaneous Accessories | | |
| BT7240 | Vertical Stabilizer Kit XD75, XD95 & XD95EL | \$1,028 |
| BT7250 | Operators Seat for XD65C Backhoe | \$552 |
| BP220 | Street Pad Kit for XD65C Backhoe | \$328 |
| BT7220 | Quick Change Bucket Adapter (XD75 & XD95) **may need to order pins for multiple buckets** | \$534 |
| BT7230 | Ripper Tool (XD75 & XD95) | \$522 |
| BP210 | Rubber Street Pad Kit (XD65) (Set of two) | \$232 |
| BP230 | Rubber Street Pad Kit (XD75 & XD95) (Set of two) | \$232 |
| Z56916 | Female Flat Face Coupler | \$42 |
| Z51920 | Male Flat Face Coupler | \$122 |
| Z51919 | Male Flat Face Coupler | \$74 |
| PTO Pump Kits | | |
| PTO605 | PTO Hydraulic Pump Kit - 7GPM (XD65C) | \$1,476 |
| PTO62 | PTO Hydraulic Pump Kit - 7 GPM (XD65) | \$1,523 |
| PTO72 | PTO72 PTO Hydraulic Pump Kit - 7 GPM (XD75 & XD95) | \$1,523 |
| Hydraulic Accessories | | |
| BFC501 | Flow Divider Kit for use on XD65C and XD65 models only when tractor hydraulics are above 8GPM | \$640 |
| BT5360 | XD65-95 Backhoe Closed Centre Kit | \$873 |
| Z51920 | Male Flat Face Coupler | \$122 |
| Z51919 | Male Flat Face Coupler | \$74 |
| Z56918 | Power Beyond Sleeve (Used to power an accessory downstream of a control valve) | \$42 |

NOTE: Backhoes ship from factory with male pioneer ends installed unless specified otherwise.

RETURN TO INDEX



| All models are available in the colors below: | |
|---|--------------------|
| Model Color Indicator | Unit Color |
| 01 | Bush Hog Red |
| 02 | Bush Hog Black |
| 03 | John Deere Green |
| 05 | Kubota Orange |
| 14 | New Holland Blue |
| 16 | Caterpillar Yellow |

AGR SERIES AG GRAPPLE

| MODEL | AGR60 | AGR72 |
|-----------------------------------|---|---------|
| Overall Depth | 25" / Closed | |
| Overall Height | 37¾" | |
| Overall Width | 5' | 6' |
| Useable Depth | N/A | |
| Useable Open Height | 31" | |
| Useable Width (inside end plates) | 5' | 6' |
| Roll Back Angle | N/A | |
| Weight | 372 lb. | 409 lb. |
| Number of Teeth | 5 | |
| Attachment Method | Universal Skid Steer Quick Attach, Euro or John Deere | |
| Maximum Tractor HP | 40 | |
| Paint Color | See Paint Color Chart Above | |

NOTICE: All units, with the exception of the AGR60JD and the AGR72JD, are available in the colors in the chart above.

HOW TO ORDER: The AGR Series Grapple is priced as a complete unit. Select your desired model from the Base Unit Selection offered. Indicate your choice of model color from the chart above. **Note: The AGR60JD and the AGR72JD models are available in green only. Do not make a color selection if you are ordering either of these two models.**

Freight NOT included in list price. Freight discount available for multiple unit orders. Please contact Customer Service for details.

BASE UNIT SELECTION

| Model Number | Description | Approx. Wt. | List Price (\$US) |
|--------------|-----------------------------|-------------|-------------------|
| AGR60SS-xx | Ag Grapple, Skid Steer, 60" | 372 lb. | \$2,187 |
| AGR60E-xx | Ag Grapple, Euro, 60" | 409 lb. | \$2,299 |
| AGR60JD | Ag Grapple, John Deere, 60" | 372 lb. | \$2,257 |
| AGR72SS-xx | Ag Grapple, Skid Steer, 72" | 409 lb. | \$2,444 |
| AGR72E-xx | Ag Grapple, Euro, 72" | 409 lb. | \$2,551 |
| AGR72JD | Ag Grapple, John Deere, 72" | 409 lb. | \$2,509 |

[RETURN TO INDEX](#)

BGR SERIES



BRGR SERIES



BGR SERIES BUCKET GRAPPLE AND BRGR SERIES BRUSH GRAPPLE

| MODEL | BGR72T | BGR84T | BGR72 | BGR84 | BRGR72 | BRGR84 |
|-----------------------------------|-----------------------------------|---------|---------------|---------|---------|---------|
| | WITH TEETH | | WITHOUT TEETH | | | |
| Overall Depth | 39¼" | | | | 37½" | |
| Overall Height | 24" | | | | 25½" | |
| Overall Width | 6' | 7' | 6' | 7' | 6' | 7' |
| Useable Depth | 33¾" | | | | 28" | |
| Useable Open Height | 45½" | | | | 46½" | |
| Useable Width (inside end plates) | 71" | 83" | 71" | 83" | 71" | 83" |
| Roll Back Angle | 20° | | | | 13° | |
| Weight | 907 lb. | 993 lb. | 827 lb. | 903 lb. | 702 lb. | 787 lb. |
| Number of Teeth | 8 | 9 | | | 8 | 10 |
| Attachment Method | Universal Skid Steer Quick Attach | | | | | |
| Paint Color | Black | | | | | |

HOW TO ORDER:

The BGR and BRGR Series Grapples are priced as complete units. Select the desired model number from the Base Unit Selection below.

Freight NOT included in list price. Freight discount available for multiple unit orders. Please contact Customer Service for details.

BGR SERIES BUCKET GRAPPLE BASE UNIT SELECTION

| Model Number | Description | Approx. Wt. | List Price (\$US) |
|--------------|---------------------------------|-------------|-------------------|
| BGR72 | Bucket Grapple, 72" | 827 lb. | \$4,923 |
| BGR72T | Bucket Grapple, with Teeth, 72" | 907 lb. | \$5,354 |
| BGR84 | Bucket Grapple, 84" | 903 lb. | \$5,207 |
| BGR84T | Bucket Grapple, with Teeth, 84" | 993 lb. | \$5,687 |

BRGR SERIES BRUSH GRAPPLE BASE UNIT SELECTION

| Model Number | Description | Approx. Wt. | List Price (\$US) |
|--------------|--------------------|-------------|-------------------|
| BRGR72 | Brush Grapple, 72" | 702 lb. | \$4,464 |
| BRGR84 | Brush Grapple, 84" | 787 lb. | \$4,776 |

RETURN TO INDEX



PF48 SERIES PALLET FORK

| MODEL | PF48SS, PF48E, PF48JD |
|-----------------------|--|
| Over Height | 41 ³ / ₈ " |
| Overall Width | 45 ⁵ / ₁₆ " |
| Overall Depth | 60 ³ / ₈ " |
| Fork Size | 1 ¹ / ₂ " x 4" |
| Fork Length | 48" |
| Fork Adjustable Width | Up to 44 ³ / ₈ " in Increments of 4" |
| Weight | 387 lb. |
| Max. Capacity | 4,400 lb. |
| Attachment Method | Universal Skid Steer Quick Attach, Euro or John Deere |
| Color | Black |

HOW TO ORDER:

The PF48 Series Pallet Fork is priced as a complete unit. Select your desired model from the Base Unit Selection offered.

Freight NOT included in list price. Freight discount available for multiple unit orders. Please contact Customer Service for details.

BASE UNIT SELECTION

| Model Number | Description | Approx. Wt. | List Price (\$US) |
|--------------|------------------------------|-------------|-------------------|
| PF48SS | Pallet Fork, Skid Steer, 48" | 387 lb. | \$1,329 |
| PF48E | Pallet Fork, Euro, 48" | 387 lb. | \$1,388 |
| PF48JD | Pallet Fork, John Deere, 48" | 387 lb. | \$1,373 |



[RETURN TO INDEX](#)

LANDSCAPE

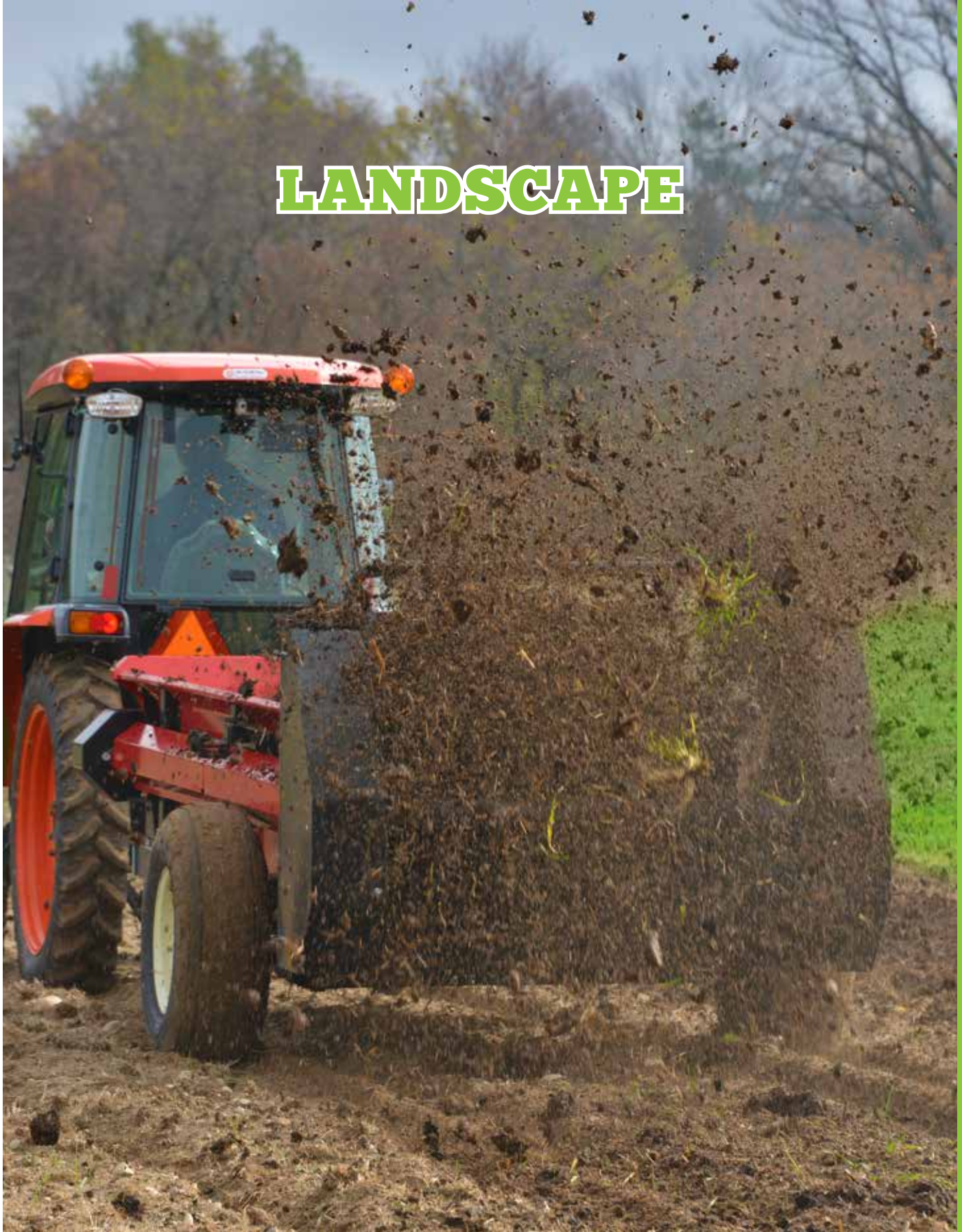

LANDSCAPE

RETURN TO INDEX



| All models are available in the colors below: | |
|---|--------------------|
| Model Color Indicator | Unit Color |
| 01 | Bush Hog Red |
| 03 | John Deere Green |
| 05 | Kubota Orange |
| 14 | New Holland Blue |
| 16 | Caterpillar Yellow |

CRB SERIES COMPACT REAR BLADE

| MODEL | CRB48 | CRB60 | CRB72 |
|--------------------|-------------------------------|-------|-------|
| Maximum Tractor HP | 24 | | |
| Hitch | ASAE Cat 1 Std & Quick Hitch | | |
| Moldboard Width | 48" | 60" | 72" |
| Moldboard Height | 12"x 1/4" | | |
| Adjustment Angles | 15° & 30° Forward and Reverse | | |

HOW TO ORDER:

The Compact Series Rear Blade is available as a lift-type implement only. It is priced as a complete unit and is shipped fully assembled. Indicate your choice of model color from the chart above.

Freight NOT included in list price. Freight discount available for multiple unit orders. Please contact Customer Service for details.

BASE UNIT SELECTION

| Model Number | Description | Approx. Wt. | List Price (\$US) |
|--------------|-------------------------------|-------------|-------------------|
| CRB48-xx | Compact Series Rear Blade, 4' | 136 lb. | \$576 |
| CRB60-xx | Compact Series Rear Blade, 5' | 150 lb. | \$614 |
| CRB72-xx | Compact Series Rear Blade, 6' | 164 lb. | \$673 |

CBX SERIES COMPACT BOX BLADE

| MODEL | CBX48 | CBX60 |
|---------------------------|---|-------|
| Maximum Tractor HP | 24 | |
| Hitch | ASAE Cat 1 Std & Quick Hitch | |
| Moldboard Width | 48" | 60" |
| Box Depth | 12" | |
| Number of Scarifier Teeth | 4 | 5 |
| Number of Blades | (2) Blades, Bolt-On Reversible Cutting Edge | |

HOW TO ORDER:

The Compact Series Box Blade is available as a lift-type implement only. It is priced as a complete unit and is shipped fully assembled.

Freight NOT included in list price. Freight discount available for multiple unit orders. Please contact Customer Service for details.

BASE UNIT SELECTION

| Model Number | Description | Approx. Wt. | List Price (\$US) |
|--------------|------------------------------|-------------|-------------------|
| CBX48-xx | Compact Series Box Blade, 4' | 248 lb. | \$921 |
| CBX60-xx | Compact Series Box Blade, 5' | 258 lb. | \$1,030 |

RETURN TO INDEX



**COMPACT SERIES
LANDSCAPE RAKE**



**COMPACT SERIES
ROAD GRADER**

| All models are available in the colors below: | |
|---|--------------------|
| Model Color Indicator | Unit Color |
| 01 | Bush Hog Red |
| 03 | John Deere Green |
| 05 | Kubota Orange |
| 14 | New Holland Blue |
| 16 | Caterpillar Yellow |

CLR SERIES COMPACT LANDSCAPE RAKE

| MODEL | CLR48 | CLR60 |
|--------------------|------------------------------|-------|
| Maximum Tractor HP | 24 | |
| Hitch | ASAE Cat 1 Std & Quick Hitch | |
| Rake Pivot | 18° & 36° | |
| Tine Spacing | 1" | |

HOW TO ORDER:

The Compact Series Landscape Rake is available as a lift-type implement only. It is priced as a complete unit and is shipped fully assembled. Indicate your choice of model color from the chart above.

Freight NOT included in list price. Freight discount available for multiple unit orders. Please contact Customer Service for details.

BASE UNIT SELECTION

| Model Number | Description | Approx. Wt. | List Price (\$US) |
|--------------|-----------------------------------|-------------|-------------------|
| CLR48-xx | Compact Series Landscape Rake, 4' | 126 lb. | \$778 |
| CLR60-xx | Compact Series Landscape Rake, 5' | 143 lb. | \$840 |

CRG SERIES COMPACT ROAD GRADER

| MODEL | CRG48 | CRG60 |
|----------------------|---|-------|
| Maximum Tractor HP | 24 | |
| Hitch | ASAE Cat 1 Std & Quick Hitch | |
| Side Panel Thickness | 3/16" | |
| Front Main Beam | 3" x 3" x 3/16" | |
| Rear Main Beam | 2" x 2" x 0.1196" | |
| Number of Blades | (2) Blades, Bolt-On Reversible Cutting Edge | |

HOW TO ORDER:

The Compact Series Road Grader is available as a lift-type implement only. It is priced as a complete unit and is shipped fully assembled. Indicate your choice of model color from the chart above.

Freight NOT included in list price. Freight discount available for multiple unit orders. Please contact Customer Service for details.

BASE UNIT SELECTION

| Model Number | Description | Approx. Wt. | List Price (\$US) |
|--------------|--------------------------------|-------------|-------------------|
| CRG48-xx | Compact Series Road Grader, 4' | 238 lb. | \$1,168 |
| CRG60-xx | Compact Series Road Grader, 5' | 297 lb. | \$1233 |

RETURN TO INDEX

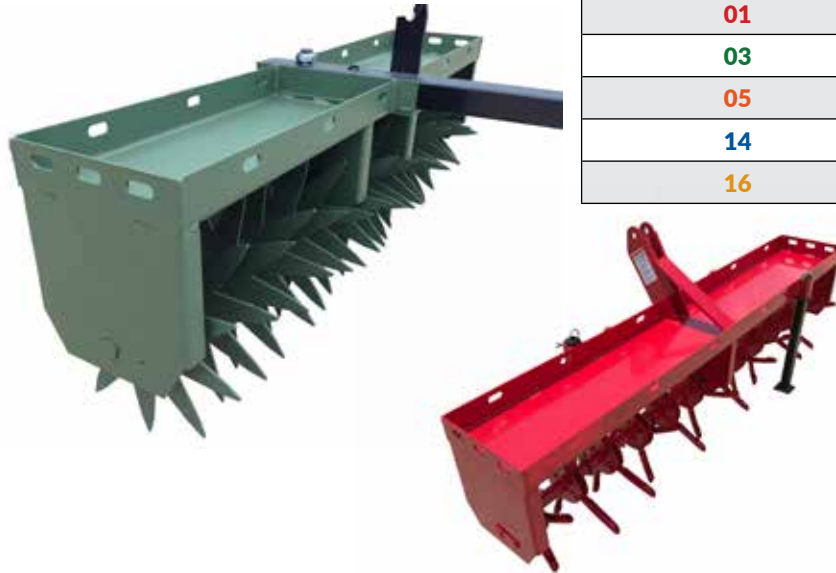

| All models are available in the colors below: | |
|---|--------------------|
| Model Color Indicator | Unit Color |
| 01 | Bush Hog Red |
| 03 | John Deere Green |
| 05 | Kubota Orange |
| 14 | New Holland Blue |
| 16 | Caterpillar Yellow |

COMPACT SERIES PLUGGER & AERATOR

| MODEL | CPG48 | CPG60 | CAR48 | CAR60 |
|-------------------------|------------------------------------|----------------------------------|------------------------------------|---------|
| Overall Width | 49 ⁷ / ₈ " | 62 ¹ / ₄ " | 49 ⁷ / ₈ " | 62 1/4" |
| Working Width | 43 ¹¹ / ₁₆ " | 56 ¹ / ₄ " | 44 ¹⁵ / ₁₆ " | 57 3/8" |
| Overall Depth | 20 ⁵ / ₈ " | 20 ⁵ / ₈ " | 20 5/8" | 20 5/8" |
| Weight | 166 lb. | 199 lb. | 166 lb. | 199 lb. |
| Number of Spoons/knives | 32 | 40 | 120 | 150 |
| Number of Hubs | 4 | 5 | 4 | 5 |
| Spoon/Knife Spacing | 6" | | 3 ¹⁵ / ₁₆ " | |
| Axle | 1 ¹ / ₄ " | | 1 ¹ / ₄ " | |
| Hitch | Cat 1 & Quick Hitch | | Cat 1 & Quick Hitch | |

HOW TO ORDER:

To receive a complete order for a Compact Plugger or Aerator, enter the correct model number and paint color code.

Freight NOT included in list price. Freight discount available for multiple unit orders. Please contact Customer Service for details.

COMPACT PLUGGER

| Model Number | Description | Approx. Wt. | List Price (\$US) |
|--------------|---------------------------------|-------------|-------------------|
| CPG48-xx | Compact Plugger, Lift Type, 48" | 166 lb. | \$1,011 |
| CPG60-xx | Compact Plugger, Lift Type, 60" | 199 lb. | \$1,257 |
| CPG72-xx | Compact Plugger, Lift Type, 72" | 219 lb. | \$1,505 |

COMPACT AERATOR

| Model Number | Description | Approx. Wt. | List Price (\$US) |
|--------------|---------------------------------|-------------|-------------------|
| CAR48-xx | Compact Aerator, Lift Type, 48" | 166 lb. | \$1,011 |
| CAR60-xx | Compact Aerator, Lift Type, 60" | 199 lb. | \$1,257 |
| CAR72-xx | Compact Aerator, Lift Type, 72" | 219 lb. | \$1,505 |

RETURN TO INDEX

| All models are available in the colors below: | |
|---|--------------------|
| Model Color Indicator | Unit Color |
| 01 | Bush Hog Red |
| 03 | John Deere Green |
| 05 | Kubota Orange |
| 14 | New Holland Blue |
| 16 | Caterpillar Yellow |

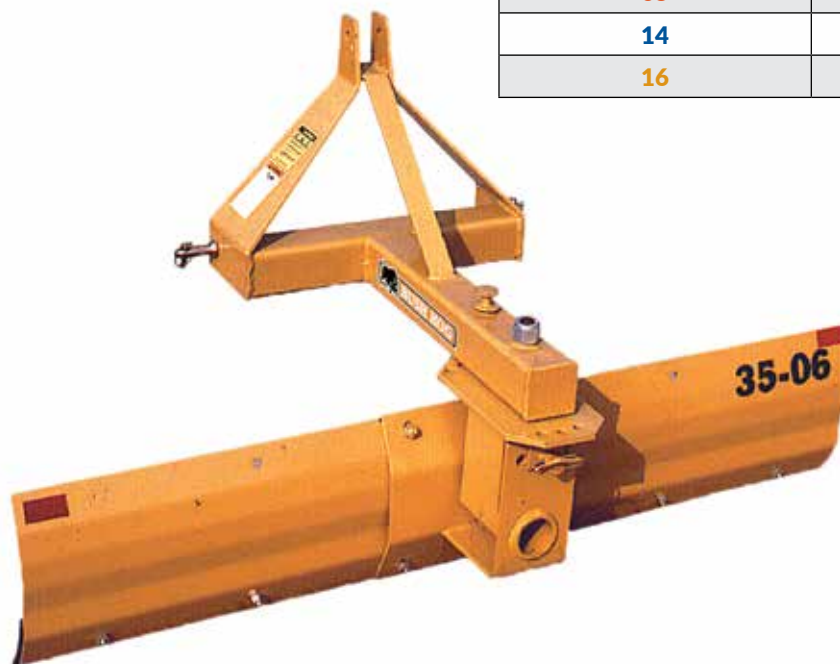

35 SERIES REAR MOUNT MEDIUM BLADE

| MODEL | 3505 | 3506 | 3507 |
|--------------------|--|------|------|
| Maximum Tractor HP | 35 (2 WD), 30 (4 WD) | | |
| Hitch | 3-Point ASAE Cat 1 & Quick Hitch | | |
| Moldboard Width | 5' | 6' | 7' |
| Moldboard Height | 14½" x 1/4" | | |
| Cutting Edge | 1/2" x 6" Reversible | | |
| King Pin Diameter | 1¼" Grade 8 | | |
| Tilt Adjustment | 15° Up or Down | | |
| Angle Adjustment | 5 Forward Positions up to 30°, 3 Reverse Positions up to 15° | | |

HOW TO ORDER:

The 35 Series Rear Mounted Blade is available as a lift-type implement only. It is priced as a complete unit and is shipped fully assembled. Indicate your choice of model color from the chart above. Additional equipment for this model is listed in the Options section below.

Freight NOT included in list price. Freight discount available for multiple unit orders. Please contact Customer Service for details.

BASE UNIT SELECTION

| Model Number | Description | Approx. Wt. | List Price (\$US) |
|--------------|-----------------------------|-------------|-------------------|
| 3505-xx | 35 Series Utility Blade, 5' | 280 lb. | \$928 |
| 3506-xx | 35 Series Utility Blade, 6' | 290 lb. | \$979 |
| 3507-xx | 35 Series Utility Blade, 7' | 325 lb. | \$1,024 |

RETURN TO INDEX



| All models are available in the colors below: | |
|---|--------------------|
| Model Color Indicator | Unit Color |
| 01 | Bush Hog Red |
| 03 | John Deere Green |
| 05 | Kubota Orange |
| 14 | New Holland Blue |
| 16 | Caterpillar Yellow |

50 SERIES REAR MOUNT MEDIUM BLADE

| MODEL | 5006 | 5007 |
|--------------------|--|------|
| Maximum Tractor HP | 50 (2 WD), 40 (4 WD) | |
| Hitch | 3-Point ASAE Cat 1 & Quick Hitch | |
| Moldboard Width | 6' | 7' |
| Moldboard Height | 16" x 5/16" | |
| Cutting Edge | 1/2" x 6" Reversible | |
| King Pin Diameter | 1 1/4" Grade 8 | |
| Tilt Adjustment | 15° Up or Down | |
| Offset Adjustment | 23" Left or Right | |
| Angle Adjustment | 5 Forward Positions up to 30°, 3 Reverse Positions up to 15° | |
| Parking Stand | Standard | |

HOW TO ORDER:

The 50 Series Rear Mounted Blade is available as a lift-type implement only. It is priced as a complete unit and is shipped fully assembled. Indicate your choice of model color from the chart above. Additional equipment for this model is listed in the Options section below.

Freight NOT included in list price. Freight discount available for multiple unit orders. Please contact Customer Service for details.

BASE UNIT SELECTION

| Model Number | Description | Approx. Wt. | List Price (\$US) |
|--------------|----------------------------|-------------|-------------------|
| 5006-xx | 50 Series Medium Blade, 6' | 390 lb. | \$1,248 |
| 5007-xx | 50 Series Medium Blade, 7' | 455 lb. | \$1,304 |

OPTIONS

| Model Number | Description | List Price (\$US) |
|--------------|---------------------------------------|-------------------|
| 50072391 | Skid Shoe Kit, 35/50/70 Series Blades | \$352 |

RETURN TO INDEX



| All models are available in the colors below: | |
|---|--------------------|
| Model Color Indicator | Unit Color |
| 01 | Bush Hog Red |
| 03 | John Deere Green |
| 05 | Kubota Orange |
| 14 | New Holland Blue |
| 16 | Caterpillar Yellow |

70 SERIES MEDIUM DUTY BLADE

| MODEL | 7006 | 7007 | 7008 |
|--------------------|---|------|------|
| Maximum Tractor HP | 70 (2 WD), 55 (4 WD) | | |
| Hitch | 3-Point ASAE Cat 1 & 2 & Quick Hitch | | |
| Moldboard Width | 6' | 7' | 8' |
| Moldboard Height | 18" x 5/16" | | |
| Cutting Edge | 1/2" x 6" Reversible | | |
| King Pin Diameter | 1 1/4" Grade 8 | | |
| Tilt Adjustment | 5 Positions up to 30° | | |
| Offset Adjustment | 18" Left or Right | | |
| Angle Adjustment | 360° Rotation, 5 Forward Positions up to 45°, 5 Reverse Positions up to 30° | | |
| Parking Stand | Standard | | |

HOW TO ORDER:

The 70 Series Rear Mounted Blade is available as a lift-type implement only. It is priced as a complete unit and is shipped fully assembled. Indicate your choice of model color from the chart above. Additional equipment for this model is listed in the Options section below.

Freight NOT included in list price. Freight discount available for multiple unit orders. Please contact Customer Service for details.

BASE UNIT SELECTION

| Model Number | Description | Approx. Wt. | List Price (\$US) |
|--------------|---------------------------------|-------------|-------------------|
| 7006-xx | 70 Series Medium Duty Blade, 6' | 510 lb. | \$1,809 |
| 7007-xx | 70 Series Medium Duty Blade, 7' | 538 lb. | \$1,910 |
| 7008-xx | 70 Series Medium Duty Blade, 6' | 572 lb. | \$2,031 |

OPTIONS

| Model Number | Description | Approx. Wt. | List Price (\$US) |
|--------------|--|-------------|-------------------|
| 50072391 | Skid Shoe Kit, 35/50/70 Series Blades | | \$352 |
| 1817 | Manual Ratchet Bundle (For Offset Function Only) | 15 lb. | \$164 |
| 50070543 | End Plate Kit, 70/91 Series Blades | | \$385 |

RETURN TO INDEX



| All models are available in the colors below: | |
|---|--------------------|
| Model Color Indicator | Unit Color |
| 01 | Bush Hog Red |
| 03 | John Deere Green |
| 05 | Kubota Orange |
| 14 | New Holland Blue |
| 16 | Caterpillar Yellow |

91 SERIES MEDIUM DUTY BLADE

| MODEL | 9107 | 9108 |
|--------------------|---|------|
| Maximum Tractor HP | 90 (2 WD), 70 (4 WD) | |
| Hitch | 3-Point ASAE Cat 1 & 2 & Cat 2 Quick Hitch | |
| Moldboard Width | 7' | 8' |
| Moldboard Height | 16" x 3/8" | |
| Cutting Edge | 1/2" x 6" Reversible | |
| King Pin Diameter | 3" | |
| Tilt Adjustment | 15° Maximum Left or Right | |
| Offset Adjustment | 20" Maximum Left or Right | |
| Angle Adjustment | 50° Maximum Left or Right, Forward or Reverse | |
| Parking Stand | Standard | |

HOW TO ORDER:

The 91 Series Rear Mounted Blade is available as a lift-type implement only. Your order must specify model number (including model color indicator from the chart above), three (3) blade adjustment selections*, and any desired additional equipment from the Options section below.

Freight NOT included in list price. Freight discount available for multiple unit orders. Please contact Customer Service for details.

BASE UNIT SELECTION

| Model Number | Description | Approx. Wt. | List Price (\$US) |
|--------------|---------------------------------|-------------|-------------------|
| 9107-xx | 91 Series Medium Duty Blade, 7' | 807 lb. | \$3,062 |
| 9108-xx | 91 Series Medium Duty Blade, 8' | 827 lb. | \$3,128 |

BLADE ADJUSTMENT SELECTION*

| Model Number | Description | Approx. Wt. | List Price (\$US) |
|--------------|----------------------------|-------------|-------------------|
| 95839 | 8" Hydraulic Cylinder Kit | 52 lb. | \$565 |
| 95838 | 16" Hydraulic Cylinder Kit | 67 lb. | \$644 |
| 89295 | 8" Pin Jack Assembly | 15 lb. | \$199 |
| 89294 | 16" Pin Jack Assembly | 37 lb. | \$240 |
| 95841 | Hose Holder Bundle | | \$95 |

*NOTE: The tilt function requires (1) 8" selection. The angle function requires (1) 16" selection, and the offset function requires (1) 16" selection. Only (1) hose holder bundle is required, regardless of the number of hydraulic functions ordered.

OPTIONS

| Model Number | Description | Approx. Wt. | List Price (\$US) |
|--------------|------------------------------------|-------------|-------------------|
| 89290 | Skid Shoes | 60 lb. | \$380 |
| 50070543 | End Plate Kit, 70/91 Series Blades | | \$385 |

RETURN TO INDEX



100 SERIES HEAVY DUTY BLADE

| MODEL | 100-08 | 100-09 |
|--------------------|---|--------|
| Maximum Tractor HP | 125 (2 WD), 80 (4 WD) | |
| Hitch | 3-Point ASAE Cat 1 & 2 & Quick Hitch | |
| Moldboard Width | 8' | 9' |
| Moldboard Height | 17" x 3/8" | |
| Cutting Edge | 1/2" x 6" | |
| King Pin Diameter | 3" | |
| Tilt Adjustment | 15° Maximum Left or Right | |
| Offset Adjustment | 20" Maximum Left or Right | |
| Angle Adjustment | 50° Maximum Left or Right, Forward or Reverse | |
| Parking Stand | Standard | |
| Hose Holder | Standard | |

HOW TO ORDER:

The 100 Series Rear Mounted Blade is available as a lift-type implement only. Your order must specify model number, three (3) blade adjustment selections*, and any desired additional equipment from the Options section below.

Freight NOT included in list price. Freight discount available for multiple unit orders. Please contact Customer Service for details.

BASE UNIT SELECTION

| Model Number | Description | Approx. Wt. | List Price (\$US) |
|--------------|---|-------------|-------------------|
| 100-08 | 100 Series Heavy Duty Blade, 8', Bush Hog Red | 836 lb. | \$3,663 |
| 100-09 | 100 Series Heavy Duty Blade, 9', Bush Hog Red | 876 lb. | \$3,790 |

BLADE ADJUSTMENT SELECTION*

| Model Number | Description | Approx. Wt. | List Price (\$US) |
|--------------|--|-------------|-------------------|
| OFFSET | 9150040400 Hydraulic Offset/Angle Blade Adjustment | 63 lb. | \$874 |
| | 00768250 Manual Offset/Angle Blade Adjustment | 38 lb. | \$325 |
| ANGLE | 9150040400 Hydraulic Offset/Angle Blade Adjustment | 63 lb. | \$874 |
| | 00768250 Manual Offset/Angle Blade Adjustment | 38 lb. | \$325 |
| TILT | 9150040004 Hydraulic Tilt Blade Adjustment | 33 lb. | \$592 |
| | 00768270 Manual Tilt Blade Adjustment | 22 lb. | \$283 |

*NOTE: Select either manual or hydraulic adjustment for each of the three functions (offset, angle and tilt).

OPTIONS

| Model Number | Description | Approx. Wt. | List Price (\$US) |
|--------------|--|-------------|-----------------------------|
| 0591240000 | End Plates | 65 lb. | \$310 |
| 0691700000 | Open Center 3-Spool Valve | | Order Through Service Parts |
| 00759684 | Valve Mounting Kit (Hose Fittings) | | Order Through Service Parts |
| 0781300000 | Selector Valve (Valve Only) | | Order Through Service Parts |
| 00768242 | Skid Shoes for 100/160/225/300 Series Blades | 30 lb. | \$401 |
| 00768321 | Gauge Wheel, Hydraulic Adjustment | 112 lb. | \$1,051 |
| 00768493 | Gauge Wheel, Ratchet Adjustment | 143 lb. | \$800 |

RETURN TO INDEX



| All models are available in the colors below: | |
|---|--------------------|
| Model Color Indicator | Unit Color |
| 01 | Bush Hog Red |
| 03 | John Deere Green |
| 05 | Kubota Orange |
| 14 | New Holland Blue |
| 16 | Caterpillar Yellow |

141 SERIES HEAVY DUTY BLADE

| MODEL | 141-08 | 141-09 |
|---------------------|--------------------------------------|--------|
| Maximum Tractor HP | 141 (2 WD), 110 (4 WD) | |
| Hitch | 3-Point ASAE Cat 2 & 3 & Quick Hitch | |
| Moldboard Width | 8' | 9' |
| Moldboard Height | 19" | |
| Cutting Edge | 1/2" x 6" | |
| King Pin Diameter | 4" | |
| Tilt Adjustment | 15° Up or Down | |
| Offset Adjustment | 35" Left or Right | |
| Angle Adjustment | 45° Left or Right | |
| Parking Stand | Standard | |
| Hose Holder (Front) | Standard | |

HOW TO ORDER:

The 141 Series Rear Mounted Blade is available as a lift-type implement only. Your order must specify model number, three (3) blade adjustment selections*, and any desired additional equipment from the Options section below.

Freight NOT included in list price. Freight discount available for multiple unit orders. Please contact Customer Service for details.

BASE UNIT SELECTION

| Model Number | Description | Approx. Wt. | List Price (\$US) |
|--------------|---|-------------|-------------------|
| 14108-xx | 141 Series Heavy Duty Blade, 8', Bush Hog Red | 1,146 lb. | \$4,804 |
| 14109-xx | 141 Series Heavy Duty Blade, 9', Bush Hog Red | 1,170 lb. | \$5,012 |

BLADE ADJUSTMENT SELECTION*

| Model Number | Description | Approx. Wt. | List Price (\$US) |
|--------------|----------------------------|-------------|-------------------|
| 95839 | 8" Hydraulic Cylinder Kit | 52 lb. | \$565 |
| 95838 | 16" Hydraulic Cylinder Kit | 67 lb. | \$644 |
| 89295 | 8" Pin Jack Assembly | 15 lb. | \$199 |
| 89294 | 16" Pin Jack Assembly | 37 lb. | \$240 |

*NOTE: The tilt function requires (1) 8" selection. The angle function requires (1) 16" selection, and the offset function requires (1) 16" selection. Only (1) hose holder bundle is required, regardless of the number of hydraulic functions ordered.

OPTIONS

| Model Number | Description | Approx. Wt. | List Price (\$US) |
|--------------|---|-------------|-------------------|
| 89290 | Skid Shoes | 60 lb. | \$380 |
| 95899 | End Plate Kit for 141/181 Series Blades | | \$571 |
| 95841 | Hose Holder Bundle | | \$95 |



RETURN TO INDEX



160 SERIES HEAVY DUTY BLADE

| MODEL | 160-08 | 160-09 | 160-10 |
|--------------------|--------------------------------------|------------------------|------------------------|
| Maximum Tractor HP | 190 (2 WD), 160 (4 WD) | 175 (2 WD), 150 (4 WD) | 160 (2 WD), 135 (4 WD) |
| Hitch | 3-Point ASAE Cat 2 & 3 & Quick Hitch | | |
| Moldboard Width | 8' | 9' | 10' |
| Moldboard Height | 18" x 1/2" | | |
| Cutting Edge | 1/2" x 6" | | |
| King Pin Diameter | 4" | | |
| Tilt Adjustment | 15° Up or Down | | |
| Offset Adjustment | 37" Left or Right | | |
| Angle Adjustment | 45° Left or Right | | |
| Parking Stand | Standard | | |
| Hose Holder | Standard | | |

HOW TO ORDER:

The 160 Series Rear Mounted Blade is available as a lift-type implement only. Your order must specify model number, three (3) blade adjustment selections*, and any desired additional equipment from the Options section below.

Freight NOT included in list price. Freight discount available for multiple unit orders. Please contact Customer Service for details.

BASE UNIT SELECTION

| Model Number | Description | Approx. Wt. | List Price (\$US) |
|--------------|--|-------------|-------------------|
| 160-08 | 160 Series Heavy Duty Blade, 8', Bush Hog Red | 1,339 lb. | \$5,305 |
| 160-09BH | 160 Series Heavy Duty Blade, 9', Bush Hog Red | 1,449 lb. | \$5,432 |
| 160-10 | 160 Series Heavy Duty Blade, 10', Bush Hog Red | 1,459 lb. | \$5,555 |

BLADE ADJUSTMENT SELECTION*

| | | | | |
|--------|------------|---|--------|-------|
| OFFSET | 9150040400 | Hydraulic Offset/Angle Blade Adjustment | 63 lb. | \$874 |
| | B69115A | Manual Offset/Angle Blade Adjustment | 45 lb. | \$342 |
| ANGLE | 9150040400 | Hydraulic Offset/Angle Blade Adjustment | 63 lb. | \$874 |
| | B69115A | Manual Offset/Angle Blade Adjustment | 45 lb. | \$342 |
| TILT | 9150040004 | Hydraulic Tilt Blade Adjustment | 33 lb. | \$592 |
| | B69116B | Manual Tilt Blade Adjustment | 28 lb. | \$342 |

*NOTE: Select either manual or hydraulic adjustment for each of the three functions (offset, angle and tilt).

OPTIONS

| | | | |
|------------|--|-----------------------------|---------|
| 9150052411 | Dual Gauge Wheel, Hydraulic Adjustment | 354 lb. | \$1,850 |
| 0691700000 | Open Center 3-Spool Valve | Order Through Service Parts | |
| 00759684 | Valve Mounting Kit (Hose Fittings) | Order Through Service Parts | |
| 0781300000 | Selector Valve (Valve Only) | Order Through Service Parts | |
| 00768242 | Skid Shoes for 100/160/225/300 Series Blades | 30 lb. | \$401 |
| 0691360000 | End Plates for 160/225/300 Series Blades | 58 lb. | \$379 |

RETURN TO INDEX



| All models are available in the colors below: | |
|---|--------------------|
| Model Color Indicator | Unit Color |
| 01 | Bush Hog Red |
| 03 | John Deere Green |
| 05 | Kubota Orange |
| 14 | New Holland Blue |
| 16 | Caterpillar Yellow |

181 SERIES HEAVY DUTY BLADE

| MODEL | 181-09 | 181-10 |
|---------------------|--------------------------------------|--------|
| Maximum Tractor HP | 180 (2 WD), 140 (4 WD) | |
| Hitch | 3-Point ASAE Cat 2 & 3 & Quick Hitch | |
| Moldboard Width | 9' | 10' |
| Moldboard Height | 18" x 1/2" | |
| Cutting Edge | 1/2" x 6" | |
| King Pin Diameter | 5" | |
| Tilt Adjustment | 15° Up or Down | |
| Offset Adjustment | 37" Left or Right | |
| Angle Adjustment | 45° Left or Right | |
| Parking Stand | Standard | |
| Hose Holder (Front) | Standard | |

HOW TO ORDER:

The 181 Series Rear Mounted Blade is available as a lift-type implement only. Your order must specify model number, three (3) blade adjustment selections, and any desired additional equipment from the Options section below.

Freight NOT included in list price. Freight discount available for multiple unit orders. Please contact Customer Service for details.

BASE UNIT SELECTION

| Model Number | Description | Approx. Wt. | List Price (\$US) |
|--------------|--|-------------|-------------------|
| 18109-xx | 181 Series Heavy Duty Blade, 9', Bush Hog Red | 1,589 lb. | \$7,829 |
| 18110-xx | 181 Series Heavy Duty Blade, 10', Bush Hog Red | 1,613 lb. | \$7,910 |

BLADE ADJUSTMENT SELECTION*

| Model Number | Description | Approx. Wt. | List Price (\$US) |
|--------------|----------------------------|-------------|-------------------|
| 95839 | 8" Hydraulic Cylinder Kit | 52 lb. | \$565 |
| 95838 | 16" Hydraulic Cylinder Kit | 67 lb. | \$644 |
| 89295 | 8" Pin Jack Assembly | 15 lb. | \$199 |
| 89294 | 16" Pin Jack Assembly | 37 lb. | \$240 |

OPTIONS

| Model Number | Description | Approx. Wt. | List Price (\$US) |
|--------------|---|-------------|-------------------|
| 89290 | Skid Shoes | 60 lb. | \$380 |
| 95899 | End Plate Kit for 141/181 Series Blades | | \$571 |
| 95841 | Hose Holder Bundle | | \$95 |

RETURN TO INDEX



225/300 SERIES HEAVY DUTY BLADE

| MODEL | 225-08 | 225-10 | 225-12 | 300-12 | 300-14 |
|------------------------------------|---------------------------------|---------|---------|---------------------------------|--------|
| Max. Tractor Draw Bar HP (2WD/4WD) | 250/225 | 225/200 | 175/160 | NA/300 | NA/250 |
| Hitch | 3-Point Cat 2 & 3 & Quick Hitch | | | 3-Point Cat 3 & 4 & Quick Hitch | |
| Moldboard Width | 8' | 10' | 12' | 12' | 14' |
| Moldboard Height | 20" x 1/2" | | | | |
| Cutting Edge | 1/2" x 6" | | | | |
| King Pin Diameter | 4 1/2" | | | 5" | |
| Tilt Adjustment (Hydraulic Only) | 15° Up or Down | | | | |
| Offset Adjustment (Hydraulic Only) | 46" Left or Right | | | 50' Left or Right | |
| Angle Adjustment (Hydraulic Only) | 45° Left or Right | | | | |
| Parking Stand | Standard | | | | |
| Hose Holder | Standard | | | | |

HOW TO ORDER:

The 225 and 300 Series Rear Mounted Blades are available as a lift-type implement only. Each model is priced as a complete unit with all hydraulics included. Your order must specify model number. Any desired additional equipment may be ordered from the Options section below.

Freight NOT included in list price. Freight discount available for multiple unit orders. Please contact Customer Service for details.

BASE UNIT SELECTION

| Model Number | Description | Approx. Wt. | List Price (\$US) |
|--------------|--|-------------|-------------------|
| 225-08 | 225 Series Heavy Duty Blade, 8', Complete, with All Hydraulics Included, Bush Hog Red | 2,120 lb. | \$10,618 |
| 225-10 | 225 Series Heavy Duty Blade, 10', Complete, with All Hydraulics Included, Bush Hog Red | 2,260 lb. | \$10,907 |
| 225-12 | 225 Series Heavy Duty Blade, 12', Complete, with All Hydraulics Included, Bush Hog Red | 2,400 lb. | \$11,333 |
| 300-12 | 300 Series Heavy Duty Blade, 12', Complete, with All Hydraulics Included, Bush Hog Red | 3,463 lb. | \$17,244 |
| 300-14 | 300 Series Heavy Duty Blade, 14', Complete, with All Hydraulics Included, Bush Hog Red | 3,603 lb. | \$17,671 |

OPTIONS

| | | | |
|------------|--|---------|-----------------------------|
| 00761806 | Dual Gauge Wheel, Hydraulic Adjustment | 421 lb. | \$2,239 |
| 0691700000 | Open Center 3-Spool Valve | | Order Through Service Parts |
| 00759684 | Valve Mounting Kit (Hose Fittings) | | Order Through Service Parts |
| 0781300000 | Selector Valve (Valve Only) | | Order Through Service Parts |
| 00768242 | Skid Shoes for 100/160/225/300 Series Blades | 30 lb. | \$401 |
| 0691360000 | End Plates for 160/225/300 Series Blades | 58 lb. | \$379 |



RETURN TO INDEX

| All models are available in the colors below: | |
|---|--------------------|
| Model Color Indicator | Unit Color |
| 01 | Bush Hog Red |
| 03 | John Deere Green |
| 05 | Kubota Orange |
| 14 | New Holland Blue |
| 16 | Caterpillar Yellow |

LLR SERIES ECONOMY LANDSCAPE RAKE

| MODEL | LLR60 | LLR72 | LLR84 |
|----------------|--|-------|-------|
| Rake Width | 60" | 72" | 84" |
| Rake Height | 15" | | |
| Hitch | ASAE Cat 1 & Quick Hitch | | |
| Tractor HP | 35 Maximum | | |
| Rake Pivot | 5 Forward Positions, Up to 30°; 3 Reverse Positions, Up to 15° | | |
| Pivot King Pin | 1¼" | | |
| Tine Spacing | 1" | | |
| Tine Material | High Carbon Spring Steel | | |
| Tine Size | 5/16" x 1" | | |

HOW TO ORDER:

The LLR Series Landscape Rake is available as a lift-type implement only. It is priced as a complete unit and is shipped fully assembled. Indicate your choice of model color from the chart above. If desired, an optional Gauge Wheel Kit may be selected from the Options section below.

Freight NOT included in list price. Freight discount available for multiple unit orders. Please contact Customer Service for details.

BASE UNIT SELECTION

| Model Number | Description | Approx. Wt. | Color | List Price (\$US) |
|--------------|---------------------------------|-------------|-----------------|-------------------|
| LLR60-xx | LLR Economy Landscape Rake, 60" | 205 lb. | See Table Above | \$1,003 |
| LLR72-xx | LLR Economy Landscape Rake, 72" | 225 lb. | See Table Above | \$1,083 |
| LLR84-xx | LLR Economy Landscape Rake, 84" | 245 lb. | See Table Above | \$1,243 |

MLR SERIES MEDIUM DUTY LANDSCAPE RAKE

| MODEL | MLR72 | MLR84 | MLR96 |
|----------------|--|-------|-------|
| Rake Width | 70" | 84" | 96" |
| Rake Height | 15" | | |
| Hitch | ASAE Cat 1 & Quick Hitch | | |
| Tractor HP | 50 Maximum | | |
| Rake Pivot | 5 Forward Positions, Up to 30°; 3 Reverse Positions, Up to 15° | | |
| Pivot King Pin | 1¼" | | |
| Tine Spacing | 1" | | |
| Tine Material | High Carbon Spring Steel | | |
| Tine Size | 5/16" x 1" | | |

HOW TO ORDER:

The MLR Series Landscape Rake is available as a lift-type implement only. It is priced as a complete unit and is shipped fully assembled. Indicate your choice of model color from the chart above. If desired, an optional Gauge Wheel Kit may be selected from the Options section below.

Freight NOT included in list price. Freight discount available for multiple unit orders. Please contact Customer Service for details.

BASE UNIT SELECTION

| Model Number | Description | Approx. Wt. | Color | List Price (\$US) |
|--------------|-------------------------------------|-------------|-----------------|-------------------|
| MLR72-xx | MLR Medium Duty Landscape Rake, 72" | 325 lb. | See Table Above | \$1,441 |
| MLR84-xx | MLR Medium Duty Landscape Rake, 84" | 345 lb. | See Table Above | \$1,535 |
| MLR96-xx | MLR Medium Duty Landscape Rake, 96" | 365 lb. | See Table Above | \$1,762 |

OPTIONS

| | | | | |
|----------|-----------------|--------|-----------------|--------------|
| 50047898 | Gauge Wheel Kit | 20 lb. | See Table Above | \$354 |
|----------|-----------------|--------|-----------------|--------------|

[RETURN TO INDEX](#)



| All models are available in the colors below: | |
|---|--------------------|
| Model Color Indicator | Unit Color |
| 01 | Bush Hog Red |
| 03 | John Deere Green |
| 05 | Kubota Orange |
| 14 | New Holland Blue |
| 16 | Caterpillar Yellow |

BBX SERIES BOX BLADE

| MODEL | BBX48 | BBX60 | BBX65 | BBX72 |
|---------------------------|--|-------|-------|-------|
| Working Width | 48" | 60" | 65" | 72" |
| Moldboard Height | 15 ⁵ / ₈ " | | | |
| Box Depth | 22" | | | |
| Overall Depth | 27" | | | |
| Overall Height | 33" | | | |
| Overall Width | 49" | 61" | 66" | 73" |
| Side Sheet Thickness | 1/4" | | | |
| Scarifier Size | 5/8" x 2 ¹ / ₂ " | | | |
| Number of Scarifier Teeth | 4 | | 5 | |
| Hitch | ASAE Cat 1 & Quick Hitch | | | |
| Lower Hitch | Single Lug | | | |
| Cutting Edge | 1/2" x 6" (Reversible) | | | |
| Number of Blades | 2 | | | |
| Maximum HP Requirement | 40 (2WD), 30 (4WD) | | | |
| A-Frame | Bolt-On | | | |

HOW TO ORDER:

The BBX Series Box Blade is available as a lift-type implement only. It is priced as a complete unit and is shipped fully assembled. Indicate your choice of model color from the chart above.

Freight NOT included in list price. Freight discount available for multiple unit orders. Please contact Customer Service for details.

BASE UNIT SELECTION

| Model Number | Description | Approx. Wt. | Color | List Price (\$US) |
|--------------|---|-------------|-----------------|-------------------|
| BBX48-xx | BBX Series Box Blade, 4 Scarifiers, 48" | 260 lb. | See Table Above | \$989 |
| BBX60-xx | BBX Series Box Blade, 4 Scarifiers, 60" | 325 lb. | See Table Above | \$1,082 |
| BBX65-xx | BBX Series Box Blade, 5 Scarifiers, 65" | 375 lb. | See Table Above | \$1,101 |
| BBX72-xx | BBX Series Box Blade, 5 Scarifiers, 72" | 390 lb. | See Table Above | \$1,122 |

RETURN TO INDEX



| All models are available in the colors below: | |
|---|--------------------|
| Model Color Indicator | Unit Color |
| 01 | Bush Hog Red |
| 03 | John Deere Green |
| 05 | Kubota Orange |
| 14 | New Holland Blue |
| 16 | Caterpillar Yellow |

SBX SERIES BOX BLADE

| MODEL | SBX48 | SBX60 | SBX65 | SBX72 | SBX78 | SBX84 |
|---------------------------|--------------------------|-------|-------|-------|-------|-------|
| Working Width | 48" | 60" | 65" | 72" | 78" | 84" |
| Moldboard Height | 18" | | | | | |
| Box Depth | 24" | | | | | |
| Overall Depth | 29" | | | | | |
| Overall Height | 35¼" | | | | | |
| Overall Width | 49" | 61" | 66" | 73" | 78" | 85" |
| Side Sheet Thickness | 3/8" | | | | | |
| Scarifier Size | 3/4" x 2½" | | | | | |
| Number of Scarifier Teeth | 4 | 5 | | 6 | | |
| Hitch | ASAE Cat 1 & Quick Hitch | | | | | |
| Lower Hitch | Double Lug | | | | | |
| Cutting Edge | 1/2" x 6" (Reversible) | | | | | |
| Number of Blades | 2 | | | | | |
| Maximum HP Requirement | 50 (2WD), 45 (4WD) | | | | | |

HOW TO ORDER:

The SBX Series Box Blade is available as a lift-type implement only. It is priced as a complete unit and is shipped fully assembled. Indicate your choice of model color from the chart above.

Freight NOT included in list price. Freight discount available for multiple unit orders. Please contact Customer Service for details.

BASE UNIT SELECTION

| Model Number | Description | Approx. Wt. | Color | List Price (\$US) |
|--------------|---|-------------|-----------------|-------------------|
| SBX48-xx | SBX Series Box Blade, 4 Scarifiers, 48" | 430 lb. | See Table Above | \$1,108 |
| SBX60-xx | SBX Series Box Blade, 5 Scarifiers, 60" | 490 lb. | See Table Above | \$1,249 |
| SBX65-xx | SBX Series Box Blade, 5 Scarifiers, 65" | 510 lb. | See Table Above | \$1,324 |
| SBX72-xx | SBX Series Box Blade, 6 Scarifiers, 72" | 550 lb. | See Table Above | \$1,385 |
| SBX78-xx | SBX Series Box Blade, 6 Scarifiers, 78" | 580 lb. | See Table Above | \$1,478 |
| SBX84-xx | SBX Series Box Blade, 6 Scarifiers, 84" | 610 lb. | See Table Above | \$1,592 |

[RETURN TO INDEX](#)



| All models are available in the colors below: | |
|---|--------------------|
| Model Color Indicator | Unit Color |
| 01 | Bush Hog Red |
| 03 | John Deere Green |
| 05 | Kubota Orange |
| 14 | New Holland Blue |
| 16 | Caterpillar Yellow |

MBX SERIES BOX BLADE

| MODEL | MBX60 | MBX72 | MBX84 | MBX96 |
|---------------------------|------------------------------|-------|-------|-------|
| Working Width | 60" | 72" | 84" | 96" |
| Moldboard Height | 18" | | | |
| Box Depth | 24" | | | |
| Overall Depth | 29" | | | |
| Overall Height | 35 ¼" | | | |
| Overall Width | 61" | 73" | 85" | 97" |
| Swinging Tailgate | Yes | | | |
| Side Sheet Thickness | 3/8" | | | |
| Scarifier Size | 3/4" x 2 ½" | | | |
| Number of Scarifier Teeth | 5 | 6 | | |
| Hitch | ASAE Cat 1 & 2 & Quick Hitch | | | |
| Lower Hitch | Triple Lug | | | |
| Cutting Edge | 1/2" x 6" (Reversible) | | | |
| Number of Blades | 2 | | | |
| Maximum HP Requirement | 65 (2WD), 55 (4WD) | | | |

HOW TO ORDER:

The MBX Series Box Blade is available as a lift-type implement only. It is priced as a complete unit and is shipped fully assembled. Indicate your choice of model color from the chart above.

Freight NOT included in list price. Freight discount available for multiple unit orders. Please contact Customer Service for details.

BASE UNIT SELECTION

| Model Number | Description | Approx. Wt. | Color | List Price (\$US) |
|--------------|---|-------------|-----------------|-------------------|
| MBX60-xx | MBX Series Box Blade, 5 Scarifiers, 60" | 580 lb. | See Table Above | \$1,493 |
| MBX72-xx | MBX Series Box Blade, 6 Scarifiers, 72" | 640 lb. | See Table Above | \$1,767 |
| MBX84-xx | MBX Series Box Blade, 6 Scarifiers, 84" | 710 lb. | See Table Above | \$2,071 |
| MBX96-xx | MBX Series Box Blade, 6 Scarifiers, 96" | 790 lb. | See Table Above | \$2,327 |

[RETURN TO INDEX](#)



RBX SERIES



RO SERIES

RBX SERIES RETRACTABLE SHANK BOX BLADE

| MODEL | RBX720 | RBX780 | RBX840 |
|------------------------|------------------------------------|--------|--------|
| Working Width | 72" | 65" | 84" |
| Number of Scarifiers | 6 | 5 | |
| Cutting Edge | Reversible 1/2" x 6", Heat Treated | | |
| Points & Shanks | Replaceable | | |
| Hitch | ASAE Cat 1 & 2, Quick Hitch | | |
| Maximum HP Requirement | 65 (2WD), 55 (4WD) | | |

HOW TO ORDER:

The RBX Series Box Blade is available as a lift-type implement only. It is priced as a complete unit and is shipped fully assembled. Indicate your choice of model from the Base Unit Selection below.

Freight NOT included in list price. Freight discount available for multiple unit orders. Please contact Customer Service for details.

BASE UNIT SELECTION

| Model Number | Description | Approx. Wt. | Color | List Price (\$US) |
|--------------|---|-------------|--------------------|-------------------|
| RBX720 | RBX Series Retractable Shank Box Blade, 72" | 829 lb. | Caterpillar Yellow | \$3,716 |
| RBX780 | RBX Series Retractable Shank Box Blade, 78" | 890 lb. | Caterpillar Yellow | \$4,006 |
| RBX840 | RBX Series Retractable Shank Box Blade, 84" | 957 lb. | Caterpillar Yellow | \$4,286 |

RO SERIES ROLL-OVER BOX BLADE

| MODEL | RO-600 | RO-650 | RO-720 | RO-840 |
|------------------------|------------------------------------|--------|--------|--------|
| Working Width | 60" | 65" | 72" | 84" |
| Number of Scarifiers | 5 | | 6 | |
| Cutting Edge | Reversible 1/2" x 6", Heat Treated | | | |
| Points & Shanks | Replaceable | | | |
| Hitch | ASAE Cat 1 & Quick Hitch | | | |
| Maximum HP Requirement | 60 (2WD), 55 (4WD) | | | |

HOW TO ORDER:

The RO Series Box Blade is available as a lift-type implement only. It is priced as a complete unit and is shipped fully assembled, with the exception of the handle. Indicate your choice of model from the Base Unit Selection below.

Freight NOT included in list price. Freight discount available for multiple unit orders. Please contact Customer Service for details.

BASE UNIT SELECTION

| Model Number | Description | Approx. Wt. | Color | List Price (\$US) |
|--------------|------------------------------------|-------------|--------------------|-------------------|
| RO-600 | RO Series Roll-Over Box Blade, 60" | 630 lb. | Caterpillar Yellow | \$2,590 |
| RO-650 | RO Series Roll-Over Box Blade, 65" | 680 lb. | Caterpillar Yellow | \$2,814 |
| RO-720 | RO Series Roll-Over Box Blade, 72" | 710 lb. | Caterpillar Yellow | \$3,008 |
| RO-840 | RO Series Roll-Over Box Blade, 84" | 780 lb. | Caterpillar Yellow | \$3,441 |

RETURN TO INDEX

| All models are available in the colors below: | |
|---|--------------------|
| Model Color Indicator | Unit Color |
| 01 | Bush Hog Red |
| 03 | John Deere Green |
| 05 | Kubota Orange |
| 14 | New Holland Blue |
| 16 | Caterpillar Yellow |



RG SERIES ROAD GRADER

| MODEL | RG60 | RG72 | RG84 |
|------------------------------|---|-------|-------|
| Hitch | Cat 1 Std & Quick Hitch | | |
| Recommended HP | 50 (2WD), 40 (FWA) | | |
| Working Width | 60" | 72" | 84" |
| Side Panel Thickness | 3/16" | 3/16" | 3/16" |
| Front Main Beam Construction | 4" x 4" x 5/16" Wall | | |
| Rear Beam Construction | 2½" x 2½" x 3/16" Wall | | |
| Skid Shoe Construction | 3/8" x 2½" x 3/16" Long | | |
| Scarifier Shanks | Three-Position Shanks with Dimpled-On Hardened Tips | | |
| Number of Scarifier Shanks | 4 | 6 | 8 |
| Cutting Edges | (Two) 1/2" x 6" Bolt-On, Replaceable and Reversible Heat-Treated Blades | | |

HOW TO ORDER:

The RG Series Road Grader is available as a lift-type implement only. It is priced as a complete unit and is shipped fully assembled. Indicate your choice of model color from the chart above.

Freight NOT included in list price. Freight discount available for multiple unit orders. Please contact Customer Service for details.

BASE UNIT SELECTION

| Model Number | Description | Approx. Wt. | Color | List Price (\$US) |
|--------------|----------------------------|-------------|-----------------|-------------------|
| RG60-xx | RG Series Road Grader, 60" | 500 lb. | See Table Above | \$1,776 |
| RG72-xx | RG Series Road Grader, 72" | 571 lb. | See Table Above | \$1,925 |
| RG84-xx | RG Series Road Grader, 84" | 642 lb. | See Table Above | \$2,069 |

OPTIONS

| Model Number | Description | List Price (\$US) |
|--------------|---|-------------------|
| DEDUCT4SHANK | Deduct (4) Shanks, RG 60 Models | -\$94 |
| DEDUCT6SHANK | Deduct (6) Shanks, RG72 and RG84 Models | -\$137 |

RETURN TO INDEX

| All models are available in the colors below: | |
|---|--------------------|
| Model Color Indicator | Unit Color |
| 01 | Bush Hog Red |
| 03 | John Deere Green |
| 05 | Kubota Orange |
| 14 | New Holland Blue |
| 16 | Caterpillar Yellow |



HDRG SERIES HEAVY DUTY ROAD GRADER

| MODEL | HDRG84 | HDRG96 |
|------------------------------|--|--------------------|
| Hitch | 3-Point Cat 1 & 2 | |
| Maximum Recommended HP | 90 (2WD), 70 (4WD) | 90 (2WD), 70 (4WD) |
| Working Width | 84" | 96" |
| Side Panel Thickness | 3/16" | 3/16" |
| Front Main Beam Construction | 4" x 4" x 3/8" | |
| Rear Beam Construction | 4" x 4" x 1/4" | |
| Skid Shoe Construction | 1/2" x 2 1/2" | |
| Scarifier Shanks | Four Position Shanks with Hardened Tips | |
| Number of Scarifier Shanks | 6 | 8 |
| Cutting Edges | 1/2" x 6" Bolt on Replaceable & Reversible Heat Treated Blades | |

HOW TO ORDER:

The HDRG Series Road Grader is available as a lift-type implement only. It is priced as a complete unit and is shipped fully assembled. Indicate your choice of model color from the chart above.

Freight NOT included in list price. Freight discount available for multiple unit orders. Please contact Customer Service for details.

BASE UNIT SELECTION

| Model Number | Description | Approx. Wt. | Color | List Price (\$US) |
|--------------|-----------------------------|-------------|-----------------|-------------------|
| HDRG84-xx | Heavy Duty Road Grader, 84" | 750 lb. | See Table Above | \$2,574 |
| HDRG96-xx | Heavy Duty Road Grader, 96" | 828 lb. | See Table Above | \$2,989 |

RETURN TO INDEX



SINGLE ROLL



DOUBLE ROLL

PV SERIES PULVERIZER

| MODEL | PVB (Bar Shank) Series | PVS (Spike Shank) Series |
|-----------------------------------|------------------------------------|--------------------------|
| A-Frame | Heavy Duty Solid | |
| Hitch | ASAE Cat 1 Heavy Duty Double Strap | |
| Shank | Bar, Reversible | Spike, Non-Reversible |
| Working Width | 60" - 84" | |
| Roller Bearing | 1" | |
| Rear Roller | Hinged | |
| Number of Rollers | (1) Single Roll, (2) Double Roll | |
| Independent Spring Tension | Yes | |
| Spikes on Roller | No | 1¼" |
| Maximum Tractor HP | 60 PTO | |
| One-Year Limited Warranty. | | |

HOW TO ORDER: The PV Series Pulverizer is available as a lift-type implement only. It is priced as a complete unit and is shipped fully assembled. Select the desired model from the ordering section below.

Freight NOT included in list price. Freight discount available for multiple unit orders. Please contact Customer Service for details.

SINGLE ROLL PULVERIZER – BASE UNIT SELECTION

| Model Number | Description | Approx. Wt. | List Price (\$US) |
|--------------|---|-------------|-------------------|
| PVB-600 | PVB Series Single Roller Pulverizer, Bar Shank, 60", Caterpillar Yellow | 530 lb. | \$2,010 |
| PVB-660 | PVB Series Single Roller Pulverizer, Bar Shank, 66", Caterpillar Yellow | 560 lb. | \$2,197 |
| PVB-720 | PVB Series Single Roller Pulverizer, Bar Shank, 72", Caterpillar Yellow | 590 lb. | \$2,403 |
| PVB-840 | PVB Series Single Roller Pulverizer, Bar Shank, 84", Caterpillar Yellow | 650 lb. | \$2,865 |
| PVS-600 | PVS Series Single Roller Pulverizer, Spike Shank, 60", Caterpillar Yellow | 530 lb. | \$2,010 |
| PVS-660 | PVS Series Single Roller Pulverizer, Spike Shank, 66", Caterpillar Yellow | 560 lb. | \$2,197 |
| PVS-720 | PVS Series Single Roller Pulverizer, Spike Shank, 72", Caterpillar Yellow | 590 lb. | \$2,404 |
| PVS-840 | PVS Series Single Roller Pulverizer, Spike Shank, 84", Caterpillar Yellow | 650 lb. | \$2,866 |

DOUBLE ROLL PULVERIZER – BASE UNIT SELECTION

| Model Number | Description | Approx. Wt. | List Price (\$US) |
|--------------|---|-------------|-------------------|
| PVB-602 | PVB Series Double Roller Pulverizer, Bar Shank, 60", Caterpillar Yellow | 640 lb. | \$2,538 |
| PVB-662 | PVB Series Double Roller Pulverizer, Bar Shank, 66", Caterpillar Yellow | 680 lb. | \$2,738 |
| PVB-722 | PVB Series Double Roller Pulverizer, Bar Shank, 72", Caterpillar Yellow | 720 lb. | \$3,099 |
| PVB-842 | PVB Series Double Roller Pulverizer, Bar Shank, 84", Caterpillar Yellow | 790 lb. | \$3,630 |
| PVS-602 | PVS Series Double Roller Pulverizer, Spike Shank, 60", Caterpillar Yellow | 640 lb. | \$2,538 |
| PVS-662 | PVS Series Double Roller Pulverizer, Spike Shank, 66", Caterpillar Yellow | 680 lb. | \$2,736 |
| PVS-722 | PVS Series Double Roller Pulverizer, Spike Shank, 72", Caterpillar Yellow | 720 lb. | \$3,097 |
| PVS-842 | PVS Series Double Roller Pulverizer, Spike Shank, 84", Caterpillar Yellow | 790 lb. | \$3,630 |

RETURN TO INDEX



PG & MPG SERIES PLUGGERS | CORE-TYPE & SLICING AERATORS

| MODEL | PG-600 | PG-720 | MPG-600 | MPG-720 |
|-----------------------------------|-------------------------------------|--------|---------|---------|
| Working Width | 60" | 72" | 60" | 72" |
| Shaft | 1 1/4" | | | |
| Sleeves | Greaseable | | | |
| Spoons | 3/4" Hard Spoons With Closed Design | | | |
| Number of Hubs | 8 | 10 | 12 | |
| Number of Spoons | 64 | 80 | 96 | |
| Number of Slicing Knives | 32 | 40 | 48 | |
| Weight Box | Heavy Duty Steel Weight Rack | | | |
| Hitch | (Lift) ASAE Cat 1 Std & Quick Hitch | | | |
| Maximum Tractor HP | 60 (PTO) | | | |
| One-Year Limited Warranty. | | | | |

| | |
|----------------------|---|
| HOW TO ORDER: | The Plugger Series Core Type Aerator is available as a lift-type implement only. It is priced as a complete unit and is shipped fully assembled. Select the desired model from the ordering section below. Optional Slicing Knife, available for all models, may be selected from the Options list. |
|----------------------|---|

Freight NOT included in list price. Freight discount available for multiple unit orders. Please contact Customer Service for details.

PG SERIES PLUGGER – BASE UNIT SELECTION

| Model Number | Description | Approx. Wt. | List Price (\$US) |
|--------------|--|-------------|-------------------|
| PG-600 | PG Series Plugger, 8 Hubs, 64 Spoons, 60", Caterpillar Yellow | 350 lb. | \$3,571 |
| PG-720 | PG Series Plugger, 10 Hubs, 80 Spoons, 72", Caterpillar Yellow | 390 lb. | \$4,048 |

MPG SERIES PLUGGER – BASE UNIT SELECTION

| Model Number | Description | Approx. Wt. | List Price (\$US) |
|--------------|---|-------------|-------------------|
| MPG-600 | MPG Series Plugger, 10 Hubs, 80 Spoons, 60", Caterpillar Yellow | 460 lb. | \$3,733 |
| MPG-720 | MPG Series Plugger, 12 Hubs, 96 Spoons, 72", Caterpillar Yellow | 500 lb. | \$4,265 |

OPTIONS

| Model Number | Description | List Price (\$US) |
|--------------|--|-------------------|
| 95159 | Slicing Knives (To receive a complete unit with Slicing Knives instead of Spoons, add Part Number 95159 to your order) | \$29 |



RETURN TO INDEX



FSP SERIES FERTILIZER SPREADER

| MODEL | FSP-500 | FSP-800 |
|-------------------|-------------------------------|---------|
| Hitch | 3-Pt ASAE Cat 1 (Not QH) | |
| Hopper | Polyethylene | |
| Hopper Capacity | 500 lb. | 800 lb. |
| Distribution Fins | Electroplated | |
| Distribution | Spin | |
| Frame | Heavy Tube, Powder Coat Paint | |
| PTO Speed | 540 | |
| Spread Swath | Approx. 49' | |

HOW TO ORDER:

The FSP Series Fertilizer Spreader is priced as a complete unit. These units are available in multiples of two (2) only.

Freight NOT included in list price. Freight discount available for multiple unit orders. Please contact Customer Service for details.

BASE UNIT SELECTION

| Model Number | Description | Approx. Wt. | List Price (\$US) |
|--------------|---|-------------|-------------------|
| FSP-500 | FSP Series Fertilizer Spreader, 3-Pt Hitch, 500 lb. Hopper Capacity | 123 lb. | each \$853 |
| FSP-800 | FSP Series Fertilizer Spreader, 3-Pt Hitch, 800 lb. Hopper Capacity | 128 lb. | each \$914 |

NOTE: Must be ordered in multiples of two (Models can be mixed).



RETURN TO INDEX



| All models are available in the colors below: | |
|---|------------------|
| Model Color Indicator | Unit Color |
| 01 | Bush Hog Red |
| 03 | John Deere Green |
| 05 | Kubota Orange |
| 14 | New Holland Blue |
| 34 | Grey |

***** THIS PRODUCT IS PRICED AT LIST LESS 25% *****

MANURE SPREADER

HOW TO ORDER:

Select a model number and be sure to add a color code to the end.

Freight NOT included in list price. Freight discount available for multiple unit orders. Please contact Customer Service for details.

BASE UNIT SELECTION

** Please use Model Color Indicator behind product model number (ex. MS500G-03)

| Model Number | Description | List Price (\$US) |
|--------------------------------------|---|-------------------|
| GROUND DRIVE MANURE SPREADERS | | |
| MS250G | 25 Bushel capacity, ground drive, 3 speed apron drive, poly floor, full length frame, no jack | \$4,347 |
| MS500G | 50 bushel capacity, ground drive, 3 speed apron drive, poly floor, full length frame, with jack stand | \$6,286 |
| MS800G | 80 bushel capacity, ground drive, 3 speed apron drive, poly floor, full length frame, with jack stand | \$6,892 |
| PTO DRIVE MANURE SPREADERS | | |
| MS500P | 50 bushel capacity, PTO drive, 3 speed apron drive, poly floor, full length frame, with jack stand | \$6,286 |
| MS800P | 80 bushel capacity, PTO drive, 3 speed apron drive, poly floor, full length frame, with jack stand | \$6,892 |
| MS1300P | 130 bushel capacity, PTO drive, 2 speed apron drive, plus clean out speed, Tires-11L-15 SL/6 | \$15,386 |
| MS1300X | 130 bushel capacity, PTO drive, 2 speed apron drive, plus clean out speed, T model c/w re- tread - Re-tread tire size 11R22-5/8 | \$15,386 |

OPTIONS

JACK STANDS

| | | |
|--------|---|-------|
| Z91513 | Flat bottom jack, optional on MS250G, std on all other models | \$121 |
|--------|---|-------|

TOP BEATER FOR MS1300 & 1300X MODEL ONLY

| | | |
|-------|-------------------|---------|
| M7640 | Top Beater Option | \$1,227 |
|-------|-------------------|---------|

FINES PANS

| | | |
|-------|--|---------|
| M7550 | Fines pan for MS250G | \$383 |
| M7610 | Fines pan: Fits MX50P (all serial numbers); MX50G SN# B07920001 and up | \$439 |
| M7620 | Fines pan: Fits MX130 & MX130T models only | \$1,438 |

END GATES

| | | |
|-------|---|---------|
| M7570 | End Gate: Fits MX50P (all serial numbers); MX50G SN# B07920001 and up | \$674 |
| M7580 | End Gate: Fits MX80G SN# A0596023 and up; MX80P SN# A0597011 and up | \$653 |
| M7630 | End Gate: Fits MX130 & MX130T models only. Hydraulic operated | \$1,893 |

[RETURN TO INDEX](#)



| All models are available in the colors below: | |
|---|--------------------|
| Model Color Indicator | Unit Color |
| 01 | Bush Hog Red |
| 03 | John Deere Green |
| 05 | Kubota Orange |
| 14 | New Holland Blue |
| 16 | Caterpillar Yellow |

CULTIPACKER

| MODEL | CP960 | CP972 | CP984 | CP996 | CP1560 | CP1572 | CP1584 | CP1596 | CP1660 | CP1672 | CP1684 | CP1696 |
|--------------------|---------------------|--------|--------|---------|------------------|--------|--------|---------|----------------------|--------|--------|---------|
| Hitch | Cat 1 & Quick Hitch | | | | | | | | | | | |
| Overall Width | 67.19" | 80.38" | 91.78" | 103.19" | 67.72" | 80.91" | 92.31" | 103.72" | 67.72" | 80.91" | 92.31" | 103.72" |
| Working Width | 60" | 72" | 84" | 96" | 60" | 72" | 84" | 96" | 60" | 72" | 84" | 96" |
| Overall Length | 16.79" | | | | 20.47" | | | | 21.12" | | | |
| Overall Height | 33.11" | | | | 37.53" | | | | 38.18" | | | |
| Roller Diameter | 9.6" | | | | 15" | | | | 16.3" | | | |
| Roller Material | Notched Gray Iron | | | | Smooth Gray Iron | | | | Notched Ductile Iron | | | |
| Unit Weight (lb) | 427 | 501 | 564 | 625 | 614 | 717 | 816 | 917 | 712 | 835 | 954 | 1073 |
| Minimum Tractor HP | 35 | | | | | | | | | | | |

HOW TO ORDER: Select a model number and color code indicator to receive a complete unit.

Freight NOT included in list price. Freight discount available for multiple unit orders. Please contact Customer Service for details.

BASE UNIT SELECTION

| Model Number | Description | Approx. Wt. | List Price (\$US) |
|--------------|--|-------------|-------------------|
| CP960-xx | 3-Pt 60" Cultipacker, 9.5" Gray Iron Notched - 1.75" Axle | 427 lb. | \$1,978 |
| CP972-xx | 3-Pt 72" Cultipacker, 9.5" Gray Iron Notched - 1.75" Axle | 501 lb. | \$2,170 |
| CP984-xx | 3-Pt 84" Cultipacker, 9.5" Gray Iron Notched - 1.75" Axle | 564 lb. | \$2,366 |
| CP996-xx | 3-Pt 96" Cultipacker, 9.5" Gray Iron Notched - 1.75" Axle | 625 lb. | \$2,668 |
| CP1560-xx | 3-Pt 60" Cultipacker, 15" Gray Iron Smooth - 2" Axle | 614 lb. | \$2,387 |
| CP1572-xx | 3-Pt 72" Cultipacker, 15" Gray Iron Smooth - 2" Axle | 717 lb. | \$2,859 |
| CP1584-xx | 3-Pt 84" Cultipacker, 15" Gray Iron Smooth - 2" Axle | 816 lb. | \$3,332 |
| CP1596-xx | 3-Pt 96" Cultipacker, 15" Gray Iron Smooth - 2" Axle | 917 lb. | \$3,819 |
| CP1660-xx | 3-Pt 60" Cultipacker, 16.3" Ductile Iron Notched - 2" Axle | 712 lb. | \$2,603 |
| CP1672-xx | 3-Pt 72" Cultipacker, 16.3" Ductile Iron Notched - 2" Axle | 835 lb. | \$3,124 |
| CP1684-xx | 3-Pt 84" Cultipacker, 16.3" Ductile Iron Notched - 2" Axle | 954 lb. | \$3,640 |
| CP1696-xx | 3-Pt 96" Cultipacker, 16.3" Ductile Iron Notched - 2" Axle | 1,073 lb. | \$4,146 |

RETURN TO INDEX



BUSH HOG QUICK HITCH

| MODEL | BHQA1 | BHQA2 |
|------------------------|----------------------------------|----------------------------------|
| Width | 32 ³ / ₄ " | 39 ¹ / ₄ " |
| Maximum Recommended HP | 50 HP | 100 HP |
| ISO CERTIFIED | | |

HOW TO ORDER:

The BH Series Quick Attachment is priced as a complete unit. Indicate your choice of model from the Base Unit Selection below. Note: Bush Hog Quick Hitches are sold in packs of 2 units.

Freight NOT included in list price. Freight discount available for multiple unit orders. Please contact Customer Service for details.

BASE UNIT SELECTION

| Model Number | Description | Approx. Wt. | List Price (\$US) |
|--------------|-------------------------------------|-------------|-------------------|
| BHQA1 | Quick Hitch for Category 1 Tractors | 75 lb. | \$295 |
| BHQA2 | Quick Hitch for Category 2 Tractors | 108 lb. | \$480 |

** BHQA1 & BHQA2 Quick Hitches are sold in packs of two same size units **



[RETURN TO INDEX](#)

TILLAGE

TILLAGE

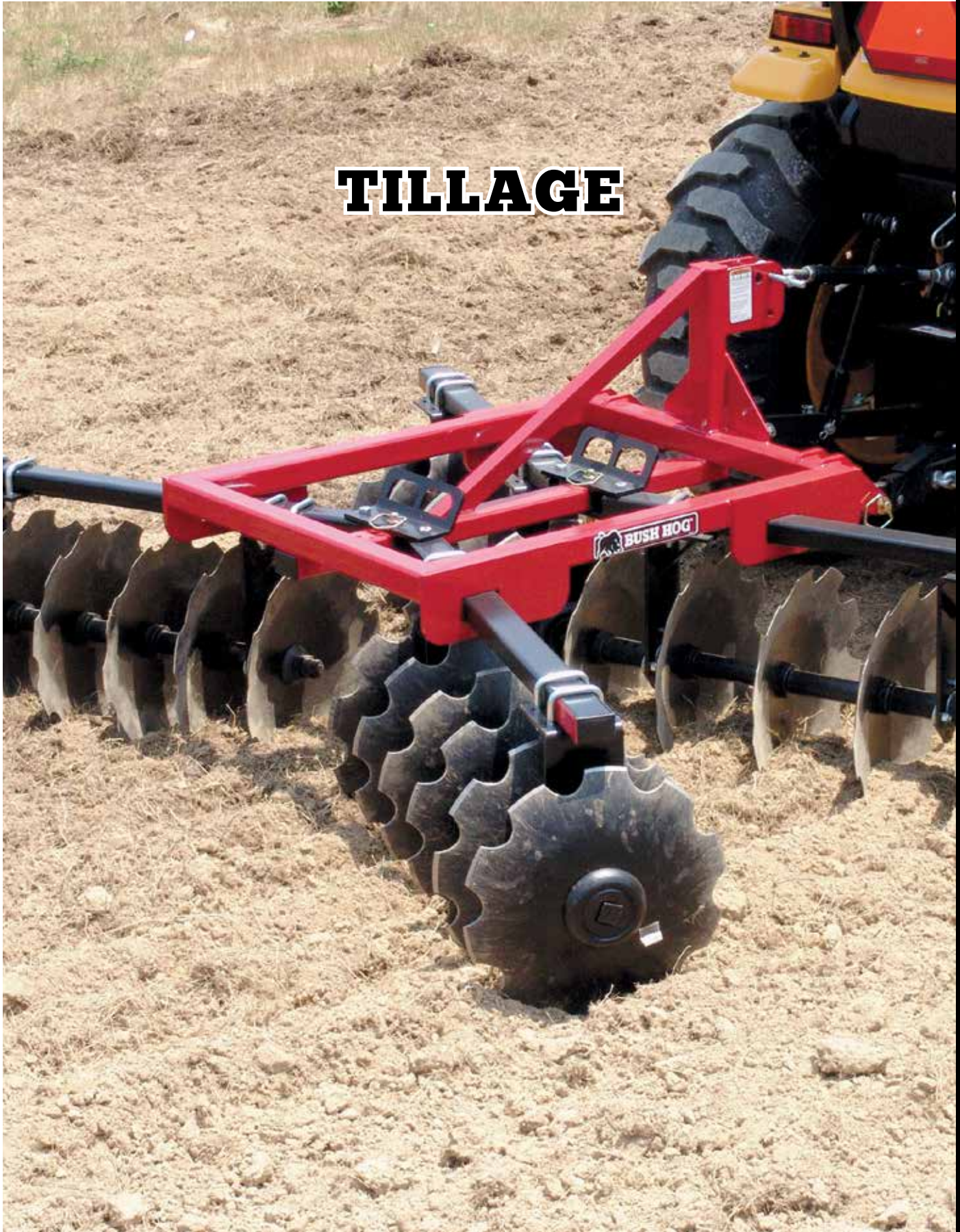

RETURN TO INDEX



RTC SERIES ROTARY TILLER

| MODEL | RTC |
|----------------------------|------------------------|
| Tractor HP Range | 15 PTO |
| Hitch | ASAE Cat 1 Quick Hitch |
| Offset | Center Mount |
| Tillage Width | 48" |
| Number of Flanges (Rotor) | 5 |
| Number of Blades | 30 |
| Rotor Speed (540 PTO) | 253 rpm |
| Blades | C Type |
| Power to Rotor | Gear |
| Transmission Depth of Cut* | 6" |
| Slip Clutch | Standard |

Five-Year Limited Gearbox Warranty. One-Year Limited Machine Warranty.

*May require additional passes, depending on soil type.

HOW TO ORDER:

The RTC Series Rotary Tiller is priced as a complete unit and is shipped fully assembled except for the hitch.

Freight NOT included in list price. Freight discount available for multiple unit orders. Please contact Customer Service for details.

BASE UNIT SELECTION

| Model Number | Description | Approx. Wt. | Approx. Ship Wt. | List Price (\$US) |
|--------------|---|-------------|------------------|---------------------|
| RTC50G-03 | RTC Series Rotary Tiller, JD Green, 48" Tillage Width, 15 LH Blades, 15 RH Blades, Slip Clutch Standard | 374 lb. | 395 lb. | each \$2,280 |
| RTC50G-05 | RTC Series Rotary Tiller, Kubota Orange, 48" Tillage Width, 15 LH Blades, 15 RH Blades, Slip Clutch Standard | 374 lb. | 395 lb. | each \$2,280 |
| RTC50G-14 | RTC Series Rotary Tiller, New Holland Blue, 48" Tillage Width, 15 LH Blades, 15 RH Blades, Slip Clutch Standard | 374 lb. | 395 lb. | each \$2,280 |
| RTC50G-21 | RTC Series Rotary Tiller, Bush Hog Red, 48" Tillage Width, 15 LH Blades, 15 RH Blades, Slip Clutch Standard | 374 lb. | 395 lb. | each \$2,280 |

RTC Series tillers are sold in packs of two, same size and same color.

RETURN TO INDEX



RTG SERIES ROTARY TILLER

| MODEL | RT60G | RT60GR | RT72G | RT72GR | RT84G | RT84GR |
|---|------------------------------------|---------|----------|--|----------|---------|
| Rotation | Standard | Reverse | Standard | Reverse | Standard | Reverse |
| Drivetrain | Gear | | | | | |
| Hitch | ASAE Cat 1, Std and Quick Hitch | | | ASAE Cat 1 & 2, Std and Quick Hitch | | |
| Working Width | 59" | | 70.5" | | 82.5" | |
| Total Width | 66" | | 78" | | 90" | |
| Number of Flanges | 7 | | 9 | | 11 | |
| Blades per Flange | 6 | | | | | |
| Rotor/Blade Rotation Diameter | 17" | | | | | |
| Rotor Shaft Diameter | 3" | | | | | |
| Rotor RPM | 211 | | | | | |
| Weight | 673 lb. | 683 lb. | 747 lb. | 759 lb. | 817 lb. | 831 lb. |
| PTO Driveline with Slip Clutch | ASAE Category 4 | | | | | |
| Tilling Depth* | 7.5" | | | | | |
| Minimum/Maximum Tractor H.P. (PTO) | 25/45 | | 35/55 | | 45/65 | |
| Five-Year Limited Gearbox Warranty. One-Year Limited Machine Warranty. | | | | | | |

*Requires multiple passes.

HOW TO ORDER:

The RTG Series Rotary Tiller is priced as a complete unit and is shipped fully assembled. To receive a complete unit, indicate your model choice and desired color from the Base Unit Selection of the ordering section on the following page.

Freight NOT included in list price. **Freight discount available for multiple unit orders. Please contact Customer Service for details.**



RETURN TO INDEX

| All models are available in the colors below: | |
|---|-------------------------|
| Model Color Indicator | Unit Color |
| R | Bush Hog Red |
| G | John Deere Green |
| O | Kubota Orange |
| B | New Holland Blue |

RTG SERIES ROTARY TILLER

BASE UNIT SELECTION

| Model Number | Description | Approx. Wt. | Approx. Ship Wt. | List Price (\$US) |
|--------------|---|-------------|------------------|-------------------|
| RT60G-1x | RTG Series Rotary Tiller, Standard Rotation, 59" Working Width, All Gear Drive and Driveline with Slip Clutch | 673 lb. | 798 lb. | \$2,804 |
| RT60GR-1x | RTG Series Rotary Tiller, Reverse Rotation, 59" Working Width, All Gear Drive and Driveline with Slip Clutch | 683 lb. | 808 lb. | \$3,002 |
| RT72G-1x | RTG Series Rotary Tiller, Standard Rotation, 70.5" Working Width, All Gear Drive and Driveline with Slip Clutch | 747 lb. | 877 lb. | \$3,220 |
| RT72GR-1x | RTG Series Rotary Tiller, Reverse Rotation, 70.5" Working Width, All Gear Drive and Driveline with Slip Clutch | 759 lb. | 889 lb. | \$3,417 |
| RT84G-1x | RTG Series Rotary Tiller, Standard Rotation, 82.5" Working Width, All Gear Drive and Driveline with Slip Clutch | 817 lb. | 952 lb. | \$3,779 |
| RT84GR-1x | RTG Series Rotary Tiller, Reverse Rotation, 82.5" Working Width, All Gear Drive and Driveline with Slip Clutch | 831 lb. | 966 lb. | \$3,975 |

OPTIONS

| Model Number | Description | Approx. Wt. | List Price (\$US) |
|--------------|--|-------------|-------------------|
| 50081431 | Tiller Hitch Extension Kit <i>(fits RT60, RT72 models; not compatible with RT84)</i> | 15 lb. | \$153 |
| 50076433 | Front Deflector Kit, 5' Tiller | 10 lb. | \$22 |
| 50076534 | Front Deflector Kit, 6' Tiller | 10 lb. | \$26 |
| 50076435 | Front Deflector Kit, 7' Tiller | 10 lb. | \$32 |

(For use on tractors with shorter lower lift arms. Not compatible with Quick Hitch)

RETURN TO INDEX



RTX HEAVY DUTY SERIES ROTARY TILLER

| MODEL | RTX85G | RTX92G |
|--------------------------------|------------------------------------|-----------|
| Rotation | Standard | |
| Drivetrain | Gear | |
| Hitch | ASAE Cat. 1 Std. & QH, Cat. 2 Std. | |
| Working Width | 85" | 92" |
| Total Width | 91" | 99" |
| Hood thickness | 10 ga. | |
| End Plates Thickness | .375" | |
| Number of Flanges | 9 | 10 |
| Blades per Flange | 6 | |
| Rotor Shaft Diameter | 3.5" | |
| Rotor Shaft Wall Thickness | .25" | |
| Rotor RPM | 235 | |
| Weight | 1,094 lb | 1,149 lb. |
| PTO Driveline with Slip Clutch | ASAE Category 4 | |
| Tilling Depth* | 10" | |
| Min / Max Tractor HP (PTO) | 60 / 90 | |
| Colors | Red | |

Five-Year Limited Gearbox Warranty. One-Year Limited Machine Warranty.

HOW TO ORDER:

The RTX Series Rotary Tiller is priced as a complete unit and is shipped fully assembled except for the hitch.

Freight NOT included in list price. Freight discount available for multiple unit orders. Please contact Customer Service for details.

COMPLETE UNIT SELECTION

| Model Number | Description | Approx. Wt. | List Price (\$US) |
|--------------|--|-------------|-------------------|
| RTX85G | RTX Series Rotary Tiller, 85" Working Width, All Gear Drive WITH Slip Clutch | 1,094 lb. | \$6,268 |
| RTX92G | RTX Series Rotary Tiller, 92" Working Width, All Gear Drive WITH Slip Clutch | 1,149 lb. | \$6,460 |

RETURN TO INDEX



1D SERIES LIFT DISC HARROW

| MODEL | 1D60-xx | 1D78-xx |
|-----------------------|---|---------|
| Hitch | Cat. 1 Std. & Quick Hitch | |
| Recommended HP | 35 HP | |
| Bearing Hanger | 3/8" x 6", Dual 1/2" U-Bolts | |
| Bearing Type - 2/Gang | Self-Aligning, Sealed Ball Bearings | |
| Angling Capabilities | 0, 7, 14, 21 Degrees (Front & Rear Gangs) | |
| Frame Tubes | 2" Square | |
| Gang Tubes | 3" x 1 1/2" | |
| Gang Axles | 1" Square, High Carbon Steel | |
| Options | Disc Scrapers | |

GANG INFO - 1D60-XX

| Disc Blade Spacing | Disc Blade Size | Cutting Width | Overall Width | No. Disc Blades | Gang Weight | Frame Weight | Total Weight | Axle Length |
|---------------------|-----------------|---------------|---------------|-----------------|-------------|--------------|--------------|---------------------|
| 9" Front & Rear | 16" | 51.4" | 58.2" | 12 | 308 lb. | 135 lb. | 443 lb. | 21.5" |
| 7.5" Front & Rear | 16" | 61" | 67.8" | 16 | 348 lb. | 135 lb. | 483 lb. | 26" |
| 9" Front, 7.5" Rear | 16" | 61" | 67.8" | 14 | 312 lb. | 135 lb. | 447 lb. | 21.5" (F) / 26" (R) |
| 9" Front & Rear | 18" | 51.4" | 58.2" | 12 | 344 lb. | 135 lb. | 479 lb. | 21.5" |
| 7.5" Front & Rear | 18" | 61" | 67.8" | 16 | 395 lb. | 135 lb. | 530 lb. | 26" |
| 9" Front, 7.5" Rear | 18" | 61" | 67.8" | 14 | 339 lb. | 135 lb. | 474 lb. | 21.5" (F) / 26" (R) |

GANG INFO - 1D78-XX

| Disc Blade Spacing | Disc Blade Size | Cutting Width | Overall Width | No. Disc Blades | Gang Weight | Frame Weight | Total Weight | Axle Length |
|---------------------|-----------------|---------------|---------------|-----------------|-------------|--------------|--------------|-------------------|
| 9" Front & Rear | 16" | 69" | 75.8" | 16 | 372 lb. | 135 lb. | 507 lb. | 31" |
| 7.5" Front & Rear | 16" | 76.5" | 83.3" | 20 | 312 lb. | 135 lb. | 447 lb. | 34" |
| 9" Front, 7.5" Rear | 16" | 76.5" | 83.3" | 18 | 395 lb. | 135 lb. | 530 lb. | 31" (F) / 34" (R) |
| 9" Front & Rear | 18" | 69" | 75.8" | 16 | 420 lb. | 135 lb. | 555 lb. | 31" |
| 7.5" Front & Rear | 18" | 76.5" | 83.3" | 20 | 468 lb. | 135 lb. | 603 lb. | 34" |
| 9" Front, 7.5" Rear | 18" | 76.5" | 83.3" | 18 | 339 lb. | 135 lb. | 474 lb. | 31" (F) / 34" (R) |



RETURN TO INDEX

| All models are available in the colors below: | |
|---|--------------------|
| Model Color Indicator | Unit Color |
| 01 | Bush Hog Red |
| 03 | John Deere Green |
| 05 | Kubota Orange |
| 14 | New Holland Blue |
| 16 | Caterpillar Yellow |

1D SERIES LIFT DISC HARROW

BASE UNIT SELECTION

| Model Number | Description | List Price (\$US) |
|--------------|--------------------------------|-------------------|
| 1D60-xx | 1D Series Lift Disc Harrow 60" | \$462 |
| 1D78-xx | 1D Series Lift Disc Harrow 78" | \$462 |

GANG ASSEMBLY SELECTION

| Model Number | Description | List Price (\$US) |
|--------------|---|-------------------|
| 50072592 | 1D60 Gang Assembly, 16" Scallop Disc, 7.5" Front & Rear Spacing | \$1,490 |
| 50072593 | 1D60 Gang Assembly, 16" Scallop Disc, 9" Front & Rear Spacing | \$1,388 |
| 50072594 | 1D60 Gang Assembly, 16" Scallop Disc, 9" Front, 7.5" Rear Spacing | \$1,450 |
| 50072595 | 1D60 Gang Assembly, 18" Scallop Disc, 7.5" Front & Rear Spacing | \$1,565 |
| 50072596 | 1D60 Gang Assembly, 18" Scallop Disc, 9" Front & Rear Spacing | \$1,442 |
| 50072597 | 1D60 Gang Assembly, 18" Scallop Disc, 9" Front, 7.5" Rear Spacing | \$1,511 |
| 50072598 | 1D78 Gang Assembly, 16" Scallop Disc, 7.5" Front & Rear Spacing | \$1,620 |
| 50072599 | 1D78 Gang Assembly, 16" Scallop Disc, 9" Front & Rear Spacing | \$1,542 |
| 50072600 | 1D78 Gang Assembly, 16" Scallop Disc, 9" Front, 7.5" Rear Spacing | \$1,584 |
| 50072601 | 1D78 Gang Assembly, 18" Scallop Disc, 7.5" Front & Rear Spacing | \$1,726 |
| 50072602 | 1D78 Gang Assembly, 18" Scallop Disc, 9" Front & Rear Spacing | \$1,627 |
| 50072603 | 1D78 Gang Assembly, 18" Scallop Disc, 9" Front, 7.5" Rear Spacing | \$1,672 |

OPTIONS (1D SERIES ONLY)

| Model Number | Description | List Price (\$US) |
|--------------|--|-------------------|
| 50073441 | 1D60 Scraper Kit, 16/18 Discs, 7.5" Front & Rear Spacing | \$546 |
| 50073442 | 1D60 Scraper Kit, 16/18 Discs, 9" Front & Rear Spacing | \$430 |
| 50069898 | 1D60 Scraper Kit, 16/18 Discs, 9" Front, 7.5" Rear Spacing | \$514 |
| 50073443 | 1D78 Scraper Kit, 16/18 Discs, 7.5" Front & Rear Spacing | \$661 |
| 50073444 | 1D78 Scraper Kit, 16/18 Discs, 9" Front & Rear Spacing | \$613 |
| 50070558 | 1D78 Scraper Kit, 16/18 Discs, 9" Front, 7.5" Rear Spacing | \$618 |

RETURN TO INDEX



2D SERIES

2D SERIES LIFT DISC HARROW

| MODEL | 2D78-xx | 2D96-xx |
|------------------------------|---|---------|
| Hitch | Cat. 1 Std. & Quick Hitch | |
| Recommended HP | 65 HP | |
| Bearing Hanger | 3/8" x 6", Dual 5/8" U-Bolts | |
| Bearing Type - 2/Gang | Self-Aligning, Sealed Ball Bearings | |
| Angling Capabilities | 0, 7, 14, 21 Degrees (Front & Rear Gangs) | |
| Frame Tubes | 2½" Square | |
| Gang Tubes | 3" x 2" | |
| Gang Axles | 1" Square, High Carbon Steel | |
| Options | Disc Scrapers | |

GANG INFO - 2D78-XX

| Disc Blade Spacing | Disc Blade Size | Cutting Width | Overall Width | No. Disc Blades | Gang Weight | Frame Weight | Total Weight | Axle Length |
|---------------------|-----------------|---------------|---------------|-----------------|-------------|--------------|--------------|-------------------|
| 9" Front & Rear | 18" | 70.8" | 77.6" | 16 | 452 lb. | 223 lb. | 675 lb. | 31" |
| 7.5" Front & Rear | 18" | 78.13" | 84.9" | 20 | 477 lb. | 223 lb. | 700 lb. | 34" |
| 9" Front, 7.5" Rear | 18" | 78.13" | 84.9" | 18 | 472 lb. | 223 lb. | 695 lb. | 31" (F) / 34" (R) |
| 9" Front & Rear | 20" | 70.8" | 77.6" | 16 | 504 lb. | 223 lb. | 727 lb. | 31" |
| 7.5" Front & Rear | 20" | 78.13" | 84.9" | 20 | 547 lb. | 223 lb. | 770 lb. | 34" |
| 9" Front, 7.5" Rear | 20" | 78.13" | 84.9" | 18 | 543 lb. | 223 lb. | 766 lb. | 31" (F) / 34" (R) |

GANG INFO - 2D96-XX

| Disc Blade Spacing | Disc Blade Size | Cutting Width | Overall Width | No. Disc Blades | Gang Weight | Frame Weight | Total Weight | Axle Length |
|---------------------|-----------------|---------------|---------------|-----------------|-------------|--------------|--------------|---------------------|
| 9" Front & Rear | 18" | 88.9" | 95.7" | 20 | 517 lb. | 223 lb. | 740 lb. | 39.5" |
| 7.5" Front & Rear | 18" | 91.3" | 98.2" | 24 | 580 lb. | 223 lb. | 803 lb. | 41" |
| 9" Front, 7.5" Rear | 18" | 91.3" | 98.2" | 22 | 635 lb. | 223 lb. | 858 lb. | 39.5" (F) / 41" (R) |
| 9" Front & Rear | 20" | 88.9" | 95.7" | 20 | 592 lb. | 223 lb. | 815 lb. | 39.5" |
| 7.5" Front & Rear | 20" | 91.3" | 98.2" | 24 | 648 lb. | 223 lb. | 871 lb. | 41" |
| 9" Front, 7.5" Rear | 20" | 91.3" | 98.2" | 22 | 679 lb. | 223 lb. | 902 lb. | 39.5" (F) / 41" (R) |



RETURN TO INDEX

| All models are available in the colors below: | |
|---|--------------------|
| Model Color Indicator | Unit Color |
| 01 | Bush Hog Red |
| 03 | John Deere Green |
| 05 | Kubota Orange |
| 14 | New Holland Blue |
| 16 | Caterpillar Yellow |

2D SERIES LIFT DISC HARROW

BASE UNIT SELECTION

| Model Number | Description | List Price (\$US) |
|--------------|--------------------------------|-------------------|
| 2D78-xx | 2D Series Lift Disc Harrow 78" | \$767 |
| 2D96-xx | 2D Series Lift Disc Harrow 96" | \$767 |

GANG ASSEMBLY SELECTION

| Model Number | Description | List Price (\$US) |
|--------------|---|-------------------|
| 50072738 | 2D78 Gang Assembly, 18" Scallop Disc, 7.5" Front & Rear Spacing | \$1,924 |
| 50072739 | 2D78 Gang Assembly, 18" Scallop Disc, 9" Front & Rear Spacing | \$1,776 |
| 50072740 | 2D78 Gang Assembly, 18" Scallop Disc, 9" Front, 7.5" Rear Spacing | \$1,790 |
| 50072741 | 2D78 Gang Assembly, 20" Scallop Disc, 7.5" Front & Rear Spacing | \$2,184 |
| 50072742 | 2D78 Gang Assembly, 20" Scallop Disc, 9" Front & Rear Spacing | \$2,000 |
| 50072743 | 2D78 Gang Assembly, 20" Scallop Disc, 9" Front, 7.5" Rear Spacing | \$2,027 |
| 50072744 | 2D96 Gang Assembly, 18" Scallop Disc, 7.5" Front & Rear Spacing | \$2,310 |
| 50072745 | 2D96 Gang Assembly, 18" Scallop Disc, 9" Front & Rear Spacing | \$2,189 |
| 50072746 | 2D96 Gang Assembly, 18" Scallop Disc, 9" Front, 7.5" Rear Spacing | \$2,225 |
| 50072747 | 2D96 Gang Assembly, 20" Scallop Disc, 7.5" Front & Rear Spacing | \$2,729 |
| 50072748 | 2D96 Gang Assembly, 20" Scallop Disc, 9" Front & Rear Spacing | \$2,489 |
| 50072749 | 2D96 Gang Assembly, 20" Scallop Disc, 9" Front, 7.5" Rear Spacing | \$2,503 |

OPTIONS (2D SERIES ONLY)

| Model Number | Description | List Price (\$US) |
|--------------|--|-------------------|
| 50073445 | 2D78 Scraper Kit, 18/20 Discs, 7.5" Front & Rear Spacing | \$691 |
| 50073446 | 2D78 Scraper Kit, 18/20 Discs, 9" Front & Rear Spacing | \$624 |
| 50069897 | 2D78 Scraper Kit, 18/20 Discs, 9" Front, 7.5" Rear Spacing | \$678 |
| 50073447 | 2D96/3D96 Scraper Kit, (18/20, 20/22 Discs), 7.5" Front & Rear Spacing | \$795 |
| 50073448 | 2D96/3D96 Scraper Kit, (18/20, 20/22 Discs), 9" Front & Rear Spacing | \$720 |
| 50070559 | 2D96/3D96 Scraper Kit, (18/20, 20/22 Discs), 9" Front, 7.5" Rear Spacing | \$780 |

RETURN TO INDEX



3D SERIES

3D SERIES LIFT DISC HARROW

| MODEL | 3D96-xx | 3D118-xx |
|-----------------------|--|----------|
| Hitch | Cat. 1 & 2 Std. & Quick Hitch | |
| Recommended HP | 95 HP | |
| Bearing Hanger | 1/2" x 7", Dual 5/8" U-Bolts | |
| Bearing Type - 2/Gang | Self-Aligning, Sealed Ball Bearings | |
| Angling Capabilities | 0, 7, 14, 21 Degrees (Front Gangs); 7, 14, 21 Degrees (Rear Gangs) | |
| Frame Tubes | 3" Square | |
| Gang Tubes | 4" x 3" | |
| Gang Axles | 1 1/8" Square, High Carbon Steel | |
| Options | Disc Scrapers | |

GANG INFO - 3D96-XX

| Disc Blade Spacing | Disc Blade Size | Cutting Width | Overall Width | No. Disc Blades | Gang Weight | Frame Weight | Total Weight | Axle Length |
|---------------------|-----------------|---------------|---------------|-----------------|-------------|--------------|--------------|----------------------|
| 9" Front & Rear | 20" | 88.8" | 95.7" | 20 | 773 lb. | 379 lb. | 1,152 lb. | 40.25" |
| 7.5" Front & Rear | 20" | 93.4" | 100.3" | 24 | 807 lb. | 379 lb. | 1,186 lb. | 42" |
| 9" Front, 7.5" Rear | 20" | 93.4" | 100.3" | 22 | 794 lb. | 379 lb. | 1,173 lb. | 40.25" (F) / 42" (R) |
| 9" Front & Rear | 22" | 88.8" | 95.7" | 20 | 896 lb. | 379 lb. | 1,275 lb. | 40.25" |
| 7.5" Front & Rear | 22" | 93.4" | 100.3" | 24 | 932 lb. | 379 lb. | 1,311 lb. | 42" |
| 9" Front, 7.5" Rear | 22" | 93.4" | 100.3" | 22 | 920 lb. | 379 lb. | 1,299 lb. | 40.25" (F) / 42" (R) |

GANG INFO - 3D118-XX

| Disc Blade Spacing | Disc Blade Size | Cutting Width | Overall Width | No. Disc Blades | Gang Weight | Frame Weight | Total Weight | Axle Length |
|---------------------|-----------------|---------------|---------------|-----------------|-------------|--------------|--------------|-------------|
| 9" Front & Rear | 20" | 107" | 113.9" | 24 | 867 lb. | 379 lb. | 1,246 lb. | 49.5" |
| 7.5" Front & Rear | 20" | 106.8" | 113.7" | 28 | 1,052 lb. | 379 lb. | 1,431 lb. | 49.5" |
| 9" Front, 7.5" Rear | 20" | 106.8" | 113.7" | 26 | 976 lb. | 379 lb. | 1,355 lb. | 49.5" |
| 9" Front & Rear | 22" | 107" | 113.9" | 24 | 1,002 lb. | 379 lb. | 1,381 lb. | 49.5" |
| 7.5" Front & Rear | 22" | 106.8" | 113.7" | 28 | 1,100 lb. | 379 lb. | 1,479 lb. | 49.5" |
| 9" Front, 7.5" Rear | 22" | 106.8" | 113.7" | 26 | 1,106 lb. | 379 lb. | 1,485 lb. | 49.5" |

HOW TO ORDER:

These disc harrows are available as lift type implements only. For total price, select a model, gang assembly, and any desired option. Units are shipped fully assembled.

Freight NOT included in list price. **Freight discount available for multiple unit orders. Please contact Customer Service for details.**



RETURN TO INDEX

| All models are available in the colors below: | |
|---|--------------------|
| Model Color Indicator | Unit Color |
| 01 | Bush Hog Red |
| 03 | John Deere Green |
| 05 | Kubota Orange |
| 14 | New Holland Blue |
| 16 | Caterpillar Yellow |

3D SERIES LIFT DISC HARROW

BASE UNIT SELECTION

| Model Number | Description | List Price (\$US) |
|--------------|---------------------------------|-------------------|
| 3D96-xx | 3D Series Lift Disc Harrow 96" | \$1,380 |
| 3D118-xx | 3D Series Lift Disc Harrow 118" | \$1,380 |

GANG ASSEMBLY SELECTION

| Model Number | Description | List Price (\$US) |
|--------------|--|-------------------|
| 50072750 | 3D96 Gang Assembly, 20" Scallop Disc, 7.5" Front & Rear Spacing | \$3,699 |
| 50072751 | 3D96 Gang Assembly, 20" Scallop Disc, 9" Front & Rear Spacing | \$3,645 |
| 50072752 | 3D96 Gang Assembly, 20" Scallop Disc, 9" Front, 7.5" Rear Spacing | \$3,581 |
| 50072753 | 3D96 Gang Assembly, 22" Scallop Disc, 7.5" Front & Rear Spacing | \$4,104 |
| 50072754 | 3D96 Gang Assembly, 22" Scallop Disc, 9" Front & Rear Spacing | \$3,840 |
| 50072755 | 3D96 Gang Assembly, 22" Scallop Disc, 9" Front, 7.5" Rear Spacing | \$3,943 |
| 50072756 | 3D118 Gang Assembly, 20" Scallop Disc, 7.5" Front & Rear Spacing | \$4,254 |
| 50072757 | 3D118 Gang Assembly, 20" Scallop Disc, 9" Front & Rear Spacing | \$4,068 |
| 50072758 | 3D118 Gang Assembly, 20" Scallop Disc, 9" Front, 7.5" Rear Spacing | \$4,145 |
| 50072759 | 3D118 Gang Assembly, 22" Scallop Disc, 7.5" Front & Rear Spacing | \$4,731 |
| 50072760 | 3D118 Gang Assembly, 22" Scallop Disc, 9" Front & Rear Spacing | \$4,506 |
| 50072761 | 3D118 Gang Assembly, 22" Scallop Disc, 9" Front, 7.5" Rear Spacing | \$4,588 |

OPTIONS (3D SERIES ONLY)

| Model Number | Description | List Price (\$US) |
|--------------|--|-------------------|
| 50073447 | 2D96/3D96 Scraper Kit, (18/20, 20/22 Discs), 7.5" Front & Rear Spacing | \$795 |
| 50073448 | 2D96/3D96 Scraper Kit, (18/20, 20/22 Discs), 9" Front & Rear Spacing | \$720 |
| 50070559 | 2D96/3D96 Scraper Kit, (18/20, 20/22 Discs), 9" Front, 7.5" Rear Spacing | \$780 |
| 50073449 | 3D118 Scraper Kit, 20/22 Discs, 7.5" Front & Rear Spacing | \$878 |
| 50073450 | 3D118 Scraper Kit, 20/22 Discs, 9" Front & Rear Spacing | \$777 |
| 50069896 | 3D118 Scraper Kit, 20/22 Discs, 9" Front, 7.5" Rear Spacing | \$833 |

RETURN TO INDEX



DHP SERIES PULL DISC HARROW

| MODEL | DHP8 | DHP10 | DHP12 |
|--|---|-------------|-------------|
| Drawbar Required HP | 40 - 65 HP | 45 - 100 HP | 55 - 100 HP |
| Hitch | Pull-Type with Clevis & Hole for 1 1/4" Pin | | |
| Approx. Weight Load on Each Blade | 95 - 114 lb. | 84 - 98 lb. | 78 - 90 lb. |
| Number of Bearings | 8 | 12 | |
| Disc Bearing Type | Triple Lip Sealed Ball Bearings | | |
| Angling Capabilities | 15, 16.5, 18, 19.5, 21 Degrees (Front Gangs); 12, 13.5, 15, 16.5, 18 Degrees (Rear Gangs) | | |
| Frame Tubes | 3" Square | | |
| Construction - Tubing | Slide Mainframe, Mainframe Middle, and Gang Arm - 4" x 3" x 1/4"; Mainframe Front and Rear - 5" x 3" x 1/4"; Hitch Frame - 4" x 4" x 1/4" | | |
| Gang Axles | 1 1/8" Square, High Carbon Steel | | |
| Front to Rear Leveling System | Manual Crank Adjustment | | |
| Depth Control | Cylinder Stroke Control Spacers | | |
| Hydraulic Cylinder | 3 1/2" x 8" ASAE Hydraulic Cylinder | | |
| Transport Tires and Wheels | (Two) 9.5Lx15 Tires on 15" x 6" - 5 Bolt Wheels | | |
| Park Jack | Standard | | |
| Options | Disc Scrapers, Dual Wheel Transport Kit | | |

GANG INFO - DHP8

| Disc Blade Spacing | Notched Disc Blade Size | Cutting Width | Apprx. Transport Width | No. Disc Blades | Gang Weight | Frame Weight | Total Weight | Axle Length |
|---------------------|-------------------------|---------------|------------------------|-----------------|-------------|--------------|--------------|----------------------|
| 9" Front & Rear | 20" | 90.25" | 8' 10" | 20 | 792 lb. | 1,423 lb. | 2,215 lb. | 40.25" |
| 7.5" Front & Rear | 20" | 92.5" | 8' 10" | 24 | 864 lb. | 1,423 lb. | 2,287 lb. | 42" |
| 9" Front, 7.5" Rear | 20" | 92.5" | 8' 10" | 22 | 828 lb. | 1,423 lb. | 2,251 lb. | 40.25" (F) / 42" (R) |
| 9" Front & Rear | 22" | 90.25" | 8' 10" | 20 | 856 lb. | 1,423 lb. | 2,279 lb. | 40.25" |
| 7.5" Front & Rear | 22" | 92.5" | 8' 10" | 24 | 976 lb. | 1,423 lb. | 2,399 lb. | 42" |
| 9" Front, 7.5" Rear | 22" | 92.5" | 8' 10" | 22 | 916 lb. | 1,423 lb. | 2,339 lb. | 40.25" (F) / 42" (R) |

GANG INFO - DHP10

| Disc Blade Spacing | Notched Disc Blade Size | Cutting Width | Apprx. Transport Width | No. Disc Blades | Gang Weight | Frame Weight | Total Weight | Axle Length |
|---------------------|-------------------------|---------------|------------------------|-----------------|-------------|--------------|--------------|-----------------------|
| 9" Front & Rear | 20" | 125" | 10' 10" | 28 | 1,124 lb. | 1,510 lb. | 2,634 lb. | 58.5" |
| 7.5" Front & Rear | 20" | 123.25" | 10' 10" | 32 | 1,118 lb. | 1,510 lb. | 2,698 lb. | 57.5" |
| 9" Front, 7.5" Rear | 20" | 123.25" | 10' 10" | 30 | 1,156 lb. | 1,510 lb. | 2,666 lb. | 58.5" (F) / 57.5" (R) |
| 9" Front & Rear | 22" | 125" | 10' 10" | 28 | 1,236 lb. | 1,510 lb. | 2,746 lb. | 58.5" |
| 7.5" Front & Rear | 22" | 123.25" | 10' 10" | 32 | 1,272 lb. | 1,510 lb. | 2,782 lb. | 57.5" |
| 9" Front, 7.5" Rear | 22" | 123.25" | 10' 10" | 30 | 1,254 lb. | 1,510 lb. | 2,764 lb. | 58.5" (F) / 57.5" (R) |

GANG INFO - DHP12

| Disc Blade Spacing | Notched Disc Blade Size | Cutting Width | Apprx. Transport Width | No. Disc Blades | Gang Weight | Frame Weight | Total Weight | Axle Length |
|---------------------|-------------------------|---------------|------------------------|-----------------|-------------|--------------|--------------|---------------------|
| 9" Front & Rear | 20" | 143.25" | 12' 4" | 32 | 1,240 lb. | 1,510 lb. | 2,750 lb. | 67.5" |
| 7.5" Front & Rear | 20" | 140.5" | 12' 4" | 36 | 1,300 lb. | 1,510 lb. | 2,810 lb. | 65" |
| 9" Front, 7.5" Rear | 20" | 140.5" | 12' 4" | 34 | 1,270 lb. | 1,510 lb. | 2,780 lb. | 67.5" (F) / 65" (R) |
| 9" Front & Rear | 22" | 143.25" | 12' 4" | 32 | 1,356 lb. | 1,510 lb. | 2,866 lb. | 67.5" |
| 7.5" Front & Rear | 22" | 140.5" | 12' 4" | 36 | 1,468 lb. | 1,510 lb. | 2,978 lb. | 65" |
| 9" Front, 7.5" Rear | 22" | 140.5" | 12' 4" | 34 | 1,412 lb. | 1,510 lb. | 2,922 lb. | 67.5" (F) / 65" (R) |

HOW TO ORDER:

These disc harrows are available as pull type implements only. For the total price, select a model, gang assembly, and desired option(s). Each unit is shipped in three crates for dealer assembly.

Freight NOT included in list price. **Freight discount available for multiple unit orders. Please contact Customer Service for details.**



RETURN TO INDEX

| All models are available in the colors below: | |
|---|--------------------|
| Model Color Indicator | Unit Color |
| 01 | Bush Hog Red |
| 03 | John Deere Green |
| 05 | Kubota Orange |
| 14 | New Holland Blue |
| 16 | Caterpillar Yellow |

DHP SERIES PULL DISC HARROW

| BASE UNIT SELECTION | | |
|--------------------------------------|--|-------------------|
| Model Number | Description | List Price (\$US) |
| DHP8-xx | DHP Series Pull Disc Harrow, 8', Single Axle | \$6,372 |
| DHP10-xx | DHP Series Pull Disc Harrow, 10', Single Axle | \$6,440 |
| DHP12-xx | DHP Series Pull Disc Harrow, 12', Single Axle | \$6,440 |
| DHP8 SERIES GANG ASSEMBLY SELECTION | | |
| 50072135 | DHP8 Gang Assembly, 20" Scallop Disc, 7.5" Front & Rear Spacing | \$4,633 |
| 50072136 | DHP8 Gang Assembly, 20" Scallop Disc, 9" Front & Rear Spacing | \$4,431 |
| 50072137 | DHP8 Gang Assembly, 20" Scallop Disc, 9" Front, 7.5" Rear Spacing | \$4,498 |
| 50072138 | DHP8 Gang Assembly, 22" Scallop Disc, 7.5" Front & Rear Spacing | \$4,899 |
| 50072139 | DHP8 Gang Assembly, 22" Scallop Disc, 9" Front & Rear Spacing | \$4,696 |
| 50072140 | DHP8 Gang Assembly, 22" Scallop Disc, 9" Front, 7.5" Rear Spacing | \$4,793 |
| DHP10 SERIES GANG ASSEMBLY SELECTION | | |
| 50072141 | DHP10 Gang Assembly, 20" Scallop Disc, 7.5" Front & Rear Spacing | \$5,586 |
| 50072142 | DHP10 Gang Assembly, 20" Scallop Disc, 9" Front & Rear Spacing | \$5,844 |
| 50072143 | DHP10 Gang Assembly, 20" Scallop Disc, 9" Front, 7.5" Rear Spacing | \$5,503 |
| 50072144 | DHP10 Gang Assembly, 22" Scallop Disc, 7.5" Front & Rear Spacing | \$5,905 |
| 50072145 | DHP10 Gang Assembly, 22" Scallop Disc, 9" Front & Rear Spacing | \$5,637 |
| 50072146 | DHP10 Gang Assembly, 22" Scallop Disc, 9" Front, 7.5" Rear Spacing | \$5,772 |
| DHP12 SERIES GANG ASSEMBLY SELECTION | | |
| 50072147 | DHP12 Gang Assembly, 20" Scallop Disc, 7.5" Front & Rear Spacing | \$7,513 |
| 50072148 | DHP12 Gang Assembly, 20" Scallop Disc, 9" Front & Rear Spacing | \$7,245 |
| 50072149 | DHP12 Gang Assembly, 20" Scallop Disc, 9" Front, 7.5" Rear Spacing | \$7,382 |
| 50072230 | DHP12 Gang Assembly, 22" Scallop Disc, 7.5" Front & Rear Spacing | \$7,985 |
| 50072231 | DHP12 Gang Assembly, 22" Scallop Disc, 9" Front & Rear Spacing | \$7,742 |
| 50072232 | DHP12 Gang Assembly, 22" Scallop Disc, 9" Front, 7.5" Rear Spacing | \$7,847 |
| OPTIONS | | |
| DHP8 SERIES ONLY | | |
| 50072310 | DHP8 Scraper Kit, 20/22 Discs, 7.5" Front & Rear Spacing | \$1,189 |
| 50072311 | DHP8 Scraper Kit, 20/22 Discs, 9" Front & Rear Spacing | \$993 |
| 50072312 | DHP8 Scraper Kit, 20/22 Discs, 9" Front, 7.5" Rear Spacing | \$1,058 |
| DHP10 SERIES ONLY | | |
| 50072313 | DHP10 Scraper Kit, 20/22 Discs, 7.5" Front & Rear Spacing | \$1,491 |
| 50072314 | DHP10 Scraper Kit, 20/22 Discs, 9" Front & Rear Spacing | \$1,437 |
| 50072315 | DHP10 Scraper Kit, 20/22 Discs, 9" Front, 7.5" Rear Spacing | \$1,384 |
| DHP12 SERIES ONLY | | |
| 50072316 | DHP12 Scraper Kit, 20/22 Discs, 7.5" Front & Rear Spacing | \$1,650 |
| 50072317 | DHP12 Scraper Kit, 20/22 Discs, 9" Front & Rear Spacing | \$1,568 |
| 50072318 | DHP12 Scraper Kit, 20/22 Discs, 9" Front, 7.5" Rear Spacing | \$1,596 |
| 50072233 | DHP Dual Wheel Transport Kit, Available for all DHP models | \$915 |

RETURN TO INDEX



APP SERIES ALL PURPOSE PLOW

| MODEL | APP48-3 | APP60-5 | APP66-5 | APP66-7 | APP85-7 | APP85-9 |
|-----------------------|---|----------------------------------|----------------------------------|---------|----------------------------------|---------|
| Overall Width | 49 ⁵ / ₈ " | 61 ⁵ / ₈ " | 67 ⁵ / ₈ " | | 85 ⁵ / ₈ " | |
| Maximum Working Width | 44" | 56" | 62" | | 80" | |
| Overall Depth | 39 ³ / ₄ " | | | | | |
| Overall Height | 40 ³ / ₈ " | | | | | |
| Weight (lb.) | 206 | 228 | 284 | 367 | 386 | 455 |
| Number of Shanks | 3 | 5 | | 7 | | 9 |
| Angle Iron Size | 2 ¹ / ₂ " Width x 2 ¹ / ₂ " Height x 3/8" Thickness | | | | | |
| Hole Spacing | 1" | | | | | |
| Hitch | Cat 1 Std & Quick Hitch | | | | | |
| Teeth | 5/16" x 2" x 10 ¹ / ₈ " 1080 High Carbon 38-44 Rockwell C Reversible | | | | | |
| Suggested Min. PTO HP | 24 | 35 | | 49 | | 63 |

HOW TO ORDER:

The All Purpose Plow is available as a lift-type implement only. It is priced as a complete unit and is shipped fully assembled.

Freight NOT included in list price. Freight discount available for multiple unit orders. Please contact Customer Service for details.

BASE UNIT SELECTION

| Model Number | Description | List Price (\$US) |
|--------------|---|-------------------|
| APP48-3 | All Purpose Plow, 48", 3 Shanks, Bush Hog Red | \$856 |
| APP60-5 | All Purpose Plow, 60", 5 Shanks, Bush Hog Red | \$1,220 |
| APP66-5 | All Purpose Plow, 66", 5 Shanks, Bush Hog Red | \$1,344 |
| APP66-7 | All Purpose Plow, 66", 7 Shanks, Bush Hog Red | \$1,575 |
| APP85-7 | All Purpose Plow, 85", 7 Shanks, Bush Hog Red | \$1,631 |
| APP85-9 | All Purpose Plow, 85", 9 Shanks, Bush Hog Red | \$1,875 |

RETURN TO INDEX

| All models are available in the colors below: | |
|---|--------------------|
| Model Color Indicator | Unit Color |
| 01 | Bush Hog Red |
| 03 | John Deere Green |
| 05 | Kubota Orange |
| 14 | New Holland Blue |
| 16 | Caterpillar Yellow |



HDSS SERIES HEAVY DUTY SUBSOILER

| MODEL | HDSS1S | HDSS1L | HDSS2S | HDSS2L |
|-----------------------|---|--------|--------|--------|
| Hitch | Cat 1 & 2 Quick Hitch | | | |
| Overall Width | 41" | | 49" | |
| Overall Height | 39½" | 43½" | 39½" | 43½" |
| Horsepower | Approximately 35 HP per shank up to 85 HP | | | |
| Shank Size | 11/4" x 97/16" x 26¼" (Long), 11/4" x 97/16" x 22¼" (Short) | | | |
| Number of Shanks | 1 | | 2 | |
| Cutting Point | 1" x 2½" x 9¾" | | | |
| Maximum Cutting Depth | 19¼" | 23¼" | 19¼" | 23¼" |

HOW TO ORDER:

The Heavy Duty Series Subsoiler is available as a 3-Point type implement only. It is priced as a complete unit and is shipped fully assembled. Indicate your choice of model color from the chart above.

Freight NOT included in list price. Freight discount available for multiple unit orders. Please contact Customer Service for details.

BASE UNIT SELECTION

| Model Number | Description | Approx. Wt. | List Price (\$US) |
|--------------|---------------------------------------|-------------|-------------------|
| HDSS1S-xx | Subsoiler, Heavy Duty, 1 Shank, Short | 261 lb. | \$1,339 |
| HDSS1L-xx | Subsoiler, Heavy Duty, 1 Shank, Long | 276 lb. | \$1,367 |
| HDSS2S-xx | Subsoiler, Heavy Duty, 2 Shank, Short | 420 lb. | \$2,548 |
| HDSS2L-xx | Subsoiler, Heavy Duty, 2 Shank, Long | 450 lb. | \$2,575 |

RETURN TO INDEX



SS1 SUBSOILER



LP LAYOFF PLOW

| All models are available in the colors below: | |
|---|--------------------|
| Model Color Indicator | Unit Color |
| 01 | Bush Hog Red |
| 03 | John Deere Green |
| 05 | Kubota Orange |
| 14 | New Holland Blue |
| 16 | Caterpillar Yellow |



1RCV CULTIVATOR

**SS1 SERIES SUBSOILER, LP SERIES LAYOFF PLOW,
1RCV SERIES CULTIVATOR**

| MODEL | SS1 SUBSOILER | LP LAYOFF PLOW | 1RCV CULTIVATOR |
|-----------------------|--|----------------|--|
| Hitch | Cat 1 Std & Quick Hitch | | |
| Overall Width | 32 ³ / ₈ " | | 57 ⁷ / ₈ " |
| Overall Height | 50" | 38" | 41 ³ / ₁₆ " |
| Horsepower | 25 - 45 | | |
| Shank Size | 3/4" x 6" | 3/4" x 4" | 3/8" x 1 ³ / ₄ " |
| Number of Shanks | 1 | | 6 |
| Cutting Point | 1/2" x 2 ¹ / ₂ " x 12" | 16" x 4.75 mm | 1/4" x 2 ¹ / ₂ " x 11" |
| Maximum Cutting Depth | 25 ⁵ / ₈ " | | |

HOW TO ORDER:

The Ground Engaging Implements are available as a 3-Point type implement only. Each model is priced as a complete unit and is shipped fully assembled. Indicate your choice of model color from the chart above.

Freight NOT included in list price. Freight discount available for multiple unit orders. Please contact Customer Service for details.

BASE UNIT SELECTION

| Model Number | Description | Approx. Wt. | List Price (\$US) |
|--------------|--------------------------|-------------|-------------------|
| SS1-xx | Subsoiler, Standard Duty | 113 lb. | \$454 |
| LP-xx | Layoff Plow, Light Duty | 75 lb. | \$264 |
| 1RCV-xx | Cultivator, Light Duty | 171 lb. | \$605 |

OPTIONS (1RCV MODEL ONLY)

| Model Number | Description | Approx. Wt. | List Price (\$US) |
|--------------|--|-------------|-------------------|
| 50072481 | Middle Tine Kit for 1RCV Series Cultivator | 113 lb. | \$117 |

RETURN TO INDEX



| All models are available in the colors below: | |
|---|--------------------|
| Model Color Indicator | Unit Color |
| 01 | Bush Hog Red |
| 03 | John Deere Green |
| 05 | Kubota Orange |
| 14 | New Holland Blue |
| 16 | Caterpillar Yellow |

PA SERIES PASTURE AERATOR

| MODEL | PA8 | PA10 |
|--|--|------------------|
| Tractor HP Requirements | 40 - 90 HP | |
| Working Width | 86" | 116" |
| Overall Width | 97.38" | 127.63" |
| Overall Length | 136" in Transportation Position | |
| Overall Height | 44.25" (With Tines on the Ground) | |
| Weight Box | Standard | |
| Maximum Ballast in Weight Box (Ballast Not Included with Unit) | 2,200 lb. | 2,900 lb. |
| Number of Tines | 24 (LH), 24 (RH) | 32 (LH), 32 (RH) |
| Tine Material | Forged and Heat Treated Through Steel | |
| Tine Hub Spacing | 7.5" | |
| Tine Penetration | Up to 8.125", Depending on Ground Condition | |
| Frame Construction | 4" Square Tubing, All Welded Construction | |
| Main Tongue Beam | 4" Square | |
| Rotor/Tine Support Hangers | 1" x 7" Heavy Duty Hangers | |
| Rotor Bearings | Heavy Duty Greaseable | |
| Rotor Bearing Protection | .38" x 3.5" Metal Housing | |
| Rotor Angle Adjustment | 2.5°, 5°, 7.5° | |
| Tires and Wheels | 9.5L x 15 Tires on 15" - 5 Bolt Wheels | |
| Tine Depth Control | Add Cylinder Donuts to Cylinder Rod (Included) | |
| Hydraulic Cylinder | 3.5" x 8" | |
| Transportation Lock | Manual Cylinder Lock | |
| Rear Axle Pivot | Greaseable | |
| Safety Tow Chain | Included | |
| One-Year Limited Warranty. | | |

HOW TO ORDER:

The PA Series Pasture Aerator is available as a pull-type implement only. It is priced as a complete unit, and each unit is shipped in one crate with the tongue and tailwheels to be assembled by the dealer. Indicate your choice of model color from the chart above.

Freight NOT included in list price. Freight discount available for multiple unit orders. Please contact Customer Service for details.

BASE UNIT SELECTION

| Model Number | Description | Approx. Wt. | List Price (\$US) |
|--------------|--------------------------------|-------------|-------------------|
| PA8-xx | PA Series Pasture Aerator, 8' | 1,950 lb. | \$13,068 |
| PA10-xx | PA Series Pasture Aerator, 10' | 2,500 lb. | \$15,686 |



[RETURN TO INDEX](#)



[RETURN TO INDEX](#)

HAY TOOLS



RETURN TO INDEX



DHM SERIES HAY MOWER

| MODEL | DHM7 | DHM8 | DHM9 | DHM10 |
|----------------------|----------|-----------|-----------|-----------|
| Working Width | 6' 9" | 8' | 9' 3" | 10' 6" |
| Number of Oval Discs | 5 | 6 | 7 | 8 |
| Blades Per Disc | 2 | | | |
| Driveline Size | Cat. 4 | | | |
| Minimum PTO HP | 40 | 46 | 52 | 56 |
| Hitch | Cat. 2 | | | |
| PTO Speed | 540 | | | |
| Safety Curtain | Standard | | | |
| Weight | 906 lb. | 1,235 lb. | 1,300 lb. | 1,400 lb. |

NOTICE:

Bush Hog Disc Mowers are intended for agricultural use. Do not operate mowers near structures that may be vulnerable to damage from thrown objects. Operating tractor should be equipped with a cab.

HOW TO ORDER:

The DHM Series Hay Mower is priced as a complete unit. Select the desired model number from the Base Unit Selection below.

Freight NOT included in list price. Freight discount available for multiple unit orders. Please contact Customer Service for details.

BASE UNIT SELECTION

| Model Number | Description | Approx. Wt. | List Price (\$US) |
|--------------|--|-------------|-------------------|
| DHM7 | DHM Series Hay Mower, 5 Discs, 2 Blades, 6' 7" Mowing Width, Complete | 906 lb. | \$9,180 |
| DHM8 | DHM Series Hay Mower, 6 Discs, 2 Blades, 8' Mowing Width, Complete | 1,235 lb. | \$12,782 |
| DHM9 | DHM Series Hay Mower, 7 Discs, 2 Blades, 9' 3" Mowing Width, Complete | 1,300 lb. | \$13,405 |
| DHM10 | DHM Series Hay Mower, 8 Discs, 2 Blades, 10' 6" Mowing Width, Complete | 1,400 lb. | \$16,640 |

RETURN TO INDEX



HT SERIES HAY TEDDER

| MODEL | HT210 | HT417 | HT417H | HT419H |
|-------------------------|-------------|--------|-----------|--------|
| Number of Rotors | 2 | 4 | | |
| Working Width (Approx.) | 10' | 17' 1" | | 19' |
| Number of Tines | 12 | 24 | | |
| Transport Width | 10' | | | 11' |
| Working Speed | 5 - 10 mph | | | |
| Minimum Tractor HP | 15 HP | 22 HP | | 25 HP |
| PTO Speed | 540 | | | |
| Folding | N/A | Manual | Hydraulic | |
| Tire Size | 16 x 6.50-8 | | | |

HOW TO ORDER:

The HT Series Hay Tedder is priced as a complete unit. Indicate your choice of model number from the Base Unit Selection in the order section below.

Freight NOT included in list price. Freight discount available for multiple unit orders. Please contact Customer Service for details.

BASE UNIT SELECTION

| Model Number | Description | Approx. Wt. | List Price (\$US) |
|--------------|---|-------------|-------------------|
| HT210 | Hay Tedder, Pull Type, 10' ***HT210 MUST BE ORDERED IN MULTIPLES OF 2*** | 385 lb. | \$3,104 |
| HT417 | Hay Tedder, Pull Type, 17', Spring-Assist Fold | 830 lb. | \$6,880 |
| HT417H | Hay Tedder, 17', Hydraulic Fold | 850 lb. | \$7,953 |
| HT419H | Hay Tedder, 19', Hydraulic Fold | 1,225 lb. | \$8,890 |

OPTIONS

| Model Number | Description | Approx. Wt. | List Price (\$US) |
|--------------|--|-------------|-------------------|
| 3670402 | Hydraulic Tilt Kits (fits HT417H, HT419H models) | 17 lb. | \$868 |

RETURN TO INDEX



XLRR-I SERIES PULL-TYPE V-RAKE

| MODEL | XLRR819 | XLRR1022 | XLRR1226 |
|-------------------------|-----------|----------|----------|
| Number of Finger Wheels | 8 | 10 | 12 |
| Finger Wheel Diameter | 55" | | |
| Tine Diameter | 7mm | | |
| Minimum Windrow Width* | 3' | | |
| Maximum Windrow Width* | 6' 7" | | |
| Minimum Working Width* | 16' 4" | 19' | 21' 8" |
| Maximum Working Width* | 18' | 21' | 24' 6" |
| Transport Width | 8' 5" | | |
| Minimum HP Requirement | 30 HP | | 50 HP |
| Tire Size | 205/75/15 | | |

*Depending on Crop Conditions

HOW TO ORDER:

The XLRR-I Series Pull-Type V-Rake is priced as a complete unit. Indicate your choice of model number from the Base Unit Selection in the order section below. Add any additional equipment from the Options section.

Freight NOT included in list price. Freight discount available for multiple unit orders. Please contact Customer Service for details.

BASE UNIT SELECTION

| Model Number | Description | Approx. Wt. | List Price (\$US) |
|--------------|-------------------------------|-------------|-------------------|
| XLRR819-1 | 8 Wheel V-Type Hay Rake, 19' | 1,675 lb. | \$7,788 |
| XLRR1022-1 | 10 Wheel V-Type Hay Rake, 22' | 1,875 lb. | \$8,655 |
| XLRR1226-1 | 12 Wheel V-Type Hay Rake, 26' | 2,115 lb. | \$9,640 |

OPTIONS

| Model Number | Description | List Price (\$US) |
|--------------|---|-------------------|
| 3690405 | Center "Kicker" Wheel Kit | \$864 |
| 3690416 | Tandem Wheel Kit | \$1,606 |
| 3690414 | Hydraulic Windrow Adjustment for XLRR819 & XLRR1022 | \$1,060 |
| 3690415 | Hydraulic Windrow Adjustment for XLRR1226 | \$1,083 |
| 3666777 | Solid Cover for 55" Center Rake Wheel (Price Per Wheel) | \$46 |

RETURN TO INDEX



EWR SERIES PULL TYPE WHEEL V-RAKE

| MODEL | EWR820 | EWR1023 |
|---------------------------|--------------|---------|
| Number of Finger Wheels | 8 | 10 |
| Windrow Width, Adjustable | 3' - 5' | |
| Working Width (Approx.) | 20' | 23' |
| Transport Width | 10' | |
| Minimum HP Requirement | 30 HP | |
| Tire Size | 195-70R/15 | |
| Operating Speed | Up to 14 MPH | |

HOW TO ORDER:

The RR Series Rotary Rake is priced as a complete unit. Indicate your choice of model number from the Base Unit Selection in the order section below.

Freight NOT included in list price. Freight discount available for multiple unit orders. Please contact Customer Service for details.

BASE UNIT SELECTION

| Model Number | Description | Approx. Wt. | List Price (\$US) |
|--------------|---|-------------|-------------------|
| EWR820 | EWR Series Economy Pull Type Wheel V-Rake, 20', 8 Wheels | 1,200 lb. | \$5,726 |
| EWR1023 | EWR Series Economy Pull Type Wheel V-Rake, 23', 10 Wheels | 1,355 lb. | \$6,324 |

OPTIONS

| Model Number | Description | List Price (\$US) |
|--------------|--|-------------------|
| 3660408 | Center Wheel (Kicker) Kit for EWR Series Pull Type Wheel V-Rake | each \$576 |
| 3666777 | Solid Cover for 55" Center Rake Wheel (Price Per Wheel) (Order one per wheel) | each \$46 |

[RETURN TO INDEX](#)



3PBS2 SERIES



3PBS1 SERIES



3PBU SERIES

| All models are available in the colors below: | |
|---|--------------------|
| Model Color Indicator | Unit Color |
| 01 | Bush Hog Red |
| 03 | John Deere Green |
| 05 | Kubota Orange |
| 14 | New Holland Blue |
| 16 | Caterpillar Yellow |

3PB SERIES 3-PT HAY IMPLEMENTS

| MODEL | 3PBS1 | 3PBS2 | 3PBU |
|-----------------------|--------------------------|-------------------------------|-------------------------------|
| Hitch (3-PT) | Cat. 1 Std., Quick Hitch | Cat. 1 & 2, Std., Quick Hitch | Cat. 1 & 2, Std., Quick Hitch |
| Tractor HP (Min.) | 35 HP | 35 HP | 35 HP |
| Overall Width | 31 7/8" | 39" | 69 1/2" |
| Overall Depth | 51" | 52" | 67" |
| Overall Height | 25 3/8" | 25 3/8" | 25 5/16" |
| Spear Size (Diameter) | 1.78" | 1.78" | N/A |
| Usable Spear Length | 42 1/2" | 42 1/2" | N/A |
| Maximum Load Capacity | 2,800 lb. | 2,800 lb. | 2,000 lb. |

HOW TO ORDER:

The 3PB Series Hay Implement is available as a 3-PT type implement only. It is priced as a complete unit and is shipped fully assembled. To receive a complete Single Probe Bale Spear, you must indicate your choice of basic unit in the order section below. To receive a complete Bale Unroller, you must indicate base unit selection, including your choice of model color from the chart above.

Freight NOT included in list price. Freight discount available for multiple unit orders. Please contact Customer Service for details.

BASE UNIT SELECTION

| Model Number | Description | Color | Approx. Wt. | List Price (\$US) |
|--------------|--|-----------------|-------------|-------------------|
| 3PBS1 | Single Probe Bale Spear, 3-Pt, Category 1 Only | Black Only | 80 lb. | \$419 |
| 3PBS2 | Single Probe Bale Spear, 3-Pt, Category 1 & 2 | Black Only | 97 lb. | \$466 |
| 3PBU-xx | 3PBU Series Bale Unroller, 3-Pt | See Table Above | 326 lb. | \$1,661 |

RETURN TO INDEX



BS SERIES BALE SPEAR

| MODEL | BS1 | BS2 |
|----------------------|--|---------|
| Overall Height | 21 ³ / ₁₆ " | 30" |
| Overall Width | 45 ⁵ / ₁₆ " | |
| Overall Depth | 51" | |
| Spear Size | 1.78" | |
| Useable Spear Length | 42 ¹ / ₂ " | |
| Weight | 144 lb. | 200 lb. |
| Max. Spear Capacity | 3,500 lb. @ 23 ¹ / ₂ " | |
| Attachment Method | Universal Skid Steer, EURO, or JD 300, 400, 500 Quick Attach | |
| Color | Black | |

HOW TO ORDER:

The BS Series Bale Spear is priced as a complete unit. Select your desired model from the Base Unit Selection offered.

Freight NOT included in list price. Freight discount available for multiple unit orders. Please contact Customer Service for details.

BS1 SERIES BASE UNIT SELECTION

| Model Number | Description | Approx. Wt. | List Price (\$US) |
|--------------|--------------------------------|-------------|-------------------|
| BS1SS | Bale Spear, Single, Skid Steer | 144 lb. | \$766 |
| BS1E | Bale Spear, Single, Euro | 144 lb. | \$862 |
| BS1JD | Bale Spear, Single, John Deere | 144 lb. | \$838 |

BS2 SERIES BASE UNIT SELECTION

| Model Number | Description | Approx. Wt. | List Price (\$US) |
|--------------|--------------------------------|-------------|-------------------|
| BS2SS | Bale Spear, Double, Skid Steer | 200 lb. | \$896 |
| BS2E | Bale Spear, Double, Euro | 200 lb. | \$972 |
| BS2JD | Bale Spear, Double, John Deere | 200 lb. | \$958 |



[RETURN TO INDEX](#)



[RETURN TO INDEX](#)

SNOW BLOWERS



SNOW BLOWERS

RETURN TO INDEX



***** THIS PRODUCT IS PRICED AT LIST LESS 25% *****

SINGLE AUGER SNOW BLOWER

| MODEL | SBSA54 | SBSA60 |
|------------------|-------------------------|---------|
| HP (Rec) | 15 HP | 20 HP |
| Cutting Width | 54" | 60" |
| Cutting Edge | 3/8 x 1 | |
| Auger Diameter | 14" | |
| Fan Diameter | 21" | |
| Chute Diameter | 8" | |
| Chute Rotation | Std/Opt | |
| Chute Deflector | Std/Opt | |
| Main Body Height | 25" | |
| 3PH Mount | Cat 1 Std & Quick Hitch | |
| Weight | 366 lb. | 396 lb. |

Five-Year Limited Gearbox Warranty. Two-Year Limited Machine Warranty.

HOW TO ORDER:

Choose a model from the Base Unit Selection to order a complete unit. The 54" and 60" models come standard with a manual chute rotator.

Freight NOT included in list price.

BASE UNIT SELECTION

| Model Number | Description | Approx. Wt. | List Price (\$US) |
|--------------|------------------------------|-------------|-------------------|
| SBSA54 | Single Auger 54" Snow Blower | 366 lb. | \$2,840 |
| SBSA60 | Single Auger 60" Snow Blower | 396 lb. | \$2,922 |

OPTIONS

| Model Number | Description | List Price (\$US) |
|--------------|---|-------------------|
| 50078918 | Hydraulic Chute Rotator (fits all models) | \$670 |
| 50078919 | Hydraulic Deflector Kit (fits SBSA54-72 models) | \$409 |

RETURN TO INDEX



***** THIS PRODUCT IS PRICED AT LIST LESS 25% *****

SINGLE AUGER SNOW BLOWER

| MODEL | SBSA72 | SBSA78 | SBSA87 | SBSA97 |
|------------------|-------------------------|-----------------------------|-------------------------|-----------|
| HP (Rec) | 35 HP | 50 HP | 60 HP | 75 HP |
| Cutting Width | 72" | 78" | 87" | 97" |
| Cutting Edge | 3/8 x 1 | 1/2 x 1½ | 1/2 x 2 | 1/2 x 2 |
| Auger Diameter | 14" | 15" | 19" | |
| Fan Diameter | 21" | 23" | 27" | |
| Chute Diameter | 10" | | 12" | |
| Chute Rotation | Opt/Opt | | | |
| Chute Deflector | Std/Opt | | | |
| Main Body Height | 29" | | 36" | |
| 3PH Mount | Cat 1 Std & Quick Hitch | Cat 1 & 2 Std & Quick Hitch | Cat 2 Std & Quick Hitch | |
| Weight | 540 lb. | 748 lb. | 1,034 lb. | 1,106 lb. |

Five-Year Limited Gearbox Warranty. Two-Year Limited Machine Warranty.

HOW TO ORDER:

Choose a model from the Base Unit Selection to order a complete unit. The 54" and 60" models come standard with a manual chute rotator.

Freight NOT included in list price.

BASE UNIT SELECTION

| Model Number | Description | Approx. Wt. | List Price (\$US) |
|--------------|------------------------------|-------------|-------------------|
| SBSA72 | Single Auger 72" Snow Blower | 540 lb. | \$3,324 |
| SBSA78 | Single Auger 78" Snow Blower | 748 lb. | \$4,118 |
| SBSA87 | Single Auger 87" Snow Blower | 1,034 lb. | \$4,631 |
| SBSA97 | Single Auger 97" Snow Blower | 1,106 lb. | \$4,845 |

GROUP 2 CHUTE ROTATOR SELECTION

| Model Number | Description | List Price (\$US) |
|--------------|--|-------------------|
| 50078913 | Manual Chute Rotator (fits SBSA72 model) | \$128 |
| 50078914 | Manual Chute Rotator (fits SBSA78 models) | \$128 |
| 50078915 | Manual Chute Rotator (fits SBSA87 and SBSA97 models) | \$128 |
| 50078918 | Hydraulic Chute Rotator (fits all models) | \$670 |

OPTIONS

| Model Number | Description | List Price (\$US) |
|--------------|--|-------------------|
| 50078919 | Hydraulic Deflector Kit (fits SBSA54-72, and SBPT60-68 models) | \$409 |
| 50078920 | Hydraulic Deflector Kit (fits SBSA78-97, SBPT78-97, and SBDA models) | \$409 |
| 50078922 | Multi-Hinged Deflector (fits SBSA78 and SBPT78 models) | \$468 |
| 50078923 | Multi-Hinged Deflector (fits SBSA87, SBSA97, and SBPT87 models) | \$479 |

RETURN TO INDEX



***** THIS PRODUCT IS PRICED AT LIST LESS 25% *****
DOUBLE AUGER SNOW BLOWER

| MODEL | SBDA108 | SBDA1108A | SBDA1108B |
|---------------------------|---|--|--|
| HP (Rec) | Up to 175 HP | | |
| RPM | 540 | 1,000 | |
| Driveline | 1 ³ / ₈ 6 Tractor End | 1 ³ / ₈ 21 Tractor End | 1 ³ / ₄ 20 Tractor End |
| Cutting Width | 108" | | |
| Cutting Edge | 1/2 x 6 | | |
| Auger Diameter | 19" (x1) 15" (x1) | | |
| Fan Diameter | 32" | | |
| Chute Diameter | 13" | | |
| Chute Rotation | Hydraulic | | |
| Chute Deflector (Man/Hyd) | Std/Opt | | |
| Main Body Height | 43" | | |
| 3PH Mount | Cat 2 and 3 Std & Quick Hitch | | |
| Weight | 1,980 lb. | | |

Five-Year Limited Gearbox Warranty. Two-Year Limited Machine Warranty.

HOW TO ORDER:

Choose a model from the Base Unit Selection to order a complete unit.

Freight NOT included in list price.

BASE UNIT SELECTION

| Model Number | Description | Approx. Wt. | List Price (\$US) |
|--------------|--|-------------|-------------------|
| SBDA108 | Double Auger 108" Snow Blower 540 1-3/8 6 PTO | 1,980 lb. | \$8,968 |
| SBDA1108A | Double Auger 108" Snow Blower 1,000 1-3/8 21 PTO | 1,980 lb. | \$11,651 |
| SBDA1108B | Double Auger 108" Snow Blower 1,000 1-3/4 20 PTO | 1,980 lb. | \$11,771 |

OPTIONS

| Model Number | Description | List Price (\$US) |
|--------------|--|-------------------|
| 50078920 | Hydraulic Deflector Kit (fits SBSA78-97, SBPT78-97, and SBDA models) | \$409 |
| 50078924 | Multi-Hinged Deflector (fits SBDA models) | \$502 |

RETURN TO INDEX

NEW
Models for
Winter
2020



***** THIS PRODUCT IS PRICED AT LIST LESS 25% *****

PULL TYPE SNOW BLOWER

| MODEL | SBPT60 | SBPT68 | SBPT78 | SBPT87 | SBPT97 |
|---------------------------|-------------------|-----------|-------------------|-----------|-----------|
| HP (Rec) | 25 HP | 35 HP | 50 HP | 60 HP | |
| Cutting Width | 60" | 68" | 78" | 87" | 97" |
| Cutting Edge | Bolt On, 1/2"x 4" | | | | |
| Auger Diameter | 14" | | 15" | 19" | 19" |
| Fan Diameter | 18" | 21" | 23" | 27" | 27" |
| Chute Diameter | 8" | 10" | | 12" | |
| Chute Rotation (Man/Hyd) | Std./Opt. | Opt./Opt. | | | |
| Chute Deflector (Man/Hyd) | Std./Opt. 6" Cyl. | | Std./Opt. 8" Cyl. | | |
| Main Body Height | 25" | | 28" | 32 1/2" | |
| 3PH Mount | Cat. 1 | | Cat. 1 & 2 | | Cat. 2 |
| Weight | 495 lb. | 671 lb. | 900 lb. | 1,175 lb. | 1,225 lb. |

Five-Year Limited Gearbox Warranty. Two-Year Limited Machine Warranty.

HOW TO ORDER:

To order a complete unit, choose a base unit then either a manual or hydraulic chute rotator from Group 2 below. Note only the SBPT60 comes equipped with a manual chute rotator standard.

Freight NOT included in list price.

BASE UNIT SELECTION

| Model Number | Description | Approx. Wt. | List Price (\$US) |
|--------------|---------------------------|-------------|-------------------|
| SBPT60 | Pull Type 60" Snow Blower | 495 lb. | \$4,090 |
| SBPT68 | Pull Type 68" Snow Blower | 671 lb. | \$4,525 |
| SBPT78 | Pull Type 78" Snow Blower | 900 lb. | \$5,345 |
| SBPT87 | Pull Type 87" Snow Blower | 1,175 lb. | \$6,952 |
| SBPT97 | Pull Type 97" Snow Blower | 1,225 lb. | \$7,295 |

GROUP 2 SELECTION

| Model Number | Description | List Price (\$US) |
|--------------|--|-------------------|
| 50081957 | Manual Chute Rotator (fits SBPT68 model) | \$128 |
| 50078916 | Manual Chute Rotator (fits SBPT78 model) | \$128 |
| 50078917 | Manual Chute Rotator (fits SBPT87 and SBPT97 models) | \$128 |
| 50078918 | Hydraulic Chute Rotator (fits all models) | \$670 |



RETURN TO INDEX

OPTIONS

| Model Number | Description | List Price (\$US) |
|--------------|--|-------------------|
| 50078919 | Hydraulic Deflector Kit (fits SBSA54-72, and SBPT60-68 models) | \$409 |
| 50078920 | Hydraulic Deflector Kit (fits SBSA78-97, SBPT78-97, and SBDA models) | \$409 |
| 50081958 | Rear Mounted Blade (fits SBPT60 model) | \$695 |
| 50081959 | Rear Mounted Blade (fits SBPT68 model) | \$812 |
| 50078925 | Rear Mounted Blade (fits SBPT78 model) | \$917 |
| 50078926 | Rear Mounted Blade (fits SBPT87 model) | \$1,049 |
| 50081960 | Rear Mounted Blade (fits SBPT97 model) | \$1,078 |
| 50081964 | 60" Back Drag Kit | \$378 |
| 50081961 | 60" Tivar Scraper Blade and Skid Shoe Kit | \$447 |
| 50081965 | 68" Back Drag Kit | \$392 |
| 50081962 | 68" Tivar Scraper Blade and Skid Shoe Kit | \$506 |
| 50079573 | 78" Back Drag Kit | \$514 |
| 50079575 | 78" Tivar Scraper Blade and Skid Shoe Kit | \$409 |
| 50079574 | 87" Back Drag Kit | \$548 |
| 50079576 | 87" Tivar Scraper Blade and Skid Shoe Kit | \$445 |
| 50081966 | 97" Back Drag Kit | \$518 |
| 50081963 | 97" Tivar Scraper Blade and Skid Shoe Kit | \$630 |
| 50079132 | Optional Hydraulic Lift Kit | \$733 |

RETURN TO INDEX



***** THIS PRODUCT IS PRICED AT LIST LESS 25% *****

SKIDSTEER SNOW BLOWER

| MODEL | SBSS760 SERIES |
|---------------------------|----------------------------|
| Cutting Width | 76" |
| Cutting Edge | 1/2 x 3 |
| Auger | 19" |
| Tube | 3" Square |
| Flighting | 5/16 x 2¼ |
| Auger Diameter | 19" |
| GPM (Min) | 14 |
| Mounting | Universal Skidsteer Attach |
| Chute Rotation | Hydraulic |
| Chute Diameter | 11" |
| Chute Deflector (Man/Hyd) | Std/Opt |
| Main Body Height | 31" |
| Fan Diameter | 32" |
| Fan Shaft | 2" Diameter |
| Weight | 950 lb. |

HOW TO ORDER:

Choose a model from the Base Unit Selection to order a complete unit.

Freight NOT included in list price.

BASE UNIT SELECTION

| Model Number | Description | Approx. Wt. | List Price (\$US) |
|--------------|-------------------------------------|-------------|-------------------|
| SBSS760 | Skidsteer 76" Snow Blower 14-17 GPM | 950 lb. | \$8,461 |
| SBSS761 | Skidsteer 76" Snow Blower 18-20 GPM | 950 lb. | \$8,461 |
| SBSS762 | Skidsteer 76" Snow Blower 20-22 GPM | 950 lb. | \$8,461 |
| SBSS763 | Skidsteer 76" Snow Blower 23-26 GPM | 950 lb. | \$10,580 |
| SBSS764 | Skidsteer 76" Snow Blower 27-33 GPM | 950 lb. | \$10,580 |
| SBSS765 | Skidsteer 76" Snow Blower 33-40 GPM | 950 lb. | \$10,655 |

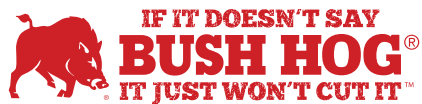

RETURN TO INDEX

| OPTIONS | | |
|---------------------|--|--------------------------|
| Model Number | Description | List Price (\$US) |
| 50078921 | Hydraulic Deflector Kit (fits SBSS models) | \$370 |
| 50078927 | 7 Pin Wire Kit - Bobcat | \$2,010 |
| 50078928 | 8 Pin Wire Kit - Cat | \$382 |
| 50078929 | 8 Pin Wire Kit - Terrex | \$382 |
| 50078930 | 14 Pin Wire Kit - Gehl/Case/NH/JCB/Volvo | \$382 |
| 50078931 | 14 Pin Wire Kit - JD | \$382 |

RETURN TO INDEX

NEW
for
**Winter
2020**



***** THIS PRODUCT IS PRICED AT LIST LESS 25% *****
LOADER MOUNT SNOW BLOWER

| MODEL | SBLM66 | SBLM66HD | SBLM76 | SBLM76HD | SBLM86 | SBLM86HD |
|----------------------|--|----------|--------|----------|--------|----------|
| Cutting Width | 66" | | 76" | | 86" | |
| HP (Rec) | 40 - 60 HP | | | | | |
| Cutting Edge | 3/8" x 3" | | | | | |
| Skid Shoes | 3/8" x 1 1/2" | | | | | |
| Auger Diameter | 19" | | | | | |
| Auger Flighting | 5/16" x 2 1/4" | | | | | |
| Auger Tube | 3 1/2" OD | | | | | |
| Fan Diameter | 26" | | | | | |
| Chute Diameter | 12" | | | | | |
| Chute Rotation | Hydraulic | | | | | |
| Chute Deflector | Hydraulic | | | | | |
| Main Body Height | 31" | | | | | |
| Loader Mount - Hitch | Universal Skid Steer, EURO (ALO), or JD 440/540 Quick Attach | | | | | |

Five-Year Limited Gearbox Warranty. Two-Year Limited Machine Warranty.

HOW TO ORDER:

To order a complete unit, choose a base unit with desired powerpak, and one of the no charge mounting kits from the selections below. Approximate weights shown are for loader mounted snow blowers and rear mounted PowerPaks. Additional mounting kits available for purchase in the options below.

Freight NOT included in list price.

BASE UNIT SELECTION

| Model Number | Description | "Approx. Weight Blower / Pak" | List Price (\$US) |
|--------------|--|-------------------------------|-------------------|
| SBLM66 | Loader Mount 66" Snow Blower, w/2-HR Duty PowerPak | 970 lb. / 535 lb. | \$16,415 |
| SBLM66HD | Loader Mount 66" Snow Blower, w/Full Duty PowerPak | 970 lb. / 575 lb. | \$19,450 |
| SBLM76 | Loader Mount 76" Snow Blower, w/2-HR Duty PowerPak | 1,015 lb. / 535 lb. | \$16,805 |
| SBLM76HD | Loader Mount 76" Snow Blower, w/Full Duty PowerPak | 1,015 lb. / 575 lb. | \$19,876 |
| SBLM86 | Loader Mount 86" Snow Blower, w/2-HR Duty PowerPak | 1,065 lb. / 535 lb. | \$17,025 |
| SBLM86HD | Loader Mount 86" Snow Blower, w/Full Duty PowerPak | 1,065 lb. / 575 lb. | \$20,138 |

GROUP 2 SELECTION - MOUNTING KIT (Choose One at No Charge - Included in Base Unit Pricing)



| Model Number | Description | List Price (\$US) |
|--------------|---|-------------------|
| 50081967NC | Quick Attach Mounting Kit, Universal Skid Steer | No Charge |
| 50081968NC | Quick Attach Mounting Kit, EURO (ALO) | No Charge |
| 50081969NC | Quick Attach Mounting Kit, JD 440/540 | No Charge |



OPTIONS (Additional Mounting Kits Available to Purchase)



| Model Number | Description | List Price (\$US) |
|--------------|---|-------------------|
| 50081967 | Quick Attach Mounting Kit, Universal Skid Steer | \$515 |
| 50081968 | Quick Attach Mounting Kit, EURO (ALO) | \$662 |
| 50081969 | Quick Attach Mounting Kit, JD 440/540 | \$712 |



RETURN TO INDEX

WHEEL & TIRE SELECTION GUIDE

| WHEEL / TIRE MODEL NUMBER | | | | | | PROFILE | TREAD |
|----------------------------------|---------------|-------------|-------------|-------------|-------------|--|---|
| 294 | | | | | |  |  |
| DESCRIPTION | | | | | | | |
| 20" Laminated Tire | | | | | | | |
| AVAILABLE ON THESE MODELS | | | | | | | |
| BH416 | 2308 | 3510 | 1815 | 2815 | 4815 | | |
| BH417 | 2310 | 3514 | 2215 | 3810 | 2820 | | |
| BH516 | 3308-2 | 1812 | 2810 | 3815 | | | |

| WHEEL / TIRE MODEL NUMBER | | | | | | PROFILE | TREAD |
|--|--|--|--|--|--|---|--|
| 97708 | | | | | |  |  |
| DESCRIPTION | | | | | | | |
| Pneumatic Aircraft Tire, 24 x 7.7 x 10 | | | | | | | |
| AVAILABLE ON THESE MODELS | | | | | | | |
| 1815 | | | | | | | |

| WHEEL / TIRE MODEL NUMBER | | | | | | PROFILE | TREAD |
|----------------------------------|-------------|-------------|-------------|-------------|--|--|---|
| 50050727 | | | | | |  |  |
| DESCRIPTION | | | | | | | |
| Used Aircraft Tire, 29 x 9 x 15 | | | | | | | |
| AVAILABLE ON THESE MODELS | | | | | | | |
| 2310 | 3510 | 2810 | 3810 | 4815 | | | |
| 3308-2 | 2215 | 2815 | 3815 | 2820 | | | |

| WHEEL / TIRE MODEL NUMBER | | | | | | PROFILE | TREAD |
|--|-------------|-------------|-------------|--|--|--|---|
| 50068834 | | | | | |  |  |
| DESCRIPTION | | | | | | | |
| Foam Filled Aircraft Tire, 26 x 6.6 x 14 | | | | | | | |
| AVAILABLE ON THESE MODELS | | | | | | | |
| 2215 | 2815 | 3815 | 2820 | | | | |
| 2810 | 3810 | 4815 | | | | | |



[RETURN TO INDEX](#)



WHEEL & TIRE SELECTION GUIDE

| WHEEL / TIRE MODEL NUMBER | PROFILE | TREAD |
|--|--|---|
| 50072403 |  |  |
| DESCRIPTION | | |
| Used Aircraft Tire, 27.75 x 8.75-24PR | | |
| AVAILABLE ON THESE MODELS | | |
| 2215 2810 2815 3810 3815 4815 2820 | | |
| 50074504 |  |  |
| DESCRIPTION | | |
| Used Aircraft Tire, 20.5 x 6.75-10 | | |
| AVAILABLE ON THESE MODELS | | |
| 1812 | | |
| 50074505 |  |  |
| DESCRIPTION | | |
| Used Aircraft Tire, Foam Filled, 20.5 x 6.75-10 | | |
| AVAILABLE ON THESE MODELS | | |
| 1812 | | |
| 50075401 |  |  |
| DESCRIPTION | | |
| 25" Laminated Tire | | |
| AVAILABLE ON THESE MODELS | | |
| 3510 2810 3810 4815 2215 2815 3815 2820 | | |

RETURN TO INDEX

WHEEL & TIRE SELECTION GUIDE

| WHEEL / TIRE MODEL NUMBER | PROFILE | TREAD | | | | | | | | | | |
|---|--|---|---------------|-------------|-------------|-------------|-------------|-------------|-------------|-------------|-------------|-------------|
| 50078502 |  |  | | | | | | | | | | |
| DESCRIPTION | | | | | | | | | | | | |
| Foam-Filled Tire, 27 x 8-18 | | | | | | | | | | | | |
| AVAILABLE ON THESE MODELS | | | | | | | | | | | | |
| <table border="0"> <tr> <td>3308-2</td> <td>1815</td> <td>2815</td> <td>4815</td> </tr> <tr> <td>3510</td> <td>2215</td> <td>3810</td> <td>2820</td> </tr> <tr> <td>3514</td> <td>2810</td> <td>3815</td> <td></td> </tr> </table> | | | 3308-2 | 1815 | 2815 | 4815 | 3510 | 2215 | 3810 | 2820 | 3514 | 2810 |
| 3308-2 | 1815 | 2815 | 4815 | | | | | | | | | |
| 3510 | 2215 | 3810 | 2820 | | | | | | | | | |
| 3514 | 2810 | 3815 | | | | | | | | | | |

| WHEEL / TIRE MODEL NUMBER | PROFILE | TREAD | | | | | | | | |
|--|---|--|--------------|---------------|--------------|--------------|---------------|--------------|--------------|--------------|
| 500BH |  |  | | | | | | | | |
| DESCRIPTION | | | | | | | | | | |
| 15 ½" Solid Laminated Tire | | | | | | | | | | |
| AVAILABLE ON THESE MODELS | | | | | | | | | | |
| <table border="0"> <tr> <td>BH215</td> <td>BH217</td> <td>BH316</td> <td>SQ84T</td> <td>3308-2</td> </tr> <tr> <td>BH216</td> <td>BH315</td> <td>BH317</td> <td>2308</td> <td>3308SH</td> </tr> </table> | | | BH215 | BH217 | BH316 | SQ84T | 3308-2 | BH216 | BH315 | BH317 |
| BH215 | BH217 | BH316 | SQ84T | 3308-2 | | | | | | |
| BH216 | BH315 | BH317 | 2308 | 3308SH | | | | | | |

NOTES



IF IT DOESN'T SAY
BUSH HOG®
IT JUST WON'T CUT IT™

2501 Griffin Avenue, Selma, Alabama 36703

Tel: 800-363-6096 | Fax: 334-874-2701



BushHog.com



CONTENT DISCLAIMER:

The products and information contained in this literature are subject to change without notice. Bush Hog® reserves the right to improve our products and make changes to specifications, designs, and standard equipment without notice. For additional product information, please visit Bush Hog®'s website or see your dealer for complete details.