



**STOCK
EXTERIOR
DOORS**



MASONITE[®]

DOORS

Masonite is committed to delivering unsurpassed performance in exterior and interior doors and glass products. We provide much more than a door; we deliver a total experience, giving you a complete line of products, services and support tools designed to enhance curb appeal and the interior aesthetics of a home.

We are your leading source for the latest trend insights and design ideas, delivering distinctive doors that complement any style and personal taste. From the classic lines of our Heritage Series, to the wide-open views of our VistaGrande collection, we offer a breadth of exterior doors to meet any design, performance and material need. It's never been easier to find the perfect door for your home.



Cleary Millwork is a proud distributor of Masonite doors to lumberyards across New England and New York.



BRIGHTEN YOUR HOME FROM FRONT TO BACK

VISTAGRANDE[®] EXTERIOR DOORS p18



Distinct Glass Collections //	2
How to Choose Your Door //	4
Exterior Door Collections //	10
Masonite [®] Codes Defined //	12
Masonite [®] Door Collections //	13
VistaGrande [®] Flush-Glazed //	19
Heritage Series [™] //	25
Modern Door Collection //	34
Masonite Expo [™] //	39
Masonite Iron [™] //	69
Masonite Classic [™] //	79
Masonite Textures [™] //	101
Masonite Linea [™] //	107
(Clear glass with grids)	
Masonite Essentia [™] //	117
(Clear glass)	
French Patio Doors //	128
Swing Patio Doors //	130
Transoms //	136
Steel Fire Doors //	137
Fast-Frame [™] //	140
ENERGY STAR //	142
Storm Guard [™] //	144
Rough Openings //	146
Fire-Rated/ADA/STC //	148
Door Handing Chart //	150
Warranty //	151
Cleary Door System //	152
Endura //	155
Entry Door Hardware //	158
Prefinishing //	160
Exterior Door Options //	162

Distinct Glass Collections

FOR EVERY STYLE

DOOR COLLECTIONS

DURABLE. AUTHENTIC. VERSATILE.



VISTAGRANDE.

BRIGHTEN YOUR HOME FROM FRONT TO BACK



HERITAGE SERIES™

AUTHENTIC CRAFTSMAN DETAIL

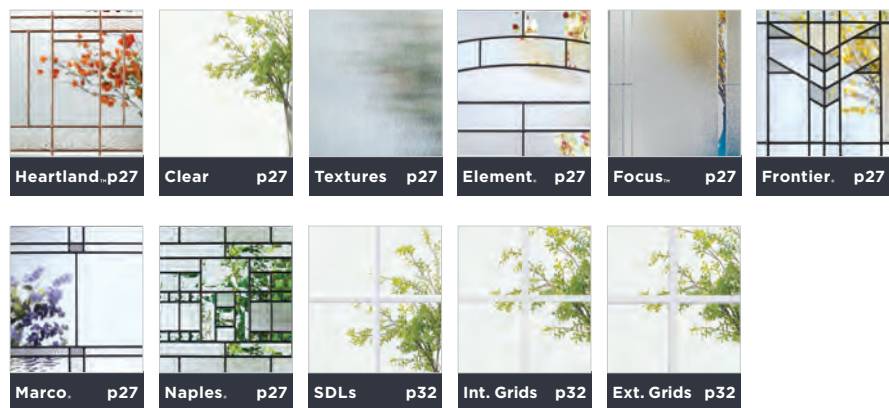

MODERN DOOR

CONTEMPORARY MINIMALISTIC DESIGNS

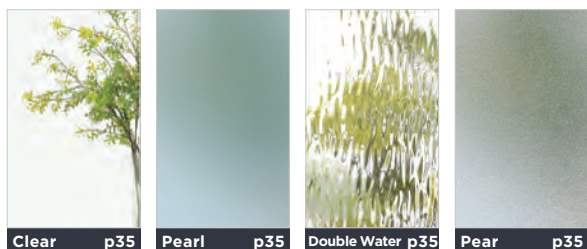

From the authentic charm of the Masonite Heritage Series™ to the sleek artistry of the Masonite Expo. series, it has never been easier to find the door to complement your design vision. Choose from hundreds of panel and glass combinations or opt for one of our panel door options.



BELLEVILLE.
THE ORIGINAL FIBERGLASS

HD STEEL
READY TO PAINT

EXPO

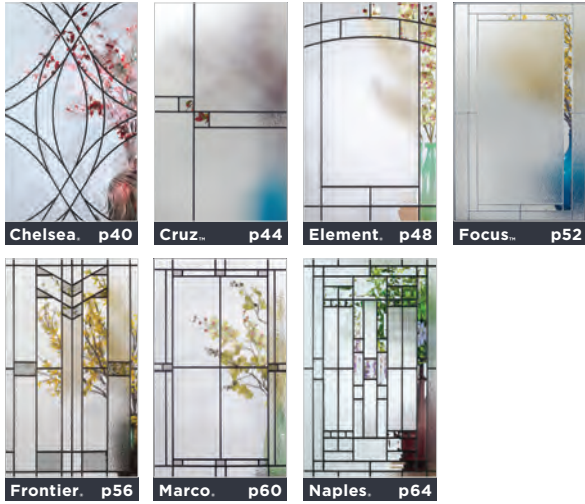

IRON

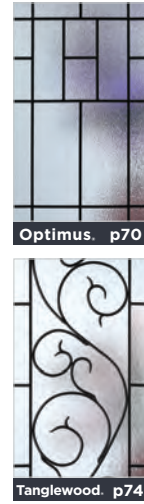

CLASSIC



TEXTURES

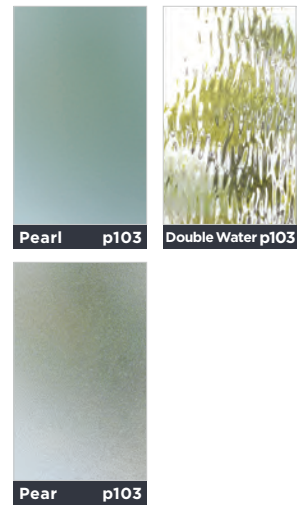

LINEA



ESSENTIA



How to Choose Your Door

USE THESE SIMPLE STEPS TO CHOOSE YOUR DREAM DOOR

1

CHOOSE YOUR GLASS

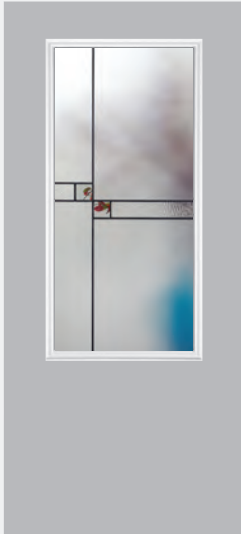

Shown: Cruz- from EXPO glass collection

EXPO // p39

ARTISTIC | CONTEMPORARY | SLEEK



Chelsea, / 341



Cruz, / 661



Element, / 328



Focus, / 627



Frontier, / 312



Marco, / 331



Naples, / 366

IRON // p69

SOLID | BOLD | STYLISH



Optimus, / 928



Tanglewood, / 686

2

CHOOSE YOUR MATERIAL

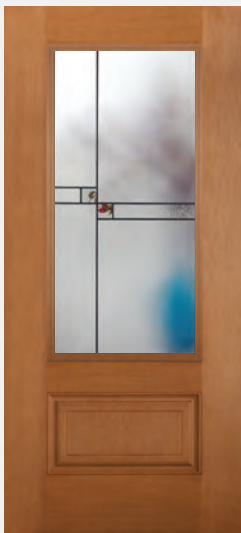

Shown: Belleville, Fir Textured Fiberglass

TEXTURED FIBERGLASS

Designed with the characteristics of real wood doors, but with superior durability and low maintenance.



Belleville, Mahogany Textured Fiberglass / BMT



Belleville, Fir Textured Fiberglass / BFT



Belleville, Oak Textured Fiberglass / BLT

CLASSIC // p79

ELEGANT | TRADITIONAL | TIMELESS



Alston, / 338



Georgian, / 515 / 517



Panama, / 724/ 725



Rozet, / 467



Sonnet, / 472

TEXTURES // p101

NATURAL | BALANCED | ORGANIC



Double Water / 113



Pear / 116



Pearl / 140

LINEA // p107

ORIGINAL | BALANCED | STRAIGHT



SDLs



Internal Grids



External Grids

ESSENTIA // p117

FUNCTIONAL | CLEAR



Clear / 010



Mini Blinds



Vents

SMOOTH FIBERGLASS

Smooth finish that's perfect for painting.



Belleville, Smooth Fiberglass / BLS

STEEL

Strong, secure and affordable in a variety of styles.



Masonite, HD Steel / MHD

3 Continued On Next Page

How to Choose Your Door

USE THESE SIMPLE STEPS TO CHOOSE YOUR DREAM DOOR

3

CHOOSE YOUR FRAME SYSTEM

See more on page 8 - 9

GOOD

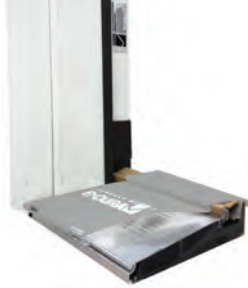

STANDARD FORCE 5 FRAME SYSTEM

- JAMB** FJ Primed Endura. jamb system
- CASING** FJ Primed exterior casing
- SILL** Endura. Z-AC self-adjusting articulating sill with sill cover (aluminum finish). Made up of all-composite substrates and synthetic caps and nosing. Includes construction cover.



BETTER

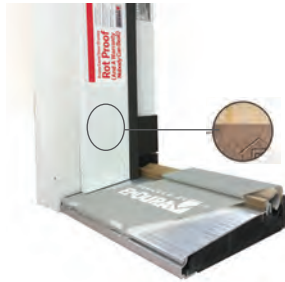

FORCE 5 SYSTEM WITH LIFETIME FRAMESAVER.

- JAMB** FrameSaver. jamb with a wood composite material that's so resistant to rot and insect damage, it's guaranteed for life with FrameSaver's transferable lifetime warranty.
- CASING** FrameSaver.
- SILL** Endura. Z-AC self-adjusting articulating sill with sill cover (aluminum finish). Made up of all-composite substrates and synthetic caps and nosing. Includes construction cover.



also available in ready-to-stain

FORCE 5 FULL COMPOSITE FRAME SYSTEM

- JAMB** Stocked in prefinished white capped, primed white or ready to stain. This poly-fiber door frame system combines the strength of wood and the enhanced properties that make it moisture, rot and insect resistant. A unique formulation means the frames will not absorb or wick moisture, and will never warp or rot. Combined with our Endura. System and our PVC casing options carries a limited lifetime warranty
- CASING** PVC Brickmould
- SILL** Endura Z-AC self-adjusting articulating sill with sill cover (aluminum finish). Made up of all-composite substrates and synthetic caps and nosing. Includes construction cover.



BEST



NORTH ATLANTIC SERIES UPGRADE

Includes all the features of our Force 5 Entry System, with Lifetime FrameSaver./Composite Jamb

- PLUS** Endura. VersaPan™. Sill Pan system
Trilennium™. multipoint lock system
2-year peace-of-mind guarantee



4 CHOOSE YOUR HINGES

You may want to match your hinge finish to other hardware hinges in your home, the coming color in your decorative glass, or to your handle set (or better yet, to all of these). We make it easy with 6 different hinge finishes to choose from.

*Ball bearing standard on fiberglass doors.



5 CHOOSE YOUR TRIM

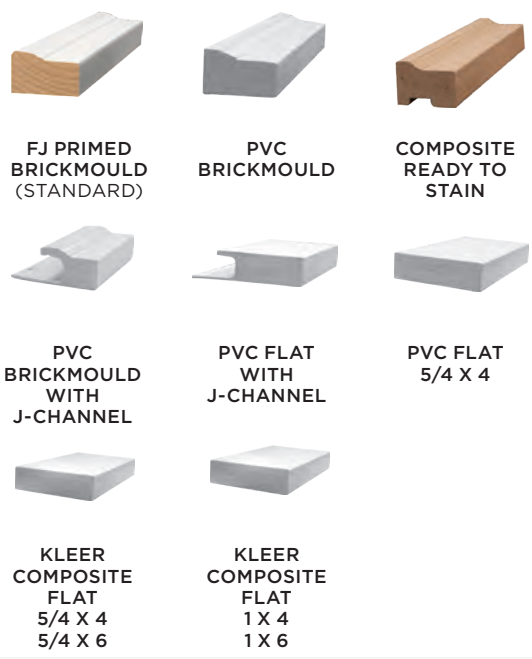

6 CHOOSE YOUR FINISHING OPTION

GOOD: DIY FINISHING

SMOOTH FIBERGLASS & HD STEEL
Factory primed surface can be finished with oil-based or acrylic paint.

TEXTURED FIBERGLASS
The fiberglass staining kit from Masonite comes with everything you need to achieve a quality stained finish.

DIY colors are not the same as Fortress factory finish colors.



BEST: FORTRESS PREFINISHED

Let us save a step for you! Our Fortress Coating Systems™ prefinished doors offer a superior finish over site finished doors and come with a Fortress Coating 10 year warranty.

Available in 13 standard paint and 22 stain colors, and an unlimited array of special order colors.



Door Systems Synergy+

WHEN THE INDUSTRY'S BEST WORK TOGETHER, YOU GET MORE

Because so much happens here beyond just opening and closing, Cleary is combining state of the art Endura technology with the trusted dependability and beauty of Masonite doors for a quality door system you can count on.

+ TIMELESS DURABILITY & PERFORMANCE

From weather stripping to locking hardware, every component works together to protect against the elements, improve performance and increase energy efficiency.

+ TESTED TO EXCEED EXPECTATIONS

Each door system is independently tested to ensure that it will consistently protect your home from whatever life throws its way.

+ BUILT WITH THE BEST, BY THE BEST

Beautiful Masonite door panels and glass paired with innovative Endura components, all built by Cleary in accordance with our commitment to consistent quality.

+ Consistent Quality + First Impressions + Lasting Impressions + Protection



IT'S MORE THAN JUST CHOOSING A DOOR...

these components are part of an Entry Door System designed to work together for reliably and efficiently.



DOOR SYSTEM SYNERGY

Look for the tag.

POWERED BY
ENDURA

Tested.
Certified.
Warranted.



1 FRAMESAVER® JAMB

Bottom portion of the legs of the jamb are comprised of a wood composite material that's resistant to rot and insect damage. It's guaranteed for life with FrameSaver's Transferable Lifetime Warranty.



2 Z-ARTICULATING CAP SILL

No adjustment needed. The cap can move up, or down, to maintain contact with the door bottom and preserve the seal. With the Z-AC at work, you are constantly protected from the weather and potentially costly damage.



3 VERSAPAN™ SILL PAN

VersaPan- Sill Pan sloped channel plate beneath sill to drain away water accumulation through integrated drainage system. Precision interlocking end caps fit channel plate for perfect fit every time.



4 TRILENNIUM. MULTI-POINT LOCKING HARDWARE

Multi-point hardware system provides more than just security, it offers homeowners better door closure and sealing than a single-point lock. Includes eclipse handle set in your choice of brass, satin nickel, or victorian bronze.



5 FORCE 5™ WEATHERSTRIPPING

Proud edge weatherstripping and corner pads sit wider on the door panel for a tighter seal against the elements. Our low wick foam formulation has been modified to provide a combination of closed-cell and open-cell structure. The patented design increases contact with the door edge for up to 10% greater performance. Low Wick™ foam limits water absorption by 50% for greater durability.

1

2

3

4

5

Exterior Door Collections

AT A GLANCE

VISTAGRANDE.

BRIGHTEN YOUR HOME
FROM FRONT TO BACK



TEXTURED

SMOOTH



Fir

Smooth

HERITAGE SERIES.

AUTHENTIC CRAFTSMAN DETAIL



TEXTURED

SMOOTH



Fir

Smooth

- ▶ VistaGrande. Flush-Glazed doors offer a wider viewing area and cleaner appearance over traditional glass inserts. Stile and rail features provide an authentic wood door look.

- ▶ Heritage Series. Craftsman door designs are available as opaque in both 6'8" and 8'0" applications to provide privacy and security or add one of the designs from our Heritage Series. decorative glass collection.

Our dedication to superior craftsmanship allows us to deliver unsurpassed quality and value in both fiberglass and steel entry doors. We offer a comprehensive selection of door styles, finishes and decorative glass options—all crafted with exacting attention to detail.



BELLEVILLE.

THE ORIGINAL FIBERGLASS



TEXTURED

SMOOTH



Mahogany Oak Fir Smooth (shown in beige)

HD STEEL

READY TO PAINT

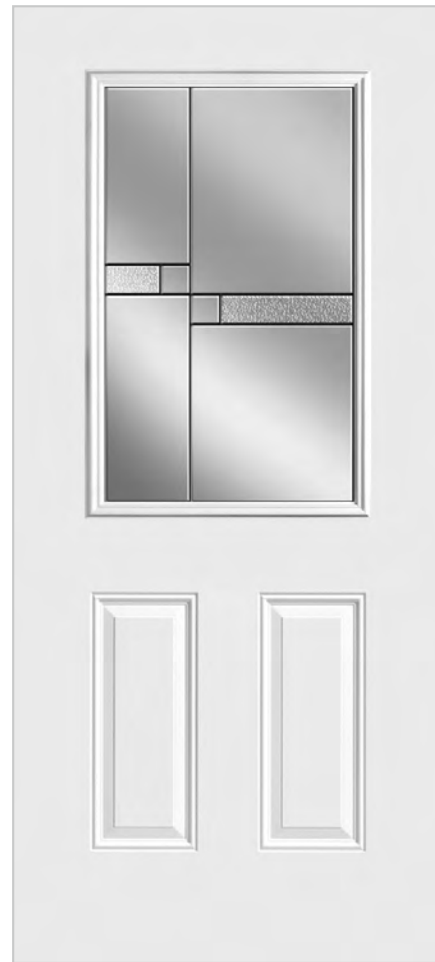

HD Steel

► Belleville. doors feature distinct architectural details, a reinforced lock area and thousands of customizable glass and panel combinations.

► Masonite. HD Steel doors come primed and ready to paint. These doors feature high-definition decorative panel profiles that closely replicate the appearance of a high-end wood door with the ultimate security.

Masonite Codes Defined

HOW TO CONFIGURE A DOOR CODE



SL = sidelite

BMTSL-450-341-1

BMT-404-341-1

DOOR MATERIAL

BMT

GLASS SHAPE & SIZE

404









GLASS DESIGN & CAMING

341







VISIBLE DOOR PANELS

1

DOOR MATERIAL

	VistaGrande. Flush-Glazed Fiberglass VFT Fir Textured		BFT Belleville. Fir Textured Fiberglass
	VistaGrande. Flush-Glazed Fiberglass VSG Smooth Fiberglass		BLT Belleville. Oak Textured Fiberglass
	Heritage Series. Craftsman Fiberglass HFT Fir		BMT Belleville. Mahogany Textured Fiberglass
	Heritage Series. Craftsman Fiberglass HGS Smooth		BLS Belleville. Smooth Fiberglass
	MHD Masonite. High-Definition Steel		

GLASS LITE & SHAPE

					
Rectangle Lite	Camber-Top Lite	Round-Top Lite	Oval Lite	Fan Lite	Camber-Top Fan Lite

106	22" x 36"	Rectangle	300	19" x 56½"	Oval
107	22" x 37½"	Camber-Top	304	16" x 40¾"	3/4 Oval
108	20" x 20"	Rectangle	404	22" x 48"	Rectangle
114	14" x 64"	Rectangle	420	20" x 48"	Rectangle
120	20" x 64"	Rectangle	426	26" x 48"	Rectangle
122	22" x 64"	Rectangle	450	8" x 48"	Rectangle
126	26" x 36"	Rectangle	617	9" x 17"	Rectangle
129	8" x 36"	Rectangle	626	26" x 74"	Rectangle
135	22" x 10"	Fan	680	8" x 6"	Rectangle
137	22" x 10"	Camber-Top Fan	682	8" x 8"	Rectangle
151	8" x 64"	Rectangle	726	26" x 68"	Rectangle
152	7" x 64"	Rectangle	810	22" x 80"	Rectangle
155	6" x 64"	Rectangle	814	14" x 80"	Rectangle
160	20" x 36"	Rectangle	820	20" x 80"	Rectangle
203	8" x 42"	Round-Top	826	26" x 80"	Rectangle
217	22" x 17"	Rectangle	852	8" x 80"	Rectangle
228	22" x 10"	Rectangle	926	26" x 64"	Rectangle

GLASS DESIGN & CAMING



AB Antique Black
BZ Antique Bronze
P Platinum
B Brass

PRIVACY RATING

1 **3** **10**
Least Obscure Most Obscure

VISIBLE DOOR PANELS

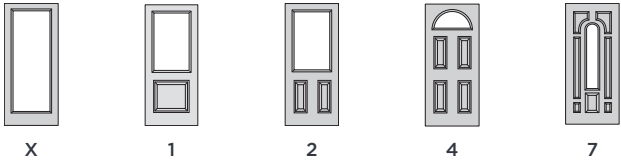

X 1 2 4 7

Sample selection of door panels shown



MASONITE

DOOR COLLECTIONS



VistaGrande. Smooth Flush-Glazed Doors with Clear Glass
Doors VSG-926-010-X

VISTAGRANDE.

HERITAGE SERIES™

MODERN

Masonite Door Collections14

VistaGrande, Flush-Glazed Doors18

Heritage Series™, Craftsman Doors 24

Modern Door Collection34

DOOR COLLECTIONS



Masonite, HD Steel 2 Panel Square / Door MHD-2ST Sidelites MHDSL-129-010-1 Transom T-010

Masonite's door collections deliver the ultimate in privacy and security in exterior doors. Our panel doors also feature an insulated inner core that helps reduce energy costs. Choose from a wide array of panel designs and sizes in both steel and fiberglass to find the perfect solution for any exterior application—from the front entryway to the back door.



DOOR COLLECTIONS

VISTAGRANDE™

HERITAGE SERIES™

MODERN



Belleville, Mahogany, Cheyenne. / Door BMT-2P

DOOR COLLECTIONS

HERITAGE SERIES, FIBERGLASS



HFT
Heritage Fir
Textured
Fiberglass



HFT-3C



HFT-3C



HGS
Heritage
Smooth
Fiberglass



HGS-3C



HGS-3C

6'8"		8'0"	
	3C		3C
HFT	•		•
HGS	•		•

BELLEVILLE, TEXTURED FIBERGLASS



BMT
Mahogany
Fiberglass



BMT-2P



BMT-6



BFT
Fir
Fiberglass



BFT-6



BLT
Oak
Fiberglass



BLT-2ST



BLT-4NE



BLT-6

BELLEVILLE, SMOOTH FIBERGLASS



BLS
Smooth
Fiberglass



BLS-X



BLS-2ST



BLS-2RO



BLS-2P



BLS-4NE



BLS-6



BLS-6



BLS-6

STEEL DOORS



MHD
HD Steel



MHD-X



MHD-X



MHD-2ST



MHD-2ST



MHD-2RO



MHD-3C



MHD-4NE



MHD-6



MHD-6



▶ VistaGrande. Fir Textured Flush-Glazed Doors with Clear Glass and Applied 3-1/2" SDL Bars
 Door VFT-926-010-S04W-X / Sidelite VFTSL-151-140-1

Masonite VistaGrande. exterior doors create a better living environment by bringing more natural light into any home. Available in a number of glass, SDL and internal grid options, VistaGrande. doors offer a wider viewing area and cleaner appearance over traditional glass inserts.

GLASS OPTIONS:



Clear / 010

OPTIONS:



VistaGrande.
 Fir / VFT



VistaGrande.
 Smooth / VSG

INTERNAL GRID OPTIONS:



TYPE D

▶ 5/8" WHITE GEORGIAN
 TYPE D



VISTAGRANDE

BRIGHTEN YOUR HOME FROM FRONT TO BACK



VistaGrande, Smooth Flush-Glazed Door with Clear Glass
Doors VSG-926-010-X

Clear Glass	20
Internal Grids	21
Mini Blinds	21
SDLs	22

VISTAGRANDE. Clear Glass

VISTAGRANDE. FIR TEXTURED FLUSH-GLAZED DOORS / CLEAR LOW-E ARGON GLASS



VISTAGRANDE. SMOOTH FLUSH-GLAZED DOORS / CLEAR LOW-E ARGON GLASS



	2'6"	2'8"	3'0"	2'6"	2'8"	3'0"	2'8"	3'0"	1'0" & 1'2" (VSG)	1'0"		3'0"
6'8"											7'0"	
	120-010-X	122-010-X	926-010-X	420-010-1	404-010-1	426-010-1	106-010-1	126-010-1	152-010-X	450-010-1		726-010-X
VFT		•	•	•	•	•	•	•	•	•		
VSG	•	•	•	•	•	•	•	•	•	•		•

VISTAGRANDE Internal Grids

VISTAGRANDE SMOOTH FLUSH-GLAZED DOORS / INTERNAL GRIDS WITH CLEAR LOW-E ARGON GLASS



VSG
Smooth
Fiberglass



VSG-926-151

VSG-426-121-1

VSG-106-091-1

	2'6"	2'8"	3'0"	2'8"	3'0"	2'8"	3'0"	1'0" & 1'2"	1'0"
6'8"									
	120-151	122-151	926-151	404-121-1	426-121-1	106-091-1	126-091-1	152-051-X	450-041-1
VSG	•	•	•	•	•	•	•	•	•

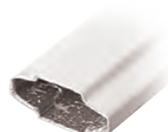

Grille Type D
White Georgian
5/8"

VISTAGRANDE Mini Blinds

VISTAGRANDE SMOOTH FLUSH-GLAZED DOORS / RAISE, LOWER & TILT MINI BLINDS WITH CLEAR LOW-E GLASS



VSG
Smooth
Fiberglass



VSG-B926-01RL-X

VSG-B106-01RL-1

VSGSL-B152-01RL-X

- ▶ All sizes feature raise, lower and tilt functionality
- ▶ Security channels provide full privacy preventing light gaps when closed (no side or bottom gaps)
- ▶ Frame fits tight to glass—no large gaps
- ▶ Spacer bars not visible in sightline of frame
- ▶ Smoother, easier and more versatile dual-mechanism operation
- ▶ Soft coat LE option for ENERGY STAR compliance

	2'8" & 3'0"	2'8"	3'0"	1'0"
6'8"				
	106-1	122-X	926-X	152-X
	B106-01RL-1	B122-01RL-X	B926-01RL-X	B152-01RL-X
VSG	•	•	•	•

VISTAGRANDE. SDLs

VISTAGRANDE. FIR TEXTURED FLUSH-GLAZED DOORS / APPLIED SDLs



VFT
Textured
Fiberglass



Applied 4 Lite 3-1/2" Bars Applied 4 Lite Applied 4 Lite Craftsman Grid Applied 6 Lite Applied 8 Lite Applied 9 Lite Prairie Applied 10 Lite Applied 15 Lite

6'8"																					
	106-504-1	106-506-1	106-509-1	126-504-1	126-506-1	126-509-1	120-504-X	120-506-X	120-508-X	120-509-X	120-510-X	120-512-X	120-515-X	122-504-X	122-506-X	122-508-X	122-509-X	122-510-X	122-512-X	122-515-X	
VFT	•	•	•	•	•	•	•	•	•	•	•	•	•	•	•	•	•	•	•	•	
VSG	•	•	•	•	•	•	•	•	•	•	•	•	•	•	•	•	•	•	•	•	•

6'8"																				
	404-504-1	404-506-1	404-508-1	404-512-1	420-504-1	420-506-1	420-508-1	420-512-1	426-504-1	426-506-1	426-508-1	426-512-1	926-504-X	926-506-X	926-508-X	926-509-X	926-510-X	926-512-X	926-515-X	
VFT	•	•	•	•	•	•	•	•	•	•	•	•	•	•	•	•	•	•	•	•
VSG	•	•	•	•	•	•	•	•	•	•	•	•	•	•	•	•	•	•	•	•

6'8"							
	152-502-X	152-503-X	152-504-X	152-505-X	450-502-1	450-503-1	450-504-1
VFT	•	•	•	•	•	•	•
VSG	•	•	•	•	•	•	•

3'0" x 7'0"											
	726-504-X	726-506-X	726-508-X	726-509-X	726-510-X	726-512-X	726-515-X	726-S09P-X	726-S04W-X	726-S03C-X	726-S04C-X
VSG	•	•	•	•	•	•	•	•	•	•	•



VISTAGRANDE. SMOOTH FLUSH-GLAZED DOORS / SDLs

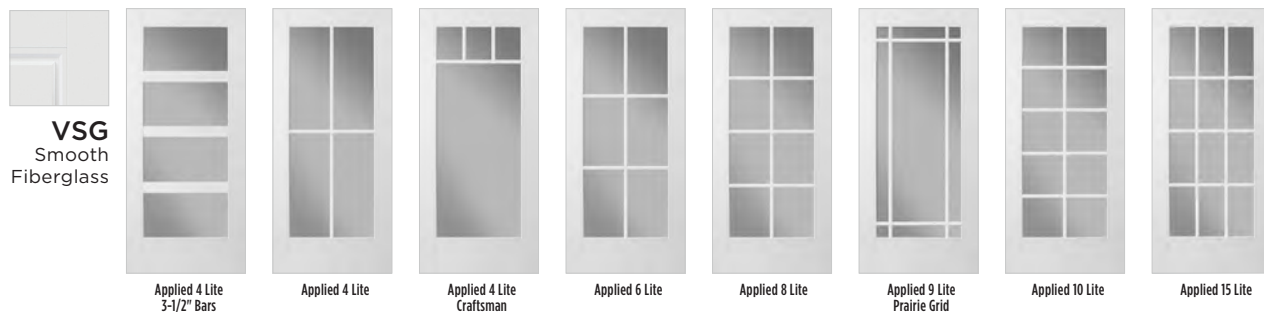

PRAIRIE GRIDS

6'8"										
	106-S09P-1	126-S09P-1	404-S09P-1	420-S09P-1	426-S09P-1	120-S09P-X	122-S09P-X	926-S09P-X	152-S06P-X	450-S06P-1
VFT	•	•	•	•	•	•	•	•	•	•
VSG	•	•	•	•	•	•	•	•	•	•

3-1/2" BARS

6'8"								
	120-S04W-X	122-S04W-X	404-S03W-1	420-S03W-1	426-S03W-1	926-S04W-X	152-S04W-X	450-S03W-1
VFT	•	•	•	•	•	•	•	•
VSG	•	•	•	•	•	•	•	•

CRAFTSMAN GRIDS

6'8"																		
	106-S03C-1	106-S04C-1	126-S03C-1	126-S04C-1	120-S03C-X	120-S04C-X	122-S03C-X	122-S04C-X	926-S03C-X	926-S04C-X	404-S03C-1	404-S04C-1	420-S03C-1	420-S04C-1	426-S03C-1	426-S04C-1	152-S03C-X	450-S03C-1
VFT	•	•	•	•	•	•	•	•	•	•	•	•	•	•	•	•	•	•
VSG	•	•	•	•	•	•	•	•	•	•	•	•	•	•	•	•	•	•



Heritage Series™ Fir Textured Doors / Doors HFT-3C

Masonite's recessed 3 Panel exterior door combines crisp, clean lines inspired by classic craftsman architecture with the proven durability of fiberglass. Select an opaque application for added privacy, or choose from our Heartland™ Craftsman decorative glass collection to fill your entryway with natural light.

GLASS OPTIONS:

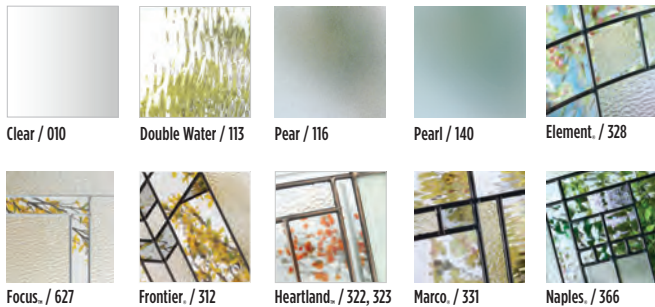

OPTIONS:

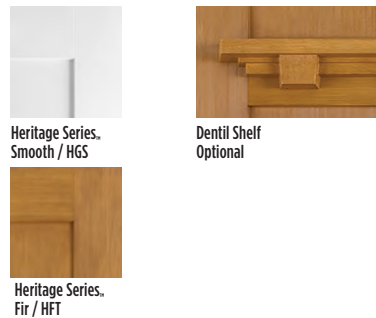

HERITAGE SERIES™

AUTHENTIC CRAFTSMAN DETAIL



► Heritage Series™ Fir Fiberglass with Element Glass / Door HFT-217-328-2C

Glass 27

Grids 32



Heritage Series™ Smooth Fiberglass with NEW Focus Glass / Door HGS-217-627-2C



Heritage Series™ Glass

T TEXTURED / AB ANTIQUE BLACK CAMING
BZ ANTIQUE BRONZE CAMING / P PLATINUM CAMING

DOOR COLLECTIONS

VISTAGRANDE™

HERITAGE SERIES™

MODERN



1
Clear / 010



7
Double Water / 113-T



9
Pearl / 140



9
Pear / 116-T



4
Heartland / 322-AB / 323-BZ



5
Focus / 627-P



4
Frontier / 312 -AB



5
Element / 328-AB



4
Marco / 331-AB



6
Naples / 366-AB

PRIVACY RATING

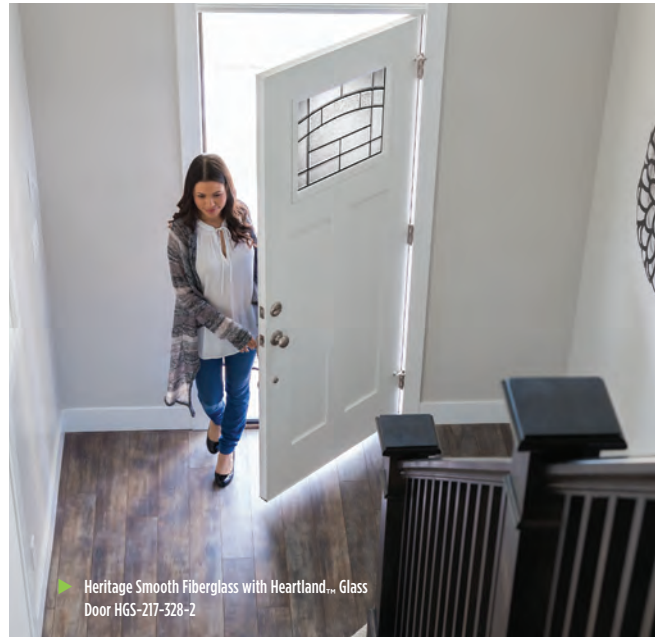

Heritage Smooth Fiberglass with Heartland™ Glass
Door HGS-217-328-2



White/Light
Amber Glass

Granite
Glass

Bronze
Caming

Seedy
Glass

Clear
Beveled
Glass

Heartland

HERITAGE SERIES™ Glass

HERITAGE SERIES™ FIR TEXTURED FIBERGLASS



CLEAR GLASS



HFT-217-010-2C



HFTSL-151-010-X



HFTSL-617-010-1

DOUBLE WATER GLASS



HFT-217-113-2C



HFTSL-151-113-X



HFTSL-617-113-1

ELEMENT. GLASS



HFT-217-328-2C



HFTSL-151-328-X



HFTSL-617-328-1

MARCO. GLASS



HFT-217-331-2C



HFTSL-151-331-X



HFTSL-617-331-1

NAPLES. GLASS



HFT-217-366-2C



HFTSL-151-366-X



HFTSL-617-366-1

PEAR GLASS







HFT-217-116-2C



HFTSL-151-116-X



HFTSL-617-116-1

	6'8"			
				
	3C	217-2C	151-X	617-1
OPAQUE	•			
CLEAR 010		•	•	•
DOUBLE WATER 113		•	•	•
ELEMENT. 328		•	•	•
FOCUS. 627		•	•	•
FRONTIER. 312		•	•	•
HEARTLAND™ 322 323		•	•	•
MARCO. 331		•	•	•
NAPLES. 366		•	•	•
PEAR 116		•	•	•
PEARL 140		•	•	•



SHOWN WITH OPTIONAL
DENTIL SHELF

Applied SDL's available for
clear and textured glass.



FOCUS.. GLASS



HFT-217-627-2C HFTSL-151-627-X HFTSL-617-627-X

FRONTIER. GLASS



HFT-217-312-2C HFTSL-151-312-X HFTSL-617-312-1

HEARTLAND.. GLASS



HFT-217-322-2C HFTSL-151-322-X HFTSL-617-322-1
HFT-217-323-2C HFTSL-151-323-X HFTSL-617-323-1

PEARL GLASS



HFT-217-140-2C HFTSL-151-140-X HFTSL-617-140-1

OPAQUE



HFT-3C

HERITAGE SERIES™ Glass

HERITAGE SERIES™ SMOOTH FIBERGLASS

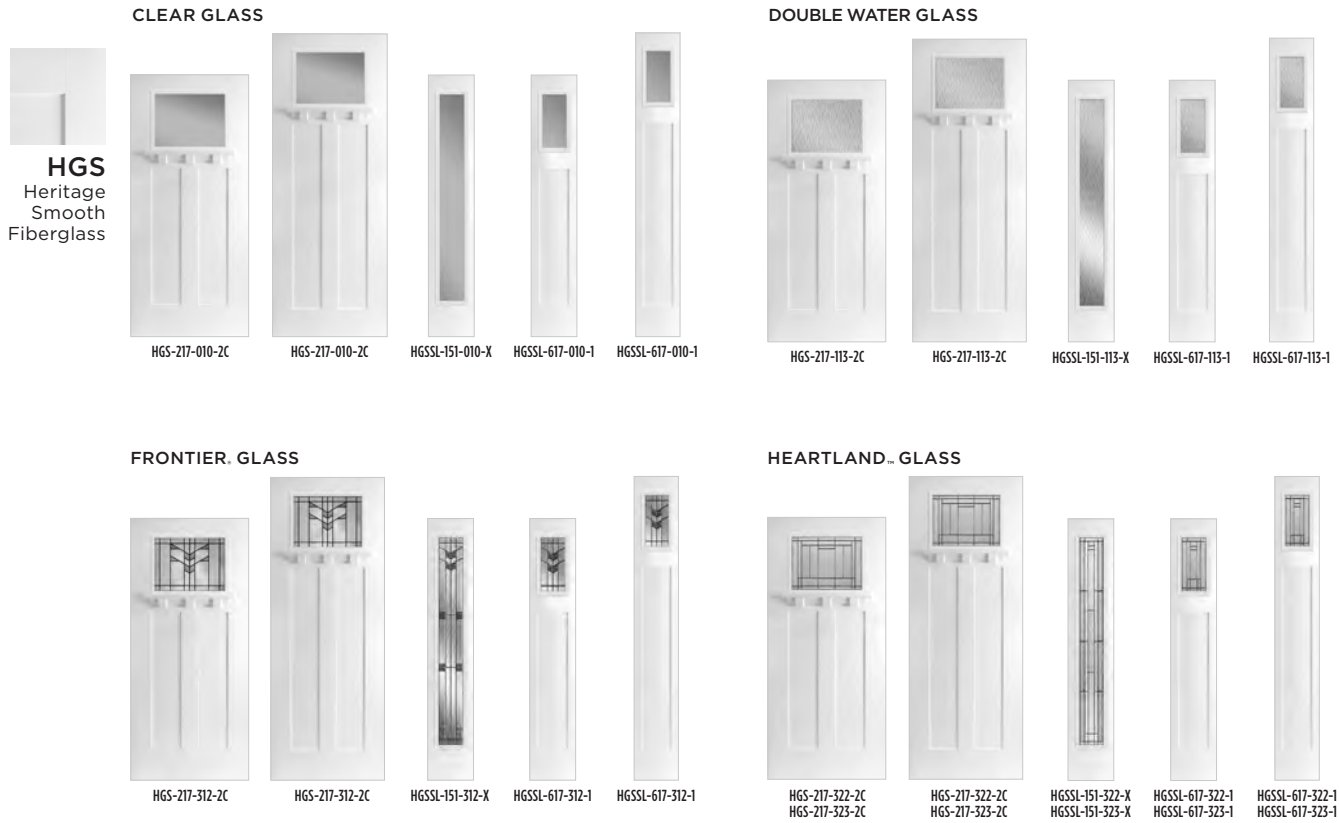

	6'8"				8'0"	6'8"		
	3C	217-2C	151-X	617-1		3C	217-2C	617-1
OPAQUE	•				•			
CLEAR 010		•	•	•		•	•	
DOUBLE WATER 113		•	•	•		•	•	
ELEMENT. 328		•	•	•		•	•	
FOCUS. 627		•	•	•		•	•	
FRONTIER. 312		•	•	•		•	•	
HEARTLAND. 322 323		•	•	•		•	•	
MARCO. 331		•	•	•		•	•	
NAPLES. 366		•	•	•		•	•	
PEARL 116		•	•	•		•	•	
PEARL 140		•	•	•		•	•	



SHOWN WITH OPTIONAL DENTIL SHELF

Applied SDL's available for clear and textured glass.



ELEMENT, GLASS

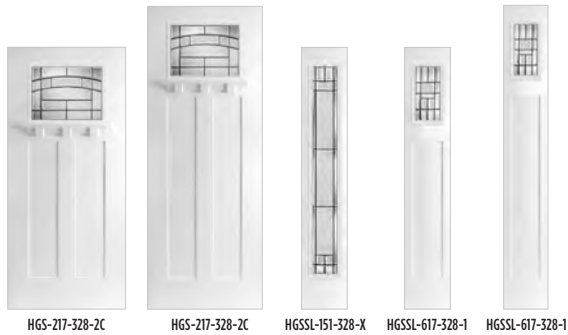

FOCUS[™] GLASS



MARCO GLASS

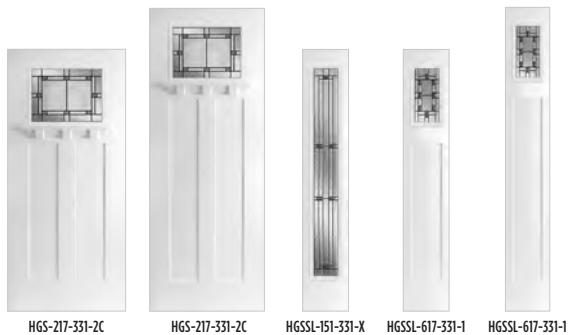

NAPLES GLASS

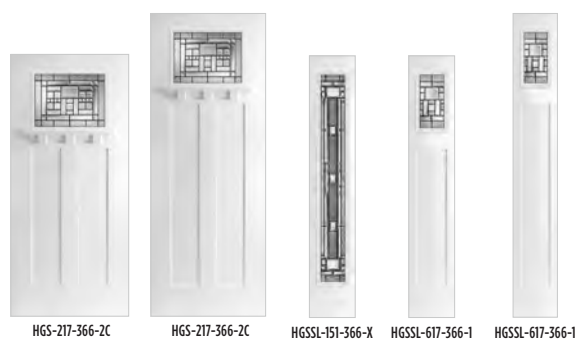

PEAR GLASS

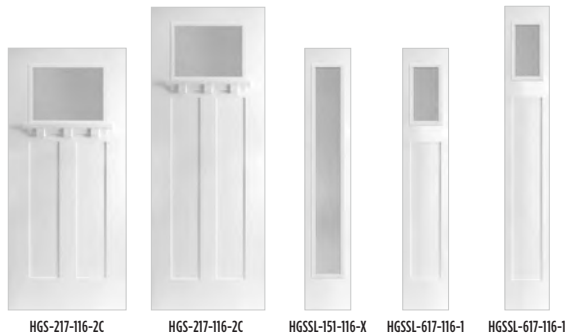

PEARL GLASS



OPAQUE



HERITAGE SERIES™ Grids

HERITAGE SERIES™ FIR TEXTURED FIBERGLASS / APPLIED SIMULATED DIVIDED LITES / LOW-E



HERITAGE SERIES™ FIR TEXTURED FIBERGLASS / INTERNAL GRIDS / LOW-E



Grille Type C
White Wide Traditional
7/8"

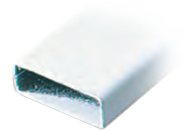

HERITAGE SERIES™ FIR TEXTURED FIBERGLASS / EXTERNAL GRIDS / LOW-E



SIMULATED DIVIDED LITES / SDLs

6'8"								
	217-S02-2C	217-S03-2C	217-S04-2C	217-S06-2C	151-S02C-X	151-S03C-X	617-S02-1	617-S04-1
HGS	•	•	•	•	•	•	•	•
HFT	•	•	•	•	•	•	•	•



HERITAGE SERIES™ SMOOTH FIBERGLASS / APPLIED SIMULATED DIVIDED LITES / LOW-E



HERITAGE SERIES™ SMOOTH FIBERGLASS / INTERNAL GRIDS / LOW-E



HERITAGE SERIES™ SMOOTH FIBERGLASS / EXTERNAL GRIDS / LOW-E



INTERNAL GRIDS

6'8"					8'0"					
	217-021-2C	217-031-2C	217-041-2C	217-061-2C		617-021-1	217-021-2C	217-031-2C	217-041-2C	217-061-2C
HGS	•	•	•	•	•	•	•	•	•	•
HFT	•	•	•	•	•					

EXTERNAL GRIDS

6'8"			8'0"		
	217-03E-2C	217-06E-2C		217-03E-2C	217-06E-2C
HGS	•	•	•	•	
HFT	•	•			

MODERN DOOR

MINIMALISTIC CONTEMPORARY DESIGNS



► Masonite - HD Steel with Centered Square Lites and Clear Glass
Door MHD-682CS-010-X

Whether you prefer the classic lines of Mid-Century Modern architecture or the sharp angles of industrial design, our Modern Door offerings deliver minimalist designs that add a unique focal point to any entryway.



► Belleville, Oak Textured with Center Vertical Lite and Clear Glass Door BLT-151C-010-X

GLASS OPTIONS:

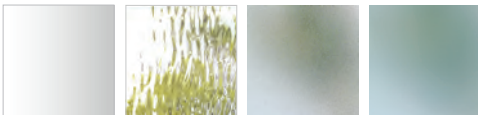

Clear / 010

Double Water / 113

Pear / 116

Pearl / 140

OPTIONS:



Belleville, Smooth / BLS

HD Steel / MHD SHD

MODERN DOOR

BELLEVILLE, SMOOTH FIBERGLASS / SHOWN WITH CLEAR GLASS

BLS
Smooth
Fiberglass



6'8"																		
Clear	151H-010-X	152H-010-X	151C-010-X	152C-010-X	151S-010-X	152S-010-X	151C2-010-X	152C2-010-X	217C3-010-X	228C4-010-X	682H3-010-X	682S3-010-X	682C3-010-X	682H4-010-X	682S4-010-X	682C4-010-X	682H5-010-X	
Double Water	151H-113-X	152H-113-X	151C-113-X	152C-113-X	151S-113-X	152S-113-X	151C2-113-X	152C2-113-X	217C3-113-X	228C4-113-X	682H3-113-X	682S3-113-X	682C3-113-X	682H4-113-X	682S4-113-X	682C4-113-X	682H5-113-X	
Pearl	151H-116-X	152H-116-X	151C-116-X	152C-116-X	151S-116-X	152S-116-X	151C2-116-X	152C2-116-X	217C3-116-X	228C4-116-X	682H3-116-X	682S3-116-X	682C3-116-X	682H4-116-X	682S4-116-X	682C4-116-X	682H5-116-X	
Pearl	151H-140-X	152H-140-X	151C-140-X	152C-140-X	151S-140-X	152S-140-X	151C2-140-X	152C2-140-X	217C3-140-X	228C4-140-X	682H3-140-X	682S3-140-X	682C3-140-X	682H4-140-X	682S4-140-X	682C4-140-X	682H5-140-X	
BLS	•	•	•	•	•	•	•	•	•	•	•	•	•	•	•	•	•	
MHD	•	•	•	•	•	•	•	•	•	•	•	•	•	•	•	•	•	

HD STEEL / SHOWN WITH CLEAR GLASS



MHD
HD STEEL



MHD-151C-010-X



MHD-151H-010-X



MHD-151S-010-X



MHD-151C2-010-X



MHD-217C3-010-X



MHD-228C4-010-X



MHD-682C1D-010-X



MHD-682C3D-010-X



MHD-682H3D-010-X



MHD-682S3D-010-X



MHD-682C3-010-X



MHD-682H3-010-X



MHD-682S3-010-X



MHD-682C4-010-X



MHD-682H4-010-X



MHD-682S4-010-X



MHD-682C5-010-X



MHD-682H5-010-X



MHD-682S5-010-X

6'8"						
	Clear 682S5-010-X	682C5-010-X	682C1D-010-X	682C3D-010-X	682H3D-010-X	682S3D-010-X
Double Water	682S5-113-X	682C5-113-X	682C1D-113-X	682C3D-113-X	682H3D-113-X	682S3D-113-X
Pearl	682S5-116-X	682C5-116-X	682C1D-116-X	682C3D-116-X	682H3D-116-X	682S3D-116-X
Pearl	682S5-140-X	682C5-140-X	682C1D-140-X	682C3D-140-X	682H3D-140-X	682S3D-140-X
BLS	•	•	•	•	•	•
MHD	•	•	•	•	•	•



► Belleville, Hollister, Fir Textured with Focus™ Glass / Door BFT-404-627-1



MASONITE
EXPO



Chelsea, Glass 341.	40
Cruz™ Glass 66144
Element, Glass 327 / 328.48
Focus™ Glass 627	52
Frontier, Glass 312.	56
Marco, Glass 331.	60
Naples, Glass 366	64

► Belleville, Smooth with Cruz™ Glass / Door BLS-122-661-X



► Belleville, Hollister, Smooth with Chelsea, Glass / Door BLS-404-341-1



Chelsea. Glass

341 - AB
ANTIQUE BLACK CAMING

EXPO

IRON

CLASSIC

TEXTURES

LINEA
(CLEAR GLASS WITH GRIDS)

ESSENTIA
(CLEAR GLASS)



► Belleville - Hollister - Smooth with Chelsea. Glass
Door BLS-404-341-1 / Sidelite BLSL-450-341-1



3



Clear Beveled Glass

Antique Black Caming

Clear Baroque Glass

Chelsea. Glass

BELLEVILLE. TEXTURED DOORS



BMT
Mahogany
Fiberglass



BMT-122-341-X



BMT-404-341-1



BMTSL-152-341-X



BMTSL-450-341-1



BFT
Fir
Fiberglass



BFT-122-341-X



BFT-404-341-1



BFTSL-450-341-1



BLT
Oak
Fiberglass



BLT-122-341-X



BLT-404-341-2



BLTSL-152-341-X



BLTSL-450-341-1

	6'8"					7'0"		8'0"	
	122-X	404-1	404-2	152-X	450-1	122-X	152-X	404-2	450-1
AB	122-341-X	404-341-1	404-341-2	152-341-X	450-341-1	122-341-X	151-341-X	404-341-2	450-341-1
BMT	•	•		•	•				
BFT	•	•			•				
BLT	•		•	•	•				
BLS	•	•	•	•	•	•	•	•	•
MHD	•			•		•			



EXPO

IRON

CLASSIC

TEXTURES

LINEA
(CLEAR GLASS WITH GRIDS)

ESSENTIA
(CLEAR GLASS)

BELLEVILLE. SMOOTH DOORS



HD STEEL DOORS



One sidelite would need to be rotated 180° to get the "bookend look."





► Belleville. Smooth with Cruz™ Glass / Door BLS-122-661-X



Cruz™ Glass

661 - AB
ANTIQUÉ BLACK CAMING

EXPO

IRON

CLASSIC

TEXTURES

LINEA
(CLEAR GLASS WITH GRIDS)

ESSENTIA
(CLEAR GLASS)

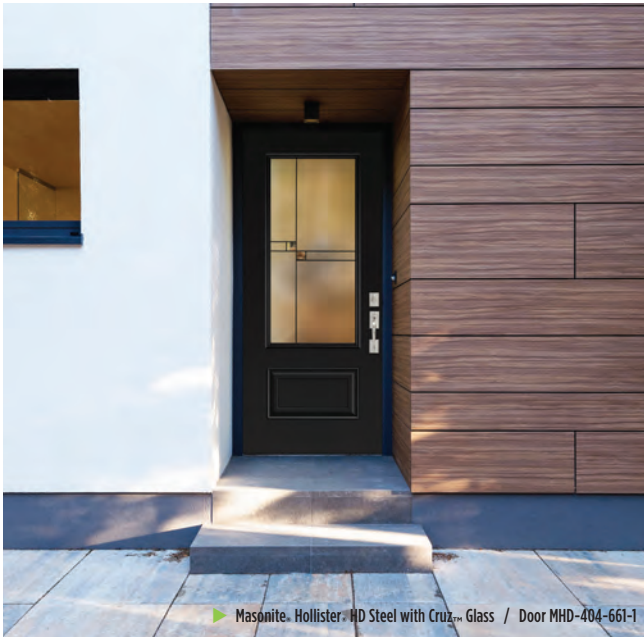

► Masonite, Hollister, HD Steel with Cruz™ Glass / Door MHD-404-661-1



8



Clear Glass

Antique Black Caming

Mistlite Glass

Granite Glass

BELLEVILLE. TEXTURED DOORS



BMT
Mahogany
Fiberglass



BMT-122-661-X



BMT-404-661-1



BMT-106-661-1P



BMT-106-661-2



BMT-228-661-4



BMTSL-152-661-X



BMTSL-450-661-1



BMTSL-129-661-1



BFT
Fir
Fiberglass



BFT-122-661-X



BFT-404-661-1



BFT-106-661-2



BFT-228-661-4



BFTSL-450-661-1



BFTSL-129-661-1



BLT
Oak
Fiberglass



BLT-122-661-X



BLT-404-661-2



BLT-106-661-1



BLT-106-661-2



BLT-228-661-4



BLTSL-152-661-X



BLTSL-450-661-1



BLTSL-129-661-1

6'8"										
	122-X	404-1	404-2	106-1	106-1P	106-2	228-4	152-X	450-1	129-1
AB	122-661-X	404-661-1	404-661-2	106-661-1	106-661-1P	106-661-2	228-661-4	152-661-X	450-661-1	129-661-1
BMT	•	•			•	•	•	•	•	•
BFT	•	•				•	•		•	•
BLT	•		•	•		•	•	•	•	•
BLS	•	•	•	•	•	•	•	•	•	•
MHD	•			•		•	•	•		•



EXPO

IRON

CLASSIC

TEXTURES

LINEA
(CLEAR GLASS WITH GRIDS)

ESSENTIA
(CLEAR GLASS)

BELLEVILLE. SMOOTH DOORS



HD STEEL DOORS

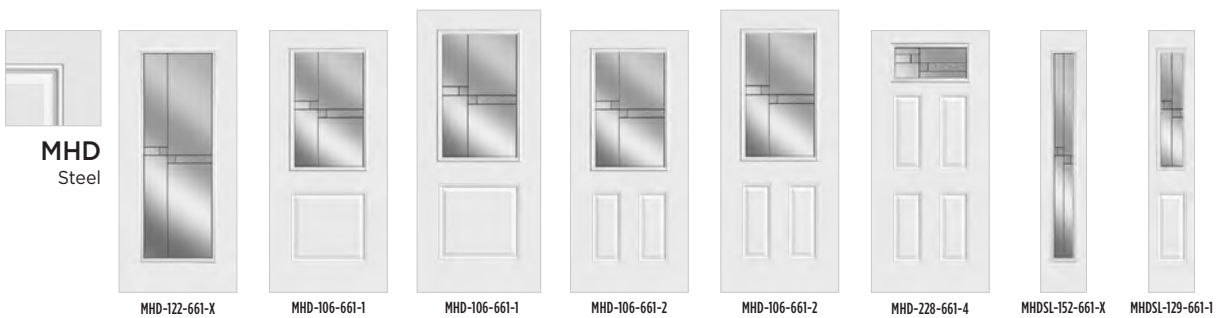

	7'0"					8'0"	
	122-X	106-1	106-2	228-4	152-X	404-2	450-1
AB	122-661-X	106-661-1	106-661-2	228-661-4	152-661-X	404-661-2	450-661-1
BMT							
BFT							
BLT							
BLS	•		•	•	•	•	•
MHD	•	•	•	•			



► Belleville. Smooth with Element. Glass / Door BLS-122-328-X / Sidelites BLSSL-152-328-X



Element. Glass

327 - P / 328 - AB

PLATINUM CAMING / ANTIQUE BLACK CAMING (SHOWN)

EXPO

IRON

CLASSIC

TEXTURES

LINEA
(CLEAR GLASS WITH GRIDS)

ESSENTIA
(CLEAR GLASS)



Masonite. Hollister. HD Steel with Element. Glass / Door MHD-404-328-1

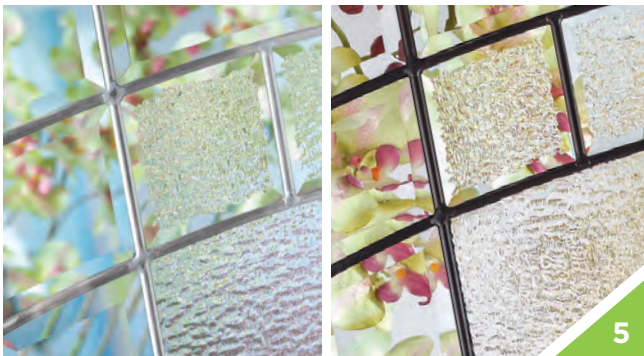

5



Granite Beveled Glass

Granite Glass

Antique Black Caming

Clear Beveled Glass

Element. Glass

BELLEVILLE. TEXTURED DOORS



BMT
Mahogany
Fiberglass



BMT-122-328-X



BMT-404-328-1



BMT-106-328-1P



BMT-106-328-2



BMT-107-328-1P



BMTSL-152-328-X



BMTSL-450-328-1



BMTSL-129-328-1



BFT
Fir
Fiberglass



BFT-122-328-X



BFT-404-328-1



BFT-106-328-2



BFTSL-450-328-1



BFTSL-129-328-1



BLT
Oak
Fiberglass



BLT-122-328-X



BLT-404-328-2



BLT-106-328-1



BLT-106-328-2



BLT-107-328-2



BLT-137-328-4



BLTSL-152-328-X



BLTSL-450-328-1



BLTSL-129-328-1

6'8"	122-X		217-X		404-1		404-2		106-1		106-1P		106-2		107-1		107-1P		107-2		217-2C		137-4		152-X		450-1		129-1		617-1	
	122-328-X	217-328-X	404-328-1	404-328-2	106-328-1	106-328-1P	106-328-2		107-328-1	107-328-1P	107-328-2																					
P																																
AB																																
BMT	•		•																													
BFT	•		•																													
BLT	•			•	•																											
BLS	•	•	•	•	•	•																										
MHD	•	•																														



EXPO

IRON

CLASSIC

TEXTURES

LINEA
 (CLEAR GLASS WITH GRIDS)

ESSENTIA
 (CLEAR GLASS)

BELLEVILLE. SMOOTH DOORS



HD STEEL DOORS

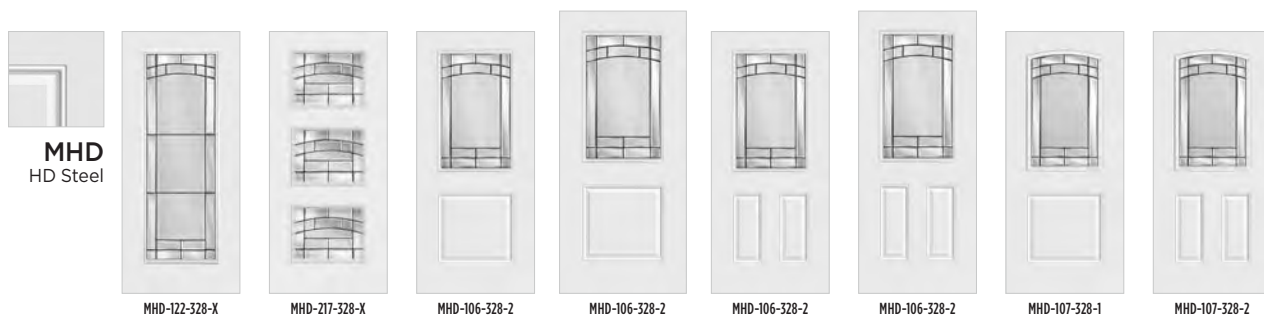

	7'0"				8'0"	
	122-X	106-1	106-2	152-X	404-2	450-1
P						
AB	122-328-X	106-328-1	106-328-2	151-328-X	404-328-2	450-327-1
BMT						
BFT						
BLT						
BLS	•		•	•	•	•
MHD	•	•	•			





► Heritage Series™ Smooth with Focus™ Glass / Door HGS-217-627-2C



Focus™ Glass

627 - P
PLATINUM CAMING

EXPO

IRON

CLASSIC

TEXTURES

LINEA
(CLEAR GLASS WITH GRIDS)

ESSENTIA
(CLEAR GLASS)



Belleville, Hollister, Fir Textured with Focus™ Glass / Door BFT-404-627-1



Granite Glass Platinum Caming Clear Glass

Focus™ Glass

BELLEVILLE. TEXTURED DOORS



BMT
Mahogany
Fiberglass



BMT-122-627-X



BMT-404-627-1



BMT-106-627-2



BMT-106-627-1P



BMT-228-627-4



BMTSL-152-627-X



BMTSL-450-627-1



BMTSL-129-627-1



BFT
Fir
Fiberglass



BFT-122-627-X



BFT-404-627-1



BFT-106-627-2



BFT-228-627-4



BFTSL-450-627-1



BFTSL-129-627-1



BLT
Oak
Fiberglass



BLT-122-627-X



BLT-404-627-2



BLT-106-627-1



BLT-106-627-2



BLT-228-627-4



BLTSL-152-627-X



BLTSL-450-627-1



BLTSL-129-627-1

6'8"												
	122-X 122-627-X	217-X 217-627-X	404-1 404-627-1	404-2 404-627-2	106-1 106-627-1	106-1P 106-627-1P	106-2 106-627-2	217-2C 217-627-2C	228-4 228-627-4	152-X 152-627-X	450-1 450-627-1	129-1 129-627-1
P	•	•	•	•	•	•	•	•	•	•	•	•
BMT	•		•			•	•		•	•	•	•
BFT	•		•				•		•		•	•
BLT	•			•	•		•		•	•	•	•
BLS	•	•	•	•	•	•	•		•	•	•	•
MHD	•	•			•		•	•	•	•		•



EXPO

IRON

CLASSIC

TEXTURES

LINEA
(CLEAR GLASS WITH GRIDS)

ESSENTIA
(CLEAR GLASS)

BELLEVILLE, SMOOTH DOORS



BLS
Smooth
Fiberglass



BLS-122-627-X BLS-122-627-X BLS-404-627-1 BLS-404-627-2 BLS-106-627-1 BLS-106-627-1P BLS-106-627-2 BLS-106-627-2 BLS-404-627-2



BLS-217-627-X BLS-228-627-4 BLS-228-627-4 BLSSL-152-627-X BLSSL-450-627-1 BLSSL-129-627-1 BLSSL-152-627-X BLSSL-450-627-1

HD STEEL DOORS



MHD
Steel



MHD-122-627-X MHD-217-627-X MHD-106-627-1 MHD-106-627-1 MHD-106-627-2 MHD-106-627-2 MHD-228-627-4 MHD-217-627-2C
Shown w/Optional Dentil Shelf

7'0"						8"		
	122-X	106-1	106-2	228-4	152-X		122-X	129-1
P	122-627-X	106-627-1	106-627-2	228-627-4	151-627-X		122-404-X	129-450-1
BMT								
BFT					•			
BLT								
BLS	•		•	•	•		•	•
MHD	•	•	•	•				



MHDSL-129-627-1 MHDSL-152-627-X



► Heritage Fir Textured Fiberglass with Frontier Glass / Door HFT-217-312-2C / Sidelites HFTSL-617-312-1



Frontier Glass

312 - AB
ANTIQUE BLACK CAMING

EXPO

IRON

CLASSIC

TEXTURES

LINEA
(CLEAR GLASS WITH GRIDS)

ESSENTIA
(CLEAR GLASS)



► Belleville, Hollister, Mahogany Textured with Frontier Glass
Door BMT-404-312-1 / Sidelites BMTSL-450-312-1



4

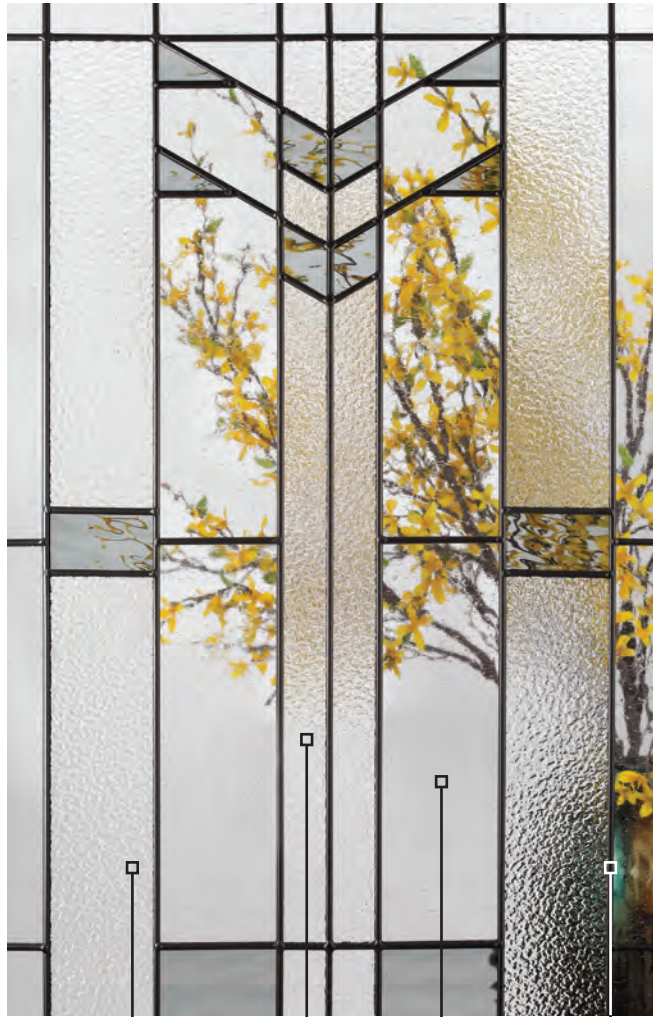

Pear Glass

Gray Water Glass

Seedy Glass

Antique Black Caming

Frontier. Glass

BELLEVILLE. TEXTURED DOORS



BMT
Mahogany
Fiberglass



BMT-404-312-1



BMT-106-312-1P



BMT-106-312-2



BMT-228-312-4



BMTSL-152-312-X



BMTSL-450-312-1



BMTSL-129-312-1



BFT
Fir
Fiberglass



BFT-404-312-1



BFT-106-312-2



BFT-228-312-4



BFTSL-450-312-1



BFTSL-129-312-1



BLT
Oak
Fiberglass



BLT-404-312-2



BLT-106-312-1



BLT-106-312-2



BLT-228-312-4



BLTSL-152-312-X



BLTSL-450-312-1



BLTSL-129-312-1

6'8"	6'8" Door Profiles												7'0" Door Profiles				8'0" Door Profiles	
	217-X	404-1	404-2	106-1	106-1P	106-2	217-2C	228-4	152-X	450-1	129-1	617-1	106-2	228-4	151-X	404-2	450-1	
AB	217-312-X	404-312-1	404-312-2	106-312-1	106-312-1P	106-312-2	217-312-2C	228-312-4	152-312-X	450-312-1	129-312-1	617-312-1				404-312-2	450-312-1	
BMT		•			•			•	•	•								
BFT		•				•				•								
BLT			•	•		•		•	•	•								
BLS	•	•	•	•	•		•	•	•	•			•	•	•	•	•	
MHD	•			•		•	•	•	•	•	•		•	•	•			



EXPO

IRON

CLASSIC

TEXTURES

LINEA
(CLEAR GLASS WITH GRIDS)

ESSENTIA
(CLEAR GLASS)

BELLEVILLE. SMOOTH DOORS



BLS
Smooth
Fiberglass



HD STEEL DOORS



MHD
HD Steel





► Belleville. Smooth with Marco. Glass / Door BLS-404-331-2



Marco Glass

331 - AB
ANTIQUÉ BLACK CAMING

EXPO

IRON

CLASSIC

TEXTURES

LINEA
(CLEAR GLASS WITH GRIDS)

ESSENTIA
(CLEAR GLASS)



► Masonite, HD Steel with Marco Glass / Door MHD-106-331-2



- Granite Glass
- Antique Black Caming
- Gray Water Glass
- Seedy Glass
- Clear Water Glass

Marco Glass

BELLEVILLE TEXTURED DOORS



BMT
Mahogany
Fiberglass



BMT-404-331-1



BMT-106-331-1P



BMT-106-331-2



BMT-228-331-4



BMTSL-152-331-X



BMTSL-450-331-1



BMTSL-129-331-1



BFT
Fir
Fiberglass



BFT-404-331-1



BFT-106-331-2



BFT-228-331-4



BFTSL-450-331-1



BFTSL-129-331-1



BLT
Oak
Fiberglass



BLT-404-331-2



BLT-106-331-1



BLT-106-331-2



BLT-228-331-4



BLTSL-152-331-X



BLTSL-450-331-1



BLTSL-129-331-1

6'8"													7'0"					8'0"		
	217-X	404-1	404-2	106-1	106-1P	106-2	217-2C	228-4	152-X	450-1	129-1	617-1		106-1	106-2	228-4	152-X		404-2	450-1
AB	217-331-X	404-331-1	404-331-2	106-331-1	106-331-1P	106-331-2	217-331-2C	228-331-4	152-331-X	450-331-1	129-331-1	617-331-1	106-331-1	106-331-2	228-331-4	151-331-X		404-331-2	450-331-1	
BMT		•			•	•		•	•	•	•									
BFT		•				•		•	•	•	•									
BLT			•	•		•		•	•	•	•						•			
BLS	•	•	•	•	•	•		•	•	•	•			•	•	•			•	•
MHD	•			•		•	•	•	•	•	•	•	•	•	•	•				



EXPO

IRON

CLASSIC

TEXTURES

LINEA
(CLEAR GLASS WITH GRIDS)

ESSENTIA
(CLEAR GLASS)

BELLEVILLE. SMOOTH DOORS



BLS
Smooth
Fiberglass



BLS-217-331-X



BLS-106-331-1



BLS-106-331-1P



BLS-106-331-2



BLS-106-331-2



BLS-404-331-2



BLS-228-331-4



BLS-228-331-4



BLSL-152-331-X



BLSL-129-331-1



BLSL-152-331-X



BLSL-450-331-1

HD STEEL DOORS



MHD
HD Steel

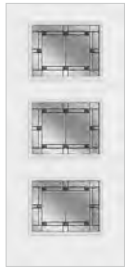

MHD-217-331-X



MHD-106-331-1



MHD-106-331-1



MHD-106-331-2



MHD-217-331-2C
Shown w/Optional Dentil Shelf



MHD-228-331-4



MHDSL-152-331-X



MHDSL-129-331-1



MHDSL-617-331-1



► Belleville, Mahogany Textured with Naples, Glass
Door BMT-106-366-2 / Sidelites BMTSL-129-366-1



Naples Glass

366 - AB
ANTIQUE BLACK CAMING

EXPO

IRON

CLASSIC

TEXTURES

LINEA
(CLEAR GLASS WITH GRIDS)

ESSENTIA
(CLEAR GLASS)



▶ Masonite® HD Steel 3P Equal with Naples® Glass / Door MHD-217-366-X / Sidelite MHD5L-152-366-X



6



Clear Beveled Glass

Narrow Reed Glass

Antique Black Caming

Granite Glass

Naples Glass

BELLEVILLE TEXTURED DOORS



BMT
Mahogany
Fiberglass



BMT-122-366-X



BMT-404-366-1



BMT-106-366-1P



BMT-106-366-2



BMT-228-366-4



BMTSL-152-366-X



BMTSL-450-366-1



BMTSL-129-366-1



BFT
Fir
Fiberglass



BFT-122-366-X



BFT-404-366-1



BFT-106-366-2



BFT-228-366-4



BFTSL-450-366-1



BFTSL-129-366-1



BLT
Oak
Fiberglass



BLT-122-366-X



BLT-404-366-2



BLT-106-366-1



BLT-106-366-2



BLT-228-366-4



BLTSL-152-366-X



BLTSL-450-366-1



BLTSL-129-366-1

6'8"	122-X		217-X		404-1		404-2		106-1		106-1P		106-2		217-2C		228-4		129-1		152-X		450-1		617-1		
	AB	122-366-X	217-366-X	404-366-1	404-366-2	106-366-1	106-366-1P	106-366-2	217-366-2C	228-366-4	129-366-1	152-366-X	450-366-1	617-366-1													
BMT	•																										
BFT	•																										
BLT	•																										
BLS	•	•	•	•	•	•	•	•	•	•	•	•	•	•	•	•	•	•	•	•	•	•	•	•	•	•	•
MHD	•	•																									



► Belleville. Smooth with Tanglewood Glass / Door BLS-404-926-1



EXPO

IRON

CLASSIC

TEXTURES

LINEA
(CLEAR GLASS WITH GRIDS)

ESSENTIA
(CLEAR GLASS)

MASONITE IRON™



► Belleville, Hollister, Smooth with Quattro, Glass
Doors BLS-404-957-1

Optimus, 928 70

Tanglewood, 926 74



Belleville. Smooth with Optimus Glass / Doors MHD-122-928-X



Optimus. Glass

928 - WR
WROUGHT IRON

EXPO

IRON

CLASSIC

TEXTURES

LINEA
(CLEAR GLASS WITH GRIDS)

ESSENTIA
(CLEAR GLASS)



▶ Belleville. Smooth with Optimus. Glass / Door BLS-404-928-Z / Sidelites BLSL-450-928-1

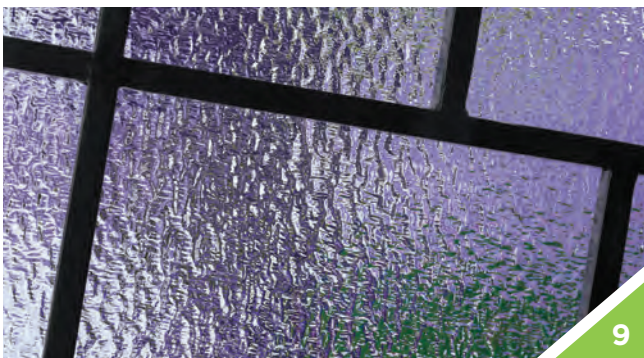

9



Tempered Granite Glass (Inside Facing)

Wrought Iron

Optimus. Glass

BELLEVILLE. TEXTURED DOORS



BMT
Mahogany
Fiberglass



BMT-122-928-X



BMT-404-928-1



BMTSL-152-928-X



BMTSL-450-928-1



BFT
Fir
Fiberglass



BFT-122-928-X



BFT-404-928-1



BFTSL-450-928-1



BLT
Oak
Fiberglass



BLT-122-928-X



BLT-404-928-2



BLTSL-152-928-X



BLTSL-450-928-1

6'8"						7'0"			8'0"		
	122-X 122-928-X	404-1 404-928-1	404-2 404-928-2	152-X 152-928-X	450-1 450-928-1		122-X 122-928-X	152-X 152-928-X		404-2 404-928-2	450-1 450-928-1
WR											
BMT	•	•		•	•						
BFT	•	•			•						
BLT	•		•	•	•						
BLS	•	•	•	•	•	•	•			•	•
MHD	•			•		•					



BELLEVILLE. SMOOTH DOORS



BLS
Smooth
Fiberglass



BLS-122-928-X



BLS-122-928-X



BLS-404-928-1



BLS-404-928-2



BLS-404-928-2



BLS-152-928-X



BLS-450-928-1



BLS-152-928-X



BLS-450-928-1

HD STEEL DOORS



MHD
HD Steel



MHD-122-928-X



MHD-152-928-X

EXPO

IRON

CLASSIC

TEXTURES

LINEA
(CLEAR GLASS WITH GRIDS)

ESSENTIA
(CLEAR GLASS)



► Belleville, Smooth with Tanglewood, Glass / Doors BLS-122-926-X / Sidelites BLSSL-152-926-X



Tanglewood. Glass

926 - WR
WROUGHT IRON

EXPO

IRON

CLASSIC

TEXTURES

LINEA
(CLEAR GLASS WITH GRIDS)

ESSENTIA
(CLEAR GLASS)



► Belleville. Hollister. Fir Textured with Tanglewood. Glass
Door BFT-404-926-1



9

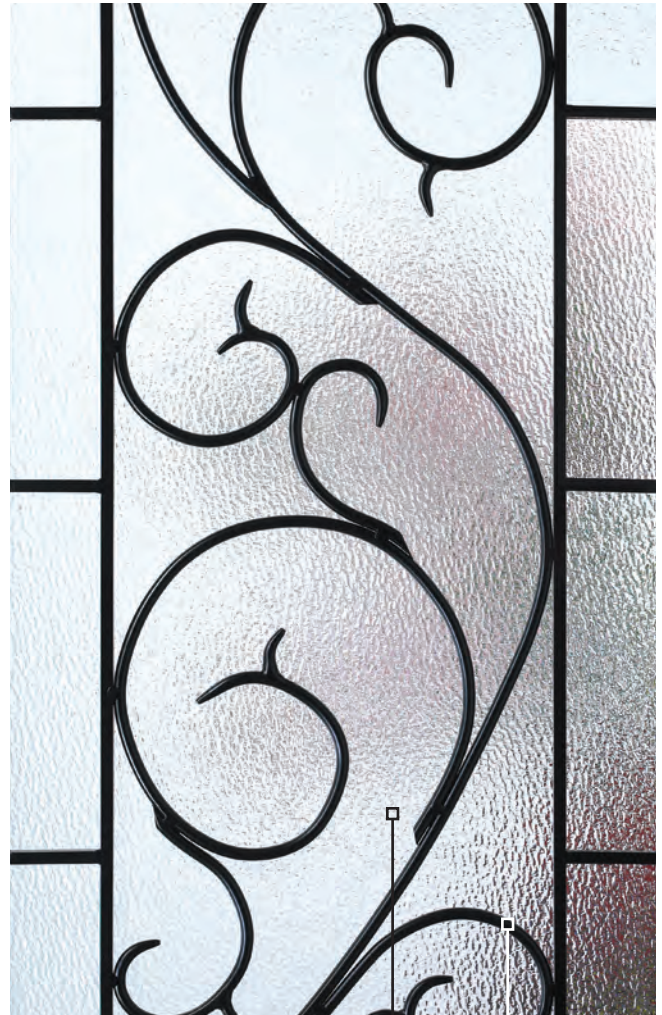

Tempered Granite Glass (Inside Facing)

Wrought Iron

Tanglewood. Glass

BELLEVILLE. TEXTURED DOORS



BMT
Mahogany
Fiberglass



BMT-122-926-X



BMT-404-926-1



BMTSL-152-926-X



BMTSL-450-926-1



BFT
Fir
Fiberglass



BFT-122-926-X



BFT-404-926-1



BFTSL-450-926-1



BLT
Oak
Fiberglass



BLT-122-926-X



BLT-404-926-2



BLTSL-152-926-X



BLTSL-450-926-1

6'8"						7'0"			8'0"		
	122-X	404-1	404-2	152-X	450-1		122-X	152-X		404-2	450-1
WR	122-926-X	404-926-1	404-926-2	152-926-X	450-926-1		122-926-X	152-926-X		404-926-2	450-926-1
BMT	•	•		•	•						
BFT	•	•			•						
BLT	•		•	•	•						
BLS	•	•	•	•	•		•	•		•	•
MHD	•			•			•				



EXPO

IRON

CLASSIC

TEXTURES

LINEA
(CLEAR GLASS WITH GRIDS)

ESSENTIA
(CLEAR GLASS)

BELLEVILLE. SMOOTH DOORS



HD STEEL DOORS

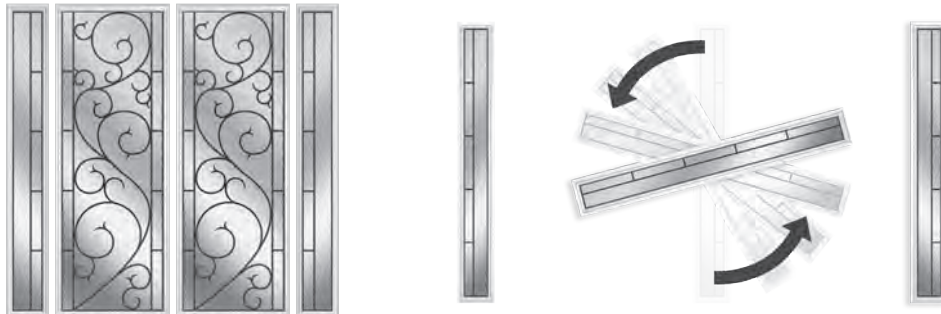

One sidelite would need to be rotated 180° to get the "bookend look."



Belleville. Smooth with Panama Glass / Door BLS-122-725-X / Sidelites BLSL-152-725-X / Transom T-725



EXPO

IRON

CLASSIC

TEXTURES

LINEA
(CLEAR GLASS WITH GRIDS)

ESSENTIA
(CLEAR GLASS)

MASONITE

CLASSIC.



► Belleville. Hollister Smooth with Alston Glass / Door BLS-404-338-1 / Sidelites BLSL-450-338-1

Alston. 338. 80

Georgian.™ 515 / 517. 84

Panama. 724 / 725 88

Rozet. 467 92

Sonnet. 472 96



► Belleville, Hollister, Fir Textured with Alston, Glass / Doors BFT-404-338-1 / Sidelites BFTSL-450-338-1



Alston Glass

338 - AB
ANTIQUE BLACK CAMING

EXPO

IRON

CLASSIC

TEXTURES

LINEA
(CLEAR GLASS WITH GRIDS)

ESSENTIA
(CLEAR GLASS)



► Belleville, Smooth with Alston Glass / Door BLS-106-338-1

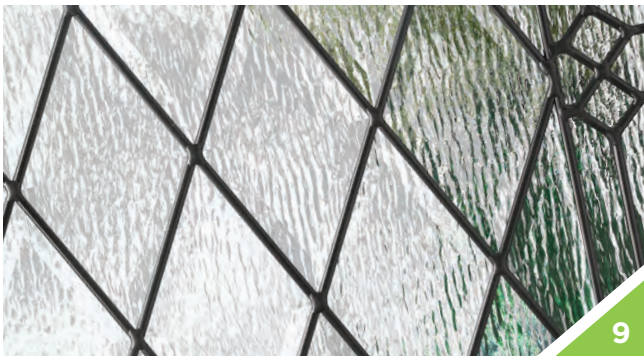

9

PRIVACY RATING 1 — 9 — 10
Least Obscure ▲ Most Obscure



Clear Beveled Glass Tempered Nagara Glass (Inside Facing) Granite Glass Antique Black Caming Tempered Water Glass

Alston Glass

BELLEVILLE, TEXTURED DOORS



BMT
Mahogany
Fiberglass



BMT-122-338-1P BMT-404-338-1 BMT-106-338-2 BMT-107-338-1P BMT-304-338-2 BMTSL-152-338-X BMTSL-450-338-1 BMTSL-129-338-1



BFT
Fir
Fiberglass



BFT-122-338-X BFT-404-338-1 BFT-304-338-2 BFT-106-338-2 BFTSL-450-338-1 BFTSL-129-338-1



BLT
Oak
Fiberglass



BLT-122-338-X BLT-404-338-2 BLT-106-338-2 BLT-106-338-1 BLT-107-338-2 BLT-304-338-3 BLT-137-338-4 BLTSL-152-338-X BLTSL-450-338-1 BLTSL-129-338-1

6'8"															
	122-X	404-1	404-2	304-2	304-3	106-1	106-1P	106-2	107-1	107-1P	107-2	137-4	152-X	450-1	129-1
AB	122-338-X	404-338-1	404-338-2	304-338-2	304-338-3	106-338-1	106-338-1P	106-338-2	107-338-1	107-338-1P	107-338-2	137-338-4	152-338-X	450-338-1	129-338-1
BMT	•	•		•			•	•		•			•	•	•
BFT	•	•		•				•						•	•
BLT	•		•		•	•		•			•	•	•	•	•
BLS	•	•	•	•	•	•	•	•	•	•	•	•	•	•	•
MHD	•					•		•	•		•	•	•		•



BELLEVILLE, SMOOTH DOORS



BLS
Smooth
Fiberglass



BLS-122-338-X BLS-122-338-X BLS-404-338-1 BLS-404-338-2 BLS-106-338-1P BLS-106-338-2 BLS-106-338-2 BLS-404-338-2 BLS-107-338-1



BLS-107-338-1P BLS-107-338-2 BLS-106-338-1 BLS-304-338-2 BLS-304-338-3 BLS-137-338-4 BLS-152-338-X BLS-450-338-1 BLS-129-338-1 BLS-152-338-X BLS-450-338-1

HD STEEL DOORS



MHD
HD Steel



MHD-122-338-X MHD-107-338-1 MHD-106-338-1 MHD-106-338-1 MHD-107-338-2 MHD-106-338-2 MHD-106-338-2 MHD-137-338-4

7'0"					8'0"		
	AB	122-338-X	106-338-1	106-338-2		152-338-X	404-338-2
BMT							
BFT							
BLT							
BLS	•		•	•		•	•
MHD	•	•	•				

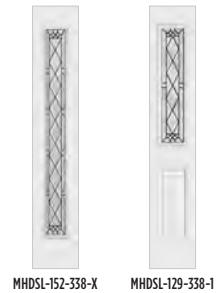

MHDSL-152-338-X MHDSL-129-338-1

EXPO

IRON

CLASSIC

TEXTURES

LINEA
(CLEAR GLASS WITH GRIDS)

ESSENTIA
(CLEAR GLASS)



► Belleville. 1/2 lite with Georgian... Glass / Door BMT-106-129-517-2 / Sidelites BLSSL-129-517-1 / Transom S-646



Georgian™ Glass

517 - P
PLATINUM CAMING

EXPO

IRON

CLASSIC

TEXTURES

LINEA
(CLEAR GLASS WITH GRIDS)

ESSENTIA
(CLEAR GLASS)



Belleville, Hollister, Mahogany Textured
With Georgian™ Glass Door BMI-304-517-1



3

PRIVACY RATING 1 — 3 — 10
Least Obscure ▲ Most Obscure



Glue Chip Glass

Clear Beveled Glass

Platinum Caming

Georgian™ Glass

BELLEVILLE™ TEXTURED DOORS



68"														
	122-X	404-1	404-2	304-2	304-3	106-1	106-1P	106-2	107-1	107-1P	107-2	152-X	450-1	129-1
P	122-517-X	404-517-1	404-517-2	304-517-2	304-517-3	106-517-1	106-517-1P	106-517-2	107-517-1	107-517-1P	107-517-2	152-517-X	450-517-1	129-517-1
BMT	•	•		•			•	•		•		•	•	•
BFT	•	•		•				•					•	•
BLT	•		•		•	•		•			•	•	•	•
BLS	•	•	•	•	•	•	•	•	•	•	•	•	•	•
MHD	•					•		•	•		•	•		•



BELLEVILLE SMOOTH DOORS



BLS
Smooth
Fiberglass



HD STEEL DOORS



MHD
HD Steel



7'0"					8'0"		
	122-X	106-1	106-2	152-X		404-2	450-1
P	122-517-X	106-517-1	106-517-2	152-517-X		404-517-2	450-517-1
BMT							
BFT							
BLT							
BLS	•		•	•		•	•
MHD	•	•	•	•			





▶ Belleville - Smooth with Panama - Glass / Door BLS-122-725-X / Sidelites BLSSL-152-725-X



Panama Glass

725 - P
PLATINUM CAMING

EXPO

IRON

CLASSIC

TEXTURES

LINEA
(CLEAR GLASS WITH GRIDS)

ESSENTIA
(CLEAR GLASS)



▶ Belleville, Oak Textured with Panama Glass / Door BLT-106-725-2



4



- Granite Glass
- Clear Beveled Glass
- Aqua Glass
- Platinum Caming

Panama. Glass

BELLEVILLE. TEXTURED GLASS DOORS



BMT
Mahogany
Fiberglass



BMT-122-725-X



BMT-404-725-1



BMT-304-725-2



BMT-106-725-1P



BMT-106-725-2



BMTSL-152-725-X



BMTSL-450-725-1



BMTSL-129-725-1



BFT
Fir
Fiberglass



BFT-122-725-X



BFT-404-725-1



BFT-304-725-2



BFT-106-725-2



BFTSL-450-725-1



BFTSL-129-725-1



BLT
Oak
Fiberglass



BLT-122-725-X



BLT-304-725-3



BLT-404-725-2



BLT-106-725-1



BLT-106-725-2



BLT-135-725-4



BLTSL-152-725-X



BLTSL-450-725-1



BLTSL-129-725-1

6'8"												
	122-X	404-1	404-2	304-2	304-3	106-1	106-1P	106-2	135-4	152-X	450-1	129-1
P	122-725-X	404-725-1	404-725-2	304-725-2	304-725-3	106-725-1	106-725-1P	106-725-2	135-725-4	152-725-X	450-725-1	129-725-1
BMT	•	•		•			•	•		•	•	•
BFT	•	•		•				•			•	•
BLT	•		•		•	•		•	•	•	•	•
BLS	•	•	•	•	•	•	•	•	•	•	•	•
MHD	•					•		•	•	•		•



EXPO

IRON

CLASSIC

TEXTURES

LINEA
(CLEAR GLASS WITH GRIDS)

ESSENTIA
(CLEAR GLASS)

BELLEVILLE. SMOOTH DOORS



BLS
Smooth
Fiberglass



BLS-122-725-X BLS-122-725-X BLS-404-725-1 BLS-404-725-2 BLS-304-725-3 BLS-304-725-2 BLS-106-725-1 BLS-106-725-1P

BLS-106-725-2 BLS-106-725-2 BLS-404-725-2 BLS-135-725-4 BLSSL-152-725-X BLSSL-450-725-1 BLSSL-129-725-1 BLSSL-152-725-X BLSSL-450-725-1

HD STEEL DOORS



MHD
HD Steel



MHD-122-725-X MHD-106-725-1 MHD-106-725-1 MHD-106-725-2 MHD-106-725-2 MHD-135-725-4 MHD-152-725-X MHD-129-725-1

7'0"					8'0"		
		122-X	106-1	106-2		152-X	404-2
P	122-725-X	106-725-1	106-725-2	152-725-X		404-725-2	450-725-1
BMT							
BFT							
BLT							
BLS	•		•	•		•	•
MHD	•	•	•				



Belleville - Smooth with Rozet - Glass / Doors BLS-122-467-X



Rozet. Glass

467 - AB
ANTIQUE BLACK

EXPO

IRON

CLASSIC

TEXTURES

LINEA
(CLEAR GLASS WITH GRIDS)

ESSENTIA
(CLEAR GLASS)



Belleville 1 Panel with Rozet. Glass
Door BLS-106-129-467-1 / Sidelites BLSS1-129-467-1



PRIVACY RATING 1 — 5 — 10
Least Obscure ▲ Most Obscure



Clear Beveled Glass
Pale Gray Water Glass
Granite Glass
Pear Glass
Antique Black Caming

BELLEVILLE. TEXTURED DOORS



BMT
Mahogany
Fiberglass



BMT-122-467-X BMT-106-467-1P BMT-404-467-1 BMT-304-467-2 BMT-107-467-1P BMT-106-467-2 BMTSL-152-467-X BMTSL-450-467-1 BMTSL-129-467-1



BFT
Fir
Fiberglass



BFT-122-467-X BFT-404-467-1 BFT-304-467-2 BFT-106-467-2 BFTSL-450-467-1 BFTSL-129-467-1



BLT
Oak
Fiberglass



BLT-122-467-X BLT-404-467-2 BLT-304-467-3 BLT-106-467-1 BLT-106-467-2 BLT-107-467-2 BLT-137-467-4 BLTSL-152-467-X BLTSL-450-467-1 BLTSL-129-467-1

6'8"															
	122-X	404-1	404-2	304-2	304-3	106-1	106-1P	106-2	107-1	107-1P	107-2	137-4	129-1	152-X	450-1
AB	122-467-X	404-467-1	404-467-2	304-467-2	304-467-3	106-467-1	106-467-1P	106-467-2	107-467-1	107-467-1P	107-467-2	137-467-4	129-467-1	152-467-X	450-467-1
BMT	•	•		•			•	•		•			•	•	•
BFT	•	•		•				•					•	•	•
BLT	•		•		•	•		•	•		•	•	•	•	•
BLS	•	•	•	•	•	•	•	•	•	•	•	•	•	•	•
MHD	•					•		•	•		•	•	•	•	



EXPO

IRON

CLASSIC

TEXTURES

LINEA
(CLEAR GLASS WITH GRIDS)

ESSENTIA
(CLEAR GLASS)

BELLEVILLE. SMOOTH DOORS



BLS
Smooth
Fiberglass

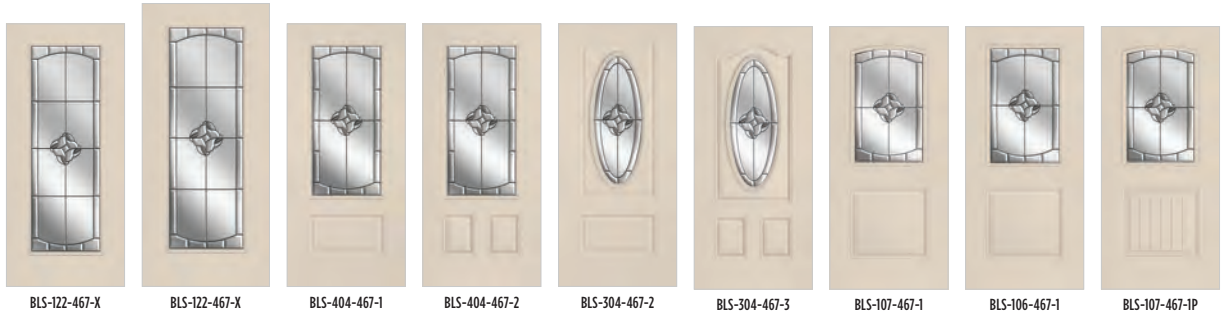

BLS-122-467-X BLS-122-467-X BLS-404-467-1 BLS-404-467-2 BLS-304-467-2 BLS-304-467-3 BLS-107-467-1 BLS-106-467-1 BLS-107-467-1P

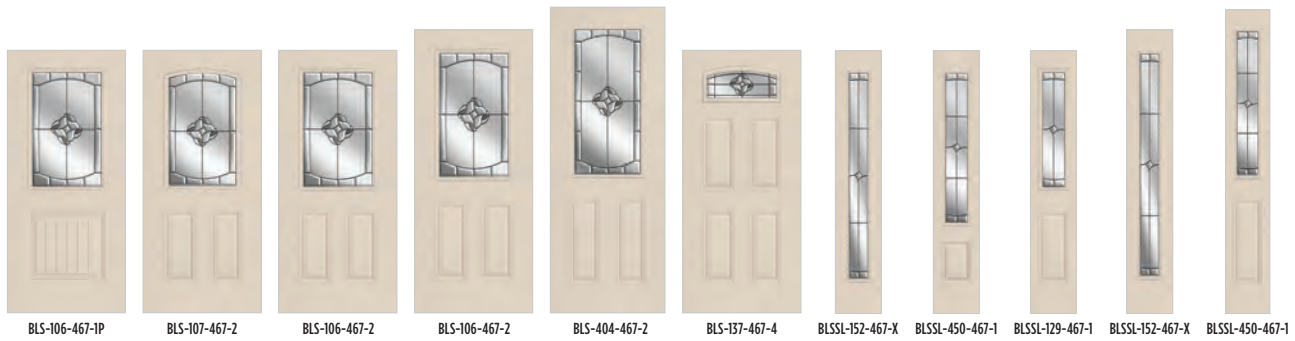

BLS-106-467-1P BLS-107-467-2 BLS-106-467-2 BLS-106-467-2 BLS-404-467-2 BLS-137-467-4 BLSL-152-467-X BLSL-450-467-1 BLSL-129-467-1 BLSL-152-467-X BLSL-450-467-1

HD STEEL DOORS



MHD
HD Steel



MHD-122-467-X MHD-107-467-1 MHD-106-467-1 MHD-106-467-1 MHD-107-467-2 MHD-106-467-2 MHD-106-467-2 MHD-137-467-4

	7'0"				8'0"	
	122-X	106-1	106-2	152-X	404-2	450-1
AB	122-467-X	106-467-1	106-467-2	152-467-X	404-467-2	450-467-1
BMT						
BFT						
BLT						
BLS	•		•	•	•	•
MHD	•	•	•			



MHDSL-152-467-X MHDSL-129-467-1



Belleville, Mahogany Textured with Sonnet, Glass / Door BMT-122-472-X



Sonnet. Glass

472 - P
PLATINUM CAMING

EXPO

IRON

CLASSIC

TEXTURES

LINEA
(CLEAR GLASS WITH GRIDS)

ESSENTIA
(CLEAR GLASS)



Belleville. Hollister. Fir Textured with Sonnet. Glass
Door BFT-404-472-1 / Sidelites BFTSL-450-472-1



5

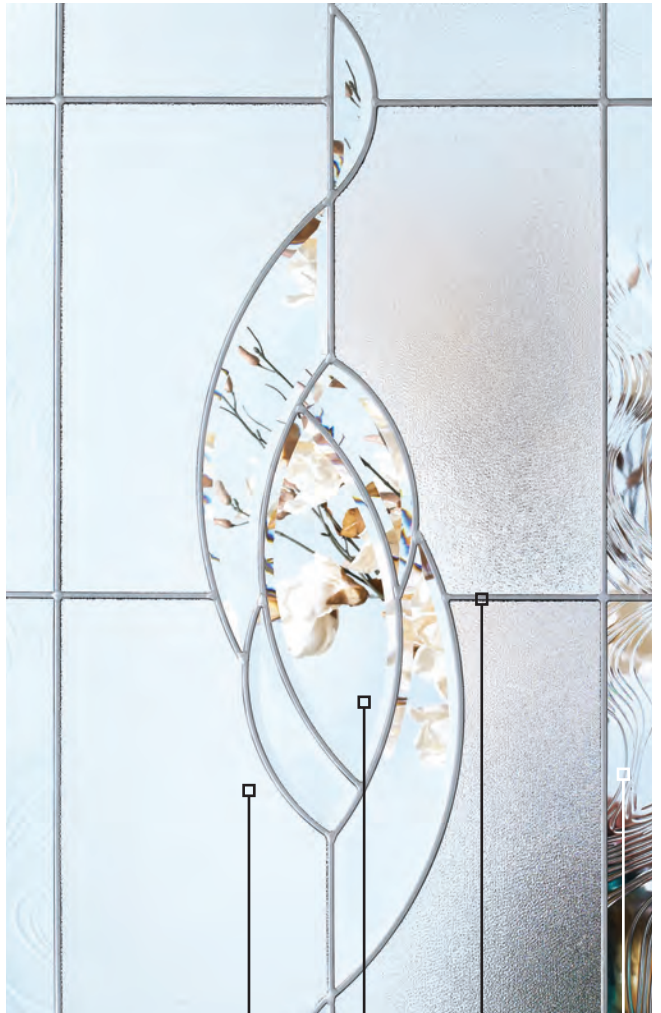

Pear Glass Clear Beveled Glass Platinum Caming Clear Baroque Glass

Sonnet Glass

BELLEVILLE. TEXTURED DOORS



BMT
Mahogany
Fiberglass



BMT-122-472-X



BMT-404-472-1



BMTSL-152-472-X



BMTSL-450-472-1



BFT
Fir
Fiberglass



BFT-122-472-X



BFT-404-472-1



BFTSL-450-472-1



BLT
Oak
Fiberglass



BLT-122-472-X



BLT-404-472-2



BLTSL-152-472-X



BLTSL-450-472-1

	6'8"					7'0"	8'0"		
	122-X	404-1	404-2	152-X	450-1		122-X	152-X	404-2
P	122-472-X	404-472-1	404-472-2	152-472-X	450-472-1	122-472-X	152-472-X	404-472-2	450-472-1
BMT	•	•		•	•				
BFT	•	•			•				
BLT	•		•	•	•				
BLS	•	•	•	•	•	•	•	•	•
MHD	•			•		•			



BELLEVILLE. SMOOTH DOORS



BLS
Smooth
Fiberglass



BLS-122-472-X



BLS-122-472-X



BLS-404-472-1



BLS-404-472-2



BLS-404-472-2



BLSSL-152-472-X



BLSSL-450-472-1



BLSSL-152-472-X



BLSSL-450-472-1

HD STEEL DOORS



MHD
HD Steel



MHD-122-472-X



MHD-122-472-X



MHD-152-472-X

EXPO

IRON

CLASSIC

TEXTURES

LINEA
(CLEAR GLASS WITH GRIDS)

ESSENTIA
(CLEAR GLASS)



Belleville Smooth with Pear Glass / BLS-404-116-1 / Sidellites BLSL 450-116-1 / Transom T-010



EXPO

IRON

CLASSIC

TEXTURES

LINEA
(CLEAR GLASS WITH GRIDS)

ESSENTIA
(CLEAR GLASS)

MASONITE TEXTURES™



▶ Belleville Textured Mahogany Full Lite with Pear Glass
Door BMT-122-116-X

Double Water 113 103

Pear 116. 103

Pearl 140 103



▶ Belleville, Smooth 2 Panel with Pear Glass / Door BLS-106-116-2 / Sidelites BLSL-129-116-1

Textured Glass

PRIVACY RATING



113 / 116 / 140 - T
TEXTURED



► Masonite. HD Steel 3 Lite Equal with Double Water Glass / Door MHD-217-113-X



7

Double Water 113 / T

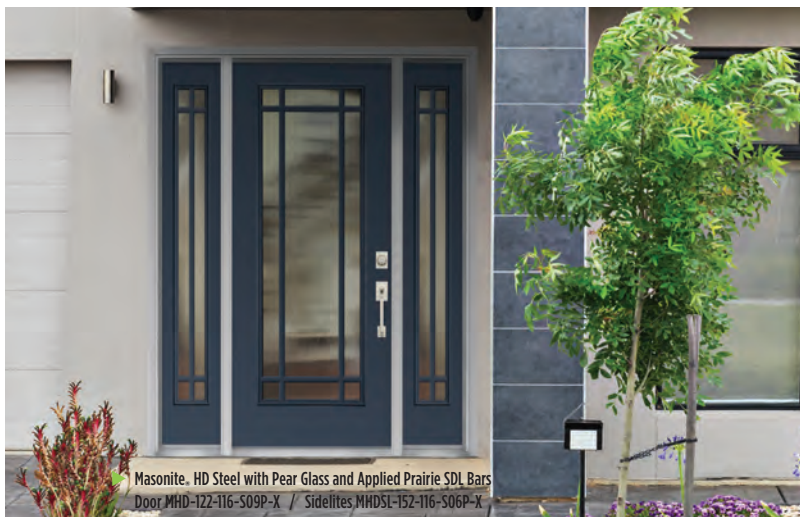

Masonite. HD Steel with Pear Glass and Applied Prairie SDL Bars
Door MHD-122-116-S09P-X / Sidelites MHD5L-152-116-S06P-X



9

Pear 116 / T



► Belleville Mahogany With Pearl Glass / Door BMT-122-140-X



9

Pearl 140 / T



EXPO

IRON

CLASSIC

TEXTURES

(CLEAR GLASS WITH GRIDS)

LINEA

(CLEAR GLASS)
ESSENTIA

Textured Glass

BELLEVILLE. TEXTURED DOORS / PEAR GLASS SHOWN



BMT
Mahogany
Fiberglass



BMT-122-116-X BMT-404-116-1 BMT-106-116-1P BMT-106-116-2 BMT-228-116-4 BMTSL-152-116-X BMTSL-450-116-1 BMTSL-129-116-1



BFT
Fir
Fiberglass



BFT-122-116-X BFT-404-116-1 BFT-106-116-2 BFT-228-116-4 BFTSL-450-116-1 BFTSL-129-116-1



BLT
Oak
Fiberglass



BLT-122-116-X BLT-404-116-2 BLT-106-116-1 BLT-106-116-2 BLT-228-116-4 BLTSL-152-116-X BLTSL-450-116-1 BLTSL-129-116-1

6'8"												
	122-X	217-X	404-1	106-1	106-1P	106-2	217-2C	228-4	152-X	450-1	129-1	617-1
T	122-113-X	217-113-X	404-113-1	106-113-1	106-113-1P	106-113-2	217-113-2C	228-113-4	152-113-X	450-113-1	129-113-1	617-113-1
T	122-140-X	217-140-X	404-140-1	106-140-1	106-140-1P	106-140-2	217-140-2C	228-140-4	152-140-X	450-140-1	129-140-1	617-140-1
T	122-116-X	217-116-X	404-116-1	106-116-1	106-116-1P	106-116-2	217-116-2C	228-116-4	152-116-X	450-116-1	129-116-1	617-116-1
BMT	•		•		•	•		•	•	•	•	
BFT	•		•			•		•		•	•	
BLT	•			•		•		•	•	•	•	
BLS		•	•	•	•			•	•	•	•	
MHD	•	•		•		•	•	•	•		•	•



EXPO

IRON

CLASSIC

TEXTURES

LINEA
(CLEAR GLASS WITH GRIDS)

ESSENTIA
(CLEAR GLASS)

BELLEVILLE. SMOOTH DOORS / PEAR GLASS SHOWN



BLS
Smooth
Fiberglass



HD STEEL DOORS / PEAR GLASS SHOWN



MHD
HD Steel



7'0"					"0.8		
	122-X	106-1	106-2	152-X		404-2	450-1
T	122-113-X	106-113-1	106-113-2	152-113-X		404-113-2	450-113-1
T	122-140-X	106-140-1	106-140-2	152-140-X		404-140-2	450-140-1
T	122-116-X	106-116-1	106-116-2	152-116-X		404-116-2	450-116-1
BMT							
BFT							
BLT							
BLS	•		•	•		•	•
MHD	•	•	•				





Belleville. Smooth with Pear Glass and Applied SDL Bars / Door BLS-122-S09P-116-X / Sidelites BLSS-152-S06P-X



EXPO

IRON

CLASSIC

TEXTURES

LINEA
(CLEAR GLASS WITH GRIDS)

ESSENTIA
(CLEAR GLASS)

MASONITE LINEA.



► Belleville, Hollister, Smooth with Pear Glass and Applied SDL Bars
Door BLS-106-S09-116-1 / Sidelites BLSSL-129-S03-116-1

Simulated Divided Lites . . . 108

Internal Grids 112

External Grids 112



► Belleville. Smooth with Clear Glass and 6 Lite Applied SDL Bars / Door BLS-106-S06-2



SDL

Simulated Divided Lites

EXPO

IRON

CLASSIC

TEXTURES

(CLEAR GLASS WITH GRIDS)

LINEA

(CLEAR GLASS)



Pearl 140 / T



Double Water 113 / T



Pear 116 / T



Standard SDL / Smooth

Clear / 010





















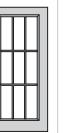
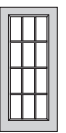



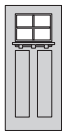





Standard SDL / Textured



Clear / 010



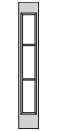

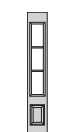

SDL Simulated Divided Lites

6'8"																	
	106-S04-1	106-S04-1P	106-S04-2	106-S06-1	106-S06-1P	106-S06-2	106-S09-1	106-S09-1P	106-S09-2	122-S04-X	122-S06-X	122-S08-X	122-S09-X	122-S10-X	122-S12-X	122-S15-X	217-S02-2C
BMT		•	•		•	•		•	•	•	•	•	•	•	•	•	
BFT			•		•			•	•	•	•	•	•	•	•	•	
BLT	•		•	•		•	•		•	•	•	•	•	•	•	•	
BLS	•	•	•	•	•	•	•	•	•	•	•	•	•	•	•	•	
MHD	•		•	•		•	•		•	•	•	•	•	•	•	•	•

6'8"																	
	217-S03-2C	217-S04-2C	217-S06-2C	404-S04-1	404-S04-2	404-S06-1	404-S06-2	404-S08-1	404-S08-2	129-S02-1	129-S03-1	151-S03-X	151-S04-X	151-S05-X	152-S03-X	152-S04-X	152-S05-X
BMT				•		•		•		•	•				•	•	•
BFT				•		•		•		•	•	•	•	•			
BLT					•			•		•	•				•	•	•
BLS				•	•	•	•	•	•	•	•				•	•	•
MHD	•	•	•							•	•				•	•	•

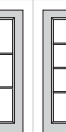
6'8"				
	450-S02-1	450-S03-1	450-S04-1	617-S02-1
BMT	•	•	•	
BFT	•	•	•	
BLT	•	•	•	
BLS	•	•	•	
MHD				•

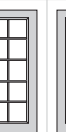
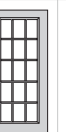
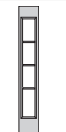
7'0"																
	106-S04-1	106-S04-2	106-S06-1	106-S06-2	106-S09-1	106-S09-2	122-S04-X	122-S06-X	122-S08-X	122-S09-X	122-S10-X	122-S12-X	122-S15-X	152-S03-X	152-S04-X	152-S05-X
BMT																
BFT																
BLT																
BLS		•		•		•	•	•	•	•	•	•	•	•	•	•
MHD	•	•	•	•	•	•	•	•	•	•	•	•	•	•	•	•



EXPO

IRON

CLASSIC

TEXTURES

LINEA
(CLEAR GLASS WITH GRIDS)

ESSENTIA
(CLEAR GLASS)

3'0" x 8'0"											
	404-S04-Z	404-S06-Z	404-S08-Z	810-S04-X	810-S06-X	810-S08-X	810-S09-X	810-S10-X	810-S12-X	810-S15-X	810-S18-X
BLS	•	•	•	•	•	•	•	•	•	•	•

8'0"							
	450-S02-1	450-S03-1	450-S04-1	852-S03-X	852-S04-X	852-S05-X	852-S06-X
BLS	•	•	•	•	•	•	•

6'8.9"						3'0" x 8'0"					
	122-S09P-X	404-S09P-Z	151-S06P-X	152-S06P-X	450-S06P-1		404-S09P-Z	810-S09P-X	820-S09P-X	450-S06P-1	852-S06P-X
BMT	•			•	•						
BFT	•		•	•	•						
BLT	•	•		•	•						
BLS	•	•		•	•		•	•	•	•	•
MHD	•			•							



Simulated divided lites profiles



► Belleville, Smooth with Clear Glass and 10 Lite Internal Grids / Door BLS-422-101-X

Internal & External Grids

INTERNAL GRID TYPES (specify grid type when ordering) Not all grid styles are available in all lite sizes. Please call for availability.

C
White Wide Traditional
7/8"

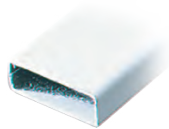

D
White Georgian
5/8"

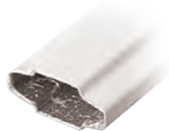

Internal Grid

Clear / 010



External Grid

Clear / 010



Internal Grids

LOW-E GLASS

6'8"											
	106-041-1	106-041-1P	106-041-2	106-091-1	106-091-1P	106-091-2	122-101-X	122-151-X	122-041-X	135-041-4	228-061-4
BMT		•	•		•	•	•	•	•		•
BFT			•			•	•	•	•		•
BLT	•		•	•		•	•	•	•	•	•
BLS	•	•	•	•	•	•	•	•	•	•	•
MHD	•		•	•		•	•	•	•	•	•

Grille Type **D**
White Georgian
5/8"

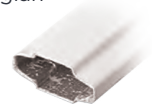

6'8"							
	404-041-1	404-041-2	404-121-1	404-121-2	129-031-1	152-051-X	450-041-1
BMT	•		•		•	•	•
BFT	•		•		•		•
BLT		•		•	•	•	•
BLS	•	•	•	•	•	•	•
MHD	•	•			•	•	•

7'0"								
	106-041-1	106-041-2	106-091-1	106-091-2	122-101-X	122-151-X	122-041-X	228-061-4
BLS	•	•	•	•	•	•	•	•
MHD	•	•	•	•	•	•	•	•

3'0" x 8'0"					
	404-S04-2	404-S08-2	450-041-1	820-181-X	852-061-X
BLS	•	•	•	•	•
MHD	•	•	•	•	•



CRAFTSMAN / HERITAGE WITH LOW-E GLASS

6'8"						8'0"					
	217-021-2C	217-031-2C	217-041-2C	217-061-2C	617-021-1		217-021-2C	217-031-2C	217-041-2C	217-061-2C	617-021-1
HFT	•	•	•	•	•						
HGS	•	•	•	•	•	•	•	•	•	•	
MHD	•	•	•	•	•						

Grille Type C
White Wide Traditional
7/8"

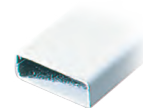

PRAIRIE INTERNAL GRID INSERTS WITH LOW-E GLASS

6'8"								7'0"				
	106-09P-1	106-09P-1P	106-09P-2	122-09P-X	404-09P-1	404-09P-2	152-06P-X		450-06P-1	106-09P-1	106-09P-2	122-09P-X
BMT		•	•	•	•		•	•		•	•	•
BFT			•	•	•		•	•		•	•	•
BLT	•		•	•	•		•	•	•	•	•	•
BLS	•	•	•	•	•		•	•	•	•	•	•
MHD	•		•	•			•	•	•	•	•	•

Grille Type D
White Georgian
5/8"



EXPO

IRON

CLASSIC

TEXTURES

LINEA
(CLEAR GLASS WITH GRIDS)

ESSENTIA
(CLEAR GLASS)

External Grids

LOW-E GLASS

6'8"									
	106-09E-1	106-09E-1P	106-09E-2	122-10E-X	122-15E-X	135-05E-4	160-09E-2	129-03E-1	152-05E-X
BLS	•	•	•	•	•	•	•	•	•
MHD	•	•	•	•	•	•	•	•	•

LOW-E GLASS

6'8"			
	217-03E-2C	217-06E-2C	617-02E-1
HFT	•	•	•
HGS	•	•	•
MHD	•	•	•

7'0"					
	106-09E-1	106-09E-2	122-10E-X	122-15E-X	152-05E-X
BLS	•	•	•	•	•
MHD	•	•	•	•	•

8'0"			
	217-03E-2C	217-06E-2C	617-02E-1
HFT	•	•	•
HGS	•	•	•



EXPO

IRON

CLASSIC

TEXTURES

LINEA
(CLEAR GLASS WITH GRIDS)

ESSENTIA
(CLEAR GLASS)

MASONITE

ESSENTIA[®]



▶ Masonite, HD Steel Door with Clear Glass / Door MHD-217-010-2C

Clear Glass 010	118
Mini Blinds	124
Vent Lites	124



▶ Belleville, Hollister, Smooth with Clear Glass / Door BLS-404-010-1

Clear Glass

BELLEVILLE. TEXTURED DOORS WITH LOW-E GLASS



	*	*	*				*	o	o	
6'8"										
	106-010-1	106-010-1P	106-010-2	107-010-1	107-010-1P	107-010-2	122-010-X	135-010-4	137-010-4	217-010-2C
BMT		•	•				•			
BFT			•				•			
BLT	•		•				•	•	•	
BLS	•	•	•	•	•	•	•	•	•	
MHD	•		•	•		•	•	•	•	•

* Also stocked in IG glass for Steel & Belleville Smooth Fiberglass (BLS)

o Only stocked in IG glass



EXPO

IRON

CLASSIC

TEXTURES

LINEA
(CLEAR GLASS WITH GRIDS)

ESSENTIA
(CLEAR GLASS)

BELLEVILLE. TEXTURED DOORS WITH LOW-E GLASS



BLT
Oak
Fiberglass



	o								o	o	*	*		
6'8"														
	217-010-X	228-010-4	304-010-2	304-010-3	404-010-1	404-010-2	680-010-4	682-010-4	129-010-1	151-010-X	152-010-X	450-010-1	617-010-1	
BMT			•		•				•		•	•		
BFT		•	•		•				•	•		•		
BLT		•		•		•			•		•	•		
BLS	•	•	•	•	•	•		•	•	•	•	•		
MHD	•	•					•		•		•		•	

	*	*	*	o	o	o	*	
7'0"								
	122-010-X	106-010-1	106-010-2	228-010-4	680-010-4	682-010-4	152-010-X	129-010-1
BLS	•		•	•		•	•	•
MHD	•	•	•	•	•			•

	o					
8'0"						
	404-010-2	810-010-X	682-010-4	228-010-4	852-010-X	450-010-1
BLS	•	•	•	•	•	•

†Shown with optional dentil shelf. MHD doors are available with wood-edge or steel-edge construction. Wood-edge sidelites are utilized on all MHD door units. All BFT and BLT doors shown are available with matching almond frames. All BMT doors shown are available with matching mahogany frames.

Clear Glass

BELLEVILLE. SMOOTH DOORS



* Also stocked in IG glass for Steel & Belleville Smooth Fiberglass (BLS)

o Only stocked in IG glass

Belleville. smooth doors shown painted beige. / Refer to chart on previous page for full availability.
Profiles for 217 lite frame is unique. Please specify Heritage Series™ sidelites to match.



HD STEEL DOORS



MHD
HD Steel

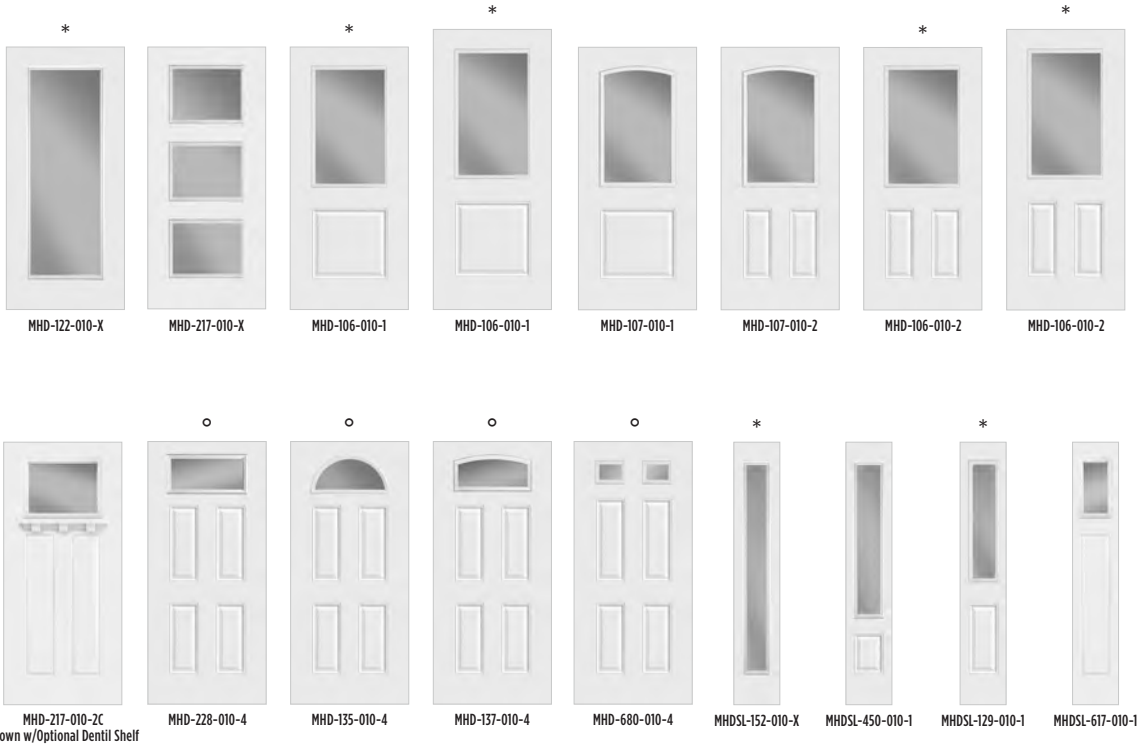

EXPO

IRON

CLASSIC

TEXTURES

LINEA
(CLEAR GLASS WITH GRIDS)

ESSENTIA
(CLEAR GLASS)



Belleville - Smooth with Clear Glass and Impact Mini Blinds / Doors SGS-B122-D1RLM-X

Mini Blinds & Vents



White Mini Blinds



Centurion® Frame

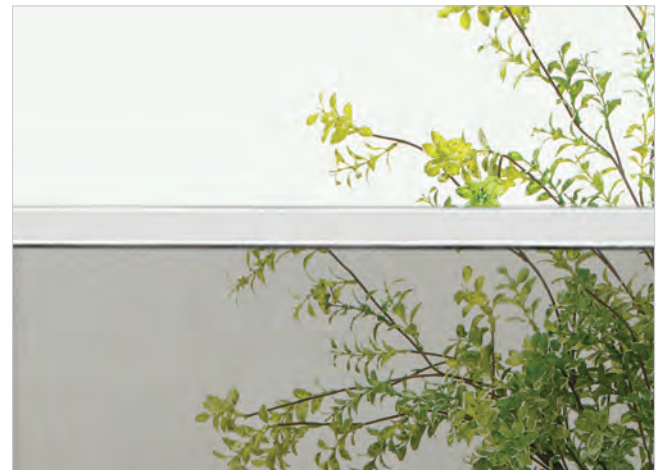













Vent Lites

Imagine a blind you don't have to dust or clean. Our blinds are built into efficient sealed units protected with tempered glass. A single touch easily opens/closes blinds for privacy and light exposure.

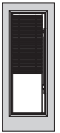
- ▶ All sizes feature raise, lower and tilt functionality
- ▶ Security channels provide full privacy preventing light gaps when closed (no side or bottom gaps)
- ▶ Frame fits tight to glass—no large gaps
- ▶ Spacer bars not visible in sightline of frame
- ▶ Smoother, easier and more versatile dual mechanism operation
- ▶ LE for ENERGY STAR compliance

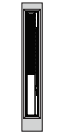



Mini Blinds & Vents

MINI BLINDS / RAISE, LOWER AND TILT WITH LOW-E GLASS

6'8"								7'0"					8'0"		
	B122-01RL-X	B404-01RL-2	B106-01RL-1	B106-01RL-2	B152-01RL-X	B450-01RL-1	B129-01RL-1		B152-01RL-X	B106-01RL-2	B152-01RL-X	B129-01RL-1		B404-01RL-2	B450-01RL-1
BFT	•			•		•	•								
BLT	•	•	•	•	•	•	•								
BLS	•	•	•	•	•	•	•		•	•	•	•		•	•
MHD	•		•	•	•		•		•	•					

Mini blinds stocked in white.

VENTING INSERTS

6'8"				
	V106-010-1	V106-010-2	V106-12i-2	V106-12i-2
BMT				
BFT				
BLT				
BLS	•	•	•	•
MHD	•	•	•	•





ADDITIONAL OFFERINGS



► Belleville, Smooth with Pearl. Glass / Door BLS-122-140-X

- French Patio Doors 128**
- Swing Patio Doors 130**
- Door Handing Chart 135**
- Cleary Transoms 136**
- Steel Fire Doors 137**
- Fast Frame 140**
- Energy Star 142**

French Patio Doors

MASONITE® & VISTAGRANDE DOOR SELECTION AND STYLE

	FP122-010-XLE	FP122-151-XLE Internal Grilles	FP122-09P-XLE	FP122-15E-XLE External Grilles
	LOW-E	LOW-E	LOW-E	LOW-E
BLS	•	•	•	•
MHD	•	•	•	•

Applied 3-1/2" SDL
No Spacer

	FP6068 926-010-LE-X	FP5468 122-010-LE-X	FP6068 926-S04WLE-X
	LOW-E	LOW-E	LOW-E
VSG	•	•	•
VFT	•	•	•

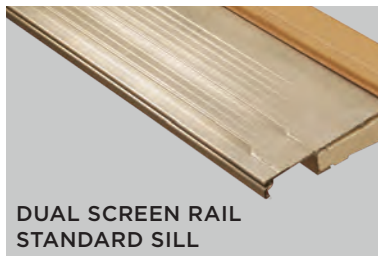

DUAL PATIO SCREENS



TWO ACTIVE SCREENS

	FP 6068 426-010-LE-1	FP5468 404-010-LE-1	FP5068 420-010-LE-1
	LOW-E	LOW-E	LOW-E
VSG	•	•	•
VFT	•	•	•

FRENCH PATIO DOOR UNIT

- ▶ 4-9/16" primed frame
- ▶ FJ Primed brickmould
- ▶ Single bore (2-3/8" backset)
- ▶ "Z" Series Adjustable Sill with sill cover (aluminum finish)
- ▶ Brass colored hinges
- ▶ Long reach compression weatherstrip (bronze)
- ▶ Endura Astragal
- ▶ Units priced with dual rail sill
- ▶ Stocked in 5'0", 5'4" & 6'0" x 6'8" only
- ▶ Other sizes available as special order with extended lead time for screen kit
- ▶ For casing & other options see back of catalog
- ▶ Turn any door into a French patio unit
- ▶ Available with multi-point astragal

	FP6068 926-151-LE-X	FP6068 426-121-LE-1	FP6068-926-S10-LE-XX
	LOW-E	LOW-E	LOW-E
VSG	•	•	•
VFT	•	•	•

6'8" Dual Screen Kit

Kit includes all tracks, side rails, easy installation instructions for 4-9/16" x 6-9/16" jamb

- Sizes stocked in 5'0", 5'4" and 6'0" x 6'8"

Multi-Point Astragal
Inswing
INSERT GLASS
DP45

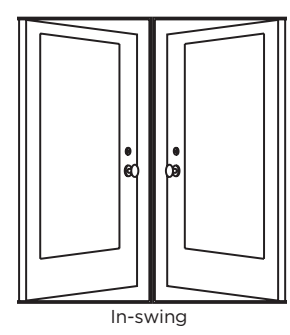

FRENCH DOOR

A French door consists of two operating doors that open in and engage in the center.

Grille Type D

White Georgian
5/16" x 5/8"

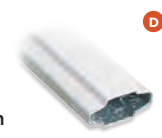

UPGRADE TO THE ULTIMATE MULTI-POINT ASTRAGAL



VISTAGRANDE SDL OPTIONS



Swing Patio Doors

VISTAGRANDE DOORS

Applied 3-1/2" SDL, no spacer

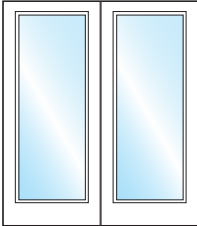
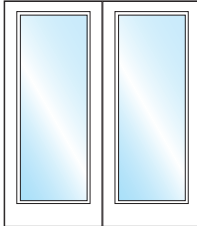
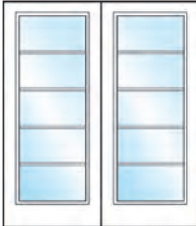
			
	6068 926-010-LE-X	5468 122-010-LE-X	6068 926-S04WLE-X
	LOW-E	LOW-E	LOW-E
VSG	•	•	•
VFT	•	•	•

PATIO ROUGH OPENINGS

5/0 x 6/8 = 64" x 82-1/2"

5/4 x 6/8 = 68" x 82-1/2"

6/0 x 6/8 = 76" x 82-1/2"

*9/0 x 6/8 = 114" x 82-1/2"

*Primed, FrameSaver® or composite jamb



			
	6068 426-010-LE-1	5468 404-010-LE-1	5068 420-010-LE-1
	LOW-E	LOW-E	LOW-E
VSG	•	•	•
VFT	•	•	•

VISTAGRANDE SDL OPTIONS



			
	FP6068 926-151-LE-X	FP6068 426-121-LE-1	FP6068-926-S10-LE-XX
	LOW-E	LOW-E	LOW-E
VSG	•	•	•
VFT			•

SWING PATIO DOOR HANDING OPTIONS

A patio door has one operating door and one fixed door, giving the appearance of a french door.

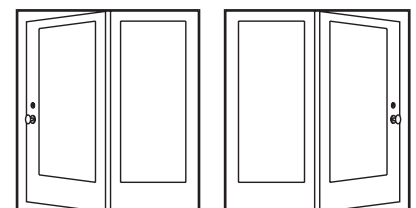

Center hinge - In-swing

Right hand
In-swing

Left hand
In-swing

Swing Patio Doors

CLEAR LOW-E GLASS, INSERT LITES



PATIO DOORS

FIRE DOORS

FAST FRAME

STANDARD RAISE, LOWER & TILT

APPLIED SDL Stocked 5/4 & 6/0 x 6/8

	122-010-X	B122-01RL-X	C122-S10X
	LOW-E	LOW-E	LOW-E
BMT	•	•	•
BFT	•	•	•
BLT	•	•	•
BLS	•	•	•
MHD	•	•	•

MASONITE® STEEL & FIBERGLASS PATIO DOORS:

- ▶ 4-9/16" primed frame
- ▶ FJ primed brickmould
- ▶ Single bore (2-3/8" backset)
- ▶ Z-AC self-adjusting sill
- ▶ Long reach compression PE650 weatherstrip (bronze)
- ▶ Add for deadbolt
- ▶ Units available as fixed 1, 2, 3 or 4 wide units. Specify sill type or swing for proper matches.

	122-151-X Internal Grids	122-09P-X Internal Grids	122-15E-X External Grids
	LOW-E	LOW-E	LOW-E
BMT	•	•	•
BFT	•	•	•
BLT	•	•	•
BLS	•	•	•
MHD	•	•	•

CREATE YOUR OWN GLASS DESIGN WITH YOUR CHOICE OF MASONITE GLASS SDL KIT OPTIONS

- ▶ smooth or textured available: white, almond and mahogany
- ▶ standard or prairie configurations available
- ▶ SDLs can be painted or stained
- ▶ feature strong, weather-resistant adhesive tape
- ▶ kit includes set for inside and outside of door

Choose Your Glass



Choose Your SDL Kit



GRILLE TYPE D GBG

White Georgian
5/16" x 5/8"

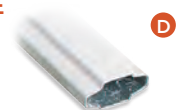

APPLIED SDL 1-1/8" x 3/8"

Shown in almond. Also available in white and mahogany.



Replacement Swing Doors

CLEAR LOW-E GLASS, INSERT GLASS

BLS-122-010-XR	BLS-122-151R	BLS-122-15ER
LOW-E	LOW-E	LOW-E
BLS	•	•

**REPLACEMENT PATIO
ROUGH OPENINGS**
6/0 x 6/8 = 72" x 80"

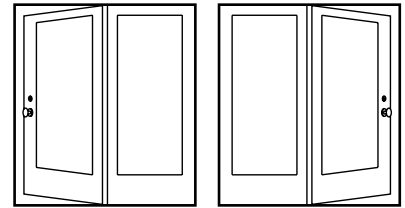





Center hinge - In-swing

Door unit dimensions 71" x 79 1/2"





PATIO DOOR SYSTEM OPTIONS

		DOUBLE UNIT	TRIPLE UNIT
JAMB OPTIONS	6-9/16 FJ Primed Jambs	•	•
	4-9/16 Endura™ FrameSaver®	•	•
	6-9/16 Endura™ FrameSaver®	•	•
	Composite 4-9/16" White Capped	•	
	Composite 6-9/16" White Capped	•	
	Composite 4-9/16" Primed Composite	•	•
	Composite 6-9/16" Primed Composite	•	•
	Composite 4-9/16" Ready-to-Stain	•	
	Composite 6-9/16" Ready-to-Stain	•	
CASING	5/4 x 4" (1-1/16" x 3-1/2") Primed Flat Casing	•	•
	PVC Brickmould NO ROT 	•	•
	PVC Brickmould with "J" Channel NO ROT 	•	•
	PVC 5/4 x 3-1/2" Flat Casing NO ROT 	•	•
	PVC 5/4 x 3-1/2" Flat Casing with "J" Channel NO ROT 	•	•
MULTI-POINT LOCK	Prep & Install standard inswing Trilennium™ 3 Point hardware Single Swing unit (no handle set)	•	
	Trilennium™ Active 3 point Eclipse hardware set Brass for single swing door unit	•	
	Trilennium™ Active 3 point Eclipse hardware set Victorian for single swing door unit	•	
	Trilennium™ Active 3 point Eclipse hardware set Satin Nickel for single swing door unit	•	
LABOR	Bore for Deadbolt and Strike Prep (prep for Schlage deadbolt)	•	
SCREEN	White screen, specify size	•	
LOCKS	Schlage F51 Brass key lock flair (Specify right or left)		
	Schlage deadbolt single cylinder B360, add deadbolt prep		
	Schlage deadbolt double cylinder B362, add deadbolt prep		

Hinged Patio
 Inswing Outswing
 INSERT GLASS INSERT GLASS
DP50 DP75

Cleary Millwork is Force 5™ Certified.
 Force 5™ System components are standard.





PATIO TRIPLE DOOR



FRENCH PATIO DOOR



CENTER HINGE PATIO DOOR



SIDE HINGE PATIO DOOR

Patio & French Door Handing Chart

HANDING CHARTS AS VIEWED FROM OUTSIDE

INSWING PATIO DOORS

1 PANEL	2 PANEL	2 PANEL	3 PANEL	3 PANEL*
F	R F F L	L S	F F F F F L	F L S F S R
R	L F F R	S R	F L F R F F	S R F* L S F*
L	F F	*French patio dual bypassing screen available.	F R F F F R	
			L F F	
4 PANEL	4 PANEL			
F R F F F L F	F S R F			
F L F F F F R F	F L S F			

F - FIXED
L - LEFT
R - RIGHT
S - SEMI-ACTIVE

Inswing patio doors are available with rolling screen option in most cases.

OUTSWING PATIO DOORS*

1 PANEL	2 PANEL	2 PANEL	3 PANEL	3 PANEL
FO	LO FO FO RO	RO SO	FO FO FO FO FO RO	FORO SO FO SO LO
RO	RO FO FO LO	SO LO	FO RO FO LO FO FO	SO LO FO RO SO FO
LO	FO FO		FO LO FO FO FO LO	
4 PANEL	4 PANEL			
FO LO FO FO FO FO RO FO	FO SO LO FO			
FO RO FO FO FO FO LO FO	FO RO SO FO			

FO = FIXED OUTSWING
LO = LEFT OUTSWING
RO = RIGHT OUTSWING
SO = SEMI-ACTIVE OUTSWING

*No screen available.
 We recommend phantom® screens.
 Visit phantomscreens.com for more information.

When ordering fixed units be sure to match inswing or outswing unit for proper alignment.

Cleary Transoms

CLEAR GLASS

RECTANGULAR TRANSOM (PRIMED WOOD)

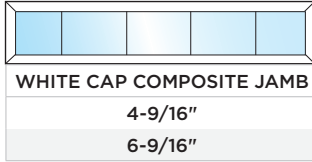

ITEM #	Dimension & Jamb Size (Unit Dimensions)	Clear IG Glass	Profiled GBG Unit	1-1/8" SDL	7/8" Profiled SDL Unit
T103010	64-1/2" x 12-1/4"	•	•	•	•
T123012	68-1/2" x 12-1/4"	•	•	•	•
T28	33-1/2" x 12-1/4"	•	•	•	•
T30	37-1/2" x 12-1/4"	•	•	•	•
T60	74-1/2" x 12-1/4"	•	•	•	•
PD60	75" x 12-1/4"	•	•	•	•
ADD FOR 6-9/16" JAMB		•	•	•	•
ADD FOR FLAT CASING		•	•	•	•



GRILLE TYPE D
White Georgian
5/16" x 5/8"

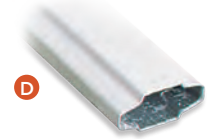

Steel Fire Doors

90-MINUTE ENTRY SYSTEMS



PATIO DOORS

FIRE DOORS

FAST FRAME

1-3/4" STEEL DOORS

90-MINUTE FIRE DOOR ENTRY SYSTEM HUNG IN STEEL FRAME



	6 PANEL 90R stocked in MHD 2'6" x 6'8", 2'8" x 6'8", 2'10" x 6'8" & 3'0" x 6'8"		FLUSH 90R stocked in MHD 2'6" x 6'8", 2'8" x 6'8" & 3'0" x 6'8"		FLUSH 1090R		FLUSH 590R		4 PANEL NEW ENGLAND 90R		2 PANEL CAMBER-TOP		2 PANEL SQUARE-TOP	
	6'8"	3'0 x 7'0"	6'8"	3'0 x 7'0"	6'8"	7'0"	6'8"	3'0 x 7'0"	6'8"	6'8"	6'8"	6'8"	6'8"	6'8"
MMS	•	•	•	•	•	•	•	•	•	•	•	•	•	•

ALL 7'0" FIRE DOORS STOCKED ONLY IN 3'0" WIDTH WITH ADA SILL

KERF ADJUSTABLE STEEL FRAME STANDARD UNIT INCLUDES:

- ▶ 90-Minute MMS Labeled Panel
- ▶ 4-1/2" - 5-1/2" Weather Stripped Kerf Adjustable Steel 90-Minute Frame
- ▶ 1 Pair 4 x 4 Satin Brass Spring Hinges
- ▶ Single Bore (2-3/8" Backset)
- ▶ Extender Kit Shipped Loose

ROUGH OPENING:
DOOR SIZE + 1-1/4" width, 1" height - ADA Sill

DOOR SIZE + 1-1/4" width, 1-1/2" height - High Dam

KERF ADJUSTABLE STEEL FRAME OPTIONS

High Dam or 1/2" ADA threshold inswing (7'0" stocked only ADA)
1/2" tileback aluminum saddle threshold
4-1/2" width bumper outswing
5-1/2" - 6-1/2" extender package loose
6-1/2" - 7-1/2" extender package loose
7-1/2" - 8-1/2" extender package loose
8-1/2" - 9-1/2" extender package loose
Deadbolt prep 5-1/2" on center
Cut down fire door in adjustable steel frame (max cut 4" from bottom-this lowers lock bore)
Non-spring hinges or nrp brass
Dull chrome spring
Brass peepsite
Chrome peepsite
No sill
Closer & panic reinforcement

STANDARD



High Dam

OPTIONAL



1/2" Aluminum Saddle Threshold (ADA)

OPTIONAL



1/2" Tileback Aluminum Saddle Threshold (ADA) Available in 4-1/4" and 6-1/4" widths. Inswing use only.

OPTIONAL



4-1/2" Width Bumper Outswing

▲ - Stocked in 2'6" width

MHD doors are wood-edge construction. For Closer & Panic reinforced 3'0" x 6'8" only, see options.

Steel Fire Doors

20-MINUTE ENTRY SYSTEMS

1-3/4" STEEL & FIBERGLASS DOORS 20-MINUTE WOOD JAMB FIRE DOOR



	6 PANEL 20 stocked in MMS 2'6" x 6'8" & 2'10" x 6'8"		FLUSH 20 stocked in MMS Flush 2'0" x 6'8" & 2'4" x 6'8"		4 PANEL NEW ENGLAND 20	2 PANEL CAMBER-TOP	2 PANEL SQUARE-TOP	3 PANEL CRAFTSMAN
	6'8"	7'0"	6'8"	7'0"	6'8"	6'8"	6'8"	6'8"
HGS								•
BLS	•					•	•	
MHD	•	•	•	•	•	•	•	•
MMS	•	•	•	•	•	•	•	

ALL 7'0" FIRE DOORS
STOCKED ONLY
IN 3'0" WIDTH

WOOD FRAME STANDARD UNIT INCLUDES:

- ▶ 20-Minute MHD Labeled Wood-edge Door on Wood Jamb (MMS is 90 minute Steel Edge Door)
- ▶ 4-9/16" FJ Primed Weather Stripped Single Rabbetted 20-Minute Frame
- ▶ 1-1/2" Pair 4 x 4 Satin Brass Hinges (Non-Spring)
- ▶ Single Bore (2-3/8" Backset)
- ▶ Endura Z-AC Self Adjusting Aluminum Z-Sill with Construction Cover for Protection
- ▶ Long Reach Compression Weatherstrip (Bronze)
- ▶ FJ Primed Brickmould

ROUGH OPENING:

DOOR SIZE + 2-1/4" width,
2-1/2" height

20-MINUTE LABEL ON MHD
WOOD-EDGE DOOR
90-MINUTE LABEL ON MMS
STEEL EDGE DOOR

Be advised that a rated door opening requires some type of closer device, either Spring Hinges or a top-mount closer.

CONSULT LOCAL CODES
for requirements on
fire-rated openings.

PRIMED WOOD STEEL FRAME OPTIONS

6-9/16" FJ Primed Jamb 6'8"
6-9/16" FJ Primed Jamb 7'0"
Bore for Deadbolt and Strike Prep Jamb (prepped for Schlage Deadbolt) 5-1/2" on Center
No Casing
Satin Brass Spring Hinges (1 pair)
Panic & Closer Reinforcement in MMS 3068 Door
Brass Peepsite Installed
Chrome Peepsite Installed
1/2" Aluminum Saddle Threshold (ADA) 4-9/16" ⚡
1/2" Aluminum Saddle Threshold Outswing (ADA) Includes 3 NRP Hinges
1/2" Tileback Aluminum Saddle Threshold (ADA) ⚡ 4-9/16 only
4-9/16" Outswing Z Series Bumber Sill (Aluminum)
6-9/16" Outswing Z Series Bumber Sill (Aluminum)
No Sill

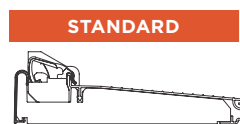

Z-AC Sill



1/2" Aluminum Saddle Threshold (ADA)



1/2" Tileback Aluminum Saddle Threshold (ADA)
Tileback sill only available in
5" width. For use on a 4-9/16" jamb only.



1-3/4" STEEL & FIBERGLASS DOORS

20-MINUTE ENTRY SYSTEMS HUNG IN STEEL FRAMES

6P & FLUSH
20-MINUTE
LABEL ON
MHD
WOOD-EDGE

Stocked in
2'6", 2'8",
2'10" and 3'0"

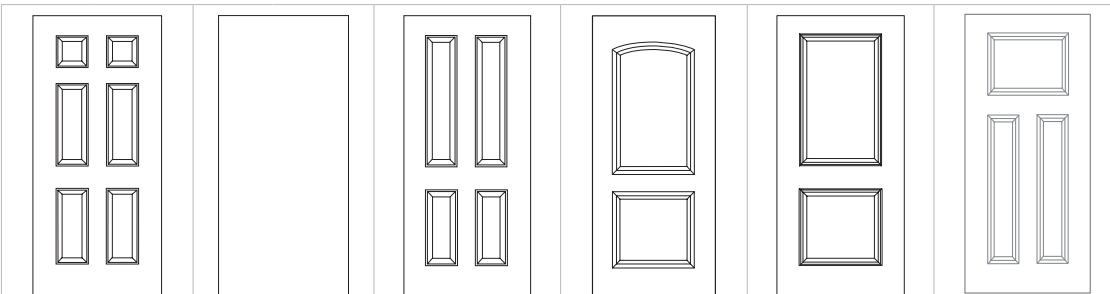

6 PANEL 20 stocked in MHD 2'6" x 6'8", 2'8" x 6'8" & 2'6" x 6'8"		FLUSH 20 stocked in MHD 2'6" x 6'8", 2'8" x 6'8", 2'10" x 6'8" & 3'0" x 6'8"		4 PANEL NEW ENGLAND 20	2 PANEL CAMBER-TOP	2 PANEL SQUARE-TOP	3 PANEL CRAFTSMAN
---	--	---	--	------------------------------	-----------------------	-----------------------	----------------------

6'8"	3'0" x 7'0"	6'8"	3'0" x 7'0"	6'8"	6'8"	6'8"	6'8"
------	-------------	------	-------------	------	------	------	------

HGS							•
3068 ONLY BLS	•				•	•	
MHD	•	•	•	•	•	•	•

ALL 7'0" FIRE DOORS
STOCKED ONLY IN 3'0"
WIDTH & WITH ADA SILL

KERF ADJUSTABLE STEEL FRAME STANDARD UNIT INCLUDES:

- ▶ 20-Minute MHD Labeled Panel
- ▶ 4-1/2" - 5-1/2" Weather Stripped Kerf Adjustable Steel 90-Minute Frame
- ▶ 1 Pair 4 x 4 Satin Brass Spring Hinges
- ▶ Single Bore (2-3/8" Backset)
- ▶ Extender Kit Shipped Loose

ROUGH OPENING:

DOOR SIZE + 1-1/4" width, 1" height - ADA Sill

DOOR SIZE + 1-1/4" width, 1-1/2" height - High Dam

KERF ADJUSTABLE STEEL FRAME OPTIONS

High Dam or 1/2" ADA threshold inswing (7'0" stocked only ADA)
1/2" tileback aluminum saddle threshold
4-1/2" width bumper outswing
5-1/2" - 6-1/2" extender package loose
6-1/2" - 7-1/2" extender package loose
7-1/2" - 8-1/2" extender package loose
8-1/2" - 9-1/2" extender package loose
Deadbolt prep 5-1/2" on center
Cut down fire door in adjustable steel frame (max 4" cut lowers lock bore)
Non-spring hinges or nrp brass
Dull chrome spring
Brass peepsite
Chrome peepsite
No sill
Closer & panic reinforcement

STANDARD



High Dam

OPTIONAL



1/2" Aluminum Saddle Threshold (ADA)

OPTIONAL



1/2" Tileback Aluminum Saddle Threshold (ADA) Available in 4-1/4" and 6-1/4" widths. Inswing use only.

OPTIONAL



4-1/2" Width Bumper Outswing

Fast-Frame.

ADJUSTABLE KERFED STEEL REPLACEMENT FRAMES



THE ULTIMATE ADJUSTABLE KERFED STEEL DOOR FRAME

Fast-Frame's advanced design adds a new dimension of flexibility and durability to Masonite's steel entry door line. Developed and manufactured exclusively for Masonite by Timely, Fast-Frame features a full 1" of adjustability to accommodate almost any variation in wall construction. This easy-to-install, user-friendly, kerfed steel door frame system is applicable to a full range of residential and commercial applications with wood or steel stud construction. Timely's expertise in innovating and manufacturing steel door frame components is second to none. Fast-Frame is engineered to meet the most stringent code requirements including structural, impact and 90-minute fire ratings.

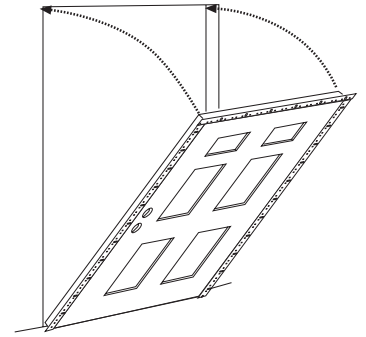

Outer Adjustable Closure

20-Gauge Steel
2 Uprights - 1 Header

TA-1 Adjustable T-Strike

1/4" of adjustment allows for ease of field installations for proper door closure.

Standard Inswing Sill

Thermally broken - 5-5/8" width. Optional extenders for larger wall sizes.

Note: Not for use on outswing applications.

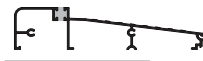

Handicap (ADA) Sill

Double Slope 4-9/16" & 6-9/16" width



Tile Face Sill

4-1/4" & 6-1/4" width
Note: Not for use on outswing applications.



Bumper Outswing Sill

4-9/16" width



Closure Span Adjustment Chart

Wall Sizes	A
4-1/2" - 5-1/2"	= 1-7/8"
5-1/2" - 6-1/2"	= 2-7/8"
6-1/2" - 7-1/2"	= 3-7/8"

Wider sizes are available upon request.

Weatherstripping

Schlegal foam-filled compression (QEBD500)
90-minute fire rating

Primed White Galvanized Steel

Galvanized 20-gauge steel provides superior corrosion resistance, matches our Masonite HD bright white doors, and is an ideal surface for painting.

Hinge Reinforcement

14-gauge, unique extruded holes provide the strength of a 12-gauge hinge reinforcement.

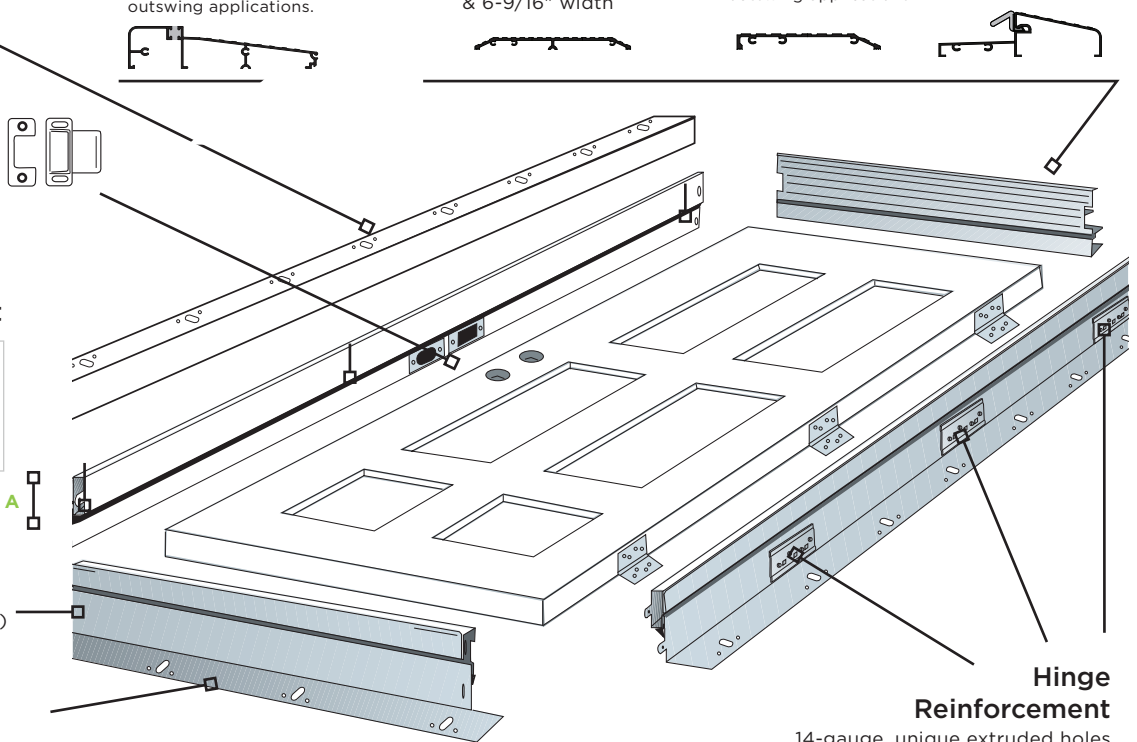

CASING OPTIONS



Wood trim and brickmould can be easily applied to Fast-Frame using nails or trim head screws without the need for custom millwork.

FAST-FRAME CASINGS

TA-8 Standard Steel Casing

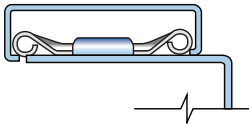

TA-30 Colonial Steel Casing

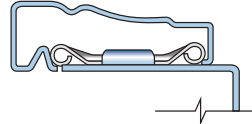

- ▶ TA-8 casings enhance any commercial or residential setting.
- ▶ It is recommended that TA-18 retainer clips be used for both casings.
- ▶ TA-30 casings add a special warmth for assisted living, motels, hotels, offices, apartments and homes.

APPLICATIONS

- ▶ Multi-Family
- ▶ Assisted Living
- ▶ Motel/Hotel
- ▶ House to Garage
- ▶ Garage to Exterior

- ▶ Double door width is with a 'Z' astragal. If using a 5/8" astragal then add 9/16" to the width.
- ▶ All dimensions shown are for doors with standard inswing sill. Deduct 13/16" for bumper outswing or handicap compliant sill.
- ▶ Add 4" to height for 7'0" height.
- ▶ Add 16" to height for 8'0" height.
- ▶ Premdor spec slabs add 1/4" to height.

FIRE LABELS

Up to 90-Minute Fire Ratings available in single and double* configurations

*A 'Z' astragal and flush bolt are required for double fire ratings (sold separately)



CLOSURE TEST

In a 90-minute application, the door will close and latch from 18" if the following Fast-Frame components are used:

- ▶ QEBD500 Foam-Filled Compression Weatherstripping
- ▶ Factory Sweep
- ▶ Adjustable T-Strike
- ▶ Factory Supplied Sills
- ▶ Self-Closing Hinges

STRUCTURAL PERFORMANCE AND IMPACT RATING

Design pressure ratings are available for compliance with national, state and local wind load and/or missile requirements. This product was tested for structural and impact performance in accordance with TAS 201, 202 and 203. Product approval is available under the Florida Department of Community Affairs (FL10357). Please note: Structural and impact performance requires use of a hurricane grade 5/8" T-astragal for double doors.

DOOR SELECTION

Fast-Frame is available in either right- or left-hand inswing or outswing and is for use with any Masonite steel entry door.

FAST-FRAME, ROUGH OPENINGS		
PREHUNG DOOR SIZES		
	Nominal Door Size	Rough Opening Size (Wood Stud)
	W x H	W x H
Single Door	2'0" x 6'8"	25-1/4" x 81-5/8"
	2'6" x 6'8"	31-1/4" x 81-5/8"
	2'8" x 6'8"	33-1/4" x 81-5/8"
	2'10" x 6'8"	35-1/4" x 81-5/8"
	3'0" x 6'8"	37-1/4" x 81-5/8"
Double Door	4'0" x 6'8"	49-1/4" x 81-5/8"
	5'0" x 6'8"	61-1/4" x 81-5/8"
	5'4" x 6'8"	65-1/4" x 81-5/8"
	5'8" x 6'8"	69-1/4" x 81-5/8"
	6'0" x 6'8"	73-1/4" x 81-5/8"

*Z astragals only available in 6'8" and 8'0" heights.



ENERGY STAR_® is a program developed by the U.S. Environmental Protection Agency and the U.S. Department of Energy. The goal of the program is to protect the environment and save you money by encouraging energy efficient products, services and practices. To that end, Masonite is proud to produce a wide variety of door and glass combinations that ensure our products can be used as part of an ENERGY STAR_®-qualified assembled door system. Masonite doors and sidelites include a premium polyurethane foam core that insulates up to five times better than wood. Our triple-pane decorative

glass with coming creates an excellent insulator against the cold in the winter and the heat of summer. A properly installed ENERGY STAR_®-qualified door system can save you money all year. Our NFRC-certified door systems may qualify for the ENERGY STAR_® program. Other criteria exist for eligibility, including U-Factor and Solar Heat Gain Coefficients. Use the charts below as a general guideline for which Masonite products may qualify.

For further information, see our website at: www.masonite.com

- 1. U-FACTOR:** Measures the rate of heat transfer through a product. It considers all elements of an assembly including conductivity, air flow and glass emissivity. A lower U-Factor indicates a better-insulating product.
- 2. SHGC (SOLAR HEAT GAIN COEFFICIENT):** Measures the amount of energy that passes through glass from the sun, creating additional heat. The lower the SHGC, the better it blocks solar heat.

Masonite ENERGY STAR_® Compliant Products

NZ Northern Zones only
HC Hard Coat - Pyrolytic Low-E
SC Soft Coat - Sputter Low-E

GLASS TYPE		GLAZING LEVEL					FULL LITE	
		OPAQUE	1/4 LITE	1/2 LITE	3/4 LITE	HC	SC	
WOOD-EDGE STEEL DOORS	Clear 1/2" IG		✓					
	Clear 1/2" IG E Grids		✓					
	Clear Blinds				✓			
	Low-E Blinds #2			✓	✓		✓	
	Clear 1" IG		✓					
	Clear 1" IG Internal Grids		✓					
	Low-E 1" IG Surface #2		✓	✓	✓	NZ	✓	
	Low-E 1" IG Surface #2 (Grids)		✓	✓	✓	✓	✓	
	Triple Pane Deco IG w/Caming		✓	✓	✓	NZ		
	Low-E Triple Pane Deco IG w/Caming					✓		

FIBERGLASS DOORS	Clear 1/2" IG		✓					
	Clear 1/2" IG E Grids		✓					
	Clear Blinds							
	Low-E Blinds #2			✓	✓		✓	
	Clear 1" IG		✓					
	Clear 1" IG Internal Grids		✓		✓			
	Low-E Surface #2 1" IG		✓	✓	✓	NZ	✓	
	Low-E Surface #2 1" IG E Grids		✓	✓	✓	✓	✓	
	Triple Pane Deco IG w/ Caming		✓	✓	✓	NZ		
	Low-E Triple Pane Deco IG w/ Caming					✓		

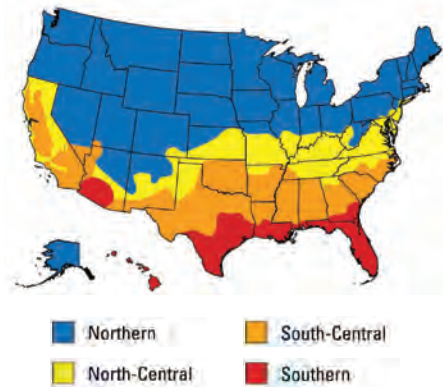

ENERGY STAR_® Product Performance Criteria

GLAZING LEVEL	U-FACTOR ¹	SHGC ²
ALL	≤ 0.17	No Rating
≤ 1/2-Lite	≤ 0.25	≤ 0.25
> 1/2-Lite	≤ 0.30	Northern North-Central ≤ 0.40
		Southern South-Central ≤ 0.25

¹ Btu/h.ft.² °F. ² Fraction of incident solar radiations Air Leakage for Swinging Doors ≤ 0.5 cfm/ft²

*U-Factor for opaque doors only. 'IG' = Insulated Glass.
 * Please verify qualification with the NFRC performance label affixed to the door.



TECHNICAL INFORMATION

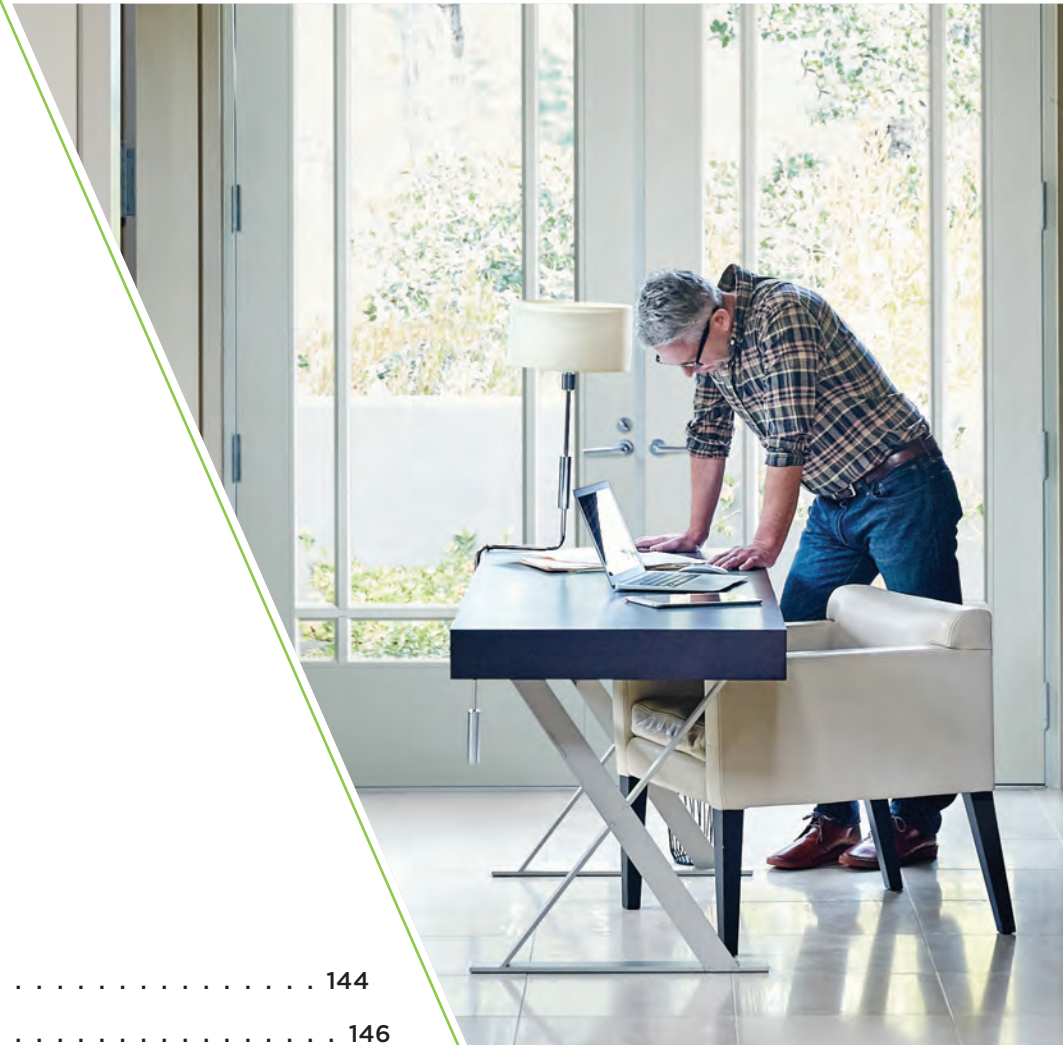

Storm Guard	144
Rough Openings	146
Fire-Rated / ADA / STC	148
Door Handing Chart	150
Warranty	151
Door Systems	152
Hardware	157
Prefinishing	160
Exterior Door Options	162

STORM GUARD.

IMPACT-RATED DOORS

Call for availability & options or refer to the Masonite full line catalog.

Coastal weather is unpredictable; a tropical storm can quickly become a hurricane. Masonite Storm Guard impact-rated doors are rigorously tested to meet the most stringent requirements, so you can count on superior protection—even in extreme conditions.



Masonite Storm Guard™ doors are available in solid panels or with impact-rated glass and superior sealant to protect homes from high winds and debris.

IMPACT-RATED STEEL DOORS

Steel-edge steel construction maximizes rigidity and durability

IMPACT-RATED FIBERGLASS DOORS

Coreshield™ technology adds an additional layer of protection



HURRICANE-PRONE REGIONS

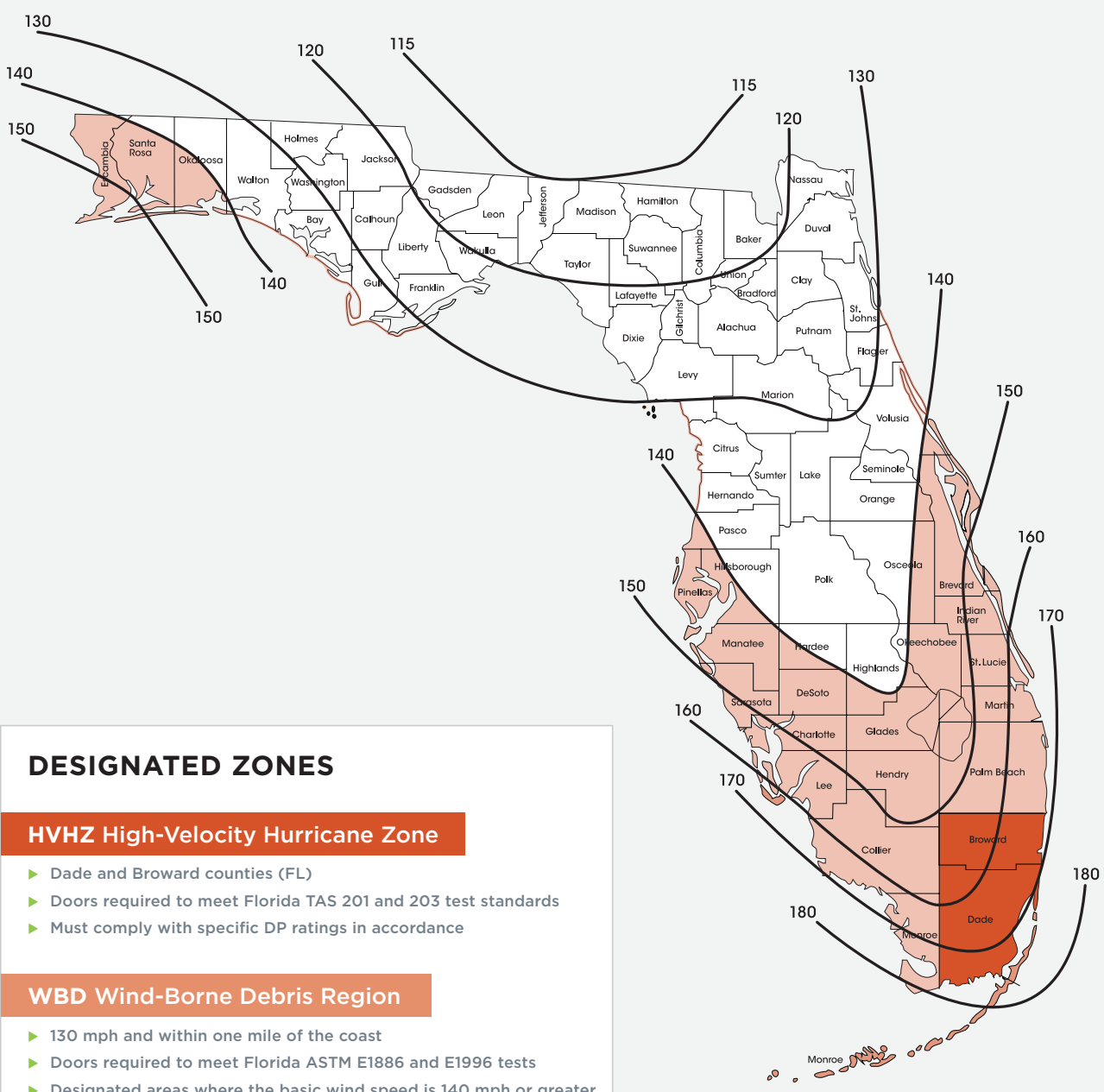

DESIGNATED ZONES

HVHZ High-Velocity Hurricane Zone

- ▶ Dade and Broward counties (FL)
- ▶ Doors required to meet Florida TAS 201 and 203 test standards
- ▶ Must comply with specific DP ratings in accordance

WBD Wind-Borne Debris Region

- ▶ 130 mph and within one mile of the coast
- ▶ Doors required to meet Florida ASTM E1886 and E1996 tests
- ▶ Designated areas where the basic wind speed is 140 mph or greater

Notes:

- ▶ Values are nominal design 3-second gust wind speeds in miles per hour (m/s) at 33 ft. (10m) above ground for Exposure C category.
- ▶ Linear interpolation between contours is permitted.
- ▶ Islands and coastal areas outside the last contour shall use the last wind speed contour of the coastal area.
- ▶ Mountainous terrain, gorges, ocean promontory and special wind regions shall be examined for unusual wind conditions.
- ▶ Wind speeds correspond to approximately a 7% probability of exceedance in 50 years (Annual Exceedance Probability = 0.00143, MRI = 700 years).

Entry Systems Rough Openings

NEW CONSTRUCTION SIZE

SINGLE DOOR

NOMINAL DOOR SIZE		DOOR UNIT ACTUAL SIZE		ROUGH OPENING SIZE (WOOD STUD)		OUTSIDE BRICKMOULD SIZE	
Width	Height	Width	Height*	Width	Height*	Width	Height*
2'6"	6'8"	31-1/2"	82"	32-1/4"	82-1/2"	34"	83-1/4"
2'8"	6'8"	33-1/2"	82"	34-1/4"	82-1/2"	36"	83-1/4"
2'8"	8'0"	33-1/2"	98"	34-1/4"	98-1/2"	36"	99-1/4"
3'0"	6'8"	37-1/2"	82"	38-1/4"	82-1/2"	40"	83-1/4"
3'0"	8'0"	37-1/2"	98"	38-1/4"	98-1/2"	40"	99-1/4"

All dimensions shown are for inswing doors - deduct 1" from the actual door size, the rough opening size and the outside brickmould size height for outswing or handicap accessible doors. See product selection detailed in the catalog to determine if the entry door style you have selected is available. Recommended rough openings for the FAST-FRAME adjustable steel frame offering are different than the dimensions shown in this chart - see rough opening chart titled FAST-FRAME. Floor covering can affect rough opening heights.

SINGLE DOOR WITH ONE L/H OR R/H SIDELITE

NOMINAL DOOR SIZE		NOMINAL SIDELITE SIZE		DOOR UNIT ACTUAL SIZE		ROUGH OPENING SIZE (WOOD STUD)		OUTSIDE BRICKMOULD SIZE	
Width	Height	Width	Height	Width	Height*	Width	Height*	Width	Height*
2'6"	6'8"	10-3/8"	6'8"	43"	82"	44-1/4"	82-1/2"	45-1/2"	83-1/4"
2'6"	6'8"	1'0"	6'8"	45"	82"	45-3/4"	82-1/2"	47-1/2"	83-1/4"
2'6"	6'8"	1'2"	6'8"	47"	82"	47-3/4"	82-1/2"	49-1/2"	83-1/4"
2'8"	6'8"	10-3/8"	6'8"	45-3/8"	82"	46-5/8"	82-1/2"	47-7/8"	83-1/4"
2'8"	6'8"	1'0"	6'8"	47"	82"	47-3/4"	82-1/2"	49-1/2"	83-1/4"
2'8"	6'8"	1'2"	6'8"	49"	82"	49-3/4"	82-1/2"	51-1/2"	83-1/4"
2'8"	8'0"	1'0"	8'0"	47"	98"	47-3/4"	98-1/2"	49-1/2"	99-1/4"
2'8"	8'0"	1'2"	8'0"	49"	98"	49-3/4"	98-1/2"	51-1/2"	99-1/4"
3'0"	6'8"	10-3/8"	6'8"	49-3/8"	82"	50-5/8"	82-1/2"	51-7/8"	83-1/4"
3'0"	6'8"	1'0"	6'8"	51"	82"	51-3/4"	82-1/2"	53-1/2"	83-1/4"
3'0"	6'8"	1'2"	6'8"	53"	82"	53-3/4"	82-1/2"	55-1/2"	83-1/4"
3'0"	8'0"	1'0"	8'0"	51"	98"	51-3/4"	98-1/2"	53-1/2"	99-1/4"
3'0"	8'0"	1'2"	8'0"	53"	98"	53-3/4"	98-1/2"	55-1/2"	99-1/4"

All dimensions shown are for inswing doors - deduct 1" from the actual door size, the rough opening size and the outside brickmould size height for outswing or handicap accessible doors. See product selection detailed in the catalog to determine if the entry door style you have selected is available. Floor covering can affect rough opening heights.

SINGLE DOOR WITH TWO SIDELITES

NOMINAL DOOR SIZE		NOMINAL SIDELITE SIZE		DOOR UNIT ACTUAL SIZE		ROUGH OPENING SIZE (WOOD STUD)		OUTSIDE BRICKMOULD SIZE	
Width	Height	Width	Height	Width	Height*	Width	Height*	Width	Height*
2'6"	6'8"	10-3/8"	6'8"	54-1/2"	82"	56-1/8"	82-1/2"	57"	83-1/4"
2'6"	6'8"	1'0"	6'8"	58-1/2"	82"	59-1/8"	82-1/2"	61"	83-1/4"
2'6"	6'8"	1'2"	6'8"	62-1/2"	82"	63-1/8"	82-1/2"	65"	83-1/4"
2'8"	6'8"	10-3/8"	6'8"	57-1/4"	82"	58-1/8"	82-1/2"	59-3/4"	83-1/4"
2'8"	6'8"	1'0"	6'8"	60-1/2"	82"	61-1/8"	82-1/2"	63"	83-1/4"
2'8"	6'8"	1'2"	6'8"	64-1/2"	82"	65-1/8"	82-1/2"	67"	83-1/4"
2'8"	8'0"	1'0"	8'0"	60-1/2"	98"	61-1/8"	98-1/2"	63"	99-1/4"
2'8"	8'0"	1'2"	8'0"	64-1/2"	98"	65-1/8"	98-1/2"	67"	99-1/4"
3'0"	6'8"	10-3/8"	6'8"	61-1/4"	82"	62-1/8"	82-1/2"	63-3/4"	83-1/4"
3'0"	6'8"	1'0"	6'8"	64-1/2"	82"	65-1/8"	82-1/2"	67"	83-1/4"
3'0"	6'8"	1'2"	6'8"	68-1/2"	82"	69-1/8"	82-1/2"	71"	83-1/4"
3'0"	8'0"	1'0"	8'0"	64-1/2"	98"	65-1/8"	98-1/2"	67"	99-1/4"
3'0"	8'0"	1'2"	8'0"	68-1/2"	98"	69-1/8"	98-1/2"	71"	99-1/4"

All dimensions shown are for inswing doors - deduct 1" from the actual door size, the rough opening size and the outside brickmould size height for outswing handicap accessible doors. See product selection detailed in the catalog to determine if the entry door style you have selected is available. Floor covering can affect rough opening heights.

TRANSOMS

E-65	T-65	S-65	C-38	C-64
Elliptical	Rectangle	Shoulder	Half Circle	Full Half Circle
Add 15-3/4" to door height	Add 12-1/4" to door height	Add 17-1/2" to door height	Add 19-1/4" to door height	Add 34-3/4" to door height

DOUBLE DOOR

NOMINAL DOOR SIZE		DOOR UNIT ACTUAL SIZE		ROUGH OPENING SIZE (WOOD STUD)		OUTSIDE BRICKMOULD SIZE	
Width	Height	Width	Height*	Width	Height*	Width	Height*
5'0"	6'8"	62"	82"	62-3/4"	82-1/2"	64-1/2"	83-1/4"
5'4"	6'8"	66"	82"	66-3/4"	82-1/2"	68-1/2"	83-1/4"
5'4"	8'0"	66"	98"	66-3/4"	98-1/2"	68-1/2"	99-1/4"
6'0"	6'8"	74"	82"	74-3/4"	82-1/2"	76-1/2"	83-1/4"
6'0"	8'0"	74"	98"	74-3/4"	98-1/2"	76-1/2"	99-1/4"

All dimensions shown are for inswing doors - deduct 1" from the actual door size, the rough opening size and the outside brickmould size height for outswing handicap accessible doors. See product selection detailed in the Catalog to determine if the entry door style you have selected is available. Recommended rough openings for the FAST-FRAME™ adjustable steel frame offering are different than the dimensions shown in this chart - see rough opening chart titled FAST-FRAME. Floor covering can affect rough opening heights.

Masonite Frame Size & Hardware Locations

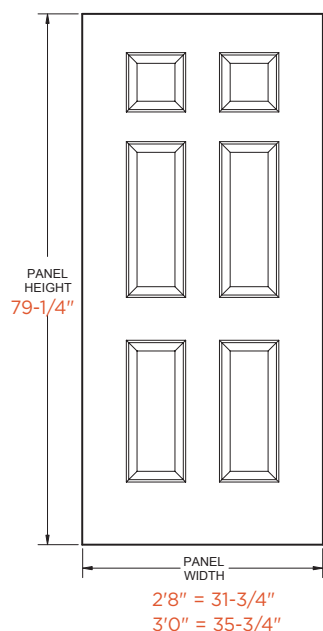

Masonite Standard Hinge Locations

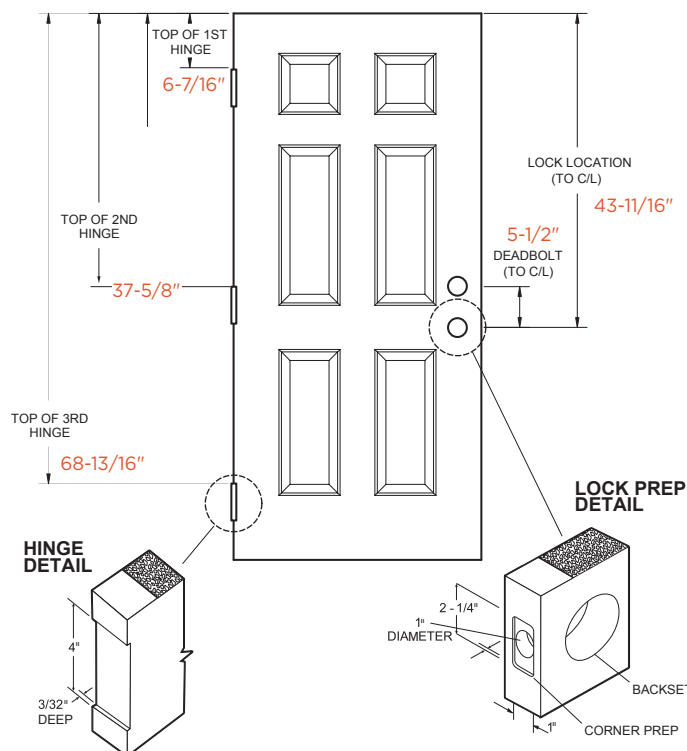

Fire-Rated / ADA / STC

COMPLIANT EXTERIOR DOORS

MASONITE FIRE-RATED



- ▶ Whether or not codes require fire-rated entry, enjoy the peace of mind that comes with knowing your home is more protected.
- ▶ Masonite offers 20- and 90-minute fire doors with the same on-trend architectural characteristics of our steel portfolio.
- ▶ Masonite runs extensive testing at the R&D center to ensure the most stringent fire-rated building codes are met.

20- or 90-minute fire-rating must be specified when ordering.

MASONITE ADA



- ▶ Masonite is proud to offer several door designs with 10" bottom rails.
- ▶ Complying with ADA (American Disabilities Act) standards, the offerings are available in a number of steel and fiberglass designs to suit many styles of architecture.
- ▶ Masonite is continually creating new and innovative products that make every home more valuable and more enjoyable.

Doors indicated as ADA eligible must be installed with ADA thresholds and ADA compliant hardware.

MASONITE
STC



▶ VistaGrande. Smooth Flush-Glazed Door with Clear Glass / Doors VSG-926-010-X

- ▶ Managing and containing sound transmission is becoming more popular in both residential and commercial construction.
- ▶ Doors can be an important component when attempting to reduce the noise that is either entering or exiting a room or building.
- ▶ STC (Sound Transmission Class) are measurements of a door's ability to reduce the transmission of airborne noise. Higher STC values represent better noise reduction.

Acoustical performance based on wood frames and 5/8" compression weatherstrip.
STC determined in accordance with ASTM E90.

Acoustical Performance

MAX SIZE	EXTERIOR DOOR UNITS WITH NO GLASS ¹	STC ¹	OITC ²
3/0 x 6/8	BARRINGTON. & BELLEVILLE. with Foam Core	22	22
3/0 x 6/8	MASONITE. HD STEEL Steel Edge with Foam Core	22	22
3/0 x 6/8	MASONITE. UTILITY STEEL with Foam Core	23	23
3/0 x 8/0	MASONITE. HD STEEL Wood Edge with Foam Core	24	22
3/0 x 8/0	BARRINGTON. & BELLEVILLE. with Particleboard Core	30	29

MAX SIZE	EXTERIOR DOOR UNITS WITH INSULATED GLASS	STC ¹	OITC ²
3/0 x 8/0	VISTAGRANDE. Fiberglass with Foam Core Full Lite - Clear 1"	30	25
3/0 x 8/0	VISTAGRANDE. Fiberglass with Foam Core Full Lite - Clear 1" with Single 1/4" Lami layer	32	29
3/0 x 8/0	VISTAGRANDE. Fiberglass with Particleboard Core Full Lite - Clear 1"	32	26
3/0 x 8/0	VISTAGRANDE. Fiberglass with Particleboard Core Full Lite - Clear 1" with Single 1/4" Lami layer	35	30

¹Sound Transmission Class

²Outdoor-Indoor Transmission Class

[†]Any opaque design

Acoustical performance values determined in accordance with ASTM E90, Standard Test Method for Laboratory Measurements of Airborne Sound Transmission Loss of Building Partitions and ASTM E413, Classification for Rating Sound Insulation. ASTM E1332, Standard Classification for Determining of Outdoor-Indoor Transmission Class.

Please visit Masonite Professional Resources section on masonite.com for a full list of available doors with an STC rating.

Door Handing Chart

FOR MASONITE ENTRY & PATIO DOORS

INSWING

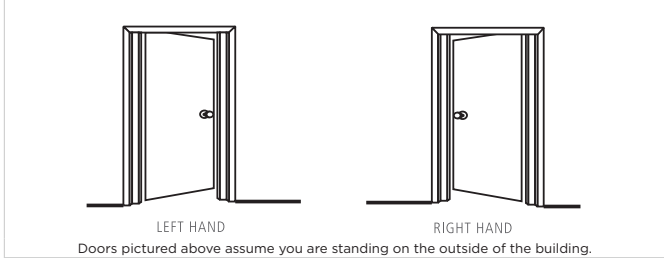

LEFT HAND
RIGHT HAND
Doors pictured above assume you are standing on the outside of the building.

OUTSWING

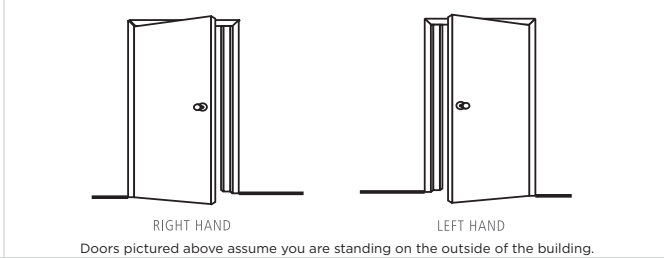

RIGHT HAND
LEFT HAND
Doors pictured above assume you are standing on the outside of the building.

SINGLE DOOR

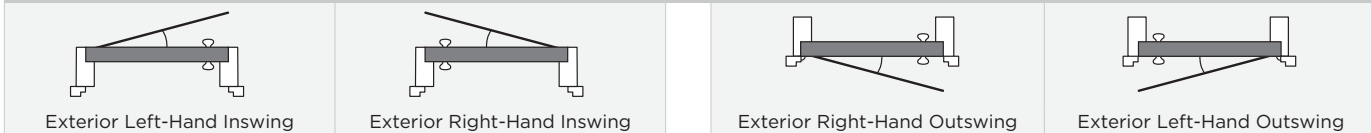

Exterior Left-Hand Inswing Exterior Right-Hand Inswing Exterior Right-Hand Outswing Exterior Left-Hand Outswing

SINGLE DOOR WITH LEFT-HAND SIDELITE

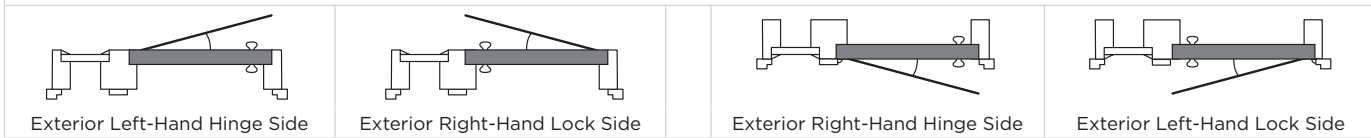

Exterior Left-Hand Hinge Side Exterior Right-Hand Lock Side Exterior Right-Hand Hinge Side Exterior Left-Hand Lock Side

SINGLE DOOR WITH RIGHT-HAND SIDELITE



Exterior Left-Hand Lock Side Exterior Right-Hand Hinge Side Exterior Right-Hand Lock Side Exterior Left-Hand Hinge Side

SINGLE DOOR WITH DOUBLE SIDELITES

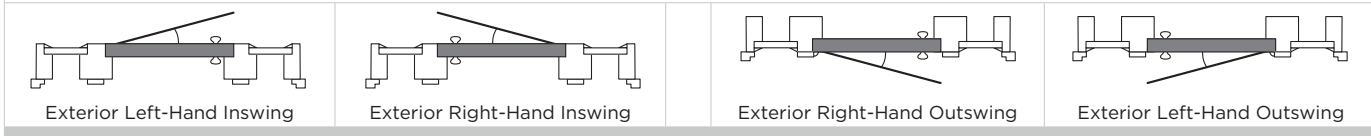

Exterior Left-Hand Inswing Exterior Right-Hand Inswing Exterior Right-Hand Outswing Exterior Left-Hand Outswing

FRENCH DOUBLE DOORS

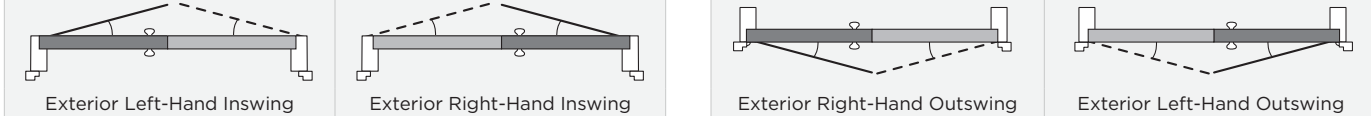

Exterior Left-Hand Inswing Exterior Right-Hand Inswing Exterior Right-Hand Outswing Exterior Left-Hand Outswing

FRENCH DOUBLE DOORS WITH DOUBLE SIDELITES

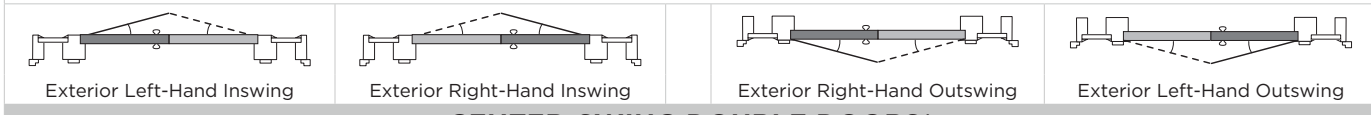

Exterior Left-Hand Inswing Exterior Right-Hand Inswing Exterior Right-Hand Outswing Exterior Left-Hand Outswing

CENTER-SWING DOUBLE DOORS*

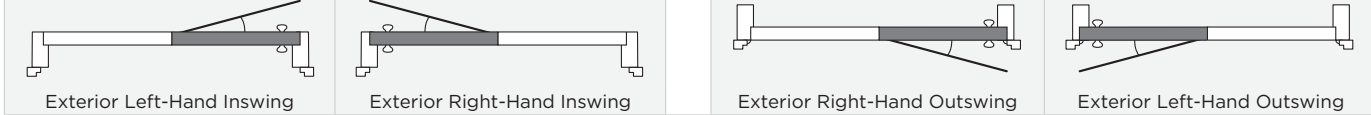

Exterior Left-Hand Inswing Exterior Right-Hand Inswing Exterior Right-Hand Outswing Exterior Left-Hand Outswing

TRIPLE FRENCH DOORS*

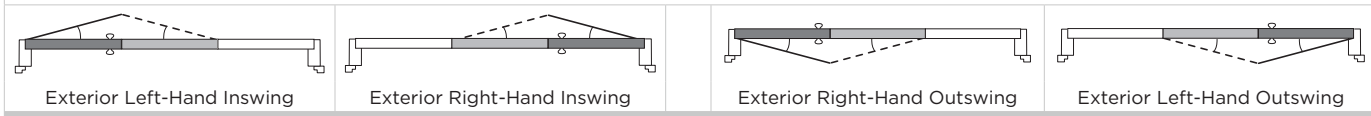

Exterior Left-Hand Inswing Exterior Right-Hand Inswing Exterior Right-Hand Outswing Exterior Left-Hand Outswing

CENTER-SWING TRIPLE DOORS*

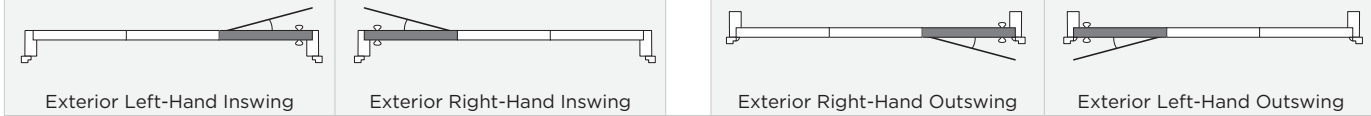

Exterior Left-Hand Inswing Exterior Right-Hand Inswing Exterior Right-Hand Outswing Exterior Left-Hand Outswing



Active Doors

Inactive Doors

Fixed Doors

Complete list of handing options available at Masonite.com

*Typically a patio configuration



Warranty

MASONITE & CLEARY WARRANTY

MASONITE / CLEARY WARRANTY MASONITE HD - HIGH DEFINITION STEEL ENTRY DOORS

Subject to the limitations and conditions set forth below, Cleary warrants that from the date of original purchase, the door panel will be free of manufacturing defects in material and workmanship for a period of at least ten (10) years. Deflection (up to 1/4") or minor scratches or other visual imperfections shall not be considered defects.

MASONITE WARRANTY BARRINGTON® FIBERGLASS ENTRY DOORS

Subject to the limitations and conditions set forth below, Masonite warrants from the date of its original purchase from Masonite that (a) the door panel will be free of manufacturing defects in material and workmanship for the expected life of the door panel; and (b) Masonite's factory-installed glass inserts and frames will be free from seal failure or extraordinary discoloration resulting from a manufacturing defect in materials or workmanship for periods of five (5) years for its clear glass inserts and ten (10) years for its decorative glass inserts.

BELLEVILLE® FIBERGLASS ENTRY DOORS

Subject to the limitations and conditions set forth below, Masonite warrants the door panel to be free of manufacturing defects in material and workmanship for the anticipated life of the door panel.

LIMITATIONS & CONDITIONS APPLY TO ALL UNITS ABOVE:

Masonite grants these warranties only to the original purchaser of the door panel and the original purchaser of the building where the door was installed. **THIS WARRANTY IS NOT TRANSFERABLE.**

The warranty excludes any defects in the coatings on the door and the accessories. Also excluded are defects resulting from (1) exposure to acid, chemicals or fumes; (2) improper use; (3) improper installation; (4) improper maintenance; (5) water-related damage; or (6) a failure to follow any applicable installation, care or maintenance instructions*. Bubbles, lines, slight surface imperfections and slight discoloration are characteristics of fine hand-crafted glass and are not considered defects. Deflections of up to 1/4" or minor surface scratches or other minor imperfections are not considered defects and are not warranted.

THIS WARRANTY IS IN LIEU OF ANY OTHER WARRANTY, EXPRESSED OR IMPLIED, INCLUDING IMPLIED WARRANTIES OF FITNESS FOR A PARTICULAR PURPOSE AND MERCHANTABILITY. MOREOVER, IN NO EVENT WILL MASONITE BE LIABLE FOR SPECIAL, INCIDENTAL OR CONSEQUENTIAL DAMAGES. This warranty gives you specific legal rights. Other rights vary from state to state and may apply to you. Some states and federal laws do not allow the exclusion of implied warranties. In the event these laws apply, then the length of any implied warranty shall be one (1) year or the shortest time in excess of one year permitted under applicable law. Similarly, some states do not allow the exclusion or limitation of consequential damages and, if applicable, this limitation will not apply.

If a defect occurs, Masonite, at its sole option, will furnish a replacement door, repair the door or refund the original purchase price. **MASONITE'S MAXIMUM LIABILITY IS LIMITED TO THE AMOUNT OF THE ORIGINAL PURCHASE PRICE. MASONITE WILL NOT PAY THE COSTS OF LABOR, INSTALLATION OR FINISHING FOR ANY REPLACEMENT DOOR.** No representative of Masonite or any other person has any authority whatsoever to assume for Masonite any other liability or responsibility in connection with the door warranted herein.

If you have a warranty claim, please notify your Masonite Dealer. Include in the notice the following information:

- | | |
|--|---|
| A. description of door; | C. proof of sale; and |
| B. name and address of owner and installer; | D. detailed explanation of defect. |

*Doors must be properly finished for warranty to apply. See staining and painting instructions outlined on pages 262 - 263

PEACE OF MIND GUARANTEE:

For a small upcharge the Peace of Mind Guarantee will cover all parts and labor for a 2-year period, from date of purchase. Cleary Millwork will provide material and labor on all warranty and workmanship issues on the entire door unit. This service includes door and sidelite panels, glass and any hardware purchased from Cleary Millwork. (Hardware could include Entrance Handle sets, Door Knockers, Kick Plates, and Peep sites, Mail slots and Stainless Steel hinge selections) This Warranty is available for all prehung Masonite exterior door units assembled by Cleary Millwork using the following Frame options: Endura "Force 5" frame system and the Composite Jamb. After the 2-year period, all manufacturer's warranties remain in place for the balance of the product's warranty period.

This service is not a warranty to correct poor installation, which is key to any of our quality products.

Peace of Mind Guarantee will be included at "No Charge" with the purchase of our "North Atlantic Series" door unit systems.

FORTRESS COATING SYSTEMS™ WARRANTY:

Thank you for purchasing your Fortress Coatings Systems™ prefinished doors. With a little care your door finish will last many years with little maintenance. With each finish there is a touch up bottle with paint, please store in cool, dry place, out of direct sunlight.

With our Fortress Stain process you will receive two touch-up bottles: a base coat color and a grain enhancement color. (This hand applied finish will be unique to each door due to the nature of the fiberglass graining and hand application of the finish.)

Painted and Fortress stained doors utilize a Sherwin Williams industrial paint with UV inhibitors to retain the color of your prefinished door. Your finish will be warranted for a period of 10 years from date of purchase (see complete limited warranty). Your products manufacturer's warranty covers any defective material.

Fortress stained doors are top-coated with a UV water-based clear coat. Proper maintenance would be to apply topcoat depending on weather exposure once every other year. Prefinished door jambs should be inspected and touched up as needed. Frame joints should be inspected and caulking maintained at the sill and jamb joints. (Prefinishing of primed finger joint jambs will show visible joints and is not considered a defect) Do not use any harsh chemicals on your door when cleaning; a simple solution of very mild soap and water should be used if needed.

Fortress coatings warranty does not cover expansion and contraction of glass light surrounds due to high situations of a non-vented storm door.

Cleary Door Systems

CLEARY DOOR SYSTEMS POWERED BY ENDURA™ COMPONENTS

Z-ARTICULATING CAP SILL (Z-AC)™



Z-AC is a sill and built-in sealing system that redefines what your door system can do for you.

- ▶ **No Sill Adjustment Ever.** Never adjust a sill again with Z-AC's unique spring-loaded cap.
- ▶ **No Haunting Install Challenges.** Built-in sealing system within Z-AC seals with wide margins and missing corner pads.

ULTIMATE SLIDE BOLT ASTRAGAL

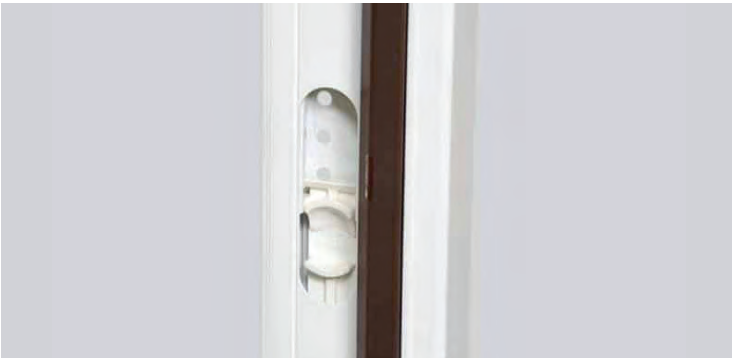

The Ultimate Slide Bolt Astragal delivers simple operation, leak-fighting power and built-in security for lasting protection, value and peace of mind.

- ▶ **Simple Operation.** Slide to engage. Slide to retract. That's it.
- ▶ **Leak-Fighting Performance.** Spring-loaded Floating Boot works with pre-installed Simple Solution™ Corner Pad and weatherstrip to fight air and water infiltration.
- ▶ **Easy Hardware Customization.** 4-way adjustable strike retainers feature Snap-n-Size™ functionality and can be easily removed, resized and repositioned without additional cutting tools.





FRAMESAVER® ROT-PROOF DOOR FRAME



FrameSaver combines the strength of wood and performance of composite in one game-changing frame solution:

- ▶ **No Rot.** FrameSaver's composite bottom is completely rot-proof.
- ▶ **No Worries.** FrameSaver is backed by an unmatched, fully transferable lifetime limited warranty

ENDURA WEATHERSEALING



Seal out air and water with Endura's PE650® Weatherstrip and Simple Solution® Corner Pad.

- ▶ **No Leaks.** Endura weathersealing components counteract upward water pressure.
- ▶ **No Margin Worries.** Patented, designs seal even with wide margins.

THE RESULT?

You get a door system that never stops working for you. With a door system Powered by Endura™, service calls, extra installation steps and quick field fixes are a thing of the past.

Cleary Door Systems

IMPERFECT CONDITIONS. PROVEN PERFORMANCE.

Masonite Door Systems Powered By Endura™ components have been tested and proven to outperform competitors, even in severe weather conditions. But don't just take our word for it. See for yourself — the numbers don't lie.

CERTIFIED TESTING

	6/8	8/0
INSWING	PERFORMANCE RANGE	PERFORMANCE RANGE
Single, Standard Lock & Deadbolt w/ Z-AC	DP50	DP35
OUTSWING	PERFORMANCE RANGE	PERFORMANCE RANGE
Single, Standard Lock & Deadbolt w/Z-AC	DP70	DP65

Each test is 23 minutes in duration. Doors are exposed to 8" of rainfall per hour and wind speeds corresponding with the DP vs. Wind Speed chart as shown.

*Testing done on Fiberglass panels

DP VS WIND SPEED IN MILES PER HOUR

Limited Water	No Wind	DP25	38.3 MPH	DP40	48.4 MPH	
	DP15	33.4 MPH	DP30	41.9 MPH	DP45	51.3 MPH
	DP20	34.2 MPH	DP35	45.3 MPH	DP50	54.1 MPH

Certified Powered By Endura™

CERTIFIED POWERED BY ENDURA™ COMPONENTS. SMARTER PERFORMANCE FOR YOU.

Certified Powered By Endura™ Door Systems are backed by the industry's strongest warranty and guaranteed to create smarter, better experiences for everyone, every time. Certified Powered By Endura™ component solutions work together to account for realworld challenges you face each day, delivering secure, hassle-free performance and unmatched quality and value.

Imagine what a Smarter Door™ experience can do for you -

Imagine your door, Powered By Endura™.



Z-ARTICULATING CAP SILL™ (Z-AC)

Z-AC™ automatically addresses real-world conditions for forgiving, lasting performance that cuts costs, not corners.

- ▶ Never needs adjustment
- ▶ Seals with missing corner pads
- ▶ Seals with strike margins up to 5/32"

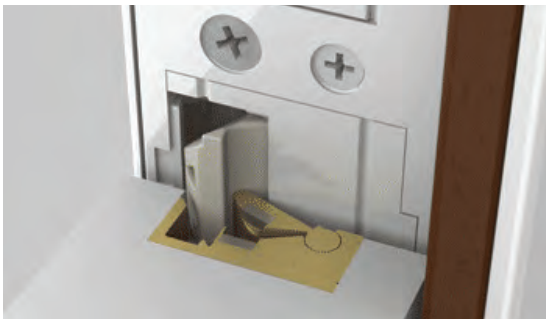

MULTI-POINT ASTRAGAL (MPA)

MPA delivers forgiving, automatic sealing power and three secure locking points.

- ▶ Built-in Flip Lever activates top and bottom Flush Bolts
- ▶ Floating Boot seals regardless of drill hole depth
- ▶ Lock Pawls engage keepers, preventing panel deflection

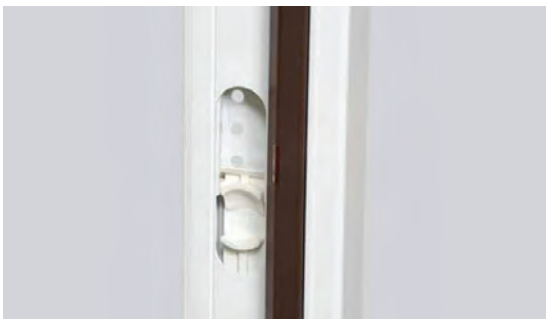

ULTIMATE SLIDE BOLT ASTRAGAL

Ultimate Slide Bolt Astragal delivers simple operation, leakfighting sealing power and built-in security for lasting protection.

- ▶ Slide to engage. Slide to retract. That's it.
- ▶ Spring-loaded Floating Boot works with pre-installed Simple Solution Corner Pad and weatherstrip to fight air and water infiltration
Seals with strike margins up to 5/32"
- ▶ Easy hardware customization



VERSAPAN™ SILL PAN

VersaPan Sill Pan creates a robust barrier against water infiltration and resulting damage.

- ▶ Drains water down and away from the door unit
- ▶ Install in any rough opening in a few simple steps. No saw or glue needed.
- ▶ Infinite Adjustability: One SKU is all you need for single and French doors.

Powered By Endura™

POWERED BY ENDURA™ COMPONENTS. SMARTER PERFORMANCE FOR YOU.



TRILENNIUM® MULTI-POINT LOCKING SYSTEM

Unmatched Strength. Ultimate Performance. Backed by the industry's highest ratings for structural and forced entry performance, Trilennium delivers 3x the strength, 3x the security and 3x the performance in one system.

UNMATCHED STRENGTH

Protects with the power of three deadbolts, while the one-piece, solid I-Beam lock construction works to strengthen the door panel.

UNMATCHED PERFORMANCE

Bolts pre-engage when unlocked to fight deflection at all times, and can correct misalignment up to 3/16" in three directions once engaged.

UNMATCHED OPERATION

A single turn of the thumbturn or key is all you need to unlock the door. With Panic Release, a single turn of the interior lever unlocks the entire system.

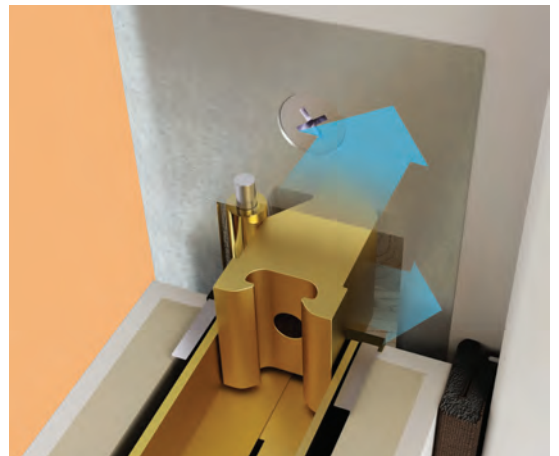

TRILENNIUM® HANDSET COLLECTION

Our extensive hardware portfolio provides ultimate customization to match your style while delivering reliable performance. Choose your level, choose your style, choose your finish—The choice is yours!

TRILENNIUM® HARDWARE



Eclipse Entry Set
Shown in
Satin Nickel



Pinnacle Entry Set
Shown in
Victorian Bronze



Rectangular
Entry Set
Shown in Black



Curved Entry Set
Shown in
Satin Nickel



Horizon Entry Set
Shown in
Bright Brass



Eclipse Grip Set
Shown in
Victorian Bronze

EMTEK®



Modern Entry Set
Shown in Polished Chrome



Stainless Steel Entry Set
Shown in Brushed Stainless Steel



Arched Entry Set
Shown in Medium Bronze Patina



Rectangular Entry Set
Shown in Medium Bronze Patina



Tuscany Entry Set
Shown in Flat Black Patina

ROCKY MOUNTAIN HARDWARE®



Curved Entry Set
Shown in Silicon
Bronze Medium



Rectangular Entry Set
Shown in Silicon
Bronze Dark



Stepped Entry Set
Shown in White
Bronze Medium



Arched Entry Set
Shown in White
Bronze Medium



Fleur de Lis Entry Set
Shown in Silicon
Bronze Light



Arched Handle Grip Set
Shown in Silicon
Bronze Rust

Entry Door Hardware

EMTEK®
ASSA ABLOY

SCHLAGE

We offer hundreds of handle sets to compliment your Masonite entry door. Following is a small selection of some common hardware from our suppliers.

SCHLAGE®



Plymouth
(Stocked in Satin Nickel)



Century
(Aged Bronze)



Greenwich
(Satin Nickel)



Camelot
(Satin Nickel)

EMTEK®



Lausanne
(Oil Rubbed Bronze)



Davos
(Polished Chrome)



Zeus
(Oil Rubbed Bronze)



Arts & Crafts
(Oil Rubbed Bronze)



Adams
(Oil Rubbed Bronze)



Wilshire
(Medium Bronze)



Melrose
(Satin Nickel)



Wilmington
(Polished Chrome)



Plymouth Accent
(Stocked in Satin Nickel)



Camelot Accent
(Stocked in Satin Nickel)



Plymouth Knob Keyed
(Stocked in Satin Nickel)



Keyed Deadbolt
(Stocked in Satin Nickel)



Stuttgart Lever
(Polished Chrome)



Octagon Knob
(Oil Rubbed Bronze)



Helios Lever
(Satin Nickel)



Round Knob
(Satin Nickel)



Merrimack Lever
(Pewter)



Egg Knob
(Satin Nickel)



Cortina Lever
(Oil Rubbed Bronze)



Norwich Knob
(Oil Rubbed Bronze)

KEYLESS ENTRY AND ELECTRONIC



Emtek



Schlage

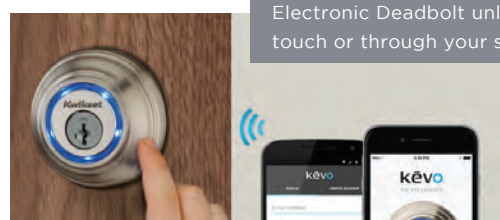

Kwikset KEVO

KEVO Bluetooth-Enabled Electronic Deadbolt unlocks with a touch or through your smartphone.

Styles available in a variety of finishes, including Bronze, Nickel, Brass, Stainless Steel and Chrome. Selection varies by style.

Fortress Coating Systems

LET CLEARLY FINISH YOUR DOOR

- ▶ For best paint results we recommend painting primed composite jambs with PVC casing.
- ▶ We can also provide our prefinishing over any of our wood jamb offerings, but it is not unusual to have raised visible wood graining and finger joints on primed material show through.
- ▶ Our staining process works best on composite “ready-stain” jambs and casing, but can also be applied to clear wood, primed jamb and FrameSaver material for a complimentary color to the grained door panel.



STOCK PAINT COLORS

Custom colors are also available. Please supply Sherwin Williams or Benjamin Moore paint number and name.

Custom paint matching available with physical sample and extended lead time.



SW 6258 TRICORN BLACK



SW 7510 CHATEAU BROWN



SW 6300 BURGUNDY



SW 7593 RUSTIC RED



SW 6244 NAVAL



SW 7669 SUMMIT GRAY

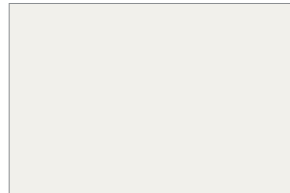

SW 7005 PURE WHITE



SW 6243 DISTANCE



SW 6454 SHAMROCK

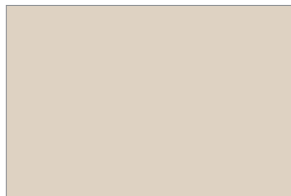

SW 7526 MAISON BLANCHE



SW 7048 URBAN BRONZE



SW 2848 ROYCROFT PEWTER



SW 2838 POLISHED MAHOGANY



SHERWIN-WILLIAMS®

Fortress COATING SYSTEMS™

STAINS FOR FIBERGLASS

Shown on fir

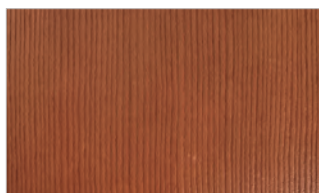

FC100 LIGHT OAK



FC200 NATURAL OAK



FC300 CEDAR

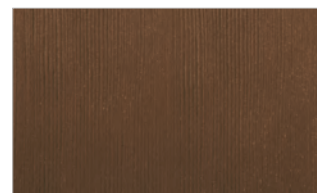

FC400 ENGLISH WALNUT

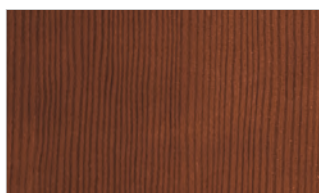

FC500 WALNUT

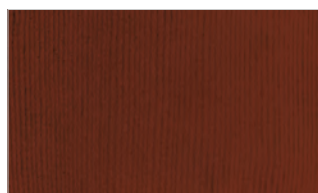

FC600 CHERRY

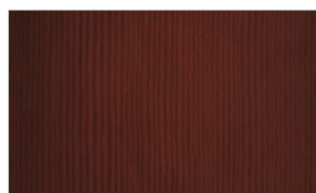

FC700 MAHOGANY

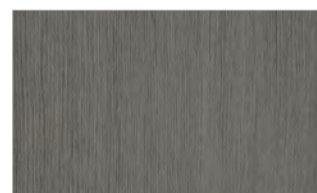

FC800 DRIFTWOOD



FC900 SLATE GREY

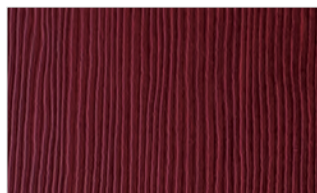

FC2000 LINCOLN RED

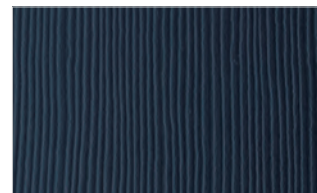

FC2010 MILLWALL BLUE

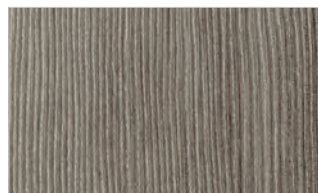

FC2020 SANDPIPER

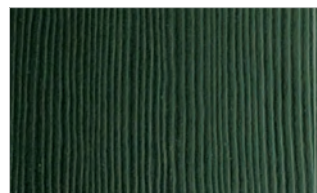

FC2030 BARRINGTON GREEN

DIY Door Finishing Kit From Masonite®

Colors are not part of Fortress Coating Systems.

Stain selection for textured wood-grain doors. Choose from light, inviting tones or darker, more dramatic hues.

Stain colors are approximate and may vary with application.

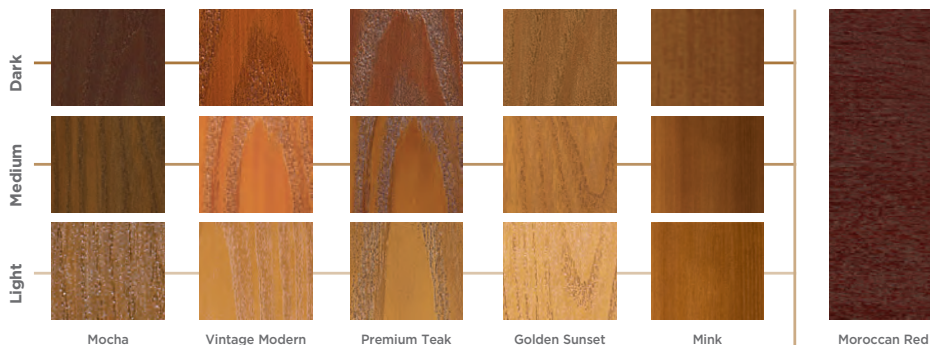

- ▶ ZAR® wood Stain (Qt.)
- ▶ Mineral spirits (4 oz.)
- ▶ Two 2" foam brushes
- ▶ One 2-1/2" synthetic bristle brush
- ▶ Cheese cloths
- ▶ Two stir sticks
- ▶ One pair of latex gloves
- ▶ Door staining instructions
- ▶ ZAR® exterior water-based polyurethane (Qt.)

Contains everything needed to make finishing easy
Enough for a door unit with two sidelites or a double door unit

EXTERIOR DOOR OPTIONS

6'8" FRAME - SINGLE UNIT 7'0", 8'0" FRAMESAVER, STANDARD		
SINGLE	DOUBLE	EACH SIDELITE

FIBERGLASS HINGE OPTIONS 4" X 4-1/4" SQUARE/RADIUS HINGES 	FIBERGLASS HINGES INSWING Bright Brass ball bearing	STANDARD		
	Antique Brass, Dull Chrome, Satin Nickel, Oil Rubbed Bronze ball bearing Stainless Steel - Lighthouse applies to this option only	•	•	
	FIBERGLASS HINGES OUTSWING Antique Brass, Dull Chrome, Satin Nickel, Oil Rubbed Bronze, Stainless Steel (drilled & pinned)	•	•	
	STEEL HINGES OUTSWING Satin Brass NRP 4" x 4" (Square/Radius) Dull Chrome NRP 4" x 4" (Square/Radius) Stainless Steel NRP 4" x 4" (Square/Radius) Primed NRP 4" x 4" (Square/Radius)	STANDARD		
STEEL HINGE OPTIONS 5/8" SQUARE/RADIUS	STEEL SPRING HINGES (1 PAIR PER PANEL) Satin Brass, Dull Chrome, Satin Nickel, Oil Rubbed Bronze 4" x 4" (Square/Radius)	•	•	
	STEEL HINGES BELOW Satin Brass Polished Brass, Antique Brass, Dull Chrome, Black, Antique Nickel, Satin Nickel, Oil Rubbed Bronze 4" x 4" (5/8 Radius) Ball Bearing Hinges - Bright Brass, Dull Chrome	STANDARD		
	MULTIPOINT LOCK Prep & Install standard Trilennium™ 3-point (single door)	6'8" OPTION	8'0" NON STOCK	
	Note: Our standard Trilennium™ Hardware for single doors includes Trilennium™ 3000 Series 3-point lock system with stainless steel edge plate, 3 (satin nickel, bright brass or victorian bronze - specify) strike plates & dust boxes, construction handle set. (Add for 3-point hardware below.) Trilennium™ Active 3-point Eclipse hardware set Brass for single swing door unit Trilennium™ Active 3-point Eclipse hardware set Victorian Bronze for single swing door unit Trilennium™ Active 3-point Eclipse hardware set Satin Nickel for single swing door unit	•	•	See Upgrade for Endura Multi-point astragal option.
NON RATED EXIT PANIC DEVICE W/ LEVER SET Von Duprin SP28 Aluminum 22EO	•			
MISCELLANEOUS	MISCELLANEOUS Prep & Install Mail Slot Brass Peep Site Dull Chrome Peep Site	•		
	STORM DOOR ADAPTOR KIT FOR CONTINUOUS HEAD & SILL SIDELITE UNITS	6'8" APPLIED EACH SIDELITE	6'8" LOOSE EACH SIDELITE	
	PFJ-4-9/16" Storm Door Adaptor Per Mull Post (FrameSaver® Standard) PFJ 6-9/16" Storm Door Adaptor Per Mull Post (FrameSaver® Standard)	•	•	
	Composite White Capped or Ready-to-Stain 4-9/16" Storm Door Adaptor Per Mull Post Composite White Capped or Ready-to-Stain 6-9/16" Storm Door Adaptor Per Mull Post	•	•	
	Boxed Construction (per sidelite) voids Force 5 Warranty			•
	White Weatherstrip Door Panel Only Masonite, Express Service (Call for details)	•	•	
	DOOR FINISHING KIT FOR MASONITE FIBERGLASS ENTRY SYSTEMS Bore for Deadbolt and Strike Prep Jamb (prepped for Schlage deadbolt)	•		
	Cut Down - Single Cut - Steel (up to 3" off the bottom) Cut Down - Single Cut - Fiberglass (up to 3" off the bottom) Cut Down - Double Cut - Steel (up to 6") Cut Down - Double Cut - Fiberglass (up to 6")	•	•	•
	FOR CUT DOWNS OTHER THAN OPTION LISTED PLEASE CALL FOR QUOTE. ADDITIONAL LAYOUT & SHOP TIME REQUIRED.			
	 "Peace of Mind" Guarantee See page 151 for details of this extended parts and labor guarantee ("Peace of Mind" Guarantee is available on complete Force 5 and composite frame systems only)	•	•	
NORTH ATLANTIC SERIES To price out a North Atlantic Series Door take the standard unit price and add the following. add for FrameSaver in jamb width desired add for your PVC casing option add for Trilennium™ hardware prep add for Trilennium™ Eclipse Handle set of your choice add Stainless steel hinge selection add Endura Versasill pan option of appropriate size Peace of Mind Guarantee — included at N/C	N/C with North Atlantic Series			













Look for the lighthouse to guide your pricing



EXTERIOR DOOR OPTIONS



EXTERIOR DOOR OPTIONS

		6'8" FRAME - SINGLE UNIT		
		SINGLE	DOUBLE	EACH SIDELITE
JAMB OPTIONS (ADD ONS)	4-9/16" FJ Primed Jambs	STANDARD		
	6-9/16" FJ Primed Jambs	•	•	•
	8-9/16" FJ Primed Jambs	•	•	•
	4-9/16" Clear Pine Jambs	•	•	•
	6-9/16" Clear Pine Jambs	•	•	•
	8-9/16" Clear Pine Jambs	•	•	•
	Rip Jamb Width (N/A on white capped or ready stain composite)	•	•	•
ENDURA FRAMESAVER 	4-9/16" Endura FrameSaver (we recommend using one of our PVC casing options)	•	•	•
	5-1/4" Endura FrameSaver (we recommend using one of our PVC casing options)	•	•	•
	6-9/16" Endura FrameSaver (we recommend using one of our PVC casing options)	•	•	•
	8-9/16" Endura FrameSaver (we recommend using one of our PVC casing options)	•	•	•
COMPOSITE JAMBS	White Capped - 4-9/16" (add for casing below)	•	•	•
	White Capped - 6-9/16" (add for casing below)	•	•	•
	Embossed Ready to Stain - 4-9/16" (add for casing below)	•	•	•
	Embossed Ready to Stain - 6-9/16" (add for casing below)	•	•	•
	Primed White - 4-9/16" (add for casing below)	•	•	•
Primed White - 6-9/16" (add for casing below)	•	•	•	
CASING OPTIONS 	Primed Brickmould 1-1/4" x 2"	STANDARD		
	FrameSaver Primed Brickmould 1-1/4" x 2"	•	•	•
	Clear Pine Brickmould 1-1/4" x 2"	•	•	•
	5/4 x 4" (1-1/16" x 3-1/2") Primed Flat Casing	•	•	•
	5/4 x 4" (1-1/16" x 3-1/2") Clear Flat Casing	•	•	•
	1" x 5" (3/4" x 4-1/2") Primed Flat Casing	•	•	•
	1" x 5" (3/4" x 4-1/2") Clear Pine Flat Casing	•	•	•
	Composite Ready to Stain Brickmould 	•	•	•
	PVC Brickmould NO ROT 	•	•	•
	PVC Brickmould with "J" Channel NO ROT 	•	•	•
	PVC 5/4 x 3-1/2" Flat Casing NO ROT 	•	•	•
	PVC 5/4 x 3-1/2" Flat Casing with "J" Channel NO ROT 	•	•	•
	Kleer Composite Flat Casing 5/4 x 4	•	•	•
	Kleer Composite Flat Casing 5/4 x 6	•	•	•
	Kleer Composite Flat Casing 1 x 4	•	•	•
Kleer Composite Flat Casing 1 x 6	•	•	•	
Notch Back Flat or 908 Casing to accommodate 4-3/4" or 6-3/4" wall (choose 4-9/16" or 6-9/16" Jamb for this option) (+add)	•	•	•	
No Casing (For Kleer casing options see page 7)	•	•	•	
SILL OPTIONS	INSWING	STANDARD		
	Z-Ac Self Adjusting Aluminum Sill With Construction Cover (Oak Grained Cap)	•	•	•
	Z-Ac Self Adjusting Aluminum Bronze Sill With Construction Cover (Walnut Cap)	•	•	•
	Z-Fen Aluminum Mill Sill, (No Construction Cover)	•	•	•
	1/2" Aluminum Saddle ADA Public Access (Commercial Grade)	•	•	•
	1/2" Aluminum Saddle Thermal Break (Commercial Grade)	•	•	•
	1/2" Aluminum Tile Back ADA (4-9/16" Jamb Only - Commercial Grade)	•	•	•
	No Sill	•	•	•
	AVAILABLE BRONZE CALL FOR PRICING	OUTSWING INCLUDES 3 NON-REMOVABLE PIN HINGES		
	4-9/16" Outswing "Z" Series Bumper Sill (Aluminum)	•	•	•
6-9/16" Outswing "Z" Series Bumper Sill (Aluminum)	•	•	•	
4-9/16" Outswing "Z" Series Bumper Sill (Bronze)	•	•	•	
6-9/16" Outswing "Z" Series Bumper Sill (Bronze)	•	•	•	
1/2" Aluminum Saddle ADA Public Access (Commercial Grade)	•	•	•	
1/2" Aluminum Saddle ADA Public Access with Thermal Break (Commercial Grade)	•	•	•	
No Sill	•	•	•	
ENDURA SURESILL PAN FLASHING SYSTEM (40" SINGLES / 80" DBL & S/L) 	Sill Pan Flashing 4-9/16" single	•	•	•
	Sill Pan Flashing 6-9/16" single	•	•	•
	Sill Pan Trimable up to 7-1/4" jamb thickness	•	•	•
DOUBLE DOOR OPTIONS 	6'8" Double door (With standard ultimate astragal)		•	
	6'8" Double door with flip lever astragal		•	
	6'8" Double door with multipoint astragal		•	
	Multi-point Astragal uses your standard lock and deadbolt, no special hardware is needed		•	
	Outswing white security flange		•	
7'0" and 8'0" options (for other options please call)		SINGLE	DOUBLE	EACH SIDELITE
JAMB OPTIONS (ADD ONS)	4-9/16" FrameSaver Primed Jambs	STANDARD		
	6-9/16" FrameSaver Primed Jambs	•	•	•
	4-9/16" Primed Composite Jambs	•	•	•
	6-9/16" Primed Composite Jambs	•	•	•
CASING OPTIONS	Primed Brickmould 1-1/4" x 2"	STANDARD		
	5/4 x 4" (1-1/16" x 3-1/2") Primed Flat Casing	•	•	•
	PVC Brickmould NO ROT 	•	•	•
	PVC Brickmould with "J" Channel NO ROT 	•	•	•
	PVC 5/4 x 3-1/2" Flat Casing NO ROT 	•	•	•
PVC 5/4 x 3-1/2" Flat Casing with "J" Channel NO ROT 	•	•	•	
DOUBLE DOOR OPTIONS	7'0" Double door is single door X 2 + Add (stock white ultimate astragal only)		•	
	8'0" Double door is single door X 2 + Add (stock white multi-point astragal only)		•	
Multi-point Astragal uses your standard lock and deadbolt, no special hardware is needed			•	



CLEARY MILLWORK 800-899-4533

WHOLESALE DOORS 800-225-4252

CLEARYMILLWORK.COM



Max

Masonite Xpress Configurator..

In just a few clicks, browse thousands of door styles and glass options to create your dream door.

COVER:
Door: Heritage Series,
4 Lite Double Water Textured

BACK COVER:
Door VistaGrande,
Fir Textured with Chord Glass

⚠ WARNING: This product can expose you to chemicals including wood dust, which is known to the State of California to cause cancer. For more information go to www.P65Warnings.ca.gov.