

BRITPART

The quality parts for Land Rovers

the

Accessory Catalogue

for the entire Land Rover marque



ISSUE THREE

www.britpart.com

1 NEW SECTION
24 NEW PAGES
OVER 225 NEW PARTS

the
**Accessory
Catalogue**

for the entire Land Rover marque

BRITPART

The quality parts for Land Rovers

Welcome to the third edition of the Britpart Accessory Catalogue!

We've added plenty more pages to accommodate all the extra new products we can now offer Land Rover owners. You may notice there is also a brand new section - **Vehicle Enhancements!** In this new section you'll find accessories for the newer Land Rover models to give your vehicle a bit of a facelift. Remember to look out for all the **NEW** products we've added.

	Pages
1 Exterior Protection	5-18
Going off-road? Then here's where to find all the protection your Land Rover will need.	
2 Chassis Protection	19-22
Offering protection against the unexpected.	
3 Side & Rear Steps	23-26
Get in and out of your Land Rover with some smart new steps.	
4 Racks & Luggage Boxes	27-32
Got a load to carry? We've got racks and luggage boxes to suit all.	
5 Wheels	33-36
Freshen up your Land Rover with a new set of wheels.	
6 Lighting Equipment	37-42
Light the way with a decent set of driving lamps.	
7 Towing Equipment	43-48
Haul that load - towing equipment for your Land Rover.	
8 Interior Protection	49-60
Dog guards, loadspace liners, mats - all that you need to protect your vehicle trim.	
9 Seats & Trim	61-70
Saggy old seats? Get some new ones and we've plenty to choose from.	
10 Off-Road Equipment	71-82
Be prepared for the worst.	
11 Winching Equipment	83-94
Never get stuck again with a Britpart winch and winching accessories.	
12 Performance Equipment	95-104
Upgrade your Land Rover from its standard spec.	
13 Suspension Equipment	105-116
Firm up your ride with some new shockers and springs.	
14 Exhausts	117-120
An exhaust that'll last a life time? We've got them here.	
15 Engines & Transmission	121-124
A wide range of new and reconditioned engines and gearboxes.	
16 Repair & Service Parts	125-142
From a new complete chassis to a jubilee clip - we've got the lot.	
17 Service Kits & Filters	143-146
Don't forget that filter again with a Britpart service kit - all you'll need to complete the job.	
18 Vehicle Enhancements	147-152
Give your Land Rover that extra special look.	
19 Miscellaneous	153-162
Land Rover gear, workshop books and much more...	

innovation, quality & style on demand

The quality parts for Land Rovers

the marque

Britpart is the leading independent wholesaler of parts and accessories for Land Rover vehicles, supplying in excess of 800 customers worldwide from government agencies to trade outlets.

The name 'Britpart' is synonymous with quality parts for Land Rovers and the company has earned a truly enviable reputation around the globe. Over the past 25 years, Land Rover enthusiasts the world over have come to identify Britpart as a brand to be trusted.

The Britpart logo has become a widely recognised and highly respected marque; it embodies excellence in the field, both in quality and commitment to meeting the needs of the customer.

products

Britpart has always reacted swiftly to the demands of the parts market for all Land Rover vehicles, aiming to provide customers with exactly what they want, when they want it. Parts have long been the mainstay of Britpart's business, with many parts simply being unavailable from other sources; however, accessories are now becoming a major part of the business as owners of Land Rovers, old and new, are customising their vehicles to suit their individual tastes and lifestyles; everything they need is now available from Britpart.

The vast array of Britpart accessories ensures that no two Land Rovers are ever identical!

Land Rover appointed Britpart as an 'Approved European Parts Distributor' for all Land Rover Genuine Parts; this, together with Britpart's own vast range of parts and accessories, along with their extensive inventory of O.E.M. product, has resulted in Britpart becoming the ultimate 'One-Stop-Shop' providing everything its customers could possibly require, all ordered and delivered from one dedicated source.



quality

Britpart is approved by Lloyd's Register Quality Assurance to BS EN ISO 9001:2000.

Britpart is renowned for quality parts at very competitive prices and takes pride in its excellent customer service, maintaining high stock levels with the aim of fulfilling orders promptly.

distribution

Parts and accessories for Land Rover vehicles continually flow in and out of the massive state-of-the-art warehouse. Britpart's fleet of vans and trucks all sport the undeniably eye-catching Britpart blue and white livery. Between them they cover the length and breadth of the United Kingdom, including Northern Ireland, delivering directly to Britpart customers on a regular basis, adding to the personal touch that customers have come to associate with Britpart.

service

Britpart has an enthusiastic and highly knowledgeable team so that you deal with people who have in-depth knowledge of the business. In addition to major government contracts, we successfully support individual parts retailers, supplying spares for Land Rover models old and new including Series, Defender, Range Rover, Discovery and Freelander.

The lively Sales operation boasts three highly trained teams; one each for Home Sales, European Sales and Export Sales with technical experts and sales advisors in each, eager to answer the telephone and organise despatch of goods to their customers within the shortest possible time.

handmade

The highly skilled team in the Trim Shop make a wide range of seats, seat covers, bases, backs and benches etc for Land Rover vehicles by hand.

Equally skilled is the team in the Lock Shop where a wide range of light engineering work is carried out.

In keeping with the Britpart philosophy, all products leaving the Trim Shop and the Lock Shop are produced to the highest standards and meet with the strictest safety regulations.

global

When Land Rover finally severed its association with Santana Motor SA it was Britpart who bought up all the existing stock from the factory in Spain and shipped it to their UK headquarters in Shropshire. The shipment included everything from small components to body panels and new engines, along with all the original drawings and tooling. Some of the stock was found to be interchangeable with Land Rover parts and a proportion of the rest is gradually making the journey back home with the assistance of our partner in Spain, Britpart España, Estanfi Automoción.

Britpart's other partners around the globe include: Britpart Belgium, Britpart Brazil, Britpart USA, Britpart Norway, Britpart Poland.

Britpart is seeking to further expand its comprehensive customer base overseas and is continually looking for well established independent stockists of Land Rover parts to work closely with.

quality parts

Britpart holds over 15,000 stock items from o-rings and oil seals to engines and exhaust systems. Customers can choose from Britpart quality parts, O.E.M. products and Land Rover Genuine Parts; all delivered promptly at competitive prices.

Everything required for servicing, repairing, restoring or even rebuilding any Land Rover can be supplied by Britpart, thus enabling customers to order all they need on just one order sheet making it easy to keep track of stock and take delivery.

quality accessories

Britpart have all the latest accessories you need to customise your Land Rover, whatever the model, to look great on the road and work better off it! From wheels to roof racks, Britpart have everything to ensure that no two Land Rovers need ever look identical.



Certification No. 910885



IN THIS SECTION....

EXTERIOR PROTECTION

A Bars	5-6
Bull bar	7
Bumper	7
Bumperettes	7
Chequer plate	8-9
Lamp guards	10-14
Mirrors & fittings	14
Mud flaps	15
Parking sensors	16
Radiator muffs	16
Rubbing strips	16
Wheel arch kits - off-road	17
Wheel arch kits - standard	17



A BARS

Defender

LR005235	Defender - up to 2006	Black rubber	Includes spot lamp brackets
STC53037	Defender - air con	Stainless steel	Includes spot lamp brackets



LR005235



STC53037

Discovery

LR005237	Discovery 3
Moulded black rubber	
Includes spot lamp brackets	



LR005237

IMPORTANT NOTICE

Please check local legislation before fitting a frontal protection device to a vehicle that is to be used on public roads.

A BARS - continued

Freelander

DA4111	Freelander - to 2000 pre Td4	Stainless steel	Includes spot lamp brackets
STC50413	Freelander	Preformed plastic & foam	No spot lamp brackets
STC53129	Freelander V6	Preformed plastic & foam	No spot lamp brackets
VUB501330	Freelander - from VIN4A00001	Moulded grey rubber	No spot lamp brackets



DA4111



STC50413



STC53129



VUB501330

Add some front end protection to your vehicle with an A Bar - also a great addition if you'd like to add spot lights to your Land Rover!



VUB501980

Range Rover

VUB501980	Range Rover Sport	Moulded grey plastic	Includes spot lamp brackets
------------------	-------------------	----------------------	-----------------------------

IMPORTANT NOTICE

Please check local legislation before fitting a frontal protection device to a vehicle that is to be used on public roads.

BULL/NUDGE BARS

VUB501270 Discovery 3 Flat

Serious front end protection for your Discovery 3!



VUB501270

BUMPER

- DPB000270
Defender military front bumper
- RRC6681
Centre pin for bumper
- RRC6682
'R' Clip for centre pin
- DA5626
Bumper kit - contains all the above



DPB000270/RRC6681/RRC6682



Winch Bumpers - see winching equipment section

BUMPERETTES



RTC4769



DA2071



RRC2970 / RRC2971

RTC4769	Series/Defender	Front	Single	Galvanised
DA2071	Series/Defender	Rear	Pair	Black
RRC2970	Series/Defender	Rear	Single - RHS	Black
RRC2971	Series/Defender	Rear	Single - LHS	Black

Added protection!

CHEQUER PLATE



DA2052



DA2070



DA4073/DA4072



DA4049



DA4071

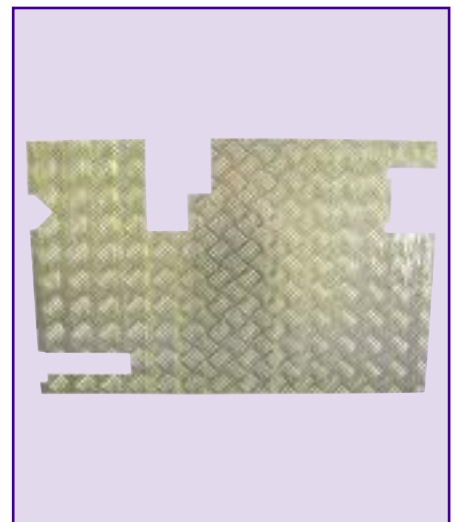

DA2068

Series

DA2004	Wing top	Pair
DA2050	Rear cross member	Single
DA2051	Load bay liner	Short wheel base Kit
DA2052	Sills	Short wheel base Pair
DA2053	Sills	Long wheel base Pair
DA2054	Bumper plate	Single
DA2067	Rear door	Without wiper Single
DA4074	Rear wing	Short wheel base Pair

Defender

DA2054	Bumper plate	Single
DA2062	Bumper tops	Pair
DA2060	Mud flap brackets	Pair
DA2061	Rear cross member	Single
DA2063	Rear floor	Single
DA2064	Rear sides	Pair
	110 County Station Wagon	
DA2066	Bonnet protector	Single
DA2067	Rear door	Without wiper Single
DA2068	Rear door	Wiper - late Single
DA2069	Rear door	Wiper - early Single
DA2070	Load bay liner	Kit
	90/Pickup/Hard top/County Station Wagon	
DA4049	Wing top	Pair
DA4072	Sills	90 Pair
DA4073	Rear wing	90 Pair
DA4100	Sills	110 Pair
DA4071	Rear wing	110 Pair

Miscellaneous

DA2065	1200mm x 2500mm Chequer plate steel
---------------	-------------------------------------



DA2060

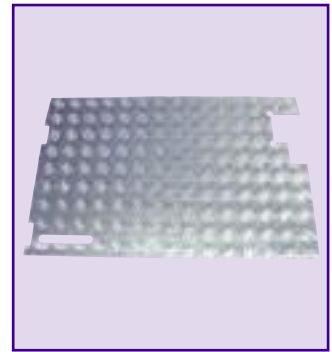

DA2067

CHEQUER PLATE - continued**Britpart Chequer Plate - Defender**

DA3078	Wing tops Natural aluminium finish	Pair
DA3080	Bonnet protector Natural aluminium finish	Defender 1983-2006 Single
DA4342	Bonnet protector Natural aluminium finish	Defender 2007 Kit
DA3079	Wing tops Satin black finish	Pair
DA3081	Bonnet protector Satin black finish	Defender 1983-2006 Single
DA4343	Bonnet protector Satin black finish	Defender 2007 Kit

Add some **heavy-duty** protection to your Land Rover!



DA3080 / DA3078



DA4342



DA4343



DA3079

Defender Chequer Plate Kit

Kit contains - bonnet, wing, sill & rear corner protection

DA4296	90
DA4297	110



DA4296



Picture courtesy of Kristjan Kristjansson

BE PART OF IT!

LAMP GUARDS

Defender

DA4077	Defender	Front	Wolf style
DA4133	Defender Td5	Rear - single	Rectangular
DA4134	Defender Td5	Rear - single	Round
DA4400	Defender Td5 - 2003 on	Front & rear kit	Wolf style
RTC8860AA	Defender - to VIN 2A	Rear	Fixed
RTC8969	Defender - up to 2A622423	Front	Fixed
STC8056	Defender 110 Hi Capacity	Rear	2 Rectangular
STC53157	Defender - from VIN 2A	Rear	1 Square & 1 L-shape
STC53158	Defender	Rear	2 Square hinged
STC53161	Defender - from 2A622424	Front	
VUB504110	Defender 90 & 110	Rear	Black



DA4077

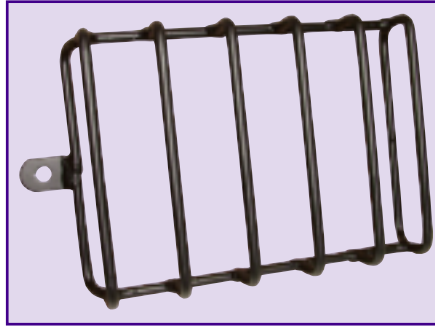

DA4133



DA4134



DA4400

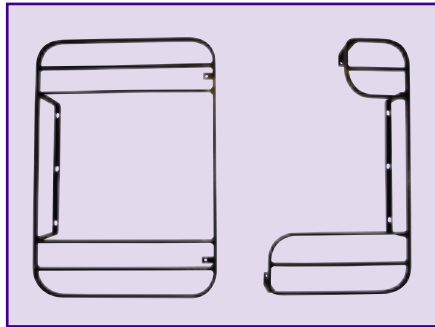

RTC8860AA

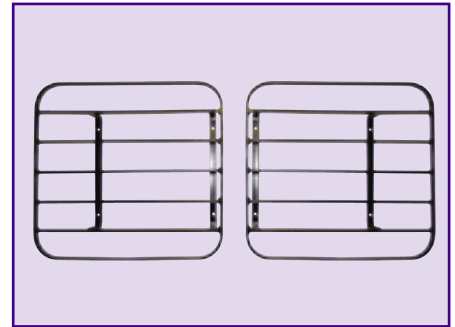

RTC8969

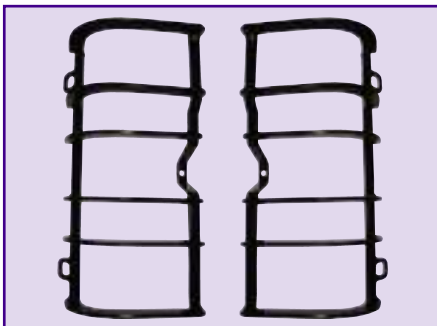

STC8056

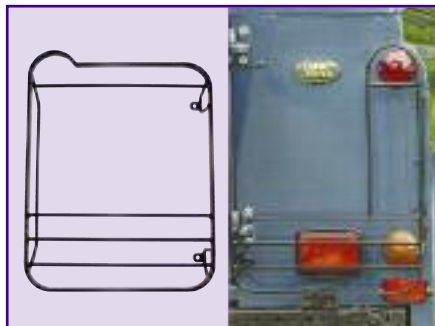

STC53157

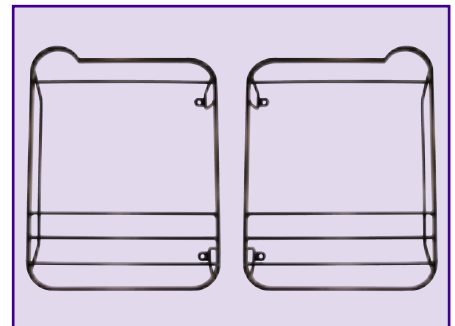

STC53158



STC53161

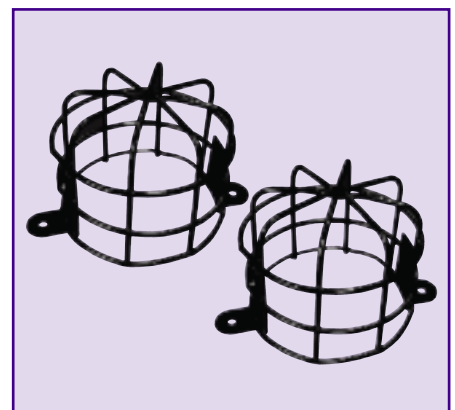

VUB504110

LAMP GUARDS - continued

Discovery

DA4130	Discovery 1 - to 1995	Front	Pair
DA4172	Discovery 1 300Tdi	Acrylic headlamp protectors	Pair
STC8452	Discovery 1 - 1995-1999	Front	Pair
STC8453	Discovery 1 - to 1999	Rear bumper - no drill	Pair
RTC9503AA	Discovery 1 - to 1999	Rear wing	Pair
DA4184	Discovery 2 - 1999 - 2002	Acrylic headlamp protectors	Pair
STC50026	Discovery 2	Front - plastic	Pair
STC50027	Discovery 2	Rear bumper & rear upper set - plastic	Pair
STC53181	Discovery 2 - from VIN 3A	Front	Pair
	Note - For fitment with nudge bar (STC53176)		
STC53193	Discovery 2 - 2003	Front	Pair
STC53194	Discovery 2	Rear wing	Pair
VUB500520	Discovery 2	Rear low	Pair
VUB501200	Discovery 3	Front	Pair
VUB501380	Discovery 3	Rear	Pair

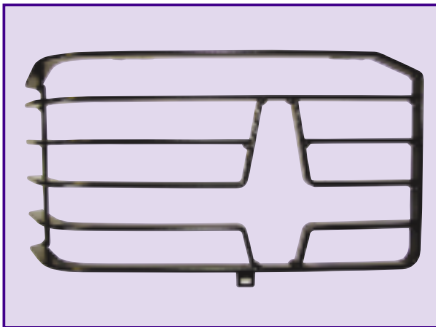

DA4130



DA4172



STC8452



STC8453



RTC9503AA



DA4184



STC50026



STC50027

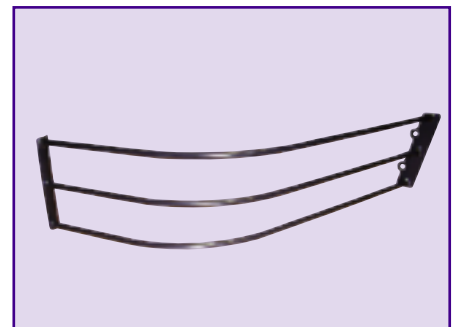

STC53181



Picture courtesy of Kristjan Kristjansson

Protect those valuable headlights from accidental damage either on or off-road!

> More Discovery lamp guard pictures over the page...

LAMP GUARDS - continued

Discovery - continued



STC53193



STC53194



VUB500520



VUB501200



VUB501380

Freelander

STC7960	Freelander - to 2004	Rear kit - no drill	Set of 4
STC7962AA	Freelander - to 2004	Front	Pair
VUB501390	Freelander - 2004 on	Front	Pair
VUB501400	Freelander - 2004 on	Rear	Pair
LR002408	Freelander 2	Front	Pair
LR003685	Freelander 2	Rear	Pair



STC7960



STC7962AA



VUB501390



VUB501400



LR002408



LR003685

LAMP GUARDS - continued

Range Rover

STC8026	Range Rover Classic	Front - hinged	Pair
STC8027	Range Rover Classic	Rear - hinged	Pair
STC8503AA	Range Rover P38	Front - drill fit	Pair
STC8504AB	Range Rover P38	Rear - drill fit	Pair
DA4173	Range Rover P38 - to 1999	Acrylic headlamp protectors	Pair
VUB001070	Range Rover L322 - pre 2006	Front	Pair
Note - Front lamp guards not compatible with wraparound protection bar			
VUB502610	Range Rover L322 - 2006	Front	Pair
VUB001080	Range Rover L322	Rear	Pair
VUB501930	Range Rover Sport	Front	Pair
VUB501920	Range Rover Sport	Rear	Pair

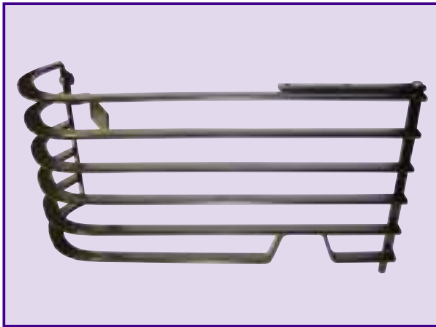
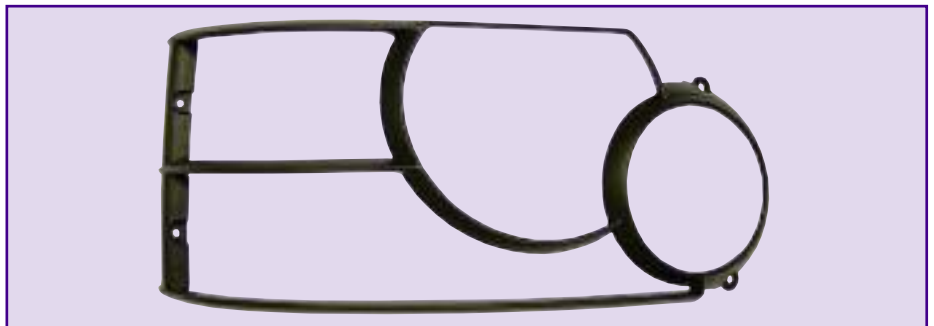
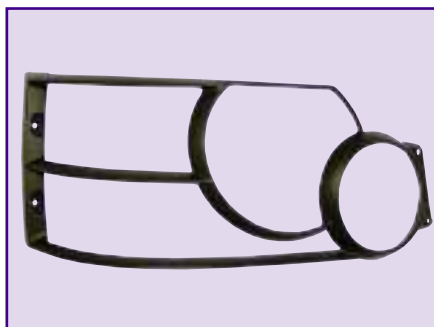
**STC8026****STC8027****STC8503AA****STC8504AB****DA4173****VUB001070****VUB502610****VUB001080****VUB501930****VUB501920**

LAMP GUARDS - continued

Series

345985	Series		Front
MRC316	Series		Rear
345985P	Series	Plastic coated	Front
MRC316P	Series	Plastic coated	Rear

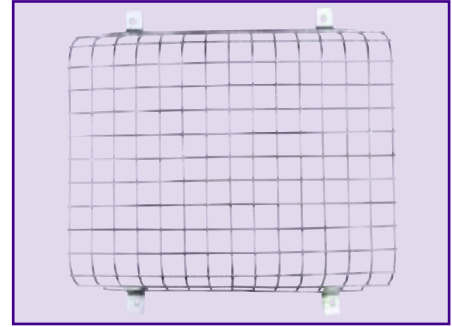

345985

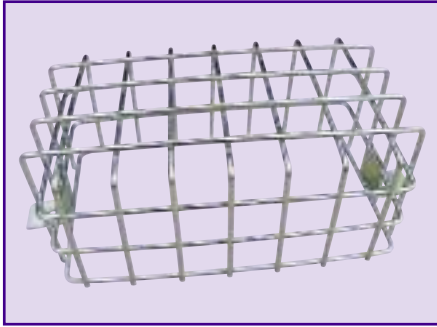

MRC316

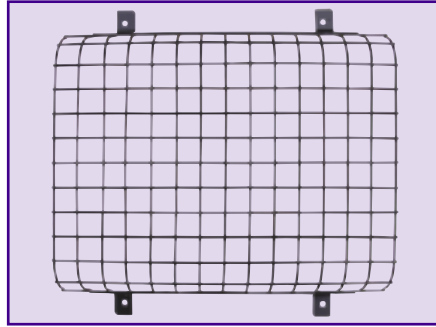

345985P

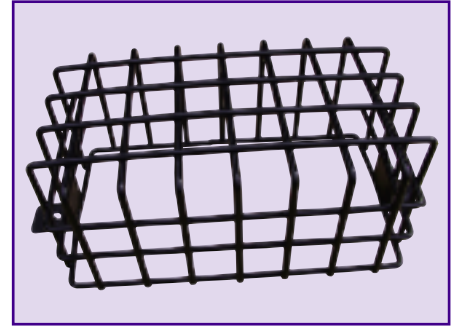

MRC316P

MIRRORS & FITTINGS



DA4404



DA4405



DA4406

Unbreakable Mirrors for Defenders

- > Optical quality polycarbonate lens - will not shatter like glass or discolour in sunlight
- > Strong, flexible polypropylene casing - will absorb hard blows without breaking
- > Universal - can be fitted to either left or right of vehicle
- > Lightweight - puts less strain on body fixings
- > Hard lacquer coating on lens - will repel condensation and surface water
- > Excellent reflectivity - superb daylight and night time vision

Good visibility is imperative on today's highways and byways so these new high impact resistant mirror heads are essential stock items.

		Head Dimensions	Arm Length	
DA4404	Flat mirror	204 x 140mm (8 x 5 ¹ / ₂ "		Flat with fixing kit
DA4405	Flat mirror	204 x 140mm (8 x 5 ¹ / ₂ "	170mm	Flat with fixing kit and short arm
DA4406	Flat mirror	204 x 140mm (8 x 5 ¹ / ₂ "	290mm	Flat with fixing kit and long arm
DA4407	Convex mirror	204 x 140mm (8 x 5 ¹ / ₂ "		Convex with fixing kit
DA4408	Convex mirror	204 x 140mm (8 x 5 ¹ / ₂ "	170mm	Convex with fixing kit and short arm
DA4409	Convex mirror	204 x 140mm (8 x 5 ¹ / ₂ "	290mm	Convex with fixing kit and long arm

Mirrors & Fittings

DA2128	Series arm standard
DA2130	Series head 7 x 5"
DA2301	Series glass 7 x 5"
DA4034	Defender head 6 x 10 ¹ / ₂ "
MTC5083	Mirror arm - 90/110
MTC5084	Mirror head - 90/110
MTC5217	Assembly - 90/110
RRC8443	Arm 11 ¹ / ₂ " long

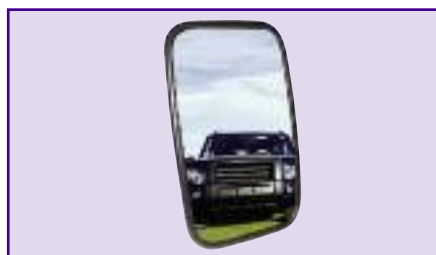

DA4034



MTC5217

MUD FLAPS**Britpart branded Defender rear mudflaps**

CAT500410PMA	RHS - universal fitment	Black logo	Single
CAT500450PMA	LHS - no exhaust cut-out	Black logo	Single
CAT500540PMA	LHS - exhaust cut-out	Black logo	Single
DA4531	90 - exhaust cut-out	Yellow logo	Pair
DA4532	90 - no exhaust cut-out	Yellow logo	Pair

**CAT500540PMA****DA4531****RTC6821****CAS500010PCL - FITTED****CAT500010PCL - FITTED****LR003324****CAT500070PMA****CAS500070PCL****Other mudflaps**

RTC9479	Defender 90 & 110 - from 2007	Front	Pair
RTC6820	Discovery 1 - kit	Front	Pair
RTC6821	Discovery 1 - kit	Rear	Pair
CAS500010PCL	Discovery 3	Front	Pair
CAT500010PCL	Discovery 3	Rear	Pair
LR003324	Freelander 2	Front	Pair
LR003322	Freelander 2	Rear	Pair
CAS000150PMA	Range Rover L322 - up to VIN 5A999999	Front	Pair
CAT000180PMA	Range Rover L322 - up to VIN 5A999999	Rear	Pair
CAS500060PMA	Range Rover L322 - from VIN 6A198416	Front	Pair
CAT500070PMA	Range Rover L322 - from VIN 6A198416	Rear	Pair
CAS500070PCL	Range Rover Sport	Front	Pair
CAT500120PCL	Range Rover Sport	Rear	Pair



PARKING SENSORS

These bumper* mounted sensors will detect the distance between your vehicle and any rear obstruction and warn the driver to any potential obstructions.

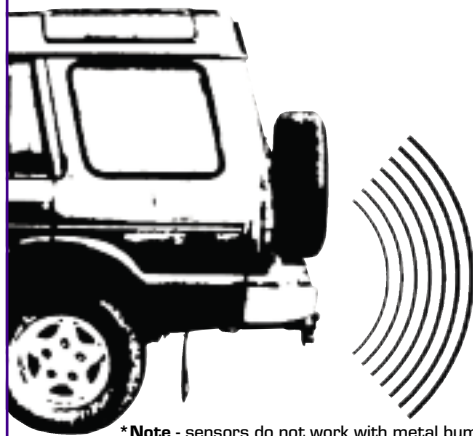

*Note - sensors do not work with metal bumpers.



DA4510

Add an extra set of 'eyes' when reversing...

DA4510

Three stage alarm sound warning system

Kit contents include -

- > 4 x Bumper fit sensors
- > 1 x Warning buzzer
- > 1 x Control unit
- > 1 x Wiring harness
- > 1 x Cutting tool
- > 1 x Fitting accessories
- > 1 x Installation instructions



DA4511

DA4511

Three stage alarm sound warning system with LED display

Kit contents include -

- > 4 x Bumper fit sensors
- > 1 x Warning buzzer and LED display
- > 1 x Control unit
- > 1 x Wiring harness
- > 1 x Cutting tool
- > 1 x Fitting accessories
- > 1 x Installation instructions

RADIATOR MUFFS



DA4025BLACK

Series 2

DA4025BLACK	Black edging
DA4025BLUE	Blue edging
DA4025BROWN	Brown edging
DA4025GREEN	Green edging



DA2160BLACK

Series 3

DA2160BLACK	Black edging
DA2160BLUE	Blue edging
DA2160BROWN	Brown edging
DA2160GREEN	Green edging



DA2158BLACK

Defender

DA2158BLACK	Black edging
DA2158BLUE	Blue edging
DA2158BROWN	Brown edging
DA2158GREEN	Green edging

Note - The radiator muffs are black with either black, blue, brown or green coloured edging.

Control the flow of air into your radiator with a quality British made radiator muff!

RUBBING STRIPS

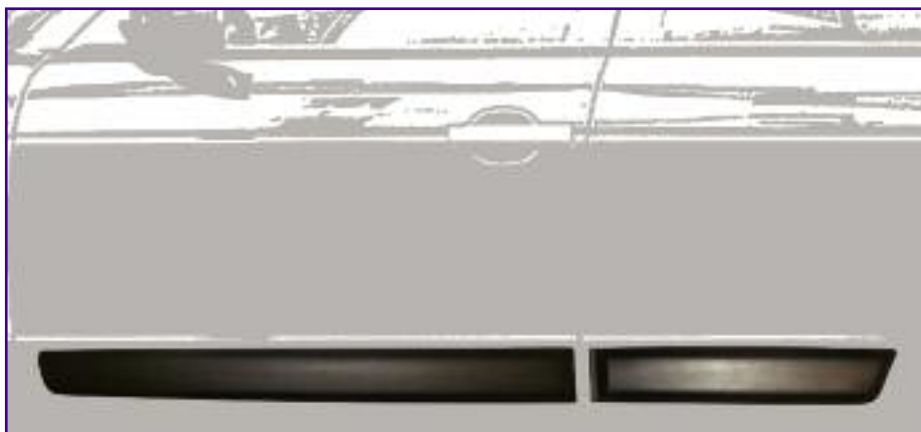

DGJ500140PMA

Protect your bodywork from dents and scrapes with a smart set of 4 solid and durable bodyside moulding strips.

DGJ500140PMA

Range Rover L322

DGJ500020PCL

Range Rover Sport

WHEEL ARCH KITS - OFF-ROAD



DA2366



DA2364

DA2364 Discovery 1 & Range Rover Classic 3-door
DA2365 Discovery 1 & Range Rover Classic 5-door
DA2366 Defender - suitable for Defender 90 from 1984 to present and from 90 to 130 wheelbase and Hi-Cabs. 2" wider than standard enabling tyres up to 14" wide and/or wheel spacers to be fitted while being legal for MOT testing. Made from an unbreakable plastic - ideal for extreme off-road use.

DA1960 Discovery 2 50mm

DA1961 Discovery 2 75mm

These two Discovery 2 wheel arches enable larger tyres to be fitted while still being legal as these arches cover the tyres when wider tyres are fitted. The 50mm ones are required for large off set wheels while the 75mm arches will cover the tyres when wheel spacers are used. They are virtually indestructible and all fixings are supplied with the kit. Up to 35" diameter tyres are ok with a 2" lift and these arches as just over 40mm is cut out of the wings when fitting them.



DA2365

Everything required for **servicing, repairing, restoring** or even **rebuilding** any Land Rover can be supplied by Britpart, thus enabling customers to order all they need on just one order sheet making it easy to keep track of stock and take delivery.

WHEEL ARCH KITS - STANDARD



DA1059



STC7629

DA1059 Defender eyebrow kit 4 eyebrows and rivets

STC7629 XS Style integrated body side moulding set for Discovery 1 5-door July 1995. Kit includes side moulding and wheel arch covers. Matches the later Discovery bumper style. Made from polyurethane.



Picture courtesy of Kristjan Kristjansson

IN THIS SECTION....

CHASSIS PROTECTION

Diff guards - bolt on	19
Steering guards	20
Swivel housing gaiter kits	21
Transmission guard	21



DIFF GUARDS - BOLT ON

Give your vehicle some extra protection with a diff guard. These guards are simple to fit (no drilling) and have the added advantage of having the fill plugs accessible at all times.

DA2250

Defender/Discovery
Bright galvanised finish

DA2250B

Defender/Discovery
Electroplate finish



DA2250



DA2250B

Keep up to date
with all the latest
developments from
Britpart by e-mail.

Simply log on to
www.britpart.com and
register your details in the
'Mailing List' section or
simply send an e-mail to -
marketing@britpart.co.uk



BE PART OF IT!

STEERING/SUMP GUARDS



DA2227



DA2228



DA5507



STC50437



DA5508

DA2227	Defender - 1985 onwards Aluminium	RHD & LHD
DA2228	Defender - 1985 onwards Galvanised steel	RHD & LHD
DA5507	Defender - 1985 onwards Aluminium	RHD
DA5507LHD	Defender - 1985 onwards Aluminium	LHD
STC50437	Defender - 1987 onwards Steel	RHD & LHD
DA5508	Discovery 1 & Range Rover Classic Aluminium	RHD & LHD

Added **protection!**



SWIVEL HOUSING GAITER KITS

DA3056	Series
DA3057	Defender/Discovery/Range Rover Classic

- > Bond in place under existing flange
- > Completely seals against dust, water and grit
- > Moulded in high performance neoprene rubber
- > Kit includes two gaiters, metal straps, bonding agent, gloves and full instructions
- > No special tools required
- > Proven tongue and groove for easy assembly
- > Two year guarantee

Permanent protection for swivels, spheres and joints!



DA3056/DA3057



TRANSMISSION GUARD - DEFENDER

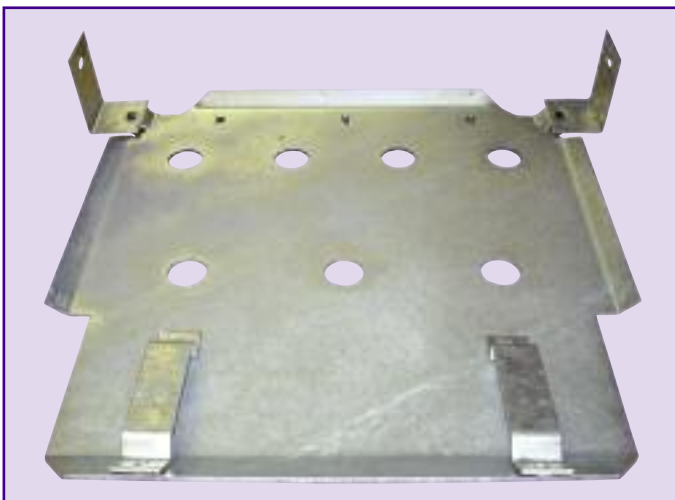

DA5625



DA5625 FITTED

DA5625

Reduce damage to your 90! Made from galvanised steel, this transmission guard protects your 90's gear box and cross members from snagging and reduces damage to your vehicle. Bolts on and is easy to fit and importantly it is also easy to remove when your vehicle needs servicing. Fits pre-Td5 or can be fitted to Td5 with centre exhaust removed and pipe fitted.



Britpart

- for wherever you drive!



Britpart

- for wherever you drive!

IN THIS SECTION....

SIDE & REAR STEPS

Defender	23
Discovery	24
Freelander	25
Range Rover	26



SIDE & REAR STEPS



DA7012



DA7011



DA4101



DA4060

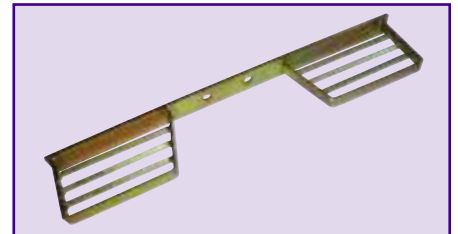

DA4070

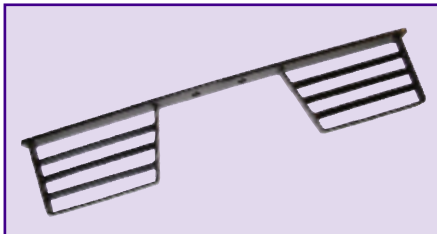

DA4070B



STC50269AA



STC7631

Defender

DA7012	90 including Td5	Side steps - pair	Chequer plate
DA7011	110 including Td5	Side steps - pair	Chequer plate
DA4101	90 including Td5	Side steps - pair	Rubber top
DA4060	110 including Td5	Side steps - pair	Rubber top
DA4070		Rear tow ball step - double	Zinc plated
DA4070B		Rear tow ball step - double	Black
STC50269AA	90 from XA onwards	Rear step - includes regulation tow bracket	
STC50301	110 from XA onwards	Rear step - includes regulation tow bracket	
STC7631		Side step	Folding
STC7632		Rear door step	Folding



STC7632

SIDE & REAR STEPS - continued

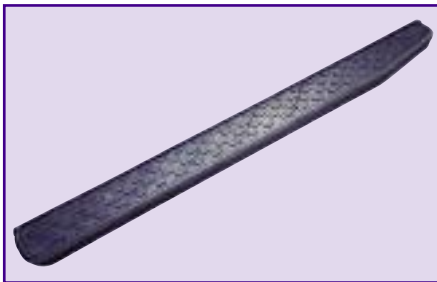

DA4047



RTC9505AC



STC8130AB



DA4258



STC50030



STC50031



STC50032



VTD500010



VTD500020



VTK500010

Discovery

DA4047	Discovery 1	Side steps	Black rubber	Pair
RTC9505AC	Discovery 1	Rear retractable step		
RTC9593AA	Discovery 1	Spare shock absorber for rear retractable step (RTC9505AC)		
STC8130AB	Discovery 1	Side steps	Chevron tread	Pair
DA4258	Discovery 2	Side steps - including mudflaps	Black rubber	Pair
KVL100040	Discovery 2	Spare shock absorber for rear retractable step		
STC50030	Discovery 2	Side steps - including mudflaps	Chevron tread	Pair
STC50031	Discovery 2	Side steps - including mudflaps	Oasis tread	Pair
STC50032	Discovery 2	Side steps - including mudflaps	Stainless steel	Pair
VTD500010	Discovery 3	Black steel side protection tubes		Pair
VTD500020	Discovery 3	Stainless steel side protection tubes		Pair
VTK500010	Discovery 3	Side steps With polypropylene side step top and a brushed aluminium side trim		Pair

Britpart have a wide range of steps
to suit your vehicle

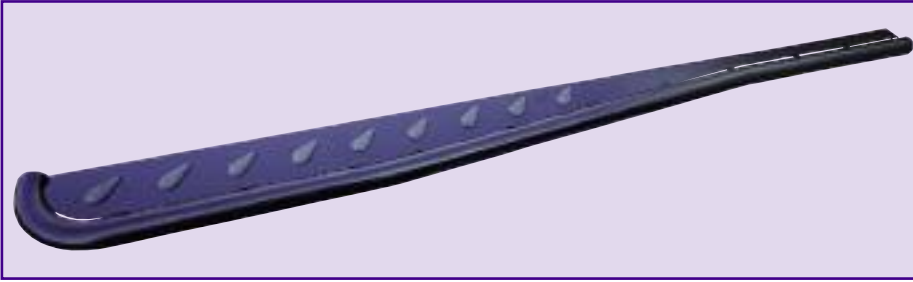
SIDE & REAR STEPS - continued**STC53077****STC53078****LR002773****LR003318****LR003840****Freelander**

STC53077	Freelander - from 2002 onwards	Side steps	Black	Pair
STC53078	Freelander - from VIN2A000001	Side steps	Stainless steel	Pair
LR002773	Freelander 2	Side steps		Pair
	With thermo plastic elastomer side step top and a brushed aluminium side trim			
LR003318	Freelander 2	Side protection tubes	Stainless steel	Pair
LR003840	Freelander 2	Side protection tubes	Black	Pair

Need sandtracks?



Find them in the off-road equipment section!

BE PART OF IT!

SIDE & REAR STEPS - continued

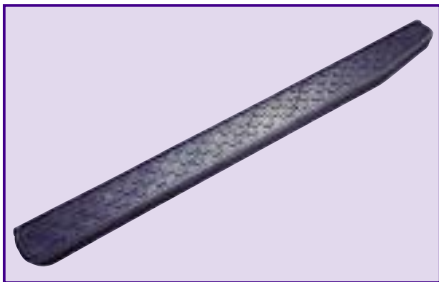

DA4047



STC8505AA



VUB001230



VUB002510

Range Rover

DA4047

Range Rover Classic Pair
Side steps - black rubber

STC8505AA

Range Rover P38 Pair
Side steps Oasis pattern
Not including mudflaps - front STC8535

VUB001230

Range Rover L322 Pair
Stainless steel side protection tubes

VUB002510

Range Rover L322 Pair
Black steel side protection tubes

Note - Both above tubes can be fitted with or without front mudflaps

VUB503660

Range Rover L322 Pair
Side steps including front mudflaps with EPDM (synthetic rubber) top and hard plastic trimming

VUB001300

Range Rover L322
Side step replacement insert moulding for VUB503660

Right hand side Single

VUB001310

Range Rover L322
Side step replacement insert moulding for VUB503660

Left hand side Single

VTK500020

Range Rover Sport Pair
Side steps
With thermo plastic elastomer side step top and a brushed aluminium side trim



VUB503660

Replacement inserts available
- see text for details



VTK500020

Britpart have a wide range of steps to suit your vehicle

IN THIS SECTION....

RACKS & LUGGAGE BOXES

Bike racks	27
Ladder - Defender	27
Land Rover - roof rails	27
Roof racks - Britpart Expedition	28
Roof racks - galvanised flat pack kits	29
Roof racks & boxes - Mont Blanc	30
Roof racks & boxes - Thule	31



BIKE RACKS



DA4118



DA4119



DA4121

These bike racks mount to the spare wheel carrier and are easy to fit.

DA4118

Discovery 1 4 Bike

DA4119

Discovery 2 4 Bike

DA4121

Freelander 3 Bike

STC7929

Freelander/Freelander 2 2 Bike

STC50063

Discovery 2/Discovery 3/
Range Rover Sport 2 Bike



STC7929



STC50063

LADDER - DEFENDER



STC50417

STC50417

Roof rack access ladder for a Defender

LAND ROVER - ROOF RAILS



VUB502790

VUB502790

Range Rover L322

- > Roof rails/sports bars
- > Easy to remove fixed position crossbars with aerodynamic profile
- > Load capacity 96.2kg

ROOF RACKS - BRITPART EXPEDITION**BRITPART**
EXPEDITION

Rugged, durable and strong, these Britpart Expedition aluminium roof racks are easy to fit and are powder coated to prevent any corrosion or tarnishing. The racks fit into the gutters with aluminium legs and stainless steel clamps.

**DA3070****DA3072****DA3075****DA3070**

Defender 110

2,800 x 1,400mm x 180mm - 30kgs

DA3072

Defender 90

2,000 x 1,400mm x 180mm - 18.5kgs

DA3073

Defender - 90/110 - Ladder

DA3075

Discovery 1 & 2

1,400 x 1,400mm - Short rack - 17kgs

DA3071

Discovery 1 & 2 - Door ladder

**DA3073****Roof tents...**

Available from Britpart, see off-road section!

**DA3071**

ROOF RACKS - GALVANISED FLAT PACK KITS



DA1089

DA1090

LWB/110 Flat floor

DA1091

SWB/90 Contour floor

DA1092

LWB/110 Contour floor

DA1093

SWB/90 Flat floor

DA1089

For above kits Ladder

Note - Contour racks must **NOT** be used on vehicles fitted with a sunroof.



DA1091



DA1093

Note -

SWB flat packed roof racks - length 1990mm (78¹/₂""); height 420mm (16¹/₂""); width 120mm (5"); weight 25kgs

LWB flat packed roof racks - length 2800mm (110¹/₂""); height 420mm (16¹/₂""); width 120mm (5"); weight 30.5kgs



BE PART OF IT!

ROOF RACKS & BOXES - MONT BLANC



DA4332



DA4333



SYSTEM 400 - STANDARD



SYSTEM 3000 - PREMIUM



DA4315



DA4316



DA4317



DA4318

Roof Boxes

DA4331	Vista 380	Half width	
380 litre	2000 x 650 x 450mm (LxWxH)		Weight 15kg
DA4332	Vista 540	Full width	
540 litres	2000 x 950 x 420mm (LxWxH)		Weight 17kg

- > Secure-Assure - keys cannot be removed until locks securely engaged
- > 2 or 3 point central lock system
- > Lock up struts - new improved design with side opening for ease of loading
- > 80mm width fixings to suit most roof bar sizes
- > UV resistant, high impact ABS
- > Load securing straps included

DA4333	Triton 450	430 litres	2240 x 940 x 430mm (LxWxH)
DA4334	Triton 650	620 litres	1970 x 830 x 380mm (LxWxH)

- > Premium roof box range with modern design for all kind of activities
- > Made of UV-resistant ABS plastic with gas struts for soft opening and closing of box
- > Three point central locking
- > Load securing straps included
- > Flexible attachment to the load bar
- > Unique quick attachments - the box is attached from the inside
- > Fits both square bars and aluminium bars with C-slots

MONT BLANC®

Roof Bars & Rails

DA2312	Discovery 1	System 400 - Standard
DA2310	Freelander 1	System 400 - Standard
DA4313	Range Rover P38	System 400 - Standard

- > Easy to fit, good value load carrier system with fully galvanised roof bars.

DA4312	Discovery 3	System 3000 - Premium
DA4311	Freelander 1	System 3000 - Premium
DA2311	Defender	System 3000 - Premium
DA2315	Range Rover P38	System 3000 - Premium
DA4314	Range Rover Sport	System 3000 - Premium
DA4319	Range Rover L322	System 3000 - Premium

- > Premium roof bar system with quick fit and release feature and Integrated lock system (excluding gutter fit) with max load range 75-100kg
- > Manufactured to DIN standard 75302/15011154

Carriers

DA4315 Discovery - cycle carrier

- Roof mounted with stylish aluminium profile • Wheels fit into moulded profile which holds the cycle upright leaving both hands free to secure the frame and wheels • Locking the cycle into frame holder secures carrier to load carrier • Black-painted frame holder tube in special steel • Base unit made of aluminium and UV-resistant composite material • Takes frame diameters from 20 up to 80mm • Max. tyre width 2.2 inches • Manufactured in accordance with DIN75302 • Will fit to both standard and aluminium bars • Weight: 4.2 kg

DA4316 Scott - cycle carrier

- Stable easy-to-use roof mounted cycle holder • Frame holder with quick attachment for easy fitting without tools • Takes frame diameters from 25 up to 80mm • Wheels rest in adjustable wheel holders and are fastened with strong securing straps • Lockable to roof rack as well as bicycle • Can be fitted on all standard load bars and aluminium profiles.

DA4317 Barracuda - cycle carrier

- Wheels locate in a moulded profile, which holds the cycle in an upright position - you can use both hands when securing the wheels and the frame • When the cycle is attached to the frame holder, the cycle holder is secured to the load carrier • Cycle is secured in the frame holder • Chromium-plated frame holder tube in special steel • Base unit made of UV-resistant composite material • Takes frame diameters from 20 up to 80mm • Max tyre width 2.2 inches • Manufactured in accordance with DIN 75302 • Max weight capacity 17kg

DA4318 Tahiti 6 - surfboard and canoe carrier

- Stable and gentle holder for surfboards, canoes, kayaks, etc. • Holder comes complete with cradles, straps and a holder for a mast or paddle • Rubber-covered cradles are kind to the hull and allow the boat/surfboard to lie steadily during transport

ROOF RACKS & BOXES - THULE

Roof Boxes

DA4321 X1 450 litres
1900 x 900 x 380 (LxWxH) Load capacity 75kg Weight 23kg

Rugged design for those who want to stand out from the crowd

- > Quick-Snap mounting system, for easy fitting of the box
- > Dual-Side opening for convenient mounting, loading and unloading
- > Central safety locking system
- > Unique and spacious design in special tech silver colour

DA4322 Atlantis 600 340 litres
1900 x 630 x 410 (LxWxH) Load capacity 75kg Weight 16kg

Spacious roof boxes featuring exciting design and smart functions.

- > Patented Power-Grip quick mount system, for fast and secure fitting using one hand
- > Aerodynamic design for great stability, reduced air resistance, wind noise and vibrations
- > Dual-Side opening for convenient mounting, loading and unloading
- > Central safety locking system with grip-friendly key



DA4321



DA4322

Roof Bars & Rails

DA3005	Defender	Roof bars - high foot
DA2990	Discovery 1	Roof bars
DA2991	Discovery 2 (with modified trim)	Roof bars
DA4323	Discovery 2	Roof rails
DA4325	Discovery 3 - (T Profile)	Roof bars
DA4324	Discovery 3	Roof rails
DA4328	Freelander 1 1998-2003 3dr and 5dr	Roof bars
DA4329	Freelander 1	Roof rails
DA4326	Freelander 2	Roof bars
DA4327	Freelander 2	Roof rails
DA3002	Range Rover Classic	Roof bars
DA2993	Range Rover P38	Roof bars
DA2996	Range Rover Sport	Roof bars
DA4330	Range Rover L322	Roof bars



DA4329



DA2996



DA4327



DA4323

THULE[®]
SWEDEN
CAR RACK SYSTEMS

Carrier

STC7969 Cycle carrier

The smartest, most elegant solution for loading and transporting a bike on the roof.

- > The self-adjusting and upright frame holder into which the bike automatically slides, makes bike loading easy
- > Adjusting and securing is done comfortably and quickly, with a turning knob, at roof height
- > Quick-release straps, adjustable for different wheel sizes, hold the wheels securely in place
- > Light and convenient aluminium design
- > Can easily be fitted on either side of the car roof
- > Lockable - bike to bike carrier, bike carrier to load carrier
- > Best in test
- > Fits frame dimensions up to 100mm



STC7969

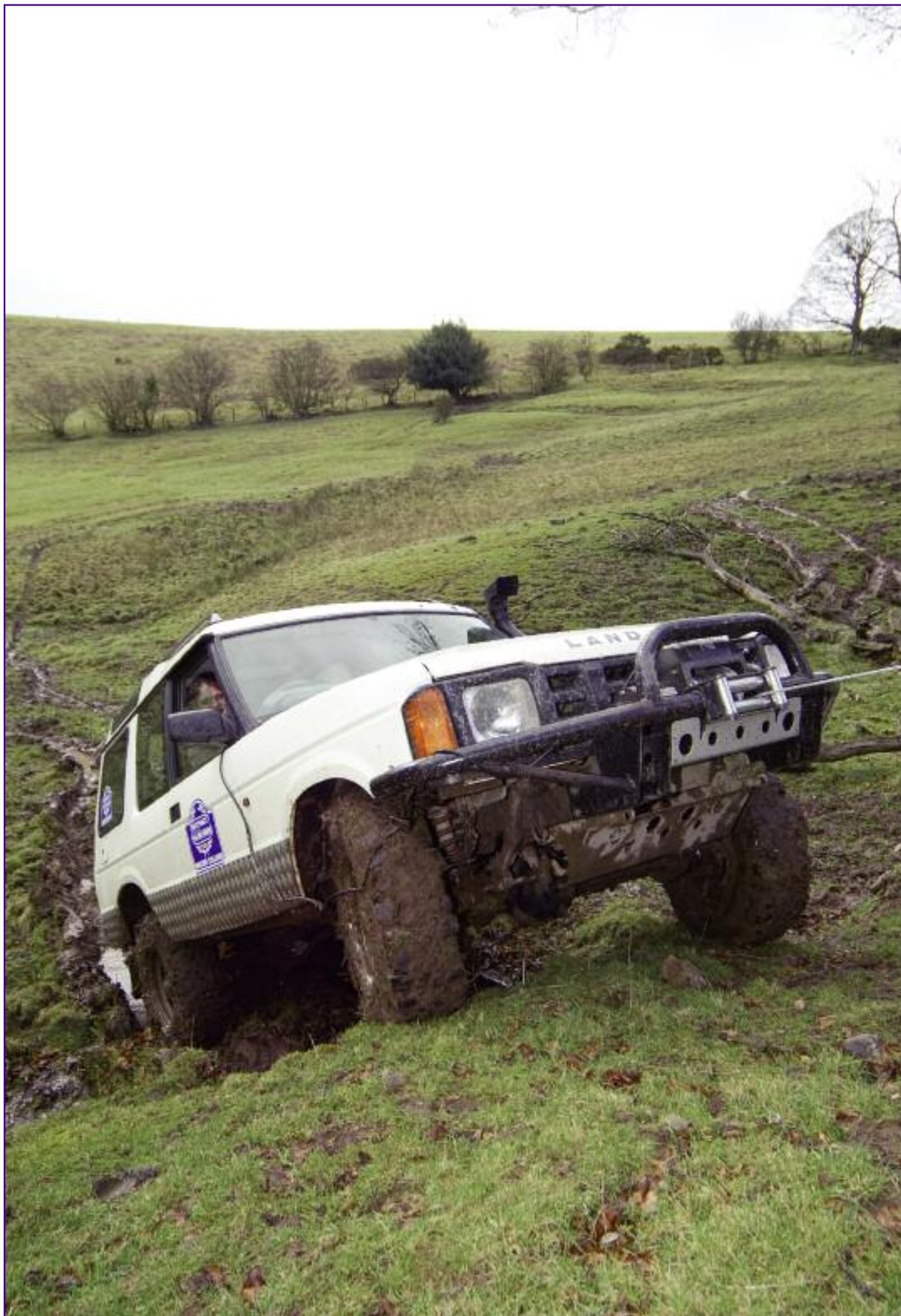

IN THIS SECTION....

WHEELS

Inner tube	34
Locking wheel nuts, keys & caps	33
Spare wheel carrier	34
Spare wheel covers	34
Tyre pressure monitoring system	35
Tyre repair kit & air compressors	34
Wheel spacers & adaptor kits	35
Wheel wrenches	35
Wheels	36
Zu rims	32



LOCKING WHEEL NUTS, KEYS & CAPS



RRB100510



RTC9535

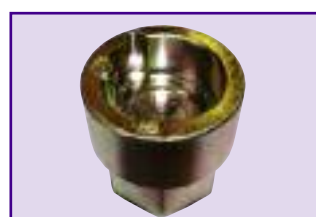

STC3420



STC3601



STC7623



STC8513



STC50080



STC8843AA

Locking wheel nut keys for Defender/Discovery 1/Discovery 2/Range Rover P38

Code A	STC3420
Code B	STC3421
Code C	STC3422
Code D	STC3423
Code E	STC3424
Code F	STC3425
Code G	STC3426
Code H	STC3427
Code I	STC3428
Code J	STC3429

Protect your
valuable wheels
and tyres from
theft!

Locking wheel nuts and keys for Freelander to 2006

	Locking wheel nut	Locking wheel nut key
Code A	RRD100520	KBM100450
Code B	RRD100530	KBM100460
Code C	RRD100540	KBM100470
Code D	RRD100550	KBM100480
Code E	RRD100560	KBM100490
Code F	RRD100570	KBM100500
Code G	RRD100580	KBM100510
Code H	RRD100590	KBM100520
Code I	RRD100600	KBM100530
Code J	RRD100610	KBM100540

Locking wheel nuts keys for

Defender 1987-2006 & 2006 -/Discovery 1	
Code F	STC3415
Code H	STC3417

ANR6094L	Freelander locking wheel nut cap
KBP10001	Universal nut cover removal tool
RRB100510	Discovery 2 with alloy wheels Kit contains - 1 x nut; 1 x key; 1 x cover; 1 x removal tool
RRB500070	Discovery 3/Range Rover L322/ Range Rover Sport Kit contains - 4 x nuts; 1 x key
RRD000100	Range Rover L322 - Locking wheel nut - 35
RRD000110	Range Rover L322 - Locking wheel nut - 36
RRD000120	Range Rover L322 - Locking wheel nut - 37
RRD000130	Range Rover L322 - Locking wheel nut - 38
RRJ000030	Range Rover L322 Wheel nut cap
RTC9535	Range Rover Classic 1989 to 1994/ Defender/Discovery 1 with steel wheels Kit contains - 5 x nuts; 1 x key (black finish)
STC3582	Discovery 2/Range Rover P38 Locking wheel nut key - code C
STC3601	Defender/Discovery 1 with alloy wheels Kit contains - 5 x nuts; 1 x key; 1 x black bag for key
STC7623	Defender with deep dish alloy wheels Kit contains - 5 x nuts; 2 x keys
STC8513	Range Rover P38A with alloy wheels Kit contains - 4 x nuts; 1 x key
STC50080	Discovery 2 - Full set of wheel nuts Kit contains - 4 x locking nuts; 4 x spare caps; 18 x normal nuts (inc. caps); 1 x key; 1 x remover tool
STC8843AA	Range Rover Classic 1989 to 1994/ Defender/Discovery 1 with alloy wheels (not deep dish wheels) Kit contains - 5 x nuts; 1 x key

SPARE WHEEL CARRIER



DA2215

DA2215
Defender/ Series
Rear door mount

SPARE WHEEL COVERS



DA2026

DA2021	750 x 16	Plain black
DA2022	600 x 16	Plain black
DA2026	205 x 16	Plain black

INNER TUBE



DA3000

DA3000 750 x 16

TYRE REPAIR KIT & AIR COMPRESSORS



DA2390

Don't get caught out with a flat tyre or two!
Pack and leave an easy to use Britpart tyre repair kit in your vehicle.*

DA2390 - Tyre repair kit in travel case

How It Works

1. Find and remove the item that caused the puncture.
2. Apply rubber solution to the reamer tool then push the reamer into the puncture and work up and down until the reamer moves easily in the hole.
3. Thread one rubber tyre plug in the hook tool.
4. Push the rubber tyre plug into the hole until 1/2" of the tyre plug remains outside the tyre then turn the hook tool a quarter turn and pull out slowly.
5. Cut off the excess tyre plug as close to the tyre as possible.
6. If the puncture is too big have the tyre fixed by a professional.

*Recommended for off-road use only.

It's no good being able to repair your tyre if you can't inflate it!

DA2392 Double-pump air compressor
> Air flow - 150ltr/min

DA2354 Single-pump air compressor
> Air flow - 72ltr/min

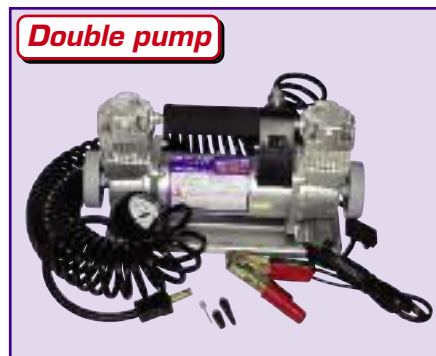

DA2392



DA2354

See the off-road section for more details on the portable air compressors from Britpart.

TYRE PRESSURE MONITORING SYSTEM

Are your tyres at the right pressure?

DA4512

This system is an advanced monitoring & alert system of tyre conditions. It monitors tyre pressure and temperature then relays the state of each tyre to a display unit. When any abnormalities are detected, the system will display the status of the affected tyre and sound an alarm to ensure you take action to remedy the problem. Keeping your tyres in good condition at the right pressure can extend the life of your tyres, reduce fuel consumption and improve handling.

Tyres that are at the right pressure will -

- > Improve fuel consumption
- > Increase the tyre life span
- > Help enhance vehicle handling & braking
- > Reduce susceptibility to hydroplaning

System contents -

1 x Display, 1 x Receiver, 4 x Tyre sensors, 3 x Display brackets, 2 x 3M stickers, 1 x Instruction manual



DA4512

WHEEL SPACERS & ADAPTOR KITS



DA2075



DA5005



DA5006

Wheel Adaptor Kit

DA2075

To fit Range Rover L322 wheels to Range Rover P38 - aluminium

DA5005

To fit Range Rover P38 wheels to Range Rover Classic

DA5006

To fit Discovery 2 wheels to Defender

Wheel Spacers

DA5004

Defender/Range Rover Classic/Discovery 1

30mm thick, steel machine finish complete with wheel nuts and OEM studs



DA5004

WHEEL WRENCHES



537179



DA4026



NTC7829



NTC7829HD

537179 15/16"
DA4026 27mm

NTC7829 27mm
NTC7829HD 27mm Heavy-duty

WHEELS



ANR4583PM



ANR4583SILVER



ANR5593PM



ANR1534PM



ANR4636PM



ANR4635PM



NTC5193PM



NTC7739MUE



RRC114560MUW



ANR3973



ANR5307MNH



RRC503600PM



RRC503400MNH

Smarten up your Land Rover..

...with a smart new set of alloy wheels.



ANR3631MNH



RRC505360MNH



RRC505370MNH



RRC501470MCM

ANR4583PM	Defender - Note - Use longer studs (FRC7577)	Steel Wolf rim welded tubeless 16" x 6.5J black
ANR4583SILVER	Defender - Note - Use longer studs (FRC7577)	Steel Wolf rim welded tubeless 16" x 6.5J silver
ANR5307MNH	Defender - from TA/Discovery 1	16" x 7 Tornado alloy
ANR5593PM	Defender	Steel Wolf rim welded tube type 16" x 6.5J primed
RRC503400MNH	Defender - 1987 onwards	Boost alloy - 16" x 7
RRC503600PM	Defender - 1987 onwards	Steel tubeless - 16" x 5.5
ANR3631MNH	Defender/Discovery 1	16" x 7 Deepdish alloy
ANR1534PM	Defender/Series	Steel 1 ton 569204 welded 16" x 6.5 primed
ANR4636PM	Defender/Series	Steel standard welded tube type 16" x 5.5F primed
ANR4635PM	Defender/Range Rover Classic	16" x 6 Steel Ro-Style NTC2165 primed
NTC5193PM	Discovery 1	Steel 16" x 7 primed
NTC7739MUE	Discovery 1	Alloy Propeller/Cyclone type 16" x 7 Quicksilver
RRC114560MUW	Discovery 2	Steel silver 16" x 7J
RRC501470MCM	Discovery 2/Range Rover P38	18" x 8 Hurricane alloy
RRC505360MNH	Discovery 3/Range Rover Sport	18" x 8 10 spoke alloy wheel with silver sparkle finish
ANR3973	Freelander	Steel 15" x 5.5J
RRC505370MNH	Range Rover Sport	19" x 9 alloy wheel with silver sparkle finish

NEW ZU RIMS**Discovery 2/Range Rover P38**

- > 38mm offset
- > 1,400kg rating
- > 12kg each

DA2430	16 x 8	White
DA2431	16 x 8	Silver
DA2432	16 x 8	Black - gloss
DA2438	16 x 8	Black - matt
DA2433	16 x 8	Anthracite

**Defender/Discovery 1/
Range Rover Classic**

- > 11mm offset
- > 1,400kg rating
- > 10.4kg each

DA2434	16 x 7	White
DA2435	16 x 7	Silver
DA2436	16 x 7	Black - gloss
DA2439	16 x 7	Black - matt
DA2437	16 x 7	Anthracite

RRJ500030MNH Wheel cap

Discovery 2/Range Rover P38

ANR2763MMM Alloy wheel nutDefender up to 2006/Discovery 1/
Range Rover Classic**ANR3679** Alloy wheel nut

Discovery 2

- > Super strong
- > Super light
- > TÜV approved and meets or exceeds UK - European - U.S. - Canadian - Australian - South African and Japanese wheel manufacturing specifications
- > Uses standard Land Rover alloy wheel nuts
- > Easy to balance
- > Manufactured in the UK



DA2437



DA2434



DA2435



DA2433



DA2431

Super strong
Super light



DA2432

BE PART OF IT.

BRITPART Shock absorbers

From the normal...



Britpart have an extensive range of shock absorbers.

If your vehicle is a standard Defender or a Range Rover Classic with raised suspension; we have the shock absorber for you.

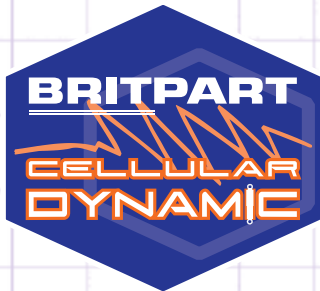

As standard, both our Super Gaz and Cellular Dynamic range of shock absorbers have a 2 year/50,000 mile warranty to give peace of mind.*

*Terms and conditions apply



...to the not so normal!



BRITPART

The quality parts for Land Rovers

www.britpart.com/suspension

IN THIS SECTION....

LIGHTING EQUIPMENT

Light bars	37
Light conversion kits	37
Light kits	37
Light mounting kits	40
Light upgrade kits	40
Lights - driving	38
Lights - fog	39
Lights - Roo-lites	39
Map reading lamp	40
NAS lights	41



LIGHT BARS

DA5624	Defender - non air-con models	Black finish
DA1101	Discovery 2	Stainless steel

Note - Light bars exclude lights



DA5624

LIGHT CONVERSION KITS

PRC7994K	Sealed beam to halogen Series/Defender/Range Rover Classic Left hand drive	Pair
RTC4615K	Sealed beam to halogen Series/Defender/Range Rover Classic Right hand drive	Pair
RTC4615C	Crystal halogen headlamp Clear lenses and profiled back reflector offer brilliant lighting. Fully E-marked. Series/Defender/Range Rover Classic	Pair



RTC4615K



RTC4615C

LIGHT KITS

DA1077	Defender/Series
DA1080	Defender 300Tdi



DA1077



DA1080

LIGHTS - DRIVING



DA4088



DA4088C



DA4088W



DA4088COVER



DA4099



PRC8238



STC7644



STC8480

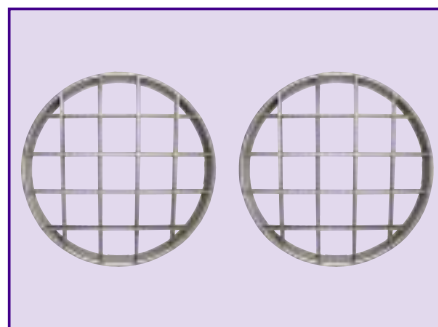

STC8842



VUB001090



XQB500080

DA4088	8" Light	Black	Pair
DA4088C	8" Light	Chrome	Pair
DA4088W	Wipac 8" Light	Black	Pair
Note -	> High power, 100 watt 8", halogen lamp	> Fits all 12 volt vehicles	
	> Black body, chrome rim	> Easy installation	
	> Universal fitting	> Armoured cable	
	> Fitted plastic stone guards		
DA4088BULB	Replacement bulb for DA4088C	100 watt	
DA4088COVER	Replacement 8" spot light cover for DA4088/DA4088C/DA4088W		
DA4099	Hella Rallye 3000	Black	Single
PRC8238	Spoiler lamps classic	Black	Pair
STC7644	Hella Rallye 1000 long range	Black	Single
STC8480	Land Rover Safari 5000	Black	Single
	Defender 1987-2006/Discovery 1/Discovery 2/ Range Rover Classic 1992-1994/Range Rover P38		
STC8842	Lamp guard for Land Rover Safari 5000 driving & fog lamp		Pair
VUB001090	Range Rover L322 driving light kit	Black	Pair
	Includes electrics & fittings		
XQB500080	Discovery 3 driving light kit	Black	Pair
	Includes electrics & fittings		

Light the way with
additional driving lamps!

LIGHTS - ROO-LITES

DA1062 Roo-lite

- > High performance lighting with super strength construction
- > 7 1/4" round long range spot lamps with "stone-proof" clear polycarbonate lens
- > Super strength housing with a Osram 100 watt XENOPHOT long life technology bulb
- > Variable focus from spot to fog beam pattern
- > Lightweight for reduced vibration
- > Reflector unit is screw-on for easy bulb change
- > 12V - 100W - 8 amps

Note - Roolites sold individually

DA1062AMBER Amber coloured cover

DA1062BLUE Blue coloured cover

DA1062COVER Protective cover

Note - Roolites covers sold individually

DA1063 Spare bulb

DA1064 Harness

- > Harness is of a heavy gauge wire to ensure safe operation of high wattage lamps. It includes digital switch, in-line fuse, built-in relay and wiring harness.



DA1062



DA1062AMBER

DA1062BLUE



DA1064



DA1062COVER

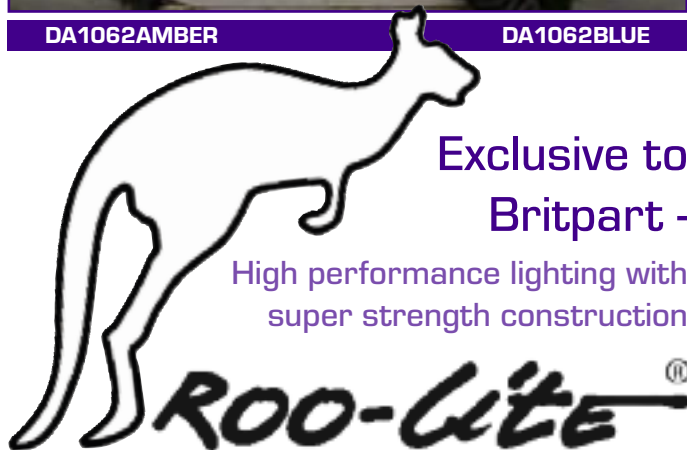

Exclusive to
Britpart -

High performance lighting with
super strength construction

ROO-LITE®

LIGHTS - FOG

RTC8922

Defender/Range Rover Classic
Hella Comet 550 rectangular - pair
Black

Note - 195mm wide x 96mm high x
83mm deep. 12 volt

STC7643

Hella Rallye 1000
Black



RTC8922



STC7643

BE PART OF IT!

LIGHT MOUNTING KITS



DA3010



DA3010B

DA3010
Series/Defender
8" Headlamp
Chrome

DA3010B
Series/Defender
8" Headlamp
Black

LIGHT UPGRADE KITS



STC50383



STC50408

STC50383
Range Rover P38
Right hand drive lamp upgrade kit
Note - Does not include headlamps

STC50408
Range Rover P38
Left hand drive lamp upgrade kit
Note - Does not include headlamps

“ The Britpart logo has become a widely recognised and highly respected marque; it *embodies excellence* in the field, both in quality and commitment to meeting the needs of the customer. ”

MAP READING LAMP



AMR4910

AMR4910
Defender
24 Volt

Flexible interior lamp!

Got something
to tow?



Towing gear for all
Land Rovers - see towing
equipment section!

NAS LIGHTS**AMR6521****AMR6522****AMR6526**

Defender lights with North American specification.

AMR6521

Round Clear Reverse or side lamp

AMR6522

Round Red Rear fog lamp

Note - Supplied with mounting plinth and screws.

AMR6526

Round Red Stop or tail lamp

AMR6527

Round Amber Indicator lamp

Note - Supplied without mounting plinth and screws.

AMR6528

Round Clear Reverse or side lamp

Note - Supplied with mounting plinth but without screws.

**AMR6527****AMR6528****Sundry items**

AMR3850	Mounting plinth	
SE105161L	Screws	
STC1188	Link leads	2 wire for indicator, side, reverse and fog lamp
STC4637	Link leads	3 wire for stop and tail lamp

**BE PART OF IT!**



IN THIS SECTION....

TOWING EQUIPMENT

All Land Rover models	43
Defender	44
Discovery	45
Freelander	46
Range Rover	47
Series	47

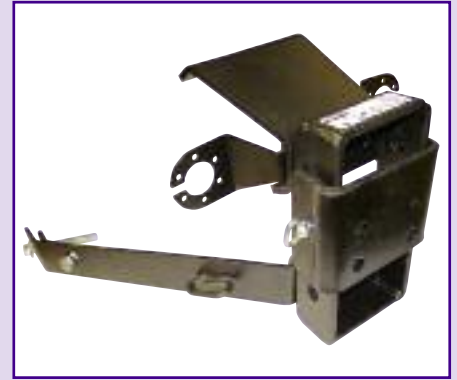

ALL LAND ROVER MODELS



67187



201691



DA2123

67187	All	Pin universal coupling HD (201691)
201691	All	Ball and jaw + pin HD 4 bolt mounted (Ball 3.5 ton/Jaw 5 ton)
579408	All	7 Pin trailer plug
ANR3635	All	50mm Tow ball cover
DA2123	All	Ball & jaw + pin (RTC8159)
DA2123A	All	Replacement chain, tag, clip
DA2194	All	Replacement pin for DA2123
DA2195	All	Replacement slider bracket - 1 pin
DA2118	All	Replacement slider bracket - 2 pin
DA2196	All	Replacement slider pin
DA2197	All	Replacement slider pin 'R Clip'
DA5100	All	Tow hitch - to tow 3,500kgs gross
KNB100640	All	Towing jaw (3 ¹ / ₂ ton)
NRC2051	NATO	Tow hitch
RTC8831	All	Saddle slider - fits all Dixon Bates kits



DA2118

Britpart have the equipment to get you hitched up and towing!



NRC2051



DA5100

DEFENDER



DA2120



DA2136



DA2165



RTC8891AA



DA2123/STC50255AA

DA2120	Defender	Plate extension kit
DA2121	Defender	Adjustable kit (RTC8828)
DA2136	Defender 90 - from WA	Towbar assembly (VUB105460) - no electrics
DA2137	Defender 110 - from WA	Towbar assembly (VUB105470) - no electrics
DA2165	Defender 90	Drop plate
RTC8872	Defender	'N' Type electrics
RTC8891AA	Defender	50mm Tow ball
STC50255AA	Defender Td5 90	Adjustable tow kit
STC50256AA	Defender Td5 110	Adjustable tow kit
YWJ101500	Defender Td5	'N' Type electrics plug

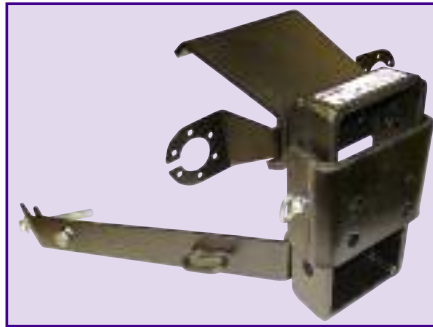

Picture courtesy of Craig Grey - Australia

DISCOVERY**DA2125****DA2134****RTC8891AA****DA2138****STC50289AB****LR007484****STC8919AA****KNB500013**

DA2125	Discovery 1 - 1994 on	Adjustable coupling (RTC8830, STC8060)
DA2134	Discovery 1 - to 1994	Tow kit (STC8816) to 1994 - includes electrics but not plug-in electrics
RTC8891AA	Discovery 1	50mm Tow ball
DA2138	Discovery 2	Towing kit - includes electrics
STC50287AB	Discovery 2	Tow kit - coil suspension - no electrics
STC50289AB	Discovery 2	Tow kit - air suspension - no electrics
KNB500011	Discovery 3	Quick release tow bar
KNB500013	Discovery 3	Towing hook assembly - quick disconnect without height adjustment
LR007484	Discovery 3	Adjustable tow hook kit
STC8919AA	Discovery 3	Tow strap
YWJ500201	Discovery 3	Tow bar electrics kit 'N' & 'S' type



Chassis protection required?

**We've got it covered at Britpart
- see Chassis Protection section**

FREELANDER



VUB501500



LR002738



LR002742

STC50391	Freelander	Tow kit - includes electrics but not plug-in electrics or tow ball
VUB501490	Freelander	Towing kit - UK style 50mm ball fitted Note - This has a plug connection to the vehicle loom - with electrics
VUB501500	Freelander	Towing kit - Swan neck detachable - with plug-in electrics
LR002738	Freelander 2	Tow bracket kit
LR002740	Freelander 2	Tow bracket kit - detachable ball tow bar
LR002742	Freelander 2	Tow bracket kit - swan neck
LR002744	Freelander 2	Tow bracket kit - Canada, Mexico, USA
LR003106	Freelander 2	Electrics kit - 12N/12S 7 pin socket
LR003107	Freelander 2	Electrics kit - 13 pin socket
LR003108	Freelander 2	Electrics kit - Canada, Mexico, USA



RANGE ROVER

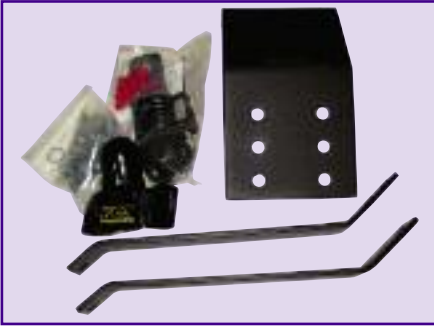

DA2134



RTC8829



KNB500013



LR007484



STC8919AA



VUB000720

DA2125	Range Rover Classic	Adjustable coupling (RTC8830, STC8060)
DA2134	Range Rover Classic	Tow kit (STC8816) to 1994 - includes electrics but not plug-in electrics
RTC8829	Range Rover Classic	Towing kit
DA4030	Range Rover P38	Tow kit
KNB500011	Range Rover Sport	Quick release tow bar
KNB500013	Range Rover Sport	Towing hook assembly - quick disconnect without height adjustment
LR007484	Range Rover Sport	Adjustable tow hook kit
STC8919AA	Range Rover Sport	Tow strap
VUB501430	Range Rover Sport	Multi-height tow bar
STC8919AA	Range Rover L322	Tow strap
VUB000720	Range Rover L322	Multi-height tow bar - includes carry bag
VUB000730	Range Rover L322	Quick release tow bar
VUB000740	Range Rover L322	Tow bar armature - towing subframe - pre 2006 model years
VUB503960	Range Rover L322	Note - The tow bar armature accepts quick release, multi-height tow bars and bike carrier
YWC000840	Range Rover L322	Tow bar armature - towing subframe - 2006 model year only
YWJ500450	Range Rover L322	Towing electrics control unit
		Tow bar electrics kit 12'N' & 12'S' type

SERIES



DA2122



RTC8891AA



DA2129

DA2012	Series SWB	Plate and bracket (short)
DA2122	Series	Adjustable kit
DA2133	Series 109/88	Drop plate extension
RTC8891AA	Series	50mm tow ball
DA2129	Lightweight	Adjustable tow hitch



IN THIS SECTION...

INTERIOR PROTECTION

Air conditioning kits	49
Dash trim kits	49
Dog guards	49-51
Gear box gaiters	51
Loadspace liners	52-53
Loadspace nets & retention kit	54
Mats	55-56
Waterproof seat covers	57
Waterproof seat covers - Britpart	57-60
Wind deflectors	60



AIR CONDITIONING KITS

DA2343R	Defender 90/110 300 Tdi	RHD
DA2342R	Defender 90/110 Td5	RHD
DA2343L	Defender 90/110 300 Tdi	LHD
DA2342L	Defender 90/110 Td5	LHD
DA2344	Defender - 2007	RHD & LHD

- > As OE fitment, no drilling required
- > Once fitted the system is indistinguishable from factory fitted units
- > Plugs straight into the existing Land Rover wiring loom and fuse board
- > Easy to install as components are pre-assembled
- > Kit uses high performance condenser which eliminates need for an extended nose cone
- > Parts interchangeable with Land Rover parts



DASH TRIM KITS

Discovery 1 dash trim kit

DA2090	Black
DA2091	Blue
DA2096	Grey
DA2098	Brown

Put a stop to the dreaded dash peel!



DA2091



DA2098 - FITTED

DOG GUARDS

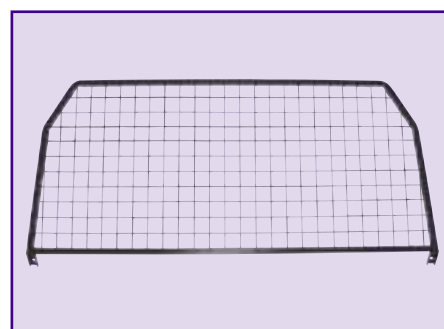

DA4027

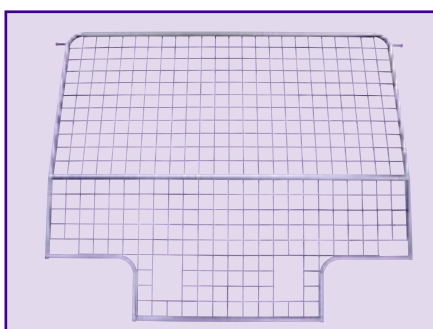

STC7555

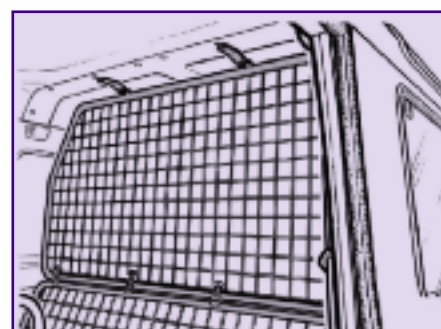

STC50479

Defender/Series

DA4027	Series/Defender to 2002	Mesh type	Black
STC7555	Defender 110 County Station Wagon	Mesh type	Grey
STC50479	Defender 90 1987-2006	Mesh type	Grey
	Full height guard for vehicles without a bulkhead		

More dog guards overleaf...

DOG GUARDS - continued

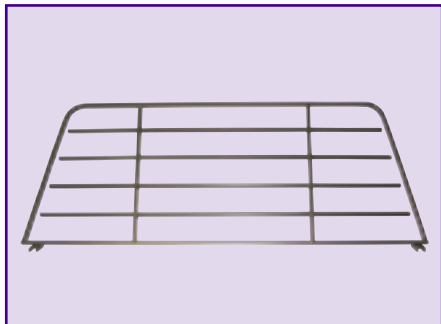

STC7570

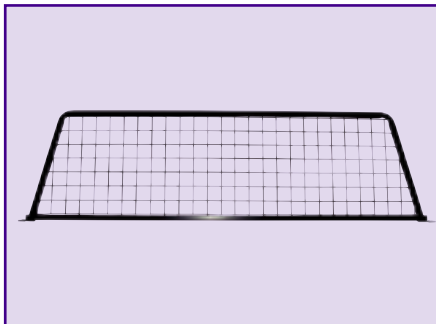

STC8414

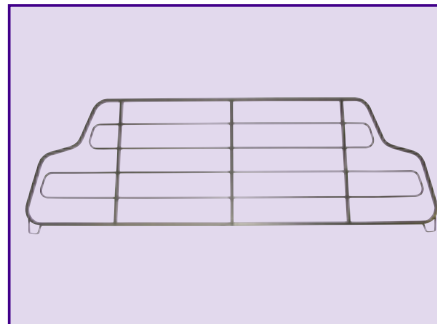

STC50082AA



STC50323



DA5511



VUB501170

Discovery

STC7570	Discovery 1	Bar type	Half length	Grey
STC8414	Discovery 1	Mesh type	Half length	Grey
STC50323	Discovery 2 - 2003	Mesh type	Half length	Grey
STC50082AA	Discovery 2	Bar type	Half length	Grey
DA5511	Discovery 3	Mesh type	Half length	Grey
VUB501170	Discovery 3	Mesh type	Full length	Black



Keep Rover in his place!



STC7939AB



DA5801



LR002521

Freelander

STC7939AB	Freelander	Bar type	Floor to roof	Grey
DA5801	Freelander 2	Half height	Full width	Grey
	Easy to fit and remove. No vehicle modifications needed.			
LR002521	Freelander 2	Full height	Full width	Black
LR002522	Freelander 2	Full height	Half width	Black

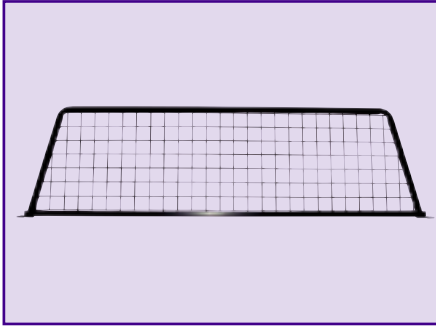
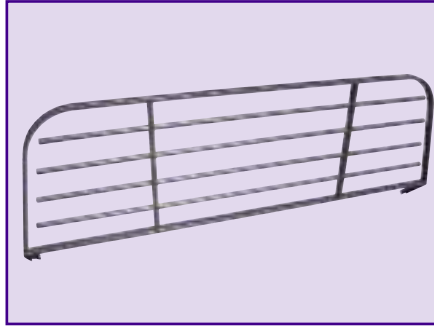
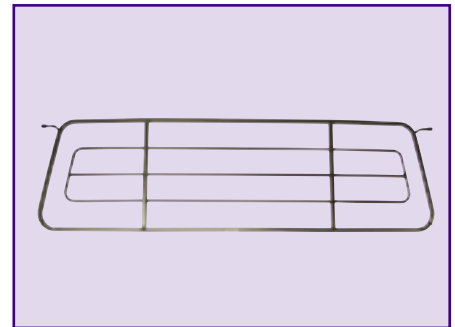
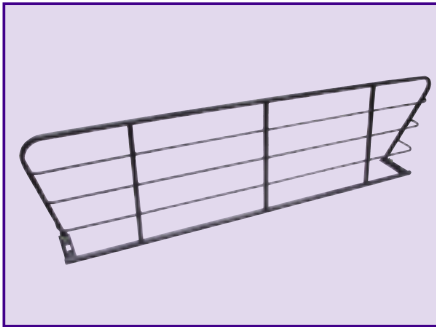

LR002522

DOG GUARDS - continued**DA4141****RTC8093****STC8161****STC8524****VUB002120****DA5800****Range Rover**

DA4141	Range Rover - 1986 - 1994	Mesh type	Black
RTC8093	Range Rover Classic - to 1994	Bar type	Grey
STC8161	Range Rover Classic - 1992 - 1994	Bar type	Grey
STC8524	Range Rover P38	Tubular type	Grey
VUB002120	Range Rover L322	Mesh type	Black
DA5800	Range Rover Sport	Mesh type	Dark grey

GEAR BOX GAITERS

Got a Defender with a tatty gear box gaiter? Well replace it with a smart new hard wearing one from Britpart!

DA5498	Grey
DA5499	Black

For details of the alloy gear stick knobs (DA5500) see the new section - Vehicle Enhancement.

**Smarten up your
Defender's interior!**

**DA5498****DA5499 - FITTED**

BE PART OF IT!

LOADSPACE LINERS



DA4470

Defender

DA4470 Defender 90 Rubber



And now she needs a lift home in the back of your nice clean Land Rover!

Keep your Land Rover's interior clean and tidy!



DA4183



DA4169



STC50050



STC50052AA

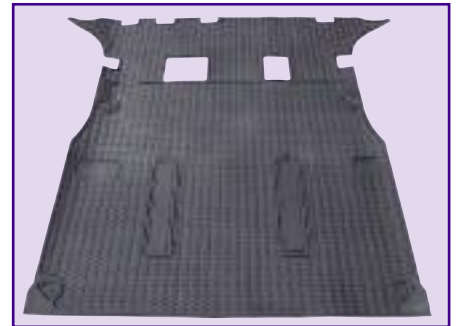

STC50053AA



DA5602



EBF500010

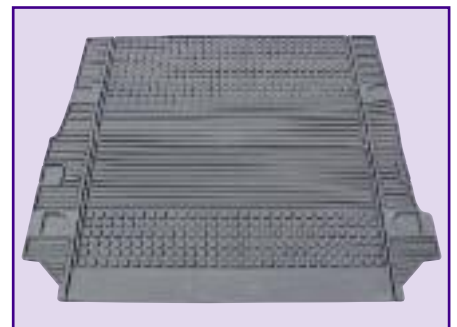

LR003895

Discovery

DA4183	Discovery 1	Loadspace liner	2" deep sides	Semi-rigid
DA4169	Discovery 2	Loadspace liner	3" deep sides	Semi-rigid
STC50050	Discovery 2	Loadspace liner	5" deep sides	Rigid
STC50052AA	Discovery 2	Loadspace mat	Half length	Rubber
STC50053AA	Discovery 2	Loadspace mat	Full length	Rubber
DA5602	Discovery 3	Loadspace liner	3" deep sides	Semi-rigid
EBF500010	Discovery 3	Loadspace liner	6" deep sides	Rigid
LR003895	Discovery 3	Loadspace mat	Full length	Rubber

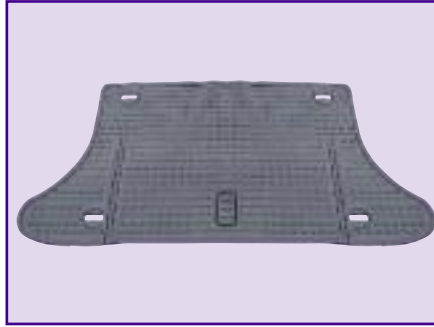
LOADSPACE LINERS - continued**DA4171****STC50435****DA5554****LR002516****LR002424**

Shown here fitted to Range Rover Sport

VPLFS0014**Freelander**

DA4171	Freelander	Loadspace liner	2" deep sides	Semi-rigid
STC50435	Freelander	Loadspace mat		Rubber
DA5554	Freelander 2	Loadspace liner	2" deep sides	Semi-rigid
LR002516	Freelander 2	Loadspace mat		Rubber
LR002424	Freelander 2	Loadspace liner	3" deep sides	Semi-rigid
VPLFS0014	Freelander 2	Luggage compartment protection		

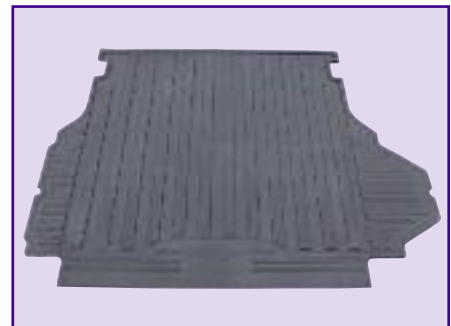
**DA4170****DA5555****VPLSS0016****DA5556****EBF000040****LR003894****Range Rover**

DA4170	Range Rover P38	Loadspace liner	3" deep sides	Semi-rigid
DA5555	Range Rover Sport	Loadspace liner	2" deep sides	Semi-rigid
VPLSS0016	Range Rover Sport	Luggage compartment protection		
DA5556	Range Rover L322	Loadspace liner	2" deep sides	Semi-rigid
EBF000040	Range Rover L322	Loadspace liner	6" deep sides	Rigid
LR003894	Range Rover L322	Loadspace mat		Rubber

LOADSPACE NETS & RETENTION KIT



VUB000700 - FLOOR NET



VUB000700 - RATCHET STRAPS



VUB000710

VUB000700	Range Rover L322 Restricts the movement of goods in the rear of the vehicle.	Loadspace retention kit	Contents - 1 x floor net & 2 x ratchet straps
VUB000710	Range Rover L322 A convenient way of storing luggage to maximise load space.	Luggage nets	Contents - 2 x side nets



MATS**331401****DA4503****BTR7895****BTR7896****BTR7897****BTR7898****Defender Rubber Mats****Individual Mats**

331401	SWB Series 88 & Defender 90	Floor only
DA4503	110 Hard top & truck cab 5mm rubber with 6mm foam backing - 93 x 198cm	Rear loadspace mat
BTR7895	LT77 Gearbox	Front floor left hand - heavy duty with foam backing
BTR7896	LT77 Gearbox	Front floor right hand - heavy duty with foam backing
BTR7897	1993 on	Front floor left hand - heavy duty with foam backing
BTR7898	1993 on	Front floor right hand - heavy duty with foam backing

Mat Sets

DA4501	LT77 Gearbox Contains - BTR7895 & BTR7896	Front right & left hand
DA4502	1993 on Contains - BTR7897 & BTR7898	Front right & left hand
LR005039	2007 MY onwards	Front right & left hand
STC50172	Pre-2007 MY	Front right & left hand

Keep your Land Rover interior clean with a set of mats from Britpart

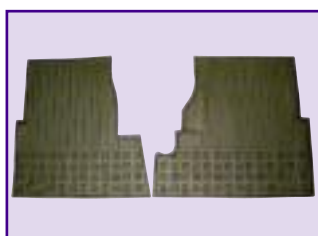
**DA4422****DA4423****DA4424****DA4425****DA4426****DA4427****DA4428****DA4429****DA4430****DA4431****Rubber Over Mats**

DA4422	Series 2 & 3	Front
DA4423	Defender	Front
DA4424	Discovery Td5	Front
DA4425	Discovery Td5	Rear
DA4426	Discovery - 1989 - 1998	Front
DA4427	Discovery - 1989 - 1998	Rear
DA4428	Freelander - 1997 on	Front
DA4429	Freelander - 1997 on	Rear
DA4430	Range Rover - 1994 - 2003	Front
DA4431	Range Rover - 1994 - 2003	Rear

Note - Quality fitted mats, black and in pairs.

MATS - continued



DA4022BLACK



DA4023GREY



DA4024BLUE



EAH500052PMA



EAH500054PMA

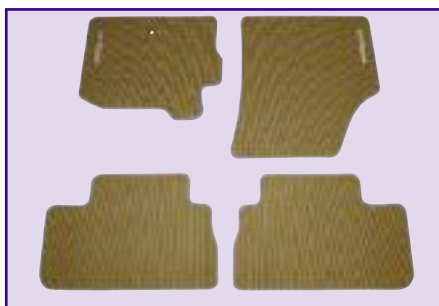

LR002485



EAH000300SUN

Carpet Mat Sets

DA4022BLACK	Defender - 5 Speed (Front set only)	Black
DA4023BLACK	Discovery	Black
DA4023BLUE	Discovery	Blue
DA4023GREY	Discovery	Grey
DA4024BLACK	Range Rover Classic - 1986 on	Black
DA4024BLUE	Range Rover Classic - 1986 on	Blue
DA4024GREY	Range Rover Classic - 1986 on	Grey

Note - Front and rear carpet sets with rubber backing

Premium Mats

EAH500052PMA	Discovery 3	Rubber 4 piece set - RHD	Black
EAH500012PVJ	Range Rover Sport	Carpet 4 piece set - RHD	Ebony
EAH500054PMA	Range Rover Sport	Rubber 4 piece set - RHD	Black
EAH000300PVA	Range Rover L322	Premium carpet 4 piece set	Jet
EAH000300JMN	Range Rover L322	Premium carpet 4 piece set	Navy
EAH000300LUP	Range Rover L322	Premium carpet 4 piece set	Aspen
EAH000300SUN	Range Rover L322	Premium carpet 4 piece set	Sand
EAH000261PMA	Range Rover L322	Rubber 4 piece set - RHD	

Note - Premium 4 piece sets are deep pile carpet with a protective waterproof backing

LR002481	Freelander 2	Rubber 4 piece set contour floor - RHD	
LR002483	Freelander 2	Rubber 4 piece set contour floor - LHD	
LR002484	Freelander 2	Carpet set - RHD	Ebony black
LR002485	Freelander 2	Carpet set - RHD	Alpaca beige
LR002486	Freelander 2	Carpet set - LHD	Ebony black
LR002497	Freelander 2	Carpet set - LHD	Alpaca beige

Protect your vehicle interior with a set of smart floor mats



WATERPROOF SEAT COVERS

STC8178AA	Defender	Front	Grey
LR005058	Freelander 2	Front	Aspen
LR005059	Freelander 2	Front	Sand
DA4083	Range Rover Classic	Front & rear	Grey/Navy
DA4084	Range Rover Classic	Front & rear	Grey/Green
HBD000320JMN	Range Rover L322	Front set	Navy
	Standard seats including head and arm rest - pair		
HBD000320LUP	Range Rover L322	Front set	Aspen
	Standard seats including head and arm rest - pair		
HBD000320LYR	Range Rover L322	Front set	Charcoal
	Standard seats including head and arm rest - pair		
HBD000320SUN	Range Rover L322	Front set	Sand
	Standard seats including head and arm rest - pair		

**STC8178AA****WATERPROOF SEAT COVERS - BRITPART****Defender****DA2815GREY**

Defender - up to 2007
3 Seats - Front

DA2815BLACK**DA2815BLUE****DA2815GREEN****DA2815GREY**

Covers in kit -

3 x full seat

(excludes headrest covers)

**DA2816GREY**

Defender - up to 2007
110 Station Wagon - 60/40
- 2nd Row

DA2816BLACK**DA2816BLUE****DA2816GREEN****DA2816GREY**

Covers in kit -

1 x two-seat back & cushion

1 x one-seat back & cushion

Note - Will fit 110 Crew Cab
with minor modification to seat
covers.

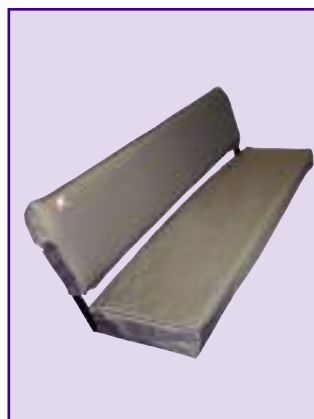
**DA2817GREY**

Defender - up to 2007
110 Station Wagon
- Bench Rear Inward Facing

DA2817BLUE**DA2817GREEN****DA2817GREY**

Covers in kit -

2 x bench-seat back & cushion

Note - For 1,200mm long seat**DA2815BLACK**

Defender 2007 - onwards
Front

DA2818BLACK

Covers in kit -

2 x full seat

2 x headrest



What better way to
protect your Land
Rover seats than
these waterproof
covers from
Britpart?

- > An extensive range of quality and stylish waterproof seat cover sets.
- > Front and rear sets available with headrests and armrests included in the Range Rover and Freelander range. Rear inward facing sets are also available for the 7-seater Discovery models.
- > The hard-wearing washable covers are made from waterproof woven polyester with a PVC backing.
- > Snug, tailor fit covers available in 3 stylish colours.
- > Easy to put on the seats and just as easy to remove again.

WATERPROOF SEAT COVERS - BRITPART - continued

Discovery



DA2807GREY



DA2808GREY



DA2809GREY

Discovery 1 - Front

DA2807BLACK

DA2807BLUE

DA2807GREEN

DA2807GREY

Covers in kit -

2 x full seat

Discovery 1 - Rear

DA2808BLACK

DA2808BLUE

DA2808GREEN

DA2808GREY

Covers in kit -

1 x two-seat back & cushion

1 x one-seat back & cushion

Discovery 1 - Boot

DA2809BLUE

DA2809GREEN

DA2809GREY

Covers in kit -

2 x full seat



DA2800BLUE



DA2801BLUE



DA2802BLUE

Discovery 2 - Front

DA2800BLACK

DA2800BLUE

DA2800GREEN

DA2800GREY

Covers in kit -

2 x full seat

2 x headrest

2 x armrest

Discovery 2 - Rear

DA2801BLACK

DA2801BLUE

DA2801GREEN

DA2801GREY

Covers in kit -

1 x two-seat back & cushion

1 x full seat

1 x armrest

3 x headrest

Discovery 2 - Boot

DA2802BLUE

DA2802GREEN

DA2802GREY

Covers in kit -

2 x full seat

2 x roof headrest (not shown)



Picture courtesy of Kristjan Kristjansson

Discovery 3 - Front

DA2822BLACK

Covers in kit -

2 x full seat

2 x headrest

2 x armrest



WATERPROOF SEAT COVERS - BRITPART - continued

Freelander

**DA2810GREEN**

Freelander 1
3 Door - Front
DA2810BLACK
DA2810BLUE
DA2810GREEN
DA2810GREY

Covers in kit -
 2 x back, cushion & headrest

Freelander 1
3 Door Sport - 2 Rear Seats
DA2812BLUE
DA2812GREEN
DA2812GREY

Covers in kit -
 2 x back, cushion & headrest

**DA2811BLUE**

Freelander 1
5 Door - Front
DA2811BLACK
DA2811BLUE
DA2811GREEN
DA2811GREY

Covers in kit -
 2 x back, cushion & headrest

Freelander 2
Front
DA2821BLACK

Covers in kit -
 2 x full seat
 2 x headrest
 2 x armrest

**DA2813GREEN**

Freelander 1
3 or 5 Door - Rear
60/40 split without armrest
DA2813BLACK
DA2813BLUE
DA2813GREEN
DA2813GREY

Covers in kit -
 1 x two-seat back & cushion
 1 x one-seat back & cushion
 3 x headrest

**DA2814BLUE**

Freelander 1
3 or 5 Door - Rear
60/40 split with armrest
DA2814BLUE
DA2814GREEN
DA2814GREY

Covers in kit -
 1 x two-seat back & cushion
 1 x one-seat back & cushion
 3 x headrest* *pre-Td4 only



Helping you
 protect your
 Land Rover!



BE PART OF IT!

WATERPROOF SEAT COVERS - BRITPART - continued

Range Rover



DA2803GREY



DA2804GREY



DA2805BLUE



DA2806BLUE

Range Rover Classic

4 Door - Front

DA2803BLACK

DA2803BLUE

DA2803GREEN

DA2803GREY

Covers in kit -
2 x back, cushion, armrest &
headrest

Range Rover Classic

4 Door - Rear

DA2804BLUE

DA2804GREEN

DA2804GREY

Covers in kit -
1 x two-seat back & cushion
1 x one-seat back & cushion
3 x armrest

Range Rover P38 - Front

DA2805BLUE

DA2805GREEN

DA2805GREY

Covers in kit -
2 x full seat, headrest &
armrest

Note - Not suitable for
vehicles with rear air bags
mounted in the front seats.

Range Rover P38 - Rear

DA2806BLUE

DA2806GREEN

DA2806GREY

Covers in kit -
1 x two-seat back & cushion
1 x one-seat back & cushion
3 x headrest
1 x armrest

Range Rover Sport - Front

DA2819BLACK

Covers in kit -
2 x full seat
2 x headrest
2 x armrest

Range Rover L322 - Front

DA2820BLACK

Covers in kit -
2 x full seat
2 x headrest
2 x armrest



WIND DEFLECTORS



DA4175

DA4174	Discovery 1	Front doors only
DA4175	Discovery 2	Front doors only
VUB502390	Discovery 3	4 piece kit
DA4176	Range Rover Classic	Front doors only
DA4177	Range Rover P38	Front doors only
VUB000610	Range Rover L322	4 piece kit
VUB502520	Range Rover Sport	4 piece kit

Allows for fresh air to enter the vehicle by enabling the driver to have the windows open whilst being shielded from the wind and rain. Custom designed for each vehicle and easily attached using the fitting kit supplied - no drilling required for install.



DA6070

These Britpart wind deflectors will be joining the range soon - keep a look out on britpart.com for further details or visit there to sign up for our monthly e-mail newsletter.

DA6070	Discovery 1	4 piece kit
DA6071	Discovery 2	4 piece kit
DA6072	Discovery 3	4 piece kit
DA6073	Freelander 1 - 2 door only	2 piece kit
DA6074	Freelander 2	4 piece kit
DA6075	Range Rover L322	4 piece kit
DA6076	Range Rover Sport	4 piece kit

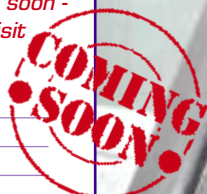

IN THIS SECTION...

SEATS & TRIM

Cubby boxes	61-62
Door trim	63
Extended slide seat rails & bulkhead bars	63
Fume curtain	64
Hoods	64
Re-trim kits - Defender	65
Seats - Defender & Series	66
Seats - Techno style	67
Seats - XS style	68
Window kits	69



CUBBY BOXES

Defender/Series 3 Cubby Boxes

With a Britpart cubby box in your Land Rover you can ensure your vehicle remains clutter free with these handy storage devices. Now with a double cup holder as standard, spilt drinks are a thing of the past. If security is a worry, then peace of mind can be achieved with our cubby box made from metal with a padded lid which is lockable.

	Top	Body
DA2035	Black	Black
DA2035LCS	Grey	Grey
DA2035RPI	Vinyl twill	Grey
DA2035T	Techno	Grey
DA2149	Grey	Black - Security box - 2 keys & 3 removable cup holders

**RANGE
IMPROVED**

Now with a double cup holder!!



DA2035

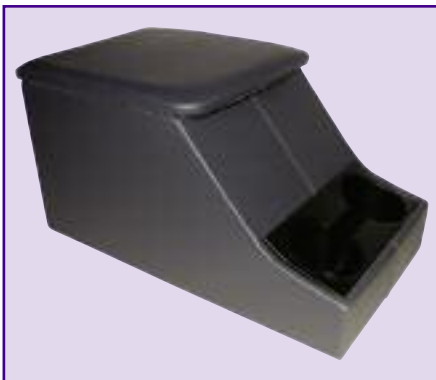

DA2035LCS



DA2035RPI

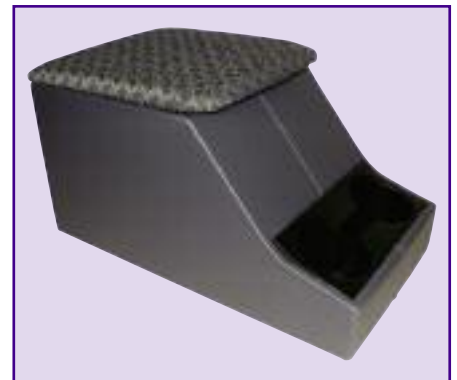

DA2035T



DA2149



excludes travel mug - DA8015

FWJ500020PMA

Defender Cubby Box Cup Holder

FWJ500020PMA

Double cup holder for both old and new model Defenders - ideal for holding a Britpart travel mug or two!!

Note - To fit to existing carpet lined cubby box the lining may have to be taken out. Fits XS Style cubby boxes too.

Keep your Defender or Series 3 clutter free!

More cubby boxes
overleaf...

CUBBY BOXES - continued

XS Style Cubby Boxes

Hand-built in the UK, these quality XS style cubby boxes are suitable for Series 3 and Defenders. Well crafted with precision tools using a hard wearing leatherette outer and velour trim inner. Each box has locking stay brass hinges. These XS Style cubby boxes match our range of XS Style seats - see this section. Now with a double cup holder as standard, spilt drinks are a thing of the past.

	Top	Body
DA2035BLUE	Blue	Black
DA2035BROWN	Light brown	Dark brown
DA2035CHAR	Charcoal	Black
DA2035GREEN	Green	Black
DA2035GREY	Light grey	Dark grey

RANGE ✓
IMPROVED

Now with a double cup holder!!



DA2035BLUE



DA2035BROWN



DA2035CHAR



DA2035GREEN

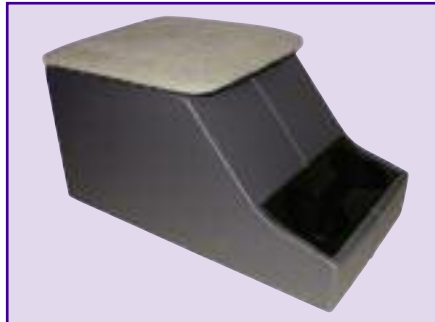

DA2035GREY

*Keep your
Defender or
Series 3
clutter free!*

Freelander 2 Cubby Boxes



DA5101



DA5103

Add some extra storage space in your Freelander 2 with one of these stylish cubby boxes.

- > Innovative design
- > Strong ABS storage base
- > Large storage capacity
- > Easy do-it-yourself installation in only 5 minutes in the original point

DA5101	RHD	Black real leather
DA5102	RHD	Black eco leather
DA5103	RHD	Alpaca leather
DA5104	LHD	Black real leather
DA5105	LHD	Black eco leather
DA5106	LHD	Alpaca leather



Picture courtesy of Kristijan Kristjansson

DOOR TRIM

ALR6852	Defender	Rear door - less spare wheel carrier From MA939976 to 1A622423	
STC1424	Defender	Rear door - less spare wheel carrier From AA242000 to KA929577	
DA4143	Defender	Front door skin - push button handle	RH
DA4144	Defender	Front door skin - push button handle	LH
DA2024	Defender/Series	Door skin safari - rear	
DA2124	Defender/Series	Door trim safari - rear	
RTC6247	Defender/Series	Safari rear door Unglazed with spare wheel	
RTC6248	Defender/Series	Safari rear door Glazed without spare wheel	
RTC6248NG	Defender/Series	Safari rear door Unglazed without spare wheel	
395529	Series	Door bottom	RH
395530	Series	Door bottom	LH
DA2002	Series	Window channel 2m length	
DA2007	Series	Door rubber 30m roll	
DA2023N	Series	Door skin	N/S
DA2023O	Series	Door skin	O/S
DA2029	Series	Door trim lower	RH
DA2030	Series	Door trim lower	LH
DA2169	Series	Door top seal and caulk	
DA4086	Series	Door bottom repair	
MTC5382	Series	Door top unglazed	RH
MTC5383	Series	Door top unglazed	LH
MTC5382G	Series	Door top glazed	RH
MTC5383G	Series	Door top glazed	LH



MTC5382

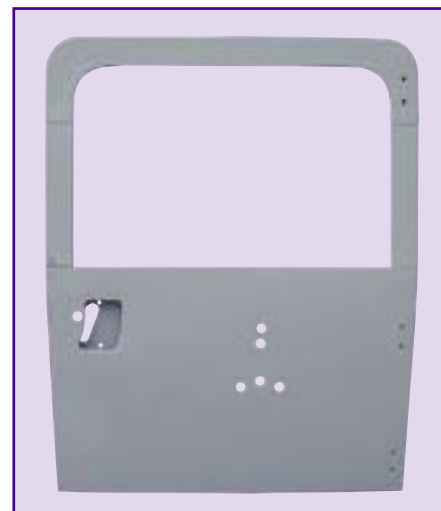

RTC6247

EXTENDED SLIDE SEAT RAILS & BULKHEAD BARS

DA2148

Give your Defender seats 3" of extra slide with a pair of these seat rails. Ideal for the taller driver to give a more practical and comfortable driving position. One pair of rails is suitable for one seat.

> Ideal for the taller driver

> A more practical and comfortable driving position



DA2148

DA2351

Up until recently, Land Rover hasn't catered (in the Defender) for the people with stature. The bulk head removal bar alleviates the problem without compromising strength. The bulk head removal bar allows an extra 105mm of seat rake at the top and 50mm of travel on the seat base. The tubular bar creates a rigid bracing for the front of the Defender tub. As well as the added benefits of extra room in the vehicle due to the seats been more manoeuvrable, access to the rear of the Defender is now not compromised by a higher bulk head. Powder coated and supplied complete with all the necessary fixings.

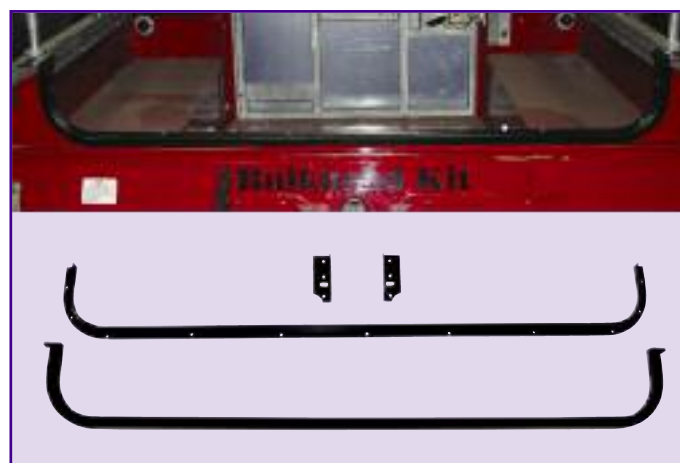

DA2351

FUME CURTAIN



MRC3519

MRC3519

Series & Defender

Note - Metal bar not included



HOODS



331110AG - SIDE VIEW

Got a Land Rover with a hood that has seen better days? Tears? Frayed fixings? Scratched windows? Well give your vehicle a quick facelift with a new canvass hood from Britpart.

- > Hoods are made from the original 18oz canvas made by the original manufacturer for Land Rover.
- > All fittings are brass made by the original manufacturer.
- > Webbing is made the same way as the original.
- > Polypropylene rope is the same construction as the original rope.
- > Ropes are all inserted into the hood to help customers.
- > Care instruction are included.



331110AG - REAR VIEW

331110AG	Series	88"	Full hood	Khaki	Without windows
331113AG	Series	88"	Full hood	Khaki	With windows
331110SA	Series	88"	Full hood	Sand	Without windows
331113SA	Series	88"	Full hood	Sand	With windows
331371AG	Series	88"	Three quarters hood	Khaki	Without windows

331259AG	Series	109"	Full hood	Khaki	Without windows
331260AG	Series	109"	Full hood	Khaki	With windows
331259SA	Series	109"	Full hood	Sand	Without windows
331260SA	Series	109"	Full hood	Sand	With windows
331308AG	Series	109"	Three quarters hood	Khaki	Without windows
MUC2437	Series	109"	V8 High capacity pick-up Three quarters hood	Khaki	Without windows

MUC4122ABE	Defender	90	Full hood	Sand	With windows
-------------------	----------	----	-----------	------	--------------



331113AG



331371AG

Other hoods available on request - please ask for details.

RE-TRIM KITS - DEFENDER

Going off-road? Got a working Land Rover? Well the chances are your seats won't be in showroom condition, luckily here at Britpart we have the answer - a Defender re-trim kit.

Outer Seats

An outer Britpart re-trim kit includes:

1 x Fitment guide CD - This 20 minute tutorial will give you a detailed step-by-step guide to disassembling and assembling your Defender seat and information on the correct use of the included parts.

- | | |
|-----------------------------------|---------------------|
| 1 x Can of contact adhesive spray | 1 x Cushion foam |
| 1 x Squab foam | 1 x Cushion cover |
| 1 x Squab cover | 1 x Headrest cover |
| 6 x Plastic nails | 2 x Metal rods |
| 3 x Cable ties | 1 x Rubber retainer |

DA5627

Vinyl twill

DA5628

Techno

DA5629

Black

DA5630

Grey



DA5628

Centre Seats

A centre Britpart re-trim kit includes:

- | | |
|-----------------------------------|---------------------|
| 1 x Can of contact adhesive spray | 1 x Cushion foam |
| 1 x Squab foam | 1 x Cushion cover |
| 1 x Squab cover | 6 x Plastic nails |
| 1 x Metal rods | 1 x Rubber retainer |

DA5632

Vinyl twill

DA5633

Techno

DA5634

Black

DA5635

Grey



DA5635

Breathe life back into your old saggy Defender seats with a Britpart re-trim kit.



VINYL TWILL



TECHNO



BLACK

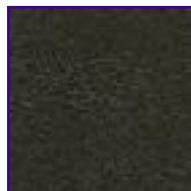

GREY

Swatches

Material colours are an approximate match. Sample swatches of the actual material are available on request.



BE PART OF IT!

SEATS - DEFENDER & SERIES



Defender Seats

DA4028	Seat cover	Base outer	Black
DA4041	Seat cover	Back outer	Black
MWC3302	Seat	Back RH	Black
MWC3303	Seat	Back LH	Black
MWC4535	Seat	Base outer	Black
MWC1010	Headrest assembly		Black
DA4029	Seat cover	Base outer	Grey
DA4042	Seat cover	Back outer	Grey
MWC5670LCS	Seat	Base outer	Grey
MWC9843LCS	Seat	Back LH	Grey
MWC9844LCS	Seat	Back RH	Grey
AWR5701RPI	Seat cover	Base outer	Vinyl twill
AWR5702RPI	Seat cover	Back outer	Vinyl twill
AWR5708RPI	Headrest assembly		Vinyl twill
AWR5700RPI	Seat	Base outer	Vinyl twill
BTR8140RPI	Right hand assembly	Less headrest	Vinyl twill
BTR8141RPI	Left hand assembly	Less headrest	Vinyl twill
DA4031	Seat foam	Base outer	
DA4055	Seat foam	Back outer	
DA4056	Seat foam	Centre to 07/95	

All products leaving the Trim Shop are produced to the highest standards!

The skilled team in the Trim Shop make a wide range of seats and seat covers for Land Rover vehicles by hand. The material arrives in vast reams and has to be cut with great precision before being stitched together and then assembled into seat bases, seat backs, seat benches etc. In keeping with the Britpart philosophy, all products leaving the Trim Shop are produced to the highest standards and meet with the strictest safety regulations.

Defender & Series Seats

320737	Bench seat	Rear assembly SWB	Black
DA3059	Bench seat	Rear assembly LWB	Black
DA4067	Rear seat	Individual inward facing	Black
320737CB	Bench seat	Rear assembly SWB	County brown
320737CG	Bench seat	Rear assembly SWB	County grey
320737LCS	Bench seat	Rear assembly SWB	Grey
DA4075	Rear seat	Individual inward facing	Grey
320737T	Bench seat	Rear assembly SWB	Techno style
DA4075T	Rear seat	Individual inward facing	Techno style
320737RPI	Bench seat	Rear assembly SWB	Vinyl twill
DA4075RPI	Rear seat	Individual Inward facing	Vinyl twill

Series Seats

320698	Seat back - pin fitment - adjustable	Standard outer	Black
320699	Seat base - adjustable	Standard outer	Black
320726	Seat base	Standard centre	Black
349967	Seat base	Standard outer	Black
MUC1488	Seat back	Standard centre	Black
MUC1520	Seat back - pin fitment	Standard outer	Black
MUC1520G	Seat back - bolt fitment	Standard outer	Black
DA4305	Standard seat kit		

Note - Kit contains - 2 x 349967; 2 x MUC1520; 1 x 320726 & 1 x MUC1488

MRC6980	Seat base	Deluxe outer	Black
MRC6982	Seat back	Deluxe outer	Black
MRC6982H	Seat back with headrest	Deluxe outer	Black
MRC6985	Seat base	Deluxe centre	Black
MTC3181	Seat back	Deluxe centre	Black
DA4298	Deluxe seat kit		

Note - Kit contains - 2 x MRC6982; 2 x MRC6980; 1 x MTC3181 & 1 x MRC6985



A COMPLETE BRITPART SEAT



320737



DA4298

SEATS - TECHNO STYLE

Hand-built in the UK, these quality seats with the ever popular 'Techno' pattern are suitable for 90, 110 and Defenders. Well-crafted with precision tools using a hard wearing velour trim. Comfort is ensured with injection moulded foam.

HAG100970LOY	Base	
HCA106010LOY	Cover base	
HAJ101400LOY	Squab assembly - no pockets	Right hand side
HAJ101410LOY	Squab assembly - no pockets	Left hand side
HBA106190LOY	Squab cover - no pocket	
HBA106180LOY	Squab cover - with pocket	
HAH103510LOY	Headrest	
320737T	Rear seat assembly	
DA4075T	Rear seat individual inward facing	
HHD102280	Runner & sub-frame	Right hand side
HHD102290	Runner & sub-frame	Left hand side

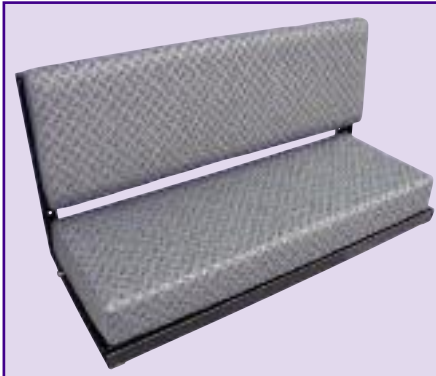
**320737T****TECHNO****Swatch**

Material colour is an approximate match. A sample swatch of the actual material are available on request.

**TECHNO STYLE SEAT****BE PART OF IT!**

SEATS - XS STYLE



DA5610 & DA5611



DA5612 & DA5613



DA5614 & DA5615



DA5616 & DA5617

Hand-built in the UK, these quality XS style seats are suitable for 90, 110 and Defenders. Well-crafted with precision tools using a hard wearing leatherette outer and velour trim inner. Comfort is ensured with injection moulded foam. Seats complete with base, back and headrest but the runners are not included.

	Outer	Inner	Side
DA5610	Dark grey	Light grey	Right
DA5611	Dark grey	Light grey	Left
DA5612	Black	Green	Right
DA5613	Black	Green	Left
DA5614	Black	Blue	Right
DA5615	Black	Blue	Left
DA5616	Dark brown	Light brown	Right
DA5617	Dark brown	Light brown	Left
DA5618	Black	Charcoal	Right
DA5619	Black	Charcoal	Left
HHD102280	Runner & sub-frame		Right hand side
HHD102290	Runner & sub-frame		Left hand side



DA5618 & DA5619

Comfort is ensured

Swatches

Material colours are an approximate match. Sample swatches of the actual material are available on request.



BLUE



LIGHT BROWN

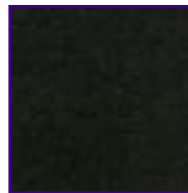

CHARCOAL



LIGHT GREY



GREEN

Re-trim Kit

A Britpart XS Style re-trim kit includes:

1 x Fitment guide CD - This 20 minute tutorial will give you a detailed step-by-step guide to disassembling and assembling your Defender seat and information on the correct use of the included parts.

1 x Can of contact adhesive spray
 1 x Squab foam
 1 x Squab cover
 6 x Plastic nails
 3 x Cable ties

1 x Cushion foam
 1 x Cushion cover
 1 x Headrest cover
 2 x Metal rods
 1 x Rubber retainer

DA5636

Outer - Black

Inner - Charcoal



DA5636



Need a dog guard?
 See interior protection section!

WINDOW KITS



DA4032GREY



DA4033



DA4033GREEN

Standard

DA4032	Clear
DA4032GREEN	Green tinted
DA4032GREY	Grey tinted
DA4032BRONZE	Bronze tinted

Standard kits have metal catch

Deluxe

DA4033	Clear
DA4033GREEN	Green tinted
DA4033BRONZE	Bronze tinted

Deluxe kits have rubber mounting strips to cover rivets and plastic catch

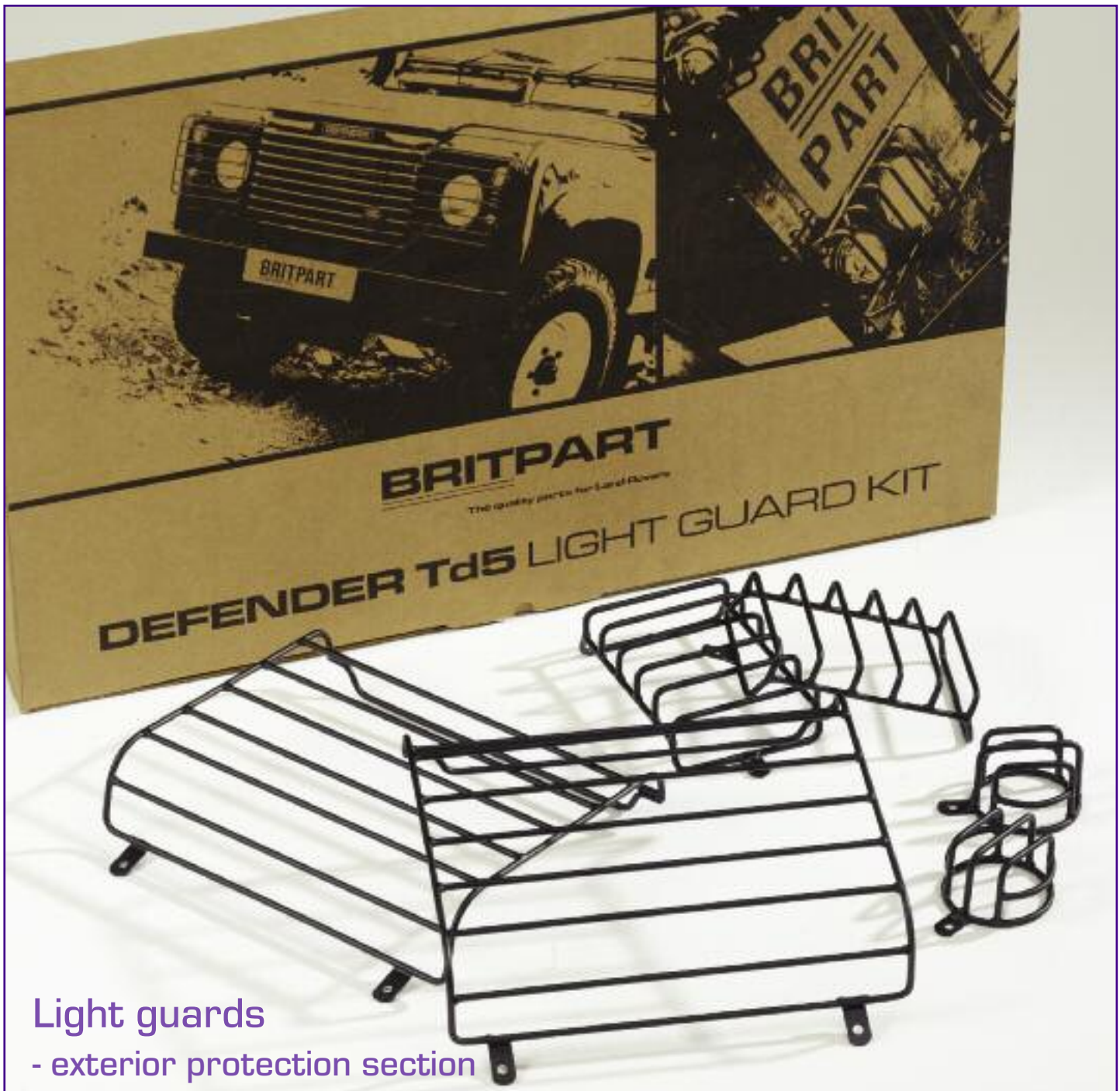

Light guards

- exterior protection section



IN THIS SECTION....

OFF-ROAD EQUIPMENT

Air compressors & tyre repair kit	71
Diff lockers - uprated - ARB	72
Diff lockers - uprated - Detroit	73
Diff lockers - uprated - KAM	74
Fire extinguishers	75
Hammer - emergency	75
Jacking equipment	78
Jacks - Hi-Lift	77
Jacks - Jackall	76
Jerry cans	75
Ladders	78
Land meters	78
Raised air intake - Britpart	79

Raised air intake - Safari	80-81
Roof tents	82



AIR COMPRESSORS & TYRE REPAIR KIT

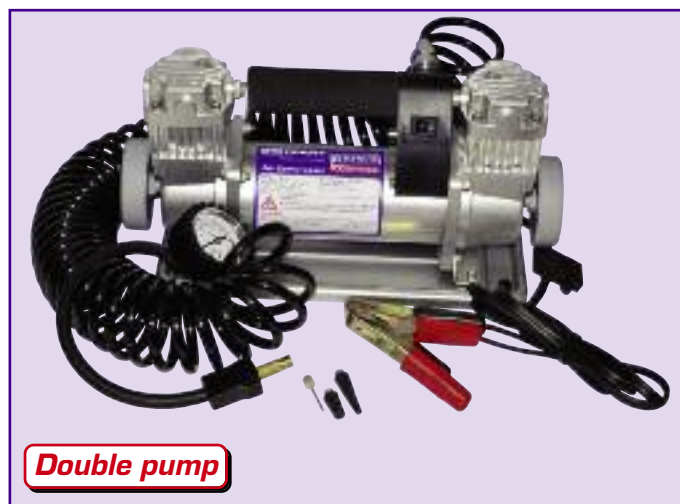

Double pump

DA2392



Single pump

DA2354

- | | |
|---|--|
| <p>DA2392 - double-pump</p> <ul style="list-style-type: none"> > Air flow - 150ltr/min | <p>DA2354 - single-pump</p> <ul style="list-style-type: none"> > Air flow - 72ltr/min |
|---|--|
- Features for both air compressors*
- > 12 volt / 30 amp
 - > Max. pressure - 150psi
 - > Automatic cut off to prevent overheating
 - > 2 metre electric hose with heavy-duty clamps
 - > 10 metre air hose with heavy-duty gauge and brass fittings
 - > Integrated sand tray
 - > Blow moulded carrying case
 - > Also great for camping and outdoor use

Ideal for 4x4 use!



Blow moulded case



Heavy-duty gauge



10m coiled hose



3 nozzles

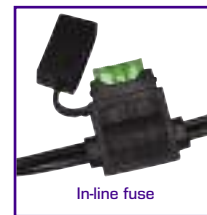

In-line fuse



Heavy-duty battery clips



Screw in air filter

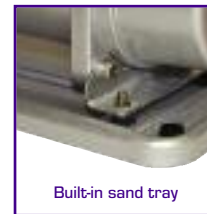

Built-in sand tray



Anti-vibration rubber feet

Don't get caught out with a flat tyre or two!

*Pack and leave an easy to use Britpart tyre repair kit in your vehicle.**

DA2390
Tyre repair kit in travel case

See the wheels section for more details on the tyre repair kit from Britpart.



**Recommended for off-road use only.*

DA2390

DIFF LOCKERS - UPDATED - ARB



Air Locker locking differentials allow you to tackle the toughest terrain. As the world's premier traction aid, ARB Air Lockers keep you moving in all conditions.

- > Provides 100% traction on demand without affecting on road driveability or driveline wear
- > Vastly improved traction means less reliance on momentum, thus reducing the likelihood of vehicle damage and environmental impact
- > Easy, convenient operation allows the driver to concentrate on the terrain without leaving the comfort and safety of their seat
- > Ultra durable and extremely strong - only the highest quality materials used in construction
- > Incredibly simple yet effective design that employs minimal moving parts, thereby ensuring maximum reliability
- > Thoroughly tested and proven design - trusted and used in over 80 countries around the world
- > Easy installation and maintenance - no special tools, skills or additives required
- > Two year warranty guarantees the Air Locker will be free of defects in materials

Ultra durable and extremely strong - only the highest quality materials used in construction



DA4191

Part Number	Vehicle/ Model	Axle Location	Year	Shaft Description	Shaft Diameter	Spline	Ratio
DA4191 ^{1,4}	Range Rover Classic	Front	To 1992	Rover type	28.2 (1.11")	10	3.54
DA4193 ^{1,5}	Range Rover Classic	Front	1993-1996	Rover type	31.5 (1.24")	24	3.54
DA4191 ^{1,4}	Range Rover Classic	Rear	To 1992	Rover type	28.2 (1.11")	10	3.54
DA4193 ^{1,5}	Range Rover Classic	Rear	1993-1996	Rover type	31.5 (1.24")	24	3.54
DA4344 ⁵	Range Rover P38	Front	1996-2002	Rover type, P38A	31.5 (1.24")	24	3.54
DA4344 ⁵	Range Rover P38	Rear	1996-2002	Rover type, P38A	31.5 (1.24")	24	3.54
DA4191 ¹	Discovery 1	Front	To 1993	Rover type	28.2 (1.11")	10	3.54
DA4193 ^{1,5}	Discovery 1	Front	1993-1998	Rover type	31.5 (1.24")	24	3.54
DA4191 ¹	Discovery 1	Rear	To 1993	Rover type	28.2 (1.11")	10	3.54
DA4193 ^{1,5}	Discovery 1	Rear	1993-1998	Rover type	31.5 (1.24")	24	3.54
DA4193 ^{1,5}	Discovery 2	Front	All	Rover type	31.5 (1.24")	24	3.54
DA4193 ⁶	Discovery 2	Rear	All	Rover type	31.5 (1.24")	24	3.54
DA4344 ⁶	Discovery 2	Rear	2002 on	Rover type, P38A	31.5 (1.24")	24	3.54
DA4191 ¹	Defender 110, 130	Front	1983-1993	Rover type	28.2 (1.11")	10	3.54
DA4193 ^{1,5}	Defender 110, 130	Front	1993 on	Rover type	31.5 (1.24")	24	3.54
DA4192	Defender 110, 130	Rear	1983-2002	Salisbury type	31.5 (1.24")	24	3.54
DA4193 ⁶	Defender 110, 130	Rear	2002 on	Rover type	31.5 (1.24")	24	3.54
DA4344 ⁶	Defender 110, 130	Rear	2002 on	Rover type, P38A	31.5 (1.24")	24	3.54
DA4191 ¹	Defender 90	Front	1984-1993	Rover type	28.2 (1.11")	10	3.54
DA4193 ^{1,5}	Defender 90	Front	1993 on	Rover type	31.5 (1.24")	24	3.54
DA4191 ¹	Defender 90	Rear ²	1983-1993	Rover type, 4 cyl. petrol & diesel engines	28.2 (1.11")	10	3.54
DA4193 ^{1,6}	Defender 90	Rear	1993 on	Rover type	31.5 (1.24")	24	3.54
DA4344 ⁶	Defender 90	Rear	2002 on	Rover type, P38A	31.5 (1.24")	24	3.54
DA4191 ^{2,3}	Series 1, Series 2, Series 3	Front	1948-1985	Rover type	28.2 (1.11")	10	4.7
DA4191 ^{2,3}	Series 1, Series 2, Series 3	Rear	1948-1985	Rover type	28.2 (1.11")	10	4.7
DA4345	Series 1, Series 2, Series 3	Rear	1948-1985	Salisbury type	31.5 (1.24")	24	4.7

Notes: 1 If vehicle was manufactured during 1993, check spline count. 2 Air Locker not available for vehicles equipped with high load option. 3 Ring gear spacer required. Longer ring gear bolts (not supplied) are also necessary - (Land Rover part no. 576521). 4 When an DA4191 Air Locker is to be installed in Range Rovers manufactured prior to 1980 (approx.), special carrier bearings (No. K11300/K11162) may also be necessary - Land Rover part no. RTC3426. 5 Some vehicles have crown wheel bolts which cannot be reused and must be replaced. Consult service manual. 6 P38A is most commonly found in traction control equipped vehicles. Identify P38A type diff by large 205mm [8.07"] flange diameter. P38A was not used on North American delivered Discoverys - use DA4193.

- > Designed for Air Locker use
- > High flow, compact 12v compressor
- > Sealed for moisture and dust resistance
- > Hard anodised cylinder bore and Teflon impregnated carbon fibre piston seal for reduced friction and maximum trouble free life
- > Heavy-duty maxi-fuse equipped for professional in-line circuit protection
- > Quality components for quiet operation and extra long life
- > Anodised mounting brackets dissipates motor heat and allows compressor to be repositioned 180°
- > Constructed entirely of lightweight, high strength engineering grade materials
- > Over-pressure safety valve equipped
- > Motor is internally thermal protected against extreme temperature damage

DA4190 Compressor assembly 12 volt

DA4194 Dash switch for compressor



DA4190

DIFF LOCKERS - UPDATED - DETROIT

Detroit Locker

- > 100% locking differential
- > Legendary traction
- > Ultimate performance

The legendary Detroit Locker began the revolution in performance differentials and still leads the industry today as an Eaton brand. The Detroit Locker is the most durable and dependable locking differential available. The Detroit Locker maximises traction by delivering 100% of the torque to both drive wheels. It is engineered to keep both wheels in a constant drive mode, and has the ability to automatically allow wheel speed differentiation when required. No other performance differential has the reputation for delivering traction in mud, snow, rocks and on the track. The choice of professional racers and off-road enthusiasts around the world! The durability of the Detroit Locker is unmatched!

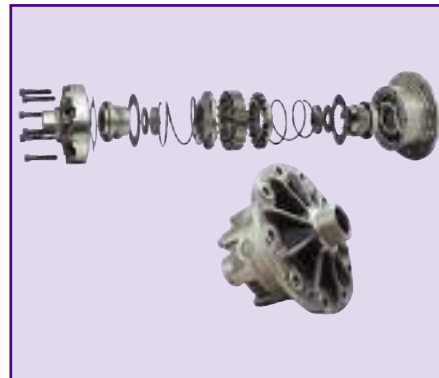

DETROIT LOCKER

DA5700	Series 3/Defender/Discovery 1/Range Rover	Detroit Locker	24 spline	Rear
DA5701	Series 3/Defender/Discovery 1/Range Rover	Detroit Locker	10 spline	Rear
DA5704	Defender - Salisbury axle	Detroit Locker	24 spline	Rear

Detroit Truetrac

- > Smooth operation
- > Performs open until needed
- > Fully automatic limited slip

Note - when fitting to non-metric diff casings 2 x RTC3095 bearings are required.

The Detroit Truetrac was the first helical gear differential ever introduced into the automotive aftermarket as an Eaton brand. It remains the leading helical gear-type limited slip differential in the industry. Detroit Truetrac's proven helical gear design eliminates the need for wearable parts, resulting in maintenance free traction. Recognised not only for its toughness but also its smooth and quiet operation. Engineered to work efficiently in front and rear axles, semi-floating (C-clip axles) and transfer cases. Power transfer is so smooth, it literally goes unnoticed by the driver - even in front wheel drive axles. Proven design, low cost and effective performance, all make the Detroit Truetrac limited slip differential the ideal choice for a wide variety of vehicle applications. No maintenance - Just Traction!

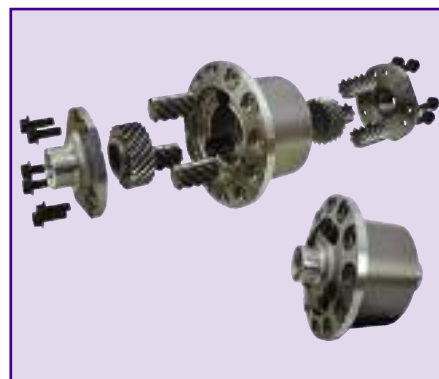

DETROIT TRUETRAC

DA5705	Series 3/Defender/Discovery 1/Range Rover	Detroit Truetrac	10 spline	Rear
DA5706	Series 3/Defender/Discovery 1/Discovery 2/Range Rover	Detroit Truetrac	10 spline	Front
DA5709	Series 3/Defender/Discovery 1/Discovery 2/Range Rover	Detroit Truetrac	24 spline	Rear
DA5710	Series 3/Defender/Discovery 1/Discovery 2/Range Rover	Detroit Truetrac	24 spline	Front
DA5711	Defender - Salisbury axle	Detroit Truetrac	24 spline	Rear



Picture courtesy of Kristjan Kristjansson

DIFF LOCKERS - UPRATED - KAM



Vehicle Mobility Specialists



KAM LIMITED SLIP DIFF



KAM DIFF LOCKER

The KAM locking system has evolved from the previous air and cable operated versions.

Crown Wheel & Pinion

DA4440	3.8 crown wheel & pinion to fit 4.7 carrier	24 spline
DA4441	3.9mm spacer ring for crown wheel for 3.8, 2.83, 4.1 & 4.75 gears Note - not Salisbury gears	
DA4442	KAM 3/8 25h UNF bolts 12/9	
DA4455	2.83 crown wheel & pinion to fit RR 3.54	24 spline
DA4457	4.1 crown wheel & pinion to fit 4.7 carrier	24 spline
DA4458	4.75 crown wheel & pinion to fit 4.7 carrier	24 spline
DA4459	3.8 Salisbury crown wheel & pinion	
DA4460	4.7 Salisbury crown wheel & pinion - standard production	

KAM offer a choice of ratios to suit varying engines and tyre sizes. If you are increasing the payload of the vehicle then the gearing dynamics need to be changed. With the ratios they can offer both speed reduction and speed increases to suit your application, combined with considerable extra strength of the gear.

Classic Diff - Heavy Duty Carrier + LSD

DA4443	LSD carrier sun gears	24 spline
DA4444	P38 heavy-duty carrier	24 spline
DA4447	P38 LSD carrier	24 spline
DA4448	Upgrade LSD clutch pack from KAM 4-pin	
DA4449	P38 upgrade with locking dog gear flange	24 spline
DA5512	Heavy-duty 4 pinion carrier	24 spline
DA5519	Rear solenoid locking diff kit including heavy-duty 4 pinion carrier and shafts	24 spline
DA5520	Front solenoid locking diff kit including heavy-duty 4 pinion carrier and shafts	24 spline
DA5521	Rear solenoid locking diff kit including heavy-duty 4 pinion carrier and shafts including LSD kit	24 spline
DA5522	Front solenoid locking diff kit including heavy-duty 4 pinion carrier and shafts including LSD kit	24 spline

KAM diff lockers -

- > double vehicle traction
- > improved strengthened parts
- > improved towing ability
- > LSD - diff locker combination
- > push button operation
- > replaces most internal parts
- > ideal for reconditioning

With a KAM system installed to both front and rear axles, drive can be instantly be doubled and applied evenly to all 4 wheels when the system is engaged.

CV Parts + Conversions

DA4450	CV conversions 32 to 23 with 24-23 shafts plus 3 x stubs
DA4451	CV conversions 32 to 23 without shafts plus 3 x stubs
DA4452	CV stub shafts 26.5 - 27 - 27.5 - 28mm

KAM produce a range of CV's that are an uprated version of the standard part.

Heavy-duty Shafts

DA4461	Range Rover/90-Pre 300	Rear	No oil seal	Short - 705mm	24/24 splines
DA4462	Range Rover/90-Pre 300	Rear	No oil seal	Long - 979mm	24/24 splines
DA4463	Tdi 300/Td5	Rear	With oil seal	Short - 683mm	24/24 splines
DA4464	Tdi 300/Td5	Rear	With oil seal	Long - 953mm	24/24 splines
DA4465	Tdi 200/300/Td5 110 - 1994>	Front		Short - 456mm	32/24 splines
DA4466	Tdi 200/300/Td5 110 - 1994>	Front		Long - 843mm	32/24 splines
DA4467	Range Rover/90-Pre 300 Tdi>	Front		Short - 452mm	23/24 splines
DA4468	Range Rover/90-Pre 300 Tdi>	Front		Long - 837mm	23/24 splines

KAM shafts have greater flexibility and are approximately 40% stronger than standard shafts. The KAM shafts have been used for the last 16 years in many trail and competition vehicles world wide.

Optional Upgrades For Locker

DA4453	Aluminum 8mm diff cover - replaces ABS plastic cover
DA4454	Spacer for 10-hole hub to fit wide conversions
DA5523	KAM heavy-duty bling 10 hole hub - narrow

Note - All locking diff kits are available to suit Defender (excluding Salisbury Axle), Discovery 1 & 2 and also Range Rover Classic. The locking diff kits we supply for stock are always metric. The metric to imperial change was in 1998. These kits will fit any application <1998.

FIRE EXTINGUISHERS



STC8529AA

STC8529AA

- > 1Kg kit
- > One-handed operation fire extinguisher
- > High rating
- > Checkable & re-chargeable
- > With crash-tested bracket
- > Attractive design
- > Controlled discharge



STC8138AB

STC8138AB

- > 2Kg kit
- > Long-life - 100% polyester resin coated fire extinguisher
- > Safe handling & crash proof fastening
- > Readiness to operate displayed by manometer
- > Precision brass valve

HAMMER - EMERGENCY

DA6500

Life Hammer - The Original

- > Double-sided steel hammer for shattering windows quickly and easily for a safe and quick exit from any vehicle.
- > Razor sharp blade cuts through seatbelts to ease escape.
- > Fluorescent button allows hammer to be located in the dark.
- > Installation mounting bracket ensures hammer is accessible when you most need it.



DA6500

JERRY CANS



DA2166



DA2170



DA2171



DA2172



Jerry can not included.

DA2182

- DA2166 Jerry can - 20ltr new
- DA2170 Jerry can - 20ltr stainless steel
- DA2171 Jerry can - 10ltr stainless steel
- DA2172 Jerry can spout - stainless steel
- DA2182 Jerry can holder for 20ltr cans

JACKS - JACKALL



DA3121	48" Jack (4ft)
DA3122	60" Jack (5ft)
DA3130	Top clamp
DA3132	Tow hitch adaptor
DA4058	Maintenance kit
DA4059	Jacking point adaptor
DA4061	Mounting kit jack rack

8,000lbs capacity Jacks - Versatile! Rugged! Pow'R-ful!

Built with a patented 'Safety Link', the Maasdam Jackall is the 'Jack with More!' Larger base for greater stability. 'Safety Link' mechanism that prevents abuse, misuse and makes operations safer. Jacks come with a lifetime warranty and are built to current ANSI/ASME specifications. When safety and dependability matter most, continue to rely on Jackall.

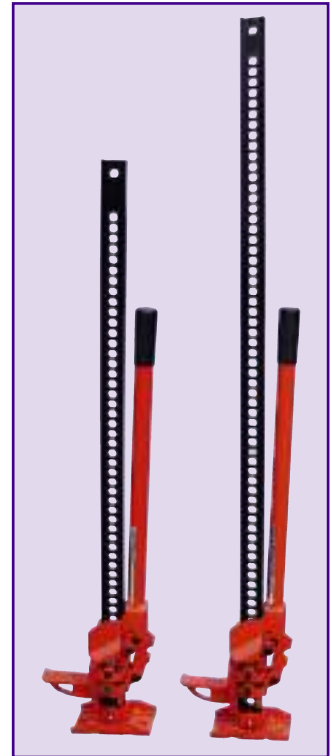

DA3121 & DA3122



DA3130



DA3132



DA4058



DA4059

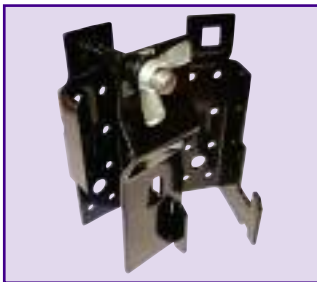

DA4061

Features

- > Patented "safety link" mechanism
- > Heavy ribbed, extra large base
- > Cast components
- > Hot roll-formed, alloy steel beam
- > Steel handle locks against beam
- > Powder coated through and through

Benefits:

- > Prevents abuse and misuse
- > Provides strength and greater load stability
- > Assures long life, trouble free operation
- > Strong and reliable
- > For convenient storage
- > Reduces scratching, greater corrosive resistance

Patented "Safety Link" pitman mechanism prevents abuse and misuse. "Safety Link" yields when capacity exceeded — load can no longer be lifted. Operational safety at its best.



Got bikes to carry? - see racks & boxes section



JACKS - HI-LIFT



rugged, highly versatile jack

DA3120

DA2243

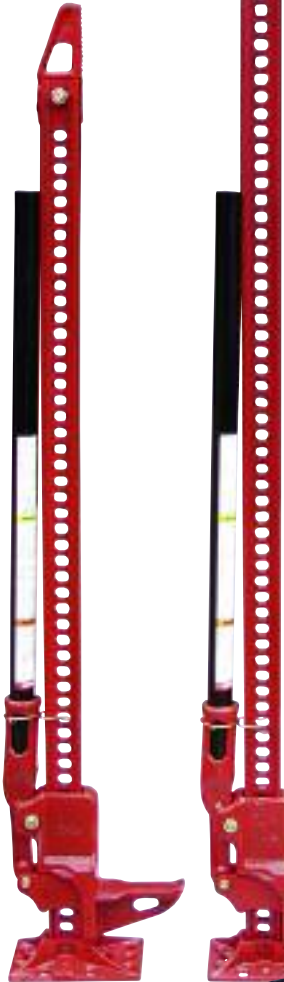

DA2243 - 48" Jack (4ft)
DA3120 - 60" Jack (5ft)

The Hi-Lift jack is a rugged, highly versatile jack that puts you in command of situations requiring lifting, pushing, pulling, winching, and clamping. Although light in weight and easy to manoeuvre, the Hi-Lift jack offers a rated lifting capacity of 2 1/3 tons (2,114kgs).

Specifications

- > Approximate weight: 30lbs (14 kg)
- > 4,660lbs (2,113kgs) rated capacity
- > Climbing pins of specially processed steel with 125,000psi tensile strength and 100,000psi yield
- > Steel bar is manufactured of specially rolled extra high carbon steel with 80,000lbs minimum tensile and carbon 0.69 to 0.82
- > Steel handle of 14-gauge high-yield structural tubing with minimum yield of 55,000psi 1 5/16" diameter x 30" long

Features

- > Every jack comes complete with an adjustable top clam clevis for use in clamping and winching
- > For speedy disengaging, lifting unity automatically drops away when load is removed
- > 4 1/2" (11cm) long lifting nose for positive contact with load
- > Safety bolt is designed to shear at 7,000lbs. (3,175 kg)
- > Steel bar can be reversed for extra long life
- > Low pickup of 4 1/2" (11cm)
- > 28" square base plate

DA2248



DA2174

DA2243EYE



DA4351

DA4353



DA4354

DA4355

DA4352



accessories

- DA2174** *Off-road base*
Alleviates jack sinkage on soft surfaces. Suits all models.
- DA2243EYE** *Jacking eye*
Spare jacking eye.
- DA2248** *Fix-it-kit*
The maintenance kit contains all the key components for servicing all Hi-Lift jacks.
- DA4350** *4XRAC*
Heavy-duty mounting system for the serious off-roader.
- DA4351** *Loc-Rac*
Conveniently mounts and locks your Hi-Lift jack. Includes lock and suits all models.
- DA4352** *Jack protector*
The jack protector vinyl bag protects your jack from the elements. One size fits all.
- DA4353** *Lift mate*
Designed to provide a lift point from most wheels for quick and easy lifting. The lifting capacity is 5,000lbs/2,273kgs.
- DA4354** *Off-road kit*
The Hi-Lift winching kit includes a winch attachment, winch tensioner, tree strap, d-ring shackle, Hi-Lift gloves and gear bag. Winch time is reduced significantly using the winch attachment and tensioner together.
- DA4355** *Bumper lift*
Designed to fit curved steel bumpers. The rugged design of the bumper lift has a lifting capacity of 3,000lbs/1,361kgs.
- DA4356** *Neoprene jack cover*
This jack cover offers a level of mud and dirt protection for the main lifting mechanism of the jack when not in use. It zips on easily over the foot of the jack and provides a tight fit.
- Adjustable tube jack mount**
Designed for mounting a Hi-Lift® jack to round and square tube bumpers, bull bars, roll cages and roof racks, this accessory allows for easy and adjustable mounting on tubes from 1" to 3" in diameter.
- DA4357** *Small set* is for use on round tubes from 1-2" in diameter, which works on many roof racks. It can also be used on ATV/UTV bars, bumpers and roll cages
- DA4358** *Large set* is intended for round tubes from 2-3" in diameter that will work on most vehicle bull bars and roll cages

JACKING EQUIPMENT



ANR4489 (KIT), KAJ100570 & KAH000050 (INDIVIDUAL)

ANR4489	Jack and handle (KAJ100570 & KAH000050)	
KAJ100570	Standard bottle jack	
KAH000050	Handle for KAJ100570	
	Note - Defender only	
DA2244	Jacking point adaptor	
DA3153	Anti-rattle jack clamp	Red
DA3154	Anti-rattle jack clamp	Black
DA3155	Anti-rattle jack clamp	Yellow
DA5607	Jack base - 310x195x38mm	Grey



DA3153/DA3154/DA3155



DA2244

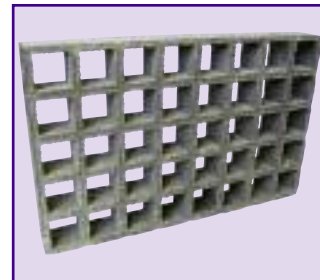

DA5607

LADDERS



DA2231



DA5601

DA2231	Sandtrack 4mm aluminium	1,500 long x 390mm wide - pair	
DA5600	Fibreglass bridging ladders	1,200 long x 270 wide x 50mm deep - pair	Blue with gritted surface for extra traction
DA5601	Fibreglass bridging ladders	1,220 long x 270 wide x 38mm deep - pair	Grey with gritted surface for extra traction

LAND METERS



DA1003



DA1004

- > Independent twin meter
- > Convenient for seeing the pitching and rolling of the vehicle body or terrain
- > Transparent illumination for easy-to-see readings at night

DA1003	Double incline land meter
	Jeep
DA1004	Double incline land meter
	Land Rover

RAISED AIR INTAKE - BRITPART

If you're likely to be driving your Land Rover in circumstances which could mean wading deep water or driving in very dusty conditions then you should consider fitting a raised air intake to your vehicle. This version from Britpart is a classic mushroom-top snorkel for Defender. Featuring heavy-duty metal pipe work, cyclone pre-cleaner and a durable attractive matt black finish

DA2225 Defender - 300Tdi/Td5

PHD500340 Defender - 2007 onwards

NRC6920 Raised air intake cleaner



NRC6920



DA2225



Be prepared for the **unexpected**
with off-road equipment from **Britpart!**

RAISED AIR INTAKES - SAFARI

Pioneered in Australia in the early 1980's, Safari Snorkels were born out of a need to protect 4WD engines from the hazards of dust and water commonly encountered in touring and off road applications. Safari snorkels are manufactured to the highest standards in durable, UV stable, cross linked polyethylene material, using stainless steel hardware where appropriate. Each system includes quality fixtures and fittings, which offer superior sealing, presentation and long-term durability. In arguably the best, if not toughest environment, Safari Snorkel Systems are thoroughly researched, tested and tooled for each model of Land Rover. The Safari Snorkel delivers a continuous and cooler supply of air for maximum engine performance. It is positively sealed as well to ensure the best protection against deep water crossings and dust.



DA3024

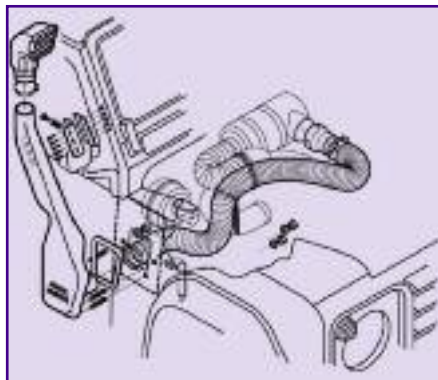

DA3025

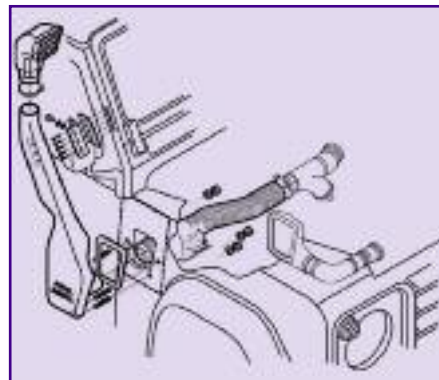

DA3026

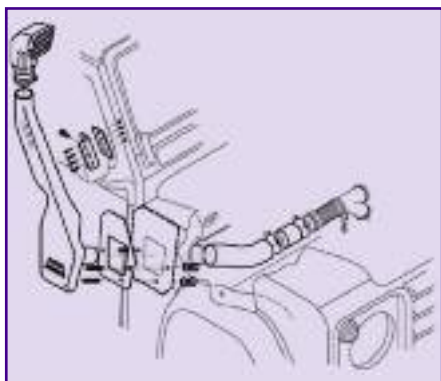

DA3027

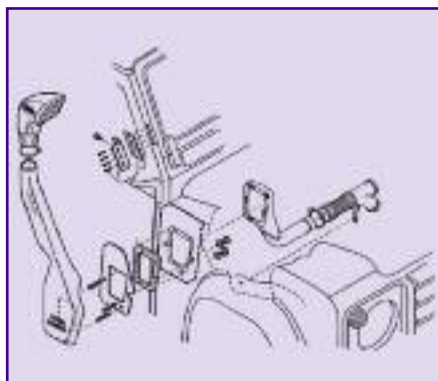

DA3027LH



DA2374



DA3141/DA3142

Defender

DA3024	200Tdi 1990 - 1994	LHS
DA3025	V8 1984 - 1994	RHS
DA3026	300Tdi 1994 - 1999	RHS
DA3027	Td5 1999 onwards - right hand drive	RHS
DA3027LH	Td5 1999 onwards - left hand drive	RHS
DA3069	2007 onwards	RHS
DA2374	Stainless steel air ram grille (shown attached to air ram - grille only)	
DA3141	3" replacement air ram for DA3024	
DA3142	3 1/2" replacement air ram for DA3025, DA3026, DA3027, DA3027LH	

Note - Fitment from seated internal view - RHS - right hand side and LHS - left hand side.

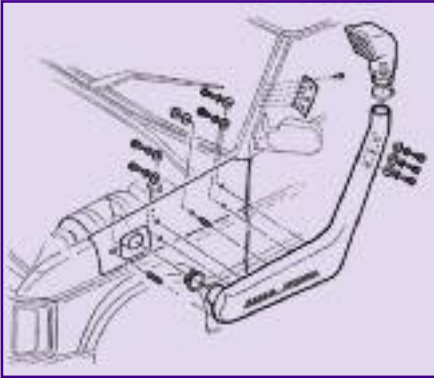
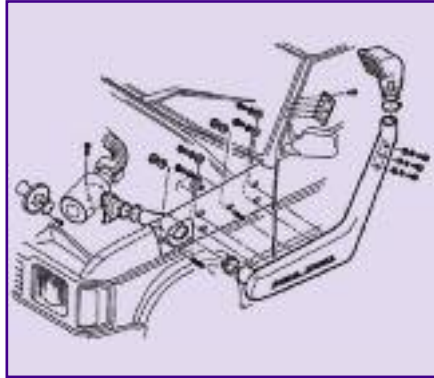
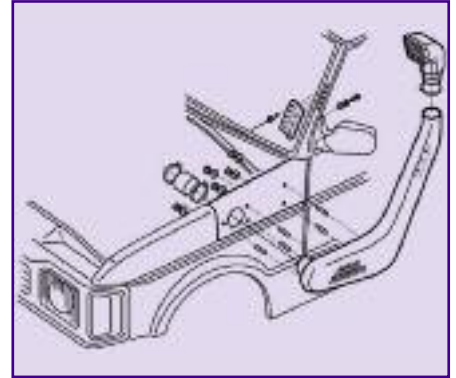
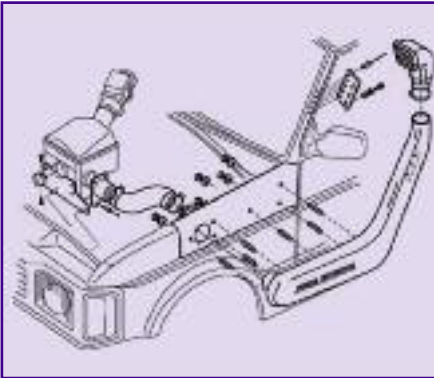
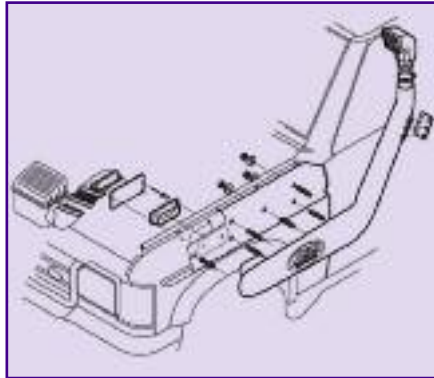
RAISED AIR INTAKES - SAFARI - continued**DA3015****DA3018****DA3020****DA3022****DA3023****DA2374****DA3141/DA3142****DA3021****Discovery**

DA3015	Discovery 1	200Tdi - 1990-1994	LHS
DA3018	Discovery 1	V8 1990 - 1994	LHS
DA3020	Discovery 1	300 Tdi (none EGR)/V8 - 1994-1999 - Non ABS	LHS
DA3022	Discovery 1	300 Tdi (none EGR)/V8 - 1994-1999 - ABS	LHS
DA3023	Discovery 2	Td5/V8 - 1999 on	LHS
DA3021	Discovery 3	TdV6 SE	RHS
DA2374	Stainless steel air ram grille (shown attached to air ram - grille only)		
DA3141	3" replacement air ram for DA3015, DA3018, DA3020, DA3022, DA3023		
DA3142	3 1/2" replacement air ram for DA3021		

Note - Fitment from seated internal view - RHS - right hand side and LHS - left hand side



BE PART OF IT!

ROOF TENTS

Britpart are proud to be the sole European distributor for Echo roof top tents. They are the only heavy-duty tents available with convenient one-piece pitching and self-support.

Roof Top Tents

- > Manufactured from washable UV-varnished PVC canvas with welded seams.
- > 100% waterproof and they have been tested to withstand extreme weather conditions.
- > Ample ventilation is provided by having windows and doors on each side and each is covered with insect netting.
- > Maintenance-free floor - constructed from lightweight aluminium.
- > Comfort is ensured with a 60mm two-layer laminated foam mattress.
- > Removable two-section ladder provides easy access.
- > Quick and easy to store with the fold-up bungee system with dust cover.

'T' Top Tents

The same superior quality design as the above Roof Top Tents but with a unique designed versatile tent that allows access into the main rooftop from inside the tent. The bottom tent has 4 roll-up side panels which could be used as awnings and as doors to access your vehicle from inside the tent. Easy to open and close, no maintenance.



DA2501 - with add-on room not fitted

DA2500

Roof top tent - inc condensation sheet

Open - 1,300 x 2,400mm;

Closed - 1,300 x 1,200mm

DA2501

'T' Top tent - inc add-on room &

condensation sheet

Open - 1,300 x 2,600mm;

Closed - 1,300 x 1,200mm



DA2501 - Alternative fitting option with add-on room opened out

They are the only **heavy-duty** tents available with convenient one-piece pitching and self-support.



DA2501 - alternative fitting option



DA2501 - with add-on room fitted



DA2500

IN THIS SECTION....

WINCHING EQUIPMENT

Batteries - Optima	83
Britpart winch - DB12000i	84
Britpart winch - DB9500i	84
Britpart winch - DB9000C	85
Britpart winch - DB8000	85
Britpart winch - DB6000	86
Britpart winch - DB2000	86
Warn winches	87
Winch bumper kits	87
Winch bumpers	88
Winch spare parts	89
Winching accessories	90-92
Winching accessory kits	92



Get to where you want to go!



BATTERIES - OPTIMA

OPTIMA
BATTERIES
THE ULTIMATE POWER SOURCE™



DB1018	Yellow Top	Top terminals
DB1019	Red Top	Top terminals
DB1020	Yellow Top	Side terminals
DB1021	Red Top	Side terminals

Yellow Top

Demand more from your vehicle? Then get more from your battery. Optima Yellow Top batteries are made for the extremes. If your vehicle is designed to take the abuse of off-road driving, you need increased performance and reliability from your battery. Optima batteries combine patented Spiralcell® Technology to deliver that performance. The deep cycle characteristics of this technology coupled with its extreme resistance to vibration provides performance vehicles with the repetitive power they need, packaged in a spill-proof compact design.

If your vehicle is fitted with high drain accessories such as additional lighting, tracking devices, ICE systems, winches, hydraulics etc, then this ultimately demands more from your battery. Optima Yellow Top batteries provide the extra performance and deep cycling capability that your vehicle demands.



DB1018



DB1020

With its patented Spiralcell® Technology, Optima batteries offer 15 times the vibration resistance and up to twice the life of ordinary batteries. The Optima is like no other battery found in today's market. Optima's unique patented Spiralcell® design offers the best technology by providing a strong and clean power source that far surpasses any of today's traditional lead acid batteries. With Optima as your choice, you can count on a longer lasting battery.

> Twice the life of ordinary batteries

> 15 times the vibration resistance



DB1019



DB1021

Red Top

Optima Red Top batteries are built to withstand the abuse 4x4's experience on and off-road. Spiralcell® Technology immobilises the internal components of the battery, enabling Optima batteries to withstand incredible amounts of vibration.

Vehicles modified for improved engine performance demand more from a battery. Optima batteries withstand the high engine bay temperatures associated with these performance vehicles. The sealed construction makes the battery spill-proof, even if you install it on its side! This prevents external gassing and leaking which can damage engine components and reduce battery performance.

If your battery is used in applications that demand extra reliability endurance and performance, or if you just take pride in getting the best performance out of your vehicle, Optima Red Top batteries deliver the performance you demand.

BE PART OF IT!

BRITPART WINCH - DB12000i - 12 & 24 VOLT



DB12000i

Features

- > 3.6Kw (4.8Hp) heavy duty series wound DC motor
- > Weather and dustproof contactor controls for longer life and improved amperage draw
- > Planetary gear system for fast line speed
- > Automatic load-holding brake
- > Free spooling
- > Power in and power out
- > Low electric current
- > Hardened drum
- > Thermal overload protection

Specification

- > Rated line pull - single line 5,443kgs 12,000lbs
- > Gear reduction ratio 294:1
- > Motor (series wound) 3.6Kw 4.8Hp
- > Drum size (D x L) 63 x 228mm 2.5 x 9"
- > Cable supplied 9.53mm x 30.5m 3/8" x 100'
(Galvanised aircraft cable with minimum break force 14,400lbs)
- > Overall dimension (L x W x H) 548 x 160 x 254mm 21.57 x 6.3 x 10"
- > Net weight 41.7kgs 92.0lbs
- > Mounting bolt pattern 254 x 114.3mm 10 x 4.5"

Performance of 1st Layer

Line Pull		Line Speed				Motor Current	
		12 volt		24 volt		12 volt	24 volt
Lbs	Kgs	Fpm	Mpm	Fpm	Mpm	Amp	Amp
0	0	14.60	4.45	16.40	5.00	90	58
2,000	907	12.81	3.90	14.43	4.40	145	95
4,000	1,814	9.68	2.95	12.46	3.80	185	120
6,000	2,722	7.90	2.41	10.83	3.30	230	160
8,000	3,629	7.07	2.15	9.50	2.90	270	190
10,000	4,536	5.06	1.54	7.87	2.40	315	230
12,000	5,443	4.45	1.36	5.90	1.80	375	280

Line Pull & Cable Capacity by Layer

Cable Layer	Rated Line Pull		Cable Capacity	
	Lbs	Kgs	Feet	Meters
1	12,000	5,443	15	5.0
2	10,200	4,627	38	11.5
3	8,400	3,810	64	19.5
4	7,300	3,310	95	29.0
5	6,500	2,948	100	30.5

DB12000i Britpart Pulling Power 12,000lbs 12 volt winch
DB12000i24 Britpart Pulling Power 12,000lbs 24 volt winch

BRITPART WINCH - DB9500i - 12 & 24 VOLT



DB9500i

Features

- > 3.6Kw (4.8Hp) heavy duty series wound DC motor
- > Weather and dustproof contactor controls for longer life and improved amperage draw
- > Hardened drum
- > Planetary gear system for fast line speed
- > Free spooling
- > Automatic load-holding brake
- > Low electric current
- > Power in and power out
- > Thermal overload protection

Specification

- > Rated line pull - single line 4,309kgs 9,500lbs
- > Gear reduction ratio 212:1
- > Motor - series wound 3.6Kw 4.8Hp
- > Drum size (D x L) 63 x 228mm 2.5 x 9"
- > Cable supplied 9.53mm x 30.5m 3/8" x 100'
(Galvanised aircraft cable with minimum break force 14,400lbs)
- > Overall dimension (L x W x H) 548 x 160 x 254mm 21.57 x 6.3 x 10"
- > Net weight 41.7kgs 92.0lbs
- > Mounting bolt pattern 254 x 114.3mm 10 x 4.5"

Performance of 1st Layer

Line Pull		Line Speed				Motor Current	
		12 volt		24 volt		12 volt	24 volt
Lbs	Kgs	Fpm	Mpm	Fpm	Mpm	Amp	Amp
0	0	18.70	5.70	21.30	6.50	85	58
2,000	907	13.12	4.00	16.70	5.10	150	110
4,000	1,814	10.50	3.20	13.12	4.00	210	135
6,000	2,722	7.90	2.41	10.17	3.10	270	185
8,000	3,629	5.91	1.80	7.71	2.35	320	220
9,500	4,309	4.32	1.32	5.90	1.80	365	240

Line Pull & Cable Capacity by Layer

Cable Layer	Rated Line Pull		Cable Capacity	
	Lbs	Kgs	Feet	Meters
1	9,500	4,309	15	5.0
2	7,500	3,402	38	11.5
3	6,200	2,812	64	19.5
4	5,300	2,404	95	29.0
5	4,630	2,100	100	30.5

DB9500i Pulling Power 9,500lbs 12 volt winch
DB9500i24 Pulling Power 9,500lbs 24 volt winch

BRITPART WINCH - DB9000C**Features**

- > 3.3Kw (4.5Hp) permanent magnet motor
- > Dustproof contactor controls for longer life and improved amperage draw
- > Low electric current
- > Planetary gear system for fast line speed
- > Free spooling
- > Automatic load-holding brake
- > Power in and power out
- > Hardened drum

Specification

- > Rated line pull - single line 4,082kgs 9,000lbs
- > Gear reduction ratio 212:1
- > Motor (permanent magnet) 3.3Kw 4.5Hp
- > Drum size (D x L) 63 x 228mm 2.5 x 9"
- > Cable supplied 9.53mm x 30.5m $\frac{3}{8}$ " x 100'
(Aircraft cable with minimum break force 14,400lbs)
- > Overall dimension (L x W x H) 560 x 160 x 280mm 22 x 6.3 x 11"
- > Net weight 38.0kgs 84.0lbs
- > Mounting bolt pattern 254 x 114.3mm 10 x 4.5"

**DB9000C****Performance of 1st Layer**

Line Pull		Line Speed		Motor Current
Lbs	Kgs	Fpm	Mpm	Amp
0	0	13.0	4.0	30
4,000	1,814	7.5	2.3	130
6,000	2,722	6.3	1.9	180
8,000	3,629	5.0	1.5	240
9,000	4,082	4.3	1.3	300

Line Pull & Cable Capacity by Layer

Cable Layer	Rated Line Pull		Cable Capacity	
	Lbs	Kgs	Feet	Meters
1	9,000	4,082	15	5.0
2	7,300	3,311	38	11.5
3	6,200	2,812	64	19.5
4	5,400	2,449	95	29.0
5	4,200	1,905	100	30.5

DB9000C Britpart Pulling Power 9,000lbs 12 volt winch**Don't forget!**

When fitting a winch to a Defender don't forget to order the extended winch wiring kit with cut-off switch. **DB1014**

BRITPART WINCH - DB8000**Features**

- > 3.0Kw (4.1Hp) heavy duty electric permanent magnetic DC motor
- > Weather and dustproof contactor controls for longer life and improved amperage draw
- > Hardened drum
- > Planetary gear system for fast line speed
- > Free spooling
- > Automatic load-holding brake
- > Low electric current
- > Power in and power out

Specification

- > Rated line pull - single line 3,632kgs 8,000lbs
- > Gear reduction ratio 210:1
- > Motor - perm. magnet - 12v 3.0Kw 4.1Hp
- > Drum size (D x L) 63 x 228mm 2.5 x 9"
- > Cable supplied 9.53mm x 30.5m $\frac{3}{8}$ " x 100'
(Galvanised aircraft cable with minimum break force 14,400lbs)
- > Overall dimension (L x W x H) 564 x 179 x 295mm 22.2 x 7.0 x 11.6"
- > Net weight 36kgs 80lbs
- > Mounting bolt pattern 254 x 114.3mm 10 x 4.5"

**DB8000****Performance of 1st Layer**

Line Pull		Line Speed		Motor Current
Lbs	Kgs	Fpm	Mpm	Amp
0	0	8.2	2.5	35
2,000	900	7.8	2.4	100
4,000	1,810	7.2	2.2	180
6,000	2,710	6.5	2.0	230
8,000	3,620	5.0	1.5	300

Line Pull & Cable Capacity by Layer

Cable Layer	Rated Line Pull		Cable Capacity	
	Lbs	Kgs	Feet	Meters
1	8,000	3,620	15	5.0
2	6,335	2,876	38	11.5
3	5,243	2,380	64	19.5
4	4,473	2,030	95	29.0
5	3,900	1,770	100	30.5

DB8000 Britpart Pulling Power 8,000lbs 12 volt winch**BE PART OF IT!**

BRITPART WINCH - DB6000



DB6000

Features

- > 2.7Kw (3.6Hp) permanent magnet motor
- > Dustproof contactor controls for longer life and improved amperage draw
- > Planetary gear system for fast line speed
- > Free spooling
- > Low electric current
- > Automatic load-holding brake
- > Power in and power out

Specification

- > Rated line pull - single line 2,724kgs 6,000lbs
- > Gear reduction ratio 210:1
- > Motor (permanent magnet) 2.7Kw 3.6Hp
- > Drum size (D x L) 63 x 140mm 2.5 x 5.51"
- > Cable supplied 7.94mm x 26m 5/16" x 85'
(Aircraft cable with minimum break force 10,000lbs)
- > Dimensions (L x W x H) 438 x 158 x 185mm 17.24 x 6.22 x 7.28"
- > Net weight 31.8kgs 70.0lbs
- > Mounting bolt pattern 166 x 114.3mm 6.535 x 4.5"

DB6000 Britpart Pulling Power 6,000lbs 12 volt winch

Performance of 1st Layer

Line Pull		Line Speed		Motor Current
Lbs	Kgs	Fpm	Mpm	Amp
0	0	15.0	4.6	30
1,000	454	11.5	3.5	80
3,000	1,361	9.0	2.7	120
5,000	2,268	7.0	2.0	170
6,000	2,722	4.9	1.5	210

Line Pull & Cable Capacity by Layer

Cable Layer	Rated Line Pull		Cable Capacity	
	Lbs	Kgs	Feet	Meters
1	6,000	2,722	12.7	3.87
2	5,000	2,268	27.5	8.38
3	4,250	1,928	44.0	13.41
4	3,720	1,687	64.0	19.51
5	3,330	1,497	85.0	25.91

Get to where you want to go!



BRITPART WINCH - DB2000



DB2000

Features

- > 1.0Kw (1.5Hp) heavy duty electric permanent magnetic motor
- > Planetary gear system for fast line speed
- > Free spooling
- > Power in and power out
- > Low electric current
- > Tension plate to prevent rope entanglement

Specification

- > Rated line pull - single line 907kgs 2,000lbs
- > Gear reduction ratio 153:1
- > Motor - perm. magnet - 12v 1.0Kw 1.5Hp
- > Drum size (D x L) 32 x 71mm 1.26 x 2.8"
- > Cable supplied - 4mm x 15.2m 5/32" x 50'
(minimum break force 4,000lbs)
- > Dimension (L x W x H) 320 x 105 x 110.5mm 12.6 x 4.13 x 4.35"
- > Net weight 6.6kgs 14.6lbs
- > Mounting bolt pattern 48 x 76mm 1.89 x 3"

DB2000 Britpart Pulling Power 2,000lbs 12 volt winch

Performance of 1st Layer

Line Pull		Line Speed		Motor Current
Lbs	Kgs	Fpm	Mpm	Amp
0	0	14.0	4.3	14
1,000	454	9.0	2.7	60
1,500	680	7.5	2.3	90
2,000	907	5.9	1.8	115

Line Pull & Cable Capacity by Layer

Cable Layer	Rated Line Pull		Cable Capacity	
	Lbs	Kgs	Feet	Meters
1	2,000	907	6	1.8
2	1,636	742	13	4.0
3	1,385	628	22	6.7
4	1,200	544	33	10.0
5	1,059	480	44	13.4
6	947	430	50	15.2

WARN WINCHES



Other Warn winches available on request - please ask for details.

DA2212
Warn 9500Ti
DA2247
Winch cover - Warn HS95/XD9/M8/M6



DA2212



WINCH BUMPER KITS



DB1310



DB1319



DB1320



DB1324/DB1325

DB1310	Defender - non air-con	Standard bumper	9500i winch	Extended wiring kit including safety cut-off switch
DB1313	Defender - non air-con	Standard bumper	12000i winch	Extended wiring kit including safety cut-off switch
DB1319	Defender - non air-con	Tubular bumper	12000i winch	Extended wiring kit including safety cut-off switch
DB1321	Defender - air-con	Tubular bumper	12000i winch	Extended wiring kit including safety cut-off switch
DB1320	Discovery 1	Tubular bumper	12000i winch	
DB1324	Discovery 1/Range Rover Classic	Heavy-duty bumper	9500i winch	
DB1325	Discovery 1/Range Rover Classic	Heavy-duty bumper	12000i winch	

WINCH BUMPERS



DA5604



DA5609



DA5623



DA5643



Winch and A Bar not included

DA5620

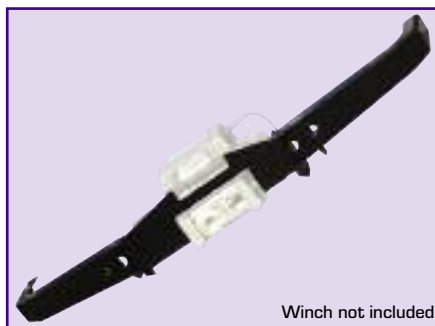

Winch not included

DA5621



DA5622

A range of winch bumpers to suit your vehicle!

DA5604

- > Stylish tubular steel space-frame construction for strength to fit Discovery 1
- > Suitable for DB12000i, DB9500i, DB9000C & DB8000 winches
- > Extremely close fitting for maximum approach angle
- > Compatible with many steering guards
- > Integral rock guard
- > Built in high-lift jacking points
- > Supplied with full fitting

DA5609

- > Stylish tubular steel space-frame construction for strength to fit Defender with air con
- > Suitable for DB12000i, DB9500i, DB9000C & DB8000 winches
- > Extremely close fitting for maximum approach angle
- > Compatible with many steering guards
- > Integral rock guard
- > Built in high-lift jacking points
- > Supplied with full fitting

DA5620

- > Heavy duty steel winch bumper for Defender
- > Suitable for DB12000i, DB9500i & DB9000C winches

DA5623

- > Heavy duty steel winch bumper for Defender with air con
- > Suitable for DB12000i, DB9500i & DB9000C winches

DA5621

- > Heavy duty steel winch bumper for Discovery 1 & Range Rover Classic
- Note - not suitable for V8 automatic vehicles
- > Suitable for DB12000i, DB9500i, DB9000C & DB8000 winches

DA5622

- > Stylish tubular steel space-frame construction for strength to fit Defender - no air con
- > Suitable for DB12000i, DB9500i, DB9000C & DB8000 winches
- > Extremely close fitting for maximum approach angle
- > Compatible with many steering guards
- > Integral rock guard
- > Built in high-lift jacking points
- > Supplied with full fitting

DA5643

- > Heavy duty steel winch bumper for Defender with air-con
- > Suitable for Warn 9000 and 9.5 Series winches

WINCH SPARE PARTS**DB1300****DB1301****DB1302****DB1303****DB1304****DB1305****DB1307****DB1326****DB1328**

DB1300	Winch motor - suitable for DB9500i & DB12000i
DB1301	Winch motor - suitable for DB8000
DB1302	Solenoid assembly - suitable for DB8000
DB1303	Solenoid assembly - suitable for DB9500i & DB12000i
DB1304	Brake service kit - suitable for DB9500i & DB12000i
DB1305	Thermal switch - suitable for DB9500i & DB12000i
DB1307	Roller fairlead - suitable for DB8000, DB9500i & DB12000i
DB1326	Remote control - with 15mm socket - suitable for DB8000, DB9500i & DB12000i
DB1327	Remote control - with 20mm socket - suitable for DB8000, DB9500i & DB12000i
DB1328	Replacement winch cable with hook - 30.5m x 9.5mm

**BRITPART DB2000 FITTED TO A WORKING MODEL OF A LAND ROVER***BE PART OF IT!*

WINCHING ACCESSORIES



DB1003



DB1004



DB1005



DB1315



DB1316



DB1317

Fairleads

DB1003	Hawse fairlead Mounting holes 255mm, large aperture
DB1004	Hawse fairlead Mounting holes 255mm, medium aperture
DB1005	Hawse fairlead - mounting holes 125mm
DB1315	Hawse fairlead - aluminium
DB1316	Roller fairlead - stainless steel
DB1317	Hawse fairlead - stainless steel

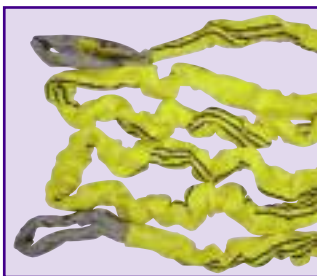

DA3014



DB1006



DB1011



STC8919AA



DA3028



DA3030



DA3034



DB1007

Ropes & Strops

DA2246	Tow strop	2t WLL	5m x 60mm
DA3014	4WD towing sling		4m
DB1006	Tow strap - 60mm x 9 metre with a breaking strength of 8,000kgs and reinforced eyes		
DB1011	High elasticity tow sling - 9 metre with a 10 ton pulling capacity. Complete with reinforced eyes and overload warning tag.		
STC8919AA	Tow strap Discovery 3/Range Rover L322/Range Rover Sport		
DA3028	Rope - polypropylene	2t WLL/8t MBL	5m x 24mm
DA3029	Rope - nylon	2t WLL/12t MBL	5m x 24mm
DA3030	Kinetic recovery rope - octoplait	2t WLL/12t MBL	5m x 24mm
DA3031	Kinetic recovery rope - octoplait	2t WLL/12t MBL	8m x 24mm
DA3032	Tree strop	2t WLL/14t MBL	3m x 90mm
DA3033	Tree strop	2t WLL/14t MBL	4m x 90mm
DA3034	Tree strop	2t WLL/14t MBL	6m x 90mm
DB1007	Tree protection belt - 1.6 metre 4 ton		

Note -
WLL = working load limit (lifting)
MBL = minimum breaking load

WINCHING ACCESSORIES - continued

DA3160



DB1002



DB1008



DB1009



DB1012



DB1322

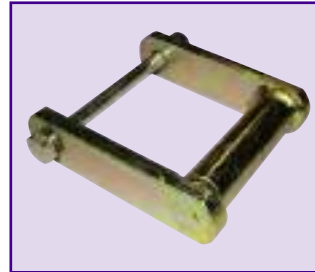

DB1323



DB1329

Shackles & Pulleys

DA3160	Swivel recovery eye - stainless steel. Note - not suitable for standard Land Rover bumpers
DB1002	Snatch block - high quality tempered steel suitable for winch ropes from 5mm to 10mm. Maximum head load - 16,000lbs
DB1008	Pulley hook - SWL loads 1,500kgs for pulling, 750kgs for lifting
DB1009	Shackle - 1.4 ton
DB1012	Shackle - 4.7 ton
DB1322	Swivel shackle
DB1323	Non-forged jate ring
DB1329	Forged jate ring



More winching accessories over the page...



DA2037



DA3156



DB1000



DB1010

Safety Equipment

DA2037	Battery isolator switch universal
DA3156	Winch in safety book
DB1000	Wheel chocks - pair
DB1010	Gloves - for protection winch operation
DB1016	Winch blanket - manufactured from heavy-duty vinyl, the blanket will absorb most of the recoil in the unlikely event of the cable breaking. It's also very useful to kneel on in the mud!



DB1016

WINCHING ACCESSORIES - continued



DB1001



DB1014



DB1318

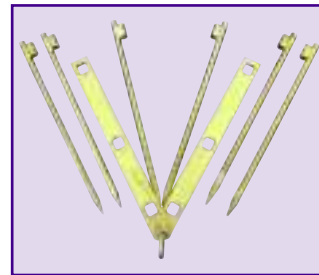

DB1314



DB1013



DB1328

Get to where you want to go!

Other Essential Winching Accessories

- DB1001** Winch bag - a heavy-duty black and green bag
- DB1013** 12 Strand plasma winch line - 9.5mm (3/8"), 17,500lbs NBS x 100ft (30.5m). Supplied fully finished with a galvanised tube thimble, large safety hook and 2m of heavy-duty black rock guard.
- DB1014** Extended winch wiring kit - 1 x red, 1 x black wire, each 1.8m in length with end connectors and cut-off switch for Defender vehicles
- DB1314** Ground anchor set
- DB1318** Ground anchor bag set - 2 x Pulling Power bags, ground anchor not included (DA1314)
- DB1328** Replacement winch cable with hook 30.5m x 9.5mm

WINCHING ACCESSORY KITS



DB1017

DB1017 Contents -

- 1 x DB1001 Winch kit bag
- 1 x DB1002 Snatch block - 16,000lbs
- 1 x DB1006 Tow strap - 8 ton, 60mm x 9m
- 1 x DB1007 Tree strop
- 1 x DB1010 Winching gloves
- 2 x DB1012 Alloy bow shackle - 4.75 ton



DB1015

DB1015 Contents - as per DB1017 plus

- 1 x DB1000 Wheel chocks (pair)
- 1 x DB1011 Snatch tow sling - 10 ton
- 1 x DB1016 Winching blanket

Britpart Pulling Power winching recovery kits come with all the basic items needed to ensure your winch can be used to the best effect. There is a choice of a starter or professional kit depending on your needs.



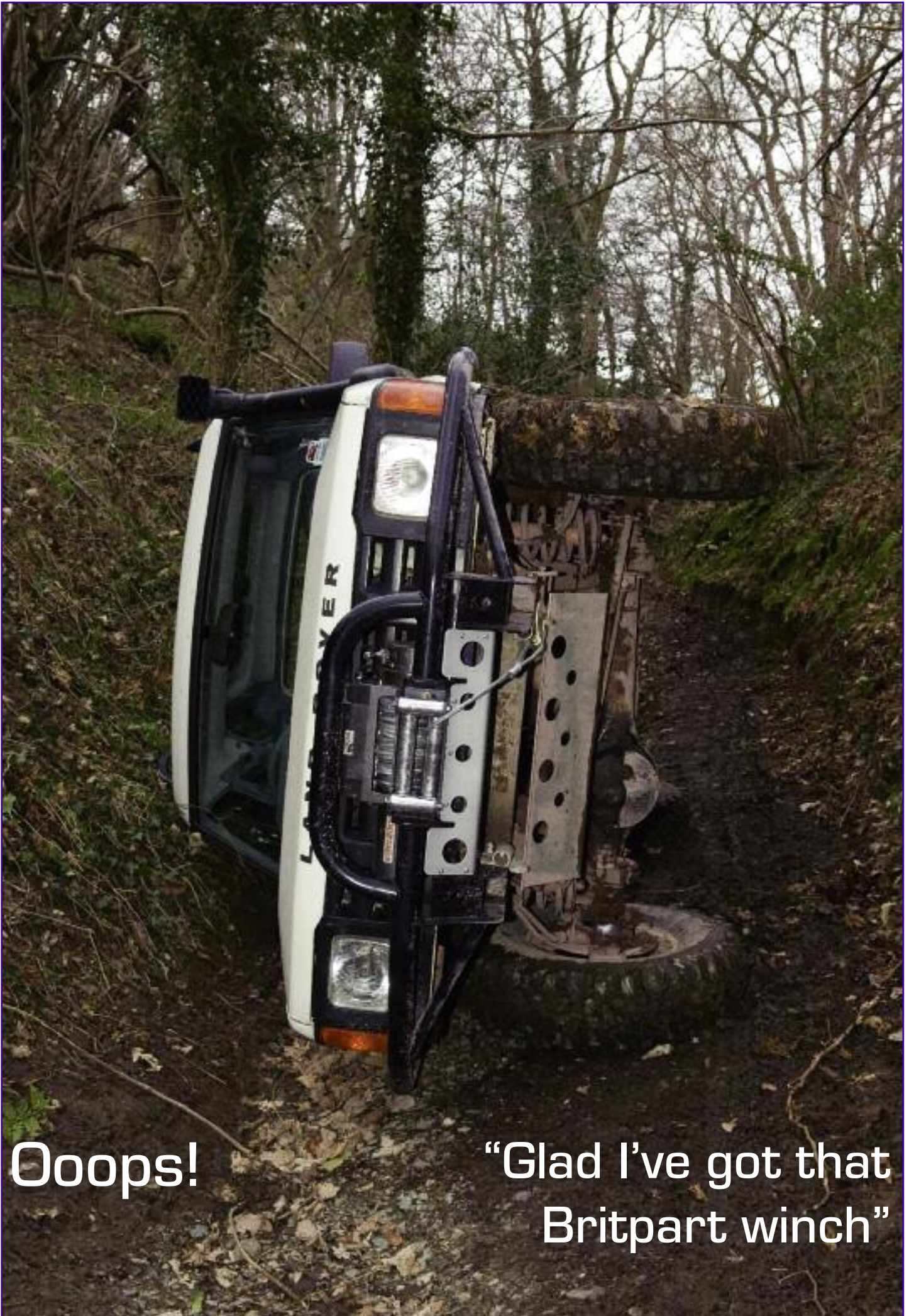

Ooops!

“Glad I’ve got that
Britpart winch”



Picture courtesy of Kristjan Kristjansson

IN THIS SECTION....

PERFORMANCE EQUIPMENT

Air filters - Britpart	95
Air filters - K&N	96
Brake hose kits	97
Britpart performance discs	98
EBC brake parts	98-100
Handbrake conversion kits	100
Hiclone	101
Intercoolers - performance	102
PSI power tuning products	103
Tunit diesel tuning products	103
Weber carburetors	104



AIR FILTERS - BRITPART

DA3138 Series 3 - 4-cylinder - fits Zenith and Weber carbs

DA3139 Corresponds to PHE000112

Discovery 3 - 2.7 V6 diesel, 4.0 V6 petrol
& 4.4 V8 petrol

Range Rover Sport - 2.7 V6 diesel, 4.0 V6 petrol
& 4.4 V8 petrol

DA4260 Corresponds to ESR4238

Defender 90/110/130 - 2.5 Td5 1999 - 2007

Discovery 2 - Td5 1999 - 2004

Discovery 2 - 4.0i 1999 - 2004

Freelander 1 - V6 petrol

Range Rover P38 - 2.5DSE diesel

[BMW engine] 1998 - 2002

Range Rover P38 - 4.0i V8 1994 - 2002

Range Rover P38 - 4.6i V8 1994 - 2002

DA4261 Corresponds to ESR1445

Discovery 1 - 2.0i Mpi petrol

Discovery 1 - 2.5 300Tdi 1994 - 1997

Discovery 1 - 3.9i V8 1994 - 1997

Range Rover Classic - 2.5 300Tdi 1992 - 1994

Range Rover Classic - 3.9i V8 Efi 1994

DA4262 Corresponds to NTC1435 & ESR2623

Defender 90/110/130 2.5 300Tdi 1994 - 1997

Discovery 1 - 2.5 200Tdi 1989 - 1992

Range Rover Classic - 2.4D VM Turbo 1986 - 1992

Range Rover Classic - 2.5D VM Turbo 1986 - 1992

DA4266 Range Rover Classic - 3.5 carb V8

Cone type - replaces 605191 - 2 filters required

DA4269 Corresponds to NRC9238

Defender 90/110/130 - 2.5 petrol 1983 - 1990

Defender 90/110/130 - 2.5 D & Td 1983 - 1990

DA4270 Corresponds to NTC6660

Defender 90/110/130 - 2.5 200Tdi 1990 - 1993

DA4272 Range Rover Classic - 3.5 carb V8

Cone type off-road extreme power filter
2 filters required

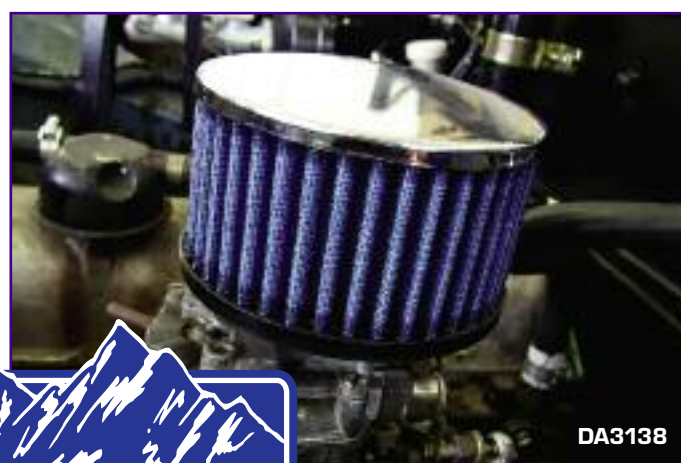

DA3138



- > A range of performance filters tailored to fit your Land Rover
- > Maximum breathing efficiency for your engine means more power or better fuel mileage

- > No compromise on quality - the engine gets more air but the dirt particles are trapped by the quality filters
- > No need to replace as easy cleaning means maximum performance guaranteed
- > Easy fit, directly replaces standard air filter
- > Ideal for use in hot dusty conditions to reduce engine wear
- > Compatible with snorkels, ideal for use in conjunction with other performance modifications
- > Filters don't need pre-oiling and if the filter gets dirty there is no need to use a cleaner to clear the dirt on the filter - just use air, water or detergent

More part numbers available during 2009!



Increase your Land Rover's performance with a new Britpart Peak Performance air filter!

DA4272

BE PART OF IT!

AIR FILTERS - K&N



K&N's lifetime replacement air filters are designed to increase horsepower and acceleration while providing excellent filtration. These filters are custom designed to fit into the existing factory air box. Their drop-in design means adding performance is simple. Simply remove the disposable air filter and replace it with a K&N; there is NEVER any cutting or fitting required.

- DA4259** Corresponds to PHE000040
Range Rover L322 - Td6

- DA4263** Corresponds to PHE100500L
Freelander 1 - 2.0 Td4 (BMW engine) 2001 - 2006

- DA4264** Corresponds to ESR1049
Discovery 1 - 2.5 200Tdi 1992 - 1994
Range Rover Classic - 2.5 200Tdi - 1992 - 1994

- DA4265** Corresponds to ESR341
Range Rover Classic - 4.0i V8 1990 - 1995
Range Rover Classic - 4.2i V8 1990 - 1995
Range Rover Classic - 4.6i V8 1990 - 1995
Range Rover P38 - 2.5DSE diesel
(BMW engine) 1994 - 1997

- DA4267** Corresponds to ESR4103
Freelander 1 - 1.8 16v 1997 - 2000
Freelander 1 - 2.0i Td4 diesel
(Rover engine) 1997 - 2000

- DA4268** Corresponds to RTC4683
Discovery 1 - 3.5i V8 Efi 1990 - 1993
Range Rover Classic - 3.5i V8 Efi 1985 - 1989
Range Rover Classic - 3.9i 1989 - 1994

- DA4271** Corresponds to ESR4238
Defender 90/110/130 - 2.5 Td5 1999 - 2007
Discovery 2 - Td5 1999 - 2004
Discovery 2 - 4.0i 1999 - 2004
Freelander 1 - V6 petrol
Range Rover P38 - 2.5DSE diesel
(BMW engine) 1998 - 2002
Range Rover P38 - 4.0i V8 1994 - 2002
Range Rover P38 - 4.6i V8 1994 - 2002

- DA4273** Range Rover Classic - 3.9i Efi 1989 - 1992
Cone type. Includes hose and fixing kit

- DA4274** Corresponds to 605191
Series 3 - 109 3.5 V8 1979 - 1982
2 filters required
Discovery 1 - 3.5 V8 carb 1989 - 1990
2 filters required
Range Rover Classic - 3.5 V8 carb 1972 - 1986
2 filters required

K&N Dirt Retention Lubricating Oil

- DA4275** K&N Oil - 200ml Aerosol
 - DA4276** K&N Oil - 250ml Bottle
-
- ### K&N Cleaning Solution
- DA3136** 1ltr Bottle
 - DA3137** Cleaning Kit
200ml cleaning fluid & 200ml lubricating oil



DA4275



DA4276



DA3136



DA3137



Looking for Range Rover parts? Britpart have an extensive range!

BRAKE HOSE KITS

	Standard		Plus 40mm	
	Goodridge	Britpart Stainless Steel	Goodridge	Britpart Stainless Steel
Defender 90				
1984 to 1998 WA159806		DA2400S		DA240040S
1999 to 2004 from XA159807 metric non abs	DA2401	DA2401S	DA240140	DA240140S
Defender 110				
1983 to 1998 WA159806		DA2402S		DA240240S
Discovery 1				
1989 to 1992 to JA034313	DA2410	DA2410S		DA241040S
1992 to 1995 KA034314 to LA081991	DA2411	DA2411S	DA241140	DA241140S
1995 to 1999 from MA018992 non-abs	DA2412	DA2412S		DA241240S
1995 to 1999 from MA018992 abs	DA2413	DA2413S	DA241340	DA241340S
Discovery 2				
ABS		DA2414S		DA241440S
Range Rover Classic				
Up to 1981 UNF non-abs			DA240340	DA240340S
1981 to 1990 metric non-abs				DA240440S
107 up to 1981 UNF non-abs			DA240540	
1990 to 1992 abs			DA240640	DA240640S
1992 abs			DA240740	DA240740S
1992 to 1995 non-abs			DA240840	
Range Rover P38				
1995 to 2001		DA2409S		
Series 2 & 3				
88 imperial 1960 to 1979	DA2418	DA2418S	DA241840	DA241840S
88 metric 1980 to 1984	DA2419	DA2419S	DA241940	DA241940S
109 imperial 1971 to 1979 approx	DA2420	DA2420S	DA242040	DA242040S
109 metric 1980 to 1984	DA2421	DA2421S	DA242140	DA242140S

These brakelines are constructed from the finest quality hose, consisting of a PTFE inner and stainless steel overbraid and both the Britpart and Goodridge brands offer -

- > Eliminates sponginess under heavy braking
- > Increases braking efficiency
- > Abrasion and corrosion resistant

> **Increases braking efficiency**

BRITPART

The quality parts for Land Rovers



BRITPART HOSE



GOODRIDGE HOSE



BE PART OF IT!

IMPORTANT BRAKE INFORMATION

For exact change over points with vehicle applications please contact your local Britpart distributor with the full chassis number for the correct application. These references are intended as a guide only!



One of the fleet of Britpart vehicles - delivering to our customers across the UK and Ireland on a daily basis!

BRITPART PERFORMANCE DISCS



DA4600



DA4600 - FITTED

- > Slotted design to increase braking efficiency by reducing dust, debris, water and gas on the disc.
- > To improve brake cooling, reduce weight and to offer an escape route for dirt and gasses these performance discs are drilled with rows of holes.
- > Excellent upgrade for your Land Rover to aid braking, especially under a heavy load.

BRITPART

- > Ideal for off-road use.
- > Manufactured to British Standard BS1452 Grade 220 and DIN1691 GG20.
- > Supplied in pairs.

Quality manufactured slotted brake discs!

DA4600	FRC7329	Front	Defender 1987-2006, 2007->/Discovery 1/Range Rover Classic 1986-1991
DA4601	FTC1381	Rear	Defender 1987-2006, 2007->/Discovery 1/Range Rover Classic 1986-1994
DA4602	FTC902	Front	Defender 1987-2006, 2007->/Discovery 1/Range Rover Classic 1986-1994
DA4603	NTC8780	Front	Range Rover P38 1995-2002
DA4604	SDB000470	Rear	Range Rover P38 1995-2002/Discovery 2
DA4605	SDB000330	Rear	Defender 1987-2006, 2007->
DA4606	SDB000380	Front	Discovery 2
DA4607	SDB100830	Front	Freelander 1 1996-> - up to YA999999
DA4608	SDB101070	Front	Freelander 1 1996-> - from 1A000001

EBC BRAKE PARTS

EBC Discs - Pairs

DA4147	NTC8780	Front	Vented	Range Rover P38 1995-2002
DA4148	NTC8781 & SDB000470	Rear	Solid	Range Rover P38 1995-2002/Discovery 2
DA4151	FTC902	Front	Vented	Defender 1987-2006, 2007->/Discovery 1/Range Rover Classic 1986-1994
DA4152	FTC1381	Rear	Solid	Defender 1987-2006, 2007->/Discovery 1/Range Rover Classic 1986-1994
DA4158	ANR4582 & SDB000380	Front	Vented	Discovery 2
DA4165	FRC7329	Front	Solid	Defender 1987-2006, 2007->/Discovery 1/Range Rover Classic 1986-1991
DA4166	571762	Front	Solid	Range Rover Classic to 1985
DA4167	571912	Rear	Solid	Range Rover Classic to 1985
DA4475	SDB000604	Front	Vented	Discovery 3/Range Rover Sport - various applications
DA4473	SDB000636	Rear	Vented	Discovery 3/Range Rover Sport - various applications
DA4187	SDB000614	Front	Vented	Discovery 3/Range Rover Sport - various applications
DA4188	SDB000646	Rear	Vented	Discovery 3/Range Rover Sport - various applications
DA4472	SDB000211	Rear	Solid	Range Rover L322 - various applications
DA4474	SDB000201	Front	Vented	Range Rover L322 - various applications
DA4476	SDB500193	Front	Vented	Range Rover L322 - various applications
DA4477	SDB101070	Front	Vented	Freelander 1 1996-> - from 1A000001

EBC BRAKES

- > Wide aperture slots that draw cool air under the pad surface.
- > Slots that expel all dirt dust and debris from the braking area.
- > Blind drilled dimples that eliminate cracking common with through drilled sport rotors whilst helping maintain perfect pad contact.
- > Gold zinc corrosion resistant coating.



EBC DISCS

EBC BRAKE PARTS - continued

- > New AF42/66 friction material which completely eliminates brake judder and produces a high friction long lasting brake pad.
- > Unique powder coat finish to both pad and back plate gives lifetime resistance to corrosion and prevents moisture ingress.
- > Unique Brake-In surface coating provides instant brake efficiency on installation and conditions the brake rotor removing glaze, black spotting etc from disc surface.
- > All pads feature centre line slot which prevents heat expansion cracks and reduces brake noise.
- > All pads feature edge chamfers which have major technical benefits;
 - Significant reduction in brake noise
 - Prevents 'edge lifting' under left and right extremities of pad which can cause corrosion ingress and eventual pad de-bond
 - Can extend pad life by virtue of improved pad efficiency
- > Most pads in the Ultimax range features factory fitted noise reduction shims.

*pad sets excludes shims

**EBC HEAVY-DUTY PADS****EBC Ultimax Heavy-duty Pads - Sets**

DA3300	SFP100460	Front	Range Rover P38 1995-2002/Discovery 2
DA3301	SFP500100	Front	Freelander 1 1996-> - from 1A000001
DA3302	SFP100360	Front	Freelander 1 1996-> - up to YA999999
DA3303	SFC500050	Front	Range Rover L322 - various applications
DA3304	SFP500010	Front	Range Rover L322/Range Rover Sport/Discovery 3 - various applications
DA3306	LR004936	Front	Freelander 2
DA3307	STC9186	Front	Range Rover Classic to 1986/Defender 90 to 1986
DA3308*	STC2950	Front	Defender 110 to 1986
DA3309*	STC9187	Front	Range Rover Classic 1986 to 1991/Discovery 1 to 1993
DA3310*	STC2952	Front	Defender 110 from 1986/Defender 90 from 1991
DA3311*	STC9191	Front	Defender 90 1986 to 1991/Discovery 1 from 1994
DA3312*	STC9190	Front	Discovery 1/Range Rover Classic 1986 to 1996 with sensor
DA3313*	STC1601	Rear	Defender 110 from 1994
DA3314	SFP100470	Rear	Range Rover P38 1995-2002/Discovery 2
DA3315	SFP000120	Rear	Range Rover L322 - various applications
DA3316	SFP500140	Rear	Range Rover L322/Range Rover Sport/Discovery 3 - various applications
DA3318	SFP000270	Rear	Range Rover Classic to 1985/Discovery 1 without sensor/Defender 90 from 1994
DA3319*	STC9189	Rear	Range Rover Classic from 1986/Discovery 1 with sensor

IMPORTANT BRAKE INFORMATION For exact change over points with vehicle applications please contact your local Britpart distributor with the full chassis number for the correct application. These references are intended as a guide only!

- > 100% British design and manufacture.
- > Superb gloss powder coat paint finish to reduce corrosion.
- > Unique engineering finish with noise reduction slots and edge chamfers.
- > Extra high friction compounds for better stops, these pads will improve your stopping power by up to three vehicle lengths.
- > Special compound ingredients that prevent "Outline Etching" eliminating brake stiction onto the rotor in damp conditions.
- > Unique "Brake-In" surface coating to accelerate pad bed in after installing new pads which also guarantees brake efficiency from install.
- > Super quiet braking with rubber-steel-rubber noise reduction shims on the reverse, this dampens all possible noise.
- > Extra heavy duty compound lasts longer than low cost standard pads
- > Fully ECE R 90 approved and legal for road and off road use.

**EBC GREEN STUFF PADS****EBC Green Stuff High Performance Pads - Sets**

DA4149	SFP100460 & SFP100480	Front	Range Rover P38 1995-2002/Discovery 2
DA4150	SFP100470 & SFP500130	Rear	Range Rover P38 1995-2002/Discovery 2
DA4153	STC9186 & STC9187	Front	Range Rover Classic to 1986/Defender 90 to 1986
DA4154	STC9189	Rear	Range Rover Classic to 1985/Discovery 1 with sensor/Defender 90 from 1994
DA4155	SFP500200	Rear	Range Rover Classic from 1986/Discovery 1 with sensor
DA4156	STC9190	Front	Discovery 1/Range Rover Classic 1986 to 1996 with sensor
DA4157	STC9191	Front	Defender 90 1986 to 1991/Discovery 1 from 1994
DA4159	STC2952 & SFP000260	Front	Defender 110 from 1986/Defender 90 from 1991
DA4185	STC1601 & SFP000280	Rear	Defender 110 from 1994
DA4478	SFP500100	Front	Freelander 1 1996-> - from 1A000001
DA4479	SFP100360	Front	Freelander 1 1996-> - up to YA999999
DA4480	SFC500050	Front	Range Rover L322 - various applications
DA4481	SFP500010	Front	Range Rover L322/Range Rover Sport/Discovery 3 - various applications
DA4482	SFP500070	Front	Range Rover L322/Range Rover Sport - various applications
DA4483	SFP000120	Rear	Range Rover L322 - various applications
DA4484	SFP500140	Rear	Range Rover L322/Range Rover Sport/Discovery 3 - various applications
DA4485	SFP000270	Rear	Range Rover Classic to 1985/Discovery 1 without sensor/Defender 90 from 1994

EBC
BRAKES
MORE EBC PADS
OVER THE PAGE

EBC BRAKE PARTS - continued

EBC Yellowstuff brake pads are British made with Aramid fibres such as Kevlar and Twaron and are one of the highest friction brake pad compounds on today's market. Not only high in friction from first application when brakes are cold but extremely effective at higher brake temperatures as encountered in faster driving and towing/trailing. These pads are a favourite with the military and are used on armoured vehicles in several countries to handle the higher loads and heat and offer a good brake upgrade. Fitted with shims chamfers, centre slots and the unique EBC Brake in coating for fast bedding in of new brakes these pads are also long lasting and silent in operation.

- > High friction compound
- > Effective from cold up to high heat
- > Effective brake upgrade for heavy duty braking
- > Long lasting powerful brakes
- > Shims, edge chamfers and slots for silent braking



EBC YELLOW STUFF PADS

EBC Yellow Stuff Performance Race Pads - Sets

DA4335	SFP500010	Front	Range Rover L322/Range Rover Sport/Discovery 3 - various applications
DA4336	SFP500150	Front	Range Rover P38 1995-2002/Discovery 2
DA4337	SFP500070	Front	Range Rover L322/Range Rover Sport - various applications
DA4338	SFC500050 & SFC500080	Front	Range Rover L322 - various applications
DA4339	SFP500130	Rear	Range Rover P38 1995-2002/Discovery 2
DA4340	SFP500140	Rear	Range Rover L322/Range Rover Sport/Discovery 3 - various applications
DA4341	SFP500210	Rear	Range Rover L322 - various applications

HANDBRAKE CONVERSION KIT



DA5513

DA5513 Defender 1987-2006



DA5526

DA5526 Discovery 1 & 2
Range Rover Classic

The standard Land Rover hand brake can easily get bunged up with dirt if you drive off-road a lot and once the mechanism gets clogged up it doesn't work as efficiently as it should. Britpart now offer a solution to that problem - a drum to disc conversion kit.

This kit uses a powerful caliper whose mechanism is sealed to prevent the access of mud! The special pads provide greater friction than the standard ones and are resistant from abrasion from mud.

Beef up your handbrake!



**New section added to accessory catalogue -
vehicle enhancement!**

Hiclone is a simple non-moving stainless steel device that sits inside the air induction system of an engine. Like a static mixer, it vigorously swirls the air, improving the fuel/air mixture and atomisation, promoting more complete combustion as more of the available fuel is consumed. More efficient burning of the fuel cuts smoke and other hydrocarbon emissions.

Hiclone also smoothes out the engine torque curve, resulting in a reduction in gear changes and a quieter engine, especially on the motorway. With Hiclone fitted you can corner and go uphill in a higher gear; this makes the vehicle easier to drive, improves the ride and reduces engine wear. Additionally Hiclone improves low down grunt of turbo charged engines making towing and hauling heavy loads more effective.

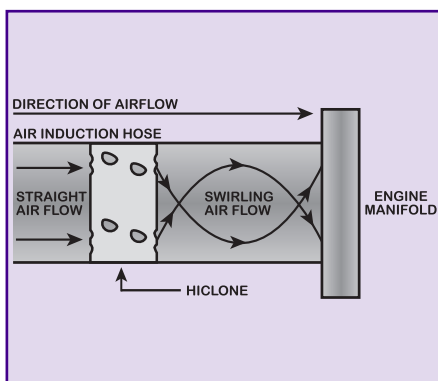

HOW A HICLONE WORKS

Hiclone makes the power in each cylinder more even, reducing friction, resulting in a more stable performance with less noise and abrasion.

Hiclone will not damage the engine or invalidate the vehicle's warranty. Hiclone itself has a lifetime warranty. Fitting is simple; no special tools or engine modifications are needed and it is maintenance free.

Note - Hiclones are designed to fit snugly into existing pipes. However, if a pipe is old, or, in poor condition, the Hiclone may not fit properly. In this circumstance we recommend fitting a new pipe.

Hiclone smoothes out the engine torque curve, resulting in a reduction in gear changes and a quieter engine!

Series

DA3119	Series 2	2.25ltr diesel	58mm
DA3094	Series 3	2.25ltr diesel	65mm
DA3096	Series 3	3.5ltr petrol	2 x 60mm

Defender

DA3088	2.5 D nat. asp.	63mm
DA3089	2.5 Td	63 & 50mm
DA3090	200 Tdi	68 & 50mm
DA3126	200 Tdi EGR	68 & 45mm
DA3091	300 Tdi	73 & 53mm
DA3098	Td5	75 & 60mm
DA3102	3.5L carb & 3.5 carb	2 x (55 x 25mm)

Discovery

DA3092	Discovery 1	200 Tdi	60 & 53mm
DA3128	Discovery 1	200 Tdi EGR	60 & 45mm
DA3093	Discovery 1	300 Tdi	60 & 53mm
DA3129	Discovery 1	300 Tdi EGR	60 & 45mm
DA3100	Discovery 1	3.5/3.9/V8	75 & 65mm
DA3124	Discovery 1	Bosch engine	75mm
DA3101	Discovery 2	Td5	75 & 60mm

Freelander

DA3104	1.8K Series	65mm
DA3125	Td4	55mm
DA3133	2.0ltr diesel	70 & 50mm

Range Rover

DA3102	Classic	3.5L carb & 3.5 carb	2 x (55 x 25mm)
DA3124	Classic & P38	Bosch engine	75mm
DA3103	P38	2.5 DSE	58 & 48mm
DA3134	P38	4.0ltr & 4.6ltr	2 x 75mm

INTERCOOLERS - PERFORMANCE



DA4630



DA4631



DA4632



DA4633



DA4634

These high performance and robust units are constructed from polished aluminium and are 30% larger than the standard intercooler. As a result air has a chance to cool before entering the engine. This cooler air can increase engine power by up to 25bhp (subject to application). Other benefits include better throttle response and reduction in fuel consumption depending on driving conditions. Ideal for on or off road use. Fully pressure tested, capped and sealed. Manufactured in the UK.

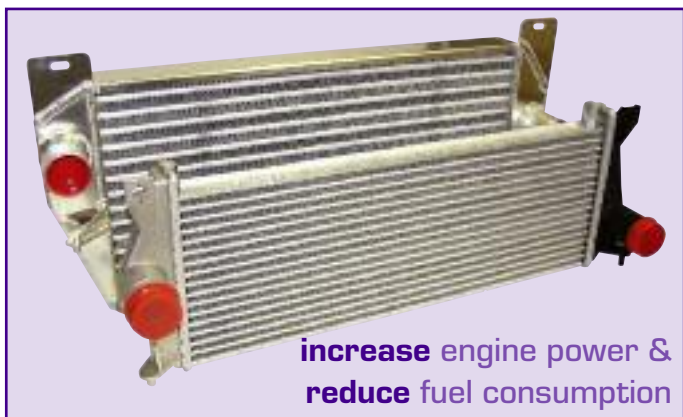

increase engine power &
reduce fuel consumption

DEFENDER COMPARISON - PERFORMANCE VS STANDARD

DA4630

Defender 90/110 Td5 - 1998-2006 Including air con vehicles
60mm deep x 300mm high

DA4634 **NEW** Coming soon...

Defender 90/110 Td5 - 2007 onwards Including air con vehicles

DA4631

Discovery 2 Td5 - Automatic - 1999-2004
60mm deep x 235mm high

DA4632

Discovery 2 Td5 - Manual - 1999-2004
60mm deep x 300mm high

DA4633

Range Rover P38 DSE
60mm deep x 280mm high

Notes - Dimensions for main intercooler body only. If you have a winch fitted please check clearance before fitment.



PSI POWER TUNING PRODUCTS



DA4419

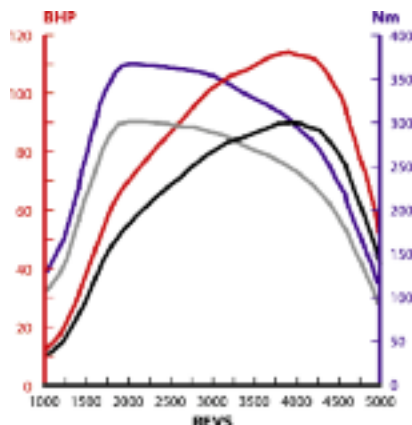

Improves
torque

Performances for Defender Td5:
Standard: 122 HP 90 kW 300 Nm
PSI: 155 HP 114 kW 365 Nm

The Power Box houses a digital microprocessor which intercepts the fuelling signals being transmitted from the ECU to the fuel pump; it then modifies them to ensure the exact amount of diesel required for enhanced performance. Such efficient use of the fuel optimises consumption, reduces smoke emissions and there is less engine stress, enhancing engine life in many cases.

The Power Box improves torque enabling the vehicle to change gears earlier and hold higher gears at lower speeds, making driving more pleasurable.

The unit fits using the original manufacturers plugs; these existing plugs are opened and the Power Box is secured in between. Full fitting instructions are included with every unit.

Features

- > Plug-in unit
- > No intervention with the original ECU
- > 1-year equipment warranty & 1-year engine warranty - subject to terms*
- > TUV approval
- > Compact size
- > Shock resistant & waterproof
- > Competitively priced

*vehicles up to 40,000km and up to 3 years old

Benefits

- > Can be removed prior to sale or used as a selling point
- > Traceless
- > Peace of mind
- > Quality product which is legal & safe
- > Unobtrusive in interior of vehicle
- > No worries off road
- > A good investment

DA4418

Freelander - Td4 2000 - 2006

DA4419

Range Rover - 2.5Td 1995 - 1999

DA4420

Range Rover - 2.5Td 2000 - 2001

DA4421

Range Rover - Td6 2002 onwards

DA4433

Defender & Discovery - Td5 1995 - 2007

DA4436

Defender 2007 onwards

Performance improvement - (before/after)

	Power - HP	Power - Kw	Torque - Nm
DA4418	112/129	82/95	260/300
DA4419	136/160	100/118	268/310
DA4420	136/160	100/118	268/310
DA4421	177/203	130/149	390/440
DA4433	122/155	90/114	300/365
DA4436	122/150	90/110	360/415

TUNIT DIESEL TUNING PRODUCTS



TUNIT UNIT

- > Improve fuel economy
- > Adjustable performance
- > Increase power & torque
- > Self install or dealer fit

DA4434

Range Rover Sport & Discovery 3 - TdV6 Euro 3

DA4439

Range Rover Sport & Discovery 3 - TdV6 Euro 4

DA4438

Range Rover Sport - 3.6 TD V8 2005 onwards

DA4437

Freelander 2 - 2.2 Td4 2007 onwards

Performance improvement - (before/after)

	Power - HP	Power - Kw	Torque - Nm
DA4434	190/220	140/164	322/363
DA4437	152/177	112/130	295/325
DA4438	271/315	202/234	472/547
DA4439	190/220	140/164	322/363

Tunit Diesel Performance - The Diesel Tunit has been forged from many years of experience to bring a world class unbeatable range of diesel performance solutions.

Tunit Features - Tunit possesses many advantageous features not seen in other tuning solutions such as chips, eprom serial reprogramming (flashing) or other types of fixed map devices. It is interchangeable between vehicles and able to be upgraded. External to the ECU or `Plug and play` as it is often called means no interference with the original manufacturers engine equipment. Its option to adjust power and performance provides easy manual adjustment for the novice or finer electronic alterations for the more dedicated tuner. Tunit is backed up by an outstanding after sales service, part exchange program and class beating three year warranty.

Fuel Savings - Tunit has become advantageous in reducing fuel costs for a variety of applications; not just improving performance but now helping with saving fuel costs.

Installation - The tunit is normally connected to original plugs on the vehicle and can either be self-installed or by a professional mechanic.

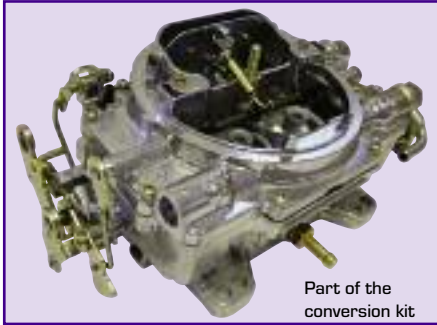
WEBER CARBURETTORS

Part of the conversion kit

DA3049**DA2126****ERC2886W****DA3049**

V8 4-Barrel conversion kit including manifold

The Webcon 4 barrel replacement carburettor kit is a direct replacement for the twin Stromberg or SU carbs fitted to the Rover V8. Calibrated to work perfectly on the 3.5 and 3.9 engines, the Webcon kit is the most complete on the market and features a Webcon modified Weber 4 barrel 500cfm carburettor; intake manifold, air filter and every single nut, bolt washer, gasket and hose that could possibly be needed. The kit adds up to 20bhp at the wheels and transforms the driveability and economy. Starting becomes instant either hot or cold and with no balance adjustment to worry about with twin carbs, the engine is simply superbly smooth as indeed a V8 should be.

DA2126 Series

To replace Solex use also STC541 adaptor

DA2206

Service kit for DA2126

ERC2886W Series

Replacements for the Zenith 36IV

Available for LHD, RHD, with or without fuel shut off solenoid, the Weber range of carburettor kits to replace the Zenith 36IV offer the optimum balance of power and economy together with the legendary quality and reliability of Weber. Shipped as complete turnkey solutions, all kits are supplied with every nut, bolt, washer and gasket required and comprehensive, easy to follow instructions ensure that installation can be carried out with no specialist carburettor knowledge.

DA3049AF

Replacement air filter for DA3049

DA2126A

Choke cable for DA2126



IN THIS SECTION....

SUSPENSION EQUIPMENT

Air spring conversion kit - Britpart	105	Radius arms	108
Air spring conversion kits - Atlantic British	105	Shock absorbers - Bilstein	111
Air springs - Britpart	106	Shock absorbers - Delphi De Carbon	111
Anti-roll bar kit	106	Shock absorbers - heavy-duty	111
Britpart Cellular Dynamic shock absorbers	109	Spring retainers	113
Britpart polyurethane bushes	107	Springs - coil	112
Britpart Super Gaz shock absorbers	110	Springs - parabolic	112
Bush fitting tool	108	Steering arms - heavy-duty	113
Bush sets - Britpart	108	Suspension kits - Britpart	114
Dislocation cone	106	Wide angle propshafts	114
Polybush sets	108		



AIR SPRING CONVERSION KIT - BRITPART

DA5136

Discovery 2

Air to coil conversion kit

It is a sad fact that sometimes the air suspension at the rear of a Discovery 2 will fail. You then have a choice to make. Do you replace it with a replacement air spring system which is comfortable but not comfortable on the wallet or replace with an equally comfortable but much more affordable coil suspension system. Well Britpart have the complete kit for air to coil suspension conversion making your decision that bit easier.

Kit -

- 2 x Rear springs
- 2 x Isolators
- 2 x Spring seats
- 4 x Bolts
- 1 x Instructions



DA5136

AIR SPRING CONVERSION KITS - ATLANTIC BRITISH

The EAS (Electronic Air Suspension) System found on Range Rover 4.0 and 4.6 vehicles can present expensive, recurring maintenance problems. If you've had an air spring failure before, you know this first hand.

Atlantic British now has a revolutionary coil spring conversion kit for Range Rover 4.0/4.6 that makes switching to coil springs seamless and error-free. Conversion to coil springs provides a better, maintenance-free ride that will save you significant money over time. This exclusive EAS Override Module suppresses all typical false dashboard display errors and buzzers seen when converting to coil springs.

Kit provides everything needed to complete
a professional installation

Any mechanic or Range Rover owner can install this exclusive coil spring conversion kit without having to go to a Land Rover dealer or Autologic-equipped repair shop to eliminate false dash warning light errors.

The EAS Override Module and Coil Spring Conversion Kit is an Atlantic British exclusive! The exclusive kit features:

- > Detailed step-by-step instructions.
- > The Atlantic British exclusive EAS Override Module overrides all typical computer errors seen when converting to a coil spring system.
- > Eliminates the need for a costly shop visit.
- > Aluminium spring perch adapters, exclusive Atlantic British Ltd. design.
- > Britpart custom made coil springs provide standard ride height and maximum articulation.
- > Affordable alternative to expensive, recurring air suspension failures.
- > Trip computer compatibility - maintains operation of your vehicle's trip computer.
- > Kit provides everything needed to complete a professional installation.

DA4136

Range Rover P38 1995 - 2002
Petrol models and diesel light duty

DA4136HD

Range Rover P38 1995 - 2002
Heavy-duty 1" lift including diesel models

DA4179

Range Rover Classic - no module



DA4136

AIR SPRINGS - BRITPART



BRITPART AIRSPRINGS



DA2371



DA2372



DA2373

DA2371	Discovery 2 - with self levelling	Rear
DA2372	Range Rover P38	Front
DA2373	Range Rover P38	Rear
NTC9819	Range Rover Classic	Front

NTC9820	Range Rover Classic	Rear
RKB101200	Discovery 2	Rear
REB101740	Range Rover P38	Front
RKB101460	Range Rover P38	Rear

Air springs can be susceptible to air leaks due to the fact the rubber seals dry out. Why not firm up your suspension and replace them with these quality air springs from Britpart. **Note** - All sold individually.



NTC9819 & NTC9820



RKB101200



REB101740 & RKB101460

ANTI-ROLL BAR KIT

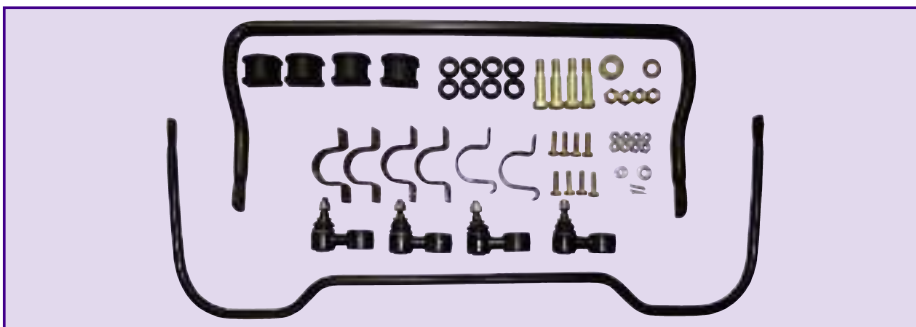

STC8156AA

STC8156AA

Defender 90
Discovery 1

Kit for stiffening up the rear on your Defender 90 and Discovery 1. Complete with fitting instructions.

DISLOCATION CONE



DA2186

DA2186
90/Discovery 1 only
Rear only
Pair

This clever product ensures your springs relocate correctly when using your Land Rover in extreme conditions. Manufactured from stainless steel. Use in conjunction with spring retainers.

Britpart - Individual bush sets

548205PY	Shackle bush polyurethane
548205PY-YELLOW	Shackle bush set polyurethane
552818PY	Shock absorber bush set
552818PY-YELLOW	Shock absorber bush set
552819PY	Shock absorber bush set
552819PY-YELLOW	Shock absorber bush set
568858PY	Washer - steering damper
568858PY-YELLOW	Washer - steering damper
569746PY	Chassis bush set polyurethane
569746PY-YELLOW	Chassis bush set polyurethane
572068PY	Radius arm/chassis outer bush set
572068PY-YELLOW	Radius arm/chassis outer bush set
572180PY	Mounting
572180PY-YELLOW	Mounting
575580PY	Panhard rod bush set
575580PY-YELLOW	Panhard rod bush set
90577434PY	Bush chassis polyurethane
90577434PY-YELLOW	Bush chassis polyurethane
ANR1721PY	Shock absorber bush set
ANR1721PY-YELLOW	Shock absorber bush set
ANR2563PY	Bush
ANR2563PY-YELLOW	Bush
ANR3285PY	Bush rear radius
ANR3285PY-YELLOW	Bush rear radius
ANR3305PY	Bush
ANR3305PY-YELLOW	Bush
ANR3332PY	Bush - radius arm
ANR3332PY-YELLOW	Bush - radius arm
ANR3410PY	Panhard rod bush set
ANR3410PY-YELLOW	Panhard rod bush set
ANR6947PY	Rear radius arm to axle bush
ANR6947PY-YELLOW	Rear radius arm to axle bush
NRC4514PY	Bush set - radius arm to chassis
NRC4514PY-YELLOW	Bush set - radius arm to chassis
NRC5593PY	Bush set - shock absorber
NRC5593PY-YELLOW	Shock absorber bush set
NTC1772PY	Bush set - lower link/axle
NTC1772PY-YELLOW	Bush set - lower link/axle
NTC1773PY	Bush set - upper mounting
NTC1773PY-YELLOW	Upper mounting bush set
NTC1775PY	Bush - steering damper
NTC1775PY-YELLOW	Bush - steering damper
NTC6781PY	Bush set - radius arm/axle
NTC6781PY-YELLOW	Bush set - radius arm/axle
NTC6828PY	Bush
NTC6828PY-YELLOW	Bush
NTC7307PY	Bush set - radius arm/axle
NTC7307PY-YELLOW	Bush set - radius arm/axle
NTC7394PY	Bush
NTC7394PY-YELLOW	Bush
RBX101240PY	Bush - anti-roll bar
RBX101240PY-YELLOW	Bush - anti-roll bar
RBX101340PY	Bush kit - front panhard rod
RBX101340PY-YELLOW	Front panhard rod
RBX101680PY	Bush - front radius arm to axle
RBX101680PY-YELLOW	Front radius arm to axle
RBX101690PY	Bush - anti-roll bar front
RBX101690PY-YELLOW	Bush - anti-roll bar front
RBX101730PY	Bush - radius arm to chassis
RBX101730PY-YELLOW	Radius arm to chassis
RBX101780PY	Bush - lower arm
RBX101780PY-YELLOW	Bush - lower arm
RBX101790PY	Bush - lower arm
RBX101790PY-YELLOW	Bush - lower arm
RDB100080PY	Bush
RDB100080PY-YELLOW	Bush
RGX100970PY	Bush assy polyurethane
RGX100970PY-YELLOW	Bush assy polyurethane
RGX101000PY	Bush - trailing link
RGX101000PY-YELLOW	Bush - trailing link
RGX101010PY	Bush
RGX101010PY-YELLOW	Bush
RGX101020PY	Bush - outer
RGX101020PY-YELLOW	Bush - outer
RGX101440PY	Bush
RGX101440PY-YELLOW	Bush
RNF100090PY	Mounting - rubber
RNF100090PY-YELLOW	Mounting - rubber
STC618PY	Bush kit
STC618PY-YELLOW	Bush kit

BRITPART

The quality parts for Land Rovers

POLYURETHANE BUSH SETS

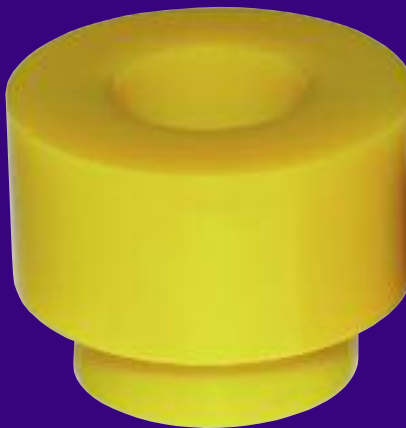

Britpart - Yellow suspension bush sets

DC7000	Discovery 1
DC7001	Discovery 2
DC7002	Freelander
DC7003	Series 1, 2 & 3 - excluding 3 LWB (see DC7004)
DC7004	Series 3 LWB
DC7005	Range Rover up to 1986
DC7006	Range Rover 1986 - 1994
DC7007	Range Rover P38
DC7008	Defender 1999 - 2007
DC7009	Defender up to 1993
DC7010	Defender 1994 - 1999
DC7011	Defender 2007 onwards

DA2425 Defender - Steering damper bush set

Britpart - Black suspension bush sets

DC7100	Discovery 1
DC7101	Discovery 2
DC7102	Freelander
DC7103	Series 1, 2 & 3 - excluding 3 LWB (see DC7104)
DC7104	Series 3 LWB
DC7105	Range Rover up to 1986
DC7106	Range Rover 1986 - 1994
DC7107	Range Rover P38
DC7108	Defender 1999 - 2007
DC7109	Defender up to 1993
DC7110	Defender 1994 - 1999
DC7111	Defender 2007 onwards

DA2426 Defender - Steering damper bush set

Britpart are proud to present an exclusive range of Yellow and Black polyurethane bushes. Manufactured exclusively for Britpart using the latest Vulkollan™ polyurethane technology.

Machined to exact tolerances once cast to produce the highest finish available.

Produced in both yellow and black they are both the same compound which gives similar ride characteristics to the standard rubber bushes, but they offer improved articulation, vibration damping and last longer.

The black bushes are ideal for replacing individual bushes as they can be fitted without a press.

The DC range of kits include shock absorber and A-frame bushes.

BE PART OF IT!

Note - Part numbers without yellow as a suffix indicate the bush colour is black.

also available in
black

www.britpart.com

BUSH SETS - BRITPART OTHER



DA4035BLUE



DA2353

Bush Fitting Tool - for ANR3332

Fitting new front radius arm bushes (part number ANR3332) for the Range Rover 38A is impossible to do without using the Land Rover special tool.

LRT-60-004

Land Rover special tool



LRT-60-004

Britpart - Blue

DA4035BLUE

Defender 90/110/130 to 1993 with drum brakes

DA4036BLUE

Range Rover - 1986 onwards/Discovery 1 & Defender 1994 onwards

Britpart - Other

DA2353

Front radius arm to chassis kit
Defender 1987-1997/Discovery 1/Range Rover Classic 1986-1994

DA4035YELLOW

Defender 90/110/130 to 1993 with drum brakes

POLYBUSH SETS



Classic



COMFORT



Dynamic

Polybush sets available from Britpart - full details supplied on request.



RADIUS ARMS

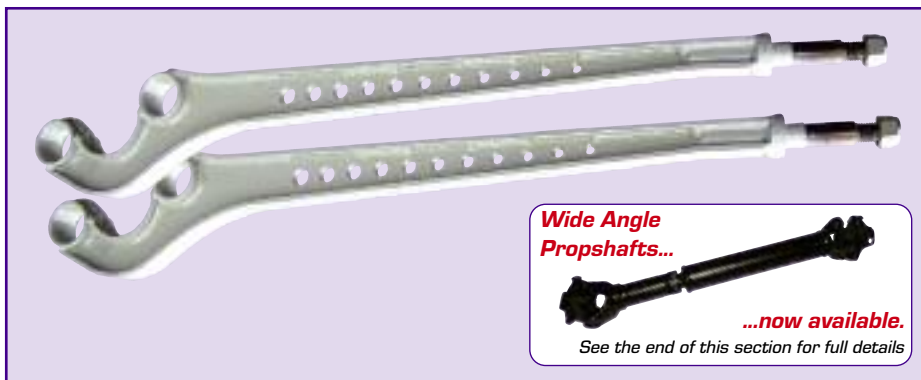

Wide Angle Propshafts...



...now available.

See the end of this section for full details

DA5505 & DA5506

- > Designed for vehicles with an extended 1 to 3" lift.
- > Front radius arms correct castor alignment which in turn ensure safe driving.
- > Rear radius arms provide full rear axle articulation.
- > Fitting the radius arms will contribute to a much better off-road capability for your vehicle by fully utilising your spring and shock absorber set.
- > Zinc passivated with a heavy-duty powder coating finish to complement each component.

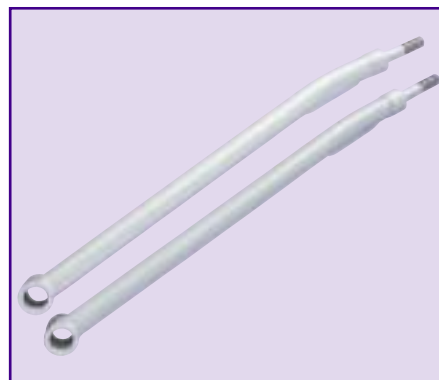

DA5510

DA5505

3° Heavy-duty Narrow
Use with NTC7307 bush 38mm

DA5506

3° Heavy-duty Wide
Use with NTC6781 bush 45mm

DA5510

2" Lift rear radius arm

BRITPART

CELLULAR DYNAMIC

2 year
WARRANTY
50,000
miles

- > cellular technology tube
- > sintered 18mm rod
- > piston diameter 41mm
- > polyurethane bush
- > teflon piston with multi-lip seal
- > single piece eye ring



The Britpart Cellular Dynamic Shock Absorber represents a significant advance in Land Rover suspension systems. It features a cellular foam insert instead of a normal nitrogen gas or air; this is to stop the oil from boiling. The foam takes up less room which means more room for oil, 50% more, which offers maximum heat dispersion.

This heat dispersion translates to a very subtle but controlled ride that will not fade no matter how hard you push them. They are ideal for a driver who needs more control to complement performance improvements or to enhance a standard vehicle.

The unique design ensures ride comfort and cornering ability is maximised and of course they are superb off-road.

BE PART OF IT!



www.britpart.com

DC6000	Range Rover Classic/Discovery 1/Defender		Front
DC6000L	Range Rover Classic/Discovery 1/Defender	50mm Lift	Front
DC6001	Range Rover Classic/Discovery 1/Defender		Rear
DC6001L	Range Rover Classic/Discovery 1/Defender	50mm Lift	Rear
DC6002	Range Rover P38 - air suspension		Front
DC6003	Range Rover P38 - air suspension		Rear
DC6010	Discovery 2		Front
DC6011	Discovery 2		Rear
DC6004	Defender		Steering Damper
DC6005	Range Rover Classic/Discovery 1/Series		Steering Damper
DC6006	Range Rover P38		Steering Damper
DC6009	Discovery 2		Steering Damper



BRITPART

The quality parts for Land Rovers

Super Gaz Shock Absorbers

Britpart Super Gaz Shock Absorbers offer a 35mm bore tube filled with Fuchs shock absorber fluid, using the best seal available, single piece eye rings, polyurethane bush mounts and a very durable powder coated finish. These offer a vast improvement in ride quality and damping performance. They are ideal for use with either of the Britpart Yellow Spring range or standard Land Rover Springs. Please ask for a CD of the shock absorbers in use or see the suspension section on the Britpart website!



24 month / 50,000 mile

Warranty*

DC5000		Front
Discovery 2		
DC5001		Rear
Discovery 2		
DC5002		Front
Defender/Range Rover Classic/Discovery 1		
DC5002L	50mm Lift	Front
Defender/Range Rover Classic/Discovery 1		
DC5003		Rear
Defender/Range Rover Classic/Discovery 1		
DC5003L	50mm Lift	Rear
Defender/Range Rover Classic/Discovery 1		
DC5004	Steering damper	
Defender		
DC5005	Steering damper	
Range Rover Classic/Discovery 1/Series		

*Super Gaz Shock Absorbers
Terms and conditions apply



The Best Brand!

www.britpart.com

SHOCK ABSORBERS - HEAVY-DUTY

DA4210	Defender 90/110	Rear
DA4211	Defender 90/110	Front

Heavy-duty oil filled shock absorbers

**DA4210****SHOCK ABSORBERS - BILSTEIN****Shock Absorbers**

DA1005	Range Rover Classic/Discovery/Defender	Front
DA1006	Range Rover Classic/Discovery to 1994/Defender	Rear
DA1008	Discovery - 1999 on	Front
DA1009	Discovery - 1999 on	Rear
DA1010	Range Rover Classic - air suspension	Front
DA1011	Range Rover Classic - air suspension	Rear
DA1012	Range Rover P38 - air suspension	Front
DA1013	Range Rover P38 - air suspension	Rear
DA1016	Defender - 1998 on	Front
DA1067	Discovery 3	Front
DA1068	Discovery 3	Rear

Steering Dampers

DA1014	Defender
DA1060	Discovery Td5
DA1061	Range Rover P38

**BILSTEIN SHOCK ABSORBER****Echo Roof Tents - exclusive to Britpart!!**

Full details of this new range in the off-road equipment section.

SHOCK ABSORBERS - DELPHI DE CARBON**Shock Absorbers**

DA4162	Series LWB/SWB	Front
DA4163	Series SWB	Rear
DA4164	Series LWB	Rear
DA4090	Range Rover Classic/Defender to 1999/Discovery to 1994 including air suspension	Front
DA4091	Range Rover Classic/Defender to 1999/Discovery to 1994 including air suspension	Rear
DA4092	Discovery - 1994 - 1999	Rear
DA4181	Range Rover Classic/Defender to 1999/Discovery to 1994	Front +2"
DA4182	Range Rover Classic/Defender to 1999/Discovery to 1994	Rear +2"

Note - Boxed as a pair, priced individually

Steering Dampers

DA4160	Series/Range Rover Classic/Discovery to 1998
DA4161	Defender

**DA4163**

SPRINGS - COIL

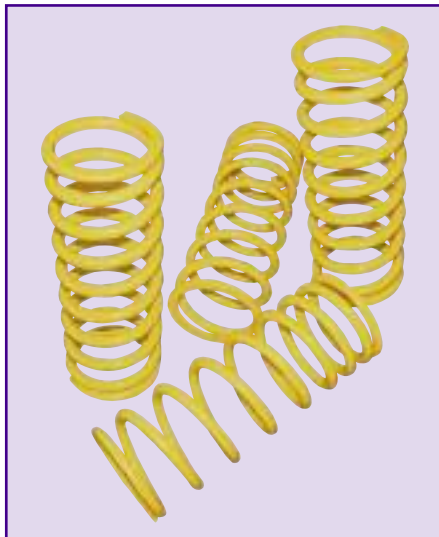

PERFORMANCE SPRINGS

Britpart Performance - Lifted Springs

Our yellow performance springs are high quality, versatile and competitively priced - the right choice when replacing the old sagging original springs.

Developed by one of the world's top spring manufacturers these high quality, powder coated springs have been designed with the needs of today's Land Rover owners in mind.

As Land Rovers are often working vehicles as well as the family car, uprated springs must offer the ability to carry loads, handle off-road terrain and provide a good ride on road. The progressive front springs offer a compliant ride when lightly loaded, but firm up as the load increases.

Note - Spring quantity 1 = 1 pair

The right choice when replacing the old sagging original springs!

				Lift	Load	Bar Diameter	Rate LBF/IN	Free Height
DA4201	Range Rover Classic/Discovery/90/110	Front		25mm	25kg	16mm	200	400mm
DA4202	90/110/130/Range Rover Classic/Discovery	Front		40mm	50kg	16mm	230	390mm
DA4203	Range Rover Classic/Discovery/90 + Td5	Rear		40mm	Light	17mm	220	430mm
DA4204	Range Rover Classic/Discovery/Discovery 2/90	Rear		50mm	100kg	18mm	300-340	420mm
DA4205	Range Rover Classic/Discovery/90 + Td5	Rear		50mm	200kg	19mm	360	420mm
DA4206	Defender 110 NEW Light-duty	Rear		40mm	100kg	17mm	170-195	445mm
DA4208	110/130 Heavy-duty	Rear		50mm	500kg	21mm	420	435mm
DA4197	Discovery 2 Heavy-duty	Rear		40mm	Medium	18mm	290	433mm
DA4198	Discovery 2 Heavy-duty	Front		40mm	50 - 100kg	16mm	180	390mm
DA4199	Discovery 2 Heavy-duty	Front		40mm	20 - 50kg	16mm	180	400mm



DA4277

Britpart Performance - Standard Height Springs

Our yellow springs are designed for the enthusiast who wants a performance spring without having to raise the vehicle. They offer a firmer ride with less body roll, ideal for a vehicle with uprated performance or one used for carrying heavy loads.

The springs are designed to offer full articulation off road with a compliant ride. They also look stunning in the Britpart yellow powder coating.

Note - Spring quantity 1 = 1 pair

DA4277

90/110/Discovery to 1999/Range Rover Classic

Front springs Rating - 225lbs/in Height - 376mm

DA4278

90/Discovery 1/Range Rover Classic

Rear springs Rating - 285lbs/in Height - 376mm

DA4279

110

Rear springs Rating - 330lbs/in Height - 407mm

SPRINGS - PARABOLIC



DA4106



DA4107

DA2003

4 Leaf LWB Rear kit pair

DA4106

2 Leaf SWB/LWB Front kit pair

DA4107

3 Leaf SWB Rear kit pair

High quality replacement parabolic springs from Britpart. Designed to match the original Santana specification, giving a very comfortable and controlled ride.

Note - Includes 'U' bolts and nuts.

SPRING RETAINERS**DA2362**

Front

DA2363

Rear

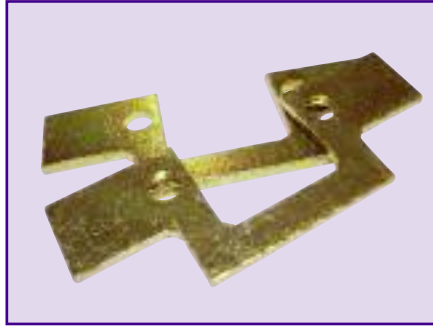
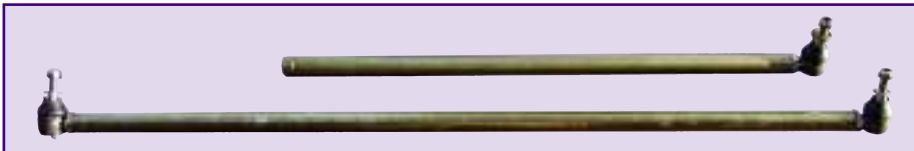
**DA2362****DA2363****STEERING ARMS - HEAVY-DUTY****DA5501****DA5501**All Series vehicles
4 track rod ends**DA5502****DA5502**All 90/110/Defender
3 track rod ends**DA5503****DA5503**Range Rover Classic/Discovery 1
3 track rod ends**DA5504****DA5504**Discovery 1
4 track rod ends**DA5509**Discovery 2
4 track rod ends**HEAVY-DUTY STEERING ARM**

Improves
steering response

- > All OEM track rod ends
- > Solid heavy-duty arms which are suitable for off-road use
- > Improves steering response
- > Zinc plate finish to increase corrosion resistance

**BE PART OF IT!**

SUSPENSION KITS - BRITPART



CELLULAR DYNAMIC - 40MM LIFT KIT



SUPER GAZ - STANDARD HEIGHT KIT

Britpart can offer a complete or partial suspension package suitable for whatever you intend to use your Land Rover for.

24 month / 50,000 mile Warranty on Super Gaz & Cellular Dynamic Shock Absorbers*

*Terms and conditions apply

Super Gaz Suspension Kits

DA4284	Defender 90/Range Rover Classic/Discovery 1	Heavy-duty	Standard height
DA4285	Defender 110	Heavy-duty	Standard height
DA4286	Defender 90/Range Rover Classic/Discovery 1	Heavy-duty	40mm Lift
DA4287	Defender 110	Heavy-duty	40mm Lift
DA4288	Defender 90 - to 1994/Range Rover Classic to 1986 - narrow bush	Heavy-duty	40mm Lift
DA4289	Defender 90 - from 1994/Range Rover Classic from 1986/Discovery 1 - wide bush	Heavy-duty	40mm Lift
DA4299	Defender 110 - to 1994 - narrow bush	Heavy-duty	40mm Lift
DA4300	Defender 110 - from 1994 - wide bush	Heavy-duty	40mm Lift
DA4301	Range Rover Classic	Heavy-duty	25mm Lift



Cellular Dynamic Suspension Kits

DA4284C	Defender 90/Range Rover Classic/Discovery 1	Heavy-duty	Standard height
DA4285C	Defender 110	Heavy-duty	Standard height
DA4286C	Defender 90/Range Rover Classic/Discovery 1	Heavy-duty	40mm Lift
DA4287C	Defender 110	Heavy-duty	40mm Lift
DA4288C	Defender 90 - to 1994/Range Rover Classic to 1986 - narrow bush	Heavy-duty	40mm Lift
DA4289C	Defender 90 - from 1994/Range Rover Classic from 1986/Discovery 1 - wide bush	Heavy-duty	40mm Lift
DA4299C	Defender 110 - to 1994 - narrow bush	Heavy-duty	40mm Lift
DA4300C	Defender 110 - from 1994 - wide bush	Heavy-duty	40mm Lift
DA4301C	Range Rover Classic	Heavy-duty	25mm Lift

WIDE ANGLE PROPSHAFTS



DA6353

If your Land Rover has raised suspension or been modified for extreme axle articulation then the joints on the existing prop shaft will become strained. This will cause the prop shaft to lock up or vibrate and wear the universal joints prematurely.

reduces vibration, universal joint 'bind-up' and premature wear

Dropping the axle further away from the chassis is great for looks, articulation and off-road performance - a neat solution is to fit a wide angle prop shaft. This allows drivetrain angles of up to 32 degrees which reduces vibration, universal joint 'bind-up' and premature wear on the joints. These wide angle shafts have greasable universal joints which are more desirable where longer life is required.

DA6350	Front	Defender up to 2007/Discovery 1/ Range Rover Classic 1986-1991	FRC8386
DA6352	Front	Defender up to 2007	FRC8390/FRC5566
DA6351	Rear	Defender 90 - 4 cylinder up to 2007	FRC8392
DA6353	Rear	Defender 90 - V8 up to 2007	FRC8393
DA6354	Rear	Discovery 1 - 1989-1994 and V8 from 1997	FRC8387

We've got suspension covered!

Britpart can offer a complete or partial suspension package suitable for whatever you intend to use your Land Rover for.



The Britpart Cellular Dynamic Shock Absorber represents a significant advance in Land Rover suspension systems. It features a cellular foam insert instead of normal nitrogen gas or air, this is to stop the oil from boiling. The foam takes up less room

which means more room for oil, 50% more, which offers maximum heat dispersion.

This heat dispersion translates to a very subtle but controlled ride that will not fade no matter how hard you push them. They are ideal for a driver who needs more control to complement performance improvements or to enhance a standard vehicle. The unique design ensures ride comfort and cornering ability is maximised and of course they are superb off-road.

Features

- > cellular technology tube
- > piston diameter 41mm
- > teflon piston with multi-lip seal
- > sintered 18mm rod
- > polyurethane bushes
- > single piece eye ring



Britpart Super Gaz shock absorbers offer a 35mm bore tube filled with Fuchs shock absorber fluid, using the best seal available, single piece eye rings, polyurethane bush mounts and a very durable powder coated finish. These offer a vast

improvement in ride quality and damping performance. They are ideal for use with either of the Britpart Yellow Spring range or standard Land Rover springs.



All suspension products now available from your local Britpart distributor and the Cellular Dynamic and Super Gaz shock absorbers have a **24 month / 50,000 mile warranty****

	Super Gaz			Cellular Dynamic		
	Standard Height	25mm Lift*	40mm Lift*	Standard Height	25mm Lift*	40mm Lift*
Defender - 90						
Front spring	DA4277	DA4201	DA4202	DA4277	DA4201	DA4202
Rear spring	DA4278		DA4203	DA4278		DA4203
Front shock absorber	DC5002	DC5002L	DC5002L	DC6000	DC6000L	DC6000L
Rear shock absorber	DC5003	DC5003L	DC5003L	DC6001	DC6001L	DC6001L
Steering damper	DC5004	DC5004	DC5004	DC6004	DC6004	DC6004
Suspension kit	DA4284	DA4301	DA4286	DA4284C	DA4301C	DA4286C
Complete kit - narrow bush			DA4288			DA4288C
Complete kit - wide bush			DA4289			DA4289C
Defender - 110						
Front spring	DA4277	DA4201	DA4202	DA4277	DA4201	DA4202
Rear spring	DA4279		DA4208	DA4279		DA4208
Front shock absorber	DC5002	DC5002L	DC5002L	DC6000	DC6000L	DC6000L
Rear shock absorber	DC5003	DC5003L	DC5003L	DC6001	DC6001L	DC6001L
Steering damper	DC5004	DC5004	DC5004	DC6004	DC6004	DC6004
Suspension kit	DA4285		DA4287	DA4285C		DA4287C
Complete kit - narrow bush			DA4299			DA4299C
Complete kit - wide bush			DA4300			DA4300C
Discovery 1						
Front spring	DA4277	DA4201	DA4202	DA4277	DA4201	DA4202
Rear spring	DA4278		DA4203	DA4278		DA4203
Front shock absorber	DC5002	DC5002L	DC5002L	DC6000	DC6000L	DC6000L
Rear shock absorber	DC5003	DC5003L	DC5003L	DC6001	DC6001L	DC6001L
Steering damper	DC5005	DC5005	DC5005	DC6005	DC6005	DC6005
Suspension kit	DA4284	DA4301	DA4286	DA4284C	DA4301C	DA4286C
Complete kit			DA4289			DA4289C
Discovery 2						
Front spring - 50-100kg load			DA4198			DA4198
Front spring - 20-50kg load			DA4199			DA4199
Rear spring - medium load			DA4197			DA4197
Front shock absorber	DC5000			DC6010		
Rear shock absorber	DC5001			DC6011		
Steering damper				DC6009		
Range Rover Classic						
Front spring	DA4277	DA4201	DA4202	DA4277	DA4201	DA4202
Rear spring	DA4278		DA4203	DA4278		DA4203
Front shock absorber	DC5002	DC5002L	DC5002L	DC6000	DC6000L	DC6000L
Rear shock absorber	DC5003	DC5003L	DC5003L	DC6001	DC6001L	DC6001L
Steering damper	DC5005	DC5005	DC5005	DC6005	DC6005	DC6005
Suspension kit	DA4284	DA4301	DA4286	DA4284C	DA4301C	DA4286C
Complete kit - narrow bush			DA4288			DA4288C
Complete kit - wide bush			DA4289			DA4289C
Range Rover P38 - air suspension						
Front shock absorber				DC6002		
Rear shock absorber				DC6003		
Steering damper				DC6006	DC6006	DC6006
Series						
Steering damper	DC5005	DC5005	DC5005	DC6005	DC6005	DC6005

*approximate lift height - check specification before ordering **terms & conditions apply



40MM LIFT KIT



STANDARD HEIGHT KIT

The suspension packages are available with either Britpart Cellular Dynamic or Super Gaz shock absorbers - please see above table for details

BRITPART

The quality parts for Land Rovers

BE PART OF IT!

www.britpart.com



IN THIS SECTION....

EXHAUSTS

Exhausts - stainless steel	117-118
Rear silencers	120
Sports exhausts - stainless steel	119
Utility link pipes - Britpart	120



EXHAUSTS - STAINLESS STEEL



All Double 'S' exhaust systems carry a lifetime guarantee.

Double 'S' is recognised as one of Europe's leading manufacturers of stainless steel automotive components with a wide selection of systems for off-road.

Using only the finest austenitic and ferritic stainless steels and employing the latest in CNC mandrel and empty tube bending, measuring and inspection equipment, means increasingly high levels of product quality.

All Double 'S' exhaust systems carry a lifetime guarantee. Double 'S' will replace or repair any part of their Stainless Steel Exhaust Systems found defective through corrosion during the period that the system remains the property of the original owner. Provided that the system is inspected by a garage or exhaust fitting centre annually to ensure that the rubber and other mountings are in good condition.



DA4528



DA4233

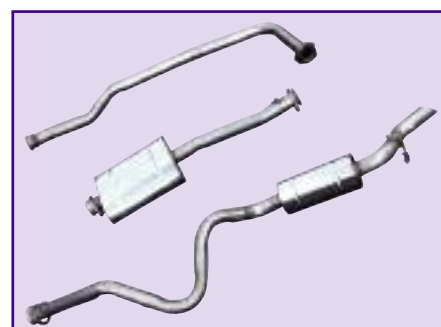

DA4229

Series

DA4251	Series 3	2.25 Diesel	Front pipe Link pipe Rear silencer
DA4528	Series 3	2.25 Petrol	Front pipe Link pipe Rear silencer

Defender

DA4231	90	200 Tdi	Front pipe Centre box Rear silencer
DA4232	90 - 1994 - 1995	300 Tdi	Front pipe Centre box Rear silencer
DA4233	90 - 1995 - 1997	300 Tdi	Front pipe Centre box Rear silencer
DA4234	90 - 1997 - onwards	300 Tdi	Centre box Rear silencer
DA4235	90	Td5	Centre box Rear silencer
DA4244	110	Td5	Centre box Rear silencer
DA4228	110	200 Tdi	Front pipe Centre box Rear silencer
DA4229	110	300 Tdi	Front pipe Centre box Rear silencer

EXHAUSTS - STAINLESS STEEL - continued



DA4246

Discovery

DA4221	Discovery 1	2.5TD & 200 Tdi Manual	Front pipe Centre box Rear silencer
DA4222	Discovery 1	200 Tdi Automatic	Centre box Rear silencer
DA4223	Discovery 1	300 Tdi	Centre box Rear silencer
DA4224	Discovery 2	2.5 Td5	Centre box Rear silencer



DA4240

Freelander

DA4226	Freelander 1	1.8 Petrol	Centre box Rear silencer
DA4227	Freelander 1	2.0 Diesel	Link pipe Rear silencer
DA4246	Freelander 1	1.8 Petrol	Transplex rear silencer (2 x 3" in/roll tailpipe)



DA4241

Range Rover

DA4237	Range Rover Classic	3.9 V8 cat back	Centre box non-cat Rear silencer cat
DA4238	Range Rover P38	2.5 BMW diesel single tailpipe	Centre box Rear silencer
DA4239	Range Rover P38	4.0/4.6 single tailpipe	Centre box Rear silencer
DA4240	Range Rover P38	4.0/4.6 twin tailpipe	Centre box LH rear silencer RH rear silencer
DA4241	Range Rover P38	2.5 BMW twin tailpipe	Centre box LH rear silencer RH rear silencer



Picture courtesy of Kristijan Kristjansson

STAINLESS STEEL SPORTS EXHAUST SYSTEMS

Defender

DA4236	90	3.5 V8 Sports system	LH manifold RH manifold Y-Pipe Rear silencer Tailpipe Fitting bracket
DA4230	110	3.5 V8 Sports system	LH manifold RH manifold Y-Pipe Extension pipe Centre box Tailpipe Fitting bracket
DA4249	90	Td5 - Sports	Sports centre link pipe Rear silencer



All Double 'S' exhaust systems carry a lifetime guarantee.

Discovery

DA4225	Discovery 1	3.9 V8 Japanese Spec Sports	Centre box Link pipe Rear silencer
---------------	-------------	--------------------------------	--

Range Rover

DA4242	Range Rover Classic	3.5 V8 Sports system with tubular manifold	LH manifold RH manifold Y-Pipe Centre box Rear silencer
DA4243	Range Rover Classic	3.9 V8 Sports system with tubular manifold	LH manifold RH manifold Y-Pipe Centre box Link pipe Rear silencer
DA4245	Range Rover P38	4.0/4.6 Sports system with twin tailpipe	LH rear silencer RH rear silencer Y-Pipe Centre box
DA4247	Range Rover P38	2.5 diesel Sports system with twin tailpipe	LH rear silencer RH rear silencer Y-Pipe Centre box



DA4236



DA4249



DA4225



DA4243



DA4245



BE PART OF IT!

UTILITY LINK PIPES



These are 304 stainless steel exhaust silencer replacement pipes. They are designed to directly replace the front silencer in your Td5 and Tdi exhaust system.

Quick and easy to install with more power.

Once replaced the pipe will give your vehicle more power or reduced fuel consumption with only a small increase in cabin noise.

Reduced fuel consumption

CNC mandrel formed for a perfect fit with laser cut flanges, the pipes have a sateen finish, deep luster appearance. Quick and easy to install.



DA4292



DA4294



DA4293



DA4302



DA4290

Britpart Link Pipe Part No.	Vehicle	Model	Double 'S' Rear silencer Part No.
Defender			
DA4292	90	Td5	DA3250
DA4294	90	300 Tdi 1994-1995	DA3251
DA4294	90	300 Tdi 1995-1997	DA3252
DA4304	90	300 Tdi 1997-1999	DA3253
DA4295	90	200 Tdi	DA3254
DA4293	110	Td5	DA3255
DA4302	110	300 Tdi	DA3256
DA4306	110	200 Tdi	DA3257

Discovery

DA4291	Discovery 1	300 Tdi	DA3258
Note - Will only fit with Double 'S' rear silencer (DA3258)			
DA4223S	Discovery 1	300 Tdi	N/A
Note - Kit includes Double 'S' rear silencer (DA3258)			
DA4303	Discovery 1	200 Tdi	DA3259
DA4290	Discovery 2	Td5	DA3260



IN THIS SECTION....

ENGINES & TRANSMISSION

Engines - new	122
Engines - reconditioned	122
Gear boxes - new	123
Gear boxes - reconditioned	123
Transfer boxes - new	123

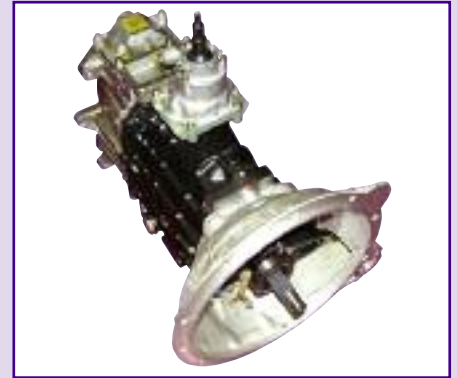

ENGINES

Complete Engines

Include fuel pump, injectors, injector pipes, timing assembly and bell housing. Complete engines are tested prior to despatch. Once tested the flywheel and manifolds are removed and the engine is packed without these parts. Outer timing covers, pulleys, manifolds, flywheel and turbo charger are not included.

Stripped Engines

Include sump, block, cylinder head, rocker cover, inner timing cover, camshaft and crankshaft gear.

Short Engines

Consist of block, crank, con-rods and pistons only.

Re-conditioned Engines

These engines have been through the following rigorous processes:

- > Complete strip down
- > Removal of all core plugs
- > Thorough cleaning in environmentally-friendly, solvent-free washing machines
- > Removal of all parts subject to wear
- > Inspection of casings for signs of damage and corrosion
- > Crack-testing of camshafts before and after re-grinding
- > Re-boring of blocks and machining of decks to the correct surface finishes
- > Fitting of perfectly-balanced, machined con-rods in accordance with manufacturers recommended piston protrusions
- > Meticulous re-building of engines in individual, contaminant-free workstations
- > Renewal of all bearings and gaskets throughout the engine
- > Renewal/overhaul of oil pumps
- > Replacement of all core plugs
- > Dyno-testing of complete engines
- > Final inspection
- > Wrapping in cellophane and fitting into rigid, steel transportation frames



New & reconditioned engines overleaf...

ENGINES - NEW



STC4723N



LBB110410N

A full range of engines - available from Britpart!

STC1675		300 Tdi	Short	
STC4723N		300 Tdi	Stripped	
DA2047	Discovery 2	V8 4.0 56D	Short	
DA2082		V8 4.0	Short	Also need DA2999 crank spacer
DA2079		V8 4.6	Short	(MEMS) Bosch
DA2084		V8 4.6	Short	(GEMS) Lucas
ERR5013ST		V8 4.6	Stripped	With distributor drive for Range Rover Classic 3.5 and Discovery 1 with tin sump
DA2109		V8 4.0	Stripped	
DA2038		Td4	Complete	
DA2039	Freelander	1.8K	Complete	
LBB110410N	Freelander	2.0 D	Stripped	
LBB000561	Freelander	2.5 V6	Complete	



ENGINES - RECONDITIONED



DA4220

DA4220		2.5 NA	Short
DA4215		2.5 NA	Stripped
DA4216		2.5 NA	Complete
DA4217		2.5 Td	Short
DA4218		2.5 Td	Stripped
DA4219		2.5 Td	Complete
DA4212		200 Tdi	Short
DA4249DEF	Defender	200 Tdi	Stripped
DA4249DIS	Discovery	200 Tdi	Stripped
DA4250DEF	Defender	200 Tdi	Complete
DA4250DIS	Discovery	200 Tdi	Complete
DA4252		300 Tdi	Complete
DA4214		Td5	Short
DA4256	Freelander	2.0D	Stripped - less injectors

Please enquire on availability for these engines.

GEAR BOXES - NEW

TRC103150	Defender	LT77 - 50A suffix L
TRC103260	Defender	R380 - not oil cooled 68A Td5
TRC103330	Defender	R380 - oil cooled 74A Td5
TRC103270	Discovery 2	V8 efi
TRC103350	Discovery 2	Diesel - less oil cooler
TRC102900	Freelander	Petrol 1.8K16

**GEAR BOX****GEAR BOXES - RECONDITIONED**

DA3050	Defender	4 Cylinder to 200 Tdi	LT77/S	50G/H
DA3051	Defender	200 Tdi	LT77/S	56G/H
TRC103160E	Defender	300 Tdi	R380	56J
DA3058	Defender	Td5	R380	68A
DA3052	Discovery	200 Tdi	LT77/S	55G/H
DA3054	Discovery	300 Tdi	R380	55J
DA3068	Discovery 2	Td5	R380	73A
DA3055	New Range Rover	Diesel	R380	65J

**GEAR BOX****TRANSFER BOXES - NEW**

IAB500104	Defender	Prefix 57D Td5 from 3A
IAB500106	Defender	Prefix 58D 4 cylinder petrol from 3A
IAB000010	Discovery 2	Less diff lock
IAB500090	Discovery 2	Prefix 70D
IAB500100	Discovery 2	Prefix 68D & 69D

**TRANSFER BOX**

Check out the comprehensive range of off-road equipment from Britpart in the off-road section!



IN THIS SECTION....

REPAIR & SERVICE PARTS

Automatic transmission service kit	125	Cylinder liner kit	133	Land Rover genuine consumables	138
Brake kits	125	Damper kit	133	Loctite consumables	139
Britpart Liquid Gloves	137	Diff coupling shaft	134	Oil pump gear set	140
Chassis' - complete	126	Diff repair pans	134	Pressure relief valve kit	140
Chassis & components - Defender	127	Door hinge kit	134	Propshaft bearing	140
Chassis & components - Discovery 1	128	EGR blanking kit	134	Propshaft kit	140
Chassis & components - Freelander	128	Electronic conversion kits	134	Swivel housing grease	140
Chassis & components - Range Rover Classic	129	Gasket kits	135	Swivel pin kits	141
Chassis & components - Series 2 & 3	130	Head bolt sets	135	Timing kits	141
Clips, clamps & nipples	131	Heater blower motor kit & resistor kit	135	Tools	141
Clutch kit & flywheel - TD5	131	Heater matrix	136	Touch up paint pens	142
Clutch kits	132	Heater plug upgrade kit	136	Wheel bearing kits	142
CV joint kits - Britpart	133	Hylomar sealants & compounds	137	Wing protectors	142
		Ignition lead sets	137		

AUTOMATIC TRANSMISSION SERVICE KIT

DA4500

Kit comprises of oil screen, seals, o-rings and sealing washer.



DA4500

BRAKE KITS

Series SWB

DA6042	Front	Up to June 1980
DA6043	Rear	Up to June 1980
DA6044	Front	From July 1980
DA6046	Rear	From July 1980

Series LWB

DA6044	Front	4 cylinder except 1 ton
DA6045	Front	6 cylinder & 109 V8 Stage 1
DA6047	Rear	Including V8



DA6042



DA6047

Kits include - > Brake shoes > Wheel cylinders > Brake springs > Screws (where applicable)



BE PART OF IT!

CHASSIS' - COMPLETE

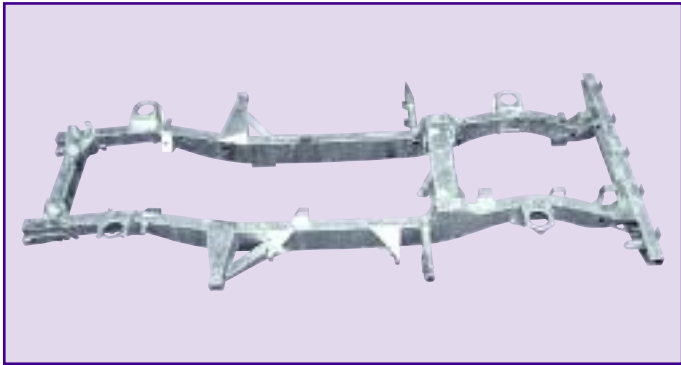

DA2056



DA2057

Defender - Chassis Frames

DA2056	90	Nat. Asp./2.5 Td/200 Tdi	Galvanised
DA2056-300TDI	90	300 Tdi	Galvanised
KVD500040	90	300 Tdi	Black
KVD500710	90	Td5	Galvanised
DA2057*	110	Nat. Asp./2.5 Td/200 Tdi	Galvanised
DA2057-300TDI*	110	300 Tdi	Galvanised
KVD500730	110	Td5	Galvanised
KVD500140	130	Td5	Galvanised

*suitable for pick-up and station wagons

Series - Chassis Frames

NRC4356	Series	LWB	Galvanised
NRC4642G	Series	SWB	Galvanised

IMPORTANT

This page is a selection of the chassis' that we do. Please enquire if the chassis you require is not listed here.



DA2057-300TDI



KVD500710



KVD500730



KVD500140



NRC4642G

Britpart Suspension Products - see the suspension equipment section



CHASSIS COMPONENTS - DEFENDER

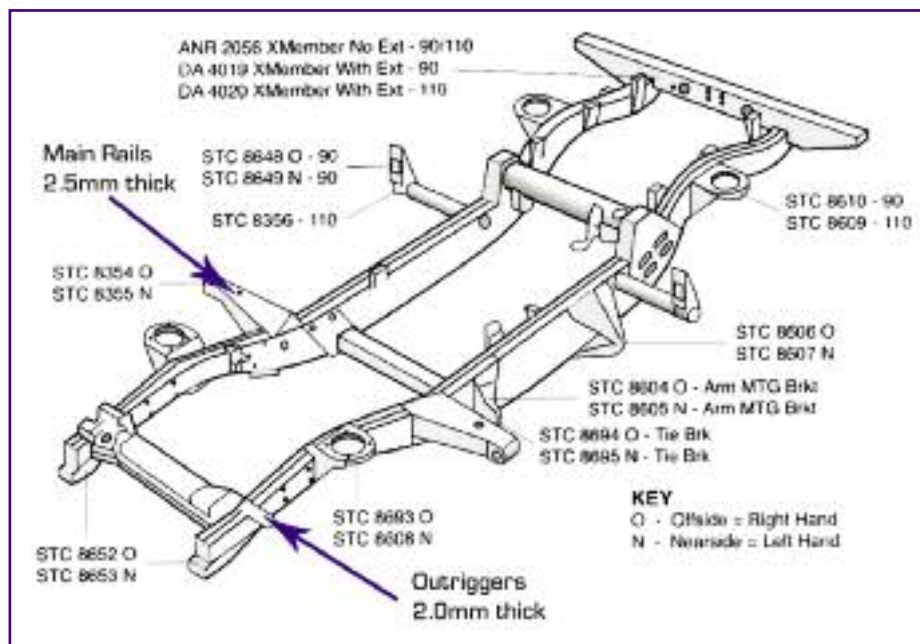

For right hand drive

O/S = Right side

N/S = Left side

For left hand drive

O/S = Left side

N/S = Right side



DA4020



DA4065N



DA4518



DA4527

DA4019	90	Rear crossmember plus extensions	
DA4020	110	Rear crossmember plus extensions	
ANR2056	90/110	Rear crossmember no extensions	
KVB000290	90/110	Rear crossmember no extensions from VIN 2A627496	
NRC4171	110	Rear body crossmember	
DA40650	90/110 O/S	Bulkhead upper repair panel	
DA4065N	90/110 N/S	Bulkhead upper repair panel	
STC8354	90/110	Bulkhead outrigger	RH
STC8355	90/110	Bulkhead outrigger	LH
STC8356	110	Rear outrigger	RH, LH
STC8604	90/110	Front radius arm mount	RH
STC8605	90/110	Front radius arm mount	LH
STC8606	90/110	Rear radius arm mount	RH
STC8607	90/110	Rear radius arm mount	LH
STC8608	90/110	Front spring seat	LH
STC8609	110	Rear spring seat	RH, LH
STC8610	90	Rear spring seat	RH, LH
STC8648	90	Rear tubular outrigger	RH
STC8649	90	Rear tubular outrigger	LH
STC8652	90/110	Front chassis leg	RH
STC8653	90/110	Front chassis leg	LH
STC8693	90/110	Front spring seat	RH
STC8694	90/110	Tie bracket from bulkhead rigger	LH
STC8695	90/110	Tie bracket from bulkhead rigger	RH
DA4515		Shock absorber bracket - pair	
DA4516		Tie bar mounting bracket - single	
DA4518		Rear axle spring mount - 40mm lift	
DA4527		Rear axle spring mount - standard	
MRC9720		Front floor	RH
MTC2248		Front floor	LH
ALR1742	Tdi/V8/Td5	Floor panel - front	RH
ALR1743	Tdi/V8/Td5	Floor panel - front	LH
BIC710260		Rear door - 1 piece	
CQB000140		Glass for BIC710250	
CQB000150		Heated glass for BIC710250	
CVW500010		Glazing rubber for BIC710250	
DA4143	90/110	Door skin - front	RH
DA4144	90/110	Door skin - front	LH



BE PART OF IT!

CHASSIS COMPONENTS - DISCOVERY 1



MWC4840

ASR1186	Rear floor plate		
ASR1594	Floor panel	RH	
ASR1595	Floor panel	LH	
ALR6272	Bulkhead		Front From MA081991
MWC6702	Bonnet assembly		
ALR8519	Front floor crossmember		
ASR1187	Rear floor crossmember		
ALR8520	Rear crossmember		
STC1066	Crossmember assembly rear floor		
DA4530	Rear crossmember end repair panels for crossmember STC1066		Pair

STC2814	Outer sill	RH	3-Door
STC2813	Outer sill	LH	3-Door
STC2816	Outer sill	RH	5-Door
STC2815	Outer sill	LH	5-Door
MWC9060	Inner sill	RH	3/5-Door
MWC9061	Inner sill	LH	3/5-Door

ALR5822	Door outer skin	RH	Front	From MA163103
ALR5823	Door outer skin	LH	Front	From MA163103
ALR8576	Door outer skin	RH	Front	From TA163104
ALR8577	Door outer skin	LH	Front	From TA163101
ALR8572	Door outer skin	RH	Rear	From TA163104
ALR8573	Door outer skin	LH	Rear	From TA163104
MWC9084	Door outer skin	RH	Rear	From MA112622
MWC9085	Door outer skin	LH	Rear	From MA112622
ALR6682	Wing	RH	Front	From MA
ALR6681	Wing	LH	Front	From MA
ALR9878	Wing	RH	Front	From VA
ALR9877	Wing	LH	Front	From VA
MWC6754	Wing	RH	Front	To LA081991
MWC6755	Wing	LH	Front	To LA081991
MWC4840	Wheel arch panel	RH	5-Door	
MWC4841	Wheel arch panel	LH	5-Door	

DA4515	Shock absorber bracket	Pair		For right hand drive
DA4516	Tie bar mounting bracket	Single		O/S = Right side
DA4519	Rear body mount			N/S = Left side
DA4514	Front axle spring mount	RH		
DA4513	Front axle spring mount	LH		For left hand drive
DA4518	Rear axle spring mount	40mm lift		O/S = Left side
DA4527	Rear axle spring mount	Standard		N/S = Right side



DA4515



DA4516

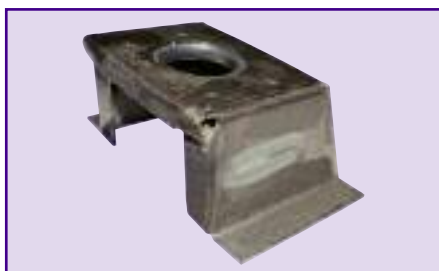

DA4519



DA4513 / DA4514



DA4518 / DA4527

CHASSIS & COMPONENTS - FREELANDER

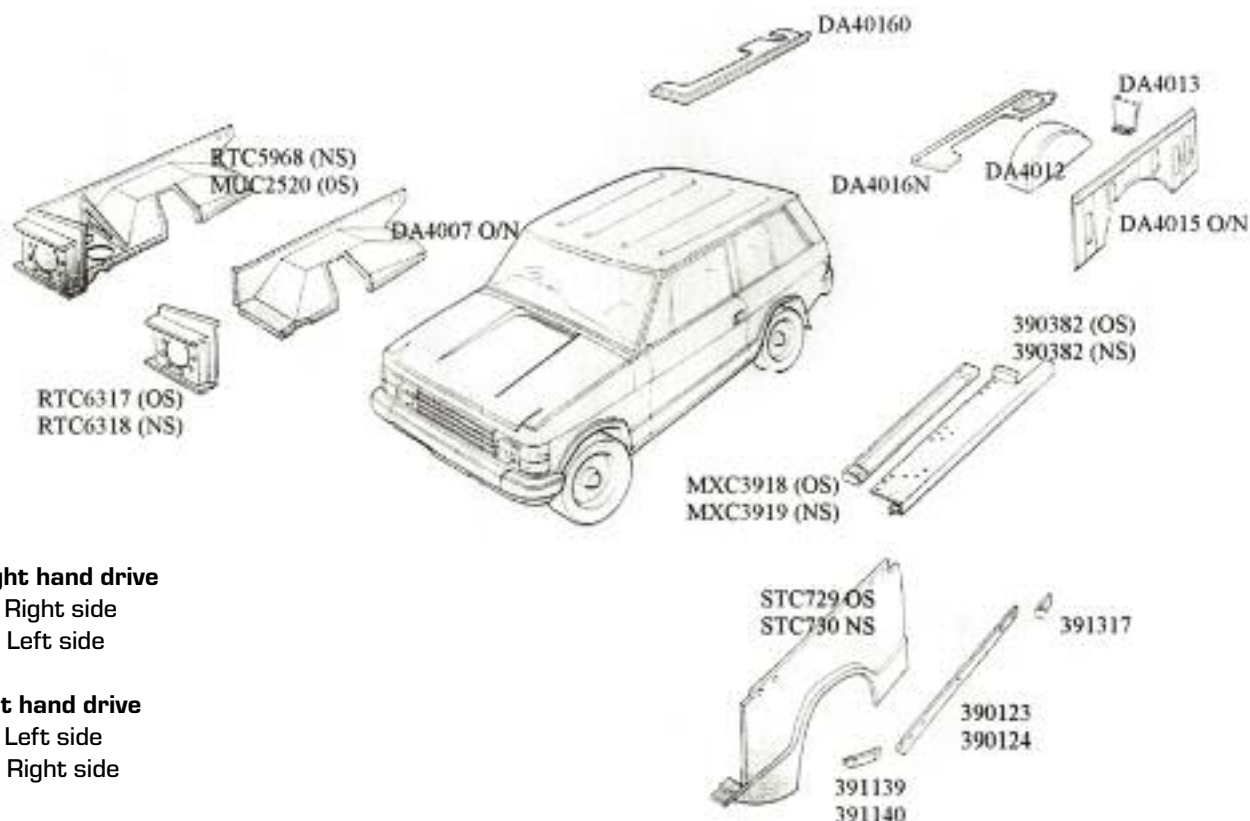

ALR8710	Bulkhead	Front
ASR2512	Bonnet assembly	

CHASSIS COMPONENTS - RANGE ROVER CLASSIC**For right hand drive**

O/S = Right side

N/S = Left side

For left hand drive

O/S = Left side

N/S = Right side

STC1135	Outer sills 4-door	N/S
STC1136	Outer sills 4-door	O/S
DA3016	Outer sills 2-door	O/S
DA3017	Outer sills 2-door	N/S
MXC3918	Sill inner 2-door	O/S
MXC3919	Sill inner 2-door	N/S
390381	Complete sill 2-door Outer, no mounts	O/S
390382	Complete sill 2-door Outer, no mounts	N/S
DA4120N	Half sill (repair) 4-door outer	N/S
DA4120O	Half sill (repair) 4-door outer	O/S
DA4007N	Inner wing	N/S
DA4007O	Inner wing	O/S
RTC6317	Headlamp box	O/S
RTC6318	Headlamp box	N/S
DA4012	Rear wheel arch	Fits both sides
DA4013N	Rear arch extension	N/S rear
DA4013O	Rear arch extension	O/S rear
DA4015N	Inner wing	N/S rear
DA4015O	Inner wing	O/S rear
DA4016N	Inner floor side	N/S rear
DA4016O	Inner floor side	O/S rear
NRC4717	Tailgate crossmember	Rear
ALR5595	Door assembly - front	LH
ALR5596	Door assembly - front	RH
MXC1408	Wing - RH	O/S front
MXC1409	Wing - LH	N/S front
MXC2063	Door outer skin - 4-door - LH	Front
MXC2064	Door outer skin - 4-door - RH	Front
RTC6203	Light panel - RH	Rear
RTC6204	Light panel - LH	Rear
STC1653	Bonnet assembly - from MA647605	
STC729	Wing - RH	Front
STC730	Wing - LH	Front
DA4515	Shock absorber bracket - pair	
DA4516	Tie bar mounting bracket - single	
DA4518	Rear axle spring mount - 40mm lift	
DA4527	Rear axle spring mount - standard	

**STC1135****DA3017****NRC4717**

CHASSIS COMPONENTS - SERIES 2 & 3

For right hand drive

O/S = Right side

N/S = Left side

For left hand drive

O/S = Left side

N/S = Right side

KEY - Ref. RHD Vehicles

O - Offside = Right Hand

N - Nearside = Left Hand

LWB - Long Wheel Base

SWB - Short Wheel Base

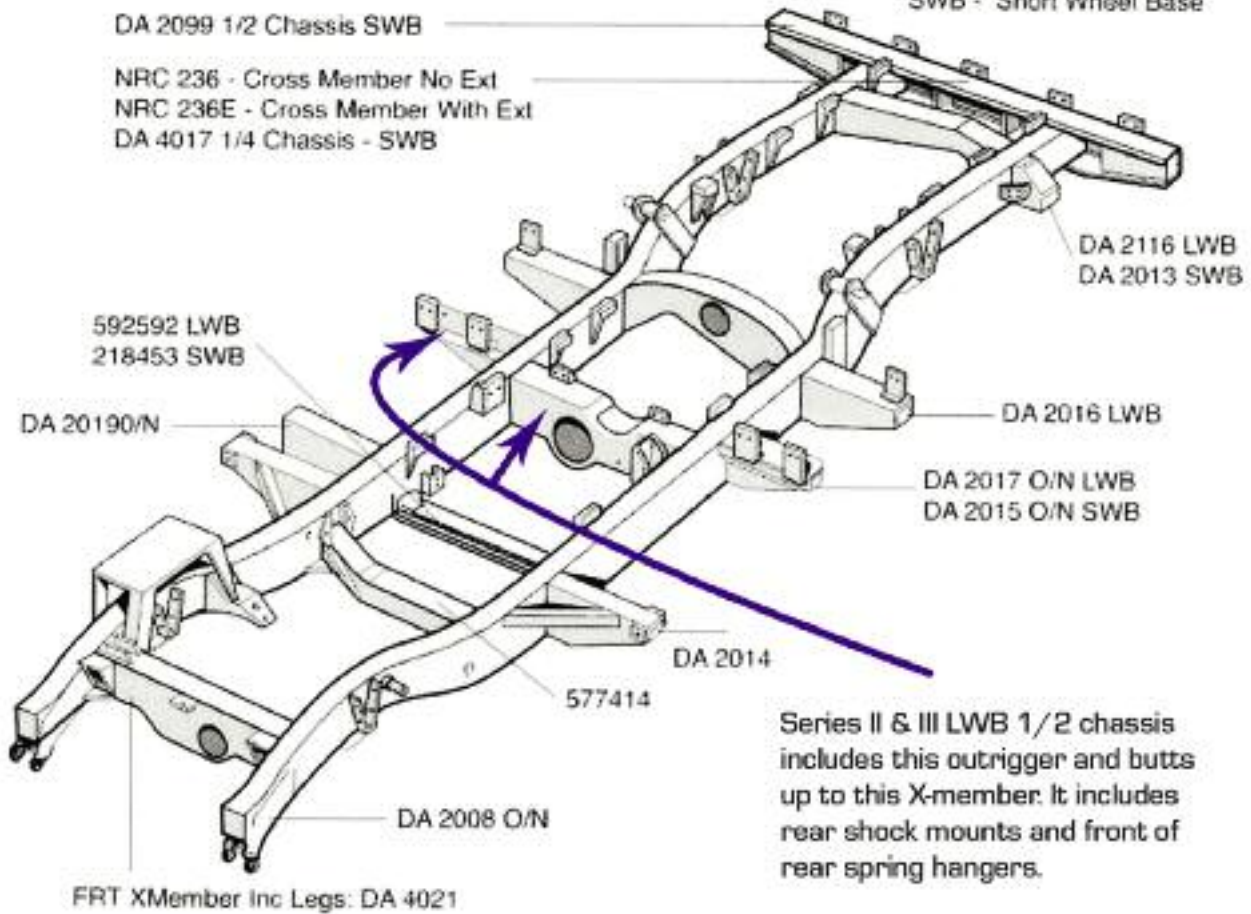

NRC4642G	Chassis frame		SWB	Galvanised
DA2008N	Chassis leg	N/S		Front
DA2008O	Chassis leg	O/S		Front
DA2013	Spring hanger		SWB	
DA2016	Spring hanger		LWB	Front
DA4021	Crossmember and legs			Front
DA2014	Bulkhead outrigger			
DA2019N	Front tank outrigger	N/S	SWB	
DA2019O	Front tank outrigger	O/S	SWB	
DA2015N	Rear tank outrigger	N/S	SWB	
DA2015O	Rear tank outrigger	O/S	SWB	
DA2017N	Rear tank outrigger	N/S	LWB	
DA2017O	Rear tank outrigger	O/S	LWB	
DA2116	Spring hanger		LWB	Rear
DA2099	1/2 Chassis		SWB	
NRC236	Rear crossmember	No extensions	SWB/LWB	
NRC236E	Rear crossmember	With extensions, no hangers	SWB/LWB	
DA4017	Rear crossmember / 1/4 chassis	With extensions and hangers	SWB	
559822	Rear crossmember			Military
DA2009	Extension piece (2 x 'U' shape sections)		For rear x-member	
DA4018N	Footwell	N/S	LHD	
DA4018O	Footwell	O/S	LHD	
DA2001N	Footwell	N/S	RHD	
DA2001O	Footwell	O/S	RHD	
DA2026N	Door pillar repair	N/S		Bulkhead/bracket
DA2026O	Door pillar repair	O/S		Bulkhead/bracket
DA4054	Bracket for DA2026	O/S, N/S	Pair	
218453	Gearbox crossmember - weld on		SWB	
592592	Gearbox crossmember - weld on		LWB	
MRC9720	Floor panel	Front	RH	
MTC2248	Floor panel	Front	LH	
DA2156	Series 3	Glazing kit	Door top	

CLIPS, CLAMPS & NIPPLES**JUBILEE CLIPS**

CN100208L	20mm	Qty 10
CN100508L	32 - 52mm	Qty 5
CN100909	70 - 90mm	Qty 1

**EXHAUST CLAMPS**

DA4062	45mm	Qty 1
DA4063	60mm	Qty 1
DA4064	65mm	Qty 1

**GREASE NIPPLES**

TYL100030	Short thread	Qty 10
234532	Long thread	Qty 10

CLUTCH KIT & FLYWHEEL - TD5**DA2357HD**

Heavy-duty one-piece dual mass replacement flywheel designed to outlast the original. Kit also includes modified release bearing.

HEAVY-DUTY**DA2357HD****BE PART OF IT!**

Changing your clutch?

Then demand your dealer uses a clutch kit from Britpart!

Heavy-Duty Britpart Clutch Kits



EXTREME USE CLUTCH KIT

DA5551 200 & 300 Tdi
Clutch kit - plate, cover & bearing

DA5551

DA5550	Td5	Clutch kit - plate, cover & bearing
DA2357HD	Td5	Clutch kit - plate, cover, heavy-duty flywheel & bearing
DA2357	Td5	Clutch kit - plate, cover, flywheel & bearing
STC8358	Defender - diesel (non Td5)/Discovery 1 - diesel/Range Rover Classic (non VM)	Clutch kit - plate, cover & bearing
FTC2957HD	Most applications	Clutch fork - heavy-duty
STC8363	Series 3	Clutch kit - plate, cover & bearing
DA2369	Series 2A	Clutch kit (9") - plate & cover
DA2370	Series 2A	Clutch kit (9 1/2") - plate & cover
URB500060	Freelander 1.8	Clutch kit - plate, cover & bearing



Team Britpart recommend Britpart clutches because -

- > Premier friction material gives longer life
- > Self centering bearing provides smooth operation
- > Intense quality control ensure fit first time

BRITPART

The quality parts for Land Rovers

www.britpart.com



- > Extensive testing determined the ultimate specification - see a video of the Britpart V8 in action at www.britpart.com/v8

FTC2957HD



CV JOINT KITS - BRITPART

Britpart has put together these boxed kits to help the fitter have all the necessary parts to do the job in one hit, saving time and money trying to find the necessary parts to do the job.

These kits are also helpful to pass over the trade counter instead of having to hunt for the individual parts.

One kit does one CV joint.

DA6050

Range Rover to 1985

DA6051

Range Rover 1986 to 1988 non ABS axle suffix A to VIN EA305589

DA6052

Range Rover 1989 to 1991 non ABS axle suffix B from VIN EA305590 to HA610293

Range Rover 1992 on non ABS to VIN JA624755

DA6053

Range Rover 1986 to 1991 with ABS to VIN HA610293

DA6054 **Note** - 10 spline on half shaft to diff end

Range Rover 1992 on non ABS from VIN KA624756 to P38A

Range Rover 1992 on with ABS to P38A

DA6055 **Note** - 24 spline on half shaft to diff end

Range Rover 1992 on non ABS from VIN KA624756 to P38A

Range Rover 1992 on with ABS to P38A

DA6056

Range Rover P38A 1995 to 2002

Save time and
money with a
Britpart
CV Joint kit

**DA6061****DA6057**

Defender non ABS with 23 internal splines

DA6058

Defender 1986 on non ABS with 32 internal splines

DA6059

Defender non ABS and ABS models from VIN LA930456

DA6060

Discovery 1 non ABS to VIN JA32850

DA6061

Discovery 1 non ABS from VIN JA032851 10 splines axle shaft to diff end

DA6062

Discovery 1 no ABS from VIN JA032851 24 splines axle shaft to diff end

Discovery 1 ABS models from VIN JA032851

DA6063

Discovery 2

DA6064

Freelander To VIN YA999999 TCIE diesel and 1.8 petrol

CYLINDER LINER KIT**LCJ000050LKIT**

Liner and piston for 1.8 litre K series engines.

**LCJ000050LKIT**

BRITPART

The quality parts for Land Rovers

BE PART OF IT!

DAMPER KIT**DA2352**

Freelander pre-2006 4-cylinder

Why pay for a new and expensive viscous coupling on your Freelander when all you need to replace, to remedy the fault, is the damper?

**DA2352**

BE PART OF IT!

DIFF COUPLING SHAFT**DA2355****DA2355**

The Range Rover L322 - 2002 onwards, suffer from a common problem with the coupling shaft spline wearing between the front propshaft and front differential, thus losing drive to the differential. The problem purely relates to the coupling shaft and the differential itself is not affected. Currently the only solution offered by Land Rover is to replace the propshaft and the whole complete front differential assembly - a very expensive option!

We are now able to offer a cheaper alternative!

Using this new coupling shaft will enable you to replace just the propshaft and coupling shaft and leave the differential in place, therefore reducing both time (the differential need not be removed from the vehicle) and cost.

DIFF REPAIR PANS**DA1043****DA1044****DA1045****DA1043**

Front - includes filler plug

DA1044

Rear - includes filler plug

DA1045

Front & rear - excludes filler plug

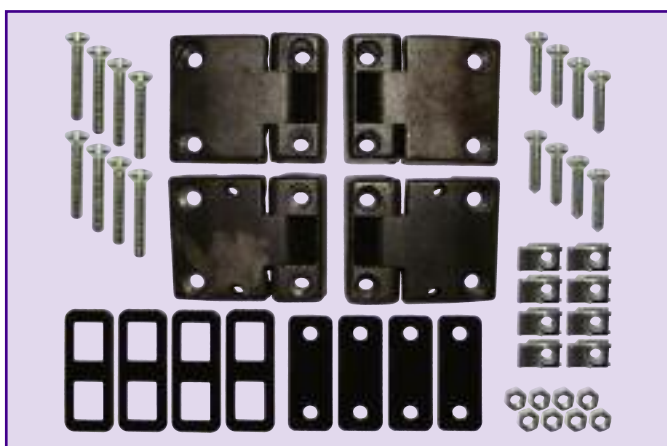
DOOR HINGE KIT**DA1069****DA1069**

Front door hinge kit for Series 3 and 90 & 110 Defender

EGR BLANKING KIT**DA1108****DA1108**

300Tdi EGR blanking kit

ELECTRONIC CONVERSION KITS**ERC4536K****ERC4536K**

This electronic conversion kit is for V8 points and has built in dwell adjustment with rpm protection when not running

**ETC5835K**

Dodgy points and condenser?

ETC5835K

The Britpart electronic conversion kit replaces the existing points and condenser with a new reliable electronic module. For 4-cylinder petrol engines the Britpart electronic ignition module has been developed to work with the standard ignition coil and provides service free and accurate ignition timing. The kit can be easily fitted to standard points type 45D4 distributors without having to fit a new electronic ignition coil.

We'd recommend fitting a new coil at the same time - PRC9858. Also available a new distributor with points to which this kit can be fitted - ETC5835.

GASKET KITS

TD5

DA2112	Head set	No gasket
DA2112-1	Head set	1-hole gasket
DA2112-2	Head set	2-hole gasket
DA2112-3	Head set	3-hole gasket
DA2113	Bottom set	

Freelander 1.8 16v

DA2114	Head set
DA2115	Bottom set

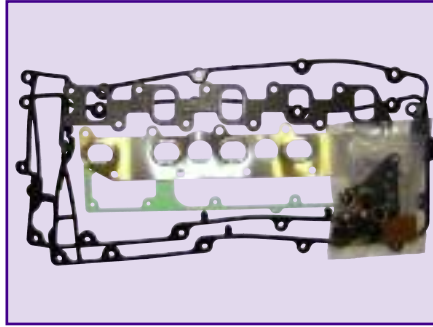

DA2112

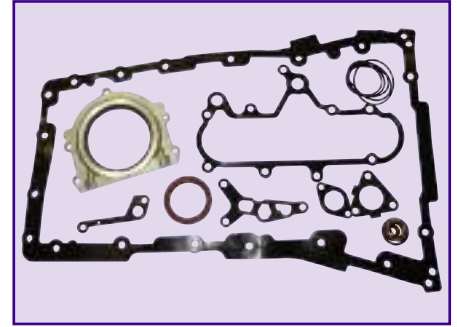

DA2113

HEAD BOLT SETS

DA2005	300 Tdi
DA2006	200 Tdi

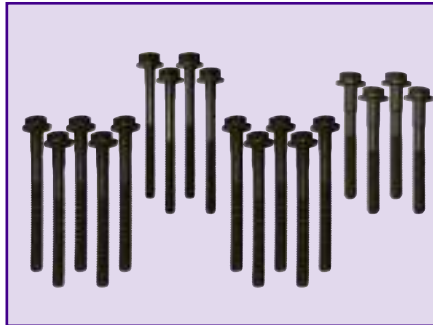

DA2005

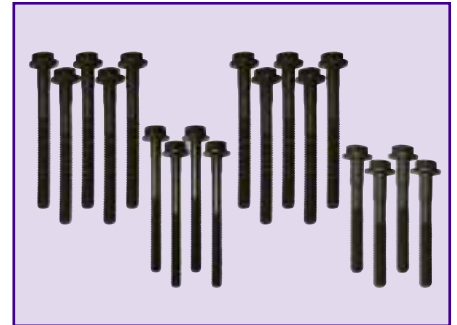

DA2006



A full range of filters available from Britpart!
See service kits & filter section.

HEATER BLOWER MOTOR KIT & RESISTOR KIT

DA4178

Range Rover Classic 1990 - 1994 & Discovery 200 Tdi with air con

Atlantic British has developed this all inclusive kit designed and engineered to replace failed heater motors. The kit includes heater blower motor, blower wheel, motor mounting bracket and mounting screws, heater assembly seals, nylon ties, solder, shrink tubing (for soldered connections) and complete instructions.

Note - When replacing the heater blower motor the vehicle's resistor must be upgraded to DA4178RESISTOR



DA4178

DA4178RESISTOR

The air con blower motor resistor controls the speed of the blower motor and the force of the airflow out of the dash vents, it features a thermal-sink aluminium mounting plate that dissipates circuit heat effectively.



DA4178RESISTOR

HEATER MATRIX



DA2155



AAP817



UTP1725



STC250



STC3135



JEF100150

DA2155	Series 3
AAP817	Defender - downward facing pipes
UTP1725	Defender - horizontal inlet/outlet pipes
JEF100220	Defender - LHD from XA159807
STC250	Discovery 1/Range Rover Classic - 1986 -1994
STC3135	Discovery 1/Range Rover Classic - 1992 -1994
JEF100150	Freelander - To YA999999
STC3261	Range Rover P38

HEATER PLUG UPGRADE KIT



DA1057

DA1057 Series 2¹/₄ diesel engine



HYLOMAR SEALANTS & COMPOUNDS

RTC3347

Hylomar Universal Blue - gasket & jointing compound - 100g tube

- > Non setting universal jointing compound
- > Resistant to fuels, coolants and lubricants
- > Use on gaskets and machined metal surfaces
- > High temperature capability up to 250°C
- > Unlimited assembly time
- > Easy disassembly for service maintenance
- > Allows for differential thermal expansion of components
- > Excellent vibration resistance



RTC3347



RTC3254

RTC3254

Hylomar 101 Silicone Sealant - gasketing, sealing & bonding compound - 85g tube

- > Engineering grade
- > Forms any size or shape of gasket instantly
- > Remains flexible, will not shrink
- > Bonds to metal, glass, ceramics, plastics, fibres and wood
- > Resists most solvents
- > Electrical insulator
- > Maximum constant operating temperature 250°C
- > Neutral curing
- > Ensure surfaces are free from oil and grease



STC4404



STC4600

STC4404

Hylomar 607 Silicone Sealant - 300ml cartridge

- > Excellent gap filling properties
- > Engineering grade
- > Forms any size or shape of gasket instantly
- > Remains flexible, will not shrink
- > Bonds to metal, glass, ceramics, plastics, fibres and wood
- > Resists most solvents
- > Good fluid resistance - not petrol or diesel
- > Electrical insulator
- > Maximum constant operating temperature 250°C
- > Neutral curing
- > Tolerant of some oil and grease, ensure surfaces are clean

STC4600

Hylomar 3400 Anaerobic Gasket Compound - 300ml cartridge

- > Excellent resistance to automotive fluids including fuels
- > Operating temperature -40°C to 150°C
- > Machined metal to metal surface only, not suitable for pressed steel
- > No gap filling
- > Latest generation anaerobic gasket compound
- > Single part product
- > Suitable for K-series engines
- > Ensure surfaces are free of oil and grease

IGNITION LEAD SETS

DA4102

Range Rover P38 V8 up to 1999
Defender 4.0

DA4104

Discovery
Range Rover Classic V8

Note - Includes king lead STC9124

NGC103740/810

Range Rover P38A
Discovery 2 from 1999

NGC500370/410

Freelander 1.8K



DA4104



NGC103740/810

LIQUID GLOVES - BRITPART

DA5650

Britpart Liquid Gloves Hand Barrier Cream. No need to use hot water, soap or chemicals, easily removed with cold water! Biodegradable. Protects hands from grease and grime. Prevents ingrained dirt, cracks and calluses. Moisturises and softens hands. Specially designed for the automotive industry. Viable alternative to latex gloves. 1 litre bottle.



DA5650

No need to use hot water, soap or chemicals to protect your hands!

LAND ROVER GENUINE CONSUMABLES

Antifreeze

PDA500300	Antifreeze	1 litre
PDA500310	Antifreeze	5 litres
STC50529	Antifreeze - extended life	1 litre
STC50530	Antifreeze - extended life	5 litres
ZLA000001AF	Antifreeze - MG Rover long life	1 litre

Batteries

STC4757	Battery	Type 072 12 volts
YGD000271	Battery	110 amp - Range Rover L322
YGD500100	Battery	12 volts
STC8587	Battery - wet	P38 diesel
YGD100860	Battery - wet	V8 Efi

Cleaners

STC8972	Brake cleaner	500ml
STC50543	General purpose/brake cleaner	200ml
STC50544	General purpose/brake cleaner	400ml
STC50547	Citrus hand cleaner	400ml
STC50549	Paint and resin hand cleaner	400ml
BAC500490	Leather & vinyl cleaner - contents	
	1 x 150ml leather protection cream	
	1 x 150ml leather soft cleaner	
	1 x sponge and cloth	

Fluids

SIJ500030	Brake fluid	500ml
SIJ500040	Brake fluid - Dot 4	1 litre
STC4862	Texamatic 7045E Dexron III ATF	1 litre
STC4863	Automatic transmission fluid LT71141	1 litre
STC8263	Automatic transmission fluid type G	1 litre
STC50531	Automatic transmission fluid 402	1 litre
STC4861	Transmission fluid - transfer box	500ml
STC9157	Manual transmission fluid 94	5 litres
STC9158	Manual transmission fluid 94	1 litre
STC50519	Power assisted steering fluid	1 litre

Miscellaneous

STC4676	De-icer	500ml
STC4672	Screen wash	250ml
STC4687	Screen wash	500ml
STC9155	Specialised lubricant	250ml
STC50545	Service lube	200ml
STC50550	Loctite 5900 gasket adhesive	50ml
STC50551	Flexible adhesive sealant	300ml
CES500020	Glass repair kit	

Oils

STC9181	Engine oil - 15W/40	1 litre
VYK000020	Gear oil - MTF94	2.5 litres
TYK500070	Transmission oil - 75W/90	1 litre
STC9176	Transmission oil - rear axle	25 litres

Paints

STC2862A	Aerosol	Monza red	150ml
RTC6401VA	Aerosol	Windjammer blue	150ml
STC1773VA	Aerosol	Biaritz blue	150ml
Touch up kit - contains paint stick and clear lacquer			
RTC6870VT	Touch-up kit	Alpine white	
STC2864VT	Touch-up kit	Oxford blue	
STC2828VT	Touch-up kit	Rioja red	
STC1774VT	Touch-up kit	Epsom green	
STC4829VT	Touch-up kit	Vienna green	
STC4235VT	Touch-up kit	Blenheim silver	
STC4596VT	Touch-up kit	Oslo blue	



STC50519



STC50544



SIJ500030

LOCTITE CONSUMABLES

**Super Glue**

3g tube

High performance instant adhesive with thousands of applications

DA6300

**Super Glue Brushable**

5g bottle

Brushable version for extra accuracy and greater coverage

DA6301

**Spray Adhesive**

500ml aerosol

Rapid bonding spray adhesive for bonding various materials

DA6302

**Repair Express Power Putty**

Blister pack

Fills, sticks, seals and re-builds thousands of items without tools

DA6303

**Rear View Mirror Bonder**

1 shot tube

Unique bonding system for rear view mirrors, car telephone aerials and all window mounted material

DA6304

**Lock 'N Seal**

24ml bottle

Fast acting thread lock and sealant

Replaces traditional locking methods

DA6305

**Stud 'N Bearing Fit**

24ml bottle

Locks and seals studs into position

Seals against leaks and vibration

DA6306

**Lock 'N Seal 243**

50ml bottle

Fast-acting thread lock and sealant

Prevents bolts, screws and nuts from vibrating loose

DA6307

**Stud 'N Bearing Fit 2701**

50ml bottle

Retains bearings into new and used housings

DA6308

**Instant Adhesive 401**

20g tube

Surface insensitive formulation creates a permanent bond with virtually any material

DA6309

**Freeze and Release**

400ml aerosol

Shock freezing (-43°C) is a quick and convenient method for releasing seized and corroded parts

DA6310

**Quick Gasket**

200ml aerosol

Permanently flexible flange sealant for non-rigid flanges and for plastic-to-plastic and metal-to-metal assemblies

DA6311

**Chemical Metal**

Mini blister pack

The original rock-hard multi-purpose repair paste

DA6312

**Leak Fix**

Mini blister pack

Seals and repairs leaks in petrol tanks, radiators and sumps

DA6313

**Super Steel Epoxy-Weld**

2 x 25g tube

Sets like steel

Seals, repairs, bonds, fixes and replaces

DA6314

**Terodicht Elastic Window Sealant**

310ml cartridge

Ideal for re-sealing rubber mounted windscreens

DA6316

**Terolan Special Sealant**

1.4kg can and brush

Vehicle body sealant for application with special brush

DA6317

**Fast Set Epoxy 3430**

24ml syringe

Two part general purpose epoxy adhesive

DA6318

**Teroson Etch Primer**

500ml aerosol

Provides excellent adhesion to steel, galvanised steel and aluminium

DA6319

**Glass Adhesive**

3ml tube

Glass to glass or glass to metal. Adhesive is triggered by UV rays in normal daylight. Clear bond line, water and detergent resistant

DA6320

OIL PUMP GEAR SET



DA4189

DA4189

Oil pump gear set for V8 engines
Discovery 1/Discovery 2/
Range Rover P38

PROPSHAFT KIT



DA6355

DA6355

Defender/Discovery 1/
Range Rover Classic
For vehicles with L230 transfer boxes
Double cardan extreme use front
propshaft with flange and fitting kit.
Note - Flange must be fitted to transfer
box.

PRESSURE RELIEF VALVE KIT



DA2376

DA2376

300 Tdi oil pump relief valve
Defender/Discovery/
Range Rover Classic

BRITPART

The quality parts for Land Rovers

PROPSHAFT BEARING



DA2395

*Instead of replacing your whole propshaft -
just replace the centre bearing!*

DA2395

Centre bearing assembly
Discovery 3 rear propshaft - TVB500360

SWIVEL HOUSING GREASE



STC3435



STC3435S

STC3435 370gm bottle

STC3435S 370ml sachet

- > Formulated for all leaf & coil spring Land Rover, Discovery and Range Rover models - 1951 - to date.
- > Lubricates swivel pins and housing seals, protects spheres.
- > A semi-fluid grease designed to withstand shock loading in oscillating joints.
- > Reinforced with solid lubricants, highly resistant to water and salt corrosion.
- > Better lubrication while driving, less leaks while standing.
- > One shot gives 'filled for life' protection.

SWIVEL PIN KITS



DA2178

532268	Series 2 conversion
DA2178	Series
DA2211	Defender



DA2211

TIMING KITS



DA1300

DA1200	200 TDi
DA1300	300 TDi

Contents -

- > Timing belt tensioner
- > Timing belt - OEM
- > Gaskets
- > Seals

TOOLS

Specialist socket for prop shaft fasteners on most Land Rovers. The $\frac{9}{16}$ " socket end is a perfect hexagon with rounded tip profiles to ensure the whole turning power is transferred onto the flanks of the nuts instead of on the corners. The socket's slim wall construction and wine glass profile, coupled to an integral slimline extension means it fits perfectly between the UJ yokes and over the prop shaft nuts without fouling. The $\frac{9}{16}$ " AF nuts are common to Series Land Rovers, Defenders (90 & 110 up to latest vehicles), Discoverys (up to and including Discovery 2 model) and Range Rovers (up to and including P38 model).

- > Size: $\frac{9}{16}$ " 6 point (Hexagon)
- > Total Length: 150mm
- > Outside diameter: 20mm

DA1065

Specialist socket for propshaft
Drive - $\frac{3}{8}$ " square drive

DA1119

Specialist socket for propshaft
Drive - $\frac{1}{2}$ " square drive



DA1065 / DA1119



DA3140

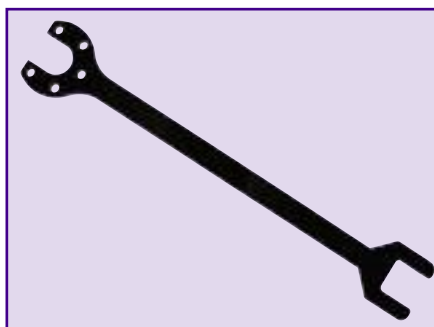

LRT-12-093



LRT-12-094

DA3140

Timing kit - 12 piece 2.5D/Tdi

LRT-12-093

Viscous coupling holding tool
V8 petrol/Td5 diesel/2.5L Td diesel/
300 Tdi Diesel

LRT-12-094

Viscous fan coupling wrench
V8 petrol/Td5 diesel/V6 2.7L
diesel/2.5L Td diesel/
Td6 diesel/300 Tdi diesel

LRT-12-058

Timing pin flywheel tool
Td5 diesel/Td4 diesel/4-cyl petrol

LRT-12-158

Timing pin Td5 diesel



LRT-12-058



LRT-12-158

TOUCH UP PAINT PENS

**Exclusive to Britpart
in the UK!!**

These superior touch up pens are made in the US and are as easy to use as a fine felt tip marker. They use a quality urethane paint for a superior colour match.

**The best you can get
without repainting!**

The AutoSharp Pen has many unique features not otherwise available:

The Pen - Paint is held in a barrel and automatically dispensed through a fine felt tip, providing the user unparalleled control over their painting instrument.

The Paint - High quality urethane paint is used which is the same as your vehicles manufacturer. This paint provides the user with a much closer colour match than other companies which primarily use lacquer (old technology) paints.

The Results - The best you can get without refinishing the damaged areas.

More details and FAQs can be found at www.britpart.com/paintpens

Note - If your colour is not listed then please contact us.



TOUCH UP PEN IS EASY TO USE!

DA6200	Beluga Black	DA6220	Buckingham Blue
DA6201	Portofino Red	DA6221	Cairns Blue
DA6202	Alpine White	DA6222	Tonga Green
DA6203	British Racing Green	DA6223	Atacama Sand
DA6204	Epsom Green	DA6224	Vesuvius Orange
DA6205	Oxford Blue	DA6225	Zermatt Silver
DA6206	Rioja Red	DA6226	Arctic Frost
DA6207	Rutland Red	DA6227	Rimmi Red
DA6208	White Gold	DA6228	Narvik Black
DA6209	Woodcote Green	DA6229	Caledonia Blue
DA6210	Chawton White	DA6230	Belize Green
DA6211	Java Black	DA6231	Kinver Sand
DA6212	Alveston Red	DA6232	Icelandic Blue Mica
DA6213	Oslo Blue	DA6233	Atlantis Blue
DA6214	Bonatti Grey	DA6234	Silver Sparkle - <i>Ideal for touching up alloy wheels</i>
DA6215	Vienna Green	DA6235	Stornoway Grey
DA6216	Zambezi Silver	DA6236	Biarritz Blue
DA6217	Adriatic Blue	DA6237	Alaska White
DA6218	Giverny Green	DA6238	Tangiers Orange
DA6219	Maya Gold		

WHEEL BEARING KITS



RTC3534

DA2379	Defender - up to KA	Front
DA2380	Defender - up to KA	Rear
DA2381	Defender - from LA	Front & rear
DA2382	Discovery 1 - up to JA032850	Front & rear
DA2383	Discovery 1 - from JA032851	Front & rear
DA2384	Range Rover Classic - non-ABS from JA624517	Rear
DA2385	Range Rover Classic - non-ABS to JA624516	Rear
DA2386	Range Rover Classic - ABS	Rear
DA2387	Range Rover Classic - ABS	Front
DA2388	Range Rover Classic - non-ABS	Front
RTC3534	Series 2 & 3 - short wheel base	Front & rear
RTC3537	Series 2 & 3 - long wheel base	Front & rear
FTC1507	Range Rover P38 - Note - bearing only	Front & rear

WING PROTECTORS



DA5631

DA5631

Protect your Defender's wings with a pair of these sturdy easy to fit protectors.

IN THIS SECTION....

SERVICE KITS & FILTERS

Britpart bulk filters	146
Britpart service kits - Defender	143
Britpart service kits - Discovery	144
Britpart service kits - Freelander	144
Britpart service kits - Range Rover	145
Britpart service kits - Series	146



BRITPART SERVICE KITS

Ever started servicing a Land Rover and then suddenly realised you haven't ordered a filter or forgot the sump plug washers?

Well now thanks to Britpart with one simple part number you can order your Land Rover kit safe in the knowledge that all the parts you need will be there for you to complete the job. No more half finished services!

The Britpart service kits contain quality products which are -

- > Manufactured to O.E. specification
- > Competitively priced
- > Available from stock



DA6004

Servicing a Land Rover just got a whole lot easier with Britpart!



Defender

DA6000

Defender 2¹/₂ petrol 7:1 compression ratio

1	ERR3340	Oil filter
1	NRC9238	Air filter
1	JS660L	Fuel filter
1	243959	Sump plug washer
or 1	FRC4808	Sump plug washer
4	RTC3571	Spark plugs
		7:1 compression ratio

DA6001

Defender Turbo D

1	ERR3340	Oil filter
1	NRC9238	Air filter
1	RTC6079	Fuel filter
1	FRC4808	Sump plug washer

DA6002

Defender 200 Tdi

1	ERR3340	Oil filter
1	NTC6660	Air filter
1	AEU2147L	Fuel filter
1	213961L	Sump plug washer
or 1	ETC7398	Sump plug washer

DA6003

Defender 300 Tdi

1	ERR3340	Oil filter
1	ESR2623	Air filter
1	AEU2147L	Fuel filter
1	UAM2857L	Sump plug washer
or 1	ALU1403L	Sump plug washer

DA6004

Defender TD5

1	LPX100590	Oil filter
1	ESR4238	Air filter
1	ERR6299	Rotor filter
1	ESR4686	Fuel filter
1	CDU1001L	Sump plug washer

DA6040

Defender 2007 Duratorq TDCI

1	LR004459	Oil filter
1	WJ1500040	Fuel filter
1	PHE500060	Air filter
1	1013938	Oil drain plug inc rubber seal

BRITPART SERVICE KITS - continued



Discovery

DA6005

Discovery 1 200 Tdi to VIN JA018272

1	ERR3340	Oil filter
1	NTC1435	Air filter
1	AEU2147L	Fuel filter
1	213961L	Sump plug washer

DA6006

Discovery 1 200 Tdi from VIN JA018273

1	ERR3340	Oil filter
1	ESR1049	Air filter
1	AEU2147L	Fuel filter
1	213961L	Sump plug washer

DA6007

Discovery 1 300 Tdi

1	ERR3340	Oil filter
1	ESR1445	Air filter
1	AEU2147L	Fuel filter
1	UAM2857L	Sump plug washer
or 1	ALU1403L	Sump plug washer

DA6008

Discovery 1 3.5 EFi

1	ERR3340	Oil filter
1	RTC4683	Air filter
8	ERR3799	Spark plugs
1	ESR4065	Fuel filter in line
1	213961L	Sump plug washer

DA6009

Discovery 1 3.9 EFi

1	ERR3340	Oil filter
1	ESR1445	Air filter
1	ESR4065	Fuel filter
1	ETC7398	Sump plug washer

DA6004

Discovery 2 TD5

1	LPX100590	Oil filter
1	ESR4238	Air filter
1	ERR6299	Rotor filter
1	ESR4686	Fuel filter
1	CDU1001L	Sump plug washer

DA6010

Discovery 2 V8 4.0

1	ERR3340	Oil filter
1	ESR4238	Air filter
8	NLP100320	Spark plugs
1	ALU1403L	Sump plug washer

DA6035

Discovery 3 2.7 Diesel to 6A999999

1	1311289	Oil filter
1	PHE000112	Air filter
1	LRO10075	Fuel filter
1	JKR500010	Cabin filter
1	JKR500020	Cabin filter
1	1013938	Oil drain plug inc rubber seal

DA6041

Discovery 3 2.7 Diesel from vin 7A

1	1311289	Oil filter
1	PHE000112	Air filter
1	JKR500010	Cabin filter
1	JKR500020	Cabin filter
1	LRO09705	Fuel filter
1	1013938	Oil drain plug inc rubber seal

DA6037

Discovery 3 4.4 Petrol

1	LRO07160	Oil filter
1	PHE000112	Air filter
8	LRO05253	Spark plugs
1	JKR500010	Cabin filter
1	JKR500020	Cabin filter
1	1013938	Oil drain plug inc rubber seal



Freelander

DA6011

Freelander 1.8 petrol to VIN YA999999

1	CDU1268	Oil filter
1	ESR4103	Air filter
1	JKR100200	Pollen filter
1	ALU1403L	Sump plug washer
4	NLP100290L	Spark plugs

DA6012

Freelander 1.8 petrol from VIN 1A000001

1	CDU1268	Oil filter
1	ESR4103	Air filter
1	JKR100280	Pollen filter
1	ALU1403L	Sump plug washer

DA6013

Freelander 2.0 diesel TCIE

1	ERR5542	Oil filter
1	ESR4103	Air filter
1	WJN10046	Fuel filter
1	JKR100200	Pollen filter
1	ALU1403L	Sump plug washer

DA6014

Freelander TD4 to VIN 2A209830

1	LRF100150L	Oil filter
1	PHE100500L	Air filter
1	JKR100280	Pollen filter
1	ALU1403L	Sump plug washer
1	MUN000010	Fuel filter

DA6015

Freelander TD4 from VIN 2A209831

1	LRF100150L	Oil filter
1	PHE100500L	Air filter
1	JKR100280	Pollen filter
1	ALU1403L	Sump plug washer
1	WJN000080	Fuel filter

DA6038

Freelander 2 - 2.2 Diesel

1	LRO01247	Oil filter
1	LRO05816	Air filter
1	LRO01313	Fuel filter
1	LRO00899	Cabin filter
1	LRO00901	Cabin filter
1	LRO06295	Drain plug gasket

DA6039

Freelander 2 - 3.2 Petrol

1	LRO01419	Oil filter
1	LRO05816	Air filter
6	LRO05483	Spark plugs
1	LRO00899	Cabin filter
1	LRO00901	Cabin filter
1	LRO00506	Drain plug gasket

The Britpart service kits contain quality products which are -



- > Manufactured to O.E. specification
- > Competitively priced
- > Available from stock

Servicing a Land Rover just got a
whole lot easier with Britpart!

BRITPART SERVICE KITS - continued



Range Rover

DA6016

Range Rover 3.5 1970 - 1975

1	RTC3186	Oil filter
2	605191	Air filters
1	JS660L	Fuel filter
8	RTC3573	Spark plugs
1	213961L	Sump plug washer
2	603330	Flame traps
1	RTC6623	Points (fixed)
1	RTC3472	Condenser

DA6017

Range Rover 3.5 1975 - 1982

1	ERR3340	Oil filter
2	605191	Air filters
1	JS660L	Fuel filter
8	RTC3573	Spark plugs
1	213961L	Sump plug washer
2	603330	Flame traps
1	RTC6623	Points (fixed)
1	RTC3472	Condenser

DA6018

Range Rover 3.5 1982 - 1983

1	ERR3340	Oil filter
2	605191	Air filters
1	JS660L	Fuel filter
8	RTC3570	Spark plugs
1	213961L	Sump plug washer
2	603330	Flame traps
1	RTC6626	Points (sliding)
1	RTC3472	Condenser

DA6019

Range Rover 3.5 1984 - 1986

1	ERR3340	Oil filter
2	605191	Air filters
1	JS660L	Fuel filter
8	RTC3570	Spark plugs
1	213961L	Sump plug washer
2	603330	Flame traps

DA6020

Range Rover 3.5 carb 1986 - 1991

1	ERR3340	Oil filter
2	605191	Air filters
1	JS660L	Fuel filter
8	RTC3812	Spark plugs
1	213961L	Sump plug washer
2	603330	Flame traps

DA6021

Range Rover 3.5 & 3.9 EFi 1986 - 1991 to GA464553

1	ERR3340	Oil filter
1	RTC4683	Air filter
1	NTC5958	Fuel filter
1	213961L	Sump plug washer

DA6022

Range Rover 3.9 EFi 1986 - 1994 from HA464554 to LA647644

1	ERR3340	Oil filter
1	RTC4683	Air filter
1	ESR4065	Fuel filter
1	213961L	Sump plug washer

DA6023

Range Rover 3.9 EFi 1992 - 1994 from MA647645

1	ERR3340	Oil filter
1	ESR1445	Air filter
1	ESR4065	Fuel filter
8	ETC7244	Spark plugs
1	213961L	Sump plug washer

DA6024

Range Rover 4.2 1992 - 1994

1	ERR3340	Oil filter
1	ESR1445	Air filter
1	ESR4065	Fuel filter
8	ERR3799	Spark plugs
1	213961L	Sump plug washer

DA6006

Range Rover Classic - 200 TDI

1	ERR3340	Oil filter
1	ESR1049	Air filter
1	AEU2147L	Fuel filter
1	213961L	Sump plug washer

DA6007

Range Rover Classic - 300 TDI

1	ERR3340	Oil filter
1	ESR1445	Air filter
1	AEU2147L	Fuel filter
1	UAM2857L	Sump plug washer
or 1	ALU1403L	Sump plug washer

DA6025

Range Rover P38 4.0 & 4.6 to TA346793 & from WA376580 to WA385948

1	ERR3340	Oil filter
1	ESR341	Air filter
1	ESR4065	Fuel filter
8	ERR3799	Spark plugs
2	BTR8037	Pollen filters
1	UAM2857L	Sump plug washer
or 1	ALU1403L	Sump plug washer

DA6026

Range Rover P38 4.0 & 4.6 from VA346794 to VA376579 & from WA385949 onwards

1	ERR3340	Oil filter
1	ESR4238	Air filter
1	ESR4065	Fuel filter
8	ERR3799	Spark plugs
2	BTR8037	Pollen filters
1	UAM2857L	Sump plug washer
or 1	ALU1403L	Sump plug washer

DA6027

Range Rover P38 2.5 DT to engine no. 33978348 to (Dec 1995) type A oil filter

1	STC2180	Oil filter type A
1	ESR341	Air filter
1	STC2827	Fuel filter
2	BTR8037	Pollen filters
1	VYX000040	Sump plug washer

DA6028

Range Rover P38 2.5 DT from engine no. 33988348 from (Dec 1995) to VIN TA346793 type B oil filter

1	STC3350	Oil filter type B
1	ESR341	Air filter
1	STC2827	Fuel filter
2	BTR8037	Pollen filters
1	VYX000040	Sump plug washer

DA6029

Range Rover P38 2.5 DT from engine no. 33988348 from (Dec 1995) from VIN TA346794 type B oil filter

1	STC3350	Oil filter type B
1	ESR4238	Air filter
1	STC2827	Fuel filter
2	BTR8037	Pollen filters
1	VYX000040	Sump plug washer

DA6030

Range Rover L322 3.0 diesel

1	LPZ000020	Oil filter
1	PHE000040	Air filter
1	WFL000070	Fuel filter
1	JMO000010	Pollen filter
1	VYX000040	Sump plug washer

DA6031

Range Rover L322 4.4 V8 M62

1	LPW000010	Oil filter
1	PHE000050	Air filter
1	JMO000010	Pollen filter
1	VYX000040	Sump plug washer
8	NLP000030	Spark plugs

DA6035

Range Rover Sport 2.7 Diesel

1	1311289	Oil filter
1	PHE000112	Air filter
1	LRO10075	Fuel filter
1	JKR500010	Cabin filter
1	JKR500020	Cabin filter
1	1013938	Oil drain plug inc rubber seal

DA6036

Range Rover Sport 3.6 Diesel

1	LRO02338	Oil filter
1	PHE000112	Air filter
1	LRO09705	Fuel filter
1	JKR500010	Cabin filter
1	JKR500020	Cabin filter
1	1013938	Oil drain plug inc rubber seal

DA6037

Range Rover Sport 4.2 & 4.4 Petrol

1	LR007160	Oil filter
1	PHE000112	Air filter
8	LR005253	Spark plugs
1	JKR500010	Cabin filter
1	JKR500020	Cabin filter
1	1013938	Oil drain plug inc rubber seal

BRITPART SERVICE KITS - continued



Series

DA6032

2¹/₄ petrol from 1964

- Lucas ignition (fixed points)

1	RTC3184	Oil filter
1	606168	Fuel filter (in line)
4	RTC3570	Spark plugs
1	RTC3270	Points (fixed)
1	RTC3472	Condenser
1	243959	Sump plug washer

DA6034

2¹/₄ petrol from 1964

- (Ducellier ignition)

1	RTC3184	Oil filter
1	606168	Fuel filter (in line)
4	RTC3570	Spark plugs
1	RTC6625	Points
1	RTC6620	Condenser
1	243959	Sump plug washer

DA6033

2¹/₄ petrol from 1964

- Lucas ignition (sliding points)

1	RTC3184	Oil filter
1	606168	Fuel filter (in line)
4	RTC3570	Spark plugs
1	RTC364	Points (sliding)
or 1	RTC3288	Points (sliding)
1	RTC6621	Condenser
1	243959	Sump plug washer

BRITPART BULK FILTERS

Minimum order quantity - 50

ESR1445X	Air	Discovery 1/Range Rover Classic
ESR2623X	Air	Defender 1987-2006
ESR4238X	Air	Defender 1987-2006/Discovery 2 1998-2004/Freelander/Range Rover P38
AEU2147LX	Fuel	Defender/Discovery 1/Range Rover Classic 1986-1994
ESR4686X	Fuel	Defender/Discovery 2
ERR3340X	Oil	Defender/Discovery 1/Discovery 2/Range Rover Classic/Range Rover P38
LPX100590X	Oil	Defender/Discovery 2
RTC3184X	Oil	Series 2/Series 3
BTR8037X	Pollen	Range Rover P38
JM0000010X	Pollen	Range Rover L322
JKR500010X	Pollen - Air intake	Discovery 3/Range Rover Sport
JKR500020X	Pollen - Odour & particles	Discovery 3/Range Rover Sport
JKR100200X	Pollen	Freelander - pre 1A
JKR100280X	Pollen	Freelander - 1A onwards
ERR6299X	Rotor	Defender/Discovery 2



Explore the world with Britpart...

IN THIS SECTION....

VEHICLE ENHANCEMENTS

Defender	152
Discovery 3	150-151
Freelander 2	151
Range Rover L322	149
Range Rover Sport	148



**Enhance the
look of your
*Land Rover!***

BE PART OF IT!

RANGE ROVER SPORT



DA3350

DA3350	Air intake grille - left hand side	Chrome effect	Single
DA3351	Air intake grille - right hand side	Chrome effect	Single
DA3352	Air intake grille kit (DA3350 & DA3351)	Chrome effect	Pair
JAK500320WWH	Air intake grille - right hand side	Tungsten/Titan	Single
JAK500330WWH	Air intake grille - left hand side	Tungsten/Titan	Single
LR006304	Air intake grilles	Chrome	Pair
	Headlight washer jet caps		Pair

DA7600 - Java Black; **DA7601** - Stornoway Grey; **DA7602** - Zermatt Silver;
DA7603 - Buckingham Blue; **DA7604** - Alaska White

DA7610	Clear indicator lamp with orange bulb		Single
VUB503880MMM	Wing mirror covers	Chrome effect	Pair
DA5642	Side runners		Pair
	Mudflaps - Front CAS500070PCL, Rear CAT500120PCL		

VTK500020	Side steps		Pair
------------------	------------	--	------

VUB501980	A Bar - moulded plastic - includes spot lamp brackets		Grey
------------------	---	--	------



JAK500320WWH



Enhance the look of your
Range Rover Sport!



LR006304



DA7602



Shown here fitted to Discovery 3

DA7610



Shown here fitted to Discovery 3

VUB503880MMM



VTK500020



VUB501980

RANGE ROVER L322

**NEW****DA5108**

Smart replacement grille for Range Rover L322. Same as DHB500550LQV but with Brunel outer and chrome inner.

DA1071	Rear bumper cover	Stainless steel	Single
DA1072	Oval rear badge surround	Chrome	Single
DA1073	Lower sill step covers - front & back	Brushed finish	Pair
VUB001230	Side protection tubes	Stainless steel	Pair
VUB002510	Side protection tubes	Black steel	Pair
Note - Tubes can be fitted with or without front mudflaps			
VUB503660	Side step including front mudflaps		Pair
VUB001300	Side step replacement insert moulding for VUB503660	Right hand side	Single
VUB001310	Side step replacement insert moulding for VUB503660	Left hand side	Single
VUB503650	Air intake grille	Chrome	Pair
VUB503880MMM	Wing mirror covers	Chrome effect	Pair



DA1071



DA1073

FRONT

REAR



DA1072



VUB001230



VUB002510



VUB503660



VUB503650



VUB503880MMM

BE PART OF IT!

DISCOVERY 3



Headlight washer jet caps	Pair
DA7600	- Java Black
DA7601	- Stornoway Grey
DA7602	- Zermatt Silver
DA7603	- Buckingham Blue
DA7604	- Alaska White
DA7610	Single
Clear indicator lamp with orange bulb	
EBN500041	Tread plate
Front & rear kit	Set of 4
JAK000065MMM	Side vent trim
Single	Stainless steel
LR005237	A Bar
Moulded black rubber	
Includes spot lamp brackets	
VUB501270	Bull/Nudge bar
Flat	Black
VUB503880MMM	
Wing mirror covers	Chrome effect
Pair	

Enhance the look of
your *Discovery 3!*



DA7602



DA7610



JAK000065MMM



EBN500041

FRONT



REAR



LR005237



VUB503880MMM



VUB501270

DISCOVERY 3 - continued**VTD500010**

Side protection tubes

Black steel

Pair

VTD500020

Side protection tubes

Stainless steel

Pair

VTK500010

Side runners

Pair

**VTK500010****VTD500020****VTD500010****FREELANDER 2****DA7610**

Clear indicator lamp with orange bulb

Single

LR002525

Front and rear sill tread plate kit

Polished stainless steel

Set of 4

LR002773

Body side step

Rubber top

Pair

LR003318

Body side step - tube type

Stainless steel

Pair

LR003840

Body side step - tube type

Black

Pair

VUB503880MMM

Wing mirror covers

Chrome effect

Pair

*Shown here fitted to Discovery 3***DA7610****LR002525***Shown here fitted to Discovery 3***VUB503880MMM****LR002773****LR003318****LR003840**

DEFENDER



DA2356

Front grille
Stainless steel Natural

DA2356B

Front grille
Stainless steel Black

DA4000

Air intake grille
Single Left hand side
Black

DA4001

Air intake grille
Single Right hand side
Black

DA5498

Replacement gear box gaiter - single
Grey

DA5499

Replacement gear box gaiter - single
Black

DA5500

Gear lever and transfer gear lever set for
R380 gearbox Anodised alloy

DPT100070

Bumper end cap
Rubber Single

Note - does not include fixings
DZM100080



DA5500 with DA5499

15" 3-spoke sports wheels

DA4650 Black vinyl Black centre

DA4653 Black leather Polished centre

14" 3-spoke sports wheels

DA4654 Black vinyl Black centre

DA4657 Black leather Polished centre

Note - To fit steering wheel to vehicle you'll need a new boss kit.

DA4659 16mm shaft 36 splines

DA4660 19mm shaft 48 splines



Also available in stainless steel -
DA2356

DA2356B



DA4000/DA4001



DPT100070



Shown with
boss kit fitted

DA4650 & DA4654



Shown with
boss kit fitted

DA4653 & DA4657

**Enhance
the look
of your
Defender!**

See exterior
protection section
for our range of A
bars, lamp guards,
chequer plate etc.

IN THIS SECTION...

MISCELLANEOUS

Britpart merchandise	155
First aid kit	153
Haynes manuals	156-157
Land Rover gear	158-159
Original technical publications	160
Parts & general interest books	161
Wiper blade - heavy-duty	161



FIRST AID KIT

STC7642

First aid kit - Land Rover

To DIN 13164, the industry standard first aid kit solution for cars, vans and commercial vehicles when on the move.



STC7642



BE PART OF IT!

Going off-road? Make sure your vehicle is well equipped for all situations. A Britpart electric winch will help you to...

Get to where you want to go!

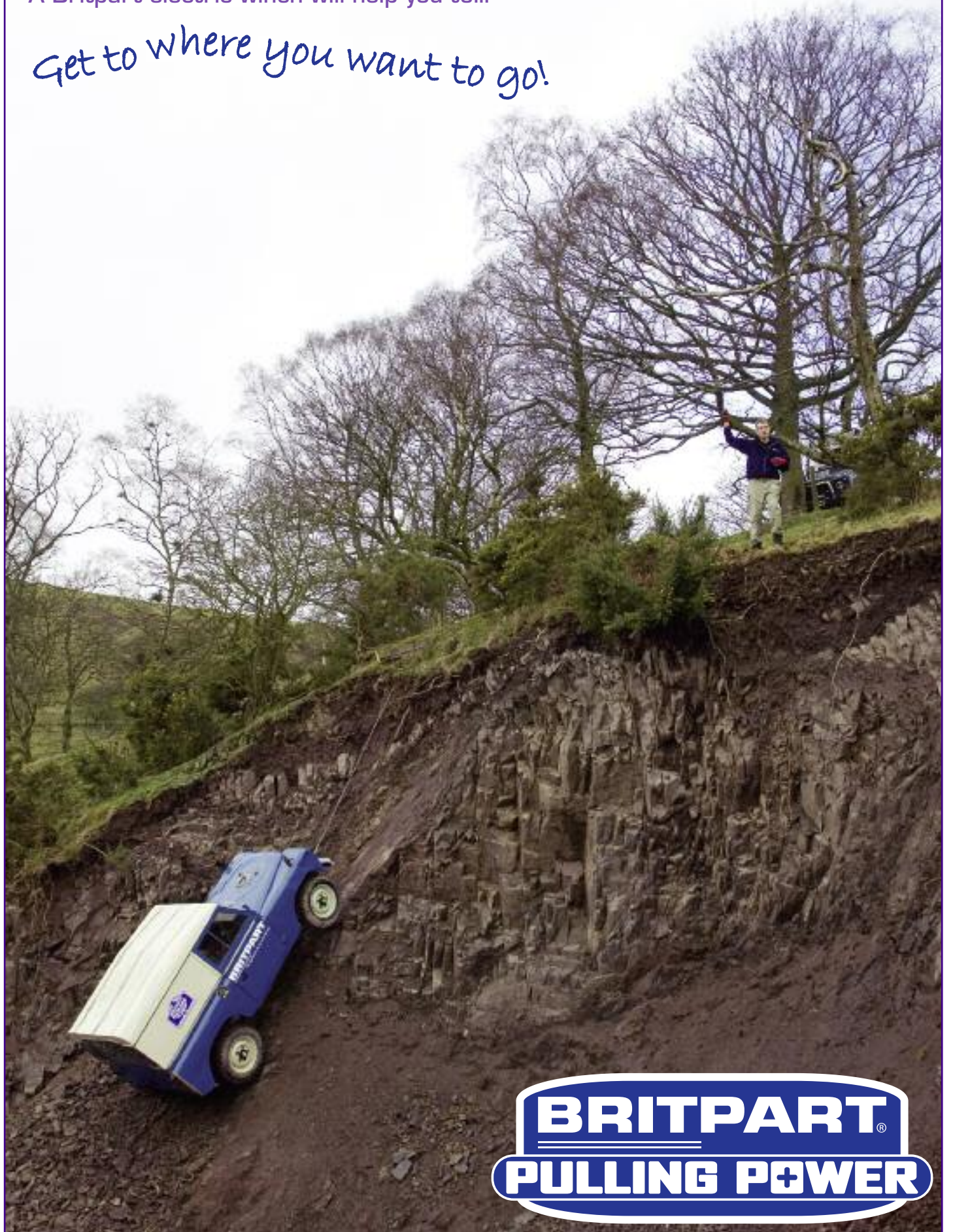

BRITPART
PULLING POWER

We now offer a wider range of Britpart branded merchandise for you or your customers!



DA8016



DA8000



DA8003

DA8002



DA8015



DA8013

DA8017



DA8004

DA8021



Britpart Merchandise



DA8005



DA8009



DA8018



DA8020



Rear of polo shirt and sweatshirt

- DA8000 Mouse & mug mat set
- DA8002 Key ring
- DA8003 Ball point pen
- DA8004 Mug - single
- DA8005 Polo shirt - medium
- DA8006 Polo shirt - large
- DA8007 Polo shirt - x large
- DA8008 Polo shirt - xx large
- DA8009 Sweat shirt - medium
- DA8010 Sweat shirt - large
- DA8011 Sweat shirt - x large
- DA8012 Sweat shirt - xx large

- DA8013 Ski hat
- DA8015 Stainless steel travel mug - single
- DA8016 5" Teddy bear
- DA8017 Long handled cotton shopping bag
- DA8018 Fleece - x large
- DA8019 Fleece - xx large
- DA8020 T-shirt - x large
- DA8021 Baseball cap

BE PART OF IT!

HAYNES MANUALS



DA3035



DA3040

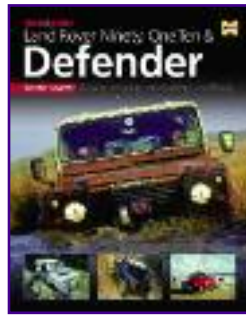

DA3046

Defender

DA3035
90, 110 & Defender - 1983 - 2007
(up to 56 reg) - Diesel

DA3040
Restoration Manual - Land Rover 90, 110 & Defender by Lindsay Porter

DA3046
You and Your Land Rover 90, 110 & Defender - Buying, enjoying, maintaining & modifying by Martin Hodder

Discovery

DA2093 Extreme - Discovery - The definitive guide to modifying

DA3036 Discovery 1989 - 1998 (G to S reg) - Petrol & Diesel

DA4493 Discovery 1998 - 2004 (S to 04 reg) - Diesel



DA2093

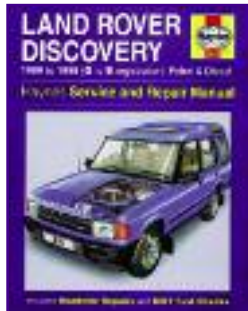

DA3036



DA4493



the worldwide market leader in automotive repair manuals



DA2980



DA4494

Freelander

DA2980
Land Rover Freelander 1997 - 2002
(R reg onwards) - Petrol & Diesel

DA4494
Freelander 2003 - 2006
(53 to 56 reg) - Petrol & Diesel



Free stand with 10 manuals!

Ask for full details



DA3042



DA3048



DA3105

Range Rover

DA3042
Restoration Manual - Range Rover Classic by Dave Pollard

DA3048
Range Rover 1970 - Oct 1992
(up to K reg) - Petrol

DA3105
You and Your Range Rover - Buying, enjoying, maintaining & modifying by Dave Pollard

HAYNES MANUALS - continued

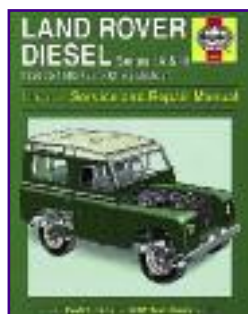

DA3037

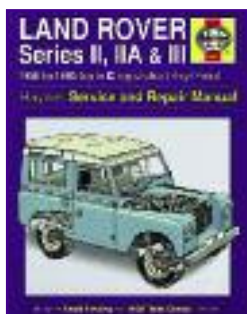

DA3038



DA3041

Series

DA3037

Series 2a & 3 (up to C reg) - Diesel

DA3038

Series 2, 2a & 3 1958 - 1985
(up to C reg) 4-cylinder - Petrol

DA3041

Restoration Manual - Land Rover Series 1, 2 & 3
by Lindsay Porter

General Interest

DA3039 Tuning Rover V8 Engines - How to get the best performance for road and competition use by David Hardcastle

DA3043 Land Rover - Simply The Best by Martin Hodder

DA3044 The Off Road 4 Wheel Drive Book - Choosing, using and maintaining go anywhere vehicles by Jack Jackson

DA3108 4x4 Book - The essential guide to buying, owning, enjoying & maintaining an off road vehicle by Paul Guinness

DA3159 Land Rover Expeditions - Where to go off-roading in the UK

DA4490 Land Rover - Buying and Selling Manual - How to do the best deals by Les Roberts

DA4491 Land Rover - 60 Years of Adventure by Nick Dimbleby

DA4495 4WD in 1000 Photos



DA3039

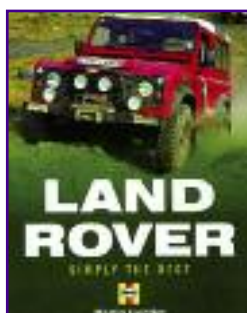

DA3043

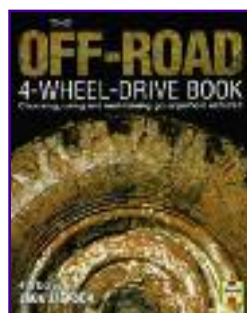

DA3044

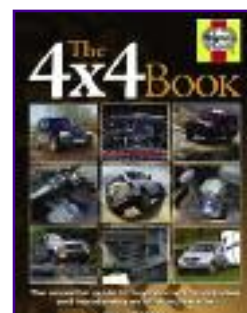

DA3108



DA3159



DA4490



DA4491

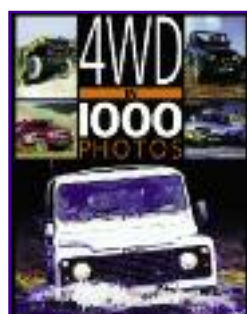

DA4495



the worldwide market leader in
automotive repair manuals

Haynes Internal Combustion Engine

DA4310

Build a realistic working model of a combustion engine. Includes light and sound features, light up spark plugs and moving pistons, valve gear and fan belt. Includes a 'Haynes Manual' Finished model size 180 x 270 x 140 mm (H x W x D)

Build a working model
of an engine!



DA4310

LAND ROVER GEAR



LRO 0407



LRO 0008



LRO 0754



LRO 0784



LRO 1075



LRO 1686



LRO 1093



LRO 1355



LRO 1895



LRO 1431



LRO 1517



LRO 1535

LAND ROVER GEAR - continued**LRO 1621****LRO 1685****LRO 1753****LRO 1867****LRO 1868****LRO 1873****LRO 1986****LRO 2033****LRO 2054****LRO 2090****LRO 2278****SOX 0593**

Ideal birthday or Christmas gift ideas for any Land Rover enthusiast - what ever their age!

LRO 0008	Pin badge	Small pin badge of famous logo
LRO 0407	Series 1 model	Green 1:32 scale
LRO 0754	Key ring	Karabiner style made from aluminium alloy
LRO 0784	Pencils	Made from recycled materials - pack of 10
LRO 1075	Safari bear	A bear destined for an African safari
LRO 1093	Key holder	G4 Challenge Karabiner style quick release key ring
LRO 1355	Parking sign	Heavy-duty metal sign
LRO 1431	Logo badge	Silver pin badge
LRO 1517	Bottle opener	With laser etched logo
LRO 1535	Letter opener	Cast metal
LRO 1621	Dog tags	Circular metal with full colour Land Rover logo; suitable for engraving on the reverse
LRO 1685	Key ring	A key chain made from webbing, with a silicon badge Land Rover badge on one side and Go Beyond on the reverse
LRO 1686	Radio controlled Land Rover	G4 Challenge Freelander with fully functional radio control, 4-wheel drive and working headlights
LRO 1753	Umbrella	Sturdy golfing size with carbon fibre shaft
LRO 1867	Key ring	Clip it compass & thermometer on clip-on key ring
LRO 1868	Key ring	Clip on mini torch and key ring incorporating a handy compass
LRO 1873	Hudson eyewear clip	Perfect for securing your driving glasses in the car
LRO 1895	Series 1 - 60th Anniversary	Limited edition of the world famous Series 1 - 1:32 scale
LRO 1986	Orang-utan	Loveable resident of Borneo
LRO 2033	Eco-lanyard	Earth friendly - made with organic inks and plant material
LRO 2054	Key ring	Silver with wire attachment
LRO 2090	Ripper wallet	Alberta style with multi-sectioned interior suitable for all currency and credit cards
LRO 2278	Travel mug	Insulated stainless steel for hot or cold drinks
SOX 0593	Socks	Navy, green & black sports socks with cushion foot - pack of 3

ORIGINAL TECHNICAL PUBLICATIONS

19LHP1

Range Rover Classic - 1970 to 1985
Parts publications/service publications/owners literature

19LHP2

Range Rover Classic - 1986 to 1995
Parts publications/service publications/owners literature

19LHP3

Land Rover Discovery - 1989 to 1994
Parts publications/service publications/owners handbooks

LHP19

Land Rover Series 1 - 1948 to 1958
Parts publications/service publications/owners literature

LHP20

Land Rover Series 2 - 1958 to 1961
Parts publications/service publications/owners literature

LHP21

Land Rover Series 2A & 2B - 1961 to 1971
Parts publications/owners handbooks

LHP22

Land Rover Series 3 - 1971 to 1985
Parts publications/service publications/owners literature

LHP23

Land Rover 88 Half Ton Military - 1968 to 1984
Parts publications/service publications/owners handbooks

LHP24

Land Rover 101 One Tonne Military - 1975 to 1978
Parts publications/service publications/owners handbooks

LHP25

Land Rover 90, 110 & XD Military - 1984 to 1999
Parts publications/service publications/owners handbooks

LHP26

Land Rover 90, 110 & 127 - 1983 to 1989
Parts publications/service publications/owners handbooks

LHP27

Land Rover Defender 90, 110 & 130 - 1990 to 1999
Parts publications/service publications/owners handbooks

LHP28

Land Rover Defender 90 & 110 North America - 1993 to 1997
Parts publications/service publications/owners handbooks/supplementary information/sales brochures

LHP29

Range Rover Classic (North America) - 1987 to 1995
Parts publications/service publications/owners literature/supplementary information/sales brochures

LHP32

Land Rover Discovery - 1994 to 1998
Parts publications/service publications/owners literature

LHP33

Land Rover Discovery North America - 1994 to 1998
Parts publications/service publications/owners literature/supplementary information/sales brochures



19LHP1



19LHP2

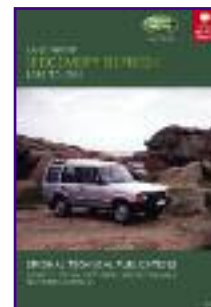

19LHP3



LHP19



LHP20



LHP21



LHP22



LHP23



LHP24

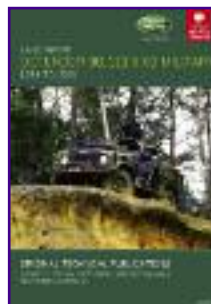

LHP25

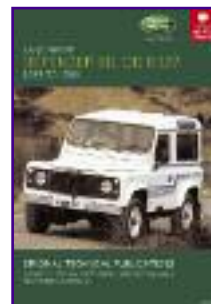

LHP26

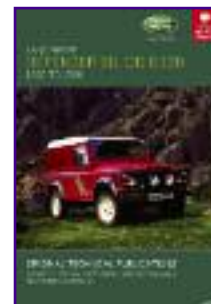

LHP27

Handy and easy to use!

Note - Minimum system requirements - Windows 2000 or XP/Pentium III/64MB RAM/Adobe Acrobat Reader Vr 6.0. They are not currently Vista compatible but will be when Windows issue Service Pack 1.0 for Vista. Due to copy protection the CDs only work on Macs with Intel processors running Windows.



LHP28

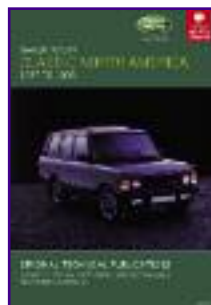

LHP29

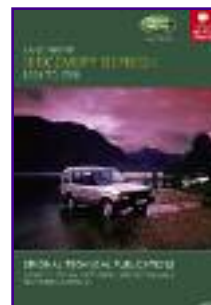

LHP32

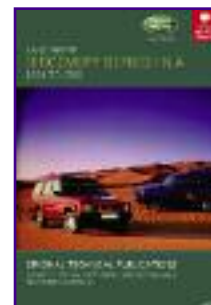

LHP33

These are an exciting new range of original technical publications on CD-Rom. On the CD you'll get original parts books, workshop manuals and handbooks. Each CD-Rom focuses on one model as shown above and each has the same format: the original parts catalogues (from parts book and/or microfiche, as appropriate) are followed by the workshop manuals and driver's handbooks, all reproduced in an easy-to-use and easy-to-print PDF format.

PARTS & GENERAL INTEREST BOOKS

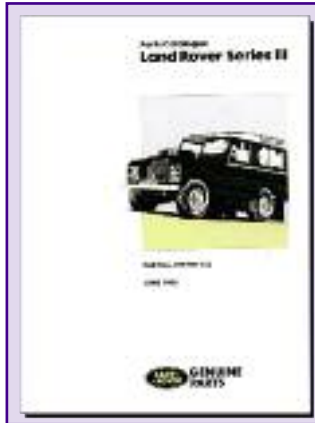

RTC9841CE

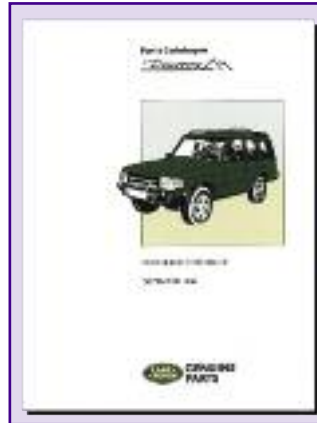

RTC9947CF



DA3156



DA3157

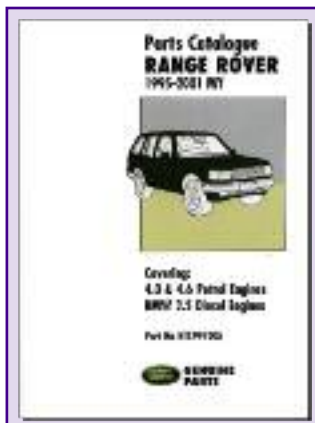

RTC9970CE

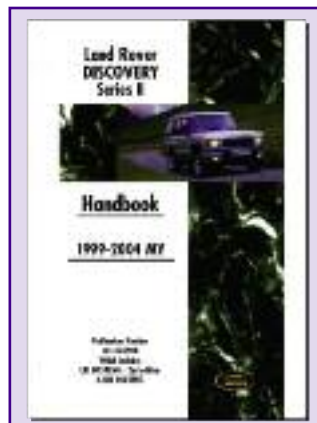

DA3161

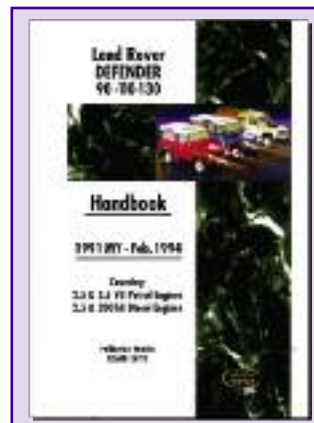

DA3162

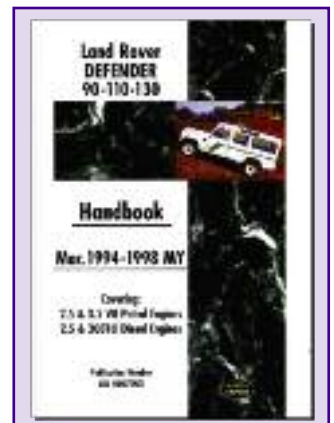

LRL0087ENG

Parts catalogues

RTC9841CE	Series 3
RTC9947CF	Discovery covering 1989 - 1998 MY - 2.0 Mpi & 3.5 & 3.9 V8 petrol and 200Tdi & 300Tdi diesel engines
STC9021CC	Defender 90/110/130 - covering 1987 - 2006 MY
RTC9970CE	Range Rover P38 covering 1995 - 2001 MY - 4.0 & 4.6 petrol and BMW 2.5 diesel engines

Handbooks

DA3161	Discovery 2 covering 1999 - 2004 MY
DA3162	Defender 90/110/130 covering 1991 MY - February 1994 - 2.5 & 3.5 V8 petrol and 2.5 & 200Tdi diesel engines
LRL0087ENG	Defender 90/110/130 covering March 1994 - 1998 MY - 2.5 & 3.5 V8 petrol and 2.5 & 300Tdi diesel engines

Other publications

DA3156	Winch In Safety - A5 book by Land Rover with pictures throughout, over 100 pages.
DA3157	Defender Td5 1999-2005 MY onwards with 300 Tdi. Includes workshop manual and electrical manual.
LRL0178ENG	Replacement service portfolio
SJR901FRWM	Discovery workshop manual

WIPER BLADE - HEAVY-DUTY

DKC500010PMD

Heavy-duty winter wiper blade
Discovery 2
Front
Pair



DKC500010PMD

BE PART OF IT!

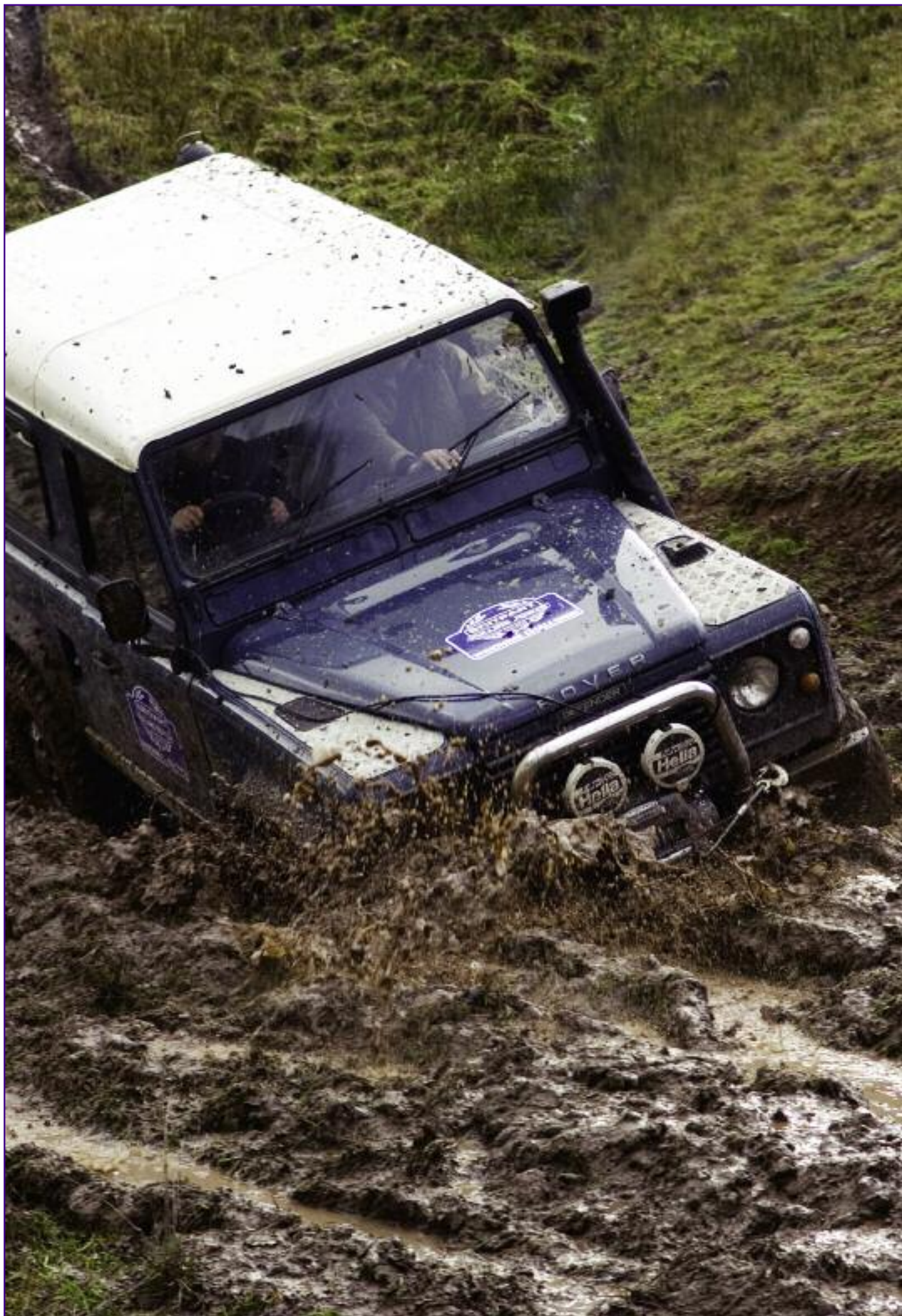

PART NUMBER FINDER

Part No.	Page No.	Part No.	Page No.	Part No.	Page No.	Part No.	Page No.	Part No.	Page No.	Part No.	Page No.
67187	43	ANR3410PY-YELLOW	107	DA20010	130	DA2138	45	DA240440	97	DA2811GREEN	59
201661	43	ANR3631MNH	36	DA2002	63	DA2148	63	DA240440S	97	DA2811GREY	59
201691	43	ANR3635	43	DA2003	112	DA2149	61	DA240540	97	DA2812BLUE	59
218453	130	ANR3679	32	DA2004	8	DA2155	136	DA240640	97	DA2812GREEN	59
234532	131	ANR3973	36	DA2005	135	DA2156	130	DA240640S	97	DA2812GREY	59
320698	66	ANR4489	78	DA2006	135	DA2158BLACK	16	DA240740	97	DA2813BLACK	59
320699	66	ANR4583PM	36	DA2007	63	DA2158BLUE	16	DA240740S	97	DA2813BLUE	59
320726	66	ANR4583SILVER	36	DA2008N	130	DA2158BROWN	16	DA240840	97	DA2813GREEN	59
320737	66	ANR4635PM	36	DA2008O	130	DA2158GREEN	16	DA2409	97	DA2813GREY	59
331401	55	ANR4636PM	36	DA2009	130	DA2160BLACK	16	DA2409S	97	DA2814BLUE	59
345985	14	ANR5307MNH	36	DA2012	47	DA2160BLUE	16	DA2410	97	DA2814GREEN	59
349967	66	ANR5593PM	36	DA2013	130	DA2160BROWN	16	DA241040	97	DA2814GREY	59
390381	129	ANR6094L	33	DA2014	130	DA2160GREEN	16	DA241040S	97	DA2815BLACK	57
390382	129	ANR6947PY	107	DA2015N	130	DA2165	44	DA2410S	97	DA2815BLUE	57
395529	63	ANR6947PY-YELLOW	107	DA2015O	130	DA2166	75	DA2411	97	DA2815GREEN	57
395530	63	ASR1186	128	DA2016	130	DA2169	63	DA241140	97	DA2815GREY	57
532268	140	ASR1187	128	DA2017N	130	DA2170	75	DA241140S	97	DA2816BLACK	57
537179	35	ASR1594	128	DA2017O	130	DA2171	75	DA2411S	97	DA2816BLUE	57
559822	130	ASR1595	128	DA2019N	130	DA2172	75	DA2412	97	DA2816GREEN	57
579408	43	ASR2512	128	DA2019O	130	DA2174	77	DA241240	97	DA2816GREY	57
592592	130	AWR570ORPI	66	DA2021	34	DA2178	140	DA241240S	97	DA2817BLUE	57
19LHP1	160	AWR5701RPI	66	DA2022	34	DA2182	75	DA2412S	97	DA2817GREEN	57
19LHP2	160	AWR5702RPI	66	DA2023N	63	DA2186	106	DA2413	97	DA2817GREY	57
19LHP3	160	AWR5708RPI	66	DA2023O	63	DA2194	43	DA241340	97	DA2818BLACK	57
320737CB	66	BAC500490	138	DA2024	63	DA2195	43	DA241340S	97	DA2819BLACK	60
320737CG	66	BIC710250	127	DA2026	34	DA2196	43	DA2413S	97	DA2820BLACK	60
320737LCS	66	BTR7895	55	DA2026N	130	DA2197	43	DA2414	97	DA2821BLACK	59
320737RPI	66	BTR7896	55	DA2026O	130	DA2206	104	DA241440S	97	DA2822BLACK	58
320737T	66 & 67	BTR7897	55	DA2029	63	DA2211	140	DA2414S	97	DA2980	156
331110AG	64	BTR7898	55	DA2030	63	DA2212	87	DA2418	97	DA2990	31
331110SA	64	BTR8037X	146	DA2035	61	DA2215	34	DA241840	97	DA2991	31
331113AG	64	BTR8140RPI	66	DA2035BLUE	62	DA2225	79	DA241840S	97	DA2993	31
331113SA	64	BTR8141RPI	66	DA2035BROWN	62	DA2227	20	DA2418S	97	DA2996	31
331259AG	64	CAS000150PMA	15	DA2035CHAR	62	DA2228	20	DA2419	97	DA3000	34
331259SA	64	CAS500010PCL	15	DA2035GREEN	62	DA2231	78	DA241940	97	DA3002	31
331260AG	64	CAS500060PMA	15	DA2035GREY	62	DA2243	77	DA241940S	97	DA3005	31
331260SA	64	CAS500070PCL	15	DA2035LCS	61	DA2243EYE	77	DA2419S	97	DA3010	40
331308AG	64	CAT000180PMA	15	DA2035RPI	61	DA2244	78	DA2420	97	DA3010B	40
331371AG	64	CAT500010PCL	15	DA2035T	61	DA2246	90	DA242040	97	DA3014	90
345985P	14	CAT500070PMA	15	DA2037	91	DA2247	87	DA242040S	97	DA3015	81
548205PY	107	CAT500120PCL	15	DA2038	122	DA2248	77	DA2420S	97	DA3016	129
548205PY-YELLOW	107	CAT500410PMA	15	DA2039	122	DA2250	19	DA2421	97	DA3017	129
552818PY	107	CAT500450PMA	15	DA2047	122	DA2250B	19	DA242140	97	DA3018	81
552818PY-YELLOW	107	CAT500540PMA	15	DA2050	8	DA2301	14	DA242140S	97	DA3020	81
552819PY	107	CES500020	138	DA2051	8	DA2310	30	DA2421S	97	DA3021	81
552819PY-YELLOW	107	CN100208L	131	DA2052	8	DA2311	30	DA2425	107	DA3022	81
568858PY	107	CN100508L	131	DA2053	8	DA2312	30	DA2426	107	DA3023	81
568858PY-YELLOW	107	CN100909	131	DA2054	8	DA2315	30	DA2430	32	DA3024	80
569746PY	107	QGB000140	127	DA2056	126	DA2342L	49	DA2431	32	DA3025	80
569746PY-YELLOW	107	CQB000150	127	DA2056-300TDI	126	DA2342R	49	DA2432	32	DA3026	80
572068PY	107	CVW000010	127	DA2057	126	DA2343L	49	DA2433	32	DA3027	80
572068PY-YELLOW	107	DA1003	78	DA2057-300TDI	126	DA2343R	49	DA2434	32	DA3027LH	80
572180PY	107	DA1004	78	DA2060	8	DA2344	49	DA2435	32	DA3028	90
572180PY-YELLOW	107	DA1005	111	DA2061	8	DA2351	63	DA2436	32	DA3029	90
575580PY	107	DA1006	111	DA2062	8	DA2352	133	DA2437	32	DA3030	90
575580PY-YELLOW	107	DA1007	111	DA2063	8	DA2353	108	DA2438	32	DA3031	90
90577434PY	107	DA1008	111	DA2064	8	DA2354	34 & 71	DA2439	32	DA3032	90
90577434PY-YELLOW	107	DA1009	111	DA2065	8	DA2355	134	DA2500	82	DA3033	90
AAP817	136	DA1010	111	DA2066	8	DA2356	152	DA2501	82	DA3034	90
AEU2147LX	146	DA1011	111	DA2067	8	DA2356B	152	DA2800BLACK	58	DA3035	156
ALR1742	127	DA1012	111	DA2068	8	DA2357	132	DA2800BLUE	58	DA3036	156
ALR1743	127	DA1013	111	DA2069	8	DA2357HD	131 & 132	DA2800GREEN	58	DA3037	157
ALR5595	129	DA1014	111	DA2070	8	DA2362	113	DA2800GREY	58	DA3038	157
ALR5596	129	DA1016	111	DA2071	7	DA2363	113	DA2801BLACK	58	DA3039	157
ALR5822	128	DA1017	111	DA2075	35	DA2364	17	DA2801BLUE	58	DA3040	156
ALR5823	128	DA1043	134	DA2079	122	DA2365	17	DA2801GREEN	58	DA3041	157
ALR6272	128	DA1044	134	DA2082	122	DA2366	17	DA2801GREY	58	DA3042	156
ALR6681	128	DA1045	134	DA2084	122	DA2369	132	DA2802BLUE	58	DA3043	157
ALR6682	128	DA1057	136	DA2090	49	DA2370	132	DA2802GREEN	58	DA3044	157
ALR6852	63	DA1059	17	DA2091	49	DA2371	106	DA2802GREY	58	DA3046	156
ALR8519	128	DA1060	111	DA2093	156	DA2372	106	DA2803BLACK	60	DA3048	156
ALR8520	128	DA1061	111	DA2096	49	DA2373	106	DA2803BLUE	60	DA3049	104
ALR8572	128	DA1062	39	DA2098	49	DA2374	80 & 81	DA2803GREEN	60	DA3049AF	104
ALR8573	128	DA1062AMBER	39	DA2099	130	DA2376	140	DA2803GREY	60	DA3050	123
ALR8576	128	DA1062BLUE	39	DA2109	122	DA2379	142	DA2804BLUE	60	DA3051	123
ALR8577	128	DA1062COVER	39	DA2112	135	DA2380	142	DA2804GREEN	60	DA3052	123
ALR8710	128	DA1063	39	DA2112-1	135	DA2381	142	DA2804GREY	60	DA3054	123
ALR8977	128	DA1064	39	DA2112-2	135	DA2382	142	DA2805BLUE	60	DA3055	123
ALR8978	128	DA1065	141	DA2112-3	135	DA2383	142	DA2805GREEN	60	DA3056	21
AMR3850	41	DA1067	111	DA2113	135	DA2384	142	DA2805GREY	60	DA3057	21
AMR4910	40	DA1068	111	DA2114	135	DA2385	142	DA2806BLUE	60	DA3058	123
AMR6521	41	DA1069	134	DA2115	135	DA2386	142	DA2806GREEN	60	DA3059	66
AMR6522	41	DA1070	150	DA2116	130	DA2387	142	DA2806GREY	60	DA3068	123
AMR6526	41	DA1071	149	DA2118	43	DA2388	142	DA2807BLACK	58	DA3069	80
AMR6527	41	DA1072	149	DA2120	44	DA2390	34 & 71	DA2807BLUE	58	DA3070	28
AMR6528	41	DA1073	149	DA2121	44	DA2392	34 & 71	DA2807GREEN	58	DA3071	28
ANR1534PM	36	DA1077	37	DA2122	47	DA2395	134	DA2807GREY	58	DA3072	28
ANR1721PY	107	DA1080	37	DA2123	43	DA2400	97	DA2808BLACK	58	DA3073	28
ANR1721PY-YELLOW	107	DA1089	29	DA2123A	43	DA240040S	97	DA2808BLUE	58	DA3075	28
ANR2056	127	DA1090	29	DA2124	63	DA2400S	97	DA2808GREEN	58	DA3078	9
ANR2563PY	107	DA1091	29	DA2125	45 & 47	DA2401	97	DA2808GREY	58	DA3079	9
ANR2563PY-YELLOW	107	DA1092	29	DA2126	104	DA240140	97	DA2809BLUE	58	DA3080	9
ANR2763MMM	32	DA1093	29	DA2126A	104	DA240140S	97	DA2809GREEN	58	DA3081	9
ANR3285PY	107	DA1101	37	DA2128	14	DA2401S	97	DA2809GREY	58	DA3088	101
ANR3285PY-YELLOW	107	DA1119	141	DA2129	47	DA2402	97	DA2810BLACK	59	DA3089	101
ANR3305PY	107	DA1200	141	DA2130	14	DA240240	97	DA2810BLUE	59	DA3090	101
ANR3305PY-YELLOW	107	DA1300	141	DA2133	47	DA240240S	97	DA2810GREEN	59	DA3091	101
ANR3332PY	107	DA1960	17	DA2134	45 & 47	DA2402S	97	DA2810GREY	59	DA3092	101
ANR3332PY-YELLOW	107	DA1961	17	DA2136	44	DA240340	97	DA2811BLACK	59	DA3093	101
ANR3410PY	107	DA2001N	130	DA2137	44	DA240340S	97	DA2811BLUE	59	DA3094	101

PART NUMBER FINDER - continued

Part No.	Page No.	Part No.	Page No.	Part No.	Page No.	Part No.	Page No.	Part No.	Page No.	Part No.	Page No.
DA3096	101	DA4027	49	DA4173	13	DA4285	114	DA4442	74	DA5505	108
DA3098	101	DA4028	66	DA4174	60	DA4285C	114	DA4443	74	DA5506	108
DA3100	101	DA4029	66	DA4175	60	DA4286	114	DA4444	74	DA5507	20
DA3101	101	DA4030	47	DA4176	60	DA4286C	114	DA4447	74	DA5507LHD	20
DA3102	101	DA4031	66	DA4177	60	DA4287	114	DA4448	74	DA5508	20
DA3103	101	DA4032	69	DA4178	135	DA4287C	114	DA4449	74	DA5509	113
DA3104	101	DA4032BRONZE	69	DA4178RESISTOR	135	DA4288	114	DA4450	74	DA5510	108
DA3105	156	DA4032GREEN	69	DA4179	105	DA4288C	114	DA4451	74	DA5511	50
DA3107	156	DA4032GREY	69	DA4181	111	DA4289	114	DA4452	74	DA5512	74
DA3108	157	DA4033	69	DA4182	111	DA4289C	114	DA4453	74	DA5513	100
DA3119	101	DA4033BRONZE	69	DA4183	52	DA4290	120	DA4454	74	DA5519	74
DA3120	77	DA4033GREEN	69	DA4184	11	DA4291	120	DA4455	74	DA5520	74
DA3121	76	DA4034	14	DA4185	99	DA4292	120	DA4457	74	DA5521	74
DA3122	76	DA4035BLUE	108	DA4187	98	DA4293	120	DA4458	74	DA5522	74
DA3124	101	DA4035YELLOW	108	DA4188	98	DA4294	120	DA4459	74	DA5523	74
DA3125	101	DA4036BLUE	108	DA4189	140	DA4295	120	DA4460	74	DA5526	100
DA3126	101	DA4041	66	DA4190	72	DA4296	9	DA4461	74	DA5550	132
DA3128	101	DA4042	66	DA4191	72	DA4297	9	DA4462	74	DA5551	132
DA3129	101	DA4047	24 & 26	DA4192	72	DA4298	66	DA4463	74	DA5554	53
DA3130	76	DA4049	8	DA4193	72	DA4299	114	DA4464	74	DA5555	53
DA3132	76	DA4054	130	DA4194	72	DA4299C	114	DA4465	74	DA5556	53
DA3133	101	DA4055	66	DA4197	112	DA4300	114	DA4466	74	DA5600	78
DA3134	101	DA4056	66	DA4198	112	DA4300C	114	DA4467	74	DA5601	78
DA3136	96	DA4058	76	DA4199	112	DA4301	114	DA4468	74	DA5602	52
DA3137	96	DA4059	76	DA4201	112	DA4301C	114	DA4470	52	DA5604	88
DA3138	95	DA4060	23	DA4202	112	DA4302	120	DA4472	98	DA5607	78
DA3139	95	DA4061	76	DA4203	112	DA4303	120	DA4473	98	DA5609	88
DA3140	141	DA4062	131	DA4204	112	DA4304	120	DA4474	98	DA5610	68
DA3141	80 & 81	DA4063	131	DA4205	112	DA4305	66	DA4475	98	DA5611	68
DA3142	80 & 81	DA4064	131	DA4208	112	DA4306	120	DA4476	98	DA5612	68
DA3153	78	DA4065N	127	DA4210	111	DA4310	157	DA4477	98	DA5613	68
DA3154	78	DA4065O	127	DA4211	111	DA4311	30	DA4478	99	DA5614	68
DA3155	78	DA4067	66	DA4212	122	DA4312	30	DA4479	99	DA5615	68
DA3156	91 & 161	DA4070	23	DA4214	122	DA4313	30	DA4480	99	DA5616	68
DA3157	161	DA4070B	23	DA4215	122	DA4314	30	DA4481	99	DA5617	68
DA3159	157	DA4071	8	DA4216	122	DA4315	30	DA4482	99	DA5618	68
DA3160	91	DA4072	8	DA4217	122	DA4316	30	DA4483	99	DA5619	68
DA3161	161	DA4073	8	DA4218	122	DA4317	30	DA4484	99	DA5620	88
DA3162	161	DA4074	8	DA4219	122	DA4318	30	DA4485	99	DA5621	88
DA3250	120	DA4075	66	DA4220	122	DA4319	30	DA4490	157	DA5622	88
DA3251	120	DA4075RPI	66	DA4221	118	DA4321	31	DA4491	157	DA5623	88
DA3252	120	DA4075T	66 & 67	DA4222	118	DA4322	31	DA4493	156	DA5624	37
DA3253	120	DA4077	10	DA4223	118	DA4323	31	DA4494	156	DA5625	21
DA3254	120	DA4083	57	DA4223S	120	DA4324	31	DA4495	157	DA5626	7
DA3255	120	DA4084	57	DA4224	118	DA4325	31	DA4500	125	DA5627	65
DA3256	120	DA4086	63	DA4225	119	DA4326	31	DA4501	55	DA5628	65
DA3257	120	DA4088	38	DA4226	118	DA4327	31	DA4502	55	DA5629	65
DA3258	120	DA4088BULB	38	DA4227	118	DA4328	31	DA4503	55	DA5630	65
DA3259	120	DA4088C	38	DA4228	117	DA4329	31	DA4510	16	DA5631	142
DA3260	120	DA4088COVER	38	DA4229	117	DA4330	31	DA4511	16	DA5632	65
DA3300	99	DA4088W	38	DA4230	119	DA4331	30	DA4512	35	DA5633	65
DA3301	99	DA4090	111	DA4231	117	DA4332	30	DA4513	128	DA5634	65
DA3302	99	DA4091	111	DA4232	117	DA4333	30	DA4514	128	DA5635	65
DA3303	99	DA4092	111	DA4233	117	DA4334	30	DA4515	127, 128 & 129	DA5636	68
DA3304	99	DA4099	38	DA4234	117	DA4335	100	DA4516	127, 128 & 129	DA5643	88
DA3306	99	DA4100	8	DA4235	117	DA4336	100	DA4518	127, 128 & 129	DA5650	137
DA3307	99	DA4101	23	DA4236	119	DA4337	100	DA4519	128	DA5700	73
DA3308	99	DA4102	137	DA4237	118	DA4338	100	DA4527	127, 128 & 129	DA5701	73
DA3309	99	DA4104	137	DA4238	118	DA4339	100	DA4528	117	DA5704	73
DA3310	99	DA4106	112	DA4239	118	DA4340	100	DA4530	128	DA5705	73
DA3311	99	DA4107	112	DA4240	118	DA4341	100	DA4531	15	DA5706	73
DA3312	99	DA4111	6	DA4241	118	DA4342	9	DA4532	15	DA5709	73
DA3313	99	DA4118	27	DA4242	119	DA4343	9	DA4600	98	DA5710	73
DA3314	99	DA4119	27	DA4243	119	DA4344	72	DA4601	98	DA5711	73
DA3315	99	DA4120N	129	DA4244	117	DA4345	72	DA4602	98	DA5800	51
DA3316	99	DA4120O	129	DA4245	119	DA4350	77	DA4603	98	DA5801	50
DA3318	99	DA4121	27	DA4246	118	DA4351	77	DA4604	98	DA6000	143
DA3319	99	DA4130	11	DA4247	119	DA4352	77	DA4605	98	DA6001	143
DA3350	148	DA4133	10	DA4249	119	DA4353	77	DA4606	98	DA6002	143
DA3351	148	DA4134	10	DA4249DEF	122	DA4354	77	DA4607	98	DA6003	143
DA3352	148	DA4136	105	DA4249DIS	122	DA4355	77	DA4608	98	DA6004	143 & 144
DA4000	152	DA4136HD	105	DA4250DEF	122	DA4400	10	DA4630	102	DA6005	144
DA4001	152	DA4141	51	DA4250DIS	122	DA4404	14	DA4631	102	DA6006	144 & 145
DA4007N	129	DA4143	63 & 127	DA4251	117	DA4405	14	DA4632	102	DA6007	144 & 145
DA4007O	129	DA4144	63 & 127	DA4252	122	DA4406	14	DA4633	102	DA6008	144
DA4012	129	DA4147	98	DA4256	122	DA4407	14	DA4634	102	DA6009	144
DA4013N	129	DA4148	98	DA4258	24	DA4408	14	DA4650	152	DA6010	144
DA4013O	129	DA4149	99	DA4259	96	DA4409	14	DA4653	152	DA6011	144
DA4015N	129	DA4150	99	DA4260	95	DA4418	103	DA4654	152	DA6012	144
DA4015O	129	DA4151	98	DA4261	95	DA4419	103	DA4657	152	DA6013	144
DA4016N	129	DA4152	98	DA4262	95	DA4420	103	DA4659	152	DA6014	144
DA4016O	129	DA4153	99	DA4263	96	DA4421	103	DA4660	152	DA6015	144
DA4017	130	DA4154	99	DA4264	96	DA4422	55	DA5004	35	DA6016	145
DA4018N	130	DA4155	99	DA4265	96	DA4423	55	DA5005	35	DA6017	145
DA4018O	130	DA4156	99	DA4266	95	DA4424	55	DA5006	35	DA6018	145
DA4019	127	DA4157	99	DA4267	96	DA4425	55	DA5100	43	DA6019	145
DA4020	127	DA4158	98	DA4268	96	DA4426	55	DA5101	62	DA6020	145
DA4021	130	DA4159	99	DA4269	95	DA4427	55	DA5102	62	DA6021	145
DA4022BLACK	56	DA4160	111	DA4270	95	DA4428	55	DA5103	62	DA6022	145
DA4023BLACK	56	DA4161	111	DA4271	96	DA4429	55	DA5104	62	DA6023	145
DA4023BLUE	56	DA4162	111	DA4272	95	DA4430	55	DA5105	62	DA6024	145
DA4023GREY	56	DA4163	111	DA4273	96	DA4431	55	DA5106	62	DA6025	145
DA4024BLACK	56	DA4164	111	DA4274	96	DA4433	103	DA5136	105	DA6026	145
DA4024BLUE	56	DA4165	98	DA4275	96	DA4434	103	DA5498	51 & 152	DA6027	145
DA4024GREY	56	DA4166	98	DA4276	96	DA4436	103	DA5499	51 & 152	DA6028	145
DA4025BLACK	16	DA4167	98	DA4277	112	DA4437	103	DA5500	152	DA6029	145
DA4025BLUE	16	DA4169	52	DA4278	112	DA4438	103	DA5501	113	DA6030	145
DA4025BROWN	16	DA4170	53	DA4279	112	DA4439	103	DA5502	113	DA6031	145
DA4025GREEN	16	DA4171	53	DA4284	114	DA4440	74	DA5503	113	DA6032	146
DA4026	35	DA4172	11	DA4284C	114	DA4441	74	DA5504	113	DA6033	146
										DA6034	146
										DA6035	144 & 145

PART NUMBER FINDER - continued

Part No.	Page No.	Part No.	Page No.	Part No.	Page No.	Part No.	Page No.	Part No.	Page No.	Part No.	Page No.
DA6036	145	DA7011	23	DC6009	109	KVD500040	126	MTC5083	14	RGX101440PY-YELLOW107	
DA6037	144 & 145	DA7012	23	DC6010	109	KVD500140	126	MTC5084	14	RKB101200	106
DA6038	144	DA7600	148 & 150	DC6011	109	KVD500710	126	MTC5217	14	RKB101460	106
DA6039	144	DA7601	148 & 150	DC7000	107	KVD500720	126	MTC5382	63	RNF10009OPY	107
DA6040	143	DA7602	148 & 150	DC7001	107	KVD500730	126	MTC5382G	63	RNF10009OPY-YELLOW107	
DA6041	144	DA7603	148 & 150	DC7002	107	KVL100040	24	MTC5383	63	RRB100510	33
DA6042	125	DA7604	148 & 150	DC7003	107	LBB000561	122	MTC5383G	63	RRB500070	33
DA6043	125	DA7610	148, 150 & 151	DC7004	107	LBB110410N	122	MUC1488	66	RRC114560MUW	36
DA6044	125	DA8000	155	DC7005	107	LCJ000050LKIT	133	MUC1520	66	RRC2970	7
DA6045	125	DA8002	155	DC7006	107	LHP19	160	MUC1520G	66	RRC2971	7
DA6046	125	DA8003	155	DC7007	107	LHP20	160	MUC2437	64	RRC501470MCM	36
DA6047	125	DA8004	155	DC7008	107	LHP21	160	MUC4122ABE	64	RRC503400MNH	36
DA6050	133	DA8005	155	DC7009	107	LHP22	160	MWC1010	66	RRC503600PM	36
DA6051	133	DA8006	155	DC7010	107	LHP23	160	MWC3302	66	RRC505360MNH	36
DA6052	133	DA8007	155	DC7011	107	LHP24	160	MWC3303	66	RRC505370MNH	36
DA6053	133	DA8008	155	DC7100	107	LHP25	160	MWC4535	66	RRC6681	7
DA6054	133	DA8009	155	DC7101	107	LHP26	160	MWC4840	128	RRC6682	7
DA6055	133	DA8010	155	DC7102	107	LHP27	160	MWC4841	128	RRC8443	14
DA6056	133	DA8011	155	DC7103	107	LHP28	160	MWC5670LCS	66	RRD000100	33
DA6057	133	DA8012	155	DC7104	107	LHP29	160	MWC6702	128	RRD000110	33
DA6058	133	DA8013	155	DC7105	107	LHP32	160	MWC6754	128	RRD000120	33
DA6059	133	DA8015	155	DC7106	107	LHP33	160	MWC6755	128	RRD000130	33
DA6060	133	DA8016	155	DC7107	107	LPX100590X	146	MWC9060	128	RRD100520	33
DA6061	133	DA8017	155	DC7108	107	LR002408	12	MWC9061	128	RRD100530	33
DA6062	133	DA8018	155	DC7109	107	LR002424	53	MWC9084	128	RRD100540	33
DA6063	133	DA8019	155	DC7110	107	LR002481	56	MWC9085	128	RRD100550	33
DA6064	133	DA8020	155	DC7111	107	LR002483	56	MWC9843LCS	66	RRD100560	33
DA6070	60	DA8021	155	DGJ500020PCL	16	LR002484	56	MWC9844LCS	66	RRD100570	33
DA6071	60	DB1000	91	DGJ500140PMA	16	LR002485	56	MXC1408	129	RRD100580	33
DA6072	60	DB1001	92	DKC500010PMD	161	LR002486	56	MXC1409	129	RRD100590	33
DA6073	60	DB1002	91	DPB000270	7	LR002497	56	MXC2063	129	RRD100600	33
DA6074	60	DB1003	90	DPT100070	152	LR002516	53	MXC2064	129	RRD100610	33
DA6075	60	DB1004	90	EAH000261PMA	56	LR002521	50	MXC3918	129	RRJ000030	33
DA6076	60	DB1005	90	EAH000300JMN	56	LR002522	50	MXC3919	129	RRJ500030MNH	32
DA6200	142	DB1006	90	EAH000300LUP	56	LR002525	151	NGC103740/810	137	RTC3184X	146
DA6201	142	DB1007	90	EAH000300PVA	56	LR002738	46	NGC500370/410	137	RTC3254	137
DA6202	142	DB1008	91	EAH000300SUN	56	LR002740	46	NRC2051	43	RTC3347	137
DA6203	142	DB1009	91	EAH500012PVJ	56	LR002742	46	NRC236	130	RTC3534	142
DA6204	142	DB1010	91	EAH500052PMA	56	LR002744	46	NRC236E	130	RTC3537	142
DA6205	142	DB1011	90	EAH500054PMA	56	LR002773	25 & 151	NRC4171	127	RTC4615C	37
DA6206	142	DB1012	91	EBF000040	53	LR003106	46	NRC4356	126	RTC4615K	37
DA6207	142	DB1013	92	EBF500010	52	LR003107	46	NRC4514PY	107	RTC4769	7
DA6208	142	DB1014	92	EBF500050	53	LR003108	46	NRC4514PY-YELLOW	107	RTC6203	129
DA6209	142	DB1015	92	EBN500041	150	LR003318	25 & 151	NRC4642G	126 & 130	RTC6204	129
DA6210	142	DB1016	91	ERC2886W	104	LR003322	15	NRC4717	129	RTC6247	63
DA6211	142	DB1017	92	ERR4536K	134	LR003324	15	NRC5593PY	107	RTC6248	63
DA6212	142	DB1018	83	ERR3340X	146	LR003685	12	NRC5593PY-YELLOW	107	RTC6248NG	63
DA6213	142	DB1019	83	ERR5013ST	122	LR003840	25 & 151	NRC6920	79	RTC6317	129
DA6214	142	DB1020	83	ERR6299X	146	LR003894	53	NTC1772PY	107	RTC6318	129
DA6215	142	DB1021	83	ESR1445X	146	LR003895	52	NTC1772PY-YELLOW	107	RTC6401VA	138
DA6216	142	DB12000i	84	ESR2623X	146	LR005039	55	NTC1773PY	107	RTC6820	15
DA6217	142	DB12000i24	84	ESR4238X	146	LR005058	57	NTC1773PY-YELLOW	107	RTC6821	15
DA6218	142	DB1300	89	ESR4686X	146	LR005059	57	NTC1775PY	107	RTC6870VT	138
DA6219	142	DB1301	89	ETC5835K	134	LR005235	5	NTC1775PY-YELLOW	107	RTC8093	51
DA6220	142	DB1302	89	FTC1507	142	LR005237	5 & 150	NTC5193PM	36	RTC8829	47
DA6221	142	DB1303	89	FTC2957HD	132	LR006304	148	NTC6781PY	107	RTC8831	43
DA6222	142	DB1304	89	FWJ500020PMA	61	LR007484	45 & 47	NTC6781PY-YELLOW	107	RTC8860AA	10
DA6223	142	DB1305	89	HAG100970LOY	67	LRL0087ENG	161	NTC6828PY	107	RTC8872	44
DA6224	142	DB1307	89	HAH103510LOY	67	LRL0178ENG	161	NTC6828PY-YELLOW	107	RTC8891AA	44, 45 & 47
DA6225	142	DB1310	87	HAI101400LOY	67	LRO 0008	159	NTC7307PY	107	RTC8922	39
DA6226	142	DB1313	87	HAI101410LOY	67	LRO 0407	159	NTC7307PY-YELLOW	107	RTC8969	10
DA6227	142	DB1314	92	HBA106180LOY	67	LRO 0753	159	NTC7394PY	107	RTC9479	15
DA6228	142	DB1315	90	HBA106190LOY	67	LRO 0754	159	NTC7394PY-YELLOW	107	RTC9503AA	11
DA6229	142	DB1316	90	HB0000320JMN	57	LRO 0770	159	NTC7739MUJ	36	RTC9505AC	24
DA6230	142	DB1317	90	HB0000320LUP	57	LRO 0784	159	NTC7829	35	RTC9535	33
DA6231	142	DB1318	92	HB0000320LYR	57	LRO 1075	159	NTC7829HD	35	RTC9593AA	24
DA6232	142	DB1319	87	HB0000320SUN	57	LRO 1093	159	NTC9819	106	RTC9841CE	161
DA6233	142	DB1320	87	HCA106010LOY	67	LRO 1355	159	NTC9820	106	RTC9947CF	161
DA6234	142	DB1321	87	HHD102280	67 & 68	LRO 1419	159	PDA500300	138	RTC9970CE	161
DA6235	142	DB1322	91	HHD102290	67 & 68	LRO 1431	159	PDA500310	138	SE105161L	41
DA6236	142	DB1323	91	IAB000010	123	LRO 1517	159	PHD500340	79	SIJ500030	138
DA6237	142	DB1324	87	IAB500090	123	LRO 1535	159	PRC7994K	37	SIJ500040	138
DA6238	142	DB1325	87	IAB500100	123	LRO 1621	159	PRC8238	38	SJR901FRWMM	161
DA6300	139	DB1326	89	IAB500104	123	LRO 1685	159	RBX101240PY	107	SOX 0593	159
DA6301	139	DB1327	89	IAB500106	123	LRO 1686	159	RBX101240PY-YELLOW107		STC1066	128
DA6302	139	DB1328	89 & 92	JAK500320WWH	148	LRO 1753	159	RBX101340PY	107	STC1135	129
DA6303	139	DB1329	91	JAK500330WWH	148	LRO 1867	159	RBX101340PY-YELLOW107		STC1136	129
DA6304	139	DB2000	86	JEF100150	136	LRO 1868	159	RBX101680PY	107	STC1188	41
DA6305	139	DB6000	86	JEF100220	136	LRO 1873	159	RBX101680PY-YELLOW107		STC1424	63
DA6306	139	DB8000	85	JKR100200X	146	LRO 1895	159	RBX101690PY	107	STC1653	129
DA6307	139	DB9000C	85	JKR100280X	146	LRO 1986	159	RBX101690PY-YELLOW107		STC1675	122
DA6308	139	DB9500i	84	JKR500010X	146	LRO 2033	159	RBX101730PY	107	STC1773VA	138
DA6309	139	DB9500i24	84	JKR500020X	146	LRO 2054	159	RBX101730PY-YELLOW107		STC1774VT	138
DA6310	139	DC5000	110	JMD000010X	146	LRO 2090	159	RBX101780PY	107	STC250	136
DA6311	139	DC5001	110	KAH000050	78	LRO 2278	159	RBX101780PY-YELLOW107		STC2813	128
DA6312	139	DC5002	110	KAJ100570	78	LRT-12-058	141	RBX101790PY	107	STC2814	128
DA6313	139	DC5002L	110	KBM100450	33	LRT-12-093	141	RBX101790PY-YELLOW107		STC2815	128
DA6314	139	DC5003	110	KBM100460	33	LRT-12-094	141	RDB100080PY	107	STC2816	128
DA6316	139	DC5003L	110	KBM100470	33	LRT-12-158	141	RDB100080PY-YELLOW		STC2828VT	138
DA6317	139	DC5004	110	KBM100480	33	LRT-60-Q04	108			STC2862A	138
DA6318	139	DC5005	110	KBM100490	33	MRC316	14	REB101740	106	STC2864VT	138
DA6319	139	DC6000	109	KBM100500	33	MRC316P	14	RGX100970			

PART NUMBER FINDER - continued

Part No.	Page No.	Part No.	Page No.	Part No.	Page No.	Part No.	Page No.	Part No.	Page No.	Part No.	Page No.
STC3425	33	STC50082AA	50	STC53181	11	STC8363	132	STC9181	138	VUB501200	11
		STC50172	55	STC53193	11	STC8414	50	TRC102900	123	VUB501270	7 & 150
STC3426	33	STC50255AA	44	STC53194	11	STC8452	11	TRC103150	123	VUB501330	6
STC3427	33	STC50256AA	44	STC618PY	107	STC8453	11	RC103160E	123	VUB501380	11
STC3428	33	STC50269AA	23	STC618PYYELLOW	107	STC8480	38	TRC103260	123	VUB501390	12
STC3429	33	STC50287AB	45	STC729	129	STC8503AA	13	TRC103270	123	VUB501400	12
STC3435	140	STC50289AB	45	STC730	129	STC8504AB	13	TRC103330	123	VUB501430	47
STC3435S	140	STC50301	23	STC7555	49	STC8505AA	26	TRC103350	123	VUB501490	46
STC3582	33	STC50323	50	STC7570	50	STC8513	33	TYK500070	138	VUB501500	46
STC3601	33	STC50383	40	STC7623	33	STC8524	51	TYL100030	131	VUB501920	13
STC4235VT	138	STC50391	46	STC7629	17	STC8529AA	75	URB500060	132	VUB501930	13
STC4404	137	STC50408	40	STC7631	23	STC8587	138	UTP1725	136	VUB501980	6 & 148
STC4596VT	138	STC50413	6	STC7632	23	STC8604	127	VPLFS0014	53	VUB502390	60
STC4600	137	STC50417	27	STC7642	153	STC8605	127	VPLSS0016	52	VUB502520	60
STC4637	41	STC50435	53	STC7643	39	STC8606	127	VTD500010	24 & 151	VUB502610	13
STC4672	138	STC50437	20	STC7644	38	STC8607	127	VTD500020	24 & 151	VUB502790	27
STC4676	138	STC50479	49	STC7929	27	STC8608	127	VTK500010	24 & 151	VUB503650	149
STC4684	138	STC50519	138	STC7939AB	50	STC8609	127	VTK500020	26 & 148	VUB503660	26 & 149
STC4687	138	STC50529	138	STC7960	12	STC8610	127	VUB000610	60	VUB503880MMM	
STC4723N	122	STC50530	138	STC7962AA	12	STC8648	127	VUB000700	54	148, 149, 150 & 151	
STC4757	138	STC50531	138	STC7969	31	STC8649	127	VUB000710	54	VUB503960	47
STC4829VT	138	STC50543	138	STC8026	13	STC8652	127	VUB000720	47	VUB504110	10
STC4861	138	STC50544	138	STC8027	13	STC8653	127	VUB000730	47	VYK000020	138
STC4862	138	STC50545	138	STC8056	10	STC8693	127	VUB000740	47	XQB500080	38
STC4863	138	STC50547	138	STC8130AB	24	STC8694	127	VUB001070	13	YGD100860	138
STC50026	11	STC50549	138	STC8138AB	75	STC8695	127	VUB001080	13	YGD500100	138
STC50027	11	STC50550	138	STC8156AA	106	STC8842	38	VUB001090	38	YG0000271	138
STC50030	24	STC50551	138	STC8161	51	STC8843AA	33	VUB001230	26 & 149	YW0000840	47
STC50031	24	STC53037	5	STC8178AA	57	STC8919AA	45, 47 & 90	VUB001300	26 & 149	YWJ101500	44
STC50032	24	STC53077	25	STC8261	138	STC8972	138	VUB001310	26 & 149	YWJ500201	45
STC50050	52	STC53078	25	STC8263	138	STC9021CC	161	VUB002120	51	YWJ500450	47
STC50052AA	52	STC53129	6	STC8354	127	STC9155	138	VUB002510	26 & 149	ZLA000001AF	138
STC50053AA	52	STC53157	10	STC8355	127	STC9157	138	VUB00520	11		
STC50063	27	STC53158	10	STC8356	127	STC9158	138	VUB501160	150		
STC50080	33	STC53161	10	STC8358	132	STC9176	138	VUB501170	50		

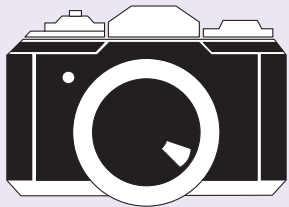

We'd like to see your pictures!

If you have a great picture of your Land Rover and would like to see it featured in the next Britpart catalogue, then please send it to marketing@britpart.co.uk with all your details. We look forward to seeing them and for each one we feature we'll send you a small prize!

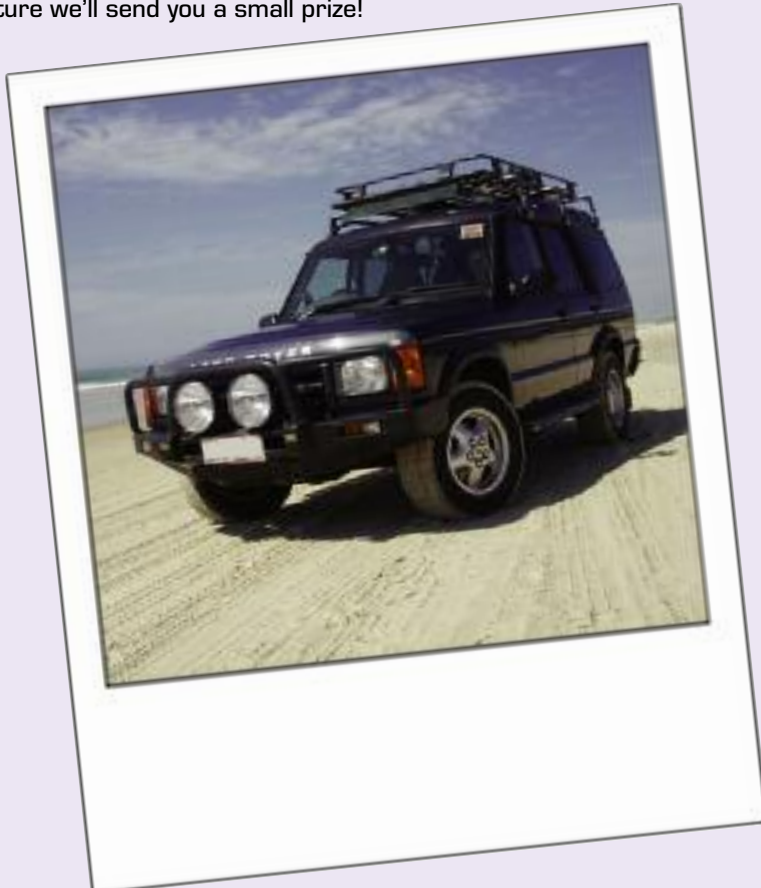

Picture courtesy of Craig Grey - Australia

THE SMALL PRINT

- > Part numbers used for identification purposes only and do not imply or indicate the identity of a manufacturer.
- > Parts are subject to stock and supply.
- > Pictures are for reference only and specifications may alter without notice.
- > Colour swatches are for reference only - samples are available on request
- > All products available at time of printing and we reserve the right to withdraw any product at any time.
- > Land Rover logos and trade names are for reference only.
- > No part of this catalogue may be used or reproduced by any means without the express permission of Britpart.
- > Product specifications are given but it is up to the end user to ensure that the product is fit for that purpose.
- > E&OE

A Bars	5-6	Coil springs	112	Head bolt sets	135
Accessories, winching	90-92	Compounds, Hylomar	137	Heater blower motor kit	
Adaptor kits, wheel	35	Compressors, air	34 & 71	& resistor kit	135
Air compressors	34 & 71	Consumables, Land Rover	138	Heater matrix	136
Air conditioning kits	49	Consumables, Loctite	139	Heater plug upgrade kit	136
Air filters - Britpart	95	Conversion kit, handbrake	100	Hiclone	101
Air filters - K&N	96	Conversion kits, air spring	105	Hinge kit, door	134
Air intake grilles	152	Conversion kits, electronic	134	Hoods	64
Air spring conversion kits	105	Conversion kits, light	37	Hylomar sealants & compounds	137
Air springs	106	Cosmetic enhancements	147-152	Ignition lead sets	137
Alloy wheels	32 & 36	Covers, waterproof seat	57	Inner tube	34
Antifreeze	138	Covers, wheel	34	Intercoolers - performance	102
Anti-roll bar kit	106	Cubby boxes	61-62	Jacking equipment	78
ARB diff lockers	72	CV joint kits - Britpart	133	Jacks - Hi-Lift	77
Automatic transmission service kit	125	Cycle carriers	27, 30 & 31	Jacks - Jackall	76
Batteries	83 & 138	Cylinder liner kit	133	Jerry cans	75
Bearing, propshaft	134	Damper kit	133	Jubilee clips	131
Bearings, wheel	142	Dash trim kits	49	KAM diff lockers	74
Bike racks	27	Deflectors, wind	60	Keys, wheel nut	33
Bilstein, shock absorbers	111	De-icer	138	Kit, automatic transmission service	125
Books	156-157 & 161	Delphi, shock absorbers	111	Kit, damper	133
Boot liner	52-53	Detroit diff lockers	73	Kit, heater plug upgrade	136
Boxes, cubby	61-62	Diff coupling shaft	134	Kit, tyre repair	34 & 71
Boxes, roof	30	Diff guards - bolt on	19	Kits, brake hose	97
Brake discs	98-100	Diff lockers - uprated - ARB	72	Kits, clutch	132
Brake fluid	138	Diff lockers - uprated - Detroit	73	Kits, CV joint	133
Brake hose kits	97	Diff lockers - uprated - KAM	74	Kits, electronic conversion	134
Brake kits	125	Diff repair pans	134	Kits, re-trim	65
Brake pads	98-100	Dislocation cone	106	Kits, suspension	114
Britpart bulk filters	146	Dog guards	49-51	Kits, swivel housing gaiter	21
Britpart Liquid Gloves	137	Door hinge kit	134	Kits, swivel pin	140
Britpart merchandise	155	Door trim	63	Kits, timing	141
Britpart performance discs	98	Driving lights	38	Kits, wheel bearing	142
Britpart polyurethane bushes	107	EBC brake parts	98-100	Ladder - Defender	27
Britpart service kits - Defender	143	Electronic conversion kits	134	Ladder - vehicle	27
Britpart service kits - Discovery	144	Emergency hammer	75	Ladders - off-road	78
Britpart service kits - Freelander	144	Engines - new	122	Lamp guards	10-14
Britpart service kits - Range Rover	145	Engines - reconditioned	122	Land meters	78
Britpart service kits - Series	146	Exhaust clamps	131	Land Rover - roof rails	27
Britpart winches	84-86	Exhausts - stainless steel	117-118	Land Rover gear	158-159
Bulkhead bars	63	Extended slide seat rails		Land Rover genuine consumables	138
Bull bar	7	& bulkhead bars	63	Lead sets, ignition	137
Bumper	7	Extinguishers, fire	75	Light bars	37
Bumper kits, winch	87	Facia	150	Light conversion kits	37
Bumperettes	7	Fairleads	90-92	Light kits	37
Bumpers, winch	88	Filters	146	Light mounting kits	40
Bush fitting tool	108	Fire extinguishers	75	Light upgrade kits	40
Bush sets - Britpart	108	First aid kit	153	Lights - driving	38
Bushes	107-108	Fog lights	39	Lights - fog	39
Cans, Jerry	75	Fume curtain	64	Lights - Roo-lites	39
Carburettors, Weber	104	Gaiter kits	21	Liner kit, cylinder	133
Carpet mats	55-56	Gaiters, gear box	51	Liner, boot	52-53
Carrier, wheel	34	Gasket kits	135	Loadspace liners	52-53
Cellular Dynamic shock absorbers	109	Gear box gaiters	51	Loadspace nets & retention kit	54
Chassis' - complete	126	Gear boxes - new	123	Locking wheel nuts, keys & caps	33
Chassis & components - Defender	127	Gear boxes - reconditioned	123	Loctite consumables	139
Chassis & components - Discovery 1	128	Gear lever set	152	Manuals	156-157
Chassis & components - Freelander	128	Gloves	91	Map reading lamp	40
Chassis & components - Range Rover Classic	129	Glue	139	Matrix, heater	136
Chassis & components - Series 2 & 3	130	Grease nipples	131	Mats	55-56
Chequer plate	8-9	Grilles	152	Merchandise	155 & 158-159
Clamps, exhaust	131	Guard, transmission	21	Mirrors & fittings	14
Cleaners	138	Guards, dog	49-51	Models	158-159
Clips, clamps & nipples	131	Guards, lamp	10-14	Mud flaps	15
Clips, Jubilee	131	Guards, steering	20	Muffs, radiator	16
Clothing	155 & 158-159	Guards, sump	20	NAS lights	41
Clutch kit & flywheel - TD5	131	Hammer - emergency	75	Net, loadspace	54
Clutch kits	132	Hand protection	137	Nipples, grease	131
		Handbrake conversion kits	100	Nudge bar	7
		Haynes manuals	156-157	Oil	138

INDEX

Oil pump gear set	140	Service kits	143	Towing Equipment - Series	47
Optima batteries	83	Shackle	91	Transfer boxes - new	123
Original technical publications	160	Shock absorbers	109-111	Transmission fluid	138
Paints	138 & 142	Shock absorbers - Bilstein	111	Transmission guard	21
Pans, diff repair	134	Shock absorbers - Cellular Dynamic	109	Tree straps	90
Parabolic springs	112	Shock absorbers - Delphi De Carbon	111	Trim, door	63
Parking sensors	16	Shock absorbers - heavy-duty	111	Tuning products	103
Parts & general interest books	161	Shock absorbers - Super Gaz	110	Tunit diesel tuning products	103
Pens, touch up	138 & 142	Side & rear steps - Defender	23	Tyre pressure monitoring system	35
Polybush sets	108	Side & rear steps - Discovery	24	Tyre repair kit	34-71
Pressure relief valve kit	140	Side & rear steps - Freelander	25	Utility link pipes - Britpart	120
Propshaft bearing	134	Side & rear steps - Range Rover	26	Vehicle enhancements - Defender	152
Propshaft kit	140	Side runners	23	Vehicle enhancements -	
Propshafts, wide angle	114	Side steps	23	Discovery 3	150-151
Protection tubes	23	Silencers	120	Vehicle enhancements - Freelander 2	151
PSI power tuning products	103	Snatch block	90-92	Vehicle enhancements -	
Radiator mufflers	16	Snorkels	79-81	Range Rover L322	149
Radius arms	108	Spare parts, winch	89	Vehicle enhancements -	
Raised air intake - Britpart	79	Spare wheel carrier	34	Range Rover Sport	148
Raised air intake - Safari	80-81	Spare wheel covers	34	Vents	152
Rear silencers	120	Sports exhausts - stainless steel	119	Warn winches	87
Rear steps	23	Spring retainers	113	Waterproof seat covers	57
Recovery eye	91	Springs - coil	112	Waterproof seat covers - Britpart	57-60
Repair kit, tyre	34 & 71	Springs - parabolic	112	Weber carburettors	104
Retainers, spring	113	Springs, air	106	Wheel arch kits - off-road	17
Re-trim kits - Defender	65	Steel wheels	36	Wheel arch kits - standard	17
Rims	32 & 36	Steering arms - heavy-duty	113	Wheel bearing kits	142
Roof boxes	30-31	Steering guards	20	Wheel carrier	34
Roof rack ladder	27	Steering wheels	152	Wheel covers	34
Roof racks	30-31	Sump guards	20	Wheel keys	33
Roof racks - Britpart Expedition	28	Super Gaz shock absorbers	110	Wheel nut caps	33
Roof racks - galvanised flat pack kits	29	Suspension kits - Britpart	114	Wheel nuts	33
Roof racks & boxes - Mont Blanc	30	Swivel housing gaiter kits	21	Wheel spacers & adaptor kits	35
Roof racks & boxes - Thule	31	Swivel housing grease	140	Wheel wrenches	35
Roof rails	27 & 30-31	Swivel pin kits	140	Wheels	32 & 36
Roof tents	82	Tents	82	Wide angle propshafts	114
Ropes, tow	90-92	Timing kits	141	Winch bumper kits	87
Rubber mats	55-56	Tools	108 & 141	Winch bumpers	88
Rubbing strips	16	Touch up paint pens	142	Winch spare parts	89
Screen wash	138	Tow electrics	43	Winches	84-86
Sealant	139	Tow hitch	43	Winching accessories	90-92
Sealants, Hylomar	137	Tow kit	43	Winching accessory kits	92
Seat covers	57-60	Tow ropes	90	Wind deflectors	60
Seat rails	63	Towing equipment - all models	43-47	Window kits	69
Seats - Defender & Series	66	Towing Equipment - Defender	44	Wing protectors	142
Seats - Techno style	67	Towing Equipment - Discovery	45	Wiper blade - heavy-duty	161
Seats - XS style	68	Towing Equipment - Freelander	46	Wrenches	35
Sensors, parking	16	Towing Equipment - Range Rover	47	Zu rims	32

Keep up to date
with all the latest
developments from
Britpart by e-mail.

NEW

Simply log on to
www.britpart.com and
register your details in
the 'Mailing List' section
or simply send an e-mail to
marketing@britpart.co.uk



Available from -

BRITPART

The quality parts for Land Rovers

Britpart

The Grove
Craven Arms
Shropshire
SY7 8DA
United Kingdom

Main Tel: +44 (0) 1588 672711
UK Sales Tel: +44 (0) 1588 674200
UK Sales Fax: +44 (0) 1588 672720
Export Sales Fax: +44 (0) 1588 674203

Email: sales@britpart.co.uk
Web: www.britpart.com

