

NEW RANGE ROVER VELAR

2018



ABOVE & BEYOND





BY APPOINTMENT TO
HM THE QUEEN
MANUFACTURERS OF
MOTOR VEHICLES
JAGUAR LAND ROVER LIMITED
COVENTRY



BY APPOINTMENT TO
HRH THE DUKE OF EDINBURGH
MANUFACTURERS OF
MOTOR VEHICLES
JAGUAR LAND ROVER LIMITED
COVENTRY



BY APPOINTMENT TO
HRH THE PRINCE OF WALES
MANUFACTURERS OF
MOTOR VEHICLES
JAGUAR LAND ROVER LIMITED
COVENTRY



ABOVE & BEYOND

Ever since the first Land Rover vehicle was conceived in 1947, we have built vehicles that challenge what is possible. These in turn have challenged their owners to explore new territories and conquer difficult terrains. Our vehicles epitomize the values of the designers and engineers who have created them. Each one instilled with iconic British design cues, delivering capability with composure. Which is how we continue to break new ground, defy conventions and encourage each other to go further. Land Rover truly enables you to make more of your world, to go above and beyond.









NEW RANGE ROVER VELAR

Land Rover is proud to introduce the New Range Rover Velar. A brand new addition to the Range Rover family, sitting between the Range Rover Evoque and the Range Rover Sport. A new dimension in glamour, modernity and elegance, with emotionally charged DNA and unquestionable design pedigree.

CONTENTS

Introducing a new type of Range Rover	6	VERSATILITY	
		Truly Flexible	38
DESIGN		SPECIFY YOUR RANGE ROVER VELAR	
Celebration of Exterior Design	8	Step 1 – Choose your Model	42
Celebration of Interior Design	11	Step 2 – Choose your Engine	46
PERFORMANCE AND CAPABILITY		Step 3 – Choose your Specification Package	48
Engines and Transmission	12	Step 4 – Choose your Exterior	50
Refined Performance	14	Step 5 – Choose your Interior	60
Capability	17	Step 6 – Choose your Options and Land Rover Gear	70
TECHNOLOGY		TECHNICAL DETAILS	78
Infotainment	21	THE WORLD OF LAND ROVER	
Audio	22	There's a World Out There	80
Connectivity	24	Your Peace of Mind	82
Driver Assistance	28		
Efficient Technologies	33		
SAFETY	34		

Search 'Range Rover Velar' to see the vehicle in action.

Vehicle shown: 2018 Range Rover Velar R-Dynamic HSE with optional equipment.

INTRODUCING A NEW TYPE OF RANGE ROVER

"The interior of the New Range Rover Velar is a calm sanctuary, created through elegant simplicity and a visually reductive approach, with design enabled technologies like the Touch Pro Duo infotainment system. All-LED lights and flush deployable door handles on the exterior complete a truly compelling design and, of course, it's a Land Rover with unrivalled capability.

Introducing the New Range Rover Velar: the Avant Garde Range Rover."

Gerry McGovern,
Land Rover Chief Design Officer

COMPELLING DESIGN

The design of the Range Rover Velar is revolutionary. Its elegant look and exemplary range of standard features such as deployable flush door handles and integrated rear spoiler all improve aerodynamic efficiency, while the foil-stamped grille gives the vehicle's front profile an undeniable presence. Sleek LED headlights and rear lights are also standard. See page 8 for details.

INTELLIGENT VERSATILITY

To make your trip even more comfortable, Range Rover Velar provides 38 inches head clearance and 37 inches knee clearance for occupants, along with exemplary cargo space of 34.4 cubic feet*. Electronic Air Suspension** enables automatic access height for elegant entry and the Powered Gesture Tailgate† allows simple loading with hands free access. See page 38 for details.

DISTINCTIVE INTERIOR AMBIANCE

The Range Rover Velar cabin is a calm sanctuary. Wind and road noise are minimized through the use of aerodynamic undertrays and acoustically laminated front glazing. Rear passengers can benefit from Reclining Rear Seats†, optional Four-zone Climate Control and two optional 8" Rear Seat Entertainment screens†. See page 11 for details.

DESIGN ENABLED TECHNOLOGIES

The standard Touch Pro Duo infotainment system makes life more connected and entertaining. The system seamlessly integrates two 10" high-definition Touchscreens to enable you to make a phone call on one screen while navigating on the other‡. Touch Pro Duo is complemented with full-color Head-Up Display†, an optional state-of-the-art system†† providing sharp graphics and optional Interactive Driver Display† with configurable touch steering wheel controls. See page 21 for details.

*When Reduced Section Steel Spare or Alloy Spare Wheel is fitted. **Standard on P380 engine.

†Not available on the Range Rover Velar. ††These systems are not a substitute for driving safely with due care and attention and will not function under all circumstances, speeds, weather and road conditions, etc. Driver should not assume that these systems will correct errors of judgment in driving. Please consult the owner's manual or your local authorized Land Rover Retailer for more details.

‡Do not use Land Rover InControl® features under conditions that will affect your safety or the safety of others. Driving while distracted can result in loss of vehicle control.

Features and their availability may differ by vehicle specification. For full feature and option availability please refer to the accompanying Specification and Price Guide or visit your local Land Rover Retailer.

Vehicle shown: 2018 Range Rover Velar R-Dynamic HSE with optional equipment.



OUTSTANDING CRAFTSMANSHIP AND MATERIALS

A specialist team has meticulously developed every component that you see and touch, to deliver a refined, tactile experience. Supple leathers or premium textile and suedecloth can be specified for seats, steering wheel and extensively throughout the cabin. See page 11 for details.

SPORTS COMMAND DRIVING POSITION

The Sports Command Driving Position helps deliver a more confident, engaged drive. See pages 11 and 34 for details.

CAPABILITY

Range Rover Velar has world-renowned Land Rover capability at its core. Standard features include: All Wheel Drive (AWD) with Intelligent Driveline Dynamics (IDD), Adaptive Dynamics, Electronic Air Suspension**, and Torque Vectoring by Braking to deliver a connected drive^{††}. Adding to driver assurance off-road, optional features include: All Terrain Progress Control (ATPC), Terrain Response[®] 2 and an Active Rear Locking Differential^{††}. Impressive wading depth of up to 25.6 inches helps provide composure and sure-footed progress in challenging conditions. See pages 14 to 19 for details.

REFINED EFFICIENT POWER

A choice of V6 and 4-cylinder Ingenium engines deliver refined and responsive driving. The V6 P380 engine delivers 332 lb-ft of torque while the D180 engine delivers CO₂ from just 142 g/km. See page 12 for details.

DESIGN

CELEBRATION OF EXTERIOR DESIGN



Sophisticated. Intelligent. Advanced. Refined power and effortless elegance combine with exquisite effect in this outstanding example of contemporary automotive design. The Range Rover Velar is beautifully balanced, with optimized proportions. Its proud Range Rover lineage is instantly recognizable, from the formal, powerful volumes of the front end, through a flowing, continuous waistline, culminating in a taut and elegantly tapered rear.

The sleek volumes of the lower body, with its flawlessly integrated deployable flush door handles, bear witness to our obsession with the finest detail. Optional 22" wheels enhance the vehicle's stunning proportions, further emphasizing the spectacular on road presence of the Range Rover Velar. At the rear, the vehicle's design is distinguished by quad tail light signature elements within a full-width graphic incorporating the iconic Range Rover script, seamlessly harmonizing the vehicle's lines to stunning effect.

Search 'Range Rover Velar Design' for full details.





CELEBRATION OF INTERIOR DESIGN

The cabin of the Range Rover Velar exudes elegant simplicity. The familiar Range Rover interior design architecture, with its strong elegant horizontal lines, blends seamlessly with innovative features to give a feeling of calm, and enhance the driving experience.

Two seamlessly integrated 10" Touchscreens* and minimalist controls as standard, give easy control of the latest advanced technology*. As the vehicle is started and comes to life, the revolutionary Touch Pro Duo technology reinforces the overall sense of luxury and innovation. Everything has been designed and crafted to help you and your passengers arrive relaxed. The twin sliding armrests, which operate independently, help maximize your individual comfort.

Beautiful materials, including optional Windsor leather with a signature Diamond Cut pattern throughout the cabin, add a contemporary twist. Modern premium textiles, expertly constructed in collaboration with one of Europe's leading manufacturers of high quality and design led textiles, Kvadrat, are offered as an alternative to leather.

The elevated position of our renowned Sports Command Driving Position, is designed to enable you to see further down the road and view your surroundings with greater clarity so you stay in control no matter what the conditions or traffic.

The option of Configurable Ambient Interior Lighting in a choice of ten colors creates the right mood. While the panoramic roof floods the cabin with light, bringing the outside in.

Search 'Range Rover Velar Design' for full details.

*Driving while distracted can result in loss of vehicle control. Do not operate, adjust or view the navigation or multimedia systems under conditions that will affect your safety or the safety of others. Only use mobile phones and other devices, even with voice commands, when it is safe to do so.

Interior shown: 2018 Range Rover Velar R-Dynamic HSE with Light Oyster/Ebony interior in Windsor leather and optional equipment.



Optional Sliding Panoramic Roof



Windsor leather with Cut Diamond pattern



Twin sliding armrests

PERFORMANCE AND CAPABILITY

ENGINES AND TRANSMISSION

Power, sheer driving pleasure and refinement, there is a range of engines available for the Range Rover Velar and each has been optimized for specific attributes to cater for all needs. All engines are equipped with Stop/Start technology and smart regenerative charging; this feature harvests kinetic energy from braking to charge the battery for maximum economy, especially during city driving. Ingenium technology underpins all of the 4-cylinder engines in the Range Rover Velar models. These low friction, all-aluminum engines have stiff cylinder blocks and twin balancer shafts to ensure inherently low levels of vibration, for smooth day-to-day performance.

Search 'Range Rover Velar Performance' for full details.



DIESEL ENGINES

D180

The Ingenium 2.0 liter 4-cylinder 180HP Turbocharged Diesel engine produces 317 lb-ft of torque and is optimized to deliver the best fuel economy in the range.

- High-pressure common rail direct fuel injection, exhaust variable cam timing and a high-efficiency water-cooled intercooler work in combination for a clean, efficient combustion.
- Intelligent, electronically controlled, adaptive engine cooling only engages when required – minimizing fuel consumption and CO₂ emissions.
- The engine features a variable geometry turbocharger that adapts to the changing flow of exhaust gases for high torque throughout the rev range and responsiveness that is uniform, progressive and reduces lag.

	HP	LB-FT			CC
	POWER (HP)	TORQUE (LB-FT)	ACCELERATION 0-60 MPH* (SECONDS)	TOP SPEED (MPH)*†	CAPACITY (CC)
D180*	180	317	8.4	130	1,999

8-SPEED AUTOMATIC TRANSMISSION

All Diesel and Gas engines in the Range Rover Velar are coupled with an 8-speed Automatic Transmission. With eight closely spaced ratios, the transmission ensures that you are always in the optimum gear, enhancing fuel efficiency and acceleration. Gear changes are almost imperceptible and shift schedules intelligently adapt to your driving style.



GAS ENGINES

P250

The Ingenium 2.0 liter 4-cylinder 247HP Turbocharged Gas engine produces 269 lb-ft of torque and delivers outstanding driveability.

- The intelligent Continuously Variable Valve Lift (CVVL) system varies the extent to which inlet valves are opened, reducing engine-pumping losses. This lets the engine 'breathe' with maximum efficiency, optimizing power and torque.
- CVVL works in combination with dual independent variable cam timing for ultimate operating flexibility, resulting in excellent power across the rev range.
- For exceptional acceleration and effortless overtaking, maximum torque is available between 1,200-4,500rpm.
- The twin scroll turbocharger is fed by an integrated exhaust manifold which increases the transfer of energy to the turbine - reducing turbo lag and improving engine response.

P380

The 3.0 liter V6 380HP Supercharged Gas engine produces 332 lb-ft of torque and is the top of the range for ultimate performance.

- The Roots-type twin vortex supercharger provides linear power delivery and maximizes responsiveness.
- A spray guided direct injection system carefully manages the air-fuel mixture in the combustion chamber for improved combustion, extracting more energy from the fuel injected. This results in excellent power.
- The engine also features dual independent variable cam timing to vary inlet and exhaust valve operation, working alongside lightweight pistons with ultra-low friction piston rings, for increased performance and efficiency.
- A twin, contra-rotating balancer shaft system is employed to maximize refinement; resulting in an engine with incredibly smooth power delivery.

	HP	LB-FT			CC
	POWER (HP)	TORQUE (LB-FT)	ACCELERATION 0-60 MPH* (SECONDS)	TOP SPEED* (MPH)	CAPACITY (CC)
P250	247	269	6.4	135	1,998
P380	380	332	5.3	155	2,995

REFINED PERFORMANCE

The drive of the Range Rover Velar is supremely confident, connected and effortlessly delivered thanks to a carefully engineered suite of technologies.

ALL WHEEL DRIVE WITH INTELLIGENT DRIVELINE DYNAMICS

All Wheel Drive (AWD) with Intelligent Driveline Dynamics (IDD), fitted as standard, delivers both outstanding on-road performance and the full off-road capability expected of a Range Rover. Working together, AWD with IDD continually optimizes the engine torque distribution to the front and rear wheels and to provide improved traction and in variety of road and weather conditions*. Uniquely developed for the Range Rover Velar, the durable transfer box uses an electro-mechanically activated multi-plate wet clutch to deliver smooth and precise distribution to the front and rear wheels. This ensures the constant optimization is imperceptible from the cabin and available engine torque is maximized to give efficient vehicle traction.

IDD determines the required distribution by continually monitoring the vehicle and its interaction with the road. Typically starting with a 50:50 distribution to ensure maximum controlled stability from the first vehicle movement, the system has the full capability of 100 percent rear bias to 100 percent front bias should road conditions require it. Predictive, as well as reactive, the system helps prevent losing traction as well as working to regain it*.

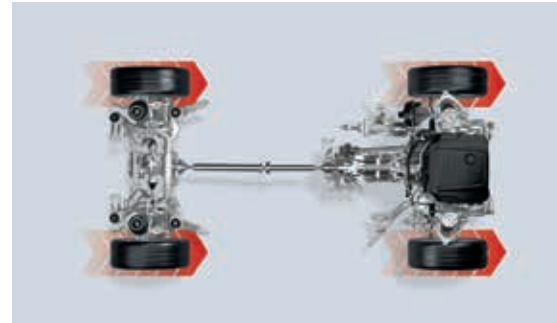

LOW TRACTION CONDITIONS

On slippery surfaces, such as wet grass and snow, torque can be balanced between the front and rear wheels to improve traction. In extreme conditions where only the front wheels have traction, up to 100 percent of engine torque can be distributed to the front wheels for enhanced grip*.

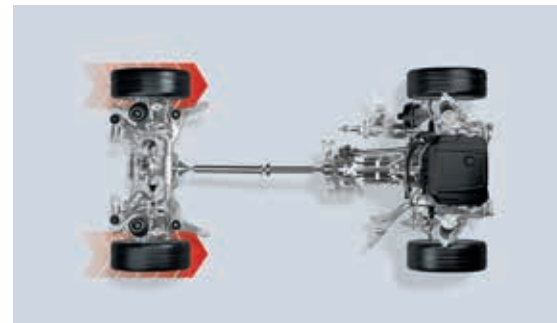

HIGH TRACTION CONDITIONS

On smooth, dry surfaces, Range Rover Velar provides intelligent torque distribution to the rear wheels for the most efficient drive as well as delivering precise agility and handling*.

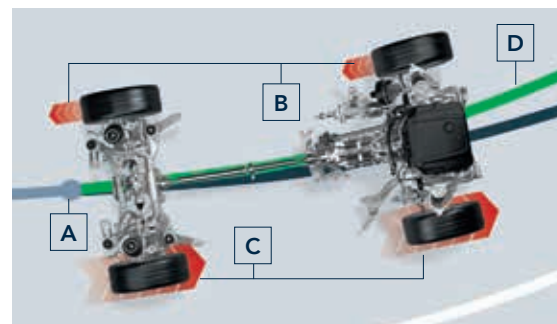

TORQUE VECTORING BY BRAKING

Torque Vectoring by Braking is designed to deliver controlled, responsive cornering by reducing near-limit understeer through controlled braking of the inside wheels*.

- A** Understeer detected
- B** Braking force to inner wheels
- C** Torque to outside wheels maintained
- D** Line corrected

*These systems are not a substitute for driving safely with due care and attention and will not function under all circumstances, speeds, weather and road conditions, etc. Driver should not assume that these systems will correct errors of judgment in driving. Please consult the owner's manual or your local authorized Land Rover Retailer for more details.

Vehicle shown: 2018 Range Rover Velar R-Dynamic HSE in Silicon Silver with optional equipment.

ADAPTIVE DYNAMICS

The standard Adaptive Dynamics system delivers both precise dynamics and a supple, luxurious ride by monitoring wheel position and body movements. To do this, the system is designed to constantly analyze acceleration, steering, throttle and brake pedal activity. The electronically controlled dampers adjust to optimize the suspension settings and provide optimum balance between comfort, refinement and agility*.

CONFIGURABLE DYNAMICS

To enhance either refinement and comfort or the vehicle's performance, the optional Configurable Dynamics function allows you to configure the throttle mapping, gearbox shift points, steering settings and suspension to suit your driving needs.

Search 'Range Rover Velar Capability' for full details.







CAPABILITY

The first vehicle to combine luxury and refinement with Land Rover-renowned capability, Range Rover continues to be leading-edge. Range Rover Velar offers new levels of style, while its unique Land Rover technologies and optimized geometry secure its position at the forefront of all-terrain capability.

The Land Rover patented Hill Descent Control (HDC[®]) is a standard feature. It is designed to assist the driver with controlled descents of difficult slopes. It does so by maintaining a constant speed and applying braking separately to each wheel. Hill Launch Assist, which also comes as standard, is designed to help prevent the vehicle from rolling backwards as it pulls away on an incline. The vehicle also utilizes Gradient Release Control, which is also standard, and is designed to prevent the vehicle accelerating too quickly on a steep incline when the driver releases the brake[†].

ELECTRONIC AIR SUSPENSION

A sure-footed, composed drive is completed by the latest Electronic Air Suspension*, which provides exceptional wheel articulation and poise. It changes the vehicle's height quickly, allowing cross-linking of the diagonal wheels to keep all four wheels on the ground on very uneven surfaces. Added to which, it makes loading heavy objects into the trunk easier as you can alter the vehicle's height by +/- 2 inches to suit your needs. These functions can be operated via the 10" Touchscreen or button in the cargo space area. The Speed Lowering System also uses the Electronic Air Suspension to reduce aerodynamic drag and fuel consumption at cruising speeds by lowering the vehicle from normal ride-height when the speed reaches 65 mph[‡].

ALL TERRAIN PROGRESS CONTROL

All Terrain Progress Control (ATPC) is a state-of-the-art optional system that enables you to set and maintain a steady speed in challenging conditions such as slippery surfaces, including: mud, wet grass, snow and dirt roads. Operating like a cruise control system, it functions between 2.2 mph and 19 mph, enabling you to maintain full concentration on steering and finding a path through obstacles[†].

^{*}Only available when optional towing equipment is selected. [†]These systems are not a substitute for driving safely with due care and attention and will not function under all circumstances, speeds, weather and road conditions, etc. Driver should not assume that these systems will correct errors of judgment in driving. Please consult the owner's manual or your local authorized Land Rover Retailer for more details. [‡]Always follow local speed limits.

Vehicle shown: 2018 European model R-Dynamic HSE in Silicon Silver with optional equipment.





TERRAIN RESPONSE®

When you manually select Land Rover's unique standard Terrain Response system, it sets the vehicle up optimally to match the demands of the terrain, by adapting the responses of the vehicle's engine, gearbox, differentials and chassis systems. There are six Terrain Response settings: Comfort, Grass/Gravel/Snow, Mud and Ruts, Sand, ECO and Dynamic Mode*.

TERRAIN RESPONSE® 2

Terrain Response 2* is an option that takes the capabilities of the award-winning system to a new level. This features an automatic setting which monitors the current driving conditions and systematically selects the most suitable terrain setting*. This function works seamlessly through the Touch Pro Duo's Control Panel (lower Touchscreen).



SAFETY

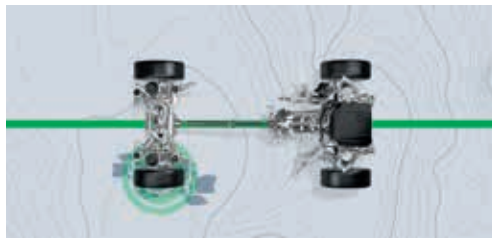

ULTIMATE CAPABILITY



COMPOSURE

ACTIVE LOCKING REAR DIFFERENTIAL

The Active Locking Rear Differential*† is designed to enhance traction in various weather conditions.

A typical open differential transfers equal torque to the driven wheels meaning that if one wheel slips then torque transfer to the other wheel is also limited, which reduces traction. Whereas, Range Rover Velar's All Wheel Drive (AWD) with Intelligent Driveline Dynamics (IDD) and Electronic Traction Control (ETC), both fitted as standard, go two steps further by distributing torque to both the front and the rear wheels, and by braking the wheels independently to improve traction respectively. The addition of the Active Locking Rear Differential delivers the ultimate combination to maximize traction through limiting slip across the rear wheels*.

A second multi-plate wet clutch between the rear wheels can lock almost instantly to provide full engine output torque to both wheels. This can be especially useful to deliver effortless capability in low grip conditions such as wet grass or during wheel articulation off-road. It also provides enhanced traction when exiting a corner, as when the inside wheel becomes unloaded due to weight transfer, the Active Locking Rear Differential increases the torque to the outside wheel*.

Search 'Range Rover Velar Capability' for full details.



TECHNOLOGY

INFOTAINMENT

The new Land Rover InControl® infotainment system, Touch Pro Duo not only looks like no other, it performs like no other. Delivering a wealth of information and entertainment, it features intuitive and advanced integrated technologies to ensure everyone can make the most of their trip†.

Search 'Range Rover Velar Technology' for full details.



TOUCH PRO DUO

The new standard 10" dual high-definition Touchscreens allow the user to view required information while simultaneously being able to interact with additional features, for increased flexibility and efficiency of use††. For instance, you can use the navigation system in the upper screen while playing media on the lower screen††. Direct access to cabin and seat temperature controls are also available via the new multi-function Dynamic Dials.

For a truly elegant and streamlined appearance, the steering wheel also has new hidden-until-lit, touch-sensitive switches as standard. One of these switches is programmable, so that it can be personalized to your preferences to accomplish a host of functions.



INTERACTIVE DRIVER DISPLAY†

The Range Rover Velar ensures you're always entertained, informed and connected. R-Dynamic SE and HSE models feature a 12.3" high-definition Interactive Driver Display that can receive and project a vast amount of driving information, entertainment and data including navigation, phone and media. Its high resolution ensures the utmost clarity and its refined processing engine delivers smooth moving pin sharp graphics. Features can be accessed on either the Interactive Driver Display or the Touch Pro Duo Touchscreens.



HEAD-UP DISPLAY†

To reduce distraction or the need for you to take your eyes off the road, Head-Up Display* is an option that presents key vehicle data such as your speed, gear position and navigation directions on the windshield. It features crystal clear full-color graphics in high resolution, enabling you to see all driver inputs and information with ease. It can also display information from the Touch Pro Touchscreen including phone and media information such as the name of the track you are listening to. The feature can be turned on and off dependent on driver preference**.



REAR SEAT ENTERTAINMENT†

The optional Rear Seat Entertainment System† provides two 8" screens built in to the rear of the front headrests. It includes 'Trip Status', a Navigation Summary screen which displays a pop-up for the rear occupant detailing the time and distance to destination. The system comes with four WhiteFire® digital wireless headphone sets and HDMI, Mobile High-Definition Link (MHL) and USB connections.

*Image shown with optional Traffic Sign Recognition and Adaptive Speed Limiter. **These systems are not a substitute for driving safely with due care and attention and will not function under all circumstances, speeds, weather and road conditions, etc. Driver should not assume that these systems will correct errors of judgment in driving. Please consult the owner's manual or your local authorized Land Rover Retailer for more details. †Do not use Land Rover InControl® features under conditions that will affect your safety or the safety of others. Driving while distracted can result in loss of vehicle control. ††Driving while distracted can result in loss of vehicle control. Do not operate, adjust or view the navigation or multimedia systems under conditions that will affect your safety or the safety of others. Only use mobile phones and other devices, even with voice commands, when it is safe to do so. †Not available on Range Rover Velar.

Interior shown: 2018 Range Rover Velar R-Dynamic HSE with Light Oyster/Ebony interior in Windsor leather with optional features. WhiteFire® is a registered trademark of Unwired Technology LLC and any use of such marks by Land Rover is under licence.

AUDIO

A vehicle's cabin is the ideal place within which to experience your personal choice of music and the Range Rover Velar has the option of four different audio systems to bring your music to life:



LAND ROVER SOUND SYSTEM

Outstanding acoustic range through eight speakers. Only available on Range Rover Velar.

MERIDIAN™ SOUND SYSTEM

Great definition, crystal clear highs and full, deep bass – delivered through the careful arrangement of 11 door-mounted speakers including a dual channel subwoofer. Only available on Range Rover Velar S.

MERIDIAN SURROUND SOUND SYSTEM

All the fullness and clarity of a live performance delivered through an arrangement of 17 front, side and rear speakers including a dual channel subwoofer – seamlessly brought together using Trifield™ technology. Exclusive to Meridian, Trifield perfectly blends the center and surround channels with left and right channels ensuring an optimum, consistent sound experience for each passenger. Optional on Range Rover Velar S, standard on Range Rover Velar R-Dynamic SE and HSE.

MERIDIAN SIGNATURE SOUND SYSTEM

This delivers truly life-like reproduction, creating a profound, personal sound experience for every seat. World-first Trifield 3D technology takes surround sound to the next level, the Signature Sound System includes 23 speakers including a dual channel subwoofer. Incredibly authentic, the sense of cabin space is expanded to a 3D experience – rendering all the instruments, performers and venues of your favorite performances in true scale and location. Not available on Range Rover Velar.

SIRIUS XM® SATELLITE RADIO AND HD RADIO™

The option of HD satellite radio technology offers improved sound quality, and a wide choice of stations and entertainment*.











*A 3-month trial subscription to the Sirius All Access package is included with the vehicle, which gives you access to 150+ channels of premium programming. Plus you can stream SiriusXM on your computer, smartphone or tablet – it's included in your trial. If you decide to continue service after your trial, the subscription plan you choose will automatically renew thereafter and you will be charged according to your chosen payment method at then-current rates. Fees and taxes apply. To cancel you must call SiriusXM at 1-866-635-2349. See the SiriusXM Customer Agreement for complete terms at siriusxm.com. All fees and programming are subject to change. SiriusXM Satellite Radio is not available in Alaska or Hawaii.

MERIDIAN

Formed in 1977 in Cambridgeshire, England, Land Rover’s audio partner Meridian has pioneered many firsts including active speakers and the world’s first digital surround sound processor.

Meridian’s audio technology input has helped ensure that Range Rover Velar is the most superb space within which to experience sound. Meridian Cabin Correction technology was utilized to analyze cabin shape, acoustics and resonance characteristics in order to help remove unwanted sounds.

The advanced algorithm ensures that the rhythm, punch and timing of any piece of music are heard precisely how the artist intended, providing a consistently exceptional quality audio experience for all passengers in the vehicle.

	UNIQUE MERIDIAN TECHNOLOGY	SPEAKERS	WATTS
LAND ROVER SOUND	N/A	8	250
MERIDIAN SOUND	  	11	380
MERIDIAN SURROUND SOUND	   	17	825
MERIDIAN SIGNATURE SOUND	   	23	1600

Search 'Range Rover Velar Technology' for full details.



DIGITAL SIGNAL PROCESSING

Brings all elements of the audio system together as one, for performance that would otherwise require significantly larger speakers.



MERIDIAN CABIN CORRECTION

The advanced algorithm of Meridian’s Cabin Correction tailors the sound experience to the precise acoustics of the interior of the Range Rover Velar.



MERIDIAN DIGITAL DITHER SHAPING

To maintain the quality of musical recordings, they are converted into a common digital format. Meridian Digital Dither Shaping ensures that digital signal conversions are made smoothly and seamlessly, preserving the finest details of the audio performance. The result is authentic musical conversion, evoking the emotions of the original recording.



TRIFIELD

Exclusive to Meridian, Trifield blends the center and surround channels seamlessly with left and right channels, delivering a consistent, concert-like experience for all occupants.



TRIFIELD 3D

Building on Meridian’s proven Trifield surround sound technology – world-first in-car Trifield 3D truly brings musical performances to life. Through the addition of dedicated height channels, the sense of cabin space is expanded to a 3D experience, for a supreme sense of scale and definition to your music.

Meridian is a trademark of Meridian Audio Ltd.
Trifield and the “three fields” device is a trademark of Trifield Productions Ltd.
Features and their availability may differ by vehicle specification.



CONNECTIVITY

Land Rover InControl® is a suite of standard and optional features that connects you to your vehicle and links you seamlessly, with the outside world. With a selection of apps, even when you're away from your vehicle, some of the InControl features stay with you, making sure the Land Rover experience is more enjoyable than ever*.

Search 'Range Rover Velar Technology' for full details.

*Do not use Land Rover InControl® features under conditions that will affect your safety or the safety of others. Driving while distracted can result in loss of vehicle control.

STANDARD FEATURES

VOICE RECOGNITION SYSTEM

Understands clear spoken instructions, so you can concentrate on the road ahead with fewer distractions.

REMOTE PACKAGE

InControl® Remote app provides upgraded information on your vehicle and enables you to interact with your vehicle remotely. Compatible with most smartphones, Android™ Wear or the Apple Watch®, this service includes:

- **Remote Lock/Unlock** – Lock or unlock your doors from your smartphone with the click of a button. Simply press the 'lock' button on the Vehicle Security screen of the InControl Remote smartphone app to single lock the doors, arm the alarm, fold in the side mirrors and close the windows. Press the 'unlock' button to unfold the side mirrors, turn on the low beam headlights and cause the hazard lights to flash twice to help you locate your vehicle.
- **Stolen Vehicle Locator** – Uses tracking technology to alert you to an attempted theft, and signals your vehicle's location to the relevant authorities, for a timely recovery.
- **Beep/Flash** – This feature turns on your Land Rover's hazard lights, low beam headlights and sounds an audible alert to help you locate your vehicle in a crowded parking lot.
- **Journey Tracking** – This opt-in feature can automatically record your trip history including your route and mileage statistics. This information can be exported by email to use for expense reporting and can be imported to a spreadsheet.
- **Vehicle Status Check** – Check current fuel level and range, and status of door and window position and locks. See the last parked location of the vehicle and find your way back to it with on-foot directions.

Land Rover Optimized Assistance – If you breakdown you can make a direct call to the Land Rover Assistance team by pressing the button on the overhead console or from the Assistance screen within the InControl Remote smartphone app.

SOS Emergency Call – In cases where the airbags deploy, SOS Emergency Call will automatically connect you to the emergency response team who will notify emergency services to your location.

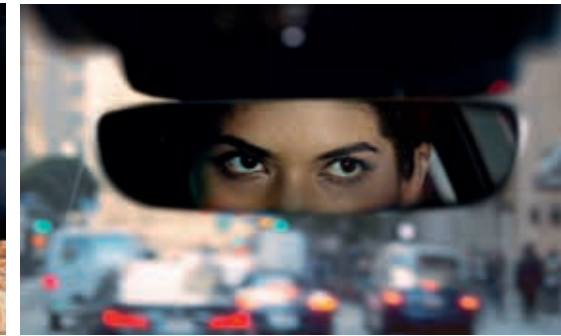

Android™ is a trademark of Google Inc. Apple Watch® is a registered trademark of Apple Inc., registered in the US and other countries. Mobile network connectivity cannot be guaranteed in all locations. InControl Apps will need to be downloaded from the Apple/Play Store.

NAVIGATION PRO

Navigation Pro** allows you to save your favorite places, use pinch and zoom gestures for simple map exploration and can display a choice of either 2D or 3D crystal clear map graphics. Navigation Pro functionality is further enhanced by the **Connect Pro Package**.

CONNECT PRO**

Connect Pro* consists of 4G Wi-Fi Hotspot, and Pro Services, and is designed to enhance your in-car and out-of-car experience, ensuring you and your passengers enjoy the trip while remaining connected to the world.

Connect Pro Services include:

- **Real Time Traffic Information** – Uses live traffic data feeds to give you the most accurate picture of what the traffic is like on the way to your destination.
- **Online Search** – Wherever you are, you can search the surrounding area for places of interest. The system can access expert destination information, travel tips and inspiration as well as online travel reviews of the local area.
- **Planning Routes and Door-to-Door Routing** – Before setting off, use the Route Planner app or online search, save locations or set your destination. The app uses the Cloud to send your destination automatically to your vehicle's navigation screen. Once you've parked, the Route Planner app will guide you to your destination – a true door-to-door experience which includes public transportation options.
- **Share ETA** – You can share your estimated time of arrival so your selected contact(s) will know exactly when you will arrive, as calculated by the navigation guidance system. If you're running late, Share ETA can then send automatic updates via text messages or email, without any further action from you.
- **Satellite View** – There may be times when you want to get the context of your surroundings from overhead. With Connect Pro you can switch to satellite view with a single tap.
- **Street Level Imagery** – To help you recognize your destination as you approach it, the screen can display a 360 degree panoramic street level image.
- **Fuel Prices** – When you're going to fill up, the Fuel Price service not only finds gas stations along your route, it also enables you to compare fuel prices so you can keep your costs down.
- **Commute Mode** – Allows the system to learn your commutes and automatically advises you of the expected journey time based on live and historical traffic movements without you having to input a destination. The system learns the routes you take for a given destination and then advises which of those is the quickest. The feature can be turned on and off dependent on driver preference.

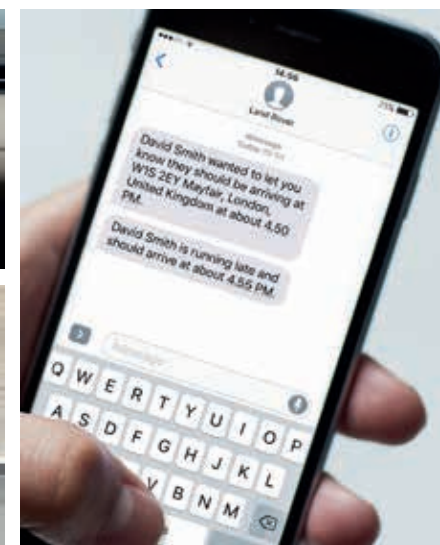
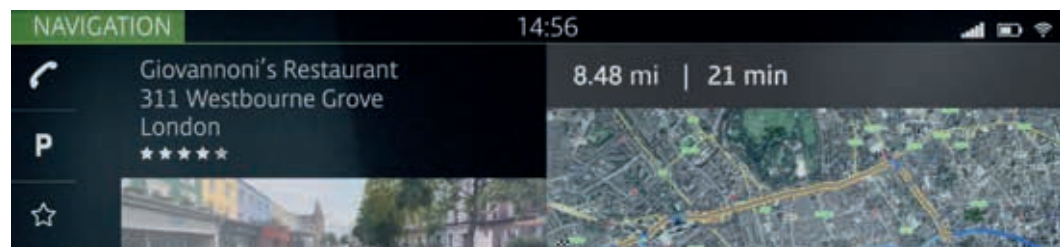

*Available as standard on S, SE, and R-Dynamic SE, HSE models. Not Available on the Range Rover Velar.
**Do not use Land Rover InControl® features under conditions that will affect your safety or the safety of others. Driving while distracted can result in loss of vehicle control. Do not operate, adjust or view the navigation or multimedia systems under conditions that will affect your safety or the safety of others. Only use mobile phones and other devices, even with voice commands, when it is safe to do so. Mobile network connectivity cannot be guaranteed in all locations. InControl Apps will need to be downloaded from the Apple/Play Store.

CONNECT PRO** CONTINUED

- **Parking Service** – As you approach your destination, you can see where parking is available. Simply tap on your preferred parking garage and the navigation system updates to direct you to it.
- **Online Routing** – While you're on your way to a destination the system monitors live traffic conditions and takes into account typical traffic patterns for that time of day, keeping you on the optimum route.
- **Safety Cameras** – This feature audibly and visually alerts you when approaching a safety camera.

Land Rover InControl Apps technology allows vehicle-optimized apps on your Android or Apple smartphone to be controlled through the vehicle's Touchscreen, including contacts, calendar and music player via a USB cable to the USB slot. You can also download third-party apps offering a vast range of services. Applications include:

- **Spotify[†]** – Access a library of more than 30 million songs with this seamlessly integrated app. Featuring all the same intuitive functionality as the Spotify smartphone app, you can search songs, stations and recommendations, create playlists and access your music in offline mode.
- **Tile^{**}** – Helps you find lost or misplaced items in seconds. Attach a tiny Bluetooth[®] tracker Tile to your keys, wallet or bag. The easy-to-use Tile app can then help you find these items should they be misplaced. The app is accessible any time through your vehicle's Touchscreen, allowing you to make sure you have everything you need with you, before you set off on your trip.

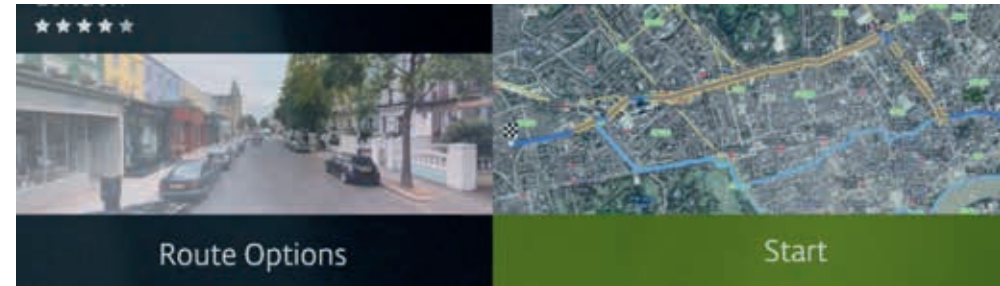

[†]Only available on Apple smartphones. Not available on Android smartphones. ^{**}Requires InControl Apps. Mobile network connectivity cannot be guaranteed in all locations. InControl Apps will need to be downloaded from the Apple/Play Store.

The Bluetooth[®] word mark and logos are owned by the Bluetooth SIG, Inc. and any use of such marks by Land Rover is under license. Tile Inc. Tile and the Tile design are trademarks of Tile, Inc.

DRIVER ASSISTANCE

MAKING DRIVING EASIER

From negotiating city traffic or the highway, to providing additional assistance for you and your passengers, there's a wealth of innovative technologies available; either as standard, optional or as part of an optional package. Whichever you choose, you'll find every single feature has been designed and engineered to heighten your enjoyment of the vehicle.

Search 'Range Rover Velar Technology' for full details.

STANDARD DRIVE FEATURES



Lane Departure Warning

Cruise Control with Speed Limiter allows the driver to maintain the current speed of the vehicle without the need for continued use of the accelerator pedal, making driving easier and more enjoyable. The Speed Limiter will also allow the driver to pre-set a maximum specified speed which the vehicle will not exceed. Both functions can be easily turned on or off by the driver as desired[†].

Autonomous Emergency Braking can help to prevent foreseeable collisions with other vehicles or pedestrians. If a potential frontal collision is detected, a warning is displayed giving you time to take action. A camera at the front of the vehicle monitors at speeds from 3 to 50 mph for frontal collisions and 3 to 37 mph^{††} for pedestrians. If a collision is still anticipated and you have taken no action, this system will apply the brakes to help reduce the severity of the possible impact[†].

Lane Departure Warning can help make long trips more enjoyable. The system senses when your vehicle is unintentionally drifting out of your lane, and notifies you with a visual alert and a gentle vibration of the steering wheel[†].

OPTIONAL DRIVE FEATURES



Adaptive Cruise Control with Queue Assist and Intelligent Emergency Braking

Adaptive Cruise Control[‡] when you're cruising on the highway or traveling in slow-moving traffic, it is designed to keep your vehicle a set distance from the one in front should it slow or stop. Should the vehicle in front stop completely, your vehicle will come to a smooth halt. Once the traffic moves, simply touch the accelerator and Adaptive Cruise Control will resume following the vehicle in front. The system can be activated from 9.9 mph up to highway speeds[†].

If a collision is unavoidable, Adaptive Cruise Control will engage Intelligent Emergency Braking.

^{*}Only available on S and R-Dynamic SE. ^{**}Only available on Range Rover Velar S. [†]These systems are not a substitute for driving safely with due care and attention and will not function under all circumstances, speeds, weather and road conditions, etc. Driver should not assume that these systems will correct errors of judgment in driving. Please consult the owner's manual or your local authorized Land Rover Retailer for more details. ^{††}Always follow local speed limits.

[‡]Standard on HSE, Package Option on S and SE, not available on Range Rover Velar. Adaptive Cruise Control does not react to pedestrians or objects in the highway. Adaptive Cruise Control does not react to pedestrians or objects in highway

Features and their availability may differ by vehicle specification. Please refer to Specification and Price Guide for details or contact your nearest Land Rover Retailer, for more information.

DRIVE PACKAGES

OPTIONAL DRIVE PACKAGE**



Traffic Sign Recognition with Adaptive Speed Limiter

The optional Drive Package offers a range of features that help keep you informed. The Drive Package includes:

Driver Condition Monitor is designed to detect if you're starting to feel drowsy and gives you an early warning when you need to take a break[†].

Blind Spot Monitor is designed to alert you to vehicles in, or quickly approaching your blind spot. When a vehicle is detected, a small warning light will illuminate in the corresponding side mirror. If you apply the turn signal in the direction of the obstacle, the warning light will flash to highlight potential danger[†].

Traffic Sign Recognition keeps you informed and aware on the road, by displaying speed limits and no passing signs in the instrument cluster, where they can easily be seen. When activated, Adaptive Speed Limiter uses Traffic Sign Recognition information to adjust your vehicle's speed accordingly[†].

OPTIONAL DRIVE PRO PACKAGE*



Blind Spot Assist

Making every journey more relaxing. The optional Drive Pro Package contains all the technologies within the Drive Package, plus the following enhancements:

Lane Keep Assist is designed to detect when your vehicle is unintentionally drifting out of your lane, and gently steers you back[†].

Blind Spot Assist is designed to help prevent foreseeable collisions. If your vehicle detects another car in your blind spot when you begin to change lanes, this system provides precisely calculated steering torque – guiding your vehicle away from the approaching car[†].

Adaptive Cruise Control with Queue Assist and Intelligent Emergency Braking^{††} – See page 28 for description.

ENJOY STRESS-FREE PARKING

Range Rover Velar offers the most advanced technologies to deliver intuitive and easy parking solutions. Whether reversing, parallel parking or getting into or out of tight spaces, these features make life easier. Available as standard, optional or as part of an optional package.

Search 'Range Rover Velar Technology' for full details.

STANDARD PARK FEATURES



Rear Parking Aid

Rear Parking Aid helps make reversing into tight spaces easier. When you select Reverse, sensors located in the rear bumper are automatically triggered. As you park, the Touchscreen display and audio feedback indicates how close you are to obstacles*.

Rear View Camera provides improved visibility when reversing. This valuable parking aid also helps when hitching a trailer. Static lines representing the vehicle's outer perimeter and predicted path are superimposed on the rearward image, to make parking in tight spots as easy as possible*.

OPTIONAL PARK FEATURES



Surround Camera System

Surround Camera System^A uses four digital cameras discretely placed around the vehicle, providing a 360° overhead view on the Touchscreen. With the capacity to display several different views at the same time, this helps with various maneuvers from parking by a curb, to getting in and out of tight spaces and intersections*.

*These systems are not a substitute for driving safely with due care and attention and will not function under all circumstances, speeds, weather and road conditions, etc. Driver should not assume that these systems will correct errors of judgment in driving. Please consult the owner's manual or your local authorized Land Rover Retailer for more details. **Not available on Range Rover Velar. [†]Only available on Range Rover Velar S models. [‡]Only available on Range Rover Velar R-Dynamic SE. ^ΔNot available on the base model Range Rover Velar. [▲]Park Assist is only programmed to steer you out of a parallel parking space. Park Assist is not meant for use on perpendicular parking spaces.

PARK PACKAGES

OPTIONAL PARK PACKAGE†



360° Parking Aid

The optional Park Package assists you with maneuvering in tight spaces and in city environments, it features:

360° Parking Aid gives you confidence when maneuvering in tight spaces. Sensors located around the vehicle are automatically triggered when Reverse is selected, or can be manually activated, with a graphic appearing on the Touchscreen showing an overhead view of the vehicle. As you park, the Touchscreen display and audio feedback indicates how close you are to obstacles*.

Reverse Traffic Detection is particularly useful when reversing out of a parking spot. The system warns you of vehicles, pedestrians or other hazards, approaching from either side of your vehicle. It will alert you with both audio and visual warnings so you know what's behind you even when the view is obstructed*.

OPTIONAL PARK PRO PACKAGE†



Park Assist

The optional Park Pro Package enables you to park and maneuver more easily in and out of tight spaces and into traffic that is obscured by buildings or other vehicles.

The package contains all the technologies within the Park Package, plus the following enhancement:

Park Assist^Δ (includes 360° Parking Aid) makes parallel and perpendicular parking easier than ever by steering your vehicle into a suitable space[†]. You just have to select the appropriate gear and control the vehicle's speed with the brake and accelerator pedals. Graphics and notifications guide you through the maneuvers. Park Assist will also steer you out of a space[▲], taking all of the stress out of parking.

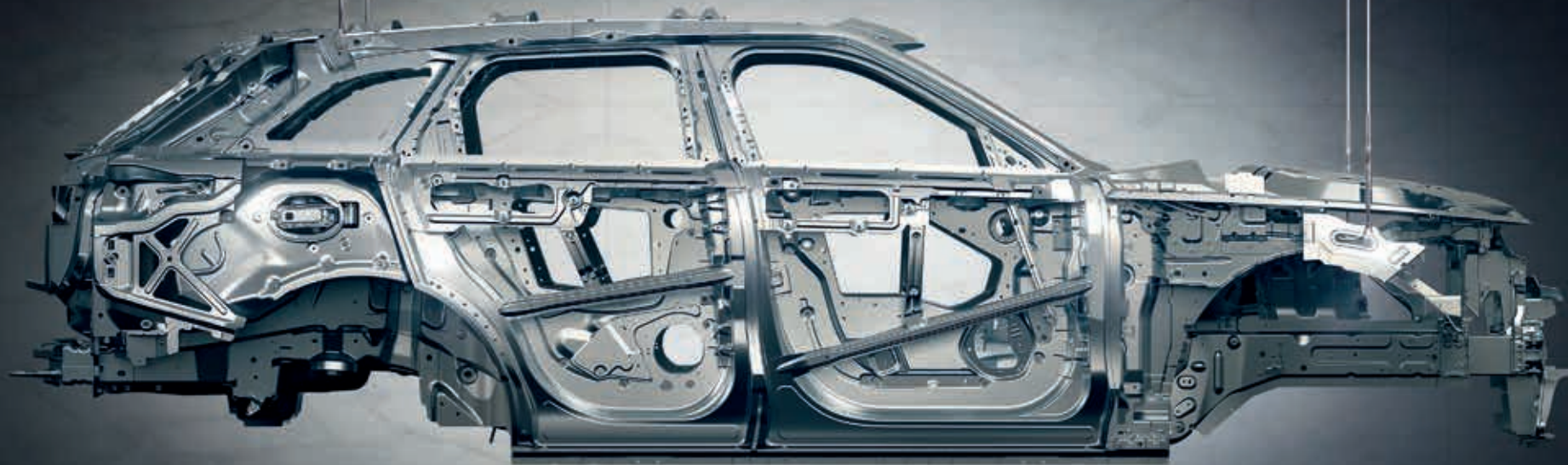

EFFICIENT TECHNOLOGIES

SUSTAINABLE BY DESIGN

Land Rover are committed to producing vehicles that use more sustainable materials, produce less waste and use fewer natural resources as part of our approach to sustainability excellence. The development process of the Range Rover Velar has included a full life cycle assessment and has been designed to be 85 percent recyclable/re-usable and 95 percent recoverable at the end of the vehicle's life.

Due to its advanced lightweight properties, the body structure of the Range Rover Velar is 82 percent aluminum. Our innovative design incorporates up to 50 percent closed-loop recycled material from the manufacturing process of the body sheet, resulting in significant performance benefits and lower life cycle CO₂ emissions. The closed-loop supply chain reclaims scrap aluminum from the stamping process, segregates it and re-melts it into the same grade quality sheet, thereby reducing the need for primary aluminum production, while maintaining the highest quality.

ADVANCED AERODYNAMICS

The streamlined design of our latest vehicle has been carefully optimized to make Range Rover Velar the most aerodynamic Range Rover ever. A rear spoiler with two integrated slots to direct airflow over the tailgate minimizes rear windshield soiling and provides a reduction in drag. The option of aerodynamically designed and engineered wheels can also help reduce drag by 5 percent.

ENGINE MANUFACTURING CENTER

Jaguar Land Rover's Engine Manufacturing Center, where our engines are developed, has been built to the highest environmental standard (BREEAM Excellent) and features the largest rooftop solar panel installation in the UK. Comprising no fewer than 22,600 individual panels, which are capable of providing up to 6,2 megawatt (MW) (enough energy to power up to 1,600 homes), the panels generate more than 30 percent of the site's energy, reducing the plant's CO₂ footprint by over 2,400 tons per year.

Search 'Range Rover Velar Sustainability' for full details.



Vehicle shown is R-Dynamic HSE in Silicon Silver with optional equipment and optional 22" 9 split-spoke 'Style 9007' wheels with Diamond Turned finish.

DRIVER ASSISTANCE

DRIVER ASSISTANCE

The Range Rover Velar has been engineered to include standard features to assist to protect you and your passengers, and to help avoid accidents.

The elevated Sports Command Driving Position in the Range Rover Velar provides enhanced visibility. You can see more of the road and be more easily seen by others on the road; providing an enhanced feeling of confidence.

Legendary sure-footed All Wheel Drive (AWD) with Intelligent Driveline Dynamic (IDD) capability, as standard, helps you stay firmly planted on the road, in a variety of weather or environment conditions*.

The Range Rover Velar is further enhanced by the latest technologies included as standard:

Dynamic Stability Control (DSC) monitors the dynamic behavior of the Range Rover Velar, intervening to enhance vehicle stability. DSC reduces engine torque and applies braking to the appropriate wheels to correct the vehicle's direction of travel by counteracting understeer or oversteer*.

Anti-lock Braking System (ABS) allows the vehicle to maintain traction with the road surface while braking and prevents wheels from locking – thereby retaining the vehicle's ability to steer. The system helps to shorten the braking distance.

Electronic Brake-force Distribution (EBD) automatically varies the braking force to each axle in order to minimize stopping distance, while still maintaining stability and the vehicle's ability to steer*.

Electronic Traction Control (ETC) enhances traction and stability by controlling wheel spin. The ETC system reduces torque to the spinning wheel, then applies braking to the wheel, if required*.



Cornering Brake Control (CBC) automatically varies the braking force to each wheel when the vehicle's brakes are applied around a corner and the limit of grip is reached. The system is designed to prevent the vehicle's wheels from locking up and skidding in this event through varying the braking force applied to each wheel*.

Roll Stability Control (RSC) is integrated with DSC to reduce the possibility of rollover, while providing agility and ability to steer around obstacles. It monitors the vehicle motion and cornering forces to detect any potential risk of rollover. When risk is detected, braking is applied to the outside front wheel to reduce forces which contribute to rollover*.

Emergency Brake Assist understands when you apply the brakes quickly but without the necessary force to maximize stopping performance. It therefore boosts the brake pressure through the ABS pump to ensure you stop in time.

To help reduce the risk of a collision, the Emergency Stop Signal system automatically activates the hazard warning lights during emergency braking*.

Autonomous Emergency Braking – see page 28 for details.

For easier installation, two LATCH points for baby/child seat restraints are fitted on each side of the rear seats and a comprehensive system of six airbags including driver, passenger, side curtain and thorax airbags are standard to protect you.

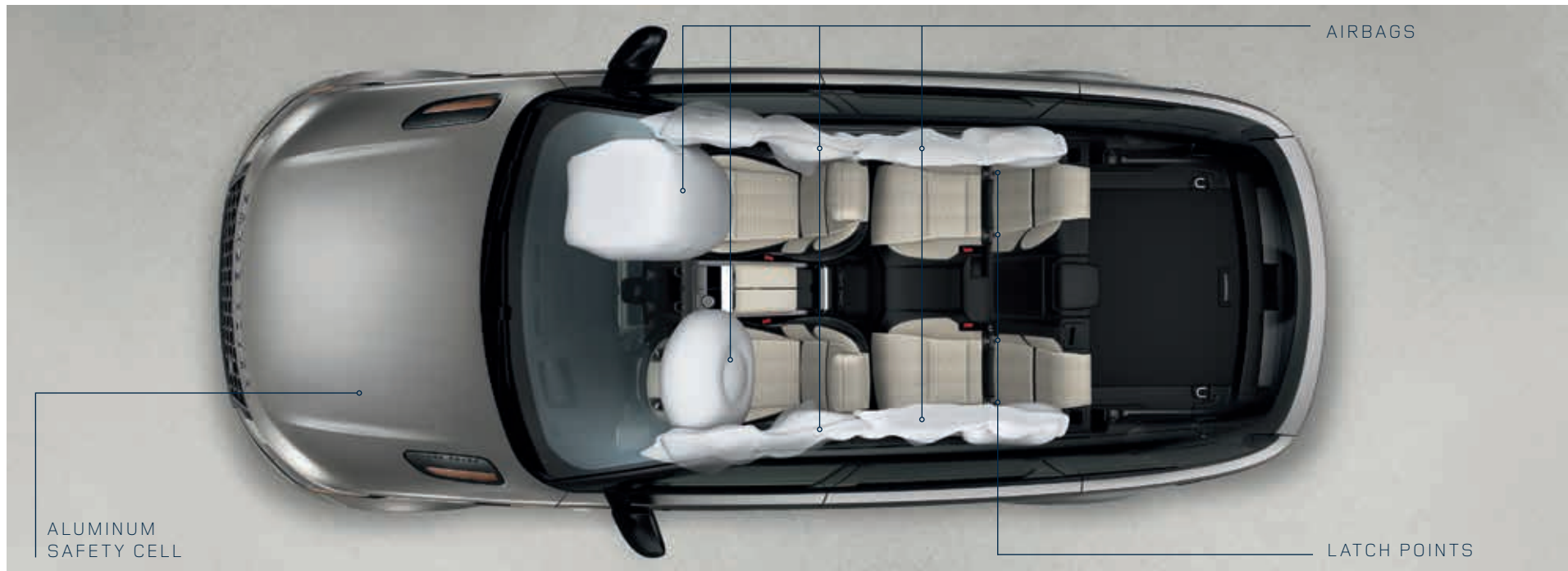



LED LOW BEAM 158 YD

BRIGHTER LIGHTS, FOR NIGHT-TIME DRIVING

The Range Rover Velar features all-round exterior LED lighting as standard. LED lights are designed to last the lifetime of the vehicle and are more fuel-efficient as they use less energy. The quality of light produced is closer to daylight conditions, to make driving at night less tiring.

Daytime Running Lights (DRL's) and Animated Directional Indicators help reduce the time it takes other road users to recognize the intended direction of travel.

Driving at night or in poor visibility is made easier by the available Auto High Beam Assist (AHBA) which detects lights ahead and automatically lowers the high beam for oncoming traffic*.

Search 'Range Rover Velar Driver Assistance' for full details.



LED HIGH BEAM 360 YD



	LED HEADLIGHTS	PREMIUM LED HEADLIGHTS WITH SIGNATURE DRL
Headlight Power Wash	-	■
LED Headlights	■	■
Animated Directional Indicators	-	■
Auto High Beam Assist (AHBA)	-	■

■ Standard - Not Available.



AIR SUSPENSION LOWERS BY 2 INCHES

VERSATILITY

TRULY FLEXIBLE

Range Rover Velar enjoys optimum levels of space. Occupants can enjoy the highest levels of comfort and exemplary levels of storage.

Automatic Access Height, as part of the Electronic Air Suspension*, allows you to get in and out of the vehicle with greater ease. When you arrive at your chosen destination and auto access height initially lowers the vehicle suspension height by up to 0.9 inches lower than normal height. Then, as you open the door, it drops to its full access height of 1.6 inches lower than normal, making exit – and entry – more relaxed and elegant. The ride height automatically returns to its normal height as you pull away.

Exceptional 38 inches head clearance and 37 inches legroom in the second row enables passengers to stretch out and relax. An electric recline function is also available for the rear seats, offering occupants in the second row additional comfort.

Optional Four-zone Climate Control helps make life more comfortable for everyone, by adjusting temperature levels, direction and intensity of airflow.

The 40:20:40 second row seat configuration features a rear-seat pass-through for storage of skis, an armrest and for the greatest possible storage space, the entire row can be folded. Optional Rear Seat Remote Release Levers are located in the luggage compartment and, when released, mechanically fold all the seats down. Even when you're heading off on an extended road trip, there is plenty of space. With a maximum cargo space of 34.4 cubic feet, you can carry several suitcases or other bulky items with ease.

*Standard on P380 engine.



5 SEATS
34 CUBIC FEET



4 SEATS
33 CUBIC FEET



3 SEATS
52 CUBIC FEET



2 SEATS
70 CUBIC FEET

A tow hitch receiver* with a maximum tow capacity of 5,512lbs is available as an option, including all electrics and appropriate attachments for your trailer allowing you to use items from the Land Rover Gear range more easily, adding even more versatility to the vehicle. Everything has been designed and engineered for ease of use and adaptability, to fit perfectly with your lifestyle. A Tow Package is also available which includes the tow hitch receiver, fixed rear recovery eye, Advanced Tow Assist** and Surround Camera†.

Search 'Range Rover Velar Versatility' for full details.



*Requires Fixed Rear Recovery Eye. Maximum tow capacity assumes a braked trailer. **See page 76 for details. †These systems are not a substitute for driving safely with due care and attention and will not function under all circumstances, speeds, weather and road conditions, etc. Driver should not assume that these systems will correct errors of judgment in driving. Please consult the owner's manual or your local authorized Land Rover Retailer for more details.

THE RANGE ROVER VELAR OFFERS AN EXCLUSIVE RANGE OF CHOICES THAT ALLOW YOU TO PERSONALIZE YOUR VEHICLE.

The following pages take you through a logical series of steps to personalize your Range Rover Velar. You have a number of choices; from selecting your model and engine, to exterior and interior colors, wheels, finishes and those detailed touches that make the vehicle your own.

You can start with our online configurator at landroverusa.com

42-45

1

**STEP 1
CHOOSE YOUR MODEL**

If you would like Land Rover designers to choose your Range Rover Velar features for you, turn to page 42 to see our First Edition.

If you would like to specify your own vehicle, turn to page 44 where you can compare the standard features across Range Rover Velar and Range Rover Velar R-Dynamic.

46-47

2

**STEP 2
CHOOSE YOUR ENGINE**

You can select from a range of powerful diesel or gas engines.

48-49

3

**STEP 3
CHOOSE YOUR
SPECIFICATION PACKAGE**

You can individualize your Range Rover Velar even further from a choice of superbly designed and engineered premium specification packages.

50-59

4

**STEP 4
CHOOSE YOUR EXTERIOR**

There's a wide range of exterior options to select from; roof styles, paint colors, exterior design packages and wheels – all enable you to truly express yourself.

60-69

5

**STEP 5
CHOOSE YOUR INTERIOR**

Once you've chosen your seat style, select your preferred color combinations and choice of finishers.

70-77

6

**STEP 6
CHOOSE YOUR OPTIONS
AND LAND ROVER GEAR**

You can choose from a wealth of options to create the exact vehicle you want. A range of accessories which your retailer can fit is also available to select from.

78-79

TECHNICAL DETAILS

Technical information and data for dimensions, performance and specifications.

1

CHOOSE YOUR MODEL

SELECT FIRST EDITION



Flux Silver



Corris Grey



Silicon Silver

Range Rover Velar First Edition represents the epitome of the vehicle's design story. First Edition is only available in the first year of sales and includes the very finest touches and options as standard. It is presented in three exterior colors: Flux Silver, Corris Grey or Silicon Silver.

Search 'Range Rover Velar First Edition' for full details.



**22" 9 SPLIT-SPOKE 'STYLE 9007'
WITH DIAMOND TURNED FINISH**

Standard on First Edition



**21" 5 SPLIT-SPOKE 'STYLE 5047'
WITH DIAMOND TURNED FINISH**

Optional on First Edition



**20" 10 SPOKE 'STYLE 1032'
WITH DIAMOND TURNED FINISH**

Optional on First Edition



First Edition includes all of the features available on R-Dynamic HSE (see page 49) plus the following:

PERFORMANCE AND CAPABILITY

Fitted with the 380 HP engine. Further information on this powertrain is available on page 12 and 13.

The following performance features are standard:

- All Terrain Progress Control (ATPC)*
- Terrain Response® 2*
- Configurable Dynamics
- Active Rear Locking Differential*

EXTERIOR

Select either the metallic exterior color Corris Grey, or the premium metallic Silicon Silver.

Select either the 22" 9 split-spoke 'Style 9007' with Diamond Turned finish or choose from one of the two additional optional wheels, the 20" 10 spoke 'Style 1032' with Diamond Turned finish or the 21" 5 split-spoke 'Style 5047' with Diamond Turned finish.

The following exterior features are standard:

- Exclusive First Edition badging on the B-pillar
- Black contrast roof
- 22" 'Style 9007' Diamond Turned Wheel

INTERIOR

The following interior features are standard:

- 20-way heated/cooled front seats with memory and massage settings in Light Oyster/Ebony perforated Windsor leather with heated rear reclining seats
- Full Extended Leather Upgrade
- Unique Carbon Fiber with Copper Wire Weave trim finishers with exclusive First Edition script
- Suedecloth headlining
- Illuminated treadplates
- Premium carpet mats
- Configurable Ambient Interior Lighting
- Heated steering wheel
- Heated windshield
- Head-up Display*
- Meridian™ Signature Sound System with 23 speakers
- 4 x USB, 3 x 12V
- Instrument panel chrome ends
- Reduced section alloy spare wheel
- Surround Camera System*
- Activity Key



When you have selected your preferred engine, color and wheels, visit pages 70-77 to choose from our wide range of Options and Land Rover Gear.

Meridian is a trademark of Meridian Audio Ltd.

*These systems are not a substitute for driving safely with due care and attention and will not function under all circumstances, speeds, weather and road conditions, etc. Driver should not assume that these systems will correct errors of judgment in driving. Please consult the owner's manual or your local authorized Land Rover Retailer for more details.

SELECT RANGE ROVER VELAR OR RANGE ROVER VELAR R-DYNAMIC

To help you choose between the Range Rover Velar or Range Rover Velar R-Dynamic models, this guide provides the standard features across both models, plus the additional features included with the Range Rover Velar R-Dynamic.

The elegant proportions and unmistakable Range Rover design cues create a vehicle that simply demands attention.

STANDARD FEATURES

TRANSMISSION AND DYNAMICS

- Single-speed transfer box
- Electric Parking Brake (EPB)
- 8-speed Automatic Transmission
- Terrain Response®
- Adaptive Dynamics**
- Torque Vectoring by Braking**
- Hill Descent Control (HDC®)**
- Hill Launch Assist**
- Gradient Release Control (GRC)**
- Electronic Traction Control (ETC)**
- Dynamic Stability Control (DSC)**
- Cornering Brake Control (CBC)**
- Autonomous Emergency Braking**
- Lane Departure Warning**
- Electronic Brake-force Distribution (EBD)**
- Roll Stability Control (RSC)**
- Speed Proportional Electronic Power Assisted Steering (EPAS)
- Low Traction Launch**
- Coil suspension
- Electronic Air Suspension*
- Stop/Start
- Trailer Stability Assist (TSA)**
- Advanced Emergency Brake Assist**
- Permanent AWD with Intelligent Driveline Dynamics

EXTERIOR FEATURES AND FINISH

- Rain sensing wipers
- Tailgate slotted spoiler
- Flush deployable door handles
- Heated exterior mirrors
- Solid paint
- Solar attenuating windshield
- Privacy Glass
- Body-colored sliding panoramic roof

HEADLIGHTS AND LIGHTING

- Automatic headlights
- Follow me home lighting
- Rear fog lights
- Front and rear LED lights

WHEELS AND OPTIONS

- Tire Pressure Monitoring System (TPMS)
- 18" 15 spoke 'Style 1022'
- All season tires
- Reduced Section Steel Spare Wheel

INTERIOR FEATURES

- Touch Pro Duo†
- Sunvisors with illuminated vanity mirrors
- Push Button Start
- Morzine headlining
- Painted door finishers
- Leather steering wheel
- 5" display with instrument panel
- Black gearshift paddles
- Metal cargo space scuff plate and metal front treadplates
- Two-zone Climate Control
- Ambient Interior Lighting
- Bluetooth® connectivity‡
- Air Quality Sensor
- Auto-dimming interior rear view mirror
- Land Rover Sound System with 8 speakers
- Remote
- Carpet Mats

SEATING FUNCTIONALITY

- Luxtec and suedecloth seats
- 10-way electric front seats
- Two piece sliding front center armrest
- 40:20:40 split fold rear seat
- Second row center headrest

CONVENIENCE

- Keyless Entry
- Cruise Control with Speed Limiter
- Manual tailgate
- Cargo space cover
- Voice Control
- 2 x USB, 3 x 12V
- Lockable glovebox
- Electric windows with one-touch open/close and anti-trap
- Garage Door Opener (HomeLink®)
- Rear View Camera**

SAFETY

- Perimetric alarm and immobilizer
- Anti-Lock Braking System (ABS)
- 12.8 inch front brakes
- Brake pad wear indicator
- 6 airbags
- Seat belt reminder
- Rear LATCH
- Power operated child locks

*Standard on 380 HP engine. **These systems are not a substitute for driving safely with due care and attention and will not function under all circumstances, speeds, weather and road conditions, etc. Driver should not assume that these systems will correct errors of judgment in driving. Please consult the owner's manual or your local authorized Land Rover Retailer for more details. †Do not use Land Rover InControl® features under conditions that will affect your safety or the safety of others. Driving while distracted can result in loss of vehicle control. ‡Driving while distracted can result in loss of vehicle control. Do not operate, adjust or view the navigation or multimedia systems under conditions that will affect your safety or the safety of others. Only use mobile phones and other devices, even with voice commands, when it is safe to do so.

For full feature and option availability please refer to the accompanying Specification and Price Guide or visit your local Land Rover Retailer. HomeLink® is a registered trademark of Johnson Controls, Inc.

RANGE ROVER VELAR



RANGE ROVER VELAR R-DYNAMIC



Range Rover Velar R-Dynamic has a purposeful stance with Burnished Copper bumper accents, hood vents and side vents adding to its sophisticated contemporary look and allure. The hood badge, tailgate script and grille are finished in Shadow Atlas while inside, the vehicle features Satin Chrome gearshift paddles and Bright metal pedals to enhance the sportier feel.

R-DYNAMIC FEATURES IN ADDITION TO STANDARD FEATURES:

- R-Dynamic treadplates
- Leather steering wheel with Chrome bezel
- Unique front and rear bumper design including integrated exhaust finishers*
- Satin Chrome gearshift paddles
- Shadow Aluminum trim finisher
- Bright metal pedals
- Ebony Morzine headlining
- Gloss Black mirrors with Narvik Black scalps
- Front fog lights
- Satin dark grey wheel finisher

2

CHOOSE YOUR ENGINE

Choose from three powertrains: one diesel and two gas. Range Rover Velar delivers effortless performance from its advanced line-up of refined diesel and gas engines, which are paired with a smooth and responsive 8-speed Automatic Transmission.

DRIVELINE AND ENGINE PERFORMANCE

ENGINE		DIESEL
		AUTOMATIC D180*
Driveline		All Wheel Drive (AWD)
Maximum power (hp @ rpm)		180 @ 4,000
Maximum torque (lb-ft @ rpm)		317 @ 1,500
Capacity (cc)		1,999
No. of cylinders		4
Cylinder layout		In-line
PERFORMANCE		
Maximum speed*	mph**	130
Acceleration (seconds)	0-60 mph**	8.4

DRIVELINE AND ENGINE PERFORMANCE

ENGINE	GAS	
	AUTOMATIC	AUTOMATIC
	P250	P380
Driveline	All Wheel Drive (AWD)	All Wheel Drive (AWD)
Maximum power (hp @ rpm)	247 @ 5,500	380 @ 6,500
Maximum torque (lb-ft @ rpm)	269 @ 1,200-4,500	332 @ 3,500-5,000
Capacity (cc)	1,999	2,995
No. of cylinders	4	6
Cylinder layout	In-line	Longitudinal V6
PERFORMANCE		
Maximum speed	mph**	135
Acceleration (seconds)	0-60mph**	6.4
		5.3



3

CHOOSE YOUR SPECIFICATION PACKAGE

This guide will help you select your ideal Range Rover Velar. No matter which model you choose, the standard specification Range Rover Velar, through to one of the three Specification Packages; S, SE or R-DYNAMIC in both SE and HSE – you can always select additional options from those featured on page 70 to make your vehicle even more individual.

S



SE



R-DYNAMIC – SE



R-DYNAMIC – HSE



	S*	SE	HSE
WHEELS	<ul style="list-style-type: none"> – 19" 5 spoke 'Style 5046' 	<ul style="list-style-type: none"> – 20" 7 spoke 'Style 7014' <p>When R-Dynamic is specified:</p> <ul style="list-style-type: none"> – 20" 10 spoke 'Style 1032' with Satin Dark Grey finish 	<ul style="list-style-type: none"> – 21" 10 spoke 'Style 1033' with Satin Dark Grey finish
VISION	<ul style="list-style-type: none"> – Premium LED headlights with Signature Daytime Running Lights (including power wash) and Automatic High Beam Assist (AHBA) 	<ul style="list-style-type: none"> – Premium LED headlights with Signature Daytime Running Lights (including power wash) and Automatic High Beam Assist (AHBA) 	<ul style="list-style-type: none"> – Premium LED headlights with Signature Daytime Running Lights (including power wash) and Automatic High Beam Assist (AHBA)
POWERED CONVENIENCE	<ul style="list-style-type: none"> – Powered Gesture Tailgate – Auto-dimming, power fold, heated door mirrors with approach lights 	<ul style="list-style-type: none"> – Powered Gesture Tailgate – Auto-dimming, power fold, heated door mirrors with approach lights 	<ul style="list-style-type: none"> – Powered Gesture Tailgate – Auto-dimming, power fold, heated door mirrors with approach lights – Power adjustable steering column
SEATING	<ul style="list-style-type: none"> – Perforated grained leather seats – 10-way seats with driver memory (including rear armrest and power recline) 	<ul style="list-style-type: none"> – Perforated grained leather seats – 10-way seats with driver memory (including rear armrest and power recline) <p>When R-Dynamic is specified:</p> <ul style="list-style-type: none"> – Perforated grained leather seats with suedecloth bolsters 	<ul style="list-style-type: none"> – Perforated Windsor leather seats – 20-way seats with driver/passenger memory massage and heated/cooled front (including rear armrest and power recline) – Extended Leather Upgrade includes: Windsor leather door top roll lower, Windsor leather mid instrument panel, Windsor leather driver airbag cover
INFOTAINMENT†	<ul style="list-style-type: none"> – Land Rover InControl® Apps – Connect Pro (Pro Services and Wi-Fi Hotspot) – Navigation Pro – Meridian™ Sound System 380W with 11 speakers (including subwoofer) 	<ul style="list-style-type: none"> – Land Rover InControl® Apps – Connect Pro (Pro Services and Wi-Fi Hotspot) – Navigation Pro – Meridian Surround Sound System 825W with 17 speakers (including subwoofer) – Interactive Driver Display 	<ul style="list-style-type: none"> – Land Rover InControl® Apps – Connect Pro (Pro Services and Wi-Fi Hotspot) – Navigation Pro – Meridian Surround Sound System 825W with 17 speakers (including subwoofer) – Interactive Driver Display
DRIVING AIDS**	<ul style="list-style-type: none"> – Rear Parking Aid – Lane Departure Warning – AEB – Speed Limiter – Rear View Camera 	<ul style="list-style-type: none"> – Drive Package consisting of; Blind Spot Monitor, Driver Condition Monitor and Traffic Sign Recognition and Adaptive Speed Limiter – Park Package consisting of; 360° Parking Aid and Reverse Traffic Detection 	<ul style="list-style-type: none"> – Drive Pro Package consisting of; Adaptive Cruise Control with Queue Assist and Intelligent Emergency Braking, Lane Keep Assist, Blind Spot Assist, Driver Condition Monitor and Traffic Sign Recognition and Adaptive Speed Limiter – Park Pro Package consisting of; Park Assist (includes 360° Parking Aid) and Reverse Traffic Detection

*Only available on Range Rover Velar. **These systems are not a substitute for driving safely with due care and attention and will not function under all circumstances, speeds, weather and road conditions, etc. Driver should not assume that these systems will correct errors of judgment in driving. Please consult the owner's manual or your local authorized Land Rover Retailer for more details. †Driving while distracted can result in loss of vehicle control. Do not operate, adjust or view the navigation or multimedia systems under conditions that will affect your safety or the safety of others. Only use mobile phones and other devices, even with voice commands, when it is safe to do so.

4

CHOOSE YOUR EXTERIOR

SELECT YOUR ROOF

The standard body-colored sliding panoramic roof enhances the sense of space in the vehicle's interior, flooding it with natural light and opens fully to let the outside in. You can also select the optional Black contrast roof to further enhance your vehicle's exterior.



Body-colored Sliding Panoramic Roof (Standard)



Black Contrast Sliding Panoramic Roof* (Optional)

SELECT YOUR PAINT COLOR

Now you have chosen your preferred roof style, you can select your exterior paint color. From rich, deep lusters to smooth, crisp metallics, our paints incorporate the latest in pigment technologies. Our solid paints produce a deep flat color. Our optional metallics deliver a sparkle finish that is sure to catch the eye. And our optional premium metallic paints further enhance the exterior form through the intensity of the liquid like smoothness to give your vehicle even more presence.



Fuji White (Solid)



Narvik Black* (Solid)



Indus Silver (Metallic)



Corris Grey (Metallic)



Firenze Red (Metallic)



Byron Blue (Metallic)



Aruba (Premium Metallic)



Yulong White (Metallic)



Kaikoura Stone (Metallic)



Carpathian Grey (Premium Metallic)



Santorini Black* (Metallic)



Silicon Silver (Premium Metallic)

SELECT BETWEEN RANGE ROVER VELAR DESIGN PACKAGES

You can tailor the exterior of your Range Rover Velar with the addition of any of the following packages: Premium Exterior Package*, Black Exterior Package* and Premium Black Exterior Package. Each one elevates the vehicle's sense of sophistication, with specific detailing providing another level of individuality.

Please note that these packages are not available on R-Dynamic models. Instead, for the Range Rover Velar R-Dynamic model, the R-Dynamic Black Package is available. See pages 56 and 57.

STANDARD RANGE ROVER VELAR



Atlas grille inner surround
Atlas grille mesh
Satin Black lower blade
Satin Black lower finisher
Satin Black front bumper lower

Satin Black pinstripe finisher
Atlas fender vents

Dark Techno Silver tow eye cover surround
Atlas RANGE ROVER hood and tailgate script

PREMIUM EXTERIOR PACKAGE*



Narvik Black mid finisher
Atlas lower blade
Narvik Black lower finisher
Front fog lights

Narvik Black pinstripe finisher
Narvik Black door cladding lower
Narvik Black front bumper lower

Narvik Black rear bumper lower
Indus Silver tow eye cover surround
Narvik Black tow eye cover

*Only available on Range Rover Velar S and SE models.

BLACK EXTERIOR PACKAGE*



Narvik Black grille inner surround
Narvik Black grille mesh
Narvik Black lower blade

Gloss Black mirror lowers with
Narvik Black scalp
Narvik Black side vents and
door finisher blade

Narvik Black tow eye cover surround
Narvik Black tow eye cover
Narvik Black RANGE ROVER hood
and tailgate script

PREMIUM BLACK EXTERIOR PACKAGE*



Narvik Black lower blade
Narvik Black mid finisher
Narvik Black lower finisher
Front fog lights

Narvik Black pinstripe finisher
Narvik Black door cladding lower
Narvik Black front bumper lower

Narvik Black tow eye cover surround
Narvik Black tow eye cover
Narvik Black RANGE ROVER hood
and tailgate script
Narvik Black rear bumper lower



SELECT THE RANGE ROVER VELAR R-DYNAMIC BLACK PACKAGE

The R-Dynamic Black Package provides the most superb enhancement to the already sporty look of the Range Rover Velar R-Dynamic. It is only available on the R-Dynamic model for all exterior paint options and includes a Gloss Black grille mesh, Narvik Black hood vent blades, hood and tailgate script.



Narvik Black grille mesh
Narvik Black grille inner surround
Narvik Black RANGE ROVER hood and tailgate script
Narvik Black lower blade



Narvik Black hood vent blades
Narvik Black air curtain inserts



Narvik Black side vents and door finisher blade
Gloss Black mirror lowers with Narvik Black scalps



Narvik Black exhaust finishers
Narvik Black tow eye cover surround

SELECT YOUR WHEELS

There are 17 wheel styles to choose from*, with sizes ranging from 18" to the highly desirable 22". With distinctive design cues, each one adds its own character to the overall look of the vehicle.



**18" 10 SPOKE
'STYLE 1021'**

Optional on all models except Range Rover Velar and First Edition.



**18" 15 SPOKE
'STYLE 1022'**

Standard on Range Rover Velar. Optional on all models except First Edition.



**19" 5 SPOKE
'STYLE 5046'**

Standard on Range Rover Velar S. Optional on all models except Range Rover Velar and First Edition.



**19" 5 SPOKE 'STYLE 5046'
WITH SATIN DARK GREY FINISH**

Optional on all models except Range Rover Velar and First Edition.



**20" 7 SPLIT-SPOKE
'STYLE 7014'**

Standard on Range Rover Velar SE. Optional on all models except Range Rover Velar and First Edition.



**20" 7 SPLIT-SPOKE 'STYLE 7014'
WITH GLOSS BLACK FINISH**

Optional on all models except Range Rover Velar and First Edition.



**20" 10 SPOKE
'STYLE 1032'**

Optional on all models except Range Rover Velar and First Edition.



**20" 10 SPOKE 'STYLE 1032'
WITH SATIN DARK GREY FINISH**

Standard on Range Rover Velar R-Dynamic SE. Optional on all models except Range Rover Velar and First Edition.



**20" 10 SPOKE 'STYLE 1032'
WITH DIAMOND TURNED FINISH**

Optional on all models except Range Rover Velar



**21" 5 SPLIT-SPOKE
'STYLE 5047'**

Optional on all models except Range Rover Velar and First Edition.



**21" 5 SPLIT-SPOKE 'STYLE 5047'
WITH DIAMOND TURNED FINISH**
Optional on all models except
Range Rover Velar



**21" 10 SPOKE 'STYLE 1033'
WITH GLOSS BLACK FINISH**
Optional on all models except
Range Rover Velar and First Edition.



**21" 10 SPOKE 'STYLE 1033'
WITH SATIN DARK GREY FINISH**
Standard on Range Rover Velar R-Dynamic
HSE. Optional on all models except
Range Rover Velar and First Edition.



**22" 7 SPLIT-SPOKE
'STYLE 7015'**
Optional on all models except
Range Rover Velar and First Edition.



**22" 7 SPLIT-SPOKE 'STYLE 7015'
WITH GLOSS BLACK FINISH**
Optional on all models except
Range Rover Velar and First Edition.



**22" 9 SPLIT-SPOKE
'STYLE 9007'**
Optional on all models except
Range Rover Velar and First Edition.



**22" 9 SPLIT-SPOKE 'STYLE 9007'
WITH DIAMOND TURNED FINISH**
Standard on Range Rover Velar First Edition.
Optional on all models except
Range Rover Velar.



**22" 10 SPOKE 'STYLE 1051'
WITH DIAMOND TURNED SATIN
TECHNICAL GREY FINISH****

5

CHOOSE YOUR INTERIOR

SELECT YOUR SEAT MATERIAL AND FUNCTIONALITY

Seats are available in a choice of five different premium materials, with a range of manual and powered operation including: optional memory, heating, cooling and massage functionality. The seat materials include Luxtec and suedecloth, perforated grained leather, perforated grained leather and suedecloth, perforated Windsor leather and an all-new premium textile and suedecloth seat – available as an option on select models.

FUNCTIONALITY	A - 10-way seats with driver memory†	B - 18-way driver/passenger seats with memory, massage and front heated/cooled seats**	C - 20-way driver/passenger seats with memory, massage and front heated/cooled seats††
MOVEMENT			
Forward/Backward	Powered (2)	Powered (2)	Powered (2)
Cushion height	Powered (2)	Powered (2)	Powered (2)
Cushion tilt	Powered (2)	Powered (2)	Powered (2)
Cushion extension		Powered (2)	Powered (2)
Recline	Powered (2)	Powered (2)	Powered (2)
Lumbar		Powered (4)	Powered (4)
Bolsters		Powered (2)	Powered (2)
Headrest height	Manual (2)	Manual (2)	Powered (2)
Manual winged headrest			Manual (2)
FEATURES			
Driver memory**	■	■	■
Passenger memory**	–	■	■
Heated and cooled front**	–	■	■
Massage front**	–	■	■
Rear center armrest	■	■	■
Rear power recline**	■	■	■
OPTIONAL FUNCTIONALITY			
Heated front	■	–	–
Heated rear	■	□	□

■ Standard □ Optional – Not Available.



Luxtec and suedecloth



Perforated grained leather**







Perforated grained leather and suedecloth**



Perforated Windsor leather**



Premium textile and suedecloth**

SEAT MATERIAL	A	B	C
 <p>Luxtec and suedecloth: Technically advanced, Luxtec is a smooth soft touch material which is complemented by suedecloth. This is a sustainable, lightweight, premium microfiber suede fabric made from recycled materials.</p>	■	–	–
 <p>Perforated grained leather: Grained leather is embossed with a natural robust leather grain which makes it both durable and easy on the eye.</p>	■	–	–
 <p>Perforated grained leather and suedecloth: Grained leather is embossed with a natural robust leather grain which makes it both durable and easy on the eye. This is matched by suedecloth which is an eco-sustainable, lightweight, premium microfiber suede fabric made from recycled materials.</p>	■	–	–
 <p>Perforated Windsor leather: Smooth in appearance and extremely supple to the touch, Windsor leather is made using high-grade hides and minimal processing. It has a light dye coating so is a more natural product.</p>	–	□	■
 <p>Premium textile and suedecloth¹: A premium, contemporary textile developed in collaboration with Europe's leading quality upholstery textiles manufacturer, Kvadrat. This material is an exceptional new option.</p>	–	□	■

■ Standard □ Optional – Not Available.

SELECT YOUR INTERIOR COLOR COMBINATION

A calm sanctuary. That's how it feels to be in the cabin of Range Rover Velar where the choice of materials, finishers and craftsmanship all combine so effortlessly.

Use the table below to select your color combinations. Or see the full range in greater detail on pages 63-65.



		1	2	3	4	5
COLORWAYS		DOOR ARMREST AND DOOR ROLL LOWER	DOOR ROLL UPPER	INSTRUMENT PANEL UPPER	CENTER CONSOLE	MID INSTRUMENT PANEL
(A)	Ebony	Ebony	Ebony	Ebony	Ebony	Ebony
(B)	Acorn	Acorn	Ebony	Ebony	Acorn	Acorn
(C)	Light Oyster	Light Oyster	Ebony	Ebony	Light Oyster	Light Oyster
(D)	Ebony/Ebony*	Ebony	Ebony	Ebony	Ebony	Ebony
(E)	Light Oyster/Ebony*	Light Oyster	Ebony	Ebony	Light Oyster	Light Oyster
(F)	Eclipse/Ebony*	Eclipse	Ebony	Ebony	Eclipse	Eclipse
(G)	Vintage Tan/Ebony*	Vintage Tan	Ebony	Ebony	Vintage Tan	Vintage Tan
(H)	Dapple Grey/Ebony**	Dapple Grey/Ebony	Ebony	Ebony	Dapple Grey	Ebony
(I)	Dapple Grey/Light Oyster**	Dapple Grey/Light Oyster	Ebony	Ebony	Dapple Grey	Light Oyster

*Duo tone colorways are standard on R-Dynamic, SE and HSE. Optional on all other Range Rover Velar models.

**Only available when the Premium Textile Interior Package is selected.

INTERIOR COLOR COMBINATIONS

The color combinations add to that sense of serenity with a comprehensive range offered to suit all tastes. Color combinations shown are available on all models, please check the table on pages 60 and 61 for seat functionality and material availability.

- A** **Ebony**
(available with Luxtec and suedecloth, perforated grained leather or perforated Windsor leather)



Interior shown: SE interior in Ebony with Ebony perforated grained leather and Shadow Aluminum finisher.

- B** **Acorn**
(available with perforated grained leather or perforated Windsor leather)



Interior shown: SE interior in Acorn with Acorn perforated grained leather and Satin Blonde Linear veneer.

- C** **Light Oyster**
(available with perforated grained leather or perforated Windsor leather)



Interior shown: SE interior in Light Oyster with Light Oyster perforated grained leather and Argento Pinstripe High Gloss veneer.

D Ebony/Ebony
 (available with perforated grained leather and suedecloth)



Interior shown: R-Dynamic SE interior in Ebony/Ebony with Ebony perforated grained leather and suedecloth and Carbon Fiber with Copper Wire Weave finisher.

E Light Oyster/Ebony
 (available with perforated grained leather and suedecloth or perforated Windsor leather)



Interior shown: R-Dynamic SE interior in Light Oyster/Ebony with Light Oyster/Ebony perforated grained leather and suedecloth and Carbon Fiber with Copper Wire Weave finisher.

F Eclipse/Ebony
 (available with perforated grained leather and suedecloth or perforated Windsor leather)



Interior shown: R-Dynamic SE interior in Eclipse/Ebony with Eclipse perforated grained leather and suedecloth and Carbon Fiber with Copper Wire Weave finisher.

G Vintage Tan/Ebony
 (available with perforated Windsor leather)



Interior shown: R-Dynamic HSE interior in Vintage Tan/Ebony with Vintage Tan/Ebony perforated Windsor leather and Carbon Fiber with Copper Wire Weave finisher.

PREMIUM TEXTILES

Range Rover Velar offers a fresh alternative to leather with contemporary and beautifully crafted textiles. In partnership with the world-renowned designers and craftspeople at Kvadrat, durable wool blend and suedecloth fabrics can be selected in a choice of color combinations*. Tested to the limits, these technologically advanced textiles are a superb alternative to leather and are available in all models.

H Dapple Grey/Ebony



Interior shown: R-Dynamic HSE interior in Dapple Grey/Ebony with Dapple Grey premium textile and suedecloth and Satin Charcoal Ash veneer.

I Dapple Grey/Light Oyster



Interior shown: R-Dynamic HSE interior in Dapple Grey/Light Oyster with Dapple Grey premium textile and suedecloth and Satin Charcoal Ash veneer.

*Only available when the Premium Textile Interior Package is selected.

SELECT YOUR INTERIOR FINISHERS

Now you've chosen your interior color combination, choose one of eight interior finishers that are beautifully displayed above the door armrests, indicated by the number 1 below.



STANDARD

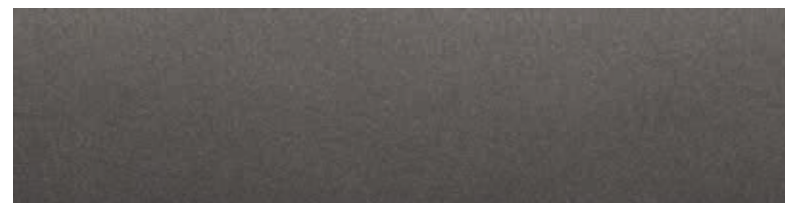

Range Rover Velar – Cosmic Grey finisher*

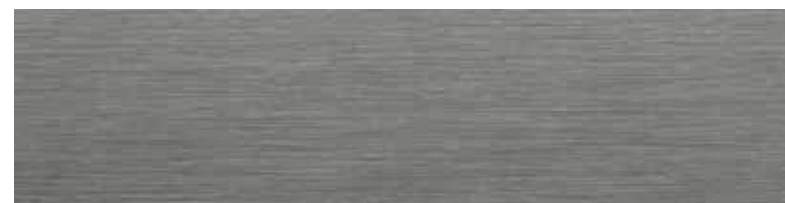

Range Rover Velar R-Dynamic – Shadow Aluminum finisher†

OPTIONAL



Satin Blonde Linear veneer**



Satin Charcoal Ash veneer**

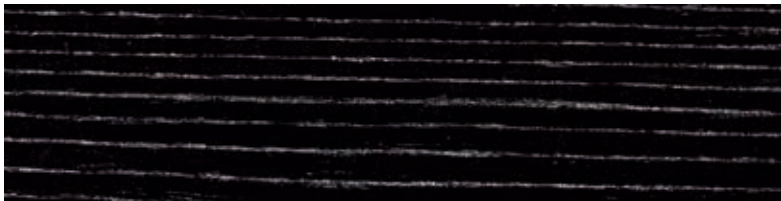

Argento Pinstripe High Gloss veneer**



Satin Umber Linear veneer**



Grand Black veneer**



Carbon Fiber with Copper Wire Weave finisher**

SELECT AN INTERIOR DESIGN PACKAGE

To add additional touches of individuality, sophistication and comfort to your cabin space, you can choose from three interior design packages.

S MODEL



As standard the Range Rover Velar S model includes perforated grained leather seats, Cut Diamond grain Luxtec on the mid instrument panel and door top roll lowers. A leather steering wheel with Black gearshift paddles is also included.

LUXURY PACKAGE*



Windsor leather on the mid instrument panel, door top roll lower, and driver airbag cover.

Leather steering wheel**, airbag cover with Satin Chrome bezel and Satin Chrome gearshift paddles.

LUXURY PACKAGE PLUS*



Windsor leather on the mid instrument panel, instrument panel topper, door top roll uppers and lowers, and driver airbag cover.

Leather steering wheel**, airbag cover with Satin Chrome bezel and Satin Chrome gearshift paddles.

PREMIUM TEXTILE PACKAGE

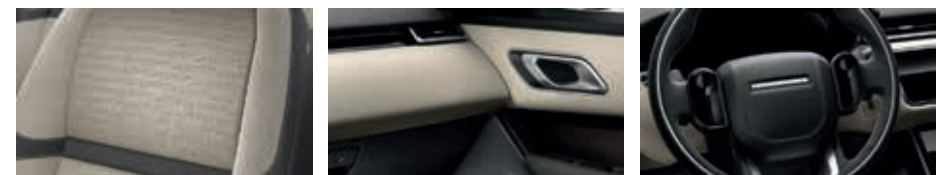

Premium textile seats with wool blend and suedecloth.

Cut Diamond grain Luxtec on the mid instrument panel and door top roll lowers.

Suedecloth steering wheel with Satin Chrome bezel and Satin Chrome gearshift paddles.

6

CHOOSE YOUR OPTIONS AND LAND ROVER GEAR

SELECT YOUR OPTIONS

A wealth of options are available to select from at the point of ordering your new vehicle, to help you express your individuality and appoint your Range Rover Velar with precisely the premium features you require.

For full feature and option availability please refer to the accompanying Specification and Price Guide or visit your local Land Rover Retailer.

EXTERIOR FEATURES

Roof Rails

Roof rails facilitate easy fitment of cross bars for truly stable roof carrying. Pre-set positioning points ensure cross bars are fixed in optimum position for weight distribution and dynamics. Available in Black or Silver finishes. Not available as Land Rover Gear – Accessories fit.

No Badges

You have the option to remove both the derivative and engine badges from the rear of the vehicle.

Heated Windshield

Offers a quick and convenient way to defrost or demist the windshield. Featured heated washer jets prevent washer fluid from freezing so you can easily keep your windshield clean in cold conditions.

Premium LED Headlights with Signature Daytime Running Lights (DRL)*
See page 36 for details.

Powered Gesture Tailgate*

Powered Gesture Tailgate enables the driver to operate the tailgate (both to open and close) from the curbside without needing to physically touch either the vehicle or the key fob. And as the system is compatible with accessory towing solutions, you can still tackle demanding situations with the least amount of fuss.



Roof Rails



Powered Gesture Tailgate

TIRES AND SPARE WHEELS

Summer Tires*

Summer tires are optional on all wheel sizes except 18". Load index and speed ratings dependent on wheel sizes.

Reduced Section Alloy Spare Wheel

Lightweight reduced section alloy spare wheel. Includes tool kit.

DRIVING AIDS

Configurable Dynamics

See page 15 for details.

All Terrain Progress Control (ATPC)

See page 17 for details.

Terrain Response® 2

See page 18 for details.

Active Rear Locking Differential**

See page 19 for details.

Drive Features

See page 28 for details.

Park Features

See page 30 for details.



Reduced Section Alloy Spare Wheel

SEATING AND INTERIOR TRIM

Rear Seat Remote Release Levers^{††}

Remote release of the rear seats via levers in the cargo space area makes folding the rear seats for additional loading capacity even easier.

Premium Carpet Mats[†]

23 oz per sq. yd twistpile Ebony floor mats with metal Range Rover Velar ingot protect your vehicle in exclusive style. They feature Ebony suede effect binding and single Ebony stitching.

Chrome Instrument Panel End Caps[†]

Chrome end caps that finish the instrument panel.

Power Adjustable Steering Column[†]

This feature allows electrical adjustment of the steering column's reach and rake. Adjustment memory is linked to seat positioning if memory seats are taken.

Heated Steering Wheel[†]

For the ultimate driver comfort in colder climates, a heated leather steering wheel is available.

Suedeclot Steering Wheel^{††▲}

An all-new Suedeclot steering wheel with Satin Chrome bezel and gearshift paddles is available. This gives you a better grip, is warmer in the cold and doesn't get hot in the sun's glare. The material feels soft to the touch and adds a special look to the vehicle.

Leather Steering Wheel with Chrome Bezel[†]

Leather steering wheel with beautifully integrated Chrome bezel, perforation in the inner rim and thumb grips for better comfort and grip.

Illuminated Metal Cargo Space Scuff Plate[†]

Elegantly styled rear cargo space scuff plate illuminated by soft blue lighting when the tailgate is opened. It protects the cargo space edge from scratches when loading and unloading. Not compatible with full size spare wheel.

Illuminated Metal Front and Metal Rear Treadplates[†]

Illuminated aluminum treadplates, featuring R-Dynamic script are available on driver and front passenger sides.

Morzine Headlining

Woven cloth headlining available in Light Oyster or Ebony.

Suedeclot Headlining[†]

Premium suedeclot headlining option available in Light Oyster or Ebony



Illuminated Metal Front and Metal Rear Treadplates^{**}

INTERIOR FEATURES AND PACKAGES

Satin Chrome Gearshift Paddles[†]

Complete the look and feel of your steering wheel with premium paddles. Gearshift paddles are finished in Satin Chrome to provide exceptional wear resistance with a premium finish.

Bright Metal Pedals[†]

Stainless steel Bright finish sports pedal covers are easy to fit and feature hidden fixings for a clean finish.

Configurable Ambient Interior Lighting[†]

With ten colors to chose from, this feature allows you to vary the color and shade; changing the ambience of the cabin to suit your mood.

Lockable Cooled Glovebox

Cooled glovebox gives the option to vent the cooled air from the air conditioning system entering the cabin into the glovebox.

Four-zone Climate Control

This system provides separate controls for the driver, front passenger and those on each side of the second row of seats. Includes additional vents in the B-pillar. Must be selected with Lockable Cooled Glovebox and Cabin Air Ionization.

Cabin Air Ionization

This technology helps the well-being of both driver and passengers alike. It is designed to improve the air quality within the vehicle cabin, and helps to remove allergens, viruses and odors. It does so by ionizing particles in the air, making them attract to surfaces and thus helping to cleanse the air. It can be switched on or off.

Cargo Space Partition Net[†]

Designed to protect vehicle occupants against the displacement of luggage. Following initial retailer installation the luggage partition can be easily removed with appropriate fitting tool.

Cargo Space Storage Rails[†]

Cargo space rails extend and adjust to secure items. Not compatible with full size spare wheel.

Smoker's Package[†]

Add a lighter socket and ashtray to the center console.

On/Off Road Package

This adds Terrain Response[®] 2, All Terrain Progress Control (ATPC) and Configurable Dynamics to assist driving on a variety of surfaces.

Climate Package^{*}

This includes the Four-zone Climate Control, Cabin Air Ionization and Lockable Cooled Glovebox.

Convenience Package^{††}

This offers Activity Key, Rear Seat Remote Release Levers and the Cargo Space Partition Net.

CONVENIENCE AND INFOTAINMENT

Activity Key[†]

Makes living life to the full even easier. For extra convenience, you can wear the Activity Key if you prefer not to carry a key fob. The wristband is robust and fully waterproof. It allows you to enjoy a range of activities – and keep your vehicle key with you. You can use the Activity Key while keys remain in the vehicle as the conventional key fob is deactivated for security.

8" Rear Seat Entertainment^{††}

See page 21 for details.

Power Socket Package

Power Socket Package 3^{††}

Provides two additional USB charge points in the second row and one additional 12V socket in the front.

Head-up Display[†]

See page 21 for details.

Interactive Driver Display[†]

See page 21 for details.

Audio Systems

See page 22 for details.

Connectivity Features

See page 24 for details.



Activity Key

TOWING[◇]

Fixed Rear Recovery Eye^{††}

When another vehicle is stuck in mud, snow or sand, this feature comes in handy. Stable, robust and strong, it is ideal for tough situations – especially off-road.

Tow Hitch Receiver^{††}
See page 39 for details.

Advanced Tow Assist^{††}

Advanced Tow Assist allows you to control the direction of your trailer when reversing. Using the Terrain Response[®] 2 reconfigurable rotary dial via the Touch Pro controls, the system controls the vehicle's steering to achieve the desired trailer trajectory. The Touchscreen will display both the current and desired trailer trajectory.



Advanced Tow Assist

[◇]Towing weight may vary per engine. Please contact your nearest Land Rover Retailer for more information.

SELECT YOUR LAND ROVER GEAR

A range of stylish, tough and practical accessories is available, bringing you the opportunity to personalize your Range Rover Velar even further. These accessories can be purchased through your Land Rover Retailer and added at any stage during the vehicle's life – not just when it's new. Naturally, Land Rover Approved Accessories are designed, tested and manufactured to the same exacting standards as the original equipment fitted to your vehicle.

For our full range of accessories please search 'Land Rover Accessories' to view the online accessories catalog.



TOURING ACCESSORIES

Cross Bars (optional Roof Rails required, see page 70) VPLYR0162

Elegantly designed roof rails (which are an option fit only) facilitate easy fitment of cross bars for roof carrying. Pre-set positioning points ensure cross bars are fixed in optimum position for weight distribution and dynamics. Maximum payload is 163 lbs**. Durable Bright finish aluminum cross bars, with T-track design which utilize the full length of the bars, providing space to mount multiple accessories. Aerodynamic profile minimizes drag and wind noise. The incremental height when fitted is 3.6 inches.

Large Sports Roof Box* VPLWR0100

Power-click quick mounting system with integrated torque indicator for easy and secure fixation with a single-handed grip. Opens from both sides with handles on the lid and inside the box, for convenient fitting, loading and unloading. Integrated base mat for extra secure loading. Load capacity eight skis/five-six snowboards, max length of skis 80 inches. Volume 113 gallons. Maximum payload 163 lbs**.

Center Armrest Cooler/Warmer Box VPLVS0176

Food and drinks chiller and warmer that acts as a rear center armrest. With a leather-covered top, it is held in place by the center seat belt and powered from the rear auxiliary socket. Ideal for long trips with the family.

iPhone® Connect and Charge Dock VPLRV0119

The iPhone connect and charge dock has been designed to allow visibility of the phone while charging, utilizing the cupholder space in the center console. When connected the iPhone media is accessible and has the ability to be controlled via the integrated infotainment/audio system. The 'cut-out' design of the holder is such that the home button is also accessible for use when parked. The iPhone USB charger can be easily disconnected if the USB connection is required for other use.

Wireless Phone Charging Cupholder VPLRV0118

The wireless phone charging cupholder has been designed to allow visibility of the phone while charging, utilizing the cupholder space in the center console. The holder will accommodate phones up to 2.8 inches wide securely in place. The charger displays an LED light to indicate when charging, and turns off when complete.

Click and Go Accessory System VPLRS0388

The Click and Go range is a multi-purpose seat-back system for second row passengers. The versatile Click and Go Base fastens between the headrest mountings and further attachments can be added to hold tablets, bags and shirts or jackets. Each attachment is sold separately. The base can be easily removed when not in use.



Cross Bars



Click and Go Accessory System

*Roof Rails and Cross Bars are required for all Land Rover roof mounted accessories. Objects placed above the roof mounted satellite antenna may reduce the quality of the signal received by the vehicle and could have a detrimental effect on the navigation and satellite radio system, if fitted.

**Maximum payload equals the load capacity of the roof mounted accessory.

iPhone® is a trademark of Apple Inc., registered in the US.

DESIGN ACCESSORIES

Deployable Side Steps

Please contact your nearest Land Rover Retailer for fitment options. These smart, practical steps make it easier to get in and out of the vehicle. Neatly stowed under the sills, the side steps automatically deploy as soon as the door is opened, or when activated by the key fob. They store automatically when the door is closed. The side steps are sensitive to obstructions and will not deploy in off-road or low range settings. Automatic mode can be overridden to allow access to the roof when the doors are closed. The deployable side steps are compatible with front mudflaps and feature a stainless steel finish with laser etched Range Rover Velar branding.

Sports Rear Spoiler

VPLYB0354
Sleek and dynamic Carbon Fiber rear spoiler for Range Rover Velar.

Carbon Fiber Mirror Covers

VPLVB0145
Stunning high grade Carbon Fiber mirror covers, with a High Gloss finish, provide a performance-inspired premium styling update.

Carbon Fiber Side Vents

VPLYB0355
High grade Carbon Fiber side power vents with a High Gloss finish provide a performance-inspired styling upgrade.

Personalized Illuminated Metal Front and Rear Treadplates

VPLYS0458
Personalized illuminated treadplates allow you to choose a personalized message using an approved set of fonts/typefaces which will be highlighted in white illumination when the front doors are open. Illuminated treadplates with Range Rover script and halo surround. Rear treadplates feature illuminated halo only.

Illuminated Cargo Space Scuffplate*

VPLYS0456
Manufactured from stainless steel with a Bright finish, the rear cargo space treadplate finisher provides protection for the cargo space trim when loading or unloading and provides a premium finish to the cargo space with subtle illumination.



Deployable Side Steps

SPORTING ACCESSORIES

Aqua Sports Carrier**

VPLGR0107
Carries one canoe or kayak. Includes lockable multi-purpose holder to carry oars or paddles. Tilts to facilitate easy loading/unloading. Features lockable straps and rubber supports to maintain optimum weight distribution while protecting the equipment and vehicle from scratches or scuffs. Maximum load capacity 99 lbs[†].

Ski/Snowboard Holder**

LR006849
Carries four pairs of skis or two snowboards and incorporates slider rails for easy loading and is also lockable for security. Maximum payload 79 lbs[†].

Luggage Carrier**

VPLRR0159
Flexible rack system to facilitate roof carrying. Maximum payload 134 lbs[†].

Wheel Mounted Bike Carrier**

VPLFR0091
Lockable bike carrier designed for holding a single bike up to 44 lbs.

Kayak Carrier**

VPLWR0099
Carries two kayaks or canoes. Also suitable for transporting crafts such as surfboards or small boats. Includes lockable multi-purpose holder to carry paddles. Tilts to facilitate easy loading/unloading. Maximum load capacity 45 lbs.



Luggage Carrier

OUTDOOR ACCESSORIES

Protective Second Row Seat Covers VPLC0318

Protects seats from wet, dirty clothes as well as general wear and tear. Simple to fit and easily wipeable. Includes headrest and armrest covers.

Full Height Luggage Divider with Cargo Space Partition Net* VPLY0455

Designed to prevent luggage from entering the passenger compartment. Manufactured in Black nylon coated steel, this full height luggage partition is easy to remove when not required.

Front and Rear Mudflaps

VPLYP0318 – Front
VPLYP0319 – Rear

Mudflaps are a popular upgrade for reducing spray and ensuring paintwork is protected from debris and dirt. Designed to complement vehicle exterior styling.

Rubber Mat Set – Ebony

VPLY0413

Rubber footwell mats for front and second row occupants help provide protection from general dirt. Branded and with bright accent Range Rover ingot and durable metal corner piece to the external edge.

Cargo Space Rubber Mat

VPLY0411

Land Rover branded waterproof rubber mat, with retaining lip, helps to protect the rear cargo space carpet from general dirt. This waterproof mat extension covers the back of the rear seats when they are folded down.

Cargo Space Semi-Rigid Liner Tray

VPLY0417

Semi-rigid waterproof cargo space liner tray with a raised lip on three sides to protect cargo space floor and side wall carpets from dirt or wet equipment.



Cargo Space Rubber Mat

OTHER ACCESSORIES

Windshield Sun Shield

VPLY0427

UV windshield sun shield reflects the sun's rays and helps to keep the vehicle interior cool in hot weather.

Gearshift Paddles

VPLVS0187CAY – Red
VPLVS0187MMU – Aluminum

Complete the look and feel of your steering wheel with premium gearshift paddles. Gearshift paddles are machine polished, anodized and hand brushed to provide exceptional wear resistance with a premium red or aluminum finish.

Cargo Space Partition Net*

VPLY0424

Designed to prevent luggage from entering the passenger compartment. The design of the cargo space partition net has been optimized to second row seating featuring tilt functionality.

Luxury Carpet Mats

VPLY0419

Luxurious, tailored, deep pile 23 oz/yd² carpet mat set, with waterproof backing, provides a well appointed finishing touch to the interior.

Cargo Space Retention Kit

VPLY0459

The cargo space retention kit consists of a package of attachments that fix into the cargo space rails via a quick lock/quick release system to help provide a comprehensive and flexible solution for retaining luggage and other items within the cargo space. The attachment package includes a retractable strap with inertia reel and telescopic rod. Requires cargo space rails for fitment.

Luxury Cargo Space Carpet Mat

VPLY0429*

VPLY0415 – When Full Size Spare Wheel is specified
Luxurious, tailored, deep pile 23 oz/yd² cargo space carpet mat, with waterproof backing, provides a well appointed finishing touch to the interior.



Windshield Sun Shield

TECHNICAL DETAILS

DIMENSIONS AND CAPABILITIES

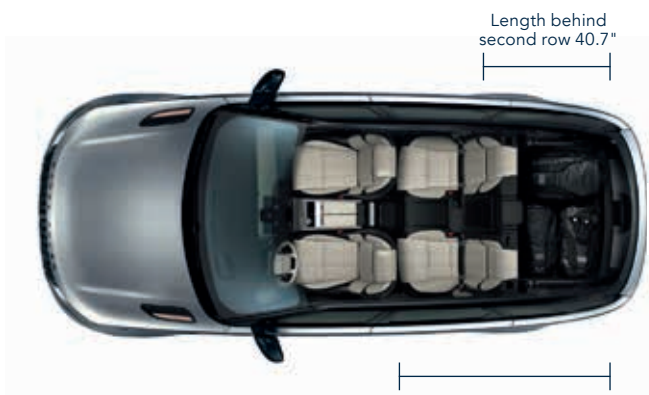

Standard Ride Height

With roof rails 65.3"
 With roof antenna 66.3"
 With panoramic roof open 67.1"
 Access height air suspension setting will reduce each of the above by 1.6"

Headroom

Maximum front headroom with panoramic roof 38.1"
 Rear headroom 38"

Legroom

Maximum front legroom 40.3"
 Maximum rear legroom 37.2"

Cargo space Capacity

Rear seats upright
 Height 41.1", Width 49"
 Cargo space volume 34.4 cubic feet
 Cargo space width between arches 41.3"
 Length at floor 40.7"

Rear seats forward
 Height 41.1", Width 49"
 Cargo space volume 70 cubic feet
 Cargo space width between arches 41.3"
 Length at floor 70.6"

Obstacle Clearance

Off-road height 9.8**
 Standard ride height 8.3"

Turning Circle

Curb-to-curb 38 ft.
 Wall-to-wall 39 ft.
 Turns lock-to-lock 2.52

Wading Depth**

Maximum wading depth
 25.6" (Electronic Air Suspension)
 23.6" (Coil Suspension)

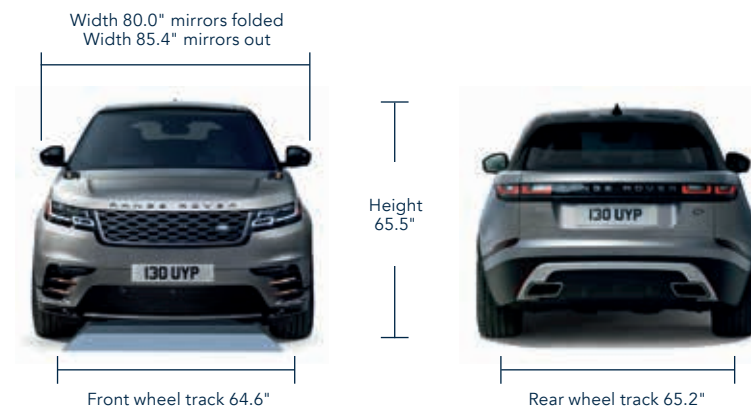

	A	B	C
Ride Height	Approach Angle	Ramp Angle	Departure Angle
Off-road from (R-Dynamic)*	28.9° (27.2°)	23.5°	29.5° (29.1°)
Standard from (R-Dynamic)*	25.9° (25.1°)	21°	27.3° (26.8°)



*Electronic Air Suspension only.

TECHNICAL SPECIFICATION AND PERFORMANCE DATA

POWER (HP)	DIESEL	GAS	
	180 HP	247 HP	380 HP
ENGINE DATA			
Bore (mm)	83	83	84.5
Stroke (mm)	92.4	92	89
Compression ratio (:1)	15.5:1	10.5:1	10.5:1
BRAKES			
Front type	Single Piston Sliding Caliper Ventilated Disc	Single Piston Sliding Caliper Ventilated Disc	Single Piston Sliding Caliper Ventilated Disc
Front diameter (inches / mm)	12.8 / 325	12.8 / 325	13.8 / 350
Rear type	Single Piston Sliding Caliper Ventilated Disc	Single Piston Sliding Caliper Ventilated Disc	Single Piston Sliding Caliper Ventilated Disc
Rear diameter (inches / mm)	12.8 / 325	12.8 / 325	12.8 / 325
Park Brake	Motor on Caliper	Motor on Caliper	Motor on Caliper
WEIGHTS (lbs)			
Weight from	4,359	4,217	4,471
Maximum laden weight	5,490	5,445	5,600
Maximum mass on each axle (front)	2,623	2,623	2,734
Maximum mass on each axle (rear)	3,131	3,131	3,175
TOWING (lbs)			
Unbraked trailer	1653	1653	1653
Maximum towing	5,291	5,291	5,511
Maximum coupling point/nose weight	386	386	386
Maximum vehicle and trailer combination/Gross Train Weight	10,780	10,736	11,111
ROOF CARRYING (lbs)			
Maximum roof load (including roof rails)	174	174	174
PERFORMANCE			
Maximum speed (mph) [†]	130 [‡]	135	155
Acceleration (secs) 0-60 mph [†]	8.4	6.4	5.3
Fuel tank capacity – usable (US gallons)	16.6	16.6	16.6
Diesel Particulate Filter (DPF)	■	–	–

■ Standard – Not Available.

[†]Always follow local speed limits. [‡] If vehicle is fitted with 18" wheels the top speed will be 120mph.

THE WORLD OF LAND ROVER

THERE'S A WORLD OUT THERE

Your Land Rover vehicle has been designed and engineered to help you make more of your world. It can take you to places other vehicles simply can't reach in a style that cannot be matched. To celebrate the Land Rover lifestyle, we've put together a range of experiences, publications and Land Rover branded goods. There's a world to explore. Get out there and enjoy it.

LAND ROVER EXPERIENCE

Land Rover Experience Centers have expert instructors on hand to help you make the most of driving Land Rover vehicles. You can enjoy a Taster Drive to a Full Day course at one of the centers in our expanding network around the world, visit one of our factories or go even further on one of our Adventure Travel holidays.

ONELIFE MAGAZINE

The official Land Rover magazine features the best in photography, authoritative journalism and expert insights. Onelife takes you right into the heart of exclusive experiences and extraordinary adventures, while keeping you up to date with the latest innovations, design and lifestyle choices.

PARTNERSHIPS

We are delighted to partner with individuals, teams and events who share our pioneering spirit. As Title and Exclusive Innovation Partner to Ben Ainslie Racing, Land Rover are an integral part of the team challenging for the biggest prize in world sailing, the 35th America's Cup. With pioneering spirit core to what makes Land Rover unique, our association with Virgin Galactic continues a proud tradition.

HUMANITARIAN PARTNERSHIPS

Since 1954, Land Rover have supported the International Federation of Red Cross and Red Crescent Societies (IFRC) in reaching 150 million people needing aid in 189 National Societies.

SPECIAL VEHICLE OPERATIONS

Utilizing the very latest in technologies and craftsmanship, our state-of-the-art Special Vehicle Operations facility creates the ultimate in truly personalized vehicles.

LAND ROVER COLLECTION

Our latest range of clothing and luxury leather goods is crafted with the same design excellence and attention to detail as our vehicles. We also have a collection that honors Land Rover's unique heritage and features expedition-inspired gifts and apparel.



Search 'Land Rover Experience' for full details



Search 'Land Rover Responsibility' for full details

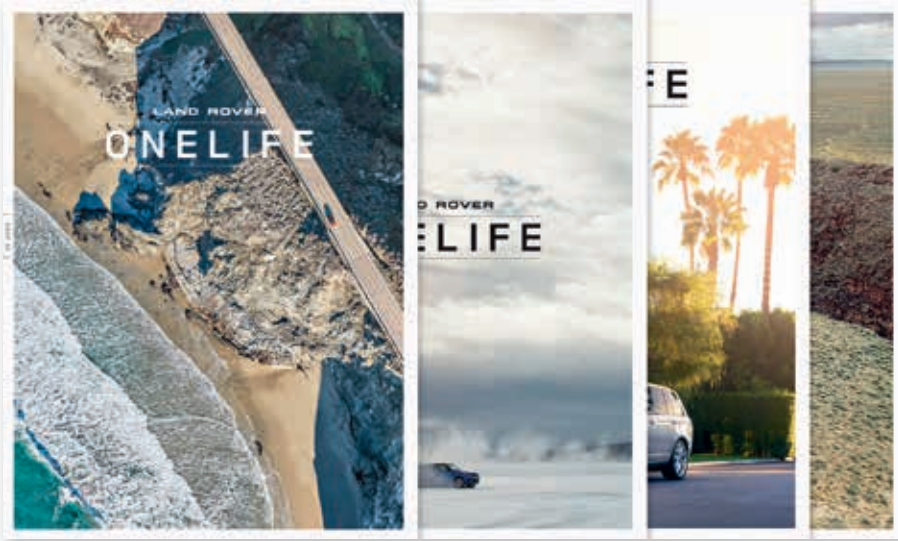

Search 'Land Rover Featured Articles' for full details



Search 'Land Rover Partnerships' for full details



Search 'Jaguar Land Rover Special Vehicle Operations' for full details



Search 'Land Rover Collection' for full details or visit your local Land Rover Retailer

YOUR PEACE OF MIND

CUSTOMER SERVICE

When you bring your Land Rover vehicle to us, we use proprietary Land Rover diagnostic equipment to assess all your vehicle's mechanical and electronic systems. Our factory-trained Technicians use tools specifically designed for our vehicles and only fit genuine Land Rover parts and accessories. A choice of service plans are available which, together with Roadside Assistance, ensures complete peace of mind. For further details contact your local Land Rover Retailer or search 'Land Rover Ownership'.

LAND ROVER ROADSIDE ASSISTANCE

Land Rover Assistance provides assistance in motoring emergencies, from immobilization due to breakdown or accident to minor problems such as punctures. You can rely on our roadside assistance, whatever the situation, anywhere in North America during the vehicle warranty period.

For further details please consult your Warranty Benefits handbook, contact your nearest Land Rover Retailer or search 'Land Rover Roadside Assistance'.

LAND ROVER FINANCIAL SERVICES

Getting the keys to your very own Land Rover has never been so simple. And it's more affordable than you might think. New or used, for personal or business use, we have an option that puts you in complete control. For further details contact your local Land Rover Retailer or search 'Land Rover Finance'.

FLEET & BUSINESS

Land Rover is dedicated to being the premium manufacturer of choice for fleets and businesses, by providing a highly attractive range of vehicles and exemplary customer service.

Distinctive, capable and versatile, all Land Rover vehicles deliver low Total Cost of Ownership through strong residual values, competitive service and low maintenance and repair costs.

We are also committed to providing a totally customer-focused aftersales service, which will ensure every Land Rover vehicle is kept on the road and in top condition, in the easiest and most cost-efficient way for businesses.

Search 'Land Rover Fleet and Business' for full details.

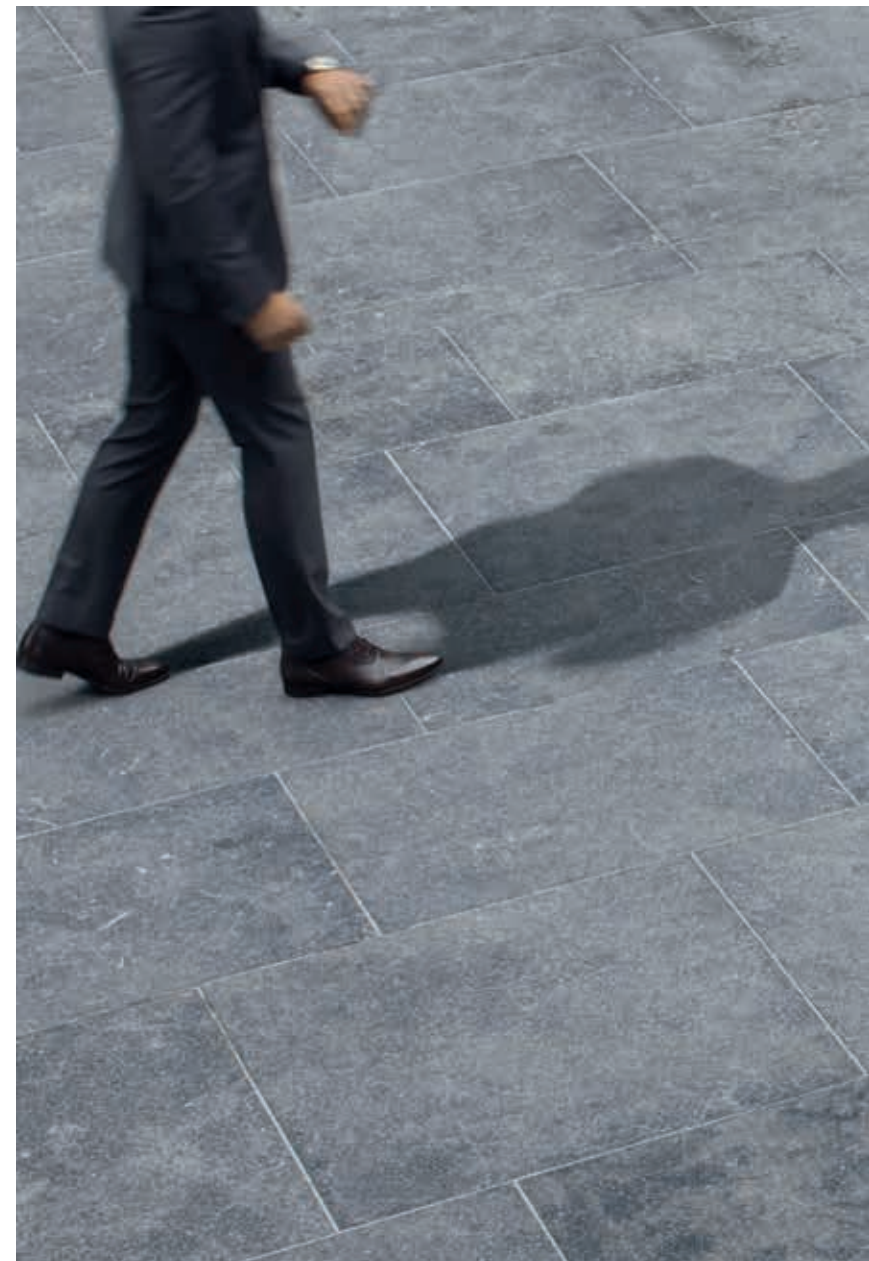



IMPORTANT NOTICE: Jaguar Land Rover Limited is constantly seeking ways to improve the specification, design and production of its vehicles and alterations take place continually. While every effort is made to produce up to date literature, this brochure should not be regarded as an infallible guide to current specifications, nor does it constitute an offer for the sale of any particular vehicle. Distributors and Retailers are not agents of Jaguar Land Rover Limited by any express or implied undertaking or representation.

All Land Rover Gear – Accessories fitted by a Land Rover Retailer within one month or 1,000 miles of the handover of a new registered vehicle will benefit from the same warranty terms and period of cover as the vehicle warranty. Accessories purchased outside of these parameters will be subject to a 12 month unlimited mileage warranty. All Land Rover Gear – Accessories are rigorously tested to the same exacting standards as those applied to our vehicles. Performance in extreme hot and cold temperatures, corrosion resistance, impact and airbag deployment highlight some of the exhaustive product testing carried out to ensure accessories are both durable and importantly, continue to comply with current legislation. Some of the accessories featured are not available on all models. Please consult your nearest Land Rover Retailer for more information.

All our accessories are designed to be an integral part of Land Rover vehicles. While many items such as roof carriers are simple to fit, some products require specialist tools and diagnostic equipment to ensure correct integration with the vehicle structure and electrical systems. These products vary from market to market, please consult your Land Rover Retailer who will be pleased to advise you on current specifications and any query you may have.

The colors reproduced here are subject to the limitations of the printing process and may therefore vary slightly from the actual vehicle. The company reserves the right to alter or withdraw any color finish without notice. Some of these colors may not be obtainable in your country. Please check availability of colors and current specifications with your Land Rover Retailer. Distributors and retailers are not agents of Jaguar Land Rover Limited and have absolutely no authority to bind Jaguar Land Rover Limited to any express or implied undertaking or representation.

Castrol EDGE Professional recommended by Land Rover.

Vehicle shown: 2018 Range Rover Velar R-Dynamic HSE with optional equipment.

Jaguar Land Rover North America, LLC

555 MacArthur Boulevard
Mahwah, NJ 07430-2327

landroverusa.com

© Jaguar Land Rover North America, LLC 2017.
1L5601810CC0BUSEN01P



European model shown.