

90-9

CRREL REPORT



# **Wheels and Tracks in Snow**

## **Validation Study of the CRREL Shallow Snow Mobility Model**

George L. Blaisdell, Paul W. Richmond, Sally A. Shoop,  
Charles E. Green and Russell G. Alger

November 1990



*For conversion of SI metric units to U.S./British customary units of measurement consult ASTM Standard E380, Metric Practice Guide, published by the American Society for Testing and Materials, 1916 Race St., Philadelphia, Pa. 19103.*

*Cover: Small Unit Support Vehicle and Heavy Expanded Mobility Tactical Truck in the snow.*

CRREL Report 90-9

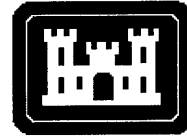

**U.S. Army Corps  
of Engineers**  
Cold Regions Research &  
Engineering Laboratory

# **Wheels and Tracks in Snow**

## **Validation Study of the CRREL Shallow Snow Mobility Model**

George L. Blaisdell, Paul W. Richmond, Sally A. Shoop,  
Charles E. Green and Russell G. Alger

November 1990

Prepared for  
OFFICE OF THE CHIEF OF ENGINEERS

Approved for public release; distribution is unlimited.

## PREFACE

This report was prepared by George L. Blaisdell, Research Civil Engineer, Paul W. Richmond, Mechanical Engineer, and Sally A. Shoop, Research Civil Engineer, all of the Applied Research Branch, Experimental Engineering Division, U.S. Army Cold Regions Research and Engineering Laboratory; Charles E. Green, Research Civil Engineer, Mobility Investigations Group, Mobility Systems Division, U.S. Army Waterways Experiment Station; and Russell G. Alger, Research Engineer, Keweenaw Research Center, Michigan Technological University. Technical review of the manuscript was graciously and ably provided by Dr. Malcolm Mellor and Gunars Abele of CRREL.

The report documents some of the efforts expended in a joint study conducted by CRREL and WES. The Keweenaw Research Center of Michigan Technological University was contracted with to provide services and expertise for this project as well. Funding for this report was provided by DA Project 4A762784AT42, *Cold Regions Engineering Technology*; Work Unit CS/040 *Wheels vs Tracks in Winter*.

The authors wish to express their gratitude to William B. Greeley, Carl Craven, and the WES Mobility Systems Division technicians and engineers, all of whom provided valuable and necessary efforts toward the completion of this project. Without their pleasant and eager cooperation, this work would have been difficult.

The contents of this report are not to be used for advertising or promotional purposes. Citation of brand names does not constitute an official endorsement or approval of the use of such commercial products.

## CONTENTS

	Page
Preface .....	ii
Nomenclature .....	v
Introduction .....	1
Background .....	1
Field experiments .....	2
Test location and test sites .....	2
Test vehicles .....	2
Test procedures .....	3
Results .....	5
CIV traction and motion resistance .....	5
<i>Wheels/tracks</i> vehicles traction and motion resistance .....	6
Shear annulus device .....	6
Accuracy and limitations of data .....	6
Snow conditions .....	9
Analysis .....	10
Determination of snow strength parameters .....	11
Traction analysis .....	17
Traction model predictions .....	19
Resistance analysis .....	23
Resistance model predictions .....	23
Conclusions and recommendations .....	24
Literature cited .....	24
Appendix A: Shallow snow mobility model, version 1.0 .....	25
Appendix B: Test vehicle data .....	39
Appendix C: Selected test data .....	43
Appendix D: Snow data .....	47
Appendix E: Shallow snow mobility model code, version 2.0 .....	65
Abstract .....	71

## ILLUSTRATIONS

Figure	
1. Field shear annulus device .....	4
2. Idealized traction test results .....	5
3. Idealized resistance test results .....	6
4. Shear stress versus time .....	6
5. Shear strength versus normal stress .....	9
6. Shear stress versus initial snow density for various normal loads .....	11
7. Shear strength versus normal stress with density .....	13
8. Relationship between snow strength and initial density from the shear annulus device .....	13
9. Shear stress versus initial snow density for various normal loads .....	14
10. Shear strength versus normal stress with snow density .....	15
11. Relationship between snow strength and initial density from a tire .....	15

Figure	Page
12. Comparison of $c$ , $\theta$ and $\rho_o$ relationships from SSM1.0, the shear annulus and a tire .....	16
13. Tractive coefficient versus initial snow density for each vehicle tested .....	17
14. Shear stress versus normal stress for the 23 Jan 88 vehicle tests .....	18
15. Shear stress versus normal stress using all data .....	19
16. Flow chart for SSM2.0 .....	20
17. Normalized motion resistance as a function of a depth-times-density snow parameter .....	22

## TABLES

Table	
1. CIV traction and motion resistance data .....	5
2. Traction and motion resistance data for the <i>wheels/tracks</i> vehicles .....	7
3. Shear annulus test results .....	9
4. Summary of snow characteristics .....	10
5. Results of regression analysis on motion resistance data .....	23

## NOMENCLATURE

### Symbols

$A$	total contact area ( $m^2$ )
$A_1$	curved portion of contact area ( $m^2$ )
$A_2$	flat portion of contact area ( $m^2$ )
$b$	maximum tire (track) width (m)
$c$	cohesion ( $N/m^2$ or kPa)
$d_t$	apparent distance traveled by wheel or track
$d_v$	distance actually traveled by vehicle
$DBP$	drawbar-pull test cable force (N)
$DIV$	differential interface velocity (m/s)
$h$	snow depth (m)
$h_o$	initial snow depth (m)
$l$	length of flat portion of track in contact with ground (m)
$n$	total number of tires or tracks on vehicle
$N$	total number of driven tires or tracks on vehicle
$p$	tire inflation pressure (kPa)
$r$	tire's radius or theoretical radius for a tracked vehicle
$R_h$	hard surface motion resistance (N)
$R_s$	motion resistance due to snow (N)
$R_t$	total motion resistance (N)
$s$	snow shear strength (kPa)
$TC$	traction coefficient (nondimensional)
$T_n$	total net traction for the vehicle (N)
$TMR$	towing motion resistance to test cable force (N)
$T_g$	gross traction generated per tire or per track
$\bar{W}$	normal load on individual tire or track (N)
$z$	sinkage (m)
$\alpha$	percentage of width of tire or track operating in undisturbed snow
$\phi$	angle of internal friction (degrees)
$\mu$	tractive coefficient (nondimensional)
$\mu_r$	resistance coefficient (nondimensional)
$\rho_o$	initial snow density ( $kg/m^3$ )
$\rho_f$	final snow density ( $kg/m^3$ )
$\sigma$	normal stress (kPa)
$\tau_a$	shear stress measured by annulus (kPa)
$\tau_g$	gross tractive stress measured at tire or track (kPa)
$v$	coefficient of friction (= $\tan\phi$ )

### Abbreviations

APC	Armored Personnel Carrier
BFVS	Bradley Fighting Vehicle System
CIV	CRREL Instrumented Vehicle
HEMTT	Heavy Expanded Mobility Tactical Truck
HML	Hard Mobile Launcher
HMMWV	High Mobility Multi-Purpose Wheeled Vehicle
KRC	Keweenaw Research Center
LAV	Light Armored Vehicle
SSM1.0	Shallow Snow Mobility model, version 1.0
SSM2.0	Shallow Snow Mobility model, version 2.0
SUSV	Small Unit Support Vehicle

# Wheels and Tracks in Snow

## Validation Study of the CRREL Shallow Snow Mobility Model

GEORGE L. BLAISDELL, PAUL W. RICHMOND, SALLY A. SHOOP,  
CHARLES E. GREEN AND RUSSELL G. ALGER

### INTRODUCTION

In 1986, CRREL developed a model for predicting the mobility of tracked and wheeled vehicles operating on shallow snow covers. (Shallow snow is defined here by requiring that the deformational zone in the snow beneath the tire or track intersect the ground or firm surface upon which the snow lies. In contrast, a deep snow appears to a vehicle to be semi-infinite.) This shallow snow mobility model predicts the basic mobility parameters of motion resistance and gross driving traction. From these quantities, net traction, or the amount of tractive force available for acceleration, payload, towing force, hill climbing, etc., can be calculated.

The initial version of the shallow snow model used an empirically derived relationship between snow shear strength and initial density to make its predictions of gross traction. This relationship has been developed from mobility data obtained with the CRREL Instrumented Vehicle (CIV) over past field seasons. Motion resistance is predicted from a calculation of the energy expended in compacting the snow using a theoretically established expression. During January 1988, a 2-year mobility study was launched jointly by WES and CRREL. This so-called *winter wheels/tracks* study provided the first opportunity to compare the model's predictions with actual snow mobility data for a wide variety of vehicles. It was also the intent of this study to compare directly the performance of wheeled and tracked vehicles in snow. The selected family of test vehicles included four wheeled vehicles and three tracked vehicles.

During the *wheels/tracks* study, we also hoped to add to the CIV snow strength–density data base, and to explore whether or not the strength–density relationship developed with the CIV could be duplicated using a shear annulus device. This report describes the results of our first year's effort.

### BACKGROUND

The primary goal of this study was to validate the shallow snow mobility model. As previously mentioned, this model is based on theoretical relationships and empirical expressions developed in the past, and a large, but scattered, data base. Since the shallow snow model has not appeared in the literature in the past, we begin by describing the approach used in version 1.0 (SSM1.0) for predicting mobility.

The two principal quantities that govern mobility are traction and motion resistance. Commonly, two types of traction (net and gross) and two types of motion resistance (internal and external) are identified.

External motion resistance  $R_s$ , for our case, is a manifestation of the energy expended in deforming and displacing the snow. Internal motion resistance is attributable to a combination of tire flexing or friction on track linkages, friction on the bearings and gears along the vehicle's drive line, and other inefficiencies inherent in transferring torque from the engine to the snow surface (or other operating surface). Most resistance measuring techniques unavoidably result in a measure of the total



motion resistance  $R_t$  (both external and internal). Our interest is in understanding and predicting only the external resistance  $R_s$  due to snow deformation, since internal resistance has no fundamental significance in limiting traction.

Gross traction  $T_g$  is defined as the forward thrust developed at the tire/snow or track/snow interface. It is a function of the snow's shear strength and the geometric and adhesive ability of the tire or track to engage this shear strength. The tractive device's ability to pull a load, accelerate, or climb a slope is found by summing the forces at the contact patch. Thus

$$T_n = T_g - R_s \quad (1)$$

where  $T_n$  is the net traction and is a measure of the traction available for use by the vehicle. Here,  $T_g$  is positive pointing towards the direction of intended travel and  $R_s$  is positive in the opposite direction.

All traction measurement methods known to us measure  $T_n$ . These tests are also designed to determine the maximum net traction for a given tire-snow or track-snow condition, and it is this maximum value that is most often reported. If we assume that the vast majority of tires or tracks in use are capable of engaging the shear strength of the snow (usually true for all but bald tires or smooth tracks), then it follows that the snow's shear strength places an upper bound on  $T_g$ . From eq 1 then, the same is true for  $T_n$ . Thus, a reasonable approach for predicting maximum  $T_g$  is to base it on the shear strength of snow.

Using energetics principles, we can describe the compaction of snow by a tire or track. Equating the energy of compaction to resistance to vehicle motion in snow, we can obtain a theoretical expression for  $R_s$ .

The shallow snow model SSM1.0 described in Appendix A uses this approach to produce estimates of  $T_g$  and  $R_s$  and to calculate net traction (i.e., mobility) from eq 1.

## FIELD EXPERIMENTS

### Test location and test sites

The field experiments described in this report were conducted at the Keweenaw Research Center (KRC) located at the Houghton County Airpark, Michigan. KRC is located on the Keweenaw Peninsula of upper Michigan, about 900 km (550 miles) northwest of Detroit. Two vehicle test areas were used to obtain differing snow conditions. The

majority of the testing took place at the KRC "ice rink," a large (25,000-m<sup>2</sup> [270,000-ft<sup>2</sup>]) leveled area often used for winter vehicle traction tests on ice. The remaining tests were done on an unplowed taxiway at the Houghton County airport.

### Test vehicles

#### CRREL instrumented vehicle

The CRREL instrumented vehicle (CIV) is based on a 1977 Jeep Cherokee with modifications to its braking and driving components to accommodate typical mobility tests. In addition to an on-board computer-based data acquisition system, the vehicle contains a number of transducers for force and speed measurements. The front two wheels are equipped with triaxial load cells that measure the vertical, longitudinal and lateral forces acting at the tire/ground interface. Individual wheel and vehicle speeds can also be measured. For this test program, the CIV was equipped with Goodyear Tiempo tires, size P225/75R15, and they were tested with inflation pressures of 179 and 103 kPa. Basic vehicle and tire characteristics are given in Appendix B.

#### Wheels/tracks test vehicles

The vehicles and test tires used in the winter wheels/tracks performance program were:

M988 High-Mobility Multipurpose Wheeled Vehicle (HMMWV), 4x4, Michelin 37x12.5R16.5LT tires.

LAV 25 Light Armored Vehicle, 8x8, Michelin 11.00R16 tires.

LAV 25 Light Armored Vehicle, 8x8, Michelin 12.50R20 tires.

M977 Heavy Expanded Mobility Tactical Truck (HEMTT), 8x8, Michelin 16.0R20 tires.

M923 5-ton truck, 6x6, Goodyear 14.00R20XL tires.\*

M973 Small Unit Support Vehicle (SUSV), articulated, tracked.

M113A1 Armored Personnel Carrier (APC), tracked.

M2 Bradley Fighting Vehicle System (BFVS), tracked.

The gross vehicle test weights and individual tire or track loads are given in Appendix B.

---

\* The M923 was not initially selected for the wheels/tracks program; however, it was used because of its availability, and because it differed from the other wheeled vehicles. It was not loaded to its published capacity.

## Test procedures

The test procedures followed are typical for mobility field studies, in that measurements of net traction  $T_n$  and total motion resistance  $R_t$  (internal plus external resistance) were made with each vehicle under varying snow conditions. Wheeled vehicle tests were generally conducted at two tire inflation pressures to document the effect of tire deflection on mobility levels. A shear annulus device was also operated side by side with the vehicles. Snow type, depth, temperature and density were measured as well as air temperature and solar input.

### CIV

Motion resistance is measured with the CIV while the rear tires are driving and the front wheels are rolling free. Since the triaxial load cells are located just inside the front wheels, this test measures the amount of resistance felt at the front tires. With the rear tires driving, the whole vehicle mass, including the front axles from the center of the vehicle out to the load cells, is being moved by the rear wheels. Force measurements are, therefore, against this frame of reference and constitute total front tire motion resistance  $R_t$  only.

The internal motion resistance  $R_h$  is first established on a level, undeformable surface. Measurements of  $R_h$  are obtained for each tire type and selected inflation pressure. By convention, motion resistance tests are done at a vehicle speed of 8 km/hr. Our past test experience in snow has shown that resistance values are independent of slight variations in vehicle speed. Variations in  $R_h$  values between tire types are the result of differences in the forces necessary for tire flexing and can be attributed to differences in their design.

Motion resistance tests on snow, then, result in measurement of both internal and external motion resistance  $R_t$ .  $R_s$  is found by subtracting  $R_h$  from the value of  $R_t$  measured when the CIV is operating on snow.

A traction test is performed with the CIV by accelerating the front (driving) wheels while braking the rear wheels to hold the vehicle speed constant at  $8 \pm 1$  km/hr ( $5 \pm 0.5$  miles/hr). In this manner the front tires are driven through a wide range of slip values, starting at zero slip. A plot of measured  $T_n$  vs Differential Interface Velocity (DIV) is used to obtain tractive effort. The  $T_n$  value is taken as an average of the upper 15% of the tractive force readings. This results in averaging over a range of slip values that could reasonably be maintained by a vehicle operator. Gross traction  $T_g$  is

then calculated using eq 1 for each pair of resistance and traction tests.

### Wheels/tracks vehicles

Tractive performance of the *wheels/tracks* vehicles was determined by measuring DrawBar Pull (DBP) and Towed Motion Resistance (TMR). Drawbar pull tests were conducted by measuring the force that a vehicle can exert on a cable that is being used to resist vehicle motion. Thus

$$DBP = (T_n) (N) \quad (2)$$

where  $N$  is the number of driven tires or tracks. Motion resistance is determined by measuring the vehicle's resistance to towing with an instrumented cable. Here

$$TMR = (R_t) (n) \quad (3)$$

where  $n$  is the number of tires or tracks.

Our procedure for measuring DBP is as follows. A load vehicle of approximately the same size and performance as the test vehicle was selected to apply a resistance to the test vehicle. A steel cable 0.016 m (5/8 in.) in diameter and 15 m (50 ft) in length was connected from the front of the load vehicle to a load cell attached to the rear pintle hook of the test vehicle. A string pay-out system for measurement of true ground distance was also mounted on the test vehicle. Tachometers mounted on the drive wheels or sprockets were used to measure wheel or track travel during a test.

Each test vehicle was operated in its lowest gear and at optimum engine rpm (yielding a ground speed of 3–8 km/hr [2–5 miles/hr]). The vehicle proceeded into the test lane with the load vehicle following and the cable between the two vehicles being slack and unloaded. The load vehicle driver initially applied load to the test vehicle by braking and then increased the applied load in steps. The test sequence proceeded from the test vehicle initially experiencing a no load–no slip condition and increased by steps up to a high load–high slip condition or a power limited condition in which the test vehicle could not maintain the desired track or tire speed. Forward speed and wheel or track speed were maintained (very nearly) constant for several seconds of steady-state pull measurements. Vehicle slip was calculated from a magnetic tape record of both vehicle and ground speed. The vehicle slip, calculated for short time windows in the record, in percent, is equal to

$$\text{Slip} = \frac{d_t - d_v}{d_v} (100). \quad (4)$$

where  $d_t$  = apparent distance traveled by the wheel or track

$d_v$  = distance actually traveled by the vehicle.

Continuous measurements were made in this manner until a sufficient number of load and slip combinations were recorded to develop a drawbar pull-slip curve (usually two complete test sequences).

The procedure used for obtaining *TMR* of the test vehicle in each test area was to tow the vehicle (with its transmission in neutral) at a speed of approximately 3 km/hr (2 miles/hr). After each traction test, the vehicle was steered into an undisturbed area adjacent to each traction test area, usually in a position straddling the ruts of the associated traction test. The load vehicle then towed the test vehicle to determine *TMR*. The test proceeded for a sufficient distance to permit the load cell readings to stabilize and to be recorded on magnetic tape. An average value during the stable portion of the record was taken as *TMR*. *TMR* was also measured on an undeformable surface.  $R_s$  is once again found by taking the difference between measurements on snow and the hard surface.

As with  $T_n$  in the CIV traction test, *DBP* is a function of slip or *DIV*. Generally, in low density snow (less than 500 kg/m<sup>3</sup>) maximum *DBP* occurs

at rates of slip greater than 20%. However, little useful work is being done at very high slip rates and the efficiency of operation is inversely proportional to slip. Thus, the maximum *DBP*, which occurred near 20% slip, was used for the calculation of  $T_n$  (eq 2). Equation 1, again, is used to determine gross traction, where  $R_s$  is obtained from the towing tests.

#### *Shear annulus device*

The KRC shear annulus used in this study is installed on a slide rail that is mounted on the side of a Pole Cat. This allows a series of tests to be run without moving the vehicle. A computer program (run on an IBM PC) controls the start and stop of data collection from outside the vehicle, and also collects data throughout the sequence of tests.

The annulus used in this study had a smooth rubber face. The outside radius of the ring was 9.21 cm (3.625 in.) and the inside radius was 6.67 cm (2.625 in.). The surface area of the rubber ring is then 126.64 cm<sup>2</sup> (19.63 in.<sup>2</sup>). Figure 1 shows the shear device.

The test procedure involves rotating the annulus at 10 rpm, while recording rotational displacement and applied torque. Each set of shear tests is run using five different normal loads on the annulus. These loads are in increments of 89 N (20 lbf) and range from 89–445 N (20–100 lbf). The first run is made without any added weight, since the shaft and annulus weigh 89 N. The apparatus is lowered to the surface of the snow and the initial sinkage of



Figure 1. Field shear annulus device.

the annulus is measured. An outside operator then controls the start and stop of the test from a remote switch. Once the test has started, the annulus is allowed to turn through one full revolution. After one revolution, the operator releases the switch and both the motor and the computer data-acquisition system stop. The final sinkage of the ring is measured and the annulus is pulled out of the snow. After each run, the device is moved forward on the slide rail to a new position. Another 89-N increment of weight is added and the test is repeated. When all five runs are complete, the data are stored. The entire sequence of five normal loads is repeated three times at each test site.

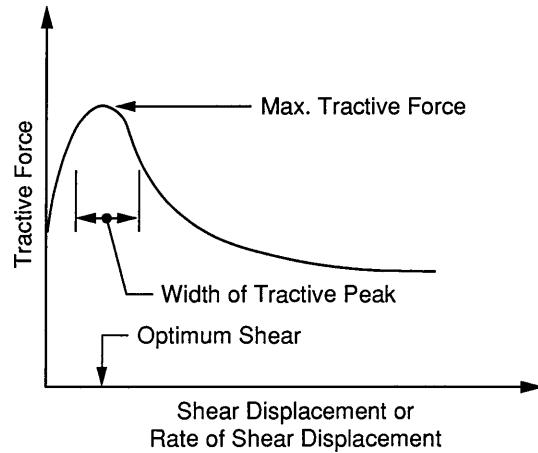

Figure 2. Idealized traction test results.

## RESULTS

### CIV traction and motion resistance

Idealized traction test results for a driven tire on the CIV are shown in Figure 2. The CIV directly measures  $T_n$  during a traction test. The average value of the top 15% of the data (to remove local spikes in the force record) is taken as the peak

tractive force. A typical resistance test result is shown in Figure 3, where  $R_t$  is taken as an average of all of the data.

Table 1 summarizes the data obtained with the CIV during the *wheels/tracks* field program at KRC. Date, temperature, snow density and depth, and

Table 1. CIV traction and motion resistance data.

Date	Temp. (°C)	Density (kg/m <sup>3</sup> )	Depth (cm)	Pressure (kPa)	Measured gross traction coefficient $T_g/W$	Measured external resistance coefficient $R_s/W$
19 Jan 88	-2	550	5	179	0.46	0.020
				103	0.43	0.032
21 Jan 88	-5	60	2-5	170	0.36	0.014
				103	0.35	0.023
22 Jan 88	-5	160	7	170	0.38	0.005
				103	0.37	0.019
23 Jan 88	-5	75	12	170	0.33	0.019
				103	0.35	0.028
23 Jan 88	-2	75	10	170	0.32	0.010
				103	0.33	0.023
26 Jan 88	-5	148	9	170	0.35	0.048
				103	0.34	0.056
10 Feb 88	-8	220	31	170	0.37	0.164
				103	0.41	0.192
10 Feb 88	-7	250	22	170	—	0.116
				103	0.37	0.129
12 Feb 88	-16	230	22	170	0.36	0.115
				103	0.45	0.161

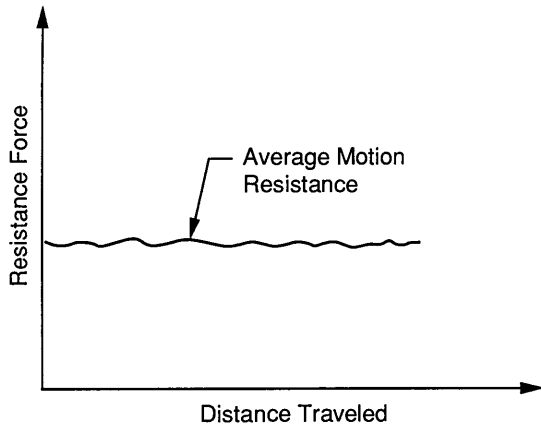

Figure 3. Idealized resistance test results.

tire pressure are self explanatory (a consensus of values was taken when KRC and CRREL records differed).  $R_s$  and  $T_g$  (for two driven wheels) are listed in coefficient form ( $R_s/W$  and  $T_g/W$ ). Each traction and resistance coefficient reported in Table 1 is the average of at least two traction tests (in most cases four to six tests). The CIV's average normal wheel load is 6174 N (1388 lbf).

#### Wheels/tracks vehicles traction and motion resistance

Table 2 summarizes the traction and motion resistance data taken for the wheeled and tracked vehicles used in this study. The values listed for motion resistance and peak gross traction are in coefficient form ( $R_s/W$  and  $T_g/W$ , respectively), and were obtained from the measured TMR and

DBP values (eq 2 and 3, see Appendix C for sample test vehicle field results). Resistance and traction from the test vehicle records, although for whole vehicles rather than for single wheels, are determined in the same manner as was done for the CIV (see Fig. 2 and 3), and will be discussed later.

#### Shear annulus device

Figure 4 shows how measured shear stress varies with time during a shear annulus device test. From these data, the shear strength  $\tau_a$  is assigned the value of the constant stress level  $\tau_a$  that results after an initial spike caused by static friction. The plot of shear strength values for the various normal loads shown in Figure 4 is given in Figure 5. The slope of a least squares regression line through these data is defined as  $\tan\phi$  and the  $y$ -intercept of this plot is called cohesion  $c$ . For the test shown, a straight line fits the data very well. This is representative of most of the tests run. Table 3 is a complete listing of the results over the test period (see Table 4 for associated snow properties).

#### Accuracy and limitations of data

The CIV's load cells are accurate to  $\pm 2\%$  of measured value down to 130 N (30 lbf). Forces lower than this are shown from calibration to be accurate to  $\pm 9$  N (2 lbf).

DBP and TMR of the wheels/tracks vehicles were measured using load cells with the following ranges:

- BFVS, HEMTT—89,000 N (20,000 lbf)
- LAV, SUSV, APC, 5-ton—44,500 N (10,000 lbf)
- HMMWV—22,200 N (5,000 lbf).

The accuracy associated with each of these load

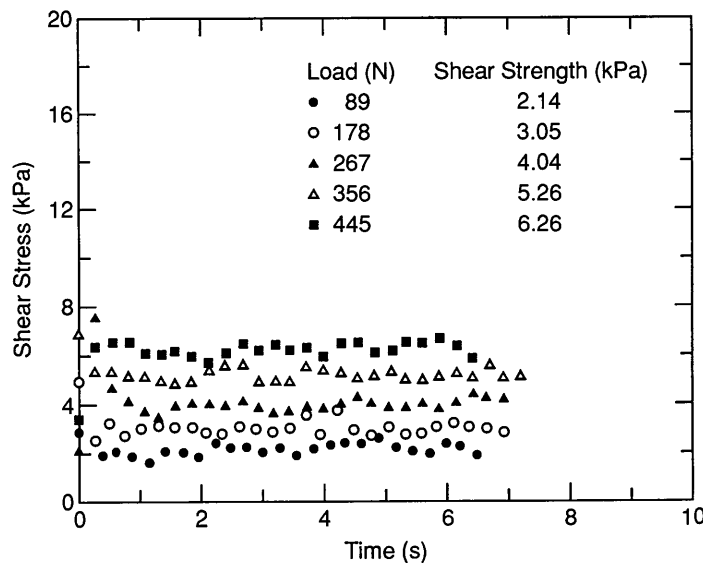

Figure 4. Shear stress versus time (shear annulus).

**Table 2. Traction and motion resistance data for the *wheels/tracks* vehicles.**

Date	Temp. (°C)	Density (kg/m <sup>3</sup> )	Depth (cm)	Tire pressure (kPa)	Traction					External resistance		
					Measured gross	Predicted gross (SSM1.0)		Predicted gross (SSM2.0)		Measured	Predicted	%Δ
						%Δ	%Δ	%Δ	%Δ			
<b>a. 5-ton</b>												
28 Jan 88	-8	80	11	207	0.36	0.32	11	0.33	-8	0.037	0.033	-11
11 Feb 88	-11	220	25	207	0.31	0.37	20	0.33	6	0.087	0.082	-6
11 Feb 88	-8	200	18	207	0.36	0.36	0	0.33	8	0.047	0.061	30
							10*			2*		4*
							8†			7†		22†
<b>b. HMMWV</b>												
19 Jan 88	-2	550	5	138/152	0.40	0.33	-17	0.37	-7	0.027	0.00	-100
21 Jan 88	-5	60	2-5	138/152	0.40	0.37	-7	0.37	-7	0.027	0.019	-30
23 Jan 88	-5	75	12	138/152	0.42	0.42	0	0.37	-11	0.047	0.070	49
26 Jan 88	-5	—	9	138/152	0.29	—	—	0.37	27	0.067	—	—
28 Jan 88	-8	80	11	138/152	0.32	0.42	31	0.37	16	0.027	0.065	30
10 Feb 88	-8	220	31	138/152	0.29	0.55	90	0.37	28	0.117	0.176	50
10 Feb 88	-7	250	22	138/152	0.38	0.53	40	0.37	-2	0.077	0.116	51
13 Feb 88	-10	290	30	138/152	0.35	0.57	63	0.37	6	0.127	0.140	10
26 Jan 88	-5	148	18	138/152	0.42	0.47	12	0.37	-12	0.047	0.111	136
13 Feb 88	-14	240	17	138/152	0.28	0.51	82	0.37	33	0.097	0.092	-5
							33*			5*		33*
							37†			15†		47†
<b>c. LAV</b>												
12.5R20												
19 Jan 88	-2	550	5	207	0.28	0.27	4	0.35	25	0.025	0.00	-100
				103	0.35	0.41	17	0.37	6	0.021	0.00	-100
21 Jan 88	-5	60	2-5	207	0.45	0.30	-33	0.35	-22	0.035	0.007	-80
				103	0.45	0.41	-7	0.37	-18	0.021	0.004	-81
23 Jan 88	-5	75	12	207	0.34	0.31	-9	0.35	3	0.035	0.026	-26
				103	0.45	0.42	-7	0.37	-18	0.021	0.014	-33
28 Jan 88	-8	80	11	207	0.43	0.31	-8	0.35	-19	0.045	0.024	-47
				103	0.48	0.42	12	0.37	-23	0.051	0.013	-75
28 Jan 88	-8	80	11	207	0.31	0.31	0	0.35	13	0.045	0.024	-47
				103	0.46	0.42	-9	0.37	-20	0.051	0.013	-75
28 Jan 88	-8	150	11	207	0.28	0.32	14	0.35	27	0.045	0.028	-38
				103	0.31	0.44	39	0.37	19	0.071	0.015	-79
13 Feb 88	-10	290	30	207	0.30	0.35	18	0.35	18	0.115	0.060	-48
				103	0.36	0.49	36	0.37	3	0.051	0.032	-37
13 Feb 88	-12	250	23	207	0.25	0.34	38	0.35	43	0.095	0.052	-45
				103	0.25	0.47	88	0.37	48	0.081	0.028	-65
11.0R16												
13 Feb 88	-10	290	30	289	0.33	0.31	6	0.32	3	0.116	0.085	-27
				165	0.40	0.38	-5	0.35	-12	0.059	0.047	-20
13 Feb 88	-12	250	23	289	0.25	0.30	20	0.32	28	0.096	0.071	-26
				165	0.36	0.37	3	0.35	3	0.059	0.041	-30
15 Feb 88	-5	—	—	289	0.42	—	—	—	—	0.016	—	—
				165	0.45	—	—	—	—	0.019	—	—
15 Feb 88	-5	270	30	289	0.31	0.30	3	0.32	7	0.076	0.089	17
				165	0.38	0.38	0	0.35	-8	0.069	0.051	-26
15 Feb 88	-5	270	30	289	0.30	0.30	0	0.32	-7	0.026	0.089	242**
				165	0.43	0.38	-12	0.35	-8	0.029	0.051	76
							8*			4*		-44*
							24†			20†		38†

**Table 2 (cont'd). Traction and motion resistance data for the *wheels/tracks* vehicles.**

Date	Temp. (°C)	Density (kg/m <sup>3</sup> )	Depth (cm)	Tire pressure (kPa)	Traction					External resistance		
					Measured gross	Predicted gross (SSM1.0)	%Δ	Predicted gross (SSM2.0)	%Δ	Measured	Predicted	%Δ
<b>d. HEMTT</b>												
21 Jan 88	-5	60	2-5	241/275	0.32	0.29	-10	0.33	3	0.018	0.006	-67
				138/207	0.31	0.33	10	0.33	-6	0.014	0.005	-64
23 Jan 88	-2	75	10	241/275	0.31	0.29	-6	0.33	6	0.008	0.019	137
				138/207	0.33	0.35	6	0.33	0	0.024	0.015	-38
28 Jan 88	-8	80	11	241/275	0.35	0.29	-17	0.33	-6	0.028	0.021	-25
				138/207	0.37	0.35	-6	0.33	-11	0.034	0.017	-50
11 Feb 88	-11	220	25	241/275	0.36	0.31	-13	0.33	8	0.028	0.047	67
				138/207	0.40	0.38	-5	0.33	-17	0.054	0.032	-41
11 Feb 88	-8	200	18	241/275	0.26	0.30	16	0.33	27	0.028	0.035	25
				138/207	0.37	0.37	0	0.33	-11	0.054	0.024	-56
							-3*					11*
							10†		-1*			67†
<b>e. SUSV.</b>												
21 Jan 88	-5	60	2-5	—	0.51	2.24	339	0.54	6	0.060	0.002	-97
26 Jan 88	-5	148	9	—	0.57	2.28	300	0.54	-5	0.090	0.005	-94
28 Jan 88	-10	150	11	—	0.59	2.28	286	0.54	8	0.100	0.006	-94
10 Feb 88	-8	220	31	—	0.63	2.36	275	0.54	-14	0.100	0.017	-83
10 Feb 88	-7	250	22	—	0.63	2.34	271	0.54	-14	0.100	0.011	-89
13 Feb 88	-10	290	30	—	0.63	2.37	276	0.54	-14	0.080	0.014	-83
13 Feb 88	-12	250	23	—	0.62	2.34	277	0.54	-13	0.070	0.012	-83
							289*					-89*
							22†		-9*			6†
<b>f. M113</b>												
22 Jan 88	-5	160	7	—	0.36	0.72	100	0.42	17	0.014	0.006	57
23 Jan 88	-5	75	12	—	0.30	0.71	140	0.42	40	0.004	0.008	100
28 Jan 88	-8	80	11	—	0.37	0.71	92	0.42	8	0.034	0.008	-76
10 Feb 88	-8	220	31	—	0.37	0.75	103	0.42	14	0.084	0.024	-71
10 Feb 88	-7	250	22	—	0.30	0.75	150	0.42	4	0.044	0.016	-64
13 Feb 88	-10	290	30	—	—	0.76	—	0.42	—	—	0.019	—
13 Feb 88	-12	250	23	—	0.41	0.75	83	0.42	2	0.084	0.017	-80
							111*					-40*
							25†		14*			70†
<b>g. Bradley</b>												
21 Jan 88	-5	60	2-5	—	0.36	0.67	86	0.42	17	0.011	0.001	-90
23 Jan 88	-2	75	10	—	0.31	0.68	119	0.42	35	0.011	0.005	-54
28 Jan 88	-8	80	11	—	0.35	0.68	95	0.42	20	0.031	0.005	-84
12 Feb 88	-16	230	22	—	0.45	0.70	56	0.42	-7	0.031	0.011	-92
12 Feb 88	-12	260	16	—	0.36	0.70	94	0.42	17	0.061	0.008	-87
							90*					-82*
							20†		16*			15†

\* Average.

† Standard deviation.

\*\* Not included in average and standard deviation calculation.

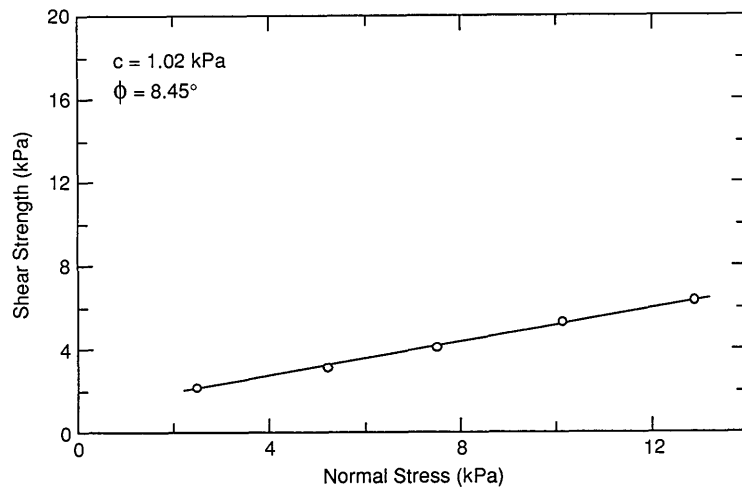

Figure 5. Shear strength versus normal stress (shear annulus).

Table 3 Shear annulus test results ( $\tau_a$  values [kPa] listed).

Date	Time	$\sigma$ (kPa)					Average density ( $\text{kg/m}^3$ )
		7.03	14.06	21.08	28.11	35.14	
22 Jan 88	14:32	3.31	5.65	7.45	8.27	9.45	80
23 Jan 88	14:10	3.79	5.93	7.45	7.93	8.89	60
23 Jan 88	14:58	3.52	4.83	7.24	8.69	9.24	60
26 Jan 88	11:40	3.72	4.69	6.00	7.03	8.07	130
26 Jan 88	13:05	2.28	3.45	4.69	5.72	7.58	130
26 Jan 88	13:13	3.17	4.34	5.79	6.48	7.86	130
28 Jan 88	10:45	2.83	3.79	5.58	7.10	8.76	150
28 Jan 88	10:59	3.72	5.65	6.14	7.45	8.34	150
11 Feb 88	15:17	2.96	4.00	5.72	6.83	8.48	200
13 Feb 88	9:19	3.03	4.83	5.58	7.38	8.27	220
13 Feb 88	9:32	2.83	3.86	4.69	7.10	8.27	220
13 Feb 88	10:18	3.03	4.27	5.86	7.24	8.41	230
13 Feb 88	10:33	3.03	4.34	5.93	7.10	8.62	230
13 Feb 88	12:27	3.17	4.41	5.86	7.17	8.69	270
13 Feb 88	12:35	2.90	4.48	6.07	7.24	8.48	270
13 Feb 88	13:04	3.17	4.27	5.93	7.45	8.69	239
15 Feb 88	14:32	2.90	4.27	5.58	7.45	8.55	250
17 Feb 88	14:09	2.69	3.72	4.69	6.14	7.58	280
18 Feb 88	11:34	3.59	4.83	5.31	6.07	6.96	260
18 Feb 88	14:53	3.59	4.62	4.76	5.31	5.79	280
18 Feb 88	14:58	3.52	3.93	4.69	5.10	5.72	280
18 Feb 88	15:20	3.10	3.79	4.62	5.31	5.93	260
28 Feb 88	15:27	3.45	3.93	4.76	5.24	5.79	260
25 Feb 88	11:22	3.17	4.14	4.76	6.00	7.45	180
25 Feb 88	11:30	2.90	4.48	5.65	6.83	8.21	180
25 Feb 88	13:37	3.31	4.62	6.14	7.03	8.21	190
25 Feb 88	13:45	3.59	4.83	5.93	6.89	8.14	190
2 Mar 88	15:32	3.24	3.93	4.07	4.34	4.62	220
2 Mar 88	15:38	3.31	3.31	4.00	4.76	5.58	220
3 Mar 88	8:47	2.90	4.14	5.52	7.17	8.48	240
3 Mar 88	8:53	2.90	4.21	5.10	6.83	3.21	240
3 Mar 88	13:54	3.59	4.83	5.38	6.83	8.21	240
3 Mar 88	13:59	4.27	5.10	6.14	7.17	8.34	210
4 Mar 88	10:41	4.14	4.62	5.03	5.86	6.96	190
4 Mar 88	10:46	4.07	4.55	5.79	6.41	7.38	190
16 Mar 88	15:37	3.31	3.93	4.55	4.76	5.38	200
16 Mar 88	15:42	3.10	3.86	5.03	4.83	5.17	200
17 Mar 88	9:12	3.10	3.65	4.27	4.27	5.17	220
17 Mar 88	9:18	3.17	4.21	4.62	5.24	5.58	229
Total Avg.		3.24	4.34	5.45	6.48	7.52	

cells is  $\pm 1/2\%$  of full scale. Since accuracy or error is based on the full-scale or maximum capacity, the largest error will be observed in the smallest measurement made with a particular load cell. Thus, measurements for the HMMWV are within 100 N (24 lbf). Accuracy is within 200 N (50 lbf) for the 44,500-N load cell and within 400 N (100 lbf) for the 89,000-N load cell. The test vehicle data were all reported to the nearest 0.01 W, a value that is considerably larger than the limits placed on accuracy by the load cells.

The torque cell installed on the shear annulus device had a range of 22.5 N m (200 in. lbf). This cell was calibrated before testing and several times throughout the test period to ensure that it had not been damaged. The normal range of measured values is from 0 at the low end to around 11.3 N m (100 in. lbf) at the high end. The smallest value of torque that can be read by the data acquisition system is approximately 0.005 N m (0.04 in. lbf). This is greater resolution than we can expect from the torque cell itself, since the cell was calibrated using a meter with an accuracy of only 0.11 N m (1.0 in. lbf). This results in an accuracy of about 1/2% of full scale.

### Snow conditions

For each test with any vehicle or for tests with the shear annulus device, KRC and CRREL both made a set of snow characterizations. This included measuring density throughout the snow's depth, determining its temperature, crystal size and type, noting the location of discontinuities such as ice and frozen snow layers, and visually observing its free water content. The results of the measurements made by KRC are found in Appendix D. Table 4 is a condensed listing of the same results.



**Table 4. Summary of snow characteristics.**

<i>Date</i>	<i>Time</i>	<i>Site*</i>	<i>Total depth (cm)</i>	<i>Visual wetness†</i>	<i>Avg. snow temperature (°C)</i>	<i>Avg. snow density (kg/m<sup>3</sup>)</i>
21 Jan 88	16:00	Slopes	56.0	dry	-1.0	230
22 Jan 88	15:00	Rink	14.0	dry	-5.0	80
23 Jan 88	14:25	Rink	10.0	dry	-1.0	<60
26 Jan 88	14:00	Runway	11.0	dry	-10.5	130
28 Jan 88	11:20	Rink	11.0	dry	-8.0	150
10 Feb 88	12:00	Rink1	17.5	dry	-7.0	200
10 Feb 88	12:00	Rink2	27.0	dry	-5.0	210
11 Feb 88	16:00	Rink2	31.0	dry	-8.3	200
11 Feb 88	16:15	Rink1	17.5	dry	-7.7	190
12 Feb 88	13:10	Rink2	29.0	dry	-12.3	210
12 Feb 88	13:20	Rink1	16.0	dry	-12.5	220
13 Feb 88	9:50	Rink1	17.0	dry	-12.0	220
13 Feb 88	10:51	Rink2	30.0	dry	-9.0	230
13 Feb 88	11:00	Slopes	83.0	dry	—	320
13 Feb 88	11:18	Texas1	39.0	dry	-7.0	230
13 Feb 88	11:18	Texas	76.0	dry	-7.0	260
13 Feb 88	12:51	Sorun	32.0	dry	-8.0	270
13 Feb 88	13:17	Norun	23.0	dry	-10.3	230
15 Feb 88	14:44	Rink2	31.0	dry	-5.0	250
16 Feb 88	10:00	Slopes	41.0	dry	-3.2	250
17 Feb 88	14:30	Rink1	17.0	dry	-3.7	280
18 Feb 88	11:40	Rink2	28.0	dry	-2.0	260
18 Feb 88	15:09	Rink1	12.5	wet	-1.5	280
18 Feb 88	15:33	Rink2	20.0	wet	-1.3	260
25 Feb 88	11:45	W/T Field	19.0	dry	-5.0	180
25 Feb 88	13:55	Road	30.0	dry	-6.0	190
2 Mar 88	16:00	W/T Field	10.0	wet	0.0	220
3 Mar 88	9:05	W/T Field	11.0	dry	-9.5	240
3 Mar 88	14:10	W/T Field	12.0	wet	-1.0	210
4 Mar 88	11:00	W/T Field	7.0	dry	-2.5	190
16 Mar 88	15:45	W/T Field	21.0	wet	-0.2	200
17 Mar 88	9:35	W/T Field	25.0	dry	-3.3	220

\* Slopes: Series of hills of variable grade constructed for vehicle slope climbing evaluation.

Rink: Large level (graded) area of soil, devoid of vegetation, often flooded to produce ice sheet in winter. Rink1 designates the east half and Rink2 the west half of the whole graded area.

Runway: Southwest end of NE-SW runway at Houghton County Airport. Norun designates the north portion and sorun the south portion of this section of the runway.

Texas: A large field with short, naturally occurring grass cover—surface is ungraded but quite level. Texas1 designates a portion of the Texas field where vegetation was stripped from the surface.

W/T Field: Small field cleared of old snow located near KRC buildings.

Road: Access road leading to W/T Field.

† Determined by visual observation.

Each set of data in Appendix D contains the depth from the snow surface at which a measurement was made. Densities are reported at depth increments of about 0.03 m because of the size of the sampling device. Ice and frozen snow layers are indicated when present.

As can be seen from the data, a range of densities was tested over the period. Most of the high density

snows resulted from their being wind blown; their crystal size was relatively small.

#### ANALYSIS

The main emphasis of this study was to validate SSM1.0 in its entirety. Most of our time and effort

during the first field season, however, centered on the traction algorithm and evaluation of different means of obtaining the snow strength parameters  $c$  and  $\phi$ .

### Determination of snow strength parameters

The SSM1.0 uses eq A4 to generate snow strength properties for input to the traction calculation in eq A14. As stated previously, eq A4 stems from back-calculation of  $c$  and  $\phi$  from actual mobility data collected with the CIV. Since these  $c$  and  $\phi$  vs  $\rho_o$  relationships resulted from averaging very scattered data, we were unsure of their accuracy and perhaps even their validity. Within this study we had several means of comparing calculated values of  $c$  and  $\phi$  with eq A4, including the results of shear annulus tests, vehicle traction measured at two tire deflections with some of the test vehicles, and additional traction measurements at two tire deflections with the CIV.

The shear annulus produced  $c$  and  $\phi$  values as described above. This results in a  $c$  and  $\phi$  value for every test set (multiple normal loads) (Table 3). Plots of these data against  $\rho_o$  showed significant scatter, as was also the case for the CIV data used to produce eq A4. An alternative method of using the shear annulus results to obtain snow strength values was then attempted to see if clearer trends appeared. In this approach, we plotted measured shear stress  $\tau_a$  against  $\rho_o$  for each level of normal load (Fig. 6). A least squares regression routine was applied to these data, resulting in a series of equations for  $\tau_a$  as a function of  $\rho_o$ . These equations were then used to produce a shear stress vs normal stress plot for various densities (Fig. 7). Values of  $c$  and  $\phi$ , as a function of  $\rho_o$ , can then be obtained from Figure 7. This has the effect of reducing the scatter in the results by recognizing that the field data probably contain a degree of unidentifiable variability. Rather than to carry this variability on into the cal-

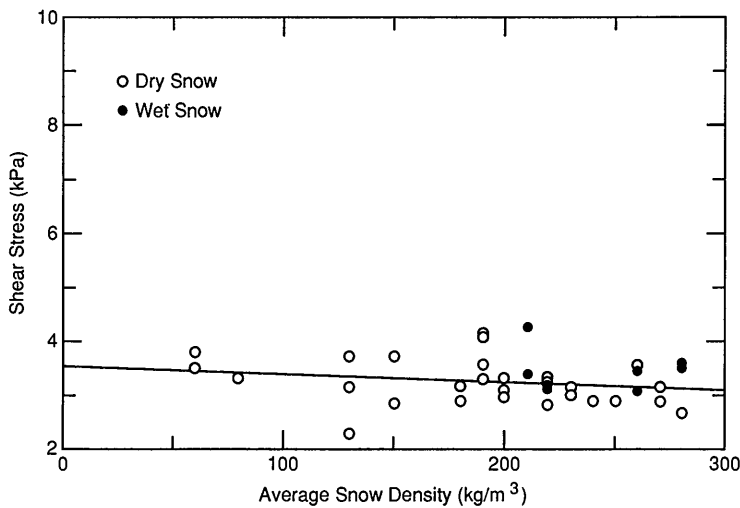

a.  $\sigma = 7.03 \text{ kPa}$ .

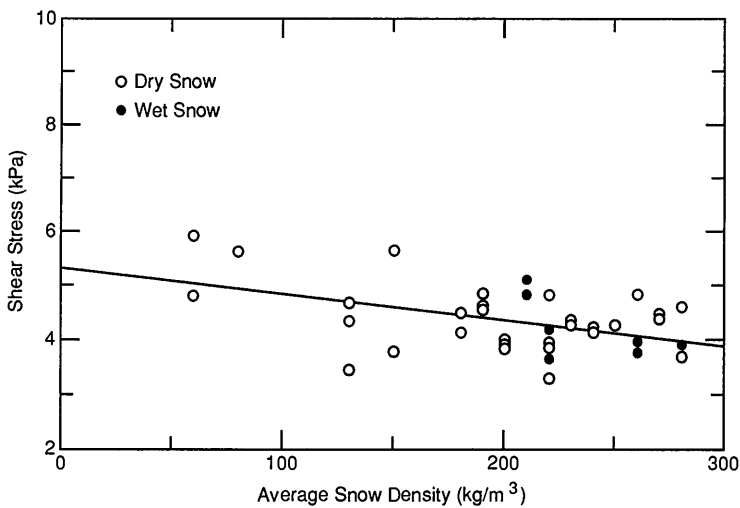

b.  $\sigma = 14.07 \text{ kPa}$ .

Figure 6. Shear stress versus initial snow density for various normal loads (shear annulus).

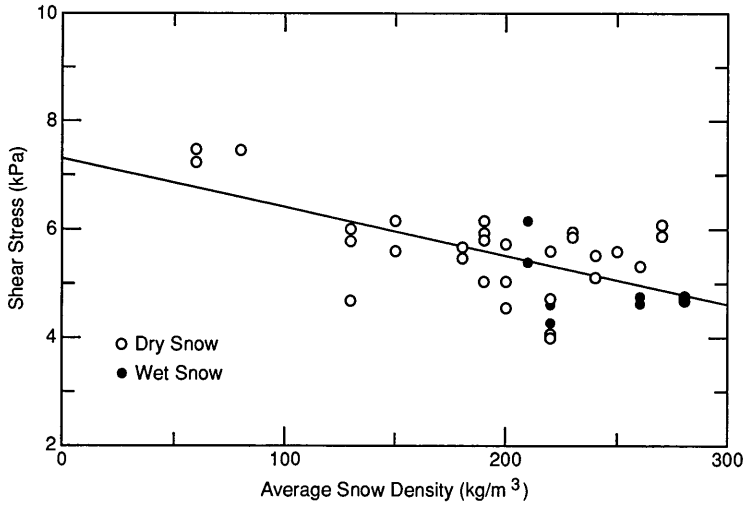

c.  $\sigma = 21.10 \text{ kPa}$ .

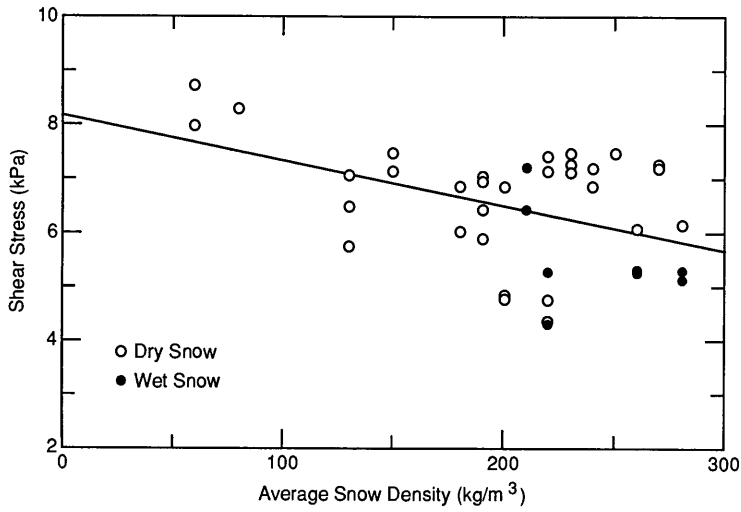

d.  $\sigma = 28.13 \text{ kPa}$ .

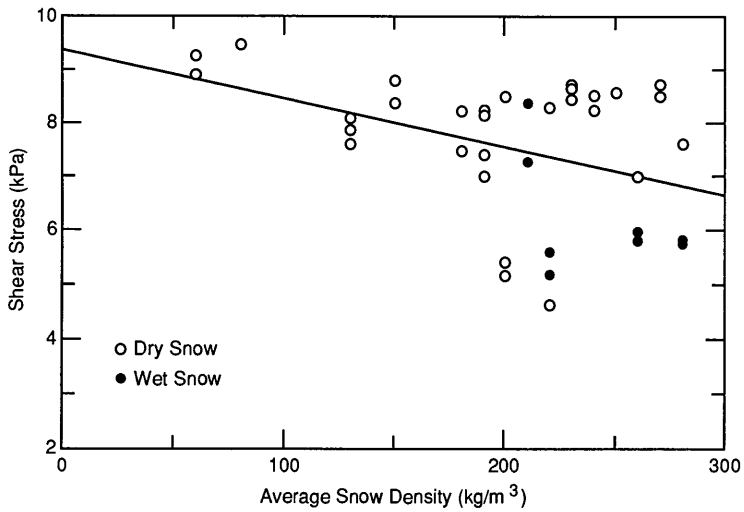

e.  $\sigma = 35.16 \text{ kPa}$ .

Figure 6 (cont'd). Shear stress versus initial snow density for various normal loads (shear annulus).

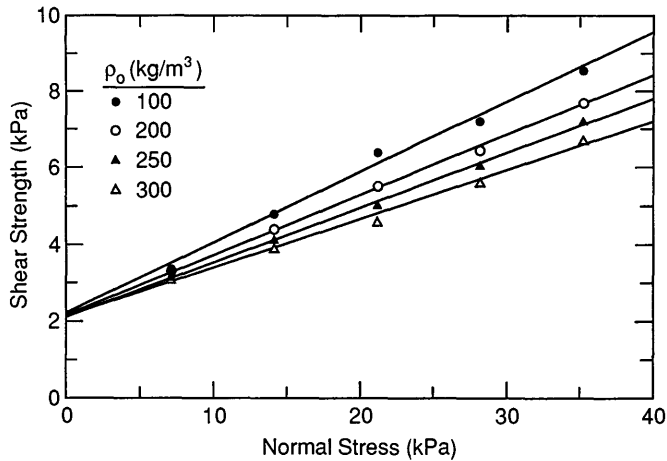

Figure 7. Shear strength versus normal stress with density (shear annulus).

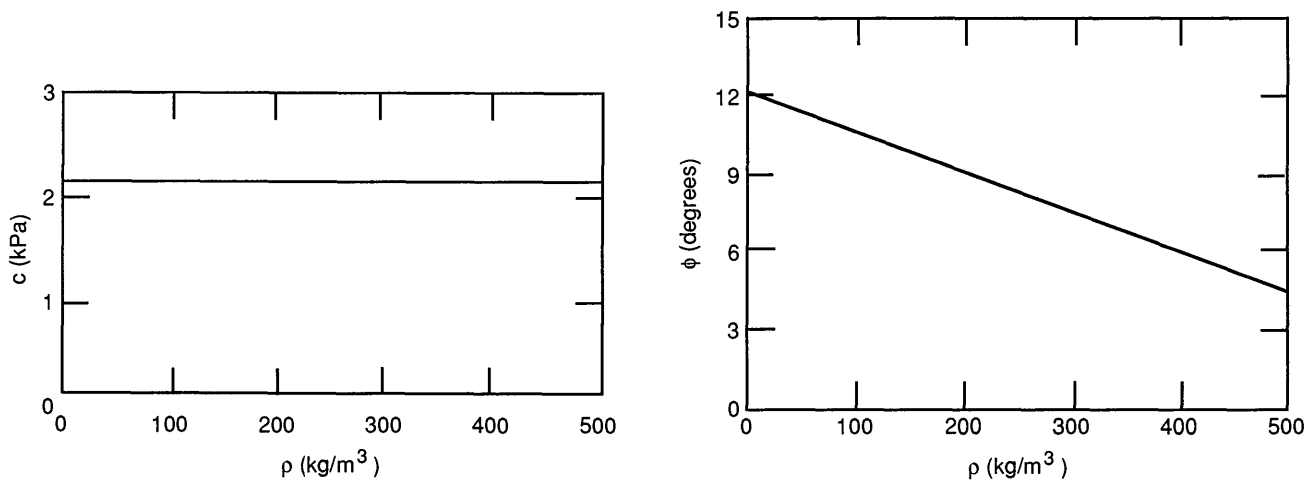

Figure 8. Relationship between snow strength and initial density from the shear annulus device.

culations, this scheme removes the scatter at the outset.

The results of this exercise are shown in Figure 8 and can be given mathematically by the expressions

$$\phi = 12.1 - 0.0156 \rho_0 \quad (5)$$

$$c = 2.14.$$

where  $c$  is in kilopascals,  $\rho_0$  is in kilograms per cubic meter and  $\phi$  is in degrees.

We indicated earlier that, using eq A3,  $c$  and  $\phi$  could be calculated directly from data obtained with a vehicle. This is accomplished by obtaining two values of  $T_g$  through a variation of either  $A$  or  $W$  or both. (It is usually more expedient to change  $A$  by altering tire pressure, while adding and subtracting weight is cumbersome.) The two equations so produced can then be solved simultane-

ously for  $c$  and  $\phi$ . The CIV was operated at the tire pressures of 179 and 103 kPa (26 and 15 lb/in.<sup>2</sup>) during this test series to allow determination of snow strength from vehicle test results.

As with the shear annulus, two methods of relating these data to  $\rho_0$  are possible. The first is to relate directly the individual values of  $c$  and  $\phi$  to initial density, just as was done originally to produce eq A4. The alternate approach, as used above for the shear annulus device and which will be followed here as well, attempts to remove experimental variability first. By determining linear best-fit relationships for the vehicle-produced gross tractive stress  $\tau_g$  vs  $\rho_0$  data for each normal stress level (Fig. 9), and then plotting  $\tau_g$  against normal stress by solving these relationships for specific values of  $\rho_0$  (Fig. 10), we obtain  $c$  and  $\phi$  as a function of density (Fig. 11). These relationships are given by

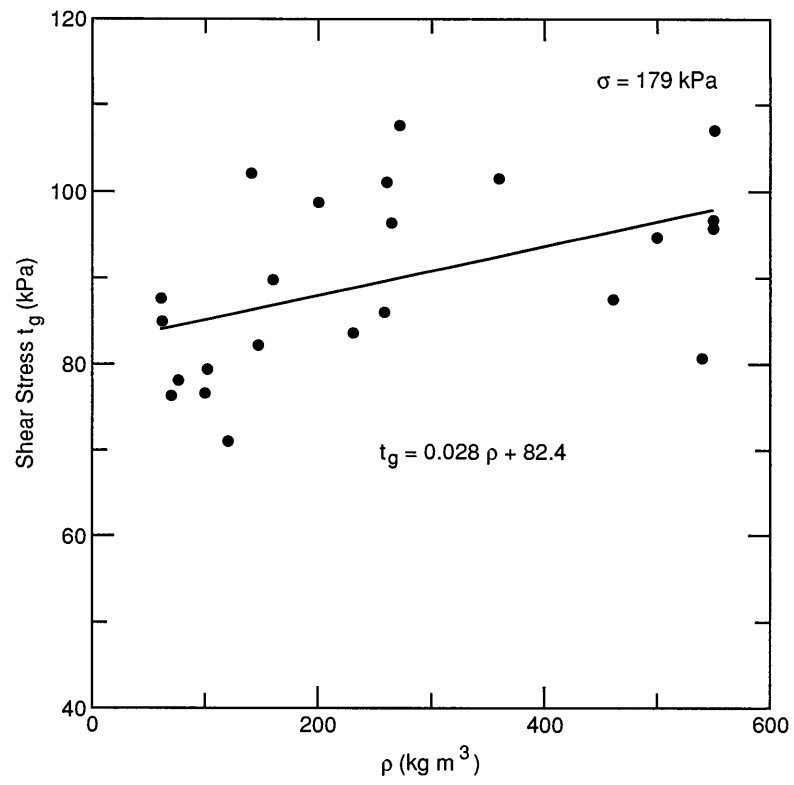

a.  $\sigma = 179$  kPa.

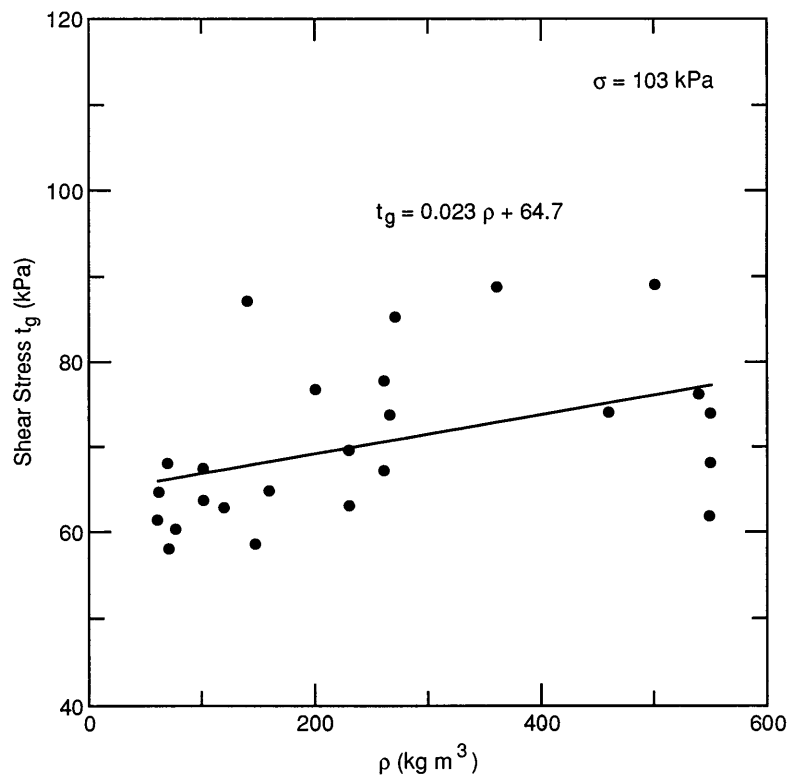

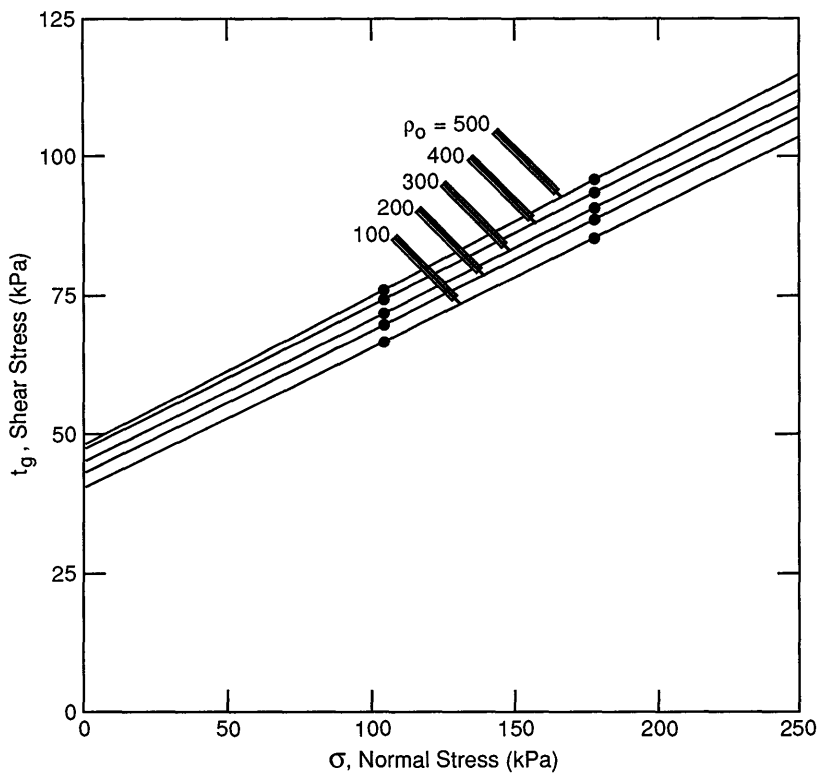

Figure 10. Shear strength versus normal stress with snow density (tire).

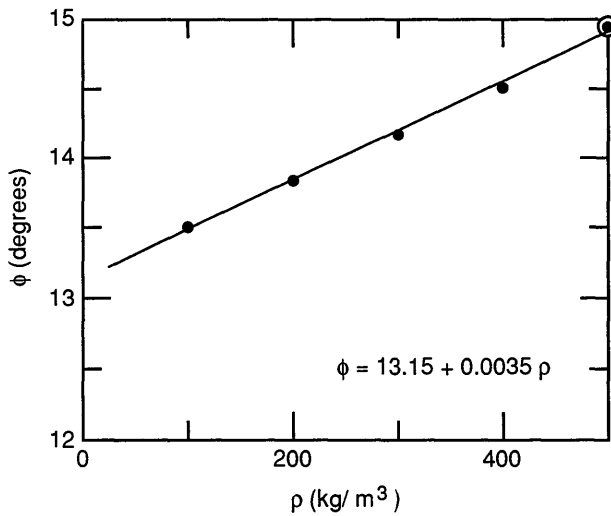
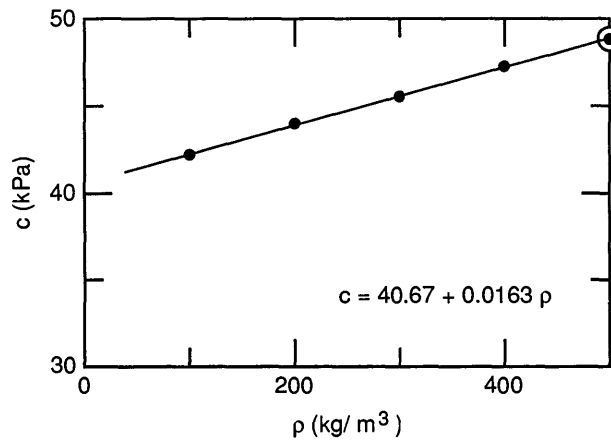

Figure 11. Relationship between snow strength and initial density from a tire.

$$c = 40.67 + 0.0163\rho_0 \quad (6)$$

$$\phi = 13.15 + 0.0035\rho_0$$

Comparison of  $c$  and  $\phi$  given by eq A4 (from CIV data obtained before 1986 [SSM1.0]), eq 5 (from shear annulus data) and eq 6 (from 1988 CIV data) is made in Figure 12. It can clearly be seen that there is little agreement between these expressions.

One possible reason for the difference between the CIV and shear annulus relationships is the difference in magnitude of the normal contact pressures; the CIV at the two tire pressures tested had an average contact pressure of 184.4 and 201.6 kPa, while the shear annulus varied between 7 and 35.1 kPa. Along these same lines, the shear rate for the shear annulus is 0.083 m/s, while the tire operates with shear rates of 0 to greater than 5 m/s, with the peak traction value occurring between 0.45 and 2.2 m/s. As noted by others (e.g., de Montmollin 1982, McClung 1977), snow is a very rate dependent material. The most likely explanation, however, centers on the shear surfaces; the annulus had a smooth rubber face, while the tire had a distinct tread pattern. This allows the tire to utilize the shear strength of the snow, while the annulus principally only engaged the surface friction characteristics of the snow. This is very apparent in Figure 12, where the cohesion term is a constant and the  $\phi$  term, really a coefficient of friction  $\nu$  ( $\nu = \tan\phi$ ), shows a strong variation with initial snow density for the annulus. It was also very apparent in the field that the annulus engages only the surface properties of the snow, whereas the tire engaged a finite thickness of the snow in the process of shearing. Because of these gross differences in the mechanics of loading the snow, one should not expect too many similarities between the annulus and a tire.

Although the SSM1.0 relationships (eq A4) were generated with CIV data, these  $c$  and  $\phi$  values were established per test, rather than via the alternate method described above. In part, this may explain why the new CIV expression (eq 6) and the SSM1.0 expressions (eq A4) are dissimilar.

Another possible conclusion that could be reached from Figure 12 is that  $c$  and  $\phi$  as measured here with a tire are not really functions of initial density, or that some other basic snow properties exert a much stronger influence.

In studying the mechanism of a tire producing traction on snow, and thinking about our attempt to relate  $c$  and  $\phi$  derived from tire traction values to initial snow density, it soon became obvious to us

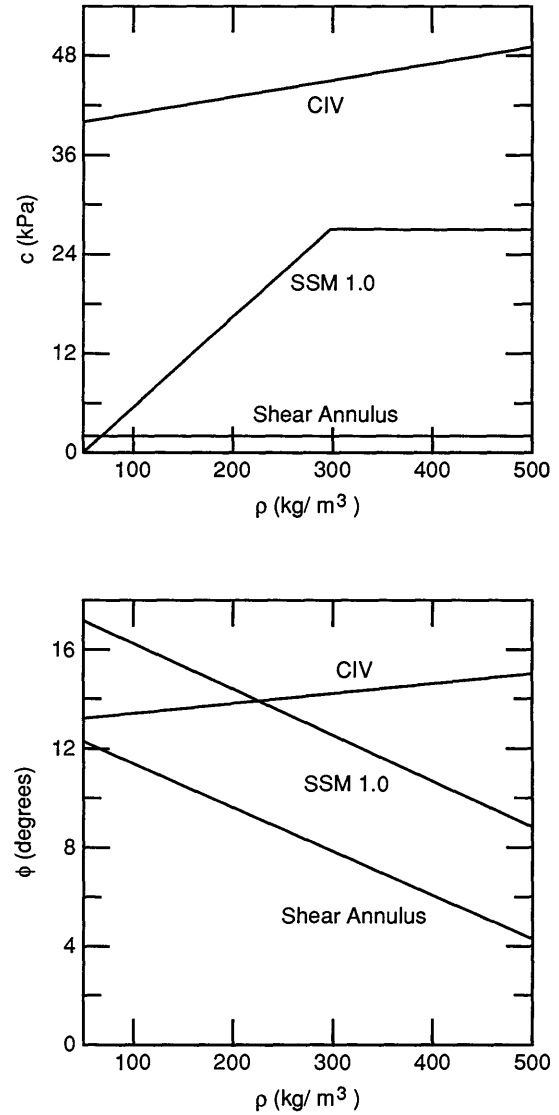

Figure 12. Comparison of  $c$ ,  $\phi$  and  $\rho_0$  relationships from SSM1.0, the shear annulus and a tire.

why we were not seeing clear trends. The bulk of the tractive force developed by a tire or track is located in the “flat” portion of the contact patch. The leading portion of the snow/tire or snow/track interface is usually smaller than the flat area, and, because of its curved geometry, is aligned more to compact the snow than to provide forward thrust. In the flat, horizontal portion of the contact patch, the snow has been fully compacted. Its properties, especially its shear strength, are vastly different from initial conditions. Additionally, since we originally were attempting to relate  $c$  and  $\phi$  to density, we noted that the snow density resulting from vehicle compaction was close to a constant for most vehicles operating in shallow snow, varying between 400 and 500 kg/m<sup>3</sup>.

These revelations suggested that it would be wise to either search for other basic initial snow properties that influence the compacted snow's  $c$  and  $\phi$ , or to attempt to establish constants for the values of compacted snow  $c$  and  $\phi$  to replace expressions like those in eq A4, 5 and 6. We hoped that analysis of the traction data for the *wheels/tracks* vehicles would give us a clue as to which approach was most viable.

### Traction analysis

The simplest and probably most common means of reporting traction for a vehicle is by use of a coefficient. Customarily, this tractive coefficient  $\mu$  is calculated from net traction measurements. For this study we will use gross traction and define  $\mu$  for a vehicle by

$$\mu = \frac{\sum_{i=1}^N T_{g_i}}{\sum_{i=1}^N W_i} \quad (7)$$

where the summation is over the driven tires or tracks only. The measured gross traction columns in Table 2 list the average values of  $\mu$  calculated for all of the test repetitions for each snow surface.

Use of  $\mu$  is fine for comparing surfaces and tires' ability to support or generate traction, and will serve to allow comparison of the output of SSM1.0 with measured traction; however, by itself, it does not tell us much about the mechanics involved in snow traction. Specifically, we would like to explore further the accuracy of treating snow as a Mohr-Coulomb material and the relationship between  $c$  and  $\phi$  calculated from vehicle tests and initial snow density  $\rho_0$ .

To follow up on the earlier proposal that  $\rho_0$  has an insignificant effect on  $T_g$ , we plotted all of the traction data for the *wheels/tracks* vehicles, and for the CIV, against  $\rho_0$  for all of the measured  $\mu$  values. Figure 13 shows that for all of the vehicles except the SUSV and the Bradley, one could easily argue that no clear dependence on  $\rho_0$  exists. This supports the supposition made from examination of the snow strength parameters data.

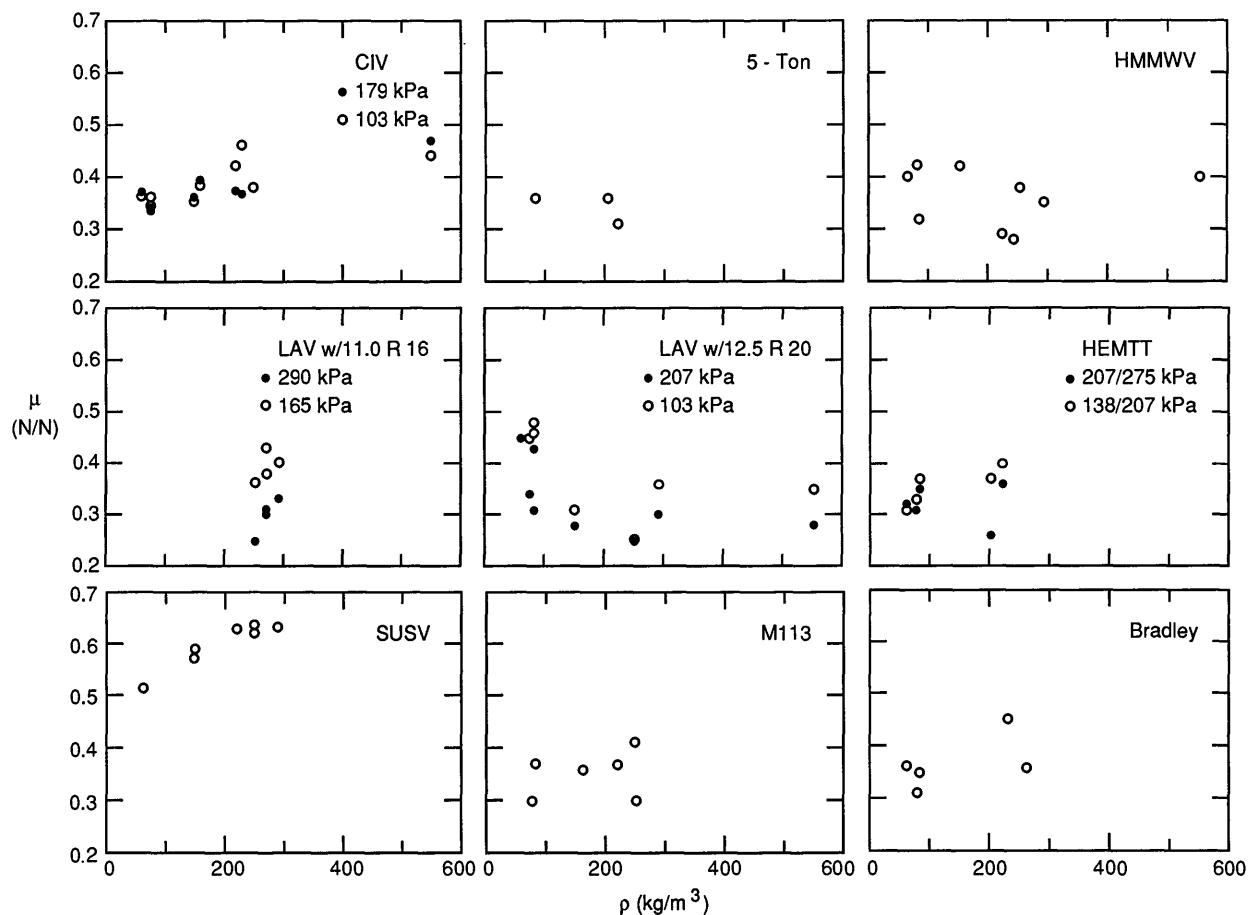
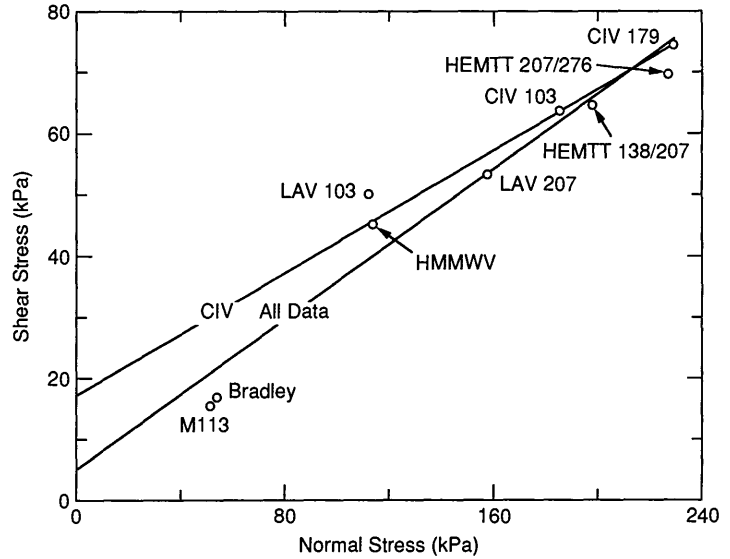

Figure 13. Tractive coefficient versus initial snow density for each vehicle tested.



Figure 14. Shear stress versus normal stress for the 23 Jan 88 vehicle tests.



Assuming that the snow properties were essentially constant over the span of a single day, it would follow that  $c$  and  $\phi$  should remain fixed throughout the day also. Thus, if determination of  $c$  and  $\phi$  from vehicle tests is a valid means of obtaining true material properties, data from each of the vehicles tested during a single day should give rise to identical values of  $c$  and  $\phi$ . On 23 January, gross traction data exist for six vehicles, including three at two contact pressures. These were plotted (Fig. 14) in terms of normal ( $\sigma$ ) and shear ( $\tau_g$ ) stresses. A linear regression performed on these data resulted in an intercept ( $c$ ) of 4.5 kPa and a slope ( $\phi$ ) of  $17.5^\circ$  (Fig. 14).

Recalling that SSM1.0 used only CIV data to obtain  $c$  and  $\phi$  values, we also passed a best-fit line through the CIV data by itself (Fig. 14). Clearly, this line has a lower slope ( $14.5^\circ$ ) and a much higher intercept (16.1 kPa). The significance of this result will be discussed later.

It is readily apparent in Figure 14 that the wheeled vehicle data fit a straight line well, while the two data points corresponding to the tracked vehicles do not lie along this same line. This suggests that perhaps a nonlinear expression describes the relationship between normal load and shear failure of snow.

Mohr's original shear failure criterion for soils stated only that the shear stress at failure was a function of the normal stress  $\sigma$  on that plane. (Coulomb chose to define the function as a straight line for limited normal stress ranges.) Since we are considering a wide range of normal stresses (values of 15 kPa for the SUSV up to 265 kPa for the LAV) it is perfectly justifiable (and still within

Mohr-Coulomb theory confines) to choose a nonlinear function that better fits these data.

Other single-day data were plotted in a fashion similar to Figure 14. Each resulted in very similar distributions in the data. This observation, coupled with our earlier proposition that the compacted snow provides the bulk of the tractive force and that the compacted snow is not only close to constant from vehicle to vehicle, but from day to day, led us to place all of the winter's data on one plot (Fig. 15). A distinct trend is obvious, and one must assume that gross traction developed by tires or tracks is principally a function of normal stress on the driven elements, regardless of the initial snow properties.

A straight line placed through the data in Figure 15 yields  $c$  and  $\phi$  values of 4.6 kPa and  $17.9^\circ$ , respectively, with a correlation coefficient of 0.92 for the fit. This is certainly a strong correlation; however, the large number of wheeled vehicle data and their distribution on the normal stress axis resulted in a poor fit for the tracked vehicles. As noted earlier, there is no reason not to believe that a nonlinear relationship governs shear failure in snow. A power function was thus chosen to model these data. This yielded the expression

$$\tau_g = 0.851 \sigma^{0.823} \quad (8)$$

where  $\sigma$  is in kilopascals. The correlation coefficient for eq 8 is 0.97.

The scatter present in the data displayed in Figure 15, although small by mobility test standards, can perhaps be explained by several factors. First, we have only associated a single value of  $\sigma$

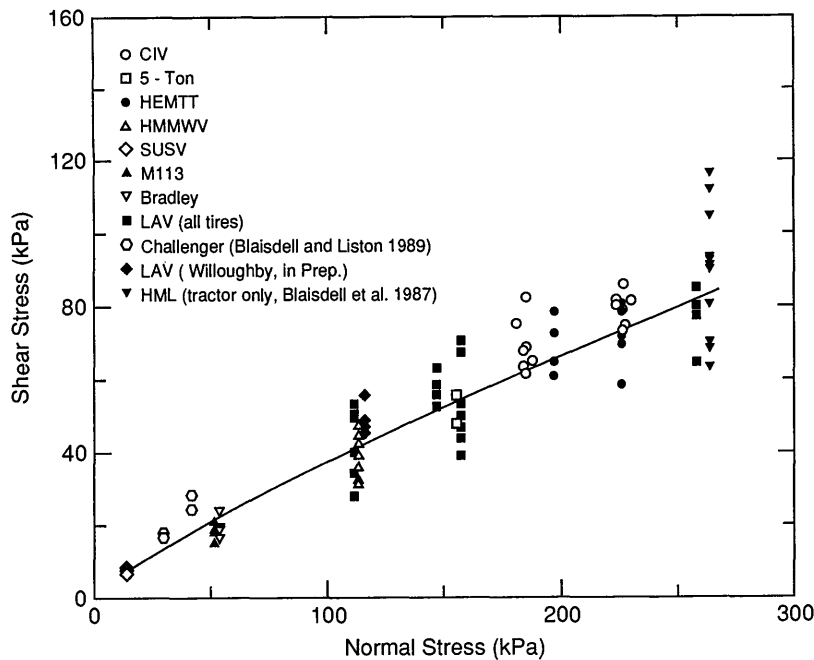

Figure 15. Shear stress versus normal stress using all data.

with each vehicle. This value is determined statically and is an average for the whole vehicle, being gross vehicle weight divided by the number of contact points and the average contact area of these points as measured on a hard paved surface. Obviously, during testing on deformable surfaces under dynamic conditions, both contact area and normal load may vary considerably. If an average  $A$  and  $\sigma$ , for each tire or track, were available to associate with the measured  $T_n$ , for each test, a more accurate plot could be produced.

Additionally, Figure 15 plots gross tractive stress, which is the result of adding the measured net traction  $T_n$  with the measured motion resistance  $R_s$ . Recall that these quantities are collected from two separate tests, one with the tractive elements driving, the other with them free rolling. During the motion resistance test, only sinkage attributable to the vehicle's normal stress occurs, while the traction test may generate both normal load sinkage and slip sinkage. Thus, the value of  $R_s$  we add to  $T_n$  to obtain  $T_g$  does not account for the added motion resistance caused by slip sinkage.

Another possible explanation for the variation in measured values in Figure 15 is that a given test may not have been conducted in a manner that resulted in engaging the full available shear strength of the snow. This happens when a tire or track experiences little or no slippage (i.e., power limitation) or if only a few tires on a vehicle slipped (i.e., action of differentials). All values of shear stress below the shear strength of snow are acceptable.

Lastly, as with other geologic materials, snow properties vary in time and space. The strength, depth, structure, water content, temperature, and even type and strength of supporting material, undoubtedly were not constant along a single test lane or from lane to lane. This gives rise to variations in sinkage and to the available shear strength. Considering these factors, we would expect some variation in  $\tau_g$  for any given vehicle.

### Traction model predictions

To test the viability of SSM1.0, the model was run for all of the snow conditions at which data were collected with the *wheels/tracks* family of vehicles. In this way, actual and predicted values of traction could be compared. Table 2 contains a listing of the measured and predicted values of gross traction. Another column also shows the degree to which the predicted values vary from the measured values. The errors range from a 4% underprediction for the HEMTT to a 298% overprediction of traction for the SUSV. In general, the SSM1.0 does a good job of predicting for the wheeled vehicles; an average error of 15% exists among them. The model, however, grossly overpredicts for the tracked vehicles, with an average offset of 162%.

While the results of the SSM1.0 prediction are encouraging for the wheeled vehicles, quite the opposite can be said for tracks. We recall that the model predicts traction based on application of eq 1, using eq A1, A2 and A4 (generated with the CIV). Returning to Figure 14, we see that using only the

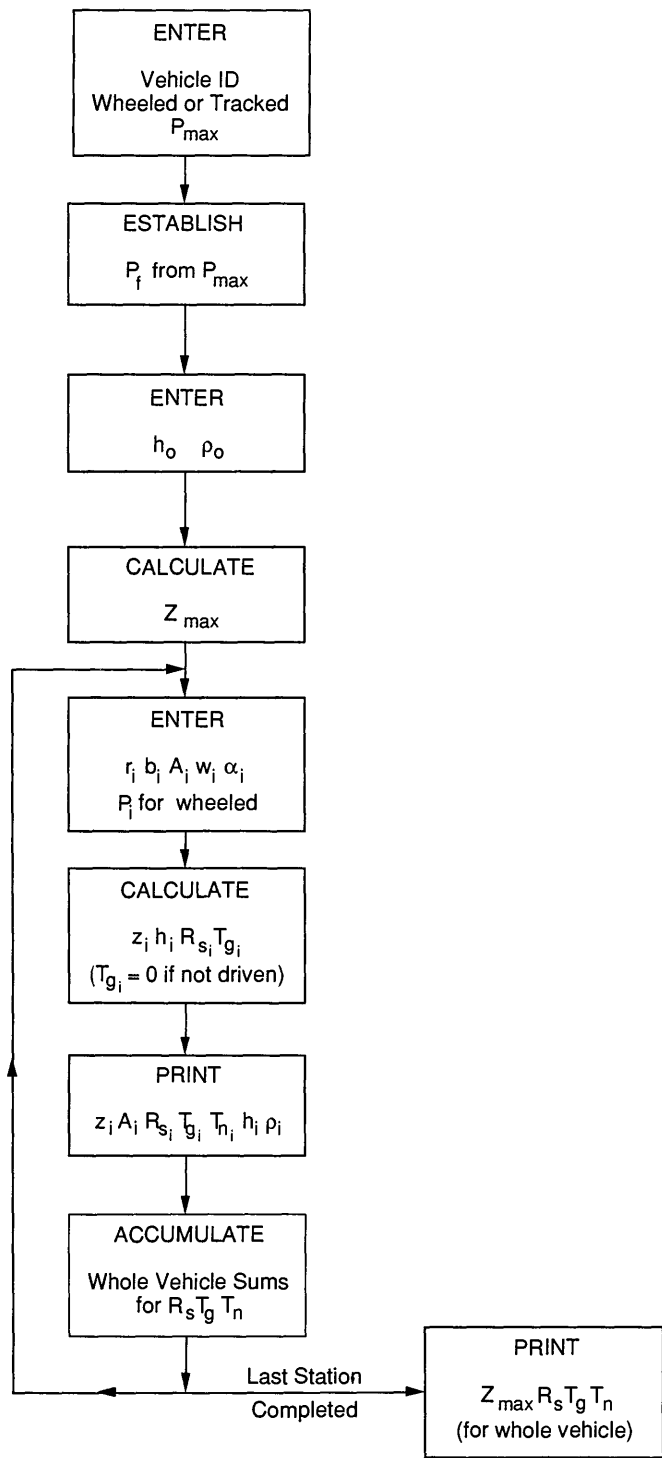

Figure 16. Flow chart for SSM2.0.

CIV data to produce a straight-line expression to describe the normal stress–shear stress relationship results in grossly overshooting the tracked vehicle data. This line, however, is not too far from passing through the majority of the wheeled vehicle data.

Clearly, the CIV-produced line has a much higher intercept ( $c$ ) and a slightly lower slope ( $\phi$ ) than the line generated for all of the vehicle data. Thus, the ( $W \tan\phi$ ) term from eq A3 should differ little for either wheeled or tracked vehicles, depending on which  $\phi$  is used. The two  $c$  values are significantly different, leading to considerable differences in the ( $Ac$ ) term from eq A3. For wheeled vehicles, this term contributes little to gross traction; however, for tracked vehicles, their large contact area makes this term the dominant one.

Obviously, extrapolation of the CIV data down to the contact pressure range for tracked vehicles results in huge over-predictions. Interestingly, the prediction error magnitudes for the whole family of *wheels/tracks* vehicles is in direct proportion to the difference between their ground pressures and the CIV's.

The SSM1.0 uses initial snow density to calculate traction for the leading tire and various compacted snow densities (depending on the contact pressure for that tire or track) for trailing tires (eq A14). Figure 15 indicates that this scheme is not necessary. The snow that is supporting tractive forces is essentially constant for all vehicles and conditions within the range of snows tested in this study.

In light of the prediction errors associated with SSM1.0 and the new relationship portrayed in Figure 15, we instituted a change in the traction prediction algorithm contained in SSM1.0. The updated model, SSM2.0 (Appendix E, including sample output; flow chart given in Fig. 16), now predicts traction based on eq 8. Although this may seem to result in an entirely empirical relationship specific to this study, we use two points to defend the introduction of a new traction algorithm for future use. First, the data plotted in Figure 15 show a very good correlation (correlation coefficient of 0.97) to a power curve. The new relationship is based on the same premise used in the previous traction model, and with the most popular traction prediction method referenced in the literature over the past 30 years (eq A3). Additionally, the data in Figure 15 are for a wide variety of vehicles—vehicles with gross differences in weight, traction elements, configurations, etc.—yet a strong correlation exists. This suggests to us that eq 8 depicts a

universal relationship for snow traction, rather than a one-time, site-specific correlation.

Our second defense rests on comparing three external data sets (data generated in other studies) with eq 8. The LAV was tested in sometimes deep alpine snow at Pickle Meadows, California, several years ago. These data (Willoughby, in prep.) show an average agreement with eq 8 of 15% with a standard deviation of 9%. Also available are mobility data for the prototype Hard Mobile Launcher tractor (HML) (8×8) from Great Falls, Montana (Blaisdell et al. 1987). The snow traversed by the HML was wet and sometimes very shallow. Agreement with eq 8 for the HML was also very good, with an average agreement within 5% (standard deviation is 21%). Mobility data for the Challenger C65 rubber-belted tractor are also compared here. These data (Blaisdell and Liston 1989), for two track widths, display an average agreement of 26% and standard deviation of 3% with the model's predictions. All of these external data (also shown in Fig. 15) agree with the *wheels/tracks* data quite well, despite being from different test locations. Two of these data sets were also gathered with different vehicles from those used in the *wheels/tracks* study (the Challenger and HML), yet they, too, complement the *wheels/tracks* vehicle data.

The second generation shallow snow model, SSM2.0, uses the gross traction relationship (for a single driven tire or track)

$$T_{g_i} = 0.851 A_i (W_i/A_i)^{0.823} \quad (9)$$

where  $W$  is in kilonewtons and  $A$  is in square meters. In SSM2.0, no adjustments need to be made for different areas or percent of new snow compacted or snow conditions such as density and depth, as was the case in SSM1.0 (see eq A14). In essence, the result is that gross traction on snow becomes a constant for a given vehicle ground pressure, and that differences in  $T_n$  for different snows or different vehicles are the result of different magnitudes of  $R_s$ . (This is limited to shallow dry snows with densities of less than 500 kg/m<sup>3</sup>.)

Using the SSM2.0,  $T_g$  was also calculated for the cases where actual *wheels/tracks* data were taken. Table 2 includes a column with the new model prediction and its degree of accuracy is compared with the measured values. For the *wheels/tracks* vehicles, differences between predicted and measured range from –9 to 16%. The SSM2.0 still shows a larger difference for the tracked vehicles than for the wheeled vehicles, but a much more acceptable

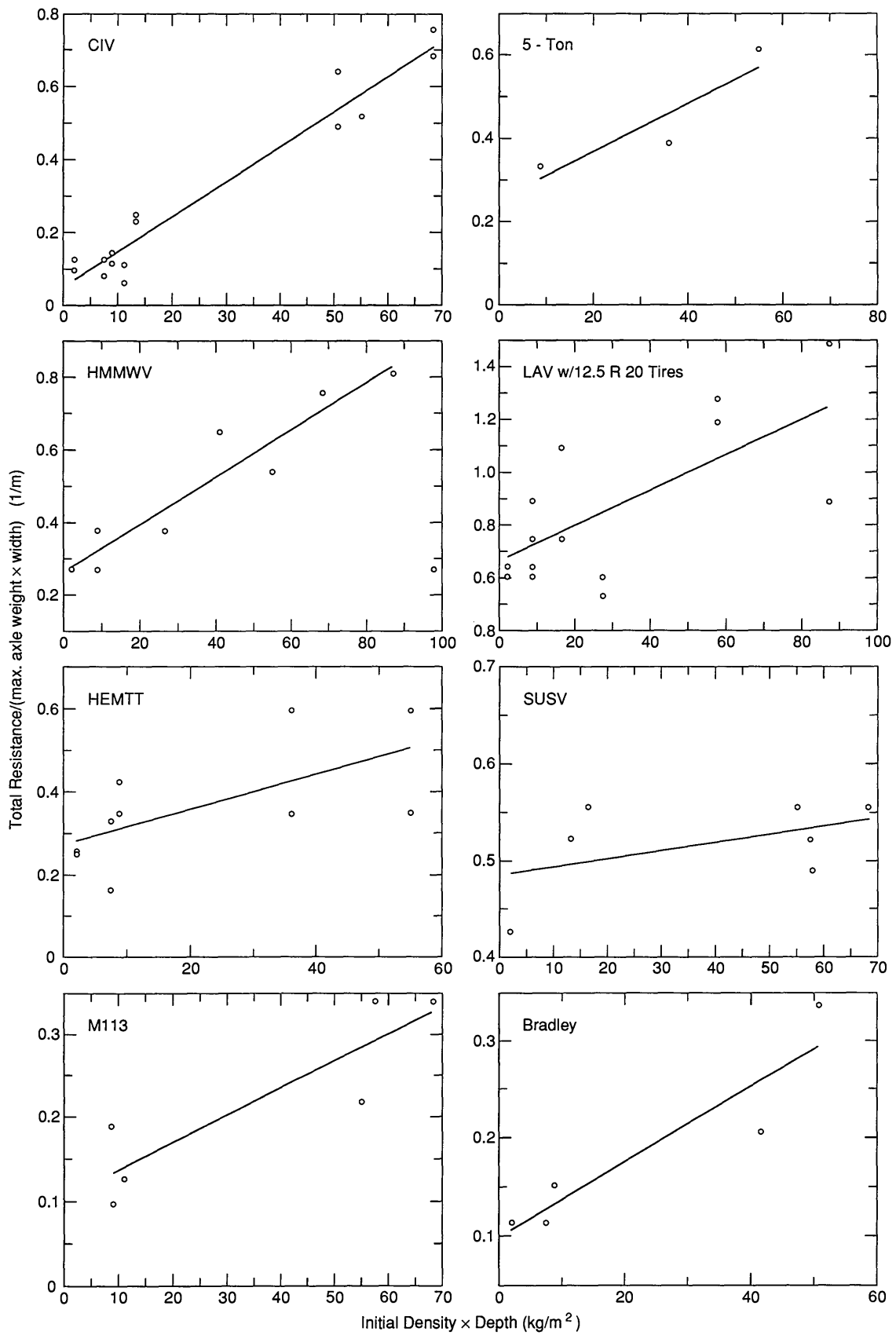

Figure 17. Normalized motion resistance as a function of a depth-times-density snow parameter.

level of difference exists between predicted and measured gross traction in all cases.

### Resistance analysis

As described above (eq 1), a measure of vehicle mobility can be determined from the difference between the gross traction  $T_g$  and external motion resistance  $R_s$ . Although this study concentrated primarily on the prediction of  $T_g$ , the accurate determination of  $R_s$  is equally important. Motion resistance data were used to 1) calculate  $T_g$  for validation of the traction algorithm, and 2) validate the resistance algorithm used in the SSM1.0 (or SSM2.0, since version 2.0 differs from version 1.0 only in the traction algorithm).

As with gross traction, resistance was presented in coefficient form ( $R_s/W$ ), and this coefficient will be used to compare measured and predicted resistance. This, however, does not provide a great deal of insight into the mechanisms taking place that give rise to  $R_s$ . Our hope, once again, was to develop a simple relationship between vehicle parameters and snow characteristics.

The majority of motion resistance for the vehicles used in this study was assumed to occur at the front axle; the bulk of the snow compaction takes place here. The total sinkage after vehicle passage will be governed by the greatest axle load. We also note that tire or track width should also be an important factor. Two of the simply measured snow properties that affect resistance are snow density and depth. With these ideas in mind, we constructed Figure 17, where the  $x$ -axis contains a combined snow parameter (initial density times depth) and the  $y$ -axis displays the vehicle parameter ( $R_s/W_{max} \times b$ ). The snow depth included in the  $x$ -axis parameter is limited to compactible snow (i.e.,  $\rho_o < 500 \text{ kg/m}^3$ ). All of the data are presented except those for the LAV25 with 11.00R16 tires. These data did not fit the general trend presented by the other vehicles and lead us to question their validity. The LAV25 with 12.5R20 tires shows more scatter than the other vehicle data but follows the same trend. Straight lines are fit to these data for each vehicle and the slopes and intercepts are presented in Table 5. In this table it can be seen that the slope decreases as tire radius increases or as gross vehicle weight increases. The intercepts are greater than zero and are probably associated with the tire or track rolling resistance on compacted snow where no sinkage is displayed. Compacted snow undoubtedly displays some elastic behavior, so some tires and tracks probably generate a small amount of recoverable deformation as they roll over the snow.

**Table 5. Results of regression analysis on motion resistance data.**

Vehicle	Slope	Intercept	Weight (N)	Average tire radius (m)
CIV	0.00946	0.0314	24,696.4	0.352
HMMWV	0.0068	0.253	33,450.5	0.429
LAV 25*	0.0068	0.663	125,483.7	0.429
5-ton	0.0057	0.253	105,778.2	0.554
Bradley	0.0039	0.097	223,299.6	0.356**
SUSV	0.00086	0.485	61,340.7	0.264**
M113	0.00283	0.137	104,087.9	0.368**
10-ton	0.0037	0.331	268,560.1	0.603

\* LAV25 with 12.5 R20 tires.

\*\* Estimated radius at leading edge of track (from SSM1.0).

This rolling resistance was not measured, but is no doubt greater than the resistance felt on an undeformable surface. The CIV can be considered as a one-axle vehicle in this plot since only the front wheel resistance was measured. The hard surface motion resistance of the front wheels of the CIV is on the order of 100 N, which corresponds to a value of 0.031 on the  $y$ -axis of Figure 17; this is almost exactly as predicted by the regression analysis (0.0314). These observations suggest that a simple empirical algorithm could be developed with which to predict motion resistance in snow.

Since a second year's study is planned for the *wheels/tracks* project, the resistance model was developed no further at this time. Instead, the second year of study will concentrate on understanding motion resistance in snow.

### Resistance model predictions

We complete our analysis with a comparison of the SSM1.0 resistance prediction with the resistance values measured in the field tests. Table 2 contains both measured and predicted (eq A13) resistance, in coefficient form, and, as for the traction comparison, the percent difference between the predicted and measured values was calculated. The CIV data were not compared with the model since the CIV measures  $R_f$  at the front wheel only and the SSM1.0 predicts whole vehicle motion resistance. Motion resistance is generally under-pre-

dicted for the tracked vehicles (by as much as nearly 90% in one case), while no clear trend is seen for the wheeled vehicles. The lack of any clear trend in wheeled vehicle comparisons and the underprediction of tracked vehicle motion resistance suggests that the resistance algorithm may not be appropriate for all vehicles. The possibility of excessive (arbitrarily set at less than  $\pm 20\%$ ) error is much greater for the resistance algorithm (80% chance of excessive error) than for the new traction algorithm and thus it is the weakest part of SSM1.0 or SSM2.0.

## CONCLUSIONS AND RECOMMENDATIONS

Use of the CIV-generated snow strength–initial density relationship to predict gross traction (as is done in SSM1.0) was found to produce marginal correlation with measured values for wheeled vehicles, and dismal results for tracked vehicles. We explored the possibility of producing the  $c$  and  $\phi$  vs density relationship with a shear annulus device, and found that it did not even show a trend similar to that found with the CIV. We concluded that initial snow density, in the range from 50 to 500 kg/m<sup>3</sup>, has little or no effect on the traction levels generated by vehicles.

By plotting traction for all of the vehicles, in terms of a failure shear stress, against normal pressure exerted by the vehicles, we discovered a Mohr-type failure relationship. Regression analysis resulted in a very good fit for a power function, and predictions based on this relationship show excellent agreement with measured values (averaging within 7%) and hold considerable promise for the future. Version 2.0 of the shallow snow model contains this new traction algorithm.

The resistance algorithm used in SSM1.0 and SSM2.0 was compared with the data collected and poor agreement was observed. This is clearly the weakest part of the model and thus must be improved. An initial analysis of the resistance data was made and it appears that a simple empirical algorithm may be obtainable. These data may also be

used to assist in the development of a new analytical model; both approaches should be considered.

## LITERATURE CITED

- Abele, G.** (1970) Deformation of snow under rigid plates at a constant rate of penetration. USA Cold Regions Research and Engineering Laboratory, Research Report 273.
- Blaisdell, G.L. and R. A. Liston** (1989) Evaluation of the Caterpillar Challenger tractor for use in Antarctica. USA Cold Regions Research and Engineering Laboratory, Technical Note (unpublished)
- Blaisdell, G.L., E.C. Chamberlain and M. Mellor** (1987) Evaluation of the cold regions aspects of mobility and hardening of the mobile test bed at Malmstrom Air Force Base. Final report to U.S. Air Force Ballistic Missile Office.
- Liston, R.A.** (1974) Operation of the M151 1/4 ton truck in shallow snow. USA Cold Regions Research and Engineering Laboratory, Technical Note (unpublished).
- McClung, D.M.** (1977) Direct simple shear tests on snow and their relation to slab avalanche formation. *Journal of Glaciology*, **19**(18): 101–109.
- de Montmollin, V.** (1982) Shear tests on snow explained by fast metamorphism. *Journal of Glaciology*, **28**(98): 187–198.
- Mellor, M.** (1964) Properties of snow. USA Cold Regions Research and Engineering Laboratory, Cold Regions Science and Engineering Monograph III-A1.
- Willoughby, W.E.** (in prep.) Results of snow mobility test with the light armored vehicle. USA Waterways Experiment Station, Technical Report.
- Yong, R.N. and M. Fukue** (1977) Performance of snow under confined compression. *Journal of Terramechanics*, **14**(2): 59–82.
- Yong, R.N. and M. Fukue** (1978) Snow mechanics: Machine–snow interaction. In *Proceedings of the 2nd International Symposium on Snow Removal and Ice Control Research, 15–19 May, Hanover, N.H.* Transportation Research Board, Special Report 185, p. 9–13.

## APPENDIX A: SHALLOW SNOW MOBILITY MODEL, VERSION 1.0.

### DESCRIPTION

Motion resistance  $R_s$  is a function of the parameters that affect vehicle sinkage and the tendency to displace snow laterally. A partial list includes the load, contact pressure, snow strength and depth, and width of the tire or track. During the past 30 years, several resistance models have been proposed in the literature for deformable materials. With the goal of keeping SSM1.0 simple (i.e., a model that has a short list of input parameters that are easily obtained) and allowing it to address a broad range of vehicle and snow conditions, these resistance expressions were scrutinized. The vehicle data required by each of these expressions are similar from model to model, and are readily accessible. The snow data required to process any of these expressions, however, vary considerably. The only model that requires snow data that can be quickly and routinely obtained in the field is that of Liston (1974).

Liston assumes that a hyperbolic relationship exists between compacting pressure and volume. Applying energetics, he then integrates between the initial and final volumes of snow involved in compaction to obtain the work of snow compaction. This implicitly assumes that there is no bulldozing (displacement) of the snow. If there is no volume change, no work is done. Finally, the work of compaction is equated to motion resistance  $R_s$  times the horizontal distance traveled.

If we assume that lateral flow of the snow during compaction is insignificant (i.e., compaction is confined to the width of the tire or track), volume change in the snow can be expressed in terms of the sinkage  $z$ . Further, if the total mass of the snow does not change during compaction, then initial and final volumes of snow can be related to the initial and final densities of snow. We can then write

$$R_s = pbh \rho_o \left\{ \left[ \frac{1}{(\rho_f - \rho_o)} \right] \ln(\rho_f / \rho_o) - \left( 1 / \rho_f \right) \right\} \cdot \rho_o < \rho_f (z > 0) \tag{A1}$$

$$R_s = 0 \qquad \rho_o = \rho_f (z = 0)$$

where  $p$  = tire inflation pressure  
 $b$  = maximum tire or track width  
 $h$  = snow depth  
 $\rho_o$  = initial snow density (prior to tire or track passage)  
 $\rho_f$  = ending snow density (after tire passage)  
 $z$  = sinkage.

Driving traction is also a sum of the interaction of many snow and vehicle parameters. Those that were mentioned above for resistance still apply, along with more detailed features of the tire or track (e.g., tread pattern, tire or track "rubber" compound, grouser spacing and height, grouser or tread geometry). The number of traction models proposed in the literature is fewer than is the case for motion resistance. These models seem to fall into two categories—either they are very simplistic, lumping many parameters together into a few constants, or they are exceedingly detailed.

We assumed for SSM1.0 that the gross tractive force  $T_g$  in snow is developed by a tire or track through a combination of frictional forces and engaged snow shear strength developed in the tire/snow interface region. The magnitude of the frictional force at the interface is a function of the snow type and the tire tread compound. Shear forces are developed by the internal friction and cohesion of the snow.



Opting once again to keep the SSM1.0 simple, our traction model is based on the Mohr–Coulomb relationship for soil shear failure

$$s = c + \sigma \tan\phi , \tag{A2}$$

where  $s$  = shear strength at failure

$\sigma$  = normal stress

$c$  = cohesion

$\phi$  = internal angle of friction.

Use of this criterion for snow could be questioned, but Yong and Fukue (1978) present direct shear test data for snow that can be represented by eq A2 quite well. Additionally, eq A2 has been used as the basis for modeling traction for some time, and the more rigorous models of snow failure are far too complicated for the mobility model we sought.

For mobility purposes, eq A2 is rewritten in terms of forces. Multiplying through by area, we obtain

$$T_g = Ac + W \tan\phi \tag{A3}$$

where  $T_g$  is the highest possible gross traction attainable by a single driven tire or track, or the maximum shear strength available from the snow.  $A$  is the tire or track's contact area. Unfortunately, the snow strength parameters  $c$  and  $\phi$  are not readily available in all cases. Historically,  $c$  and  $\phi$  are determined from shear annulus (e.g., bevameter) test results using eq A2. It is also possible to obtain  $c$  and  $\phi$  from eq 1 and A3 using actual vehicle tests, where

net traction and motion resistance data are collected at two or more different inflation pressures or at two or more different normal loads, or both.

Using eq A3 for calculation of gross traction naturally limits SSM1.0's predictions to those cases where  $c$  and  $\phi$  data exist. Because of the paucity of these snow strength parameters for snow and questions about the reliability of  $c$  and  $\phi$  values obtained with a shear annulus, we sought a means of determining these parameters from snow data that were more readily available or predictable.

Since initial snow density is the most sophisticated of the simply and customarily measured snow properties, we attempted to relate the strength parameters  $c$  and  $\phi$  to this snow property. Each set of traction data available from CIV experiments conducted before 1986 was used to determine  $c$  and  $\phi$  values for each traction test. These values were subjected to a least squares regression analysis with initial snow density  $\rho_o$  as the independent parameter. Although considerable scatter was present in the  $c$  and  $\phi$  versus density plots, the SSM1.0 used the results of this regression analysis, which can be stated as (and shown in Fig. A1)

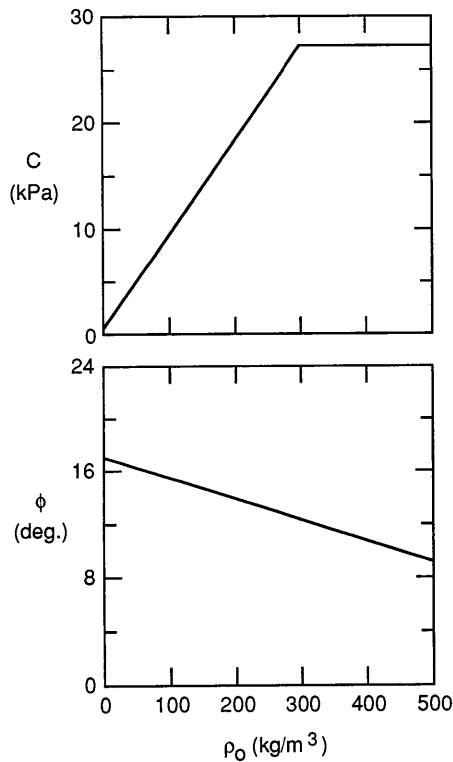

Figure A1. Relationship between snow strength and initial density as used in SSM1.0.

$$c = \left\{ \begin{array}{ll} 0.66 + 0.0887 \rho_o & 0 < \rho_o < 300 \\ 27.27 & 300 < \rho_o < 500 \end{array} \right\} \quad (A4)$$

$$\phi = 17.06 - 0.0163 \rho_o$$

where  $c$  is in kilopascals,  $\rho_o$  is in kilograms per cubic meter and  $\phi$  is in degrees.

The mobility expressions given by eq 1, A1 and A3 should be thought of for a single tire or traction element. For a mobility model to be flexible, neither the specific nor general configuration of a vehicle should be limited by the model. Being per tire or per track, the relationships for traction and resistance given here are used on the vehicle's tires or tracks, one at a time, in the SSM1.0 until all of the traction elements have been accounted for. In this way, tires or tracks with different loads, inflation pressures, sizes, configurations (dual or single, driven or free-wheeling), degree of tracking, and position on the vehicle are all accommodated for with one set of equations. Placed in a loop in SSM1.0, these expressions are used for each station, and a running sum for the whole vehicle is accumulated to produce a measure of the net performance of the vehicle. A station is defined here as a transverse section of the vehicle including a single set of wheels (single or dual tire) or tracks on each side of the vehicle (i.e., the vehicle is assumed to be symmetric about its longitudinal centerline).

Clearly, to apply the traction and resistance equations above to even a single tire or track, it is necessary that we calculate several parameters (as they are not readily known or measurable before or after the vehicle is in the field). In the determination of  $T_g$ , it is necessary to know the area of contact  $A$  between the tire or track and the snow. As will be apparent later, the sinkage of the tire or track is required to find  $A$ . To calculate  $R_s$ , initial and final densities associated with the passage of a tire or track are necessary. In the following paragraphs, we first describe how these parameters are determined and then proceed to show how the mobility equations are adapted for application to a whole vehicle in SSM1.0.

Contact area is determined using a simplistic approach where  $A$  is broken down into two regions. The flat area directly under the tire or track,  $A_2$ , is calculated from

$$A_2 = \left\{ \begin{array}{l} W/p \text{ (tire)} \\ b \ell \text{ (track)} \end{array} \right\} \quad (A5)$$

where  $\ell$  is the track length. The tire's sidewall strength has been ignored. The remainder of the area  $A_1$  is curved and occurs as a result of the tire's or track's sinkage into the snow. Using a geometric approach, this area can be found from the expression

$$A_1 = br \arccos \frac{r-z}{r} \quad (A6)$$

where  $r$  is the tire's radius or a theoretical radius for a tracked vehicle (Fig. A2). The total contact area  $A$  is the sum of these two components; obviously, tires or tracks that exhibit no sinkage have no curved contact area component.

Using eq A5 and A6 to calculate  $A$ , we must know, at each station, the vehicle parameters  $p$ ,  $W$  (for wheeled vehicles only),  $\ell$  (for tracked vehicles only), and  $b$  and  $r$  of the tire or track. For the snow, it is required that we know  $z$ . To determine sinkage, it is assumed that compaction (within the realm of loads that are most common for vehicles) only occurs in the vertical dimension. First, we claim that the maximum sinkage  $z_{\text{final}}$  that will occur as the result of vehicle passage can be calculated from

$$z_{\text{final}} = h_o \left(1 - \frac{\rho_o}{\rho_f}\right), \quad (\text{A7})$$

where  $h_o$  = depth of the virgin snow

$\rho_f$  = maximum or final density (Yong and Fukue 1977) in any rut following vehicle passage.

It is reasonable to believe that  $z_{\text{final}}$  and thus  $\rho_f$  will occur under the tire or track applying the largest ground pressure;  $\rho_f$  is thus determined in the SSM1.0 based on the highest pressure ( $p_{\text{max}}$ ) exerted by any tire or track on the vehicle. Four major categories were defined (based on experience) as follows:

Max. ground pressure (kPa)	Final density (kg/m <sup>3</sup> )
< 210	500
211 – 350	550
351 – 700	600
> 701	650

Intermediate values of sinkage  $z$ , for tires or tracks with inflation or contact pressures ( $p$ ) less than  $p_{\text{max}}$ , were determined by applying the ratio of ( $p/p_{\text{max}}$ ) to  $z_{\text{final}}$ . Since the pressure–sinkage relationship is obviously not linear for compressible snow ( $\rho_o < 500 \text{ kg/m}^3$ ) (Abele 1970), we assume that a power function relates ground pressure to sinkage. The SSM1.0 calculates sinkage (referenced to the original snow depth  $h_o$ ) for a given station from

$$z = z_{\text{final}} (p/p_{\text{max}})^{0.5} \quad (\text{A8})$$

(see Mellor 1964, Fig. III-34).

The sinkage  $z_i$ , at a given station  $i$  on the vehicle, can then be calculated from (Fig. A3)

$$z_i = z_{\text{final}} (p_i/p_{\text{max}})^{0.5} - \sum_{j=1}^{i-1} z_j \quad ((p_i > p_{i-1}, p_{i-2} \dots)) \quad (\text{A9})$$

$$z_i = 0 \quad (p_i \leq p_{i-1}, p_{i-2} \dots)$$

We now have all of the parameters necessary to calculate  $T_g$  using eq A3 (i.e.,  $W, p$  [or  $\ell$ ],  $b, r, z, c$  and  $\phi$ ).

Recognizing that the snow properties are different in the flat and curved portions of the contact zone, we divide the traction equation into two parts

$$T_1 = A_{1i} c_{i-1} + A_{2i} c_i + \frac{A_{1i}}{A_i} W_i \tan \phi_{i-1} + \frac{A_{2i}}{A_i} W_i \tan \phi_i \quad (\text{A10})$$

where  $c_{i-1}$  and  $\phi_{i-1}$  are the snow strength parameters for the snow in the curved contact region  $A_{1i}$ , and  $c_i$  and  $\phi_i$  are for the snow directly under the tire or track at station  $i$  (Fig. A3). Equations A4 are used with  $\rho_{i-1}$  to obtain  $c_{i-1}$  and  $\phi_{i-1}$ , and with  $\rho_i$  to get  $c_i$  and  $\phi_i$ . This expression assumes that the normal load supported by  $A_{1i}$  is proportional to the ratio of that area to the total area  $A_i$ . The load on  $A_{2i}$  is treated similarly.

To calculate motion resistance  $R_s$  we need to know the intermediate values of snow density as compaction progresses from initial density  $\rho_o$  to  $\rho_f$ . We have already stated that  $\rho_f$  is associated with maximum sinkage  $z = z_{\text{max}}$  and  $\rho_o$  corresponds to a sinkage of  $z = 0$ . Recalling eq A7, and the assumptions that it is based on, we can find the density beneath a particular station  $i$  from

$$\rho_i = \frac{\rho_{i-1}}{1 - (z_i/h_{i-1})} \quad (\text{A11})$$

where  $\rho_{i-1}$  and  $h_{i-1}$  are the snow density and depth prior to the passage of the tire or track at station  $i$ , and  $z_i$  (eq A9) is the sinkage produced at this station (Fig. A3).

Lastly, we recognize that not all of the tires or tracks on a particular vehicle may be traveling in undisturbed snow. Some tires or tracks may follow exactly in the path of a preceding element, or may operate in undisturbed snow (e.g., a narrow or wide trailer behind a vehicle) or may encounter both compacted and uncompacted snow (e.g., dual tires following a single tire). We need then to account for the possibility of tires (tracks) having some percentage ( $\alpha$ ) of their width compacting new snow while the remainder is traveling in a previously created rut. The equations for  $A_1$ ,  $R_s$  and  $T_g$  are therefore modified to become

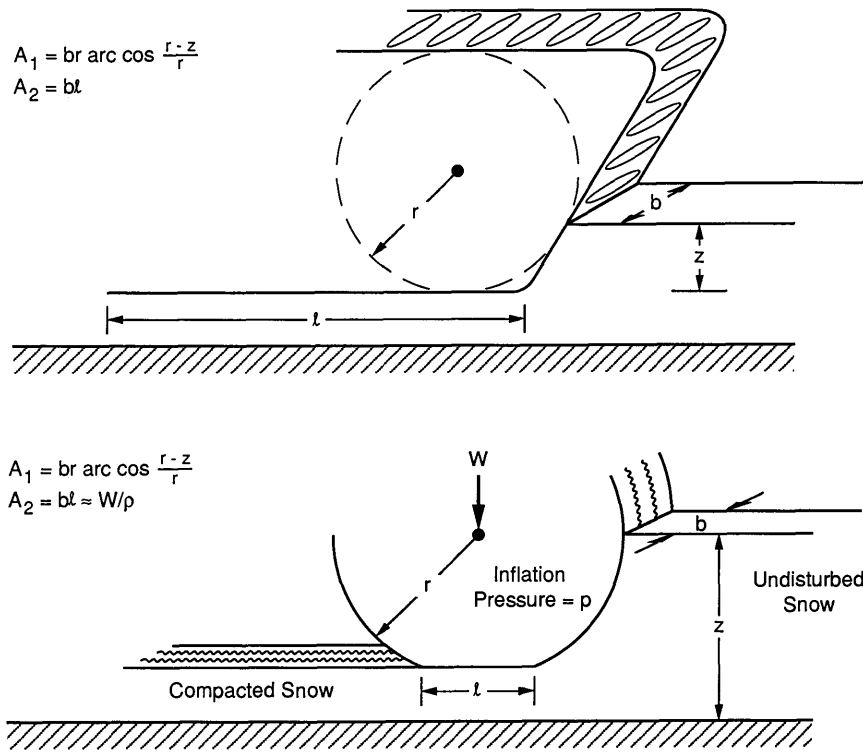

Figure A2. Tire and track contact areas for SSM1.0.

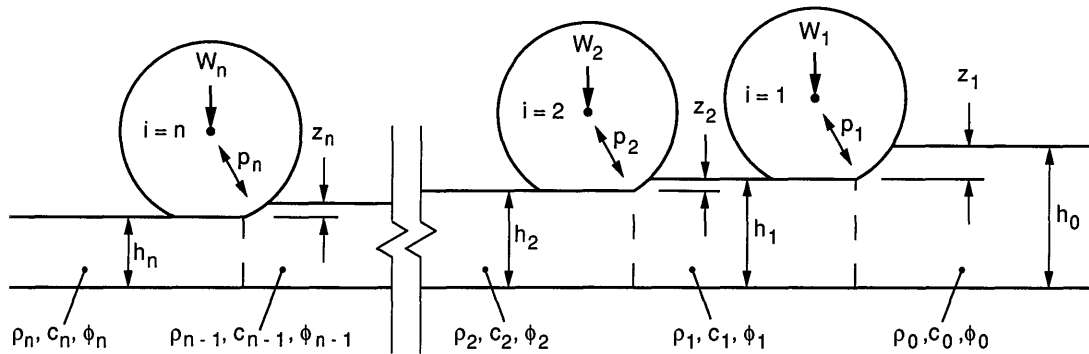

Figure A3. Depiction of progressive change in snow parameters with tire or track passage.

$$A_{1i} = \alpha \left[ b_i r_i \arccos \left( \frac{r_i - \sum_{j=1}^i z_j}{r_i} \right) \right] + (1 - \alpha) \left[ b_i r_i \arccos \left( \frac{r_i - z_i}{r_i} \right) \right] \quad (\text{A12})$$

$$R_{Si} = \alpha \left[ p_i b_i h_o \rho_o \left( \frac{1}{\rho_i - \rho_o} \ln \frac{\rho_i}{\rho_o} - \frac{1}{\rho_i} \right) \right]$$

$$+ (1 - \alpha) \left[ p b_i h_{i-1} \rho_{i-1} \left( \frac{1}{\rho_i - \rho_{i-1}} \ln \frac{\rho_i}{\rho_{i-1}} - \frac{1}{\rho_i} \right) \right] \quad \rho_i > \rho_{i-1}$$

$$R_{Si} = \alpha \left[ p_i b_i h_o \rho_o \left( \frac{1}{\rho_i - \rho_o} \ln \frac{\rho_i}{\rho_o} - \frac{1}{\rho_i} \right) \right] \quad \rho_i = \rho_{i-1} > \rho_o$$

$$R_{Si} = 0 \quad \rho_i = \rho_o \quad (\text{A13})$$

$$T_{gi} = A_{2i} c_i + \left( \frac{A_{2i}}{A_i} W_i \right) \tan \phi_i + \alpha \left[ A_{1i} c_o + \left( \frac{A_{1i}}{A_i} W_i \right) \tan \phi_o \right]$$

$$+ (1 - \alpha) \left[ A_{1i} c_{i-1} + \left( \frac{A_{1i}}{A_i} W_i \right) \tan \phi_{i-1} \right] \quad (\text{A14})$$

for each station. Equations A13 and A14 provide the essence of the SSM1.0. These equations are executed for each station of the vehicle and a running sum for traction and resistance accumulated. The ultimate ability of the vehicle to move (total net traction,  $T_n$ ) is then determined from

$$T_n = \sum_{i=1}^n (T_{gi} - R_{Si}) \quad (\text{A15})$$

where  $n$  is the number of tires or tracks on the vehicle. If  $T_n$  is positive, the vehicle is mobile and has the capacity to accelerate, climb hills or pull a payload in proportion with the magnitude of  $T_n$ . A value of zero indicates impending immobilization, and a negative value of  $T_n$  predicts a definite no-go situation. A copy of the SSM1.0, in HP Basic computer code is contained in the next section, along with the output from sample runs, and a flow chart is provided in Figure A4.

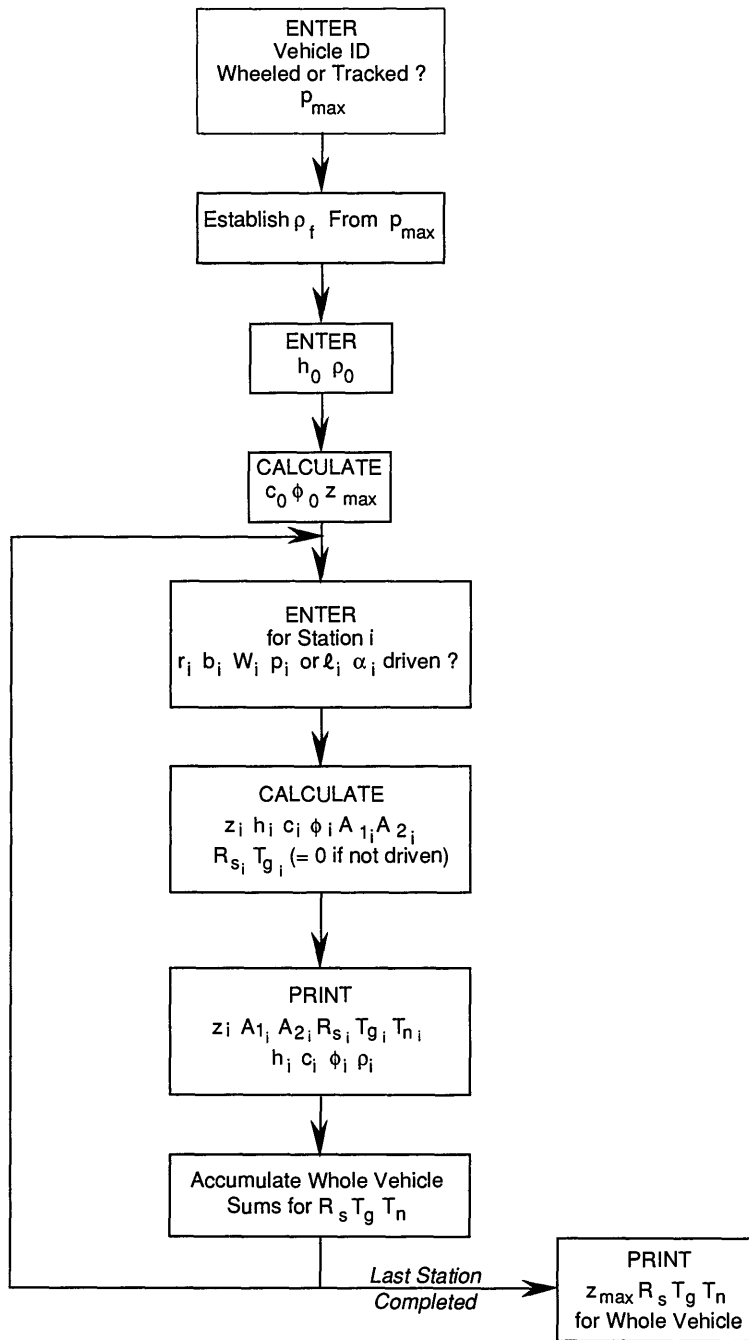

Figure A4. Flow chart for SSM1.0.

## COMPUTER CODE AND SAMPLE OUTPUT

```

10 !
20 !   SSM/1.01
30 !           (trig tr sinkage and snow density function of cont. pr.)
40 !           (manual input of all vehicle and snow data)
50 !           (Liston's resis; best-fit c, phi, two-area traction)
60 !
70 net=0
80 RR=0
90 DB=0
100 go=0
110 pl=0
120 z=0
130 sumz=0
140 DISP "vehicle?"
150 INPUT Veh$
160 DISP "wheeled (w) or tracked (t)?"
170 INPUT type$
180 DISP "highest station ground pressure (kPa)="
190 INPUT pmax
200 pmax=pmax*0.1 ! convert from kPa to N/cm^2
210 !
220 ! ** establish final density based on largest footprint pressure **
230 sigmaf=0.5
240 IF pmax>21 THEN sigmaf=0.55
250 IF pmax>35 THEN sigmaf=0.6
260 IF pmax>70 THEN sigmaf=0.65
270 !
280 DISP "snow depth (cm) ="
290 INPUT h0
300 DISP "snow density (g/cm^3) ="
310 INPUT sigma0
320 sigma1=sigma0
330 sigma2=sigma0
340 h1=h0
350 !
360 PRINT "Vehicle: ";Veh$
370 PRINT " "
380 PRINT USING format1 ; "initial state:  snow depth =";h0;" cm"
390 PRINT USING format2 ; "                snow density =";sigma0;" g/cm^3"
400 !
410   zmax=h0*(1-sigma0/sigmaf) ! calculate maximum sinkage
420   IF zmax<0 THEN zmax=0
430 !
440 ! ** calculate snow's cohesion based on the initial snow density **
450   coh0=0.666+88.7*sigma0
460   coh0=coh0*1000 ! convert from kPa to Pa
470   IF coh0>27270 THEN coh0=27270 ! clip high cohesion values
480 !
490 ! ** calculate snow's angle of friction based on initial density **
500   phi0=17.06-16.3*sigma0
510   phi0=phi0*(PI/180) ! convert from degrees to radians
520 !
530   coh1=coh0
540   phi1=phi0
550   coh2=coh0
560   phi2=phi0
570 !
580 RAD ! compute in radians units for trig functions
590 !
600 PRINT " "
610 PRINT USING format1 ; "                cohesion = ";coh0;" N/m^2 (Pa)"
620 PRINT USING format2 ; "                angle of friction = ";phi0;" radians"
"
630 PRINT " "
640 !
650 ! ** enter vehicle data one tire station at a time **

```

```

660 DISP "how many wheel or track stations on each side of the vehicle?"
670 INPUT N
680 !
690 FOR I=1 TO N
700 DISP ""
710 DISP "station ";I
720 DISP "wheel radius or approx radius of compacting portion of track cm) ="
730 INPUT rads
740 DISP "single tire or track width at this location (cm) ="
750 INPUT wid
760 DISP "single tire or track load (N) ="
770 INPUT loa
780 IF type$="t" THEN GOTO skip1
790 DISP "inflation pressure (kPa) ="
800 INPUT pres
810 pres=pres*0.1 ! convert from kPa to N/cm^2
820 GOTO skip2
830 !
840 skip1: DISP "length of flat portion of track (cm)"
850 INPUT t1
860 pres=loa/(t1*wid) ! calculate ground pressure in N/cm^2
870 !
880 skip2: DISP "driven?"
890 INPUT r$
900 IF type$="t" THEN GOTO skip3
910 DISP "duals ?"
920 INPUT R$
930 IF R$<>"y" AND R$<>"Y" THEN GOTO 970
940 wid=wid*2
950 loa=loa*2
960 !
970 skip3: DISP "percent of width compacting virgin snow (%)"
980 INPUT prcnt
990 !
1000 IF pres>p1 AND sigma2<sigmaf THEN GOTO 1060 ! check for added sink. here
1010 z=0
1020 tempres=0
1030 IF prcnt>0 AND sigma2>sigma0 THEN GOTO 1180
1040 resis=0
1050 GOTO 1240
1060 z=(pres/pmax)^0.5*zmax-sumz ! calculate additional sinkage this station
1070 !
1080 ! ** set rut bottom values **
1090 h2=h1-z
1100 sigma2=sigma1/(1-z/h1)
1110 phi2=(17.06-16.3*sigma2)*(PI/180)
1120 coh2=(0.666+88.7*sigma2)*1000
1130 IF coh2>27270 THEN coh2=27270 ! clip high cohesion values
1140 !
1150 ! ** calculate resistance parameter **
1160 tempres=1/(sigma2-sigma1)*LOG(sigma2/sigma1)-1/sigma2 ! in rut
1170 !
1180 ! ** calculate motion resistance at this station **
1190 resis=prcnt/100*(pres*wid*h0*sigma0) ! in virgin snow
1200 resis=resis*(1/(sigma2-sigma0)*LOG(sigma2/sigma0)-1/sigma2) !virgin snow
1210 moreres=tempres*(1-prcnt/100)*(pres*wid*h1*sigma1) ! in rut
1220 resis=resis+mores
1230 !
1240 ! ** calculate area in contact with the snow **
1250 areal=prcnt/100*(wid*rads*ACS((rads-(sumz+z))/rads)) ! in virgin snow
1260 areal=areal+(1-prcnt/100)*(wid*rads*ACS((rads-z)/rads)) ! in cm^2
1270 areal=areal/100^2 ! convert to m^2
1280 area2=loa/pres ! in cm^2
1290 area2=area2/100^2 ! convert to m^2
1300 area=areal+area2
1310 !
1320 ! ** calculate gross traction at this station **
1330 trac=areal*coh1+area2*coh2

```



```

1340 trac=trac+area1/area*loa*TAN(phi1)+area2/area*loa*TAN(phi2)
1350 IF type$="t" THEN GOTO 1380 ! negate first time adjustment
1360 IF I=1 THEN trac=area*coh1+loa*TAN(phi1) ! no rut bottom adjustment
1370 !
1380 IF r$="n" OR r$="N" THEN trac=0 ! no traction if not driven
1390 !
1400 ! ** double to account for both sides of the vehicle **
1410 area=2*area
1420 trac=2*trac
1430 resis=2*resis
1440 !
1450 ! ** print output for this station **
1460 a1=2*area1 ! for printout
1470 a2=2*area2 ! for printout
1480 PRINT " "
1490 PRINT "station ";I
1500 PRINT USING format1 ; " additional sinkage =";z;" cm"
1510 PRINT USING format2 ; " total area=";area;" m^2 (curved =";a1;" ,flat =";a2;)"
1520 PRINT USING format1 ; " snow resis =";resis;" N"
1530 PRINT USING format1 ; " snow trac =";trac;" N"
1540 !
1550 ! ** running summation for whole vehicle **
1560 RR=RR+resis ! sum for whole vehicle
1570 DB=DB+trac ! sum for whole vehicle
1580 net=trac-resis ! calculate net traction for individual station
1590 PRINT USING format1 ; " net snow traction for station = ";net;" N"
1600 PRINT USING format1 ; " rut bottom: depth=";h2;" cm"
1610 PRINT USING format2 ; " density=";sigma2;" g/cm^3"
1620 PRINT USING format1 ; " cohesion=";coh2;" N/m^2"
1630 PRINT USING format2 ; " friction=";phi2;" radians"
1640 go=go+net ! sum net traction for vehicle
1650 !
1660 ! ** save last station values for next iteration **
1670 IF pres>p1 THEN p1=pres
1680 sigma1=sigma2
1690 h1=h2
1700 sumz=sumz+z
1710 coh1=coh2
1720 phi1=phi2
1730 !
1740 NEXT I
1750 !
1760 ! ** calculate mobility in English units for output **
1770 eRR=RR/4.448222
1780 eDB=DB/4.448222
1790 ego=go/4.448222
1800 ez=sumz/2.54
1810 !
1820 ! ** print out whole vehicle results **
1830 PRINT " "
1840 PRINT " "
1850 PRINT USING format1 ; " total sinkage for vehicle= ";sumz;" cm (";ez;" in
)"
1860 PRINT USING format1 ; " total snow resistance = ";RR;" N (";eRR;" lb)"
1870 PRINT USING format1 ; " total snow traction =";DB;" N (";eDB;" lb)"
1880 PRINT " "
1890 PRINT USING format1 ; " net traction for vehicle = ";go;" N (";ego;" lb)"
1900 PRINT " "
1910 PRINT " "
1920 PRINT " "
1930 !
1940 format1: IMAGE 3(K,DDDDDD.DD)
1950 format2: IMAGE 3(K,DZ.DDDD)
1960 !
1970 END

```

Vehicle: HMMWV

initial state: snow depth = 5.00 cm  
snow density = 0.5500 g/cm<sup>3</sup>

cohesion = 27270.00 N/m<sup>2</sup> (Pa)  
angle of friction = 0.1413 radians

station 1

additional sinkage = 0.00 cm  
total area= 0.1048 m<sup>2</sup> (curved = 0.0000 ,flat = 0.1048)  
snow resis = 0.00 N  
snow trac = 4915.01 N

net snow traction for station = 4915.01 N

rut bottom: depth= 0.00 cm  
density= 0.5500 g/cm<sup>3</sup>  
cohesion= 27270.00 N/m<sup>2</sup>  
friction= 0.1413 radians

station 2

additional sinkage = 0.00 cm  
total area= 0.1252 m<sup>2</sup> (curved = 0.0000 ,flat = 0.1252)  
snow resis = 0.00 N  
snow trac = 6115.90 N

net snow traction for station = 6115.90 N

rut bottom: depth= 0.00 cm  
density= 0.5500 g/cm<sup>3</sup>  
cohesion= 27270.00 N/m<sup>2</sup>  
friction= 0.1413 radians

total sinkage for vehicle= 0.00 cm ( 0.00 in)  
total snow resistance = 0.00 N ( 0.00 lb)  
total snow traction = 11030.92 N ( 2479.85 lb)

net traction for vehicle = 11030.92 N ( 2479.85 lb)

Vehicle: HEMTT (241/276)

initial state: snow depth = 25.00 cm  
snow density = 0.2200 g/cm<sup>3</sup>  
  
cohesion = 20180.00 N/m<sup>2</sup> (Pa)  
angle of friction = 0.2352 radians

station 1  
additional sinkage = 14.03 cm  
total area= 0.6517 m<sup>2</sup> (curved = 0.3947 ,flat = 0.2570)  
snow resis = 11515.55 N  
snow trac = 28007.95 N  
net snow traction for station = 16492.41 N  
rut bottom: depth= 10.97 cm  
density= 0.5014 g/cm<sup>3</sup>  
cohesion= 27270.00 N/m<sup>2</sup>  
friction= 0.1551 radians

station 2  
additional sinkage = 0.00 cm  
total area= 0.2608 m<sup>2</sup> (curved = 0.0000 ,flat = 0.2608)  
snow resis = 0.00 N  
snow trac = 16949.49 N  
net snow traction for station = 16949.49 N  
rut bottom: depth= 10.97 cm  
density= 0.5014 g/cm<sup>3</sup>  
cohesion= 27270.00 N/m<sup>2</sup>  
friction= 0.1551 radians

station 3  
additional sinkage = .97 cm  
total area= 0.3636 m<sup>2</sup> (curved = 0.1040 ,flat = 0.2595)  
snow resis = 1230.94 N  
snow trac = 20383.43 N  
net snow traction for station = 19152.48 N  
rut bottom: depth= 10.00 cm  
density= 0.5500 g/cm<sup>3</sup>  
cohesion= 27270.00 N/m<sup>2</sup>  
friction= 0.1413 radians

station 4  
additional sinkage = 0.00 cm  
total area= 0.2613 m<sup>2</sup> (curved = 0.0000 ,flat = 0.2613)  
snow resis = 0.00 N  
snow trac = 17374.44 N  
net snow traction for station = 17374.44 N  
rut bottom: depth= 10.00 cm  
density= 0.5500 g/cm<sup>3</sup>  
cohesion= 27270.00 N/m<sup>2</sup>  
friction= 0.1413 radians

total sinkage for vehicle= 15.00 cm ( 5.91 in)  
total snow resistance = 12746.49 N ( 2865.52 lb)  
total snow traction = 82715.30 N ( 18595.14 lb)  
  
net traction for vehicle = 69968.82 N ( 15729.61 lb)

Vehicle: SUSV

initial state: snow depth = 9.00 cm  
snow density = 0.1480 g/cm<sup>3</sup>  
  
cohesion = 13793.60 N/m<sup>2</sup> (Pa)  
angle of friction = 0.2556 radians

station 1  
additional sinkage = 6.35 cm  
total area= 2.5505 m<sup>2</sup> (curved = 0.2280 ,flat = 2.3226)  
snow resis = 313.84 N  
snow trac = 71574.85 N  
net snow traction for station = 71261.01 N  
rut bottom: depth= 2.65 cm  
density= 0.5024 g/cm<sup>3</sup>  
cohesion= 27270.00 N/m<sup>2</sup>  
friction= 0.1548 radians

station 2  
additional sinkage = 0.00 cm  
total area= 2.3226 m<sup>2</sup> (curved = 0.0000 ,flat = 2.3226)  
snow resis = 0.00 N  
snow trac = 68106.12 N  
net snow traction for station = 68106.12 N  
rut bottom: depth= 2.65 cm  
density= 0.5024 g/cm<sup>3</sup>  
cohesion= 27270.00 N/m<sup>2</sup>  
friction= 0.1548 radians

total sinkage for vehicle= 6.35 cm ( 2.50 in)  
total snow resistance = 313.84 N ( 70.55 lb)  
total snow traction =139680.97 N ( 31401.53 lb)  
  
net traction for vehicle = 139367.14 N ( 31330.98 lb)

## APPENDIX B: TEST VEHICLE DATA

CIV, 179 kPa WHEELED  
 GVW = 24696.4 N  
 MAXIMUM GROUND (INFLATION) PRESSURE 179.30 kPa  
 AVERAGE HARD SURFACE CONTACT AREA 0.028 m<sup>2</sup>

STATION	RADIUS (cm)	WIDTH (cm)	WEIGHT PER		TIRE		NEW SNOW
			WHEEL (N)	PRES. (kPa)	DRIVEN	DUALS	
1	35.6	25.4	6174.1	179.3	Y	N	100
2	35.6	25.4	6174.1	179.3	N	N	0

CIV, 103 kPa WHEELED  
 GVW = 24696.4 N  
 MAXIMUM GROUND (INFLATION) PRESSURE 110.30 kPa  
 AVERAGE HARD SURFACE CONTACT AREA 0.0345 m<sup>2</sup>

STATION	RADIUS (cm)	WIDTH (cm)	WEIGHT PER		TIRE		NEW SNOW
			WHEEL (N)	PRES. (kPa)	DRIVEN	DUALS	
1	34.9	26.7	6174.1	110.3	Y	N	100
2	34.9	26.7	6174.1	110.3	N	N	0

HEMTT, 207/276 kPa WHEELED  
 GVW = 268560.1 N  
 MAXIMUM GROUND (INFLATION) PRESSURE 275.80 kPa  
 AVERAGE HARD SURFACE CONTACT AREA 0.149 m<sup>2</sup>

STATION	RADIUS (cm)	WIDTH (cm)	WEIGHT PER		TIRE		NEW SNOW
			WHEEL (N)	PRES. (kPa)	DRIVEN	DUALS	
1	61.7	46.5	31004.0	241.3	Y	N	100
2	61.7	46.5	31459.9	241.3	Y	N	0
3	61.7	47.5	35785.8	275.8	Y	N	0
4	61.7	47.5	36030.4	275.8	Y	N	0

HEMTT, 138/207 kPa WHEELED  
 GVW = 268560.1 N  
 MAXIMUM GROUND (INFLATION) PRESSURE 206.80 kPa  
 AVERAGE HARD SURFACE CONTACT AREA 0.171 m<sup>2</sup>

STATION	RADIUS (cm)	WIDTH (cm)	WEIGHT PER		TIRE		NEW SNOW
			WHEEL (N)	PRES. (kPa)	DRIVEN	DUALS	
1	58.9	48.9	31004.0	137.9	Y	N	100
2	58.9	48.9	31459.9	137.9	Y	N	0
3	58.9	48.3	35785.8	206.8	Y	N	0
4	58.9	48.3	36030.4	206.8	Y	N	0

HMMWV, 138/152 kPa WHEELED  
 GVW = 33450.5 N  
 MAXIMUM GROUND (INFLATION) PRESSURE 151.70 kPa  
 AVERAGE HARD SURFACE CONTACT AREA 0.074 m<sup>2</sup>

STATION	RADIUS (cm)	WIDTH (cm)	WEIGHT PER		TIRE		NEW SNOW
			WHEEL (N)	PRES. (kPa)	DRIVEN	DUALS	
1	42.9	32.0	7228.3	137.9	Y	N	100
2	42.9	33.0	9496.9	151.7	Y	N	0

LAV, (12.5X20) 207 kPa WHEELED  
 GVW = 125483.7 N  
 MAXIMUM GROUND (INFLATION) PRESSURE 206.80 kPa  
 AVERAGE HARD SURFACE CONTACT AREA 0.100 m<sup>2</sup>

STATION	RADIUS (cm)	WIDTH (cm)	WEIGHT PER		TIRE		NEW SNOW	
			WHEEL (N)	PRES. (kPa)	DRIVEN	DUALS	PERCENT	
1	44.5	35.3	16102.5	206.8	Y	N	100	
2	44.5	35.3	17281.3	206.8	Y	N	0	
3	44.5	35.3	14501.1	206.8	Y	N	0	
4	44.5	35.3	14857.0	206.8	Y	N	0	

LAV,(12.5X20) 103 kPa WHEELED  
 GVW = 125483.7 N  
 MAXIMUM GROUND (INFLATION) PRESSURE 103.40 kPa  
 AVERAGE HARD SURFACE CONTACT AREA 0.141 m<sup>2</sup>

STATION	RADIUS (cm)	WIDTH (cm)	WEIGHT PER		TIRE		NEW SNOW	
			WHEEL (N)	PRES. (kPa)	DRIVEN	DUALS	PERCENT	
1	41.4	37.8	16102.5	103.4	Y	N	100	
2	41.4	37.8	17281.3	103.4	Y	N	0	
3	41.4	37.8	14501.1	103.4	Y	N	0	
4	41.4	37.8	14857.0	103.4	Y	N	0	

LAV,(11X16) 289 kPa WHEELED  
 GVW = 119634.3 N  
 MAXIMUM GROUND (INFLATION) PRESSURE 289.60 kPa  
 AVERAGE HARD SURFACE CONTACT AREA 0.058 m<sup>2</sup>

STATION	RADIUS (cm)	WIDTH (cm)	WEIGHT PER		TIRE		NEW SNOW	
			WHEEL (N)	PRES. (kPa)	DRIVEN	DUALS	PERCENT	
1	43.4	31.4	15346.3	289.6	Y	N	100	
2	43.4	31.4	16480.6	289.6	Y	N	0	
3	43.4	31.4	13822.8	289.6	Y	N	0	
4	43.4	31.4	14167.5	289.6	Y	N	0	

LAV,(11X16) 165 kPa WHEELED  
 GVW = 119634.3 N  
 MAXIMUM GROUND (INFLATION) PRESSURE 165.50 kPa  
 AVERAGE HARD SURFACE CONTACT AREA 0.102 m<sup>2</sup>

STATION	RADIUS (cm)	WIDTH (cm)	WEIGHT PER		TIRE		NEW SNOW	
			WHEEL (N)	PRES. (kPa)	DRIVEN	DUALS	PERCENT	
1	41.7	33.2	15346.3	165.5	Y	N	100	
2	41.7	33.2	16480.6	165.5	Y	N	0	
3	41.7	33.2	13822.8	165.5	Y	N	0	
4	41.7	33.2	14167.5	165.5	Y	N	0	

SUSV TRACKED  
 GVW = 61340.7 N  
 MAXIMUM GROUND (INFLATION) PRESSURE 13.20 kPa  
 AVERAGE HARD SURFACE CONTACT AREA 1.180 m<sup>2</sup>

STATION	RADIUS (cm)	WIDTH (cm)	WEIGHT PER		TRACK		NEW SNOW	
			TRACK (N)	LENGTH (cm)	PERCENT			
1	26.40	60.96	15390.80	190.50	100.00			
2	26.40	60.96	15279.60	190.50	0.00			

M113 TRACKED  
 GVW = 104087.9 N  
 MAXIMUM GROUND (INFLATION) PRESSURE 51.02 kPa  
 AVERAGE HARD SURFACE CONTACT AREA 1.020 m<sup>2</sup>

STATION	RADIUS (cm)	WIDTH (cm)	WEIGHT PER		TRACK		NEW SNOW	
			TRACK (N)	LENGTH (cm)	PERCENT			
1	36.80	38.10	52043.50	266.70	100.00			

BRADLEY TRACKED  
 GVW = 223299.6 N  
 MAXIMUM GROUND (INFLATION) PRESSURE 53.09 kPa  
 AVERAGE HARD SURFACE CONTACT AREA 2.090 m<sup>2</sup>

STATION	RADIUS (cm)	WIDTH (cm)	WEIGHT PER TRACK (N)	TRACK LENGTH (cm)	NEW SNOW PERCENT
1	35.60	53.34	111649.75	391.20	100.00

5-TON, 207 kPa WHEELED  
 GVW = 105778.2 N  
 MAXIMUM GROUND (INFLATION) PRESSURE 206.80 kPa  
 AVERAGE HARD SURFACE CONTACT AREA 0.171 m<sup>2</sup>

STATION	RADIUS (cm)	WIDTH (cm)	WEIGHT PER WHEEL (N)	TIRE PRES. (kPa)	DRIVEN	DUALS	NEW SNOW PERCENT
1	55.4	40.8	23842.4	206.8	Y	N	100
2	55.4	39.2	14523.4	206.8	Y	N	0
3	55.4	39.2	14523.4	206.8	Y	N	0

APPENDIX C: SELECTED TEST DATA

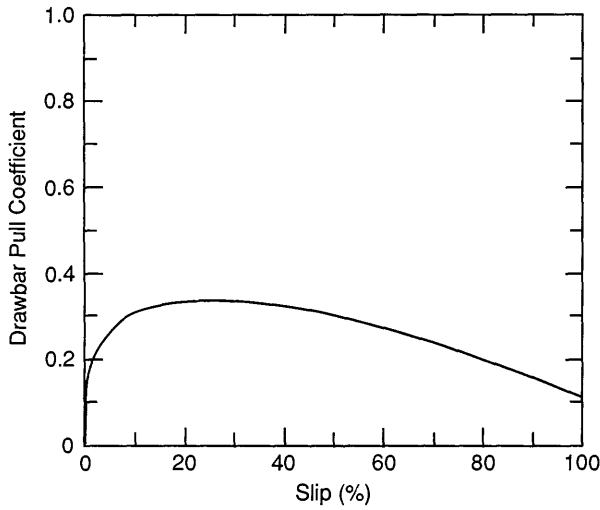

Figure C1. HMMWV on hard-packed snow, 26 January 1988.

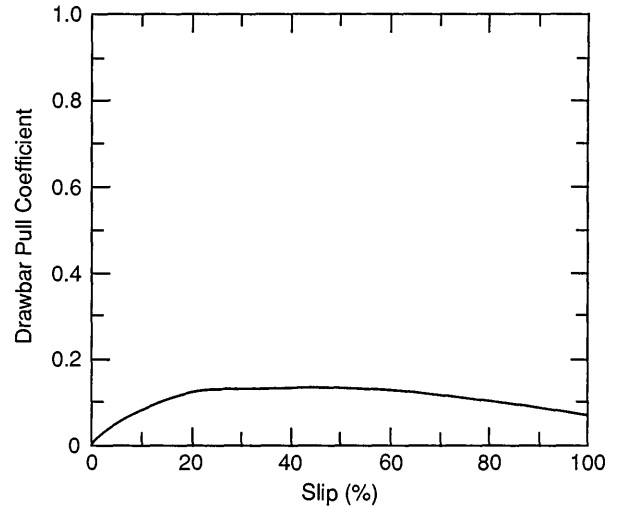

Figure C2. HMMWV on old snow, 10 February 1988.

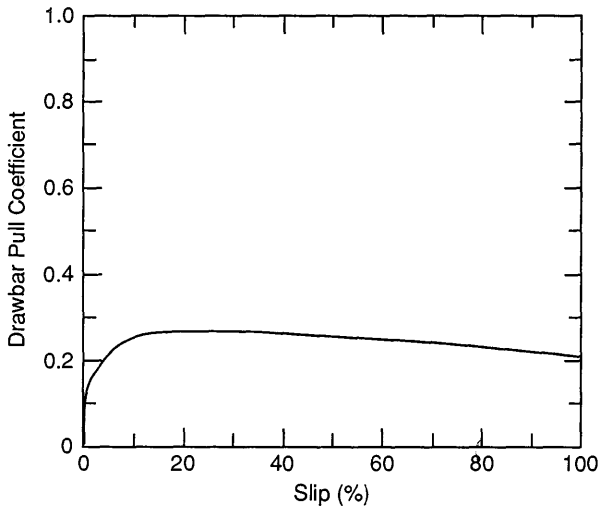

Figure C3. HMMWV on old snow, 10 February 1988.

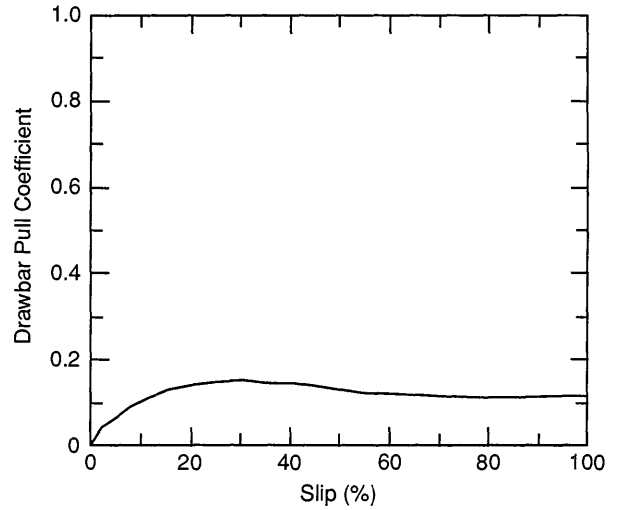

Figure C4. HMMWV on new snow, 13 February 1988.

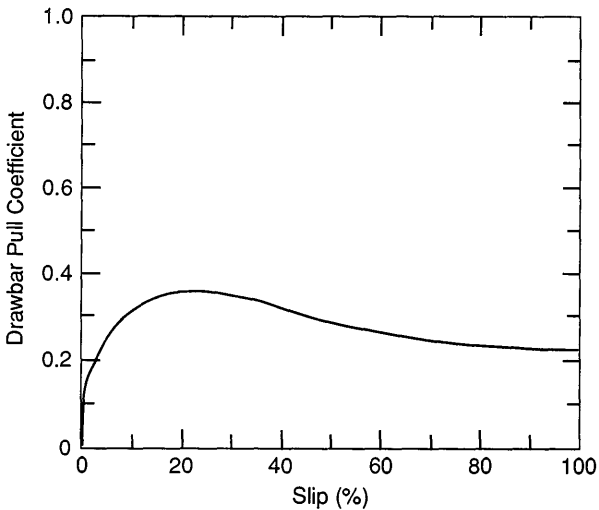

Figure C5. LAV on hard-packed snow, 21 January 1988.

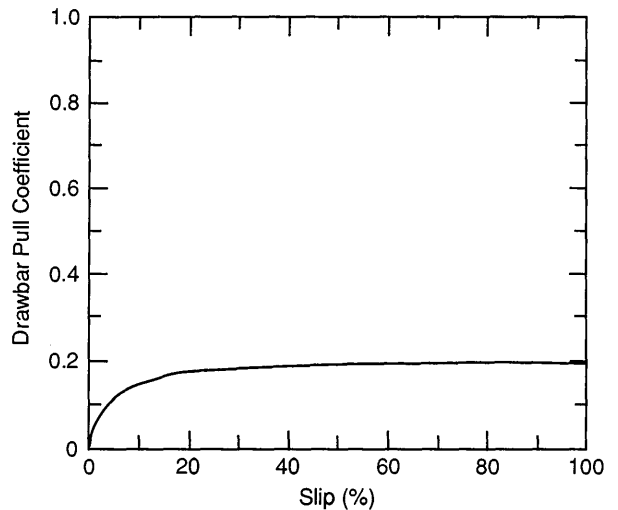

Figure C6. LAV on old snow, 28 January 1988.



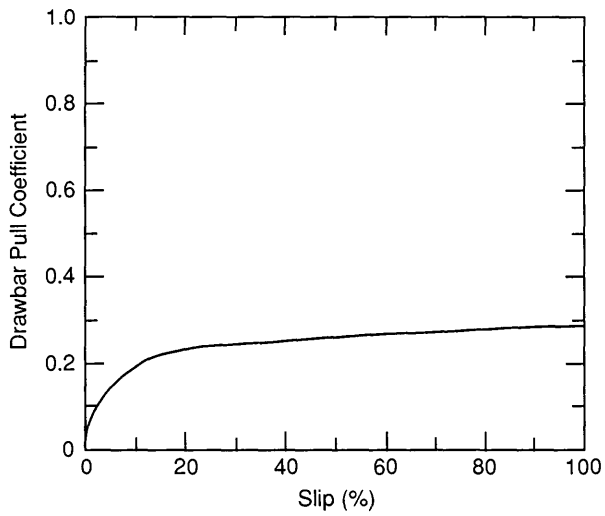

Figure C7. LAV on old snow, 13 February 1988.

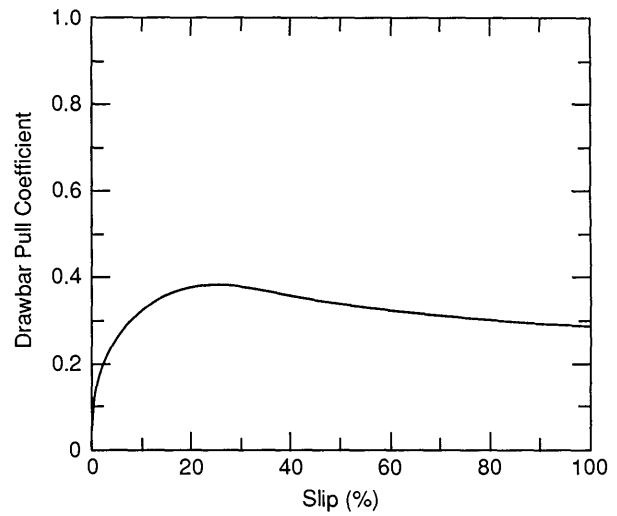

Figure C8. LAV on fresh snow, 15 February 1988.

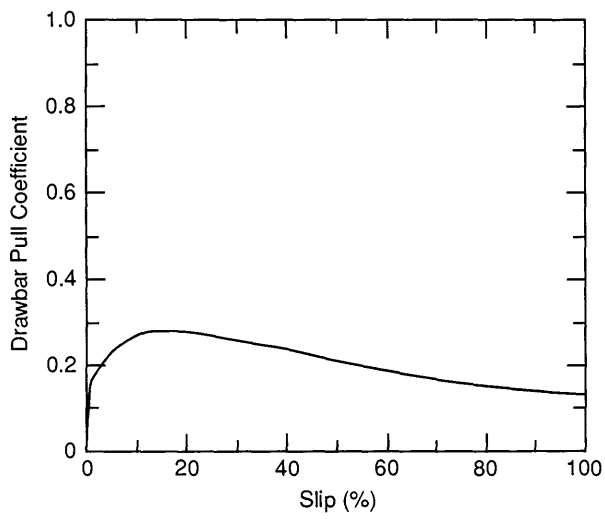

Figure C9. HEMTT on hard-packed snow, 23 January 1988.

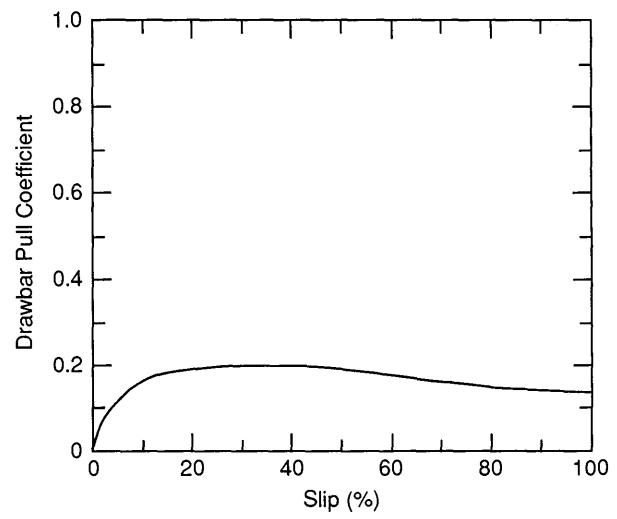

Figure C10. HEMTT on old snow, 11 February 1988.

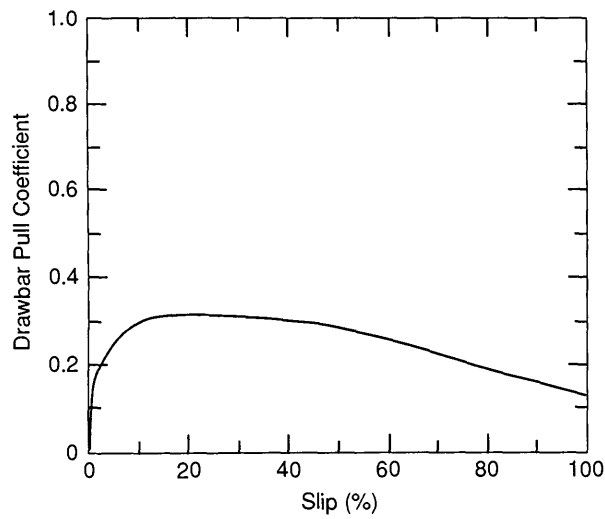

Figure C11. HEMTT on new snow, 11 February 1988.

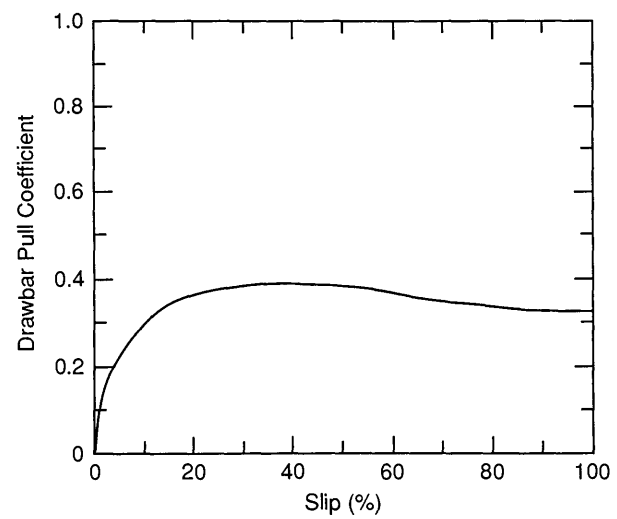

Figure C12. SUSV on hard-packed snow, 21 January 1988.

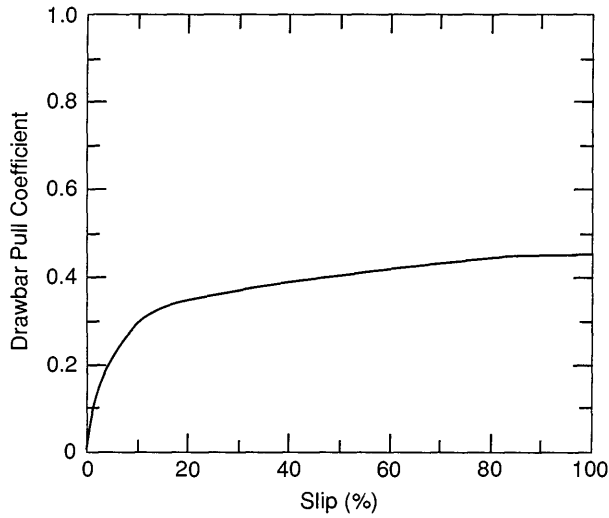

Figure C13. SUSV on new snow, 10 February 1988.

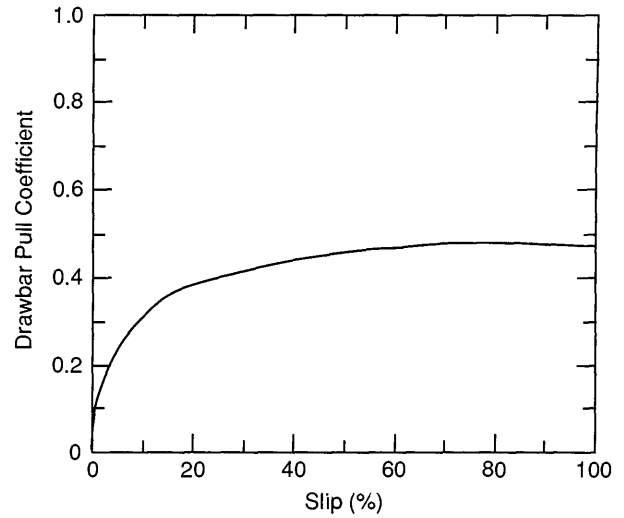

Figure C14. SUSV 13 February 1988.

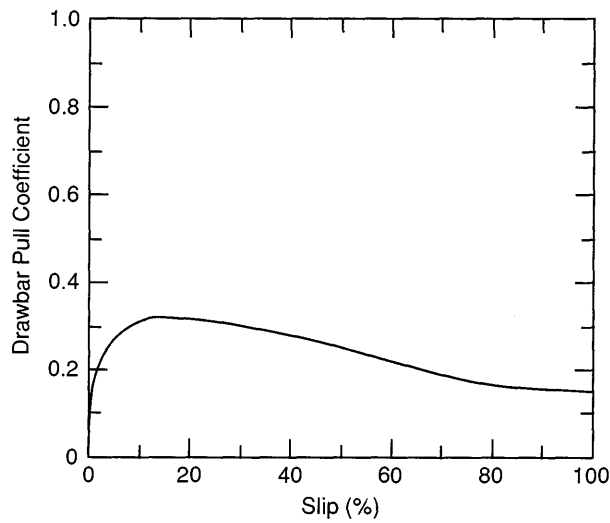

Figure C15. M113 on hard-packed snow, 22 January 1988.

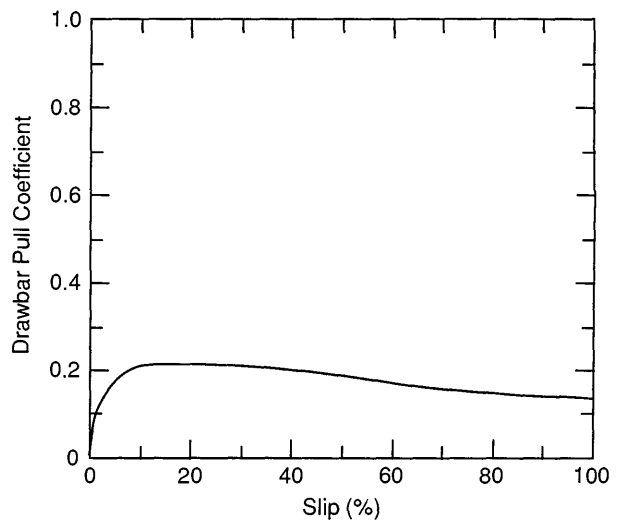

Figure C16. M113 on new snow, 10 February 1988.

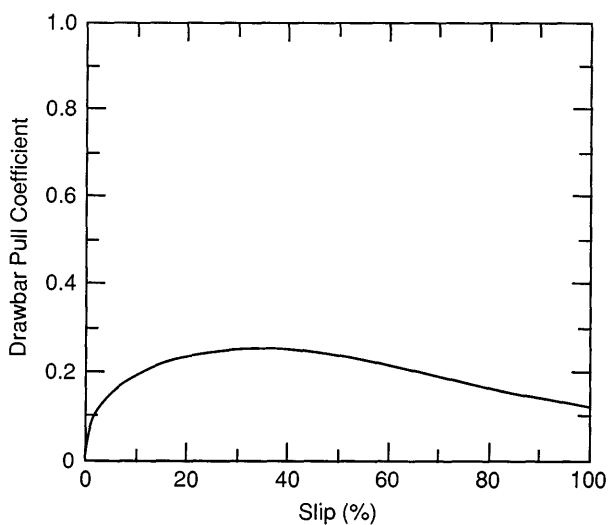

Figure C17. M113 on old snow, 10 February 1988.

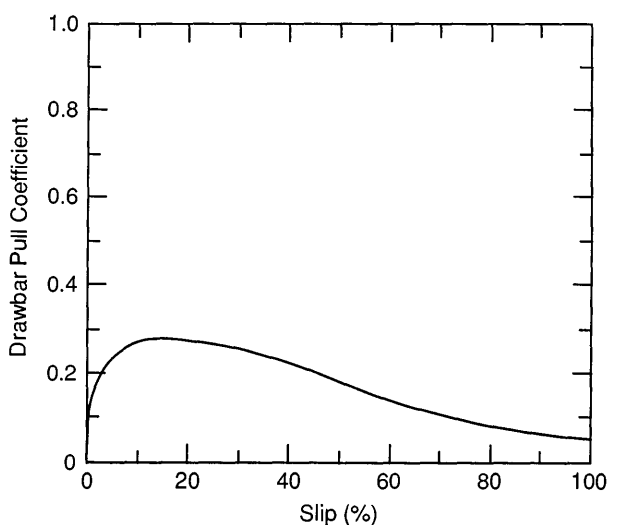

Figure C18. BFVS on hard-packed snow, 28 January 1988.

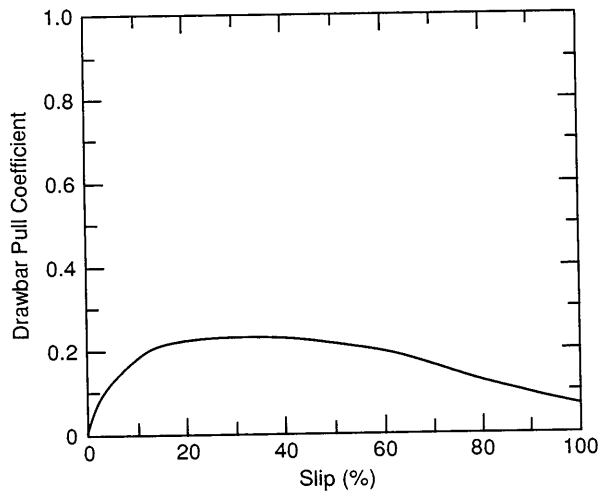

Figure C19. BFVS on old snow, 12 February 1988.

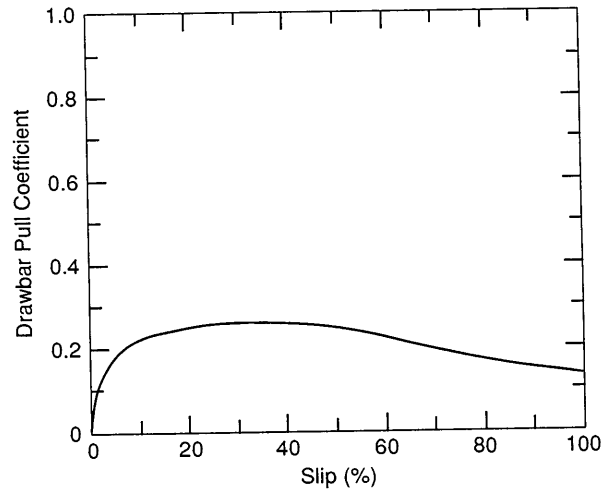

Figure C20. BFVS on new snow, 12 February 1988.

APPENDIX D: SNOW DATA

UNDISTURBED SNOW CHARACTERIZATION

DATE 01-21-88

TIME 16:00

AMB TEMP (°C) \_\_\_\_\_

SITE NAME SLOPES

DEPTH (cm)	DENSITY (g/cm³)	TEMPERATURE (°C)
10	0.09	-3
20	0.26	-1
30	0.30	0
40	0.28	0
56	ground	

DEPTH (cm)	CRYSTAL SIZE (mm)	ICE THICKNESS (cm)
10-56	1-1.5	

Note: Depths are measured down from the pack surface

DATE 1-22-88

TIME 15:00

AMB TEMP (°C) -5.5

SITE NAME Rink

DEPTH (cm)	DENSITY (g/cm³)	TEMPERATURE (°C)
0-3	<0.06	
5		-5
10-13	0.10	
14	ground	

DEPTH (cm)	CRYSTAL SIZE (mm)	ICE THICKNESS (cm)
0-14	1 (light)	

Note: Depths are measured down from the pack surface

## UNDISTURBED SNOW CHARACTERIZATION

DATE 01-23-88  
 TIME 14:25  
 AMB TEMP (°C) -9.2  
 SITE NAME RINK

DEPTH (cm)	DENSITY (g/cm <sup>3</sup> )	TEMPERATURE (°C)
0-10	<0.06	-1
10	ground	

DEPTH (cm)	CRYSTAL SIZE (mm)	ICE THICKNESS (cm)
0-10	1 mm (light)	

Note: Depths are measured down from the pack surface

DATE 1-26-88  
 TIME 14:00  
 AMB TEMP (°C) -13  
 SITE NAME Runway

DEPTH (cm)	DENSITY (g/cm <sup>3</sup> )	TEMPERATURE (°C)
0-3	0.12	
5		-12
5-8	0.15	
10		-9
11	ground	

DEPTH (cm)	CRYSTAL SIZE (mm)	ICE THICKNESS (cm)
0-11	1	

Note: Depths are measured down from the pack surface

# UNDISTURBED SNOW CHARACTERIZATION

DATE 01-28-88  
 TIME 11:20  
 AMB TEMP (°C) -10  
 SITE NAME Rink

DEPTH (cm)	DENSITY (g/cm <sup>3</sup> )	TEMPERATURE (°C)
1-4	0.13	
5		-8
6-9	0.17	
11	ground	

DEPTH (cm)	CRYSTAL SIZE (mm)	ICE THICKNESS (cm)
0-11	1	

Note: Depths are measured down from the pack surface

DATE 02-10-88  
 TIME 12:00  
 AMB TEMP (°C) -17.0  
 SITE NAME RINK 1

DEPTH (cm)	DENSITY (g/cm <sup>3</sup> )	TEMPERATURE (°C)
0-3	0.09	
3-6	0.17	
4		-8
7-10	0.26	
8		-7
10-13	0.27	
13		-6
14-17	0.22	
17.5	ground	

DEPTH (cm)	CRYSTAL SIZE (mm)	ICE THICKNESS (cm)
0-17.5	1	

Note: Depths are measured down from the pack surface

## UNDISTURBED SNOW CHARACTERIZATION

DATE 02-10-88  
 TIME 12:00  
 AMB TEMP (°C) -14  
 SITE NAME RINK 2 (Entrance End)

DEPTH (cm)	DENSITY (g/cm <sup>3</sup> )	TEMPERATURE (°C)
0-3	0.09	
7-10	0.23	-8
14-17	0.22	-5
19-22	0.21	-2
24-27	0.31	
27	ground	

DEPTH (cm)	CRYSTAL SIZE (mm)	ICE THICKNESS (cm)
0-17	1 (tight)	
17		0.5
17.5-27	1 - 1.5 (loose)	

Note: Depths are measured down from the pack surface

DATE 02-10-88  
 TIME 12:00  
 AMB TEMP (°C) -14  
 SITE NAME RINK 2 Center

DEPTH (cm)	DENSITY (g/cm <sup>3</sup> )	TEMPERATURE (°C)
0-3	0.10	
5		-10
6-9	0.21	
12-15	0.23	
15		-8
16-19	0.21	
22-25	0.23	
27		-3
28-31	0.23	
32	ground	

DEPTH (cm)	CRYSTAL SIZE (mm)	ICE THICKNESS (cm)
0-20	1 (tight)	
20		0.5
20.5-32	1-1.5 (loose)	

Note: Depths are measured down from the pack surface

## UNDISTURBED SNOW CHARACTERIZATION

DATE 02-11-88  
 TIME 16:00  
 AMB TEMP (°C) -14  
 SITE NAME RINK 2

DEPTH (cm)	DENSITY (g/cm <sup>3</sup> )	TEMPERATURE (°C)
0-3	0.11	
5-8	0.17	
9-12	0.26	
10		-11
15-18	0.22	
20		-8
21-24	0.21	
26-29	0.24	
30		-6
31	ground	

DEPTH (cm)	CRYSTAL SIZE (mm)	ICE THICKNESS (cm)
0-20	1 (right)	
20		1
21-31	1-1.5 (loose)	

Note: Depths are measured down from the pack surface

DATE 02-11-88  
 TIME 16:15  
 AMB TEMP (°C) -14  
 SITE NAME RINK 1

DEPTH (cm)	DENSITY (g/cm <sup>3</sup> )	TEMPERATURE (°C)
0-3	0.12	
5-8	0.20	
5		-10
10-13	0.24	
10		-7
14-17	0.20	
15		-6
17.5	ground	

DEPTH (cm)	CRYSTAL SIZE (mm)	ICE THICKNESS (cm)
0-17.5	1 (right)	

Note: Depths are measured down from the pack surface



## UNDISTURBED SNOW CHARACTERIZATION

DATE 2-12-88  
 TIME 13:10  
 AMB TEMP (°C) -16  
 SITE NAME Rink 2

DEPTH (cm)	DENSITY (g/cm <sup>3</sup> )	TEMPERATURE (°C)
1-4	0.12	
5-8	0.24	
5		-16
10-13	0.24	
10		-13
17-20	0.22	
20		-8
23-26	0.24	
29	ground	

DEPTH (cm)	CRYSTAL SIZE (mm)	ICE THICKNESS (cm)
0-15	1 (tight)	
15		1
16-29	1-1.5 (loose)	

Note: Depths are measured down from the pack surface

DATE 02-12-88  
 TIME 13:20  
 AMB TEMP (°C) -16  
 SITE NAME Rink 1

DEPTH (cm)	DENSITY (g/cm <sup>3</sup> )	TEMPERATURE (°C)
0-3	0.15	
5		-15
6-9	0.26	
10-13	0.26	
10		-10
16	ground	

DEPTH (cm)	CRYSTAL SIZE (mm)	ICE THICKNESS (cm)
0-16	1 (tight)	

Note: Depths are measured down from the pack surface

## UNDISTURBED SNOW CHARACTERIZATION

DATE 02-13-88  
 TIME 9:50  
 AMB TEMP (°C) -14.6  
 SITE NAME RINK 1

DEPTH (cm)	DENSITY (g/cm <sup>3</sup> )	TEMPERATURE (°C)
0-3	0.14	
4		-16
5-8	0.22	
8-11	0.26	
8		-11
13-16	0.24	
13		-9
17	ground	

DEPTH (cm)	CRYSTAL SIZE (mm)	ICE THICKNESS (cm)
0-17	1 (tight)	

Note: Depths are measured down from the pack surface

DATE 02-13-88  
 TIME 10:51  
 AMB TEMP (°C) -12  
 SITE NAME RINK 2

DEPTH (cm)	DENSITY (g/cm <sup>3</sup> )	TEMPERATURE (°C)
1-4	0.14	
5-8	0.22	
5		-14
9-12	0.27	
13-16	0.23	
15		-10
19-22	0.23	
25-28	0.26	
25		-3
30	ground	

DEPTH (cm)	CRYSTAL SIZE (mm)	ICE THICKNESS (cm)
0-17	1 (tight)	
17		1
18-30	1-2 (loose)	

Note: Depths are measured down from the pack surface

# UNDISTURBED SNOW CHARACTERIZATION

DATE 02-13-88  
 TIME 11:00  
 AMB TEMP (°C) -14  
 SITE NAME SLOPES

DEPTH (cm)	DENSITY (g/cm <sup>3</sup> )	TEMPERATURE (°C)
9-12	0.22	
22-25	0.35	
40-43	0.36	
57-60	0.34	
83	ground	

DEPTH (cm)	CRYSTAL SIZE (mm)	ICE THICKNESS (cm)
0-83	1- (windblown)	

Note: Depths are measured down from the pack surface

DATE 02-13-88  
 TIME 11:18  
 AMB TEMP (°C) -14  
 SITE NAME Texas cleared area

DEPTH (cm)	DENSITY (g/cm <sup>3</sup> )	TEMPERATURE (°C)
1-3	0.14	
8-11	0.26	
10		-13
17-20	0.27	
25		-6
26-29	0.23	
31-34	0.25	
32		-2
39	ground	

DEPTH (cm)	CRYSTAL SIZE (mm)	ICE THICKNESS (cm)
0-23	1 (tight)	
23		1
24-39	1-1.5 (loose)	

Note: Depths are measured down from the pack surface

## UNDISTURBED SNOW CHARACTERIZATION

DATE 02-13-88  
 TIME 11:18  
 AMB TEMP (°C) -14  
 SITE NAME Texas uncleared

DEPTH (cm)	DENSITY (g/cm <sup>3</sup> )	TEMPERATURE (°C)
4-7	0.16	
5		-16
12-15	0.25	
24-27	0.25	
30		-3
37-40	0.26	
48-51	0.32	
55		-2
64-67	0.34	
76	ground	

DEPTH (cm)	CRYSTAL SIZE (mm)	ICE THICKNESS (cm)
0-24	1 (tight)	
24		1
25-45	1-1.5 (loose)	
45		1
46-76	1-2 (loose)	

Note: Depths are measured down from the pack surface

DATE 02-13-88  
 TIME 12:51  
 AMB TEMP (°C) -11  
 SITE NAME South End Runway

DEPTH (cm)	DENSITY (g/cm <sup>3</sup> )	TEMPERATURE (°C)
0-3	0.19	
5-8	0.25	
5		-12
10-13	0.30	
15-18	0.30	
20-23	0.28	
20		-8
27-30	0.27	
30		-4
32	ground	

DEPTH (cm)	CRYSTAL SIZE (mm)	ICE THICKNESS (cm)
0-25	1 (tight)	
25		1
26-32	1-2 (loose)	

Note: Depths are measured down from the pack surface

## UNDISTURBED SNOW CHARACTERIZATION

DATE 02-13-88  
 TIME 13:17  
 AMB TEMP (°C) -10  
 SITE NAME North End Runway

DEPTH (cm)	DENSITY (g/cm <sup>3</sup> )	TEMPERATURE (°C)
0-3	0.20	
5-8	0.29	
5		-13
13-16	0.20	
14		-10
17-20	0.24	
20		-8
24	ground	

DEPTH (cm)	CRYSTAL SIZE (mm)	ICE THICKNESS (cm)
0-11	1 (tight)	
11		1
12-24	1-2 (loose)	

Note: Depths are measured down from the pack surface

DATE 02-15-88  
 TIME 14:44  
 AMB TEMP (°C) -11.0  
 SITE NAME RINK 2

DEPTH (cm)	DENSITY (g/cm <sup>3</sup> )	TEMPERATURE (°C)
0-3	0.20	
4-7	0.24	
5		-7
8-11	0.29	
12-15	0.27	
15		-5
19-22	0.23	
24-27	0.26	
25		-3
28-31	0.28	
31	ground	

DEPTH (cm)	CRYSTAL SIZE (mm)	ICE THICKNESS (cm)
0-17	1 (tight)	
17		1
18-31	1-2 (loose)	

Note: Depths are measured down from the pack surface

## UNDISTURBED SNOW CHARACTERIZATION

DATE 02-18-88  
 TIME 15:09  
 AMB TEMP (°C) +6.5  
 SITE NAME RINK 1

DEPTH (cm)	DENSITY (g/cm <sup>3</sup> )	TEMPERATURE (°C)
0-3	0.30	
4-7	0.29	
4		0
9-12	0.25	
9		-3
12.5	ground	

DEPTH (cm)	CRYSTAL SIZE (mm)	ICE THICKNESS (cm)
0-12.5	1 (wet)	

Note: Depths are measured down from the pack surface

DATE 02-18-88  
 TIME 15:33  
 AMB TEMP (°C) +6.4  
 SITE NAME RINK 2

DEPTH (cm)	DENSITY (g/cm <sup>3</sup> )	TEMPERATURE (°C)
1-4	0.28	
4		0
5-8	0.25	
10-13	0.24	
12		-2
14-17	0.27	
17		-2
20	ground	

DEPTH (cm)	CRYSTAL SIZE (mm)	ICE THICKNESS (cm)
0-8.5	1 (wet)	
8.5		
9.5-20	1-2 (loose)	

Note: Depths are measured down from the pack surface

## UNDISTURBED SNOW CHARACTERIZATION

DATE 02-16-88  
 TIME 10:00  
 AMB TEMP (°C) -5  
 SITE NAME Near Slopes

DEPTH (cm)	DENSITY (g/cm <sup>3</sup> )	TEMPERATURE (°C)
1-4	0.20	
6		-3.5
8-11	0.21	
15-18	0.25	
20-23	0.26	
21		-3
28-31	0.27	
35-38	0.30	
41	ground	

DEPTH (cm)	CRYSTAL SIZE (mm)	ICE THICKNESS (cm)
0-24	1-1.5 (loose)	
7.5		0.5
24		1
25-41	1-2 (loose)	

Note: Depths are measured down from the pack surface

DATE 02-17-88  
 TIME 14:30  
 AMB TEMP (°C) -6  
 SITE NAME RINK 1

DEPTH (cm)	DENSITY (g/cm <sup>3</sup> )	TEMPERATURE (°C)
0-3	0.24	
4-7	0.28	
5		-4
7-10	0.30	
10		-4
12-15	0.28	
15		-3
17	ground	

DEPTH (cm)	CRYSTAL SIZE (mm)	ICE THICKNESS (cm)
0-17	1-1.5	

Note: Depths are measured down from the pack surface

## UNDISTURBED SNOW CHARACTERIZATION

DATE 02-18-1988  
 TIME 11:40  
 AMB TEMP (°C) +2  
 SITE NAME RINK 2

DEPTH (cm)	DENSITY (g/cm <sup>3</sup> )	TEMPERATURE (°C)
0-3	0.26	
4-7	0.28	
5		-2
9-12	0.23	
15		-2
18-21	0.23	
23-26	0.28	
25		-2
28	ground	

DEPTH (cm)	CRYSTAL SIZE (mm)	ICE THICKNESS (cm)
0-16	1 (tight)	
16		1
17-28	1-2 (loose)	

Note: Depths are measured down from the pack surface

DATE 2/25/88  
 TIME 11:45  
 AMB TEMP (°C) -10  
 SITE NAME KRC

DEPTH (cm)	DENSITY (g/cm <sup>3</sup> )	TEMPERATURE (°C)
1-4	0.17	
5-8	0.19	
5		-7
10-13	0.17	
10		-5
14-17	0.19	
15		-3
19	ground	

DEPTH (cm)	CRYSTAL SIZE (mm)	ICE THICKNESS (cm)
0-17	1 (tight)	

Note: Depths are measured down from the pack surface



## UNDISTURBED SNOW CHARACTERIZATION

DATE 2/25/88  
 TIME 13:55  
 AMB TEMP (°C) -9.0  
 SITE NAME Road

DEPTH (cm)	DENSITY (g/cm <sup>3</sup> )	TEMPERATURE (°C)
1-4	0.17	
5		-7
6-9	0.18	
12-15	0.17	
15		-6
18-21	0.17	
23-26	0.26	
25		-5
30	ground	

DEPTH (cm)	CRYSTAL SIZE (mm)	ICE THICKNESS (cm)
0-30	1 (tight)	

Note: Depths are measured down from the pack surface

DATE 3/2/88  
 TIME 16:00  
 AMB TEMP (°C) -9.0  
 SITE NAME xpc

DEPTH (cm)	DENSITY (g/cm <sup>3</sup> )	TEMPERATURE (°C)
0-3	0.21	
3		0
3-6	0.24	
6-9	0.20	
8		0
10	ground	

DEPTH (cm)	CRYSTAL SIZE (mm)	ICE THICKNESS (cm)
0-5	1 (wet)	
5-10	1-1.5 (wet)	

Note: Depths are measured down from the pack surface

## UNDISTURBED SNOW CHARACTERIZATION

DATE 3/3/88  
 TIME 9:05  
 AMB TEMP (°C) -17  
 SITE NAME KRC

DEPTH (cm)	DENSITY (g/cm <sup>3</sup> )	TEMPERATURE (°C)
0-3	0.26	
3		-14
4-7	0.24	
7-10	0.23	
9		-5
11	ground	

DEPTH (cm)	CRYSTAL SIZE (mm)	ICE THICKNESS (cm)
0		4
4-11	1-1.5 (loose/dry)	

Note: Depths are measured down from the pack surface

DATE 3/3/88  
 TIME 14:10  
 AMB TEMP (°C) -8.0  
 SITE NAME KRC

DEPTH (cm)	DENSITY (g/cm <sup>3</sup> )	TEMPERATURE (°C)
0-3	0.15	
3-6	0.27	
5		0
7-10	0.20	
10		-2
12	ground	

DEPTH (cm)	CRYSTAL SIZE (mm)	ICE THICKNESS (cm)
0-3.5	1 (tight/damp)	
3.5		1 (snow)
4.5-12	1-1.5 (loose/damp)	

Note: Depths are measured down from the pack surface

## UNDISTURBED SNOW CHARACTERIZATION

DATE 3/4/88  
 TIME 11:00  
 AMB TEMP (°C) -4  
 SITE NAME KRC

DEPTH (cm)	DENSITY (g/cm <sup>3</sup> )	TEMPERATURE (°C)
0-3	0.18	
3-6	0.20	
5		-2.5
7	ground	

DEPTH (cm)	CRYSTAL SIZE (mm)	ICE THICKNESS (cm)
0-3	1 mm (loose/dry)	
3		1 (snow)
4-7	1-1.5 (loose/dry)	

Note: Depths are measured down from the pack surface

DATE 3-16-88  
 TIME 15:45  
 AMB TEMP (°C) -3  
 SITE NAME KRC

DEPTH (cm)	DENSITY (g/cm <sup>3</sup> )	TEMPERATURE (°C)
1-4	0.13	
5-8	0.20	
5		-0.5
9-12	0.25	
13		0
14-17	0.25	
19		0
21	ground	

DEPTH (cm)	CRYSTAL SIZE (mm)	ICE THICKNESS (cm)
0-21	1mm (damp)	

Note: Depths are measured down from the pack surface

## UNDISTURBED SNOW CHARACTERIZATION

DATE 3-17-88  
 TIME 9:35  
 AMB TEMP (°C) -2.0  
 SITE NAME KRC

DEPTH (cm)	DENSITY (g/cm <sup>3</sup> )	TEMPERATURE (°C)
0-3	0.13	
4-7	0.19	
5		-5
9-12	0.25	
12		-4
14-17	0.25	
18-21	0.29	
20		-1
25	ground	

DEPTH (cm)	CRYSTAL SIZE (mm)	ICE THICKNESS (cm)
0-25	1mm (dry)	

Note: Depths are measured down from the pack surface

APPENDIX E: SHALLOW SNOW MOBILITY  
 MODEL CODE, VERSION 2.0  
 Includes sample output

```

10 !
20 !   SSM/2.01
30 !   (trig tr sinkage and snow density function of cont. pr.)
40 !   (manual input of all vehicle and snow data)
50 !   (Liston's resis; best-fit power curve for traction)
60 !
70 net=0
80 RR=0
90 DB=0
100 go=0
110 pl=0
120 z=0
130 sumz=0
140 DISP "vehicle?"
150 INPUT Veh$
160 DISP "wheeled (w) or tracked (t)?"
170 INPUT type$
180 DISP "highest station ground pressure (kPa)="
190 INPUT pmax
200 pmax=pmax*0.1 ! convert from kPa to N/cm^2
210 !
220 ! ** establish final density based on largest footprint pressure **
230 sigmaf=0.5
240 IF pmax>21 THEN sigmaf=0.55
250 IF pmax>35 THEN sigmaf=0.6
260 IF pmax>70 THEN sigmaf=0.65
270 !
280 DISP "snow depth (cm) ="
290 INPUT h0
300 DISP "snow density (g/cm^3) ="
310 INPUT sigma0
320 sigma1=sigma0
330 sigma2=sigma0
340 h1=h0
350 !
360 PRINT "Vehicle: ";Veh$
370 PRINT " "
380 PRINT USING format1 ; "initial state:  snow depth =";h0;" cm"
390 PRINT USING format2 ; "                snow density =";sigma0;" g/cm^3"
400 !
410   zmax=h0*(1-sigma0/sigmaf) ! calculate maximum sinkage
420   IF zmax<0 THEN zmax=0
430 !
440 RAD ! compute in radians units for trig functions
450 !
460 !
470 ! ** enter vehicle data one tire station at a time **
480 DISP "how many wheel or track stations on each side of the vehicle?"
490 INPUT N
500 !
510 FOR I=1 TO N
520 DISP ""
530 DISP "station ";I
540 DISP "wheel radius or approx radius of compacting portion of track cm) ="
550 INPUT rads
560 DISP "single tire or track width at this location (cm) ="
570 INPUT wid
580 DISP "single tire or track load (N) ="
590 INPUT loa

```

```

600 DISP "contact area (m^2) ="
610 INPUT area
620 IF type$="t" THEN GOTO skip1
630 DISP "inflation pressure (kPa) ="
640 INPUT pres
650 pres=pres*0.1 ! convert from kPa to N/cm^2
660 GOTO skip2
670 skip1: pres=loa/area/10000 ! convert from N/m^2 to N/cm^2
680 !
690 skip2: DISP "driven?"
700 INPUT r$
710 IF type$="t" THEN GOTO skip3
720 DISP "duals ?"
730 INPUT R$
740 IF R$<>"y" AND R$<>"Y" THEN GOTO 780
750 wid=wid*2
760 loa=loa*2
770 !
780 skip3: DISP "percent of width compacting virgin snow (%)"
790 INPUT prcnt
800 !
810 IF pres>p1 AND sigma2<sigmaf AND h0>0 THEN GOTO 870 ! added sink. here?
820 z=0
830 tempres=0
840 IF prcnt>0 AND sigma2>sigma0 THEN GOTO 960
850 resis=0
860 GOTO 1010
870 z=(pres/pmax)^0.5*zmax-sumz ! calculate additional sinkage this station
880 !
890 ! ** set rut bottom values **
900 h2=h1-z
910 sigma2=sigma1/(1-z/h1)
920 !
930 ! ** calculate resistance parameter **
940 tempres=1/(sigma2-sigma1)*LOG(sigma2/sigma1)-1/sigma2 ! in rut
950 !
960 ! ** calculate motion resistance at this station **
970 resis=prcnt/100*(pres*wid*h0*sigma0) ! in virgin snow
980 resis=resis*(1/(sigma2-sigma0)*LOG(sigma2/sigma0)-1/sigma2) !virgin snow
990 moreres=tempres*(1-prcnt/100)*(pres*wid*h1*sigma1) ! in rut
1000 resis=resis+moresis
1010 !
1020 ! ** calculate gross traction at this station **
1030 trac=0.851*(loa/area/1000)^0.823 ! in kPa
1040 trac=trac*area*1000 ! in N
1050 !
1060 IF r$="n" OR r$="N" THEN trac=0 ! no traction if not driven
1070 !
1080 ! ** double to account for both sides of the vehicle **
1090 arrea=2*area
1100 trac=2*trac
1110 resis=2*resis
1120 !
1130 ! ** print output for this station **
1140 PRINT " "
1150 PRINT "station ";I
1160 PRINT USING format1 ; " additional sinkage =";z;" cm"
1170 PRINT USING format1 ; " total area=";arrea;" m^2"
1180 PRINT USING format1 ; " snow resis =";resis;" N"
1190 PRINT USING format1 ; " snow trac =";trac;" N"
1200 !
1210 ! ** running summation for whole vehicle **

```

```

1220 RR=RR+resis ! sum for whole vehicle
1230 DB=DB+trac ! sum for whole vehicle
1240 net=trac-resis ! calculate net traction for individual station
1250 PRINT USING format1 ; " net snow traction for station = ";net;" N"
1260 PRINT USING format1 ; "      rut bottom: depth=";h2;" cm"
1270 PRINT USING format2 ; "                        density=";sigma2;" g/cm^3"
1280 go=go+net ! sum net traction for vehicle
1290 !
1300 ! ** save last station values for next iteration **
1310 IF pres>p1 THEN p1=pres
1320 sigma1=sigma2
1330 h1=h2
1340 sumz=sumz+z
1350 !
1360 NEXT I
1370 !
1380 ! ** calculate mobility in English units for output **
1390 eRR=RR/4.448222
1400 eDB=DB/4.448222
1410 ego=go/4.448222
1420 ez=sumz/2.54
1430 !
1440 ! ** print out whole vehicle results **
1450 PRINT " "
1460 PRINT " "
1470 PRINT USING format1 ; " total sinkage for vehicle= ";sumz;" cm (";ez;" in
)"
1480 PRINT USING format1 ; " total snow resistance = ";RR;" N (";eRR;" lb)"
1490 PRINT USING format1 ; " total snow traction =";DB;" N (";eDB;" lb)"
1500 PRINT " "
1510 PRINT USING format1 ; " net traction for vehicle = ";go;" N (";ego;" lb)"
1520 PRINT " "
1530 PRINT " "
1540 PRINT " "
1550 !
1560 format1: IMAGE 3(K,DDDDDD.DD)
1570 format2: IMAGE 3(K,DZ.DDDD)
1580 !
1590 END

```

Vehicle: HMMWV

initial state: snow depth = 5.00 cm  
snow density = 0.5500 g/cm<sup>3</sup>

station 1  
additional sinkage = 0.00 cm  
total area= 0.1480 m<sup>2</sup>  
snow resis = 0.00 N  
snow trac = 5467.65 N  
net snow traction for station = 5467.65 N  
rut bottom: depth= 0.00 cm  
density= 0.5500 g/cm<sup>3</sup>

station 2  
additional sinkage = 0.00 cm  
total area= 0.1480 m<sup>2</sup>  
snow resis = 0.00 N  
snow trac = 6844.84 N  
net snow traction for station = 6844.84 N  
rut bottom: depth= 0.00 cm  
density= 0.5500 g/cm<sup>3</sup>

total sinkage for vehicle= 0.00 cm ( 0.00 in)  
total snow resistance = 0.00 N ( 0.00 lb)  
total snow traction = 12312.49 N ( 2767.96 lb)

net traction for vehicle = 12312.49 N ( 2767.96 lb)



Vehicle: HEMTT (241/276)

initial state: snow depth = 25.00 cm  
snow density = 0.2200 g/cm<sup>3</sup>

station 1

additional sinkage = 14.03 cm  
total area= 0.2980 m<sup>2</sup>  
snow resis = 11515.55 N  
snow trac = 20514.00 N  
net snow traction for station = 8998.45 N  
rut bottom: depth= 10.97 cm  
density= 0.5014 g/cm<sup>3</sup>

station 2

additional sinkage = 0.00 cm  
total area= 0.2980 m<sup>2</sup>  
snow resis = 0.00 N  
snow trac = 20761.93 N  
net snow traction for station = 20761.93 N  
rut bottom: depth= 10.97 cm  
density= 0.5014 g/cm<sup>3</sup>

station 3

additional sinkage = .97 cm  
total area= 0.2980 m<sup>2</sup>  
snow resis = 1230.94 N  
snow trac = 23084.34 N  
net snow traction for station = 21853.40 N  
rut bottom: depth= 10.00 cm  
density= 0.5500 g/cm<sup>3</sup>

station 4

additional sinkage = 0.00 cm  
total area= 0.2980 m<sup>2</sup>  
snow resis = 0.00 N  
snow trac = 23214.12 N  
net snow traction for station = 23214.12 N  
rut bottom: depth= 10.00 cm  
density= 0.5500 g/cm<sup>3</sup>

total sinkage for vehicle= 15.00 cm ( 5.91 in)  
total snow resistance = 12746.49 N ( 2865.52 lb)  
total snow traction = 87574.39 N ( 19687.50 lb)

net traction for vehicle = 74827.90 N ( 16821.98 lb)

Vehicle: SUSV

initial state: snow depth = 9.00 cm  
snow density = 0.1480 g/cm<sup>3</sup>

station 1

additional sinkage = 6.30 cm  
total area= 2.36 m<sup>2</sup>  
snow resis = 309.13 N  
snow trac = 16626.42 N  
net snow traction for station = 16317.29 N  
rut bottom: depth= 2.70 cm  
density= 0.4930 g/cm<sup>3</sup>

station 2

additional sinkage = 0.00 cm  
total area= 2.36 m<sup>2</sup>  
snow resis = 0.00 N  
snow trac = 16527.49 N  
net snow traction for station = 16527.49 N  
rut bottom: depth= 2.70 cm  
density= 0.4930 g/cm<sup>3</sup>

total sinkage for vehicle= 6.30 cm ( 2.48 in)  
total snown resistance = 309.13 N ( 69.49 lb)  
total snow traction = 33153.90 N ( 7453.29 lb)

net traction for vehicle = 32844.78 N ( 7383.80 lb)

# REPORT DOCUMENTATION PAGE

Form Approved  
OMB No. 0704-0188

Public reporting burden for this collection of information is estimated to average 1 hour per response, including the time for reviewing instructions, searching existing data sources, gathering and maintaining the data needed, and completing and reviewing the collection of information. Send comments regarding this burden estimate or any other aspect of this collection of information, including suggestion for reducing this burden, to Washington Headquarters Services, Directorate for Information Operations and Reports, 1215 Jefferson Davis Highway, Suite 1204, Arlington, VA 22202-4302, and to the Office of Management and Budget, Paperwork Reduction Project (0704-0188), Washington, DC 20503.

1. AGENCY USE ONLY (Leave blank)		2. REPORT DATE November 1990	3. REPORT TYPE AND DATES COVERED	
4. TITLE AND SUBTITLE Wheels and Tracks in Snow: Validation Study of the CRREL Shallow Snow Mobility Model			5. FUNDING NUMBERS PE: 6.27.84A PR: 4A762784AT42 TA: CS WU: 040	
6. AUTHORS George L. Blaisdell, Paul W. Richmond, Sally A. Shoop, Charles E. Green and Russell G. Alger				
7. PERFORMING ORGANIZATION NAME(S) AND ADDRESS(ES) U.S. Army Cold Regions Research and Engineering Laboratory 72 Lyme Road Hanover, New Hampshire 03755-1290			8. PERFORMING ORGANIZATION REPORT NUMBER CRREL Report 90-9	
9. SPONSORING/MONITORING AGENCY NAME(S) AND ADDRESS(ES) Office of the Chief of Engineers Washington, DC 20314-1000			10. SPONSORING/MONITORING AGENCY REPORT NUMBER	
11. SUPPLEMENTARY NOTES				
12a. DISTRIBUTION/AVAILABILITY STATEMENT Approved for public release; distribution is unlimited.  Available from NTIS, Springfield, Virginia 22161			12b. DISTRIBUTION CODE	
13. ABSTRACT (Maximum 200 words) <p>In 1986, a mobility model was developed for predicting the traction and motion resistance of both wheeled and tracked vehicles on shallow snow, and a winter field season was dedicated to gathering mobility data for a diverse family of vehicles (including four on wheels and three tracked) to validate the model. The original version of the model, SSM1.0, used the Mohr-Coulomb shear failure equation from soil mechanics to predict gross traction. This required input of the snow strength parameters <math>c</math> and <math>\phi</math>. Motion resistance is predicted by calculating the amount of work done by the tire in compacting snow and only requires snow depth and density values as input snow properties. Some effort was expended in determining an easy and reliable method of obtaining snow strength parameters. The model was originally designed to use an initial snow density-snow strength relationship established from past instrumented vehicle test results. Historically, shear annulus apparatus have been used to obtain Mohr-Coulomb strength parameters. A comparison of snow strength obtained via these three methods (shear annulus, instrumented vehicle, calculated from initial density using the relationship in SSM1.0) for individual snow covers showed no agreement. SSM1.0 assumed that snow strength parameters for mobility prediction were a function of initial snow density; however, traction is developed in the compacted snow under the driving element, whose strength properties bore little relation to those of the initial snow. It appears that the shear strength of the compacted snow is essentially a constant for all of the vehicles and snow covers tested here.</p>				
14. SUBJECT TERMS Computer modeling Drawbar pull Instrumented vehicles Mobility predictions Motion resistance Snow Snow strength Vehicle traction Vehicles			15. NUMBER OF PAGES 76	
			16. PRICE CODE	
17. SECURITY CLASSIFICATION OF REPORT UNCLASSIFIED	18. SECURITY CLASSIFICATION OF THIS PAGE UNCLASSIFIED	19. SECURITY CLASSIFICATION OF ABSTRACT UNCLASSIFIED	20. LIMITATION OF ABSTRACT UL	

13. ABSTRACT (cont'd).

Based on this finding, a new traction algorithm was developed, resulting in the creation of a second generation model, SSM2.0. This algorithm predicts gross traction, on the average for the vehicles tested, within 7% of the measured value. Motion resistance prediction remains unchanged in SSM2.0. This quantity is still not predicted with a desirable level of accuracy.