

NEW
MIRAI
 PRESS INFORMATION 2020



CONTENTS

From the Chief Engineer	01
Development Concept	02
Aim of introducing the New Mirai	03
Features of the New Mirai	04
Packaging	06
Design Concept	08
Front Design	09
Rear Design	10
Side Design	11
Body Colors	12
Design Concept	13
Design Points	14
Cockpit	16
Rear seats and comfort features	18
Executive Package	19
Interior colors	20

Evolution of Driving	21
FCEV Drive	22
Body and Chassis	23
New Fuel Cell System	26
New Fuel Cell System Safety Measures	29
Hydrogen Stations	31
Electric Supply	32
Active Safety Performance	33
Other Safety Equipment	36
Advanced Driving Support—Toyota Teammate (Advanced Park)	38
New Mirai Main Specifications	40

“I want customers to say, ‘I chose the Mirai because I simply wanted this kind of car.’”

Toyota Motor Corporation (Toyota) sees hydrogen as an effective fuel for the future. Our aim is to help address environmental and energy issues through mass production of fuel cell vehicles (FCEV). FCEVs use hydrogen to operate and are very efficient, can travel long distances, have fast refueling times, and emit only water. They have enormous potential as environment-friendly cars, or “**ultimate eco-cars.**”

In 2014, Toyota launched Mirai as the world’s first commercial FCEV, hoping to contribute to the world by selling a car that it believed could become the driver of a hydrogen energy society for the next 100 years. To date, more than 10,000 units have been sold worldwide. That first step helped to open the doors to the hydrogen society and the FCEV market.

However, because of slower than anticipated infrastructure development, and resulting limits on the number of vehicles that can be introduced into the market, we are still only halfway to **achieving widespread adoption FCEVs.** Additionally, customer feedback indicated the need for longer cruising range and improved rear seat comfort. Therefore, to increase the demand for FCEVs, we need a vehicle with better basic performance and appeal that encourages many customers to buy one, even if infrastructure constraints remain.

We took all the customer feedback to heart and redesigned and reengineered the Mirai from the ground up, with the goal of creating a vehicle people

would be excited to buy. **The development concept was “EDGE for a Fun Future.”** It means that the new Mirai was developed with the goal of creating a vehicle full of appeal, with edgy individuality, that offers an emotion-packed future. The new Mirai comes with the latest and highest levels of safety features that are increasingly important to customers. At the same time, FCEVs also offer the potential for use as social infrastructure, able to provide electricity to people affected by disasters when used as high capacity power supply vehicles, demonstrated during some recent major disasters. Therefore, rather than just creating an emotional and appealing vehicle, we wanted to lead efforts to enable FCEVs to reach their potential as **a new kind of environment-friendly vehicle** that also offers additional social value through emergency support.

We have worked to make a car that customers will want to drive all the time, a car that has an emotional and attractive design and the kind of dynamic and responsive performance that can bring a smile to the driver’s face. I want customers to say ‘I chose the Mirai because I simply wanted this car, and it just happens to be an FCEV.’

I hope the success of the new Mirai demonstrates the sustainable and bright possibilities for the world and for our children’s future as it helps us achieve a hydrogen society.



Yoshikazu Tanaka
MS Product Planning ZF (Chief Engineer)
Mid-size Vehicle Company

The new Mirai is unlike any of the eco-cars of the past, combining “EDGE” values with the true appeal of cars.

Development concept

EDGE for a Fun Future

Emotional Distinctive Genius Enjoyable

Vehicles with a design to appeal to the senses, a unique driving experience, an abundance of industry-leading innovation, and a cruising range that gives peace of mind

Emotional (design that appeals to the senses)

- Attractive exterior that anyone will be charmed by
- Simple beauty of quality interior space

Genius (industry-leading innovative mechanisms)

- Cleaning the air while driving (“negative emissions”)
- A more advanced Toyota Safety Sense

Distinctive (unique driving experience)

- Responsive handling with a quiet, comfortable ride
- Smooth and powerful driving performance

Enjoyable (cruising range that gives peace of mind)

- The same level of operability as gasoline-powered vehicles, with an extended cruising range



Mirai offers truly unique value since it is a fuel cell vehicle that has a beautiful design, high quality and great driving performance.

Toyota demonstrated its leadership with the launch of the Mirai in an effort to contribute to society by addressing emissions and energy challenges.

As the ultimate eco-car, it was a confident step toward a low-carbon, sustainable mobility society of the future.

The new Mirai is the next evolution of Toyota's efforts to create a car well-suited for the promise of the hydrogen society.

The Mirai stands out for its great style and driving performance first and as an FCEV second.

Customers will say: "I chose the Mirai because I simply wanted this car, and it just happens to be an FCEV."

The new Mirai is a fresh embodiment of the eco-car that Toyota wants to create.

To appeal to an even greater number of customers, the new Mirai represents more than just a redesign, it carries the weight of Toyota's ambition to dramatically advance the desire to use of hydrogen energy because Mirai's appeal.

The new Mirai takes FCEVs to a new level.

01. Vehicle package

The new Mirai is built on the TNGA GA-L platform, delivering dynamic and sporty proportions that are unique to rear-wheel-drive vehicles.



02. Interior and exterior design

With an emotional design featuring beautiful styling and an appealing interior space, the new Mirai will be the vehicle of choice for customers.



03. Driving performance

A new platform featuring a stiffer chassis and optimized body provide for responsive handling, smooth driving performance and an remarkably quiet and comfortable ride.



04. New fuel cell system

All systems in the vehicle have been reengineered to achieve greater efficiencies resulting in improved power, better fuel economy and longer range. While driving, the fuel system filters out particulates from the intake air resulting in cleaner air.



05. Advanced safety performance

The new Mirai is equipped with the latest safety technologies, including further evolved Toyota Safety Sense packages.



Based on the TNGA platform, a low, dynamically proportioned FCEV-specific package was developed for the new Mirai.

- ◎ A 5-seat, rear-wheel-drive vehicle built on the GA-L platform
- ◎ Longer, wider, and lower in height than the previous model, offering “wide and low” dynamic proportions
- ◎ FC stack and other key power units moved from under the front seat to the engine bay, creating a more spacious cabin
- ◎ The layout was optimized to lower the center of gravity and achieve an ideal weight balance between front and rear (50:50)

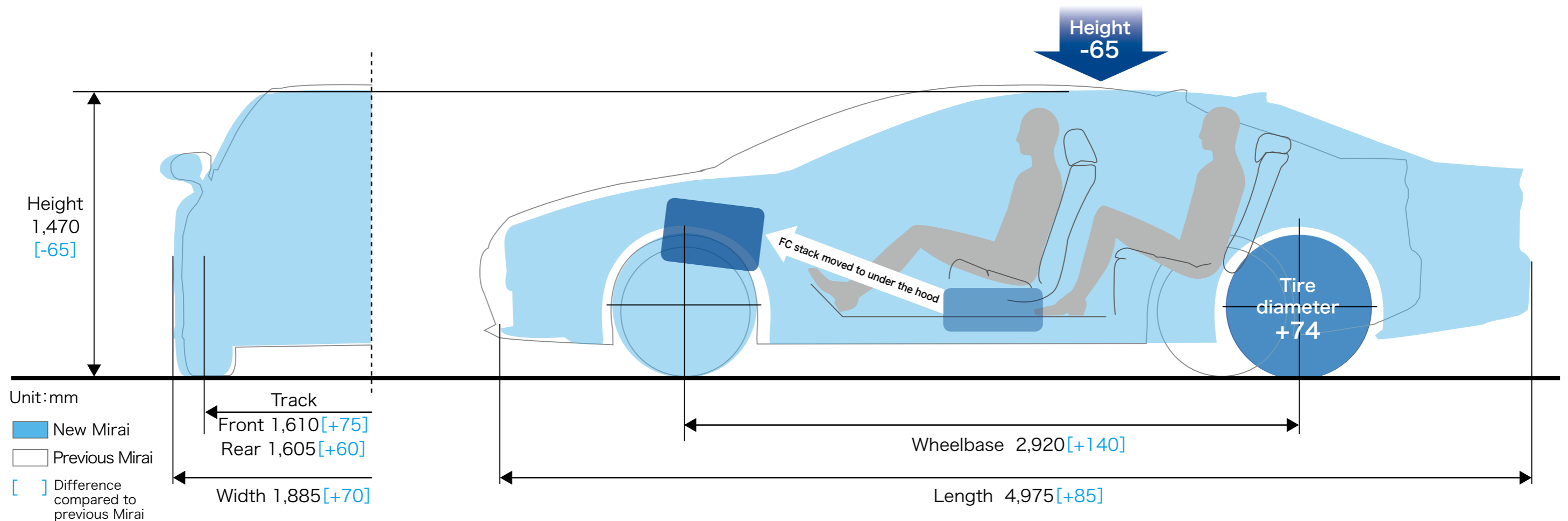

※ Based on Toyota measurements. Note. The shape and layout of the vehicle and parts in the above diagram are for the purpose of illustration only.

The new layout includes an additional hydrogen tank mounted lengthwise.

- ◎ Three high-pressure hydrogen tanks extend the cruising range; including one located lengthwise in the tunnel to avoid sacrificing spaciousness in the cabin
- ◎ FC stack and other power units moved to the engine bay instead of under the floor in the previous model
- ◎ Motor moved to the rear from the front

□ New model

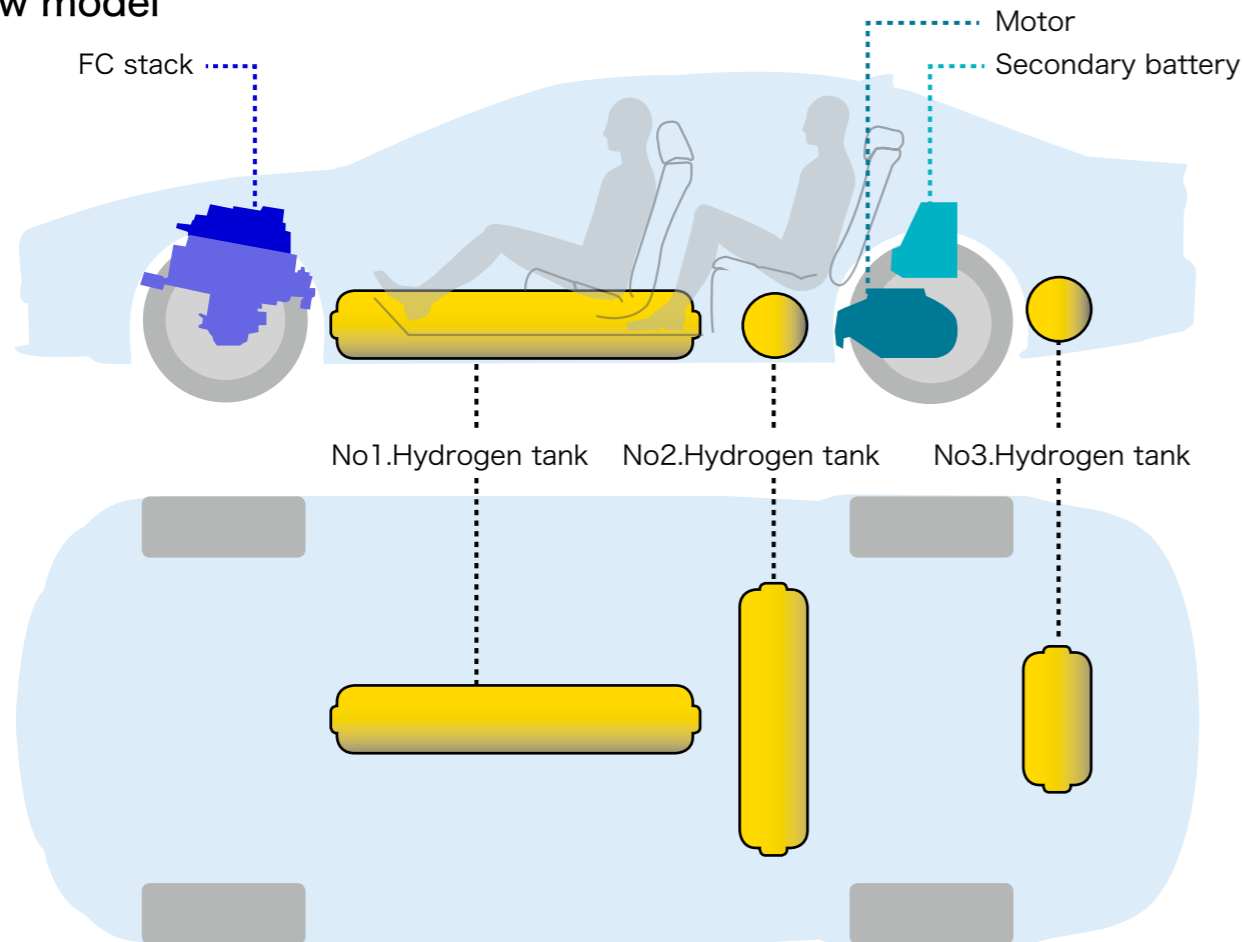

□ Previous model

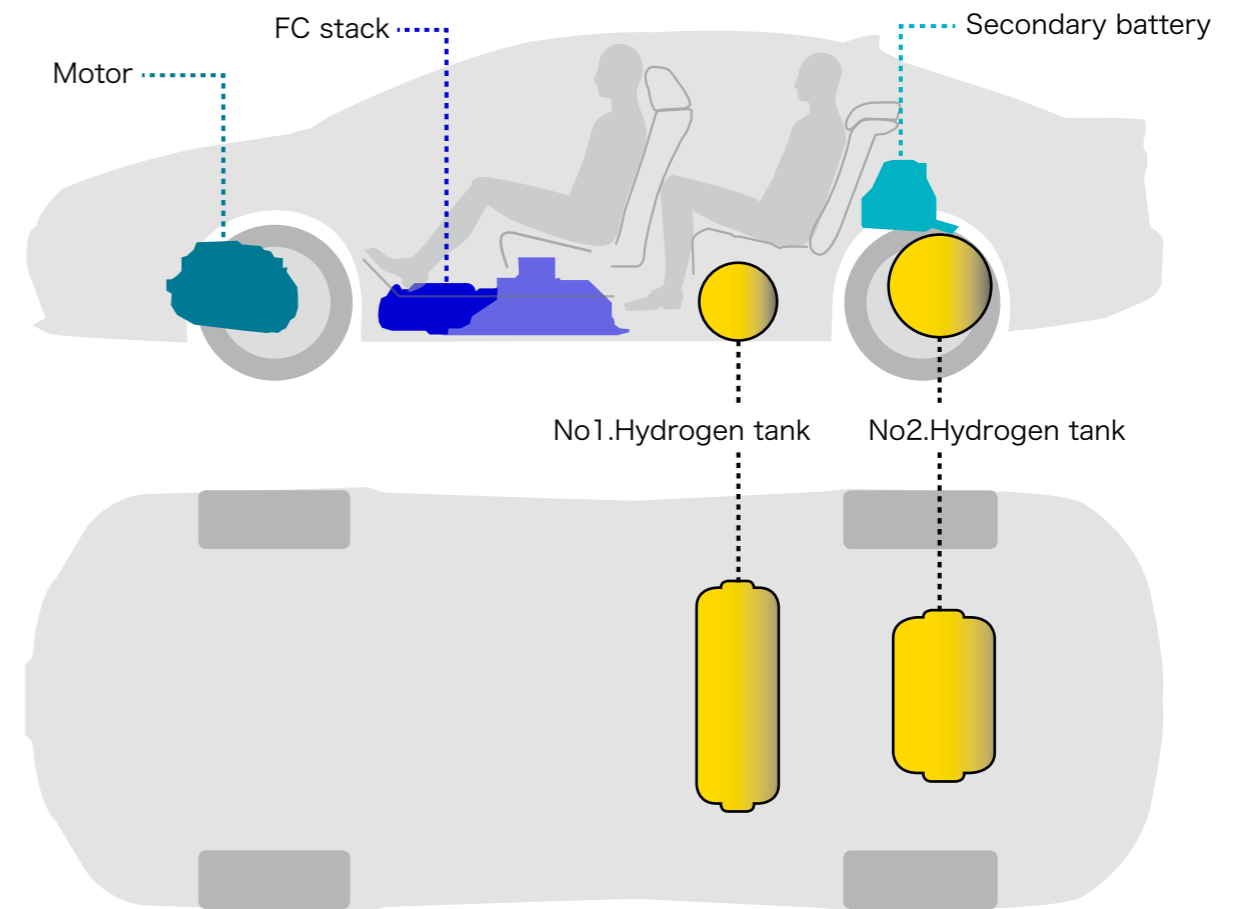

Note. The shape and layout of the vehicle and parts in the above diagram are for the purpose of illustration only. The actual system arrangement is not shown.

■ Design Development Mission

The focus was on striking looks, despite being an eco-car, to create an emotional design with styling that attracts customers, rather than relying on it being an FCEV or having an eco-car image.

■ Three Objectives for the Exterior Design Concept

① New FR Aero proportions

Lower, wider rear-wheel-drive platform with large diameter tires
In pursuit of the honest beauty of cars

② Wide front and rear stance with a low center of gravity

A stance that expresses stability with a solid grip on the earth and a nose that sits below the headlamps. An under-bumper molding and other exterior parts emphasize the wide and low center of gravity.

③ From line-featured design to mass-featured design

Instead of using character lines to express individuality, the molding itself creates a unique sense of beauty with its bold transitional surfaces and contrasting shadows.



■ Design Concept

SILENT DYNAMISM

■ Design Direction

A beautiful driving appearance ensured by speedy proportions, with a minimal and expansive outline that does not rely on bold surface changes and character lines. This new design combination brings a unique emotion to the new Mirai.

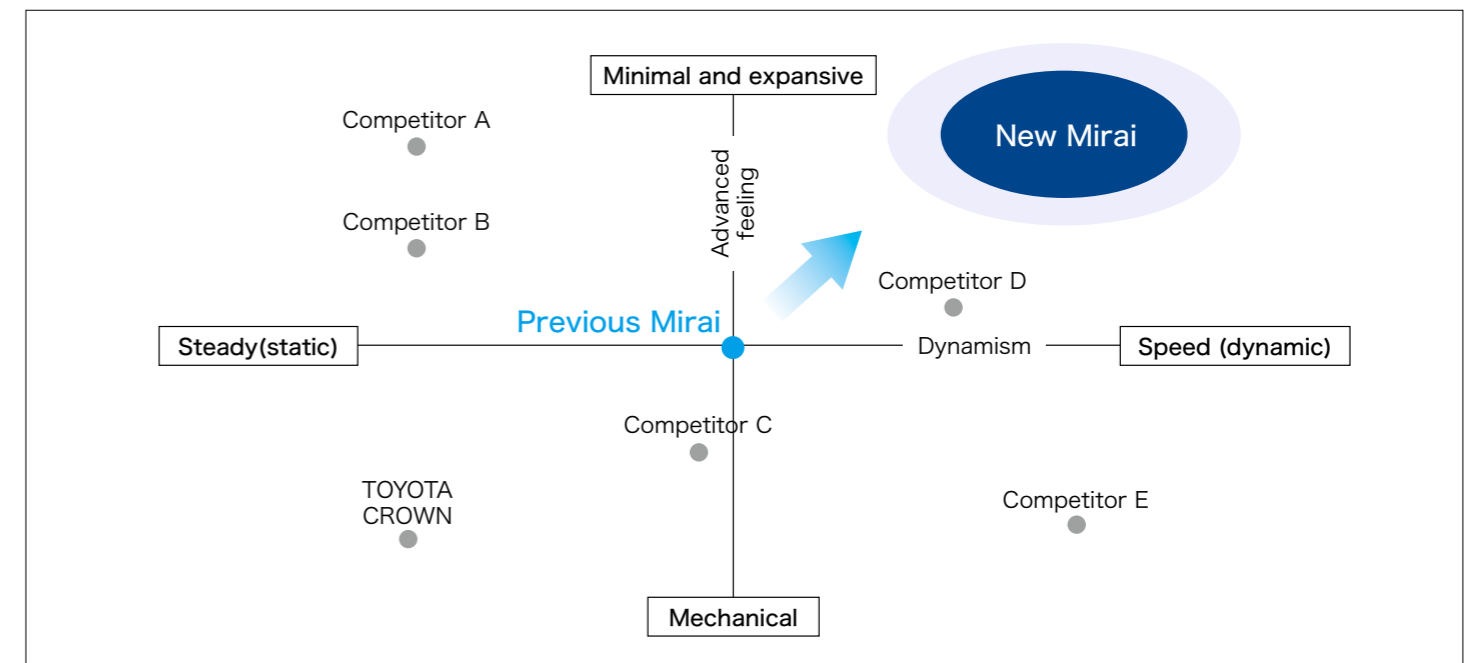

Front view with a strong, wide and stable stance and a low center of gravity



Wide and low stance expressed through protruding corners and a lower nose, etc.

Strong protruding corners give the new Mirai solid proportions that emphasize a stance with a solid grip on the earth. The placement of a plated molding at the bottom of the trapezoidal lower grille accentuates the lower stance.

■ Bi-Beam LED Headlamps

The new model features a two-tier design. On the upper tier, long and sharp headlamps flow through to the sides, while on the lower tier, long and thin turn signal lamps emphasize slimness and width. The impressive long daytime running lights (DRLs) that extend to the fenders and plated finish surrounding the main units create a simple appearance that is easily recognizable as the Mirai even from a distance.

■ Grade-dependent Light Layouts



Z "Executive Package" and Z grade headlamps

The twin-lens headlamps use Bi-Beam LEDs for switching between low and high beams and an Adaptive High-beam System (AHS) for nighttime driving. Luxurious jet-black plated extensions are also used.



G "Executive Package", G "A Package" and G grade headlamps

These single-lens Bi-Beam LED headlamps are surrounded by a stepped, plated finish that expresses keen vision. A horizontal heat sink (heat dissipation plate) between the long DRLs and Bi-Beam LEDs is used to emphasize movement and depth through to the sides. An Automatic High Beam (AHB) system is also used for nighttime driving, and the extensions are jet-black plated like the Z grade.

Rear view that emphasizes a low center of gravity and a wide stance



Spoiler shapes and bumper innovations emphasize a low center of gravity.

An imposing stance expressed through protruding corners and a solid grip on the earth completes the image started by the front design.



■ Rear Combination Lamps

The narrow design of the rear combination lamps extends horizontally across the Toyota badge. The thinness of the red lens is emphasized by darkening the lower part of the turn signal and backup lamps, which creates a more advanced feel. In addition, the three gradation lines connected as a single stroke create a high-grade texture and sense of originality.

Side view has a fluent and speedy form that positions the center of gravity further toward the rear.



■ Sporty and Dynamic Form of a Rear-wheel-drive Vehicle

The cabin silhouette flows toward the rear, before seamlessly blending into the integrated spoiler. With a cylinder-shaped door section that narrows boldly toward the front of the vehicle from the rear tire, this model demonstrates a new dynamism for rear-wheel-drive vehicles through rich dynamic transitions. These sculpted proportions and cross-sections bring a sense of movement to the solid form that expresses the unique individuality of the new Mirai.

■ Smooth Side Surface Configuration Facilitates Airflow

A mostly flush side surface configuration and silhouette directs and converges airflow to deliver improved handling stability and aerodynamics. With flat surfaces for regulating airflow in front of the tires, a silhouette with the optimal aerodynamic angle from the roof toward the rear, optimized narrowing of the side surfaces and other design elements, this new model has many inclusions to prevent anything that hinders airflow.

A total of eight body colors to choose from, including a newly developed color.

Newly Developed Color

Force Blue Multiple Layers [8Y7]

A multi-layer coating process has created a new elegant and powerful blue with shadows that accentuate the styling and vividness that stimulates motorsports fans.



A multi-layer process enhances contrast between vividness and shadow.

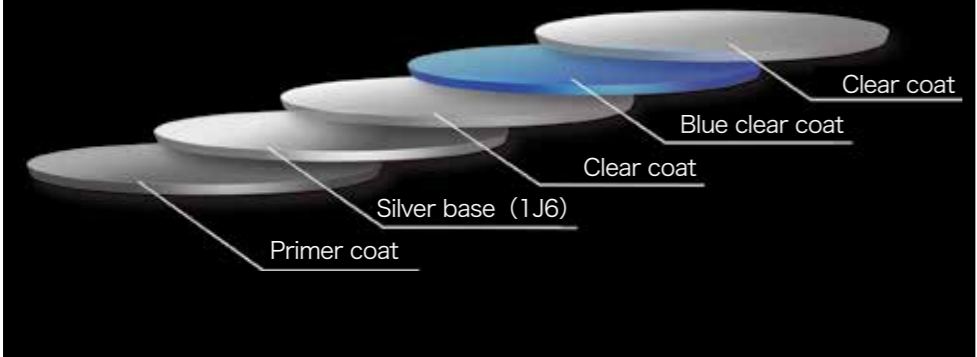

New Color

Precious White Pearl [090]

Flagship white pearl ensures a brighter, higher quality particle texture.



Precious Black Pearl [219]

A premium color with a black pearl-like glossy texture



Precious Silver [1J6]

A shaded silver that emphasizes the three-dimensional exterior



New Color

Black [202]

A modern and sporty jet-black color



New Color

Precious Metal [1L5]

A deep silver that expresses the hardness and solidness of metal.



New Color

Emotional Red II [3U5]

A red that realizes pure brightness from highlights to shades



Dark Blue Mica [8S6]

A deep blue that expresses a premium feel with a deep shade

■ Design Concept

SILENT DYNAMISM

A new coordination of minimal functional expression and textures that envelope the occupants, with an approach that simultaneously provides a fun driving experience and feeling of luxury while enabling the occupants to relax.

■ Three Objectives for the Interior Design Concept

① **Cockpit space with a new concept**

Creating a new space with advanced components and expansive outlines that gently wrap around each occupant

② **Fusion of a clear-cut interface and styling**

Information switches centralized in the meter cluster, achieving smooth operability and optimal layout for each function

③ **Expression of new materials**

Challenging the image of “advanced” as always being “cold,” a coordination of soft leather and metal textures delivers a new expression of materials

■ Design Direction

The interior emotional value delivered by the new Mirai creates a new personal space that fuses “fun to drive” and “advanced and relaxing” qualities at an even higher level.

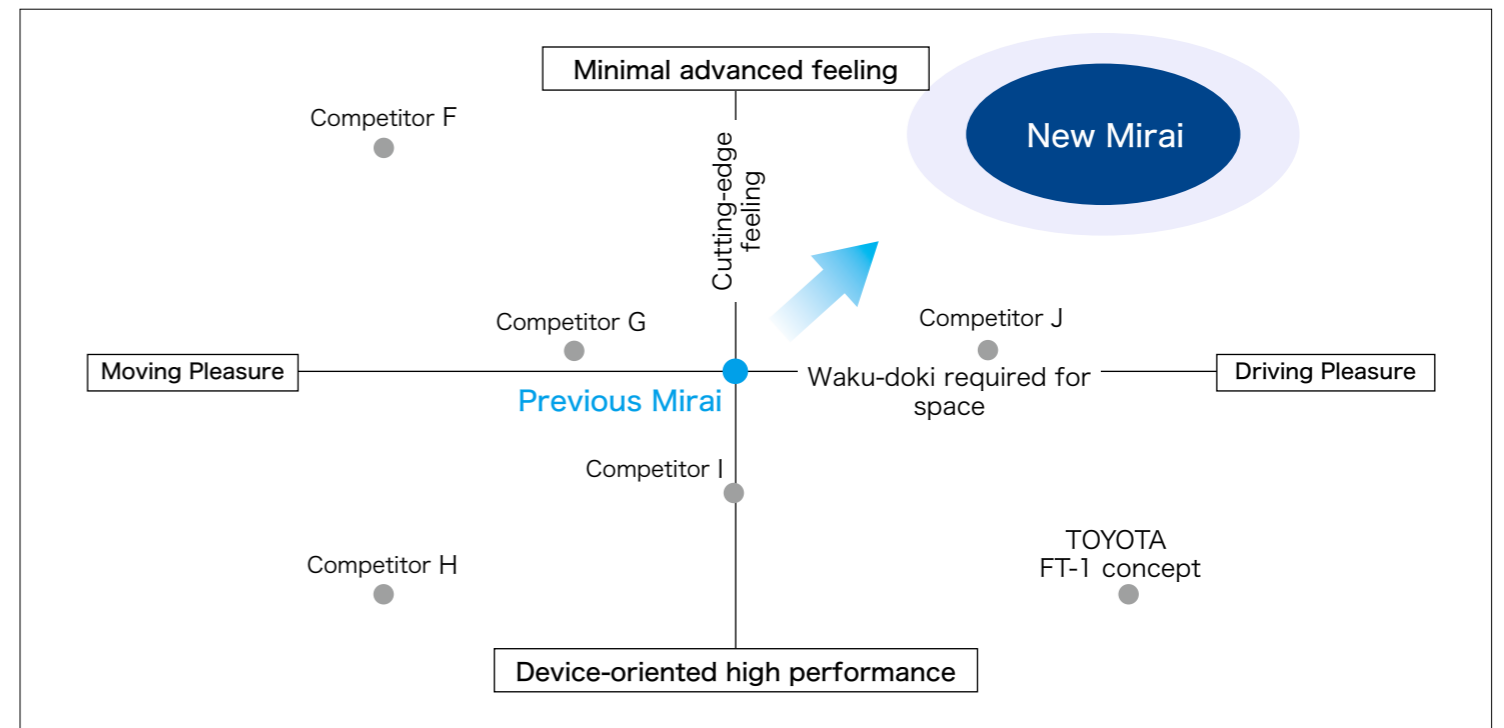

A spacious cockpit with well thought-out functionality



Cockpit styling achieves both concentration and openness of space

The driver seat provides a “wrapped feeling” while the passenger seat offers a more “expansive feeling.” The goal was to create a new cockpit space that fused “concentration” with “openness” based on a dynamic styling theme. A large display panel also brings together the information functions over soft padding. Together, these elements create an impressive space that gives shape to the contrasting elements of “concentrating on operation” and “relaxing.”



A large display with consolidated information functions

The display panel unifies the large 12.3-inch center display and meter to deliver a feeling of continuity. The large color heads-up display also continues on into the forward direction to naturally guide the driver’s gaze in the right direction. Overall, the driving environment is intuitively easy to recognize.

Zones for each function and consistently shaped switches

The cockpit of the new Mirai was also designed with ease of operability in mind. While minimizing the size of switches as much as possible, separate zones for each function create an easy to understand configuration. The switches themselves are also uniform, from their shape and cross-section to the way their concave shape fits the fingertips. The consistent design with attention to detail achieves ease of use and simplicity.

High-quality, distinctive interior spaces expressed through materials and accent details



Contrast between soft materials and a metallic finish

A high-quality metallic trim is used to accentuate the edges of the instrument panel padding and other components covered in a soft material. The contrasting look and feel of ornaments and other components extending from the console through to the passenger side are used to create a more modern atmosphere within the cabin.



Coordination achieved through texturing

To create a clean look to the upper surface of the instrument panel, with its speakers and defroster openings, a perforated finish is added to each surface to accentuate the airy profile. This is a common motif used throughout the cabin.



Warmth added through a newly developed copper finish

The new Mirai employs a satin chrome finish with a newly developed copper finish. The color scheme provides the warmth of a quality finish.

Exceptional visibility and controllability in a large advanced display panel and meter



12.3-inch high-definition TFT wide touch center display

A wide 12.3-inch type display is used for the center display. Toyota Multi-Operation Touch enables the landscape mode screen to be split into a navigation display and a user operation screen for easy visibility. Flick and multi-touch operations offer intuitive usability for easy zooming in and out. The display is symbolic of the advanced nature of the driver seat in the new Mirai.



Large color heads-up display

The color heads-up display projects the required driving information onto the windshield in the driver's view, which enables the driver to acquire information with minimal eye movement. In the new Mirai, the color heads-up display projects a large screen image (560 mm wide by 130 mm high) at a point approximately 2.6 m in front of the driver's eyes. The high brightness display also ensures excellent visibility even during daylight hours.



8.0-inch TFT color meter

The graphics and gauge dial design provides a feeling of width and depth that exceed the display size. In addition to being able to check the FC system output and regeneration status, the meter also comes with a full range of FCEV-specific display items, including an FC System Indicator to support environment-friendly driving, a hydrogen fuel gauge display, and a cruising range display.

Ease of use and a welcoming environment are well-tended in each piece of equipment



Heater control panel

The heater control panel concentrates interior comfort functions, including air conditioning, and front seat heaters and ventilation. Air conditioning operation functions are also incorporated into the large center display to reduce the number of switches. The display is easy to use, with a thin and clean design. A separator ornamentation also helps prevent accidental pushing of switches.



Steering wheel and switches

The three-spoke steering wheel is wrapped with black leather to create a sporty and high-quality look. Steering wheel switches are grouped by function in three zones on either the left or right. The switches also have enhanced visibility and operability, making continuous operation much more comfortable. The steering wheel also vibrates as a warning when the Lane Tracing Assist system detects lane departure.

- ① Infotainment operation (four-direction switch, return)
- ② Driving assist operation (Radar Cruise Control, Lane Tracing Assist)
- ③ Audio operation (volume, hands-free, mode selection, music selection, station selection)



Multi-color lighting selection display

*Selectable colors

- ① Clear Blue ② Blue ③ Turquoise ④ Purple ⑤ Red ⑥ Orange ⑦ Green ⑧ Pink

Multi-color lighting (eight selectable colors)

The new Mirai comes with interior lighting that creates a welcoming space for occupants and improves visibility and usability during nighttime driving. The lighting scheme can be changed from the center display, with a total of eight selectable colors*. A variety of different colors creates an interior space to suit every preference. Only the foot lamp is fixed, in Clear Blue.

Larger interior space and comfort features extend further comfort to the rear seats



Rear seats provide greater relaxation and comfort

The rear seats suit three occupants, which is one more than the previous model. The increased interior space provides more legroom and a greater separation from the front seats to create an even more relaxing space. In the center section, a fold-down center armrest includes cup holders (standard on all grades) and switches for operating the comfort features, audio, air conditioning, etc. (standard on some grades).

■ Seat comfort features

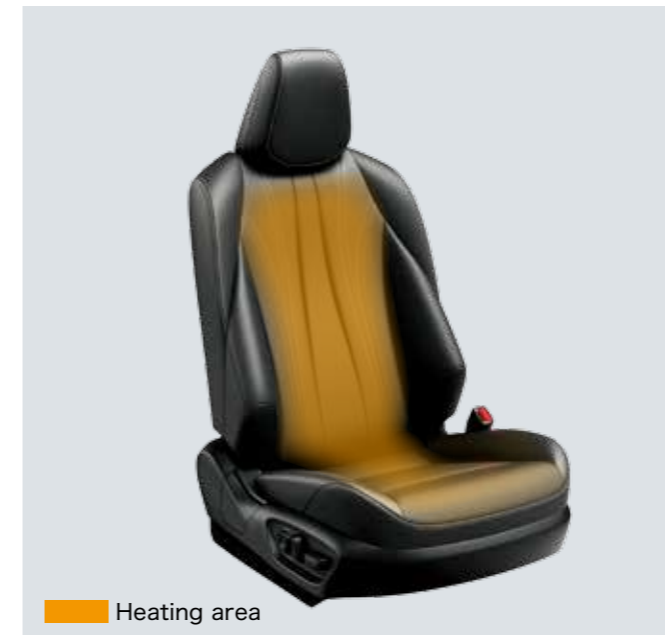

Comfortable heated seats

Seat heaters in the seat backs and seat cushions of the front seats and left and right rear seats warm the shoulders, hips and legs that get cold easily on cold days or when the air conditioning is running. The heated seats are linked to the All Auto function to provide a pleasant air-conditioned environment for every occupant just by setting the temperature of the air conditioning.

Seat ventilation

Front seats come with a seat ventilation feature that draws heat away from the leather seat cushions and seat backs, while left and right rear seats come with the same feature for the seat backs only. The seats themselves draw in the cool air from the air conditioning to quickly cool down the seats. Like the comfortable heated seats, seat ventilation is also linked to the All Auto function.

The Executive Package offers a higher level of space and comfort in the rear seats

The new Mirai includes an Executive Package for both grades to create an even higher level of relaxation on par with a luxury sedan.

To further improve comfort in the rear seats, the following additions or changes have been made to the driver and passenger seats.



Shoulder-level power seat switch (passenger seat)

This switch enables the passenger seat to be easily moved or reclined from the driver seat or rear seat positions.



Tilt-down headrest (passenger seat)

The passenger seat headrest can be tilted down to widen the field of vision and improve comfort for occupants in the rear seat.



Assist grip (driver and passenger seats)

Assist grips are attached to the back of both front seats to assist in getting in and out of the rear seats and support occupant posture when driving.

Footwell lights (driver and passenger seats) Footwell lights for the rear seats assist in getting in and out of the vehicle.

Touch screen control panel with capacitive touch switches installed in rear armrest

Switches on the touch screen control panel can be used to control seat heaters and seat ventilation, as well as audio, air conditioning, electric rear sunshade and other functions from the rear seats. The panel uses capacitive touch switches. The armrest also includes cup holders and a rear console box.



Rear door easy-close mechanism

When the rear doors are half closed, motors take over to finish closing the doors. This mechanism is designed to enable the doors to close with minimal effort.

Electric rear sunshade and manual rear side window sunshades

The rear window and rear side windows are equipped with sunshades to improve coziness and comfort.

A premium space created by two interior colors and two finish colors

Meticulously coordinated interior with different finish colors

The stitching color used for each interior color depends on which color is used for the finish color. Beige stitching is used when the copper finish is chosen, while light gray stitching is used when the satin chrome finish is chosen.



■ White and dark brown

A dark brown interior color is used when the interior space uses high contrasting white seats and instrument panel padding together with a black surrounding for the rest of the instrument panel. This warm color scheme creates a premium feeling.



Finish Color:Copper
Stitching color: Beige



Finish Color:Satin Chrome
Stitching color: Light gray



■ Black

A black interior color accentuates the chic ambiance of the interior space and elegant finish, which creates a sophisticated yet sporty feel.



Finish Color:Copper
Stitching color: Beige



Finish Color:Satin Chrome
Stitching color: Light gray

An unprecedented driving feel that points to the future of FCEVs

The new Mirai is not only the result of efforts to achieve an ultimate eco-car with superior environmental performance, but above all, to achieve a level of perfection in a car that also provides a fun and comfortable driving experience.

It comes with the torque and powerful acceleration of an FCEV, and quick responsiveness in all vehicle speed ranges.

To maximize responsiveness, Toyota was keenly focused on refining the body and chassis.

The result is a vehicle that you want to keep driving faster in,

but no matter how fast it goes, it produces zero emissions*

(and actually even better than that).

The following pages show why the new Mirai is more than “just an eco-car.”

* Zero CO₂ emissions



Comfortable acceleration provides a sense of unity with the vehicle, while delivering an outstanding level of quietness



FCEV driving performance evolved with the new Mirai

Powerful response and smooth acceleration in all vehicle speed ranges

Mirai provides instant torque and maximum acceleration is available from a start through top speed. Boasting a Toyota top-level mid-range acceleration curve, it has the unique powerful and smooth driving performance combination of an FCEV, taking the drive feel to a new level to meet the driver's needs.

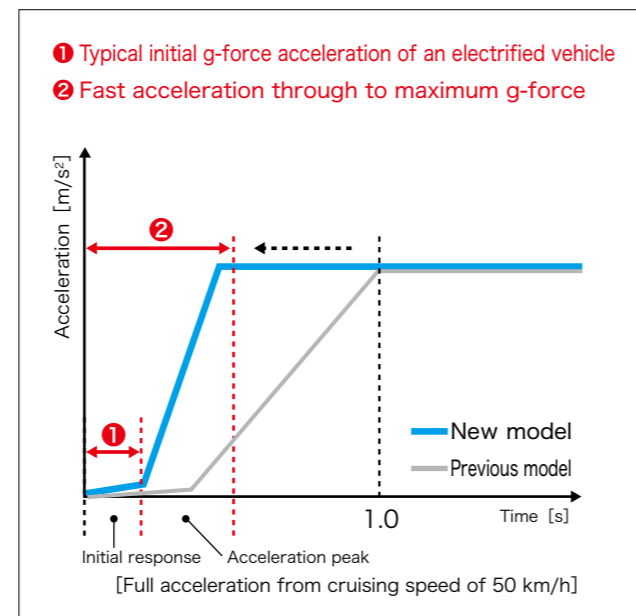

Brake Mode produces the same effect as an engine brake

The shift lever can be moved to Brake Mode to produce the same effect as an engine brake with a manual transmission. This function, which can be canceled by pressing the accelerator, provides strong deceleration when speed control is needed, such as on long downhill stretches of road.

Quietness delivered through every detail of the body

In addition to a motor drive system with no engine vibration or noise, the new Mirai comes with an outstanding level of quietness through body rigidity and use of sound insulation throughout.

Main efforts to improve quietness

- Optimal placement of sound-absorbing and sound-blocking materials through the use of foamed and sponge materials around the cabin
- Non-woven fabric with excellent sound-absorbing characteristics is used for the underfloor cover, which reduces outside noise, and road noise inside the cabin.
- A silencer is added directly above the motor to reduce motor gear noise.
- Three-layer construction is used for the dashboard inner silencer to ensure thickness
- Thicker floor panels reduce vibration and improve ride comfort
- Damping material is applied across the entire surface of the floor
- Comprehensive review and reduction of noise from all newly developed fuel cell unit components

Responsive handling and high-quality riding comfort bring genuine driving pleasure to FCEVs.

Carefully planned body and chassis designs enable new Mirai to achieve outstanding vehicle performance.

Body rigidity was improved, and power unit layouts were carefully designed to optimize the elements of inertia that contribute significantly to outstanding handling and cornering performance.



Lower center of gravity

The center of gravity has been lowered to achieve a high level of stability and controllability, and a ride comfort with little change in vehicle posture. Main changes include the power unit components, within the engine bay, engineered to be more compact and seated in a lower position.

Front-and-rear weight balance

In addition to changing the location of the fuel cell system and drive systems by using a rear-wheel-drive configuration, the center of gravity was moved to the center of the vehicle by reducing front overhang as much as possible. Other measures taken include using aluminum and other materials for parts away from the vehicle's center of gravity and reducing weight as much as possible. The resulting agile cornering and comfortable handling performance both contribute to its responsive handling.

50:50 mass distribution between front and rear to optimize for the elements of inertia

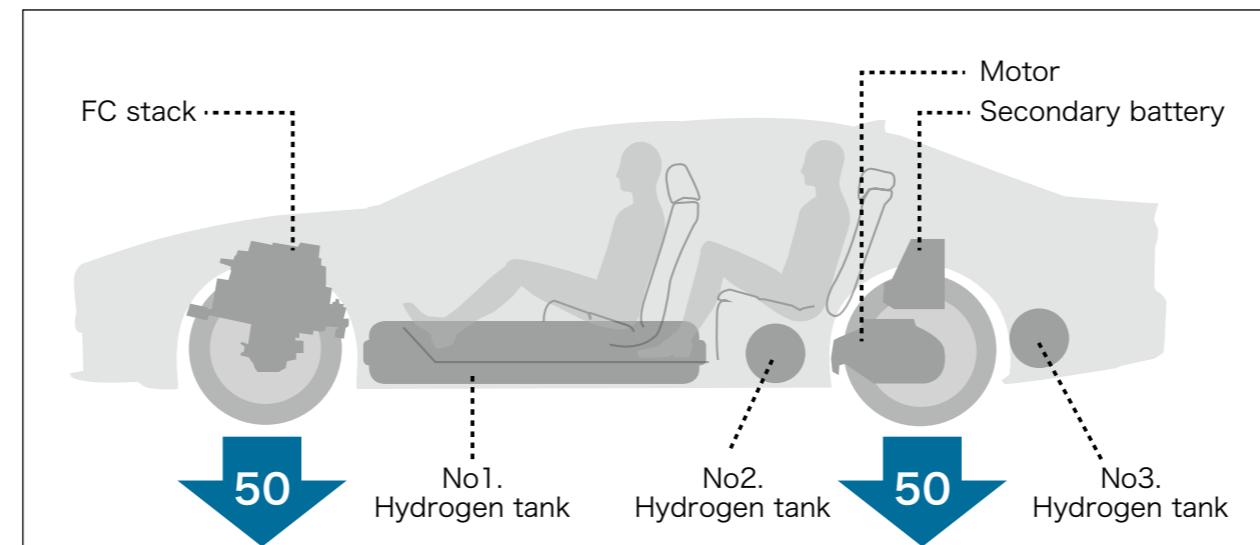

The new Mirai achieves a 50:50 weight balance between front and rear, which compares favorably with European luxury cars, thanks to a change from front-wheel-drive to rear-wheel-drive and optimal location of unit components.

Airflows also addressed to improve stability and controllability

Front and rear fender liners streamline airflows

Fender liners are shaped to streamline airflows within the wheel housings and smoothly direct the air toward the outside of the vehicle.

Flattened underbody

Taking advantage of the lack of heat sources (mufflers, etc.) in FCEVs, a full underfloor cover is used like the previous model. This has helped reduce air resistance, improve fuel economy, and extend cruising range.

Control system contributes to safe, secure and outstanding stability and controllability

The control system stabilizes the vehicle in corners to achieve a responsive steering feel. It controls deceleration in high-speed corners to prevent oversteer. It also provides a safe and secure, natural driving experience through features such as improved straight-line stability, which uses the braking force to enhance cross-wind stability when driving in strong winds.



① Active Cornering Assist (ACA) control

ACA applies the brakes to the inside drive wheel in corners to increase the driving torque of the outside wheel and produce a yaw moment. This minimizes understeer to achieve one of the best cornering limits possible.

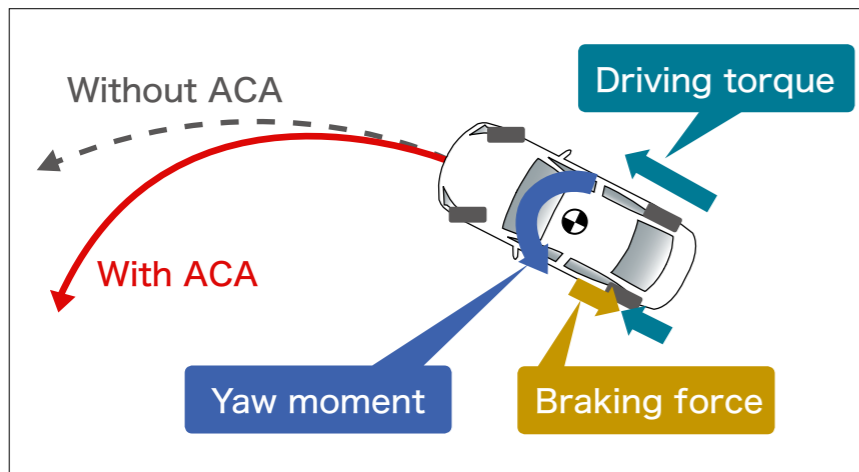

② Feed-forward tuck-in braking control

This system controls deceleration in high-speed corners to prevent oversteer caused by the vehicle tucking in when taking the foot off the accelerator in high-speed corners. This delivers good drivability and tuck-in stability for a stable vehicle posture even on highway on- and off-ramps.

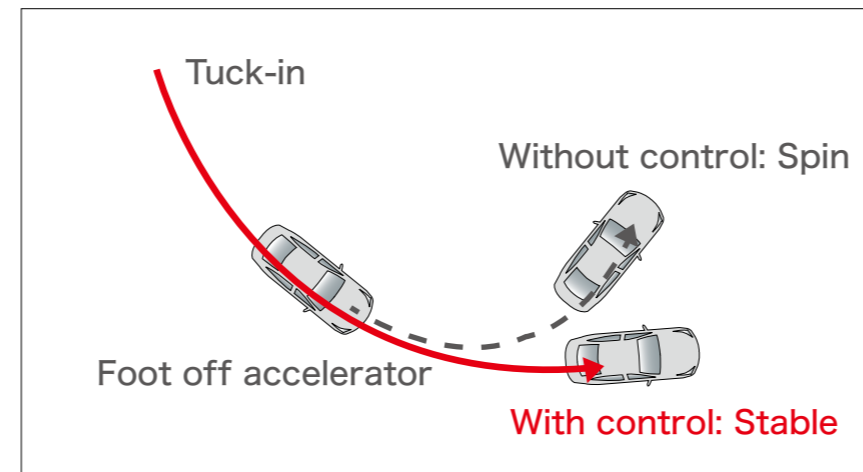

③ Cross-wind stability control

When driving in strong winds, this system uses braking force to create an anti-yaw moment. Even when subjected to cross-winds while driving, this gives the vehicle solid stability.

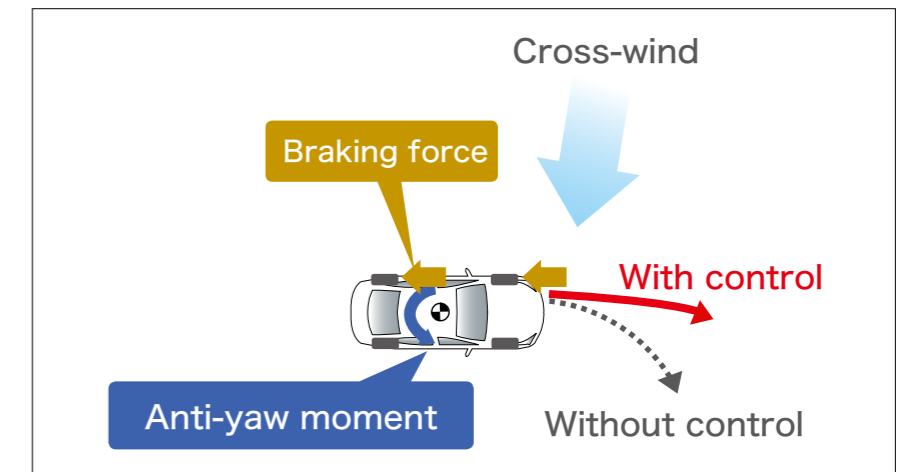

Control system contributes to safe, secure and outstanding stability and controllability

The new Mirai maintains a stable posture during deceleration and acceleration, while delivering smooth and powerful acceleration, and a sense of unity when turning the steering wheel through corners. This is achieved through refinements to body rigidity, essential for driving pleasure.

To achieve lightweight, aluminum materials and ultra-high tensile steel plates (hot-stamped) have been optimally employed on the main structural parts.

① Aluminum ② Hot-stamped steel ③ 1,180 MPa steel
④ 980 MPa steel ⑤ 780 MPa steel ⑥ 590 MPa steel

Main areas of improved high rigidity / light weighting of the body

- Additional bracing for the under-hood compartment
- Die-cast aluminum front suspension tower
- Enlarged rocker cross-section to improve body twisting and bending rigidity
- Ring structure used for cowl and instrument panel reinforcement
- Continuous flange structure used for frame connecting parts to improve joint rigidity
- Additional rear floor cross members to improve vehicle twisting rigidity
- Expanded coverage of adhesives and use of the latest laser welding technology (laser screw welding, LSW)
- New body frame used at rear, including addition of rear suspension tower

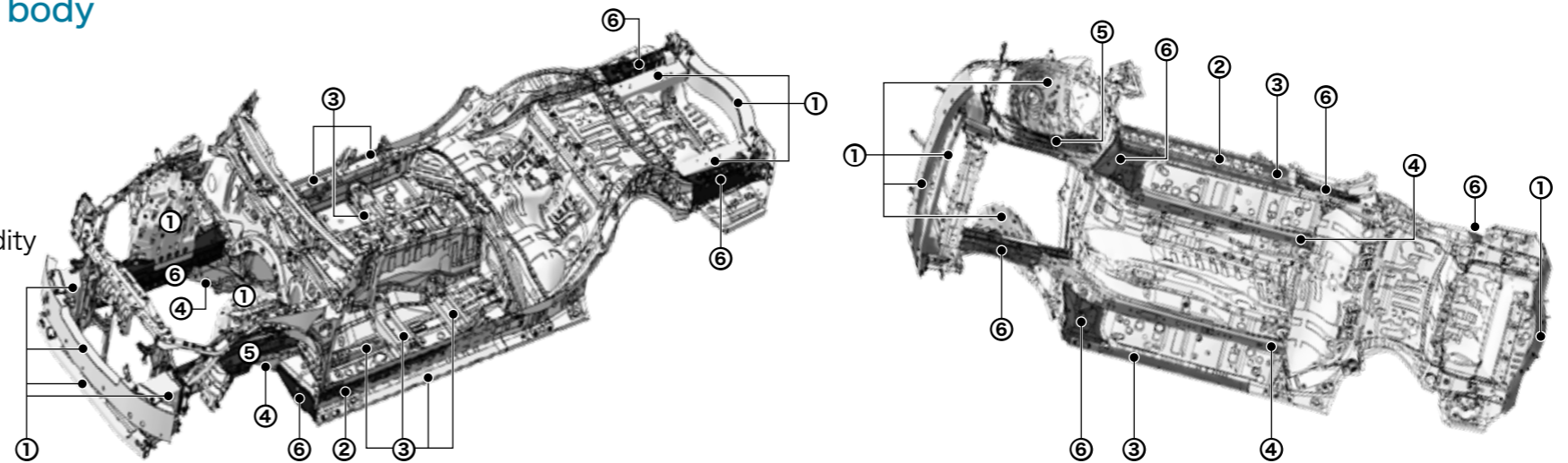

New front and rear suspension

To achieve light and clean steering, a suitable vehicle posture when cornering, and a high-quality, comfortable ride, a new suspension system is used, with high-mounted multi-link suspension at the front and low mounted multi-link suspension at the rear. It also has high stiffness at the front and rear to counter lateral acceleration in corners. Driving performance is both responsive and stable. The vehicle is also equipped with new shock absorbers at the front and rear to deliver excellent steering response and a higher level of ride comfort and sophistication with immediate response to initial movement.

Equipped with a new fuel cell system that is high performance, compact and lightweight, with a long cruising range

Changed fuel cell system layout

The FC stack and other key power units have been moved to the engine bay. The high-output motor and drive battery have been moved to the rear. There are also three high-pressure hydrogen tanks, instead of the previous two, with one of them located in the tunnel to ensure spaciousness in the cabin is not sacrificed.

Newly developed fuel cell unit (incl. fuel cells, fuel cell boost converter and power control unit)

A new fuel cell unit was developed that is smaller, has improved performance and integrates various power units such as the fuel cell boost converter and the power control unit. The new compact, high-performance unit is located in the engine bay similar to gasoline-powered vehicles.

Output density: 5.4kW/L **Maximum output: 128kW (174PS)**
(4.4kW/L including end plates)

- The fuel cells are compact and deliver world-leading high output.
- The fuel cell boost converter controls fuel cell output and boosts voltage for the drive motor high-voltage system. This is Toyota's first use of power MOS transistors, which use next-generation silicon carbide (SiC) semiconductor material to contribute to increased output.
- The power control unit controls charging/recharging of the drive battery (secondary battery).

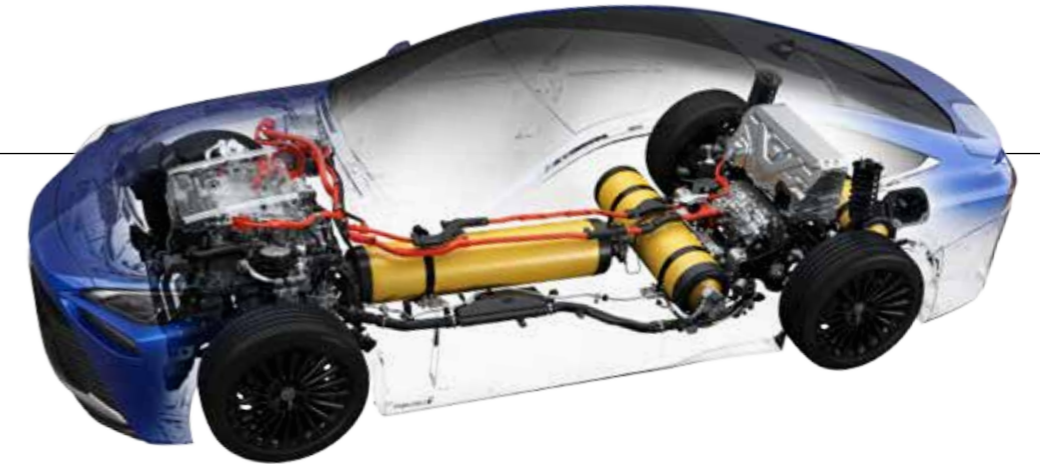

High-pressure hydrogen tanks

The high-pressure tanks hold the hydrogen fuel. To extend cruising range and provide similar spaciousness and luggage space of a gasoline-powered vehicle, one tank is located in the tunnel and two tanks are located under the floor at the rear. The tanks are filled at a high pressure of 70MPa.

High output motor

The high output, high efficiency motor was designed to deliver smooth and powerful driving performance for the FCEV. It is installed within the rear transaxle where it functions as a power generator, recovering energy during braking and deceleration.

Maximum output: 134kW (182PS) / 6,940r.p.m.

Drive battery (secondary battery)

The drive battery is a lithium-ion battery that stores energy recovered during braking and deceleration and then supplements fuel cell output during acceleration. The battery pack provides higher output while being lighter and more compact than the previous design.

Cruising range per tank (reference value)

[G*Executive Package*, G*A Package*, G] **Approx. 850km*** [Z*Executive Package*, Z] **Approx. 750km***

* Distances are calculated by multiplying the effective hydrogen capacity (kg) of the fuel cell vehicle (according to JEVS Z 902-2018) by its fuel efficiency in WLTC test mode (km/kg). Hydrogen capacity for the high-pressure hydrogen tanks depends on the filling capability of each hydrogen station, and fuel efficiency varies depending on usage conditions (weather, traffic congestion, etc.) and driving methods (sudden starts, air conditioning, etc.), so actual cruising range varies.



■ Main specifications comparison (Based on Toyota measurements)

		New Mirai	Previous model
Vehicle	Cruising range (km) Cruising range per tank (reference value)	[G*Executive Package*, G*A Package*, G] Approx. 850* [Z*Executive Package*, Z] Approx. 750*	Approx. 650 (JC08 test mode)
	Maximum speed (km/h)	175 (estimated)	175
Fuel cells	Output density (kW/L)	5.4 (4.4 including end plates)	3.5 (3.1 including end plates)
	Maximum output (kW[PS])	128 [174]	114 [155]
Hydrogen tank	Storage method	High-pressure tanks x3	High-pressure tanks x2
	Filling pressure (MPa)	70	70
Motor	Maximum output (kW[PS]/r.p.m.)	134 [182]/6,940	113 [154]
Drive	Final reduction ratio	11.691	8.779

*Distances are calculated by multiplying the effective hydrogen capacity (kg) of the fuel cell vehicle (according to JEVS Z 902-2018) by its fuel efficiency in WLTC test mode (km/kg). Hydrogen capacity for the high-pressure hydrogen tanks depends on the filling capability of each hydrogen station, and fuel efficiency varies depending on usage conditions (weather, traffic congestion, etc.) and driving methods (sudden starts, air conditioning, etc.), so actual cruising range varies.

■ FCEV mode

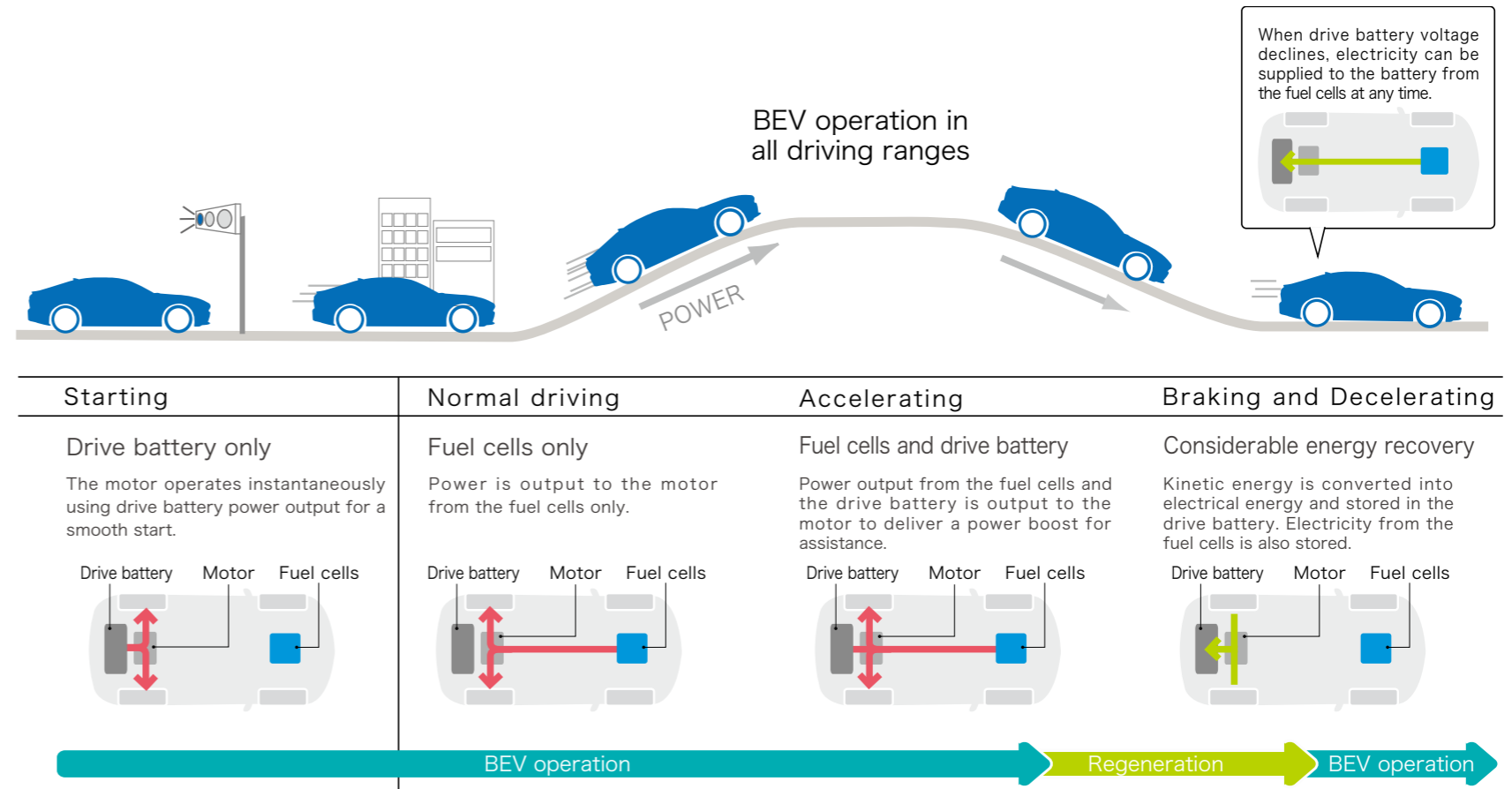

Beyond zero emissions* to “minus emissions”

Minus emissions — a new concept where more driving means cleaner air

Utilizing the unique characteristics of an FCEV, where air is drawn into the vehicle when driving to generate power, the new Mirai is equipped with an air purification system that cleans the air before emitting it as exhaust.

- ① A special air cleaning fabric (dust filter) captures fine particles as small as PM2.5.
- ② A chemical filter removes harmful chemical substances and suppresses PM2.5 particulates.

Together, this air intake system cleans more air the further the vehicle drives.



Air Purification meter visualizes the minus emissions

The large 12.3-inch center display includes an Air Purification display that shows the amount of air purified when driving through an easy-to-understand graphic of runners and digital display. It also includes an Air Purification meter that shows how much air is purified during acceleration. The meter enables the driver to feel the contribution that the new Mirai is making to the environment.

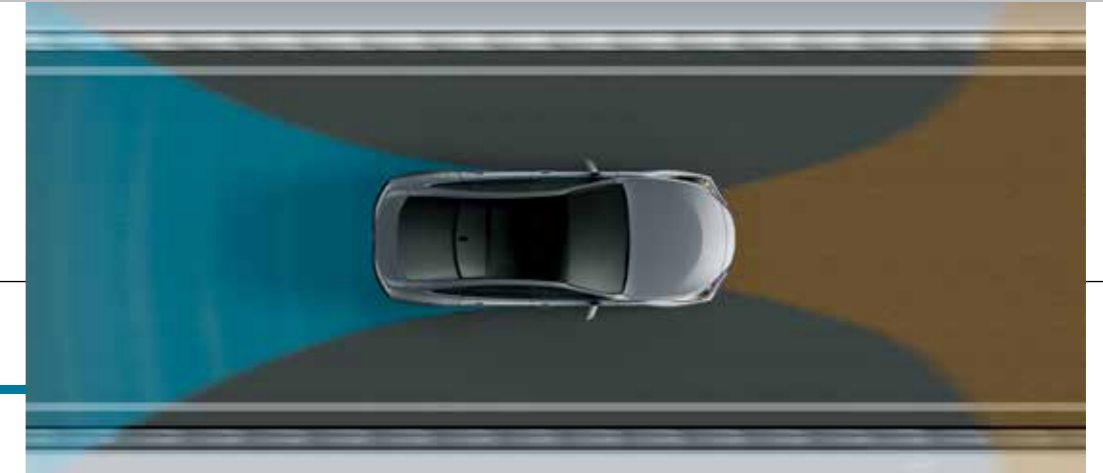

Other features

Active Sound Control (ASC)

The ASC system emits sounds from dedicated speakers in response to accelerator operation. This produces acceleration that can be felt with all five senses, providing a feeling of connection with the vehicle when driving. The audio takes advantage of the excellent quietness of the FCEV to create a sense of unity with the driver.

Water Release Switch (H₂O switch)

Water generated along with electricity in fuel cells is normally expelled automatically through the waste water pipe. This model includes a switch that enables the driver to expel the water at will. It also includes for the first time a navigation system-linked feature that enables the water to be expelled on specific roads. This can be useful if the driver forgets to operate the switch or does not want the water to be expelled in specific places such as a car park.



* “Zero emissions” refers to a system with no exhaust gas emissions, including carbon dioxide (CO₂), nitrogen oxide (NO_x) and particulates, in order to help prevent global warming and air pollution.

Body structure that protects occupants, the FC stack and hydrogen tanks



Body designed with collision-safety structure protects occupants, fuel cells and high-pressure hydrogen tanks

The new Mirai uses a strong body frame with a structure that minimizes deformation of the cabin in the event of a collision, efficiently distributing and absorbing the collision energy. It has excellent safety features that are unique to FCEVs, protecting occupants in frontal, side and rear-end collisions, while also protecting the fuel cells and high-pressure hydrogen tanks from body deformation.

Protective structure for FC stack

The FC stack is a new unit, with integrated components, that is installed in the engine compartment. New extruded aluminum members are used for the stack frame to protect the FC stack. The new unit is more compact and lightweight, while having good bending rigidity and energy absorbing parts located at the front of the stack frame. These elements work together to protect the FC stack by mitigating impact from collisions.

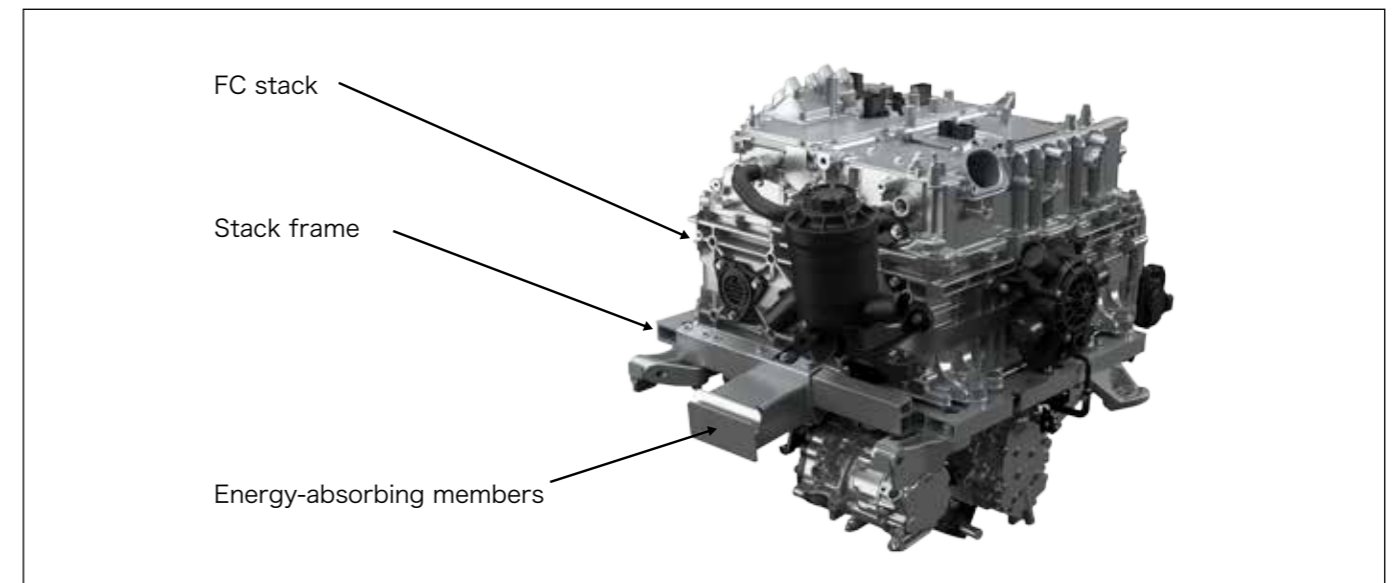

Hydrogen system safety measures that comply with strict standards

Hydrogen system safety design includes all possible measures following the basic approach of no hydrogen leaks, with immediate detection and stoppage of hydrogen flow if any leaks do occur to mitigate the accumulation of hydrogen.

>>Preventing hydrogen leaks

Strength, durability and safety measures for the hydrogen tanks

- Resin with excellent hydrogen permeation prevention performance is used for the liners inside the tanks.
- The outsides of the tanks are covered with reinforced carbon fiber resin, which is both light and strong, to improve strength.
- A safety system (fusible plug valve) will operate in a fire or other unlikely event that causes the temperature inside the tanks to increase above a set level. When the valve opens, the hydrogen inside the tank escapes and prevents a rupture.

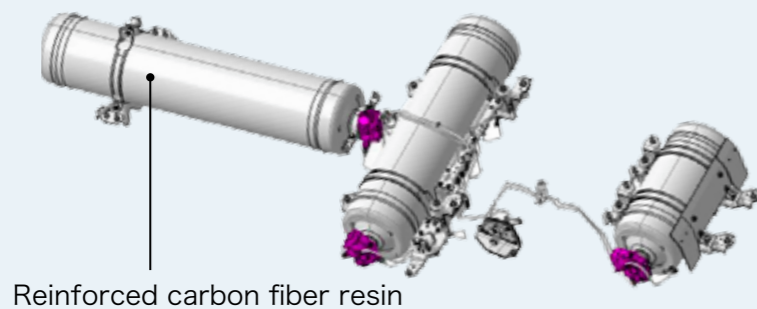

>>Detecting and stopping hydrogen leaks

System monitored for hydrogen leaks using hydrogen detectors, etc.

- Hydrogen leak detection sensors operate from when the fuel cell system starts to when it stops to detect any leaks and confirm the valves are properly closed.
- Sensors are located at various places, including the forward compartment and the hydrogen tanks, where they monitor for leaks. If a hydrogen leak of a certain concentration or higher is detected, a warning lamp appears on the meter.

■ Hydrogen sensor locations

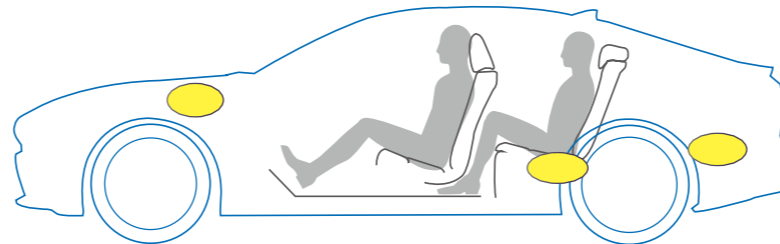

>>Preventing the accumulation of any leaking hydrogen

Hydrogen tanks located under the floor

- All three hydrogen tanks and the fuel cell unit are located outside the cabin space. The vehicle structure ensures that, even in the unlikely event that a hydrogen leak occurs, leaked hydrogen easily escapes to the outside for quick dissipation.

■ Hydrogen tank underfloor locations

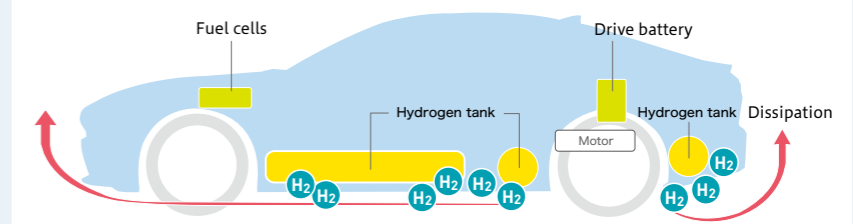

Trends and basic facts about hydrogen stations for refueling FCEVs

Hydrogen station development plans and trends

Hydrogen stations are an important piece of infrastructure for FCEVs. Established in 2018, the Japan Hydrogen Station Network (Japan H2 Mobility, JHyM) is a source of the latest information on trends in the industry as stations are operated and developed across Japan.

◎Approx. 160 hydrogen stations planned by FY2021;
with 320 stations by FY2026*

*According to the Strategic Roadmap for Hydrogen and Fuel Cells (revised) of the Ministry of Economy, Trade and Industry

◎As of July 2020, 157 hydrogen stations are operating or planned nationwide (26 planned)

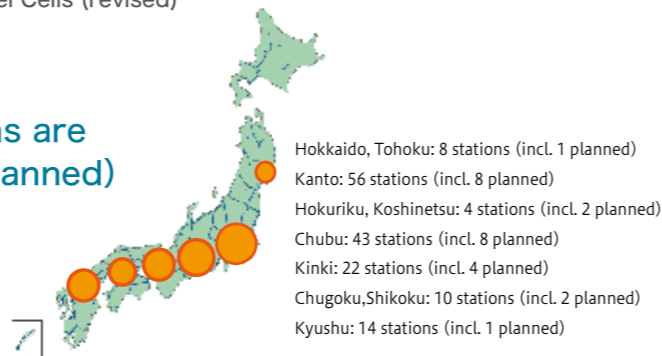

Toyota Ecoful Town



Amagasaki hydrogen station



Mobile hydrogen station



Types of hydrogen stations

Hydrogen stations can be either fixed or mobile. Among the fixed hydrogen stations, there are onsite production stations where hydrogen is produced through reforming of raw materials (kerosene, LPG, natural gas, etc.) on the premises, and offsite production stations where hydrogen is produced in separate plants and transported to the station.

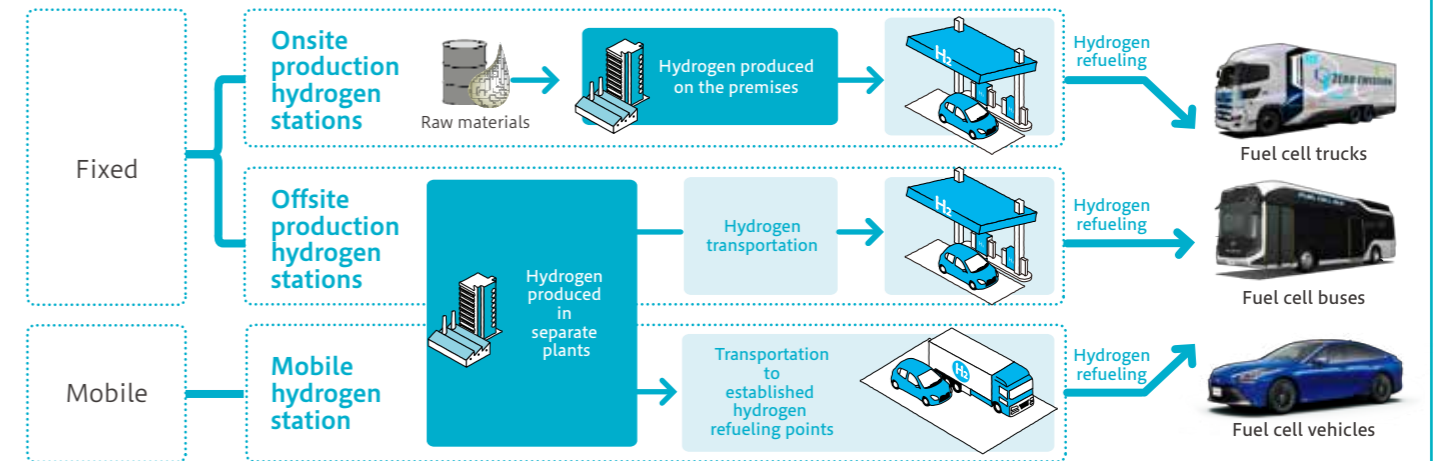

Note. Mobile hydrogen stations are flexible stations with all the required refueling equipment installed on trailers for transporting hydrogen to places that do not have the equipment for refueling.

>> Go to <https://toyota.jp/mirai/station/> for more details on hydrogen station numbers and places of operation.

Useful power supply during disasters and other emergency situations

With oxygen and hydrogen, FCEVs can produce large amounts of electricity through chemical reactions. This emergency power supply can be used during disaster-related power outages.



External DC power supply system

An external power feeding device (sold separately), connected during disasters and other emergencies, can supply high output electric power to homes and electrical products. The external power outlet is located in a compartment under the hood. In the new Mirai, accessory power outlets inside the cabin can be used even when the external DC power supply system is in operation.

An external power feeding device (sold separately), which converts direct current (DC) output from the FCEV into alternating current (AC), is required for using the external DC power supply system.

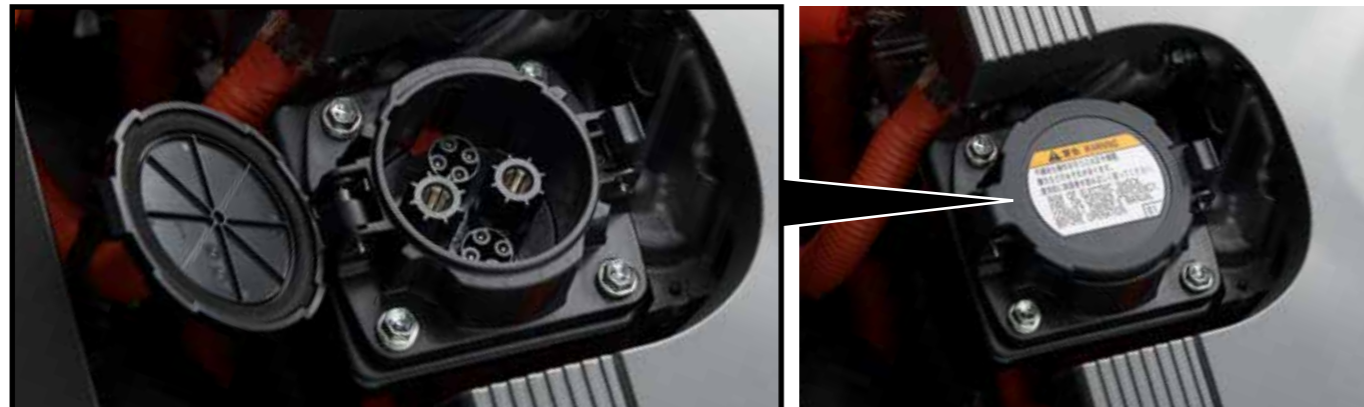

External power outlet (located in a compartment under the hood)

accessory power outlets

Electrical products can be used when connected to 1,500 W accessory power outlets in two locations.



Accessory power outlet (luggage space)



Accessory power outlet (rear of front console)

Emergency power supply system

The emergency power supply system only supplies power with the vehicle driving functions stopped.

Further peace of mind with Toyota's latest active safety package, the next-generation Toyota Safety Sense, included as standard



Next-generation Toyota Safety Sense, with five advanced features that support the driver in many situations

Collision avoidance support

Pre-Collision System

(Collision avoidance support with pedestrian detection (day and night) and bicycle rider detection (day) using millimeter wave radar and single-lens camera)

Operation speed ranges

- Pedestrian detection (day and night): Approx. 10–80 km/h
- Bicycle rider detection (day): Approx. 10–80 km/h
- Vehicle detection: Approx. 10–180 km/h

Speed reduction

- Pedestrian detection (day and night): Approx. 40 km/h
- Bicycle rider detection (day): Approx. 40 km/h
- Vehicle detection: Approx. 50 km/h

Vehicle tracking support

Radar Cruise Control (with All-speed Tracking Function)

Nighttime visibility support

Adaptive High-beam System (AHS)

Automatic High Beam (AHB)

Highway cruising support

Lane Tracing Assist (LTA)

Lane Tracing Assist provides the steering support required to stay in a lane when Radar Cruise Control is in operation. When the vehicle is about to leave the lane, warnings are provided via audio and visual alerts and steering wheel vibration. Even when Radar Cruise Control is not in operation, the lane departure prevention function and lane departure warning function operate.

Sign recognition failure support **Road Sign Assist (RSA)**

Road Sign Assist displays road signs on the meter, including speed limits, no overtaking signs, no entry signs, and stop signs.

Supplementary support: **Traffic Movement Notification (TMN)**

Extensive range of cutting-edge active safety technologies

Wall and vehicle detection during low-speed driving in parking lots, etc.

Intelligent Clearance Sonar with Parking Support Brakes (Stationary Objects)

This feature reduces collisions with obstacles and mitigates damage in the event of misapplication or excessive application of the accelerator pedal.

1 Motor output control



2 Audio alert

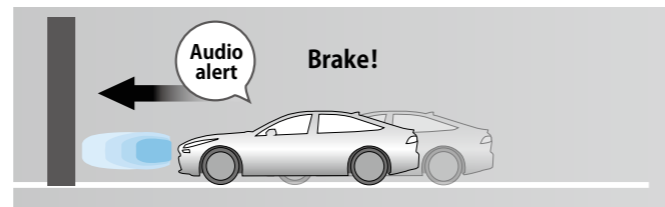

Detection of vehicles approaching from behind

Blind Spot Monitor [BSM]

This feature detects any vehicles at the rear that are difficult to see with the door mirrors, and vehicles that are rapidly approaching, and uses the indicators to notify the driver.

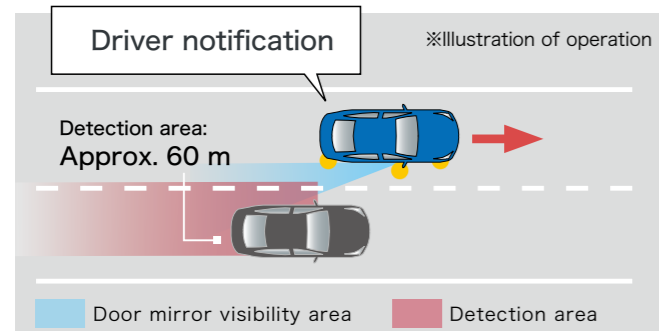

Detection of approaching vehicles and pedestrians when reversing out of a parking space.

Rear Cross Traffic Auto Brake

(Parking Support Brake: Vehicles approaching in the rear)

When reversing out of a parking space, this feature detects other vehicles approaching from the rear left or right. If there is a risk of collision, it can reduce damage via warnings and brake control.

Parking Support Brake (Pedestrians in the rear)

When reversing out of a parking space, this feature detects pedestrians in the rear. If there is a risk of collision, it can reduce damage via warnings and brake control.

Acceleration control in the event of misapplication of the accelerator pedal even when there are no obstacles present

Plus Support (speed suppression in the event of fast acceleration)

Regardless of whether an obstacle is present, if this feature detects excessive application or misapplication of the accelerator pedal, it suppresses vehicle acceleration and warns the driver via audio and visual alerts. If something happens to make the driver suddenly press the accelerator fast and hard, it operates to prevent vehicle acceleration. When the doors are unlocked with a special key*, Plus Support is automatically activated, avoiding a complicated activation process.

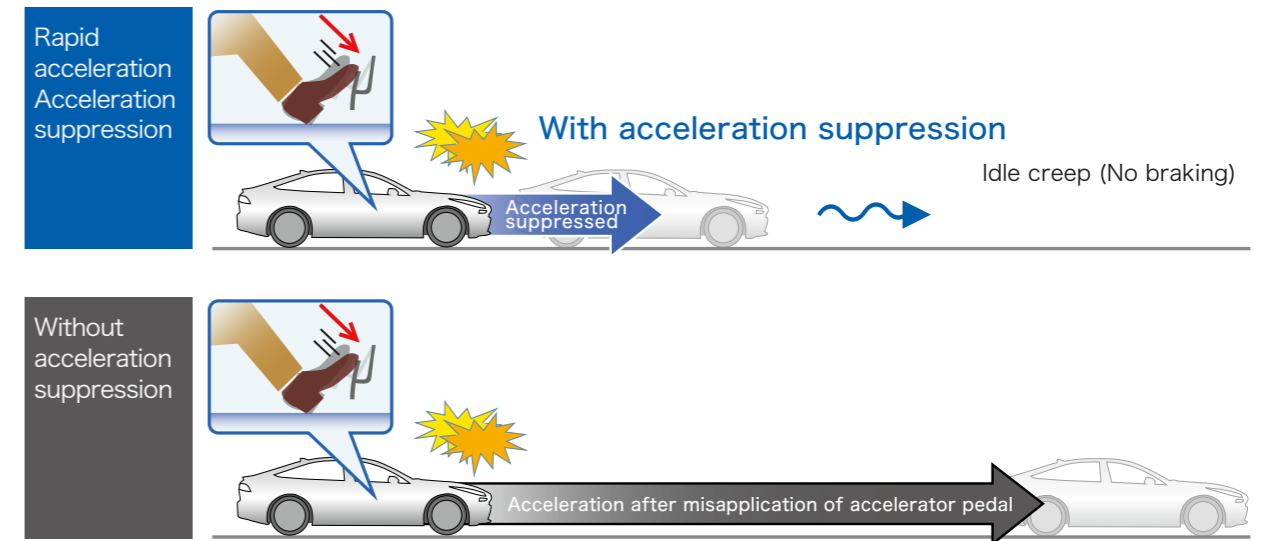

■ This is not a braking control system. ■ The system operates at speeds of up to about 30 km/h. ■ It operates in both the forward and reverse directions. ■ The system may operate unintentionally if the vehicle is driven in a manner that uses fast and hard acceleration. ■ Even with Plus Support activated, normal acceleration is possible after a left or right turn, when changing lanes, when moving off from a stop sign or after waiting at traffic signals, and when moving off or accelerating up steep inclines. However, the system may operate if turning left/right or changing lanes without using the indicator, or starting to move without previously applying the brake (such as when the vehicle is stopped using the brake hold function). In these situations, taking the foot off the accelerator and then slowly pressing it again will enable normal acceleration.

Expanded support from next-generation Toyota Safety Sense



Three additional support features in Pre-Collision System (collision avoidance support with pedestrian detection (day and night) and bicycle rider detection (day) using millimeter wave radar and single-lens camera)

●Left/right turn support at intersections (pedestrians and oncoming vehicles)

This feature is used to detect oncoming vehicles when turning right at an intersection, and pedestrians crossing the street from the opposite direction when turning right or left. (It does not detect bicycle riders.) If an oncoming vehicle or pedestrian is detected, the system warns the driver via audio and visual alerts. If there is a risk of collision, it operates the brake to avoid a collision or mitigate damage.

●Emergency Steering Assist

If the system determines that a collision is likely and there is sufficient room in the vehicle lane for avoidance, it provides steering assistance if the driver is steering to avoid the collision to ensure vehicle stability and prevent lane departure.

●Low Speed Acceleration Control

If the accelerator pedal is pressed with excessive force when driving at low speeds and the system determines that there is a possibility of a collision, it suppresses acceleration by suppressing engine output or lightly applying the brakes.

Note. This feature does not operate to detect walls and other objects detected by Intelligent Clearance Sonar with Parking Support Brakes (Stationary Objects), and cannot be used as a substitute for Intelligent Clearance Sonar with Parking Support Brakes (Stationary Objects).

New features in Radar Cruise Control (with All-speed Tracking)

●Curve speed suppression

When navigating curves, if the system determines that speed needs to be reduced, it suppresses speed from when the steering wheel starts to turn to when it returns to normal. After speed suppression, normal speed control and inter-vehicle distance control resume.

Advanced Lane Tracing Assist (LTA)

To improve lane-keeping performance, pinion angle (motor rotation angle)-based steering angle feedback control is used to achieve higher resolution detection compared to the previous model. This feature also factors in preventing overconfidence in the system by the driver, who could decide to take their hands off the steering wheel.

Driver Emergency Stop Assist

Driver Emergency Stop Assist was developed as extended functionality for LTA. The feature determines driver abnormalities if continuous non-operation of the vehicle is detected (having hands off the steering wheel, etc.). After warning the driver via audio and visual alerts, and if the situation remains unchanged, the feature gently slows the vehicle to a stop. At the same time, it warns others around the vehicle via the stop lamps, hazard lamps and horn. The system also automatically connects to HELPNET* to connect to emergency care as soon as possible.

Advanced, information technology-based safety equipment

ITS*1 Connect: Improving driving safety through vehicle-to-infrastructure communication

This system uses vehicle-to-vehicle (V2V) and vehicle-to-infrastructure (V2I) communication to provide drivers directly with the kind of safety information that cannot be picked up by onboard sensors. This includes traffic signal information and information about the presence of vehicles and pedestrians in blind spots, which helps improve driving safety.

V2I systems connecting vehicles to road-based infrastructure (DSSS*2)

These driving safety support systems use communications between infrastructure and the vehicle to obtain information about things such as oncoming vehicles, pedestrians and traffic signals, which they use to warn the driver.

Warns of the presence of a vehicle approaching from the opposite direction, or of a pedestrian crossing the road when a vehicle is turning to the right

Right-Turn Collision Caution

Right-turn Collision Caution System confirmed that it reduces the number of right-turn collision accidents' risks by approx. 40%.
(Period: April 2016 to March 2017)



Warns the driver of a red signal if the driver has not noticed it

Red Light Caution

Displays remaining time until traffic light changes when stopped at a red signal

Signal Change Advisory

V2V systems connecting vehicles to each other (CVSS*3)

These vehicle support systems use direct communication between vehicles to give and receive information about the environment surrounding the vehicles and provide driving support when required.

Provides information about emergency vehicles (ambulances), including the direction in which they are moving and their approximate distance

Emergency Vehicle Notification

Emergency Vehicle Notification System confirmed that shorten by 7.7% of average transport time in a designated area.
(Fire and Disaster Management Agency 2018 report)



Responds almost instantaneously to the acceleration and deceleration of other vehicles ahead, if they are equipped with Communicating Radar Cruise Control, to smoothly track those vehicles

Communicating Radar Cruise Control

Warns the driver of a vehicle approaching from the opposite direction while using the turn indicator and waiting to turn right at an intersection

Right-Turn Collision Caution

Warns the driver of vehicles approaching from the left or right when starting to move into an intersection

Intersection Collision Caution

Warns of the presence of approaching vehicles equipped with communication equipment and provides information on their approximate direction

Communication-Equipped Vehicle Notification

Fast dispatch of emergency vehicles HELPNET®*4 (Linked with air bags): T-Connect service

In the event of a sudden accident or driver illness, a full-time operator can contact the police or fire service to quickly dispatch an emergency vehicle. The operator is contacted automatically if the airbags are activated. This service also supports D-Call Net®*5, which can make a quick decision to dispatch a medical helicopter*6 if required.

■ For details, visit the Helicopter Emergency Medical Service Network (HEM-Net) at <http://www.hemnet.jp/>.

Safety feature to minimize injuries in the event of a collision

SRS Airbag System

This seven-SRS airbag system is included as standard on all models. In addition to the SRS airbags (driver's seat and passenger's seat) and SRS knee airbag (driver's seat), it features SRS side airbags (driver's seat and passenger's seat) and SRS curtain shield airbags (front and back seats) to protect against side collisions.

*1. Intelligent Transport Systems. *2. Driving Safety Support Systems. *3. Connected Vehicles Support Systems. *4. HELPNET is a registered trademark of Japan Mayday Service Co., Ltd. *5. D-Call Net is the registered trademark of Helicopter Emergency Medical Service Network (HEM-Net). D-Call Net® is not supported if the HELPNET button is pressed. *6. Medical helicopters are not always dispatched to collisions. Dispatch depends on factors such as the location, time and weather conditions.

Latest safety technologies providing peace of mind while driving and parking

Digital Rearview Mirror

Images from the vehicle rear camera are displayed on the digital rearview mirror. Operating the lever switches between optical mirror mode and digital mirror mode. This provides vision to the rear of the vehicle if headrests or luggage are obstructing the view.



Digital mirror mode



Optical mirror mode

Reverse control wipers

The timing of washer operation is more accurately tuned to wiper position, vehicle speed and air temperature. Optimal spraying of washer fluid ensures driver visibility and achieves superior wiping performance. The wiper stop position is also lower, which improves the exterior appearance of the vehicle.

Panoramic View Monitor (with See-through View)

Panoramic View Monitor displays images on the navigation system screen as though looking down on the vehicle from above, which enables the driver to check surroundings in real time that may be difficult to see from the driver seat alone. It also includes a See-through View function that produces an image as if looking through the vehicle to the outside. This provides additional support for checking around the vehicle when parking or in intersections.

Back Guide Monitor

This feature provides a rear view on the display to assist when reversing into parking spaces. The lines represent distances from the vehicle, width of the vehicle, and predicted trajectory based on steering wheel angle.

Camera cleaning system

A camera cleaning system, linked to the rear washer switch, is also used to clean dirt from the reversing camera and digital inner mirror camera.

※Note. The digital inner mirror and camera cleaning system are provided together as a package.

Vehicle-controlled gear changes in addition to steering, acceleration and braking Advanced Park assists in difficult parking situations

Advanced Park helps to make parking safer, more confident and easier for everyone. Referencing thousands of parking patterns, this system analyzes distances, entry angles, vehicle speeds, order of operation and other factors relevant to a parking space, while entering the parking space safely and smoothly.

Smooth parking at the push of a button

This system controls acceleration, braking, steering and gear changes using superior detection capabilities around the vehicle, such as the Panoramic View Monitor's camera, the Clearance Sonar's ultrasonic sensors, and infrared lights for nighttime recognition. After stopping next to a parking space, the driver presses the Advanced Park switch, checks around the vehicle for safety and confirms the parking space, and then presses the on-screen start switch to smoothly park the vehicle. During the Advanced Park operation, the situation around the vehicle can be viewed on the display. If an obstacle is detected, such as a moving object or a narrow pole, the system provides an audible warning and operates the brakes to avoid contact.



Advanced Park switch

Fast parking, even for experienced drivers

With memory function to enable parking even without white lines

Advanced Park assists with ① adjacent parking, and ② parallel parking and parking space departure, in parking spaces with white lines and with adjacent vehicles. It also assists in ③ parking when there are no white lines or adjacent vehicles.

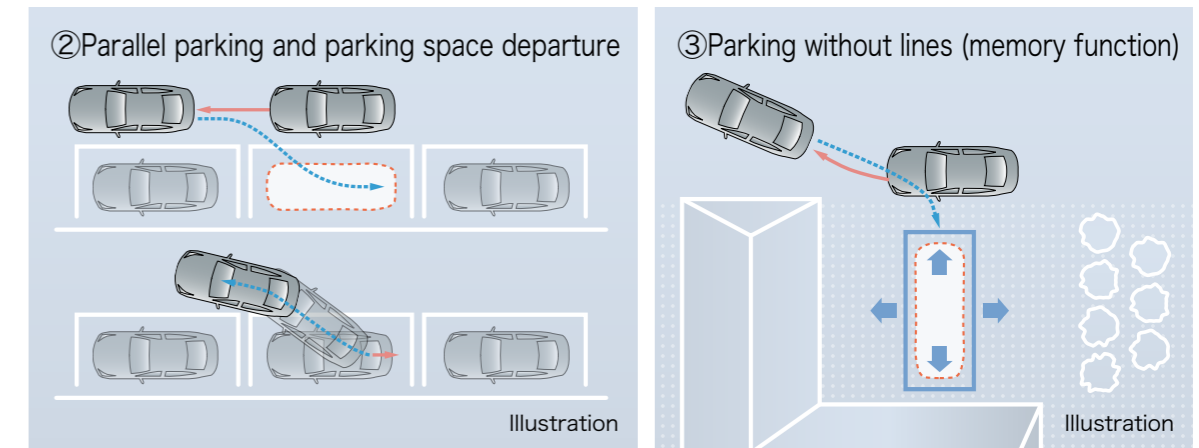
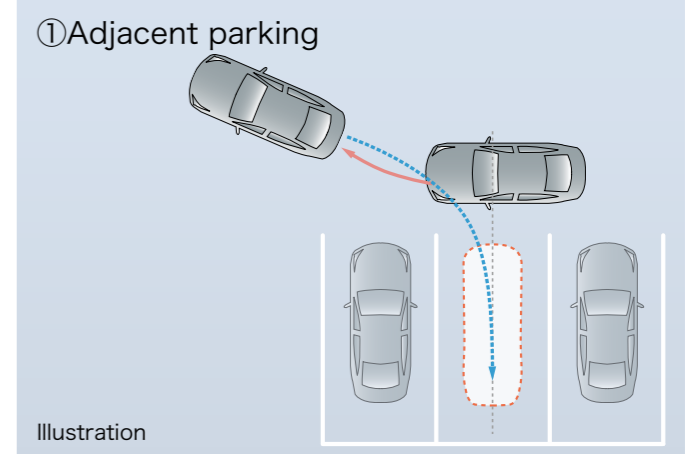

Parking operation procedure, and parking position storage procedure (without white lines at home, etc.)

Operating procedure: Adjacent parking

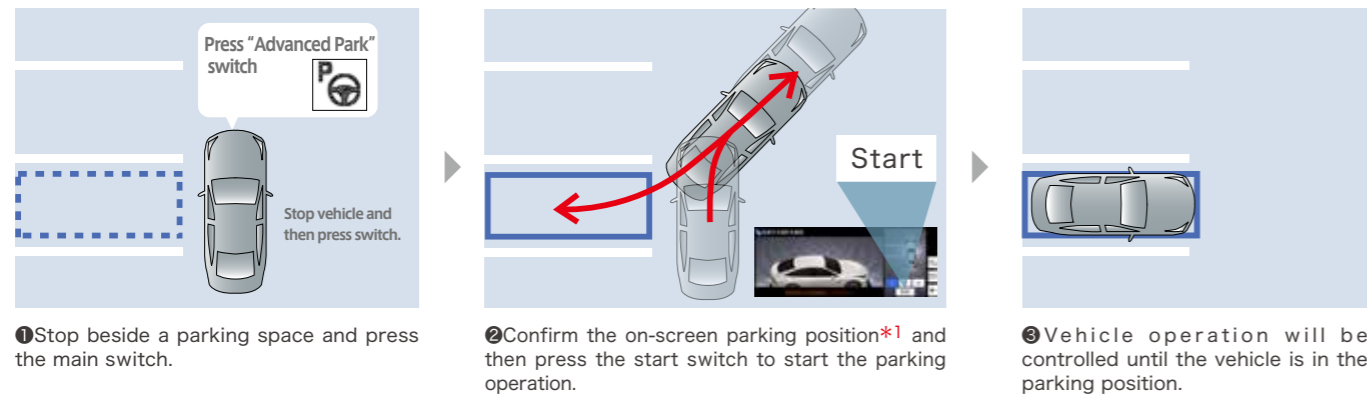

Operating procedure: Parallel parking

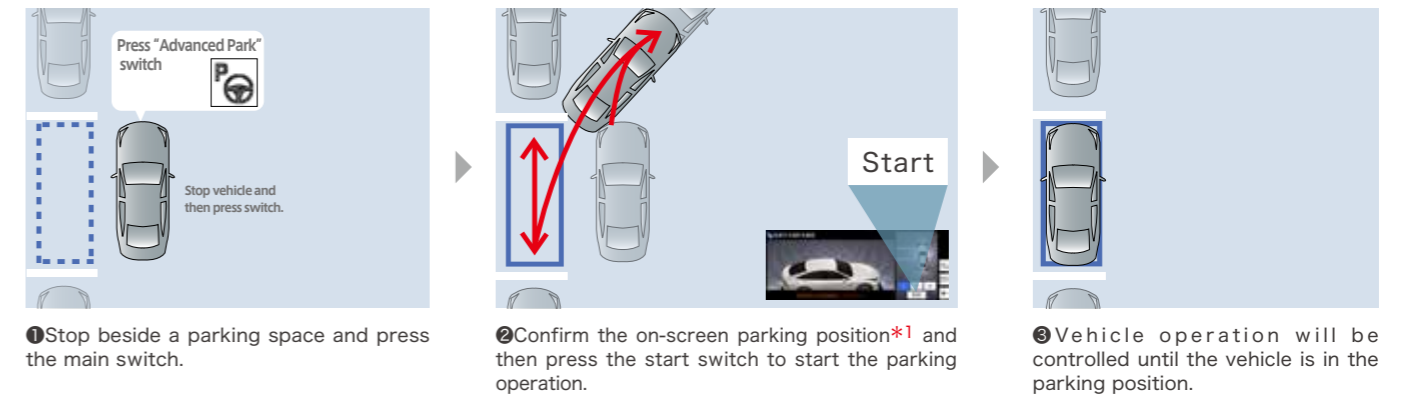

Collision damage mitigation

While monitoring the environment through cameras and sonar, this system assists with parking to provide peace of mind. If any unexpected obstacles are detected*2, it provides an audible warning and operates the brakes to avoid contact. Even during the Advanced Park operation, the driver must always remain vigilant.

Parking position storage procedure

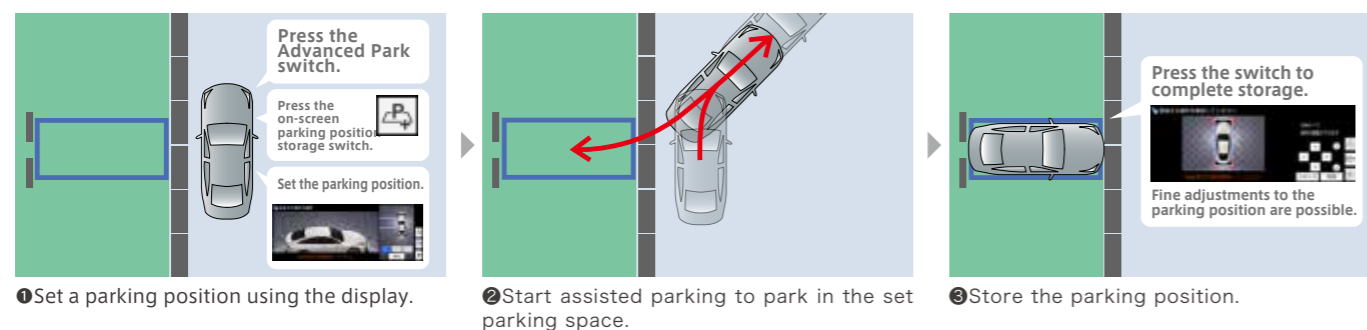

*1. Parking position can be changed if there are multiple parking spaces *2. The system might not function in some conditions (poor weather, nighttime, etc.).

		"Executive Package"	Z	"Executive Package"	"A Package"	G
Vehicle Model, Weight, Performance	Vehicle model	ZBA-JPD20-CEDHS(E)	ZBA-JPD20-CEDHS	ZBA-JPD20-CEDSS(E)	ZBA-JPD20-CEDSS(A)	ZBA-JPD20-CEDSS
	Vehicle weight	kg	1,950*1	1,930*1	1,940	1,920
	Gross vehicle weight	kg	2,225*1	2,205*1	2,215	2,195
	Minimum turning radius	m	5.8			
	Maximum speed	km/h	175(estimated)			
	Cruising range per tank (reference value)*2	km	750		850	
Fuel efficiency (according to Japanese Ministry of Land, Infrastructure, Transport and Tourism) Fuel cell vehicle (FCEV)	km/kg	135		152		
F-C stack	Model	FCB130				
	Type	Polymer electrolyte				
	Output density	kW/L	5.4(4.4 including end plates)			
	Maximum output	kW(PS)	128 (174)			
	Fuel cells	Quantity	330			
	Connection type		Serial connection			
Fuel Tanks	Fuel type	Compressed hydrogen				
	Storage method	High-pressure tanks x3				
	Tank capacity	liter	141 (64 front, 52 center, 25 rear)			
	Nominal working pressure	MPa	70			
Motor	Model	3KM				
	Type	AC synchronous electric generator (permanent magnet synchronous motor)				
	Rated output	kW	48.0			
	Maximum output (net)	kW (PS)/rpm	134(182)/6,940			
	Maximum torque (net)	N-m (kgf-m)/rpm	300 (30.6)/0~3,267			
Drive Battery	Type	Lithium-ion				
	Capacity	Ah	4.0			
	Quantity		84			
	Connection type		Serial connection			
Dimensions, Passengers	Length/width/height	mm	4,975/1,885/1,470*3		4,975/1,885/1,470	
	Wheelbase	mm	2,920			
	Track	mm	1,610/1,605			
	Minimum ground clearance*4	mm	155			
	Cabin	mm	1,805/1,595/1,135			
	Passengers	people	5			
Running System, Driveline	Suspension	Front/rear	Multi-link coil springs/Multi-link coil springs			
	Brakes	Front/rear	Ventilated disc / Ventilated disc			
	System		Hydraulic and regenerative braking system			
	Driveline		Rear-wheel drive			
Reduction ratio		11.691				

*1 Plus 10 kg with panorama roof installed. *2 Distances are calculated by multiplying the effective hydrogen capacity (kg) of the fuel cell vehicle (according to JEVS Z 902-2018) by its fuel efficiency in WLTC test mode (km/kg). Hydrogen capacity for the high-pressure hydrogen tanks depends on the filling capability of each hydrogen station, and fuel efficiency varies depending on usage conditions (weather, traffic congestion, etc.) and driving methods (sudden starts, air conditioning, etc.), so actual cruising range varies. *3 Height 1,480 mm with panorama roof installed. *4 Based on Toyota measurements.

● Fuel efficiency is calculated according to defined test conditions. It varies depending on usage conditions (weather, traffic congestion, etc.) and driving methods (sudden starts, air conditioning, etc.). ● WLTC (World Harmonized Light Vehicles Test Cycle) is an internationally recognized test cycle, and is based on average usage ratios for urban, suburban, and highway driving. Urban mode assumes relatively low-speed driving affected by traffic lights and traffic jams, suburban mode assumes driving that is not significantly affected by traffic lights and traffic jams, and highway mode assumes driving on expressways and similar.