

New Zealand Rolls-Royce & Bentley Club Inc Issue 13-2, 2013

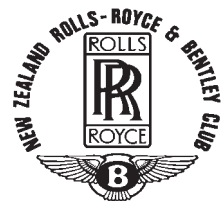



NEW ZEALAND ROLLS-ROYCE & BENTLEY CLUB (INC)

The Bentley badge and Bentley name are registered trademarks of Bentley Motors Limited.

The Rolls-Royce badge and Rolls-Royce name are registered trademarks of Rolls-Royce plc.

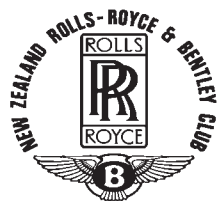

NATIONAL EXECUTIVE

CHAIRMAN Rob Carthew
85A Wharewaka Road, Taupo
Phone 07 377 4117

Email watcher@pl.net

IMMEDIATE PAST CHAIRMAN

Michael Midgley
RD 1, Culverden, Nth Canterbury 7391
SECRETARY Naomi Neill
P.O. Box 616, Gisborne 4040
Phone 06 867 1676

Email diknomi9@gmail.com

TREASURER Philip Eilenberg

3B 21 George Street, Parnell, Auckland
Phone: 09 374 5901 or Mobile 021 928 041

Email peilenbergnz@gmail.com

MEMBERSHIP REGISTRAR Clive Edmonds

156 Hill Road, RD2, Napier 4182
Phone 06 836 6644

Email clivedmonds@yahoo.com

TECHNICAL LIAISON OFFICER

Post WW2 Roy Tilley
204a Waiwhetu Road, Lower Hutt
Phone 04 566 0850 Fax 04 586 2937

Email rmt@xtra.co.nz

TECHNICAL LIAISON OFFICER

Pre WW2 Eddie Riddle

1 Wickliffe St, Mosgiel 9024

Phone 03 489 5774

Email edjoyr@xtra.co.nz

MAGAZINE EDITOR Tom King

191 Sparks Road, Christchurch 8025

Phone 03 339-8309 or Mobile 0275 880 767

Email the.king@xtra.co.nz

WEB MASTER Bruce Gordon

Phone 09 834 0570 or Mobile 0221 074 6355

Email bruce@webexpress.co.nz

NATIONAL EVENTS CO-ORDINATOR

David Merryweather

47 Flays Road RD3 Drury 2579

Phone 09 294 8552

Email oldboot@ps.gen.nz

NORTHERN REGION

CHAIRMAN Glynn Williams

24 Franklin Road, Freemans Bay, Auckland 1011

Phone 09 378 7632

Email williams24@gmail.com

SECRETARY Susie Williams

Phone 09 478 3995 or Mobile 021 0460606

Email suehowiewilliams@hotmail.com

CENTRAL REGION

CHAIRMAN Roy Tilley

204a Waiwhetu Road, Lower Hutt

Phone 04 566 0850

Email rmt@xtra.co.nz

SECRETARY Martin Taylor

24 Rangiora Avenue, Kaiwharawhara, Wellington

Phone 04 470-7666

Email porsche@globe.net.nz

SOUTHERN REGION

CHAIRMAN Keith Hunter

1/12 Heywood Terrace, Richmond, Christchurch 7391

Phone 03 366 4484 or Mobile 0274 355 220

Email kmacdh@xtra.co.nz

SECRETARY Tom King

191 Sparks Road, Christchurch 8025

Phone 03 339-8309 or Mobile 0275 880 767

Email the.king@xtra.co.nz

NEXT MAGAZINE:

Deadline for receipt of all material for Issue 13-3 is 22 May 2013.

(Front Cover)

Bob Beardsley reading the plaque which adorns Chassis 1492. See articles in this issue, pages 4 and 10.

Membership

MEMBERSHIP of the New Zealand Rolls-Royce & Bentley Club Inc is open to anyone with an interest in these two distinguished marques, whether or not they are the owner of a Rolls-Royce or Bentley. Your Membership SUBSCRIPTION includes the Club Magazine (6 issues annually), the right to attend all Club events and activities, and to partake in Club management.

FEES: Registration Fee \$ 10.00 (once only)

Membership Fee \$115.00 (annual, reduced to \$100 for prompt payment)

Family membership \$ 5.00 (annual)

CONTACT Membership Registrar NZ Rolls-Royce & Bentley Club, Inc

Clive Edmonds, 156 Hill Road, RD2, Napier 4182 Phone: (06) 336 6644 Email:

clivedmonds@yahoo.com or www.nzrrbc.co.nz, then APPLICATION FORM

Chassis Records

The Company's Construction Records, which accompanied every Rolls-Royce and Bentley chassis (since 1931) through its production at Derby or Crewe, are a valuable resource for subsequent owners. They detail the original order, any special equipment, and the results of tests and inspections prior to dispatch. The records for all cars over 10 years old are held by the RREC in the UK, and copies are available to members of that Club. The number of pages for early cars may be up to 20 or more. Records for a Silver Shadow can amount to even more pages and cost around \$NZ150. To obtain a copy of your car's records, contact the Club's Post WW2 Technical Liaison Officer, Roy Tilley, on 04 566 0850 E-mail rmt@xtra.co.nz

Advertising

Classified advertisements pertaining to Rolls-Royce and Bentley are free to Financial Members who do not deal regularly in Rolls-Royce or Bentley cars or services. All classified advertisements must be submitted to the Editor, Tom King, Phone 03 3398 309, e-mail the.king@xtra.co.nz 191 Sparks Road, Christchurch 8025. Commercial advertisements will be the subject to a charge to the advertiser. Colour advertisements are charged at \$220 per half page and \$300 for full page, payable to the NZRR&BC Inc.

Mainland Comment

Rolls-Royce and/or Bentley ownership means something tangible, yet very different and very personal to our members. Whether we prefer to regard our cars as great works of art and engineering, prized possessions, or crosses we have to bear, and the use of them as opportunities to appreciate their touring capabilities, foibles, or return in spirit to another era, our Club should exist as a forum for as wide a variety of enthusiasts as the cars which interest us.

Our Chairman, Rob Carthew, writes "I regret to advise the passing of Bruce London on 7 February. Many will recall Bruce when visiting his and Jean's home at Motuoapa, southern Lake Taupo, when returning home from the 2009 AGM held at Turangi, and seeing his eclectic collection of all sorts of memorabilia, including his Rolls-Royce and other cars, and his collection of some 2,000 hats."

We record the deaths last December of two important figures; Colin Charles Houghton Davis, the racing driver son of S.C.H. "Sammy" Davis, featured in Eoin Young's article in our 13-1; and Hugh Young, for many years a Technical Consultant for Vintage Bentleys of the Rolls-Royce Owners' Club of America, and for several years a Contributing Editor of *The Flying Lady* and frequent contributor to *The Bentley Drivers Club Review*. We have quoted from his erudite writing in our magazine, and frequently refer to his *BDC Review Index*. Thanks to the Obituary from *The Guardian* we now know that Colin Davis was not to be confused with the conductor Sir Colin Davis.

Our Founder, Roger Lloyd, has written in response to John Stewart's letter in 13-1, which was in turn a reaction to the report on the Southern Region's Run to Dunedin in 12-6.

On reading John Stewart's letter in 13-1, a brief background to the Club's beginnings may be helpful.

During the 1970 Bentley Drivers Club Rally at Mt Cook I was asked about starting a branch in Wellington, but felt it was not practicable as the region did not have the numbers.

I decided that a Rolls-Royce and Bentley club would make more sense and after discussion with others we agreed to go ahead. Initially there was not universal acceptance, but we gathered strength and local outings were well attended so Auckland and then the South Island followed.

To everyone I said that, regardless of our respective backgrounds, we had one thing in common which would bind us together; we appreciated and valued ownership of a Rolls-Royce or a Bentley. We had much to be proud of, and were a privileged few. Because these cars had a public image worldwide it was not easy to shout loudly how fortunate we were but within the confines of a Club we could talk our heads off, share experiences and learn more about our machines. The Club grew quickly and annual rallies took place in many centres.

I was keen to break down the public image of Rolls-Royce cars and their owners so we took the opportunity to put our cars on display to the public sometimes with a parade as well. Responses were amazing and funds collected went to a local charity. It was good PR and a street procession was often an addition. There were also a television documentary and a National Radio programme on Rolls-Royces in New Zealand.

Rally attendances were stronger than today; we had more time. Up to 35 cars would be there, and some 120 members for the formal dinners. The Club has achieved much with many outstanding participants and personalities and we have much to be thankful for. Our heartfelt thanks go out to the team who produce such splendid work for our magazine.

Celebrations

Fifty years ago a young Gavin Bain sold his MG TF-1500 and bought a 1924 3 litre Bentley Speed Model, chassis 728. It had originally belonged to Viscount Kingsborough and had a Park Ward tourer body. It was imported to NZ by Buddy Harding in 1949; then owned by Harry Williamson, Tai Tapu; and D.W. Jordan, Invercargill 1961. By the time Gavin bought the car its Park Ward body had been replaced by what was claimed to be a faithful copy, but its truncated appearance didn't please him, and after the 1965 visit of Miss Elizabeth Nagle in her 3 litre, Chassis 1003, Gavin was inspired to create a replica of its H.J. Mulliner boat-tailed body. This was built by Ashley Jackson in 1968, and the restoration was completed by late 1969.

Gavin Bain and 728 have been very active competitors here and



(Above) Gavin Bain and his bagpipes with his recently acquired 3 litre, chassis 728 at Pukaki Station on the 1964 Irishman Creek Rally, with Bob Beardsley in George Wright's 4 1/2 litre, chassis UK3285, showing signs of damage it received the evening before. Your editor's Riley Continental Touring Saloon on the left was painted this stagnant tomato soup colour by its first New Zealand owner, Ian Maxwell-Stewart, whose later Bentley exploits were reported in our magazine 07-6.

(Below) Gavin Bain's 3 litre chassis 728 in its current form.



in Britain for many years, and the car recently returned here for its fiftieth anniversary in Gavin's hands. In late January the Bentley Drivers Club arrived in Christchurch to start their New Zealand tour, and on a glorious summer day about twenty "W.O." Bentleys came to Gavin's and Annabelle's property at Governors Bay to help celebrate the Anniversary and meet local interested people over a catered lunch. Anything that wasn't a vintage Bentley was left on the road or in another spot out of sight, and this reporter cannot remember seeing as many Green Bentleys at one time in this country. Vanden Plas bodies seemed to predominate, but a little detective work with Stanley Sedgwick's 1976 *All the Pre-War Bentleys - As New* revealed that, for instance, a Gurney Nutting limousine body on a 6 1/2 litre chassis had been transformed into something more suitable for 24 hours at Le Mans. Roger Fry, who has built some fine bodies over many years, was here from Western Australia with a dual-cowl Vanden Plas 6 1/2 litre tourer. Panelled in alloy, it looked very similar to the fabric tourer owned some years ago by Alf Seccombe, and now owned in America by Stan Lucas.

It was instructive to wander about the cars in company with local long-time enthusiasts such as Ellis Shiers, Ron Hasell, Geoff Owen, Donald Wright, and Bob Beardsley. The absorption of knowledge over many decades has endowed these gentlemen with information important to note, and accurately too. About this time Gavin started a scrap book of histories of New Zealand based Bentleys; this is kept up to date and frequently referred to for research in our publication.

Geoffrey Williams died just after Christmas, at the age of 89. He was a student at Canterbury University when war was declared in 1939, and after training here and in Canada, served in Britain, latterly as an instructor on Bristol Blenheims. He had a distinguished flying career with National Airways Corporation, South Pacific Airlines of New Zealand, and Mt Cook Airlines, retiring as their Chief Pilot. Captain Williams said that he had never experienced an anxious moment in his flying career, and one can well believe that. That urbane gentleman's charm always left those with whom he came into contact feeling better for his presence. Until his health deteriorated at about the time of the earthquakes in

Christchurch he enjoyed water-colour painting, and his room was graced by his impression of English landscape through the "glass-house" of the Blenheim, and Bentley TT Replica, Chassis 260.

In the late 1940s he bought TT Replica Chassis 260, engine 353 (ex chassis 348) from Percy Bull, and in association with Buddy Harding components of various cars were shuffled somewhat. Bentley Drivers Club records show that the car had been in New Zealand since 1934, and that the then owner, Mr T. Wickham,

He was able to bang on the fence, and a neighbour soon had an ambulance to take him to hospital for treatment, which has helped in his recovery. Bob, a skilled engineer by training, had been a great help to the late Dave Bowman, who bought a 1928 4½ litre Chassis SL3065, but with 3 litre engine SS1365 and radiator fitted. Jim Sawers and Glynn Williams, who knew Dave Bowman well, wrote an article about him in our 09-2, and he graced the cover of our 08-5 with KR2692. When Dave bought that car in June

example to rival any of the visiting Bentleys. Bob Beardsley in UK3285 suffered a mishap on returning from Tekapo with supplies one evening, when following Dave Bowman in SL3065. Dave came over a blind brow to find that the headlights were ineffective. Unfortunately his hydraulic brake conversion proved

Geoff Owen bought 3 litre Speed Model chassis 1215 in 1960. This car was first registered in November 1925 to B. Stewart in Dundee, Scotland, but he had brought it out here by March 1926. It had a roadster body originally, but was re-bodied as a Four Seater Tourer, modified to Vanden Plas style by Johnson & Smith,

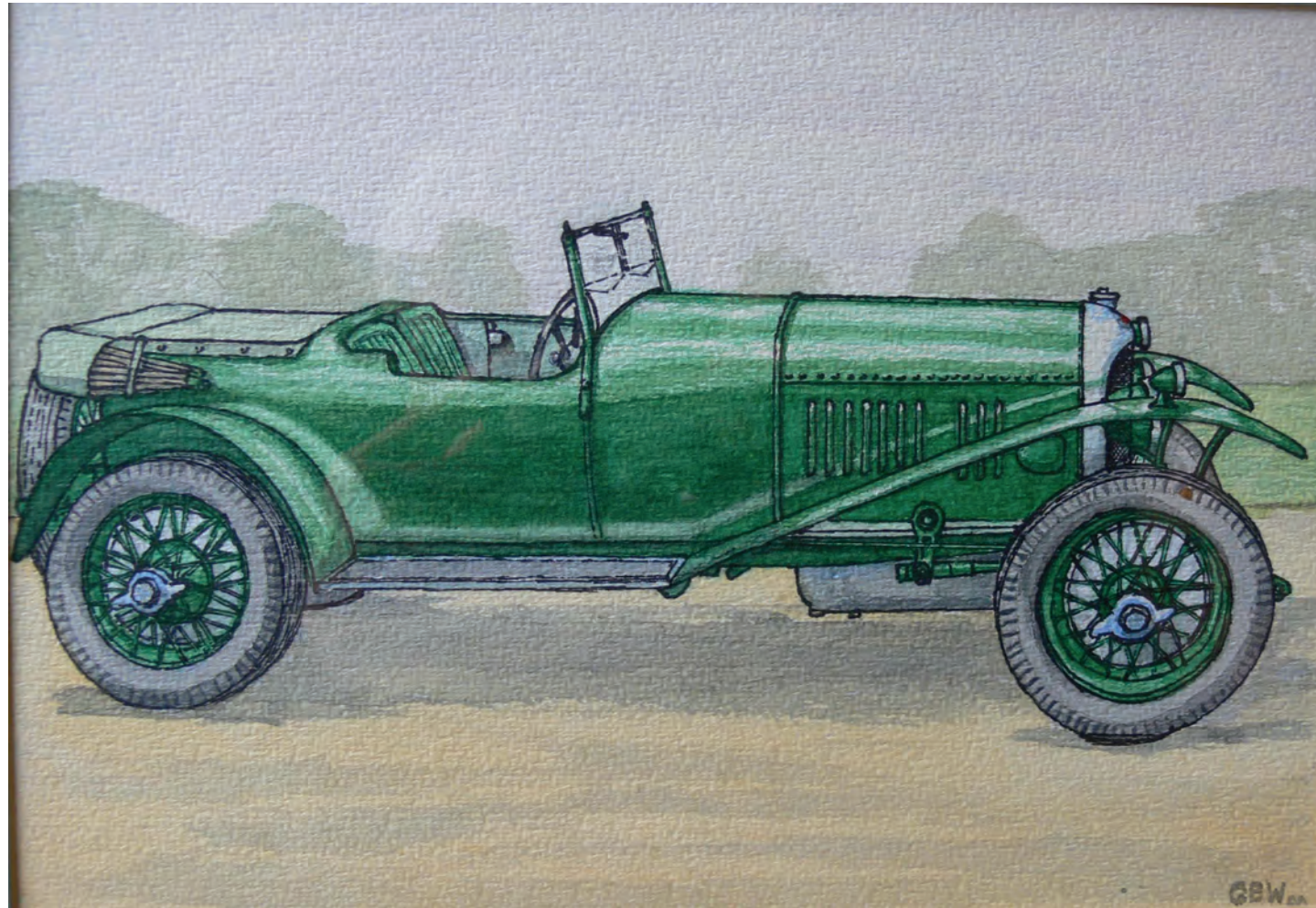

Geoffrey Williams's drawing of 3 litre TT Replica, chassis 260.

contacted Keston Pelmore, the Club's founder, in June 1936, very shortly after that club's beginnings, to enquire about joining. He had read about the BDC in *The Motor*. The following about 260 is quoted from *BDC Review* Number 42, September 1956 "which he found sitting in a suburban Christchurch street in 1949 with grass growing through its floorboards. Stripping down the engine revealed a genuine Hudson Super Six connecting rod; so heavy was this monstrosity that the three remaining Bentley rods had had their webs filled with lead for 3" up from the big-ends to create some semblance of balance. Just for good measure the three original rods were found to be bent anyway, as was the crankshaft, and the whole lot had to be replaced." When Geoffrey Williams was transferred to Dunedin he towed 260 there behind a Renault, and completed the rebuild in the National Airways Corporation's hangar at Taieri Aerodrome.

Geoffrey Williams sold 260 to Ron Hasell in 1958, starting Ron's long association with the Bentley marque, which has continued with a Mark VI and T Type. During a career in the insurance industry, Ron had the idea and drive to establish the Vintage Car insurance scheme; before that came about our cars were deemed uninsurable by unsympathetic insurance companies, and one blanches in retrospect at the memory of the havoc a mishap could have caused. Ron often attends our events, often in company with Ellis and Angela Shiers and Bob Beardsley.

Bob Beardsley's health suffered during the 22 February 2011 Christchurch earthquakes, and when down a hole he had dug to remedy a water problem he found his limbs not obeying orders.

1966, Bob bought the 4½/3 litre and campaigned it enthusiastically for many years. A festive soul, Bob competed in Irishman Creek Rallies until recently, and probably attended more of them than any other person. Always first up in the mornings in anticipation of another enjoyable day, he was likely to pour beer into the sleeping bags of malingers who had probably competed less enthusiastically than he in the indoor games the previous evening.

Donald Wright inherited the 1929 4½ litre Vanden Plas Roadster, Chassis UK3285, from his late father, George. This car was imported new by W.M. Hudson, Dunedin, and remains a fine original



John King's 1972 photograph of Bob Beardsley competing at Invermay Hill Climb with SL3065



Donald Wright's 4 ½ litre Vanden Plas Roadster chassis UK3285 at home, Annat, Canterbury

much more effective than the system on UK3285, and Bob was left with little time to decide whether to smite Dave's car, or take to the Mackenzie Country. The latter option was far the better, but Bob's passenger was a large friend, and the car rolled slowly onto its left side, suffering quite mild damage to mudguards, spare wheel mounting and windscreen frame. See Page 3.

Christchurch in 1928 for its second owner. Geoff fitted a 4½ litre engine in 1971, and he and Shirley have enjoyed the car over many thousands of miles before making the decision to pass it on to its next custodian.



(Above) Bruce Washington, on the left, the new custodian of 3/4½ litre chassis 1215, with its previous owner, Geoff Owen (Right) Gavin Bain, surrounded by Bentleys taking part in the Bentley Drivers Club Tour of New Zealand



The Exploding Battery - Beware But Be Aware By Professor Barrie Gillings

Barrie Gillings wrote this article for *Præclarvm* in 2009, and contributed it after reading Richard Hadfield's experiences in our 13-1. We are grateful to Barrie for imparting his scientific knowledge, and to the Editor of *Præclarvm*, Tim Dean, for his permission to reprint it.



There are two groups of owners of pre-1934 Rolls-Royce cars with generators. In the first group are owners who have experienced an exploding battery, and in the second group are owners who have *not*

yet experienced an exploding battery. This article attempts to explain the how and why of this unnerving and increasingly common experience. If you flunked physics and chemistry at school, it may help you to understand the science behind how it happens if you read the next few headings. But if that high school science stuff bores you, go straight to 'CORROSION', below. ATOMS, THERE ARE A LOT OF THEM ABOUT

It is perhaps hard to grasp, but everything you can see, feel, smell or taste consists of electrons, protons and neutrons. This includes the earth and everything in and on it, our planets, our sun and galaxy, and all the other galaxies. Electrons, protons and neutrons can combine, and nearly all of them do, to make atoms. Most of these atoms combine to form molecules, many of which are very big. Our bodies are full of them. An electron is very small, and has a negative charge. A proton is about 1,800 times as heavy as an electron, is about that much larger, and has a positive charge. A neutron is very much like a proton, but has no charge.

Atoms are awfully small. One cubic centimeter of a solid or liquid contains about 10^{23} (10 followed 23 zeros) atoms. The small ones are about a tenth of a nanometer (10^{-10} meters) in diameter. If threaded on a necklace-size string, like pearls, there would be about ten thousand million of them. Imagine an orange enlarged to about the size of the earth. All of the orange's atoms would then be enlarged to about the same size as the original orange.

In the Periodic Table of Chemical Elements, all the various types of atom are arranged, in order of increasing size, and thus weight. There are just over 100 varieties. For crossword enthusiasts, the first ten are: Hydrogen (H), Helium (He), (Both are gases), Lithium (Li), Beryllium (Be), Boron (B), (These are metals), Carbon (C), (Soot, coal, diamond etc), Nitrogen (N), Oxygen (O), Fluorine (F) (Reactive gases), Neon (Ne) (Inert gas). THE HYDROGEN ATOM/MOLECULE

Hydrogen has a proton, with a positive charge at its centre. A long way away from it, but orbiting it in all directions at great speed, is an electron, held in place by the attraction of its negative charge to the positively charged proton. You could visualise the arrangement as the Earth, with the Moon orbiting, but with the Earth about 1,800 times the size and weight of the Moon. And the Moon would have to be rotating around the Earth so fast that a space ship trying to reach the Earth would come up against the Moon, from any direction. Atoms are mainly empty space, with a very small, very heavy object in the centre, surrounded by a shell traced out by one or more extremely small electrons circling it at a phenomenal speed which provides an apparently solid surface.

It happens that when a Hydrogen atom meets another Hydrogen atom, they pair up as a 'molecule', and their two electrons then share the rotational duties. The combination is represented by chemists as H_2 . This is by far the most common molecule in the universe. When enough H_2 molecules join up under intense gravitational forces, they can fuse together and make Helium, releasing tremendous amounts of energy, and form a star, just as Einstein predicted. An H bomb does the same thing, on a much smaller scale. Helium has two protons and two neutrons in its nucleus, and two orbiting electrons, and is an absolutely inert gas. It has half the lifting power of Hydrogen, but does not react with anything, and that is why it is used in balloons, because it will not burn or explode. When a star dies, it may explode as a nova

and make the 100+ elements in the periodic table. All the atoms in our bodies have come from novas, so we are all made of 'star stuff'. THE OXYGEN ATOM/MOLECULE

An Oxygen atom has six electrons orbiting its nucleus, and like the Hydrogen atom, does not like to be alone. If it meets another Oxygen atom, they join together, share their orbiting electrons and become O_2 , or, in special circumstances, three join together to become Ozone, O_3 . Atmospheric Ozone filters out most of the sun's dangerous ultra-violet light for us.

The reason I have spent all this time boring you with the above is that unlike Helium, Hydrogen can burn. Burning, as we usually understand it, means something combining chemically with Oxygen and releasing energy in a self-sustaining chemical process, with the heat produced keeping the process going. If we feed Hydrogen into a gas torch and mix it with Oxygen, we get a very hot flame which can melt almost anything. In this burning process, two H atoms react with one O atom, release a whole lot of energy as heat and perhaps light, and make H_2O , which is water. This Oxy-Hydrogen flame is a controlled burn.

But if you mix Hydrogen, two parts, with Oxygen, one part, and put them in a closed container, you have a bomb ready to go off. If we introduce a source of high heat, such as a sparking plug spark, we trigger an extremely fast burn, which releases so much heat energy so quickly that the water formed is superheated to steam in what can be described as an explosion. In the cylinders of a car engine, these explosions will run the car, and that is how Hydrogen-fuelled cars work, except that they use a Hydrogen/air mixture. Because air is only 20 per cent Oxygen, there is less energy released than a pure Hydrogen/Oxygen mixture, but the explosion is still more than enough to run a car efficiently. A plus is that the exhaust gas contains water vapour instead of carbon dioxide. CORROSION

Corrosion comes in two types, chemical and electrochemical. Our cars have both. The first is a simple chemical process, where chemicals in air or water turn Copper green, Iron brown, Zinc white and so on. In some cases Oxygen forms an 'oxide' coating which protects against further corrosion. Aluminium saucepans are protected against food acids by a thin coating of Aluminium oxide. Chromium plating stays shiny because of its thin, transparent Chromium oxide coating. Its Chromium content is what makes stainless steel stainless.

But the really destructive corrosion is electrochemical. For this to occur, there must be an anode, a cathode, an electrolyte (a fluid which conducts electrons) and a current (electron) pathway. Take any one of these away and there is no corrosion. Put a sheet of copper close to a sheet of zinc, join the anode and the cathode with a conducting wire and keep them dry: no corrosion, because there is no electrolyte to provide a current pathway. Immerse them both in pure, distilled, de-ionised water: no corrosion, because pure water is not an electrolyte. Paint one or both sheets then immerse them in water (to which you have added, say, common salt, caustic soda or hydrochloric acid etc to make it an electrolyte): no corrosion, because there is no current pathway, as the paint insulates one or both sheets. Cut the conducting wire: again, no corrosion.

But if both sheets, unpainted and joined by a wire, are immersed in an electrolyte, you have created a battery, and there will be a flow of electrons (electricity) in the wire from the cathode to the anode. The anode then dissolves and the cathode accumulates a deposit from the electrolyte. The extent of this process depends on the difference in the electro-chemical potential (EP) of the two electrodes. Copper has an EP of +0.47 volts, while zinc has an EP of -0.76 volts. So they make a 'battery', with a voltage of 1.23 while the electrons are flowing. (This is a much simplified description). Aluminium has an EP of -1.70, so now you know why the copper pipes in your Rolls-Royce engine seldom corrode but the aluminium cylinder head often does. All dissimilar metals can make a battery, and cause corrosion. This effect can be used to protect, say, an outboard motor against corrosion. You attach to it a 'sacrificial anode' (say Magnesium)

which will corrode preferentially and protect the motor's Aluminium alloy, which is then a cathode, when the two are immersed in an electrolyte (salt water). You could say that your aluminium cylinder head is a sacrificial anode protecting the rest of the engine.

Pure, soft coolant water, which is a poor electrolyte, can slow down a car's cylinder head corrosion. So can anti-corrosive coolant additives, which provide the metal surfaces with a non-conducting coating, or which can inactivate dissolved substances which make the water an electrolyte. Thus anti-corrosives in your radiator water, preferably rainwater, can protect against corrosion. STARTING THE ENGINE

The above corrosion information helps to explain how your car's storage battery works as a form of controlled but reversible corrosion. A battery is essential to power your car's ignition coil. Modern cars no longer have a magneto, but use a coil to make the sparking plugs 'spark' and ignite the charge in the cylinders. The engine runs because of the exploding cylinder charges and the flywheel. The starter motor is less important than the coil, because you can hand-crank the engine or put the car in gear and 'roll start' it. Your battery may be too flat to run the starter motor and crank the engine, but might still provide enough electrons to produce a spark.

Early motor cars did not have starter motors. Cadillac introduced them around 1910. Rolls-Royce followed, belatedly, in 1919. Before WWI, most cars were hand-cranked, and starting posed problems, because cranking big-engined cars like the Silver Ghost required a lot of physical effort. Then there was also the ever-present possibility of the engine running backwards (backfiring) because of an inadvertently 'advanced' (Early) ignition. This could 'catch' the crank handle, which could then strike the wrist of the person cranking and cause the aptly named 'Chauffeur's Fracture'. STARTING AN EARLY ROLLS-ROYCE

To start a Silver Ghost from 1906 to about 1915, you first hand-cranked, with the ignition off, to prime the cylinders with an ignitable charge. Then you retarded the ignition to 'Late', advanced the Governor a little, then turned the ignition switch to both Battery Ignition and Magneto Ignition: **M&B**. The four-position switch on the steering column gives you the choice: **OFF**, **B**, **M&B** and **M**, but **M&B** is usual. The battery was a tiny thing, about the size of a small loaf of bread, and incapable of powering a starter motor. But that didn't matter, as there wasn't one.

When the switch was turned to **B** or **M&B**, this small battery activated the 'Trembler Box', which produced enormous sparks using a vibrator (buzzer or trembler) which is the electrical equivalent of a modern coil turning on and off about 400 times per second. Usually, the engine then started. As recommended by the handbook, you then switched from **M&B** to **M**, and the engine ran on magneto only. This was called 'starting off the switch', and was possible because after cranking, the engine would usually stop with one charged cylinder 60° past top dead centre, and the next cylinder to fire, also charged, 60° before top dead centre. The sparks from the Trembler Box would usually fire the spark plug in the 'past top dead centre' cylinder, because of the Silver Ghost's wide range of ignition timing. The cylinder charge, about one third of the usual, is sufficient to push the piston down, bringing the next cylinder, which also has a reduced charge, into the firing position. When it fires, the third piston arrives for firing, but it has a full charge, and the engine is then off and running.

But this system was not completely reliable, and the introduction of an effective starting system was essential for future sales. A powerful electric motor was fitted to turn the engine over, but this then required a large storage battery. Furthermore the storage battery had to be recharged, and this required the fitting of a generator (dynamo in R-R-speak) to maintain an appropriate level of charge in the battery to run lights, horn etc and for subsequent starts. So from 1919, the Silver Ghost had a starter, a generator and a large battery.

But with these came two problems. First, when the motor was running, the generator, which could be turned on or off at the switchbox, charged the battery, but when the motor was stopped, the battery could then try to run the generator as an electric motor. So a 'cut out' had to be introduced, which connected the generator to the battery only when the engine was running at more than an idling speed. Secondly, on long runs, with the generator charging,

it was possible to *overcharge* the battery. To avoid this, the handbook suggested: "When the battery is known to be fully charged it would generally be advisable for the charge to be switched off".

Now, not many people follow instructions like these. Some don't even read the handbook, and few owners do regular checks on their battery's state of charge, or know how to. We have now arrived at the reason why this whole article has been written. OVERCHARGING A CAR BATTERY

Owners of modern cars hardly ever think about their battery. This is because modern batteries have been designed to be charged, not with a generator, but an alternator. These commonly have an in-built *voltage control device* so that when the battery's charge level has dropped after, say, a few attempts at starting on a cold day, the alternator re-charges it at a high rate. The rate decreases as the battery approaches the fully-charged state, and then falls to a very low rate of charge. You can see this by observing the ammeter, if your car has one. The charge is high just after starting, but later drops down. Furthermore, when the drain on the battery increases, e.g. when you have the radio, air conditioning and head-, side- & tail-lights on, etc, the charge rate increases without any action from you. **This is NOT the case with your Silver Ghost, Phantom I, early Phantom II, 20 H.P. or early 20/25 H.P. When you drive these models, your generator is either not charging at all, or charging at the full rate.* The driver has to choose when to charge, and when to stop charging.** (*The above is not strictly true, as the output of Rolls-Royce and Bentley generators has been designed to fall at higher speeds e.g.: 13 amps at 24 mph, 10 amps at 40 mph and 7 amps at 60 mph (Phantom II No VI Handbook). But a long run can still overcharge your battery.)

An attempt was made in the early 1930s to give 20/25 owners better control of the charging rate by replacing 'IGNITION' and 'IGNITION & CHARGE' positions on the switchbox with 'IGNITION & CHARGE-SUMMER' and 'IGNITION & CHARGE-WINTER'. The idea was that in summer, you would need a lower charge rate than in winter, but this did **NOT** solve the problem of overcharging on a long run, especially as the generator could no longer be switched off. After 1934/35, all Rolls-Royce and Bentley models were fitted with an 'output regulator', which automatically adjusted the generator's output according to the battery's state of charge. And not before time! WHY WORRY?

We now come to the nub of your question "why should I know all this?" From the ranting above, it is clear that a battery requires an anode, a cathode, an electrolyte and a current pathway. The external current pathway is how the electrons get to where they are needed to run ignition, lights and so on, the chemical changes at the anode and the cathode providing the electrons. What was not explained above is that you can reverse this process by pumping electrons back into the anode and putting a positive charge on it, and taking electrons off the cathode and putting a negative charge on it, using the car's generator. This is the charge/discharge cycle. But there is a problem. Re-charging the battery restores the anode and the cathode to their fully charged state, but if you continue charging, you **OVERCHARGE** the battery, and the charging electrons, with nothing better to do, start to break up the water (H_2O) in the electrolyte. The result is the generation of two parts of Hydrogen and one of Oxygen, which, as explained above, are exactly the right proportions to create a highly explosive mixture. All that is needed is a spark.

So if you are driving a pre-1934 Rolls-Royce a long distance, and do not disconnect the generator, that is, switch from 'I On' to 'I Off' (post-1915 Silver Ghost) or 'I&C' to 'I', there is going to be a fair amount of gas being generated by your battery. If the battery cell space is well-ventilated, the Hydrogen, being very light, will quickly escape. If your battery is not a modern 'low maintenance' one, and has screw-on filler caps covering the six cells of a 12 volt unit, there will be small holes in the caps, which let the excess Hydrogen and Oxygen out. You can also check the electrolyte level in each cell by removing the cap, and then replace any water lost through overcharging by adding 'distilled water'. Perhaps you had a distilled water bottle fitted with a filler tube to top up the electrolyte level.

But when doing this, you should **NEVER** examine the cells' fluid level by a naked light, (e.g. cigarette lighter), or cause a spark by

disconnecting a battery lead when the car's electrical system is on (lights, ignition etc), or you may cause a very destructive explosion. AN EXPLOSION WHILE DRIVING

People continue to smoke, and many discard their butts in an irresponsible manner. An experienced Silver Ghost owner was ending a long drive and entering Melbourne some years ago. His battery was encased in a beautifully-crafted wooden box on the running board. The box was so well made that there was no way for any Hydrogen gas produced by overcharging to rise up and escape its heavier companion, Oxygen. We cannot be sure, but the supposition is that an errant discarded cigarette butt was blown up into the box past the battery cable hole. The resultant explosion sent bits of battery and wood everywhere. To prevent this occurring, you should provide your battery box with adequate ventilation, and take your generator

'off charge' frequently on a long run. MODERN BATTERY PROBLEMS

Many cars are now fitted with the recently developed 'low maintenance' batteries. They do not have the traditional screw-on caps (with ventilation holes) so you can't examine the electrolyte level or add distilled water. Many readers probably still have the rubber cap which they fitted to their distilled water bottle (remember them?). This would add just the right amount of water to cover the battery plates to the correct level. In modern cars, you don't have to add distilled water to your battery, because the alternator adjusts the charging rate electronically and eliminates overcharging. The label shown in Picture 1 above describes a 'Calcium-Calcium Maintenance Free' battery with 'Expanded Grid Technology, Extra Power, Extra Life' and is a fine product. The anode and cathode plates are made from an alloy which is mostly lead, but also contains Aluminium (Al), Calcium (Ca) and Tin (Sn). The Calcium, which is in the lead alloy of both the anode and cathode of the battery (hence the words Calcium-Calcium), suppresses the generation of Hydrogen and Oxygen on overcharging. **But it does not prevent it.**



The only apparent access to the battery's insides is the clear, screwed-in plastic insert, which, when you look down it, shows green, indicating a full charge, but for one cell only.

As the charge level goes down, the view through the flat top changes in stages (green, red and clear). This useful feature is achieved by green and red plastic balls, which float or sink in the electrolyte according to its specific gravity. There is a label on the battery explaining the colour changes. HOW THINGS GO WRONG

In a modern car, these low maintenance batteries are just great. You never have to worry about measuring specific gravity or adding distilled water, because the modern charging systems ensure that the battery is never over-charged. Thus the electrolyte level is maintained, because its water content is not reduced by the overcharge 'gassing' of Hydrogen and Oxygen. The clear plastic indicator window then reliably indicates by green or red colour, the battery's state of charge. These batteries may eventually replace the older style ones with removable caps for each cell.

But the 'low maintenance battery' gives us pre 1934 R-R and B owners a problem. The built-in green/red indicator in-

dicates state of charge **only if** the indicator is immersed in battery electrolyte. If the fluid level is **below** the bottom of the indicator, it shows red, regardless of the charge level of the battery.

In our Ghost, a 1910 model, we had fitted two series/parallel batteries powering a combined starter/generator, the generator part of which could not be switched off on long runs. Over the years, the standard



batteries we installed worked just fine. If the electrolyte level was low, we added distilled water to restore the appropriate level. But four years ago we replaced the old style batteries with the modern, 'no maintenance' type, as recommended by our auto electrician.

Over the next four years, it was inevitable that on long runs, the batteries were overcharged occasionally, because we could not switch our generator off. Nevertheless, the comforting green colour indicated a full charge for each. We maintained this fully charged level by connecting the batteries to a charge-maintenance unit whenever the car was off duty in the garage. This is strongly recommended.

However, in a recent trip to the auto electrician, one battery showed a red indicator, suggesting a discharged state. The auto electrician noted the four year age of the battery, concluded that it was probably beyond its useful life, and said he would attempt to recharge it.

Now it is a property of modern 'low-maintenance' batteries that they require an initial high rate of charge to recharge them from a fully discharged state. This could have explained why the magic green indication did not appear, although I had put the battery on trickle charge for several days. The auto-electrician put the battery on a fast charge (18 amps) for about ten minutes. He noted a strong smell, which in his experience indicated an internal battery problem, and he said the battery was 'stuffed'. (That is not exactly what he said, but that is the gist of what he meant.)

He then disconnected the battery from the fast charger, **but without first turning the charger off.** The spark which occurred then ignited the Hydrogen-Oxygen mixture in and around the battery plates, resulting a very loud explosion, and disintegration of much of the battery casing.

The noise deafened his left ear for about an hour, and sprayed sulphuric acid over the track pants I was wearing. We were both extremely lucky that the damage was as slight as it was.

To summarise: the red indicator, whose purpose is to denote the state of charge of the battery, showed red. But in this case the red did not show the low specific gravity of a discharged battery, but a low level of electrolyte in a fully-charged battery. Thus, charging at a high rate had the effect of producing a large amount of hydrogen and oxygen (gassing) from an already fully-charged battery. Disconnecting the charger without switching it off caused the explosion and damage. A DOWNSIDE OF OLD CAR OWNERSHIP

We old car owners should be aware that the modern developments in automotive technology may not be directly applicable to ours: e.g. electric fuel pumps with pressures that over-ride our carburettor float bowl needles; brake linings which are too hard, with resultant poor braking; engine oil which is too detergent, with accompanying release of abrasive sludge; fuel which is too volatile, causing vapour lock in hot weather. Ethanol in fuel, which can damage some seals and which is hygroscopic, absorbing water which can cause petrol

tank and other corrosion. Careful thought is often required to avoid the consequences of adopting modern technology to older cars. This battery story is a shining, of more correctly, explosive example. SUGGESTED HINTS ON BATTERIES

1) Follow your handbook's recommendation to switch from 'I&C' to 'I' or (for Silver Ghosts) 'Off' at regular intervals on long runs in your pre-1934 Rolls-Royce or Bentley motor car. If you find this too much trouble, have an auto electrician rearrange the wiring of your generator and fit a modern voltage regulator. This will ensure that you never overcharge your battery. 2) If you have a low maintenance battery, and it shows a red charge indication, unscrew the plastic insert (if possible) and check that the red indication is red because of the specific gravity of the electrolyte, and not because the electrolyte level is below its read-



ing point. If the latter, you have a problem, as you can add distilled water to that cell only. The rest are on their own, and you may have to buy a replacement battery. Alternatively, charge it up and measure its output with your auto electrician's load cell. As long as the electrolyte covers the plates, it may still function effectively, even though the charge indicator is inoperative.

3) **Never, ever**, hold a naked light anywhere near a car battery, because there may be hydrogen lurking somewhere nearby, waiting to explode. **Always** switch the battery charger **off** before disconnecting the battery charger leads from a battery, because an electric spark is just as effective in igniting the hydrogen/oxygen mixture. 4) If you use your Rolls-Royce or Bentley car only occasionally, its battery will lose charge, especially in warm weather. The rate of loss may surprise you.

Letter to the Editor

Dear Tom,
I read John Stewart's letter in the last issue, 13-1, where he questions whether we are a "social" club or a "technical" club with some amusement.

The RROC (USA) has long been said to run on 50% petrol and 50% alcohol, and so why should we in NZ be any different?

Incidentally, I note with some alarm, the discussions on the RROC's online technical forum about the dangers of using ethanol based fuel in our cars. There is concern that the "O" rings in fuel injected models fail in contact with ethanol, causing fuel leaks and engine fires -apparently Rolls-Royce now supplies an (expensive) upgrade to take care of the problem. Also, there are mentions about ethanol absorbing water and causing rust in steel fuel system components plus the suggestion that it dissolves some of the fibreglass chemical lining from service station storage tanks and the resulting mix is injurious to older, pre war cars.

So I think that I will stay with to "beverage alcohol" for my part....

Cheers,
Clive Edmonds

(Opposite) Mr and Mrs Harold Radford enjoying one of the Radford "Countryman" conversions.

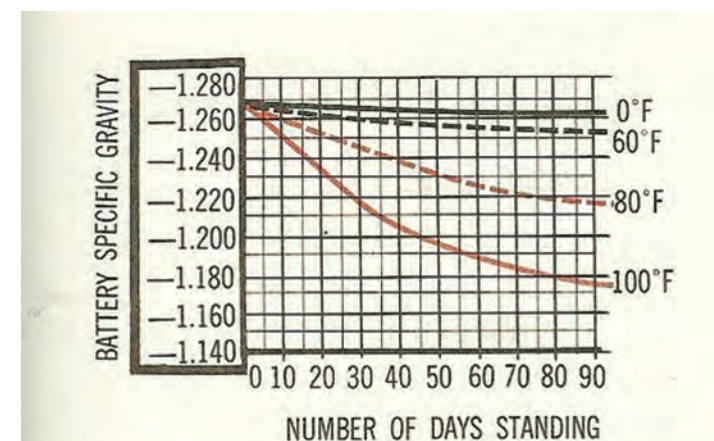

Fig. 40-10 Rate of Self Discharge



You may find that it won't run the starter when, after a month or so, you want to drive it. Buy a 'battery maintenance unit'. This is a low output charger with electronics which charge the battery only when the voltage level indicates that this is required. You leave it connected to the battery whenever the car is in the garage. I have one on all six of our cars, and recommend them highly. 4) When making that beautiful battery box for the running board, make sure you provide adequate ventilation holes, so that any hydrogen from 'gassing' can dissipate. The Oxygen is no problem. You need that to breathe, and breathing is good for you.



“Smoky”



One of the cars which took part in the recent Bentley Drivers Club Tour of New Zealand was a 3 litre which stood out from its brethren because of its spectacularly short and low form. The casual observer would think “just another Bentley Special,” and in one sense that is correct, but it differs from other modified cars because of its illustrious history. The owners, Michael and Josephine Thompson, have room in this skimpy car for some soft luggage, a lap-top computer, and a dossier documenting its history, which Michael has kindly made available for us to reproduce.

Only seventeen 100 m.p.h. cars were built on the shortest, 9' wheelbase 3 litre chassis, although an eighteenth car (Chassis AX1652) had the 9' 9½" length. Chassis 1192, with engine 1200, was off test in December 1925, and went to Jarvis of Wimbledon for a sports two-seater body, painted black, to be fitted. This was accomplished on 19 March 1926, when the first owner, Jennison Heaton, took delivery, and eleven days later he had an accident in it, repaired by the Bentley Works. Bentley Service Records, now held by the Bentley Drivers Club at Long Crendon in Buckinghamshire, show that Mr Heaton fitted new valve springs in Switzerland in October 1926, while the Works carried out two overhauls in 1927, each time including new pistons and decarbonising.

Early in 1930 the car was on the market. A prospective buyer, C.T. (“Kit”) Baker-Carr, commented to the salesman “Smoky, isn’t it?” He bought the car, and “Smoky” is the name by which it has been known since. Baker-Carr had four generations of eminent soldiers, including a Victoria Cross winner, behind him, and since he was too young to have served in the Great War, he might have been tempted by the competition potential of “Smoky” to demonstrate his own bravery. Every month or so parts were ordered for further work on the car, which by July 1930 had covered 63,284 miles. Baker-Carr had by this time joined H.M. Bentley and Partners as designer. The Bentley family remain enigmatic, initials seeming

to be preferred to Christian names, “W.O.” always referring in writing to the brother closest in age and relationship to him as “H.M.” W.O. wrote H.M.’s Obituary for the Bentley Drivers Club *Review* No 85 in June 1967, and contrived to sum up this important man’s life in just ten very vague lines. It reminds one of the late Miles Kingdon’s column in *The Independent* where, in response to a “reader’s enquiry” as to what The Dalai Lama’s close friends call him, the advice was: Of course, they call him by his first name, The. H.M. Bentley had been W.O.’s business partner since their days as concessionaires for D.F.P. cars in 1912, and took an active sales role in Bentley Motors Ltd until he resigned in 1926 when he felt that control of the Company’s future was no longer held by those in close touch with production. After the collapse of Bentley Motors in 1931 H.M. Bentley and Partners were active in converting Bentleys into a much more sporting form than they had enjoyed in their previous lives, and “H.M. Bentley Rebuild” cars have gained a caché of their own.

The work on “Smoky” was completed by early 1932, and an unsigned article appeared in *Country Life* magazine on 16 April entitled “A Mysterious Car” with details of the 4½ litre engine EXP-5 which H.M. Bentley and Partners had by now installed. This engine was the first 4½ litre engine built, and had originally been fitted to “Mother Gun” the first production 4½ litre car, chassis ST3001, and a victim of the “White House Crash” at Le Mans in 1927. It was the winning engine at Le Mans in 1928, but by the early 1930s EXP-5 had been swapped among several chassis before roosting in 1192. A very high axle ratio had been fitted, giving 32.5 m.p.h. per 1,000 r.p.m. for 113 m.p.h. at an easily attainable 3,500 r.p.m., and the article concludes “...very high cruising speeds could be maintained with the minimum of fuss and noise.”

In this form “Smoky” had its first race at Brooklands in 1933, and competed at Brooklands in 40 races up until October 1937,

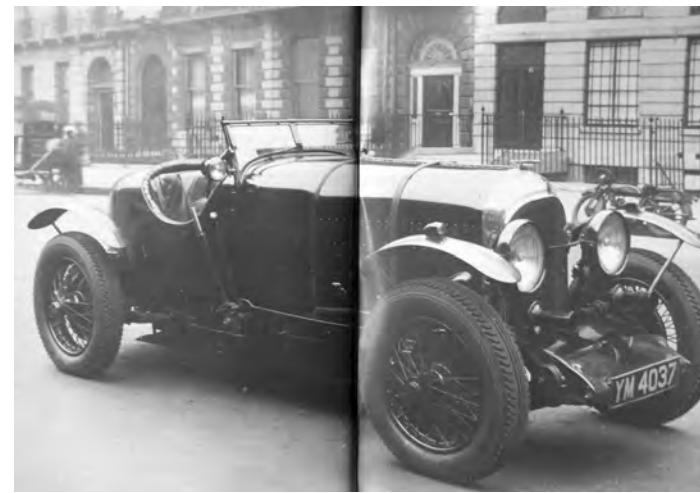

Chassis 1192, as purchased by C.T. Baker-Carr in 1931

achieving 7 wins, 5 seconds, 7 thirds, and failing to finish in only three races. Its fastest lap was at an average of 116.91 m.p.h., and Baker-Carr was one of only eighteen drivers to hold the 130 mph badge, achieved in “Mother Gun” by now fitted with a Speed Six engine and known as “The Bentley Jackson Special.”

For the 1936 racing season the Jarvis body was lowered, and the radiator shortened, for an improvement in Outer Circuit lap speeds of about 10 m.p.h. Brooklands authorities closely monitored cars’ ages, and “Smoky” was granted two extensions to the age rule before being banned from racing there for the 1938 season.

Baker-Carr was known as a skilled driver, adept at swooping



down off the Brooklands banking to overtake cars which were circulating too high. He finished his Brooklands racing career in a Delahaye sports car, and died in November 1970. His Obituary in the Bentley Drivers Club *Review* No 99 mentions his unassuming nature, and the article about his and “Smoky’s” careers by his son Christopher Baker-Carr in Bentley Drivers Club *Review* No 180 of May 1991 gives a good appreciation of “Kit” Baker-Carr, enhanced by Christopher’s being the schoolboy in one of the Brooklands photographs.

“Smoky” went to South Africa before the War, and suffered an engine disaster there. A replacement crankcase and other parts went into the long rebuild undertaken there, and this was reported



(Above) “Kit” Baker-Carr with his son, Christopher, at Brooklands, 1936

(Left) The 130 mph Trophy won by Baker-Carr in the Bentley Jackson Special

(Below) Trophies won by C.T. Baker-Carr in 1192



in Bentley Drivers Club *Review* No 24 of March 1952 as “I am sorry to report that my rebuild of the ex Baker-Carr 3/4½ (108” 3-litre chassis, part EXP-5 4½ engine) is proceeding very slowly. I have very much still to do, and very little time to do it in. In the vernacular of this country ‘ous moet’n plan maak,’ i.e. ‘I’ll have to don my thinking cap and do a spot of organising.’” Those words were written by M.A.G. Morelli, Peter’s father, and he finally achieved the rebuild of “Smoky.” Anyone who has seen Peter Morelli standing beside his 8-litre Bentley and making it look in scale with a 3-litre will appreciate the difficulty he had in fitting into “Smoky” when he inherited it. Peter has passed “Smoky” on to its present enthusiastic custodians, who have obtained all the trophies it won.

This article has been written with the help of the Bentley Drivers Club *Reviews* noted in the text, Michael Thompson, and Peter Morelli. “Smoky” appears on the cover of this issue.

An Unusual Rolls-Royce Engine

by Gilbert M. Ralph, Hon. Archivist Sir Henry Royce Foundation

This article appeared in Præclarvm 1-13, the magazine of the Rolls-Royce Owners' Club of Australia, and is reprinted with the permission of its editor, Tim Dean, and its author Gilbert M. Ralph. Those of us who took part in the Dunedin Run last November may recall the Armoured Personnel Carrier in Mark Cameron's collection, the Rolls-Royce K60 engine of which Mark fired up for us.

For most of us the mention of the name Rolls-Royce brings to mind a Silver Ghost or one or other of the 35 models bearing that name since it was adopted in 1905. You might also reflect on the occasions when you last flew in an aircraft bearing the entwined Rs on the engine casing and how you settled back knowing you were being kept aloft by reliable Rolls-Royce aero engines.

You may not have realised it at the time, but forty or fifty years ago you may well have been travelling on a train, on a boat or in a bus powered by a Rolls-Royce engine. In fact there were many diversified applications for R-R engines especially following the end of World War II when Britain was endeavouring to rebuild itself and every opportunity to export was paramount to rebuilding the nation. Companies too were keen to resume production and none more so than Rolls-Royce who had built up a large manufacturing facility at Derby and Crewe in support of the war effort.

Luxury motor cars were not their only product and in the decade following the Second World War Rolls-Royce offered a range of products eagerly sought by a redeveloping world. In addition to motor cars R-R manufactured a range of aero engines, petrol engines, diesel engines, multi-fuel engines, rocket engines and nuclear propulsion equipment. They employed 88,000 people in six major divisions – Aero Engine, Bristol Engine, Industrial & Marine, Gas Turbine, Motor Car and Oil Engine divisions with numerous subsidiary companies around the world.

The company began making diesel engines in 1951 and initially these found applications in tractors, trucks, rail cars and shunting locomotives. As the market grew Rolls-Royce took over Sentinel Engines at Shrewsbury in Shropshire where the range of engines was expanded to include the C-range, D-range and Eagle diesel engines. The reference to the Eagle engine is curious. I have read about Rolls-Royce experimenting with a diesel form of the Eagle aero engine but have no details. Can a reader throw some light on this matter?



The major components of the K-60 engine. It is a relatively simple design with two crankshafts, six cylinders, 12 pistons and no valves.

Amongst the collection in the Sir Henry Royce Foundation Archive there are some surprising items, and I thought readers might be interested in one unusual engine developed by Rolls-Royce for a particular military application. It is the K-60 multi-fuel engine developed for the British Army for use in a range of vehicles including the British FV430 series of self propelled guns and armoured personnel-carriers and trucks, and about three thousand were built between 1962 and 1971. The Mark 2 variant of the FV430 series used the Rolls-Royce K-60 engine. The 240 bhp engine was a six-cylinder, opposed-piston, two stroke, compression ignition engine with excellent power-to-weight and power-to-bulk ratios. It could run on a variety of fuels including diesel, petrol, kerosene or, as Tom Clarke remarked, 'even cabbage juice'. Its compact layout was ideal for use in tanks where a low centre of gravity was an advantage. The accompanying illustrations will help in understanding this unusual engine design.

Whilst the engine itself is compact its accessories add considerably to the bulk of the power unit as may be seen in the colour photograph. This particular engine was offered for sale in UK for £1500 in 2008. Apparently they are readily available for purchase in UK. Does any reader know of any in Australia?

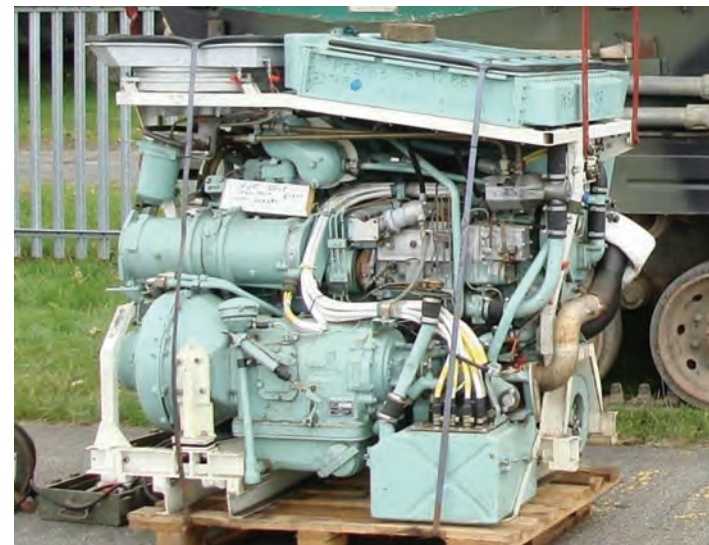

The above photograph shows a complete K-60 power unit. The engine itself is hidden by the many accessories such as the cooling fan and radiator at the top, below which is an oil filter and a heat exchanger. The large alternator is middle left and the fuel injector pump is to the right of that. The fluid flywheel and clutch are below the alternator and the gearbox is in the centre with its output shaft and universal joint which can be seen to the right of the white electric cables. The tank on the bottom right is a fuel tank which also houses a rectifier.

Following the dismantling of Rolls-Royce in the 1980s the Oil Engine Division was sold to Perkins Diesels, a well established diesel engine manufacturing company based in Peterborough, UK, and I have no information on the fate of the K-60 engine. However, for those who wish to learn more about this unusual power unit Google 'fv432 rolls royce K60' and you will be able to view one of these engines and hear it running.



(Left, Above and Below) Mark Cameron's FV432 personnel carrier powered by a K-60 engine through this tiny hatch may bring a wry smile to many faces. This vehicle is completely amphibious and can operate in extreme climatic conditions. Other variations included mortar and Wombat anti-tank gun carriers and a REME (Royal Electrical and Mechanical Engineers) mobile workshop.

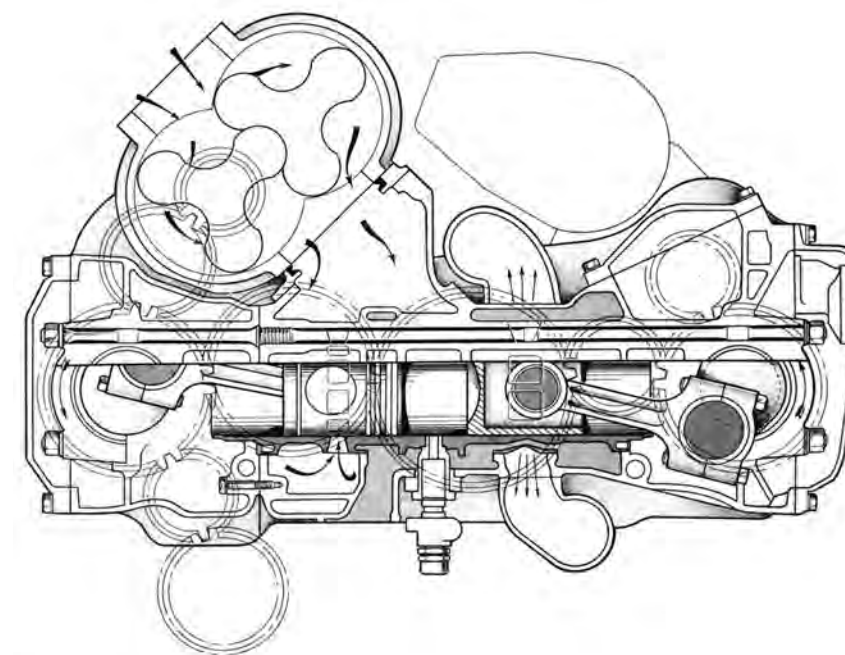

(Above) A cross-section drawing of a K-60 horizontally opposed, six cylinder, compression ignition engine developed for the British Army.



(Above) The FV430 Abbott self propelled 105mm gun which used a Rolls-Royce K-60 engine and an Allison six speed automatic gearbox which was manufactured by Rolls-Royce under licence. (Left) Truck – An all-terrain armoured truck powered by a K-60 engine.

The Great British Car Rally 17 to 22 February - Reports by Rob Carthew and Ed.



(Clockwise from Above) H.E. Vicki Treadell and some of her team taking refreshment at Hagley Park, seen between the Newbegins' Continental "R" and the Scamptons' Silver Cloud III. Shirley and Ray Scampton beside SKP249 Alastair Scott's SRH11973 in good company, with current Rolls-Royce Phantom Saloon and Coupé. The truly amazing new Morgan Aero Super Sports of Oliver and Vicki Newbegin, with Vicki consulting her oracle.

"Quite the best rally I have ever been to – but that was the previous one 14 years ago," quoth John Stewart. "If the same guy (Ross Church of Paraparamu) is organising it, it really will be GREAT". That was good enough for me despite the event clashing with the tail end of the Art Deco Weekend and, fuelled as I was by John's recommendation and a look at the website of the past event, I felt I had to make sure the Club was represented, Rolls-Royce and Bentley being the iconic British cars of all time. So off we went, my friend Basil and I, to take part in the Auckland to Wellington leg, with a plan to leave the rally after the Wellington stopover due to other commitments. As it transpired we wish we had booked for the final days of Picton to Christchurch as we had a lot of fun, met a number of new friends, and importantly the Bentley Mark VI went like a dream for the 1,100 or so miles we travelled.

A "Passport" was issued at the start and we chose to have it stamped and signed by those we met on the way during stopovers at Tauranga, Gisborne, Whakatane, Napier, Masterton and Wellington. Mayors of the various cities and towns led us in to their particular domain, and most of the townsfolk did us proud with big turnouts of admirers, bands, choral societies, radio stations, newspaper reporters and photographers, shopkeepers in appropriate garb and local schoolchildren with kapa haka and similar entertainment.

Following the example of the earlier event, we chose to dress for the occasion, as did many others, and this was rewarded by many visitors entering into the spirit and being persuaded to part with their hard earned cash for the charities we were supporting – Starship Hospital, Save the Children, Christchurch City Mission and the Christchurch-based Stepping Stone Trust.

In Wellington we were all invited to a reception in the banquet

hall in Parliament, hosted by the Speaker of the House, and that in itself was a highlight as a number of speakers talked in a light vein of their own car experiences in their younger days.

As it transpired there were a number of our members on the rally, as were a few Rolls-Royces and Bentleys owned by what I would like to think are 'prospective club members'. We were also visited by a number of our existing people, including Dick Neill at Gisborne, Clive Edmonds and Wendy Bryce at Napier, John Cameron at Wellington, and Ian Hoggard at Masterton, as we called into their towns, and in my case one stranger in Tauranga and one in Masterton came to me and professed that 'their Dad had once owned the car'.

My part will end by saying, "John, you were right". With great organisation, great support from Neil Darcy-Brain of Rolls-Royce, Auckland, from the Giltrap Group and other sponsors, it was well worth the effort of going. Roll on the next one.



Hosted by H.E. Vicki Treadell, CMG MVO, the British High Commissioner, The Great British Car Rally was held from 17 to 22 February. It started in Auckland, and finished in Christchurch on the second anniversary of The Big 'Quake with a display at Hagley Park, where other British cars were welcome to join the competitors.

Several members of our Club took part, as well as a Rolls-Royce Silver Cloud III and a Bentley Continental "R" driven by teams not in our Club. Our Chairman Rob Carthew took part in the North Island section in his Mark VI Bentley B101LH, and Alastair Scott completed the South Island section in his Silver Shadow SRH11973. Oliver and Vicki Newbegin drove their very new Morgan Aero Super Sports. Rolls-Royce Motor Cars sent down Phantoms in Series II saloon and coupé form as well as a Ghost, and Christchurch Morgan agents Fazazz, our Club members Gavin and John Bain, had a recent car on hand.

Special mention must be made of Ray and Shirley Scampton, who travelled with their friends Mr and Mrs Don Lyons from Whangarei in the immaculate midnight blue Silver Cloud III chassis SKP249. They looked forward to returning north by Arthur's Pass, with memories of its gravel status on their 1950s crossing, and returning after all this time to the site of the Denniston coal mine on its plateau. Ray was interviewed by a reporter from the Whangarei newspaper, who proceeded to write an article with unfortunate references to the "guzzling of gas," failing to take into account a car with such a level of refinement as to utterly negate the words "guzzle" and "gas." It sips petrol, and at a rate divided by its number of occupants which would not be far short of the consumption achieved by the now obligatory large conveyance on the child collection programme. When the energy used to build a four wheel drive conveyance, with a projected life span of, say, five years is compared to that expended fifty years ago on a Silver Cloud, with an infinite life span ahead of it, do we have to feel apologetic?

Blessed with perfect weather throughout the event, competitors seemed happy with the organisation. Your reporter arrived fairly early, and left quite late, but the British High Commissioner, Her Excellency Mrs Vicki Treadell, CMG MVO was already there with her team, and still there when we left.

Comment must be made about our members' understated good taste, unlike some who seemed to wish to project the image in dress and car decoration of the saucy seaside postcard.

Wanganui and the Whanganui River, Wellington Anniversary Weekend 19 to 21 January, by Wendy Bryce

Following our Central Region Committee Meeting in the Grand Hotel, we walked down to the waterfront. The i-site is placed right there in the centre with the Mud Ducks Café beside it, where patrons could eat outside at tables if they wished and view some of the vintage cars on display opposite, with the Tram Shed Museum next door. The music from the stage along the way was popular with many people "grooving by the riverside" all day long, with also many opportunities to purchase from food sellers. The riverboat "Waimarie," New Zealand's only coal fired paddle steamer, is moored there as well, having been restored after lying submerged in the river for 41 years. At the far end of the walkway, near where the paddle steamer is moored, is the Riverboat Museum, which proved very interesting. We were able to purchase a very good quality map of the Whanganui River which can be framed and treasured. One day we hope to traverse the river as far as Jerusalem, (of Suzanne Aubert and James K. Baxter fame.)

We walked up the hill to The Sarjeant Gallery in Queen's Park, a beautiful Heritage Building overlooking the city. Designed in Palladio style architecture, Neo-Classical, with a Dome and stone walls, it was built in the shape of a Greek cross, the dome itself being 13 metres high in the centre of the cross. The Sarjeant Gallery was established according to the will of Henry Sarjeant, and opened in September 1919. It now has more than 5,500 artworks in various collections, and was a highlight for me, as I had heard of the Sarjeant Gallery many years ago and had not as yet been able to visit.

We came back to the riverside to watch the finish of the Vintage Car Run, all the cars returning under the watchful gaze and chequered flag of Ed Boyd, and lazed under a tree with fellow Rolls-Royce & Bentley Club members, Elliott and Carol Snelling.

To end the perfect day we were invited to attend the Vintage Car Club's Awards Buffet Dinner in the Grand Hotel Dining Room. It was most delightful and we had a great weekend and pass our grateful thanks to Ed and Hinemoa Boyd for their hard work and fine hospitality.



Ed Boyd multi-tasking during the Vintage Weekend, in Wendy Bryce's photograph

Martin Vincent's Now Traditional Canterbury Homestead Run 27 January by Geoff Walls



One of many clusters of cars at Mt Somers Station

For some years now Martin Vincent has been organising visits to Canterbury farms with interesting homesteads and histories, and this year invited, as he put it, the Fraternity of Rolls-Royce and Bentley owners. It is always anticipated with enthusiasm, given the quality of the wonderful farming properties in the wider Canterbury area we have visited in the past, and this year was no exception.

With his wide knowledge of local history, interest in farming, and a wide network of friends, Martin is a valuable member of our Club. We should also mention that he owns a superb R-Type, B522TN, and is a thoroughly nice bloke. As is also traditional, the weather was perfect, and about 15 cars of our marques with about 54 happy picnickers gathered at Surrey Hills Station in groups under mature trees. They included Gavin Bain and Geoff Walls in 3 Litre 728, Bruce and Andrew McIlroy in the Silver Ghost 60ZG; John and Chris Ferguson in the Thrupp & Maberly Phantom III 3DL22; and Bruce and Diana Carey in the Park Ward 3½ litre B166FB, making up the pre-war complement. Henry and Joy Green had decided to bring the H.J. Mulliner Touring Limousine Silver Wraith WDC43, and those enormous R100 headlamps on a post-war car never fail to amaze the beholder. Other post-war cars included Martin's R-Type; John Bain's S2; a brace of T-Types; several Silver Shadows; a Turbo "R"; and the most recent car was the Arnage of Ian and James Jefferis and Mark Brown.

A bonus for the writer was the opportunity to passenger in Gavin



An encouraging aspect of the Homestead Run is the inclusion of younger participants, including here Katy and Emma Parish and Andrew McIlroy, to balance those of us who have acquired stoops to accompany our accumulated fund of useless information. Katy Parish has been competing for Quite Some Time in Bentley rallies, having been 18 months old when her parents, Helen and the late Edgar Ridgen, took her on her first Alpine Rally. Here, Katy learns from Joe Studholme, whose late father owned Bentley 3 Litre TT Replica, Chassis 348 before Edgar and Katy, that the engine installed in 348 came to New Zealand as a spare engine for "The Baby Bentley" Chassis 1063. Refer to Edgar's Obituary in our 06-1, and Jim Sawers's articles on The Timaru Bentleys in 10-4, and Lucy Wills in 10-6. Large images of 1063 are in 09-3 and 10-6.

Bain's 3 litre Chassis 728, now in his 50th year of ownership. Having owned Chassis 129 for ten years, this was a fine opportunity to acquaint myself with the magic of these cars, and the brilliantly sunny day on offer completed the picture.

The plan was to meet and leave from the Yaldhurst Hotel, but, having no desire to travel in a line, we left a little earlier, passing through Aylesbury and Charing Cross, then stopping for coffee at Hororata, where we were able to view John Foster's (son of Kate and Richard of Terrace Station and Veteran and Vintage Humber fame) impressive work on a late 19th century Blacksmith's shop. All credit to John for saving an important piece of local history.

As we viewed this building, several of the day's participants drove by en route to the midday homestead destination, pausing at the Rakaia Gorge bridge to view the wonderful summer colour of the river and the many jet boats taking advantage, as were we, of the outstanding weather being much enjoyed in an open car.

Following the curve of Highway 77 adjacent to local hills, and slightly south of Mt Somers village, we approached "Surrey Hills," our destination, and it was easy to see that we had yet another treat in store.

The Grigg family homestead, circa 1928, a wonderful example of Heathcote Helmore architecture, became the base for an impressive collection of Rolls-Royces and Bentleys, and suitable other makes.

Paul and Sarah Grigg extended a warm welcome and gave us a most interesting biography of the family (see below), the farm, the house (the 2011 earthquake effects, fortunately minimal) and the beautiful garden which we were able to tour with Sarah as guide and interpreter of how she has spent an enormous amount of time transforming a lot of it from virtually nothing into a thing of great beauty and interest.

A pleasant time was had mixing with members and friends, and having a picnic on the beautifully manicured lawns under the trees at the edge of the gardens.

The day ended again traversing the same route in the opposite direction and gaining quite a different perspective of this lovely countryside in '728', evoking many similar memories of similar ventures in '129'.

Our thanks must go to the Grigg family, and to Martin, for yet another opportunity to discover and explore the wonderful farms with their Homesteads and outbuildings that cover the Canterbury province. Roll on 2014!

Some more research into the Grigg family and "Surrey Hills", has produced the following, and, I think, confirms the "small world" we live in particularly for our members. Paul Grigg spoke briefly of his Grandparents who built "Surrey Hills", circa 1928, and I will add the following.

Arthur Grigg married Sarah Cracroft-Wilson (from the well known Canterbury sheep farming family and Cashmere, Christchurch residents) whose Mother was Mildred Hall, daughter of Sir John Hall of Terrace Station (great grandfather of Kate Foster, along with her husband, Richard, the present custodians of Terrace Station), and they lived at Surrey Hills which they had built. Arthur was killed in action in WW2 in North Africa in 1941, and prior to his leaving had become the National MP for Mid-Canterbury. Sarah continued to work tirelessly in the community, and was then persuaded to succeed her husband as the MP. She won the election and became the first Woman National MP in the House of Representatives.

In 1943 she married William Polson, who was the MP for Stratford, and moved to rural Taranaki. She did not seek re-election but remained politically active. After William's death in 1960, Mary returned to Christchurch as Lady Polson, and, wishing to live near her family, resided in what became Lady Polson Lane, effectively the entrance road to the Cracroft-Wilson property on the Cashmere Hills. The house she lived in was later sold to Rolfe Mills (whose mother was a Sargood, and whose family owned Wanaka Station, now Rippon Vineyard), who, whilst the Agent of Sargood Son and Ewen Ltd., in London bought the Derby Bentley which is now owned by Bruce McIlroy.

Small world!



Several hundred years of motoring experiences gather in the garden at Mt Somers Station, from left Geoff Owen, Ellis Shiers, Ron Hasell, Angela Shiers and Shirley Owen.



John King's photographs of (Above) Trevor Timms in 348 competing in the Vintage Car Club's Invermay Hill Climb, March 1975, and (Below) Dave Bowman's 6 ½ Litre KR2692 in Taranaki during a Riley Car Club National Rally in 1968. Dave is accompanied by his two sons in the back seat and a Visitor from Hawkes Bay. Those standing nearby are the late Clive Brownhill and Alan Wells, Glynn Williams, and the late Doug Dickenson. We don't remember why Alan is wearing only one shoe.





Geoff Gowing's image captures the summer ambience of the Inter-Club Concours at Ellerslie Racecourse

This year the Inter-Club Concours date clashed with the Bentley Tour of New Zealand, and the Art Deco Rally in Napier. On the day we managed to muster 10 cars: Philip Eilenberg in the 1952 Mark VI; Max Morris - 1954 R Type; Richard and Lois Green - 20/25; Geoff Gowing - Silver Spirit; Kevin Williams- Corniche FHC; Ted Worthington - 1958 S1; Mike Coleman - 20/25, Ron Craig - 1947 Silver Wraith, a Silver Shadow which used to belong to Sir Henry Kelliher; and Berwick Taylor - 1939 Bentley.

This is always an interesting day, as you get re-acquainted with lots of old faces in motoring circles. We had our club tent for our picnic lunch and much needed shade. The Motor Trade always have the newest models on display; Rolls-Royce had the recently introduced Phantom Series II, and Bentley the latest Mulsanne.



Richard and Lois Green's photos at the Summer Picnic of the other Richard's and Lois's property and members' cars, including Kay O'Connor's Christmas present.

Northern Region Picnic: We were pleased to be invited to Richard and Lois Hadfield's lovely garden property at Sunnyside Road, Albany. The day dawned drizzly and humid. Little did we realise this was to be the last rain for some months. The drizzle cleared to brilliant sunshine around midday in time for the arrival of 15 cars. This time it was the 20 HP and 20/25HP cars which were most numerous on the day. Much mixing and mingling and technical discussion ensued. It was nice to make the acquaintance of Pat and Kay O'Connor, who arrived in Kay's Christmas present, a brand new Bentley GTC in a most attractive grey with toning grey fabric top. Thanks to Richard and Lois for opening their home to us.

The Galaxy of Cars used to be an event where you just turned up on the day if the mood took you. With OSH and other "helpful" things it is now more managed and you need to book a site and be issued with tickets to get in, and cannot leave before 3.00pm. As we had not had an official Club entry at this event before, it was a bit of a guess as to how many wanted to attend. We had 6 spaces, and had 5 cars on the day. Philip Eilenberg -20HP; George Urquhart - 20/25; Berwick Taylor - 1939 Bentley; Derek Miller - 1973 T Type; and the ex Kelliher Silver Shadow. It is always interesting to have a fossick through the auto-jumble - I was pleased to get a windscreen washer bottle to replace the long cracked one on my Mark VI.



The new Wraith; Rolls-Royce Motor Cars' images unless otherwise noted

Rolls-Royce Motor Cars presented the new Wraith at the Geneva Motor Show on 5 March. Our magazine is part of the network of journals which receive information on Rolls-Royce Motor Cars activities; the initial announcement of the new Wraith came through in mid-January, with "teaser" images released in February, along with an invitation to attend the release of the new car at the Concorso d'Eleganza Villa d'Este in Geneva. Quite how the Company's Press Office would deal with an acceptance from here was not known, so your reporter kept quiet, and hopes to see the new car later in the year when it reaches New Zealand.

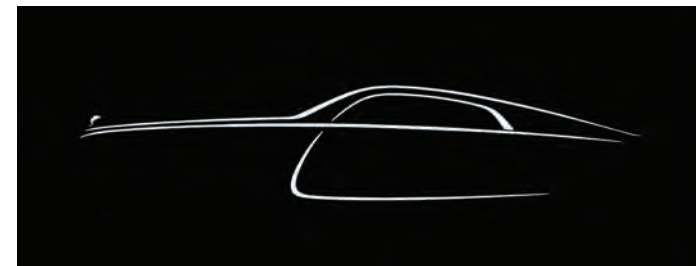

The "teaser" image of the new Wraith released in February

A two-door coupé, the new four-seater car incorporates two-tone colour schemes and a sweeping "fast-back" design which harks back to the classic pre-war Kestrel introduced by Riley (Coventry) Ltd eighty years ago. Interestingly, Sir Henry Royce had one of his assistants purchase a Riley Monaco in 1929 to analyse its design innovations as the Rolls-Royce Phantom II Continental was being developed.

Its V12 engine now develops 624 bhp/465 kW (about 60 bhp more than the Ghost), and 800 Nm at 1,500 rpm (20Nm more than the Ghost), the Wraith is the most powerful Rolls-Royce car ever built, capable of accelerating from 0 to 100 kph in 4.6 seconds.

"Today we launch the ultimate gentlemen's gran turismo, a car that embodies the spirit of Charles Stewart Rolls," commented Torsten Müller-Ötvös, CEO Rolls-Royce Motor Cars. "The

most powerful Rolls-Royce in history, Wraith promises the sense of adventure and speed that drove our founding forefather. But of course, Wraith's starting point is luxury, refinement and quality, traits that remain as important to Rolls-Royce customers today as they were more than a century ago."

Trailing, or "coach" doors have become a design feature of the new Rolls-Royce designs, and they certainly make for ease of entry and exit, while the door fastening methods recall the positive designs incorporated in the best coachbuilders' results on 1930s Rolls-Royce chassis. Rileys lacked this innovation, and most Monaco bodies had dents where the front doors had



The original "fast-back," a 1933 Riley Kestrel 6/12, although Rileys preferred "Aero lined saloons." Ian Coomber's image

smitten the rear door handles upon flying open; the World Champion Mike Hawthorn's first car was a Riley Monaco, so worn that it required rope linking the door catches, to ensure the front doors stayed closed during his spirited driving.

Wooden interior door panelling is featured, the term "Canadel Panelling" used to evoke the district in the south of France



where Henry Royce and his design team were based during the winters, and of course there is leather, and quite a lot of it.

We look forward to being able to publish a detailed analysis of the new Wraith. Company information tells us of a wider rear track, shorter wheelbase and lower roof height than its stable-mates, and that the car's suspension has also been tuned to minimise body roll and that the steering has been engineered to become heavier at high speeds, and lighter at lower speeds. For the first time, Satellite Aided Transmission (SAT) technology uses GPS data to see beyond what the driver sees; it anticipates his next move based on location and current driving style, then selects the most appropriate gear for the terrain, including corners, roundabouts and motorway junctions ahead. Advances in mechanical and electrical technology continue systems such as head-up display, which impressed your reporter during his acquaintance with that innovation in the Ghost, but another step has been taken by voice activation commands, which come with a one-touch call button located on the steering wheel. A destination no longer requires manual input from a navigation menu and route assistance begins



immediately, on-screen and via audio guidance following a voice command, helpfully exemplified in Rolls-Royce Motor Cars' Press Release as "navigate to Piccadilly in London." Hi ho.

In Europe, Wraith will be priced at approximately €245,000. Confirmation and further pricing details in all markets will be revealed later in the year, but Neil Darcy-Brain, the Brand Manager for the Rolls-Royce division of Team McMillan Ltd, advises that they will be endeavouring to have Wraith on the New Zealand market at similar pricing to Ghost and expect to start deliveries during the 4th quarter of this year.



New Members - A Warm Welcome to the Following:

Sue Jackson, Dan Young, and Stephanie Jackson-Young
432 Runciman Road, RD2, Drury,
South Auckland 2378
(09) 2388 311 (021) 0789 782
panzerrott@xtra.co.nz
2001 Bentley Arnage SCB2C32E2YCH04053

Yvonne Halliwell
40 Kanpur Road, Broadmeadows,
Wellington 6035
(04) 4771 158 (021) 0835 0986
janmorison@supanet.com
1988 Rolls-Royce Silver Spirit SCAZS00A1JCH23103



(Above) Roy Tilley's photo from British Car Day, Sunday 10 February at Trentham Race Course. Right to left, Roy Tilley's SRH12991, Elliott Snelling's SRH12321, Martin Purdy's SRH6886, Barrie Benseman's Silver Cloud III SEV249 and second cousins, three Armstrong-Siddeley Sapphires.

(Right) This photograph has recently come to light, and shows the risks that photographers at Brooklands Track took to capture such images as John Cobb in his Napier Railton airborne over the bumps at something like 130 mph



The New Bentley Flying Spur Made Its Debut at Geneva on 5 March



Bentley's most powerful four-door model ever made its global debut at the 2013 Geneva Motor Show on 5 March.

Bentley designers have produced a spacious interior which uses advanced acoustic and electronic technologies, but incorporates the traditional merits of leather, which also covers the roof and door pillars and is available in twelve colour options; and wood veneers, of which ten square metres of sustainably grown wood is used on fascia panels, consoles, waist-rails and picnic tables. To enhance the "wrap-around" appearance of the forward cabin, the veneer of the dashboard meets that of the doors in a curve, giving the impression of an unbroken arc of wood around the interior. A range of seven veneers is available; the two standard finishes are burr walnut or dark fiddle-back eucalyptus. Driver and passengers can choose between the car and the outside world, through touch-screen "infotainment," mobile connections including Wi-Fi, a rear seat entertainment suite, and a new hand-held Touch Screen Remote which allows rear-cabin occupants to control an extensive range of features from their seats.

The Flying Spur's engine is Bentley's 6 litre, twin turbo W12 engine, coupled to a ZF eight-speed transmission. Developing 625 PS (616 bhp) and 800 Nm of torque, the new Flying Spur features more power than any other Bentley four-door in history. A 14 per cent improvement in the power-to-weight ratio over the superseded model delivers a zero to 60 mph time of 4.3 seconds, and a top-speed of 200 mph (322 km/h). The power is delivered to the road through all-wheel drive, with a 40:60 rear-biased torque split, but the ability to vary this division by up to 85 per cent to the rear axle or 65 per cent to the front depending on available traction, to cope with virtually any road or weather condition. Compared with the superseded model, suspension spring rates have been softened front and rear by 10 per cent and 13 per cent respectively, for improved ride comfort in the normal operating region, but the rate of stiffness increase during harder cornering has been increased for improved control of heave, pitch and roll. Anti-roll bars are softened by 13 per cent and 15 per cent to improve single wheel impact absorption. Suspension lever bushes all-round are softened by at least 25 per cent for reduced road surface-induced noise and vibration.

The styling of the new Flying Spur incorporates a lower roof line, deeply sculpted side panels, and a longer and lower boot line. The front mudguards incorporate a vent complete with a Bentley "B" motif, and an additional feature line forms a sharply defined edge running from the front wheel all the way to the rear bumper. A wide range of materials has been used, all designed to improve overall body stiffness and refinement whilst meeting stringent crash performance targets and pedestrian protection legislation; the new body structure includes reinforcement to the B-posts, sills and front cross-members, together with deformable components in the floor pan. The bonnet includes both new reinforcement panels and deformation elements which help to ameliorate pedestrian impact

injury. The bonnet and front wings are constructed of aluminium, shaped using the aerospace-industry "super-forming" technique, employing compressed air to shape heated sheets of alloy into the required form at over 500°C. The new door structures are completely redesigned with fewer individual parts for improved quality and refinement.

Meanwhile, further weight savings are achieved through the crafting of the boot lid in a polymer composite material that also integrates the main antennae for the car's electronic systems. These measures and others throughout the car mean that the new Flying Spur is 50 kg lighter than the first generation car, despite the additional refinement measures, enhanced technology specification and stronger structure.

The new shape has achieved a drag co-efficient of just 0.29, which also helps emissions performance, and improved side window seals, an additional layer in windscreen and rear window glass, additional insulation in the doors, and larger rear mufflers have further reduced noise levels within the car. Road wheels are now 19" with a 12% increase in sidewall height, reversing the trend towards ever lower tyre profiles.

As the new Flying Spur approaches its hypothetical, for New Zealand, 200 mph (322 km/h) top speed, the ride height is automatically lowered in two stages through the air suspension system in order to compensate for aerodynamic forces, firstly by 5 mm at the front and 10 mm at the rear at 121 mph (195 km/h) and then by a further 8 mm and 13 mm respectively at 149 mph (240 km/h).

We look forward to hearing more about this car, and its New Zealand availability, in due course.





The Real Car Co Ltd
THE REAL CAR COMPANY
North Wales

Specialists in Rolls-Royce and Bentley Motorcars, 1920 to 1970s.
Around 30 to 40 cars in stock, ranging from restoration projects to concours.

We are always looking to buy similar vehicles, especially pre 1950.
Highly experienced in the Ocean Shipping of these important cars.

Web: www.realcar.co.uk Phone: 0044 1248 602649

Please contact Bernie Snalam for further information.

e-mail: bernie.s@btinternet.com



(Right) Malcolm Graham's photograph taken at a Bentley Drivers Club Silverstone race meeting.

FOR SALE: 2001 Bentley Azure

6.75 litre Turbocharged V8. Finished in Silver with Blue roof. Magnolia and Portofino blue to complete the two-tone interior.

Excellent condition all around with modern functionality. Full Service History through Bentley Service at Giltrap Prestige. Purchased as a Bentley Approved Pre-owned Vehicle from the United Kingdom in 2005. Evolved out of the Continental R, the Azure is a true automotive icon. Already a modern classic, the Azure is the most appropriate marque to add to your Bentley collection or to proudly and affordably become a first Bentley owner.

Please contact Andrew Beacham to discuss further details: (021) 905 924



MAJESTIC MOTORS LTD R.M.V.T

www.majesticmotors.co.nz email: ian@majesticmotors.co.nz

341 Queen Street, Masterton

Ph 06 370 4614 A/Hrs 0274 752 713 Fax 06 370 8300

Trade in and competitive finance available. We have top quality vehicles from luxury downwards



1990 Bentley Turbo R
Performance & Prestige
at an affordable price



1980
Rolls-Royce Corniche
Convertible



1968
Rolls-Royce Silver Shadow
Very Tidy Car



1998
Bentley Azure
Convertible, the
best open top
motorcar



2004 Rolls Royce Phantom, 6 Speed Auto
6750 V12, DVD, foot rests, umbrellas in rear
doors, height adjustment, parking control
system, remote close on rear doors, flying lady
disappears on looking car & much more.



2001 Bentley Arnage Le Mans
Limited edition model with all the very nice
special features including NZ Sat Navigation

Other Rolls Royce &
Bentley's to Arrive
1990 Silver Spur II
1985 Silver Spirit
1970 Silver Shadow

Dismantling:
1989 Bentley 8 injected
NZ new (frontal damage)

THE BEST OF CLASSIC DRIVER

CLASSIC DRIVER
NEW ZEALAND
RRP \$29.95

A DASHBOARD VIEW



COLLECTOR'S EDITION
CELEBRATING THE FIRST 10 YEARS

ORDER YOUR COPY NOW
THE BEST OF CLASSIC DRIVER

JUST \$29.95 INCLUDES POSTAGE

464 PAGES REMASTERED INTO
THIS SPECIAL COLLECTOR'S EDITION.
54 OF THE GREATEST CLASSIC DRIVER
STORIES & NZ MOTOR RACING HISTORY

RING US ON 0800 535 635

PUBLISHERS – SW MEDIA LTD,
PO BOX 9357, TOWER JUNCTION, CHRISTCHURCH

Provenance

The Rolls-Royce Motor Cars Approved Pre-Owned Programme

Only the finest pre-owned Rolls-Royce motor cars can attain the Provenance seal of approval, distinguishing them from others on the market.

This, along with a minimum of two years' warranty, two years' complimentary servicing using genuine Rolls-Royce parts and 24-hour roadside assistance, provide you with total reassurance and unrivalled peace of mind.

Provenance – exclusively through Rolls-Royce Motor Cars Auckland. For a personalised demonstration contact Neil D'Arcy-Brain on 09 969 3351 or email neil.darcybrain@rrmc-auckland.co.nz.



2007 Rolls-Royce Phantom Series I

Black non-metallic with Bespoke Cornsilk Leather Interior; Crossbanded Walnut Burr; 35,000km, 6.75l V12 Motor; Navigation, Bluetooth telephone, Tilt / slide Sunroof, Veneered Steering Wheel Spokes and Instrument Panel. A beautiful example that comes complete with Rolls-Royce two year Provenance Cover. **\$299,900**



2011 Rolls-Royce Ghost

Dark Tungsten metallic With Seashell Leather Interior; Piano Black Wood with Spirit of Ecstasy inlays, 15,000km Full Electric, Heated, Ventilated front and rear seats, Navigation, Bluetooth, Active Cruise Control, Night Vision, Full Camera System, Heads Up Display, This car gives the absolute 'magic carpet' ride with dynamic handling and performance. Balance of New Car Service. **\$445,000**



2012 Rolls-Royce Phantom Series I

Darkest Tungsten Metallic, Cornsilk / Black Contrast Interior with Cross banded Walnut Burr; Low km's, 6.75litre V12 for effortless driving, NZ Navigation, Bluetooth Telephone Hands free, Rear Seat entertainment package. Front & Rear Parking Sensors and Cameras, Balance Four Year full service. **\$585,000**



2012 Rolls-Royce Drophead Coupe

Ensign Red with Black Contrasting Leather; Piano Black Trim. 5,000km. 21" Forged Alloy Wheels, Navigation, Bluetooth, Camera System. The pinnacle of open top motoring. Balance Rolls-Royce four year Provenance Service. **\$575,000**



2012 Rolls-Royce Phantom Coupe

Diamond Black metallic with Brushed Steel Bonnet Package, Crème Light Leather Interior; Contrast RR Logos in Seats; Piano Black Wood Interior; Metal Steering Wheel Spokes, 21" part Polished Seven Spoke Alloys, Starlight Roof Lining, Full Camera System, Navigation, Bluetooth Telephone. A Simply Stunning Coupe to Drive. Full four year Rolls-Royce Factory Service.



1998 Rolls-Royce Silver Seraph*

Pearl Silver Metallic, Navy Blue Leather; Walnut Cross Banded Wood, 5.4 L V12 Motor; 5 Speed Auto Transmission, Automatic Climate Air; Lovely condition and great example of this seldom available model. **\$79,900**

* Not subject to the Provenance programme



Rolls-Royce Motor Cars Auckland

11 Great South Road, PO Box 9718, Newmarket, Auckland Telephone +64 9 969 3351 Fax +64 9 969 3354 www.rolls-roycemotorcars-auckland.com

© Copyright Rolls-Royce Motor Cars Limited 2011. The Rolls-Royce name and logo are registered trademarks.

You can trust Autovia with your pride and joy...



Entrust your pride and joy to the people who take great pride and joy in their work...

At Autovia, our staff, management and directors all have a lifelong interest in classic vehicles, including Rolls Royce and Bentley, so we can assist with all your maintenance and repair needs.

And our passion for classics means your project will always be more than just a job to us.

Left, a 1960 Alfa 2000 Spider by Touring, and Rolls Royce Silver Cloud III James Young at Autovia's workshop.



The restoration, repair and maintenance of classic vehicles

66 Cresswell Avenue, Dallington, Christchurch • Phone 03 385 9050 • Fax 03 385 9050 • Email info@autovia.co.nz • www.autovia.co.nz

COLGRAY MOTORS

Rolls Royce & Bentley Specialists



9B Beatrice Tinsley Crescent, Albany, Auckland
phone/fax: 09 414 1971 mob: 021 643 030 a/h: 09 444 3030

We specialise in the maintenance and care of Rolls-Royce and Bentley Motor Cars: servicing, repairs, overhauls and full restoration of Rolls-Royce and Bentley motor vehicles. Our Albany, North Shore workshop is fully equipped to carry out all mechanical, hydraulic, fault finding and electrical work. Restoration work can be carried out on all exterior and interior surfaces and leather work. Our experienced staff will work on your vehicle with meticulous care and attention to detail.

New & Secondhand Rolls-Royce and Bentley Parts • Motor Car Sales • Stockists of AutoGlym Car Care Products

Customers & Visitors are always welcome. Friendly Advice Available.

colin@colgray.com

www.colgray.com

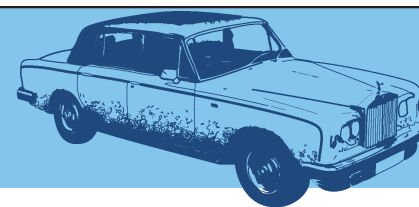

SHADOW PARTS NZ

SUPPLIERS OF GENUINE ROLLS-ROYCE AND BENTLEY PARTS, BOOKS, MAGAZINES AND BROCHURES



We offer the following parts for sale.

All items are new unused old stock unless otherwise stated.

Hubcaps for Silver Shadow and Bentley T, new and used, some repolished, both plain (early) and vented (late). Also separate trim (beauty) rings, new and used.

Radiator hoses (Shadow 1 and 2, T1 and T2) Oil filters, air filters,

Bumpers (chrome) front, right hand corner.

Lucas Square 8 fog or driving lamps, chrome or black plastic bodies.

Vee belts, for generator, alternator, power steering, air conditioning etc. in matched pairs where appropriate.

Distributor caps, for 6- and 8-cylinder engines. Side, tail and turn signal lenses.

Call me any time from 7.00 am to 11.00 pm

Roy Tilley (NZRR&BC Technical Liaison Officer)

204A Waiwhetu Rd, Lower Hutt. Ph 04.566.0850. E-mail rmt@xtra.co.nz www.royscars.co.nz



BENTLEY

BENTLEY AUCKLAND

SALES SERVICE PARTS ACCESSORIES

Factory trained technicians • Right first time guarantee • Loan cars available on booking
All genuine parts with 3 year manufacturer's warranty when fitted at Bentley Auckland



The Bentley Continental GT V8 and GTC V8 are at Bentley Auckland now.

2012 Bentley Mulsanne

Arabica with Twine Hide, Premier Specification. \$525,000.

2012 Bentley Continental GTC

Granite with Linen Hide, Naim Audio, 21" Alloy Wheels. \$310,000.

2011 Bentley Continental GT

Thunder, very high specification, Naim audio, ex Bentley fleet. \$265,000.

2008 Bentley Continental Flying Spur

Granite, 20" Alloy Wheels, Solar Sunroof. 16,000 km. \$170,000.

2005 Bentley Continental GT

Diamond Black, TV Tuner, Navigation. \$139,990.

2004 Bentley Continental GT Coupe

Moonbeam Silver with Beluga Hide. 37,000 km. \$119,990.

2003 Bentley Arnage T

Silver Storm, Beluga Mulliner interior, picnic tables. 19" Alloy wheels. \$89,990.

BENTLEY AUCKLAND 100 Great North Road, Grey Lynn, Auckland.

Ph: 09 360 3200 Email: sales@bentleyauckland.co.nz www.bentleyauckland.com

BRUCE MCILROY LTD

Authorised Bentley & Rolls-Royce Heritage Dealer



BENTLEY

VEHICLES FOR SALE



**1937 ROLLS-ROYCE
25/30**

**Black over brown with
brown hide upholstery
and brown carpets.
Recently repainted
H.J. Mulliner Saloon
coachwork.
In excellent
overall condition**

**1978 ROLLS-ROYCE
CORNICHE**

**Royal blue with beige
hide upholstery and
carpets. Coachwork
restored on arrival in
New Zealand. Recent
suspension overhaul
carried out by Bruce
McIlroy Limited**



At Bruce McIlroy Ltd we exclusively restore and service Bentley and Rolls-Royce motor vehicles ranging from 1907 Rolls-Royce vehicles to the present day Bentleys.

**SERVICING • REPAIRS • RESTORATIONS
PARTS • SALES**

CORNER OF RACECOURSE AND ALFORD FOREST ROADS, ASHBURTON 7776, NEW ZEALAND
Telephone/Fax 03 308 7282, A/H 03 308 7372, Mobile 027 223 1600, e-mail bruce.mcilroy@xtra.co.nz
www.bentleyservice.co.nz

Club Calendar

Full details are also contained on our newly enhanced Web Site www.nzrrbc.co.nz

NORTHERN REGION

April/May: Berwick Taylor is organising a local run. Details will be e-mailed once arrangements are finalised.

Sunday 28 July: Lunch at Riverhead Pub. Numbers limited to 25 people so it will be first in, first served. E-mail to members asking for numbers closer to the time.

Saturday/Sunday 28/29 September: Spring run to Russell. Staying at Duke of Marlborough Hotel.

Tuesday 12 November: Northern Region AGM & Christmas Dinner at Totara Restaurant, 249 State Highway 17, in the Old Albany Village.

CENTRAL REGION

Thursday 9 May: Manawatu Gorge railway tunnel walk combined with a "Posh Picnic" or Tui Brewery Tour.

Further details to be advised.

Friday 21 June: Annual "Solstice Dinner" at the Wellington Club.

SOUTHERN REGION

Queen's Birthday Weekend 1 to 3 June: Very Late Autumn Touring Weekend: Details to be advised.

Friday 12 to Sunday 14 July: Winter Touring Weekend: Details to be advised.

Friday to Sunday 15 to 17 November: Traditional Show Weekend Tour: Details to be advised.

Classified Advertisements

Free to Good Home: Past copies of NZR-R&BC magazines, and RREC *Bulletins*. Henry Green, (03) 308 3274



Of possible interest for your members - a significant "W.O." Bentley

I believe that it is appropriate to let your members know that a very rare Australian motor car is going to be sold, and will be auctioned by RM at the prestigious Villa d'Este auction on May 25th.

The car is well known; it is the 1929 Olympia Motor Show Bentley Sedanca de Ville. This vehicle has a 6.5 litre engine, OHC, 4 valves per cylinder, and is in excellent mechanical condition and nicely patinated. It is considered to be the only Bentley Sedanca de Ville left in the world and has been on display at Bentley Motors Heritage museum since 2007.

During that time we have used the car infrequently and on select occasions, such as the Bentley Drivers Club tour "Britain by Bentley", for a rally across France to the Mediterranean, and when the car was invited to be displayed at Pebble Beach. (Left) at The Savoy, London, and Pebble Beach.

During the time that the car has been in England I've commissioned extensive mechanical work by local Bentley specialists and have enjoyed a spectacular vintage touring vehicle as a result. It has given my wife and me great joy and we will be very sorry when it is sold. All the receipts for the work are available for inspection as is the detailed provenance report by noted Bentley Historian Dr Clare Hay. Dr Hay believes that there are only around 20 original bodied big six Bentleys left, and this vehicle being the sole remaining Sedanca plus having such unique provenance represents an excellent opportunity for a collector and enthusiast.

Of course, I would far prefer the car to remain in Australia or New Zealand which is why I would appreciate your club alerting your membership and those of other clubs to the prospective sale as early as possible. Being an Australian registered vehicle there are considerable advantages for an Australian purchaser.

Regards

Syd Reinhardt



Bentley R Type 1952 parts or project car, offers , phone Michael 0274 148 145



FOR SALE: 1960 Rolls-Royce Silver Cloud II Chassis SVB331. Good condition, imported new, always garaged. Present owner for 35 years. Comes with spare new windscreen, full set of tools (including some special), original handbook and set of workshop manuals. \$35,000 o.n.o. For more details phone Merv Warner (06) 751 2414



FOR SALE: 1993 Bentley Continental Corniche 111 Convertible. Chassis no 30587. Brooklands Green. 55000 Kms. Original, unmarked and impeccable. Owned for 10 years with 1 previous owner. Ring R.B. Cleave, (09) 5758115 or 0274 984259

E-mail rcleave@ihug.co.nz



FOR SALE: 1971 Bentley T Type Chassis SBH10636 \$30,000. New Zealand new, good service history, 130,000 miles. Original Sand over Astrakhan, Navy Blue interior in mint condition. Contact Tom King, 03.339.8309 the.king@xtra.co.nz