

DEPARTMENT OF TRANSPORTATION**DIVISION OF PLANNING AND POLICY**

Statutory Authority: 29 Delaware Code Section 8404(8),
17 Delaware Code Chapters 1 & 5
(29 Del.C. 8404(8), 17 Del.C. Ch. 1 & 5)

Summary of Evidence and Information Submitted

The Department of Transportation (Department) received written comments on the Delaware Traffic Calming Manual (Manual) from Richard Ornauer and Beverly Barnett of the Citizen Advisory Committee, Paul Stevenson of the Delaware Bicycle Council, and Michael Brywka, President, Wexford Civic Association.

Mr. Ornauer's primary concern was the requirement for 67% public support, mini circle radii requirements, neighborhood truck access, and questions about impact areas. Ms. Barnett mentioned typographical errors, wording changes, discussions about the neighborhood traffic committees, landscaping, ITMS considerations, and the production of a "Community Traffic Calming Guide." Mr. Stevenson would like to ensure that there is consideration of all modes of transportation, especially when there are exceptions to the Manual. He would also like to see design constancy and adequate maintenance. Mr. Brywka identified a typographical error, expressed an interest in including a project time line and sample forms for project requests.

Findings of Fact

Under its authority, the Department is adopting the Manual as a supplement to the Road Design Manual. The Manual offers options for the development of Subdivision streets and roads of a classification no higher than arterial, as indicated on the Department's Functional Classification System Map. The Department is doing this to directly support the provisions of the Statewide Long Range Transportation Plan, and county and local transportation and comprehensive land use plans.

Based on the comments received, the following is a summary of the changes made to the Draft Manual:

- Modified the "Traffic Calming Process" to include review by the Project Development Committee.
- Expanded the explanation of the "Priority Rating System" to include examples and a step by step procedural descriptions.
- Modified Table II 4 "Application Guidelines" to correspond to the Department's Functional Classification System. Also modified language dependent on this table throughout the Manual.
- Modified Figure IV-16 "Typical Neckdown" to allow for more flexible design considerations.
- Included language describing the process through which the Manual can be modified.
- Corrected grammatical, syntactical and typographical errors throughout.

Text and Citation**Purpose**

The purpose of the Manual is to provide the administrative procedures needed to evaluate and implement traffic calming measures, provide guidance on applications for traffic calming, and provide guidance on geometric design and signing.

Introduction

The Manual consists of roadway design standards that are intended to encourage closer adherence to posted speeds, discourage cut-through traffic, enhance vehicular and pedestrian safety and community aesthetics. The Department is doing this to directly support the provisions of the Statewide Long Range Transportation Plan, and county and local transportation and comprehensive land use plans.

Background

Over the last several years, increasing numbers of communities have approached the Department with issues of speeding and cut-through traffic. Historically, these situations could only be addressed with the use of police enforcement or speed humps.

Enforcement is expensive and limited and speed humps are not university applicable. An expanded menu of options was required to address these issues. At this time in other parts of the country, and internationally, measures to address these

concerns were being explored. In English speaking countries, these measures came to be known as "Traffic Calming."

In short, traffic calming involves changes in street alignment, installation of barriers, and other physical measures to reduce traffic speeds and/or cut-through volumes, in the interest of street safety, livability, and other public purposes

In June 1999, the Delaware Department of Transportation secured the services of a consultant to develop traffic calming measures tailored to Delaware. In the 13 months that followed, a Citizen Advisory Committee (CAC) and an in-house Technical Review Team (TRT) were established to guide the development of the document. These groups worked with the consultant to identify issues unique to Delaware, establish a nomination and implementation process, and identify measures suitable to the conditions in the State.

After months of work, several iterative reviews, a public workshop and the publication of the draft Manual in the July Issue of the Delaware Register of Regulations the Department has completed its reviews and is adopting the Manual through this supplement.

Implementation

While the Manual is supplemental to the Road Design Manual, it is intended to augment and not supersede it. It will provide alternative means to address speeding and cut-through problems. The Manual will be available for use upon approval.

Application

By providing the concepts in the Manual as an alternative to traditional street and road designs, the Department is supporting county and local governments requiring alternative traffic control methods. These guidelines apply to:

- Streets and highways within Delaware's existing urban centers; and
- Streets and highways within Delaware's master planned communities and residential subdivisions.

Questions or issues that might arise through the application of the guidelines will be decided by the Chief Traffic Engineer, or his designee, at the Division of Traffic Engineering and Management (TEAM).

Expiration

These guidelines are assumed to be perpetual unless and until the time they are updated, modified or superseded.

Decision

Pursuant to the authority in 29 Delaware Code Section 8404(8) and 17 Delaware Code Chapters 1 & 5 and after due notice as required under the Administrative Procedures Act, the Department of Transportation hereby adopts the Manual, effective September 10, 2000.

Comments or questions regarding how the Manual will be administered should be directed to:

Michael Somers, Senior Transportation Planner
The Delaware Department of Transportation
Division of Statewide and Regional Planning
P.O. Box 778
Dover, DE 19903

(302) 760-2118
(302) 739-2251 (fax)
msomers@mail.dot.state.de.us

Secretary Anne P. Canby
Date Adopted: August 11, 2000

Delaware State Department of Transportation Traffic Calming Design Manual

TABLE OF CONTENTS

	PAGE
CHAPTER I: INTRODUCTION	I-1
1. Purpose	I-2
2. Relationship to Statewide Long Range Transportation Plan	I-2
3. Applicability	I-3
4. Related Initiatives	I-3
 CHAPTER II: TRAFFIC CALMING PROCEDURES	 II-1
1. Steps in the Process	II-1
2. Priority Rating System	II-8
3. Funding	II-10
 CHAPTER III: APPROPRIATE APPLICATIONS	 III-1
1. Delaware's Toolbox of Traffic Calming Measures	III-1
2. Impacts of Traffic Calming Measures	III-9
3. Application Guidelines	III-11
 CHAPTER IV: GEOMETRIC DESIGN OF TRAFFIC CALMING MEASURES	 IV-1
1. General Guidance	IV-1
2. Volume Control Measures	IV-2
3. Vertical Speed Control Measures	IV-8
4. Horizontal Speed Control Measures	IV-17
5. Narrowings	IV-26
6. Speed Estimates	IV-31
 CHAPTER V: SIGNING AND MARKING OF TRAFFIC CALMING MEASURES	 V-1
1. General Guidance from MUTCD	V-1
2. General Signing and Marking Conventions	V-2
3. Standard Signs	V-4
4. Specific Signing and Marking Conventions	V-7
5. Special Signing for Bicycle Routes	V-13
 APPENDIX	 A-1

* PLEASE NOTE: THE ABOVE PAGE NUMBERS REFER TO THE ORIGINAL DOCUMENT AND NOT TO THE REGISTER.

CHAPTER I INTRODUCTION

Delaware's *Traffic Calming Design Manual* represents an important milestone in the development of traffic calming in Delaware. From this manual, a state engineer will receive general guidance regarding the appropriate use, design, and signing and marking of each traffic calming measure. A local official, developer, community association, or other interested party will learn what traffic calming is and how it can be applied in Delaware.

The August 1999 report by the Institute of Transportation Engineers (ITE), *Traffic Calming State-of-the-Practice*, defines traffic calming as follows: *traffic calming involves changes in street alignment, installation of barriers, and other physical measures to reduce traffic speeds and/or cut-through volumes, in the interest of street safety, livability, and other public purposes.*¹ This definition is adopted and operationalized in the present manual. Although this definition may imply that

traffic calming measures will be applied almost solely to retrofit existing roadways and streets, the guidelines in this Manual will be applied to the construction of new roadways and streets as well, whether publicly or privately initiated.

As indicated in the above definition, the reduction of traffic volume or speed is a means to other ends, such as improving the quality of life in residential areas and all parts of the community, increasing walking safety in commercial areas, or making bicycling more comfortable on commute routes. Not all roads are suitable for traffic calming. The State Department of Transportation (the Department) seeks to distinguish between cases where traffic calming is warranted, and those where it is not, through priority rating factors in Chapter II and application guidelines in Chapter III. Even when traffic calming is warranted, there may be trade-offs including less flexibility for the movements of larger vehicles such as school busses and trucks, and speed impacts for emergency vehicles.

The ITE definition covers a host of physical measures to slow or divert traffic. For each measure, physical descriptions and illustrations are provided in Chapter III, geometric design guidance is set forth in Chapter IV, and signing and marking conventions are established in Chapter V.

The ITE definition does not include non-engineering measures that may improve street appearance, address residents concerned about traffic, or, in some cases, even affect traffic volumes and speeds. Planting trees on a roadside, enforcing traffic laws more intensively, or running neighborhood traffic safety campaigns may all be worthwhile. However, they generally fall outside the Department's purview, and according to *Traffic Calming State-of-the Practice*, cannot be counted on to calm traffic. Users of this manual may wish to consult *Traffic Calming State-of-the Practice* (Chapter V) for more information on non-engineering measures, and contact other state or local agencies if they decide that these measures would be helpful on their streets.

The pioneering nature of this manual has caused the Department to be conservative in its policies. Since the manual is new, some changes may need to be made over time. Procedures for making changes to this manual will use as a guideline the procedures outlined in Delaware Road Design Manual, Appendix B – section on Procedures for Making Changes.

1. PURPOSE

The purpose of the Traffic Calming Design Manual is to provide the administrative procedures needed to evaluate and implement traffic calming measures, provide guidance on applications for traffic calming, and provide guidance on geometric design and signing.

To accomplish this purpose, Delaware's *Traffic Calming Design Manual* provides a framework for the planning, design, and implementation of traffic calming measures. Consistency and predictability are sought in four areas, each of which is the subject of a subsequent chapter:

- *procedures* (Chapter II)
- *applications* (Chapter III)
- *geometric designs* (Chapter IV)
- *signing and marking* (Chapter V)

The Appendix describes the process used to develop Delaware's *Traffic Calming Design Manual*.

2. RELATIONSHIP TO STATEWIDE LONG-RANGE TRANSPORTATION PLAN

This manual is consistent with and furthers the Statewide Long-Range Transportation Plan. The Plan establishes transportation goals, policies, strategies, and priority actions. The intent is to . preserve communities and improve the quality of life for Delaware's citizens while maintaining and improving mobility and access. This manual establishes *policies* to do just that: maintain mobility and access while improving quality of life and preserving communities via traffic calming.

In order to achieve Delaware's vision, seven *strategies* are identified in the Long-Range Plan. Traffic calming is integral to a number of these strategies, including: supporting growth management, better coordinating transportation and land use, and ensuring safe and efficient services.

The Long-Range Plan establishes *priority actions* for implementation. Among them, the Department is to work with local jurisdictions to implement traffic calming techniques in targeted areas adversely affected by high-speed traffic.

3. APPLICABILITY

This manual, and the guidelines it contains, can be applied to all streets and highways under the Department's jurisdiction, whether publicly or privately funded. This includes existing and new state routes, and existing and new subdivision streets maintained by the Department. This does not imply that traffic calming is appropriate for all streets and highways in

Delaware. Guidance on application can be found on Table III-4. Delaware is one of only five states that operate and maintain local streets. A reported 88 percent of all streets and highways fall under state control, a higher percentage than in any other state. Many minor streets, which in other states would be under city or county control, are under state control in Delaware. These streets are prime candidates for traffic calming, making the adoption of statewide policies all-the-more critical in Delaware.

This manual does *not* mandate traffic calming on existing streets under state control. But if traffic calming is nominated by residents, local officials, or others, the Department will follow the guidelines contained herein using professional judgement for exceptions. If private developers choose to install measures as determined through the plan development process (something the state encourages), they will be subject to application, geometric, and signing and marking guidelines contained in this manual.

Even with standardization of traffic calming in Delaware, design flexibility will remain. The manual sets forth guidelines, rather than rigid policies. The Department reserves the right to deviate from these guidelines in special cases. The guidelines themselves provide flexibility as well, in that they offer options rather than dictating single design solutions.

4. RELATED INITIATIVES

Two Department's initiatives are particularly relevant to this manual. The first is Delaware's *Road Design Manual*. Delaware's *Traffic Calming Design Manual* is a supplement to *the Road Design Manual*, incorporated by reference.

The second initiative is the development of *mobility-friendly subdivision street standards*. The Department's *Rules and Regulations for Subdivision Streets* are being amended to offer subdivision developers an alternative to conventional street design. Alternative standards have been established for local subdivision and minor collector subdivision streets. In return for narrower streets, subdivision developers will be required to build more interconnected street networks and to incorporate traffic calming measures so as to slow traffic in such networks. These standards must be applied in their entirety rather than one or two at a time.

1. A companion to this manual, *Traffic Calming State-of-the-Practice*, is a joint publication of the Institute of Transportation (ITE) and Federal Highway Administration (FHWA). The ITE report contains background information on legal authority and liability, emergency response and other agency concerns, impacts of traffic calming, and many other subjects. It also contains an exhaustive bibliography of traffic calming publications. The ITE report can be downloaded on the web at www.ite.org.

CHAPTER II TRAFFIC CALMING PROCEDURES

This chapter establishes procedures for traffic calming in Delaware. In deciding when, where, and how to calm its streets and highways, the Department will follow the procedures outlined in this chapter. Where desirable, procedural options are outlined rather than holding to only one approach.

1. STEPS IN THE PROCESS

A traffic calming program may be *reactive*, responding to citizen requests for action, or *proactive*, with program staff identifying problems and initiating action prior to complaints, accidents, and other negative consequences of traffic through neighborhoods. A traffic calming program may make *spot* improvements, street by street, or may plan and implement improvements on an *areawide* basis, with multiple streets treated at the same time. With two choices in each of two program areas, there are four distinct programmatic options.

The Delaware program incorporates all four options. Projects may be nominated within or outside the Department. Among its proactive stances, the Department encourages land developers to incorporate traffic calming measures into their developments. It is more cost-effective to design traffic calming into a subdivision than to come back and retrofit once streets are in place.

Projects may be either localized or areawide. In general, the Department favors areawide approaches, so traffic problems do not simply spill over from one neighborhood street to another. Even for single-street requests, treatments may ultimately extend to parallel streets.

Delaware's Traffic Calming Program is administered by the Traffic Engineering and Management (TEAM) Section, Division of Highway Operations. Projects shall be developed consistent with the Department's pipeline process, including approval by the Department's Project Development Committee (PDC). The process followed in Delaware is flow charted in Figure II-1. It is described in subsequent subsections.

FIGURE II-1 (1 OF 2) TRAFFIC CALMING PROCESS

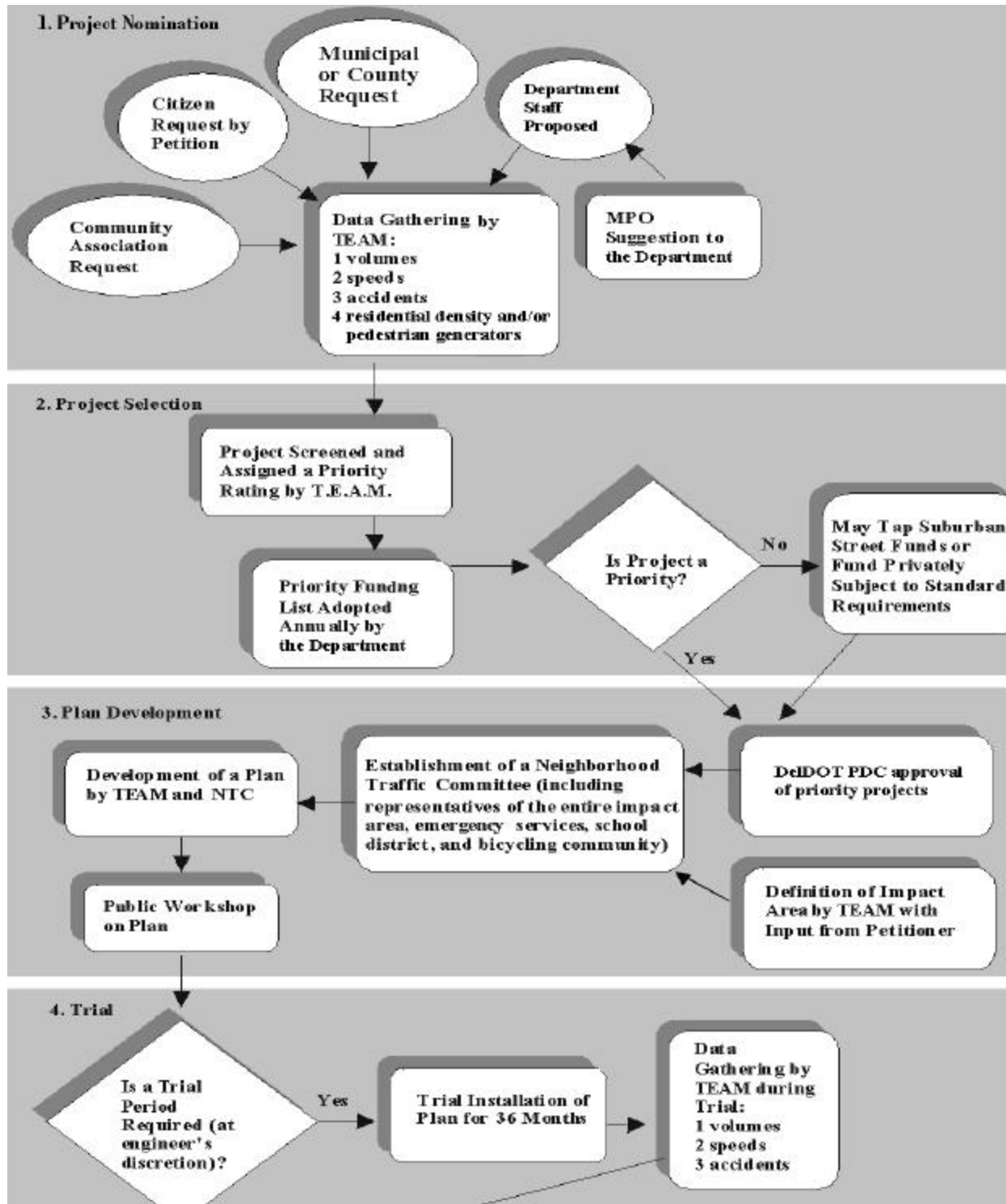
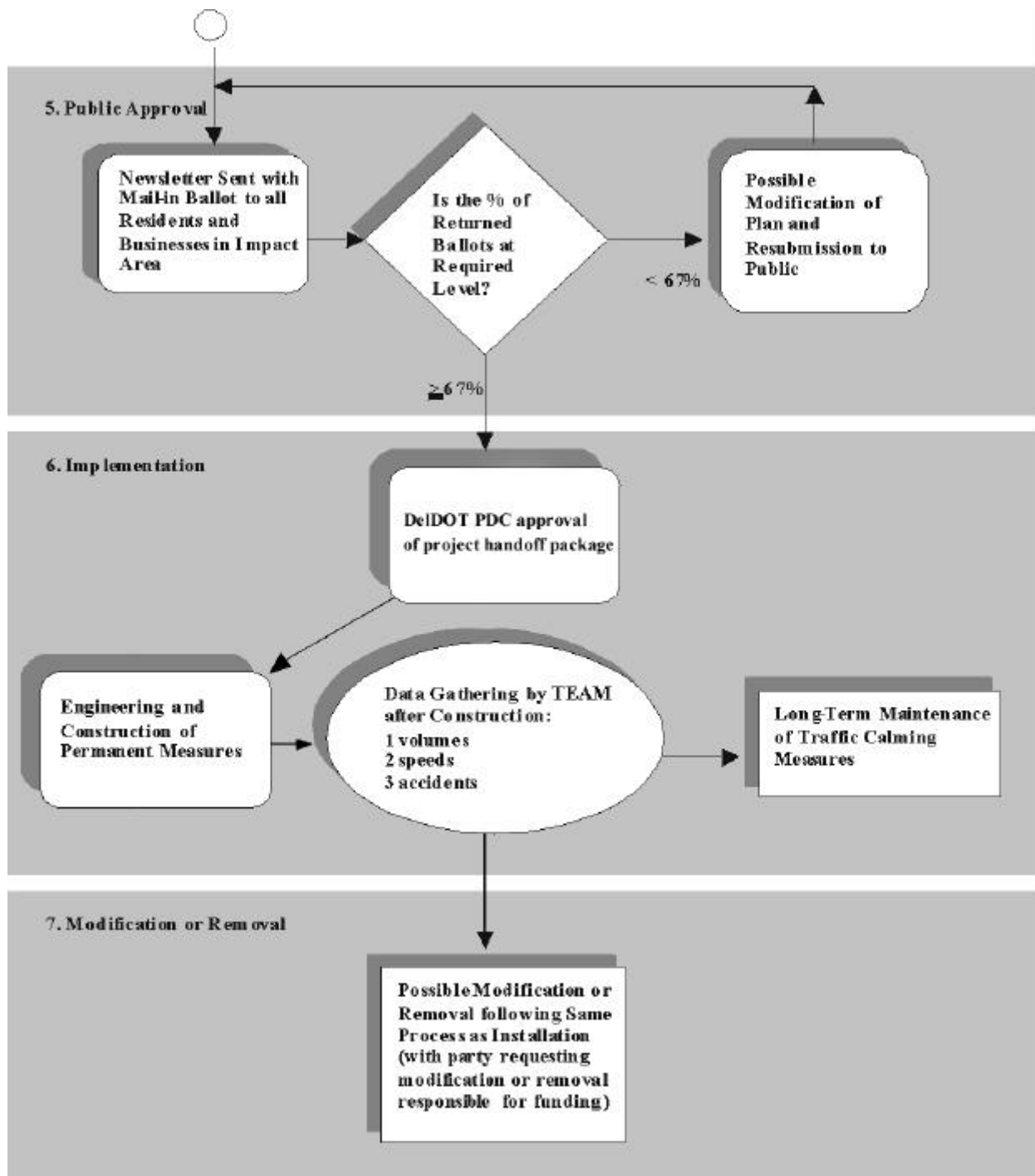

FIGURE II-1. (2 OF 2) TRAFFIC CALMING PROCESS



1.1. Project Nomination

If nominated by a city, county, or community association, a traffic calming request is presumed to have a degree of public support. If initiated by individual citizens, a threshold level of support must be demonstrated. Citizens must secure the signatures of at least 67 percent of the households and businesses on the street or streets to be traffic calmed. The petitioner shall use a standard form supplied by the Department, to which an area map shall be attached showing which streets would be treated. The form should be submitted to the Department with a cover letter requesting consideration.

The Department would prefer that traffic calming requests come from associations representing the broad interests of the community or neighborhood. The Department will encourage individuals to work through their community associations (where such associations exist) rather than filing petitions on their own.

1.2. Project Selection

1.2.a Screening

The Department will make an initial determination of eligibility for traffic calming under the Department's Application Guidelines (see Table III-1V). Traffic volume and speed data will be gathered (if not already available) for the streets in question. Streets must be at a classification level eligible for traffic calming as shown in Table III-IV, and have a daily volume and 85th percentile speed within the eligible ranges. The same volume and speed information will subsequently be used by the Department to rate projects for funding priority.

1.2.b Priority Rating

For eligible traffic calming requests, the Department will gather data for all factors in the priority rating formula (see Section 2). The Department will then rate eligible traffic calming projects, and on a fiscal year basis, rank them for funding priority. Rankings will be prepared separately for projects on state numbered routes and on subdivision streets. The highest ranked projects will be programmed for installation, subject to available funding in each category.

Traffic calming projects on state numbered routes will be funded primarily out of the Department's own funds. Subdivision street treatments will be funded primarily out of Suburban Street funds or private assessments. All traffic calming projects, even those privately funded, must meet all process and substantive requirements outlined in this manual.

1.3. Plan Development

1.3.a Impact Area

In consultation with the party requesting traffic calming, the Department (TEAM) will define the impact area of projects for purposes of plan development and public approval. This area shall encompass all streets for which traffic calming is proposed, all streets only accessible via such streets, and all streets likely to be significantly impacted by diverted traffic. A significant impact is defined as an increase of more than 100 vehicles per day (vpd) on any local subdivision street, more than 600 vpd on any minor collector subdivision street, and more than 1,000 vpd on all other residential streets.

The impact area will ordinarily be larger for volume control measures than for speed control measures, and larger for severe speed control measures such as speed humps than for mild measures such as center island narrowings. In defining the impact area, the Department will consult volume impact information contained in the Institute of Transportation Engineers' *Traffic Calming State-of-the-Practice*. In the absence of better estimates, the Department may use average percentage reductions in traffic volumes on traffic calmed streets as reported by ITE, and will assign the corresponding diverted traffic to neighboring streets in order to determine if the significance threshold is met. Volume impacts from the ITE report are reproduced in Table II-1.

TABLE II-1. VOLUME IMPACTS OF COMMON TRAFFIC CALMING MEASURES

Measure	Average % Reduction in Traffic Volume
Speed Humps	20%
Speed Tables	12
Traffic Circles	5
Narrowings	10
Full Closures	44
Half Closures	42
Diagonal Diverters	35

Source: R. Ewing, *Traffic Calming State-of-the-Practice*, Institute of Transportation Engineers, Washington, D.C., 1999.

1.3.b Neighborhood Traffic Committee

For each funded project, the Department will establish a Neighborhood Traffic Committee (NTC) to assist in the preparation of a traffic calming plan for the impact area. The entire impact area shall be equitably represented on the NTC. Membership may include the original petitioners for traffic calming, residents appointed by a community association, citizens volunteering at an initial public meeting, pedestrian groups, transit users, business owners within the impact area, and any other members deemed essential by the Department for balanced representation. Representatives of emergency services, the

school district, the bicycling community, and any transit providers shall be offered membership on the NTC.

1.3.c Traffic Calming Plan

A traffic calming plan will be prepared by the Department with input from the NTC. The planning process will include a training component for committee members receiving their first exposure to traffic calming. Traffic calming options and impacts will be described. Advantages and disadvantages of different measures will be explained. Visual media will be used to help members visualize the options available to them.

Plan development may be accomplished through a design charrette with the NTC, through a workshop at which the Department presents a preliminary plan for NTC review and refinement, or through any other process that will actively engage the NTC. From the experiences of other jurisdictions, this degree of public-staff interaction is critical for plan success.

1.3.d Public Workshop

Once a plan is developed, the Department will hold a public workshop to solicit comments. The plan may be modified based on the feedback received.

1.4. Trial

At the lead engineer's discretion, traffic calming plans may be implemented on a trial basis, subject to impact evaluation during the trial period. The trial will ordinarily last 3 to 6 months, at which time a decision on permanent installation will be made.

Trial installations may be warranted when implementing complex areawide plans, whose traffic diversion potential is difficult to predict. Trial installations may also be warranted when deploying novel traffic calming measures, as when vertical measures with unconventional profiles are first used.

The fact that installation is on a trial basis does not mean that unsightly materials may be used. The national experience suggests the importance of aesthetics for public acceptance.

1.5. Public Approval

The final plan will be distributed, along with mail-in ballots, to all households and businesses located within the impact area. All households, whether owning or renting property, shall have a vote on permanent installation. So shall all businesses, whether owning or renting space.

For permanent installation, 67 percent of those returning ballots must vote affirmatively. Once approved in this manner, measures will be programmed for permanent installation. If fewer than 67 percent of respondents approve of permanent installation, plans may be modified and submitted to the public a second time, subject to the same 67 percent approval requirement.

1.6. Implementation

The Department will design and construct traffic calming measures in accordance with geometric, aesthetic, signing, and marking guidelines contained in Chapters IV and V of this manual. Construction will be subject to narrow tolerances. As an example, plus or minus one-eighth inch (3 mm), is not an unrealistic tolerance for the height of a 3-inch speed hump. The Department will ensure traffic calming measure construction is consistent with specifications.

The Department will maintain the constructed portions of traffic calming measures. However, the maintenance of landscaped areas within traffic calming measures will, in some cases, become the responsibility of others. Specifically, all landscaped islands or curb extensions within subdivisions and all landscaping outside the travel way on state routes will be the responsibility of the community association or individuals who initially petition for traffic calming. Landscape maintenance agreements will be developed with communities in coordination with the Department's Field Services/Roadside Environmental Section.

Maintenance of brick and other decorative materials may also be turned over to such associations or individuals. A legally binding agreement will be used to enforce their maintenance obligation.

The Department will assess the performance of traffic calming measures roughly six months after permanent installation in order to learn from each project and acquire impact data of use in subsequent budget deliberations. At a minimum, speed and volume measurements will be taken after permanent installation to permit before-and-after comparisons. Accident and resident satisfaction survey data may also be gathered. The Department will also inspect traffic calming measures to ensure their integrity over time.

1.7. Modification or Removal

If monitoring indicates a significant problem with a traffic calming measure, the Department will modify or remove the measure on its own initiative. Citizens may, in addition, petition the Department for modification or removal. Ordinarily, the Department will consider such petitions only after a full year of experience with measures. The same procedural requirements that apply to initial installation will also apply to modification or removal of measures including at least 67% of affected households indicating a desire to remove measures. To discourage casual requests, the petitioners themselves will be responsible for securing funding for modification or removal in those cases not initiated by the Department.

2. PRIORITY RATING SYSTEM

A priority rating system was developed for Delaware with the help of two project advisory committees. Factors in the rating formula are listed in Table II-2. They are given equal weight in the formula.

TABLE II-2. PRIORITY RATING FORMULA

	Average Daily Traffic	85 th Percentile Speed	Collisions (3-Year Average)	Residential Density	Pedestrian Generators (#) ^a
Residential Areas	T	T	T	T	
Nonresidential Areas	T	T	T		T
Mixed Use Areas	T	T	T	T	T

- a. Included among pedestrian generators are: schools (colleges, high schools, middle schools, elementary schools); parks; recreation centers; shopping centers; hospitals; community centers; day care centers; employment centers; health centers; and convenience stores.

Being expressed in different units (vehicles per day, miles per hour, etc.), priority rating factors must be normalized before they can be combined into an overall priority rating score. That is, priority rating factors must be converted into common dimensionless units to avoid an apples-oranges problem. The most widely accepted way to normalize factor values is to express values for individual projects in terms of numbers of standard deviations above or below the average values of these factors. This is the approach taken in Delaware.

To compute standard deviation from any list of numbers, the following steps are taken:

1. Compute the mathematical average of the list of values.
2. Subtract each number on the list from the average. All results are expressed in positive (absolute value).
3. Square the individual results from Step 2.
4. Sum the squared list of numbers from Step 3.
5. Divide the sum from Step 4 by (n-1), the total number of values minus one.
6. Calculate the square root of the result of Step 5. This value will be the standard deviation.

Before the Department's traffic calming program is formally launched, it will be necessary to gather data on factor values statewide so that values for individual projects can be normalized and then combined into an overall priority rating. Alternatively, the Department may simply normalize relative to factor values for competing projects during each fiscal year. When normalizing a factor, the value for an individual project will be converted to a number of standard deviations above or below the mean value. Values can then be appropriately combined.

By way of example, overall priority ratings for projects in nonresidential areas will be computed with the formula:

$$\text{PRIORITY SCORE} = ADT + 85^{\text{th}} \text{ Speed} + \text{Collisions} + \text{Generators}$$

where the italics represent normalized values of priority rating factors. Applied to a set of hypothetical projects in Tables II-3 and II-4, the average value of ADT for competing projects is 7,729 and the standard deviation from the average is 4,314. For the first competing project, Fall Creek Avenue, the normalized value of the first factor is:

$$ADT_{\text{Fall Creek}} = (4,950 - 7,729) / 4,314 = -0.64$$

Repeating this calculation for other factors and projects, and summing normalized values for individual projects, this procedure assigns South Aurora Street the highest priority with an overall score of 3.66. South Baker Street is assigned the lowest priority, with an overall score of -3.38.

For areawide projects, values of priority rating factors will be averaged across the streets proposed for traffic calming. In the preceding example, if South Aurora St. and South Baker St. were included in the same areawide traffic calming proposal, their traffic volumes, speeds, and other factors would be averaged and the average values would be substituted into the formula to determine the project's relative priority. The neighborhood might or might not remain a priority when the low rating of South Baker St. were factored in.

TABLE II-3. FACTOR VALUES FOR COMPETING PROJECTS

Project	ADT	85 th Speed	Annual Collisions	# Generators
Fall Creek Ave.	4,950	28.8	1.92	3
South Baker St.	5,770	16.0	0.00	0
North Baker St.	7,760	18.3	1.59	4
Hector St.	5,250	14.8	0.00	1
South Aurora St.	15,000	31.0	0.73	6
Hudson St.	2,870	23.6	5.54	2
Cliff St.	6,600	35.0	0.00	4
University Ave.	13,630	37.5	0.22	0

TABLE II-4. NORMALIZED FACTOR VALUES AND OVERALL PRIORITY RATING

Project	ADT	85 th Speed	Annual Collisions	# Generators	Overall
Fall Creek Ave.	-0.64	0.37	0.35	0.23	0.31
South Baker St.	-0.45	-1.10	-0.66	-1.17	-3.38
North Baker St.	0.01	-0.83	0.18	0.70	-0.05
Hector St.	-0.57	-1.23	-0.66	-0.70	-3.17
South Aurora St.	1.69	0.62	-0.28	1.64	3.66
Hudson St.	-1.13	-0.23	2.27	-0.23	0.68
Cliff St.	-0.26	1.07	-0.66	0.70	0.85
University Ave.	1.37	1.36	-0.54	-1.17	1.01

3. FUNDING

As specific projects are identified and are ready to proceed to design and construction, funding sources must be secured by the Department in assistance to the Neighborhood Traffic Committee. Funding must be secured for planning, design, construction and project monitoring for a successful traffic calming program to be maintained. Funding sources available for Traffic Calming projects may include the following:

- Federal and State Funds as appropriated through the Delaware Department of Transportation Capital Improvement Program.
- Suburban Street Funds
- Local/Municipal Funds
- Developer Contributions
- Private/Community Contributions
- A Combination of Funding Sources

Currently, the Department has allocated funding under the Intermodal/Multimodal Transportation Improvements Program in the Capital Improvement Program to fund traffic calming projects throughout the State. The Department will fund or assist in funding traffic calming projects on roads appropriate for those measures, including subdivision streets. Proposed projects on subdivision streets must have local legislator support prior to consideration, in the form of funding contributions from their allocation of the Suburban Street Funds.

Suburban Street Funds are funds allocated to the State's legislators that are applied to transportation projects normally within their particular districts. These funds are often applied to maintenance or improvement of subdivision streets. Legislators may use Suburban Street Funds to pay for or assist in paying for traffic calming measures.

It will be possible for counties and other municipalities to fund projects within their jurisdictions if they wish to assist in the development of a given project. Such funding may augment or be in lieu of State or Federal funding.

Developers may choose to incorporate traffic calming measures into the design of their projects, or be requested by the

Department, through the approval process, to include such measures.

Communities or individuals may contribute private funds to assist in the construction of Traffic Calming measures in their communities. However, such funding will not be a consideration when establishing project priorities.

Aside from the mechanics of the funding source, other matters must be considered when funding a project. For example, projects must be reviewed for need, viability, and duplication of projects or project goals. Besides these items, the projects must compete with other projects to establish funding priorities. These funding concerns, when combined with the planning process, design and right-of-way acquisition, construction and system monitoring, make up the primary elements of what is referred to as the pipeline process.

CHAPTER III APPROPRIATE APPLICATIONS

Traffic calming involves, first, identifying the nature of traffic problems on a given street or in a given area, and then, selecting traffic calming measures capable of solving identified problems. The measures come from a toolbox of possibilities. If the problem is cut-through traffic on local streets, one set of measures may be indicated. If the problem is speeding on streets whose abutting uses are adversely affected, another set may be indicated. If the problem is a high rate of collisions, a third set may be indicated.

The process of selecting appropriate tools is described in Chapter 11. This chapter specifies which traffic calming measures are eligible for use on Delaware streets of different types with different traffic characteristics. The resulting *Application Matrix* is meant to be advisory only. It does not constitute a set of warrants or minimum requirements, but rather a set of recommendations which can be overridden in specific cases by engineering judgment.

1. DELAWARE'S TOOLBOX OF TRAFFIC CALMING MEASURES

Schematic plans and photographic examples of different measures are presented in Figures III-1 through III-18. This set of measures constitutes Delaware's traffic calming toolbox.

1.1. Volume Control Measures

Full street closures are barriers placed across a street to completely close the street to through-traffic, usually leaving only sidewalks open. They are also called *cul-de-sacs* or *dead-ends*. The barriers may consist of landscaped islands, walls, gates, side-by-side bollards, or any other obstructions that leave an opening smaller than the width of a passenger car. They will be allowed on Delaware streets only on an exception basis, if other volume control measures prove inadequate.

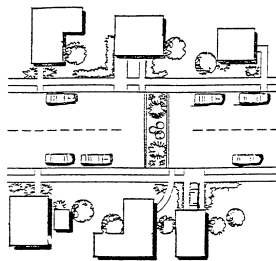

FIGURE III-1. FULL CLOSURES

Half closures are barriers that block travel in one direction for a short distance on otherwise two-way streets. They are also sometimes called *partial closures* or *one-way closures*. When two half closures are placed across from one another at an intersection, the result is a *semi-diverter* that blocks through movement on a cross street.

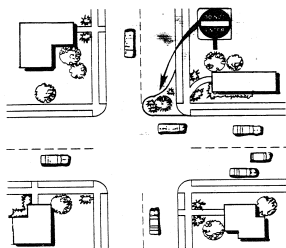

FIGURE III-2. HALF CLOSURES

Diagonal diverters are barriers placed diagonally across an intersection, blocking through movement. They are also called *full diverters* and *diagonal road closures*. *Median barriers* are raised islands located along the centerline of a street and continuing through an intersection so as to block through movement at a cross street. They are also referred to as *median diverters* or occasionally as *island diverters*. *Forced turn islands* are raised islands on approaches to an intersection that block certain movements. They are sometimes called *forced turn channelizations*, *pork chops*, or in their most common incarnation, *right turn islands*.

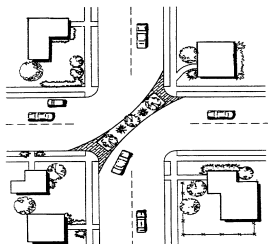

FIGURE III-3. DIAGONAL DIVERTERS

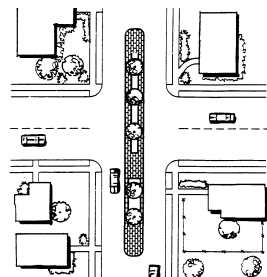

FIGURE III-4. MEDIAN BARRIERS

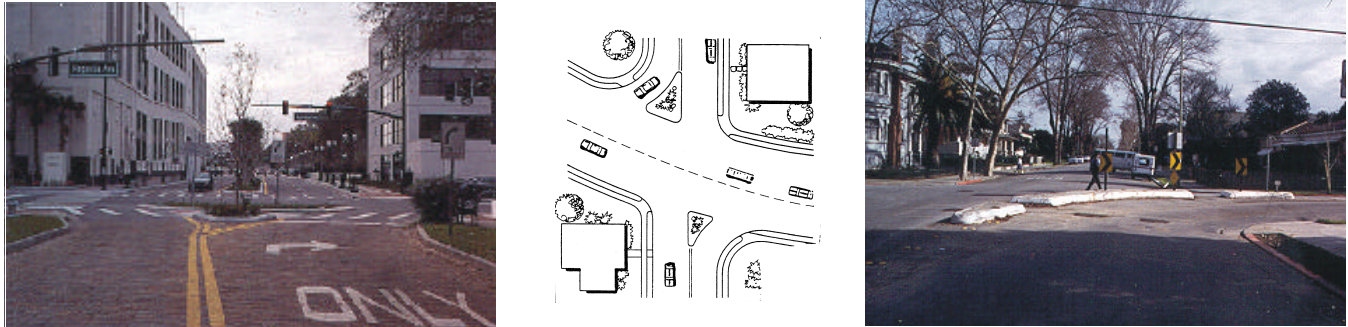

FIGURE III-5. FORCED TURN ISLANDS

1.2. Speed Control Using Vertical Measures

Speed humps are rounded raised areas placed across the road. They are also referred to as *undulations*. The standard or Watts profile hump, developed and tested by Britain's Transport and Road Research Laboratory, is the most common speed control measure in the U.S. It is the only speed control measure, at present, for which ITE provides design and application guidance.

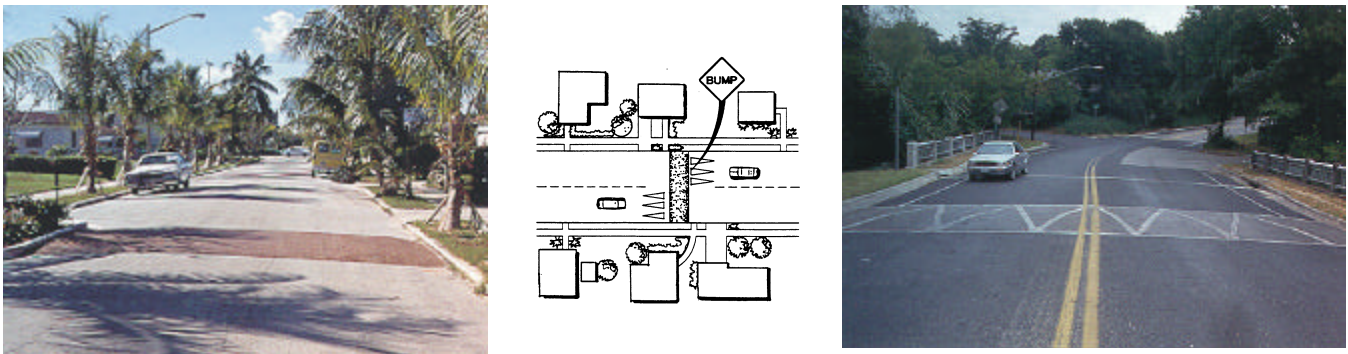

FIGURE III-6. SPEED HUMPS

Speed tables are flat-topped speed humps often constructed with a brick or other textured materials on the flat section. They are also called *trapezoidal humps*, *plateaus*, and if marked for pedestrian crossing, *raised crossings* or *raised crosswalks*. Speed tables are typically long enough for the entire wheelbase of a passenger car to rest on top. Their long flat fields give speed tables higher design speeds than humps.

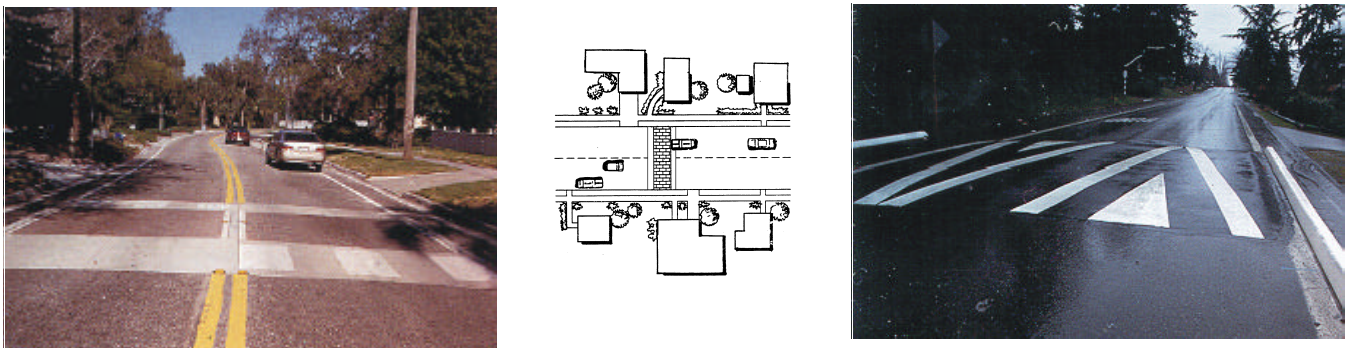

FIGURE III-7. SPEED TABLES

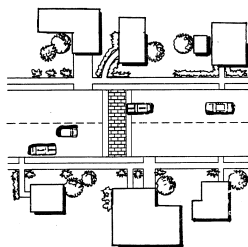

FIGURE III-8. RAISED CROSSWALKS

Raised intersections are flat raised areas covering entire intersections, with ramps on all approaches and often with brick or other textured materials on the flat section. They are also called *raised junctions* or *intersection humps*. They usually rise to sidewalk level, or slightly below to provide a "lip" for the visually impaired. They make entire intersections, crosswalks and all, pedestrian territory.

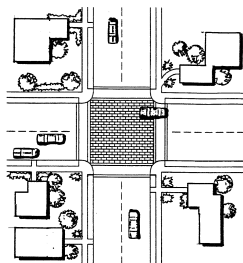

FIGURE III-9. RAISED INTERSECTIONS

1.3. Speed Control Using Horizontal Measures

Mini-traffic circles are raised islands, placed in intersections, around which traffic circulates. They are sometimes called *intersection islands*. They are usually circular in shape, though not always, and are usually landscaped in their center islands, though not always. They often have outer rings (called truck aprons) or conical shapes (with "lips") that are mountable so large vehicles can circumnavigate their small curb radii.

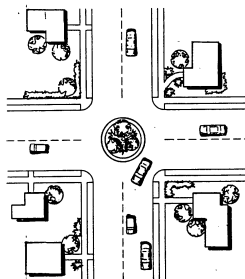
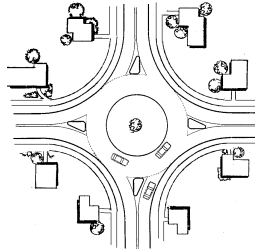
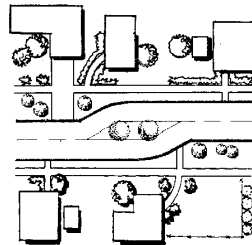

FIGURE III-10. MINI-TRAFFIC CIRCLES

Roundabouts, similar to mini-traffic circles in that traffic circulates around center islands, are used at higher volume intersections to allocate right-of-way among competing movements. Roundabouts in the U.S. are found primarily on arterial and collector streets, often substituting for traffic signals or all-way stops. They are larger than mini-traffic circles, are designed for higher speeds, and have raised splitter islands to channel approaching traffic to the right.

**FIGURE III-11. ROUNDABOUTS**

Lateral shifts are curb extensions on otherwise straight streets that cause travel lanes to bend one way and then bend back the other way in the original direction of travel. They are occasionally referred to as *axial shifts*, *staggerings*, or *jogs*. Lateral shifts, with just the right degree of horizontal curvature, are one of the few measures that can be used on collectors or even arterials, where high traffic volumes and high posted speeds preclude more abrupt measures.

**FIGURE III-12. LATERAL SHIFTS**

Chicanes are curb extensions that alternate from one side of the street to other forming s-shaped curves. They are also referred to as *deviations*, *serpentes*, and *reversing curves*. *Realigned intersections* are changes in alignment that convert T-intersections with straight approaches into curving streets meeting at right angles. A straight shot along the top of the T becomes a turning movement. Realigned intersections are sometimes called *modified intersections*.

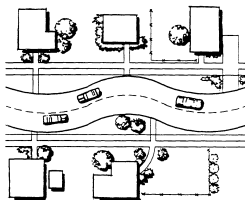
**FIGURE III-13. CHICANES**

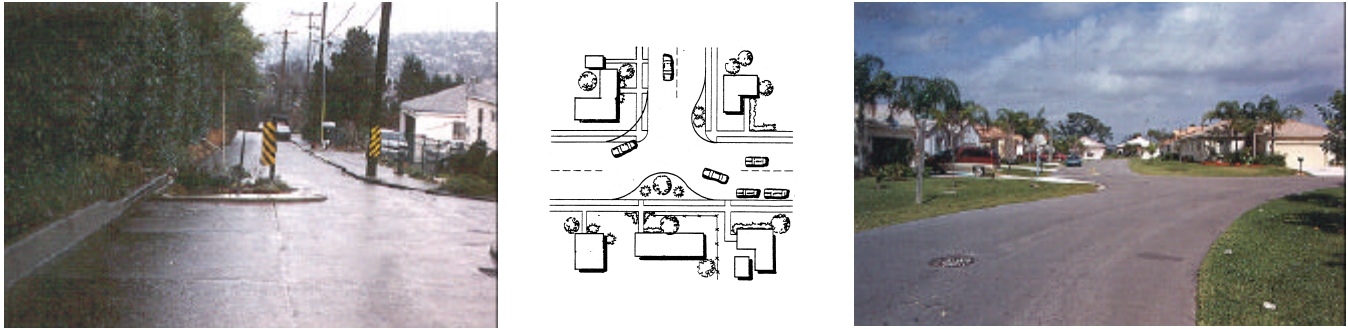

FIGURE III-14. REALIGNED INTERSECTIONS

1.4. Narrowings

Neckdowns are curb extensions at intersections that reduce roadway width curb-to-curb. They are sometimes called *nubs*, *bulbouts*, *knuckles*, or *intersection narrowings*. If coupled with crosswalks, they are referred to as *safe crosses*. Placed at the entrance to a neighborhood, often with textured paving between them, they are called *gateways*. Their effect on vehicle speeds is limited by the absence of pronounced vertical or horizontal deflection. Instead, their primary purpose is to "pedestrianize" intersections.

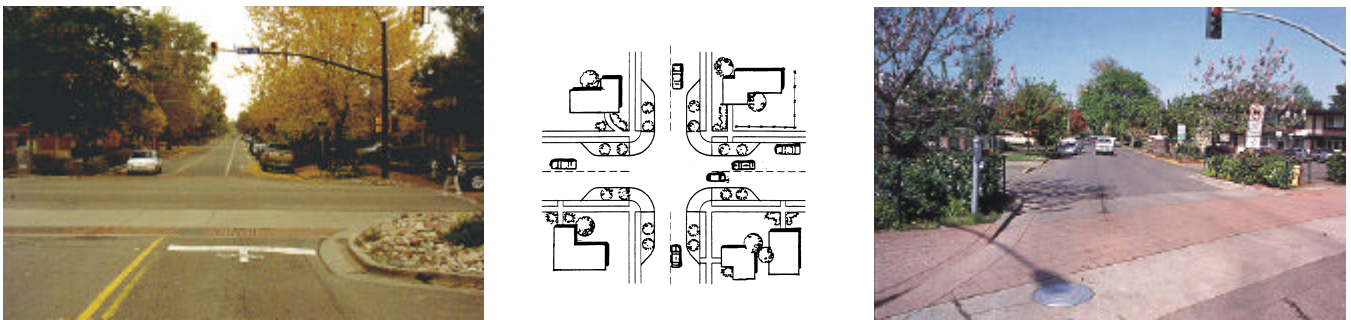

FIGURE III-15. NECKDOWNS

Chokers are curb extensions or edge islands at midblock that narrow a street at that location. In different configurations, they are called *midblock narrowings*, *midblock yield points*, and *pinch points*. If marked as crosswalks, they are also called *safe crosses*. Chokers can leave the street cross section with two lanes, albeit narrower lanes than before, or take it down to one lane. In Delaware, only two-lane chokers are permitted on two-way streets.

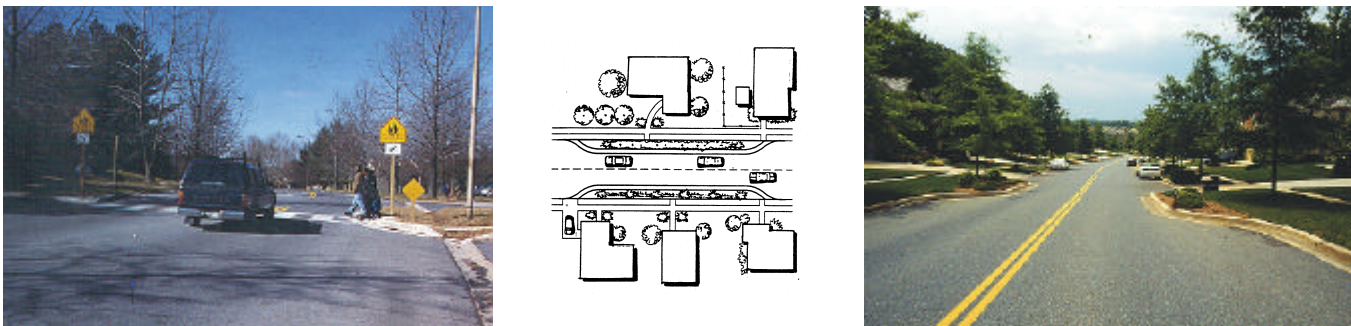

FIGURE III-16. TWO-LANE CHOKERS

Center islands are raised islands located along the centerline of a street that narrow the street at that location. They are also called *midblock medians*, *median slow points*, and *median chokers*. Placed at the entrance to a neighborhood, often with textured paving on either side, they are called *gateways*. They may be nicely landscaped to provide visual amenity and neighborhood identification as well as modest speed reduction.

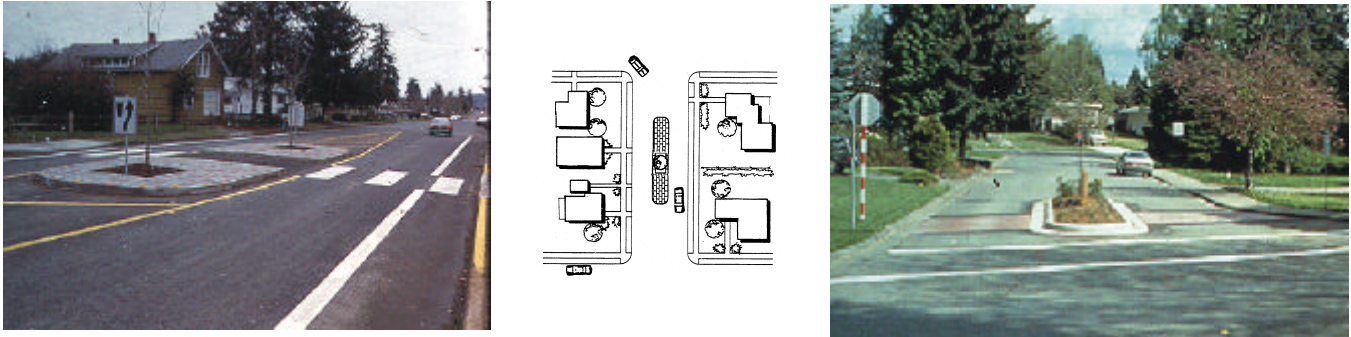

FIGURE III-17. CENTER ISLANDS

1.5. Combined Measures

The search for the optimal traffic calming measure may lead to various combinations of measures at single slow points. A standard traffic circle cannot control speeds on the top of a T-intersection, so curb extensions may be added on the approaches to achieve some horizontal deflection. A choker cannot control speeds in the absence of opposing traffic, so speed humps may be added in the gap between the curb extensions. Individual measures can be combined in any number of ways (two of are illustrated in Figure III-18).

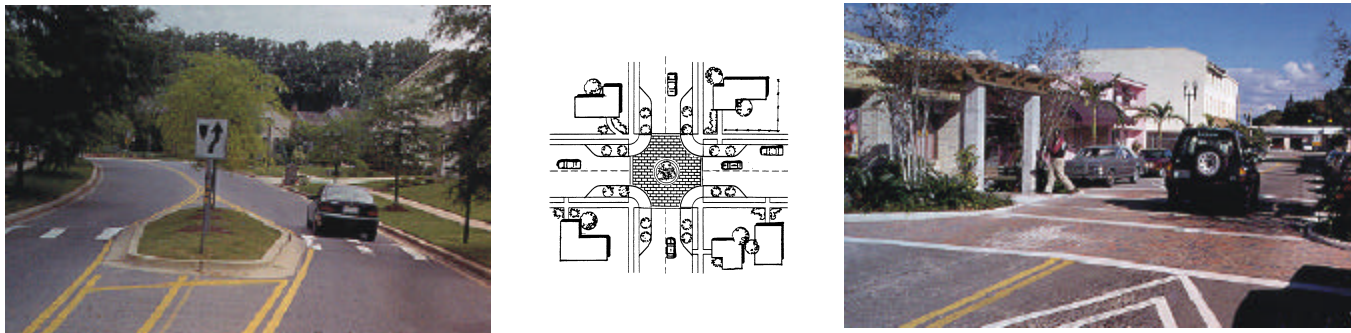

FIGURE III-18. COMBINED MEASURES

2. IMPACTS OF TRAFFIC CALMING MEASURES

As noted in the introduction to this chapter, traffic calming involves matching engineering measures to specific traffic problems. From the toolbox of measures just described, the Department attempts to choose the most cost-effective and conservative measure that will do the job.

To assist in this choice, this section summarizes speed, volume, and collision impacts of different traffic calming measures. Impact data are taken from ITE's *Traffic Calming State-of-the-Practice*, which draws on before-and-after studies to derive average values and standard deviations. The speeds reported are midpoint speeds after traffic calming. Collision impacts are reported with and without adjustments for decreases in traffic volumes after traffic calming measures are installed. On average, the different traffic calming measures all reduce speeds, volumes, and collisions. However, only certain measures do so to a statistically significant degree.

Sample averages, while no substitute for detailed analyses of proposed treatments, can be used to initially screen traffic calming measures for further considerations.

TABLE III-1. SPEED IMPACTS OF TRAFFIC CALMING MEASURES

	Sample Size	Average Speed After Traffic Calming (standard deviation from the average)	Average Change in Speed with Traffic Calming (standard deviation from the average)	Average % Change in Speed with Traffic Calming (standard deviation from the average)
14' Humps	15	25.6 (2.1)	-7.7 (2.1)	-23 (6)
22' Tables	58	30.1 (7.7)	-6.6 (3.7)	-18 (8)
Raised Intersections	3	34.3 (6.0)	-.3 (3.8)	-1 (10)
Mini-Circles	45	30.2 (4.3)	-3.9 (3.2)	-11 (10)
Narrowings	7	32.3 (2.8)	-2.6 (5.5)	-4 (22)
Half Closures	16	26.3 (5.2)	-6.0 (3.6)	-19 (11)
Diagonal Diverters	7	27.9 (5.2)	-1.4 (4.7)	-0 (17)

TABLE III-2. VOLUME IMPACTS OF TRAFFIC CALMING MEASURES

	Sample Size	Average Change in Volume with Traffic Calming (standard deviation from the average)	Average % Change in Volume with Traffic Calming (standard deviation from the average)
14' Humps	15	-529 (741)	-22 (26)
22' Tables	46	-415 (649)	-12 (20)
Circles	49	-293 (584)	-5 (46)
Narrowings	11	-263 (2178)	-10 (51)
Full Closures	19	-671 (786)	-44 (36)
Half Closures	53	-1611 (2444)	-42 (41)
Diagonal Diverters	47	-501 (622)	-35 (46)
Other Volume Controls	10	-1167 (1781)	-31 (36)

TABLE III-3. COLLISION IMPACTS OF TRAFFIC CALMING MEASURES

	Number of Observations	Average Number of Collisions Before/After Treatment	% Change in Collisions Before->After Treatment	t-statistic (significance level) Two-tailed test
14' Humps	5	4.4/2.6	-41%	-1.6 (.18)
22' Tables	8	6.7/3.7	-45%	-4.1 (.005)

Circles without Seattle	17	5.9/4.2	-29%	-2.2 (.04)
with Seattle	130	2.2/.6	-73%	-10.8 (.001)
All Measures without adjustments	192	2.6/1.3	-50%	-8.6 (.001)
with adjustments	42	3.8/3.0	-21%	-2.3 (.04)

3. APPLICATION GUIDELINES

Application guidelines have been formulated for use in Delaware (see Table III-4). These guidelines ordinarily apply to:

- Streets and highways within Delaware's *existing urban centers*; and
- Streets and highways within Delaware's *master planned communities* and *residential subdivisions*.

Other areas of the state are ordinarily not appropriate for physical traffic calming measures. In such areas, pedestrian and bicycle traffic is light, buildings are usually set well back from the street, and posted speeds are high. The common purposes of traffic calming (see Chapter I) do not apply. In such areas, any modification of driver behavior typically is accomplished via police enforcement, education, streetscaping, or other non-physical measures.

3.1 Relationship to Roadway Functional Classification

Moving down the roadway functional hierarchy in Delaware, from arterials that mainly serve through traffic to local roads and subdivision streets that mainly serve local traffic, the set of appropriate traffic calming measures expands.

At this point in the United States, traffic calming programs are heavily focused on local residential streets. Applications seldom extend up the functional hierarchy beyond minor arterials, and seldom apply to nonresidential streets other than those serving as main shopping streets. Hence in Delaware, traffic calming is recommended only for minor arterials and below.

3.2 Relationship to Traffic Volumes and Speeds

The guidelines establish maximum volumes and posted speeds for different measures (see Table III-4). Beyond these volumes and speeds, it becomes difficult to justify the use of measures from a traffic safety and/or traffic efficiency standpoint. The guidelines for posted speeds refer to the speed limits on the streets themselves. Lower advisory speeds may be posted approaching traffic calming measures.

There are no minimum traffic volumes or speeds for any of these measures. Rather, the Department has adopted a priority rating system (see Chapter II) that gives weight to traffic volumes and speeds, along with other factors, in deciding which projects most warrant funding.

TABLE III-4 APPLICATION GUIDELINES

	FHWA/DELDOT FUNCTION CLASSIFICATIONS						SUBDIVISION STREETS			Other Restrictions
	Interstates Freeways Expressways	Principal Arterials	Minor Arterials	Major Collectors	Minor Collectors	Local Roads	Major Collector Subdivision Streets	Minor Collector Subdivision Streets	Minor Streets	
Volume Control Measures										
Full Closure Half Closure	Not Recommended					Only on an exception basis.	Not Recommended		≥500 vpd ≥25% non-local traffic	
Diagonal Diverter Median Barriers Forced Turn Islands	Not Recommended					≤5,000 vpd ≥25% non- local traffic	Not Recommended		≥500 vpd ≥25% non-local traffic	
Vertical Speed Control Measures										
Speed Humps	Not Recommended					Only on an exception basis.	Daily volume ≤3,000 Posted speed ≤30 mph			grade ≤8% not on primary emergency routes or bus routes
Speed Tables Raised Crosswalks Raised Intersections	Not Recommended		Daily volume ≤ 10,000 vpd				posted speed ≤ 35mph			grade ≤8% not on primary emergency routes
Horizontal Speed Control Measures										
Mini-traffic Circles	Not Recommended					Combined approaches - daily volume ≤ 5,000 vpd posted speed ≤ 35mph				grade ≤10% not on primary emergency routes or bus routes
Roundabouts	Not Recommended		Combined approaches - daily volume ≤ 20,000 vpd				posted speed ≤45mph		Not Recommended	grade ≤6%
Lateral Shifts	Not Recommended		≤10,000 vpd				posted speed ≤35mph			
Chicanes	Not Recommended		Daily volume ≤5,000 vpd				posted speed ≤35mph			
Realigned Intersections	Not Recommended						Daily volume ≤5,000 vpd posted speed ≤35mph			grade ≤8%
Narrowings										
Neckdowns Two-Lane Chokers Center Islands	Not Recommended		Daily volume ≤ 20,000 vpd				posted speed ≤ 45mph			
Combined Measures	Not Recommended		Subject to limitations of component measures							

3.3 Summary of Guidelines

Summarizing the guidelines in Table III-4:

- The range of applicable traffic calming measures is greater for lower functional classes, and greatest for subdivision streets.
- Volume control measures are deemed appropriate for subdivision streets only. Even in subdivisions, they have limited application compared to speed control measures.
- In the "right" settings, which means highly urban and pedestrian-oriented, speed control measures may be appropriate even on minor arterials.
- Among speed control measures, speed humps, mini-traffic circles, and chicanes are applicable to the lowest traffic volumes and speeds; speed tables are applicable to intermediate volumes and speeds; and roundabouts, lateral shifts, and narrowings are applicable to somewhat higher volumes and speeds, though not to very highest volume and speed conditions.

**CHAPTER IV
GEOMETRIC DESIGN OF TRAFFIC CALMING MEASURES**

Chapter II outlined procedures for the selection of traffic calming measures. Chapter III specified which measures are acceptable in given applications. This chapter provides guidance on the geometric design of traffic calming measures thus selected.

A typical geometric design is presented for each type of traffic calming measure, and in most cases, the range of acceptable design alternatives is specified.

1. GENERAL GUIDANCE

Geometric design for traffic calming is based primarily on the desired crossing speed at slow points. This is the "design speed" of the slow points themselves. Once this speed is set, appropriate spacing of slow points can be determined based on target speeds midway between such points.

For typical geometric designs, design speeds are as indicated in Sections 3 through 5 of this chapter. For alternative geometric designs, design speeds can be estimated using formulas and tables in Section 6 of this chapter. Midpoint speeds can also be estimated using the formula in Section 6.5.

Ordinarily, crossing speeds at slow points will be no more than *5 mph (8 kph) below* the posted speed limit (though with advisory speed signs, greater differences may be acceptable). Also, as a rule, midpoint speeds will be no more than *5 mph (8 kph) above* the posted speed limit. The speed differential on a given stretch of roadway is thus limited to 10 mph (16 kph) in the interest of traffic safety, noise control, fuel conservation, and driver acceptance.

Geometric design is also based on the dimensions of vehicles in the traffic stream. For most typical designs, a single unit truck is the "design vehicle." Geometrics of slow points are set such that a single unit truck can negotiate them with relative ease (albeit at a lower speed than a passenger car, which has room to spare and can cross slow points at the full design speed).

When a single unit truck is the design vehicle, larger trucks and buses are accommodated in different ways, for example, with mountable overrun areas. While large vehicles will be forced to cross slow points at a crawl speed, this appears reasonable given the relatively few such vehicles using the streets in question-- all minor arterials or below in the functional hierarchy. Freeways and principal arterials, which carry the bulk of the heavy vehicle traffic, are ineligible for traffic calming under *Application Guidelines* in Chapter III.

Landscape plans will be developed in coordination with the Department's Field Services / Roadside Environment Section.

2. VOLUME CONTROL MEASURES**2.1 Full Closures**

Full closures will be permitted on local streets in Delaware only on an exception basis, when other volume control measures have proven inadequate. Given the rarity of such cases, and the fact that turnarounds can be designed in so many ways, no typical design is has been developed for a full street closure.

2.2. Half Closures

The typical half closure has two geometric features designed to encourage compliance with the one-way restriction (see Figure IV-1). First, the curb extension or edge island extends more than a car length along the roadway. Motorists traveling the wrong way through the half closure are doing so for an uncomfortable distance. Second, the curb extension or edge island extends all the way to the centerline of the street, or beyond on a wide street. This leaves a relatively tight opening for wrong-way traffic.

To further enhance compliance with the one-way designation, half closures should be located at intersections. Once through-traffic is already traveling down a street in the restricted direction, there is a strong tendency to continue through a half closure. On an exception basis, the Department will consider half closures at mid-block locations where commercial land uses transition to residential and the commercial uses require unrestricted access in both directions.

Along bicycle routes, the preferred design is a bicycle pass-through lane through the half closure. When bicycle lanes are bordered on both sides by vertical curbs, their channel widths shall be 5 feet (1.5 meters), wide enough to provide clearance for bicyclists but narrow enough to exclude automobiles.

Under the following circumstances, a contraflow bicycle lane may instead be located next to the motor vehicle lane: (1) for aesthetic or other reasons, a half closure is formed by a curb extension rather than an edge island, or (2) for emergency access purposes, a half closure has to have a wider opening in the unrestricted direction. In no case shall the opening be wider than 16 ft (4.9 m). When designed extra wide to accommodate turning emergency vehicles, it may be advisable to have a bicycle contraflow lane to discourage wrong-way movement of motor vehicles.

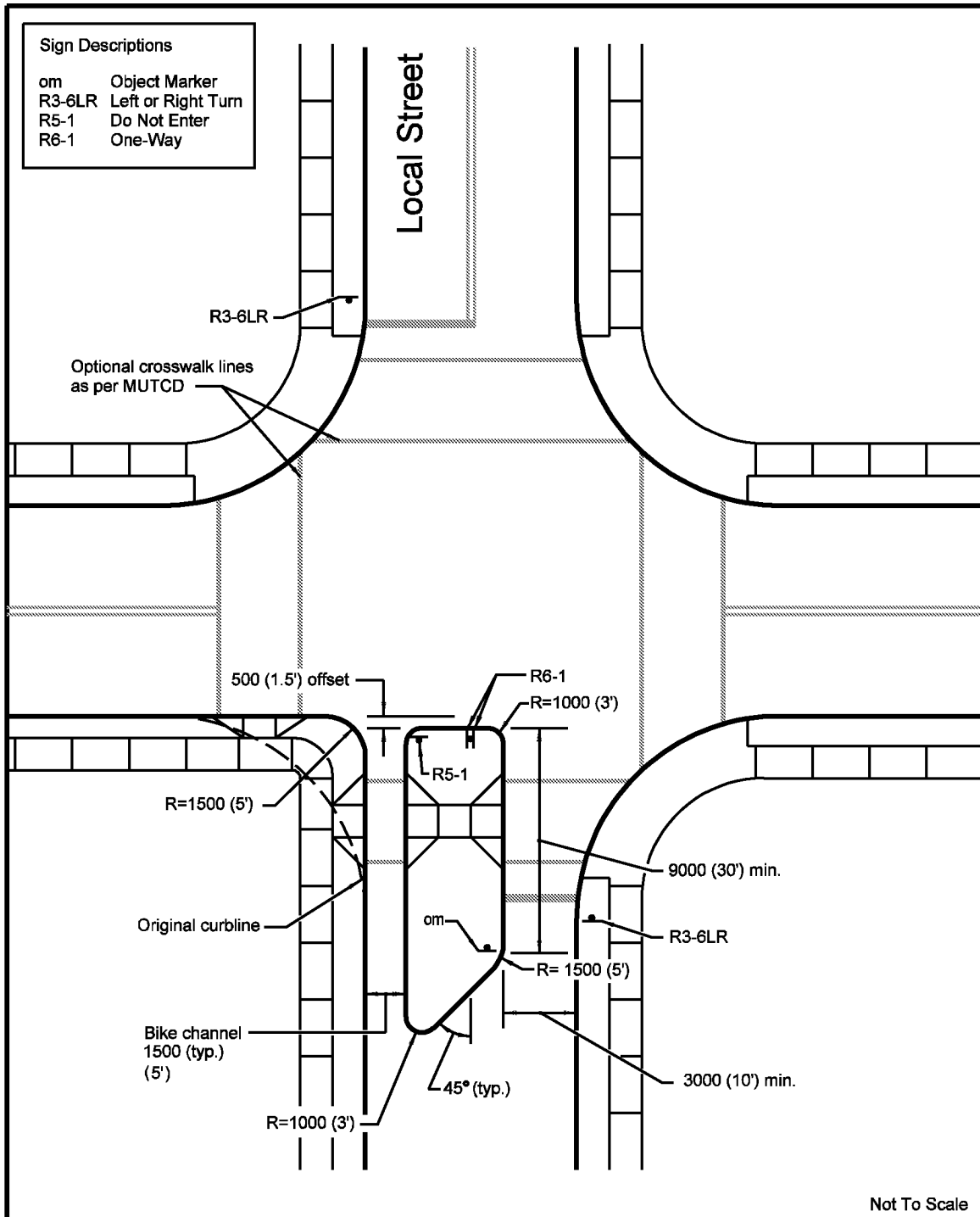

FIGURE IV-1. TYPICAL HALF CLOSURE

2.3. Other Volume Control Measures

Diagonal diverters, median barriers, and forced turn islands are also authorized for use in Delaware, subject to *Application Guidelines* in Chapter III. They present few design issues, as they are simple barriers blocking one or more movements at an intersection. The Delaware typical designs (Figures IV-2 through IV-4) have the following features:

(1) Diagonal diverters, median barriers, and forced turn islands will have clear widths sufficient for single-unit trucks to make turns at treated intersections without encroaching into opposing lanes.

(2) Diagonal diverters and median barriers will have openings 5 ft (1.5 m) wide, sufficient for bicyclists to pass through barriers but not for motorists to do so. Alternatively, diagonal diverters may have curb ramps up to the sidewalk at the corners. Such ramps must meet the Americans with Disabilities Act (ADA) Standards for Accessible Design, 28 CFR Part 36, Appendix A.

(3) Diagonal diverters and median barriers will be landscaped for aesthetic reasons and also to reinforce the idea that barriers are not to be traversed. On an exception basis, bollards may be used instead of landscape materials. Where traversal by emergency vehicles is anticipated, a clear width of at least 10 ft (3 m) shall be left free of landscaping and bollards.

(4) Diagonal diverters and median barriers will have barrier-type curbs to discourage unauthorized vehicles from traversing them. Curb heights as low as 6 inches (155 mm), less than Delaware's barrier curb, may be used to allow emergency vehicles to mount and cross barriers without encouraging the same by private vehicles.

(5) Forced turn islands will be sharply angled toward the right on the approach to discourage wrong-way movement. At pedestrian crossing points, islands shall either have pedestrian cut-throughs at grade or ADA-compliant ramps and plateau. See Section 5.2 for ADA requirements with respect to traffic islands.

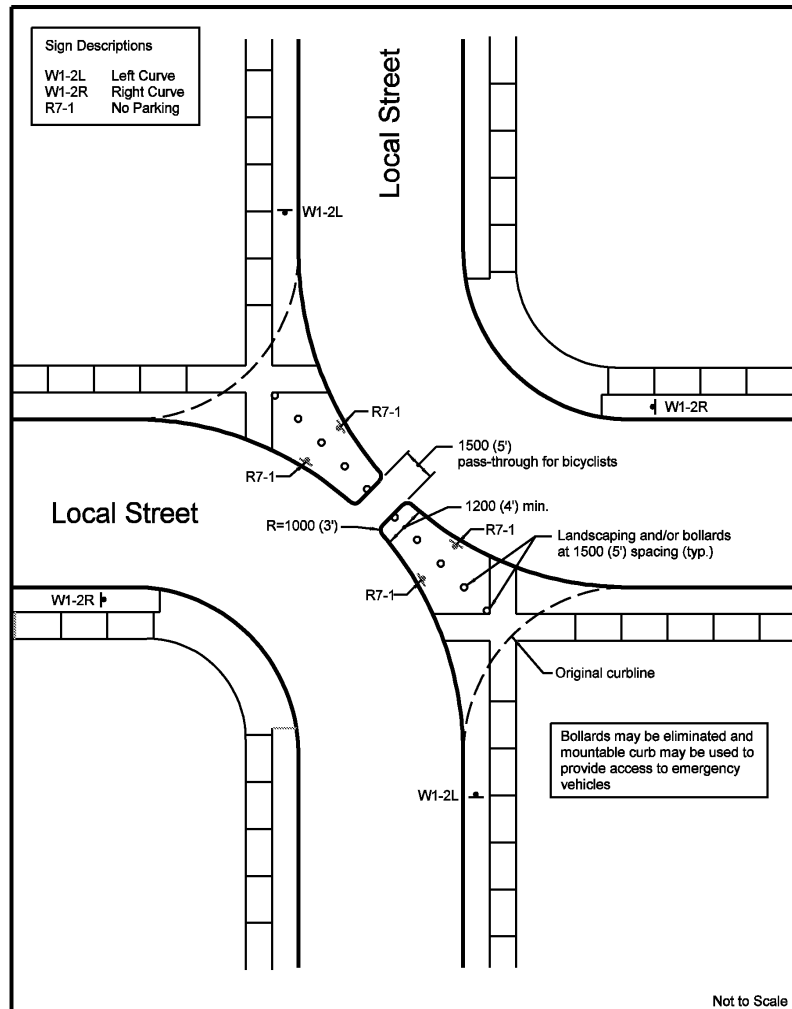

FIGURE IV-2. TYPICAL DIAGONAL DIVERTER

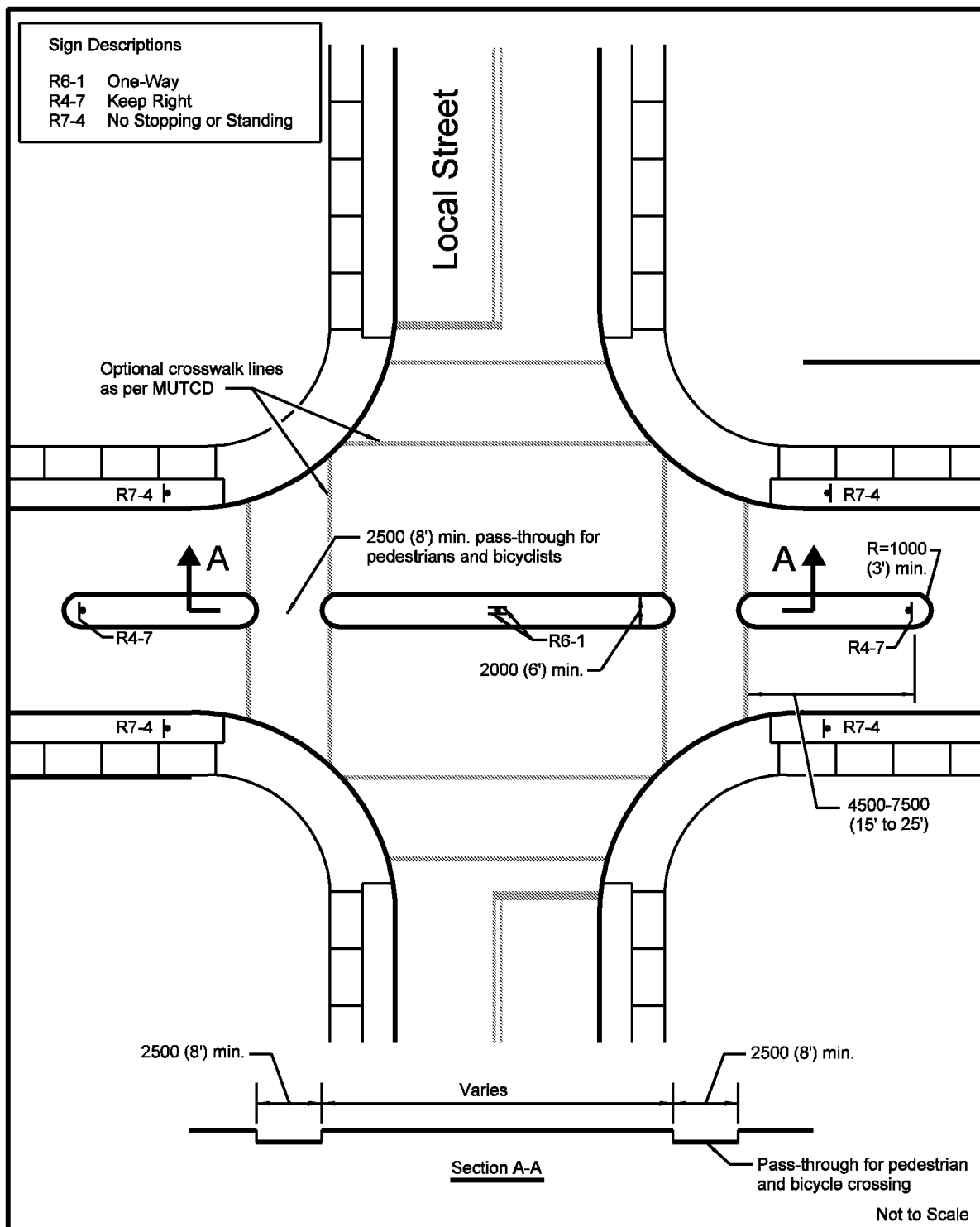

FIGURE IV-3. TYPICAL MEDIAN BARRIER

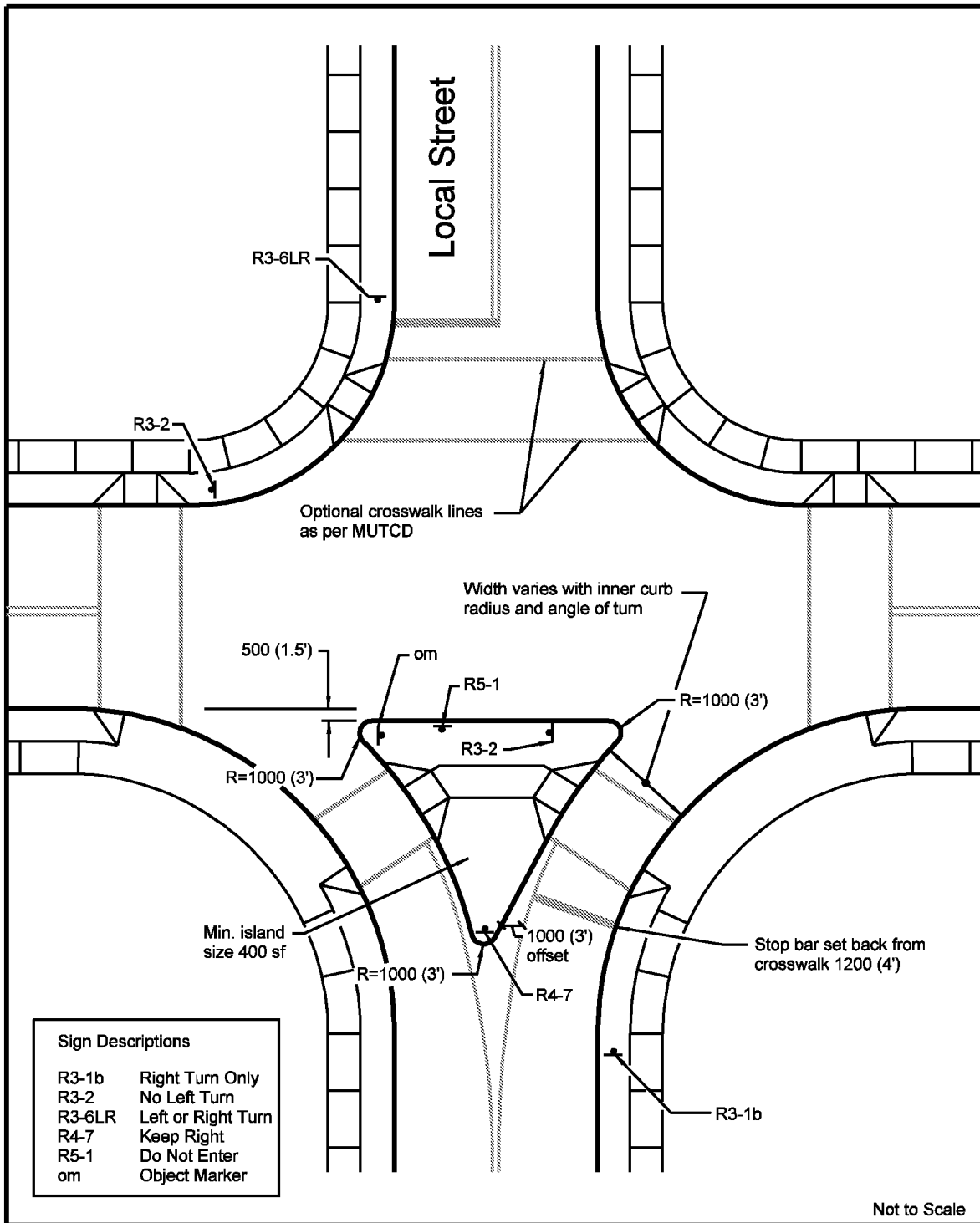

FIGURE IV-4. TYPICAL FORCED TURN ISLAND

3. SPEED CONTROL USING VERTICAL MEASURES

3.1. Speed Humps

The typical speed hump is 3 inches (75 mm) high and 14 ft (4.2 m) long in the direction of travel (see Figure IV-5). Its ramps are parabolic in shape. Its sides taper off at the gutter. It is made of asphalt, though brick is used outside the U.S., stamped asphalt is used occasionally in U.S., and rubber or thermoplastic is used for temporary (movable) humps.

The typical hump has a design speed of 25 mph (40 kph). This speed is safe and comfortable for automobiles. Larger vehicles have to cross the hump at lower speeds. The 14-ft (4.2-m) hump was chosen over the more common 12-ft (3.6-m) hump due to its slightly higher design speed and smoother ride for emergency vehicles.

On an exception basis, the Department will consider requests for humps with other profiles. To achieve particular crossing speeds, humps may range from 2 to 4 inches high (50 to 100 mm). Less than 2 inches (50 mm) produces little speed reduction, and more than 4 inches (100 mm) greatly increases the risk of grounding.

On an exception basis, humps may be shorter or longer than the typical design, though no shorter than 6 ft (1.8 m) in the direction of travel. If shorter, humps begin to function like speed bumps; vertical acceleration of the chassis and resulting discomfort are actually less at high than low speeds, encouraging motorists to speed.

Also, on an exception basis, ramps may be sinusoidal rather than parabolic in shape. The sinusoidal hump is bell-shaped rather than rounded at its ends. Because the initial rise is slower, sinusoidal humps produce a smoother ride for bicycles. Snow clearance may also be facilitated by the sinusoidal profile.

Finally, on an exception basis, the Department may allow humps that taper off before the gutter, forming a bicycle channel 4 ft (1.2 m) wide. This practice has the advantage of providing a flat surface for bicyclists but also encourages motorists to encroach into the bicycle channel, riding with one wheel up and the other down.

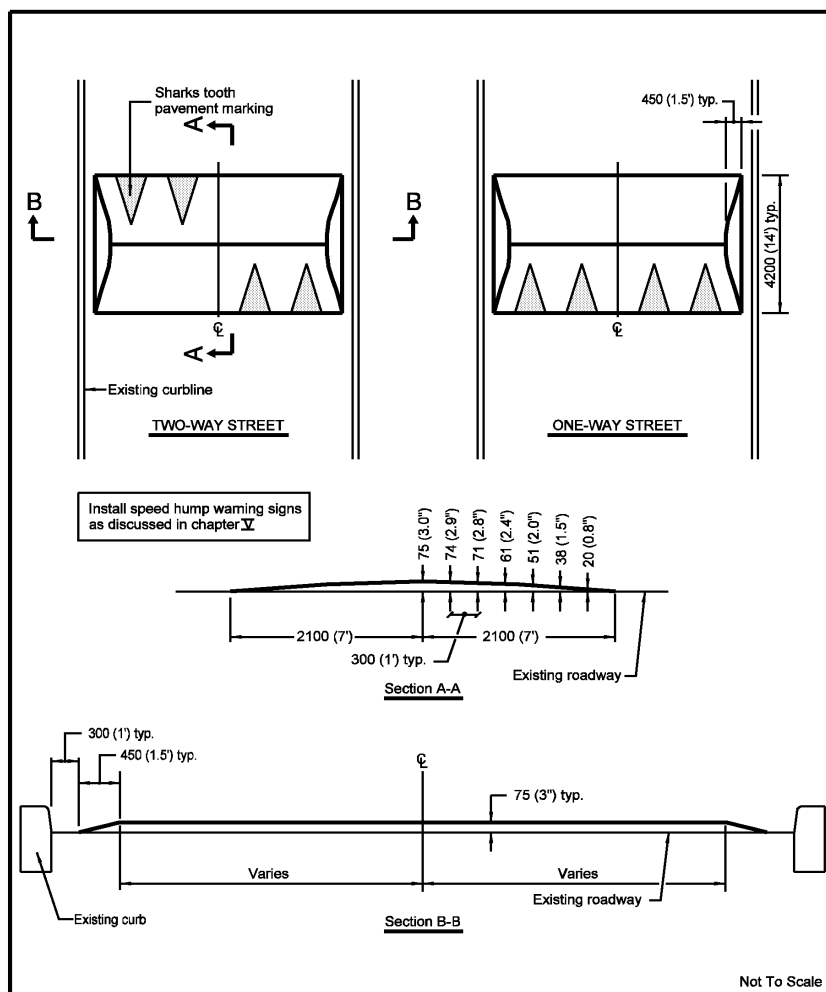

FIGURE IV-5. TYPICAL SPEED BUMP

3.2. Speed Tables

The typical speed table is 3 inches high (75 mm) and 22 ft (6.7 m) long in the direction of travel (see Figure IV-6). The plateau (flat top) is 10 ft (3 m), and each ramp is 6 ft (1.8 m). The plateau is made of asphalt, concrete, brick, concrete paver, stamped asphalt, or other patterned materials. The ramps are parabolic in shape and ordinarily made of asphalt, though concrete, brick, and concrete pavers are also used. The sides taper off at the gutter.

The typical speed table has a design speed of 30 mph (48 kph). This speed is safe and comfortable for automobiles. Larger vehicles have to cross the table at lower speeds.

On an exception basis, the Department will consider requests for tables with other profiles. Ramps may be either sinusoidal or straight (trapezoidal). For straight ramps, slopes should be no steeper than 1:10 nor less steep than 1:25. Slopes in this range render tables safe and effective. On transit and emergency response routes, the lower end of this range (1:25) is preferred.

The plateaus of speed tables may be as short as 8 ft (2.4 m) in the direction of travel. While the Department has established no upper limit on the length of speed tables or raised crosswalks, they tend to lose their effectiveness if more than 50 ft (15 m) long. Plateaus of 20 ft (6 m) or more are recommended to accommodate transit and emergency vehicles so they can cross with all wheels on the flat portion.

All other dimensional requirements for speed humps (as to height, taper, etc.) apply as well to speed tables.

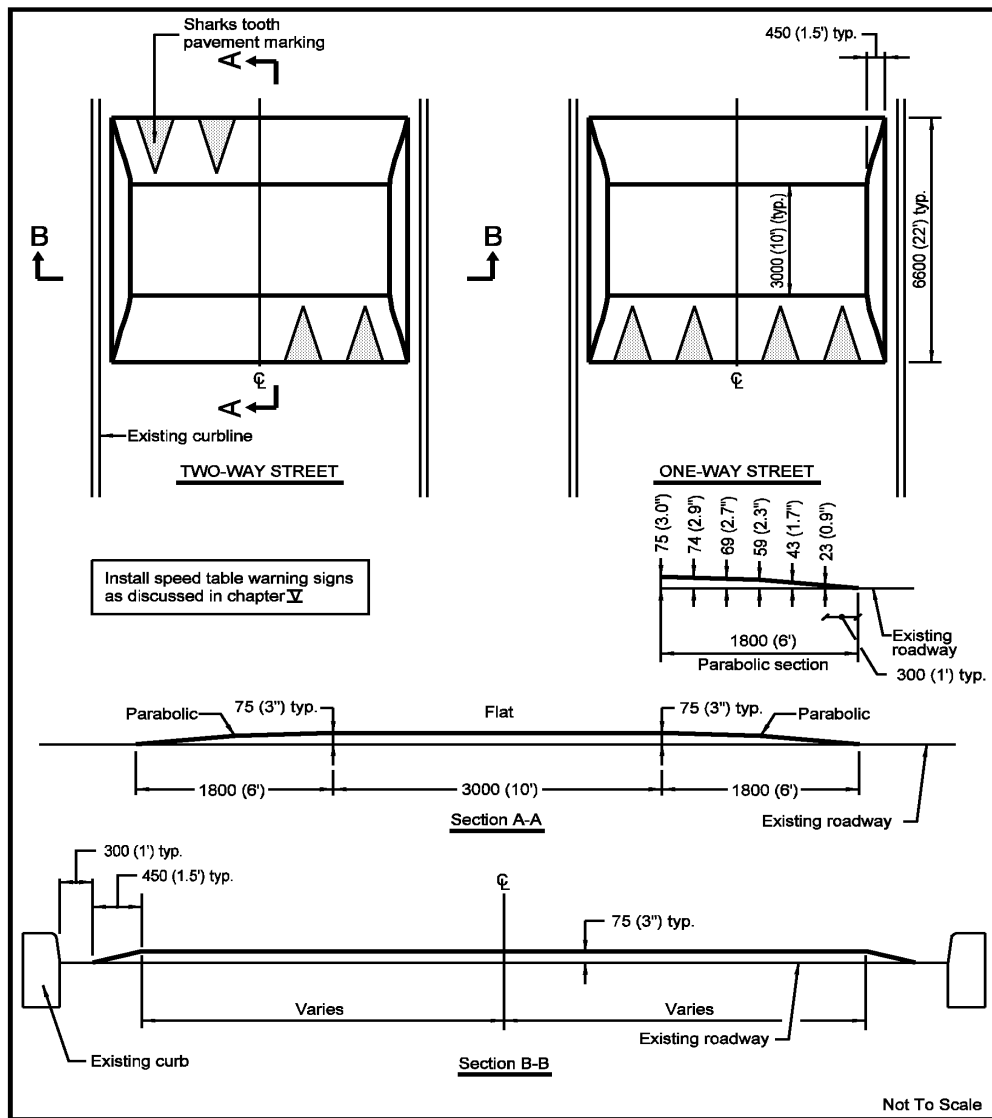

FIGURE IV-6. TYPICAL SPEED TABLE

3.3. Raised Crosswalks and Raised Intersections

A raised crosswalk is a speed table marked and signed for pedestrian crossing (see Figure IV-7). The only geometric differences between the two are: the raised crosswalk extends from *curb to curb* rather than tapering off at the gutter; and the raised crosswalk may be longer and higher than the typical speed table to bring it up to sidewalk level. All other geometric requirements for speed tables apply as well to raised crosswalks.

A raised intersection is a speed table covering an entire intersection (see Figure IV-8). All other geometric requirements for speed tables apply as well to raised intersections.

If built to typical speed table specifications, a raised crosswalk or raised intersection will stop 3 inches (75 mm) short of standard curb height and sidewalk level. The sidewalk must connect to the crosswalk via curb ramps which meet ADA Standards for Accessible Design, 28 CFR Part 36, Appendix A. Alternatively, a raised crosswalk or raised intersection may extend to the sidewalk level. In either case, the visually impaired should be warned at the street edge that they are entering a hazardous area. Such a warning should be provided by means of a tactile surface. This may be supplemented by bollards or other street furniture to protect waiting pedestrians and prevent corner cutting by motorists.

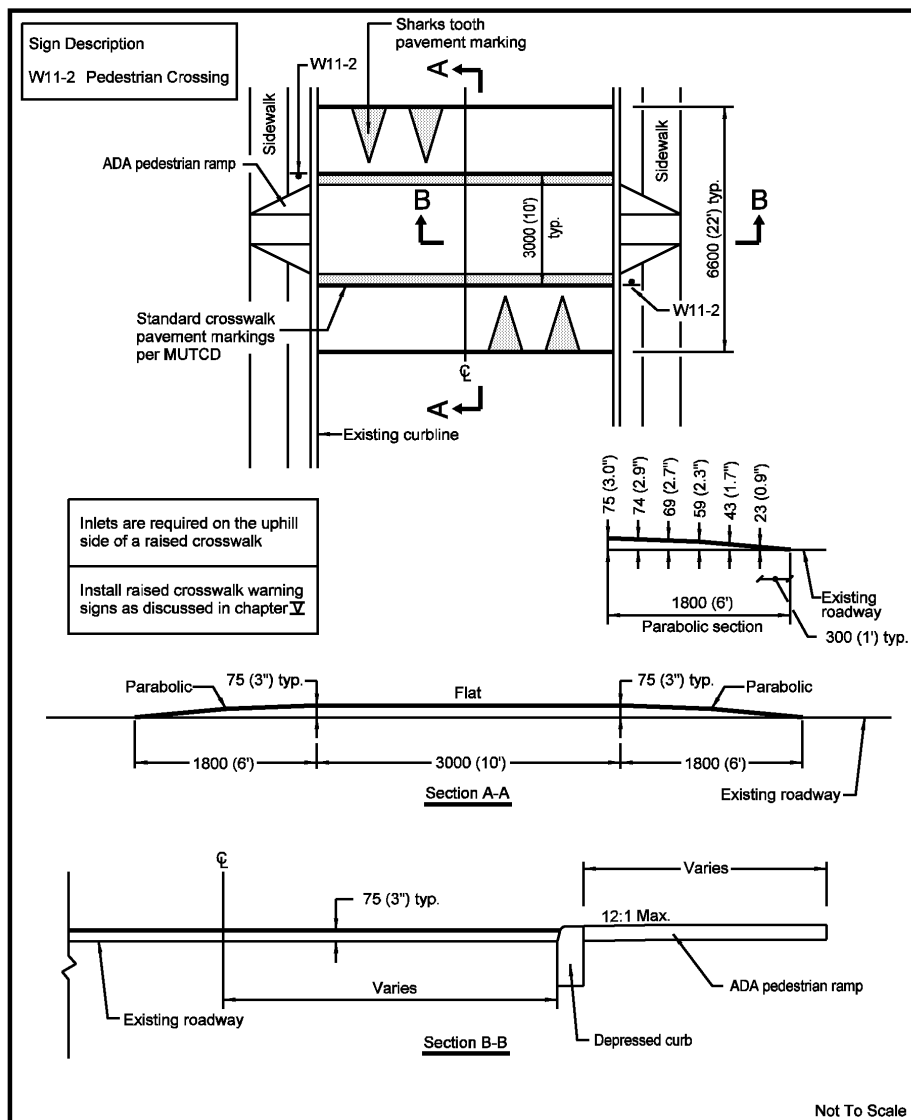

FIGURE IV-7. TYPICAL RAISED CROSSWALK

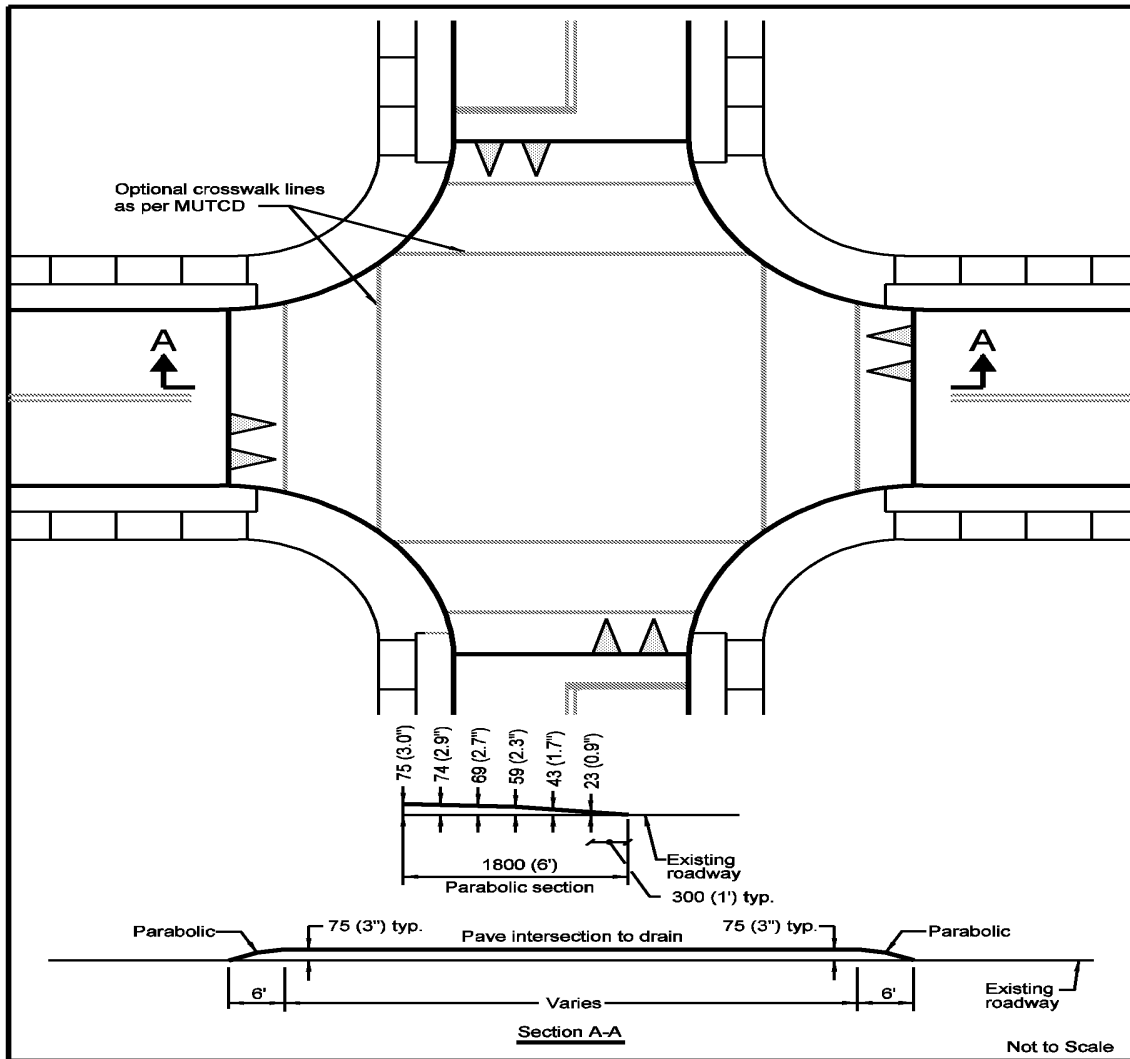

FIGURE IV-8. TYPICAL RAISED INTERSECTION

3.4. Accommodation of Bicyclists

Where cross sectional width is sufficient, the preferred treatment for bicyclists at vertical measures is a bypass lane, separated from the outside travel lane by a raised island to prevent gutter running. When bicycle lanes are bordered on both sides by vertical curbs, their channel widths shall be 5 ft (1.5 m), wide enough to provide clearance for bicyclists but narrow enough to exclude automobiles. Suitability of roadway treatment for bicyclists shall be evaluated for each traffic calming project.

Due to the tendency for gutter running in the absence of edge islands, the next best treatment for bicyclists is to direct them over vertical measures but have tapers on the edges that are gentle enough so they will not lose their balance. Where significant bicycle traffic is anticipated, side slopes on tapers shall be no steeper than 1:6.

The vertical face (i.e., the upstand or lip) on the leading edge of humps, tables, raised crosswalks, and raised intersections shall be no more than 1/4 in (6.5 mm) high to ensure a smooth ride for bicyclists.

3.5. Design Modifications for Hilly Terrain

Vertical speed control measures are ordinarily limited to grades of 8 percent or less. On an exception basis, the Department will consider the use of humps or tables on steeper grades, with appropriate modifications of vertical profiles. On grades of more than 8 percent, ramps must be steeper than normal on the uphill sides of humps or tables, and less steep than normal on the downhill sides (see Figure IV-9). Otherwise, motorists will encounter actual gradients going uphill that are excessive, and going downhill that are ineffectual, increasing the risk of grounding or becoming airborne.

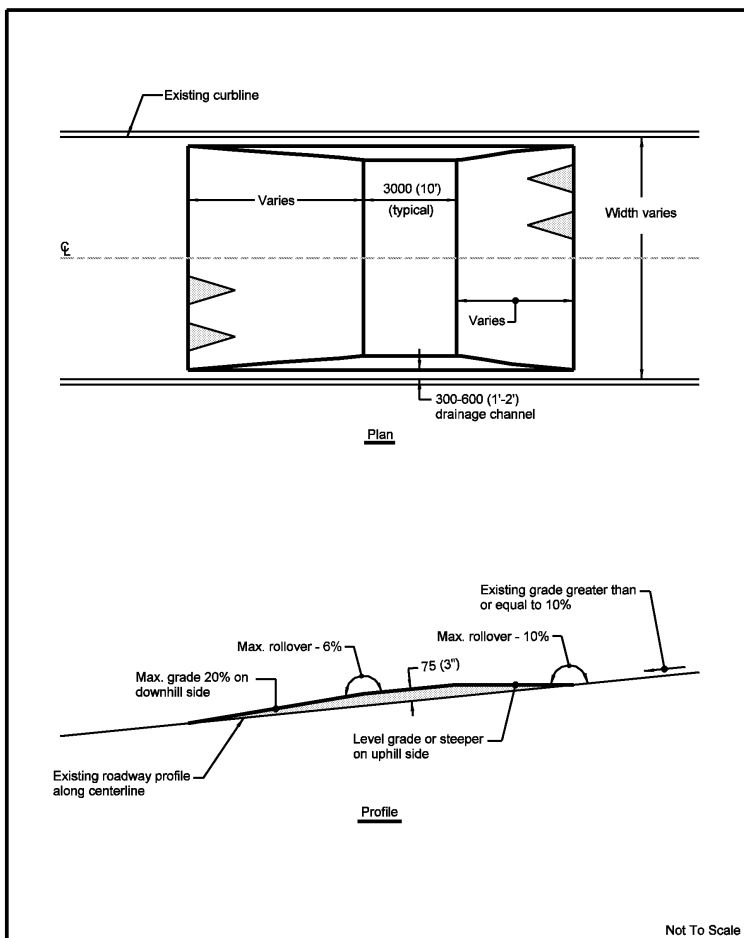

FIGURE IV-9. VERTICAL PROFILE MODIFIED TO BE SAFE AND EFFECTIVE ON A GRADE

4. SPEED CONTROL USING HORIZONTAL MEASURES

4.1. Mini-Traffic Circles

The typical traffic circle is shown in Figure IV-10. The travel path through the intersection has a horizontal curve radius of 95 ft (29 m), yielding a crossing speed of 20 mph (32 kph). See Section 6.2 for derivation. A low design speed was chosen to keep the circle as small as practical.

The design vehicle for the typical mini-circle is a single unit truck. A single-unit truck can pass through a treated intersection without having to mount the center island of the circle. Even though this circle is a relatively large for a neighborhood traffic circle, larger trucks and buses have to mount the center island when passing through a treated intersection, and trucks and buses generally cannot make left turns in prescribed manner, that is, by circulating counterclockwise around the center island.

Most traffic circles, including the typical circle in Figure IV-10, have circular center islands and circular perimeters formed by the intersection corners. Where intersecting streets differ significantly in width, the center island may be elongated to better fit the intersection. An elongated circle consists of half circles with tangent sections between them.

Most traffic circles are deployed at four-way intersections, for this is where the greatest safety benefits accrue. For traffic circles at T-intersections, curbs should be either extended at the entrance and exit to the intersection or indented within the intersection to ensure adequate deflection of vehicle paths along the top of the T.

The typical circle has a center island with two levels: a base that is mountable, and a center that is not. Automobiles and single unit trucks circulate counter-clockwise around the base, experiencing sufficient deflection to hold down their speeds. Large buses and trucks can use the base as an overrun area. If large vehicles are not part of the traffic mix, the center can be expanded and the overrun area reduced to a small mountable lip.

The center island has the cross section shown in Figure IV-11. At 2 inches (50 mm) high, the outer curb is not particularly visible from the driver's angle of view, nor is it protective of landscaping in the center island. Hence the base slopes upward toward the center and transitions into a barrier-type inner curb, 6 inches (150 mm) high, around the landscaped center. To function as an overrun area, the base must be load-bearing and should slope upward at a rate of no more than 1:15.

For aesthetics and attention-getting, the center island should be landscaped. Landscaping should be carefully planned for unrestricted visibility. To preserve sight lines, trees should have clear stem heights of at least 8 ft (2.4 m), and should be no more than 4 inches (100 mm) in diameter to ensure that they break away upon impact. Bushes or shrubs should grow to no more

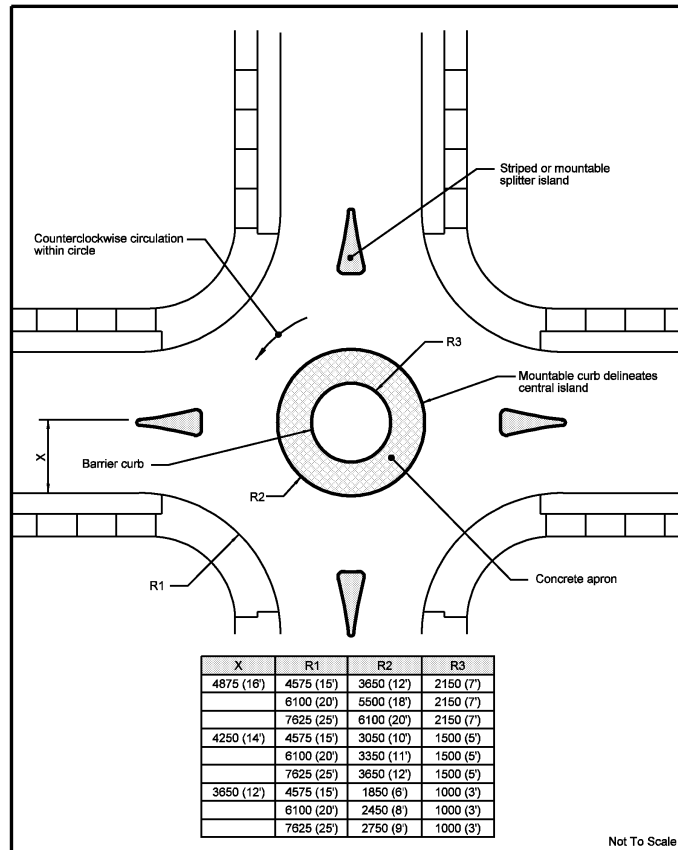

FIGURE IV-10. TYPICAL MINI-TRAFFIC CIRCLE

than 2 ft (0.6 m) height. Groundcover plantings are particularly useful for landscaping of islands because they leave sight lines open and pose no danger to out-of-control drivers.

Finally, for visibility and drainage, the circulating lane will ordinarily slope away from the center island of the traffic circle. A slope of 1 to 2 percent offers these advantages without the risk of heavy vehicles turning over due to reverse superelevation.

On an exception basis only, the Department will consider mini-circles that fit within the curb lines of smaller intersections (Figure IV-12). Left turns are permitted in front of the center island. This alternative will be considered only where two conditions are met: (1) intersection widening is infeasible; and (2) entering volumes are less than 500 vehicles per day (50 vehicles during the peak hour), and still only in rare applications.

For specified street widths and corner radii, center island dimensions for the alternative design are given in Table IV-1. For other widths and corner radii, center island dimensions can be determined from the relationship between offset distances and opening widths.²

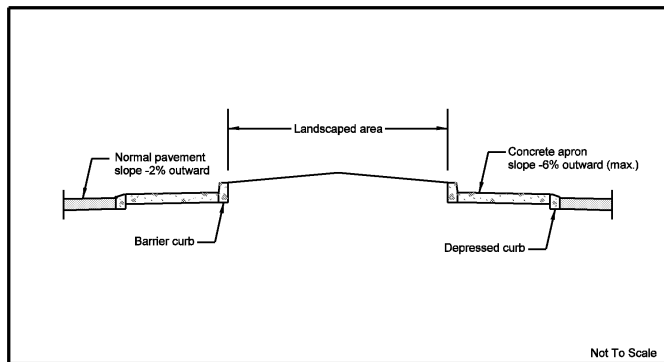

FIGURE IV-11. ISLAND SECTION

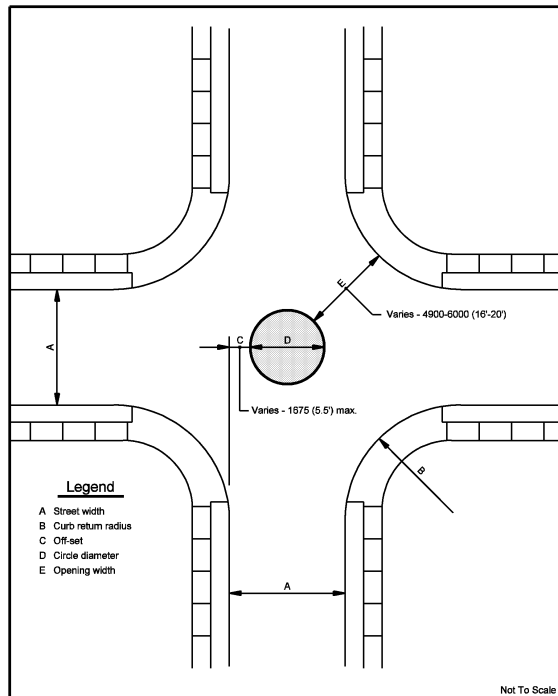

FIGURE IV-12. ALTERNATIVE DESIGN FOR A MINI-CIRCLE

TABLE IV-1. ALTERNATIVE MINI-CIRCLE DIMENSIONS

"A" Street Width	"B" Curb Radius	"C" Offset Distance	"D" Circle Diameter	"E" Opening Width
22'	<14'	reconstruct curbs		
	15	5.5'	11'	16'
	20	4.5	13	18
	25	4.0	15	19
24'	<12	reconstruct curbs		
	15	5.0	14	17
	20	4.5	15	18
	25	3.5	17	20
30'	10	5.5	19	16
	15	5.0	20	17
	20	4.0	22	19
	25	3.0	24	20
32'	10	5.5	21	16
	15	4.5	23	18
	20	4.0	24	19
	25	2.5	27	20

4.2. Roundabouts

Roundabouts are distinguished from traffic circles by larger radii, correspondingly higher design speeds and capacities, and splitter islands on all approaches to slow traffic and discourage wrong-way movements. The typical roundabout is shown in Figure IV-13. In keeping with international practice, it has a design speed of 25 mph (40 kph).

The center island of the typical roundabout extends out 27 ft (8.2 m) from the center. The inner landscaped area has a radius of 21 ft (6.4 m). The outer mountable area (often referred to as a truck apron) has a width of 6 ft (1.8 m). The inscribed circle formed by the splitter islands has a radius of 48 ft (14.6 m). Automobiles and single unit trucks circulate around the center island, whereas buses and semitrailers have to mount the concrete truck apron to negotiate the roundabout. The travel path for automobiles and single unit trucks has a horizontal curve radius of 180 ft (55 m), which combined with 2 percent reverse superelevation, yields a circulating speed of 25 mph (40 kph). See Section 6.2 for derivation.

Roundabout entry and exit curves form the envelope of each splitter island. Pavement markings and a raised island fill the envelope. If pedestrians are anticipated, the raised island should extend at least 30 ft (9 m) from the intersection. The pedestrian crossing point should be set back 20 ft (6 m), or one car length, from the yield line so pedestrians can cross behind waiting cars. The pedestrian crossing point should be marked as a crosswalk. A cut-through flush with the pavement will allow pedestrians to cross at grade (see Section 5.2 for ADA requirements). If minimal pedestrian traffic is anticipated, shorter splitter islands will be permitted.

Other relevant geometric features of the typical roundabout include:

- (1) Entry lanes flare on approaches to widths of 11 to 15 ft (3.4 to 4.6 m) at yield lines.
- (2) Entry radii are tangential to the center island.
- (3) Entry radii are smaller than the curved paths followed by vehicles traveling through the intersection.
- (4) Circulating lane widths are between 1.0 and 1.2 times maximum entry lane widths.
- (5) Exit radii are large, with straight paths preferred, to allow vehicles to accelerate as they exit. The exception is when an exit has a pedestrian crossing. In this case, a smaller exit radius is preferred to slow traffic.

On an exception basis, the Department will consider larger roundabouts with higher design speeds and greater capacity. Based on international practice, 30 mph (48 kph) is the highest circulating speed allowed in Delaware. Two lanes is the maximum number of circulating lanes, at least until considerable experience is gained with modern roundabouts. The Department will also consider smaller roundabouts with lower design speeds and less capacity. These may be appropriate on lesser streets in Delaware's functional hierarchy.

Also, on an exception basis, the Department will consider elongating roundabouts to better fit intersections whose entering roadways have different widths. An elongated roundabout consists of half circles with tangent sections between them. This design is applied on an exception basis since oval roundabouts have higher collision rates than do circular ones.

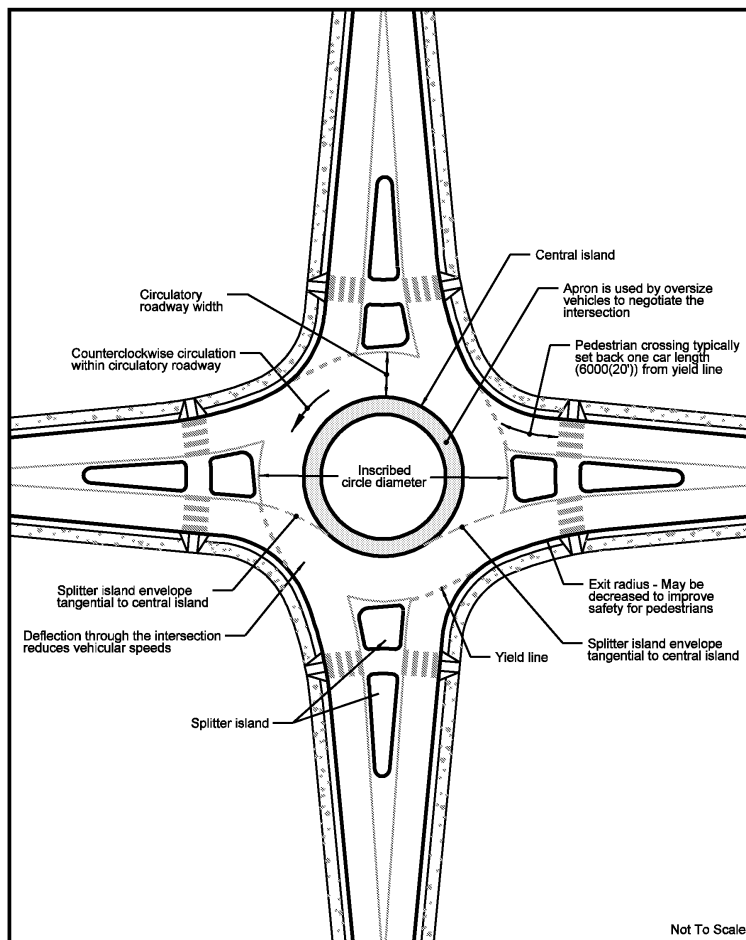

FIGURE IV-13. TYPICAL ROUNDABOUT

4.3. Chicanes

Chicanes can be created either by means of curb extensions or edge islands (see Figure IV-14). The latter are less aesthetic but leave existing drainage channels open and tend to be less costly to construct. The curb extensions or edge islands may be semi-circular, triangular, or squared off. The typical chicane has trapezoidal islands based on the finding that this shape is more effective in reducing speeds than is a semi-circular shape.

Edge line tapers shall conform to the Manual on Uniform Traffic Control Devices (MUTCD) taper formula. The curb extensions or edge islands should have 45° tapers to reinforce the edge lines.

Curb extensions or edge islands that form chicanes should have vertical elements to draw attention to them. Trees and other landscape materials meet this requirement. Landscaping guidelines for traffic circles apply as well to chicanes.

Mountable curbs should be used on curb extensions and edge islands that form chicanes. For low-speed street conditions, mountable curbs may be placed at the edge of a through lane rather than offset by 1 ft (0.3 m) or more as with barrier curbs. The use of mountable rather than barrier curbs is prompted by the complexity of movement through chicanes, and the fact that curb extensions and edge islands within chicanes are not expected to serve as pedestrian refuges.

The typical chicane separates opposing traffic by means of double solid yellow lines bordered by reflectors. Even this may not be enough to discourage some motorists from cutting across the centerline to minimize deflection. To further discourage this behavior, a raised median may be installed. The median may be narrow and mountable without landscaping. This design has proven safe and effective outside the United States. Alternatively, if right-of-way permits, the median may be wider and landscaped with mountable curbs.

On an exception basis, the Department will consider chicanes formed with parking bays, alternating from one side of the street to the other. This is a relatively inexpensive design option and is common in redesigned main streets. However, it is

also an option best exercised with care since the act of negotiating a chicane is challenging enough without having to watch for automobiles pulling in and out of parking spaces. Also, the act of pulling in and out of parking spaces is challenging enough without having to cope with reduced visibility due to road curvature.

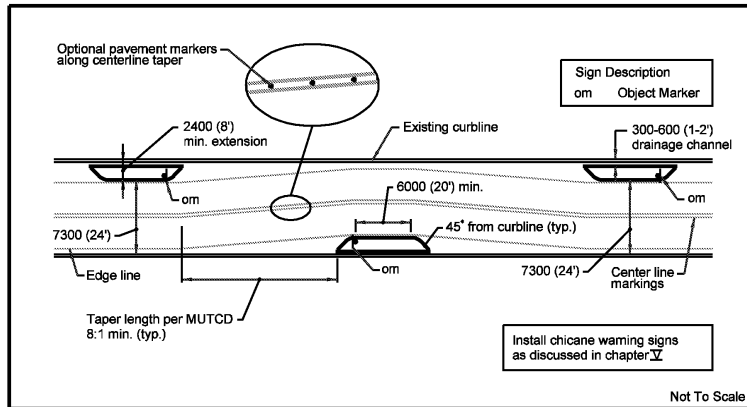

FIGURE IV-14. TYPICAL CHICANE

4.4 Lateral Shifts

The typical lateral shift is just one half of the typical chicane (see Figure IV-15). It has the same dimensions and details as the typical chicane, but because the roadway alignment shifts only once, has a crossing speed 5 mph (8 kph) higher than a chicane of the same dimensions. A higher crossing speed is desirable because lateral shifts are one of the few traffic calming measures suitable for main roads (see Chapter III).

The typical lateral shift separates opposing traffic by means of a landscaped center island. Absent such an island, some drivers will cross the centerline so as to minimize deflection. With a such island, drivers cannot veer into the opposing lane, thus ensuring the safety and effectiveness of the lateral shift. On an exception basis, the Department will consider lateral shifts formed with parking bays. The comments regarding parking bays in chicanes apply here as well.

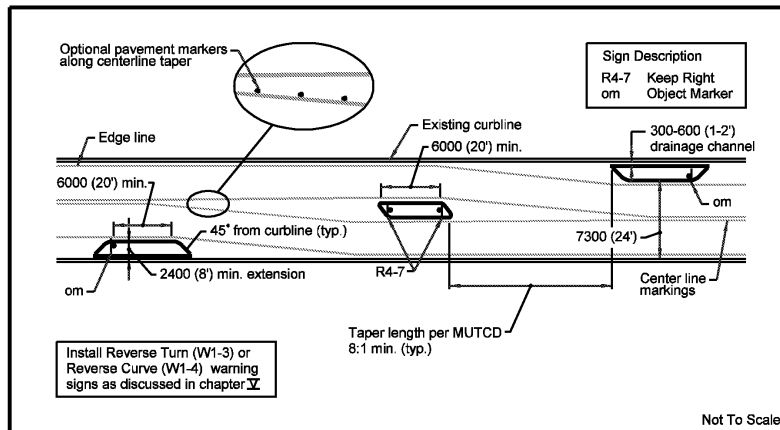

FIGURE IV-15. TYPICAL LATERAL SHIFT

4.5 Accommodation of Bicyclists

Bicyclists tend to get squeezed or cut off at horizontal speed control measures. On streets with little bicycle traffic and/or low volume motor vehicle traffic, such conflicts are sufficiently infrequent to require no special accommodation of bicyclists. Where volumes of both bicycle and motor vehicle traffic are high, special accommodation should be made.

Typical designs assume that bicycle lanes will end 70 to 100 ft (21 to 30 m) upstream of slow points. This provides ample opportunity for bicyclists to merge into the traffic stream. At higher traffic volumes, the Department will consider bypass lanes at chicanes and lateral shifts, separated from main travel lanes by raised islands. The Department will also

consider taking bicycle lanes off the roadway on approaches to roundabouts, providing separate bicycle crossings at side streets. Based on accident studies outside the United States, bypasses lanes will ordinarily be required at roundabouts when entering volumes exceed 10,000 vpd.

5. NARROWINGS

5.1. Neckdowns

The typical neckdown is used in connection with on-street parking, and unlike a conventional intersection with a large curb return radius, offers a short crossing distance and high visibility for pedestrians (see Figure IV-16). In the typical design, the curb return radii and street widths are such that single unit trucks can stay to the right of the centerlines when making right turns.

When streets are wide to begin with, and have parking lanes on main and cross streets, intersections can be narrowed down without necessitating encroachment by trucks into opposing lanes. When streets are narrow and/or without curbside parking, intersections cannot be narrowed down without encroachment. Many jurisdictions keep corner radius small and allow large vehicles to swing wide into the opposing lane when making right turns. The Department will consider this practice on an exception basis when: volumes entering the intersection are less than 500 vehicles per day (50 vehicles during the peak hour) and heavy vehicle traffic is less than 2 percent of the daily total.

In cases where streets are narrow and traffic volumes high, as on some main shopping streets, the Department will consider setting choke points and crosswalks back from intersections a short distance to allow turns within lanes and short crossing distances at the same time.

5.2 Chokers

The typical two-lane choker is 20 ft (6 m) from curb to curb. It has a constricted length of 20 ft (6 m) in the direction of travel, the length of a passenger car (see Figure IV-17). The length is kept short so as not to block driveways nor to take away too much curbside parking.

A curb-to-curb width of the typical choker, while significantly less than Delaware's standard roadway design width, will have a modest effect on speeds because vehicles can still easily pass each other. Therefore, on an exception basis, where traffic is light and the proportion of large vehicles is low, the Department will consider narrower cross sections.

Chokers can be created either by means of curb extensions or edge islands. The latter are less aesthetic but leave existing drainage channels open. They also make it possible to provide bicycle bypass lanes on streets without curbside parking. Chokers can be hazardous to bicyclists, who get squeezed by passing motorists. For this reason, bypass lanes should be considered whenever both bicycle and motor vehicle traffic are heavy.

If centering a choker will result in undersized curb extensions on both sides of the street, the Department will consider shifting the choker to one side of the street. An undersized extension is one that fails to fully shadow a parking lane, that is, one extending less than 8 ft (2.4 m) toward the centerline.

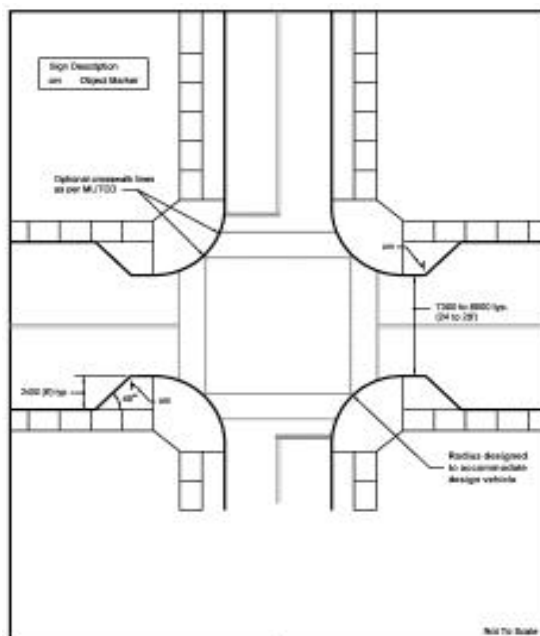

FIGURE IV-16. TYPICAL NECKDOWN

Edge line tapers shall conform to the

MUTCD taper formula. Curb extensions or islands should have 45° tapers to reinforce the edge lines. On streets without edge lines, basically streets at the bottom of the functional hierarchy, no edge lines are required at chokers.

When used in connection with curbside parking, chokers may extend to the edge of the travel lane to form protected parking bays. Absent an edge line or marked parking spaces, chokers should extend no farther than 8 ft (2.4 m) toward the centerline.

Curb extensions or edge islands that form chokers should have vertical elements to draw attention to them, preferably landscaping. Any vertical element shall be of breakaway or yielding design. Landscaping guidelines for traffic circles apply as well to chokers.

Within the choker, a change in pavement material should be considered. Textured surfaces such as brick and stamped asphalt reinforce the visual cues of narrowing and landscaping, thus warning motorists of the constriction and emphasizing its special character. Otherwise two-lane narrowings may be so subtle as to be missed.

For chokers that serve as pedestrian peninsulas, barrier curbs shall be used to provide an added measure of pedestrian protection. Otherwise, mountable curbs are preferred. Under low-speed street conditions, mountable curbs may be placed at the edge of a through lane rather than offset by 1 ft (0.3 m) or more as with barrier curbs.

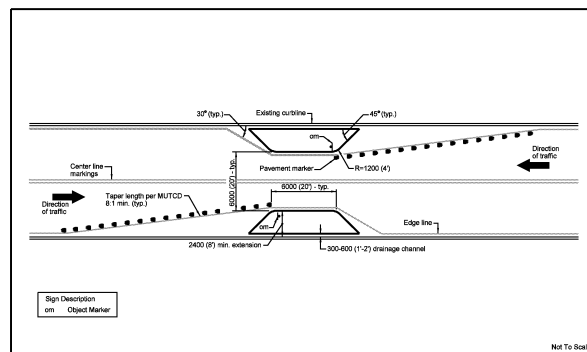

FIGURE IV-17. TYPICAL CHOKER

5.3. Center Island Narrowings

The typical center island narrowing is shown in Figure IV-18. The typical design incorporates these features:

- (1) The center island is large enough to command attention, at least 6 ft wide and 20 ft long (1.8 by 6 m);
- (2) The approach nose is offset to the left, from the perspective of approaching traffic; and
- (3) The center island curb forms a diverging taper to deflect traffic toward the right.

Center islands should be at least one car length, but not much longer. Center islands are most effective in reducing speeds when they are short interruptions to an otherwise open street section, rather than long median islands that channelize traffic and separate opposing flows. The latter have been found to actually increase running speeds, while the former (perhaps because they appear as obstacles to approaching traffic), slow traffic to a degree. Short islands have the added advantage of keeping driveway access open in both directions, which is desirable at lower functional classification levels where traffic calming is most often practiced.

When center islands are placed at pedestrian crossings, ADA requires that they have pass-throughs that are traversable by the disabled. This requirement may be met with cut-throughs flush with the roadway to provide a level crossing. Or it may be met with gentle ramps up to a plateau wide enough for a wheelchair. ADA requirements are contained in Sections 4.3 and 4.7 of the ADA Standards for Accessible Design (see Figure IV-19). Ordinarily, a cut-through will be used in Delaware since a plateau with ramps requires a much wider center island (about 16 ft or 5 m wide at a minimum). When a cut-through is used, the longitudinal cut should be 12 ft (3.7 m) or the crosswalk width, whichever is greater.

Center islands should have vertical elements to draw attention to them, preferably landscaping. Any vertical element shall be of breakaway or yielding design. Landscaping guidelines for traffic circles apply as well to center island narrowings.

For center islands that serve as pedestrian refuges, barrier curbs shall be used to provide an added measure of pedestrian protection. Otherwise, mountable type curbs are preferred. Under low-speed street conditions, mountable curbs may be placed at the edge of a through lane rather than offset by 1 ft (0.3 m) or more as with barrier curbs.

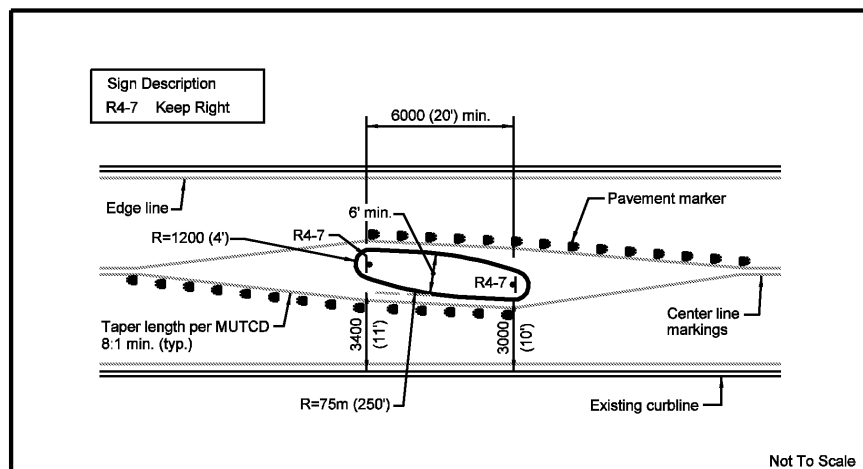

FIGURE IV-18. TYPICAL CENTER ISLAND NARROWING

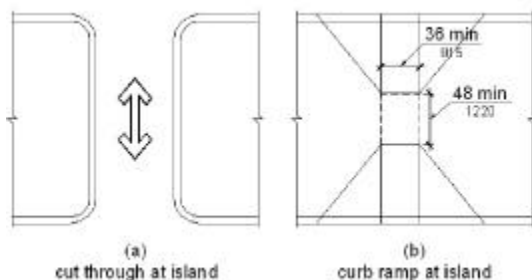

FIGURE IV-19. ADA OPTIONS FOR PEDESTRIAN CROSSINGS AT ISLAND

6. SPEED ESTIMATES

6.1 Speed vs. Vertical Curvature

6.1.a Speed Humps

Delaware's typical speed hump has an 85th percentile crossing speed of just under 25 mph (40 kph). For other speed humps that are approximately circular in shape, crossing speeds can be estimated with a formula from Institute of Transportation Engineers' *Traffic Calming State-of-the-Practice* (SOP). The formula was derived using the common 12-ft (3.7-m) hump as a reference point. Whatever forces of centrifugal acceleration are tolerable going over this hump, at its 85th percentile speed, will be tolerable going over other vertical measures at their 85th percentile speeds.

The following formula applies to any measure of approximately circular shape:

$$R = V^2/5.81$$

where R is the radius of a vertical curve in ft and V is the velocity at which the curve is traversed in mph (as in Figure IV-20). Or, equivalently:

$$V = 2.41 (R)^{1/2} \tag{1}$$

As humps becomes less circular in shape, equation (1) becomes less accurate in predicting the centrifugal forces humps impart. A method of adjusting for deviations from a purely circular shape is suggested by T.F. Fwa and C.Y. Liaw, "Rational Approach for Geometric Design of Speed-Control Road Humps," *Transportation Research Record 1356*, 1992, pp. 66-72.

Using precise hump measurements and corresponding speed data, Fwa and Liaw found that crossing speeds depend more on the shape of the hump than on the height-to-length ratio. Two humps with the same height and length can have very different crossing speeds if one's profile is more rounded and the other's more triangular shaped. For every 10 percent increase in the ratio of cross sectional area to length, the 85th percentile crossing speed dropped by 5 percent. This relationship can be used to predict crossing speeds for alternative hump profiles relative to circular humps.

6.1.b Speed Tables

Delaware's typical speed table has a design speed of 30 mph (48 kph). For other speed tables with circular (or

near-circular) ramps, speeds can be estimated using methodology introduced in ITE's *Traffic Calming State-of-the-Practice*. To illustrate, the typical speed table has 6-ft (1.8 m) ramps at both ends with the same parabolic shape as the rises of a 12-ft (3.7-m) hump; it is as if the hump were pulled apart and a flat section inserted in-between. Yet, the typical speed table has an 85th percentile speed about 8 mph (13 kph) higher than that of a 12-ft (3.7 m) hump of the same 3 inch (77 mm) height.

The effective curvature of the typical speed table must be somewhere between the curvature of a 12-ft (3.7 m) hump and the curvature of a 22-ft (6.7 m) hump with the same overall rise, 3 inches (77 mm). If the same overall rise were distributed over 22 ft (6.7 m) in a circular hump, trigonometry tells us the hump would have radius of 250 ft (76 m). From equation (1), such a hump would have an 85th percentile speed of 38 mph (61 kph). The typical speed table has a crossing speed halfway between the design speeds of the two hump profiles to which it relates—21 mph (34 kph) for a 12-ft (3.7 m) hump and 38 mph (61 kph) for a 22-ft (6.7-m) hump. This relationship (speeds halfway between extremes) can be used to estimate crossing speeds for parabolic speed tables with other dimensions.

For trapezoidal speed tables, no method of speed estimation is available. Field testing must substitute for theory. Ramp dimensions, slopes, and 85th percentile crossing speeds for three U.S. applications are presented in Table IV-2.

TABLE IV-2. CROSSING SPEEDS FOR SELECTED TRAPEZOIDAL TABLES

	Applications	Dimensions	Ramp Slopes	85 th Percentile Crossing Speeds
Boulder, CO	speed tables raised crosswalks	12' ramps 22' plateau 6" rise	1:24	24 mph (39 kph)
Cambridge, MA	raised crosswalks	6' ramps 10' plateau 6" rise	1:12	21 (34 kph)
Gwinnett County, GA	speed tables	6' ramps 10' plateau 3-5/8" rise	1:20	25 (40 kph)

The only other source of speed data for trapezoidal tables comes from Denmark (see Table IV-3). Danish guidelines apply to tables of one height only, 100 mm. Clearly, crossing speeds depend on multiple parameters: ramp slope and length, and plateau height and length. But the Danish results are the best available at this time.

**TABLE IV-3. DANISH SPEED ESTIMATES FOR FLAT-TOPPED MEASURES
(100 mm height)**

Ramp Length in ft (m)	Ramp Slope	Crossing Speed in mph (kph)
2.3 (0.7)	1:7	12 (19)
2.6 (0.8)	1:8	16 (26)
3.3 (1)	1:10	19 (31)
4.3 (1.3)	1:13	22 (35)
5.6 (1.7)	1:17	25 (40)
6.6 (2.0)	1:20	28 (45)
8.2 (2.5)	1:25	31(50)

6.2. Speed vs. Horizontal Curvature

Delaware's typical traffic circle, chicane, and lateral shift have design speeds of 20, 25, and 30 mph, respectively. For other measures with horizontal curves, crossing speeds can be estimated as described in this section.

Most horizontal speed control measures, including chicanes, lateral shifts, and even traffic circles, consist of reverse curves. They require a turn in one direction and then back in the original direction, sometimes more than once. The physics of movement is complex in reverse curves. No standard highway design text or manual provides insight into comfortable speeds on such curves. Fortunately, reverse curves can often be analyzed as a series of simple curves, and where they cannot, there has been enough field testing to make speed estimates possible.

It is standard practice to analyze measures with long horizontal curves, such as roundabouts and bends, as a series of simple curves. Where preceded or followed by short curves, the long curves tend to dominate crossing speeds and the short curves can often be ignored.

For simple horizontal curves, crossing speeds can be estimated with graphs and tables from the American Association of State Highway and Transportation Officials' *A Policy on Geometric Design of Highways and Streets* (AASHTO's Green Book). All are based on the formula from mechanics:

$$R = V^2/15(e+f) \quad (2)$$

where R is the horizontal curve radius in ft, V the speed of travel around a curve in miles per hour, e is the superelevation rate, and f is the side friction factor.

Table IV-4 relates turning speeds to horizontal curve radii, using AASHTO's side friction factors. Negligible superelevation is assumed, which is common on low-speed streets. At locations with superelevation or reverse superelevation, equation (2) can be used to refine estimates of horizontal curve radii. For example, assuming 2 percent reverse superelevation at a traffic circle, the required curve radius for a crossing speed of 20 mph (32 kph) would increase to 95 ft (29 m).

TABLE IV-4. CURVE RADII FOR DIFFERENT CROSSING SPEEDS

Desired Speed mph (kph)	Assumed Side Friction Factor	Assumed Superelevation	Curve Radius ft (m)
15 (24)	0.35	0.00	43 (13)
20 (32)	0.30	0.00	89 (27)
25 (40)	0.25	0.00	167 (51)
30 (48)	0.22	0.00	273 (83)

Source: Side friction factors are based on American Association of State Highway and Transportation Officials (AASHTO), *A Policy on Geometric Design of Highways and Streets*, Washington, D.C., 1990, Figure III-17 and Table III-17.

For measures with short reverse curves, such as chicanes and lateral shifts, crossing speeds are primarily a function of "stagger length" and "free view width," and consequently, "path angle" through the lateral shift (see Figure IV-20). Path angles of 20°, 15°, and 10° permit crossing speeds of 20, 25, and over 30 mph (32, 40 and over 48 kph), respectively. Crossing speeds are about 5 mph (8 kph) lower for full chicanes (two lateral shifts in series) than single lateral shifts of the same dimensions.

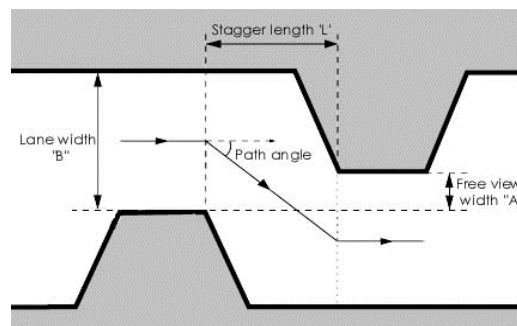

FIGURE IV-20. GEOMETRIC PARAMETERS AFFECTING CROSSING SPEEDS

An additional constraint on horizontal curvature is the presence of long wheelbase vehicles. All streets will have at least an occasional moving van, garbage truck, or emergency vehicle negotiate their curves. Many serve school buses. These vehicles can be assumed to take sharp curves at such low speeds that the only issues are the turning radius of the vehicle and its path width. A horizontal curve of 43-ft (13-m) radius, which has a crossing speed for passenger cars of 15 mph (24 kph), can be negotiated by all but the largest trucks. The bigger problem on such tight curves is the sweep of a truck or bus due to offtracking and vehicle overhang. A single-unit truck sweeps an area 15 ft (4.6 m) wide on a horizontal curve of 45-ft (14-m) radius. Such vehicles must either be accommodated through lane widening or allowed to sweep into the opposing lane when no traffic is approaching. On low-volume residential streets, the probability of two vehicles meeting at a slow point, and one vehicle being oversized, may be low enough that the latter presents no problem. On other streets, lanes must be wide enough to accommodate the swept paths of design vehicles.

TABLE IV-5. DESIGN VEHICLE CHARACTERISTICS

	Width ft (m)	Minimum Inside Radius ft (m)	Minimum Design Turning Radius ft (m)	Minimum Sweep Radius ft (m)	Maximum Swept Path ft (m)
Passenger Car	7 (2.1)	14 (4.3)	24 (7.3)	25.5 (7.8)	11.5 (3.5)
Single Unit Truck	8.5 (2.6)	27.8 (8.5)	42 (12.8)	44.1 (13.4)	16.3 (5)
Single Unit Bus	8.5 (2.6)	24.4 (7.4)	42 (12.8)	46.5 (14.2)	22.1 (6.7)
Semitrailer (WB-40)	8.5 (2.6)	18.9 (5.8)	40 (12.1)	41.5 (12.7)	22.6 (6.9)

Source: Adapted from American Association of State Highway and Transportation Officials (AASHTO), *A Policy on Geometric Design of Highways and Streets*, Washington, D.C., 1990, Tables II-1 and II-2.

6.3. Speed vs. Spacing of Slow Points

Drivers accelerate between slow points. To counter this tendency and limit midpoint speeds, many U.S. jurisdictions have established guidelines for the spacing of slow points. Prescribed spacing is typically in the range of 300 to 500 ft (90 to 150 m).

Instead of applying fixed guidelines, the Department will compute required spacing based on target speeds. Ordinarily, midpoint speeds will be allowed to climb no more than 5 mph (8 kph) above the posted speed limit. This maximum speed, along with the crossing speed at slow points and the comfortable travel speed on the street itself (between slow points), determine the required spacing of slow points.

Required spacing will be estimated with a formula from ITE's *Traffic Calming State-of-the-Practice*. As spacing increases to 600 ft (183 m) between slow points, midpoint speeds rise to 90 percent of their maximum value. The maximum value, however, is not the 85th percentile speed of the road before traffic calming but rather a speed between the pre-existing speed and the 85th percentile speed at the slow points. This means that for any reasonable spacing of slow points, the simple presence of traffic calming has a significant effect on travel speeds.

The relationship between midpoint speed and spacing of slow points is illustrated in Figure IV-21. In mathematical terms, the best-fit exponential curve is:

$$85th_{midpoint} = 85th_{slow\ point} + (85th_{street} - 85th_{slow\ point}) * a * (1 - e^{-b * spacing}) \quad (3)$$

where

85th_{midpoint} = 85th percentile speed at midpoint after calming

85th_{slow point} = 85th percentile speed at the slow point

85th_{street} = 85th percentile speed of street before treatment

a = 0.56 = estimated parameter representing the proportion of way back to pre-treatment levels that speed climbs as spacing becomes large

b = 0.0040 = estimated parameter representing the rate at which speed climbs with spacing

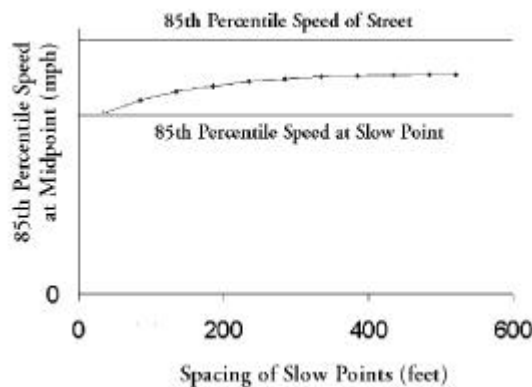

FIGURE IV-21. SPEED VS. SPACING OF SLOW POINTS

1. At higher speeds, the suspension system collapses on contact with a bump, with front wheels rising into the wheel wells while the chassis continues on a more level path than the vertical curvature would suggest. The mass of the vehicle body never has time to react.
2. The optimal relationship between offset distance and opening width is:

5.5 ft (1.67 m) max	16 ft (4.9 m) min
5 (1.52)	17 (5.2)
4.5 (1.37)	18 (5.5)
4 (1.22)	19 (5.8)
3.5 (1.07) or less	20 (6.1)

3. A 12-ft (3.7 m) hump with a height of 3-1/2 inches (90 mm) is equivalent to an arc of a circle with a radius of 62 ft (19 m). This can easily be determined from trigonometry. Such a hump has an 85-percentile crossing speed of 19 mph (31 kph). Given these values, the tolerable rate of centrifugal acceleration going over a speed hump must be on the order of 12.5 ft/sec² (3.8 m/sec²). Admittedly, the physics of crossing a hump are being oversimplified. The force of impact with the hump will tend to reduce speeds; the smaller vertical displacement as the front wheels rise into the wheel wells, will tend to increase them. It would require a much more sophisticated analysis than this one to capture these high speed effects. Here, only centrifugal forces are accounted for.

4. For information on track width and overhang for other design vehicles, see American Association of State Highway and Transportation Officials (AASHTO), *A Policy on Geometric Design of Highways and Streets*, Washington, D.C., 1990, Figure IV-24.

CHAPTER V SIGNING AND MARKING OF TRAFFIC CALMING MEASURES

If driven at excessive speeds, beyond that for which they are designed, traffic calming measures may pose a hazard to motorists. Government has a ministerial duty to warn motorists of hazardous conditions that it creates or becomes aware of. It is this duty to warn that necessitates the careful signing and marking of traffic calming measures.

To foster universal recognition, traffic calming measures in the State of Delaware shall be signed and marked according to the standard conventions outlined in this chapter. These conventions were developed with due consideration of the Federal Highway Administration's *Manual on Uniform Traffic Control Devices* (MUTCD).

The Department may deviate from its standard conventions where alternative schemes promise to be *more context-sensitive* and *equally effective*. In particular, on low-volume, low-speed streets, the Department will consider relaxation of signing and marking requirements. Alternative schemes may be proposed in writing by a municipality or neighborhood group.

1. GENERAL GUIDANCE FROM MUTCD

The MUTCD has been adopted by the State of Delaware and sets the standard for signing and marking of physical roadway features. The following general conventions apply to traffic calming measures:

- Warning signs need not be used where hazards are self-evident.
- Signs must be legible, which requires high visibility, lettering or symbols of adequate size, and short legends for quick comprehension.
- Sign lettering must be in upper-case letters of the type approved by FHWA.
- Signs must be reflectorized or illuminated to show the same shape and color by day and night.
- Signs are ordinarily placed on the right-hand side of the road, where the driver is looking for them.
- Signs are ordinarily mounted separately, except where one sign supplements another, as advisory speed plates supplement warning signs.
- Before any street is opened to traffic, all hazardous conditions must be signed and marked.
- Signs should be used conservatively.
- Symbol signs are preferred to word signs when an appropriate symbol exists.
- New symbols not readily recognizable should be accompanied by educational plaques.
- Analogous signs shall be used for new situations similar to those for which standard signs already exist.

2. GENERAL SIGNING AND MARKING CONVENTIONS

The following conventions shall be observed in the signing and marking of all traffic calming measures in Delaware.

2.1. Advance Warning Signs

Advance warning signs shall be provided for all traffic calming measures involving vertical or horizontal deflection including speed humps, speed tables, raised intersections, traffic circles, chicanes, and diagonal diverters.

Where such measures are used in a series spaced less than 500 feet apart, it is sufficient to provide a single advance warning sign before the first slow point in the series, with a rider indicating how far the series extends (as in Figure V-1). Where measures are used in isolation or at greater spacing, they shall be signed individually.

At intersecting cross streets in a series of slow points, additional warning signs shall be provided if the first slow point is more than 150 feet from the intersection. The warning sign may be placed in the direction of travel along the traffic calmed street, or may be displayed on the cross street (as in Figure V-2).

The location of advance warning signs shall generally conform to Table V-1 from MUTCD. For measures introducing vertical or horizontal deflection but maintaining travel lanes in both directions, placement guidelines for "Deceleration to Listed Advisory Speed" apply. For measures reducing a two-way cross section to a single shared lane, guidelines for "High Judgment Needed" apply.



FIGURE V-1. ADVANCE WARNING SIGN WITH RIDERS



FIGURE V-2. WARNING SIGN ON CROSS STREET

**TABLE V-1. ADVANCE WARNING SIGN PLACEMENT
(number of feet upstream of condition)**

Posted or 85 th Percentile Speed	High Judgment Needed	Deceleration to Listed Advisory Speed		
		10 mph	20 mph	30 mph
25	250	100	N/A	N/A
30	325	150	100	N/A
35	400	200	175	N/A
40	475	275	250	175
45	550	350	300	250

Source: Federal Highway Administration (FHWA), *Manual on Uniform Traffic Control Devices*, Washington, D.C., 1988, p. 2C-2A.



FIGURE V-3. WARNING SIGN WITH ADVISORY SPEED PLATE



FIGURE V-4. WARNING SIGN WITH EDUCATIONAL PLAQUE

2.2. Speed Advisories and Educational Plaques

Traffic calming signs shall be supplemented with advisory speed plates wherever the comfortable crossing speed of measures (as determined from tables and formulas in Chapter IV) is less than the posted speed limit (as in Figure V-3). Educational plaques may be used initially in conjunction with signs for which no close analogy exists in the MUTCD (as in Figure V-4).

3. STANDARD SIGNS

The following signs shall be used consistently throughout Delaware in connection with the corresponding traffic calming measures.

3.1. Standard MUTCD Signs

For certain traffic calming measures, existing MUTCD signs are adequate.

- DEAD END signs (W14-1) far enough in advance of full closures and half closures to allow traffic to turn off at the nearest intersecting street
- DO NOT ENTER signs (R5-1) at half closures or other traffic calming measures that preclude movement in a particular direction for a short distance
- Turn signs (W1-1R or W1-1L) in advance of diagonal diverters or other traffic calming measure whose geometrics require turns to be made at less than 30 mph and less than the posted speed limit approaching the turn
- Large Arrow signs (W1-6) on diagonal diverters and other measures that require sharp changes in the direction of travel
- Keep Right signs (R4-7) on center islands of any length
- Reverse Turn signs (W1-3) or Reverse Curve sign (W1-4) at lateral shifts, the appropriate sign depending on the design speed of the feature (W1-3 at 30 mph or less, W1-4 at higher speeds).

3.2. New Standard Warning Signs

For other traffic calming measures, no existing MUTCD sign is suitable. New standard warning signs have been developed for use throughout Delaware. The design of the new signs reflects a preference, on the part of both MUTCD and the Citizen Advisory Committee, for symbols over word messages. The operative principle in the design of symbol signs is that the symbol itself faithfully represent the *geometrics* and *traffic flow pattern* of the measure.

The standard signs in Figure V-5 shall be used throughout Delaware in connection with the corresponding traffic calming measures. Mirror images of symbol signs should be used where the geometry of measures is the reverse of what is shown. All are diamond-shaped warning signs with the following standard dimensions and standard colors.

Table V-2. SIGN DIMENSIONS AND COLORS

Sign Dimensions	Color Code		
	Background	Message	Border
30" x 30"	Yellow	Black	Black



SPEED HUMPH



SPEED TABLE



RAISED CROSSWALK



RAISED INTERSECTION



4-WAY

TRAFFIC CIRCLE OR ROUNDABOUT



3-WAY



ALTERNATIVE TRAFFIC CIRCLE
(left turns in front)



TWO-LANE CHICANE

FIGURE V-5. NEW STANDARD SIGNS

3.3. TRAFFIC CALMED AREA Sign

One additional standard sign has been developed for use throughout Delaware, the TRAFFIC CALMED AREA sign (see Figure V-6). It should be used on main access routes into neighborhoods, business districts, and entire communities that have been traffic calmed on a comprehensive, areawide basis.

Where four conditions are met, no additional warning signs are required in traffic calmed areas:

- TRAFFIC CALMED AREA signs are installed on all access routes, preferably on both sides of the street to emphasize the gateway effect
- an appropriate, uniform advisory speed are posted with each TRAFFIC CALMED AREA sign
- a slow point is proximate to each TRAFFIC CALMED AREA sign, and subsequent slow points are no more than 500 feet apart

It is recommended that formal gateway treatments be used on major access routes into traffic calmed areas; a formal gateway may consist of a roadway narrowing, textured and colored surface material, special landscaping, and/or other features that emphasize the fact that motorists are entering an area of special character.

4. SPECIFIC SIGNING AND MARKING CONVENTIONS

The following signing and marking conventions shall be followed with specific traffic calming measures in Delaware. For aesthetic reasons, signing and marking will be kept to a necessary minimum.

4.1 Signing and Marking of Vertical Measures

Advance warning signs will be deployed upstream of vertical measures, including speed humps, speed tables, raised crosswalks, and raised intersections. Pavement markings will be displayed on the up-ramps of the vertical measures themselves. Pavement legends will not be required in front of vertical measures. Nor will signs or object markers ordinarily be required at individual humps, tables, raised crosswalks, or raised intersections.

Signs or object markers may be useful on curbless sections to keep motorists from veering off the roadway to avoid vertical deflection (as in Figure V-7). They may also be used to mark vertical measures on snow plow routes. However, for both of these purposes, other marking alternatives are available. Landscaping and decorative bollards, for example, will serve the same purpose with better aesthetics (as in Figure V-8).



FIGURE V-6. TRAFFIC CALMED AREA SIGN



FIGURE V-7. OBJECT MARKER NEXT TO SPEED HUMP ON A CURBKESS SECTION



FIGURE V-8. AESTHETIC OPTIONS TO OBJECT MAKERS

Vertical measures in Delaware shall be marked with a simple shark's tooth pattern (as in Figures V-9 and V-10). This marking pattern has two advantages over most other common patterns: the large marked area is highly visible, and the asymmetric pattern directs drivers to the proper crossing point. There shall be at least two triangular shaped markings in each direction, and may be more than two in each direction on wider streets.



Speed Hump



Speed Table



Raised Intersection

FIGURE V-9. SHARK'S TOOTH MARKING PATTERN ON DIFFERENT VERTICAL MEASURES

The Department will consider exceptions to the shark's tooth pattern where vertical measures are marked in other ways more appropriate to the context. For example, the shark's tooth pattern may be omitted where the plateaus of raised crosswalks are marked in accordance with MUTCD guidelines for at-grade crosswalks, that is, with traverse white lines marking both edges of the crosswalk, with longitudinal white lines perpendicular to the crosswalk, or with both longitudinal and diagonal lines (see Section 3B-18, MUTCD). In a low-speed context such as traditional main street, the department will consider omission of separate markings in favor of colored and patterned surfaces of brick or concrete paver materials.

4.2. Signing and Marking of Center Islands

MUTCD requires the approach ends of traffic islands to have marked triangular neutral areas in front so as to guide vehicles in desired paths of travel along island edges. These areas may be identified by painting or by use of contrasting materials. Appropriate signs, such as the Keep Right (R4-7) sign, are placed on the approach ends facing traffic. Object markers are also placed on approach ends. These conventions shall apply to center island narrowings and midblock deflector islands on arterials and major collectors (as in Figure V-11).

On other streets, signing and marking requirements may be relaxed somewhat. MUTCD conventions apply to pedestrian refuge islands, traffic divisional islands, and traffic channelizing islands, all found on major streets and highways. On minor streets in other states, center islands are often designated with a single Keep Right sign and no object marker, and center lines shear off to the right to guide traffic past center islands rather than forming marked triangular neutral areas (as in Figure V-12). This signing and marking convention will be acceptable on such streets in Delaware. Sometimes, in other states, signs and object markers are omitted entirely in favor of reflective raised pavement markers on the approach ends and prominent landscaping within the islands. Few if any accidents occur since islands are still plainly delineated. This convention may be approved by the Department on an exception basis. Examples of signing and marking alternatives, that might be approved by the Department on an exception basis, are shown in Figure V-13.

FIGURE V-10. STANDARD MARKING PATTERN FOR VERTICAL MEASURES

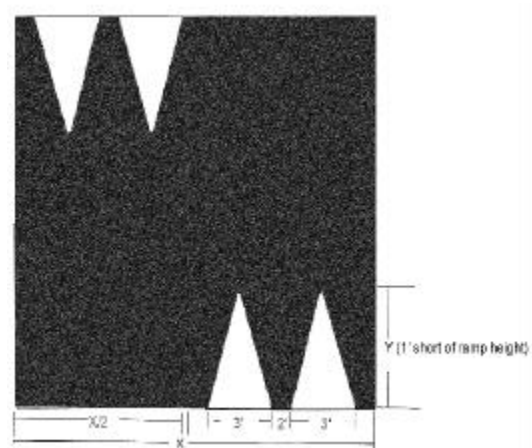



FIGURE V-11. SIGNING AND MARKING OF A CENTER ISLAND PER MUTCD



FIGURE V-12. SIGNING AND MARKING OF CENTER ISLANDS ON COLLECTOR ROADS



FIGURE V-13. SIGNING AND MARKING ALTERNATIVES ON AN EXCEPTION BASIS

4.3. Signing and Marking of Traffic Circles and Roundabouts

4.3.a Mini-Traffic Circles

Circular intersections with smaller center islands will be signed and marked as mini-traffic circles. The sign, shown in Figure V-14, will be displayed on center islands facing traffic on all approaches. It will be supplemented by reflective raised pavement markers on the curbs of center islands. Center islands will be landscaped for greater visibility than can be achieved with signs and markings alone.



4-Way Intersection



3-Way Intersection

FIGURE V-14. SIGNING AND MARKING OF MINI-TRAFFIC CIRCLES

Under certain circumstances (outlined in Chapter IV), the Department will consider an alternative traffic circle design which allows left turns in front of the center islands. Circles will be preceded by the appropriate advance warning

sign (see Figure V-5) and center islands will be outfitted with a single Type 1 object marker facing each approach (as in Figure V-15).

4.3.b Roundabouts

MUTCD signing and marking conventions for traffic-control islands may apply, by analogy, to roundabouts and large traffic circles. The center islands of circular intersections are also in the path of approaching traffic and must be passed on the right. This analogy suggests the use of appropriate signs and object markers on the islands themselves, and marked triangular neutral areas on the approaches.

The distinction between roundabouts and mini-traffic circles, from a geometric standpoint, is outlined in Chapter IV. Generally, roundabouts have center islands of 40-foot diameter or more. Center islands are so large that the required movement of entering traffic may best be conceived as a right turn. The advance warning sign has already conveyed the essential geometry and traffic flow pattern of the roundabout. Roundabout islands in other states are signed with Large Arrow signs, Chevron signs, and/or ONE WAY signs (as in Figure V-16). In Delaware, the Large Arrow sign will be used consistently to indicate direction of flow. Splitter islands will be raised with curbs, will have marked neutral areas on their approach ends, and for longer splitter islands, will have Keep Right signs on their approach ends. Center islands will be landscaped for greater visibility than can be achieved with signs and markings alone. Splitter islands may be landscaped as well.



FIGURE V-15. LEFT TURNS IN FRONT ON AN EXCEPTION BASIS



FIGURE V-16. SIGNING OF ROUNDABOUTS

4.4. Marking of Curb Extensions and Edge Islands

For curb extensions or edge islands that deflect traffic—including chicanes, lateral shifts, and one-lane chokers—object markers shall be placed on the extensions or islands toward the side on which traffic is to pass. Ordinarily, Type 3 object markers will be used to mark these measures (as in Figure V-17). The Department may approve alternative marking conventions on an exception basis (as in Figure V-18).



FIGURE V-17. TYPE 3 OBJECT MARKERS ON CURB EXTENSIONS AND EDGE ISLANDS



FIGURE V-18. MARKING ALTERNATIVES ON AN EXCEPTION BASIS

Generally, no special signing or marking is required on curb extensions or edge islands that fall outside the direct path of travel, as when curb extensions within a designated parking lane form protected parking bays (as in Figure V-19). There are exceptions to this general rule. On snow plow routes, object markers may be used to mark curbs that might otherwise be undetectable. Also, on curbless sections, object markers may be used to draw attention to the occasional island. However, for both of these purposes, other marking alternatives are available. Landscaping and monument signage, for example, can perform the same function more effectively than a simple object marker (as in Figure V-20).



FIGURE V-20. ADDITION OF LANDSCAPING ON A PROBLEM CHOKER PREVIOUSLY MARKED WITH REFLECTIVE POST ONLY

FIGURE V-19. NO MARKINGS REQUIRED WITH PROTECTED PARKING BAYS

5. SPECIAL SIGNING FOR BICYCLE ROUTES

Special signing shall be provided along traffic calmed streets that are designated as bicycle routes. Appropriate signing shall be used at closures and diverters to indicate that bicycle access is maintained; appropriate signing shall be used at horizontal measures to protect bicyclists from deflected motor vehicles. Examples of appropriate signing are shown in Figure V-22



FIGURE V-21. PRIORITY SIGNING FOR BICYCLISTS

APPENDIX

PROCESS OF MANUAL PREPARATION

Delaware's *Traffic Calming Design Manual* was prepared under the supervision of two committees, the Citizens Advisory Committee (CAC) with representatives from different stakeholder groups, and the Technical Review Team (TRT) with representatives from the Department's different divisions and offices. Represented on CAC were the Delaware State Legislature, county governments, the state's largest cities, metropolitan planning organizations, Delaware Fire Commission, Delaware State Police, Delaware Department of Education, and various civic groups. A list of participating organizations:

Citizen Representatives	Citizen's Coalition, Inc.	City of Dover
City of Wilmington	Civil Council of Brandywine Hundred	Delaware Dept. of Emergency
Delaware Dept. of Transportation	Delaware Emergency Management	Medical Services
Delaware Home Builders Assoc.	Association	Delaware Real Estate Assoc.
Delaware State Dept. of Education	Delaware State Fire Prevention Comm.	DNREC
Dover Parks & Recreation	Dover/Kent Metropolitan Planning	Elected Officials
League of Local Governments	Organization	Southern New Castle County
Sussex County	WILMAPCO	Alliance

As input to the drafting of this manual, four tasks were performed:

Task 1 - Interviews were conducted with various Department staff to determine how different Department policy initiatives might affect the traffic calming design manual.

Task 2 - Fourteen traffic calming design manuals were reviewed, including all available manuals from Europe, Canada, and Australia. Manuals were reviewed for the same subjects addressed in this manual: procedures, application guidelines and warrants, geometrics, and signing and marking.

Task 3 - Three workshops each were conducted with the CAC and TRT. The committees were given slide presentations and then asked for input via questionnaires on procedures, priority rating systems, application guidelines, geometrics, and signing and marking of measures. Prior to these workshops, photographs were taken of candidate Department streets, and procedures were flow charted for different traffic calming programs around the United States.

Task 4 - A day-long workshop was conducted with leading U.S. practitioners of traffic calming. This workshop dealt with the same issues as did prior workshops with the CAC and TRT. The five participating experts were Crystal Atkins, City of Portland, OR; Ed Cline, Cities of Arcadia, Lake Forest, and Agoura Hills, CA; Ian Lockwood, City of West Palm Beach, FL; Ed Walter, Howard County, MD; and Dave Loughery, Montgomery County, MD.

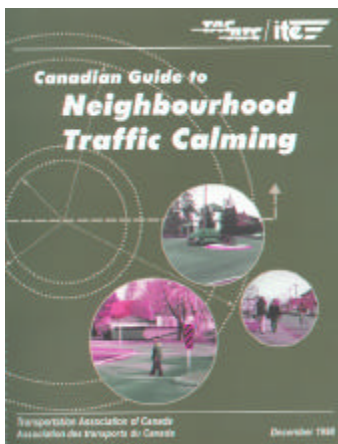

FIGURE A-1. ONE OF THE MANY FOREIGN MANUALS REVIEWED



FIGURE A-2. PRESENTATION BY ONE OF THE NATIONAL EXPERTS