



MERCEDES-BENZ

SL R129 series

1989 to 2001

Brian Long





MERCEDES-BENZ

SL R129 series

1989 to 2001

Brian Long



First printed in hardback format in 2013.

First published in ebook format 2019 by Veloce Publishing Limited, Veloce House, Parkway Farm Business Park, Middle Farm Way, Poundbury, Dorchester, Dorset, DT1 3AR, England – Fax 01305 250479 – e-mail info@veloce.co.uk – web www.veloce.co.uk or digital.veloce.co.uk.

Ebook edition ISBN: 978-1-787116-33-7

Hardback edition ISBN: 978-1-845844-48-6

© Brian Long and Veloce Publishing 2019. All rights reserved. With the exception of quoting brief passages for the purpose of review, no part of this publication may be recorded, reproduced or transmitted by any means, including photocopying, without the written permission of Veloce Publishing Ltd. Throughout this book logos, model names and designations, etc, have been used for the purposes of identification, illustration and decoration. Such names are the property of the trademark holder as this is not an official publication.

Readers with ideas for automotive books, or books on other transport or related hobby subjects, are invited to write to the editorial director of Veloce Publishing at the above address.

All ebook design and code produced in-house by Veloce Publishing.

Contents

[Introduction & Acknowledgements](#)

[1: The three-pointed star](#)

[2: The SL – born on the track](#)

[3: SL road car heritage](#)

[4: An SL for the nineties](#)

[5: The early production models](#)

[6: New powerplants](#)

[7: The first facelift](#)

[8: End of an era](#)

[9: A new generation](#)

[Appendix I: Year-by-year range details](#)

[Appendix II: Engine specifications](#)

[Appendix III: Colour & trim summary](#)

[Appendix VI: Chassis numbers & production figures](#)

[Further reading](#)

Introduction & Acknowledgements

Introduction

It's hard to believe, but the R129 series Mercedes-Benz SL was launched over 20 years ago, the series running from 1989 to 2001. However, its timeless styling has kept it fresh and attractive in the eyes of a new generation of enthusiasts, as well as those returning to the car having owned one when they were still in dealerships.

A combination of superb original design, peerless engineering and build quality simply add to the desirability of this series of classic German machines, and have ensured that many of these cars can still be seen in regular use today.

This book covers the R129 story in all major markets, year by year, to give a definitive overview of the production cars, as well as limited edition models and the AMG line. Contemporary photography sourced from the factory and augmented by other material gathered from around the world ensures an excellent guide for those looking for originality. Extensive appendices are included, covering engine specifications from 1989 onwards, chassis numbers, build numbers, and so on. To complete the story, there's also a brief overview of the vehicle's replacement in the final chapter.

By the way, this title can be read as a single volume or in conjunction with the two earlier SL books published by Veloce (covering the W113 cars and the 107 series SL and SLC). The photography is completely different from book to book, and all three titles have been presented in such a way that they will readily grace any reference library shelf or a connoisseur's coffee table.

Acknowledgements

In this day and age of commerce coming a long way ahead of enthusiasm, not just in the car world, but in the vast majority of hobby activities and life in general, it is truly refreshing to work with Daimler AG – a company, like Porsche (its neighbour in Stuttgart), that values its heritage, and treats owners of older vehicles of the marque with the same respect as an owner of a brand new car.

As with the author's earlier SL books, help came from many quarters during this project. I would particularly like to record my sincere appreciation for the services of Gerhard Heidbrink, Dennis Heck, Dr Hans Spross and Maria Feifel at Daimler AG in Stuttgart, as well as their colleagues from many years earlier – Max Gerrit von Pein and Dr Harry Niemann. Many thanks also to Diane Vatchev of Mercedes-Benz USA, for her sterling work and unstinting support, and for once again coming to the rescue on the American side of the story.

Although there are many others that have helped and supported me with this project, special mention should be made of Elif Yilmaz at EVO Eitel & Volland GmbH, who looks after older technical publications for the Mercedes-Benz Classic Collection, Kenichi Kobayashi at Miki Press, Rob Halloway at Mercedes-Benz UK, and Peter Patrone, Robert Moran and Benjamin Benson at the head office in the States.

Brian Long
Chiba City, Japan





1

The three-pointed star

There can be few trademarks so readily recognizable in all corners of the world as the Mercedes-Benz three-pointed star. The three arms signify the land, sea and air, and the Stuttgart company the star has come to represent has indeed conquered each in its own inimitable way over the years. The story behind the star, though, is a long and complicated one, so this chapter will briefly outline the brand's history to set the scene before the arrival of the first SL models.

The story starts with two men – two pioneers in the motor industry – Gottlieb Daimler, and Carl Benz. Amazingly, given the pre-eminence of the pair in a fledgling trade, not to mention their closeness geographically, the two never actually met, but the coming together of their names is the important thing here.

In 1882, Gottlieb Daimler established a small workshop at the back of his villa in Cannstatt, on the outskirts of Stuttgart, about 12 miles (20km) west of his birthplace, with Maybach working alongside him. A number of single-cylinder, air-cooled petrol engines were duly developed, and used to power the world's first motorcycle in 1885, along with a four-wheeled horseless carriage, which made its initial runs during the autumn of 1886. Within a short space of time, the engines were finding various applications on land, on water, and even in the air. By 1890, the products emanating from the Daimler Motoren Gesellschaft had caught the imagination of the engineering world.

Meanwhile, about 55 miles (90km) north in Mannheim, Carl Benz was busy working on his two-stroke petrol engines, as patents covering four-stroke power-units had already been filed by the Deutz concern, the company Daimler worked for. Eventually, Benz also opted for Otto-cycle engines, putting a single-cylinder unit in a purpose-built frame to produce the world's first petrol-driven car, patented in January 1886. By 1890, Benz & Co was Germany's second largest engine manufacturer, and, as the century drew to a close, one of the

world's most prolific automobile makers, with almost 600 cars built in 1899 alone.

A healthy rivalry

At the end of the day, Daimler and Benz were rival inventors, while the companies bearing their names fought in the showrooms and on the race tracks of Europe. The battle for the hearts of the rich and famous, and the silverware that comes with victory in competition, was never as fierce as it was in the years leading up to the First World War.

At Daimler, rapid expansion led to the purchase of a large site in Untertürkheim on the eastern edge of Stuttgart in August 1900, which would duly become the spiritual home of Mercedes-Benz.

The Mercedes moniker was first adopted by Emil Jellinek, an Austrian who, among other things, sold Daimlers to wealthy clients in the south of France. Jellinek was a clever businessman, and he proposed a number of changes that he knew would appeal to his customers and his own sporting nature, such as a lower body and longer wheelbase in order to cope with the greater power outputs he outlined.

Jellinek promised to take a large number of these vehicles (at least by the standards of the day) in return for distribution rights in France, Belgium, the Austro-Hungarian Empire and America, but also requested that they carry the 'Mercedès' badge – the name of his daughter, and the pseudonym he used during his various racing exploits.



Gottlieb Daimler being driven in the first Daimler car (a 1.1bhp machine of 1886 vintage) by his son, Adolf. The oldest of Daimler's boys, Paul (born in 1869, and the first of five children) duly became a respected engineer, following in his father's footsteps by working alongside Wilhelm Maybach.

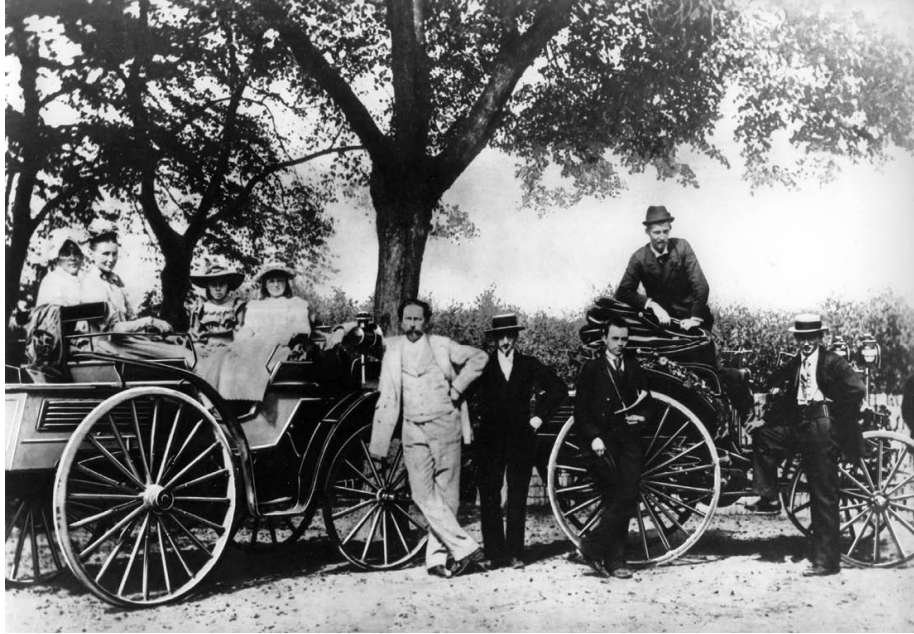

Carl Benz (in the lighter suit) pictured with his family and a Benz Vis-à-Vis in the mid-1890s. As it happens, Bertha Benz, Carl's wife, was a pioneering motorist. The other Benz vehicle, a Viktoria, belonged to Baron Theodor von Liebieg.

A deal was struck, and Wilhelm Maybach (1846-1929) set about designing the first Mercédès in conjunction with Paul Daimler. The end result, a racing car which appeared at the end of 1900, provided the foundation stone for the modern automobile, with a low, pressed steel chassis frame playing host to a 5.9-litre, 35hp engine cooled by a honeycomb radiator, and a gate for the gearchange.

The Mercédès was raced with a great deal of success, and many variations were produced for regular use, from an 8/11hp version all the way up to a 9.2-litre 60hp model. The Mercédès set the standard for the day in the high-class car market, and was built under licence – or often simply copied – by numerous manufacturers.

Six-cylinder engines followed in 1906, and there was a limited run of Knight sleeve-valve models just before the First World War. A few years after the conflict, when technology, metallurgy and production techniques made great strides, the first supercharged Mercédès made its debut, and in April 1923, Ferdinand Porsche was drafted from Austro-Daimler to become Chief Engineer, bringing overhead

camshafts and front-wheel brakes to the marque in a series of exceptionally elegant supercharged models.

Meanwhile, Benz & Cie also made giant steps forward at the turn of the century, albeit against the wishes of Carl Benz, modernizing the range with conventional two- and four-cylinder cars designed by Marius Barbarou, a Frenchman. Internal conflict ultimately led to Benz giving up his post as Chief Engineer, although he remained on the Board until his death, and also formed another company with his sons to allow himself more freedom on design policy. The latter business, founded in 1906, was short-lived, however, building cars from 1908 to 1923.

Benz & Cie continued to follow a safe path with its vehicles thereafter, with Hans Nibel in charge of design from 1910. However, Nibel's love of racing spawned a number of interesting competition cars (he had even been involved with the machine which formed the basis for the streamlined Blitzen Benz record breaker), and the Benz marque duly found favour with a wealthy clientele. One of the most ardent supporters of the brand was Prince Henry of Prussia – the brother of Kaiser Wilhelm II.

Benz introduced its first six-cylinder engine in 1914, and stuck almost exclusively to straight-sixes following the conflict. By this time, the company had produced some magnificent aero-engines, including a supercharged V12, and was also a leading light in the field of diesel technology.

In the background, however, the wheels of finance were turning, and, for a number of reasons, a huge amount of shares in both firms came to be held by the Deutsche Bank. An agreement of mutual interest was signed on 1 May 1924, with a syndicate being formed in order to save production costs in an era of high inflation, and then, on 28 June 1926, a full merger took place giving birth to Daimler-Benz AG.



A 1911 poster featuring the Mercédès 14/30hp model.

Gottlieb Daimler

Daimler was born in Schorndorf in March 1834, and, after serving an apprenticeship as a gunsmith, promptly moved into the field of engineering, gaining experience in France and Britain before returning to his homeland.

He was appointed Technical Manager of the Deutz Gas Engine Works (founded by Nikolaus August Otto, credited as the father of the four-stroke, or 'Otto-cycle' engine) in 1872, with Wilhelm Maybach as his right-hand man. However, Daimler's overwhelming interest in faster-running, more powerful petrol engines created a rift in the Cologne-based firm, and ultimately a decision was made to form an independent company dealing with this new technology.

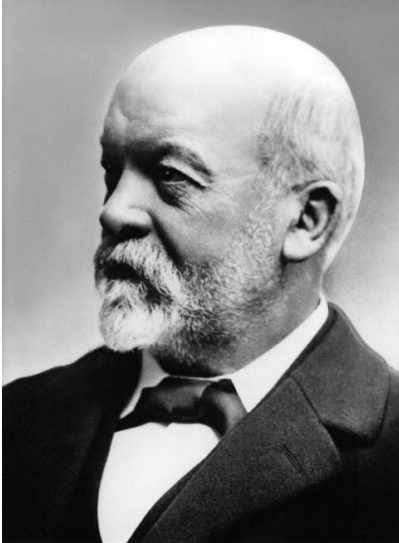

After building a second car, this time powered by a water-cooled V-twin, in 1889, it was obvious that Daimler and Maybach were on the right track. The Daimler Motoren Gesellschaft (DMG) was registered in November 1890 to manufacture and market these two-cylinder units, which were a revelation at the time. As such, Daimler was successful in selling patents to many concerns. One of the first to sign up was Panhard & Levassor in France, who duly provided engines for a number of makers, and became a highly successful car manufacturer in its own right.

Daimler and Maybach remained close friends even after the latter was forced to leave the Cannstatt company due to a clash of policy with its new investors. Meanwhile, Daimler's health was failing. Internal conflict with members of the Board probably didn't help, and, in 1894, he resigned from the company he'd founded.

Daimler and Maybach joined forces again, this time with Daimler's son Paul, and between them they designed a four-cylinder engine equipped with Maybach's innovative spray-nozzle carburettor. Known as the Phönix, it signified the rebirth of a fine team in both name and nature, and, following some political manoeuvring from Frederick Simms in England, the pair was asked to return to the DMG on new, far more favourable terms.

Gottlieb Daimler died in March 1900, although Maybach continued his work before ultimately making aero-engines for the famous Zeppelin airships. After the Great War, Maybach built a series of

luxury cars, until the Second World War put an end to production. Recently, the name was revived as a Mercedes-Benz flagship saloon.

Carl Benz

The son of a train driver, Carl Benz was born in November 1844. After moving around a number of concerns, some involved in the building of iron structures, such as bridges, Benz finally established his own engineering shop in Mannheim in 1871. This was not successful, and Benz turned his attention to two-stroke engines in 1877, with the first unit running successfully two years later.

By 1882, the Benz engine had attracted investors, and Gasmotorenfabrik Mannheim was established, although Benz left the company soon after when the shareholders tried to influence designs. Notwithstanding, in October 1883, 'Benz & Co Rheinische Gasmotorenfabrik, Mannheim' was formed, with the help of two local businessmen, and by 1886 the world's first, purpose-built vehicle to be powered by a petrol engine – the three-wheeled Benz Patent Motorwagon – had made its debut.



Four-wheeled cars were produced in 1891, and Benz continued to innovate, designing steering systems and developing the horizontally-opposed (boxer) engine amongst other things. The commercial success of the company can be gauged by the fact that Benz & Cie AG was registered in May 1899. However, by early 1903, Benz became

disillusioned with the people running the firm and resigned, although he did retain a position on the Supervisory Board until his death.

Meanwhile, Benz formed a new company with his son Eugen in 1906, called C Benz Söhne, which turned to car production after a spell in the field of gas engines. This business, based in Ladenburg, to the east of Mannheim, was duly handed over to Eugen and his younger brother Richard in 1912. This particular firm officially stopped building cars in 1923.

By the way, for many years, it was assumed and accepted that Benz's forename was Karl, in the German tradition, but the correct spelling is in fact Carl. He died in April 1929, but at least he was able to witness motoring evolve from a sport for the well-heeled into an essential part of daily life.

A new star is born

Although the company was known as Daimler-Benz, the cars were marketed using the Mercedes-Benz name, with Mercedes officially losing the accents along the way. Only two Benz models made it into the Mercedes-Benz passenger car programme, and both were gone by 1927.

There were straight-eights from October 1928, and the marque went into the mid-1930s with some magnificent creations, with the SS and SSK giving way to the 500K and 540K. By this time, the company was producing a range of vehicles that went from modest 1.3-litre saloons, with its NA four at the rear, all the way up to 7.7-litre supercharged eights with their glamorous coachbuilt bodies.



A small section of the Daimler works captured on film at the turn of the century. Incidentally, the Daimler Motor Co Limited was not linked to the Stuttgart concern, only inasmuch as the German firm granted FR Simms' English company a licence to build Daimler engines in the 1890s.

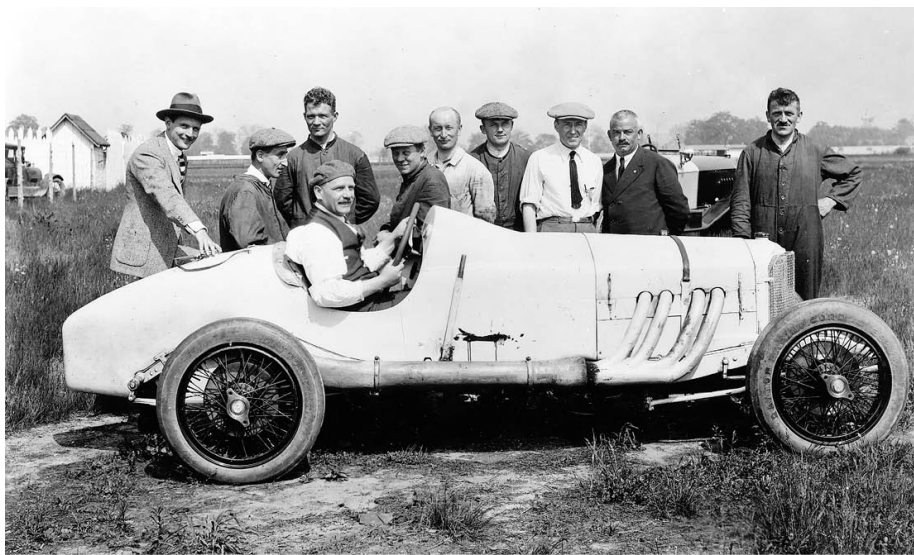

Max Sailer at the wheel of a two-litre supercharged four-cylinder Mercedes campaigned at Indianapolis in May 1923. Sailer finished the US classic in eighth, with Christian Werner bringing home a sister car in 11th.

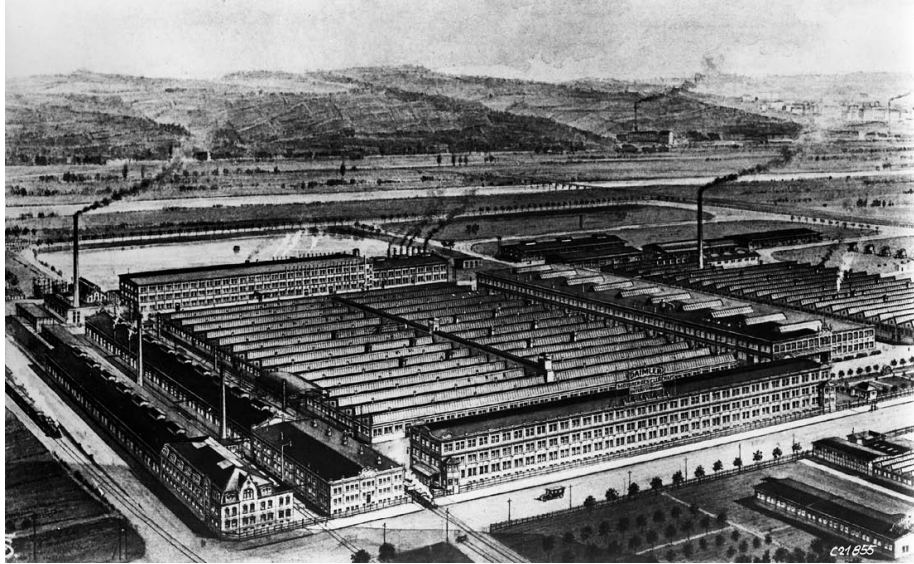

The Daimler Motoren Gesellschaft factory at Untertürkheim, as seen from the air in 1925.



The Benz works at Mannheim pictured during the Great War era.



Prince Albert Wilhelm Heinrich of Prussia, after whom the Prince Henry Trials were named, in a 1907 70hp Benz Phaeton. Carl Benz can be seen standing at the left of the vehicle.



A four-cylinder 10/30hp Benz racer at the Avus track in September 1921.

Meanwhile, 1934 had witnessed the debut of the first of the Silver Arrows – the W25 Grand Prix car. This was followed by a string of successful models that put Germany at the forefront of the motorsport

scene until the outbreak of the Second World War. Record breakers were also built, based on the GP cars, and brought the new Autobahn network into use in a rather unexpected fashion – the straight, level roads being perfect for the challenge to find the fastest man on Earth.

Then, of course, 1939 brought with it conflict, first in Europe, and then on a global scale. Virtually all of the historic Untertürkheim factory was destroyed during an Allied bombing run in September 1944, so it was difficult for Daimler-Benz to bounce back once hostilities ended in 1945.

Like so many manufacturers, Daimler-Benz warmed-over some of its pre-war designs as part of the rebuilding process, releasing its first post-war car (ignoring utilitarian versions and commercial vehicles) in July 1947 – the 1.7-litre 170V four-door sedan. Two new 170 series variants joined it in May 1949, and production continued until 1955, by which time the 180 had been introduced as a stablemate.

1951 saw the revival of six-cylinder engines with the launch of the 2.2-litre 220 series (W187), and the three-litre 300 (W186 II) models in April that year. The sporting two-door 300S made its debut at the 1951 Paris Salon, and shortly after a deal was signed with Max Hoffman, securing a good sales outlet in America. Hoffman also handled Porsche imports for the US, incidentally.

Many companies talk of pedigree. However, few can match the bloodlines of the Mercedes-Benz brand ...



Contemporary poster proclaiming the historic coming together of the Daimler and Benz brands. This particular piece is promoting commercial vehicles.



A 1936 Mercedes-Benz 540K Cabriolet B.

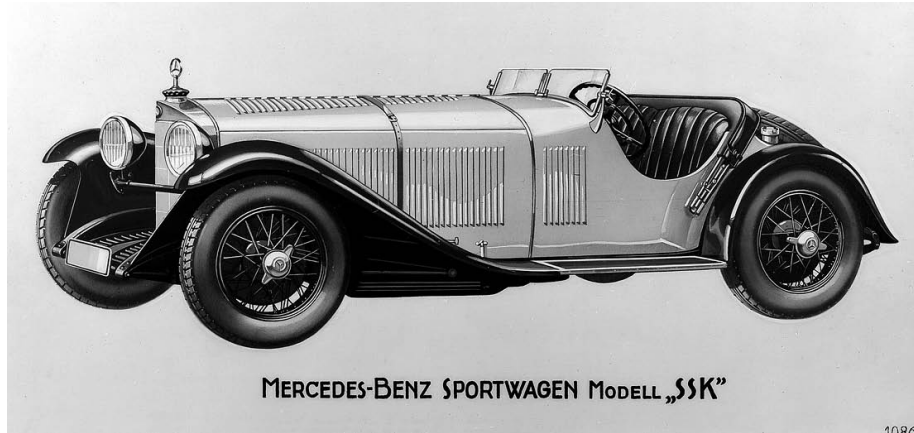

Catalogue illustration showing the highly-desirable Mercedes-Benz SSK model.



Evolution of the Three-Pointed Star



The legendary 'Silver Arrows' at the start of the 1938 Italian Grand Prix, with three 470bhp Mercedes-Benz W154 models sharing the front row with an Auto Union.



A line of 170V models (basically pre-war cars brought back to life after the Second World War) at the huge Sindelfingen plant in 1947.



Promotional material from 1951 for the elegant Mercedes-Benz Type 300 limousine. Styling was still influenced by pre-war design concepts until the arrival of the thoroughly modern 'Ponton' line.

2

The SL – born on the track

The Mercedes-Benz racing team had attained legendary status in the 1930s, with its silver cars hitting the headlines in virtually every country they appeared in. But the war had broken up the equipe, and it wasn't until March 1952 that Mercedes returned to the racing world with a purpose-built factory-backed car. This development marked the birth of the SL ...

With the cessation of hostilities and a gradual return to normality in the industrial nations of the world, Alfred Neubauer wanted to return to Grand Prix racing as quickly as possible with new versions of the pre-war W165 voiturettes, but almost as soon as the production order was granted, it was withdrawn again. A meeting of the hierarchy in Stuttgart concluded that if Neubauer wanted to go racing in 1952, it would have to be with sports cars representing the marque, and any plans to enter a GP machine should be delayed until 1954, when a new formula was set to be introduced.

With classic events like Le Mans, the Mille Miglia and Targa Florio revived, sports car racing was extremely popular following the war, as it was a perfect way of promoting a brand in a manner that allowed enthusiasts to readily relate a victorious machine with a showroom model they could buy, or at least dream about. The need for Europe to export led to an explosion of LWS models, with England leading the way, supplying an American market that was taking as many cars as the ships crossing the Atlantic could carry.

Sports car racing also appealed to those looking after company finances, as road vehicle technology could be developed and tested within the competition department budget – killing two birds with one stone, so to speak. For instance, the C-type Jaguar that had won Le Mans in 1951 was based on XK120 components, and lessons learnt during the 24 hours could then be applied to produce a better road car. In the case of the Mercedes-Benz team, the three-litre W186 II

chassis was deemed to provide a suitable starting point for a new kind of sports-racer.

W194: The first SL

The W194 concept was much the same as that of the Jaguar C-type, using as many proven XK120 parts as possible in a custom-made, lightweight frame, and enhancing power output largely via modifications to the cylinder head and carburetion. The model selected as the donor car by Daimler-Benz was the new, upmarket Type 300. It may seem an unlikely vehicle, but it was the powertrain that appealed, and one has to remember that the XK engine also powered limousines, not just sports cars, so the parallel between the Coventry and Stuttgart companies is still valid.



One of the first press pictures of the new 300SL (or 300SS as it was nearly called), with the shut line on the 'gullwing' doors finishing on the top of the vehicle's waistline. Note also the bolt-on wheels, finished with hubcaps – remarkable detailing for a racing car!

The three-litre engine – considered the main component to work around – and the Mercedes-Benz 300 model it powered were introduced at the 1951 Frankfurt Show, which opened on 19 April. The short-wheelbase 300S coupes and convertibles made their debut at the Paris Salon six months later, but already plans were at an

advanced stage for a sports-racer built around the luxury saloon's straight-six – the engineers in the racing shop, under the direction of Rudy Uhlenhaut, didn't have to wait for the more sporting variant (which came with a tuned powerplant delivering 35bhp more than the regular unit) before embarking on their project.

The sohc M186 base six had a 2996cc displacement (85 x 88mm bore and stroke), and with a pair of Solex carburettors and a modest 6.4:1 compression ratio, produced a lazy 115bhp at 4600rpm. Endowing the unit with three downdraught Solexes, a freer exhaust system, and a hotter camshaft, then hiking the c/r up to 8.0:1 (via special heads and pistons), released an extra 60 horses according to official data, while maximum torque stood at 188lbft.

Rather than sitting atop a backbone chassis, as used on the 300 saloons, the straight-six and its modified, all-synchromesh four-speed transmission was placed within a purpose-built tubular spaceframe, produced in steel and designed using the most up-to-date racing car practices. For the 300SL project, the power-unit was tilted over at a steep angle in order to allow a low body-line, despite the height of the engine.

A dry-sump lubrication system was added at an early stage after testing proved the regular system inadequate for the rigours of competition work, and the sparkplugs were moved to a new location to allow quicker changes to be carried out. As such, a different block was made for the W194 project, although it was still made in cast-iron. With all of the modifications in place, the racing unit was given the M194 moniker.

As for the chassis components, steering came courtesy of the familiar Daimler-Benz recirculating-ball system found on the other 300 series models, while the all-round suspension was also similar to that of the 300 road car, with double-wishbones and hydraulic dampers placed inside coil springs at the front, and a swing-axle arrangement at the rear, which employed separate springs and telescopic tube shocks.

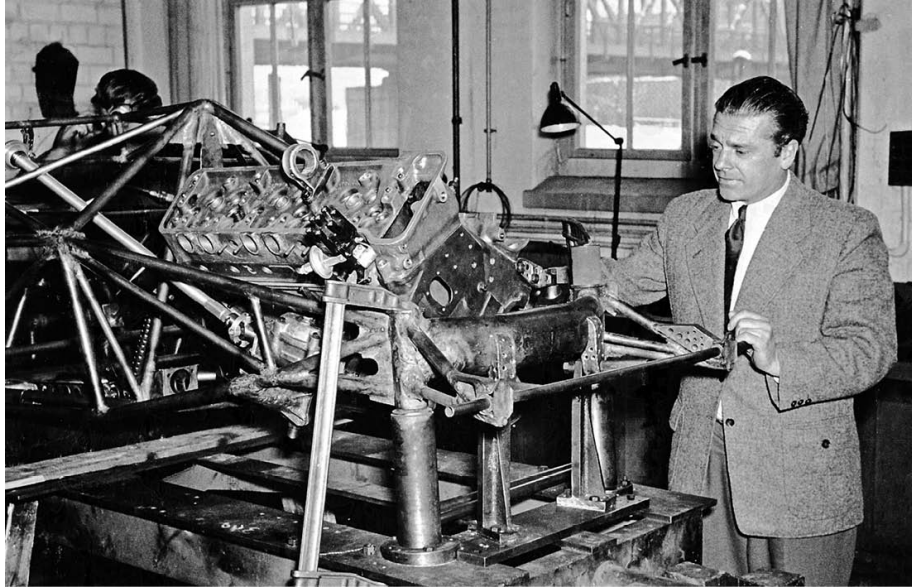

Rudy Uhlenhaut checking progress on a 300SL. Note the spaceframe and the way the engine was angled over to keep the bonnet line as low as possible.

The first pictures released showed bolt-on wheels (complete with hubcaps!), although knock-off hubs were adopted to allow for quicker wheel changes. A 15-inch wheel and tyre combination was specified, with alloy rims playing host to Continental racing rubber. Beyond the wheels, there were drum brakes on all four corners, finned for enhanced cooling, while those fitted at the front of the car had a greater friction material area than the 300 saloon's brakes due to their extra width.

As for the body, in addition to the obvious aerodynamic concerns, assuming there was adequate ventilation, a closed coupe configuration also improved driver comfort and concentration, as sports car races tended to be long, and were often held in awful weather – buffeting from an open car at high speeds can be tiring, and no driver could be expected to give his best performance whilst cold and soaked through either.

Novel 'gullwing' doors were introduced to keep the spaceframe as stiff as possible, as regular doors require a large cut-out in an area that is critical in retaining chassis strength. It was an ingenious idea, typical of the Daimler-Benz competitions department, with the original doors

being no more than windows that tilted upward to allow the driver access to the well-trimmed and beautifully prepared cockpit. However, the design was modified in time for the Le Mans race, with slightly deeper doors that pleased the folk at the ACO but lost little in the way of structural rigidity.

The wheelbase was set at 2400mm (94.5in), as opposed to 2900mm (114.2in) for a production 300S, while the height, at 1265mm (49.8in), was some 245mm (9.6in) lower, helping reduce the car's centre of gravity by a large amount. The front track was narrow to keep as much of the front wheels underneath the aluminium bodywork as possible, aiding aerodynamics, while the rear track was wider to allow the swing-axle to work efficiently at high cornering speeds.

The two spare wheels and fuel tank were placed in the tail of the car to provide better traction, and provide a balance for at least some of the weight of the powerplant up front. The aluminium-bodied 300SL was hardly lightweight by absolute standards, but, at 870kg (1914lb), it was half the bulk of a regular 300S coupé.

The first prototype was ready for testing in November 1951. Neubauer wasn't happy, demanding more power, a five-speed transmission, and bigger brakes behind a 16-inch wheel and tyre combination. However, budget and time restrictions ruled out any further changes.

March 1952 witnessed the press presentation of the new car, with motoring scribes leaving Neubauer out in the cold. As an enthusiastic John Whitten wrote in *Road & Track* at the time: "The three-litre car, according to its specifications alone, should be a winner; but when you couple it with the name of the team which is to drive it in competition, it sounds like an unbeatable combination: Rudolf Carraciola! Hermann Lang! Karl Kling!"

Whitten obviously still had lucid memories of the men that handled the Silver Arrows in the heyday of pre-war racing. But there's little doubt that the Mercedes-Benz team had strength in depth, and the advantage of Alfred Neubauer running things from the pits. Neubauer may not have given the 300SL project his full support, but he was not a man to let personal reservations dampen his determination to win.

The first race for the 300SL was the Mille Miglia, held in the first

week of May, and taking in almost 1000 miles (1564km, as it happens) of Italian roads on a return trip to Brescia via Rome. Naturally, the three works cars were painted silver! The Lang/Grupp machine was forced into early retirement, but the Kling/Klenk pairing was second, less than five minutes down on the winning Ferrari, whilst the Caracciola/Kurrle SL came home in fourth.

The next event, the sports car race before the Grand Prix in Switzerland, was basically a shakedown for Le Mans, and a chance to try a new door arrangement on the fourth works entry. Sadly, Caracciola had an accident that brought his career to an end, but the remaining cars all finished on the podium, much to the chagrin of the Ferrari contingent, and the deeper doors were approved for the 24-hour race at the same time.



Three works cars were entered for the 1952 Mille Miglia. This is the 300SL of Karl Kling (right) and Hans Klenk.

The modified car used in Berne (chassis 006/52) was rolled out as a spare at Le Mans, joined by three brand new cars with the deeper 'gullwing' doors. The spare car was used in practice to try an experimental, roof-mounted air brake, and, whilst it wasn't used in the race (more work was definitely needed on the design), the concept was good, and it would be seen again on later Mercedes-Benz sports-

racers.

Although the Kling/Klenk SL dropped out with electrical problems, the Jaguar threat soon disappeared when the new streamlined bodies presented unforeseen cooling difficulties, and the Ferraris buckled under the fast early pace. The engine in Pierre Levegh's Talbot-Lago gave way whilst he was in the lead, leaving Neubauer's team to take the spoils, with the Lang/Riess car taking the flag, and the Helfrich/Niedermayr machine coming second, 14 laps ahead of its nearest rival. In the process, the 300SL duly became the first closed car to win Le Mans.



Action from the sports car race held in Bern, Switzerland, on 18 May 1952. The 300SL of Rudolf Caracciola can be seen leading two of the three sister cars entered in the event. Victory ultimately went to Karl Kling in the number 18 machine.



Three brand new 300SLs were built for the 1952 Le Mans 24-hour race, each incorporating an extended door, and a new fuel filler arrangement.

Quality breeds Speed

Experience and success
in racing has contributed to
the evolution of one of the
world's finest and finest
motor cars.

MERCEDES-BENZ

NOW AVAILABLE IN GREAT BRITAIN
Through the Sole Concessionaire in the United Kingdom
MERCEDES-BENZ (GREAT BRITAIN) LTD., 111 Grosvenor Rd., Victoria, S.W.1
Telephone: VICTORIA 8724.

British advertising making the most of the SL's success in Switzerland.

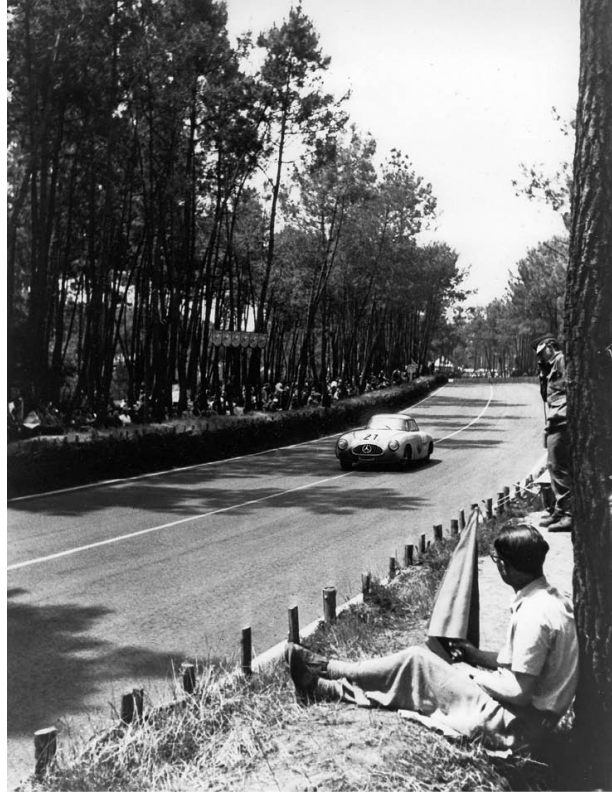

The Mercedes-Benz 300SL of Hermann Lang and Fritz Riess in action at Le Mans, en route to a fine victory in the 24-hour classic.



The roadster version of the 300SL, this particular car being chassis 006/52. Several windscreen variations were made – this one, combined with a tonneau cover, being for shorter track races, where no passenger was carried. On longer events, when a co-driver was required, a full-width screen was fitted.

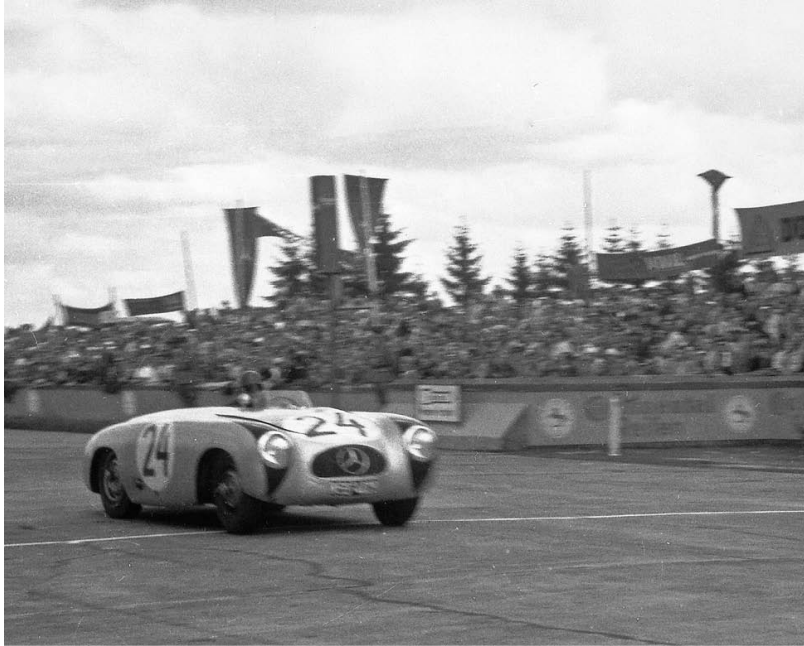

Mercedes-Benz dominated the field at the Nürburgring in August 1952. The works 300SLs filled the first four places in this German Grand Prix support race.

Next up was a German Grand Prix support race at the Nürburgring, and naturally, it was important for Daimler-Benz to put on a good show in front of a home crowd. As a short-distance sprint event, running the cars as light and powerful as possible was the key to success, acknowledgement of which came with the birth of the 300SL roadster.

Due to the spaceframe chassis, it was fairly simple to convert the W194 from a coupe into an open car, and thus reduce weight effectively as additional bracing was hardly necessary to retain rigidity. A one-off shortened version (chassis 010/52) was built, powered by a supercharged M197 engine, but traction (and early reliability) was a real problem, and the four works spiders all ran with normally-aspirated units. Lang won in 007/52 (the Le Mans winner with its new body configuration), followed home by his three team-mates.

A last minute decision was taken to enter the SL in the Mexican road race called the Carrera Panamericana, with two coupes and a roadster handled by top class drivers. The engines were bored out to give a 3105cc displacement, thus releasing a few extra horses, as this was

indeed an event in which power was king. Ultimately, John Fitch was disqualified in the open car, but the coupes overcame early tyre problems to finish one-two in a convincing display of German efficiency.

Unfortunately, the 300SL programme was cancelled long before the 1953 season started, but it was certainly a useful exercise, both from a publicity and an engineering point of view. Even the supercharged roadster debacle led to the development of the low-pivot swing-axle, which would later become a signature feature on Mercedes-Benz road cars. As the old saying goes, racing improves the breed ...



A rare contemporary colour shot from the Carrera Panamericana. This is the car shared by Hermann Lang and Erwin Grupp.



Kling and Klenk had a vulture go through the windscreen on the first stage of the Carrera. The vertical bars seen in this picture were fitted soon after to protect the new window glass.



The roadster of John Fitch and Eugen Geiger was running well in Mexico, but was disqualified for accepting assistance outside an authorized service area.



Karl Kling taking a well-earned rest during the Carrera Panamericana, an event he went on to win.



Plans were drawn up for a lighter, narrower car for 1953, complete with a fuel-injected engine, a transaxle at the rear, a modified rear suspension incorporating a low-pivot swing-axle, and a 16-inch wheel and tyre combination. However, the project was cancelled in favour of putting greater effort into the 1954 Grand Prix car and the 300SLR allowed to be based on it. Only one prototype (chassis number 11) was built as a result.

Rudolf Uhlenhaut

A key figure in the birth of the 300SL was Rudolf Uhlenhaut, born in July 1906 to a German father and an English mother. Uhlenhaut was put in charge of the new racing shop at Daimler-Benz, established in 1936 to bridge the gap between Neubauer's arm of the experimental department and the central design office. It was a huge responsibility for the young man. However, Uhlenhaut quickly proved he had the technical knowledge and enough skill behind the wheel to make him the perfect man for the job. He was able to lap a Grand Prix car on a par with the best of the Mercedes-Benz team members, and his logical mind, combined with his exceptional level of mechanical sympathy and feel, enabled many problems to be ironed out quickly and efficiently.

As Stirling Moss once said: "He could drive any of the cars nearly as fast as we could. In the 1930s, his performances merited a regular

place in the team, but he was too valuable as an engineer to be risked in a possible accident. Apart from his great influence on the design of the cars, it was he who would do everything to see that the driver had the sort of car he wanted ...”

Uhlenhaut was responsible for making the Silver Arrows into winning machines in pre-war days, and also for breathing life into the SL series, taking the notes and drawings made in numerous meetings involving management, engineers, designers and drivers, and transforming them into a car that would form the foundation stone for a new generation of Mercedes-Benz legends ...



Rudy Uhlenhaut.

The Silver Arrows

Even today, mention of the Silver Arrows immediately conjures up an image of a golden age in the 1930s when Mercedes-Benz and Auto Union dominated the Grand Prix scene with their highly advanced, but technically quite different, machines. Like Daimler and Benz in the veteran era, there was a healthy rivalry between Mercedes-Benz and Auto Union, with the two forever being inextricably linked.

The Silver Arrows legend was born when the W25 was designed to

compete in the new 750kg formula devised for the 1934 Grand Prix season. They started life finished in German racing white, but were stripped of their paint to save enough weight to qualify for their first race, and became silver by default! Silver then became synonymous with the Mercedes works team, as well as that of the rival Auto Union camp.

Rudy Uhlenhaut was responsible for refining the highly-successful W125 that followed, a car that won many of the big races of 1937. When the formula changed again, Mercedes-Benz responded with the W154, powered by a three-litre supercharged V12, and, with the contemporary Auto Unions, German domination of the race tracks unfolded. Even the Italians changing the rules for the 1939 Tripoli Grand Prix couldn't stop Mercedes winning with a 1.5-litre W165 model, built from scratch in an unbelievably short space of time.

As well as the cars and their heroic drivers, the name of Alfred Neubauer came to the fore as the perfectionist manager of the Mercedes-Benz team. Neubauer had been a racing driver himself, competing in the Porsche-designed Mercédès models of yore. As a matter of interest, there was another link between these Stuttgart neighbours (Porsche and Mercedes, that is), as Daimler-Benz had built some of the early Volkswagen prototypes – the VW Beetle being one of Professor Porsche's most acclaimed designs.

After the war, the Silver Arrows returned to the track, first via the Mercedes-Benz 300SL, and then more specialized versions of the model. By 1954, Neubauer's dream of a return to Grand Prix racing had materialized, and another era of domination began ...

3

SL road car heritage

In the vintage years, enthusiasts were able to buy touring car versions of the Mercedes-Benz racers – the SSK was as awesome on the highways and byways as it was on the track, and no-one will ever forget the lightened SSKL version built strictly for competition use. Now, shaking off the ill-effects of war once and for all, Daimler-Benz was able to modernize its passenger car range, and once again offer connoisseurs of motoring what was essentially a race car for the road

...

The summer of 1953 marked the arrival of the slab-sided 'Ponton' series, giving the styling cue for a whole new generation of Mercedes-Benz models. It was launched in 1.8-litre four-cylinder guise (W120), although a 2.2-litre six-cylinder version (W180) had joined the line-up by the following spring.

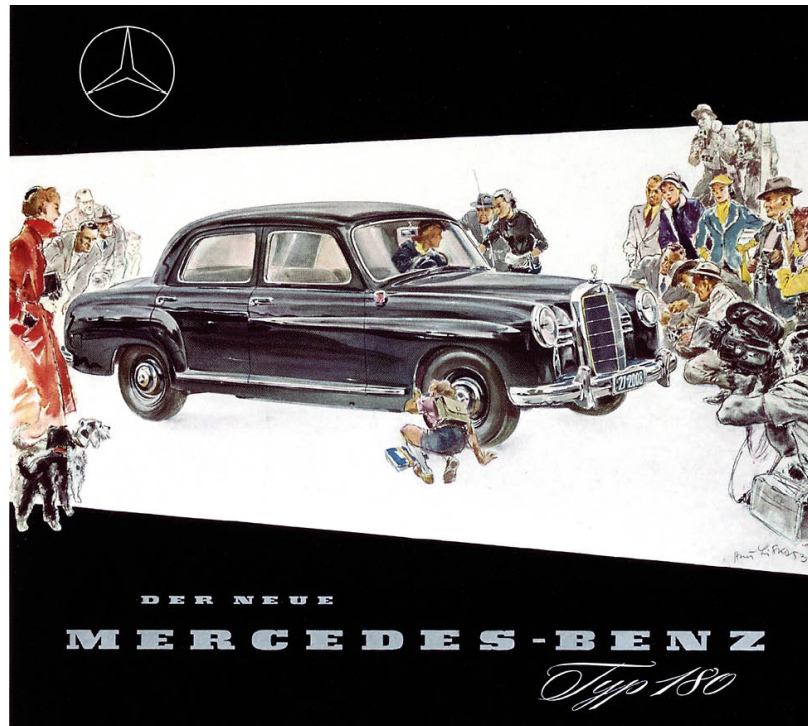

The first all-new post-war Mercedes-Benz was the Type 180 (W120), often referred to as the 'Ponton' model. This had a unit-construction body (adopted for the first time by the marque), and modern styling that would influence the passenger car line for many years after its public debut in September 1953.

Meanwhile, the announcement of two new sports cars at the 1954 International Motor Sports Show in New York had enthusiasts in raptures: the three-litre, fuel-injected 300SL, with styling inspired by the 1953 SL prototype, and the much simpler, smaller-engined 190SL. Although it would be some time before either SL made it into the showrooms (the second Type W198 300SL, for instance, wasn't built until six weeks after the New York exhibition had ended, and even that was still a pre-production prototype), it was no coincidence that they were announced just as the latest W196 F1 car was about to hit the Grand Prix scene.

With the 190SL an unexpected bonus in New York, it's not surprising that the 300SL was the first to appear in dealerships, with series production of the Type W198 model having started in August 1954. As it happens, Fritz Nallinger, the firm's Technical Director, was

bitterly opposed to the idea of a road car, but when Max Hoffman in the States placed an advance order for 500 units to kick-start the project, commercial concerns took precedence, and its birth was almost guaranteed. In many ways, it was a repeat of 1900, with a thinly disguised sports-racer acting as a technological showcase for the German brand.

Mercedes-Benz designations

For many years, Mercedes-Benz models have been identified by a vehicle class letter (or series of letters) and a number, which usually relates to an engine size. It's a system that has continued to this day, with C 350 being a C-Class saloon with a 3.5-litre power-unit, although the engine displacements don't always tie-up precisely in the way they used to.

The designation that interests us the most at this stage in the story, however, is 300SL. The '300' denotes a three-litre powerplant, while 'SL' is short for Sport and Licht – in English, this would translate into a description of a lightweight sports (LWS) model.

For reference, the addition of an 'R' suffix (to make SLR) distinguished a pure racing model from the later production road cars, while a 'C' (to make SLC) denotes a coupé version of the SL. One will also come across a 'K' quite often in Mercedes circles, which used to refer to short chassis models pre-war (as in Kurz), but nowadays is taken to mean Kompressor, the German for supercharger.

The type W198 300SL

The regular 300 series had been styled by the master, Hermann Ahrens, who had previously conceived the classic lines of the 500 and 540K Roadsters, but the thoroughly modern lines of the SL were the work of Walter Häcker and his team.

Compared with the 1952 racers, the W198 had crisper styling, with a new grille incorporating a large three-pointed star on the lower front-end, parallel power bulges in the bonnet to clear the engine, and headlights that sat more upright than before. The heavy bumpers were classed as a necessity for a road car, and the air vents on the trailing edge of the front wings had been introduced on the 1953 prototype

(built on chassis number 11) to reduce aerodynamic drag and allow better cooling of the engine bay.



The 300SL (nearest the camera) and 190SL making their debut appearance at the third International Motor Sports Show in New York, an event which opened on 6 February 1954. Although not quite production specification, they were nonetheless very close to the final design.



With the distinctive 'gullwing' doors open, one is afforded a glimpse of the cockpit of the 1954 300SL show car.

The side-exit exhaust, introduced midway through the 1952 racing season and carried over to the 1953 model, was not suitable for road use, so a normal silencer arrangement was used with a pipe poking out of the tail on the nearside, and the fussy-looking rear vents were deleted, whilst many of the other details, such as the wheelarch blisters and chrome trim on the sills, were purely cosmetic – items added in a bid to make the car more appealing visually.

Interestingly, although a spaceframe was still employed (very similar to that of the racer, with the same 2400mm/94.5in wheelbase, albeit with a certain amount of additional bracing), most of the body panels were steel for the production models, with only the front and rear lids and door skins crafted in aluminium. On saying that, a handful of all-alloy cars were built for competition work (a total of 58), and there was even a single glassfibre prototype.



Compared to the New York show car, the production 'gullwing' model had different door handles and side windows, along with numerous detail changes to the interior. The W198 300SL was built at a rate of around 25 cars per month initially, moving up to 50 soon after.



British advertising from November 1954 for the 300SL model.



A 300SL pictured in a Hollywood showroom in the USA in 1955.

The dry-sump straight-six power-unit (Type M198) was a leading

edge piece of technology, and, although already proved on the 1953 prototype, the 300SL became the first series-production road car to sport fuel-injection.

With experience relating to fuel-injection gained during the war via aero-engine development and knowledgeable engineers like Hans Scherenberg (then in charge of the central design office) assigned to the M198 project, the Bosch system was quickly releasing copious amounts of reliable power and torque, and any lingering thoughts about moving over to Weber carburettors were duly dismissed.

The configuration of the injection system was very clever, with the injector nozzles placed in the original sparkplug holes in the upper part of the six-cylinder block (a throwback to the days before the plugs were moved to a new head for the SL) to give direct injection. Air, meanwhile, was pulled in through a beautifully crafted plenum chamber and ram pipe casting that became a signature part of the 300SL's design.

With a standard 8.5:1 compression ratio, the 2996cc (85 x 88mm) unit ultimately developed 200bhp DIN at 5800rpm – a figure higher than that quoted for the original SL racing cars. Specifying the 'sports camshaft' released another 15bhp, and cars were often supplied with higher compression ratios as well; a 9.5:1 c/r gave ten more horses.



The 1000th 300SL was built in early December 1955. Incidentally, all 'gullwing' coupés were sprayed silver unless the customer specifically requested another colour.

The all-synchromesh four-speed transmission was carried over from the 1952 racer, and likewise, various axle ratios were available, the highest allowing an observed top speed of 154mph (246kph) – remarkable for the time. At this stage, the steering, suspension and braking setup was pretty much carried over, too, albeit with softer springs and dampers than the 1952 racers (those intending to use the car in competition could specify the stiffer setup as an option), and the addition of trailing links at the back. Even the 15-inch wheel and tyre combination was retained rather than taking up the 16-inch rims selected for the 1953 prototype, although a brake servo was added to the specification list for 1954 to make the car more civilized.

With a more comfortable interior, a hinged steering wheel to aid entry and egress, and greater attention paid to heating and ventilation (the grille in the front bulkhead and two slots in the trailing edge of the roof were added for this reason), the 300SL was an ideal road car, albeit much heavier than the vehicle that spawned it, being catalogued at 1260kg (2772lb). At DM 29,000, it was around DM 5000 cheaper

than the hand-built 300S line, but still twice the price of a 1.5-litre Porsche Speedster.

The company's victory in the 1955 Mille Miglia was memorable, and has been recalled in motoring publications literally hundreds of times since, although winning in such a convincing manner has always tended to overshadow the GT Class win by John Fitch's regular 300SL, which finished the Italian event in fifth; Olivier Gendebien was second in the GT category (seventh overall) in a similar machine.

Fitch later recalled that while Italian exotica had an advantage in top speed, the SL "... was tough, and that's why it won races." It also won the hearts of the press and public alike. Jesse Alexander reported in *Road & Track*: "The 300SL seems to be the perfect example of the modern trend in Continental automobiles, that of producing a fast but extremely comfortable sports touring car with the use of an aesthetically-pleasing, aerodynamic, lightweight body in conjunction with an untemperamental yet efficient engine."

The venerable John Bolster of *Autosport* fame concluded his January 1955 road test with the following prose: "The Mercedes-Benz 300SL is a car of beautiful appearance and almost incredible performance. Its construction and finish are of the very highest class, and its whole design represents a technical tour de force. It has perfect traffic manners, and the sheer joy of handling it on the open road has to be experienced to be believed. There are other cars which are kinder to the less experienced driver, but for the man who is competent to exploit its full performance, this is one of the world's greatest cars."

Coupé production ended in 1956, with the last few of the breed sold in the following year. 1400 had been built in total, with four out of every five cars ultimately shipped to the States (the 300SL was listed at close to \$7000 on arrival in the US, although prices quickly rose to \$8905). Incidentally, in 1994, a 'gullwing' 300SL came to light that was bought piece-by-piece by an enthusiast in America some two years after production of the model ended. When Bob Doehler, a Studebaker designer, acquired the final parts in 1961, he was sadly unable to complete the project, and the car sat in a half-finished state until he died in 1993. Would this add another unit onto the production total?



The 300SL was ideally suited to track work and road rallies. This picture was taken during the Swedish Grand Prix weekend in 1955, with Karl Kling leading Wolfgang von Trips. Kling went on to win the race.

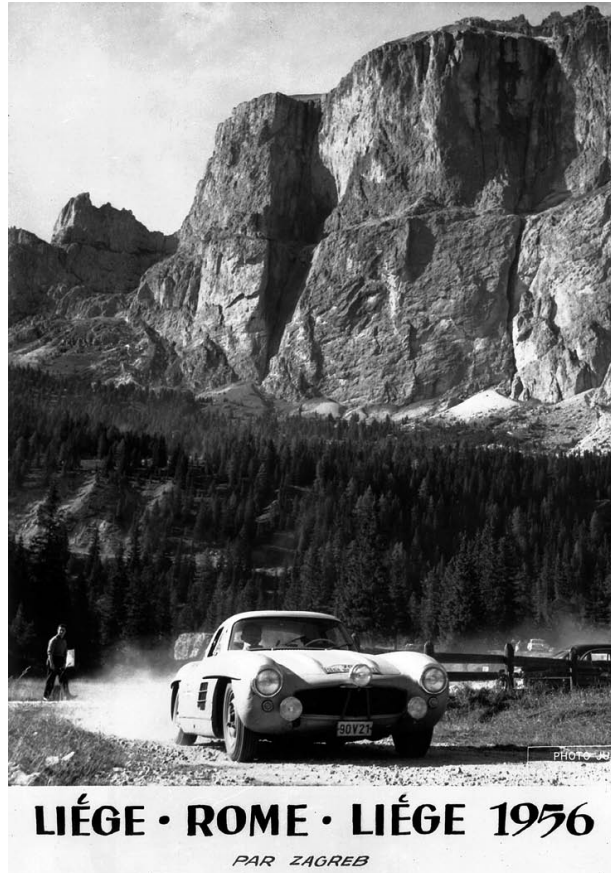

Memories of the 1956 Liège-Rome-Liège Rally, which Mercedes won.

GP racing & the 300SLR

Mercedes-Benz made its long-awaited return to Grand Prix racing in 1954 with the 2.5-litre normally-aspirated W196 model, fielded with both streamlined and open-wheeled bodies. Having made their debut at Rheims in July, the straight-eight machines went on to dominate the GP scene in 1954 and 1955 in much the same way as the pre-war Silver Arrows had.

Regulations at the time allowed sports-racers to be developed from GP cars, and Daimler-Benz responded with the 300SLR for use in the 1955 World Sports Car Championship. Being based on the Grand Prix car of the time, the 300SLR (W196S) had nothing in common with the regular 300SL, although the 2.5-litre engine was bored out to give a three-litre capacity, hence the similarity in its designation. The body enclosed the wheels, in much the same way as the streamlined GP cars used on faster circuits.

The 300SLR gave a stunning performance on the Mille Miglia, but at Le Mans, one of the cars was involved in an horrific accident on the pit straight. This prompted the decision for the Mercedes-Benz team to stop racing, although some inside the company say it was largely down to the concerns of Professor Nallinger, who felt that road car development was suffering as a result of all the firm's top designers and engineers being far too busy in motorsport-related activities. Whatever, it was certainly a sad occasion on 24 October 1955, when Alfred Neubauer dropped covers over his beloved racing cars in full view of the press. He wept openly at the event. Enthusiasts everywhere felt his sorrow ...



Mintex advertising from 1955, featuring the W196R monoposto of Stirling Moss.



Juan-Manuel Fangio about to start the 1955 Mille Miglia in a 300SLR.

The type W121 190SL

Series production of the 190SL convertible started in May 1955, about six months behind schedule. This was rather ironic, given that the 190SL was always going to provide Daimler-Benz with better volume sales in the States than the 300SL, so one would have thought it would have been more prudent to get the cheaper machine out first. However, people had an image of the 'gullwing' body whenever the SL moniker was mooted, hence the model release order, and the smaller-engined car could then ride on its fame using the same Sport Licht badge.

While it's fair to say the 300SL was built using many production parts sourced from the regular road car line, the ratio was much higher in the 190SL. Even the chassis was based on a shortened Type 180 pressed-steel floorpan rather than a dedicated tubular spaceframe, whilst most of the running gear and chassis components were simply lifted straight out of the Type 180 parts bins. This reduced cost and development time, with advantages far outweighing the disadvantages for the manufacturer.



Cover of the 190SL catalogue. The smaller-engined SL was priced at DM 16,500 in Germany.



An early 190SL on the filmset of High Society, the smaller rear lights indicating that the car was made before June 1956. Whilst always fitted to US cars, rear bumper guards had become standard for all markets in July 1957, when they were modified to carry the number plate lights.

Styled under the watchful gaze of Walter Häcker, the final prototype

was exhibited at the Geneva Show in the spring of 1955. Compared with the 1954 show car, the bonnet, bumpers and lights were revised, and the grille and rear wings brought more into line with the 300SL, although the 'Ponton' styling influence was still very much in evidence on the latter.

A hardtop was available from the off, giving the buyer the choice of a convertible roadster (with soft-top only), or a car with a hardtop, supplied with or without a hood. Interestingly, the hardtop model was called a coupé in official paperwork, and came with additional chrome trim on the sills and wheelarch blisters. Early hardtops were crafted from aluminium, but were made from pressed steel from the spring of 1956.



The 190SL may not have been quite as glamorous as the 300SL, but it was an accomplished sporting tourer that was infinitely more affordable to buy and run. The North American market was by far the most important outlet for European sports cars, of course, with the 190SL introduced to US buyers at a reasonable \$3998.



Engine bay of the 190SL.



A press photograph of a 190SL with hardtop dated June 1958. The later-style hardtop introduced in October 1959 gave far better rearward visibility. The only significant change applied to the 190SL that helped with identification after that was to the bootlid lock, which was separated from the lid lift in 1960.

The body itself was largely all-steel on the 190SL, although the front and rear lids and door skins were aluminium. Even lighter doors were announced in the New York press material and appeared in several

catalogues thereafter. These, along with the fitment of a lightweight aero-screen and removal of the bumpers helped reduce weight for those wishing to go racing at weekends.

On a more practical note, while the 300SL had next to nothing in the way of trunk space due to its oversized fuel tank, with a parcel shelf behind the seats providing the main luggage area, the 190SL had a good-sized boot. Fitted luggage was available from the maker for both cars. In addition, a third transverse jump-seat was listed for the 190SL, fitting in behind the two front ones, or a bench-style front seat was another option.

The engine was a high output 1897cc sohc four, with the same bore as the 300SL, but a shorter 83.6mm stroke. This bore/stroke combination was quite different to that of the original Type 180, adding 130cc to the cubic capacity, which had started out at 1767cc for the sedans, but it was duly adopted for the 1956 190 series, as well as the Type 180a of 1957 vintage. In the 190SL, a pair of twin-choke Solex carburettors and an 8.5:1 compression ratio gave 105bhp DIN at 5700rpm, with power taken to the rear wheels through a four-speed manual transmission.

Using the Type 180 floorpan allowed the Daimler-Benz engineers to employ the sedan's front subframe arrangement for the SL, with the engine, gearbox and front suspension system carried on an independent pressed-steel cradle that was then attached to the body via rubber mounts to isolate NVH – an incredibly advanced feature for the time. The concept was further refined in January 1956 thanks to an improvement in the way the engine was mounted in the subframe.

The suspension itself was quite conventional, with fabricated upper and lower arms at the front, coil springs around damper units, and an anti-roll bar. The back end featured a low-pivot swing axle with the addition of revised, fairly hefty trailing links to give superior roadholding, the handling situation being further helped by the adoption of 13-inch wheels and tyres, which, although of unusually small diameter for the day, had the effect of reducing the roll centre height.

Braking was via drums all-round, but with the drums themselves made from cast-iron rather than the expensive Al-Fin bimetal (ribbed

alloy sleeves over cast drums) items used on the three-litre car. They were still finned, at least, for enhanced heat dissipation, while a servo was initially offered as an option before becoming standard shortly after production began. Steering, meanwhile, was via the familiar recirculating-ball system for so long championed by the men in Stuttgart; lhd or rhd was available, unlike the 300SL coupé, which was officially sold with left-hand drive only.

The 190SL was subjected to a number of detail changes over the years. By far the most important were carried out in time for the 1960 Model Year, when the engine's compression ratio was upped to 8.8:1 to maintain power output at 105bhp (120bhp SAE), and a new hardtop was introduced to give better visibility. A total of 25,881 190SLs had been built by the time production ended in February 1963.

Bringing together the Silver Arrows

Bitter rivals in pre-war racing, it is ironic that Daimler-Benz acquired a majority interest in Auto Union in 1958. Auto Union had brought together Horch, Wanderer, Audi and DKW in 1932 – four car companies with expertise in quite different market sectors. With the end of the war, most of the Auto Union factories were placed in what became known as East Germany, so a new company was established in Ingolstadt not long after hostilities ceased. Initially, only the DKW brand rose from the ashes, however.

Complete control of Auto Union was secured in December 1959, when Daimler-Benz was also showing an interest in owning a chunk of BMW. The latter deal fell through, but the Stuttgart firm nurtured the revived Auto Union name before selling the business to Volkswagen in 1964. VW duly brought back the Audi name once it took control of its new subsidiary, later merging it with NSU, which held the rights to the Wankel rotary engine – a power-unit that set the motoring world alight, with Daimler-Benz also falling for its appeal.

Today, Auto Union is ably represented by Audi AG, its cars carrying the same four rings on their noses as the pre-war racers designed by Professor Ferdinand Porsche. Audi is still owned by the Volkswagen group, which is in merger talks with Porsche. It's a small world in the German car industry!

The second generation 300SL models

The 300SL had been a magnificent ambassador for the Mercedes-Benz marque, especially in America. Granted, the 190SL brought greater success in the showrooms, but the glamour associated with the 'gullwing' model was an advertising agent's dream. It was expensive to build, however, and the two SL lines were hardly close in concept. The new 300SL (Type W198 II), first shown at the 1957 Geneva Salon, would take most of the three-litre car's attributes and package them in a roadster body, thus bridging the gap for the marketing men to go to work on a campaign that gave meaning to the SL badge – at the request of Max Hoffman in the States, the Sport Licht moniker would from now on forever be associated with open sports cars.



Fascinating picture of the lightweight roadster body being carried to the production line. The untrimmed shell tipped the scales at 185kg (407lb).



Contemporary colour shot of an early Type W198 II model.

Full-scale production began in May 1957. The biggest difference was found in the bodywork, with the 'gullwing' arrangement giving way to an open structure with regular doors and frameless wind-up windows. This, of course, led to significant changes in the centre section of the spaceframe, which was further modified to allow a slightly longer tail (combined with a smaller fuel tank, this freed up more trunk space) and a fractionally wider track.

Although very similar to its predecessor in most other respects, careful observation revealed some beautiful detailing on the new car, with fabulous Lichteinheit front lights (bringing headlights, foglights and indicators into a single unit, although US-spec lights were different by necessity), longer chrome flashes in the side vents, and sharper swage lines in the rear wings.

In addition, while the 190SL soft-top required a regular tonneau cover, the 300SL hood dropped into an area behind the seats, being covered by a hinged metal panel when not in use – a very clever piece of design, and something carried over to future SL generations. Introduced at DM 32,500, the roadster was given the option of a removable hardtop in the summer of 1958.

Mechanically, the biggest change was applied to the rear axle, with a new low-pivot swing axle design that incorporated a novel, central compensating spring. The steering was slower than that of the

'gullwing' model, though still faster than that on the 190SL, and while drums were still fitted, the latest three-litre car gained servo-assisted discs from March 1961; the 220SE was the first Mercedes-Benz with disc brakes, although they were sourced from Girling and fitted on the front axle only in this case – the SL used a Dunlop setup on all four wheels.

Also, due to the extra chassis bracing required with an open car, plus the luxurious appointments of the interior, the new 300SL was significantly heavier than the closed coupé, so a high-lift sports camshaft was fitted as standard to enhance power output (the sohc six developed 215bhp at 6100rpm). In March 1962, the SL was given an alloy block to save weight, although cast cylinder liners were employed to prolong engine life.



Production shot from 1958, with a 300SL roadster being tended to on the line. Note the modified spaceframe chassis.

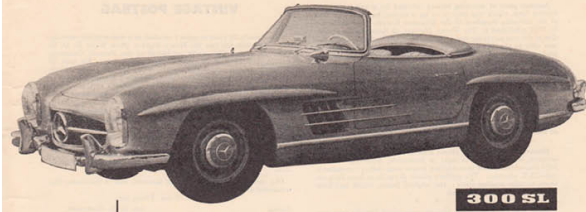

FOR EXPERIENCED DRIVERS...

The Mercedes-Benz 300SL roadster with its 240 b.h.p. fuel-injection engine, is one of the world's finest and fastest sports cars. The 300SL offers standards of comfort and safety usually found only in luxury limousines. It is a thoroughbred, through and through, direct descendant of a long line of world-famous race and rally winners.

300SL, 6-cyl., 240 b.h.p., 2,996cc engine (fuel injection); power brakes, balanced suspension system; speeds up to 155 m.p.h.

Send for free illustrated literature and name of nearest dealer

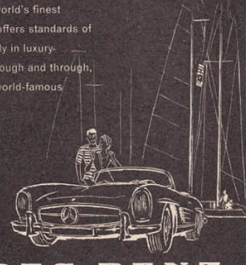

MERCEDES-BENZ

MERCEDES-BENZ (GREAT BRITAIN) LIMITED
 WEST END SHOWROOMS: 10 ALBEMARLE STREET, W.1. TEL: HYDE PARK 3351
 HEAD OFFICE, SERVICE & SPARES DEPT.: GREAT WEST RD, BRENTFORD, MIDD. X. TEL: EALING 3070

British advertising from March 1959.



This elegant roadster with optional hardtop was featured in a catalogue released in late 1959, although this particular shot was taken the previous year.

In the meantime, two lightweight roadsters were produced by the works for use in the American SCCA series. These so-called 300SLS models were completed in the spring of 1957, handing Mercedes stalwart Paul O'Shea the SCCA Class D championship by a country mile.

In the spring of 1959, *Autosport* noted: "On the whole, driving this superb machine was an exhilarating experience. Only a race-bred machine could behave like the 300SL, and although there may be a few faster cars, it would be difficult to imagine anything else which could compete as regards sheer perfection of engineering and a remarkably high standard of finish."

Like the 'gullwing' model, though, this second 300SL was also destined to be a rarity, with only 1858 units built by the time production ended in 1963. Historically significant in so many ways, these were to be the last Daimler-Benz passenger cars to feature a separate chassis.

The 'Pagoda' roof series

The last of the 300SL and 190SL models were built in February 1963. However, the 300SLs were little more than exotic, small volume masterpieces. It was the 190SL that had sold in worthwhile numbers, and the next generation Sport Licht model (first presented in March 1963 at the Geneva Show) was basically a replacement for the four-cylinder car – a mainstream vehicle using off the shelf components, blending a strong sporting image with everyday practicality – but with the added bonus of a fuel-injected six to endow the new car with a technological spirit inherited from the 300s.

As *Road & Track* pointed out at the time of the W113 series' debut: "The 230SL is a median between the 300SL and 190SL in almost all respects. The 170bhp injection engine of the 230SL offers performance between that of the 120bhp 190SL engine and the 250bhp 300SL powerplant. As a 'sports touring car,' it has good roadability with sedan smoothness. The interior is smart rather than luxurious, reflecting the functionalism associated with sports cars, although it is not quite as austere as that of true competition cars."

In effect, Daimler-Benz brought the two extremes of SL motoring together in one reasonably priced machine, ideal for road use, but less suited to serious competition duty – at least on the track, for the 230SL would later prove itself to be a fine rally car. The distinctive removable hardtop – the famous 'Pagoda' roof – gave three body configurations (open, closed via the soft-top hood, or as a comfortable coupé with the hardtop in place), while the option of a manual or automatic transmission broadened its appeal still further, especially in the United States.



An advanced styling prototype for the W113 series SL. Note the 220SL badge on the tail and the conventional profile of the hardtop. The signature 'Pagoda' hardtop that followed on production models was ultimately designed in such a way as to give maximum strength and increased glass area, while the signature concave dip in the centre section gave the car a lighter, more compact appearance, without detracting from the original intention of enhancing visibility through larger glass sizes.



Ein Sportwagen von internationalem Rang

Sein Name Mercedes-Benz 230 SL

Ein neuer Mercedes-Benz. Ein Sportwagen, geformt aus Eleganz und Kraft, aus Komfort und Sicherheit. Hier wurde eine Idee bis zu ihrer vollen, hohen Reife entwickelt. Der 230 SL ist kein Traumwagen, er ist mehr. Er ist gut. Seine Väter legten ihr ganzes Wissen und Können in ihn hinein, in sein Fahrwerk, seine Rahmen-

bodenanlage, in seine Karosserie, seinen Motor und seine Ausstattung. Den 230 SL gibt es in drei Ausführungen: als Coupé mit abnehmbarem Dachaufsatz, als Roadster mit vollversenkbarem Klappverdeck und als Coupé-Roadster, der beide Verdeck-Möglichkeiten bietet. Durch das charakteristische Flachdach der

Coupé-Ausführung wurden ein sehr bequemer Einstieg und ungewöhnlich gute Sicht erreicht. Der Einspritzmotor leistet 150 PS. Das sind nur wenige Einzelheiten. Manches dient sinnvoll der Ästhetik, vieles dem Komfort und alles, wirklich alles der Fahrsicherheit. Der 230 SL, ein neuer Mercedes-Benz von internationalem Rang.



Ihr guter Stern auf allen Straßen

MERCEDES-BENZ

German advertising for the 230SL, introduced at DM 20,600 in basic guise, which translated to around \$6700 in the States. Pilot production had begun in March 1963, with full-scale production starting four months later, in July. The fuel-injected 2.3-litre sohc six under the bonnet was the first Daimler-Benz engine to use an alternator instead of a dynamo for charging the electrical system.

The 230SL

Initial work on the Type W113 SL began in October 1958 under Fritz Nallinger, although Hans Scherenberg took over the reins as Technical Director not long after the new car was launched. In the meantime, the body design – executed by the talented Frenchman, Paul Bracq, whilst under the supervision of the new chief stylist, Friedrich Geiger – had gone through countless minor changes, not just to become more contemporary (early sketches leaned heavily toward 190SL and 300SL styling cues) and aesthetically pleasing, but also to incorporate the necessary engineering hard points prescribed by Rudy Uhlenhaut and Karl Wilfert, as well as Bela Barenyi's various safety innovations.

Whereas the 190SL had borrowed the 180 sedan's platform and technology, the 230SL was based on a shortened floorpan from the 'Fintail' 220SEb (introduced in the summer of 1959), the body being very much in keeping with the Mercedes-Benz 'family' styling of the time. Indeed, followers of Mercedes-Benz lore would be able to quite easily spot the likeness between the W113 and the larger W111/3 220SEb Coupé of 1960 vintage. One thing obvious to all, however, was how strikingly modern this new SL was compared to its predecessors.



The 230SL proved to be a useful rally car. This picture shows the winner of the 1963 Spa-Sofia-Liège Rally, handled by Eugen Böhringer and Klaus Kaiser.



Publicity shot of the 230SL taken in Paris. Despite weight-saving techniques, such as the use of aluminium doors and lids, the 230SL still tipped the scales at a hefty 1295kg (2850lb).

The frontal styling was perhaps the strongest sign of SL DNA, clearly paying homage to the last of the 300SLs. From the grille and lights back, though, a straight-line approach was much in evidence, with the W113 series character lines as sharp as those of the earlier SLs were rounded. The profile was vaguely similar to that of the 220SEb Coupé, and even the C-post on the SL's removable hardtop was narrower at the bottom than the top, aping that of its bigger brother. The tail also followed 220SEb Coupé design practice, with a familiar bumper and bootlid style, the same small fins formed by the tops of the rear wings, and the resemblance in the rear lights and chromework surrounding them.

It's fair to say the 230SL was fairly conservative from a styling point of view, but the lack of ornamentation gave the new car a very clean and functional look. In addition, a by-product of using the W111 floorpan dictated a wider track, and, after being shortened to 2400mm (94.5in), the 230SL looked far more purposeful than the 190SL it replaced. In combination with reduced overhangs and bigger wheels

and tyres filling out the arches, the new car also managed to look lighter and more nimble than its predecessor at the same time.

Just as the 190SL had used a special version of the 180 saloon's engine, the W113 SL also borrowed its motive power from the contemporary sedan family. There were thoughts of a 220SL at first, but a more powerful lump was created solely for the two-seater. It's strange, but the SL's engine was actually an evolution of the final six-cylinder 'Ponton' unit (127.980) rather than a W111 series engine, as it carried the M127 II designation, whereas the six used in the 'Fintail' SE was the M127 III (127.982). Only the 127.981 had a 2.3-litre capacity, though, achieved by increasing the bore from 80mm to 82mm, whilst retaining the 72.8mm stroke. This gave a displacement of 2306cc, instead of the 2195cc listed against the 220SE models.

The 127.981 had an alloy head that played host to bigger valves and a hotter camshaft, and while the main block was cast-iron, the lower section of the crankcase was also made of aluminium alloy to reduce weight. With a revised Bosch port injection system with a six-plunger pump, modified exhaust manifold, plus a hike in the c/r (taking it up to 9.3:1), the 2.3-litre unit developed a healthy 150bhp DIN – an increase of 35bhp on the 127.980, or 30bhp on the 127.982.

A four-speed manual transmission was the norm, although, for the first time on an SL, a Daimler-Benz four-speed automatic was available as an option, sporting the now-famous staggered selector gate to reduce the chances of unwanted changes. Interestingly, throughout the W113 era, its layout was the opposite of today's quadrant, with 'Park' at the bottom of the gate.

The suspension was taken directly from the 220SEb. It was actually quite similar to that of the 190SL up front, albeit with detail improvements. The rear, too, was also fairly familiar, although a transverse compensator spring (as used on the later 300SLs) was added aft of the differential, allowing engineers to adopt softer road springs combined with firmer damping for enhanced comfort and anti-roll characteristics.

The extra width of the 220SEb platform allowed a wider track to take full advantage of radial tyre technology, which was still pretty much in its infancy compared to the development time that had gone

into crossplies (still employed on the saloons). The ride/handling compromise was perfected by Rudy Uhlenhaut, with the latest low-pivot swing axle ideally suited to the higher cornering power of radial rubber. Both Firestone and Continental (who made a new tyre called the Halbgurtel) were approached to produce a suitable tyre for the SL, with improved driver feedback and sidewall protection. Ultimately, the 185 HR14 tyres, which were quite fat for the day, rode on 5.5J steel rims, at least until July 1964, when a 6J rim was adopted.

The servo-assisted braking system was familiar to W111 series drivers, as well, with 253mm (10.0in) diameter discs up front, and slightly smaller drums on the back. However, the SL did benefit from split circuits for added safety. The recirculating ball steering was another carry-over, with a well-weighted PAS system offered as an option.

The interior was upgraded for superior comfort, with the unusual secondary instrument layout following W111 saloon practice, while the multi-function stalk was a very modern feature. A third transverse seat was available for the back, as per the 190SL.

Dozens of minor changes were applied to the 230SL in a programme of constant development, but the most important ones included fitment of a larger fuel tank (up from 65 litres/14.3 imperial gallons to 82 litres/18.1 gallons) from November 1965, and a change in gearing and final-drive options at about the same time. Then, from May 1966, a ZF five-speed manual transmission became available as an option, with better gear spacing and an overdriven top, but delivery took time, and at DM 1200, it was quite expensive, too, being only DM 200 cheaper than an automatic gearbox. As a result, 5MT cars were something of a rarity.

The last 230SL was built in January 1967. Pilot production of the 250SL started in November 1966, with full-scale production beginning in the following month. As such, the 230 and 250 run overlapped for a short time before the 250SL made its official debut at the Geneva Show.

The 250SL

The 1967 Geneva Show opened on 9th March, providing an ideal

public launch location for the 250SL. In reality, there was little to differentiate between the 2.3- and 2.5-litre cars, as many of the running changes applied to the 230SL were carried over. It was under the bonnet, therefore, where one had to look for the biggest difference.

Surprisingly, given the overall quality of the engineering, down to the finest detail, the M127 engine had only four main bearings. This situation was changed with the introduction of the 250SL, its M129.982 six-cylinder unit – taken virtually straight from the 1967 Model Year W108 250SE saloons – having a seven-bearing bottom-end for greater refinement.

As far as the other leading features were concerned, compared with the 230SL engine, the 82mm bore was retained, but a longer, 78.8mm stroke increased the cubic capacity to 2496cc. With a revised head carrying new valves and ports, plus a hike in the compression ratio (up to 9.5:1), power output was officially the same, but torque output was improved by a worthwhile 10 per cent.

A taller final-drive was adopted on manual cars, although the three transmission options continued. The other big mechanical change was in the uprated braking system, with discs now fitted all-round. As per Porsche practice, and that of some other European sports car makers that found it difficult to produce an efficient parking brake, the rear discs had integrated drums for the handbrake only, giving the ultimate compromise between high-speed stopping power and holding ability once the car had come to a halt.

With the 250SL came an interesting variant known as the California Roadster. In this format, the hood and its metal cover were deleted to make way for a bench rear seat that could accommodate children on shorter journeys. Alternatively, once folded, it provided a useful luggage shelf. The hood could not be retro-fitted, so the arrangement was recommended only for those living in areas with little rainfall, such as the US State that lent its name to the model.

Most of the 250SL press cars had early dashboards and door furniture, although July 1967 saw a minor change in preparation for the 1968 Federal regulations. Much of the switchgear and door trim was modified to make it friendlier to those coming into contact with it in an accident situation, three-point seatbelt mounts were introduced,

a new energy-absorbing steering column was fitted (readily identified by the revised centre boss and horn ring on the wheel), foam padding was added to the windscreen frame, and the handles that secured the tops to the header rails became removable. In addition, American spec cars could be readily identified by their side repeater indicators, attached to the front and rear wings of US-bound cars for the 1968 season.

The 250SL was to be short-lived, however, the last being manufactured in January 1968, which is when 280SL production officially began (two months after an initial pilot run). The 250SL is therefore a rare model, with only 5196 built.



About the only way to distinguish a 250SL from its 2.3-litre brethren from the outside was via the badge on the tail. The soft-top dropped underneath a panel like that found on the 300SL roadsters on all W113 variants.

The 280SL

Just as the 250SE was replaced by the 280SE in the W108 line-up at the beginning of 1968, the 250SL was upgraded to the 280SL at the same time. The M130 engine was given a hotter camshaft, though, endowing the SL version with 10bhp more, 250rpm further up the rev-range. With 170bhp DIN on tap, the 2778cc engine (86.5 x 78.8mm) was 20bhp more powerful than its predecessors, and torque increased to 177lbft.

As before, 4MT, 5MT and 4AT gearboxes were offered, and there was very little change to the chassis components. More rubber bushes extended service intervals, and the tyre construction was changed (although the actual size remained the same), but otherwise there was little to report.

Apart from looking at the badge on the tail, the quickest way to identify a 280SL is by its wheel trim, which became a one-piece cover rather than a separate outer ring and nave plate that had allowed the body-coloured wheel to show through. Alloy wheels (6J x 14) were available as a dealer option from 1969, although they were ultimately offered as a factory-fitted option from August 1970.

By this time, of course, American regulations were becoming more and more demanding, especially in the fields of safety and emissions. While most of the interior and exterior changes have been documented in the 250SL section, in the name of promoting cleaner exhaust gases, 2.8-litre Federal engines sported a modified fuel-injection system, a tamer camshaft to give different valve timing, a fuel shut-off valve that kicked in when the driver backed off the throttle under low-speed deceleration, and a viscous-coupled, thermostatically-controlled cooling fan. The end result was an 8 per cent drop in power, but complying with the rules was the only way to get cars into the States – the world's biggest market for European sporting machinery. To make up for this, early cars were given a shorter rear axle ratio, although they'd fallen back into line with domestic models by the end of 1969.

The last 280SL was built in March 1971, bringing the 'Pagoda' roof generation to an end. Including the 23,885 280SLs produced, the total W113 run came to 48,912 units. The next generation was even more

successful ...



The 280SL, readily identified by its new wheelcovers. Other than the badging and wheel trims, though, there was little difference between the 2.3-, 2.5- and 2.8-litre cars from the outside. Note the 'clap hands' wipers – a signature piece of W113 design, as they were unique to this SL generation.



With ever-more stringent crash regulations, time was running out for the W113 series, despite the 280SL's popularity in the showrooms. In reality, the styling had also become dated when viewed alongside cars like the Mercedes C111.

A new direction

The W113 series had been in the showrooms for eight years, and was as popular as ever. However, the times had changed politically, and demands for cleaner and safer cars – not to mention calls for cheaper and easier repairs from insurance companies – meant that the 'Pagoda' roof models had reached the limit of their development. Some were shocked by the sheer size of their replacement, with some even stating it was a mockery of the Sport Licht moniker, but the 107 series would go on to be the longest-running model line in Daimler-Benz history nonetheless ...

Design work on the W113's replacement – the R107 – began in earnest in 1965. Initial design proposals were radically different to the established SL lines, with flowing curves replaced by a distinctly boxy character.

Ironically, due to uncertainty regarding the long-term future of the open sports car, running parallel with the new concept, a simple facelift programme was kept in place until mid-1968, when attention

turned completely toward a full model change situation, with all-new running gear in a brand new body.

Wenn ein neuer Mercedes kommt, dann kommt ein neues Auto.

Alles andere würde Mercedesfahrer verwundern.



350 SL 3,5 l V8-Motor, 200 PS.

350 SL: Sportlichkeit mit Gewissen.

Ab 17. April 1971 gibt es einen sportlichen Zweisitzer, wie es ihn nicht alle Jahre gibt. Weil ein solches Automobil lange und gründlich entwickelt werden muß. Nur so verstehen Mercedesfahrer das Wort „neu“. Sie messen Fortschritt nicht an Blechverformungen. Sondern an Technik, Fahrkomfort und Sicherheit. Die eigenwillige Karosserieform hat dem 350 SL

schon im Windkanal Bestnoten eingebracht. Sie ist modern. Aber nicht modisch. Erstens funktionsbetont. Zweitens attraktiv. Eine Reihenfolge, die Mercedesfahrer mögen.

Die Fortsetzung folgt unter der Haube:

Der 3,5 l V8-Motor, 200 PS beschleunigen in 8,8 sec von 0 auf 100 km/h. Dauerspitze 210 km/h.

Doch für Mercedesfahrer zählen andere Werte: Das hohe Drehmo-

ment, das seine Kraft aus dem Hubraum schöpft. Zwei obenliegende Nockenwellen, die sportliches Fahren ermöglichen. Die Lauftruhe eines kultivierten, ausgereiften Triebwerks. Das auf lange Lebensdauer ausgelegt ist und das verzögerungsfrei anspricht. Die elektronische Benzineinspritzung garantiert dafür. Und nicht nur dafür. Sie reduziert auch die Schadstoffe. Der V8-Motor erfüllt schon heute die europäischen Abgasvorschriften von morgen.



Oben links: Die eigenwillige Silhouette des 350 SL verleiht Fertilität und Eleganz. Nur so ist moderne Karosserie-Konzeption im Automobilbau zu verstehen. Oben rechts: Der 3,5 l V8 von Mercedes stellt ohne Zweifel das beste Triebwerk dar, das gegenwärtig in Deutschland gebaut wird, sagte ein bekannter Motorsportler. Unten links: Das Elektronische Fahrprogramm ermöglicht über neue Fein-Einstellungen der Benzinpumpe. Wie jedes Detail in Mercedes-Sicherheitsystemen auf wissenschaftlicher Grundlage aufbaut. Unten rechts: Die Sitze sind auch in der Höhe verstellbar. Ein Team von Ingenieuren, Orthopäden und Biomechanikern gab ihnen funktionssprache Form. Unten: Mehrere Rückveranker sind eine Garantie für den Hintermann. Geöffnertes Glas reduziert Verwundung. Der 350 SL ist noch nach 800 km Schweißarbeiten klar zusammenbau.



Vorteile haben ein zähes Leben.
Mercedesfahrer begegnen hin und wieder der Meinung, daß sie...
1. hochkonzentriert sind.
Weil sie technischen Fortschritt höher werten als modisch gezeigtes Karosserieblech?
2. zeitunabhängig sind.
Weil sie einen Motor mit echten Kraftreserven, Sportlenkern und Rollverleihen vorziehen?
3. orientiert beugen sind.
Weil sie sich ihr Ausdeckerleben mit Servolenkung, Servobremse und Schalthromonik erleichtern?
4. extrem risikoavers sind.
Weil sie ein optimales Sicherheitsniveau im Auto verlangen und Helium im Sicherheitsverblei bei ihnen nicht gefügt ist?
5. maßlos egoistisch sind.
Weil sie beim Service moderate Prüfstände und erwartend fordernd personal verlangen und weil sie kein Auto akzeptieren, das ständig Helmwech nach der Werkstatt hat?
6. absoluter materialistisch sind.
Weil sie ihr Auto 8000 km mehr pro Jahr fahren als der Durchschnitt, es überhaupt länger haben wollen als andere und dennoch einen hohen Wiederverkaufspreis erzielen?
Mercedesfahrer nehmen diese Vorteile in Kauf. Sie wissen eben genau, was sie wollen. Und Sie wissen es bestimmt auch.

Fahrwerk und Bremsen

Die Diagonal-Pendelachse sorgt für sicheres Fahrverhalten, gute Straßenlage und hohen Fahrkomfort. Doch wer schneller auf 100 ist, braucht auch bessere Bremsen. Deshalb werden die Scheibenbremsen des 350 SL von Turbinenschaufeln luftgekühlt. Und vorne zusätzlich innenbelüftet. Fairneß ist die Sportlichkeit, die wir auf unseren Straßen brauchen. Beherrschung der Kraft ist wichtiger als die Kraft selbst. Für Mercedesfahrer.

Zu Ihrer Sicherheit wurde auf besonderen Flankenschutz Wert gelegt. Und Windleitbleche für die vorderen Dachstaben konstruiert — um Seitenschlägen schutzfrei zu halten. Ergebnisse unserer systematischen Sicherheitsforschung. Zwei von vielen. Wenn Sie einen 350 SL probefahren, werden Sie spüren, daß ein neuer Mercedes immer ein „neues“ Auto ist.



German advertising announcing the R107 series. Rather than the usual 'W' suffix (for 'Wagen'), an 'R' was chosen for 'Roadster', allowing differentiation from the coupé model, which had a C107 code.

The first 107 series models

The R107 roadster took shape under Chief Designer Friedrich Geiger, with all manner of proposals finding their way to his desk before he settled on a Joseph Gallitzendörfer styling sketch as the basis for the final design.

Three full-size styling bucks (labelled Model I, II and III) were reviewed on 18 June 1968, alongside a mildly facelifted W113 model, and the new generation was born after the Board gave the nod to the Model III mock-up, which displayed strikingly modern and bold lines, yet still managed to incorporate enough of the earlier SL DNA to make

it recognizable as a continuation of the bloodline.

Things progressed quickly thereafter, and with the powertrain already entering production in the V8 models to be launched at the 1969 Frankfurt Show, there were even thoughts of releasing the new two-seater in the spring of 1970. However, Hans Scherenberg was still jumpy about the constant changes to US regulations, and recommended not only delaying production, but putting a back-up plan into action that gave rise to the long-wheelbase C107 – a close-coupled coupé based on the structure of the open car, known as the SLC.



The 350SL as it was first presented to the press, seen here with the hardtop in place. Note the hardtop profile, which paid homage to earlier SLs.

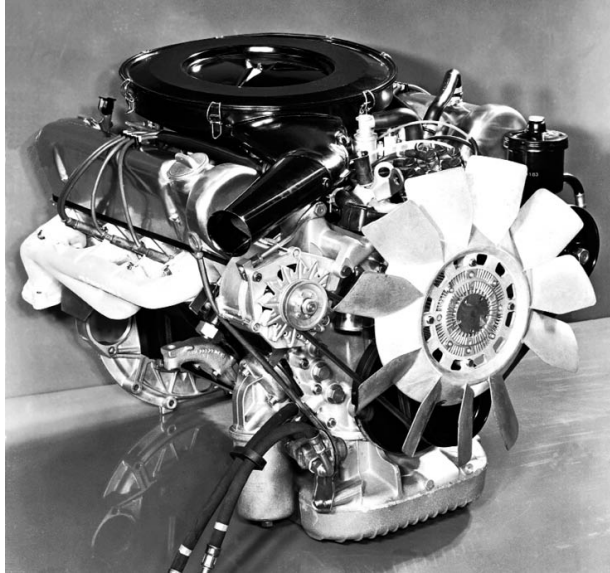

The mighty V8 engine of the 350SL.



The 350SLC making its debut at the 1971 Paris Salon.

Ultimately, the 107 series models (soft-top as standard with a removable hardtop for the SL roadster, and a fixed-head coupé configuration for the SLC), would provide the basis for a whole new generation of passenger cars, with various styling cues being duly adopted for the W116 S-Class to give a ‘family’ look to the Mercedes

range.

Compared to the W113, the R107 was bigger all-round – it was important to think ahead on the safety front, with the increasing importance of the Americans for the German maker, and the extra bulk allowed more engineering options, as well as added comfort for passengers. Indeed, with its completely modernized interior, the SL was destined to move even further away from pure sports than its predecessor, the Grand Touring car being infinitely more appealing to a wider market.

The wheelbase on the new open car was 55mm (2.2in) longer than that of the W113 models, leading to an overall length increase of 95mm (3.7in), and the width was 30mm (1.2in) up. Despite the track being slightly narrower, due to the all-steel construction of the body and more luxury features, there was a weight gain of 200kg (440lb) compared to the 280SL, but computer-aided design made the shell stronger than ever before, to the point where a Targa bar (once thought a necessity to clear Federal regulations) was no longer needed.



Modern fascia of the 107 series models, this being the 350SLC version.



An early R107 model with the hood down, hidden by the metal tonneau cover that was an SL styling signature, and the distinctive 'Barock' alloy wheels.

Motive power was provided by the 3.5-litre V8 introduced with the 280SE 3.5 and 300SEL 3.5 models – the M116 unit having a bore and stroke of 92 x 65.8mm to give a cubic capacity of 3499cc. With D-Jetronic fuel-injection and a 9.5:1 c/r, it developed a level 200bhp, along with 211lbft of torque.

However, soon after the launch of the new car, a long-stroke 4520cc version was introduced for the US market. Despite the additional displacement, this M117 engine developed 5bhp DIN less than its European counterpart, which shows how strict Federal regulations on emissions had become by this time.

A four-speed manual gearbox was the norm, with a four-speed automatic as an alternative in most countries until mid-1972, when the 3AT unit with torque convertor used in the States from day one was adopted as the automatic gearbox option.

The suspension and steering was based on W114 practice, with braking provided by discs all-round; there was actually talk of offering ABS on the new SL, but it was not ready in time. As for the footwear, low-profile 205/70 radials were mounted on 6.5J x 14 rims, either made from pressed steel or cast alloy – the latter wheels being of the cookie-cutter 'Barock' design offered as an option on the last of the W113s.

The 350SL was launched in April 1971 at a price of DM 29,970 in Germany. Exports began in the middle of the year, allowing the '350SL

4.5' to reach American showrooms in August. The 350SLC, meanwhile, made its debut at the 1971 Paris Salon, with sales starting four months later.

The 4.5-litre cars were added to the ROW line-up in the spring of 1973, by which time they were formally known as the 450SL and 450SLC. From August 1974, the European market also gained a 280SL and 280SLC, powered by a 2746cc M110 straight-six that developed 185bhp DIN.

All engines moved over from D-Jetronic to K-Jetronic fuel-injection in the mid-1970s, reducing horsepower, and lower compression ratios on certain units only served to drop output still further. At least the 2.8-litre engine had its power restored in 1978, but the V8s would not make a comeback – they were left in their weakened state until they were replaced by a new range of eight-cylinder powerplants in 1980.

New engines

The 1977 Frankfurt Show witnessed the debut of the five-litre 450SLC 5.0 prototype, which not only employed a great deal of aluminium body parts, it also had an aluminium alloy cylinder block. This signified the birth of a new line of all-alloy V8s that made their debut in the autumn of 1979, and were duly adopted on the SL and SLC models from March 1980.

While the 2.8-litre six was carried over in the 280SL/SLC (albeit hooked up to a new automatic transmission), the 350SL/SLC became the 380SL/SLC, and the 4.5-litre cars became the 500SL/SLC grade, with the old 450SLC 5.0 falling by the wayside in the process. Only the 3.8-litre machines were sold in the States, with 160bhp DIN under the bonnet (as opposed to 218bhp in Europe), while the 4973cc unit sold in other parts of the world produced a healthy 240bhp, linked to a new 4AT gearbox.



One of the first 280SL press pictures. The 2.8-litre six under the bonnet had almost as much power as a Federal-spec 4.5-litre V8, and was quite different to the earlier 280SL unit, having twin-overhead camshafts. The 280SL was available with 4MT, 5MT and 4AT gearboxes.



American-spec cars had different bumpers and headlights. This is the US version of the 450SLC for the 1977 season.



The 450SLC 5.0 model, which entered production in the spring of 1978, actually made a fine rally car, winning two WRC events. This picture shows Hannu Mikkola and Arne Hertz in action on the 1979 Safari Rally.

The SLC variant was dropped at the end of the 1981 season, replaced by the gorgeous 380SEC and 500SEC coupés. Power dropped slightly on the V8s at the same time, as emissions standards tightened up globally, and more luxury items were fitted as standard as the eighties progressed.

Well over 200,000 107 series cars had been sold by 1985, and even if one takes out the 62,888 SLCs from the figure, no-one could deny the SL was a good seller, especially given its high price. Indeed, even without the SLC's help, it had only taken to the end of 1976 to outsell the entire W113 run, despite a major fuel crisis and a dreadful world economy.

A final fling

The SL just kept selling, so the management in Stuttgart decided to keep it going with a 1986 Model Year update that would allow it to remain in the Mercedes line-up until 1989, when the all-new R129 SL made its long-awaited debut.

The main changes were in the engine bay, with new 3.0-, 4.2- and 5.0-litre power-units adopted for most markets, along with a 5.6-litre V8 for the USA, Japan and Australia. Even the 2962cc six had 188bhp available, while the 5547cc eight gave 242bhp, thus giving the SL the

performance it deserved, even in the States.

Also new was the 4AT with switchable 'Sport' and 'Economy' shift modes, whilst larger 15-inch alloy wheels covered uprated brakes, suspension settings were changed, and a redesigned rear axle was employed, simultaneously improving ride and reducing unwanted NVH. There were subtle bodywork modifications, too, such as a new front airdam and black door handles to replace the old-fashioned chrome ones.

Amazingly, there were still full order books for the SL, even at this time, and a long waiting list in certain countries – buyers in the UK were told to expect a two-year wait before getting their hands on a new car. All told, a total of 300,175 107 series models were built, including SLCs.



A 1981 Model Year 500SL. Note the dark grey lower section, applied to five-litre cars when finished in certain colours, and the rear spoiler. All cars received an aluminium bonnet at this time.



A 1983 R107 SL pictured with its illustrious predecessors.



One of the last R107 models, this being a domestic market 500SL, introduced at DM 89,091. Weighing a hefty 1610kg (3540lb), it was still capable of 140mph (224kph) and a 0-60 time of 7.8 seconds. Note the late-style alloy wheels, introduced for the 1986 season. R107 production finally came to an end in July 1989.

4

An SL for the nineties

The R107 convertibles had continued in the Mercedes line-up for far longer than anyone could have foreseen – a classic shape running alongside more modern machines, much like the Spider in the Alfa Romeo range. But whereas the Milan two-seater was simply facelifted for 1990, thus paving the way for a strikingly new open car to appear in time for the 1995 season, the SL was being treated to a fresh body, drivetrain and chassis setup. The all-new R129 ultimately made its debut in March 1989, going on sale as a 1990 model ...

The Mercedes-Benz brand has always had a reputation to uphold, with three lines in particular always viewed as the prime examples of contemporary Stuttgart thinking and styling – the cars that would ultimately be recognized as E-Class vehicles (with a proud history effectively beginning with the famous ‘Ponton’ series after the war), the larger S-Class machines, and the SL sports model.



An early one-fifth scale model of the W116 S-Class, showing definite signs of being influenced by the styling of the R107 and C107. The SL didn't always follow the Mercedes-Benz pack – sometimes it led it.



The end of an era and a glimpse of the future in the Berlin works in 1977, with, from left-to-right, Werner Niefer (later Chairman of the Daimler-Benz AG Board of Management, replacing Edzard Reuter in June 1989), technical chief Hans Scherenberg in one of his last official engagements, Helmut Schmidt (West Germany's Chancellor from 1974 to 1982), Professor Joachim Zahn (Chairman of the Daimler-Benz AG Board of Management from 1971 to 1979), and head of the Berlin works, Dieter Stobbe.

Generally speaking, the SLs had always been based on saloon car practice. For instance, on the technology side, just like its predecessor, much of the powertrain and chassis hardware for the R107 had been borrowed from existing '78' and S-Class models, duly refined to suit the sports car.

In addition, the SL had also taken its styling cues from the saloons in the past, thus inheriting a family look. In the case of the R107 SL (and the attractive C107 SLC derivative), though, it had pretty much led the way. Launched in 1971, it ultimately provided the inspiration for the W116 S-Class of late-1972, and the W123 series (the popular grandfather of the proper E-Class line, badged as such) that followed in the mid-1970s. Consequently, even when the 190 (W201) arrived at the end of 1982, over a decade into the R107 run, the other cars

in the range allowed it to retain a 'current' image.



The W123 saloon in the centre of this picture was a representative of the past, with separate bumpers and heavy window graphics. The newer W201 (left) and W126 S-Class displayed far greater attention to aerodynamics, but still managed to keep the classic Mercedes 'family look' intact. Evolution was more important than revolution.

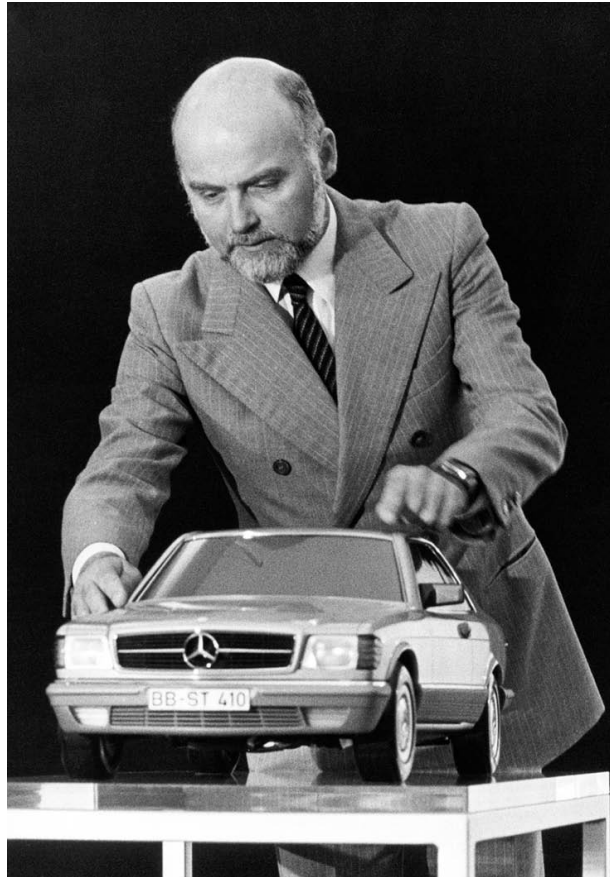

Bruno Sacco, born in Italy in November 1933, with a design study for the SEC model that replaced the SLC line. Note the continuation of the three-pointed star in the grille centre, signifying a sporting machine in Mercedes styling language, but also the softer lines of the nose, and the body cladding down the side.

However, times were changing on many fronts. The R129 SL was developed in an era of great upheaval, not only within the motor industry in general, but within the hallowed halls of Daimler-Benz itself. Members of the 'dream team' that had overseen the birth of the R107 in Stuttgart and given the post-war Mercedes-Benz its distinctive character had either retired or were about to hand over the reins in preparation for the event. Hans Scherenberg, the long-standing technical chief, retired in December 1977, while Karl Wilfert (best-known for his body development) had left the trade in 1973, the same year as Chief Designer Friedrich Geiger. Meanwhile, Rudy Uhlenhaut, Chief Engineer of Passenger Car Development from

1955, had retired in 1972.

Moreover, as development dragged on in fits and starts due to fallout created by the oil crisis and suchlike, vehicle design had moved into a new epoch, not only in the bodywork department, where insurance companies, accountants and computers combined to dramatically change the look of motor cars once and for all, but in chassis technology and engine management systems, too, the latter being increasingly employed to give cleaner emissions rather than superior power output. Electronics had also come of age, allowing engineers to add control systems that had long been on the drawing board but were previously considered impractical for production.

And in the background, with bean counters and marketing types calling the shots to a greater extent, the future of the convertible was being called into question. The scare created by the US proposal to ban open cars (which was fortunately never carried through) had slowed down or ended a lot of drophead development, and sales within the sector became negligible as a result. The analysts pointed to a fall in sales, failing to consider that buyers had a restricted choice, with fewer convertibles in the showrooms, and most of them that were available were either antiquated or expensive – sometimes both! Of course, the Mazda MX-5 Miata would prove once and for all there was still a market for open cars, but one cannot blame the men at Daimler-Benz for giving priority to saloon car projects that provided the Stuttgart firm with its bread-and-butter trade.

As such, the W126 S-Class made its debut at the 1979 Frankfurt Show, being facelifted in 1985, while the W123 ultimately gave way to the more modern-looking W124 series in the same year. In many ways, the W124 resembled the smaller 190 (W201) in appearance, and a mildly updated version was presented at the 1989 Frankfurt Show. This would duly provide the styling inspiration for the W140 S-Class, launched at the 1991 Geneva Show, and finally leaving the traditional Mercedes 'look' established by the R107 behind for good.

In this kind of company, the boxy and chrome-laden SL stood out as being a survivor rather than an integral member of the Benz lineup, even after its stopgap 1985 facelift. But this gave Bruno Sacco and his team of designers a real headache, for the survivor – rather

like the 911 being built down the road – had earned its continued place in the showrooms through popularity. You can't keep a good dog down as the old saying goes, and people kept voting for the R107 with their wallets. Its replacement, therefore, had to reflect the past almost as much as the future if one was to keep the regular clientele happy, but be a bold enough move forward to silence critics and allow a lengthy lifecycle that would take the model into the new millennia.

Getting the styling right was perhaps a primary concern on a vehicle of this type, but as the project continued to be delayed, the technological goalposts kept moving. Adding in features simply creates further delays, as the engineering hard points have to be incorporated into the design and tested, and with technology moving so quickly in the 1980s, a year's postponement can create chaos in the R&D section. Considering that the R129 project had been in train since the early-1970s, one can only imagine the level of stress the engineering boffins had to endure.

Still, all the basics were in place by the start of the 1980s – the production cycle, from initial planning to showroom, although significantly slower than Japanese rivals, was generally ten years at Daimler-Benz at this time, after all. Indeed, *Road & Track* in the States and the British *Motor* magazine had carried spy shots of the new SL as early as October 1985, when the design had already been finalized for over a year. It was caught on camera during hot-weather testing in Arizona, although the car's launch was still several years away.

A while later, in the spring of 1987, more spy shots showed the car on test in the snow, giving rise to thoughts of a 1987 Frankfurt Show launch in the press, although the German event came and went without any sign of the new vehicle. In the meantime, the rumour mill was in full swing, with pages being filled in enthusiast publications with predictions of what features the new SL would have – four-wheel drive was mentioned, along with active suspensions, rear axle steering, 24v six-cylinder engines, multi-valve V8s, and even the promise of an exotic V12 unit.

The approach of the nineties promised much, with the 'Bubble

Time' allowing designers and engineers to follow their dreams and produce vehicles incorporating futuristic styling and new levels of technology, not only to get around ever-tightening regulations, but also display their prowess. Anything, it seemed, was possible – punters were lining up for the best that manufacturers could offer, and price hardly seemed to matter. Finally, with the feel-good factor indicators pointing roughly in the right direction, and the E- and S-Class contenders safely placed on the market (with minor facelifts in train), it seemed that the timing was at last right to launch a new SL ...

A new body

As we've already noted, getting the styling absolutely right was critical. Attractive bodywork sells cars – a well-known fact, but even more so in the sports car market, where the purchase tends to be a purely emotional one rather than one guided by utilitarian concerns. But striking the balance between timeless and modern lines was also a prime concern, as the SL would doubtless be on sale for a long time. Granted, few could expect a run like that of the R107, but no-one would have raised an eyebrow if a shelf-life of a decade had been mentioned in sales presentations. However, with delays and uncertainty over the launch date, Sacco and his men had to think further ahead. Already a feat far from easy to accomplish, the car had to be designed in such a way that it wouldn't look out of place even as the new millennium dawned.

The R129 duly started to take shape under the Italian-born designer, Bruno Sacco, who'd taken over as Chief Designer in the mid-1970s following Friedrich Geiger's retirement in December 1973, and was duly appointed head of styling from 1993. Early efforts took their inspiration from the then contemporary R107 SL and C107 SLC models, with slightly sharper lines, and a Targa-type roof that allowed engineers to meet crash regulations and stay ahead of the game in America, just in case the proposal to ban open cars reared its ugly head again.



Some of the earliest R129 designs, like this one from September 1974, were rather uninspiring. Looking at this, one sometimes wonders why the R129 project designation was retained after styling work was revived in the 1980s, such is the gap between the early and later proposals. In retrospect, the vents in the front wings are interesting, though.

Being brutally frank, the first prototypes were far from inspiring, as if Sacco and his team were afraid to stray too far from the Geiger school of art. As Sacco himself once said: “A Mercedes-Benz should always look like a Mercedes-Benz.” But perhaps this philosophy was being followed too closely in the early days, which is a shame, as the Italian had already shown his creative spirit as a key member of the team that had developed the C111 in the sixties.

In some ways, we can be thankful for the energy crisis that was a key factor in putting the project on hold so many times, with the tail-end of the seventies seeing hardly any effort applied to the SL’s replacement – a ‘Baby Benz’ was far more important in terms of the company’s survival. As the eighties dawned, car design in general had matured, and Sacco had established himself and his signature styling touches, allowing a thoroughly modern vehicle to jump off the drawing board. Had the 1970s train of thought continued, there’s no doubt that the car would have dated very quickly.

It was very much a case of a new brush sweeping clean. When Hans Scherenberg retired in 1977, Werner Breitschwerdt became the new technical overlord. Not long after, with the retirement of Joachim Zahn, Professor Gerhard Prinz was elected Chairman of the Board of Management. However, he died suddenly in 1983, and Breitschwerdt found himself in the Chairman's seat. As such, continuity was assured, and with Dr Rudolf Hörnig (with Daimler-Benz since 1956) appointed the new head of R&D for passenger cars in May 1984 after Breitschwerdt's move up the ladder, and Dr Wolfgang Peter installed as Chief Engineer, peace reigned once again in Stuttgart.

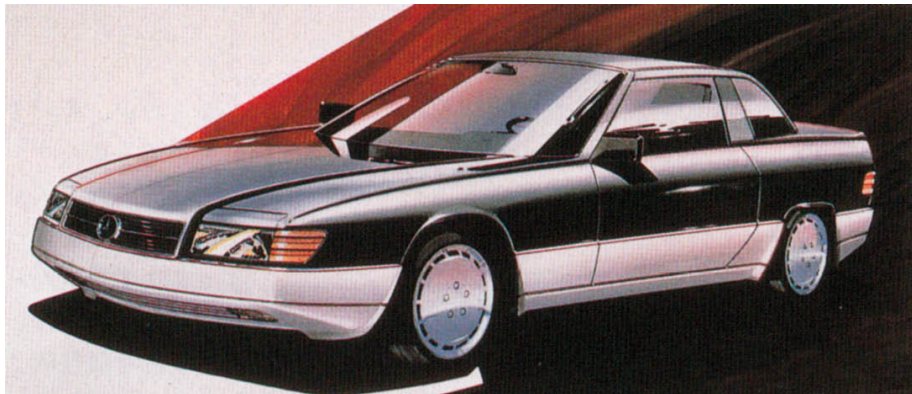
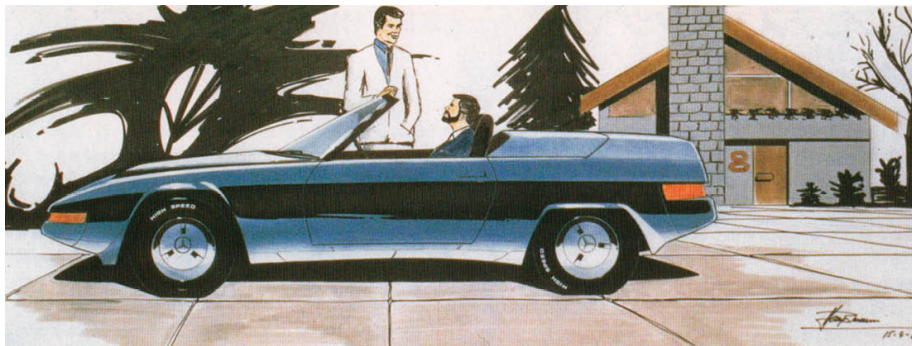

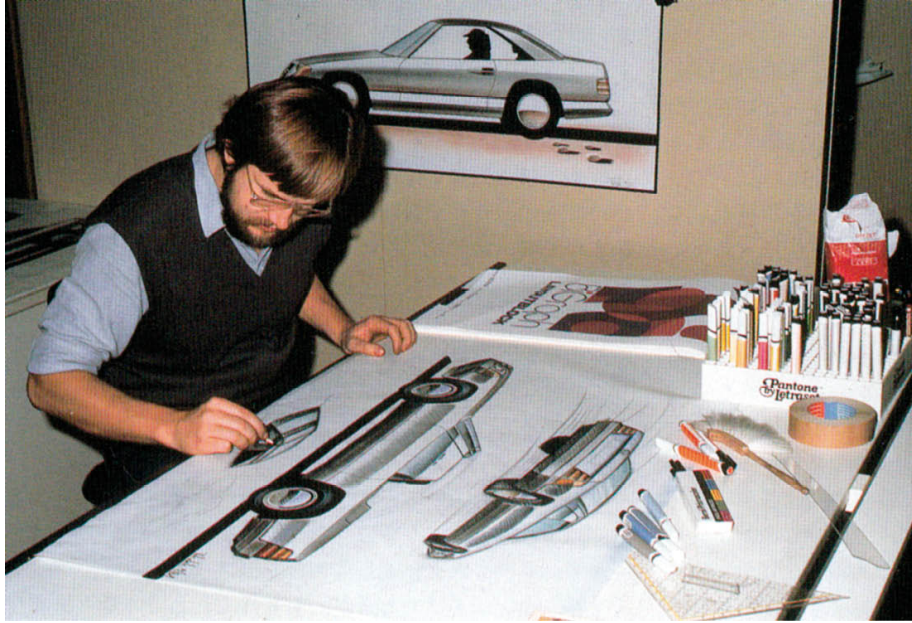

A selection of some of the earlier styling sketches from the start of the eighties.



Bruno Sacco reviewing drawings as the initial styling side of the project drew towards a close. Looking back in 1989, Sacco stated: "This was the most difficult and challenging task we ever faced. We wanted to create a truly beautiful car ..."



One of many scale models produced at a time when a Targa top still looked like a way forward.

Anyway, with the Daimler-Benz management having taken the bold decision to press the reset button, dismissing frivolous ideas of mid-engined supercars, and settling once and for all on a straightforward convertible with an FR (front engine, rear-wheel drive) configuration, and with the hierarchy established and all pulling in the same direction, progress was fast and fairly smooth from this point on in the proceedings.

Drawings dating from the spring of 1981 showed the way forward after so many false starts. Several sketches had the lower, flatter rear wheelarch profile of the earlier SLs (taking the concept even further, spats were featured in one of the proposals), but most had sharper, modern lines reflecting the straight-edge fashion that was becoming the vogue at the time. One is readily reminded of Bertone's Lamborghini Athon concept displayed at the 1980 Turin

Show, along with cars like the contemporary German Isdera Spyder and its ilk.



Fine styling is all very well and good, but packaging has to be considered at an early stage to work in engineering hard points and safety requirements.



A scale model being built for design appraisals – one of 12 such creations broken into three categories for easy reference.



A full-sized styling buck – based on Johann Tomforde’s work – being carved from clay. The final lines are already much in evidence ...

Sacco soon brought his stylists back into line, however, doubtless quoting his “A Mercedes-Benz should always look like a Mercedes-Benz” motto, and stating in retrospect: “We didn’t necessarily want to be futuristic or fashionable, but to offer continuity.”

Apart from some minor excursions into alternative Targa top proposals, which ultimately gave some rather less than happy rear quarter window graphics, plus a few final attempts to get pop-up headlights incorporated into the design, the final lines were starting to show through by the summer of 1983.

Perhaps more than any other, it was Johann Tomforde, who’d joined Daimler-Benz in 1970, who shaped the future of the Mercedes SL. A fully-trained engineer with an artistic flair, he later became one of the leading lights in the Smart project, but his input on the R129 body design, albeit done under the watchful gaze of Sacco, cannot be underestimated. After no less than 20 scale models (initially 12 one-fifth scale versions, broken into conservative, modern and futuristic categories for easy reference, and later some full-size versions) had been appraised, Tomforde’s proposal was the one selected in the second half of 1984 for fine-tuning in order to give the final design.

As Tomforde said at the time: “We wanted to integrate the look, to be unobtrusive, so we made a real effort not to look aggressive or provocative. We especially wanted to make the front restrained, whereas the rear design could look more powerful. We want people who see the SL from behind to think the look is so strong, they won’t want to overtake.”

He continued: “We wanted to make a sports car we would like to drive ourselves. Aesthetic appeal is very important and we had to remember it has to last for at least ten to 12 years ... This is a shape that won’t bore you. In five years, it will still be desirable. We managed to capture 95 per cent of the spirit of the concept car – only five per cent has been lost to engineering or production requirements.”

Starting at the front and working back, the nose was a perfect blend of ancient and modern – the full-width grille with a large Mercedes-Benz star in the centre and the horizontal anodized aluminium slats arranged around it paid homage to the past, while the self-surround created by an angled extension of the bonnet panel (rather than a hefty chrome attachment) gave the car an altogether more modern look, aping that of the SEC coupés.

However, the SEC-type nose gently evolved into a simpler, more aerodynamic one, with larger lights, sloped backwards to help the car cut through the air that much better. Having been completely different before, the lights, whilst still differing for North American and ROW markets on most Mercedes models, were now basically the same on all SLs with the introduction of the R129, at least at first glance – careful inspection revealed that the US-spec unit was slightly smaller and sat in a heavier frame. Meanwhile, the orange-coloured indicator units tacked onto the side of the headlights were obviously inspired by the W123 series more than anything else. It’s probably fair to say the simplicity of the long bonnet (which hinged at the rear and was lined with sound-deadening material), with its subtle tapered power bulge, was also influenced by the W123, as well as the W201.



From this angle and close up, it's possible to see the level of detail work that went into sculpting the nose profile. Note the soft curves and the angle of the grilles and lights for aerodynamics, blended nicely with straight edges for an illusion of strength. The chin spoiler does the job without being too low – sports cars are often a pain to park due to a front-end that's been lowered excessively, and all too readily damaged as a result.



In this picture we can see the smooth, W123-inspired bonnet, and the speed-sensitive, single-arm windscreen wiper that dropped below its raised trailing edge. The wiper covered an incredible 86 per cent of the front glass! Note also the tight panel fit, the narrow shut-lines helping reduce drag and enhance perceived quality at the same time.



Detail shot of the self-framed front grille, the ribbed indicator housings, and front bumper section with its integrated airdam. The projector beam foglamps (halogen, like the main lighting units) were part of the package, but the headlight wash/wiper system was an option in some markets.



The new SL in profile, this picture showing the elegant hardtop in place, and the shadow effect that created an impression of traditional bumpers.

The less ornate theme was carried across to the bumper and integrated airdam, with no sign of chrome whatsoever. Instead, the large panel, which was basically the same for all markets due to a universal impact absorbing arrangement, was broken up by a full-

width air intake underneath the subtle fold in the main bumper section, with small rectangular foglights at both ends, the number plate mounting, and the lower spoiler section, with its deeper corners, helping to guide air to the sides and onto the smooth undercarriage. As such, although traditional SL styling was still much in evidence, as with the new saloons, the design as a whole had moved forward into a new era, with softer, more organic lines, and the use of more modern materials, which had the added bonus for Daimler-Benz shareholders of reducing production costs.

As one moved around to the side, the reason for the fold in the bumper panel became more evident, for if the light caught it just right, it gave the impression of a bumper blade. The profile was continued in the lower body cladding applied between the wheelarches, and also on the rear bumper, as was the 'separate' apron effect. If one looked carefully at the sill area, it was just possible to pick out the slight taper at each end of the side skirts to help guide air past the wheels.

Although the top of the cladding was situated fairly high compared to the majority of cars from the period, somehow it looked less bulky on the SL than it did on the saloons, perhaps because of the shorter wheelbase, longer doors, and the venting aft of the front wheels (no doubt paying homage to the original 'gullwing' SL, but functional in that they allowed hot air to escape from the engine compartment) that helped break it up further. In reality, the cladding played a dual role, protecting the side panels from minor knocks, and helping to integrate the bumpers in the overall design, and was very much a signature styling feature of the contemporary Benz range. Incidentally, most cars had the cladding painted in a contrasting colour to the main coachwork.



The side cladding, and a close-up of the air vent found in the front wings. The shape of this vent became a useful identifying feature after the car was facelifted.



The hefty A-pillars, crafted to cheat the air, and the heated side mirrors, which folded inwards to prevent damage if they were knocked.



Another profile shot, but this time with the hood down, affording a better view of the car's beltline.



This plan view shows the strong taper in the R129's tail. It also shows how tight the bumper was kept to the body line – something that was true at both ends of the car, and a strong departure from the usual ledges that one could almost sit on. It helped make the new SL look more compact.



The image of the traditional R107 rear combination lights was retained for the R129, with heavy ribbing helping to keep them clean. Note the '300SL-24' badge arrangement, based on the regular '300SL' one to make life easy (US-bound 24v cars used the '300SL' moniker, as the 12v car wasn't sold there), and the aerial location.



The boot lock and remote control locking sensor. The remote transmitter was incorporated into the regular key holder, with a flip-out key to keep things compact. This allowed one to open or close the car from a distance, or one could use the key in the normal fashion. The central locking could also cover window operation and interior storage compartments.



The new SL was immediately given the prestigious Car Design Award, the 11-member jury concluding: “In the [latest] Mercedes-Benz SL, the ensemble of safety innovations, exemplary ergonomic solutions, and stringent adherence to the traditional design culture of the manufacturer’s brand is convincing. The new SL embodies the most valuable elements of up-to-date industrial design, without losing the flair that distinguishes every sports cabriolet.”

Above the cladding, whereas the waistline of the R107 sat fairly flat front-to-back, the R129 was given a subtle wedge profile, which, combined with the sloping nose, the steep rake on the windscreen, and the carefully shaped A-pillars, improved the car’s aerodynamic efficiency no end. Indeed, as well as channelling rain over the roof instead of to the sides, the A-posts were an important factor in keeping drag to a minimum, as they allowed the side windows to sit virtually flush as well.

In the same vein, the single windscreen wiper blade parked low down, out of the airflow (always on the driver’s side, regardless of left- or right-hand drive), the sculpted mirrors and door handles sat as flush to the body as possible, and disc wheels were employed with the minimum of embellishment.

There were slight bulges blended into the metal above the wheelarches, and a gentle curve in the top of the door, but thanks to

the flush soft-top hatch, the side view was basically very clean – free of styling gimmicks in order to follow Sacco's stated policy of "... less is more." The indicator units wrapped around at both ends, allowing all manner of lighting regulations to be met without the need for additional lighting, although the British, Japanese and Australian markets had tiny repeater indicators added to the trailing edge of the front wing to meet local rules. The fuel filler sat high up on the offside rear wing, saving the need to bend so much at the pumps, while the aerial (when fitted) was located on the opposite side.

As one moved to the rear, one was greeted by soft curves, tapering the tail from front-to-back, with the rounded upper metalwork banishing the last remnants of tail fins for good. This was all done in the name of good aerodynamics, of course, but also provided the 'family' styling required, as it matched the W201 to a certain extent. On the subject of aerodynamics, although a handful of test cars had a rear spoiler on the upper surface of the bootlid, one was not fitted on production models. Indeed, aerodynamic appendages weren't even offered as an option until AMG parts came online, eventually being mentioned in official price lists in 1993.

Interestingly, the bootlid cut lines sat vertical on the W201 and almost vertical on the R129, but went diagonal on the W124 and W140, allowing a lower trunk lip for easier loading. There's no doubt, though, that the bulkhead provided by the earlier boot designs added strength.

The R129 was basically given a Kamm tail, and to break up the bulk, a rare piece of chrome trim was added to the base of the bootlid (below the obligatory three-pointed star) and the lower apron on the valance was made bolder, helping to keep the exhaust pretty much out of sight. The ribbing in the rear combination lamps, as per other contemporary Benz models, helped keep them cleaner for longer – the indicator units at the front had more subtle ribs moulded into them to balance the design without adding drag. By the way, cars bound for the US had a third brake light above the Mercedes star on the bootlid to comply with Federal regulations, although Australia and New Zealand also adopted this safety feature. Type badges were kept to the left-hand side of the bootlid in all markets.

Finally, between the main rear light units, there was a panel with a number plate housing (the indent changing shape to suit European- or American-style registration numbers), and the bootlid lock/release off to the right of the plate. On some cars, those fitted with remote central locking, there was an infrared sensor underneath the lock, and a matching one in the trailing edge of the door handles.

Oddly, while the R129 was visually the bigger car – and it did have a longer wheelbase and broader track for sure – it was only a fraction wider overall, with the length being a touch longer than a European R107, but actually shorter than the 560SL in the classic series. There's no doubt, too, that the new body was superior aerodynamically, improving fuel consumption and reducing wind noise, and a good deal safer if ever the owner was unfortunate enough to be involved in an accident, with an automatic roll-over bar incorporated into the design, for instance, as well as a new generation of computer-aided design (CAD) to help refine the strength of the body whilst keeping its overall weight to a minimum.

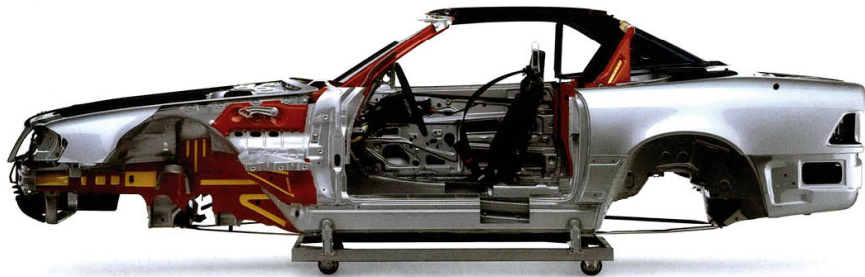

The unit construction body, which came with a lot of safety built-in thanks to the huge sill sections, and a transmission tunnel area that employed the thickest gauge steel to have been used on a Mercedes-Benz passenger car. In addition, to optimize the efficiency of the suspension, great attention was paid to getting the body strength right in the axle mounting areas.



The body-in-white viewed from above.

It's worth bearing in mind that although the R129 model looked compact enough and was only a two-seater sports car, with a very cramped '+2' facility available as an option, it was a big vehicle by normal standards, especially in this sector of the market. For instance, a contemporary Porsche 911 (Type 964) was shorter, narrower and only a fraction taller. It was also significantly lighter at just 1450kg (3190lb), while cars like the Alfa Spider were smaller all-round. On saying that, the Ferrari Mondial Cabriolet was almost exactly the same size, while the Jaguar XJ-S Convertible was longer and wider (although lighter, even in V12 form), and the Pininfarina-built Cadillac Allante was bigger in all directions, as well as heavier, tipping the scales at 1690kg (3718lb).

As always, just as much effort had been put into the R129 under the skin, even though customers rarely seem to care. However, it's this work that gives the car its safety, as well as its quality feel, and

improves the handling characteristics, too, assuming it's done properly.

One of the key elements in creating the perfect bodyshell is endowing it with a high level of torsional rigidity and resistance to bending – the less the vehicle flexes as it moves down the road, the more accurate suspension movements will be, enhancing the efficiency of chassis components, which will also help to improve vehicle ride comfort and refinement.

This, of course, is easier said than done, as one has to balance ultimate rigidity against weight, for weight will blunt driving dynamics, curbs engine power (every additional 10kg, or 22lb, over a set benchmark wastes around 1bhp in restoring the balance) and increase fuel consumption – an increasingly important thing to bear in mind as the 1980s progressed and the 'eco' movement started to gain a voice. There is also cost to consider, as well as build procedures and safety requirements – both legal and internal. This difficult conundrum becomes far more difficult to solve with an open car, as one doesn't have a roof to brace panels, or even relatively minor things like traditional seatbelt anchor points.

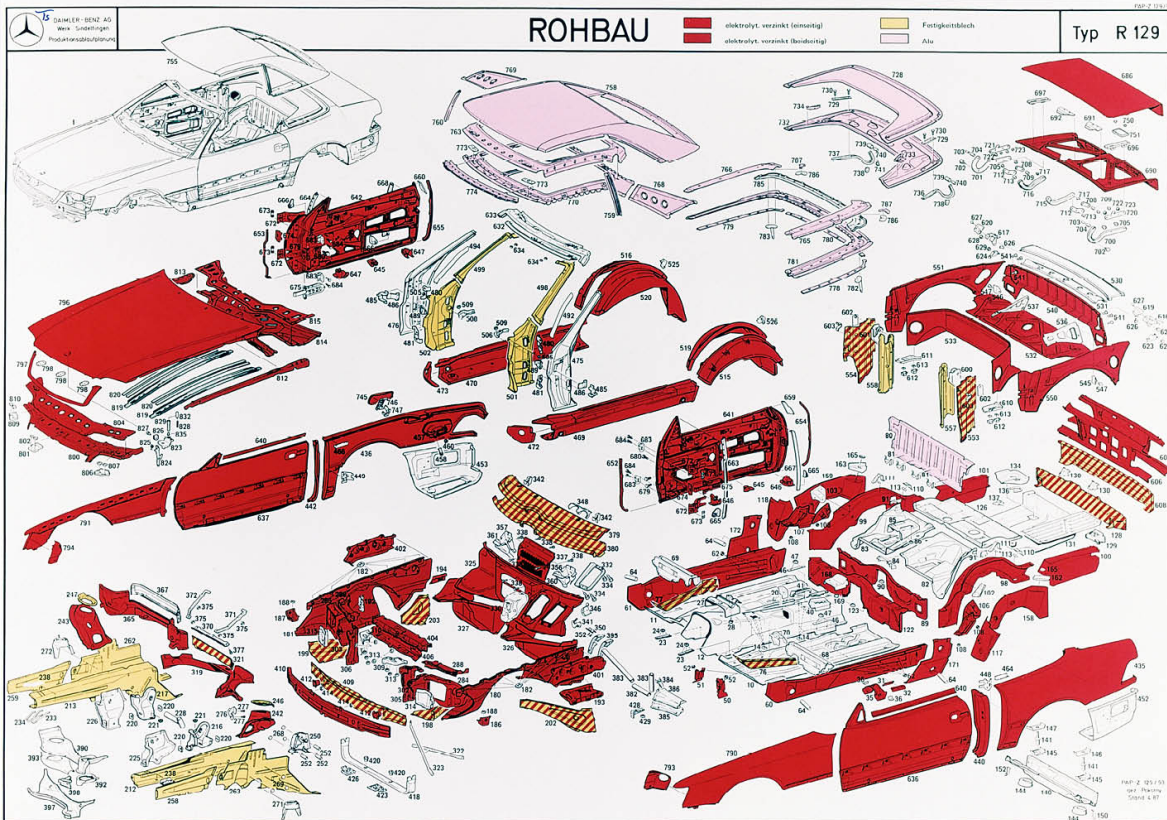

No fewer than 536 body panels were employed, but build accuracy was first-rate, nonetheless. Pieces shown in red are galvanized steel, while those in yellow are of HSLA high-tensile steel, and those in pink were pressed in lightweight aluminium.

The only advantage the Daimler-Benz engineers had was the ability to start from scratch, designing a pure convertible from the off. This is much more straightforward than converting a closed coupé into a convertible at a later date, as happened with cars like the Jaguar XJ-S and Maserati Spyder. As such, special attention could be paid to the windscreen frame and the way the A-pillars joined the side sills, and other areas could be fine-tuned to suit the vehicle's specific configuration.

Although companies like Audi had been experimenting with lightweight aluminium bodies for years, and Honda was on the verge of releasing the NSX with an all-aluminium monocoque body, the technology wasn't really available for volume production at the time

the new SL was being developed. Sticking with steel was the only answer, but the use of high-strength steels – sporting about 45 per cent greater tensile strength than traditional mild steel for a 30 per cent cost premium – in critical metalwork areas was a positive step forward, adding strength with no weight penalty compared to a conventional mild steel body. From a production angle, too, there were advantages in continuing with materials close to those one has been dealing with for decades, with familiarity making pressing tools, welding and finishing much easier to deal with than all-new technology. To keep rust in check, 68 per cent of the steel was galvanized.





Two different offset crash tests, chosen to show vehicle deformation from different angles. The doors unlocked in the event of an accident, aiding a passenger's exit or rescue attempts after a big crash. A contemporary Mercedes-Benz video shows a heavily crumpled car after it was rammed into a solid barrier, but the driver's door still opened without any effort.

As mentioned earlier, the A-pillars played a crucial role in structural rigidity. The pillars, which acted as a frame for the bonded-in windscreen and provided the front location points for the hardtop and soft-top, were made from two pieces of high-tensile steel sheet, folded over to create a hollow section that was then reinforced in specific areas by additional steel tubing to reduce the chances of scuttle shake.

The massive sill structures in the all-new floorpan were of a heavy-duty section to add strength to the sides and reduce front-to-rear flexing. Special attention was paid to the joints between the A-post and the rear bodywork that one normally regards as starting with the B-post on vehicles of this type.

However, without a roof (or Targa bar) to brace the shell from above, the door cut-outs can take away a lot of strength that's never easy to regain without a lot of extra metal, which naturally adds weight and/or reduces practicality – one only needs to think back to the first generations of the SL to see that this was hardly a new problem.

The Daimler-Benz engineers overcame this particular dilemma by the careful positioning of hefty crossmembers in the floorpan, integrating the front axle subframe into the design by connecting it to the sills via struts with their own vibration dampers, and making full use of the soft-top storage compartment, for while this added weight and complexity, it also acted as a fine bracing bulkhead, making the area above the rear wheels exceptionally stiff for an open car; the spare wheel well, getting its strength from its shape, was used as another bracing piece to tighten up the sill area, while the spare itself was positioned to help absorb crash energy from a rear-end shunt.

The engineers also designed the doors in such a way that they acted as connecting pieces in an accident, with overlapping tongues at the base to reduce the risk of intrusion from the side, thus turning the disadvantage of traditional doors (a loss of structural rigidity) into a positive advantage by preserving survival space following a heavy crash.

In a similar vein, building on the pioneering work of Bela Barenyi, crumple zones were incorporated in the front and rear structures, with special attention paid to the front cross-tie positioning in order for impact energy to be absorbed more evenly throughout the shell in the event of an offset frontal collision – an event that research had shown ultimately happens far more often than a full head-on accident.

Thanks to modern design techniques and metals, even when one includes the innovative roll-over bar (more on which later), the body-in-white was only 405kg (891lb) – just 20kg (44lb) more than the R107 shell, despite the vast improvements in safety that almost two decades of progress allowed, and a significant 30 per cent gain in torsional rigidity, which meant distortion levels easily on a par with those of a contemporary Mercedes-Benz saloon. The latest anti-corrosion methods (including sealant sprays and wax injected into cavities) also saw to it that, whilst not unheard of, even today, rust is a rare find in an R129.

Another sign of 'progress' at the time of introduction was the extensive use of plastics – lighter, cheaper to produce (from the tooling stage through to finished product), and easier to recycle in

the future. The larger panels, such as bumper assemblies, speeded up production on the line, too, with simplified fit and finish.

Interestingly, the R129 SL was one of the first cars to employ water-based paints for the bodywork in order to reduce the release of harmful volatile organic compounds (VOCs) into the atmosphere. This new type of paint was used from the off on the R129 before being adopted on certain other models in 1993. It was at this time that Daimler-Benz stated its intention to move over to the exclusive use of water-based paints by 1998.

SL dimensions

The chief differences (and areas that remained the same) between the last of the European- and American-spec R107 models, both versions being equipped with catalytic converters, and the new roadster. The width shown is the body width and does not include side mirrors, which sat slightly proud of the body line of the R129, while the height is that with the hardtop in place.

500SL (ROW)

Wheelbase: 2455mm/96.6in
Overall length: 4390mm/172.8in
Width: 1790mm/70.5in
Track (front): 1465mm/57.7in
Track (rear): 1466mm/57.7in
Height: 1297mm/51.1in
Fuel tank capacity: 85 litres
Kerb weight: 1610kg/3542lb
Power-to-weight: 7.2kg/hp DIN

560SL (USA)

Wheelbase: 2455mm/96.6in
Overall length: 4580mm/180.3in
Width: 1790mm/70.5in
Track (front): 1465mm/57.7in
Track (rear): 1466mm/57.7in
Height: 1297mm/51.1in

Fuel tank capacity: 85 litres
Kerb weight: 1680kg/3696lb
Power-to-weight: 6.9kg/hp DIN

500SL (R129)

Wheelbase: 2515mm/99.0in
Overall length: 4470mm/176.0in
Width: 1812mm/71.3in
Track (front): 1535mm/60.4in
Track (rear): 1523mm/60.0in
Height: 1293mm/50.9in
Fuel tank capacity: 80 litres
Kerb weight: 1800kg/3960lb
Power-to-weight: 5.5kg/hp DIN

Hardtop, soft-top & an innovative roll bar

Ever since the introduction of the W113 'Pagoda' SL, a hardtop has been an important signature component in SL lore, being not only practical, but complementing the rest of the design in a manner expected in few other vehicle lines, if any.

Some of the earlier R129 hardtop ideas relied on heavier B-post sections to give strength and allow better rearward vision at the corners, but none of them were particularly elegant. In the end, after no fewer than 34 attempts at refining the design, the lightweight pillar behind the door was much the same as that found on the R107 hardtop, while the C-pillar was allowed to flow backwards, steadily becoming wider at the base to provide a very glamorous coupé line that somehow seemed to visually reduce the car's overall height. Unlike the R107, the rake of the glass in the back window was actually steeper than that of the windscreen, and combined with the short roof section and visually shortened tail, the balance was just about perfect, making the classic SL look stumpy by comparison when the hardtop was attached.

On the practical side, steel gave way to lightweight aluminium as the material of choice for making the hardtop (plastics were considered at one point but rejected early on, mainly due to finish

quality concerns). Despite the larger glass area (with integrated heater elements) and ample padding and lining on the inside, this reduced weight by a significant amount, the new top tipping the scales at 34kg (75lb), although it was still best for two people to handle its mounting and removal. One could argue that the superior rigidity of steel justified the extra weight, as it should offer greater passenger protection, but the Daimler-Benz engineers had a novel idea up their sleeves when it came to roll-over safety – a spring-loaded bar that popped up from in front of the hood cover panel to create what amounted to a sort of Targa bar whenever the car's onboard sensors judged it as wise to do so.

With the hardtop in place, locked there by electromagnetic wizardry, the R129 offered the same level of safety in an accident as the forthcoming W124 saloon. In reality, though, people always tend to associate the SL with wind-in-the-hair motoring. As such, the fitting of a soft-top was taken as read, either providing shelter from the rain and cold (or scorching sun as the case may be in places like California and Japan), or hidden out of sight tucked away under a hatch, as per the R129's predecessors.



The R129 hardtop in the background, with the soft-top open and closed in the foreground, thus giving an image of the roof profiles.



As well as being supremely elegant, the latest hardtop offered excellent visibility. It was also much lighter than that fitted to the R107s, thanks to its aluminium construction.

The partially-lined fabric soft-top was available in the same three basic colours as the outgoing SL. Indeed, the general shape was similar, too, with a rectangular plastic centre window, and tiny half-portholes to either side, separated by heavy strips of the hood material.

Earlier owners would have been pleased to learn, however, that the raising and lowering of the soft-top was no longer a manual operation – one didn't have to leave the seat, find handles or even risk breaking a fingernail to get the job gone, as all the labour (including the release and locking of the hood on the header rail) was looked after by a single push-button next to the gearshift that kicked in an electrically-driven hydraulic pump, a bank of 15 hydraulic actuators (the use of high pressures kept actuator sizes down, allowing them to be integrated into the design with ease) and 11 solenoids controlled by microprocessors, as well as 17 end-position switches. As it happens, the same push-button was used to secure or unlock the hardtop automatically, although both tops had the facility for manual operation in the case of an electrical malfunction.

Although power dropheads were hardly a new idea on either side of the Atlantic, they were still a real rarity on volume production models at the time. In the case of the new Mercedes, if one wanted to drop the hood, once the car was stationary with the handbrake applied, at the flick of a rather uncharacteristically cute roof-shaped

switch, the side windows lowered, the roll bar dropped down (assuming it was deployed), the rear window moved upwards, the rear hatch opened, the latches on the windscreen header were released, the hood folded back into the hatch, which then closed, and the side windows (and roll bar) were put back into their original position. Raising the hood again was just as easy (one simply pushed the same toggle switch in the opposite direction), with either process taking under 30 seconds to complete.



The soft-top sat well, although a few complaints were voiced over the internal lining, which wasn't quite up to the high standards of the rest of the car. In reality, it was the complicated folding mechanism that dictated where the lining could and couldn't be placed. It was the same with the plastic rear screen, which also surprised a few on such an expensive machine – it needed to fold, ruling out a glass rear window.



The innovative roll-over bar, which popped up in a fraction of a second if onboard sensors determined it was wise to deploy it. It could also be raised by the driver via a switch in the centre stack.



Raising and lowering the hood was a fully automatic operation, with the driver having to do nothing more than push or pull this toggle switch to get the job done.



The power hood in action.

Apart from deserving a pat on the back for making the soft-top drop into a cavity narrower and significantly shorter than the hood itself, the engineers also did a super job of keeping the bows lined up to give the soft-top a smooth profile once erect, being tensioned internally by steel ropes to stop it ballooning at speed and give it the kind of weather- and draft-proofing properties one comes to expect from a Mercedes hood, as well as superb noise insulation.

Sitting on the inner edge of the soft-top hatch, following its contours, was the roll-over bar we mentioned earlier. This innovative passive safety feature has been blamed in the past for some of the delays in launching the car, although other factors (largely external) were probably more likely for the hold-ups, and with the R107 still selling fairly strongly, it made the decision to postpone things that much easier for the Daimler-Benz management.

The spring-loaded, pop-up roll bar (a pipe, constructed using a high-tensile steel that was some three times stronger than the regular grade, clad in polyurethane foam and then trimmed to match the interior and hood hatch finishing material) was activated automatically whenever the car's onboard sensors detected vehicle instability (with a 26-degree tilt measured side-to-side on the

onboard inclinometer in conjunction with a wheel lifting, or a 4g impact as the major default settings), or it could be raised manually at the push of a button for giving passengers of a nervous disposition some peace of mind. As a safety feature, the function of the bar was the same regardless of which configuration the car was running in – with or without hardtop, or with the soft-top in the raised or lowered position.

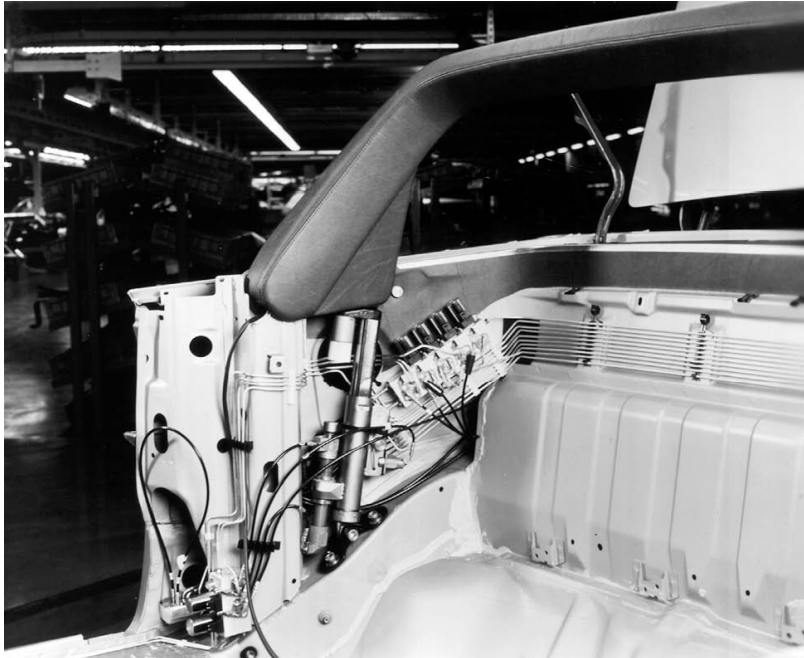

An interesting picture showing the hydraulic and electrical systems that made the roll-over bar work. On Dr Rudolf Hörnig's insistence, the R&D staff increased 50 per cent during the time R129 was being developed – one wonders if most of them were tied up developing the hood and roll-over bar designs.

The main advantage in using this type of roll-over bar – a world first that took four-and-a-half years to develop – was aesthetics, as a fixed bar (as in a Targa arrangement) is generally rather difficult to integrate into the design on an open car. Thanks to electromagnetic technology, it flipped up in 0.3 seconds when needed, and combined with the stiffened windscreen frame at the front, gave superb levels of safety should the car happen to overturn – itself an unlikely event due to the R129's low centre of gravity, wide stance and all the latest

chassis technology.

In any case, the roll bar could also be raised via hydraulics at a more leisurely pace than in an emergency situation (in four seconds to be exact!) to support the optional windblocker – a simple net, similar in principle to the one introduced a year or two earlier on the Mazda RX-7 Cabriolet, that controlled the airflow coming into the cockpit to reduce buffeting when the hood was down. Able to fold to suit the roll bar position (it could be used with the bar up or down), as Bruno Sacco observed: “Even without a full head of hair, I appreciate the effect of our draught-stop engineers’ ingenious idea.”

Incidentally, the Cd was quoted at 0.31 with the hardtop in place and 0.33 with the soft-top up, although it moved closer to 0.43 with the hood down. Nonetheless, this represented a huge improvement on the R107 model, listed at 0.44 even with the hardtop on, which naturally had a bearing on things like fuel consumption and wind noise levels. All cars came with both tops as standard equipment, at least in the early days. Overall height was listed at 1293mm (50.9in) with the hardtop in place, the soft-top adding 10mm (0.4in).

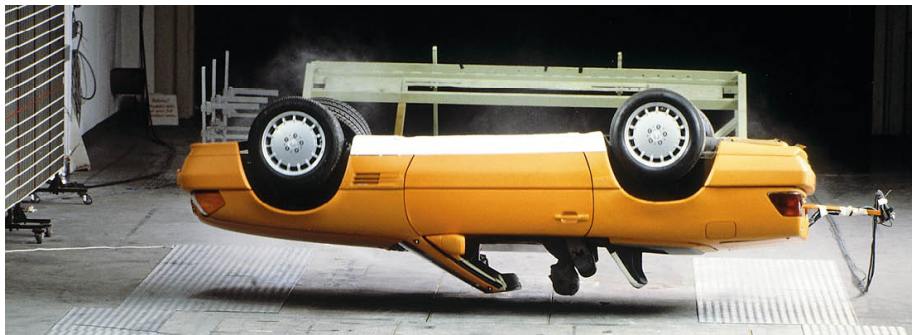

Safety limits were truly remarkable for an open car, as a number of crash tests proved. Minimum standards for saloons were easily surpassed.



The R129 in the wind tunnel, the smoke showing the airflow over the body with the car in open guise and the hardtop in place. Detail improvements in aerodynamics and a reduced frontal area allowed the new SL to slip through the air a lot better than the R107 ever did. A panel underneath the engine also helped reduce drag and noise.

The inside story

Many years had passed since the R107 SL had been introduced, but the interior had stood the test of time well, in a way the W113 model before it could never have. Subtle tweaks here and there had kept the traditional cockpit looking current, with the addition of wood trim and the gradual updating of switchgear making a world of difference.

One of the key ingredients in the successful longevity of the R107 interior design was its conservative appearance, and this fact was obviously not lost on those styling the interior for the R129. Granted, the overall impression was much sharper, with eyeball dash vents being replaced by more modern rectangular units (two in the centre, and one at each end of the fascia, each having their own direction and air volume control), revised door furniture and so on, but there was certainly no risk taking. Indeed, some commentators were quite disappointed that a more leading-edge approach was dismissed, considering it a lost opportunity almost. However, the Daimler-Benz people knew their customer base well, and those buying the Mercedes were more likely to be impressed by sophistication, quality feel, good ergonomics and the unique blend of Teutonic understated luxury, than unnecessary styling gimmicks and state-of-the-art playthings.



Designers at work creating the first batch of interior styling proposals.

The new interior was basically a reflection of contemporary W126 S-Class thinking, and a vision of what was to come in the W140 with a suitably sporting twist, such as the design of the centre armrest and crisper door trim. There was also less wood trim, too, with that

on the dashboard fascia deleted, while the burl walnut used on the centre stack was unusual in that it wrapped around to form an outer edge – the norm was to frame the wood with softer materials. It made the walnut trim by the inner door handles look less at ease somehow, but then it's well-known that Sacco was actually against the use of wood for the SL in the first place. His belief was rather like that of Jaguar until the start of the 1980s, with sports cars having plain, functional cockpits, and walnut trim being reserved for saloons. Of course, the Coventry maker went to wood accents for all cars from the summer of 1981 onwards, much to the acclaim of the critics, and this was probably a deciding factor in the Mercedes camp.

Dual airbags were incorporated into the design from the off – supplied as standard in some countries, at least on the driver's side, and optional in others. If the passenger-side airbag was fitted, it meant losing the glovebox, which eliminated a fairly large lockable storage facility. Despite this, the designers still managed to provide a small oddments storage box in the centre of the dashboard (unless it was occupied by the optional trip computer), with extra covered bins in the centre console aft of the gear selector (one for cassette tapes) and in the door panels.

Cars without the driver's-side airbag inherited the old four-spoke R107 steering wheel, while those with the SRS system had the later version, as fitted to US-bound vehicles as standard fare, but available as an option in most markets. A major difference, however, was the steering column, which was now adjustable for height and reach. The power version even moved up and inward to give easier entry and egress from the car as soon as the driver's door was opened.



An interior styling mock-up, with numerous components, such as air vents and light switches, represented by printed card stuck in place. Note also the rather characterless seat upholstery, which duly became more luxurious, and the rear compartment arrangement, set up as a 2+2.



Although not all cars were fitted with them, the R129 was designed to accept dual airbags from the start of production.



Interior of an early domestic car without airbags. Sunvisors contained illuminated vanity mirrors, by the way.

The HVAC (heating, ventilation and air-conditioning) system was overhauled, with the controls simplified and made more conventional. The regular heater and basic air-conditioning units

looked quite similar, with two dial switches controlling fan speed and air direction, while the buttons surrounding them acted as identifying features. The top air-conditioning option was fully automatic, incorporating a state-of-the-art pollen filter, with a control panel dominated by pushbuttons and a digital read-out for the desired temperature setting. All three HVAC systems channelled hot or cold air into the door cavities to add efficiency to the system with the hood down, and came with an innovative 'REST' facility, using residual heat from the powerplant to keep the cockpit warm after the engine had been shut down.



This car has a single airbag, as the steering wheel contains the SRS system, while the glovebox release is located on the right of the central air vents. One can also make out the regular (non-automatic) air-conditioning controls, and the optional Becker Mexico radio/cassette, as well as the ashtray with cigarette lighter. The 300SL had a 6200rpm red-line on the tachometer, while the 300SL-24's was marked up at 7000rpm, and the 500SL (seen here) at 6000rpm.



Adjustment of the steering column was a welcome new feature.

With the gauges and switchgear all having a familiar air about them, despite the addition of two more meters in the instrument binnacle, perhaps the most interesting feature in the latest interior was the front seats, with their lightweight five-piece diecast magnesium alloy frames, giving extra protection in a side-impact accident, and their integrated seatbelts, providing designers more freedom with the car's beltline silhouette (the need to anchor belts in the B-post area at a predetermined height played havoc with aesthetics) and users better access to the rear of the vehicle, either for luggage storage or to sit in the optional rear jump-seats.

The seatbelts were anchored at the outer top and lower edges, with power adjustment on belt height via the headrest adjuster. The tensioner and ELR (Emergency Locking Retractor) system were also incorporated into the design, with power adjustment on the cushions (up, down, forwards and backwards on the lower squab, and rake angle on the backrest) and three-position memory functions available (the latter linked into the steering column and power mirror positions, which looked after both interior and outside mirror

positions). The buckle receiver was also attached to the seat base. This called for extra strengthening underneath the seat, but it served a dual purpose, as it braced the body still further.



Close-up of the dashboard of a German market 300SL-24 showing (from left-to-right) the fuel gauge, the combined engine coolant temperature, fuel consumption and oil pressure gauge, the central speedometer (marked up to 260kph or 160mph depending on the car's destination) with analogue trip and main odometers inside the dial and an outside temperature gauge below it in the same plane as the row of warning lights, a tachometer to the right of that, and a clock on the far right. Instrument calibrations glowed yellow on black at night, while the switchgear was backlit by efficient, lightweight fibre optics. The light switch and parking brake release can be seen to the left of the steering wheel, as can the familiar multi-function 'wand' that looked after indicators, high beam and windscreen wash/wipe controls. Above the stalk in this picture is the cruise control lever, with the ignition barrel on the other side of the column. Heater controls can be made out in the middle of the central air vent, along with the air volume control wheels, and the lock and release buttons for the centre storage box and glovebox. In the centre stack, we have a regular air-conditioning unit, a Becker Grand Prix radio/cassette, switches for the rear window heater, fanfare horns, hazard warning lights, the snow programme on the ASR system, and the manual control for the roll-over bar. Below the ashtray and surrounding the gear selector, with its switchable modes, we have the power mirror toggle switch (which looked after the inside mirror

adjustment as well as the two outside ones), the power roof switch, and rocker switches for the electric windows and seat heaters. Finally, by the rearview mirror, the two switches cover interior lighting options and reading lights.



The innovative seat frame.



A view of the new seats in situ, with the release handle on the side allowing it to tilt forward to give access to the rear compartment. This shot also gives a good view of the centre console (with its lid forming an armrest), the cassette storage box in front of it, and the rare auxiliary heating switches aft of the gear selector. The traditional Mercedes-Benz foot-operated parking brake and its dash-mounted release managed to keep things tidy between the seats.



Power seat controls (with memory facility) and audio speakers on the inner door panel.

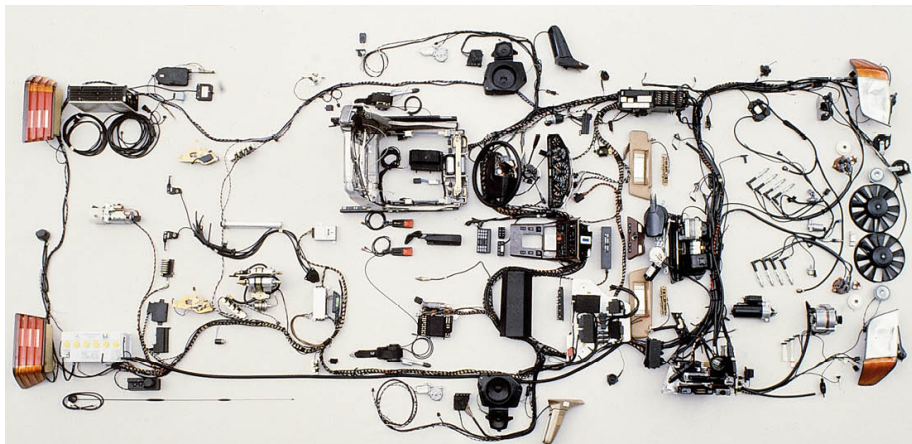

The wiring harness necessary to look after all the power-assisted gadgets, lighting and engine electrics.

As before, assuming the electric interlock permitted it (it locked the seatback as soon as the car was in motion), a release on the outside edge (significantly more sturdy than the old design) allowed the seat

to fold forward, giving access to the rear storage bins, which formed a carpeted shelf when they were closed. The bins were far superior to earlier versions, folding towards the car's centreline and having positive catches. One could also specify rear seats as an option in a number of countries, which could actually be folded themselves like the Porsche 911 back seats to form another parcel shelf. Although things were tight in the back for adults, at least up front the R129 came with substantially more shoulder and hip room than its predecessor.

Seat trim was either in supple leather with perforated inlays or a check cloth that reminded more than a few people of the upholstery employed on the 1950s racers. The door panel inlays were trimmed to match, while most – but not all – markets received a leather-wrapped steering wheel and gearshift. Velour carpeting was used to cover the footwell area, the sides of the centre console, the underside of the dashboard, the lower part of the door panels and the entire rear compartment. Overmats were provided in a similar material for the front, and the sills were finished with stainless steel treadplates, at least on production models.

All cars came with electric side windows and traditional Mercedes pneumatic key-operated central locking, which could be upgraded to a remote control system at extra cost. The doors, boot and fuel filler lid all worked off the same central locking mechanism, and it was also possible to have it extended to cover all seven of the interior storage compartments as an option – an ideal scenario for dedicated alfresco enthusiasts or those wishing to leave the hood down during a brief stop. There was also the option to lock the storage compartments only for occasions like valet parking or servicing.



Useful reference shot of the leather upholstery and 2+2 seating. The leather trim was not extended to other areas of the car unless options were specified.

The sophisticated optional alarm system was a sad sign of the times, with car crime on the rise. In Germany, just over 100,000 vehicles were stolen in 1990, but it leapt to 275,000 in 1993. In Britain, the figure was already over half-a-million in 1990, peaking at around 650,000 three years later. Add in theft from vehicles, and one can see why so many owners specified the alarm, despite its relatively high cost.

As befitting a car of this quality, the audio system was designed to match the SL's acoustics. Tweeters in the fascia used the windscreen to bounce sound into the cockpit, while each door contained a mid-range speaker combined with a larger woofer unit. The stereo unit itself was usually an option, but the engineers had obviously paid a lot of attention to detail – gone were the days of a single central speaker under the dashboard!

Before moving on, we ought to mention the boot, or trunk depending on which side of the Atlantic one lives. At 7.9cuft (0.22m³), this was slightly smaller than the 8.9cuft (0.25m³) listed against the R107, but then that was an exceptionally large luggage compartment for a sports car after all is said and done. As soon as

the bootlid was lifted, the warning triangle became visible, housed on the inside of the lid and alerting oncoming traffic instead of simply taking up space tucked away somewhere. The spare wheel, which sat in the base of the boot with the jack and toolkit, was a full-size one on a regular alloy rim. All surfaces were carpeted, and, unusually, even the inside of the bootlid was trimmed to act as a sound-deadening device.

The power units

As with the car's styling, the powertrain selection was a combination of the old and the new. The base engine, mainly for the European market (where emissions regulations weren't as strict as those in the States and Japan and one didn't have to be concerned with things like CAFE fuel economy averages) was already familiar to followers of SL lore, as it was basically the three-litre six used in the 300SL from the previous generation.

This tried and trusted M103 lump, with a displacement of 2960cc (obtained through a 88.5 x 80.2mm bore and stroke), could trace its roots back to the straight-sixes of the fifties and sixties, albeit modernized in all manner of ways.

A cast-iron block was retained for this engine (Type 103.984), although there was a light alloy cross-flow cylinder head, playing host to a chain-driven single overhead camshaft (with a slightly hotter profile compared to earlier M103 engines) operating on two valves per cylinder, and coming with hydraulic lifters to give automatic valve clearance adjustment, less wear and quieter running, with reduced noise and vibration every time a valve was opened and closed.

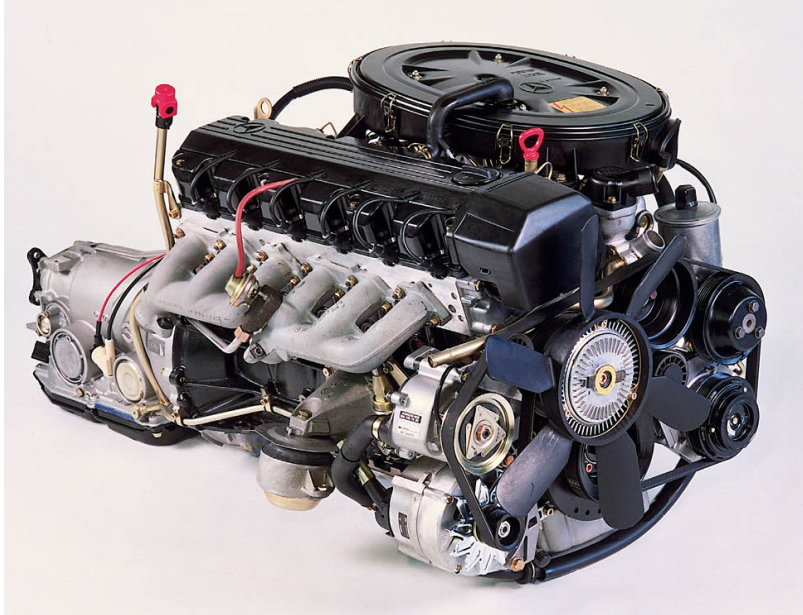

The familiar M103 unit employed in the strict 300SL, seen here with an automatic gearbox tacked onto the back.



A Mercedes catalytic converter, with the lambda sensor upstream of it, measuring oxygen levels in the exhaust and signalling the engine's ECU to adjust fuel-air mixtures and keep emissions to a minimum.

With microprocessor-controlled electronic ignition (EZL), the latest electro-mechanical Bosch KE-Jetronic (or CIS-E V) port fuel-

injection, and a 9.2:1 compression ratio, following refinements to the combustion chamber (to reduce HC emissions) and catalytic converter and exhaust system design, the engine delivered 190bhp DIN, regardless of whether the car was equipped with a catalytic converter or not. This meant a healthy gain of ten extra horses for the new unit when compared to its predecessor in 'cat' guise.

As it happens, closed-loop three-way catalytic converters had become the norm at Daimler-Benz since late-1986, and were fitted to all domestic R129 models as standard. However, unleaded fuel was far from freely available in huge swathes of Europe. In Britain, for instance, it wasn't until 1990 that widespread availability became a reality. As such, the compulsory fitting of 'cats' in new cars sold in EEC wasn't made law until the beginning of 1993. In the major export markets of America and Japan, of course, catalytic converters had been a requirement since the mid-seventies. Incidentally, all cars with catalytic converters came with an air pump and EGR (Exhaust Gas Recirculation) in order to further reduce emissions.

Meanwhile, with Daimler-Benz announcing its plans to return to top-flight motorsport in January 1988, just as the ten-millionth post-war Mercedes-Benz passenger car was being built, naturally enough, a high-tech image was more in keeping with the mood in the boardroom and the marketing office at the time. As such, it was the three- and five-litre four-valve per cylinder engines that stole the limelight.

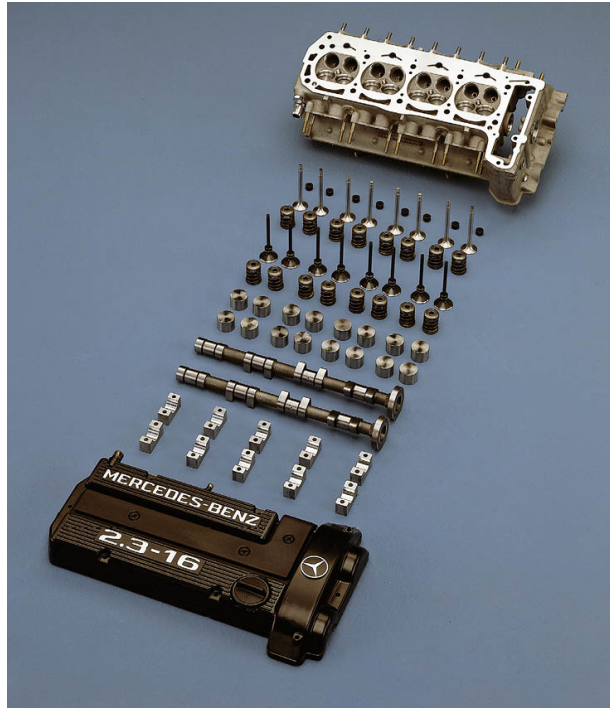

The first of the modern four-valve engines was the one used in the 190E 2.3-16 model of 1984.

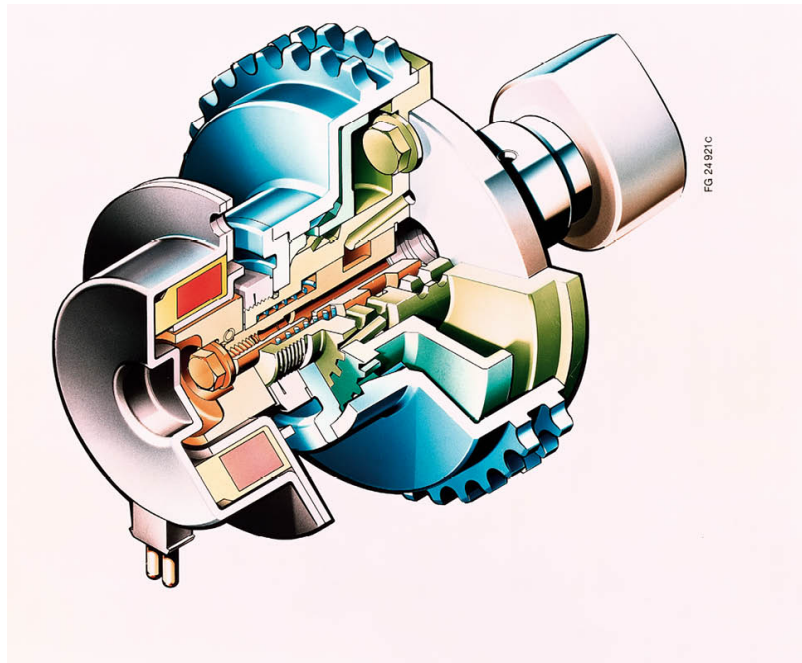

The Daimler-Benz variable valve timing mechanism.

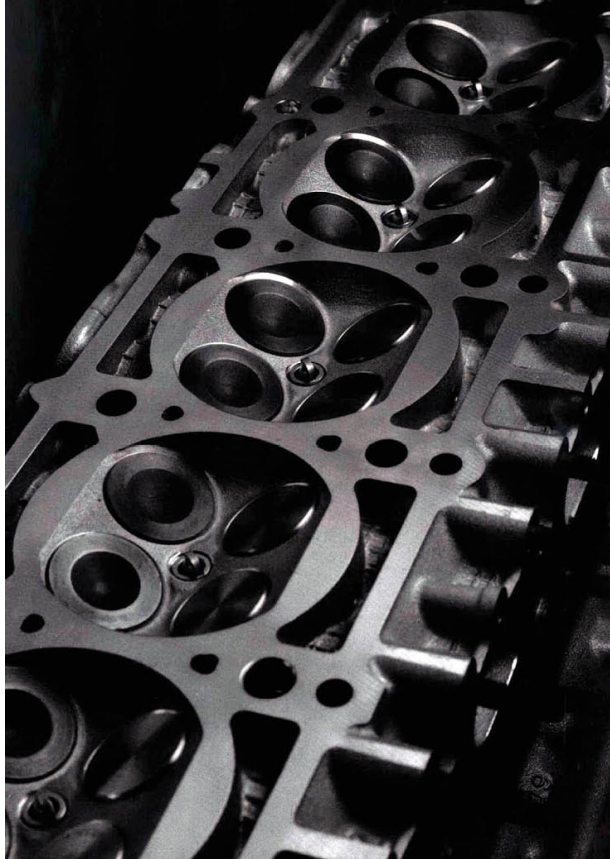

Industrial art. A detail shot of the 24v head, showing the pent-roof combustion chamber.

Although new to the SL series, four-valve engines were actually nothing new at Daimler-Benz, as the firm was using this technology in racing cars even before the First World War. The first of the modern Mercedes-Benz 4v engines was seen on the 190E 2.3-16 introduced in 1984, the design allowing a central sparkplug for uniform combustion, lighter valves to reduce inertia, and better breathing, thus endowing the engine with increased performance at high revs and lower emissions.

To overcome the problem of developing most power at higher rpm readings in combination with a rather peaky torque curve (not a problem on a racer, but an important point to consider on road vehicles, especially those equipped with an automatic transmission), variable valve timing (VVT) was introduced to enhance low-end and mid-range torque, and further reduce emissions along the way.

The thought of variable valve timing, to maximize performance over a wider rev-range by changing the valve opening and closing duration, had actually been around in principle since the 1920s. However, nothing really spectacular happened until Alfa Romeo and Fiat started working on VVT systems in the sixties and seventies. Although Alfa refined its idea to create VIVT, it was really down to the Japanese to bring variable valve timing to a widespread audience, with Nissan showcasing it in 1987 and Honda following with the famous VTEC system not long after.



Engine bay of the 300SL-24 model. All six-cylinder SL units were mounted at a 15-degree tilt to lower the bonnet-line.

In the meantime, the Daimler-Benz engineers had been working away quietly devising their own VVT system, using an electromagnetically-controlled hydraulic mechanism attached to the inlet camshaft in order to adjust the inlet valve timing and increase the power-unit's efficiency. At idle, there was zero overlap, but the inlet valves were made to stay open longer under acceleration or at higher revs.

On the new six-cylinder engines, depending on feedback from the fuel-injection system, the inlet valve timing could be adjusted by as much as 34 degrees to optimize running, with 20 degrees possible

on the V8. Even so, even this latter figure was still a huge amount compared to the ten degrees available on the contemporary Alfa setup. Working in harmony with the ignition system, which adjusted the spark timing according to engine load, this gave a desirable combination of a flatter torque curve, greater top-end power, smoother idling and reduced emissions.

The three-litre M104 four-valve per cylinder engines were developed first and foremost to power the W124 mid-range saloons. As it happens, though, the R129 model got it first, as the W124 application wasn't launched until the 1989 Frankfurt Show. It was also detuned slightly for the saloon, losing 11bhp along the way.

Like the M103 series, the free-revving M104 engine continued to employ a cast-iron block, and even had the same bore and stroke measurements as the 12v unit. As such, the 2960cc displacement was also the same, although the aluminium alloy cylinder head (with a high silicon content, and capped by a lightweight magnesium alloy cam-cover on the M104) was completely different thanks to the M104's twin-cam, 24v layout. The four valves, angled at 50 degrees, were arranged around a central sparkplug in a pent-roof combustion chamber.

The forged steel camshafts (one for the inlets, and the other controlling the exhaust valves) worked on hydraulic lifters and were chain-driven, for although belt drives were becoming increasingly common, there was still a question over durability – experience had shown that chains could remain in place for 100,000 miles or more, while rubber belts would need changing twice within the same timespan. Special attention was therefore paid to making the chain drive as quiet as possible, both through sprocket and tensioner design. Pistons, incidentally, were cast in aluminium alloy, and then nickel-plated to extend service life.

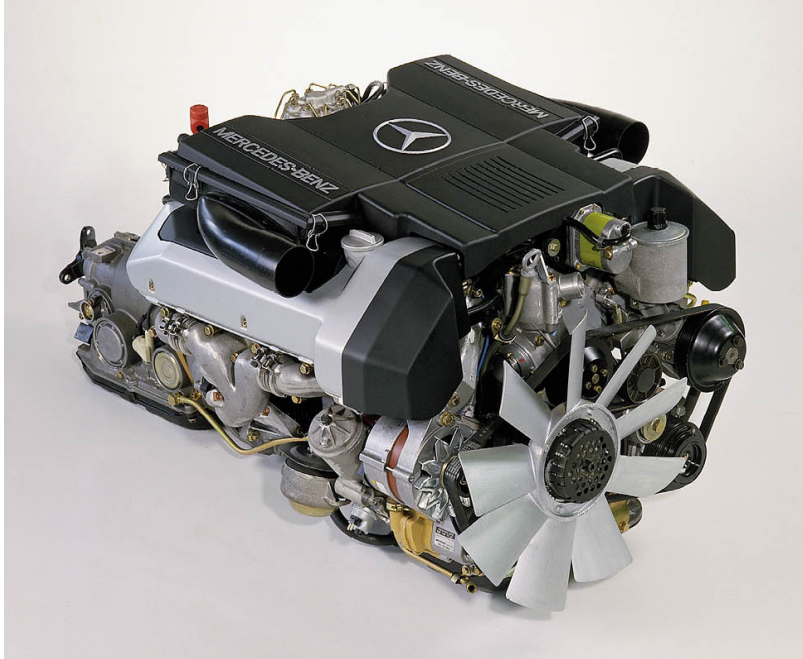

The M119 32v V8 used in the 500SL. Note the black plastic covers at the front of each bank; these housed the two distributor drives, with four sparkplug leads on each.

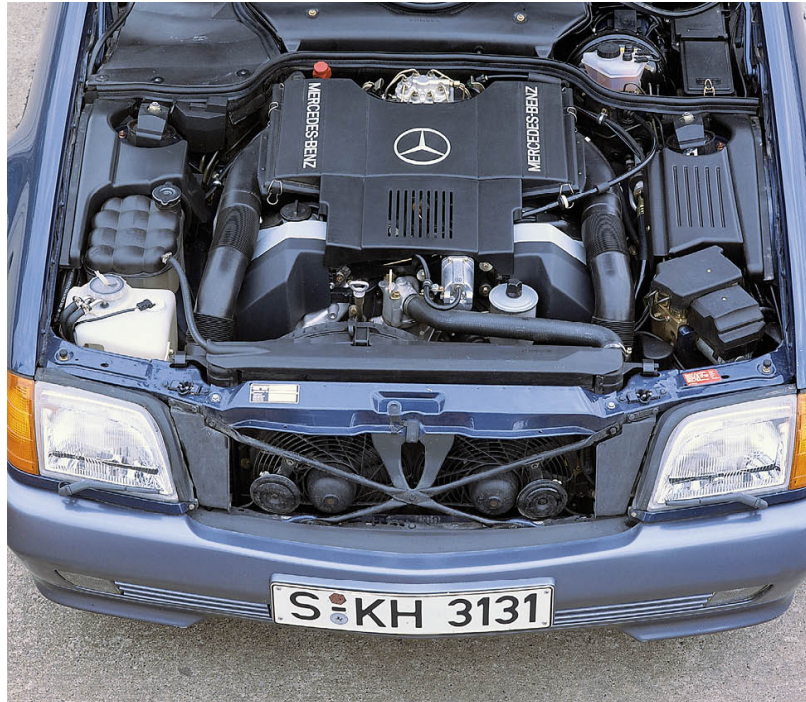

The underbonnet view of the R129 500SL was quite different to that of the R107 version, with the huge air filter housing dominating the engine bay and plastic covers everywhere to tidy things.

The latest knock sensor technology, working in conjunction with the Bosch KE5 engine management system and EZL ignition, allowed the Type 104.981 unit to run at its leanest limits without risk of damage, and combined with a higher 10.0:1 compression ratio, improved emissions levels and overall performance – rated at 231bhp, this was a significant 41bhp increase on the M103 unit, despite having the same cubic capacity and KE-Jetronic multi-point EFI system. Fuel consumption was slightly worse than the 12v engine, but within two per cent overall, which was a small price to pay for the difference in response, and the wonderfully flat torque curve.

The old five-litre M117 V8 used in the last of the R107s was an all-alloy unit with a single overhead camshaft per bank and two valves per cylinder. The new five-litre M119 V8 was based on it, but the cast alloy head was endowed with a chain-driven dohc setup and four valves per cylinder with VVT, as per the M104 engine (albeit a more

compact arrangement due to a shallower 38-degree valve angle, adopted for packaging reasons). As such, the biggest difference lay in the fact that it went from a 16v unit to a 32v one, although there were also improvements made to the lubrication system, the crankcase (reinforcements making it stiffer than before), the crankshaft and connecting rods, and the exhaust system (including the catalytic converter arrangement) at the same time.

With the familiar KE-Jetronic fuel-injection system, EZL ignition (with two distributors – one for each bank on the V8) and a 10.0:1 compression ratio, the Type 119.960 unit came with a minimum of 326bhp and 332lbft of torque on tap. Slightly more was available if a ‘cat’ was left off the spec sheet, as was still possible in certain countries at the time of the R129 launch, but whichever way one looked at it, the new 500SL was the most powerful car in the contemporary Mercedes-Benz line-up.

All engines made use of a 92Ah battery charged by a 100A alternator for the electrical system, and drew fuel from an 80-litre fuel tank, of which about 10 litres was a reserve. For those of us who still find it easier to visualize gallons, 80 litres works out at 17.6 imperial gallons, or about 21 US gallons. Ultimately, this was smaller than the R107 one, but it remained the same throughout the R129’s lifespan, no matter what the powerplant, so obviously didn’t present any problems.

In the background, there was the promise of a V12 engine, which was typical of the projects that surfaced during the ‘Bubble Time’ era. Jaguar dominated the market as far as V12s were concerned, with other exotic applications through the years upholding its mystique. However, it was probably the guys at BMW that Daimler-Benz wanted to poke in the eye, though, for the booming Munich maker was known to have a new twin-cam V8 in the pipeline (serious development started in 1984), and the V12 would allow the Stuttgart company to stay a step ahead of its German rival in terms of marketing potential.

A swept volume of six litres was thought to be a good starting point for quiet and effortless performance, while four-valve per cylinder technology and VVT kept it clean and relatively frugal, at

least in relation to the mighty power output of almost 400bhp. However, delays meant that the 600SL was not part of the original line-up, eventually being presented to the press on 13th July 1992.

Transmission options

The six-cylinder cars came with a Type 717.4 series five-speed manual gearbox (5MT) as standard, with synchromesh on all gears and a single dry plate clutch. A Type 722.3 series four-speed automatic transmission (4AT) with torque converter and a 'Standard' (some say 'Sport') and 'Economy' mode switch alongside the traditional Mercedes-Benz staggered gate could be specified as an option on the two 300SL models, but came as part of the package on the 500SL – there was no manual option on the V8 car.



300 SL

Mechanisches Getriebe

Schalthebelstellung in den einzelnen Gängen siehe Abbildung.
Schalten in den Rückwärtsgang nur bei stillstehendem Fahrzeug. Dazu den Schalthebel anheben.
Höchstgeschwindigkeit in den Gängen nicht überschreiten. Strichmarkierungen auf dem Geschwindigkeitsmesser beachten.



300 SL-24

Parken

- Pedal der Feststellbremse niederreten.
- 1. Gang oder Rückwärtsgang einlegen.
- An starken Steigungen oder Gefällen die Vorderräder gegen die Bordsteinkante drehen.

Automatisches Getriebe

Die einzelnen Gänge werden automatisch geschaltet, in Abhängigkeit von

- Wählhebelstellung
- Programmwählschalter-Stellung
- Fahrpedalstellung
- Fahrgeschwindigkeit

Anfahren

- Feststellbremse lösen. Betriebsbremse betätigen, damit die Wählhebelsperre aufgehoben wird.
- Wählhebel in eine Fahrstellung schalten. Motor im Leerlauf.
- Betriebsbremse erst zum Anfahren lösen – sonst kann es sein, daß das Fahrzeug anrollt.



Fahren

Page from the German handbook showing manual transmission (MT) gearlever shift patterns, with the 300SL layout on the left, and the 300SL-24 one on the right.

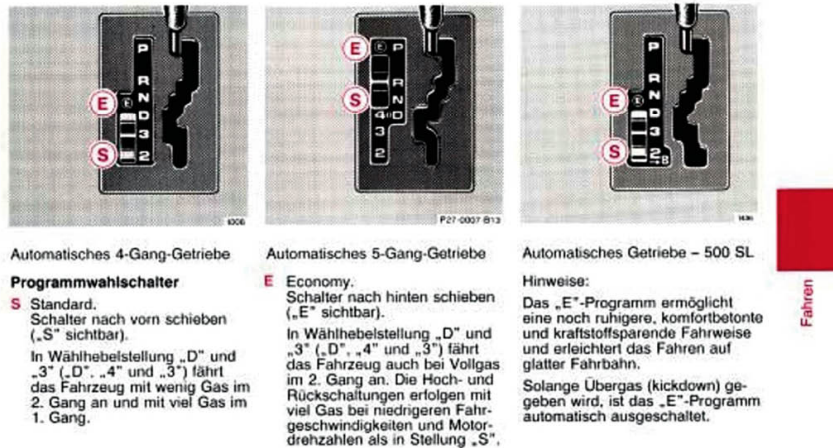

Automatisches 4-Gang-Getriebe

Automatisches 5-Gang-Getriebe

Automatisches Getriebe – 500 SL

Programmwahlschalter

S Standard. Schalter nach vorn schieben („S“ sichtbar).
In Wählhebelstellung „D“ und „3“ („D“, „4“ und „3“) fährt das Fahrzeug mit wenig Gas im 2. Gang an und mit viel Gas im 1. Gang.

E Economy. Schalter nach hinten schieben („E“ sichtbar).
In Wählhebelstellung „D“ und „3“ („D“, „4“ und „3“) fährt das Fahrzeug auch bei Vollgas im 2. Gang an. Die Hoch- und Rückschaltungen erfolgen mit viel Gas bei niedrigeren Fahrgeschwindigkeiten und Motordrehzahlen als in Stellung „S“.

Hinweise:
Das „E“-Programm ermöglicht eine noch ruhigere, komfortbetonte und kraftstoffsparende Fahrweise und erleichtert das Fahren auf glatter Fahrbahn.
Solange Übergas (kickdown) gegeben wird, ist das „E“-Programm automatisch ausgeschaltet.

Fahren

Another page from the German handbook, this time showing automatic transmission (AT) selector patterns, with the regular 4AT layout on the left, the 5AT version in the centre, and the 4AT found on the 500SL to the right, with the 'B' position for maximum engine braking on steep descents and so on.

On the base 300SL, internal ratios were listed at 3.86 on first, 2.18 on second, 1.38 on third, a direct fourth, and an overdriven 0.80 on fifth. The final-drive was 3.92:1, allowing a top speed of 142mph (228kph) and a 0-60 time of 9.3 seconds, while fuel consumption was listed at 8.5 litres per 100km when cruising – the equivalent to 33.1mpg in the UK or 27.7mpg in the States. Interestingly, the selector had four planes, with first through fourth in a typical 'H' pattern, while fifth was up and to the right, and reverse down and to the left.

To suit the rather different characteristics of the 24v engine, the 300SL-24 had its own three-plane selector layout (with second through fifth in an 'H' and first on a dog-leg to the left and back, with reverse above it) and its own set of close-ratio cogs giving internal ratios of 4.15, 2.52, 1.69, 1.24 and 1.00. Combined with a taller (numerically lower) final-drive ratio of 3.46:1, this gave a top speed of 150mph (240kph) and a brisker 8.4 second 0-60 time. Fuel consumption at a steady 56mph (90kph) was 8.8 litres/100km, which is 32.0mpg imperial or 26.7mpg Stateside. This was actually listed

as an option for the 300SL-24 at the press launch, but ended up as standard fare.

The six-cylinder cars shared the same internal ratios on the optional automatic gearbox – 3.87 on first, 2.25 on second, 1.44 on third and 1.00 on fourth. The final-drives were different, however, with the strict 300SL having a 3.29:1 one, and the 300SL-24 coming equipped with a 3.46:1 rear axle. It should be noted also that a 185mm (7.3in) diameter rear axle centre assembly was used on the 300SL, while the 24v car and V8 had a 210mm (8.3in) diameter version.

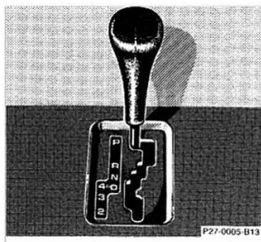

**Selector Lever Positions
300 SL**

The automatic gear shifting process can be adapted to specific operating conditions using the selector lever.

P Parking lock.

The parking lock is an additional safeguard to the parking brake when parking the vehicle. Engage only with the car stopped.

Note:

The key can be removed from the steering lock only with the selector lever in position "P". With the key removed, the selector lever is locked in position "P".

R Reverse gear.

Shift to reverse gear only with the car stopped.

N Neutral.

No power is transmitted from the engine to the rear axle. When the brakes are released, the vehicle can be moved freely (pushed or towed). Do not engage "N" while driving except to coast when the vehicle is in danger of skidding (e.g. on icy roads, see page 19).

D The transmission automatically upshifts to 5th gear. Position "D" provides optimum driving characteristics under all normal operating conditions.

4 Upshift to 4th gear only. Suitable for performance driving.

3 Upshift to 3rd gear only. Suitable for moderately steep hills. Since the transmission does not shift higher than 3rd gear, this gear selection will allow use of the engine's braking power downhill.

2 Upshift to 2nd gear only. For driving in mountainous regions or under extreme operating conditions. This gear selection will allow use of the engine's braking power when descending steep grades.

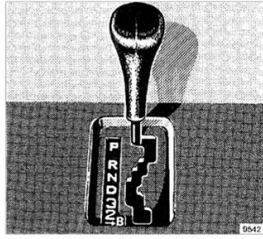

**Selector Lever Positions
500 SL**

The automatic gear shifting process can be adapted to specific operating conditions using the selector lever.

P Parking lock.
The parking lock is an additional safeguard to the parking brake when parking the vehicle. Engage only with the car stopped.

Note:

The key can be removed from the steering lock only with the selector lever in position "P". With the key removed, the selector lever is locked in position "P".

R Reverse gear.
Shift to reverse gear only with the car stopped.

N Neutral.
No power is transmitted from the engine to the rear axle. When the brakes are released, the vehicle can be moved freely (pushed or towed). Do not engage "N" while driving except to coast when the vehicle is in danger of skidding (e.g. on icy roads, see page 19).

D The transmission automatically upshifts to 4th gear. Position "D" provides optimum driving characteristics under all normal operating conditions.

3 Upshift to 3rd gear only. Suitable for moderately steep hills.

2 Upshift to 2nd gear only. For driving in mountainous regions. Since the transmission does not shift higher than 2nd gear, this gear selection will allow use of the engine's braking power downhill.

B In this position, the engine's braking effect is utilized by shifting into 1st gear. Use this position while descending very steep or lengthy downgrades and only at speeds below 60 km/h (40 mph).

Pages from the American handbook, with the 300SL (top) and 500SL selector patterns. Note that the 'Standard' and 'Economy' switches were left off Stateside-bound vehicles, with US CAFE figures meaning superior fuel consumption was given priority.

Anyway, as a result of the different gearing, the base 300SL was only fractionally slower than its manual counterpart (within two per cent performance-wise), although fuel consumption increased by eight per cent. As far as the 24v model was concerned, the 0-60 time remained the same, and top speed was listed at 147mph (235kph); economy suffered by around seven per cent, but this would be put right in the near future when a 5AT unit became available for the 300SL-24 grade.

As it happens, the 500SL also used 3.87, 2.25, 1.44 and 1.00 cogs on its 4AT unit, but came with recalibrated shift points and a 2.65:1 final-drive that was radically different. As a result, with such long legs, the car's speed was electronically governed to top out at 156mph (250kph), although the SL could run with the best of them if it picked up its skirts, covering the 0-60 dash in just 6.2 seconds. Given the performance levels, no-one could really moan at the 10.1 litres/100km fuel consumption figure – the equivalent to 27.9mpg imperial at a steady 56mph (90kph), or 23.3mpg using American measurements. Doubtless that very tall rear axle ratio had a huge

bearing on the five-litre car's overall economy. On the safety side, all Type 722.3 transmissions came with an interlock, making the driver put the car in 'Park' before the ignition key could be removed.

There were thoughts of including the option of four-wheel drive for the SL, with '4-Matic' about to come on line with the W124 series. This was an electronically-controlled 4WD system with centre and rear differential locks, kicking in automatically to give a 35:65 front/rear power distribution split in milliseconds whenever the car's electronic sensors deemed help was necessary in enhancing traction and roadholding or in the recovery of driving stability. However, the system had dropped off the option list by the time the R129 was launched, meaning it would enter production as a traditional FR roadster, and indeed, it would remain that way until the end of its days.

Part of the reason for dropping 4WD, perhaps even more so than the obvious costs, weight and packaging concerns, was because the SL really didn't need it. It was a well-mannered, inherently stable car, and there were other systems in train at Daimler-Benz that were eminently more suitable, developed under a recently-introduced programme to enhance driving dynamics (known as *Fahrdynamik-Konzept* internally) using the very latest mechanical, electrical and hydraulic systems to create new levels of active safety. ASR and ASD – both forms of traction control in essence – were good examples of the fruits of this project, activating automatically in the blink of an eye as soon as the vehicle's electronic sensors determined they were needed.

ASR (*Antriebsschlupfregelung*) was a pure traction control system for cars with an automatic transmission, managing the rear brake activation and power sent to the rear wheels as soon as slippage was detected in order to give the best possible traction in all conditions. The ASR setup also monitored cornering speeds and road curvature via four ABS (anti-lock braking system) sensors on the rear axle, and automatically reduced engine revs if there was a high potential for loss of control. Incidentally, ASR disengaged as soon as the brakes were applied, and there was also a switch to fine-tune the system to better suit the use of snow chains. However,

it could not be switched off.

Meanwhile, an electronically-controlled ASD (*Automatisches Sperrdifferenzial*) system, available on four- and six-cylinder models in the Mercedes line-up, having established that a driven wheel was slipping, automatically locked up the differential via hydraulics (up to a maximum of 100 per cent) on tricky surfaces, helping increase traction at take-off or low speeds, and was released automatically back to its default locking factor (up to 35 per cent) as soon as the car's sensors determined that conditions had improved, or if the brakes were applied in order to maintain driving stability.

Both systems were initially available as an option on the SL line-up, ASR on all cars, and ASD on the 300s. However, they were not available straight away in the States. Indeed, they didn't appear in the owners' handbook until the 1991 Model Year, along with ADS, described in the next section.

Chassis components

As mentioned earlier, the R129 had a wider track front and rear compared to the R107, and combined with a reduced ground clearance of 140mm (5.5in) and less overhang at both ends, this on its own would have improved roadholding and endowed the car with more agile handling had the original suspension setup been retained. However, the latest SL was treated to an all-new system in keeping with a flagship model.

It's fair to say that it was the W124 (forerunner of the E-Class) that provided most of the chassis technology for the R129 SL, with a lot of inspiration coming from the smaller W201 that came before it. The regular suspension setup was therefore pretty conventional, following contemporary Mercedes practice, with suitable fine-tuning to fit in with the SL's character and improve driving dynamics.

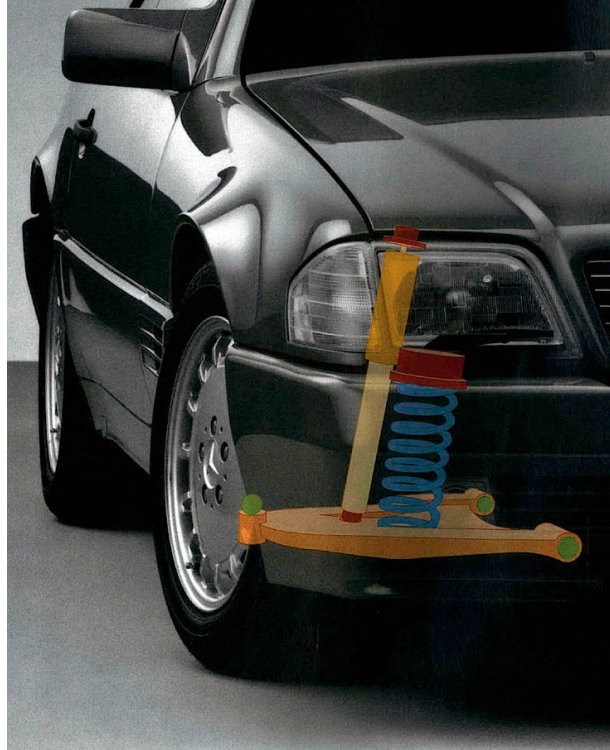

The front suspension, and its location.

In basic terms, the front suspension was made up of a broad-based lower A-arm, on which a separate coil spring and telescopic tube damper were located in the centre – the gas-filled shock absorber (or strut) closest to the wheel carrier, with the spring sitting inboard of it. It was located at three points (rather than five, as in the R107 models), via the two ends of the wishbone and at the top of the shock absorber, with rubber mounts to isolate NVH, while the 30mm (1.2in) diameter anti-roll bar ran along the front; the steering joints were attached aft of the axle, close to the brake calipers. As was the norm in Daimler-Benz passenger vehicles, the geometry was set in such a way as to give a small amount of ‘safe’ understeer, with comfort being granted equal status to roadholding and handling – one tends to find that hard suspensions can be fun for a while, but soon grow tiresome during the daily commute.

The rear suspension was all-new, being the multi-link setup first seen on the 190. This suspension evolved from an internal competition, starting with eight designs, before being whittled down

to four, and then to one – the so-called *Staengele-axle*. Development is said to have cost a billion deutschmarks! Notwithstanding, the management considered this a good investment, as it provided the company with an effective new generation suspension system that could basically be used across the whole Mercedes-Benz car range for many years to come. Advantages included precise wheel location, the accurate absorption of all forces, no matter what luggage was in the boot, consistent stability with no unwelcome steering effects, and low noise.

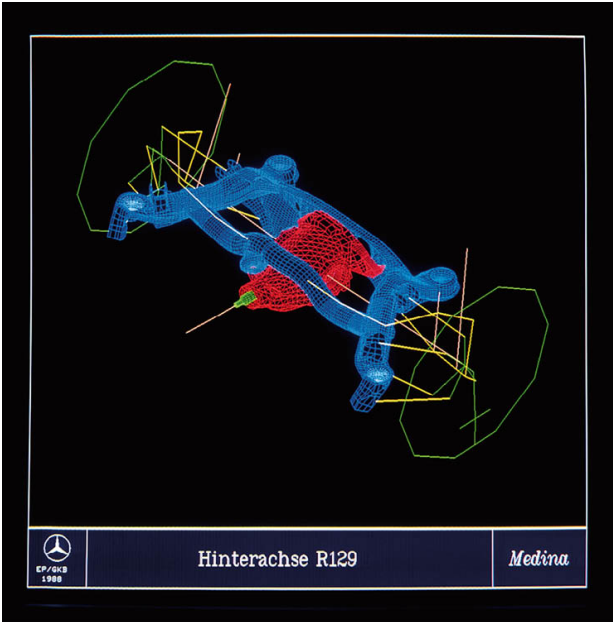

A CAD screen showing the rear suspension.

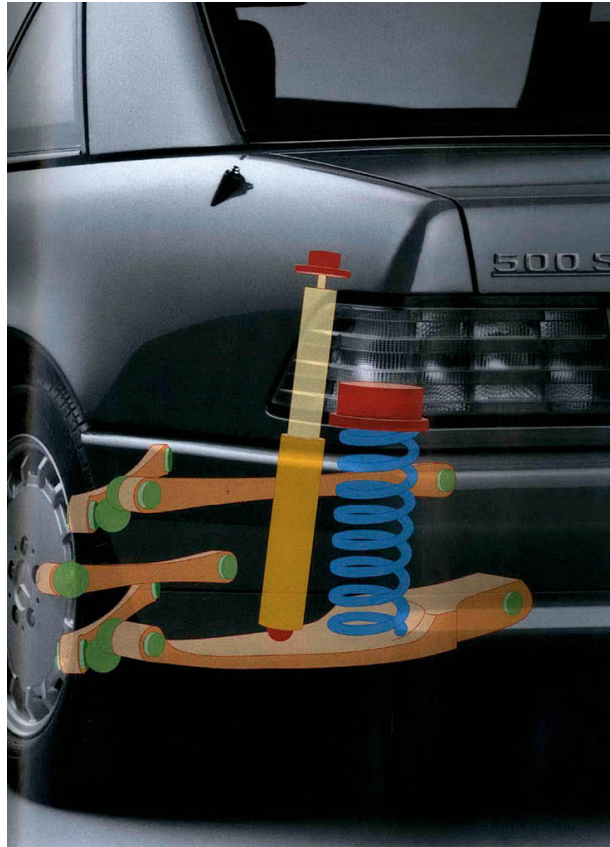

Positioning of the rear suspension.

In essence, the suspension was made up of five arms (two lateral and three diagonal links), each having its own rubber bush at each end for location – one side joining the wheel carrier, the other a subframe that carried the entire rear suspension assembly, which was then mounted to the body at four points, again using rubber mounts to reduce noise and vibration. The lower link provided a seat for the single coil spring and gas-filled telescopic damper on each side, with the spring in an inboard position, and the shock absorber close to the wheel, locked onto the body at the top like the front damper. As a sports car, naturally an anti-roll bar was fitted at the back, too, albeit far lighter, measuring 13mm (0.5in) in diameter.

For the SL, fine-tuning the geometry and bushes brought about a 95 per cent improvement in anti-squat characteristics, and a 62 per cent improvement in anti-dive control. At the same time, thanks to the calibration of the rubber bushes and their angles, a subtle

amount of toe-in was provided as cornering forces increased, giving a useful passive rear wheel steering effect, while the long spring travel made for a comfortable ride.

The much talked about ‘active suspension’ was originally being developed by Lotus of Britain, who was leading the way in using active suspension technology in F1 racing at the time, but Mercedes cancelled the contract in 1986, as Daimler-Benz engineers had come up with their own system that they believed was not only more efficient but could also be incorporated more readily into existing Stuttgart hardware.

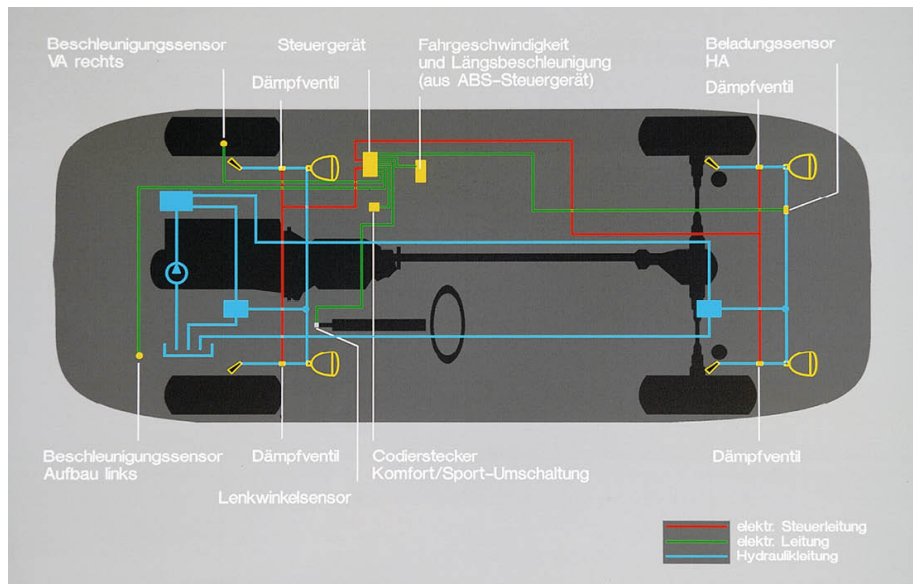

A schematic drawing showing the basic layout of the ADS (Adaptive Damping System) suspension. Red depicts electronic control lines, green electrical lines, and blue hydraulic circuits.

ADS (Adaptive Damping System) was ultimately a giant leap forward compared to earlier Mercedes suspension systems, even forcing a rethink on the forthcoming air suspension (Airmatic), scheduled to make its debut on the W140 S-Class but later delayed.

Using new shock absorber units incorporating fast-acting solenoid valves, ADS put more emphasis on comfort, making the car easier to enjoy in everyday situations – four stepped damper settings, ranging from soft (the default setting to improve overall ride quality) to sporty

yet still forgiving, were constantly being activated and deactivated 100 times a second according to criteria monitored by five sensors, such as overall speed, acceleration and braking levels, cornering forces, sudden wheel deflection caused by road conditions, steering input and vehicle weight.

With a switch for 'Sport' and 'Comfort' settings, the system automatically kept the car's ride height constant, and on European models, at speeds above 78mph (125kph), the body was lowered by 15mm (0.6in.) to improve stability, decrease lift and reduce drag. On domestic cars and those destined for certain export markets (but not the USA due to Federal bumper height regulations) the driver could also raise the body 30mm (1.2in) to give extra ground clearance at speeds of up to 31mph (50kph) if wanted. This was particularly useful on poorly maintained country roads or tracks, helping to avoid damage to the various exhaust silencer boxes.

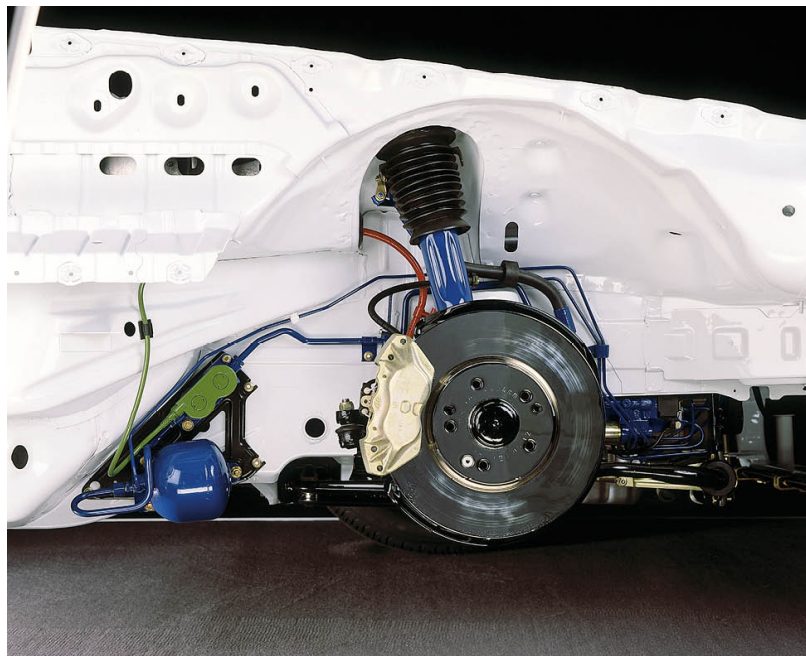

Show model showing the ADS suspension setup installed, as well as the front brakes.

Naturally, on a car like this, power-assisted steering was taken for granted. As with other Benz models of the time, variable-ratio recirculating ball PAS was selected, thanks to its reputation for

soaking up shocks from bad road surfaces. The chosen ratio gave 3.2 turns lock-to-lock, while an hydraulic damper mechanism further stifled road shocks before they could be transmitted to the steering wheel.

Alloy wheels reduce overall kerb weight, but more importantly, they reduce unsprung weight, allowing the suspension to perform better. The last of the R107s had come with alloys as standard for this reason, the rims measuring 7J x 15. However, for the new model, larger diameter wheels were specified to allow bigger brakes to be fitted.

The original R129 cast aluminium alloys were 8J x 16 wheels of a flat disc design with ornate edging created by 15 small spokes. Fixed by five bolts, they were shod with 225/55 ZR16 tyres (usually Dunlop D40 or occasionally Pirelli P600 rubber), with the same wheel and tyre combination used for all models in all markets.

As for those bigger brakes, well, the system consisted of discs all-round, with dual circuits for safety and servo assistance to reduce pedal effort. The front discs were 300mm (11.8in) across, with internal ventilation making them 28mm (1.1in) thick, while those at the rear were 278mm (10.9in) in diameter and solid, thus only 9mm (0.4in) in thickness. Four-pot calipers were employed up front, with two of the pistons smaller in size to equalize pad wear, and two-pot calipers were used at the back; ABS was a standard fitment on all cars.

A Swiss debut

Final testing was carried out under Dr Hans Liebold – a man shaped in the mould of Rudy Uhlenhaut – just before his retirement. Hot weather proving was carried out in the US States of California and Arizona, as well as in the dust of Namibia and on the Safari Rally trail in Kenya in Africa. At the other extreme, cold weather testing was done in Sweden and Canada, while track tests were carried out at the Mercedes-Benz facilities in Germany and America (based in Laredo, Texas), as well as the high-speed bowl at Nardo in Italy. Then, of course, there was the usual array of test stands and shaker machines.

A grand total of 118 prototypes, some based on R107 models in the early days, took part in a gruelling programme that encompassed enough mileage to take one around the world more than 125 times! With the final 11 hand-built pre-production cars (costing \$500,000 each) allowing things to fall into place, there was no doubt it was time to start moving toward thoughts of production.



One of the many prototypes on test. These earliest versions of the R129 wore light disguise panels, and virtually all of them carried Reutlingen registration numbers rather than Stuttgart ones. Reutlingen is only a few miles away from the Daimler-Benz headquarters, as it happens, being in the same state of Baden-Württemberg.



Another prototype on a Schenck shaker rig.

In the background, the deutschmark, which had been strengthening against the dollar at an alarming rate (from around DM 3.5 to \$1 in 1985, it stood at less than DM 1.7 to \$1 three years later) had at last started to settle against foreign currencies. Still, it made more sense for German manufacturers to concentrate on upmarket machines as a result, but with a buoyant marketplace and a public eager to embrace a new Mercedes sports car after nearly two decades of living with the R107, a release date of March 1989 was set, with the Geneva Show playing host to the launch.

Then, of course, the mood changed dramatically following Black Monday, when the world's stock markets crashed in a big way in October 1987. A lot of the bubbly atmosphere had been created on the back of lucrative share dealing, giving rise to the Yuppie, but when the Dow Jones Industrial Average dropped more than 20 per cent in a single day, the future of the breed was brought into question. At the very least, the Yuppie's spending power was seriously deflated, which must have been a great disappointment to BMW and Porsche dealers – peddlers of the wheels of choice. Of greater concern, of course, was the after effect on normal society, if one takes the Wall Street Crash of the 1920s as an example of what can happen when the stock markets collapse suddenly.

On the domestic front, Helmut Kohl, who took over as Chancellor

of West Germany after Helmut Schmidt, had been re-elected in early 1987, although unemployment was becoming a serious problem in Germany, rising from four per cent to ten per cent over the decade. Indeed, there was heavy unemployment in a number of European powerhouses, and inflation kept pushing up prices, too. Worldwide, it's easy to sum things up simply by saying there was a general slowdown in the global economy.

But there was no turning back now. The 59th Geneva Show opened on the 9th March, and all the management at Daimler-Benz could do was keep its fingers crossed that the new car was so well received that it would overcome the difficulties presented by the gloomy economic environment.

The company had invested heavily in the R129, which Johann Tomforde described as "... a new beginning" for Mercedes-Benz. Even the production system was overhauled to ensure the highest levels of build quality.

For decades, it had been the policy of the Daimler-Benz Board that Mercedes-Benz cars should be built in Germany in factories controlled by the parent company. All earlier SLs, from the original 'gullwing' car through to the last of the R107 models, had been built at the Sindelfingen plant. However, space was becoming tight, and it was decided to make the new SL at Bremen, alongside the popular 190 series models.



The Bremen works pictured in 1998, towards the end of the R129 run.

The Bremen factory was originally established by the Borgward concern in 1938, but was taken over by Daimler-Benz in 1971. A whole new production system, including fresh press machinery, was introduced for the R129 model, with a key component being a welding jig that continued to keep the car perfectly aligned until close to the end of the production process, when the road wheels are fitted and the trolley can be removed. Robots looked after the welding, with over 5000 spot welds and more than 15 metres (50ft) of seam welding being declared necessary – the latter adding strength, but all welding and panel alignment was subjected to the most stringent standards of accuracy.

For the SL, a series of star-shaped workstations was devised, allowing more time to work on lengthy production procedures than a conventional line. This, considering it took just over five days to build an SL – an extraordinary length of time by volume production standards – was definitely a good idea, helping maintain the kind of build quality the Stuttgart maker had built its reputation on.

Pilot production of the R129 began at the Bremen factory in May 1988, before full-scale production started in March 1989 – the month

in which the new SL made its public debut at the Geneva Show. Around ten cars could be built every hour with the lines at full steam ahead, but inspections were strict, and each car went through a final check on a driving simulator before being signed off. One can judge how serious Daimler-Benz was about getting the quality right by the fact that this final test was the equivalent of 1000km (620 miles) on the road.

Initial production schedules called for 20,000 units per year, with somewhere between 50 and 60 per cent of the cars built being earmarked for the US market, although, as it happens, it was the middle of the year before anywhere near this pace was achieved, and right-hand drive cars didn't start coming off the line until the autumn. As a result, a waiting list started to build up the minute the order books were opened ...

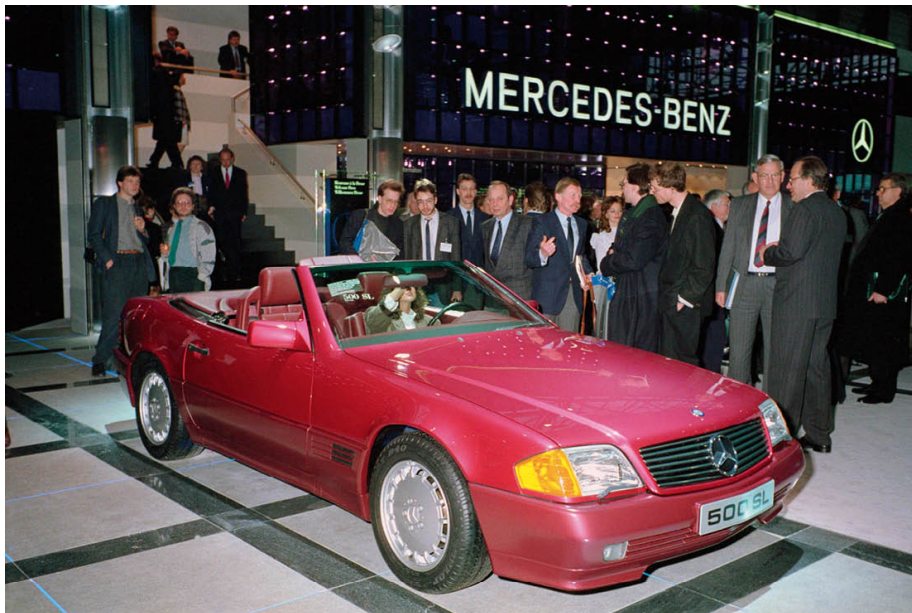

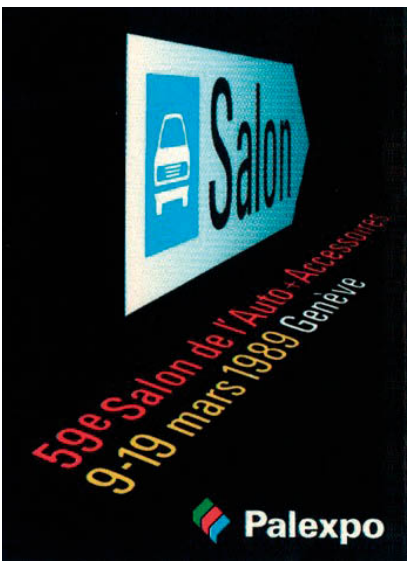

The new SL making its debut at the 1989 Geneva Show, along with the poster produced for the Swiss event.







Cover and selected pages from the preliminary catalogue, dated February 1989.



One of the many pre-production models, used for final evaluations, photography and press testing.

R129 production

The dedicated production lines and workstations put in place at the Bremen works to build the new SL. The pictures take the reader from the initial body welding stages, through to end of line testing, taking in body accuracy tests, hardtop and soft-top production and mating, and chassis component assembly along the way.

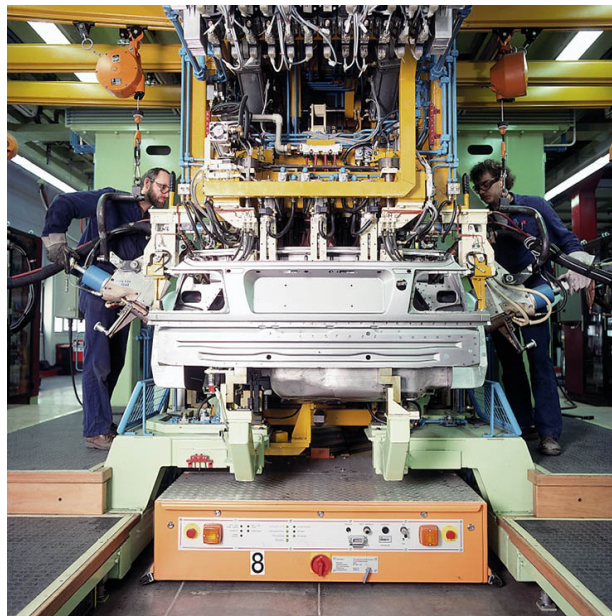
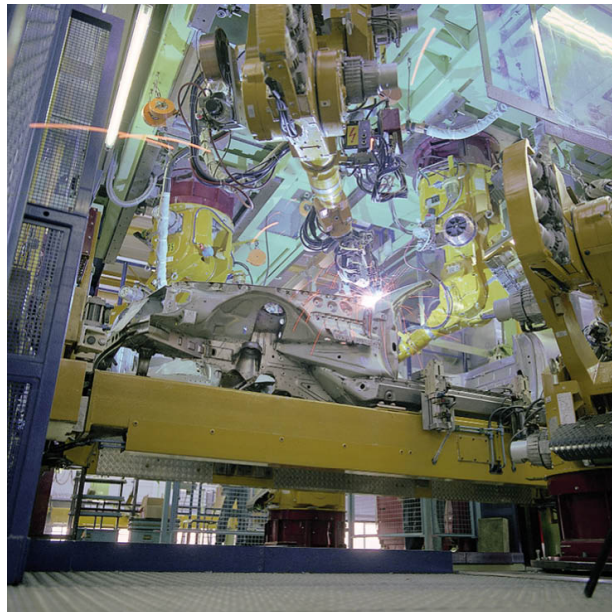

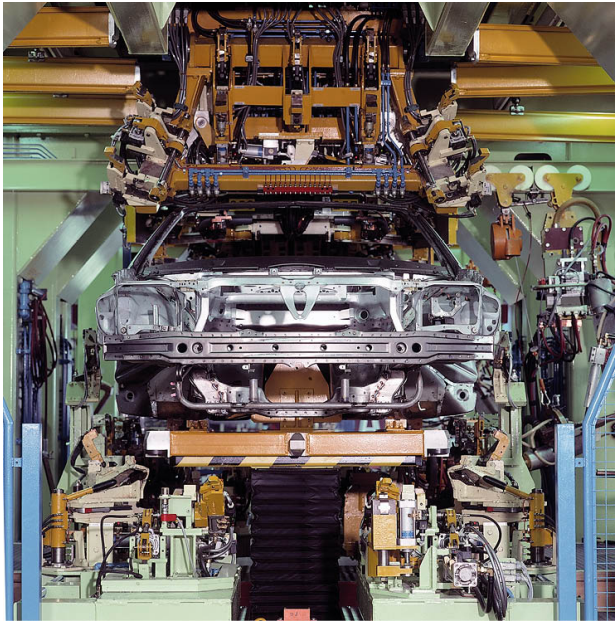
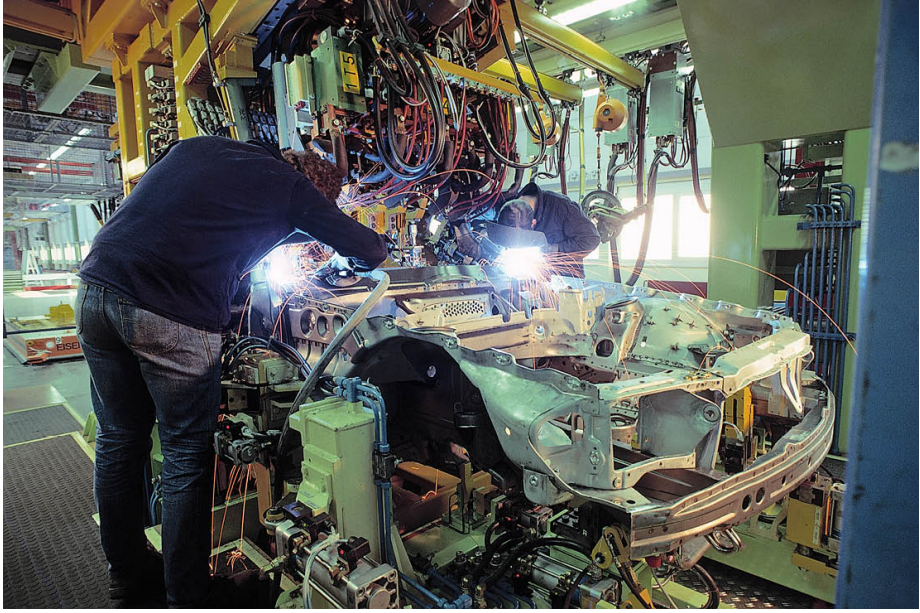



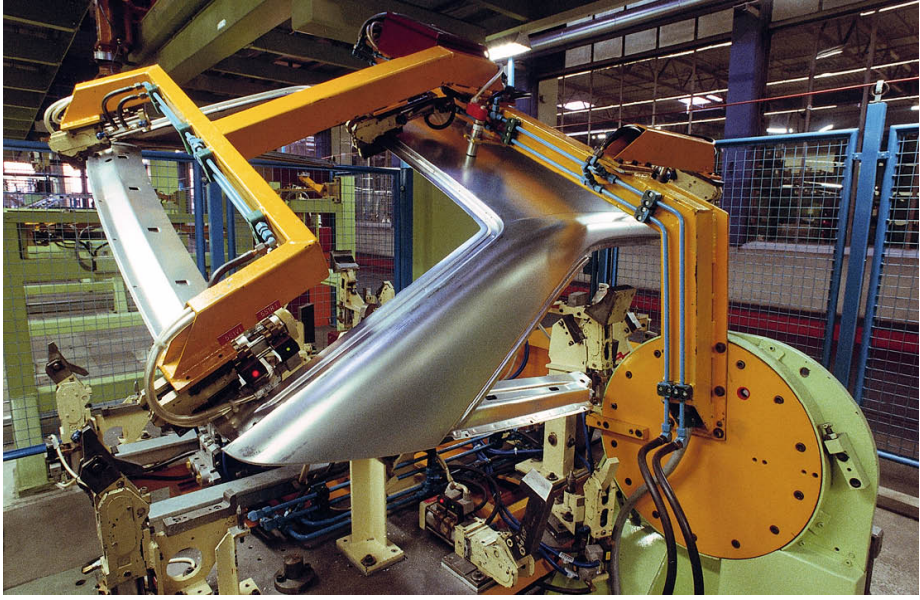

Early press reaction

As soon as the Swiss launch was out of the way, distinguished members of the world's press were invited to Estoril to drive some of the pre-production cars on the famous Portuguese track and the roads surrounding it.

The heavy A-posts caused some to moan about visibility on tight bends, and the author has written many times on the same subject in recent years – having a clear view to the sides pulling out of a junction 20 or 30 times a day is far more important than having a heavy frame to protect you on the one-in-a-million chance the car should roll over. But the Mercedes engineers had done a fine job in making a rigid shell with the absolute minimum of flexing and vibration, of that there was no doubt.

As *MotorSport* noted: “The lack of body grumbles is almost uncanny to one used to normal convertibles, even through the worst holes, and mechanical noise suppression is superb. With the top down, even the swish of the big tyres is lost to the skies, and after the hood mechanism has flexed its hydraulic muscles and closed in the occupants, the noises increase only to a restrained rumble of rubber on tarmac.

“Below about 80mph, wind noise is virtually absent, but above that point there is a mild degree of it as the roof seals lose some of their

grip.”

Tail of one of the 300SLs, with the badging on the base car in clear view.

In reality, most were in awe of the power top, with many comments being passed on how taut and well-sorted the hood was, making for quiet, refined progress with it up. It's worth noting, though, that a lot of buffeting was experienced when the hood was down without the windblocker in place.

Interior fixtures and fittings had a “... simple and clear” air about them, with “... immaculate attention to detail.” *Performance Car* summed things up in one line by stating: “The overall design is as economical as it could be. There are no frills or tricks, yet the effect is far from dull.”

Some found the huge seats tended to overwhelm the interior, leaving little legroom, and others commented they were a little hard, as is often the norm in German cars. One person even mentioned that side support was lacking due to the shape being designed to accommodate even the largest of people, but most were impressed overall, especially from a safety point of view.

Reaction was mixed on the base 300SL, with some scribes more than happy with the smooth and relaxed rate of progress on the road, while others found the 4AT version a little sluggish. Of course, there was more power on tap compared to the R107 300SL, but the new car was also some 150kg (330lb) or so heavier than its predecessor, which soon wiped out the benefit. Indeed, as such, the older car had the better power-to-weight ratio. Most agreed, however, that the manual version was like a breath of fresh air, some even going so far as to call it a benchmark machine.

Performance Car noted: “The 300SL definitely benefits from being the lightest at the front. You never doubt where the 300 is going to go, and that much became clear in some slowish corners taken quickly. Despite its bulk, the smallest of the new Mercls rushed

nimbly round curves, sitting squat on the road and feeling as balanced as you would expect from a car with almost 50:50 weight distribution.”

Stunning photography of another pre-production car. Note the clean lines of the hood when up, and the Stuttgart registration numbers used on this batch of vehicles (earlier prototypes had used Reutlingen plates).

One of the 300SL-24 pre-production cars. This picture was actually issued in the Geneva Show press pack.

A couple of shots of one of the pre-production 500SLs.

Another 500SL pre-production vehicle, seen with the hardtop in place, and with the hood down. The latter shot shows off the tapered tail to good effect, as well as the subtle bulges over the wheelarches – much easier to see from this angle. Note also the optional occasional rear seats in place.

Regarding the 24v six, which seemed to be at its best above 4000rpm, Mike McCarthy wrote for *Autosport*: “The engine is truly superb, beautifully smooth even at peak revs, with plenty of grunt throughout the rev range (that automatic valve timing really does

work) and it sounds magnificent.”

While asking for the manual gearbox to have a more positive shift action, *MotorSport* was nonetheless also impressed with the dual character afforded by the 300SL-24 unit, adding: “By playing with the throttle it is possible to feel the cam advance come in, but in ordinary use it is unnoticeable; the unit simply feels like a 3.5-litre engine.

“It offers complete choice as to driving style. Leave it in fifth and rely on the torque, even from 1000rpm, or keep the gearlever moving and the tach needle between five and seven. It will successfully fulfill its role as a cruiser for the States, and still satisfy European drivers.”

Ultimately, the 24v car, despite giving away over a litre in engine displacement, could outperform the old 420SL, especially in manual guise. Georg Kacher noted that the 5MT setup was “... quite nice” and came with “... a light and progressive clutch.” But keeping speed in check is just as important, thankfully Jesse Crosse stated: “Stopping power is enormous ... Feel on the road is firm, with little excessive travel.”

Gordon Cruikshank of *MotorSport* was happy enough with the ADS system: “In action the device is not apparent at all, except inasmuch as body movements hardly vary in amplitude whether parking or sprinting along a hill-road. At all times the chassis seems taut, but the ride is never hard. This is the first time I have ever been impressed by such a system. However, the ride quality of the non-ADS cars was in any case first-rate by conventional standards, not as liquid as an XJ-S, but happier in successive tight bends.”

The *American Automobile Magazine* was just as flattering in its appraisal of the chassis, suspension and body control: “Body roll is conspicuous by its absence. And although the handling is equally inspiring, the roadholding is even more sure-footed than in the sedans.”

Jesse Crosse of *Performance Car* added: “Back on the track, the allowed five laps demonstrated a chassis which generally remained on the understeering side of neutral. Slow corners entered fast prompted more understeer but not as much as you would normally expect, particularly from a luxury ‘sporting’ car weighing [this much].

“The SL is the sort of car where you can commit yourself deep into

the turn and still change your mind halfway round. Its limits are high, and even with a touch of drift setting in, the steering and controllability stays the same – that’s the secret of a truly excellent chassis. Everything feels collected and in tune. The springing and damping is exactly where the engineers want it, the compromise of ride and handling finely judged. Comfort is absolute, feel considerable.”

A final set of 500SL pre-production car images, this pair including a tail view to show the badging on the flagship model. As journalist Bob Nagy said in 1989: “The SL’s handsome, wedge-shaped styling can best be described as bold, innovative, and aerodynamic.”

And while several noted a vagueness in the steering in the straight ahead position, *Autosport* chipped in with the following on the V8’s chassis behaviour: “At sane speeds, the car is simply very, very neutral. Steering weighting and gearing is near-perfect, though not racing pin-sharp, while all those electronically-controlled systems add up to the fact that you can cope with any situation.”

At the press launch, a small number of 500SLs were fitted with a conventional ‘sports’ suspension, with uprated chassis components and harder brake pads for those who enjoy driving flat-out. However, the package was never offered to the public.

Testers quickly realized that the new 500SL was much quicker than its predecessors, including the 560SL for export markets. A number of journalists tried to figure out what the top speed would be if the governor was removed, with most settling on 170mph (272kph) or thereabouts.

Gordon Cruikshank observed: “Compared to the sixes, the V8 is less composed. But the overriding sensation is of the strength of the forces pushing you back in the seat as the car accelerates. It really is brilliantly quick, not just in standing starts, but on the road. Overtaking is effortless, and the instant response, so rare in an

automatic, makes the 500SL a pleasure to guide over sinuous back-roads.”

Car was equally impressed with the 500SL, commenting: “Although fast – very fast – it was incredibly faithful and sure-footed, the tail snapping out a little under acceleration and snapping back positively in response to driver input. It’s a very flattering car to drive, for its fluidity (a product of balanced and matched controls and sensibly geared steering) oozed confidence.”

Autoweek went even further, stating: “With its new SLs, Mercedes has approached car-making as an art.” But with thousands of column inches filled just after the R129 launch, it was perhaps *Motor Manual* that summed up the new car perfectly: “The 500SL is a technical and aesthetic marvel created by Mercedes-Benz for the fortunate few who can afford the best ...”

5

The early production models

No sooner had orders started flooding in for the new R129 than financial woes began hitting the headlines all over the world. While the mood had been bullish during the build-up to placing the R129 model on the market, in many ways, the timing couldn't have been worse to launch a luxury two-seater ...

When the R129 was officially announced at the Geneva Show in March 1989, naturally a domestic price list was issued, even though customers would have to wait a few months for delivery. The first volume sales were allocated to the home market, with bulk deliveries starting in June.

With the benefit of hindsight and historical perspective, that original price list makes fascinating reading, with the 300SL commanding DM 89,490, the 300SL-24 being quoted at DM 99,180 (the DM 10,000 premium was questioned by some as seeming rather excessive), and the 500SL listed at DM 125,400. This compares with a price range of DM 73,302 to DM 98,439 for the outgoing R107 series, and DM 114,500 for a contemporary Porsche 911 Carrera 4.

The R129 series was therefore far from cheap, but the new SL had been built up to a standard rather than down to a price in an era when the atmosphere was still buoyant, with fortunes being made on the stock market and in other arenas, helping bring the dream of owning a new Mercedes sports car that much closer to reality. In addition, exchange rates dictated it was better for German manufacturers to go upmarket in order to see a profit.



One of several promotional shots taken at a Mercedes-Benz dealership.



The SL: an impressive sight on the test track at Untertürkheim.

The fact that a lot of people were struggling to make ends meet in the aftermath of Black Monday didn't seem to affect initial orders for the new Benz. Originally, production schedules called for 20,000

units a year, but this proved to be a difficult figure to attain. Even had the Bremen factory been able to build this many cars in the first year, it would still have been insufficient to cope with initial demand. As such, a lengthy waiting list built up within six months of the launch in certain markets (stretching to four years in the UK at one point, for instance!), and it was found that speculators were taking delivery of their cars only to sell them the same day for a quick profit, usually around a ten per cent premium.

All domestic cars came with alloy wheels, ABS brakes, halogen foglights, electric side windows, power mirrors, cloth trim and key-operated central locking included in the price. According to the catalogues, the 300SL tipped the scales at 1700kg (3740lb), while the 300SL-24 weighed in at 1740kg (3828lb), and the 500SL was 60kg (132lb) more at 1800kg (3960lb). However, very few vehicles would ever have left the factory this light, as the list of options (Sonderausstattungen, usually shortened to SA) was long and tempting in Germany.

A switchable four-speed automatic gearbox (SA code 420) was standard on the 500SL, but DM 2570 plus tax (German VAT stood at 14 per cent back then) on the three-litre models. Those specifying an automatic transmission could also opt for Tempomat (440), which is Mercedes-speak for cruise control, at DM 590. An ASD differential (code 211) was listed for the three-litre cars, priced at DM 1580, while the ASR traction control system (code 471, and only available on cars with automatic transmission) added DM 3270 to the invoice.

Although many early cars came with two-tone paintwork, the main body colour selection was basically carried over from the R107 series, with only one metallic shade (877 Petrol) dropped from the palette in the transition to the R129 model. Metallic paint was a no-cost option on the 500SL, or a DM 1360 extra on the six-cylinder models, incidentally.

The three basic hood colour options were retained, too, all coming with a beige lining. Interior trim shades were kept the same, with eight choices for both cloth and leather (but no vinyl option this time), while burl walnut was used for the wood accents. Leather trim for the seats and steering wheel (the upper part of the inner door panel inlay was a

perforated material to match the seat centres with this option) was priced at DM 1980. Rear seats were available (SA code 565), priced at DM 1500 trimmed in cloth, or DM 2100 in leather.



Werner Niefer (left) was named Chairman of the Daimler-Benz AG Board of Management in June 1989 following a restructuring of the company.

Other options included a driver's-side airbag (SA code 442) at DM 2150, or dual airbags (291) at DM 4130. Electrical adjustment on the steering column (441) was standard on the 500SL or a DM 840 extra on the three-litre cars, while air-conditioning (580) was a DM 3820 option across the board, or DM 4590 if one moved up to the fully automatic version (581). Ten-way power seat adjustment with memory function (241 for the left-hand one, 242 for the right) commanded DM 735 a side, orthopedic padding (basically adjustable lumbar support, coded 404 for the left, 405 for the right) added DM 565 per side to the invoice, and heated seats (873) were available for DM 670.

On the audio front, there were four Becker radio/cassette units – the Avus (518) at DM 1100, the Europa (254) at DM 1375, the Grand Prix (511) at DM 1625, and the Mexico (510) at DM 2415, along with the

Mexico radio/CD unit (258) at a hefty DM 4100. To go with these there was an automatic aerial (code 531 and DM 370 when ordered with a stereo, or 532 and DM 115 more if ordered alone), or a manual one (534), priced at DM 115. A manual aerial came with all Becker units, along with a suppression kit and two speakers. The Mexico outfits could be combined with an upgraded sound system (810) costing an additional DM 500.

More minor options available at the time of the launch included tinted glass all-round (590) at DM 475, with laminated glass adding an extra DM 40. Specifying SA code 599 instead of 592, brought tinted glass all-round, but the laminated panes were restricted to the side and rear windows. At least it brought the option price back down to DM 475. Naturally, a heated rear screen (fitted as standard on the hardtop from the off) was included with these three options.

There was also an uprated battery listed (SA code 673) at DM 85, a headlight wash/wipe system (600) at DM 580, remote central locking (880) at DM 860, a memory facility on the mirrors (246, and needing to be combined with power seat and steering column adjustment) at DM 450, exit lights on the doors (code 611, but standard on the 500SL) at DM 90, an alarm system (551) at DM 835, central locking extended to the interior storage compartments (881) at DM 420, a fire extinguisher (682) at DM 160, dual-tone horns (452) at DM 270, an auxiliary heater (228) for those living in colder climes at DM 2125, and a towbar (code 550) at DM 1275.

A new price list was issued in September 1989, when the trip computer (245) listed from the start became available at last, priced at DM 1045. The windblocker, meanwhile (SA code 283) hadn't been listed in March, but everyone knew it was coming, and at DM 370, it was pretty good value considering the fine job it did of reducing buffeting in the cockpit.

Continental CTS run-flat tyres (641) were a totally new option. Priced at DM 1150 a set, they gave a marginally worse low-speed ride, but provided added peace of mind and safety for regular Autobahn users. The wheels used looked similar to the regular alloys, but the rounder cut-outs on the outer edge gave the game away.



The new SL drawing the crowds at the 1989 Frankfurt Show, held from the 14th to the 24th of September. As it happens, the huge volume of people going to the show (well over a million) prompted the IAA organizers to create two separate events for passenger cars and commercial vehicles after this.

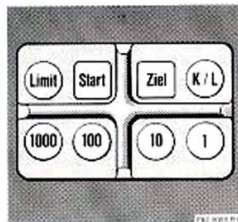

Reiserechner

Tastatur

3 Funktionstasten:

- Limit
- Start
- Ziel

Umschalttaste

- K = Kurzstreckenspeicher
- L = Langstreckenspeicher

4 Tasten für Ziffern-Eingabe



Display

Displayfach öffnen:
Taste 1 drücken.

Displayfach geschlossen:
Berechnung der Daten läuft intern weiter.

Limit-Geschwindigkeit wird weiterhin überwacht.

Einschalten

Schlüssel im Lenkschloß in Stellung 2 drehen.

Auf dem Display erscheint der Funktionsblock „AB START“ und das „K“ für Kurzstreckenspeicher.

A German handbook illustration showing the trip computer control panel, and the way the digital read-out sat in the central storage box in the fascia.

Also at this time, a Type 722.5 series five-speed overdrive automatic transmission (425) became available for the 300SL-24. This was actually the world's first production 5AT unit, created by adding an

extra planetary gear set on the end of the existing 4AT gearbox, and it was priced at DM 3900. One could still specify the four-speed automatic, though, on both the 300SL and 300SL-24, and it remained standard on the 500SL. As it happens, the first four gear ratios were the same as the 4AT unit, but the fifth cog was heavily overdriven at 0.75. In addition, the final-drive ratio was lower (numerically higher) at 3.69:1 (instead of the regular 3.46:1), dropping the official top speed slightly to 144mph (230kph). Notwithstanding, the 0-60 time was unchanged at 8.4 seconds, and fuel consumption improved by a truly significant ten per cent.

As part of Daimler-Benz's ongoing programme of refining products as and when the opportunity arose, the rear axle centre assembly mounting was modified in September 1989 to reduce noise at take-off or in close-throttle scenarios; a couple of months later, the rear axle shafts were strengthened.

Finally, although listed from day one, the ADS (Adaptive Damping System) active suspension with automatic levelling (SA code 216) eventually filtered through on production models at the end of 1989, priced at DM 5500.

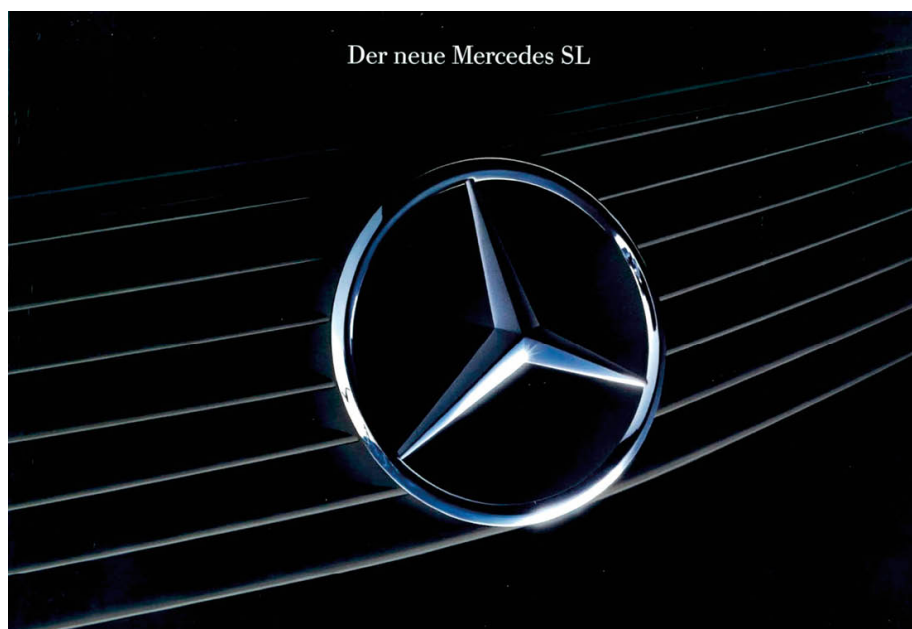



The catalogue produced for the 1989 IAA was basically a remake of the preliminary brochure with a few extra pages. This is the cover plus one of the new images, seen again as artwork used in later catalogues, albeit retouched to suit contemporary specifications.



The windblocker (officially called the wind screen, but it's a moniker too easily confused with the front glass) was attached to the roll-over bar, but could be used regardless of whether or not the steel hoop was deployed. From 1991, one could buy a container that allowed it to be stored behind a panel on the forward bulkhead of the luggage compartment.



A car fitted with the optional Continental CTS run-flat tyres.

As the New Year arrived, January 1990 saw the cost of the base car increase by almost five per cent in Germany. The automatic transmission, plus the ASD, ASR and air-conditioning options (as well as the majority of other items, such as paint and trim, the alarm system and fire extinguisher) all went up by a similar amount, but a few of the other minor option prices (including radio selections and airbags) remained unchanged.

Mercedes-Benz telephone packages were added to the price list, being an expensive novelty at this time. Also, a power aerial became standard on the 500SL, while the existing 532 and 534 options were replaced by new ones: 537 and 538, which, respectively, gave a manual aerial with six speakers (DM 450), or an automatic aerial and

six speakers (DM 820). All-weather tyres (SA code 645) were new, too, retaining the familiar 225/55 size on a 16-inch wheel, but priced at a DM 180 premium over the regular rubber.

By the way, Rudolf Hörnig left Daimler-Benz in April 1990, with Professor Hartmut Weule duly taking his place as head of R&D. Born in 1940 in Bitterfeld, Weule had been at Karlsruhe Institute of Technology for many years, and indeed returned there in 1997 after what turned out to be his second spell with Daimler-Benz came to an end.

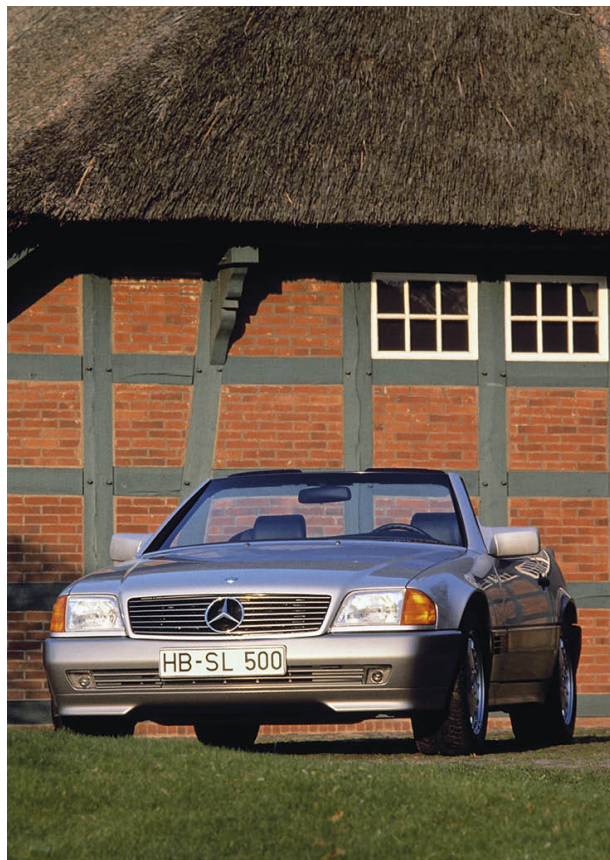



An early 500SL photographed in the historic German city of Bremen, where the R129 model was built. The farmhouse is one of many to be found on the Blockland Dykes of Bremen, while the night shot was taken in the market square.

The US debut

Most European manufacturers are heavily dependent on American sales. With Daimler-Benz selling a large range and having a loyal following in so many continents, the Stuttgart company wasn't quite so tied to North America. Indeed, from a total production figure of 595,765 units in 1987, sales in the USA accounted for just 89,918 vehicles. Although this was a quite a way short of the 1986 peak (when a change in tax laws prompted a bumper year), it was a fairly representative figure, so the sporting models, and the SL in particular, were a godsend for Erich Krampe – the head of Mercedes-Benz of North America Inc, the US distributor based in Montvale, New Jersey.

Unfortunately, Stateside sales dropped by around 6000 units in 1988, and the slowdown in the economy in the aftermath of Black Monday brought them down again, to 75,714 units in the following year. With North American sales of the R129 SL not beginning until

1st November 1989 (in order to take advantage of the availability of the five-speed automatic gearbox for the three-litre car), the 421 US dealers hadn't really had a chance to cash-in on the new car's popularity, but you can bet they had their fingers crossed that there were still enough American citizens that had untapped reserves of cash at their disposal in this post-bubble era and didn't need to resort to Janis Joplin-like appeals to obtain the new sports car.



Suitable for immortalizing.

In the 103-year history of Mercedes-Benz, no car has been the object of a more passionate engineering effort than the new SL Coupe/Roadster. No car was ever more likely a classic.

To celebrate the creation of this remarkably advanced automobile, Mercedes-Benz is offering a special four-color poster. To receive your free poster, call 1-800-432-7001.



© 1989 Mercedes-Benz USA, LLC. (Mercedes SL)

ENGINEERED LIKE NO OTHER CAR IN THE WORLD

US advertising from the time of the R129's North American launch. The cut-away drawing of the 500SL reveals the location of all the major drivetrain and suspension components employed in the latest model.

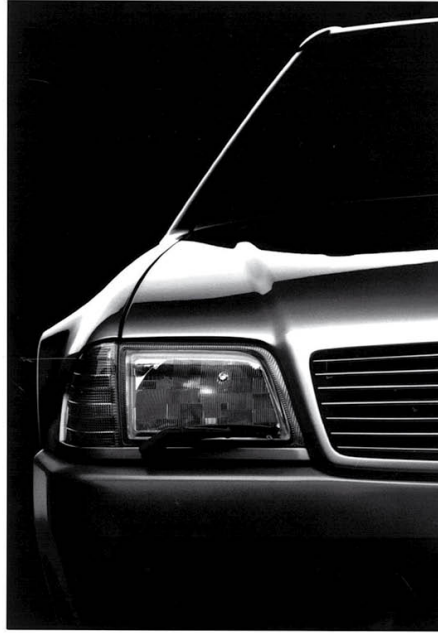

Mercedes-Benz 1910

SL

Cover of the first US brochure.



Tail of a US-spec 500SL, with a third brake light worked into the bootlid.



Overhead view of the new SL in North American specification, giving a rare view of the carpeted rear compartment and the stainless steel treadplates.



Dashboard of an early American 500SL. Note the 160mph speedometer, the different gear selector used on US cars, the (optional) heated seat switches, the lack of a release button for the glovebox due to the passenger airbag, a few subtle differences in switchgear labelling, and the Mercedes-Benz badge on the radio, with no mention of Becker.

While turbo-diesel saloons (promoted to enhance CAFE fleet fuel economy figures) were just as likely to leave the showrooms, and the SEL and SEC continued with the older 560 engine into 1991 (the beautiful SEC even limped into the 1992 season until the new big coupes were introduced), the two SL models offered in America certainly generated more than their fair share of excitement. With no base three-litre car offered across the pond, the 300SL-24 was known simply as the '300SL' in the States, while the 500SL remained badged as such.

Following the press preview in White Sulphur Springs, West Virginia, the new SL was launched as a 1990 model, with the 300SL-24 priced at \$72,500 in five-speed manual guise (with a dog-leg first, although a five-speed automatic was available as an option), and the 500SL (four-speed automatic only) listed at \$83,500. It was sold as a two-seater only, with no chance to convert the vehicle into a 2+2 in the States.

All US-bound R129 SLs came standard with alloy wheels, ABS brakes, PAS (with leather-wrapped steering wheel), self-levelling rear suspension, a headlight wash/wipe system, foglights, cruise control, automatic air-conditioning, dual airbags (a passenger-side airbag became optional on several US models at this time, but being standard on the SLs signified a faster adoption for the two-seater than other cars in the Benz range), power windows with tinted glass, power adjustment on leather-trimmed seats (with the memory function extending to the tilt steering and mirrors), remote central locking with extended coverage on interior storage compartments, an outside temperature gauge, alarm, first aid kit, and a Becker Grand Prix-based 100W radio/cassette with six speakers and an automatic antenna.

Apart from the 5AT for the 300SL, about the only other options in the States at this time were heated seats, orthopedic padding, and the windblocker. Metallic paint was a no-cost option (NCO), so doesn't really count.

Bob Nagy of *Motor Trend* observed: "A cross-country drive is generally the acid test for any vehicle. Having spent three-and-a-half days of virtual non-stop motoring, we can enthusiastically confirm the new SL as being a pur sang long-distance runner."

Nagy attributed a lot of the cruising pleasure to the seats, and found only a few minor niggles after his extended test, like the occasional stray reflection on the plastic instrument cover and the awkward sunvisors. He was also less than happy with the stereo, particularly the unit's ergonomics.

However, the R129 was a well-balanced package at the end of the day. *Road & Track* called the 500SL: "A very sophisticated car with all the bells and whistles you expect in a personal luxury car, much more comfortable than the last SL, and much more refined."

Csaba Cseré of *Car & Driver* was clearly impressed by the handling of the 500SL: "As you would expect of an autobahn-bred automobile, the SL is supremely comfortable at the elevated velocities it can so easily reach. The suspension has an uncanny ability to keep all four tyres planted firmly on the ground no matter what your speed or how rough the road surface. Indeed, during our road test the SL remained unflappable even when driven so quickly over winding roads that the

automatic roll-over bar deployed in concern.

“Driven that hard, the new SL clearly shows its superiority over its predecessors. Although its steering is slightly dead on-centre and a bit sluggish, the 500SL turns in more precisely, has more grip, and behaves better at the limit than the old 560SL. The 500SL corners with gentle, reassuring understeer, although by working the throttle you can bring the tail out in a graceful slide. The SL’s weight inhibits any notions of tossing it around, however; the car is at its best when driven in a smooth, tidy fashion.”

Motor Trend echoed the improvements: “Due to the SL’s exceptional refinement, one gets the feeling of controlling a precision-crafted machine rather than a high-strung exotic. The SL handles better than anything this big and luxurious has a right to.

“The SL’s suspension is much more closely coupled than any other Mercedes save for those now appearing in the WSPC. This taut tuning, along with its relatively low-profile 225/55 ZR16 performance tyres, transmits a bit more input to the steering wheel and seat cushion than most traditional Mercedes owners are used to. But the upside trade-off is excellent transient response and stability. Both SLs ran through our slalom course at over 63mph, a respectable speed for any car, but downright spectacular for this type of personal luxury machine.

“There’s just enough body roll to give one a good sense of the SL’s dynamic condition at any given moment, but never any sensation of float. It’s no surprise that both versions display great balance when cornering.”

Formal testing of the 1861kg (4094lb) 500SL (naturally fuelled by premium unleaded) by *Car & Driver* revealed a 0-60 time of 6.3 seconds, with the car flashing past the quarter-mile marker 8.3 seconds later. Speeds through the gears were 43mph (69kph), 74mph (118kph), 115mph (184kph) and 155mph (248kph), respectively. The same magazine recorded a commendable 0.82g on the skidpan and no brake fade. As an open two-seater, only the Chevrolet Corvette could offer better performance for less money.

Road & Track’s figures were very similar in most respects, with only the noise at idle being significantly at odds, although *Motor Trend* confirmed that the *Car & Driver* machine must have been unusually

quiet. As such, we can say that the 500SL put out about 50dBA at idle, rising to 77dBA under full throttle, while the 300SL was around ten per cent quieter at tick-over but not much different in motion.

By the way, final-drive ratios and internal gearing were the same as those specified on home market cars. The 24v 300SL had a 3.46:1 rear axle on 5MT cars, or a 3.69:1 axle on 5AT models. A 2.65:1 back axle was used on the 500SL, its 4AT unit coming with "... shifts that are uncannily smooth and quick" according to *Road & Track*.

As is often the case, *Motor Trend* seemed to get a little extra out of its test cars. The 500SL it had clocked a 0-60 of 6.1 seconds, and a standing-quarter of 14.4 seconds. This compares with 9.1 and 17.0 seconds, respectively, for the automatic 300SL the magazine tried. While there were no surprises there, the skidpan did kick up something odd, for the 300SL recorded 0.83g despite having an almost perfect 50:50 weight distribution – the 500SL was closer to 52:48, but still managed a better 0.86g.

Notwithstanding, going is only part of the equation (and often the easy bit), with braking being just as important. No problems there, though, as all magazine tests recorded some impressive stopping distances. In addition, *Motor Trend* observed: "Pedal modulation is great and directional stability superb."

While some fluttering was noticed at speed with the hood up, Csaba Csere said of the power hood's movements in and out of its hatch: "The entire operation takes place with such captivating precision that it's the perfect demonstration to persuade any doubters that this car is worth the price of a small house."

Motor Trend's Bob Nagy added: "The SL's fully automatic [soft-top] raising and lowering mechanism is arguably the best in existence ... But even with the soft-top down, cowl shake and shudder are extremely low."

Summing up for *Car & Driver*, William Jeanes noted: "Mercedes has again gifted us with a car that seems to be carved from solid steel ... As good as the SL looks inside, it looks better from the outside. The car is lean, aggressive, and says plainly that here's a member of the Mercedes family of great GT cars."

Joe Ruzs of *Road & Track* posed the question over whether the

300SL could stand up to the might of the five-litre machine, and concluded: "Of course. It's essentially the same car, so if money is the issue, less SL is better than no SL at all."

Motor Trend was thinking along the same track: "For our money, the 500SL stands as the far more enjoyable of the two. But even the junior partner of this auspicious duo would be enough to keep us happy."

For the record, to put things into historical perspective, 1989 was the year Republican Ronald Reagan stepped down from office, with George Bush (former VP) taking his place as the new President of the United States. The Bush administration basically continued Reagan's policies, so there was consistency, and, following the war in Kuwait, Bush's popularity was at an all-time high.

The UK market

After the USA, the UK was the second biggest export market for Mercedes-Benz vehicles. At the time of the R129 announcement, it was predicted that the 300SL would be available first in September, with the 24v and 500SL models following in due course. Later news items quoted the "... end of the year," with around 1200 cars a year earmarked for British buyers (as opposed to 3000 for Germany and 12,000 for America).

Two of the new 500SLs graced the Mercedes-Benz stand at the 1989 Earls Court Motor Show. This was the first time the R129 SL had been seen in the UK, but there was already a backlog on orders, despite sales not even starting officially until the first day of November, as per the States. Indeed, UK dealers were told not to take any more orders by the end of 1989 – a situation only found on the new Porsche 911, Honda's NSX and the Ferrari 348, and naturally a situation ripe for crazy premiums on cars sold on the minute they were delivered.



Group C racing teaches hard lessons, and they've been well learnt by Mercedes-Benz, just declared World Sports Car Champions for the second successive year. As all competitors discover, racing at this level punishes cars in ways that no computer model or wind tunnel experiment can match. It is final proof of the strength or weakness of design ideas and materials.

Mercedes-Benz scored eight wins in the nine-race 1990 season. An overwhelming success. And the team's satisfaction is broadly based: pride in the talent and consistency of Sauber-Mercedes drivers and engineers, delight that the racing chassis is once again in a class of its own; gratification that the basic multi-valve V8 engine, also used in Mercedes road cars, has proven its reliability and strength, as it did last year.

Spin-off benefits are also emerging. For example, the 720bhp racing version of the 5.0-litre V8 is teaching Mercedes-Benz engineers new paths to greater fuel economy through refinements to the sequential fuel-injection, among other things. All without sacrificing power or speed (petrol was strictly rationed in the nine-race series).

Such secrets will now find their way into Mercedes-Benz road cars. And so, in the foreseeable future, will new components technology, stress-tested in these mobile research laboratories at speeds of up to 250mph: carbon fibre-reinforced plastics, titanium alloys, super-light ceramics that most successfully tolerate racing engine power loads and temperatures.

The World Sports Car Championship is an examination of engineering excellence that presses all competitors to the limit. It is also a speed, endurance and economy trial where the results speak for themselves. Now, for the second year running, the most convincing answers have been provided by Mercedes-Benz.

And, for the second year running, the real winners are the drivers of Mercedes-Benz production cars.

ENGINEERED LIKE NO OTHER CAR IN THE WORLD

The learning curve

Mercedes-Benz are World Champions again, but the real winner is advanced technology

British advertising released following the end of the 1990 racing season.

Original starting price estimates of about £40,000 were ultimately not far off, but compared with earlier R107 models, this was a sizeable 15 to 20 per cent increase on the old car. As it happens, the 300SL had a sticker price of £42,130 when it made its debut, while the 300SL-24 was £4140 more. The 500SL, whilst not the flagship of the range (that honour remained with the 560SEC), commanded £58,045, and more than a few people questioned the hefty £16,000 premium compared to the base model.

All cars came with alloy wheels, front foglights, headlight wash/wipe, power mirrors, ABS braking, power-assisted steering, electric windows, key-operated central locking, and an alarm. The 500SL added other things, like remote central locking, power seat adjustment, power steering column adjustment and the seat/mirror/steering setting memory function, that were optional on the two lower grades. In addition, a four-speed automatic transmission was standard on the 500SL and a no-cost option on the sixes (the 5AT version for the 24v car added £685 to the invoice, though), while metallic paint was £610 on the three-litre machines, or a NCO on the 500SL. Leather trim also, was a no-cost option on the five-litre car, but

a £966 extra otherwise.

Options for all cars included ASR (£1820), the ASD differential (£834), air-conditioning (£2002), the windblocker (£196), cruise control (£307), a driver's-side airbag (£1264), heated front seats (£365), rear seating (£1110), a Becker radio/cassette (£1220), the six-speaker sound system (£264), and an electric aerial (£247).

Autocar & Motor opened its 500SL road test with some telling prose: "Compare the new SL with the 18-year old model it replaces and you could believe that hidden away in some secret part of Mercedes' Stuttgart factory there sits a still-born SL – the missing link. Such is the advance made by the company with the new car.

"It furthers Mercedes' groundbreaking safety record and at the same time shows that the company's stifling conservatism is at last giving way to flair and imagination. The SL is the most dramatic – some would say indulgent – production Mercedes since the gullwing 300SL."

The famous weekly was in awe of the V8: "The 32v V8 is a fine engine, muscular from the bottom to the top of its rev-range and never harsh. Ambling along, it mumbles like a Range Rover V8 and at cruising speeds it's all but inaudible. But prod the throttle and it picks up instantly, the rev counter needle surging round the dial. By 4500rpm it's wailing like a CanAm V8, and its thrust deteriorates hardly at all as it hits the 6000rpm red-line.

"The gearbox is supremely responsive in 'Sport' mode but, in true Mercedes tradition, the last fraction of throttle travel has to be used for the fullest performance. Press it to the floor at anything below 100mph and the effect is devastating. This response is still available in 'Economy' mode, the difference being at part throttle openings when the gearbox upshifts earlier."

Although not entirely happy with the steering, the optional ASR was praised: "Simply put, ASR doesn't spoil the SL's handling for the enthusiast, but it does protect the unwary." A few did mention it was still possible to get lurid oversteer in a snap throttle lift-off situation, which the safety systems couldn't take care of.

MotorSport added these words on the 500SL: "Driven towards the edge of D40 Dunlop adhesion, the Mercedes remained an obedient

servant, brakes remaining solid in action and complimented by informative power steering. Acceleration between corners is definitely worthy of the 'vivid' adjective, the automatic transmission conquering 0-60mph in some six seconds. Until we drove the Porsche Tiptronic, this was the most co-operative automatic we had encountered for hard motoring, and the gearchange quality still ranks far above the industry average.

"Of course there are things wrong with these hefty automobiles, but as a durable blend between urbane manners, restrained style and sporting zeal, the 500SL remains the standard by which others will be judged."

The early UK cars came without a catalytic converter setup, so the use of Four Star leaded or Super unleaded fuel was okay. The *Autocar & Motor* test revealed that the 1895kg (4167lb) 500SL was capable of cracking off a 0-60 dash in 5.9 seconds, and dismissing the standing-quarter in 14.4 seconds before going on to a top speed of 157mph (251kph). But with so much weight to pull around, in-gear times, such as the 60-80mph (96-128kph) increment, were much closer to the car's forte, and put the SL in touch with the Lamborghini Countach!

Given this level of performance, an average fuel consumption figure of 16.2mpg seemed a fairly small price to pay, and the one magazine average of almost 20mpg made the government steady 56mph (90kph) figure of 27.9mpg appear well within reach given the long-legged gearing.

With regard to the interior, *Fast Lane* passed an interesting comment: "There's a comfortable driving position for all except the largest of the large; the big seats actually take up enough space in the car to make the cockpit smaller than it looks. If there's a real fault with the accommodation, it's that the seats are unnecessarily hard – the shape is generally good (although adjustable lumbar support shouldn't be relegated to an option) but you'll feel the pressure after a long drive."

Staying with the interior, *Autocar & Motor* said: "Fit and finish are, as to be expected, very good, but Mercedes still fails to blend walnut veneer, leather and high quality plastics into an inviting whole. The SL lacks the homely appeal of a Jaguar for instance."

One also has to bear in mind that said Jaguar, even in silky smooth V12 drophead guise, was a very reasonable £41,200 in its home country, or one could opt for the exclusivity of a Ferrari Mondial Cabriolet for less than £63,000 – a price quickly surpassed on the Stuttgart flyer with only a handful of the most basic options.

But the overall rating was good, with nine out of ten stars: “We rate the 500SL as the world’s greatest convertible, and one of the best sports cars, too.”

Not everyone was fully convinced on the sports car credentials, though. *Fast Lane* concluded: “Maybe the 500SL is the best of all kinds of things – the most refined, the best equipped (or at least the most cleverly equipped), the most sybaritic, but it doesn’t necessarily add up to the most exciting. Don’t misunderstand, it *is* exceptional in so many ways – the performance is massively impressive, the roadholding is of a very high order, the handling is near idiot-proof, and the luxury and twin-top versatility are real. It’s even sporty in an Ascot Royal enclosure sort of way, but it isn’t a true sports car, not like the blurb says.”

However, in a rather timely article, motoring scribe Jeremy Walton summed up the new car thus: “Obvious quality and civilization are the key attributes to the 500SL. There is nothing particularly startling about the front engine, rear drive layout, but every detail is so thoroughly executed that the lengthy waiting lists and eye-watering prices become comprehensible.”

By the middle of the year, prices had increased to £44,660 for the 300SL, £49,050 for the 300SL-24, and £61,520 for the 500SL. Adaptive damping also came online, listed at a hefty £3120. Nonetheless, and in spite of a flagging economy, the waiting list just kept on growing, and reports of £20,000 to £50,000 premiums were not unheard of. Crazy times ...

As the 1990 season drew to an end, *Autocar & Motor* managed to get some road time in with the 5AT version of the 300SL-24. The magazine praised the “... fine ride and handling balance, the ergonomics and the hood design,” but was less than enthused by the “... cramped interior, unexciting performance, steering and price.”

The magazine found it difficult to justify the car’s high price if

regarded as a pure sports car, as any number of 'Hot Hatch' clones could outpace it (the 0-60 time was a fairly leisurely 8.6 seconds), while closer ragtop competitors from the likes of Jaguar, Porsche, Maserati and Mazda were available far cheaper. It also thought the ADS suspension was of very little value, although it's probably a reflection on how good the standard setup was rather than any failing in the active version.

Notwithstanding, there was praise for build quality, and it was noted: "Thankfully, the engine and gearbox make a great double act. Exceptionally smooth, the 24v six is near silent at low revs, yet snarls convincingly if gunned. This creates a feeling of urgency that is cultivated by the gearbox, which has ratios close enough to support a seamless aural attack all the way from standstill until fifth is selected at something over 130mph. Which is just as well, for the engine is happiest on full throttle."

When pushed with verve, the 5AT gearbox was not as smooth or fast changing as the 4AT unit tested in the 500SL, but in normal driving conditions there were few complaints. Indeed: "Part-throttle upshifts can be detected on the rev-counter, but rarely from any jerk in the driveline."

The weekly continued: "Apart from the obvious advantage of quieter touring brought by the fifth ratio, the five-speed gearbox also seems to have done the SL's fuel consumption no small favour." Despite the standard catalytic converter, requiring unleaded petrol, hard driving and a kerb weight of 1795kg (3949lb) to move around, the test team managed to average a creditable 19.2mpg.

However, the magazine had been so taken with the 500SL, it found it difficult to give the automatic 300SL-24 a thumbs-up ...

The new car in Japan & the Antipodes

As with the other major markets, and there was no doubt that Japan was heading that way, sales began in November 1989, with 12,920,000 yen R107 560SL giving way to the 13,800,000 yen R129 500SL. As had been the case for several years in Japan, only the one SL model was listed.

Considering that the Mercedes-Benz range started at 3,800,000 yen

back then, courtesy of the 190E, the new SL was fiercely expensive. However, as Shigeharu Kumakura of *Car Graphic* said: "The 500SL represents a pure sporting driver's battle suit, a playboy's dreamboat and a cool businessman's express. Given these three characters in one car, the asking price seems good value."

After a couple of months of going without an SL, sales began in Australia in June 1990. The timing could have been a lot better for Aussie enthusiasts, as a huge luxury tax had just been passed the month before. As such, the comparison made between the old 560SL at \$183,600 and the new 500SL at \$254,985 was a little unfair.

Like Japan, there was only one grade in a Mercedes range that started at \$77,100 – the 500SL was the flagship of the line, but this is hardly surprising given that one could buy a Ferrari 328GTS for \$193,000, a Porsche 911 C2 Cabriolet for around \$170,000, a V12 Jaguar XJ-SC for less than \$150,000, or a Saab 900 Cabriolet for just \$81,200!

The only thing in the SL's favour was that it was fully loaded, with virtually every option there was (including ADS suspension, traction control, and even a radio/CD player over and above the US-style interior specification). On saying that, there was no alarm, as it didn't comply with Australian design rules, and for the same reason, the cars were sold as pure two-seaters, with no chance to opt for 2+2 seating due to seatbelt regulations.

With only 150 cars destined for Australia in the first year and around 400 firm orders on file by the time the car arrived Down Under, the waiting list quickly stretched to three years.

In its first full road test of the new SL on home turf, *Motor Manual* stated that the car had "... outstanding dynamics." It also noted: "Ergonomics are first class and the hardtop presents no vision problems. The comprehensive instruments are housed in a very simple, cleanly styled binnacle, which is also home for a spectacular array of warning lights. Up until now Mercedes-Benz has made the effort of transferring the indicator stalk from the (European) left side of the steering wheel to the right so there's no conflict between changing gears and indicating. Amazingly for this car the stalk remains on the left, a retrograde step."

The latter situation was actually repeated on UK right-hand drive cars, too, as well as those sold in Japan as right hookers (left-hand drive was popular as a status symbol), and in New Zealand for that matter. For the record, the SL arrived in New Zealand at the same time as Australia, having the same specification, with the first cars being shown at the 1990 Auckland Motor Expo event. Only a handful of R129 500SLs were ever sold there, though.

The 1991 Model Year

After the fall of the Berlin Wall in late-1989, the reunification of Germany (officially taking place in October 1990) put more strain on the country's finances. Helmut Kohl continued to hold on to power, though.

Meanwhile, on the subject of power, a 100Ah battery became standard across the board from September 1990, replacing the original 92Ah version, and in the following month, domestic prices rose by an average of around seven percent, although a different increase was applied to each model due to some subtle standard specification changes.

Mercedes 300 SL

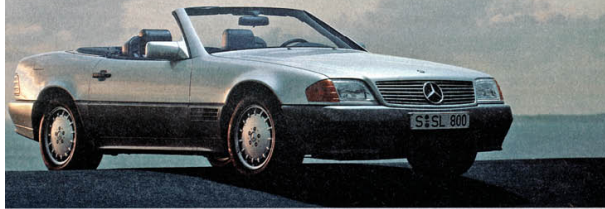

Ein Sommernachtstraum.

► Vor ungefähr 90 Jahren bestand ein Automobil im wesentlichen aus Rahmen, Karosserie, Motor, Lenkrad, Rädern und ähnlich wichtigen Bauteilen. So auch der erste Mercedes, der wegen seiner vereinfachten Bedienbarkeit den originellen Beinamen Simplex trug. Einfach am Simplex war allerdings auch sein Dach: Es war einfach nicht vorhanden.

► Wenngleich wir uns bei Mercedes-Benz schon vor Jahren

angewöhnt haben, unsere Automobile serienmäßig mit einem festen Dach auszurüsten, haben wir den Simplex nie vergessen. Deswegen bauen wir immer auch Autos, bei denen Sie in den Genuß von Wind und Sonne kommen können.

► Unser neuestes offenes Auto - den SL - haben wir mit einem elektrohydraulisch zu betätigenden Faltdach ausgerüstet. Ein Knopfdruck genügt, um es in nur 30 Sekunden aufzuklappen.

Zusätzlich ist jeder SL noch mit einem 33,5 kg leichten Hardtop ausgerüstet. Schließlich soll er ja nicht nur in Sommernächten, sondern auch während der Wintermonate ein traumhaft schönes Erlebnis für Sie sein.



Mercedes-Benz
Ihr guter Stern auf allen Straßen.

German advertising from 1991.

Dankeschön liebe Leser
für die Sportauto-Wahl
des Jahres 1990

Sieger: BRABUS SL 6.0-32

siehe sport auto Nr. 11 November 1990



BRABUS SL 6.0-32 · 300 kw/408 PS · 560 Nm · 0-100 km/h 6.0 sec* · V/ max 290 km/h*
* je nach 14-Übersetzung und Fahrzeugausstattung

BRABUS-Partner

2000 Hamburg · Behrmann Carl-Byling · 40-027 9120	6760 Kikland/Aufem · AT Tuning GmbH 06-20-12925	8740 Bad Reichenhall · Kellen Tuning 092-71-9855	BRABUS® Tuning an Mercedes-Benz
2250 Hamburg · Dörger Fahrzeugtechnik 043-91-0138	7143 Vaihingen/Enz · Seib und Zimmermann 07143-9392	CH-6424 Embrach · TGE Automobile 08465046	Kutschhofener Straße 246, 2025 22349 Sittorf, Niederw. 0241-9949-0*
3300 Bruchmühlberg/Burzenstein Fahrzeugtechnik 052-107-3070	7800 Freiburg · Hecker Autopart 078-742120	CH-5180 Bülach · ACZ Autopart 056-681777	Merano 0241-9949-0*
520 Tuisdorf · Friedberg Fahrzeugtechnik 022-417-7081	8900 Stuttgart 60 · ABT-Tuning GmbH 07141-88433	NL-3000 Rotterdam · VDF-Autopart 010-462446	Postfach 10 11 000 42699 Solingen, 021-91-1000
	8702 Helmstadt · Daxner Kraftfahrz. GmbH 093-69-2161	GR-M 11040, London · George Street Porsche BRABUS 01-925-7933	Strecke 0241-9949-0*
		S-10488 Stockholm · 804-619 Nacka Sveriges A.B. 08-71-64857	Strecke 0241-9949-0*

Mitglied im **NDN**

Brabus empfiehlt **Castrol**

Naturally, the new SL, like virtually every Mercedes before it, attracted the attention of the tuning companies. This advert shows the Brabus six-litre model that fought for a share of a small but important niche market with the likes of AMG, Lorinser and Duchatelet of Belgium.

The 300SL now stood at DM 99,066, with the 300SL-24 DM 9861 more, and the 500SL commanding DM 141,816. ASR becoming standard on the five-litre car can account for the latter having the largest increase applied, although an aerial went back on the option list again.

Audio options were revised. The Mexico radio/CD unit was unchanged, but it was now teamed up with the Becker Europa 2000 (SA code 750) at DM 1000, the Grand Prix 2000 BDS (751) at DM 1450, and the Mexico 2000 (752) at DM 2400. These units came with a manual aerial, suppression kit and four speakers as standard. Meanwhile, the 538 aerial and speaker option, whilst much the same, was made significantly cheaper, and the centre console modified internally to suit the new radios.

The armrest-mounted telephone option was deleted, leaving only a stacker unit version mounted in the centre console. At the same time, three metallic paint shades were dropped, but four new ones were added to take their place. As it happens, the cost of metallic paint was reduced to DM 1145 on this price list, although the cost of most options went up in line with the hike mentioned earlier. For example, the four-speed automatic gearbox was now DM 2805, with the 5AT version at DM 4330. The ASD was listed at DM 1770, with cruise control at DM 625, and leather trim DM 2095.

In November 1990, the rear axle shaft diameter was increased from 25mm (1.0in.) to 32mm (1.3in.) to improve ASR control characteristics. This change was applied to ASR cars only, but more shaft refinements were introduced in the following spring for all SLs to encourage more accurate assembly and improve concentricity with other rear axle components.

A few months later, in March, three solid paint colours were dropped from the coachwork palette, with only one new one being added. There were also two new metallics to replace two older shades. Incidentally, metallic paint was still a no-cost option on the 500SL, but an extra on the six-cylinder cars.

In the following month, revisions were made to the ASD unit, and again just over a year later, although neither change would have necessarily been noticed by customers. The same goes for the minor modifications on the V8's fuel-injection system made in June 1991, when door courtesy lighting became standard on all cars, and the remote central locking was upgraded to include the interior storage compartments (formally option 881).

June also witnessed a price increase of almost four per cent on the base car, pushing up the cost of SL motoring, the line-up now ranging from DM 102,771 for the 300SL to DM 146,775 for the 500SL. The price of options generally rose by a similar amount, although there were a few changes – new 8J x 16 alloys with eight scalloped holes (SA code 652) were offered as a new option at DM 300, and a smaller, 390mm (15.4in) diameter leather steering wheel (281) became listed as no-cost option. This 'Sportline' wheel came with flatter spokes and a sharper centre boss design, and was duly fitted as standard to US-

bound cars for the 1992 season.

SI INCONTRANO SPESSO AL CLUB

A 008 P A 509 V 161

Il concetto di HIGH PERFORMANCE è alla base della tecnologia YOKOHAMA. Prodotti perfetti destinati ad utilizzi specifici. Nel mondo YOKOHAMA, ricerca e sviluppo, ruotano attorno ad un concetto esclusivo di volontà di garantire "QUALITÀ TOTALE" nella guida.

YOKOHAMA
Performance Radials
YOKOHAMA Italia - Tel. (030) 9697161 - Fax (030) 9965327

Italian advertising for Japanese tyres on a German car. This Yokohama advert was issued in the spring of 1991, although Dunlop, Pirelli and Michelin rubber was generally fitted at the factory at this time.

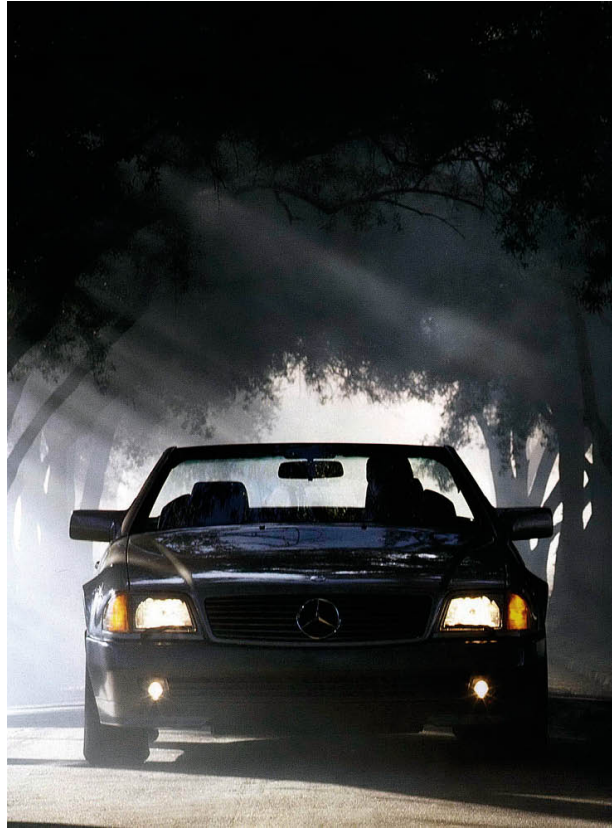

A stunning image from the US catalogue for the 1991 season.

Continuing to make improvements as and when they became available, there was a subtle change to the seat design, and the engineers made a minor change to the internals on the 722.5 AT to improve three-to-two and four-to-two downshift quality in August 1991. A few months later the brake band piston was modified to a self-adjusting design on the same transmission for further refinements in shift quality.

Other than the adoption of applicable domestic market running changes and the odd thing already noted, nothing much was happening in the export markets, as the car was still fairly new.

In America, after a new luxury tax had been imposed in January 1991, the 300SL was up to \$78,300 in manual guise, or \$79,300 if two-pedal driving was preferred, while the 500SL (4AT only) commanded \$92,700. The Gas Guzzler Tax was \$1300 on the six-cylinder car, and \$2100 on the V8.



A 300SL featured in the American brochure.





A 500SL exterior and interior shot from the 1991 US brochure.

The windblocker was now included as part of the US SL package, so the rise was more than reasonable given the recent price increases in Germany and tax hike. Options at this time included the ADS suspension (allowing a softer ride when cruising, or a tauter suspension on twisty sections or during emergency situations) at \$3800, an ASD differential for the manual 300SL at \$1050, traction control for the automatic 300SL and the 500SL at \$2475, heated seats at \$520, and adjustable lumbar support at \$335 a side. As such, at last, the North American-spec cars were now available with all the goodies offered on European machines.

Sales had been slightly better for Mercedes-Benz of America in 1990, amounting to 78,375 units across the vehicle range, but they dropped off sharply in the following year. Indeed, while 9619 SLs were moved in the States in 1990, only 7481 found new owners in 1991, with the model split being roughly two 500SLs for every 300SL sold, although the SL had accounted for 12 per cent of US new car sales for the German maker in both years. As it happens, America slipped into recession on Republican George Bush's watch in 1991, allowing Democrat Bill Clinton to take the presidency the following year.

In Britain, where Margaret Thatcher had handed over the reins of

power to John Major in November 1990, the price of Benz motoring continued to rise. At the beginning of the 1991 season, the SL line started at £46,340, but by the spring, the price of the 300SL had risen to £49,960 (three times the cost of the cheapest Mercedes on offer at the time), while the 24v car commanded £54,460. The 500SL was actually the flagship model, but at £70,090, perhaps that's not surprising – the contemporary UK average house price was £54,500!



Artwork from the 1991 US catalogue.



One of the press shots from Mercedes-Benz Inc, showing an SL at speed with the roll-over bar manually deployed.

C11 - 730bhp - 0-62mph in 1.6 secs

300E-24 - 220bhp
0-62mph in 7.8 secs

500SL - 326bhp
0-62mph in 6.2 secs

300TE-24 - 220bhp
0-62mph in 8.2 secs

Advanced multi-valve engines.
They run in the family.

British advertising from February 1991 promoting Mercedes' multi-valve engine technology.

遊 走 の 時 代
都市生活者のための(総合レジャーシステム)。





今回の会員募集は、定員になりましたので平成3年1月20日でメクラせていただきました。

- 現在ご入会されている会員のほうは、いままで通りご利用いただけますが、新システムに変更させていただきます。

●ご利用のご案内

- 予約———すべて予約制になっております。ご利用の日前までにお申し込みください。
- 予約料(日) 税別———1000円(1泊1泊) (1泊1泊)
- 料金———すべてクレジットカード決済となります。
- 当クラブの車種は、すべて最新鋭な専業エンジニアのメンテナンス管理。常にベストコンディションの車を提供いたします。

新電気株式会社ユーロクラブインターナショナル事業部 TEL: (03) 5479-8888 〒100 東京都千代田区春本町1-5-12 新電気ビルビル 

Japanese advertising from the time, with Euro Club International making the most of the SL's image. Note the Japanese lighting, which was much the same as that employed in Britain, with a repeater added on the front wing.

In Japan, the 500SL was listed at 15,800,000 yen for 1991 (in left- or right-hand drive guise), which signaled a hefty 2,000,000 yen increase over the previous year. Considering one could buy a basic domestically-built family car for that kind of money in the Land of the Rising Sun, the substantial hike must have raised one or two eyebrows. Interestingly, long before making official German price lists, Japan offered a six-litre AMG car at 24,500,000 yen, with its bored-out 32v engine delivering close to 400bhp, tuned suspension, a subtle body kit and wide rubber mounted on unique, three-piece alloy wheels made by OZ Racing.

Actually, according to the catalogue of June 1990, AMG offered a 215bhp upgrade for the strict 300SL, and there was a bored-out 3.2-litre version that delivered 235bhp. The 24v unit could be converted

into a 272bhp 3.4-litre unit, while at least one 3.6-litre straight-six was produced, presented to Thomas Muster after winning a Mercedes-sponsored tennis tournament in 1995.

There was also an interesting project overseen by the Sansei Trading Company of Tokyo – a fixed-head coupé based on the 500SL. The extended wheelbase (200mm or 7.9in longer than usual) allowed proper seating for four, adding practicality, while the Maserati-like roofline and C-post blending in with a shorter tail looked very elegant. Unfortunately, with the Japanese economic bubble bursting, there was simply no market for a 28,000,000 yen car that couldn't be backed up by a factory warranty.

Australia went the opposite way to Japan for 1991, bringing the 560SEL back as the flagship model, with the 500SL being reduced to \$229,200. Somebody obviously came to the conclusion that they had overpriced the two-seater in a difficult market.



The 12-cylinder Mercedes-Benz C291 in Group C action in 1991. This year saw new W124 super saloons in the shape of the 500E and 400E take a bow, as Benz tried to develop a more sporting image to tie-in with current thinking symbolized by the racing programme. Unfortunately, having done so well with earlier V8 racers, successfully reviving the 'Silver Arrows' legend along the way, the company dropped out of the Group C arena before the 1992 season started in order to concentrate on different disciplines, including engine suppliers for open-wheelers in F1 and CART, although the company still had a strong presence in the DTM series. Later, it would move into the FIA GT arena as well.

The 1992 Model Year

Perhaps the biggest news for the 1992 season was the long-awaited return of a four-seater convertible to the Mercedes-Benz line-up via the W124-based 300CE model. This made its debut at the 1991 Frankfurt Show, but didn't actually enter production until six months later.

While the cost of all domestic SL models rose by DM 1710 in September 1991, this was quite reasonable in reality, as a driver's-side airbag became standard, and the increase was actually less than the former option price. Dual airbags were now only DM 1500, but all other options were unchanged, including their prices. The only other item of note was the new names allocated to some of the trim, reflecting the fresh material numbers, although ordering codes (074, 075, 274 and 275) remained the same.

By this time, compared with the original cars, the six-cylinder models had both put on 50kg (110lb) in weight according to the official figures (oddly, the gain was biased toward the rear on the 300SL, but toward the front on the 24v machine), while the V8 had gained a rather more modest 30kg (66lb), with most of it going over the front axle. One wonders if a lot of this was gamesmanship to make the forthcoming V12 look less of a heavyweight on paper, as there doesn't seem to be any specification changes that would make this much difference, especially on the 300s.

Anyway, February 1992 saw an increase of around DM 4000 on the 300SL and 500SL, although the price of the 24v model went up by only a fraction. The 300SL now stood at DM 108,642 in Germany, with the 300SL-24 at DM 115,824, and the 500SL listed at DM 152,931. The cost of most options rose by a small amount, although the price of air-conditioning and dual airbags remained unchanged, and the five-speed automatic gearbox option actually went down (to DM 4200), along with the official telephone kit. Incidentally, the radio/CD unit was no longer listed, but otherwise the range of options was the same as before.

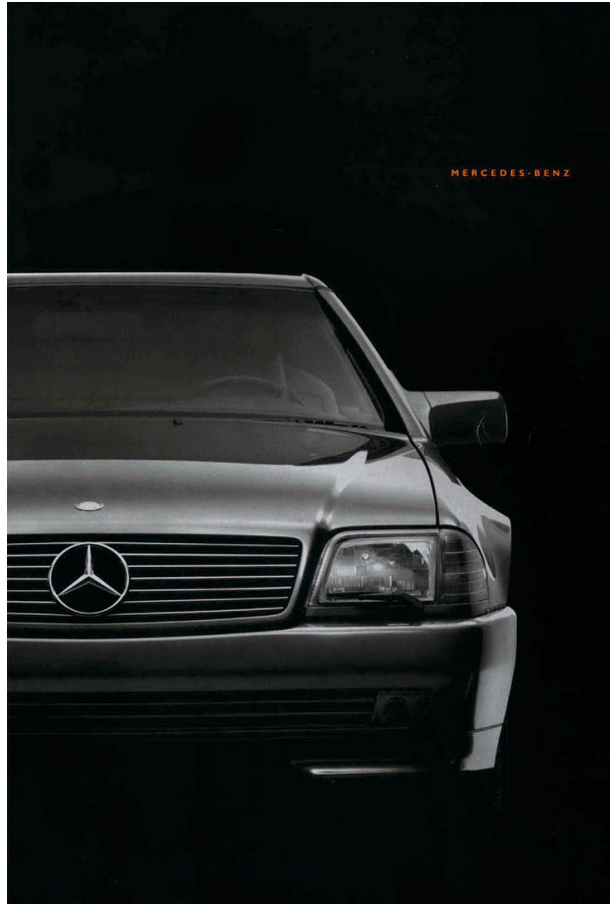

Cover of the American brochure for sporting models available in the 1992 season.

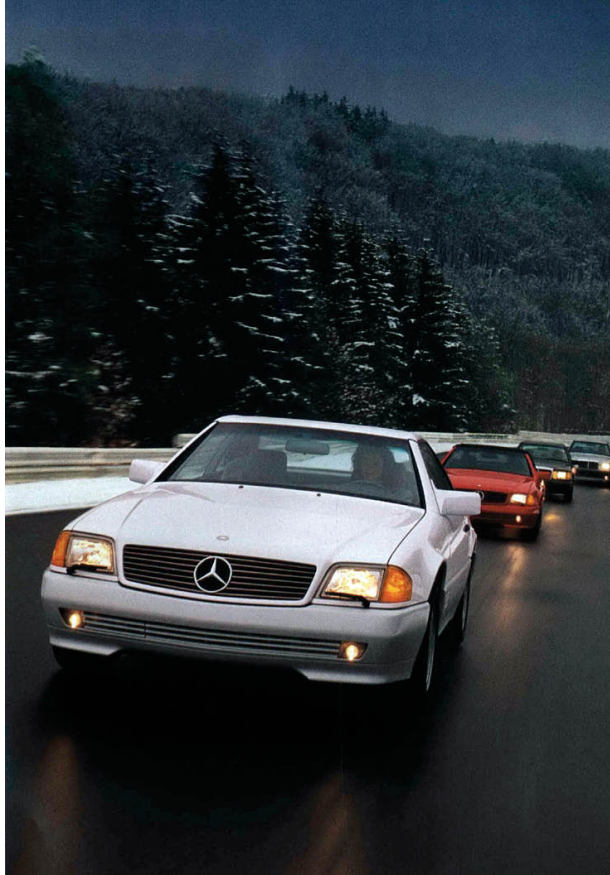

One of the pictures used in the 1992 US catalogue, and useful, as it shows the North American lighting arrangements, with the indicator units employed as running lamps.

Various minor changes had already been applied to transmissions, such as better seals and a few weight (and cost!) reduction measures. From May, the 717.41, 717.43 and 717.44 five-speed manual gearboxes had their drive, main and counter shafts freshly mounted on grooved ball bearings in order to reduce noise and improve shift quality. Then, in the following month, again to reduce NVH, the propshaft intermediate bearing arrangement was changed on V8 models, with the same revision being applied to the propshaft on the soon to be released V12 model. In August 1992, automatic SLs received a modified vacuum unit for modulating the AT operating pressure.

Now, is as good a time as any to note that Dr Dieter Zetsche was appointed Chief Engineer in 1992, with Jürgen Hubbert in charge of

the passenger car division. Zetsche (aka Dr Z) took Dr Wolfgang Peter's place, who had been moved sideways after the W140 project, which, while it had its fans, had run behind schedule and over-budget. Zetsche would later become the head of Mercedes-Benz.

Meanwhile, in the major export markets, other than a \$4200 price increase at the start of the 1992 season, there was no change in America as far as the 300SL was concerned. The cost of 500SL motoring rose by \$4800, but the extra was more than justified in this case by the fact that traction control was made standard on the five-litre car. Fresh options for 1992 included a ten-disc CD changer at \$1200, and a cellphone at \$1295. However, despite the additional goodies, US sales were slow in 1992, with fewer than 5000 SLs finding new owners – the model ratio moving to almost three 500s to every 300 sold.

In Britain, prices were carried over from the end of the 1991 season, meaning the cheapest SL was £49,960, before options, which on this model included a 5MT (available as a NCO) or 5AT gearbox (a £723 extra), as the 4AT transmission came as standard. However, the V12 Jaguar XJ-S drophead was only £640 more fully loaded, and the Maserati 2.8 SE Spyder looked an absolute bargain by comparison at £42,402. Even if one opted for Teutonic reliability, the Porsche 911 C2 Cabriolet was listed at £56,553 – not much more than a 24v SL, and £13,500 cheaper than the five-litre car.

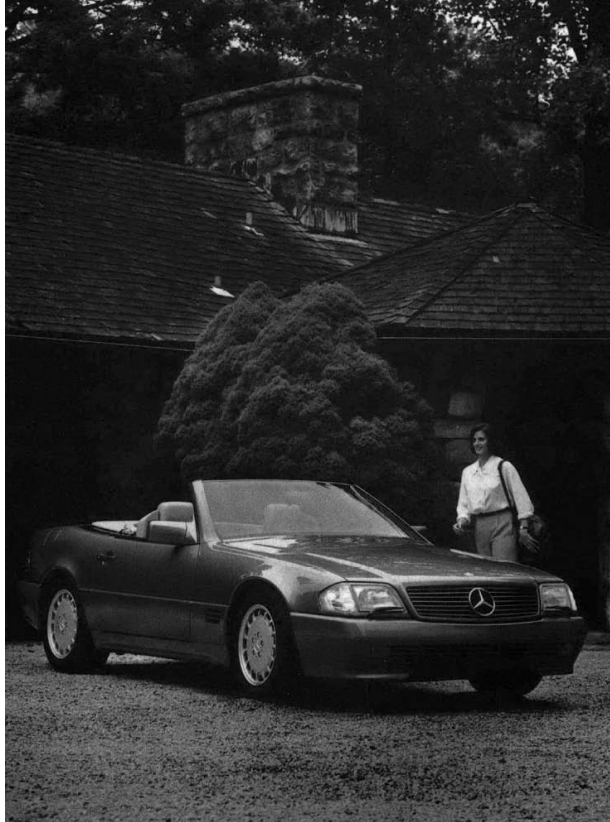

A final image from the 1992 American catalogue.

Add in the fact that options were far from cheap, with metallic paint adding £691, air-conditioning costing £2270, leather trim £1020, heated seats £414, power seats £940, power steering column adjustment £504 (plus the memory function another £270), dual airbags a hefty £2493, rear seats £1258, and the windblocker £223, and one quickly realized what good value the Coventry car represented.

But there was no doubt that the SL was a quality piece of kit, with the eight-slot alloy wheels coming as standard in the UK for 1992. A *MotorSport* test remark on the interior seemed to say it all: "We simply could not spot a single flaw in the fit and finish of the plastics, woolly carpeting, leather and walnut employed. The total absence of rattles is also uncanny."

The same magazine added: "As a driving experience, there was no doubting the safety and sheer adhesion of the 300SL-24 chassis. You can drive the SL hard for fun ... "

However, the end of the bubbly period of silly money had quickly reduced waiting lists, and delivery was down to around three months for British customers at this time. Notwithstanding, the UK's 135 dealers were still being kept busy taking orders for the Stuttgart roadster, but one special customer in particular caused quite a stir, for in February 1992, Princess Diana took delivery of her red 500SL. It was the first time a prominent member of the British Royal family had flaunted the use of a foreign car, although it was quickly given up due to public pressure (the British motor industry was on its knees after all was said and done), and the vehicle now resides in the hugely impressive Mercedes-Benz Museum in Stuttgart.

In Japan, the 500SL (lhd or rhd) went up to 16,310,000 yen for 1992, in a regular Mercedes range spanning from 5,030,000 yen for the basic 190E all the way through to 21,160,000 yen for the V12 600SEL saloon (as it happens, the SL was next in the pecking order, followed by the 560SEC at 14,800,000 yen), while the tuned AMG car broke the 25,000,000 yen barrier. At least SL prices remained the same for the 1993 season, and even started coming down after that. Further south, the price-tag on the Australian 500SL hovered around the \$250,000 mark during the same period.



Princess Diana's old 500SL in the Mercedes-Benz Museum in Stuttgart, next to the extraordinary Popemobile.

SL

卓越の性能、安全性、快適性を表現する、新次元エンジニアリングの結晶。
輝かしいスポーツカーとしての伝統に栄光の1ページを刻みます。
メルセデス・ベンツ 500SL。



500SL DOHC V-8 5.0L 32 VALVE 4-SPEED A.T. LEFT OR RIGHT HAND DRIVE

卓越した性能、安全性、快適性を高いレベルで満たし、かつ、フルオープン、ソフトトップ、ハードトップと3つのフォルムに変化するスポーツカー、メルセデス・ベンツ 500SL。DOHC V 第8気筒5.0ℓ エンジン、エレクトリックインテグラルシート、オートマチック・ロールバー、助手席にも装備されたSRSエアバッグシステム……。10数年におよぶ開発期間、500万kmものテスト走行を経て生まれた500SLには、メルセデスが誇る先進テクノロジーの粋が結集されています。その先進性と完成度は、すべてのスポーツカーが目標とするところです。



The SL page from the Japanese 1992 Model Year catalogue.

いいものだけ世界から

カーライフ 楽しむあなたのよいマナー



AMG

**AMG-Mercedes
500SL 6.0**



ENGINE DOHC V-8
DISPLACEMENT 5.996cc
POWER 381PS/5,500rpm
TORQUE 56.4kgm/4,800rpm
COMPRESSION RATIO 10.5

K I N G O F S P O R T S R O A D S T E R



エーエムシー-メルセデスについてのお問い合わせは
AMGインフォメーション 03-3452-8198
ヤナセ ネットワークを通じて販売いたします。

AMG-Mercedes 500SL 6.0 2,530万円 全国希望の先着順 税別送料
●価格については消費税は別記ください。
●本誌に掲載の価格等はあくまで目安の価格です。税別送料は別記いたします。
●価格・送料は10%増し(消費税別)とさせていただきます。価格・送料は別記いたします。

good days
ヤナセ

総輸入元
AMGジャパン株式会社
東京都港区三軒茶屋2-1-1
電話 03-3452-8198

いっしょの世界から

AMG

Dress-up & Tuning-up Parts

美しくだけではない、性能の一部。
 AMG社では、後継のモデルの完全オリジナルホイールを
 開発し、より高いパフォーマンスのホイールを
 開発。高性能の向上、そして高品質な加工により、
 スキムなデザインを表現します。

■ピニオンホイール
 サイズ 8Jx17 0n18 ¥210,000
 8.5Jx17 0n18 ¥220,000
 8.5Jx17 0n30 ¥220,000
 10Jx17 0n5 ¥230,000
 10Jx17 0n17 ¥240,000

■スローキープホイール
 サイズ 6.5Jx16 0n31 ¥78,000
 7.5Jx16 0n42 ¥79,000
 8Jx16 0n11 ¥87,000
 9Jx16 0n0 ¥140,000

■ピニオンホイール
 サイズ 7Jx15 0n25 ¥63,000
 7Jx15 0n35 ¥63,000
 7.5Jx16 0n40 ¥76,000
 7.5Jx16 0n17 ¥76,000
 8Jx16 0n11 ¥76,000
 8Jx17 0n28 ¥87,000
 8Jx17 0n11 ¥87,000

※上記価格は標準小売価格(税別)です。

AMGアクセサリパーツのお求めは、
 ●全国約40ヶ所、ネットショップ(売店・関係会社・特約販売店・販売協力店)及び下記の指定部品代理店にお問い合わせ下さい。
 ●正規指定部品代理店

関東地区 — 株式会社 東海自動車 (03) 2233-2212 (株) ウッドヘルズ (045) 541-1816 / エコープロジェクト (0482) 66-2511 (株) /
 ユニクススピード (045) 932-8391 (株) 関西地区 — 株式会社 アスポート (0726) 37-1181 中部地区 — 株式会社 (052) 704-0088 (株)

YANASE
 AMG JAPAN, LTD.
 カーライフ 楽しもうがっつり ムーヴナー

good days
 ヤナセ
 AMG JAPAN 株式会社
 東京都港区
 〒100-0001

A couple of Japanese adverts showing the 500SL 6.0 AMG and the alloy wheels available from the same tuning company. Two of these wheels were later listed in German price lists, with the upper design (made by OZ Racing) carrying the 795 option code, and the lower one, known as the 'Aero 1' in AMG circles, the 787 SA code. Note the painted centres on the wheels in the top picture.

6

New powerplants

The new SL had quickly established itself as a luxury sports car, but more was to come – the promised six-litre V12 at one end of the scale, further refining the line as the new flagship model, and new multi-valve engines to replace the three-litre units at the other end ...

Rumours of a V12 SL had been circulating for almost as long as the rumours of the R129 being ready for the showrooms. In reality, both items had been reported in enthusiast publications far earlier than 1989, and as soon as the new roadster was close to production-worthy, the 'leak' regarding a V12 engine and other forms of high-tech gizmos simply whet the appetite still further. At last, in the spring of 1992, the long-awaited 600SL finally broke cover ...

The V12 made its debut as one of the power-units for the new W140 S-Class, which first took a bow at the 1991 Geneva Show. The six-litre models duly went into production in April 1991, a month after the Swiss event, but everyone knew the exotic engine that propelled them was destined for service in the SL, too. At least it was a fairly straightforward operation compared to the majority of shoehorn jobs, as the engine bay was designed to take the V12 from the start. Indeed, the first pilot build 600SLs were produced as early as August 1991 (prototypes based on converted 500s had been running as early as 1989), with no major technical problems being encountered either in the drivetrain or chassis departments.

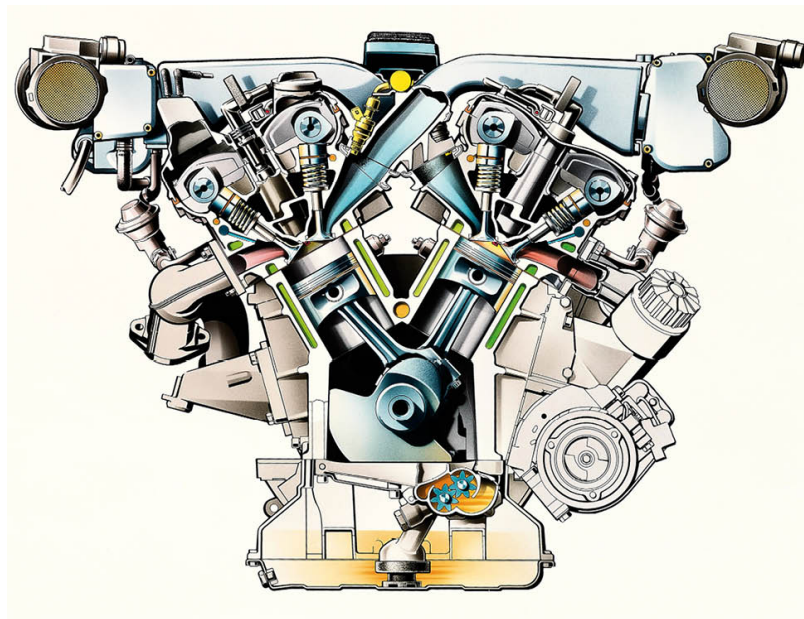
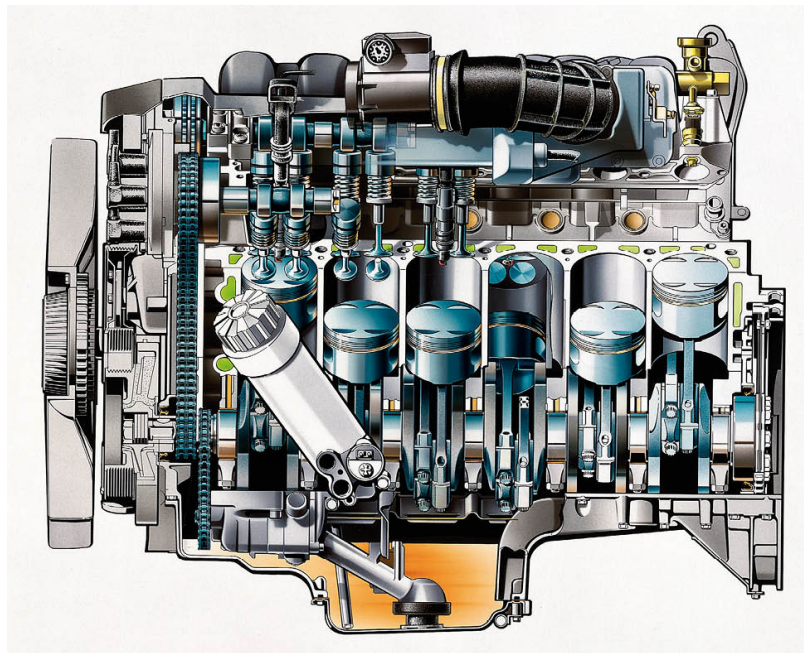

Cut-away drawings of the Mercedes V12 engine.

In its original form, the M120 six-litre twelve-cylinder engine developed a mighty 408bhp, and 428lbft of torque. By the time it was ready to go into the SL, a few modifications had taken place, including some to suit the roadster (such as a new sump, exhaust system, air filter and accessory drive), and more would be applied just before it hit the market – for although full-scale production officially started in July

1992, it wasn't really until September that the car started being built in volume ready for sales to start in earnest in the following month. By then, a new distributor cap and rotor had been created for the V12 engine, with a high carbon content to avoid cracking, new exhaust manifolds were introduced with improved insulation properties, and the fuel-injection system was completely overhauled.

The engine used in the 600SL (chassis code 129.076) carried the Type 120.981 designation. An all-alloy 60-degree V12, it had a bore and stroke of 89.0 x 80.2mm, adding up to a displacement of 5987cc. There was a seven-bearing crankshaft down the bottom, and twin-overhead camshafts in the pair of pent-roof cylinder heads, driven by chains and operating four valves per cylinder working in conjunction with the now-familiar variable timing system (allowing a maximum adjustment of 25 degrees on the intake camshafts in this case, improving mid-range punch without affecting emissions or top-end power); hydraulic self-adjustment on the bucket cam-followers was taken for granted by now.

With a digital LH-Jetronic EFI system (using hotwire anemometers for metering) and a 10.0:1 compression ratio, despite the full-load enrichment device being deleted to please environmentalists, the unit developed a healthy 394bhp at 5200rpm (800rpm off the red-line), and 420lbft of torque at 3800rpm – a loss of 14bhp and 8lbft on the original engine, but nothing to get too worked up about in percentage terms.



The V12 engine featured in a Japanese oil advert from early 1992.

The four-speed automatic gearbox was basically the same as that found in the 500SL, coming with 3.87, 2.25, 1.44 and 1.00 cogs inside, and a 2.65:1 final-drive ratio. According to official figures, despite a substantial kerb weight of 1980kg (4356lb), the 600SL dismissed the 0-60 dash in 6.1 seconds (or 5.9 seconds according to the US catalogue), and went on to a governed top speed of 156mph (250kph). Perhaps just as important in the face of rising petrol costs (although for those who could afford an SL in the first place, it was purely academic!), was the 11.3 litres/100km fuel consumption figure – the equivalent to 25.0mpg imperial at a steady 56mph (90kph), or 20.8mpg using American gallons.

To keep the beast in check, the 600SL was given an uprated version of the familiar suspension, with harder spring and damper rates to cope with the extra weight, and ADS and traction control (ASR) as standard in all markets. Wheel and tyre combinations were the same as the other SLs (albeit Michelin rubber gaining preferred status), as

was the steering, but lurking beneath the alloy rims were bigger brakes with directional discs that were ventilated all-round. The front discs were 320mm (12.6in) in diameter and a hefty 30mm (1.2in) in width, while the rear pair were 300mm (11.8in) across. Although the foot-operated parking brake was the same, the 600SL gained a more intuitive ABS programme that could better adapt the electronic proportioning in accordance with whether the car was travelling in a straight line or cornering.



A 600SL with optional alloy wheels (SA code 652) and the hardtop in place. From this angle, only the discreet 'V12' badges on the front wings allow the onlooker to know what lurks underneath the bonnet; the other clue was the badge on the tail, unless the car was destined for American shores.



Tail of the 600SL, displaying a badge that would ultimately be very short-lived indeed.



Interior of an early V12 SL. Note the unique gearlever and the extra wood applied to the centre console area, as well as the smaller-diameter 'Sportline' steering wheel introduced in mid-1991.



One of the 600SL press cars being used for publicity photography.

From the outside, only the eagle-eyed could tell the six-litre car from its stablemates, although there were subtle clues in addition to the obvious change in number on the bootlid badge. For instance, there were tiny 'V12' badges on the trailing edge of the front wings (next to the vents), and the front bumper was sat 50mm (2.0in) deeper on US-bound cars – the extra depth, clearly visible on the top edge of the panel, allowing a more suitable crush zone for the bigger engine in order to comply with Federal regulations. Oddly, this latter

modification, which naturally increased the car's overall length by a similar amount, wasn't necessary elsewhere, only in the States.

As one would expect of a flagship model, the DM 217,740 600SL came fully loaded with virtually every option available, including headlight wash/wipe, dual airbags, CFC-free automatic air-conditioning, cruise control, power seats with memory, seat heating, leather trim (only), electrical steering column adjustment with memory, mirror memory, a Mexico 2000 stereo with six speakers and power aerial, and dual-tone horns all as standard. At the same time, while a towbar was out of the question on the V12 machine, metallic paint, tinted and laminated glass all-round, and a fire extinguisher were classed as NCOs.

To give the 600SL a more impressive interior than the other models, which would be just the same with all the options, the six-litre machine had a special walnut/leather gearlever (284) not listed for other cars, the centre console box between the seats also gained wood trim to match that already found on the centre stack and the gear selector surround, and the door inlays, armrests, door pulls, sunvisors and roll-over bar were finished in leather. Rear seats were thought to be standard in pre-launch dealer paperwork, but they were later added to the option list, as per the other SLs, costing DM 2350 in leather.

There were some who rightfully questioned the timing of launching a V12 in the middle of a deepening recession, but one has to remember that the planning had been done years before, in much brighter financial, political and sociological times.

Other 1993 MY news

While there were no mechanical changes made to the three-litre cars, the 500SL was given a new M119.972 engine in September 1992, prompting the car's chassis code to become 129.067 as a result.

Most of the leading specifications were the same as the earlier 32v V8, meaning a displacement of 4973cc. The 10.0:1 compression ratio was carried over, too, although the crankcase design was revised, and a modified exhaust manifold was specified for four of the cylinders, made with a cheaper grade of cast-iron with reduced silicon content. However, by far the biggest change was in the EFI system.



A one-off 'gullwing' model by Karmann, first presented in 1993. The 300SL-24 based car still exists today, although the famous German coachbuilder filed for bankruptcy in 2009. Fortunately, the firm was rescued by Volkswagen.

Earlier V8 units used for the SL had employed the Bosch KE-Jetronic setup, but the M119.972 moved over to LH-Jetronic port-injection, as found on the V12 from day one, with electronic hotwire air-mass metering. While the richer mixture setting on full throttle was eliminated to reduce emissions, the injectors were revised at this time (from engine 000001 on the V8, and 015811 on the V12), the nozzle having two holes instead of four to give a better spray pattern.

All told, maximum power dropped a touch (the new unit was 6bhp down on its predecessor), but this was balanced nicely by a 15lbft gain in torque. As such, the latest V8 developed 320bhp at 5600rpm and 347lbft of torque at 3900rpm, and passed the recent EURO 1 emissions regulations with ease.

Improvements in efficiency are always welcome, of course, so it seems odd that the official 0-60 time on the 500SL was adjusted from 6.2 seconds to 6.5. In reality, this was probably done more to make

the V12 look better, but fuel consumption certainly improved – from 10.1 litres/100km cruising at 56mph (90kph) to 9.6, which was close to early three-litre car efficiency. This equated to 29.4mpg imperial, or 24.5 miles per US gallon – enough of a gain to reduce the car's Gas Guzzler Tax in the States.

As for general changes, the October 1992 price list revealed that dual airbags had become a standard fitment, while the Continental CTS tyres were no longer available. The 300SL was quoted at DM 109,440, with the 24v car DM 7182 extra. The 500SL commanded DM 153,729 at this time, but it was still just over DM 64,000 cheaper than the latest 600SL model.

New options included a six-CD changer in the trunk (SA code 819) at DM 980, and deletion of the hardtop (210), which gave a credit of DM 2750 on the invoice. Also newly available at this time were three Exclusive leather trim options with contrasting edge piping – black with mid-grey piping, mushroom with dark brown piping, and grey with anthracite piping. This Exclusive leather option cost DM 7415 on most cars, but it was 'only' DM 5115 on the 600SL because the door inserts were already trimmed in gathered hide, and other components, such as the sunvisors and roll-over bar, came in flat leather to match.

January 1993 saw another price increase on the domestic market, with the range now starting at DM 113,505 for the strict 300SL, and topping out at DM 219,650 for the 600SL. However, tinted glass (SA code 590) was now standard on the 600SL, with the laminated options (592 and 599) classed as NCOs on the six-litre machine.

An automatic dimming rearview mirror (249) was added to the option list, priced at DM 380, although it came fitted as standard on the 600SL. Other option prices remained largely the same, with a few up a touch, although there was a large increase on the outside mirror memory function, upped to DM 900. At the same time, an immobilizer function was added to the alarm, taking the latter's price up to DM 965.



This 500SL postcard was issued by Mercedes-Benz of North America, and used as one of the illustrations in the 1993 season brochure. The eight-slot alloy wheels were adopted as standard fare in the States from this time.

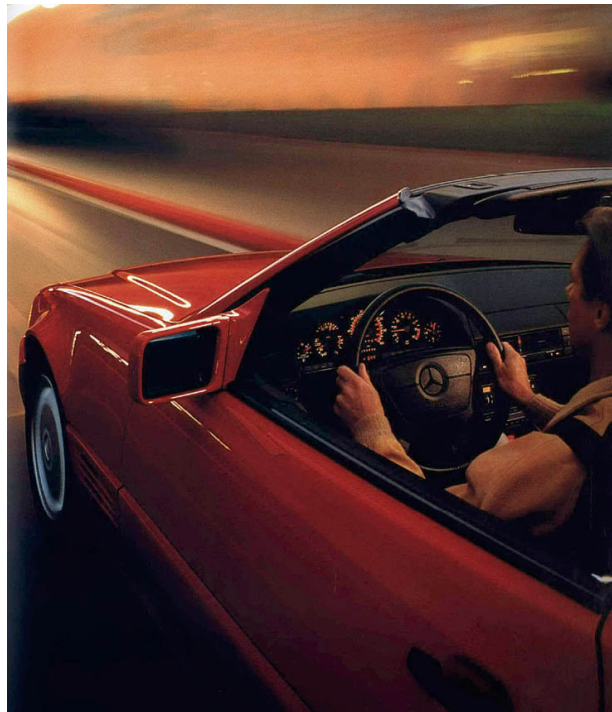

Page from the 1993 US catalogue showing the 300SL dashboard lit up at night.

US & UK review

The eight-slot alloy wheels (identified by the 652 code) were fitted as standard on all US-bound SLs for 1993, and an automatic dimming rearview mirror was added as part of the package from immediately after the start of the 1993 season. Otherwise, there were no changes to the cars that had been sold in the previous year – even the options were the same. However, as one would expect, the list price was revised, being \$800 higher on the 5MT 300SL, \$900 up on the 5AT version, and \$1000 higher on the 500SL.

With so little else to report, naturally news regarding America's 1993 season was dominated by the arrival of the 600SL, with 900 of the V12 machines being allocated for US customers each year.

The 600SL was introduced at \$119,500, its \$21,000 premium being justified by the engine and other items that came as standard on the six-litre car, such as ADS suspension, enhanced trim, heated seats, a CD changer, and even a hands-free cellular phone, which was integrated into the audio system and fitted in the compartment above the centre air vents in the dashboard. In reality, other than metallic paint (a no-cost option), the only extra that needed to be ordered at the time of production was the adjustable lumbar support, priced at \$350 a side. It seems odd, therefore, having to pay \$90 for floor mats, as one would with the cheapest car in the Mercedes range!



A press shot from the 1993 season showing a US-spec 500SL. Many of the same photographs were used in press packs for 1994, and some even found their way into the 1995 set.



Another press shot, this time showing the North American 600SL for 1993. Note the 'V12' badges on the front wings and the slightly deeper, thicker bumper: the latter unique to US V12 cars.

Notwithstanding, writing for *Car & Driver*, Frank Markus noted:

“Mercedes-Benz’s new 600SL will not be appreciated for flashy styling, a huge price-tag or supercar performance, but rather for the understated and over-engineered way in which these qualities are integrated. In terms of class and refinement, the 600SL is a world leader.

“What is it like to drive? Special. Like a nuclear-powered hovercraft. Like the Concorde, or the bullet train. To talk numbers is to bourgeoisify the experience ... With an SL, it’s not the speed, but how well the speed is achieved that counts.”

Road & Track was also impressed by the effortless performance: “Point the 600SL roadster down the road and nail the throttle to the floor. The car takes a slight squat and it’s gone ... There’s another dimension to the 600SL’s performance, because all that motivation is coming from a liquid-smooth six-litre V12. There’s no snarl or growl on this quick trip, just a deep, powerful hum that builds and grows as the speedometer needle swings quickly to the right.”

It should be mentioned, however, that this particular element in the car’s make-up – its quiet progress – wasn’t appreciated by everyone, with a few testers remarking that perhaps the exhaust was too muffled for a sporting machine.

But as John Lamm mentioned in a different *Road & Track* article: “[The smooth] power builds strongly rather than erupts. Also smooth is the manner in which the 600SL reacts to road surfaces, whether your concern is ride or handling. Even on ever-turning and twisting desert roads, the added weight of the engine isn’t apparent. The 600SL doesn’t push ... it hauls.”

Push, of course, has been used as a play on words here, but Lamm, is in reality referring to the lack of understeer reported by his colleagues and in other magazines. Not all were in agreement, though, with *Sports Car International* observing that while “ ... the 600SL imparts the impression of being firmly planted at all times, on the road, the added front-end weight makes itself felt. The 600SL exhibits slightly more understeer than its 500SL twin.”

The final summary on the 600SL goes to Barry Winfield of *Car & Driver*: “I have some difficulty bringing my emotional response to the 600SL in line with my objective realizations. I mean, the SL hardly

needs a six-litre V12 engine just to move two people, and the marginal performance increase over the 500SL can't justify the big engine or the higher price of this extravagant transplant. But it only takes a day in this splendid vehicle to smash those sensible arguments to dust. The smoothness, solidity, power and mechanical harmony of it is gloriously intoxicating. Despite the price, I bet Mercedes moves them all."

Reviewing several contemporary road tests by leading enthusiast publications gave an average 0-60 time of 5.8 seconds, and a standing-quarter of 14.2 seconds. The car pulled 0.83g on the skidpan, which was much the same as the three-litre car. Interestingly, the average fuel consumption of around 15.0mpg (US) tied-in rather nicely with the EPA rating of 13/18 – reasonable for a six-litre machine, but not good enough to allow the 600SL to escape the eye-watering \$3000 Gas Guzzler Tax imposed on it.

Incidentally, the Mercedes-Benz stand at the 1993 Detroit Show, which opened in the second week of January, featured a rather special 600SL with a unique panorama glass roof, custom mother of pearl white paint, and a two-tone black/white all-leather interior. This roof was a glimpse of the future, as it happens, for it was later made available on production SLs.

In Britain, 1993 season prices actually went down a touch compared to those quoted in mid-1992, with the 300SL costing £48,918 (representing a reduction of more than £800), the 300SL-24 £53,291 (or £54,015 in 5AT guise), and the 500SL £68,348. The V12 600SL was introduced at the British International Motor Show held at the NEC at the end of October, and went on sale at £88,707, fitting into a line-up that ranged in price from £16,156 to £89,666. Not long after, though, the cost of SL motoring increased to between £53,200 and £96,400, perhaps to make the new cars going online look more reasonable.



The Detroit Show car with the forerunner of the panorama roof.

Rather surprisingly, *Autocar & Motor's* Peter Robinson wasn't all that impressed by the new V12 car. He noted that the extra weight up front was immediately apparent in the driving dynamics, making itself felt both in the steering and in the braking. And the harder spring rates also made the ride a tad harsher than the 500SL on certain surfaces, which didn't help endear the big SL to the veteran tester: "First impressions are of a lazy, opulent car that's far removed from a traditionally agile and responsive two-seater."

As the 600SL was given its head, however, it seemed to lighten up, and Robinson conceded: "A full-throttle kickdown and the Merc seemingly sheds 500kg as the speedo and tacho needles climb inexorably. It doesn't feel all that fast, because the engine note barely changes above a rather sombre rumble, but the rate of acceleration is prodigious. Any clumsiness vanishes and the 600SL becomes lithe, energetic and crushingly quick. The contrast in character is as extraordinary as it is welcome."

He added: "Directional stability is undeniably brilliant; composure is rock-solid, safe and utterly civilized. There's nothing dramatic about the way the 600SL performs – just blistering mid-range urge that

doesn't let up below 140mph."

A top speed of 159mph (254kph) was recorded at the Millbrook testing facility, and the 0-60 and standing-quarter sprints dismissed in 6.0 and 14.5 seconds, respectively. In summary, though, the *Autocar & Motor* team was not swayed by the appeal of the silky V12: "For £20,000 less, the 500SL is quicker in real life, more economical and a better car. The reasons are manifold, and in truth, unimportant to the 20 people a day who will buy this car and have stretched the waiting list to 1995."

500SL Special Loan and Leasing

メルセデス・ベンツ日本株式会社
メルセデス・ベンツファイナンス株式会社

500SLの誘惑が始まった。
500SLスペシャルローン&リース実施中

ただ目的地へ移動するだけでなく、暖かくなった日差しに、つい高鳴ってしまうドライバーのスポーツマインドにきちんと応え、心地よい風を顔に送る。そんな、スポーツカーならではの性能が、メルセデス・ベンツ500SLには備わっています。V8、5.6エンジンが生き力強い走り。緊急時には、わずかに3秒で作動するオートマチック・ロールオーバーが実現した、美しいフォルムと安全性の統合。世界中の人々を魅了してきたメルセデスのロードスターが、いよいよこの春、誰よりもドライバーズシートを愛するあなたに向かって、走り始めます。

より多くの方に、そのパフォーマンスと時代を超えた楽しさを実感していただくために、4月30日まで、500SL(92年モデル)3.5%スペシャルローンを実施します。

お支払い例(ローン対象金額800万円、60回払いの場合)		
実買年率	3.5%	6.9%
月々のお支払い額(59回)	78,800円	91,300円
ローンお支払い総額	8,732,000円	9,481,600円
6.9%通常ローンとの差額	749,600円	

500SL(92年モデル)の特別価格 ¥16,300,000

月々350,000円でオーナーに、4月30日まで、安心してご利用いただける500SL(92年モデル)特別リースプログラムをご用意しました。●適用車種:500SL(92年モデル)●リースシステム:ファイナンス・リース、クローズド・エンド方式●リース期間:36ヶ月●月額リース料:350,000円(任意保険料、消費税3%は含まれておりません)

Mercedes-Benz

詳しいお問い合わせは、メルセデス・ベンツファイナンス株式会社(03-3437-0957)または、正規販売店ヤナセネットワーク、シュテルンネットワークへどうぞ。

Japanese advertising for the 500SL, this piece dating from early 1993.

In spite of the high price, however, the 600SL, which averaged around 16mpg in daily use, had no shortage of fans. Alice Fowler wrote for the *Daily Mail*: "It's an absolute dream to drive – so smooth and powerful, it quite takes one's breath away. It's like kicking Aldaniti in the ribs after spending all one's life on nothing more than an aged Shetland pony."

Writing for *Classic Cars*, Ian Fraser was another left in awe of the power-unit: "At times the engine was so unobtrusive that it was hard to believe that it was still running – until I jabbed the accelerator, that is, and experienced the silken surge of power that was always available through the four-speed automatic gearbox."

Ex-F1 driver Perry McCarthy also fell for the V12 car: "The Mercedes-Benz 600SL subtly conveys an image of success, importance and style on behalf of itself *and* its driver. Naturally, I loved every bit of it."

Meanwhile, in a three-way test that brought together the 500SL, Jaguar XJS Convertible V12 and Aston Martin Virage Volante, Car quickly dropped the hugely expensive Aston in the final choice. It concluded: "We're looking for that special contentment when all rational thoughts about value fly out of the open cockpit. The Jaguar is a fine car, but we pick the 500SL. It fills its brief so comprehensively. It's practical, safe and durable, but it's also fast, handles well and is beautifully wrought. It would be the best long-term ownership proposition and, in the meantime, it's a joy both to drive and to behold."

A new designation

The Mercedes vehicle designation system was changed after the W202 C-Class replaced the 190 in May 1993. Soon after, the W124 series became officially recognized as the E-Class, and the renumbering of the S-Class model also fell into line with the new thinking. Not surprisingly, the roadster line followed suit, so after four decades of having the 'SL' moniker as a suffix, from July 1993 onwards, the model designation was officially changed to show the vehicle class listed first, followed by the engine size. As such, the 500SL became the SL500, and so on ...

At the same time, the chance was taken to introduce two new dohc 24v M104 series straight-sixes of 2.8- and 3.2-litre capacity to replace the existing six-cylinder engines in the SL line-up. The 2.8-litre engine had already been used in the W124 and S-Class since late-1992, providing the same kind of power as the old M103 unit but giving far superior fuel consumption figures thanks to its variable intake valve

timing, while the larger unit had been in service since the spring of 1991, offering better torque characteristics than the twin-cam three-litre powerplant due to its increased displacement.

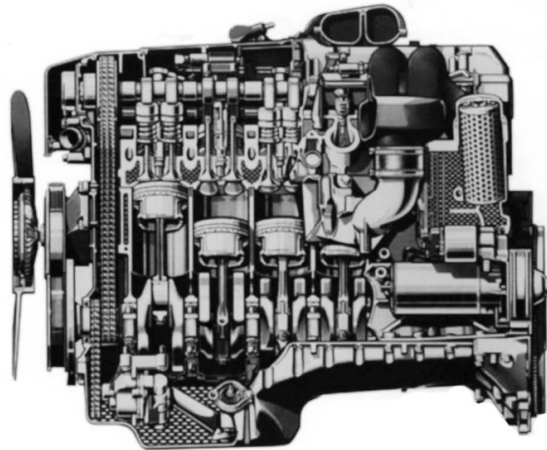

Cut-away drawing of the straight-six used in the SL320, with four valves per cylinder, variable valve timing, Bosch HFM Motronic injection, and a tuned resonance intake manifold made of composite material.

These engines were basically direct developments of the existing 300SL-24 unit, and even looked much the same. The bore was increased from 88.5mm to 89.9mm, and then the stroke was adjusted to give the new capacity – 73.5mm in the case of the 2799cc unit (Type 104.943), and 84.0mm for the 3199cc version (designated Type 104.991).

Both retained the 10.0:1 compression ratio of their predecessor, but came fitted with a new Bosch HFM Motronic fuel-injection system. The 2.8-litre unit pushed out 193bhp at 5500rpm, and 199lbft of torque at 3750rpm – 3bhp and 7lbft more than the old M103 three-litre six could offer, with enhanced emissions and economy as a bonus. The 3.2-litre lump, on the other hand, delivered 231bhp at 5600rpm and 232lbft at 3750rpm – the same power as the M104 three-litre six, but a significant 31lbft more, available from almost 1000rpm lower down the rev-range. This was a perfect scenario for an automatic transmission, which is perhaps a good thing, as only the

SL280 was offered with a manual gearbox.

With gearing and shift pattern carried over from the 300SL to the 1760kg (3872lb) SL280 and from the 300SL-24v to the SL320, official data revealed a 0-60 time of 10.2 seconds for the 2.8-litre machine (the automatic versions were actually slightly quicker, as they didn't have to contend with a 3.92:1 final-drive) and a top speed of 144mph (230kph). Fuel consumption was quoted at 10.5 litres/100km cruising at 56mph (90kph), which was the equivalent of 26.9mpg imperial or 22.4mpg in the States. As expected, the 3.2-litre car was quicker all-round (with 0-60 being dismissed 1.8 seconds faster, and a top speed of 150mph/240kph), but the 10.0 litres/100km economy made it more fuel efficient than the smaller-engined SL! By any stretch of the imagination, 28.2mpg imperial (23.5mpg US) was something to be applauded in a luxury sporting vehicle, let alone one carrying 1780kg (3916lb) around in base trim.

On introduction, the SL280 (5MT) was listed at DM 114,655, with a four-speed automatic transmission (SA code 420) available for DM 2930, or one could opt for a five-speed version (425) at DM 4200. The new SL320 (5AT) was listed at DM 125,925, the SL500 (4AT) at DM 160,310, and the SL600 (4AT) at DM 220,110. Therefore, the SL320 was about DM 5000 more expensive than its predecessor, but this was mainly due to the five-speed automatic gearbox coming as standard on the latter. Only small price increases were applied to the other models.

On the subject of automatic gearboxes, July 1993 witnessed a change to the AT's control pressure cable and vacuum actuators, with numerous parts being standardized to cut production costs. At the same time, stiffer spring link rubber mounts were employed on all cars to improve driving stability (later being standardized with the W202 series), and the 500SL adopted the larger brake discs previously restricted to the six-litre model.





Various shots of the domestic SL320 at the time of its launch, the rear view showing the new badging. The eight-slot wheels were still an option in Germany, by the way.

Although much the same as those listed for the last of the original R129s, it's worth going through the options again properly at this stage. For the domestic 1994 season, ASR traction control (SA code 471) was standard on the SL500 and SL600, but a DM 3780 option on the six-cylinder cars. An ASD differential (211, and only available on the SL280 and SL320) was DM 1875, while adaptive suspension (216) was standard on the SL600, or DM 6470 on lesser grades.

Metallic paint was a no-cost option on the SL500 and SL600, or DM 1580 otherwise. The eight-hole alloy wheels (652) introduced in 1991 were listed at DM 310 for all cars, while all-weather tyres (645) were DM 200 extra. The headlight wash/wipe system (600) was standard on the SL600, or DM 670 on the other models. Tinted and laminated glass options were the same as before (590, 592, 599) with prices ranging from DM 545 to DM 590.

Interior trim colour options were reduced from eight to six on cloth and leather, with the Brazil and Pine Green shades being deleted. The regular leather trim gained new material codes at this time (although the ordering numbers were kept the same), while the cloth upholstery and three Exclusive leather trim options remained unchanged, the latter using exactly the same hide and piping combinations as before.

Leather upholstery was standard on the SL600 or DM 2300 otherwise, with Exclusive leather trim commanding DM 7415 (or DM

5115 on the SL600). Power seats with memory (241/242) were standard on the SL600, or DM 850 a side on other grades. Orthopedic seats (404/405) were priced at DM 595 a side for all cars. Rear seats (565) were available for DM 1735 trimmed in cloth, or DM 2420 in leather. Seat heating (873), which came as standard on the SL600, cost DM 770.

The basic air-conditioning option was gone, leaving only the fully automatic version (581); this was standard on the SL600 or DM 4840 otherwise. Electrical adjustment on the steering column (441) came standard on the V8 and V12 models, but cost DM 970 for the six-cylinder cars. A 'Sportline' leather-wrapped steering wheel (281) was still listed as an NCO on all cars, while cruise control (440) was now standard on all SLs except the SL280, on which it was a DM 685 extra. A trip computer (245) was available at DM 1210, while auxiliary heating (228) added DM 2455 to the invoice.

On the audio front, the latest Mercedes-Benz radio packages, combined with a basic sound system and power aerial, included the Classic RDS (515) at DM 1610, Special RDS (512) at DM 1960, and Exquisite RDS (510, and standard on SL600) at DM 2610. A power aerial supplied without a radio (538) was available at DM 1030, by the way, while a CD changer unit (819) came in at DM 980. The Bose Acoustimass Sound System (810) was listed at DM 1100, which was a lot more than the earlier version – twice the price, in fact.

An alarm/immobilizer (551) was available at DM 965, with remote central locking (880) at DM 1010, and an automatic dimming rearview mirror (249) priced at DM 380, or DM 900 when combined with the mirror memory (246) function (both standard on the SL600). A fire extinguisher (682) was a no-cost option on the SL600 but DM 185 otherwise, while a towbar (550) was DM 1475. There was also an updated and far more reasonably priced telephone system that could be wired into the stereo.

AMG parts were now listed on the official German Mercedes-Benz price list. The six-litre engine conversion on the SL500 (957) was available at DM 29,800, or the exhaust system only (777) could be specified for DM 2050 for all cars. The engine was a beautifully crafted piece, based on the M119, and displacing 5956cc through an

increase in the bore and stroke. With a 10.0:1 compression ratio and KE-Jetronic injection, it delivered a mighty 374bhp and 406lbft of torque. Unlike most aftermarket tuning products, though, those fielded by AMG carried the full factory warranty.

A colour-coded AMG front spoiler, side skirt and rear valance set (772) was DM 7000 for all SLs, with a colour-coded rear spoiler (773) adding a further DM 1500. As for the AMG wheels, there were one-piece alloys for the SL500, with the 8.5J x 17 rims shod with 245/45 tyres combination (SA code 786) listed at DM 12,400 a set, or there was the DM 12,600 option – 8.5J x 17 rims with 235/45 rubber up front, plus 10J x 17 wheels and 255/40 tyres for the rear (787). Split-rim alloys were available for all cars. Two sets were listed: 8.5J x 17 rims with 245/45 tyres (794) at DM 9450 a set, or 8.5J x 17 wheels with 235/45 tyres up front combined with 10J x 17 rims mounted with 255/40 rubber at the rear (795) at DM 9650 a set. It was also possible to specify AMG wheels painted in 199 Blue-Black (779) for DM 620 extra.



Vom Traum zur Wirklichkeit.

Aerodynamikteile, Leichtmetall-Räder, Sportfahrwerke, Auspuffendöpfe, edle Innenausstattungen, Holz/Leder-Lenkräder und vieles mehr in unterschiedlichen Varianten. Für Ihren Mercedes.

D-71364 Winnenden · Linsenhalle 5 · Tel. (07195) 181-0 · Fax (07195) 181-200
D-71332 Waiblingen · Alte Bundesstr. 45 · Tel. (07151) 136-0 · Fax (07151) 136-112
A-5020 Salzburg · Saalachstraße 84 · Tel. (0662) 43 46 17 · Fax (0662) 43 18 90

Lorinser Sportservice
Sportliche Autoausrüstung GmbH

German advertising for the SL, as tuned by the Lorinser concern.

As it happens, September 1993 saw the SL60 AMG listed at DM 194,580 as a turnkey model, complete with 378bhp on tap (as well as 428lbft of torque), and the latest LH-Jetronic fuel-injection system.

Actually, AMG had been displaying complete cars in German

dealerships since mid-1991, but this was the first time the AMG SL had been listed alongside the regular version. However, the price didn't include the distinctive body kit or wheels at this stage, presumably because not all customers wanted to attract the additional attention.

Thomas Bryant of *Road & Track* travelled to Germany to try one, and noted: "Though its top speed is limited to 155mph through an agreement with the German transport ministry, the six-litre V8 is working athletically at speeds near that upper limit, no strain, no sweat. Acceleration to pass other cars is instantaneous. Handling to accomplish lane changes and tackle curves in the road is characterized by vault-like stability. Hour after hour, the AMG Mercedes tracks on, never tiring. Its power is hypnotizing.

"It is a superb everyday exotic. By that I mean a car that you could usefully drive to work, to the concert, to the country club or to the market. It has the drivability and reliability for which Mercedes-Benz and AMG are both famous. It is comfortable, safe and secure. It is fast, it handles well and stops like a boat anchor. All in all, the AMG SL is a prime investment in driving excitement."

Meanwhile, the six-cylinder engines received a new exhaust manifold in January 1994 to promote faster warming-up through improved insulation. At the same time, the air pump was discontinued in many countries to facilitate quicker heating up of the catalytic converter – the faster speed being critical in the efficient control of emissions once an engine is first started. However, the latter wasn't applied to cars destined for use in the USA, Japan, Switzerland, Austria, Sweden, Norway, and Finland.



The 1994 version of the 'Mille Miglia' limited edition, seen here with some of its predecessors from the SL line.

The rubber flange joining the intake manifold and cylinder head was changed to a metal one on the V12 powerplant in March (from engine number 004623). There was also a minor modification to the 722.5 automatic transmission, with a new bore arrangement on the intermediate plate on the shift valve housing, thus improving 'D' engagement quality. Soon after, the gearlever attachment arrangement was revised on manual cars.

March 1994 saw the introduction of a different alarm (SA code 882) offering interior and tow-away protection. Priced at DM 150, it couldn't be combined with the existing alarm. Also new at this time was a smaller, 390mm (15.4in) diameter leather/walnut steering wheel (289) priced at DM 950 for all cars.

Going through the option listing revealed that the automatic gearbox option for the SL280 had gone down in price, with the 4AT unit quoted at DM 2430, and 5AT version at DM 3860. Air-conditioning, power seats, heated seats, the headlight wash/wipe system and alarm were also cheaper, but otherwise everything was carried over. For the record, all seat trim, wood trim and hood options remained the same as those from May 1993. Two-tone paint combinations were also the same, after several earlier changes.

On the AMG side, only the SA 787 one-piece wheel and tyre combination was continued, priced at DM 11,200 (which was less than before), although not available on the SL600. The split-rim

combination was also reduced to one option only – the 795 version, priced at DM 7800. The wheel colouring option was no longer listed, although the various bodywork appendages remained exactly the same.

Midway through the 1994 season (from chassis number 097567), the odometer and trip meter were changed to a digital readout, and around the same time, a small run of ten ‘Mille Miglia’ 500SLs was produced, with Brilliant Silver paint, the eight-slot alloy wheels that were usually an option in Germany, special blue leather trim with contrasting stitching, blue check cloth inlays, dark wood accents, and identifying badges on the front wings and top of the gearlever – the latter carrying the car number (01 to 10). This was the first of many limited edition SLs – the value added package being the marketing tool of the nineties.

In June, the cost of six-cylinder SL motoring went up, with the price of the SL280 and SL320 models increasing by DM 1150, but maybe the jump wasn't so bad after all, as they inherited Electronic Traction Support, or ETS – a basic low-speed traction control system that automatically switched off at 50mph (80kph), minus engine power control, thus leaving the market for the more complex ASR system still open. Notwithstanding, the ASR traction control option (already standard on the V8 and V12 machines) was reduced from DM 3780 to DM 1905 at the same time to make it more attractive, while the ASD option disappeared. There were no other changes whatsoever, as the 1995 season was fast looming ...

The AMG story

The Mercedes brand has always managed to attract the attention of tuning companies, but few are as synonymous with the Stuttgart maker as AMG of Burgstall, Baden-Württemberg, and later Affalterbach, a few miles to the north-east of Stuttgart.

AMG was officially founded in June 1967 by Hans-Werner Aufrecht (who'd worked for Daimler-Benz, and had been in the competition department building engines in the glory days of the 1950s) and Erhard Melcher. For the first ten years of its history, AMG concentrated on engine and suspension development to further its highly-successful

racing programme, but body kits and wheels were added to the firm's catalogue, and ultimately complete cars were built and offered for sale, either in turnkey guise or to the specific requests of customers.

In 1983, AMG developed a four-valve per cylinder head for the V8, leading to signature vehicles like the Hammer, but it also provided the foundation stone for further expansion, not just in Germany, but in places as far afield as America and Japan. The bored-out, six-litre 32v conversion on the five-litre V8, around since 1987, would duly provide enthusiasts with the 500SL 6.0 AMG.

The real breakthrough, however, came in October 1990, when AMG secured a deal in which its tuning parts could be sold and fitted via Mercedes-Benz dealerships, and complete cars started filtering through into domestic showrooms by May 1991. In addition, the racing programme was treated as a partnership, with the works DTM cars being prepared by Aufrecht's company. On the 1st January 1999, DaimlerChrysler bought a 51 per cent stake in AMG, sealing the relationship once and for all with the foundation of Mercedes-AMG GmbH.

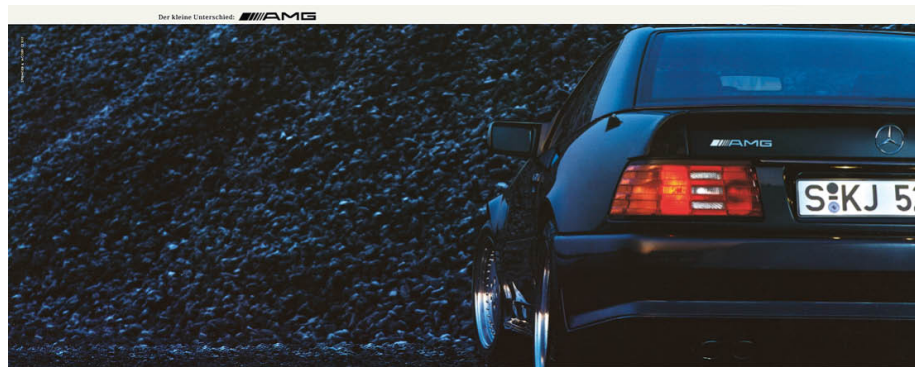

Ein neues Sportabzeichen von Mercedes.

► Wer sich für einen Wagen mit Stern entscheidet, erwartet keine Massenware, sondern einen automobilen Maßanzug. Um auch Ihre ausgefallensten Wünsche erfüllen zu können, haben wir unser Angebot um drei kleine, aber feine Buchstaben erweitert: AMG. Jeder Mercedes, der das neue Sportabzeichen am

Heck trägt, ist ein Produkt der Zusammenarbeit der Sternbauer aus Stuttgart mit den Stern-tunern aus Affalterbach.

Wer sich für Motorsport interessiert, weiß, was AMG bedeutet, denn in der Deutschen Tourenwagenmeisterschaft arbeiten wir seit Jahren erfolgreich zusammen. Und wenn Ihnen

AMG auf der Straße begegnet, dann haben Sie vor sich ein Stück feinstes schwäbischer Maßarbeit.

► Jeder Mercedes kann mit AMG noch mehr auf den Geschmack seines Fahrers zugeschnitten werden. Man hat die Wahl aus einem großen Angebot an leistungsgestützten Motoren, Fahrwerksveränderungen,

Außen- und Innendesign sowie zahlreichen Sonderausstattungen. Damit wird ein AMG-Mercedes immer ein besonders sportlicher, individueller Mercedes.

► Seitdem wir mit AMG zusammenarbeiten, gibt es AMG-Tuning direkt von Mercedes-Benz. Das bedeutet für Sie, daß Sie sich Ihren Mercedes mit dem neuen

Sportabzeichen jetzt wie jeden anderen unserer Wagen auch bei Ihrem Mercedes-Partner bestellen und fix und fertig abholen können. Anstatt wie früher erst auf den Neuwagen und dann noch auf den Umbau zu warten. Und natürlich ist auch dieser Mercedes mit sämtlichen Mercedes-Benz Originalgarantien und dem gesamten

umfassenden Servicepaket ausgestattet. Denn - wie schon gesagt - auch ein AMG-Mercedes ist und bleibt in erster Linie ein Mercedes.



Mercedes-Benz
Ihr gater Stern auf allen Straßen.

Export market review

With the Mercedes line-up ranging in price from \$29,900 to \$133,300 (for the S600 coupé), the US 1994 season started on 26th July 1993 as

far as the SL was concerned, with the launch of the \$85,200 SL320 to replace the 300SL, the \$99,500 SL500 to supercede the 500SL, and the \$120,100 SL600 to take the place of the 600SL.

This equated to a price hike of between \$600 and \$1000 across the range (allowing for the standard 5AT gearbox on the 3.2-litre car), but with the stereo being uprated to the 200W Bose Acoustimass system, the increase was negligible. Also, while the SL320 was \$800 more expensive than its predecessor on paper, thanks to a nine per cent improvement in fuel economy, it escaped Gas Guzzler Tax, actually making it cheaper in reality.

All other leading specifications and options were unchanged, other than those introduced in the domestic market during the year, which included the loss of a manual gearbox for the States, seeing as the SL280 wasn't sold there.



Cover from the American SL catalogue for the 1994 season.

Road & Track tried an SL320 soon after its debut, and noted: “Never mind the wind whistling around your ears or the sunlight glinting off the polished interior; with an endless string of corners rushing into the windshield, your mind is elsewhere. Yet, midway through a tight, uphill right-hander, just as you boot the throttle hard to widen your

line, it dawns on you – this car is so tight, so competent, that you've somehow forgotten this is a convertible.

“Only a few roadsters can manage this trick. These are the kinds of conditions that bring out the worst in most drop-tops, making them creak and groan like a tramp steamer at a wooden pier. When it comes to mating the chassis performance of a coupé with the open-air pleasure of a convertible, few cars can match a Mercedes SL.”

The magazine recorded a 0-60 time of 7.6 seconds, and a 15.7-second standing-quarter – not bad at all for a car that tipped the scales at 1934kg (4255lb) in test trim. Considering this latter figure, the EPA fuel rating of 17/24 seemed more than reasonable, although with gas at \$1.09 a gallon (46 per cent cheaper than Britain at the time), few probably cared that much about the latter statistic.

Like the domestic six-cylinder machines, the US SL320 gained ETS (Electronic Traction Control System) in the middle of 1994, prompting the American distributor to class the cars sold late in the 1994 season to be registered as early 1995 models. An unexpected treat was the \$6900 price reduction on the SL320, and the \$9600 lopped off the cost of an SL500, although those in the market for an SL600 were considered immune to discount tactics. After all, when the price of the V12 machine was almost exactly the cost of the average house at the time, and virtually ten times the average car budget, a couple of thousand here and there was hardly going to make any difference on securing a deal.

Stateside sales had held steady at around the 4800 mark in 1992 and 1993, but jumped to 5919 units for the 1994 calendar year, no doubt pleasing Mercedes-Benz of North America's new President, Michael Basserman.

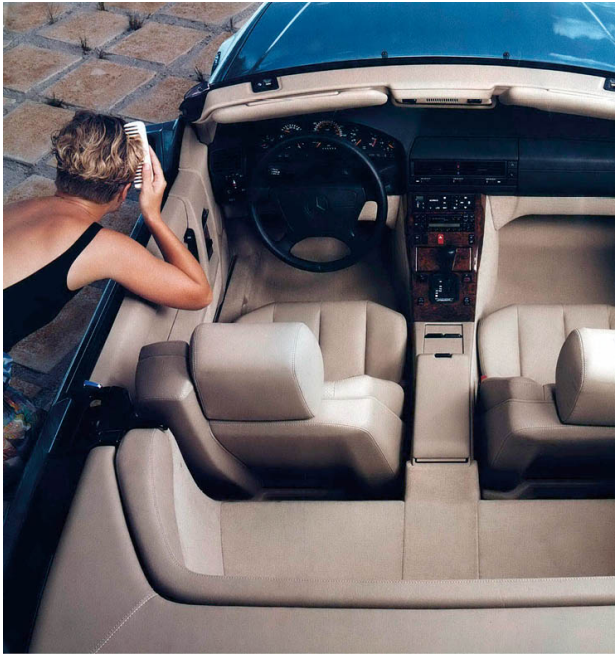

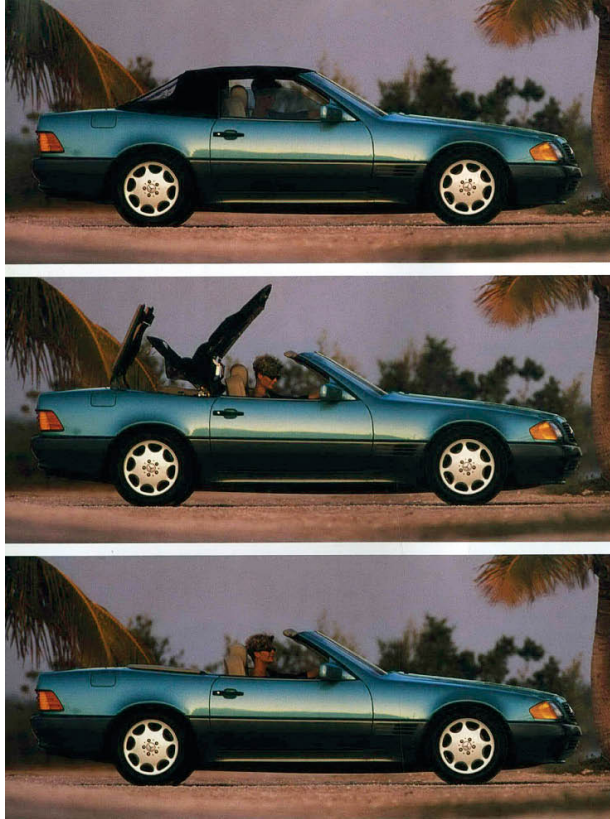

Selected pages from the US 1994 Model Year catalogue, showing the SL from all exterior angles, the interior, and the power soft-top in action.

In Britain, the new engine had little effect on pricing. In fact, the 300SL's £53,200 price-tag was carried over to the SL280, and so on, meaning the SL320 was £58,000, the SL500 was £74,400, and the SL600 commanded £96,400 – just £1000 shy of the contemporary flagship model, the S600 coupé. An automatic gearbox for the 2.8-litre car cost £725, at a time when the cheapest Mercedes in Britain was listed at £17,600.

Most of the news centred on the announcement that Mercedes-Benz UK was going to start importing 15 SL60 AMG models each year. Although it didn't happen straight away, there was a rush of British road tests using the well-known AMG demonstrator, S-LM 9542, as the 1994 season came to an end.

Autocar & Motor observed: "Nobody ever said Mercedes-Benz's most powerful sports car, the SL600, was slow. But there are some

who say there's too much limousine in its nature – and in particular too much nose weight from its gargantuan front-mounted V12 – to allow it the kind of nimbleness keen drivers expect from roadsters with six-figure prices.

“For about the same [money] as an SL600, buyers can now choose an SL60 AMG, a superheated V8-engined SL with even better performance credentials than the V12 and less nose weight, a sportier suspension, lots more rubber – and the single-minded performance image of the factory-approved tuning firm, AMG. The result is a car with true supercar performance, but far greater ease of driving and a more believable promise of longevity than most mid-engined exotic cars.”

Clocking 0-60 in 5.6 seconds, *Top Gear* noted that the SL60 AMG, with its fat 17-inch Bridgestone rubber, wasn't as at ease on British tarmac as it was on the smoother stretches of German and French roads. Nonetheless: “It's the perfect indulgence for storming across Europe in – it makes you believe that the motor car's golden years aren't over yet.”





The SL60 AMG demonstrator that was used extensively by the British motoring press in 1994. In line with the German catalogue, it didn't have a body kit, but did have AMG wheels fitted – the split-rim version seen here (SA code 795) a DM 7800 option.

By the end of the 1994 Model Year, Mercedes-Benz UK had shifted no less than 5217 R129 SLs, but there was still no sign of the AMG car making the British showrooms. It eventually made it across the English Channel in the spring of 1995.

In Japan, prices were reduced for the 1994 season, with the SL500 (lhd or rhd) at 14,000,000 yen, and the left-hand drive only SL600 at 18,200,000 yen; the ultra-expensive AMG car was listed at 25,300,000 yen, which would have bought 15 top-of-the-range Honda Civics.

In Australia, the SL500 was up to \$273,242 in the showrooms, with the SL600 a staggering \$351,705. *Wheels* magazine managed to secure a V12 car for test, and reported: "There might be 180 extra kilos hanging over the front axle compared with the SL500, but in truth it's barely noticeable beyond a slight tendency for the nose to run wider through tight corners. The V12 tracks arrow straight and remains impressively composed through corners, regardless of road surface and conditions."

There was praise for the ADS suspension and a touch of

disappointment in the steering's linearity, but enthusiast drivers would have paid attention to the next few paragraphs of this balanced article: "While the grip is stupendous, the chassis feels curiously numb. Power oversteer is impossible because of the traction control, and the traction control's ability to shut down the fire mid-corner means Benz's chassis engineers have worked hard to eliminate any trace of trailing throttle oversteer as well. The result is a car that's very difficult to balance properly on anything other than Autobahn fast sweepers.

"The awesome onboard computer power allows almost any clod to drive the SL to within 95 per cent of its potential. But perfection engineered to accommodate the lowest common denominator is ultimately extremely frustrating.

"There's no small irony in the cover line on the glossy SL brochure that reads 'Technology For The Future'. If the future is high-tech, computer-controlled cars that are absurdly easy to drive up to a point but offer no reward beyond, then count us out. That wonderfully extravagant V12 rescues the SL from the techno-boredom tomorrow's cleaner, safer, more politically correct cars will inevitably bring. Peel back the roof and go for a speed. It'll be something to tell your great-grandchildren about ... "

メルセデス・ベンツ日本株式会社

風になつたメルセデス。



2011年12月現在、日本国内で最も人気のあるオープンカー。その名は、メルセデス・ベンツの歴史の中で最も輝かしいページの一つに記されています。

速いだけでは十分ではない。美しいだけでは満たされない。私たちは、ロードスターの理想をそう考えます。ニュー・コンセプトメルセデスSL。世界で初めて自動車を使用したメルセデスが、進歩的なまでの命題を課したロードスター。力強い大胆、しかも繊細な造りであるが、機軸は走る性能とメルセデスならではの安全性が共存している。究極的なオープンカー。それは、静かな「ロードスター」までそれぞれのシーンで最高の快適性を発揮できる。そのすべてを高次元で実現しながら、あはれ美しいスタイルを守っている。その一つ一つの対する答えが、V12、V8エンジン、独自のマルチリンクリアアサスペンション、衝撃吸収構造ボディ、危険を感知すると約0.2秒で起き上がるオートマチックロールバー。そして、奇をてらることなく、常に見る者の心を奪ってやまない美しいフォルムに息づいています。メルセデスの思想とテクノロジーに込められたロードスターだけが、走りながら風になる。

Mercedes-Benz

ニュー・コンセプトメルセデス **SL**

メルセデス・ベンツの価格表
 SL500 (5AT) ¥14,000,000 SL600 (4AT) ¥18,200,000
 MERCEDES CALL ☎0120-190-610

1994 Japanese advertising for the SL500.

The 1995 Model Year

The SL line-up for the 1995 season looked most impressive, sporting five distinct models, each offering the driver something a little different. The SL280 was priced at DM 117,875 with a five-speed manual gearbox, the SL320 at DM 129,317 (5AT standard), the SL500 at DM 163,070 (4AT standard), the SL600 at DM 223,330 (4AT standard), and the SL60 AMG at DM 197,915 (4AT standard).

The cost of air-conditioning had increased by DM 85, adaptive suspension went up to DM 6600, while the five-speed automatic transmission for the SL280 was reduced to DM 3635 (oddly, the price of the four-speed AT went up DM 50 at the same time). Leather trim and AMG wheels were also more expensive, but the cost of most other options went up only a fraction if at all.

No new options were listed for 1995, but, tying in with the S-Class facelift revealed at the 1994 Geneva Show a few months earlier, the front indicator lenses became clear units for the domestic market.

Interestingly, cars destined for North America got a different version, which was mainly clear with an amber trailing edge, leading to some clever touching up of photographs for the catalogue. These US-type lights were also adopted in a number of other markets, such as the UK, Japan, Australasia, and South Africa.

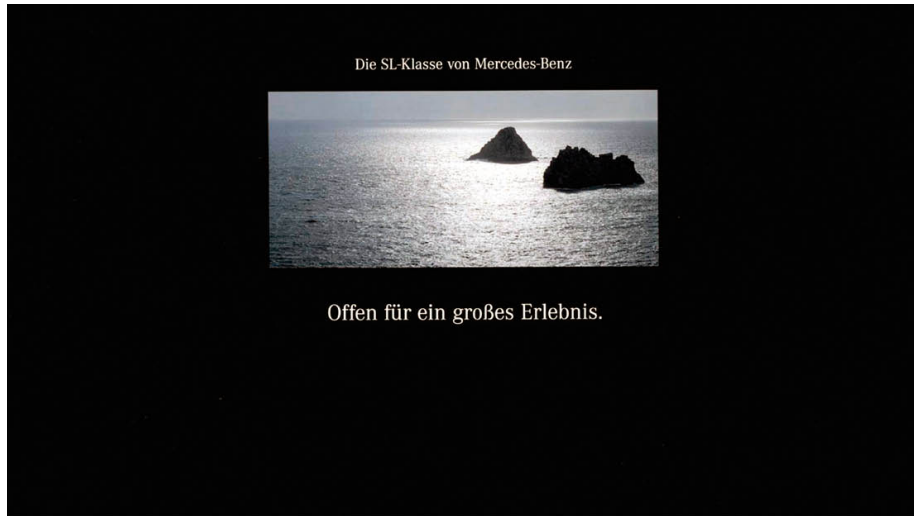



Cover and a couple of pages from the German catalogue for 1995, with the inside pages showing a contemporary SL600 interior (note the new radio design and digital odometer), and the latest indicator lenses used on the domestic market.

October 1994 saw a new fuel pump system adopted, with the earlier double pump arrangement superseded by a Pierburg screw spindle-type pump. The fuel hoses between the pump and filter were changed from steel to flexible pipes at the same time, and two cloth trim options were dropped from the domestic list. Six months later, the steering lock was changed (yet again, as it happens, as this was already the fifth version fitted to the R129), and a simplified roll-over bar control system was introduced to reduce costs and production time.

Meanwhile, the 1995 Geneva Show witnessed the launch of the first global limited edition R129 model – the ‘Mille Miglia’ SL. This was created to commemorate the company’s success on the 1955 Mille Miglia, and rather fittingly, the first one built was presented to Stirling Moss, who duly registered the car SM 7. Based on the SL320 or SL500, the 1995 version of the ‘Mille Miglia’ featured Brilliant Silver paintwork, polished six-spoke alloy wheels, special badges on the front wings, US-style front indicator lenses, black and red two-tone leather upholstery with red stitching, and carbon trim accents replacing the wooden interior components. A total of 630 were built.

At the time the 'Mille Miglia' model was making its debut, there were four cloth options, as well as six regular and three Exclusive leather options (black/medium grey with black piping, mushroom with stone piping, and grey with medium grey piping). Walnut was used for wood trim, as before, and the three familiar hood colour choices were also carried over.

In May 1995, the SL280 (from engine 001165 on MT cars, or 004755 on AT vehicles) and SL320 (from engine 014252) received new intake manifolds with mounting points for an intake noise muffler. In the following month, the clamp connection used on the propshaft of the six-cylinder SLs was changed to a sliding joint, as per the V8 and V12 models.

On the corporate front, Helmut Werner had replaced Werner Niefer as Chairman of the Board of Management in May 1993, but his reign at the top was short-lived, as in May 1995, it was Jürgen Erich Schrempp's turn to head the company, just as the new twin-headlight E-Class (W210) was being released. For the record, Schrempp, who was born in Freiburg in 1944, was still in the Chairman's office when the R230 was launched.

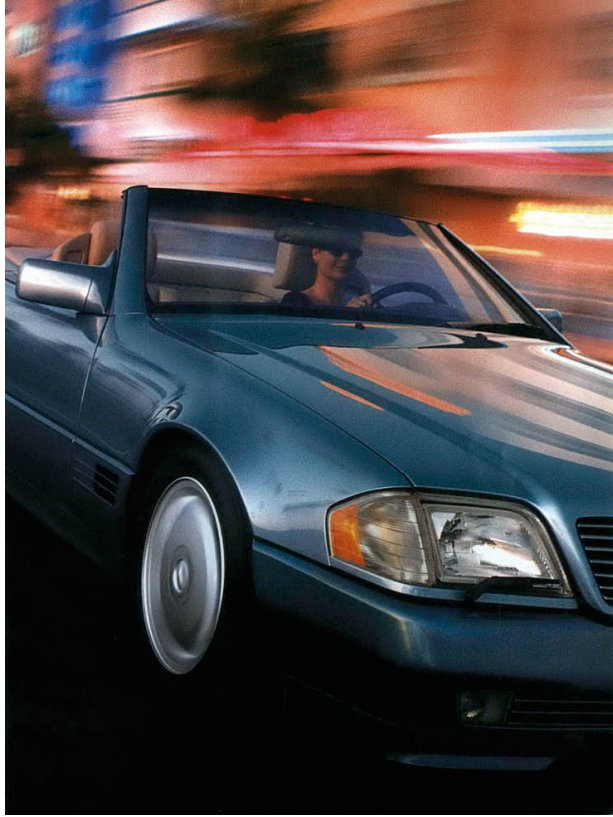

A 1994 US catalogue picture suitably retouched for 1995, with the new style of indicator lens used in the States in clear view.

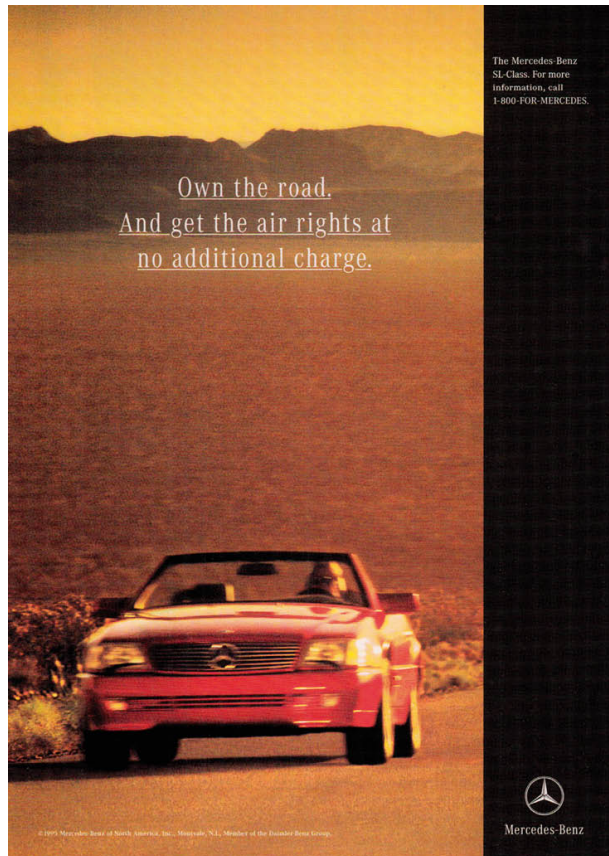

American advertising from 1995.

Moving abroad, there was little to report that hasn't already been mentioned in the States. Indeed, due to the dealers classing the late 1994 models as early 1995 cars (rather than 1994 1/2 MY, as is common practice), specifications and even prices were carried over. The only difference on the SL line was the option of a portable cellphone for the SL600, priced at \$900; the fixed unit remained standard on the V12 car.

Road & Track took an SL600 and put it up against a BMW 850Ci, a Ferrari 456GT and a Jaguar XJS Convertible, also powered by a six-litre V12 by this time, for a touch of cross-country touring on the roads of California. Thomas Bryant noted: "While we can all appreciate the agility and fun of a lightweight sports car, for long-distance travel the hefty Mercedes offers a superior level of comfort and safety."

The SL600 also offered a good level of sensible luggage space for touring, and "first-rate" workmanship inside and out. Bryant summed

this up nicely by saying: "In this business we are often asked what car we would choose if we could have any car in the world. The SL600 grabs a spot on that list."

During 1995, when AMG cars started to appear in the US line-up (but not the SL60 AMG, as it wasn't able to meet emissions regulations), a total of 6964 SLs were sold Stateside, the breakdown including 609 SL600s, plus 2184 SL320s and 4171 SL500s. All told, sales were about 1000 units up on the previous year.

In the meantime, SL prices increased in the UK, and then again in May 1995. This latest hike left the SL280 at £55,600 (an extra £764 being required for an automatic gearbox), the SL320 at £60,700, the SL500 at £77,800, the SL600 at £99,950, and the new SL60 AMG at £89,950. To put things into perspective, for £5000 more than the asking price for the V12 car, one could have secured a Rolls-Royce Silver Spirit!

Japan was still moving in the opposite direction, however, with prices going down by between 800,000 and 1,000,000 yen, depending on the grade – the V12 model got the smallest discount, with the AMG car getting the largest; the SL500 sat in-between, being 900,000 yen cheaper than it was in the previous season. Further south, there was no change in Australia, with the SL500 and SL600 at the same price as 1994 levels.

Wunderbar.

A car can be fast. A car can be stylish. Or comfortable. Or reliable. But it will never be a Mercedes if it isn't first safe.

This view led us to invent many of the safety features you'll find in any modern car.

But none of them, we imagine, are quite as dramatic as the one that you see demonstrated here. The unique roll-over bar on the Mercedes SL.

It comes up in 0.3 of a second should either of the rear wheels leave the road and the car tips over by more than 20°.

This view of safety also led our thinking in the development of the new Mercedes C-class.

By the time it was launched, we'd crashed more than £2m worth of them. (Which might explain why Automotor and Sport magazine found

the C-class to be the safest car they had ever tested for critical head injuries.)

Which just goes to prove what we have always said. The most important feature of any Mercedes is safety. Bar none.

Mercedes-Benz.
 Engineered like no other car.

MERCEDES C-CLASS FROM £19,200 SL SHOWN FROM £35,600 EXCLUDES DELIVERY (JGS UK MAINLAND) AND NUMBER PLATES. PRICES CORRECT AT TIME OF GOING TO PRESS. FOR MORE INFORMATION PHONE 011-544 802 EXT 101 OR WRITE TO 1301 ARCADE HOUSE, 41-55 PERVA ROAD, GATFELD HILL, ESDEN, CO. DER. WE ALSO OFFER FINANCE, INSURANCE AND RENTAL. MERCEDES-BENZ MEMBER OF THE DAIMLER BENZ GROUP.

British advertising from the tail-end of the 1995 season, promoting the safety angle of the SL and Mercedes-Benz cars in general.

メルセデス・ベンツ日本株式会社

コーナーを曲がらば、目の前が開けた。視界が広いの草原。次のコーナーへ、進めたいけれど、すべての物が一年でいばらば、またくねり出す季節。それは、ロードスターの季節。でも、あのガルウイングモデルの最終セリ(理想のロードスター、ニュー・コンセプト)メルセデスSL。先進のテクノロジーと、ロードスターを愛してはならない人々に贈られた走りは、どこまでもダイナミックに、あまほまで美しく、スチアリングを握る者の気持ちを一気に解放。試み、その瞬間、あなたたちは、新境地に到達。それが、ニュー・コンセプトロードスターを、愛する人びとに、愛する人びとに、メルセデスの歴史、刻む理想が込められている。あまほまで、感動しを宿げながら、いばらば、走らつづける。道はどこまでもつづいている。

**ニュー・コンセプト
メルセデス SL**

太陽にいちばん近いメルセデス。

Mercedes-Benz

SL 320 980万円 SL 500 1,310万円 SL 600 1,740万円

メルセデス・ベンツ正規販売店マゼンネットワーク
シユアレンネットワークまでお問い合わせください。 MERCEDES CALL ☎ 0120-190-610

One of the last Japanese adverts released before the facelift.

7

The first facelift

Although the R129 had already had a number of minor changes applied to it, particularly in the export markets, the car's first official facelift was announced in the autumn of 1995, with the 56th Frankfurt Show (held between the 14th and 24th of September) hosting the debut of the revised model ...

While chassis codes were carried over, and only one engine code was changed, the September 1995 facelift was nonetheless a significant milestone in the history of the R129 model. The cars built between late 1995 and the middle of 1998 (when a second facelift was phased in) looked different, with the subtle revisions made to the bodywork providing a definitive clue for vehicle dating that could be readily picked up on.





Front, side and rear views of one of the first facelifted models – this being an SL280 with the optional Xenon headlights, repeater indicators, and third brake light swaged into the bootlid. Note the latest 12-spoke alloy wheel design.

The main exterior changes centred on giving the SL more sporting appeal, as opposed to furthering the suave and sophisticated image it had projected from the time of its announcement.

Of the various components adopted at this time, the front bumper stood out as being the most obvious. The upper face of the panel was deeper, allowing one part to be used for all models again (US V12 models needed a special bumper to meet Federal requirements), a wraparound insert was introduced at number plate level, and the front airdam was slightly lower than the original. This new bumper took the car's overall length to 4499mm (177.1in), but other dimensions were unchanged.

Above the front bumper, the number of slats in the front grille was reduced from seven to six, the wider spacing enhancing the car's sporting image. The intake in the airdam, situated underneath the number plate, was also opened up to match the main grille. As before, foglamps were integrated into the design, placed at either side of the airdam's mouth.

New Xenon headlamps were made available, usually as an option, although some countries listed them as standard on the SL600. Boasting double the candlepower provided by regular halogen bulbs, the Xenon lights had a special level control system to avoid dazzling oncoming drivers. At the same time, the clear indicator units tacked onto the side of the headlights were given more widespread use (domestic cars had employed them in the previous season), although America held onto its 1995 design, and side repeaters, as seen in countries like Britain and Japan, were made available as an option in places that didn't require them by law.





Two views of the facelifted SL500 for the domestic market. One can see that it was possible to combine Xenon headlamps with a wash/wipe system in Germany, although certain markets, like the North American one, didn't allow it.

Moving around the side, a character line was created at the top of the cladding by dropping it down a touch, and the cladding itself was smoother and usually finished in body colour, like the latest bumpers, with no chance to opt for two-tone paintwork after May 1996. Closer inspection revealed the design of the front wing vents had changed, with the three squared slots being replaced by two rounded ones. Also, the side skirts were slightly deeper than before to match the new front airdam depth, while the mirrors were subtly revised, too, having a slightly softer outer edge profile.

At the back, the rear bumper's lines were a touch softer, and with a similar insert to the one used at the front, it looked less bulky as a result. New bichromatic combination lamps were adopted, with a sharper look and red outer lenses rather than amber ones. It was also possible to order the third brake light in the centre of the bootlid in countries where it wasn't already a legal requirement.

Another interesting new option, not available in all countries straight away, but certainly listed in Germany from this time, was the panorama roof, in which the regular hardtop was replaced by one with

a 5mm (0.2in) thick heat-reflecting, tinted glass roof panel and a roller blind to keep out the sun. It will be remembered that a similar roof had been displayed on a concept car displayed at the 1993 Detroit Show, although the home market was the first to receive the chance to buy the elegant component – the Americans had to wait until the 1997 season.



A final selection of early facelift press images, this pair showing the SL600 with the optional 652 alloys. The side view is particularly interesting, as it shows the quite different profile of the panorama roof. Note that the 'V12' badges were retained above the restyled front wing vents.

The facelift was completed from a styling point of view by new 8J x 16 aluminium alloy wheels with 12 delicately sculptured spokes – they were almost as fussy as the original alloys were simple, although the eight-hole wheel (SA code 652) continued as an option in some countries (including Germany) all the way through to June 1998.

Inside, were new seats with rounded edges and an altogether much softer image compared to the Teutonic buckets of the early cars, although they were actually much the same beneath the upholstery. Even the so-called 'multi-contour' seat option was just a new moniker applied to the orthopedic padding of old, but it sounds far more impressive than adjustable lumbar support! Black was now the only cloth option.

There was also a fresh door panel design, with all-new door furniture, polished walnut veneer inlays just beneath the cappings, and the ability to house side airbags, which became standard in all markets for 1996.

To round off the interior upgrade, a new, sporty-looking four-spoke steering wheel was adopted on the six- and eight-cylinder cars, with separate horn buttons on each of the upper spokes. At the same time, the V12 model inherited the leather/walnut steering wheel that had previously been available as option 289. Also, at least on US-spec cars, the ashtray and cigarette lighter was moved to the small covered storage box underneath the bank of centre stack switches, allowing cupholders to be fitted in the console in front of the centre armrest at the cost of losing the cassette storage compartment. Cupholders could usually be specified as an option elsewhere.

The Type M104.943 and M104.991 six-cylinder engines were basically carried over from the previous season, although the V8 and V12 units received a number of modifications – the V8, in particular. Indeed, while the V12 held onto its Type M120.981 moniker, the V8 was given a new M119.982 designation.



The new seat design adopted for the 1996 season.



The revised interior, with new seats and door trim, as well as a new four-spoke steering wheel and gearlever.

The five-litre V8 powerplant continued to sport most of the same leading specifications, with even the maximum power and torque output remaining unchanged, but there were some significant differences, such as a new Bosch ME 1.0 engine management system for controlling the ignition and the Motronic fuel-injection, a new crankshaft, a revised valve control system, lighter pistons, and

individual ignition coils for each cylinder; the six-litre V12 engine gained the new black box and individual coils.

In addition to the V8 and V12 engine modifications, the transmission was also updated for these powerplants, with the old four-speed automatic gearbox being replaced by a new, electronically-controlled five-speed unit with a lock-up clutch on the top three gears. Internal ratios for both cars were 3.59 on first, 2.19 on second, 1.41 on third, 1.00 on fourth, and 0.83 on fifth, combined with a 2.65:1 final-drive.

The earlier 'S' and 'E' mode switch (when fitted, as not all markets had this feature) was replaced by an 'S' and 'W' switch for standard and winter settings – the latter always starting the car off in second gear and shifting up earlier, so it was actually much like the original dual mode setup in reality. This new arrangement, located on the sector gate as before, was seen on all cars worldwide, as was the new gearlever, topped off by a Mercedes-Benz star inlaid into the leather.

The latest five-speed transmission (Type 722.6) was light and compact compared with the majority of 5AT units, and was tied into the engine's ECU, allowing a momentary reduction in torque prior to shifts for smoother progress.

As well as this enhanced refinement, the new SL500 and SL600 drivetrain delivered a seven per cent improvement in fuel consumption, and a 40 per cent reduction in emissions. This was a timely advance, as January 1996 witnessed the beginning of the stricter EURO 2 regulations, with CO emissions having to drop from 2.72g/km to a maximum of 2.20g/km, and NOx levels needed to go from 0.97g/km to 0.50g/km. It also helped reduce Gas Guzzler Tax in the United States.

Another technological advance was the ESP stability programme, first announced in March 1994, but now a standard fitment on the SL600 and an option on the SL500. This system used the ABS sensors to determine the onset of oversteer or understeer, and selectively reduced engine torque or applied one of the rear brakes to bring the car back into control. For enthusiastic drivers, it was possible to cancel ESP via a dash-mounted rocker switch.

The home market

The September 1995 price list quoted the manual SL280 at DM 122,475, with a 4AT gearbox adding DM 2785, or the 5AT unit could be specified for an extra DM 1155 on top of that. The SL320, with the older five-speed automatic as standard, was listed at DM 133,917, while the SL500, with the latest 5AT gearbox, came with a DM 167,670 sticker price. This meant that exactly DM 4600 had been added to cost of the sixes and regular V8 model.

Meanwhile, being listed at DM 223,330, the cost of the V12 SL600 was unchanged, although there was a big jump of around DM 20,000 on the price of the AMG car. This is because the SL60 AMG, commanding DM 217,465 at the start of the 1996 season, now came with a full AMG body kit and 18-inch wheels as standard. As such, the 652 alloy wheel option was no longer available on the AMG machine.

Fully automatic air-conditioning was now part of the package on all SLs, as standardizing a specification ultimately saved the difference in cost on installing a cheaper heating unit. Similarly, remote control central locking (with the sensor moved to the rearview mirror and new measures to stop thieves 'code grabbing' as owners opened or locked their vehicle) and a power aerial were added to the spec sheet, and the window glass became tinted and laminated on all cars, also in the name of standardization.

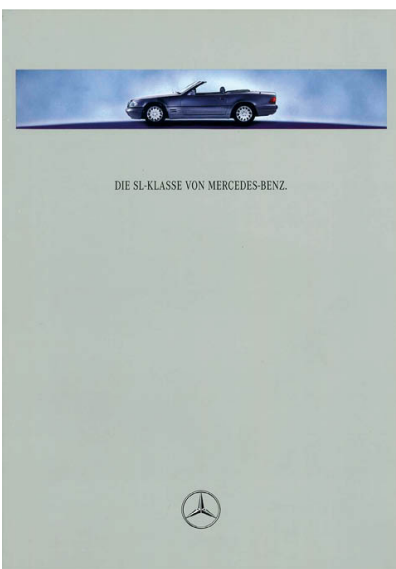

Die S-Klasse

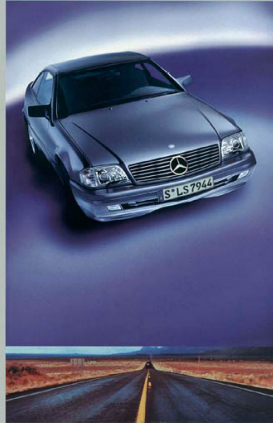

Ob breit oder schmal, gerad
oder leicht, genau oder sanft
die S, das ist jeder Straße gut.

6

Die S-Klasse

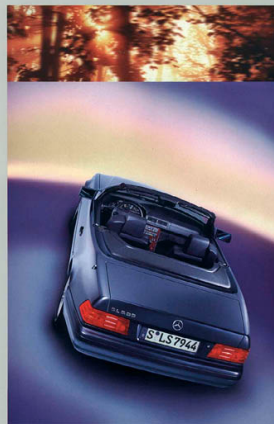

Die Funktionen der S werden für sich selbst
sowie für Autos der Klasse überlassen.
Aber die S-Klasse verbindet.

7

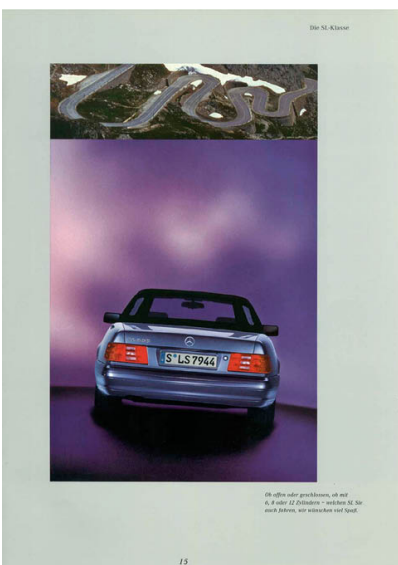

Cover and selected pages from the domestic catalogue issued in September 1995.

The adaptive suspension (ADS) changed its option code from 216 to 214 after a subtle revision, but it was still DM 6600, or standard on the SL600. The ASR traction control system (471) was much cheaper than before at DM 1200, but no longer listed against the SL600, as ESP took its place on the spec sheet, even though its features built on the ASR's hardware.

New options for all cars included the panorama roof (SA code 415) at DM 4700, repeater indicator lights (341) at DM 60, a third brake light (340) at DM 75, and cupholders (309) as an NCO. In addition, the special walnut/leather gearlever was still standard on the SL600, but became an option for all cars at this time (SA code 284), priced at DM 285. Matched with the 289 steering wheel, one could now make any SL interior look like that of the V12. Xenon headlights (612) were priced at DM 1550 (or DM 990 on the SL600), while ESP (472) was DM 1500 for the five-litre car.

Audio options were cheaper than before, and changes were made to the carphone line-ups. The stereo could now be hooked up to a new 533 six-speaker outfit, at DM 830 (standard on the SL600), or the existing 810 sound system.

As for the AMG components, oddly, the rear spoiler (773) was no

longer listed, along with the exhaust system (777), but at least the 772 body kit (standard on the SL60 AMG) was still available on all models.



The AMG body kit on a 1996 model and the latest 793 AMG two-piece alloy wheels.



A Designo interior with carbonfibre trim accents, although clients were often more likely to simply specify their own combination of two-tone leather upholstery and the like. This level of individualization was similar to the Porsche Exclusive programme. This V12 car also has a trip computer, lumbar support, auxiliary heating, a mobile phone, and fire extinguisher fitted. Note the air-conditioning controls, which would change in the near future.



The price of the SL60 AMG increased to DM 219,190 in March 1996. Note the beefy exhaust system and badging on the AMG machine.

On the AMG wheel front, the 17-inch alloys were gone. New split-rim wheels measuring 8.5J x 18 shod with 245/40 ZR rubber up front, and 10J x 18 rims mounted with 275/35 tyres for the rear made up the 783 option, priced at DM 12,100 for the SL280, SL320 and SL500, or DM 3450 for the AMG model. The same sizes were used for the similar-looking two-piece 793 option, which was DM 8650 for the SL280, SL320 and SL500, but came as standard on the AMG car.

The brake pipes were modified almost as soon as the facelifted cars started rolling off the line, and a new fuel sender unit assembly was adopted in October. Still on the subject of modifications, but from a rather different angle, in the following month, the first Designo consulting centre was opened at the Sindelfingen plant, with five more centres being planned for Germany.

The price of the SL60 AMG went up to DM 219,190 in March 1996, but the big news came three months later when the six-cylinder cars adopted the ME 2.1 engine management system and the Type 722.6 five-speed automatic gearbox already in service in the V8 and V12 models (optional on the SL280, and standard on the SL320).

The new cars benefited from a new pressure feed valve added on the 722.6 five-speed unit to improve third to second downshift quality (from transmission number 0027083). Both sixes shared internal ratios of 3.93 on first, 2.41 on second, 1.49 on third, 1.00 on fourth, and 0.83 on fifth. However, the SL280 had a 3.67:1 final-drive, while the SL320 had a 3.45:1 one.

Cruise control was included with the new transmission, and with the end of the old 4AT and 5AT units, this was the only option available for the SL280 (SA code 423, priced at DM 2990). At the same time, ASR traction control, already part of the SL500 package, became newly standard on the SL280 and SL320 models, while the newer ESP version (previously optional on the SL500 and standard on the SL600) became a fresh option for the six-cylinder cars.

There were some minor changes made to some telephone and mirror options, and the control module for the automatic air-conditioning was replaced by a new version featuring redesigned pushbutton controls and a larger, more modern LCD display panel, but that was about it for the 1996 season.

It should be noted, however, that Professor Hartmut Weule retired as the head of R&D in 1996, handing the reins to Klaus-Dieter Vöhringer, who would continue to hold this position until well after the R129's replacement had been launched.

The new car abroad

The first major facelift took place just in time for the US 1996 Model Year. Naturally, the American-spec cars inherited most of the revisions applied to domestic vehicles, but there were also a few market specific changes, and a few things – like the front indicator lens units – that remained the same in order to meet Federal regulations.

Prices were carried over on the SL320 (\$78,300) and SL500 (\$89,900), although there was a small increase applied to the SL600, now retailing at a cool \$122,000, but with ESP as standard. All cars had a five-speed automatic transmission, although, as per Germany and elsewhere, only the V8 and V12 models had the all-new 5AT initially.

The latest adaptive damping suspension system was adopted as standard on the SL600, and was available as a \$4260 option on the other models. The US version of ADS was now basically the same as the German one, featuring manual car height adjustment for the first time. Also standard on the six-litre car were the gas-discharge Xenon headlights, although this meant losing the headlamp wash/wipe system, as the two couldn't be combined in the States. Again, this feature was listed as an option on the SL320 and SL500, priced at \$950.

Other options included heated seats for the SL320 and SL500 at \$595, multi-contour seats at \$380 a side, ASR traction control for the SL320 at \$1200, and ESP for the SL500 at \$1870, to upgrade the ASR supplied as standard.

Aping the S600, US-bound SL600s for 1996 now came with two-tone Exclusive leather seat trim, the upper and lower insert being in a different shade to the side bolsters and headrest. Even more than the ESP traction control and stability programme, this was probably the reason for the V12 car's \$1900 price hike compared to the previous season.

Metallic paint was an NCO on all cars, while a portable mobile phone was listed for the SL600 at \$930 – a fixed unit was still fitted as standard on the V12 model, and either phone package could be ordered as a dealer-fitted accessory for the other SLs, along with the CD changer already fitted to the SL600.

Interestingly, the US cars for 1996 had grey secondary kph speedometer markings rather than the orange ones used earlier (scientific research has shown that eyes are attracted to orange, but visual priority was required on the mph calibrations), cupholders were standard (not surprising in the States), and at last, floormats were supplied as part of the SL package rather than a \$100 accessory.



British advertising from the spring of 1996 for the W210 E-Class, linking it to the SLR racer of the past. Mercedes-Benz has always made good use of its heritage in marketing.

OBD, or onboard diagnostic systems, can help with accurate troubleshooting, keeping emissions levels spot-on, and aid meaningful vehicle testing. A basic version had been fitted to California cars virtually since the start of R129 production. However, all US cars had to have it by the 1996 season (the enhanced OBD-II system), with Europe following suit in 2001.

In an all-out performance test, *Road & Track* found that compared

with the Porsche 911 Turbo and Dodge Viper GTS, the "... SL600 was a few seconds off the pace, although it hardly embarrassed itself, what with its fluid V12 power and almost imperceptible automatic gearshifts. Consider that for all its casual ease, it nevertheless posted a better 0-100-0 time than the [Chevrolet] Corvette LT4."

Sales of Mercedes passenger vehicles in the States rose as a whole from 76,752 units in 1995, to 90,844 in 1996 (a fair chunk of the annual car production total of 645,156 units). However, the SL line only managed to hold steady, with a slight drop of 108 units recorded. Still, SL sales (including 680 six-litre models and around 3500 five-litre machines) accounted for 7.6 per cent of the market share, which can't be bad for a luxury sports car sold within a wide-ranging line-up.

In Great Britain, the price of the three 'cheaper' models increased by a touch, with the updated SL280 commanding £55,950, the SL320 £61,250, and the SL500 £78,950. The AMG car remained the same, though, at £89,950, as did the flagship V12 model, which was listed at £99,950.

Japan's SL500, SL600 and SL60 AMG also had their prices carried over from the previous season, but new for 1996 was the SL320, introduced at 9,800,000 yen. Sold in left-hand drive guise only (albeit odd for a country with a road network much the same as Britain's), it cost 3,300,000 yen less than the SL500. As it happens, Australia's distributors also decided to try a smaller-engined SL at this time, adding the \$199,700 SL280 to the price list, augmenting the \$284,900 SL500 and \$366,100 SL600. However, time was running out for the SL Down Under.

The SLK

In much the same way as the 190SL was a baby brother to the 300SL, with little more than the Sport Licht name linking the two, the R129 SL was joined by a modern interpretation of the Type W121 halfway through its 12-year run – the SLK, with the 'K' in the moniker standing for Kurz, implying that this was a shortened version of the SL. In fact, the new car (Type R170) was smaller all-round compared to its R129 brethren, both in terms of overall size and engine capacity.

The two-seater SLK made its first appearance as a concept car at the

Turin Show at the end of April 1994. Developed under Dieter Futschik on a C-Class platform, Bruno Sacco and his men had a free hand on design details – production considerations that numb creativity don't have to be taken into account on concept cars, so at this time, the vehicle didn't even have a roof.

A second concept was displayed at the 1994 Paris Salon, this time featuring the distinctive power-operated 'vario' steel folding roof, which took about 25 seconds to open or close. Although there was still work to do on the styling, the basics were in place, with the roll-over hoops behind the seats becoming another signature SLK feature.

Finally, the showroom version took a bow at the 1996 Turin Show, which opened on the 25th of April, with full-scale production beginning a few months later in September. Most of the concept car's spirit was left intact, with only the lighting units at both ends being toned down to any great extent. Interior space was impressive for such a small machine, thanks to the application of the latest safety technology.

Power was provided by a normally-aspirated 136bhp two-litre four or a 193bhp supercharged 2.3-litre version, while certain markets, such as Italy, had a supercharged two-litre engine to overcome tax issues. One could choose a five-speed manual gearbox or a five-speed automatic transmission with any of these power-units.

Prices started at DM 52,900 on introduction in Germany, with the 2.3-litre car eventually going on sale in the States in January 1997. The 5MT gearbox wasn't available in America straight away, but filtered through in time for the 1999 season, by which time, the US market had introduced a 'Sport' version fitted with an AMG body kit and wheels as well.



Scale models showing some of the styling proposals for the R170 SLK.



An early two-litre, normally-aspirated SLK. This was the entry-level model at the time of the SLK's launch.

The car was treated to a minor facelift for 2000, with the updated styling aping the revisions made to the SL. Having been first presented at the Detroit Show, full-scale production started in February 2000, with SLK200 Kompressor and SLK230 Kompressor models listed in Germany (the two-litre NA unit was dropped), along with a 218bhp V6-engined SLK320. Transmissions were now either 6MT or 5AT units.

The 2001 Detroit Show marked the debut of the SLK32 AMG, powered by a supercharged version of the V6 pumping out 354bhp. Capable of dismissing 0-60 in 5.2 seconds, it came with a tuned five-speed 'SpeedShift' automatic gearbox, a full body kit and uprated chassis components.

The original SLK was duly replaced by the all-new R171 series that had made its debut at the 2004 Geneva Show, its Vision SLR-inspired styling taking the SLK line further upmarket in the process ...



An SLK230 with its folding steel top erected. The folding metal top of the SLK was the perfect compromise for European open car enthusiasts who often have to deal with inclement weather.



An SLK on display at the 2004 San Jose Show, a couple of months before the R171 series was introduced.



British advertising for the facelifted SLK, introduced at the start of 2000.

The 1997 season

In September 1996, the upholstery trim moved over from the 071/271/571 series to the 061/261/561 series, meaning new trim

codes, with new material numbers across the board. Only one cloth option was listed, with six regular and three Exclusive leather options. Walnut was used for wood trim, as before, and the three familiar hood colour choices were also carried over.

Other than this and the adoption of a black boot plinth to replace the old chrome one, nothing much was happening on the domestic front after so many changes brought in during the previous season, although November 1996 witnessed the announcement of Brake Assist (BAS), the system calculating and applying maximum possible braking pressure in a split second if an emergency stop situation was detected. Combined with ABS, it significantly reduced braking distances, and became standard on the SL and S-Class a month later.

In March 1997, the price of the SL280, SL320 and SL500 went up by about DM 1700, although the cost of the SL600 and SL60 AMG were unchanged, as were the price of options, which hadn't really moved since the 1995 season. By this time, the passenger seat had been modified to take a weight sensor, which duly sent a signal to stop the passenger-side airbag deploying if no-one or a small child was there.

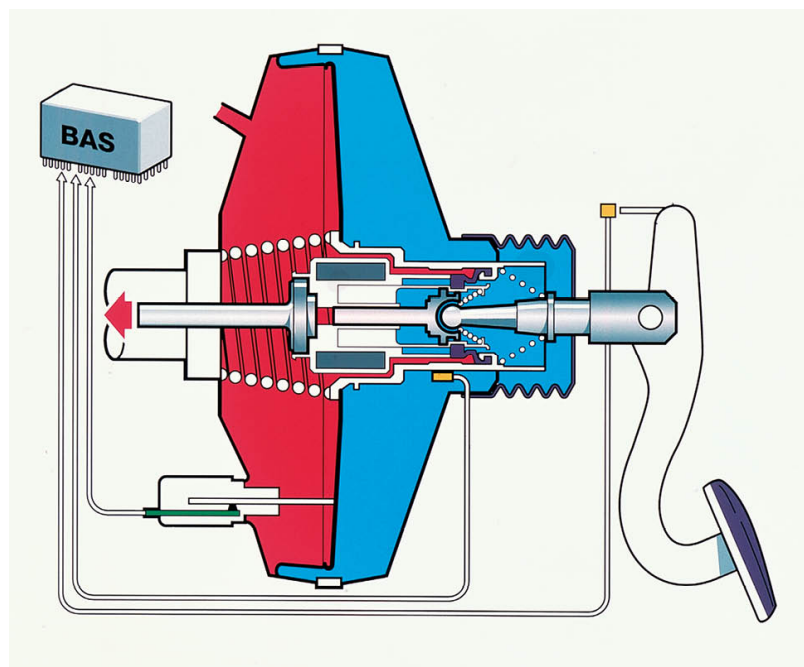

The Brake Assist (BAS) system.

In the following month, a new plant was opened in Bad Cannstatt for the production of the new series of fuel-efficient three valves per cylinder M112 and M113 twin-plug vee-engines that would ultimately go on to replace the straight-sixes and update the existing V8 lines. This environmentally friendly “factory of the future” employed state-of-the-art manufacturing methods to increase capacity. Indeed, the first million units had been built there after just three years!

Back to the SL, and in June 1997, repeater indicator lights became standard in Germany, and a service reminder feature (ASSYST) was added in the revised odometer section at the same time.

Folding power door mirrors (SA code 500) were added to the option list at DM 410 for all cars, along with a new automatic dimming rearview and driver’s-side mirror combination (249) to suit, which was DM 450, although already specified as part of the SL600 package.

On the audio front, the Mercedes-Benz ‘Special’ radio/CD unit (755) was newly added at just DM 180, being an NCO on the SL600. The ‘Exquisite’ unit (510) was still standard on the V12 model, but much cheaper for other cars now, at just DM 680, while the Bose sound system and CD changer continued as before. A CD storage box in the centre console (330) was added at DM 80 for all cars.

In America, with prices ranging from \$80,195 to \$123,795, 1997 cars gained a rain-sensing feature to control the intermittent wiper speed, a transponder key for added security, and a new automatic garage door opener integrated into the rearview mirror. In addition, ASR became standard on the SL320, the panorama roof became available at last (a \$3500 option for all cars), and a new ‘Sport Package’ was put together for US customers. This incorporated an AMG body kit (with a new front airdam, side skirts and rear apron), 18-inch AMG alloys (these SA code 901 rims were basically larger diameter versions of the 787 wheel, in this case being an 8J and 9J combination shod, respectively, with 245/40 and 275/35 rubber), a new gearknob, and ‘Sport’ badges on the front wings.



A 1997 Model Year SL600 with optional eight-slot alloys and conventional German lighting arrangements.

Coackwork colours were quite restricted in the States, being limited to Polar White, Brilliant Silver, Smoke Silver, Moonstone Grey, Black, Black Opal, Brilliant Emerald, Midnight Blue, Azure Blue, imperial Red and Ruby, and the red shade was missing from the leather line-up. Over the next couple of years, however, the palette really evolved for the US market, with the Americans receiving unique hood colour options, too.

Road & Track put an SL500 up against a Jaguar XK8 drophead – Coventry’s new challenger, and a spiritual successor to the E-type, some \$20,000 cheaper than the Stuttgart machine.

The Jaguar was deemed to be sportier in the handling department, but the Benz was faster in a straight line. The test concluded: “If you value the qualities of German solidity, exemplary ergonomics, superior acceleration, and the hard-to-quantify worth of an ingenious convertible top, then the Mercedes-Benz is for you. But we’re mesmerized by the Jaguar’s styling, its warmth, its effortless cruising manners and, above all, its value.”



1997 MERCEDES-BENZ



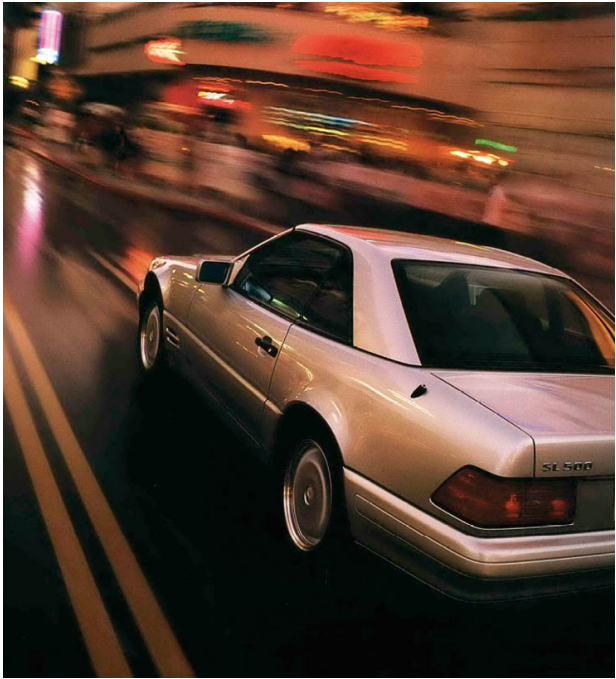
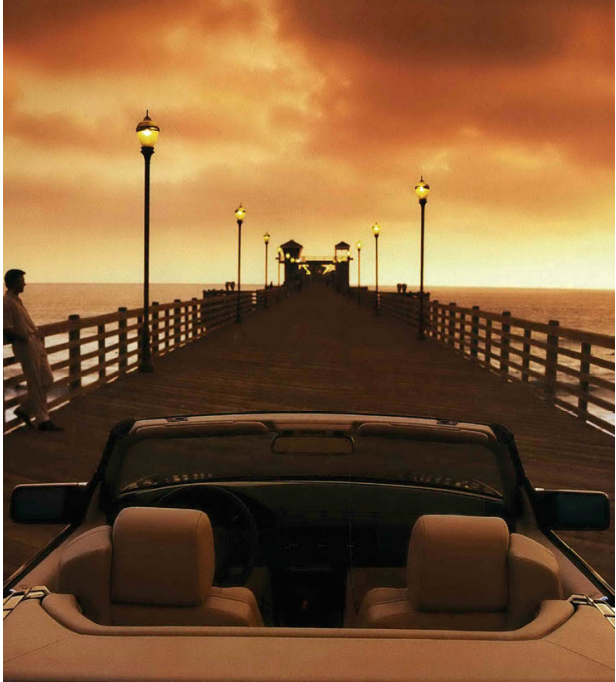

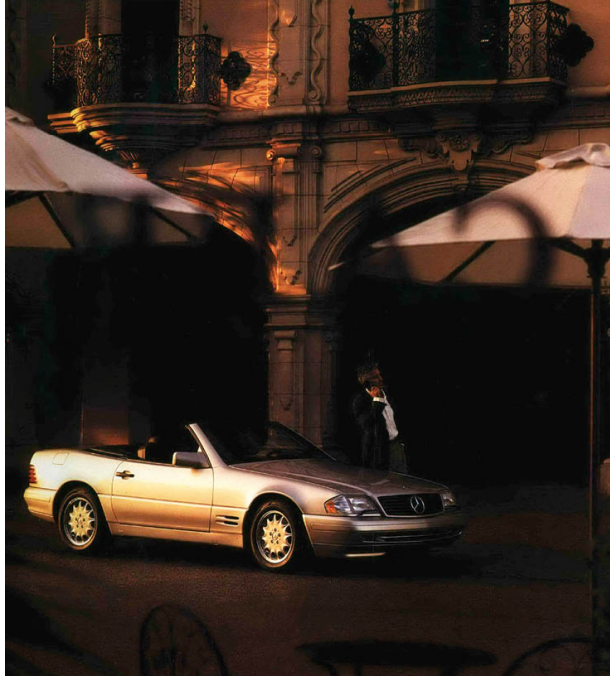

Cover and selected pages from the US catalogue issued for the 1997 season. Note the latest style air-conditioning controls, introduced in Germany during the summer of 1996.

A 40th anniversary roadster

in an automotive world

where there's rarely a 40th

anniversary anything.

Presenting the 40th Anniversary SL500, with its distinctive crimson metallic

paint, special parchment leather, chestnut wood trim, 6-spoke 17" wheels

with larger performance-rated tires, heated seats, and CD changer, all

standard at no additional cost.* Now you can drive a limited edition**

Mercedes-Benz with a 40-year heritage dating back to the legendary 1957

300SL Roadster. For more information, call 1-800-FOR-MERCEDES. The SL Class.



For more details, explore our Web site, <http://www.mercedes.com>. *Special paint, upholstery, and wood trim not available as options on SL Class. Only CD changer and heated seats available as options on SL500. **Only 500 40th Anniversary SL500 produced. SEE DEALER. A SUPPLEMENTAL RESTRAINT SYSTEM, SO REMEMBER AIR BAG SAFETY. ALWAYS WEAR YOUR SEATBELT. ©1997 Mercedes-Benz of North America, Inc., Montclair, NJ, Member of the Daimler-Benz Group.

Advertising for the US-only '40th Anniversary Edition SL' model announced at the 1997 New York Show. On sale from May that year, it commemorated the birth of the 300SL Roadster, with 250 SL320s and 500 SL500s being made available with special paint and trim. The 3.2-litre car had Quartz Blue paintwork combined with a dark blue hood, a grey leather interior and maple wood accents. The five-litre version had Crimson paint, a black soft-top, 17-inch 'Evo II' six-spoke alloy wheels (SA code 649), parchment leather trim and chestnut woodwork. Both cars came with heated seats and a CD changer.

AMG

AMG Mercedes





■AMG SL500 6.0/DOHC V-12/287ps、69.8kg-m ■AMG SL600 6.0/DOHC V-12/440ps、81.2kg-m ■AMG SL600 7.0/DOHC V-12/495ps、73.4kg-m

THE ROADSTER, AMG SL. 風の中を駆け抜けるオープン・エア・モータリングの喜び、ワインディングロードへ心を開かせる走りのハイバランス、純粋にクルマを愉しむロードスターのコンセプトを忠実に貫いた、かつてないスポーツカーの世界。美しくダイナミックに磨かれたスタイリングの中には、丁寧に仕立てられたインテリアがあらため、AMGチューニングテクノロジーの粋をつくしたパフォーマンスがみられます。SL500 6.0、SL600 6.0に加え、496ps/5500rpm、73.4kg-m/3900rpmのパワー&トルクを生み出すSL600 7.0をラインナップ、AMG SL。ステアリングを握るオーナーが手にするのは至福の時です。

P U R E M O T O R I N G P L E A S U R E A M G

本誌掲載の小売価格(車両本体価格/税別)です。
 AMG SL500 6.0: **1,950**万円 AMG SL600 6.0: **2,290**万円 AMG SL600 7.0: **2,700**万円
価格については消費税は別途加算です。本誌の小売価格はあくまでも目安です。価格には納入の異なるオプションや送料、納期、車種ごとの費用は含まれておりません。

AMGメディアについてのお問い合わせは AMGのワンストップ 03-3452-8198 AMGの最新情報がインターネットでいただけます。 <http://www.AMG.co.jp>
 AMGメルセデスAMCの最新情報は 一安心の正規販売網「マツコト」グループ及びジュピタネットグループへ。

総輸入元
AMGジャパン株式会社
 〒105 東京都港区芝浦1丁目2番地
 電話 東京 03-3462-4111(大代表)

AMG advertising from Japan, listing an SL60 AMG, the SL600 with a body kit and chassis upgrades, and a seven-litre version of the V12 car – the SL70 AMG. The SL70 was a new and relatively short-lived AMG variant, the conversion costing DM 81,657, although not listed as an official model in Germany.

Sales really picked up in the States – almost 20,000 units up on the previous year, allowing the US distributor to break the 100,000 unit barrier for the first time ever. No less than 8025 SLs found new owners, with over 5600 being five-litre cars and around 750 being SL600s; the SL320 made up the remainder.

In Britain, where John Major lost the election to Tony Blair, putting Labour in power for the first time since 1979 (despite a distinct shortfall in delivery of election promises, Blair was re-elected for a second term in June 2001), the price of SL motoring was on the rise again, with the regular SL line-up going up by between £2340 and

£3040, while the AMG model shot up to £98,040 – an increase of £8090.

In Japan, the SL320 was priced at 9,700,000 yen for the 1997 season, while the SL500 commanded 12,500,000 yen, the SL600 16,200,000 yen, and the AMG model, a hefty 22,900,000 yen. However, prices were carried over for 1998, as they were in Australia, too, where the SL280 was listed at \$199,700, the SL500 at \$285,200, and the SL600 at \$366,400. The SL600 was the flagship in the Aussie range, which started at just \$52,700 with the C180 model.

Chassis number information

A rough but nonetheless useful guide to the final chassis numbers for each season, plus or minus around 300 units due to the various models in production:

1990 MY to chassis number 014300

1991 MY to chassis number 038400

1992 MY to chassis number 064200

1993 MY to chassis number 085300

1994 MY to chassis number 105000

1995 MY to chassis number 126200

1996 MY to chassis number 140700

1997 MY to chassis number 155300

1998 MY to chassis number 171200

1999 MY to chassis number 188000

The 1998 Model Year

With another facelift about to be announced, and a flurry of activity launching new product lines (including the SLK in mid-1996, and the CLK coupé and M-Class SUV in early 1997), as one would expect, the car was left pretty much the same for 1998. In February, there was a minor change to the wheel carriers, as the bolted connections on the various arms were modified, and a new compressor was adopted for the air-conditioning a couple of months later to give better belt protection and simpler wiring.

December 1997 witnessed the launch of the 500-off 'Special

Edition' model in Germany, with Obsidianschwarz paintwork and a red soft-top – both unique at the time, even though both became available a little while later. AMG wheels were included, as well as special badging, while inside, there was red and black leather upholstery, dark wood trim, a red instrument panel, and purpose-made treadplates and floormats.

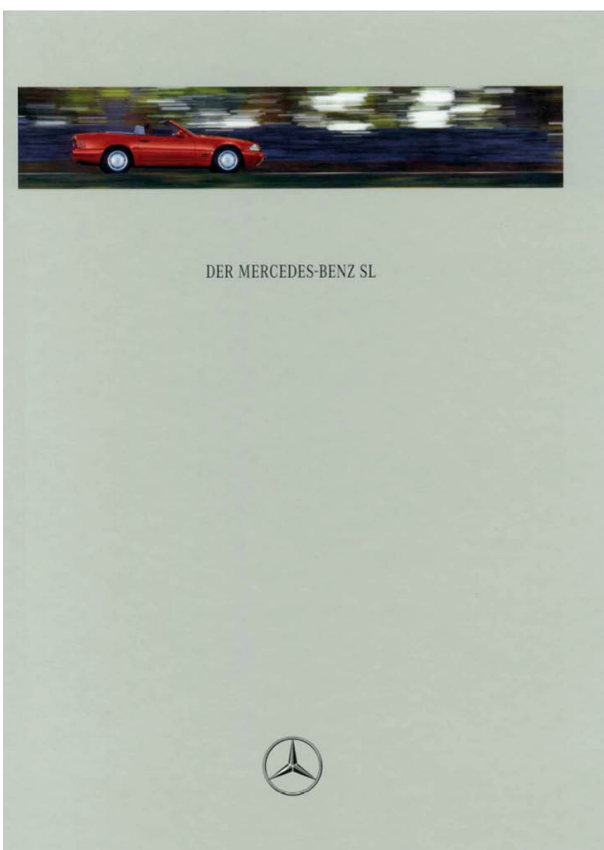



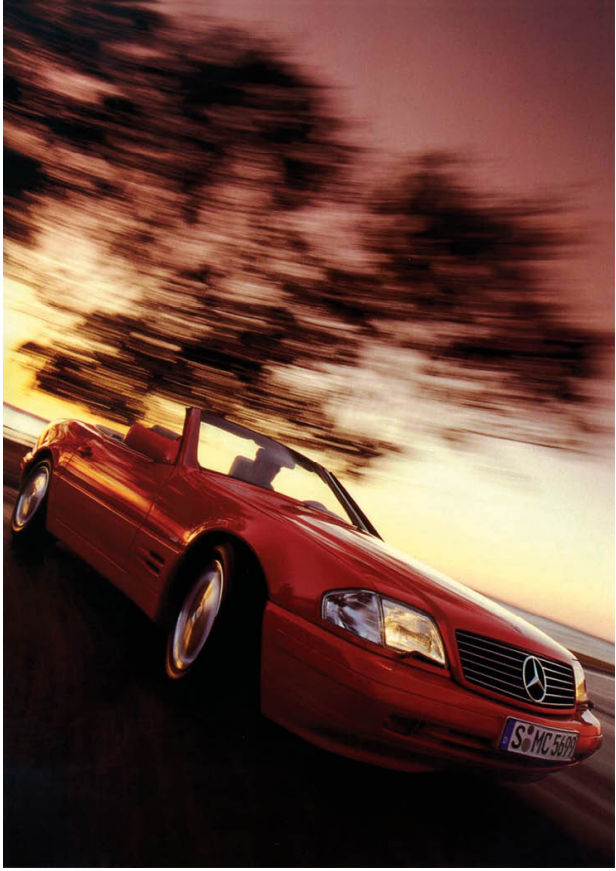

Gesehen von Clint Clemens



*Ob Sonne oder Regen, Sommer
oder Winter – im SL fühlt man sich
bei jedem Klima wohl.*

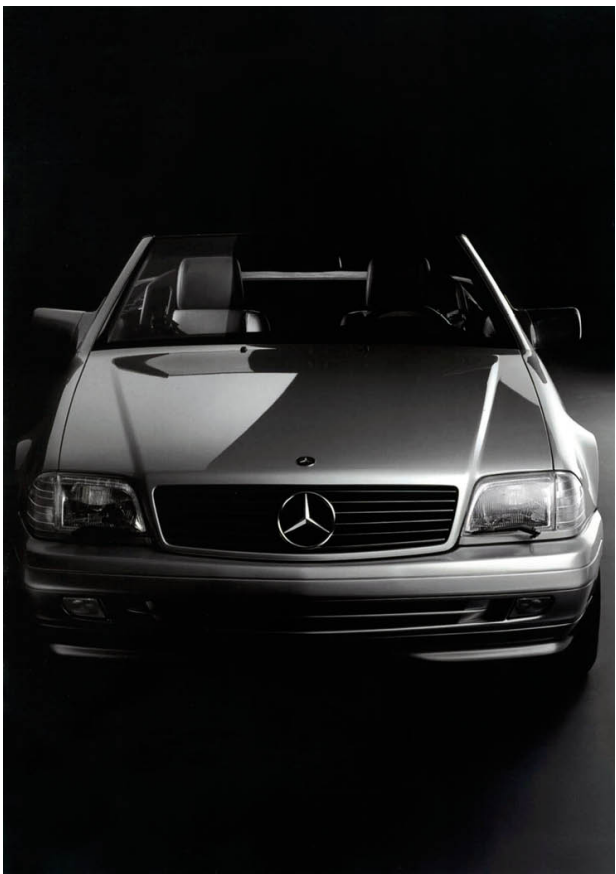



Gesehen von Dietmar Henneke



*Softtop, Hardtop oder Panorama-
Glasdach? Die schönste Entscheidung
ist vermutlich, das Dach einfach
wegzulassen.*



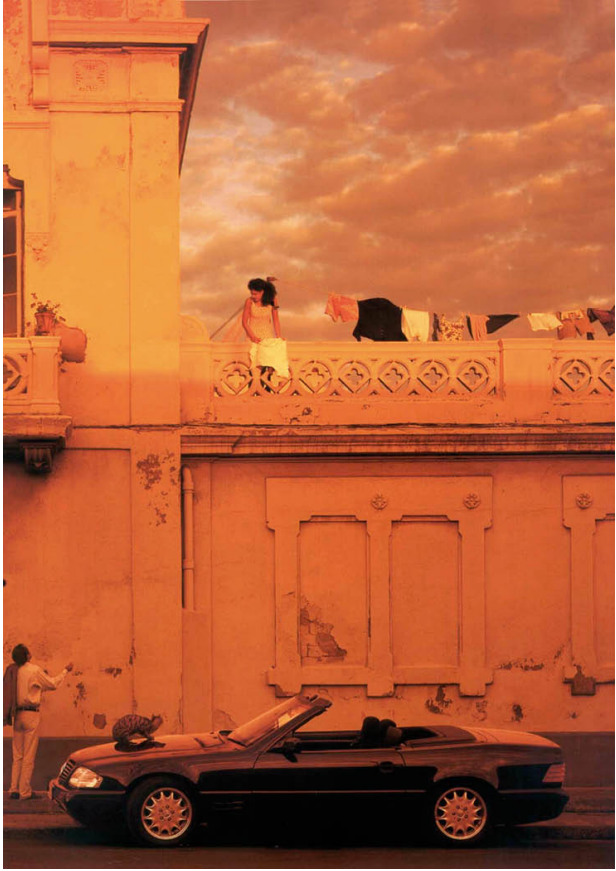



Bei allem Fahrvergnügen bietet der
SL Leistung, Sicherheit und
Komfort auf Mercedes Niveau.

Cover and various pages from the German catalogue of August 1997.
This featured the tasteful photography of Clint Clemens, Dietmar Henneka and Anatol Kotte. Not all of the cars are from the correct era for the brochure, but the pictures are too good to dismiss for that reason.



A press shot of the 'Special Edition' of December 1997, and an SL500 version at the 1998 Geneva Show. All four engine options were available.

In America, the SL line-up was realigned, with the SL320 being dropped and the SL500 given a new \$79,900 sticker price – basically the same as the discontinued six-cylinder car. At the same time, the SL600, now with an electronic brake force distribution (EBD) feature, commanded exactly a quarter-of-a-million dollars; enough to secure six \$39,700 SLK230s.

Options were carried over, with major items including the 'Sport

Package' priced at \$4970, the panorama roof at \$3600, and ESP and ADS for the SL500, listed at \$990 and \$4390, respectively.

SL sales in the States amounted to 7747 units in 1998, including 7173 SL500s and 574 SL600s, although this total included quite a few facelifted models, which started filtering through in the 1999 Model Year, introduced on the 14th September 1998.



In early 1998, an R129 model was used to test a drive-by-wire system with joysticks to control the steering, accelerator and brake. The car now resides in the Mercedes-Benz Museum.

In Britain, 1998 season prices went up by just £50 across the board, meaning the SL line ranged from £58,340 for the SL280 all the way up to £103,040 for the V12 machine. At this time, the cheapest Mercedes sold in the UK was the £16,000 A-Class model, while the flagship was the 600CL, listed at £107,840.

The 150-off SL320 'Designo' model was launched in the UK in 1998, having Vario Blue paintwork, a blue hood, 649 six-spoke alloy wheels, and a grey leather interior. Japan also had a limited edition 'Designo' model for 1998, limited to 67 units, with green paint and a two-tone grey/green interior.

Meanwhile, Daimler-Benz AG and America's Chrysler Corporation announced a merger in May 1998, with approval from shareholders

finally coming through in September. Although now officially DaimlerChrysler AG, Jürgen Schrempp continued in his position as Chairman of the Board of Management, with Bob Eaton by his side as Co-Chairman – the two of them duly bought the first share of the newly combined business from the floor of the New York Stock Exchange on the 17th of November, six months after the merger was first mooted. It was hardly a match made in heaven, though, and the two firms ultimately parted company once and for all in August 2007. Soon after, the Daimler AG name was adopted for the Stuttgart firm ...





Three illustrations from the American brochure for the 1998 season, showing a front three-quarter view of the SL500, and the tail and interior of the SL600. Note the V12 car's two-tone grey leather trim (with perforated inserts being seen for the last time), the 'V12' insignia in the top of the gearlever, and continuation of the older-style steering wheel on the SL600.

8

End of an era

The 67th Turin Show, which opened its doors on the 20th April 1998, was the venue chosen to unveil the second major facelift for the R129 SL. This time, however, the update was centred on the powertrain rather than styling revisions, although, just for good measure, there were a few of those, too ...

The years had been kind to the R129 model – it still looked as fresh as it did back in 1989, and a new line of engines would ensure its survival for a little while longer, at least until the R230 (the chassis code for the R129's replacement, already being bandied around in enthusiast publications) could be made ready. According to contemporary press reports, the launch was scheduled for 2001, and this ultimately turned out to be a good prediction, with the new car duly taking a bow that July.

While the Turin Show finished on the 5th of May, it wasn't until the following month that production of the facelifted SL began at the Bremen factory, the timing being chosen to launch the revised car as a 1999 model in the States, where one in every two R129 models built finally ended up.





Three early press images released to introduce the new car to the public, with the new exterior and interior styling plain to see. The SL320 used was fitted with the 644 alloy wheel option.

New engines

As already mentioned, it was the new engine line-up that spearheaded the changes on the facelifted car. The M104-based straight-sixes were replaced by M112 90-degree V6s, the M119 V8 was superseded by a new M113 unit, and even the M120 V12 lump had a few

modifications applied to it.

The AMG engines were also revised in line with the changes to the range, so the DM 223,648 SL60 AMG was phased out at the end of May, signalling the swansong of the six-litre V8 – a total of 633 SL60 AMGs had been built by this time (164 with the M119.972 engine, and 469 with the M119.872 unit), but there would now be a short hiatus on complete cars carrying the fabled AMG badge.

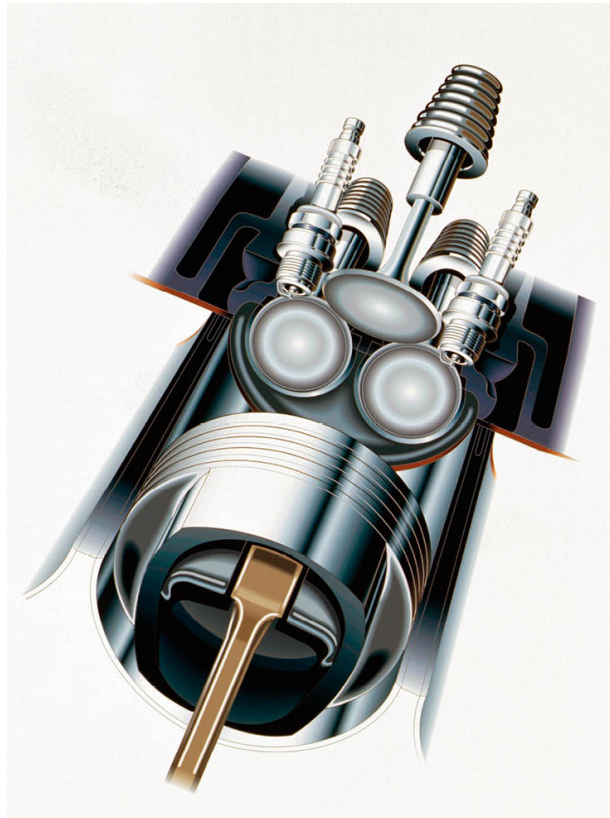

The unusual three-valve per cylinder arrangement of the M112 and M113 engines, with two inlets and a single exhaust valve. Note also the sparkplug location.

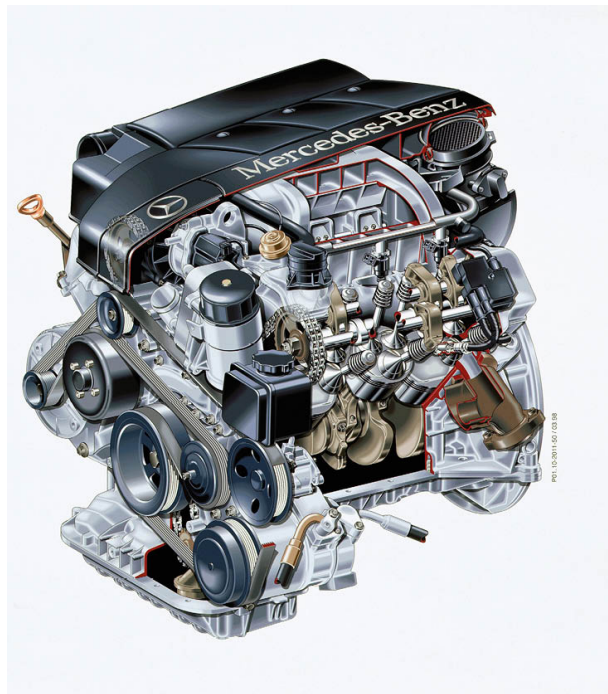

The M112 engine in 2.8-litre S-Class guise.

The M112 V6s, mentioned in the previous chapter, were perhaps the most important, with their all-aluminium alloy construction (rather than the alloy head and cast-iron block arrangement of the straight-sixes) saving a significant amount of weight. In a world first, even the cylinder liners were made of light alloy, with a high silicon content, allowing a good compromise between reducing weight and friction whilst maintaining long-term service and reliability levels.

The M112 units were unusual in having three valves per cylinder instead of four (a single exhaust valve to one side of the combustion chamber, with two smaller inlet valves the other), their operation being designed in such a way as to allow the use of a single overhead camshaft per bank. From a technical standpoint, the single exhaust valve lowered heat loss in the exhaust gases, thus making the catalytic converter heat up quicker and work in its most efficient operating band more of the time.

Another interesting feature was the dual ignition, with two coils and two sparkplugs per cylinder, the plugs being located in a line directly between the exhaust valve and the pair of inlet valves, with one plug to each side of the valve cluster. All told, the new specification

promised a ten per cent fuel saving, faster warm-up times, and significantly lower emissions values.

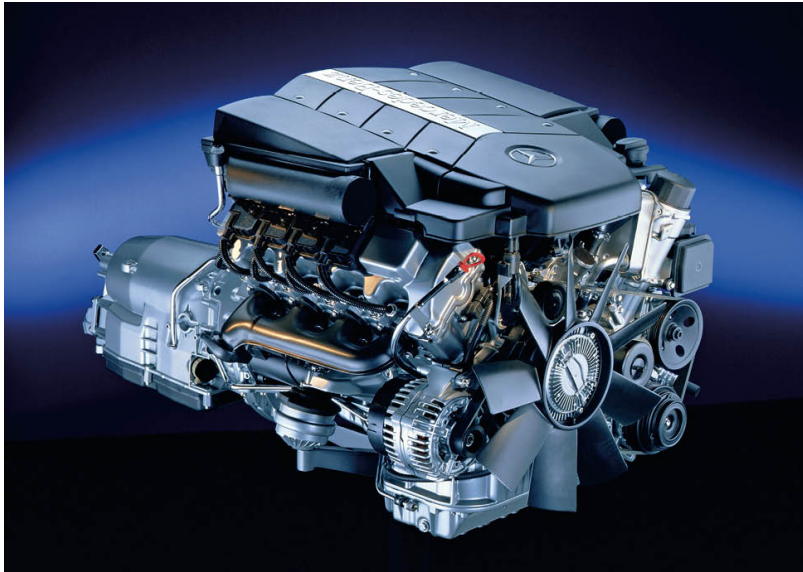

The M113 V8 power-unit.

To enhance engine flexibility, the sequential port fuel-injection took advantage of variable length intake manifold technology, with the manifold structure being cast in magnesium alloy as part of the weight saving programme. Indeed, the intelligent selection of lightweight materials throughout the powerplant made the new V6s 25 per cent lighter than their straight-six predecessors. Although the configuration was quite different, the bore and stroke dimensions were carried over on the 2.8- and 3.2-litre units chosen for use in the SL range, meaning cubic capacities of 2799cc and 3199cc, respectively. Even the 10.0:1 compression ratio was retained on both units, but a balance shaft was something new for the V6, reducing first and second order vibration.

The SL280 engine (Type 112.923) was rated at 204bhp, and delivered 199lbft of torque at 3000rpm. Fuel consumption at a steady 56mph (90kph) was quoted at 8.6 or 8.7 litres/100km depending on the transmission, which is about 32.5mpg imperial, or 27.0mpg in the States. The SL320 unit (Type 112.943) gave similar economy figures at 8.8 litres/100km, but power increased to 224bhp, and maximum torque output rose to 232lbft at 3000rpm.

The all-alloy V8 used in the SL500 (Type 113.961) was basically an M112 unit with two extra cylinders tacked on. As such, being a modular engine, most of the technical features were the same as the new V6s. Indeed, even the 84.0mm stroke of the 3.2-litre unit was shared, although the 97.0mm bore was completely different; combined with eight cylinders, the displacement was 4966cc as a result.

With a 10.0:1 compression ratio, Bosch ME 2.0 black box and an electronic throttle, the five-litre engine delivered 306bhp and a wider torque band than before, along with 9.6 litres/100km economy – equivalent to 29.4mpg imperial, or 24.5 miles to the US gallon. Amazingly, due to these figures and its low emissions, the new SL500 managed to qualify as an LEV in the States.

The power-unit used in the SL600 (Type 120.983) was pretty much carried over, even retaining the ME 1.0 engine management system. As such, power and torque output was unchanged (at 394bhp and 420lbft, respectively), while fuel consumption at a steady 56mph (90kph) was a respectable 10.9 litres/100km, which is 25.9mpg imperial or 21.6 miles to the US gallon.

Naturally, things looked quite different under the bonnet on the V6 and V8 cars, with a new black dressing piece giving the engines a family look, but there was something new at the back, too, with oval-shaped exhaust pipe finishers peeking out underneath the car, becoming clearly visible for the first time.

All the transmissions were carried over, including the internal ratios and final-drives – all except one that is, for the back axle on the manual 2.8-litre car went from 3.92:1 to 3.89:1 at this time. This gave a top speed of 145mph (232kph) on this 1810kg (3982lb) model – 2.5mph (4kph) faster than the automatic version, and 4mph (6kph) down on the 3.2-litre machine. As before, the 1890kg (4158lb) V8 and 2050kg (4510lb) V12 models had governors fitted to limit their top speed to 156mph (250kph), which was more than enough in the real world.

Other changes

Perhaps the most obvious change for the 1998 facelift was the

adoption of a fresh 17-inch alloy wheel design. The standard wheel had five heavy spokes, the rim measuring 8.25J x 17, and fitted with 245/45 ZR-rated tyres. The optional wheel (standard on the US SL600) was a five-hole design (SA code 644), that was obviously an evolution of the old 652 rim (dropped at this time), and was supplied in the same size as the new standard wheel, shod with the same rubber.

There was also a new AMG five-spoke wheel design (8.5J x 18 with 245/40 ZR tyres up front, combined with 9.5J rims and 275/35 rubber at the rear). These could be specified as an option (SA code 794) for all cars, but they also came as part of the North American market's 'Sport Package'.







This SL500 with panorama roof shows the changes made during the 1998 facelift in more detail, including the standard alloys, the new mirrors and lighting arrangements, colour-keyed door handles, and the interior revisions, such as the latest steering wheel and fresh trim items, like new leather and wood, plus a map net in the passenger footwell.

Other details included body-coloured door handles, new door mirrors with a more rounded profile, like those of the SLK, restyled repeater lights on the front wings (fitted to the majority of cars, except those bound for the States), a bootlid-mounted third brake light for all markets, and new monochromatic rear combination lamps with softer and fewer ridges, aping the design first seen on the S-Class way back in March 1994.

Inside, there was new upholstery featuring Nappa leather (the familiar perforated leather inserts were deleted at the same time), a fresh four-spoke steering wheel with the hefty centre pad activating the horn (the SL600 had a distinctive wood/leather version), and a new gearshift knob (again, the V12 car had a wood/leather one).

Chestnut veneer (8G25) was now used for the wood trim, with walnut (8G88) becoming optional. However, certain markets had their own policy on this – America, for instance, specified walnut for black

and grey (ash) leather interiors, and chestnut for cars with java and helios (shell) trim. Domestic cars with Exclusive trim stuck with walnut, and the German SL600, meanwhile, continued with the use of a leather/walnut steering wheel and gearlever as standard, although other options were available through the Designo range.

A new net was attached to the transmission tunnel in the passenger footwell for holding maps and so on, and slim chrome bezels were used to surround the five gauges in the dashboard meter panel, with the oil pressure gauge being replaced by an oil temperature one. There was also a new starter system, in which the driver just turned the key in the ignition barrel, and electronics took care of the rest.



Detail shot of the updated SL600, with the bezels added to the dash panel, and the latest steering wheel and gearknob. This V12 model has retained walnut trim.

The home market

With sales beginning in June 1998 in Germany, to give the new W220 S-Class all the limelight in September, the facelifted SL280 was priced at DM 127,020 in manual guise, while the automatic-only SL320 commanded DM 138,504 on introduction, the SL500 DM 173,420,

and the SL600 a cool DM 225,272. Options were carried over in the main, although it's worth doing a recap here seeing as we're entering a new chapter and a new phase in the development of the R129 series.

A five-speed automatic gearbox for the SL280 (SA code 423) cost DM 2990, ADS suspension (214, but standard on the SL600) was listed at DM 6600, and the ESP stability programme (472), which was now standard on the SL500 as well as the V12 model, was available at DM 1500 for the six-cylinder cars.

The new five-spoke alloys (644) were priced at DM 500. Also available for six- and eight-cylinder cars were the 18-inch AMG split-rim wheels (783), carried over but cheaper than before at DM 10,950, the two-piece 793 AMG option at DM 7500 for all cars, or the new 794 AMG one-piece five-spoke wheels at DM 4500. All-weather tyres (645) were still listed at DM 205.

The panorama roof (415), now coming with a power-operated blind, was available for DM 4700, while green was added as a new colour option for the soft-top. Folding power mirrors (500) cost DM 410, and an automatic dimming inner and driver's-side door mirror (249) was DM 450, although already standard on the SL600. Xenon headlights (612) were priced at DM 1550, or DM 990 on the SL600 as the DM 560 headlight wash/wipe system (600) was already fitted on the V12 car. For the more sporting owner, the AMG body kit (772) was listed at DM 7000, still without a rear spoiler. The towbar option (550) continued, by the way, priced at DM 1505.

Power seat adjustment with memory (241/242) was standard on the SL600, or DM 560 per side otherwise, while orthopedic seats (404/405) were listed at DM 605 per side; seat heating became standard on all cars. Rear seats (565) were DM 2470, or DM 2850 if Designo leather was involved.

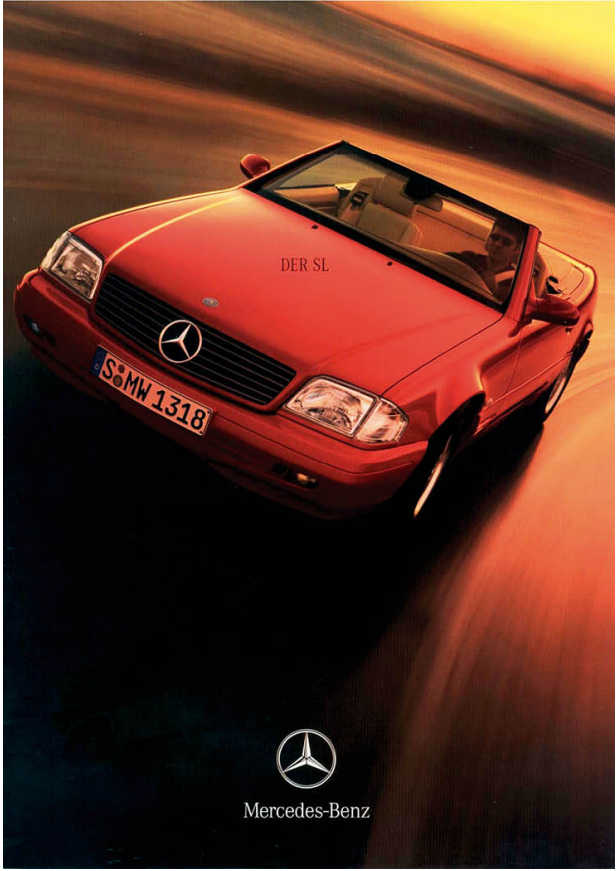

DER SL

S-MW 1318



Mercedes-Benz



Cover and one of the more dramatic pictures from the first German catalogue released after the 1998 facelift.

Electrical steering column adjustment (441) was DM 990 on the six-cylinder cars (standard on V8 and V12 models), and the trip computer (245) added DM 1235 to the invoice. The auxiliary heater (228) was much cheaper than before, priced at DM 1980.

Cupholders (309) were classed as a no-cost option on all cars, along with walnut trim (731), as chestnut was now considered the norm. The alarm system (551) was reduced to just DM 500, despite incorporating the old 882 option from now on. A fire extinguisher (682) was an NCO on the V12 model, or DM 190 otherwise.

There were new audio options, with a Mercedes-Benz Audio 10 unit with CD player (756) an NCO on the SL600, or DM 180 on other cars. The Mercedes-Benz Audio 30 (750) was standard on the SL600, or DM 680 otherwise. An APS navigation system could be integrated into

the Audio 30 radio (351) at DM 3100, although it came DM 500 cheaper on the V12 machine. A CD changer located in the boot (819) was listed at DM 750, while the Bose Sound System (810) was DM 1100; one could also specify the Dynamic sound setup (815) for DM 1500. There were also changes to the telephones, with two options that could be fitted to the armrest (316 and 317), and one (312) that was console mounted.

Other new options not already mentioned included a garage door opener integrated into the rearview mirror (231) at DM 350, and the Designo paint and trim selection, including special leather upholstery and wood (grained curly maple only) and carbon trim.

Metallic paint was still DM 1580 (although it was an NCO on V8 and V12 models), but now the Designo range was added (DM 3600), as well as the Designo Varicolor (DM 5000) and Designo LCP (DM 9800) colour palettes, all three being DM 1600 cheaper on the SL500 and SL600.

The Designo leather and wood options caused more changes. The regular 289 walnut/leather steering wheel (standard on the SL600, or DM 970 for other cars) was now joined by a version using Designo wood and leather (code Y95, still available without any additional cost on the V12 model, but DM 1400 on other SLs), and a two-tone leather version (code Y96, an NCO on the SL600, DM 950 otherwise). In addition, the regular 284 walnut/leather gearlever (standard on the SL600, DM 285 otherwise) was now joined by a Designo wood and leather one (code Y94), which was available on the SL600 as a no-cost alternative, but was priced at DM 350 for other cars. Designo wood trim accents were also available at DM 2100 (or DM 700 more on an SL600), while carbon trim accents with Designo stitching came in at DM 2600 for all cars.

The cloth trim option was gone, with Nappa leather becoming standard on all cars; as such, the trim codes were all new, with the 061/261 series being replaced by the 231 series. However, Exclusive leather trim was still available at DM 5215, while seats, door panel trim and carpet edges trimmed in Designo leather (single- or two-tone, building on 231 black) could be ordered for DM 2250. Alternatively, the same thing using 511 black as a base, with Designo stitching

colours and other areas in Exclusive leather added DM 7650 to the invoice. Trim options stayed the same until the end of the R129 run after this.





Stunning series of publicity photographs of an early facelifted SL320.

In the political arena, Helmut Kohl eventually lost the 1998 elections to Gerhard Schröder of the SPD, who worked as Germany's Chancellor from October 1998 to November 2005. A new era had begun ...

Never content, the Mercedes engineers changed the plain bearing on the input shaft of the 722.6 automatic transmission to a needle bearing to reduce friction in January 1999. Likewise, six months later, new bearings were employed in the sun wheel of the rear planetary gearset for the same reason.

The cost of all SL base cars increased by DM 1160 in February 1999, although this was ultimately the last price hike applied to the SL600, which remained at DM 226,432 until the end of production.



A typical Designo interior from the time.

The Mercedes-Benz Standard telephone package could be updated with the novel TELEAID system (347) from March 1999, DM 1790 being charged in this case rather than the usual DM 1540. With TELEAID, the crash sensors that trigger the safety devices also send a message to the telephone to summon emergency services whilst giving a location fix on the vehicle.

Designo LCP paintwork was dropped in the same month, while a Designo Red soft-top (code Y93) was added to the option list at DM 700, basically bringing the 1997 Special Edition convertible roof to a wider audience.



Tail and engine bay of the SL55 AMG.



Contemporary AMG interior, with chunkier steering wheel and 'AMG' badging in the centre of the 300kph speedometer – regular cars had speedos calibrated to 260kph, or 150mph or 160mph depending on the market.



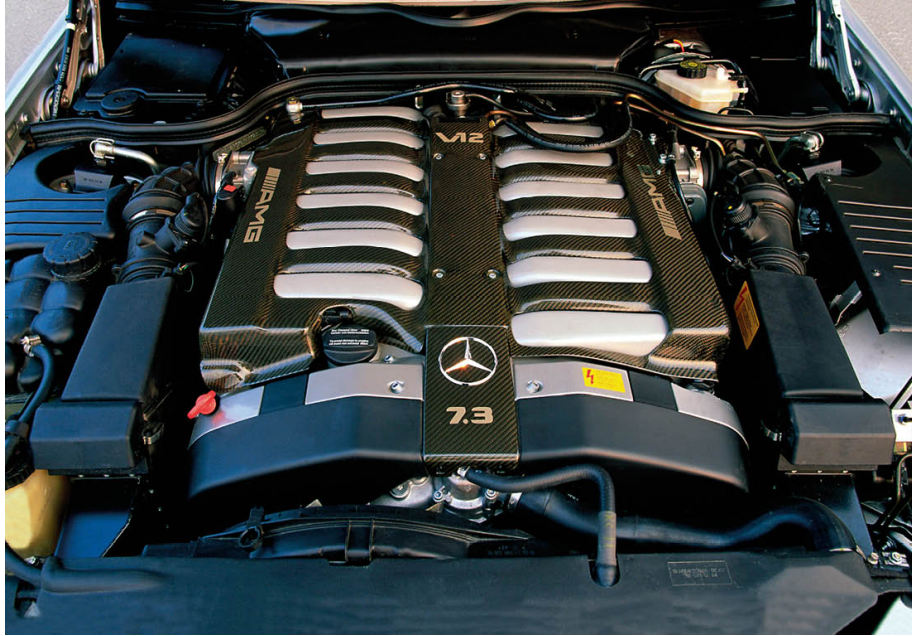

The ultra-rare SL73 AMG, with detail shots of the engine and the subtle yet somehow imposing badge on the bootlid.

It was at this time that Bruno Sacco retired as head of styling, with Peter Pfeiffer duly taking Sacco's place in April 1999. Sacco would have been pleased with the response the C215 CL received when it was launched at the Geneva Show, its front mask giving a huge hint of what was to come for the new SL.

April was also the month in which a fresh batch of AMG prices was released – the SL55 AMG conversion costing DM 37,120, and the SL73 AMG one commanding a hefty DM 99,180. The 5.4-litre engine duly gained widespread use in the official Mercedes-Benz line-up,

with the E55 AMG being very popular. The 7.3-litre lump was a real rarity, though, with only 42 SL73 AMGs being produced, although the unit was later used by Pagani for the Zonda sports car range.

As it happens, one of the first SL55 AMGs was part of a limited run called the 1999 'Mille Miglia' edition. This car, of which just 12 were built, featured an AMG body kit with Designo Silver paintwork, 793-type AMG alloy wheels, two-tone grey leather trim with darker door panels, dashboard and carpeting, and carbon-fibre trim to replace the wood components.

Annual passenger car production passed the one-million mark for the first time ever in 1999, which was a significant achievement for the Stuttgart company. The figure rose to 1,161,601 units in the following year, proving it was no fluke.

The vision SLR

The front engine, rear-wheel drive Vision SLR concept car was unveiled in coupé guise at the Detroit Show in January 1999, with a roadster version following eight months later at the Frankfurt Show, both providing a glimpse of future generations of the SL and SLK, and a sneak preview of the Mercedes-Benz SLR McLaren of 2003 vintage.

The supercharged 5.4-litre AMG V8 in the 1999 car was delivering 557bhp, which gives stunning performance levels in a vehicle weighing just 1400kg (3080lb) courtesy of the latest lightweight materials. Ultimately, production machines, built by McLaren in England, were developing over 600bhp to make up for a little bulk gained in making the car production worthy.



The Vision SLR roadster (nearest the camera), coupé (centre), and the car that inspired them from the fifties.



An SLR McLaren at the 2003 Frankfurt Show, with Ron Dennis of McLaren (left) and F1 driver David Coulthard in the background, and Jürgen Hubbert (the long-serving head of the Mercedes car division) to the right.

The main export markets

With Mercedes prices ranging from \$31,200 to \$137,300 for 1999, America's two-car SL line-up was once again given a luxury specification, with the \$81,100 SL500 coming with items like ESP, alloy wheels, rain-sensing windscreen wipers, headlight wash/wipe, power mirrors and seats with three-position memory, leather upholstery and door inlays, remote control central locking, an alarm with an integrated 'panic' button, and a radio/cassette with a Bose Acoustimass sound system.

The six-litre SL600 cost \$45,800 more, but included in the package were additional items like the ADS suspension, the 644-type alloy wheels, Xenon headlights (but no wash/wipe on these headlamps in the States), full Exclusive leather trim (now back to a single shade) and extra wood furnishings, plus a CD changer unit in the trunk, and a mobile phone.

Metallic paint was a no-cost option on both cars, while the panorama roof commanded \$3695, and lumbar adjustment on the seats was \$700 per pair. A new \$1795 'SL2' package was established for the 1999 SL500, including Xenon headlights, heated seats and the CD changer – all previously available as separate options. The \$4970 'Sport Package' was given the 'SL1' moniker, with the familiar body kit and new 794-type AMG five-spoke alloy wheels.

In Britain, the full SL range was on offer, with the SL280 priced at £58,340, the SL320 at £63,540, the SL500 at £81,340, the SL600 at £103,040, and the last of the SL60 AMGs at £98,090, which remained in the UK price lists until the start of 2000.

Japan was still in the midst of its AMG love affair as the 1999 season dawned, listing the SL55 AMG at 20,500,000 yen, the SL60 AMG at 23,700,000 yen, and the SL70 AMG at 28,500,000 yen. As for the regular cars, the SL320 (left- or right-hand drive) was up to 9,900,000 yen, the SL500 12,500,000 yen, and the V12 SL600 16,200,000 yen.

In Australia, the SL280 was listed at \$200,700, the SL500 at \$286,700, and the SL600 at \$368,400. However, the SL dropped off the Aussie price list in the spring of 1999, with the distributors concentrating on the new S-Class. Ultimately, with cars like the Porsche Boxster available for \$110,000, the SL had priced itself out of

the market.

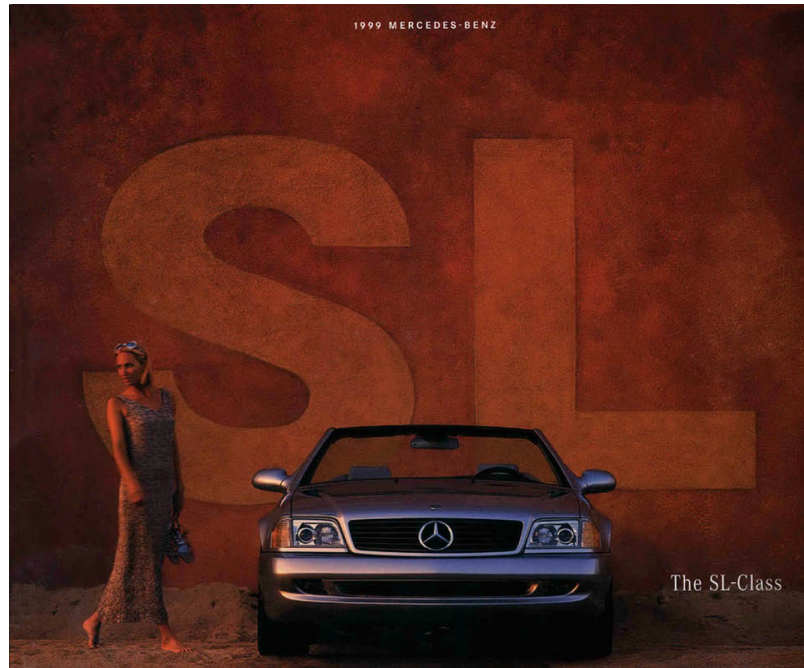

Cover from the North American market SL brochure for the 1999 season.

The 2000 Model Year

With the engineers and marketing department concentrating their efforts on the E-Class facelift, very little was happening on the SL front. The price of the six-cylinder SL base cars went up by DM 580 for the 2000 season, after EPS became standard on the smaller-engined cars as well as the V8 and V12 models, but the cost of the SL500 and SL600, and options, as it happens, was unchanged from the previous year.

Domestic prices increased again in January 2000, taking the cost of an SL280 up to DM 129,920, the SL320 to DM 141,404, the SL500 to DM 175,740, and the SL600 to DM 226,432. Seeing as the average monthly wage in Germany was around DM 3400 at this time, the SL could definitely be classed as a luxury purchase.

This was the month in which the stricter EURO 3 regulations were introduced, with CO emissions limits dropping from 2.20g/km to 1.30g/km, and NOx from 0.50g/km to 0.15g/km. From this moment

on, Europe's tailpipe emissions regulations were actually tighter than those of America.

The March 2000 price list displayed a few minor adjustments made to the price of options. For instance, the cost of the 644 alloy wheels increased by DM 10, while AMG alloys went up by between DM 50 to DM 100 a set, and the AMG body kit by DM 100. The headlight wash/wipe and Xenon headlight options were a touch more expensive, and the cost of the automatic dimming mirror feature (SA code 249) increased by DM 50.

At the same time, the automatic V6s now came with a more advanced cruise control system, previously found on the SL500 and SL600 only; this was available for DM 3200 on the SL280, but standard on the SL320 and AMG models.



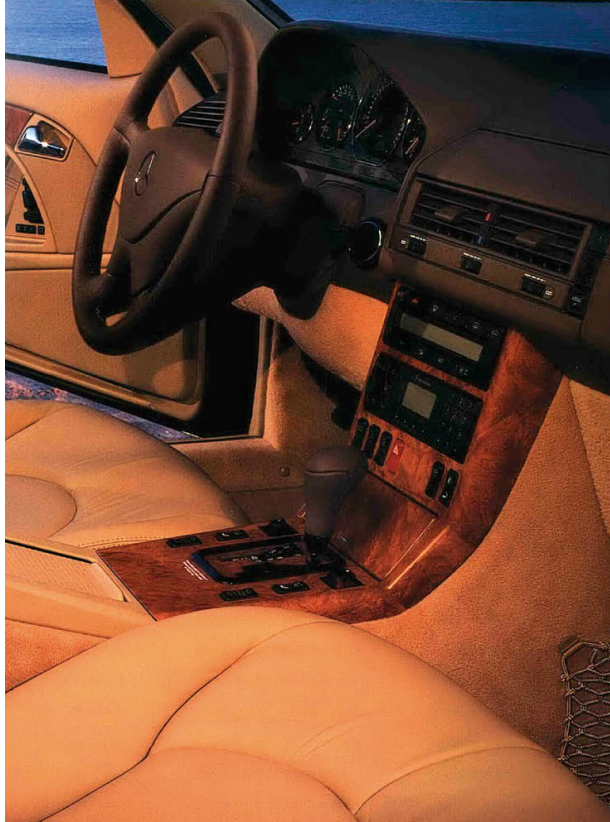

The SL500 and its interior as seen in the 1999 US catalogue.

The cost of leather trim options went up a fraction, along with the Designo wood and carbon trim accents, and the leather/wood and two-tone leather steering wheels and leather/wood gear selector. The alarm was DM 10 more than before, but the Mercedes-Benz Audio 30 APS unit was DM 200 cheaper. In addition, the Dynamic sound setup (815) was DM 500 cheaper than before, although the price of the Bose sound system went up by DM 30.

Meanwhile, the crankcase ventilation pipe was modified on the V12 engine, with plastic pipework being replaced by aluminium, and several improvements were made to the Type 722.6 automatic gearbox, including changes to the helical gear angles to reduce transmission noise.

Spring 2000 also witnessed the launch of the limited run 'SL Edition' model, of which 708 were produced in the end. Built on either the SL320 or SL500 base car, the 'SL Edition' featured Designo Mysticblau paintwork and soft-top (although 744 silver and a black top could be

specified at no extra cost), two-piece 18-inch six-spoke wheels (SA code P30), silver-painted brake calipers and drilled discs at the front, chrome accents on the hardtop/panorama roof and windblocker, a stainless exhaust pipe finisher, black Nappa leather with perforated inlays on the front and rear seats, dark wood on the half-leather steering wheel and gearknob, as well as the door trim and centre stack/console, an engine-turned aluminium instrument panel and gear selector gate, and special floormats and badging.

Limited edition models came thick and fast after this, with the tasteful 'Final Edition' SL based on the SL500 (674 built), and a 2000 version of the 'Mille Miglia' with silver paint and the P30 alloy wheels. Only 12 of these were built, including ten SL320s and two SL500s. The last of the German specials was the 13-off 2001 'Mille Miglia' – similar to the US 'Silver Arrow' launched that year with its silver paint, body kit and P30 wheels.

On the subject of America, the 2000 season saw the SL500 priced at \$82,600, and the SL600 at \$128,950 – increases of \$1500 and \$2050 respectively over the previous season. Although essentially the same, TELEAID was new for 2000, being standard on both SLs, and heated front seats became a separate option again for the SL500 for those not wanting the 'SL2' package.

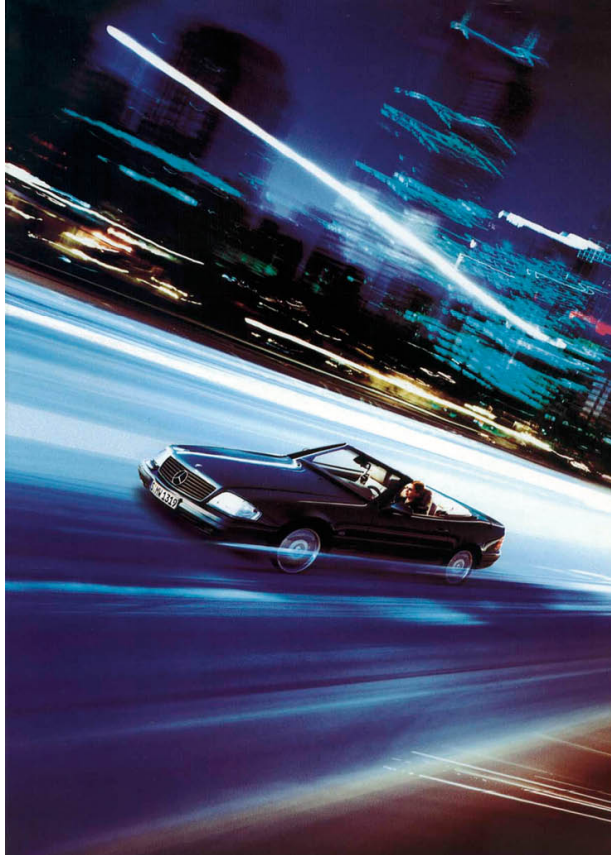

One of the more striking illustrations from the German catalogue dated November 1999.



A V12 SL interior featured in the domestic 2000 MY brochure. The bank of switches in the centre stack cover (left-to-right) bootlid release, tow-away alarm setting, central locking activation, hazard warning lights, folding mirrors (favoured in countries like Japan, but not available in the US), ADS settings, ESP on/off, and the manual control of the roll-over bar.



Mercedes-Benz at the 2000 Geneva Show, with CLK, SLK and SL open cars taking pride of place on the stand.

Also new for 2000 was the \$4900 Designo 'Black Diamond Edition'

package, which brought Black Diamond paintwork, two-tone black and red leather upholstery, and carbon interior trim accents. The other alternative was the \$5700 Designo 'Slate Blue Edition' package, with Slate Blue coachwork, black/dark blue leather, and charcoal maple wood trim.

In a *Road & Track* test, racer Steve Millen was impressed by the way the SL500 tackled the Thunderhill circuit. The magazine's Matt DeLorenza added: "After a few laps of probing the limits of the SL500's chassis and finding it predictable and enjoyable to point and shoot from corner to corner, I drove back to San Francisco with a new-found appreciation for an old friend."

After being held the same for more than two years, UK prices actually fell in the middle of the 2000 season, with the SL line ranging from £54,640 for the SL280 to £96,370 for SL600 – this represented a substantial £6670 reduction on the V12 model.

The Mercedes-Benz distributors in Britain caught the limited edition bug, too, with two 50-off models being launched in 2000 – the Designo Heritage Edition UK with burgundy paintwork and P30 alloys, and the Designo Vintage Edition UK with dark green paint and the same wheels.

Japanese prices were carried over on the regular models for 2000, although there were some adjustments made to the AMG line-up, with the SL55 AMG commanding 19,500,000 yen, and the SL73 AMG version 27,500,000 yen.





Exterior and interior shots of the 'SL Edition' model of 2000.

The 2001 Model Year

The new W203 C-Class had priority at this stage in the proceedings, with a new SL already waiting in the wings. Indeed, by January 2001, the SL600 no longer appeared on domestic price lists, although production continued for a few months, until May, to clear existing orders in train.

The final prices for the other cars were DM 131,134 (€67,048) for the SL280, DM 142,705 (€72,964) for the SL320, and DM 176,963 (€90,480) for the SL500. In reality, the Euro was not widely used until January 2002, when the first banknotes and coins were circulated, but both currencies were being listed by this time.

There were some minor changes on the telephone options, with a simplified range, and Designo Chromaflair paint was added to the list, priced at DM 9600 (or DM 8000 on the SL500), although carbon trim accents and the Dynamic sound system were deleted along the way. Interestingly, other than the few changes noted in the text, and a DM 105 rise on the SL280's five-speed automatic gearbox and a DM 30 increase on the garage door opener at this time, many option prices had remained the same as those posted in June 1998.

R129 production finished in July 2001, with sales of the R230

starting in the following month in Germany. Meanwhile, the export markets continued to sell the older car for a little while longer.



The supremely tasteful 'Final Edition' SL for the German market.

In America, the Mercedes range took on a more sporting note for the 2001 season. The 'Formula One Edition USA' was launched to commemorate the long-awaited return to F1 racing in America in September 2000, the 20 SL500s having an AMG body kit, 794-type AMG alloys, silver paintwork, a grey soft-top, a chrome frame on the windblocker, a grey interior with two-tone steering wheel and gearknob, silver-painted centre console and door trim sections, drilled pedals, and special badges.

The standard US cars were also more sporty, gaining AMG body kits and 18-inch five-spoke alloy wheels from the same tuning company, although the \$83,800 SL500 had the 794 one-piece type, while the \$128,950 V12 model had the more expensive 793 two-piece rims. Otherwise, there were no changes for the States.

There were changes outside the Mercedes dealerships, though, with George W Bush taking Bill Clinton's place in the White House in January 2001 after winning the 2000 presidential race.

Not surprisingly, the US 2002 Model Year SL line-up was pretty much the same as that of the 2001 season, even the pricing, although

it became possible to delete the AMG body kit and wheels via the 227 option, in which case, the cars reverted to their old 17-inch wheel and tyre combinations.

There was also a 'Silver Arrow Edition' announced in the spring of 2001 as an early 2002 model. This was a limited edition planned for 1500 units (100 SL600s and 1400 SL500s, priced at \$86,300 and \$132,950, respectively), although eventually 1515 were sold by the time US sales of the R129 came to an end in March 2002.

The 'Silver Arrow Edition' was actually quite spectacular, with special silver paint, a black soft-top, polished P30-type alloy wheels with cross-drilled brake discs and silver-painted calipers beyond, Xenon headlamps, chrome detailing on the grille, side window graphics (including the hardtop, or the panorama roof supplied with the SL600 version), boot plinth and windblocker frame, a stainless steel exhaust pipe finisher, and special badging.



Interior of the 'Formula One Edition USA' model.



One of the illustrations used in the US 2001 Model Year SL brochure, with a V12 SL600 in the foreground and an SL500 behind. Note the AMG body kits and the use of different AMG alloys for the two grades.



The Mercedes-Benz line-up as seen in the US range brochure for the 2001 season. The SL still looked fresh up against its more modern stablemates.

Inside, the black Exclusive leather trim was complemented by black maple wood accents on the steering wheel, gearknob, centre console and door cappings on the SL600 version, although the five-litre car had black/silver-grey two-tone leather trim, with wood finding service only on the console and doors. All cars, however, received heated

seats (those on the six-litre car had adjustable lumbar support), a six-CD changer unit, a turned aluminium dash panel and gear selector gate, as well as drilled aluminium pedals, special 'Silver Arrow Edition' badging on the illuminated stainless steel door sills, seats and ashtray, Exclusive floormats, and a comprehensive accessory kit and authenticity certificate provided in a metal briefcase. It was a fine way to bow out.

Meanwhile, in Britain, with the 2001 MY Mercedes range starting at £12,790 and going up to £82,440 for the CL55 AMG, the SL line-up was close to the top end, with the SL280 at £49,640 (less than in 1999) and the SL600 at a significantly reduced £80,900. There were no AMG SLs listed, and before the middle of 2001, the SL600 had slipped away, too.

In the meantime, the UK had introduced its own 'Silver Arrow' special edition in March 2001, limited to 100 cars. From the outside, it looked much like the US version (except for the front light units, of course, which continued to be different in the States), although the interior was more in keeping with British tastes, with cream leather seats and plenty of polished wood. Two more Designo special editions were launched at the same time – the Alanite and Almandine models.



American advertising for the 'Silver Arrow Edition' from spring 2001.

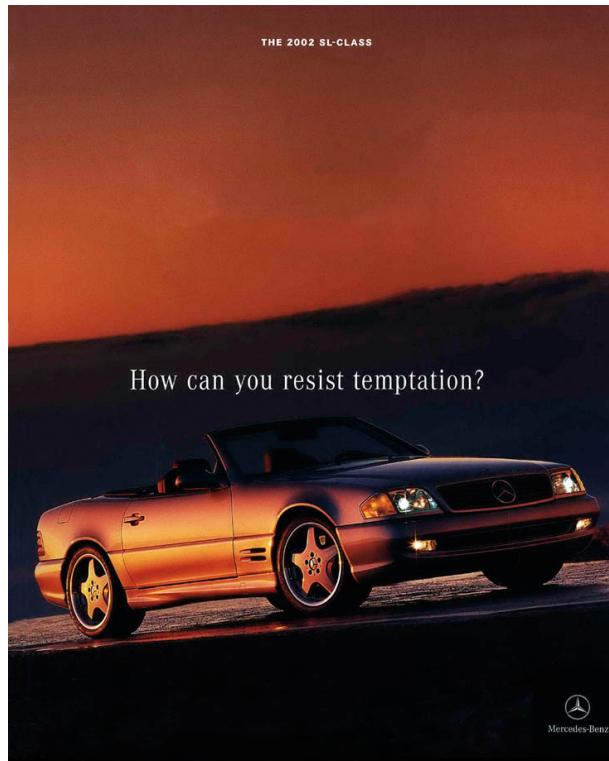

The 2002 Model Year catalogue from the States.

In February 2002, by which time post-war Mercedes-Benz passenger car production had passed the 20 million mark, the R230 cars were listed, with the new SL500 commanding £67,790 (£2450 more than the last of the five-litre R129s) and the SL55 AMG £89,040.

In Japan, the SL600 disappeared from the 2001 price list, but otherwise things remained the same. As the season came to an end, the 9,900,000 yen SL320 Edition and 12,500,000 yen SL500 Edition models were the only SLs listed, with no AMG variants.

The R230 was launched in Japan in time for the start of the 2002 Model Year, introduced at a reasonable 12,800,000 yen, but the R129's history wasn't quite over in the Land of the Rising Sun, as Toshihiko Ohno converted a few from 2003 onwards. Earlier Ohno Naomis had employed Mazdas and Toyotas as base cars, but the Naomi IV used the R129 SL for its basic structure; the Naomi V was SLK-based, incidentally. But there we have it, the end of an era ...



Exterior and interior shots of the 'Silver Arrow' special edition for the British market. Note the 160mph speedometers fitted to UK cars.



The three limited edition models that provided a final swansong for the R129 model in Britain.



Tailpiece ...

9

A new generation

The R129 had done a sterling job of upholding the SL's honour in an era of change and rapid progress in the world of automotive engineering. Pictures in range brochures from the turn of the century showed it had stood the test of time well, but the 31st of July 2001 marked the official debut of its replacement – the R230.

Working on a 45mm (1.8in) longer wheelbase, the new SL was characterized by a twin-light front mask similar to that of the CL, and more particularly the W203 C-Class. It was that long-established policy of giving the SL a 'family' face showing through again, but the styling cues borrowed from the saloons looked more overtly sporting on the SL.



The styling department, with the R230 taking shape. Chief designer Peter Pfeiffer, who was duly appointed head of styling after Bruno Sacco retired, can be seen on the left.

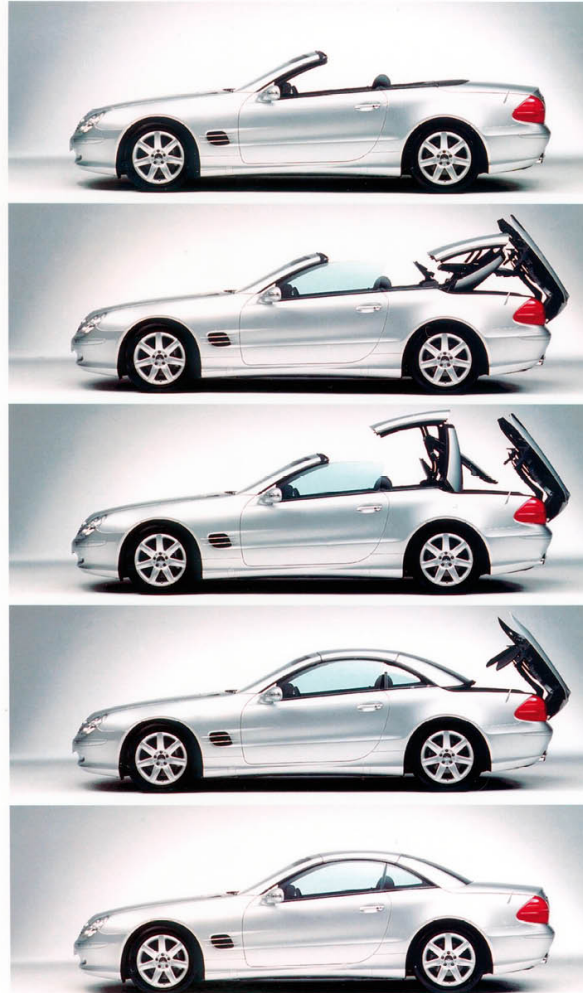

The new R230 SL had a power roof similar to that of the SLK. Partial raising was possible to allow better access to the luggage area.

There was a distinctive wedge profile when looking at the car from the side, the extra bulk over the rear wheels allowing the vehicle to look a lot more compact than it was in reality. Apart from the aesthetic value, the raised tail also helped with practical issues, for the R230 came with a fast-acting folding metal top similar to that seen on the SLK. While this top had been applauded for its ease of use, it had also been criticized by some for encroaching too much on luggage space once the roof was down. However, with the tail shape of the new SL, luggage capacity wasn't all that much different to that of the outgoing model.

Around the back, organic shapes were blended with sharp angles

and huge triangular taillights to break up the large area, while the styling inside was even more modern. In fact, if anything, this was one area where the stylists had tried too hard, with the multitude of rounded lines never quite having the same harmony as the R129 cockpit – it was almost as fussy as the old car was conservative.

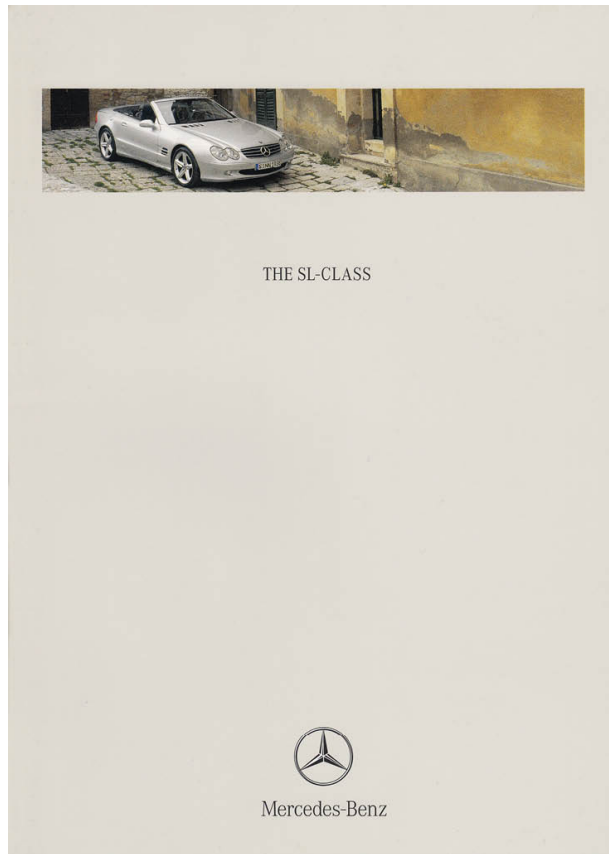

Cover of the first catalogue for the R230 model.

Overall dimensions were up a fraction in virtually all directions, with the 35mm (1.4in) gain in length being the greatest difference, so one can see there were no dramatic changes to the basic size. In fact, it was the track dimensions (up 25mm/1.0in at the front, and 10mm/0.4in at the rear) that accounted for the biggest moves in percentage terms, while kerb weight was actually reduced by 45kg (99lb) thanks to the use of lightweight metals, and modern materials like plastics and GRP-reinforced SMC. At the same time, the aerodynamics were improved, the car having a Cd figure of 0.29.

On the mechanical front, the SL500 had the 306bhp five-litre V8 carried over from the R129, while the SL55 AMG unveiled at the 2001 Frankfurt Show had a supercharged 5.4-litre V8 pumping out a massive 476bhp, which was soon updated to an even 500bhp. A five-speed automatic was standard on both, but a 7AT unit became available on the normally-aspirated car for the 2004 season.

Several 3.2-litre V6 prototypes had been built in 2000 and 2001, but 3.5-litre models took their place on the production line, the SL350 making it into the 2003 season's line-up, while the SL600 was added to the range a few months later. For absolute power freaks, the SL65 AMG was launched in mid-2004, with over 600 horses under the bonnet!

The engineering side was developed under the watchful gaze of Frank Knothe, with the suspension following the latest Mercedes-Benz practice, and incorporating adaptive damping and Active Body Control – something that was introduced a couple of years before the R230 made its debut, using hydraulics to adjust the positioning of the coil spring mounts by just enough to reduce body roll and squat. There was also all manner of driver assistance programmes and the latest electronic Sensotronic braking system, which built on all existing technology to reduce braking distances by a further three percent. Just as big an event was the loss of the traditional Mercedes recirculating ball PAS, the old form of steering being replaced by a more accurate rack-and-pinion unit.



Overhead view of the R230 SL500 (left) with one of its illustrious predecessors from the Mercedes-Benz SL line – a W198 II 300SL roadster.

A black and white advertisement for the Mercedes-Benz SL-Class. The scene is set in a dimly lit room, possibly a restaurant or a formal event. In the center, a silver Mercedes-Benz SL is parked on a raised platform. Two women in elegant, floor-length gowns stand on the platform, one facing the car and the other facing away. The foreground shows the silhouettes of people seated at tables, looking towards the stage. The text "Style. Unlike any other." is printed in the lower left. At the bottom, there is a line of small text: "Nowhere does form follow function with greater flair than in a Mercedes. Like the new SL with its retractable hardtop and sleek profile. Call 1-800-FOR-MERCEDES. Visit MBUSA.com. The SL-Class" and the Mercedes-Benz logo in the bottom right corner.

©2001 Mercedes-Benz USA, LLC. A DaimlerChrysler Company.

Style. Unlike any other.

Nowhere does form follow function with greater flair than in a Mercedes. Like the new SL with its retractable hardtop and sleek profile. Call 1-800-FOR-MERCEDES. Visit MBUSA.com. **The SL-Class**

Mercedes-Benz

Advertising from the June 2002 issue of Vogue magazine.



The tail displayed altogether more modern lines, taking styling cues from other vehicles in the contemporary Mercedes line-up.

Introduced at DM 184,450 (€94,308), thanks to new manufacturing techniques, SL500 (chassis code 230.475) production was already up to 8036 units in 2001. By 2002, the figures read 1542 SL350s, 24,035 SL500s, 6350 SL55 AMGs and 30 SL600s giving an annual production total of 31,957 units – better than any R129 year by a quite considerable margin.

The R230 went on sale in America in March 2002, incidentally, priced at \$86,655, and was joined by the \$113,915 SL55 AMG five months later. Like the V12 model that followed in due course, the AMG car could crack off a 0-60 dash in under five seconds! Road & Track's John Lamm summed things up by saying: "Think of the SL55 AMG as a Viper with breeding."

There was a minor facelift done in time for the 2006 Geneva Show, but it was the same event two years later that witnessed the first major changes for the R230, distinguished by new headlight units. The next generation SL with an all-aluminium body ultimately went on sale in March 2012.

Appendix I

Year-by-year range details

This appendix brings together the brief specifications for all R129 series models, arranged in chronological/engine size order. Column one shows the vehicle type, the second column shows the basic engine details (to be used in conjunction with Appendix II, as there are subtle differences depending on the year and destination), whilst the third contains any useful notes, including the main market (if nothing is listed, one can assume worldwide sales, while the cars with 'European market' against them are not always restricted to EU countries – please refer to the main text for definitive details). Only production road cars are listed for each model year (MY), and one should also note that sales continued into the 2002 season in certain export markets:

1990

300SL (129.060): M103.984, Pilot build from May 1988. Full-scale production starts March 1989. European market.

300SL-24 (129.061): M104.981, Pilot build from July 1988. Full-scale production starts March 1989.

500SL (129.066): M119.960, Pilot build from June 1988. Full-scale production starts March 1989.

1991

300SL (129.060): M103.984, European market.

300SL-24 (129.061): M104.981

500SL (129.066): M119.960

500SL 6.0 AMG (129.066): M119.960 AMG, European market. From September 1990.

1992

300SL (129.060): M103.984, European market.

300SL-24 (129.061): M104.981

500SL (129.066): M119.960, To September 1992.
500SL 6.0 AMG (129.066): M119.960 AMG

1993

300SL (129.060): M103.984, European market. To June 1993.
300SL-24 (129.061): M104.981, To June 1993.
500SL (129.067): M119.972, From September 1992 to June 1993.
600SL (129.076): M120.981, Pilot build from August 1991. Full-scale production starts July 1992, but ended June 1993.
500SL 6.0 AMG (129.067): M119.960 AMG, European market. To August 1993.

1994

SL280 (129.058): M104.943, Pilot build from February 1993. Full-scale production starts July 1993. European market.
SL320 (129.063): M104.991, Pilot build from February 1993. Full-scale production starts June 1993.
SL500 (129.067): M119.972, From June 1993.
SL600 (129.076): M120.981, From June 1993.
SL60 AMG (129.067): M119.972 AMG, European market. From September 1993.

1995

SL280 (129.058): M104.943, European market. To August 1995.
SL320 (129.063): M104.991, To August 1995.
SL500 (129.067): M119.972, To August 1995.
SL600 (129.076): M120.981, To August 1995.
SL60 AMG (129.067): M119.972 AMG, European market.

1996

SL280 (129.058): M104.943, Facelift model. European market. From September 1995.
SL320 (129.063): M104.991, Facelift model. From September 1995.
SL500 (129.067): M119.982, Facelift model. From September 1995.
SL600 (129.076): M120.981, Facelift model. From September 1995.
SL60 AMG (129.067): M119.972 AMG, European market. To

December 1995.

SL60 AMG (129.067): M119.982 AMG, Facelift model. European market. From April 1996.

1997

SL280 (129.058): M104.943, European market.

SL320 (129.063): M104.991

SL500 (129.067): M119.982

SL600 (129.076): M120.981

SL60 AMG (129.067): M119.982 AMG, European market.

1998

SL280 (129.058): M104.943, European market. To June 1998.

SL320 (129.063): M104.991, European market. To June 1998.

SL500 (129.067): M119.982, To June 1998.

SL600 (129.076): M120.981, To June 1998.

SL60 AMG (129.067): M119.982 AMG, European market. To May 1998.

1999

SL280 (129.059): M112.923, Facelift model. Pilot build from October 1997. Full-scale production starts June 1998. European market.

SL320 (129.064): M112.943, Facelift model. Pilot build from October 1997. Full-scale production starts June 1998. European market.

SL500 (129.068): M113.961, Facelift model. Pilot build from October 1997. Full-scale production starts June 1998.

SL600 (129.076): M120.983, Facelift model. From June 1998.

SL55 AMG (129.068): M113.985, European market. From May 1999.

SL73 AMG (129.076): M120.990, European market. From April 1999.

2000

SL280 (129.059): M112.923, European market.

SL320 (129.064): M112.943, European market.

SL500 (129.068): M113.961

SL600 (129.076): M120.983

SL55 AMG (129.068): M113.985, European market.

SL73 AMG (129.076): M120.990, European market.

2001

SL280 (129.059): M112.923, European market. To June 2001.

SL320 (129.064): M112.943, European market. To July 2001.

SL500 (129.068): M113.961, To July 2001.

SL600 (129.076): M120.983, To May 2001.

SL55 AMG (129.068): M113.985, European market. To July 2001.

SL73 AMG (129.076): M120.990, European market. To May 2001.

Appendix II

Engine specifications

The following is a survey of all the mainstream production engines employed in the R129 series models featured in this book, complete with the leading specifications and any other notes of interest. One should bear in mind that engines with 'Europe' listed as the main market are not always restricted to EU countries – please refer to the main text for definitive details. The best-known of the AMG-modified engines for the R129 are also included for handy comparison.

Type 103.984 (M103 E30)

Production (MY): 1990-1993

Cylinders: Straight-six, water-cooled

Main bearings: Seven, in cast-iron block

Valve operation: Sohc, 12v, in alloy head

Bore & stroke: 88.5 x 80.2mm

Cubic capacity: 2960cc

Compression ratio: 9.2:1

Fuel delivery system: KE-Jetronic fuel-injection

Power @ rpm: 190bhp (140kW) DIN @ 5700

Torque @ rpm: 192lbft (260Nm) DIN @ 4500

Main market: Europe

Notes: *Used from March 1989 to June 1993. Peak power output was the same regardless of whether or not a catalytic converter was fitted.*

Type 104.943 (M104 E28)

Production (MY): 1994-1998

Cylinders: Straight-six, water-cooled

Main bearings: Seven, in cast-iron block

Valve operation: Dohc, 24v, in alloy head

Bore & stroke: 89.9 x 73.5mm

Cubic capacity: 2799cc

Compression ratio: 10.0:1

Fuel delivery system: Motronic-based fuel-injection

Power @ rpm: 193bhp (142kW) DIN @ 5500

Torque @ rpm: 199lbft (270Nm) DIN @ 3750

Main market: Europe

Notes: *Used from July 1993 to June 1998. Change in fuel-injection system from June 1996.*

Type 104.981 (M104 E30)

Production (MY): 1990-1993

Cylinders: Straight-six, water-cooled

Main bearings: Seven, in cast-iron block

Valve operation: Dohc, 24v, in alloy head

Bore & stroke: 88.5 x 80.2mm

Cubic capacity: 2960cc

Compression ratio: 10.0:1

Fuel delivery system: KE-Jetronic fuel-injection

Power @ rpm: 231bhp (170kW) DIN @ 6300

Torque @ rpm: 201lbft (272Nm) DIN @ 4600

Main market: Worldwide

Notes: *Used from March 1989 to June 1993. Peak power output was the same regardless of whether or not a catalytic converter was fitted.*

Type 104.991 (M104 E32)

Production (MY): 1994-1998

Cylinders: Straight-six, water-cooled

Main bearings: Seven, in cast-iron block

Valve operation: Dohc, 24v, in alloy head

Bore & stroke: 89.9 x 84.0mm

Cubic capacity: 3199cc

Compression ratio: 10.0:1

Fuel delivery system: Motronic-based fuel-injection

Power @ rpm: 231bhp (170kW) DIN @ 5600

Torque @ rpm: 232lbft (315Nm) DIN @ 3750

Main market: Europe

Notes: *Used from June 1993 to June 1998. Change in fuel-injection system from June 1996.*

Type 112.923 (M112 E28)

Production (MY): 1999-2001

Cylinders: V6, water-cooled

Main bearings: Four, in alloy block

Valve operation: Sohc per bank, 18v, in alloy head

Bore & stroke: 89.9 x 73.5mm

Cubic capacity: 2799cc

Compression ratio: 10.0:1

Fuel delivery system: Motronic-based fuel-injection

Power @ rpm: 204bhp (150kW) DIN @ 5700

Torque @ rpm: 199lbft (270Nm) DIN @ 3000

Main market: Europe

Notes: *Used from June 1998 to June 2001.*

Type 112.943 (M112 E32)

Production (MY): 1999-2001

Cylinders: V6, water-cooled

Main bearings: Four, in alloy block

Valve operation: Sohc per bank, 18v, in alloy head

Bore & stroke: 89.9 x 84.0mm

Cubic capacity: 3199cc

Compression ratio: 10.0:1

Fuel delivery system: Motronic-based fuel-injection

Power @ rpm: 224bhp (165kW) DIN @ 5600

Torque @ rpm: 232lbft (315Nm) DIN @ 3000

Main market: Europe

Notes: *Used from June 1998 to July 2001.*

Type 113.961 (M113 E50)

Production (MY): 1999-2001

Cylinders: V8, water-cooled

Main bearings: Five, in alloy block

Valve operation: Sohc per bank, 24v, in alloy head

Bore & stroke: 97.0 x 84.0mm

Cubic capacity: 4966cc

Compression ratio: 10.0:1

Fuel delivery system: Motronic-based fuel-injection

Power @ rpm: 306bhp (225kW) DIN @ 5500

Torque @ rpm: 339lbft (460Nm) DIN @ 3000

Main market: Worldwide

Notes: *Used from June 1998 to July 2001.*

Type 113.985 (M113 E55)

Production (MY): 1999-2001

Cylinders: V8, water-cooled

Main bearings: Five, in alloy block

Valve operation: Sohc per bank, 24v, in alloy head

Bore & stroke: 97.0 x 92.0mm

Cubic capacity: 5439cc

Compression ratio: 10.5:1

Fuel delivery system: Motronic-based fuel-injection

Power @ rpm: 354bhp (260kW) DIN @ 5500

Torque @ rpm: 391lbft (530Nm) DIN @ 3000

Main market: Europe

Notes: *Used in AMG models from May 1999 to July 2001.*

Type 119.960 (M119 E50)

Production (MY): 1990-1992

Cylinders: V8, water-cooled

Main bearings: Five, in alloy block

Valve operation: Dohc per bank, 32v, in alloy head

Bore & stroke: 96.5 x 85.0mm

Cubic capacity: 4973cc

Compression ratio: 10.0:1

Fuel delivery system: KE-Jetronic fuel-injection

Power @ rpm: 326bhp (240kW) DIN @ 5500

Torque @ rpm: 332lbft (450Nm) DIN @ 4000

Main market: Worldwide

Notes: *Used from March 1989 to September 1992. Developed 333bhp (245kW) and 339lbft (460Nm) of torque without catalytic converter.*

Type 119.960 AMG (M119 E60)

Production (MY): 1992-1993

Cylinders: V8, water-cooled

Main bearings: Five, in alloy block

Valve operation: Dohc per bank, 32v, in alloy head

Bore & stroke: 100.0 x 94.8mm

Cubic capacity: 5956cc

Compression ratio: 10.0:1

Fuel delivery system: KE-Jetronic fuel-injection

Power @ rpm: 374bhp (275kW) DIN @ 5250

Torque @ rpm: 406lbft (550Nm) DIN @ 4000

Main market: Europe

Notes: *Used in AMG models from September 1991 to August 1993.*

Type 119.972 (M119 E50)

Production (MY): 1993-1995

Cylinders: V8, water-cooled

Main bearings: Five, in alloy block

Valve operation: Dohc per bank, 32v, in alloy head

Bore & stroke: 96.5 x 85.0mm

Cubic capacity: 4973cc

Compression ratio: 10.0:1

Fuel delivery system: LH-Jetronic fuel-injection

Power @ rpm: 320bhp (235kW) DIN @ 5600

Torque @ rpm: 347lbft (470Nm) DIN @ 3900

Main market: Worldwide

Notes: *Used from September 1992 to August 1995.*

Type 119.972 AMG (M119 E60)

Production (MY): 1994-1996

Cylinders: V8, water-cooled

Main bearings: Five, in alloy block

Valve operation: Dohc per bank, 32v, in alloy head

Bore & stroke: 100.0 x 94.8mm

Cubic capacity: 5956cc

Compression ratio: 10.0:1

Fuel delivery system: LH-Jetronic fuel-injection

Power @ rpm: 378bhp (278kW) DIN @ 5500

Torque @ rpm: 428lbft (580Nm) DIN @ 3750

Main market: Europe

Notes: *Used in AMG models from September 1993 to December 1995.*

Type 119.982 (M119 E50)

Production (MY): 1996-1998

Cylinders: V8, water-cooled

Main bearings: Five, in alloy block

Valve operation: Dohc per bank, 32v, in alloy head

Bore & stroke: 96.5 x 85.0mm

Cubic capacity: 4973cc

Compression ratio: 11.0:1

Fuel delivery system: Motronic-based fuel-injection

Power @ rpm: 320bhp (235kW) DIN @ 5600

Torque @ rpm: 347lbft (470Nm) DIN @ 3900

Main market: Worldwide

Notes: *Used from September 1995 to June 1998. Same power and torque output as earlier Type 119.972 unit.*

Type 119.982 AMG (M119 E60)

Production (MY): 1996-1998

Cylinders: V8, water-cooled

Main bearings: Five, in alloy block

Valve operation: Dohc per bank, 32v, in alloy head

Bore & stroke: 100.0 x 94.8mm

Cubic capacity: 5956cc

Compression ratio: 10.0:1

Fuel delivery system: Motronic-based fuel-injection

Power @ rpm: 381bhp (280kW) DIN @ 5500

Torque @ rpm: 428lbft (580Nm) DIN @ 3750

Main market: Europe

Notes: *Used in AMG models from April 1996 to May 1998.*

Type 120.981 (M120 E60)

Production (MY): 1993-1998
Cylinders: V12, water-cooled
Main bearings: Seven, in alloy block
Valve operation: Dohc per bank, 48v, in alloy head
Bore & stroke: 89.0 x 80.2mm
Cubic capacity: 5987cc
Compression ratio: 10.0:1
Fuel delivery system: LH-Jetronic fuel-injection
Power @ rpm: 394bhp (290kW) DIN @ 5200
Torque @ rpm: 420lbft (570Nm) DIN @ 3800
Main market: Worldwide
Notes: *Used from July 1992 to June 1998. Motronic-based fuel-injection system from September 1995.*

Type 120.983 (M120 E60)

Production (MY): 1999-2001
Cylinders: V12, water-cooled
Main bearings: Seven, in alloy block
Valve operation: Dohc per bank, 48v, in alloy head
Bore & stroke: 89.0 x 80.2mm
Cubic capacity: 5987cc
Compression ratio: 10.0:1
Fuel delivery system: Motronic-based fuel-injection
Power @ rpm: 394bhp (290kW) DIN @ 5200
Torque @ rpm: 420lbft (570Nm) DIN @ 3800
Main market: Worldwide
Notes: *Used from June 1998 to May 2001. Same power and torque output as earlier Type 120.981 unit.*

Type 120.990 (M120 E73)

Production (MY): 1999-2001
Cylinders: V12, water-cooled
Main bearings: Seven, in alloy block
Valve operation: Dohc per bank, 48v, in alloy head
Bore & stroke: 91.5 x 92.4mm
Cubic capacity: 7291cc

Compression ratio: 10.5:1

Fuel delivery system: Motronic-based fuel-injection

Power @ rpm: 525bhp (386kW) DIN @ 5500

Torque @ rpm: 553lbft (750Nm) DIN @ 4000

Main market: Europe

Notes: *Used in AMG models from April 1999 to May 2001.*

Appendix III

Colour & trim summary

Much confusion exists regarding standard paint colours, and trim and upholstery designations, where the same term was often used for a different shade. Depending on year, ordering material by name only could result in the wrong hue being supplied, and some countries used different names altogether. This list will help when restoring a car to original specification.

Solid paint colours

No: 040

Year info: 1989-01

German name: Schwarz

English name: Black

Other names: -

No: 143

Year info: 1997-01

German name: Firnweiss

English name: Firn White

Other names: Glacier White

No: 147

Year info: 1989-93

German name: Arktikweiss

English name: Arctic White

Other names: -

No: 149

Year info: 1993-97

German name: Polarweiss

English name: Polar White

Other names: -

No: 540

Year info: 1989-93

German name: Barolorot

English name: Barolo Red

Other names: Desert Red

No: 568

Year info: 1989-93

German name: Signalrot

English name: Signal Red

Other names: -

No: 582

Year info: 1993-98

German name: Imperialrot

English name: Imperial Red

Other names: -

No: 586

Year info: 1998-01

German name: Magmarot

English name: Magma Red

Other names: -

No: 623

Year info: 1989-91

German name: Hellelfenbein

English name: Light Ivory

Other names: -

No: 651

Year info: 1989-92

German name: Pueblobeige

English name: Pueblo Beige

Other names: -

No: 751

Year info: 1989-91

German name: Liasgrau

English name: Lias Grey

Other names: Ascot Grey

No: 752

Year info: 1991-91

German name: Carraragrau

English name: Carrara Grey

Other names: -

No: 815

Year info: 1989-91

German name: Achatgrün

English name: Agate Green

Other names: -

No: 900

Year info: 1989-91

German name: Surfblau

English name: Surf Blue

Other names: Deep Blue

No: 904

Year info: 1989-01

German name: Dunkelblau

English name: Dark Blue

Other names: Midnight Blue

No: 960

Year info: 2001-01

German name: -

English name: Alabaster White

Other names: -

Note: Alabaster White was not listed in Germany. It was restricted to 2002 Model Year cars shipped to North America.

Metallic paint colours

No: 122

Year info: 1989-93

German name: Perlmuttergrau

English name: Mother of Pearl

Other names: Pearl Grey

No: 172

Year info: 1989-94

German name: Anthrazitgrau

English name: Anthracite Grey

Other names: -

No: 189

Year info: 1995-01

German name: Smaragdschwarz

English name: Emerald Black

Other names: Green-Black, Black Opal

No: 197

Year info: 1997-01

German name: Obsidianschwarz

English name: Obsidian Black

Other names: -

No: 199

Year info: 1989-95

German name: Blauschwarz

English name: Blue-Black

Other names: Black Pearl

No: 249

Year info: 1990-94

German name: Malachit

English name: Malachite

Other names: Spruce Green

No: 254

Year info: 1989-90

German name: Nachtgrün

English name: Night Green

Other names: Dark Green

No: 256

Year info: 1991-93

German name: Kristallgrün

English name: Crystal Green

Other names: -

No: 257

Year info: 1998-01

German name: Circongrün

English name: Zircon Green

Other names: Dark Turquoise

No: 261

Year info: 1989-91

German name: Nelkengrün

English name: Clove Green

Other names: Sea Foam Green

No: 269

Year info: 1995-98

German name: Turmalingrün

English name: Turmalin Green

Other names: Brilliant Emerald

No: 279

Year info: 1996-00

German name: Vivianitgrün

English name: Vivianite Green

Other names: -

No: 341

Year info: 1996-99

German name: Aquamarinblau

English name: Aquamarine Blue

Other names: -

No: 348

Year info: 1990-95

German name: Perlblau

English name: Pearl Blue

Other names: Ice Blue

No: 355

Year info: 1989-90

German name: Diamantblau

English name: Diamond Blue

Other names: -

No: 359

Year info: 2000-01

German name: Tansanitblau

English name: Tanzanite Blue

Other names: Capri Blue

No: 366

Year info: 1994-00

German name: Azuritblau

English name: Azure Blue

Other names: -

No: 432

Year info: 1989-90

German name: Bisonbraun

English name: Bison Brown

Other names: Havana Brown

No: 441

Year info: 1989-91

German name: Impala

English name: Impala

Other names: Desert Taupe

No: 475

Year info: 1993-94

German name: Nutria

English name: Nutria

Other names: -

No: 481

Year info: 1990-96

German name: Bornit

English name: Bornite

Other names: Blackberry

No: 485

Year info: 1993-94

German name: Rosenholz

English name: Rosewood

Other names: -

No: 512

Year info: 1989-95

German name: Almandinrot

English name: Almandine Red

Other names: Garnet Red

No: 548

Year info: 1998-01

German name: Bernsteinrot

English name: Berstein Red
Other names: Firemist Red, Amber Red

No: 572

Year info: 1995-98
German name: Rubin
English name: Ruby
Other names: Ruby Red

No: 587

Year info: 1989-92
German name: Pajettrot
English name: Pajett Red
Other names: Cabernet Red

No: 693

Year info: 1999-01
German name: Travertinbeige
English name: Travertine Beige
Other names: Desert Silver

No: 702

Year info: 1989-99
German name: Rauchsilber
English name: Smoke Silver
Other names: -

No: 721

Year info: 1994-97
German name: Onyxgrau
English name: Onyx Grey
Other names: Moonstone Grey

No: 735

Year info: 1989-91
German name: Astralsilber
English name: Astral Silver
Other names: -

No: 744

Year info: 1991-01
German name: Briliantsilber
English name: Brilliant Silver

Other names: -

No: 810

Year info: 2000-01

German name: Prismatingrün

English name: Prismatic Green

Other names: Laguna Green

No: 814

Year info: 1998-01

German name: Mineralgrün

English name: Mineral Green

Other names: -

No: 888

Year info: 1990-96

German name: Beryll

English name: Beryl

Other names: Teal Blue

No: 929

Year info: 1989-94

German name: Nautikblau

English name: Nautical Blue

Other names: -

No: 941

Year info: 2000-01

German name: Aragonitblau

English name: Aragonite Blue

Other names: Wedgwood Blue

Two-tone contrast paint colours

No: 166

Year info: 1990-96

German name: Violettgrau

English name: Violet Grey

Match with: 481

No: 176

Year info: 1989-96

German name: Muschelgrau

English name: Seashell Grey

Match with: 172, 651, 702

No: 177

Year info: 1989-91

German name: Stratusgrau

English name: Stratus Grey

Match with: 735, 744, 751

No: 181

Year info: 1991-96

German name: Atlasgrau

English name: Atlas Grey

Match with: 744

No: 201

Year info: 1993-96

German name: Marmorgrau

English name: Marble Grey

Match with: 149

No: 202

Year info: 1994-96

German name: Achatgrau

English name: Agate Grey

Match with: 721

No: 204

Year info: 1995-96

German name: Lautitgrau

English name: Lautite Grey

Match with: 189

No: 205

Year info: 1994-96

German name: Sodalithblau

English name: Sodalite Blue

Match with: 366

No: 211

Year info: 1989-93

German name: Kiwigrün

English name: Kiwi Green

Match with: 254, 256, 261, 815

No: 250

Year info: 1990-96

German name: Lago

English name: Lago

Match with: 888

No: 301

Year info: 1989-94

German name: Andorblau

English name: Andor Blue

Match with: 355, 900, 929

No: 303

Year info: 1995-96

German name: Augitgrün

English name: Augite Green

Match with: 269

No: 306

Year info: 1996-96

German name: Libellengrün

English name: Dragonfly Green

Match with: 279

No: 309

Year info: 1989-96

German name: Noblau

English name: Rio Blue

Match with: 904

No: 477

Year info: 1989-91

German name: Chincilla

English name: Chincilla

Match with: 432, 441

No: 515

Year info: 1989-93

German name: Tartanrot

English name: Tartan Red

Match with: 568

No: 521

Year info: 1989-95

German name: Navarrarot

English name: Navarra Red

Match with: 512, 540, 587

No: 524

Year info: 1993-96

German name: Paprikarot

English name: Pepper Red

Match with: 582

No: 549

Year info: 1995-96

German name: Korundrot

English name: Corundum Red

Match with: 572

No: 631

Year info: 1989-91

German name: Safari beige

English name: Safari Beige

Match with: 623

No: 700

Year info: 1989-96

German name: Altograu

English name: Alto Grey

Match with: 040, 122, 199

No: 738

Year info: 1989-93

German name: Satograu

English name: -

Match with: 147

Hood options

No: 740

Year info: 1989-01

German name: Schwarz

English name: Black

Other names: -

No: 744

Year info: 1989-01

German name: Blau

English name: Blue

Other names: -

No: 746

Year info: 1989-01

German name: Braun

English name: Brown

Other names: -

No: 747

Year info: 1998-01

German name: Grün

English name: Green

Other names: -

No: -

Year info: 1998-01

German name: -

English name: Java

Other names: Light Brown

No: -

Year info: 1998-01

German name: -

English name: Ash

Other names: Grey

No: Y93

Year info: 1999-01

German name: Designo-Rot

English name: Designo Red

Other names: Red

Note: The Java and Ash hoods were not listed in Germany, but they were available in the North American market.

Cloth trim

No: 061

Year info: 1996-98

German name: Schwarz

English name: Black

Other names: -

No: 071

Year info: 1989-96

German name: Schwarz

English name: Black

Other names: -

No: 072

Year info: 1989-95

German name: Blau

English name: Blue

Other names: -

No: 073

Year info: 1989-93

German name: Brasil

English name: Brazil

Other names: Dark Brown

No: 074

Year info: 1989-91

German name: Dattel

English name: Date

Other names: Palomino

No: 074

Year info: 1991-94

German name: Safran

English name: Saffron

Other names: -

No: 075

Year info: 1989-91

German name: Cremebeige

English name: Cream Beige

Other names: -

No: 075

Year info: 1991-95
German name: Champignon
English name: Mushroom
Other names: -

No: 076

Year info: 1989-93
German name: Piniengrün
English name: Pine Green
Other names: Dark Green

No: 077

Year info: 1989-94
German name: Mittelrot
English name: Medium Red
Other names: Burgundy

No: 078

Year info: 1989-95
German name: Grau
English name: Grey
Other names: -

Leather trim

No: 231

Year info: 1998-01
German name: Schwarz
English name: Black
Other names: -

No: 232

Year info: 1998-01
German name: Blau
English name: Blue
Other names: -

No: 234

Year info: 1998-01
German name: Java
English name: Java
Other names: -

No: 238

Year info: 1998-01

German name: Oriongrau

English name: Orion Grey

Other names: Ash, Blue-Grey, Grey

No: 239

Year info: 1998-01

German name: Helios

English name: Helios

Other names: Shell, Cream-Beige, Yellow

No: 261

Year info: 1996-98

German name: Schwarz

English name: Black

Other names: -

No: 262

Year info: 1996-98

German name: Blau

English name: Blue

Other names: -

No: 264

Year info: 1996-98

German name: Safran

English name: Saffron

Other names: Light Tan, Saddle

No: 265

Year info: 1996-98

German name: Champignon

English name: Mushroom

Other names: Parchment

No: 267

Year info: 1996-98

German name: Mittelrot

English name: Medium Red

Other names: -

No: 268

Year info: 1996-98
German name: Grau
English name: Grey
Other names: -

No: 271

Year info: 1989-96
German name: Schwarz
English name: Black
Other names: -

No: 272

Year info: 1989-96
German name: Blau
English name: Blue
Other names: -

No: 273

Year info: 1989-93
German name: Brasil
English name: Brazil
Other names: Dark Brown

No: 274

Year info: 1989-91
German name: Dattel
English name: Date
Other names: Palomino

No: 274

Year info: 1991-96
German name: Safran
English name: Saffron
Other names: -

No: 275

Year info: 1989-91
German name: Cremebeige
English name: Cream Beige
Other names: -

No: 275

Year info: 1991-96

German name: Champignon

English name: Mushroom

Other names: -

No: 276

Year info: 1989-93

German name: Piniengrün

English name: Pine Green

Other names: Dark Green

No: 277

Year info: 1989-96

German name: Mittelrot

English name: Medium Red

Other names: Burgundy, Maroon

No: 278

Year info: 1989-96

German name: Grau

English name: Grey

Other names: -

No: 511

Year info: 1998-01

German name: Schwarz

English name: Black

Other names: -

No: 514

Year info: 1998-01

German name: Java

English name: Java

Other names: -

No: 518

Year info: 1998-01

German name: Oriongrau

English name: Orion Grey

Other names: Ash

No: 519

Year info: 1998-01

German name: Helios

English name: Helios

Other names: Shell

No: 561

Year info: 1996-98

German name: Graumittel

English name: Medium Grey

Other names: Black

No: 565

Year info: 1996-98

German name: Champignon

English name: Mushroom

Other names: Parchment

No: 568

Year info: 1996-98

German name: Grau

English name: Grey

Other names: -

No: 571

Year info: 1992-96

German name: Schwarz

English name: Black

Other names: -

No: 575

Year info: 1992-96

German name: Champignon

English name: Mushroom

Other names: -

No: 578

Year info: 1992-96

German name: Grau

English name: Grey

Other names: -

Note: For Designo and two-tone leather options, see main text.

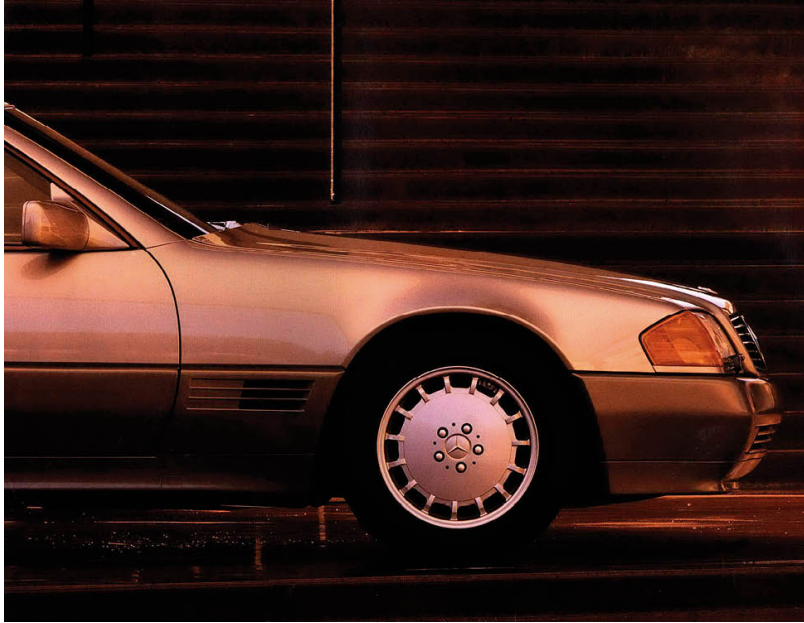

Appendix VI

Chassis numbers & production figures

Chassis numbers

The body codes and chassis start numbers for each model type:

Type: SL280

Model Year: 1994-1998

Body Code: R129.E28

Chassis No.: WDB129058**

Type: SL280

Model Year: 1999-2001

Body Code: R129.E28

Chassis No.: WDB129059**

Type: 300SL

Model Year: 1990-1993

Body Code: R129.E30

Chassis No.: WDB129060**

Type: 300SL-24

Model Year: 1990-1993

Body Code: R129.E30

Chassis No.: WDB129061**

Type: SL320

Model Year: 1994-1998

Body Code: R129.E32

Chassis No.: WDB129063**

Type: SL320

Model Year: 1999-2001

Body Code: R129.E32

Chassis No.: WDB129064**

Type: 500SL

Model Year: 1990-1992

Body Code: R129.E50

Chassis No.: WDB129066**

Type: 500SL/SL500
Model Year: 1993-1998
Body Code: R129.E50
Chassis No.: WDB129067**

Type: SL500
Model Year: 1999-2001
Body Code: R129.E50
Chassis No.: WDB129068**

Type: 600SL/SL600
Model Year: 1993-2001
Body Code: R129.E60
Chassis No.: WDB129076**

Note: The first asterisk in the above chassis numbers is to be replaced by a '1' for left-hand drive, or a '2' for right-hand drive. The second asterisk is to be replaced by a letter ('F' through 'H') to show the car was built in the Bremen plant, followed by a sequential six-digit production serial number, starting on 000001.

For America and certain other countries, the 17-digit VIN starts 'WDB' to identify Daimler-Benz. The next four digits describe the model (with 'F' for 129 series, followed by 'A' for petrol engine, then a model key, such as '63' which is a shortened version of 129.063). The eighth digit shows restraint systems, and the ninth is simply a check digit, which is a number ('0' to '9') or an 'X' in place of the number ten. The tenth gives the year of manufacture, which is defined by letters (K = 1989, L = 1990, M = 1991, N = 1992, P = 1993, R = 1994, S = 1995, T = 1996, V = 1997, W = 1998, X = 1999, Y = 2000, and 1 = 2001). Next is a letter for the Bremen plant ('F' through 'H'), followed by a six-digit sequential serial number.

Build numbers

Production quantities for each model type, arranged by engine size and basic type:

Type: SL280

Model Year: 1994-1998
Number Built: 10,319
Type: SL280
Model Year: 1999-2001
Number Built: 1704
Type: 300SL
Model Year: 1990-1993
Number Built: 12,020
Type: 300SL-24
Model Year: 1990-1993
Number Built: 26,984
Type: SL320
Model Year: 1994-1998
Number Built: 32,223
Type: SL320
Model Year: 1999-2001
Number Built: 7070
Type: 500SL/SL500
Model Year: 1990-1998
Number Built: 79,830
Type: SL500
Model Year: 1999-2001
Number Built: 23,704
Type: 600SL/SL600
Model Year: 1993-2001
Number Built: 11,086

Note: AMG models are included in these figures, as the factory did not allocate a separate chassis designation – that of the base vehicle was carried over. Around 1000 AMG R129 SLs were built, the vast majority being based on the 500SL/SL500 line.

A different breakdown of the build numbers, this time showing how many of each model type was produced within a given calendar year (CY), including prototypes:

Year: 1988 CY

300SL (12v): 27

300SL (24v): 28

500SL/SL500: 31

SL500 (24v): -

600SL/SL600: -

Year: 1989 CY

300SL (12v): 407

300SL (24v): 1507

500SL/SL500: 3413

SL500 (24v): -

600SL/SL600: -

Year: 1990 CY

300SL (12v): 2236

300SL (24v): 7902

500SL/SL500: 10,649

SL500 (24v): -

600SL/SL600: -

Year: 1991 CY

300SL (12v): 3115

300SL (24v): 7833

500SL/SL500: 15,056

SL500 (24v): -

600SL/SL600: -

Year: 1992 CY

300SL (12v): 4543

300SL (24v): 7417

500SL/SL500: 12,165

SL500 (24v): -

600SL/SL600: 2107

Year: 1993 CY

300SL (12v): 1692

300SL (24v): 2297

500SL/SL500: 6090

SL500 (24v): -

600SL/SL600: 2066

Year: 1994 CY

300SL (12v): -
300SL (24v): -
500SL/SL500: 6172
SL500 (24v): -
600SL/SL600: 1526

Year: 1995 CY

300SL (12v): -
300SL (24v): -
500SL/SL500: 7538
SL500 (24v): -
600SL/SL600: 1112

Year: 1996 CY

300SL (12v): -
300SL (24v): -
500SL/SL500: 6097
SL500 (24v): -
600SL/SL600: 1249

Year: 1997 CY

300SL (12v): -
300SL (24v): -
500SL/SL500: 8117
SL500 (24v): 3
600SL/SL600: 1164

Year: 1998 CY

300SL (12v): -
300SL (24v): -
500SL/SL500: 4502
SL500 (24v): 5618
600SL/SL600: 821

Year: 1999 CY

300SL (12v): -
300SL (24v): -
500SL/SL500: -
SL500 (24v): 8864
600SL/SL600: 557

Year: 2000 CY

300SL (12v): -

300SL (24v): -

500SL/SL500: -

SL500 (24v): 5755

600SL/SL600: 286

Year: 2001 CY

300SL (12v): -

300SL (24v): -

500SL/SL500: -

SL500 (24v): 3464

600SL/SL600: 198

Year: 1992 CY

SL280 (I6): 1992 CY

SL280 (V6): 3

SL320 (I6): -

SL320 (V6): 3

Year: 1993 CY

SL280 (I6): 1993 CY

SL280 (V6): 1927

SL320 (I6): -

SL320 (V6): 4688

Year: 1994 CY

SL280 (I6): 1994 CY

SL280 (V6): 2961

SL320 (I6): -

SL320 (V6): 6795

Year: 1995 CY

SL280 (I6): 1995 CY

SL280 (V6): 2178

SL320 (I6): -

SL320 (V6): 7497

Year: 1996 CY

SL280 (I6): 1996 CY

SL280 (V6): 1556

SL320 (I6): -

SL320 (V6): 6872

Year: 1997 CY

SL280 (I6): 1997 CY

SL280 (V6): 1316

SL320 (I6): 3

SL320 (V6): 4832

Year: 1998 CY

SL280 (I6): 1998 CY

SL280 (V6): 378

SL320 (I6): 594

SL320 (V6): 1536

Year: 1999 CY

SL280 (I6): 1999 CY

SL280 (V6): -

SL320 (I6): 647

SL320 (V6): -

Year: 2000 CY

SL280 (I6): 2000 CY

SL280 (V6): -

SL320 (I6): 302

SL320 (V6): -

Year: 2001 CY

SL280 (I6): 2001 CY

SL280 (V6): -

SL320 (I6): 158

SL320 (V6): -

Overall production figures

A table showing a summary of the annual production (by CY) for all R129 SL models combined (including prototypes), followed by a cumulative figure, valid at the end of each calendar year:

Year: 1988 CY

Number Built: 86

Cumulative Production: 86

Year: 1989 CY

Number Built: 5327

Cumulative Production: 5413

Year: 1990 CY

Number Built: 20,787

Cumulative Production: 26,200

Year: 1991 CY

Number Built: 26,004

Cumulative Production: 52,204

Year: 1992 CY

Number Built: 26,238

Cumulative Production: 78,442

Year: 1993 CY

Number Built: 18,760

Cumulative Production: 97,202

Year: 1994 CY

Number Built: 17,454

Cumulative Production: 114,656

Year: 1995 CY

Number Built: 18,325

Cumulative Production: 132,981

Year: 1996 CY

Number Built: 15,774

Cumulative Production: 148,755

Year: 1997 CY

Number Built: 15,438

Cumulative Production: 164,193

Year: 1998 CY

Number Built: 15,766

Cumulative Production: 179,959

Year: 1999 CY

Number Built: 12,365

Cumulative Production: 192,324

Year: 2000 CY

Number Built: 8000

Cumulative Production: 200,324

Year: 2001 CY

Number Built: 4616

Cumulative Production: 204,940

Total R129 series models built: 204,940



More great ebooks from Veloce Publishing

Mercedes-Benz SL & SLC – 107-series 1971 to 1989
Brian Long

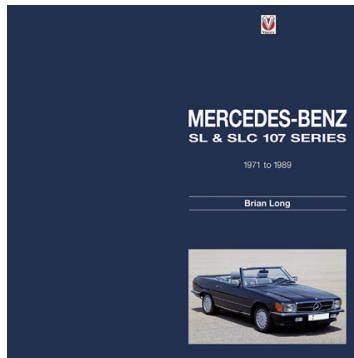

This detailed and beautifully illustrated book covers the Mercedes-Benz 107 series, which ran from 1971 to 1989. Written by a highly regarded motoring historian, with many years' ownership of the type in question, this is THE definitive study of the subject. All major world markets are looked at, along with competition history. Extensive appendices cover engine specifications, chassis numbers, build numbers, and so on.

Ebook ISBN – 978-1-845848-56-9

Print ISBN – 978-1-845842-99-4

digital.veloce.co.uk/ebooks/eV4856.html

**Mercedes-Benz 280-560SL & SLC – W107 series Roadsters & Coupes
1971 to 1989
Chris Bass**

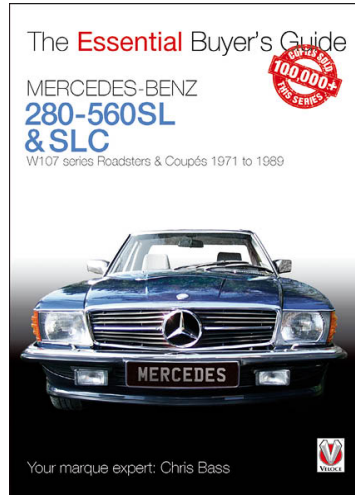

STOP! Don't buy a Mercedes-Benz 280-560SL or SLC without buying this book first! Having this book in your pocket is just like having a real marque expert by your side. Benefit from Chris Bass's years of Mercedes ownership: learn how to spot a bad car quickly and how to assess a promising one like a professional.

Ebook ISBN – 978-1-787113-20-6

Print ISBN – 978-1-787111-82-0

digital.veloce.co.uk/ebooks/eV5320.html