

LAND ROVER & RANGE ROVER **ACCESSORIES**

ORIGINAL, OEM & AFTERMARKET
PARTS & ACCESSORIES

1948 TO PRESENT DAY



Exterior Styling
Mudflaps
Wheels
Protection
Interior Styling
Mats and Carpets
Waterproof Seat Covers
Touring
Towing
Lighting
Winching
Jacking
Hoods
Seating
General Accessories
Tools
Chemicals
Literature
Performance

Telephone: 01522 568000 | E-mail: lrsales@rimmerbros.co.uk

www.rimmerbros.co.uk



Welcome to our Land Rover & Range Rover Accessory Catalogue

This is our very first, dedicated, Land Rover & Range Rover accessory catalogue, offering the most comprehensive range of Genuine, OEM & Aftermarket products available to enhance your vehicle - all at competitive prices!

Over 200 pages filled with quality accessories, carefully selected by us from manufacturers and distributors around the world. All models are covered, from Series 1 to the latest All New Discovery, Range Rover Classic to Evoque, 1948 to 2017 and beyond.

Featuring a vast array of products from the latest LED conversions, to garage workshop products, exterior mods including chequer plate, bumpers and light guards. Interior upgrades, stainless steel exhausts, wheels, performance enhancements and more. Additionally, we have not forgotten the very essence of Land Rovers - there are many off-road protection & performance enhancing products too. And take a look at our detailed application data by model on oils, transmission fluids & touch-up paints - all available from stock.

Make your Land Rover stand out from the crowd - there is something in here for everyone!

POPULAR PARTS CATALOGUE

In addition to our Accessory Catalogue, our Popular Parts Catalogue features those other parts you may need. We also have more detailed parts catalogues for Range Rover Classic & P38, Range Rover Sport, Discovery 1, 2 and 3, Defender and Freelander 1 - please request your free copy. Details of all our other catalogues can be found on the inside rear cover.

We pride ourselves in being able to offer from stock, a vast array of genuine, OEM and Aftermarket parts at competitive prices and deliver them fast - worldwide. We have sophisticated systems to handle, process and track your order - delivering the service you expect from a name that has been in the parts business for over 35 years.

PARTS IDENTIFICATION - USING OUR ACCESSORY CATALOGUE

We identify parts so that you know what you are buying. When there are alternatives to the original Land Rover part, where options are available, we use a simple numbering system so that you can select the part that best suits your needs and budget. This avoids any confusion when comparing quality and price:

- Genuine (Land Rover boxed) part - will have a plain number
- Aftermarket (reproduction) part - will have a P suffix
- OEM (original equipment manufacturer) part - will have a P1 suffix

Technical Help

We are also able to offer a full technical sales and customer service back-up to help select the parts you need and to ensure that everything you order meets expectations.

Can't find what you're looking for?

Rimmer Bros is an authorised Land Rover Parts Distributor. We have access to the full range of genuine Land Rover parts - for every model direct from Land Rover. For parts not listed in this catalogue, please contact us quoting your full VIN number.

HOW TO ORDER

Website: www.rimmerbros.co.uk
 Telephone: UK - 01522 568000
 UK office hours only
 Overseas - +44 1522 568000
 From the USA - 1 855 7462767
 (UK office hours only)
 Email: lrsales@rimmerbros.co.uk
 Fax: UK - 01522 567600
 Overseas - +44 1522 567600
 Post: Triumph House, Sleaford Road,
 Bracebridge Heath, Lincoln LN4 2NA, England
 Collect in Person: Our sales counter is open 8.30am-5.30pm
 Monday to Friday and 8.30am-1pm Saturday.
 We also offer a 'click and collect' service to save you time.



SALES OFFICE



THE LAND ROVER, JAGUAR ('98 ON), TRIUMPH, MINI & MG ROVER PARTS SPECIALIST

PAYMENTS

We accept all major credit, debit and charge cards and also Paypal on orders where all items are in stock. Orders can also be pre-paid by bank transfer (in GBP/Euro/US Dollar-please add £7.00 to cover bank charges) or cheque (in GBP-please allow a few extra days for clearance). If you send cash or Rimmer Bros Vouchers, please use registered mail, as we cannot accept responsibility for any loss.

Our bank details for GBP are:- NAT WEST Bank, Account No. 05839874
Sort Code 54-10-23 IBAN No GB74NWBK54102305839874 IBAN BIC NWBKGB2L

Our bank details for Euro are:- NAT WEST Bank, Account Prefix 550/00/
Account No. 06848516 IBAN No GB25NWBK60720906848516 IBAN BIC NWBKGB2L

Our bank details for US Dollar are:- NAT WEST Bank, Account Prefix 140/00/
Account No. 15012506 IBAN No GB16NWBK60730115012506 IBAN BIC NWBKGB2L

PRICING

The prices in this Catalogue were correct at the time of printing but are subject to change without prior notice. Please confirm all prices when ordering.

Our website gives up-to-the minute information regarding availability and the price of any item. We show two prices in GBP, one excluding VAT (for worldwide, outside EU countries) and one including UK VAT at 20%. Orders shipped to certain EU countries will be charged EU VAT at that country's prevailing rate - please see 'VAT' below.

All orders will be invoiced and charged in GBP. All goods are sold subject to the price ruling at the time of invoicing.

VAT

Residents of the UK and certain EU countries pay 20% UK VAT (Sales Tax) on parts and delivery. Due to EU legislation, where we exceed the export threshold to a country, we must VAT register and charge VAT at that country's prevailing rate. UK VAT is charged at 20% on EU shipped orders except in the following countries; Austria 20%, Belgium 21%, Denmark 25%, Finland 24%, France 20%, Germany 19%, Ireland 23%, Italy 22%, Netherlands 21%, Portugal 23%, Portugal Azores 18%, Portugal Madeira 22%, Spain 21%, Sweden 25%. Our EU VAT number will be shown on the invoice.

Note that books and manuals are generally zero rated for VAT purposes.

For EU businesses who are VAT registered, we require your VAT number and official order to export at VAT exempt prices.

For Worldwide (outside the EU) orders sent direct from our premises, VAT is not charged however, any local import duty, taxes or customs clearance are not included in our prices and must be paid for by you, usually at the time of delivery by the Carrier.

Visitors to our shop & sales counter from outside the EU can reclaim the VAT (when leaving the country) using a VAT407 Reclaim Form which we can provide upon request. This form cannot be used for Mail Order transactions.

QUOTATIONS

If you require a written quotation for the part(s) and/or delivery charge(s) before ordering, please contact us.

BACK ORDERS

Back-ordered parts are not charged for until despatch. Upon despatch we will charge the price (in GBP) quoted at the time of ordering. Prices will be unaffected by any subsequent price alterations unless advised in writing to you.

Please notify us in writing (letter, fax or email) if you wish to cancel any back ordered items. Back orders are automatically cancelled after 3 months. Back Ordered parts will be sent carriage free (some exclusions apply for export overseas). If you would prefer that your order is sent complete, please request this at the time of ordering.

SPECIAL ORDERS

Certain items (coloured trim, carpets, one-off type parts, etc) are sometimes only available by special order. This means we have to order them for you specially from the manufacturer. For this reason, we require a 20% non-refundable deposit upon taking your order. The balance is payable when the goods are despatched.

Please note that special order items can take several weeks to be supplied and are non returnable.



SHOP COUNTER



CARS ON DISPLAY IN OUR SHOWROOM



Below is a key to the models & codes covered in this catalogue.

LAND ROVER SERIES MODEL LINE	YEAR
Series I SWB	1948 to 1958
Series I LWB	1948 to 1958
Series II 88	1958 to 1971
Series II109	1958 to 1971
Series IIa 88	1958 to 1971
Series IIa109	1958 to 1971
Series III 88	1971 to 1985
Series III 109	1971 to 1985
LAND ROVER 90/110/127 MODEL LINE	1983 to 1990
Land Rover 90/110/127	
LAND ROVER DEFENDER 90/110/130 MODEL LINE	
Land Rover Defender 90/110/130 UK & ROW	1991 to 2016
Land Rover Defender 90/110 NAS (USA, CDN, Mex)	1993 to 1997
LAND ROVER DISCOVERY MODEL LINE	
Land Rover Discovery 1 UK & ROW	1989 to 1998
Land Rover Discovery 1 NAS (USA, CDN, Mex)	1995 to 1998
Land Rover Discovery 2 (L318)	1999 to 2004
Land Rover Discovery 3 (LR3/L319)	2005 to 2009
Land Rover Discovery 4 (LR4/L319)	2010 to 2016
Land Rover All New Discovery (Discovery 5)	2017 on
Land Rover Discovery Sport	2015 on
LAND ROVER FREELANDER MODEL LINE	
Land Rover Freelander 1 (L314)	1996 to 2006
Land Rover Freelander 2 (LR2/L359)	2007 to 2014
RANGE ROVER MODEL LINE	
Range Rover Classic UK & ROW	1979 to 1995
Range Rover Classic NAS (USA, CDN, Mex)	1987 to 1995
Range Rover P38A	1995 to 2002
Range Rover L322	2002 to 2012
Range Rover L405	2013 on
RANGE ROVER SPORT MODEL LINE	
Range Rover Sport L320	2005 to 2013
Range Rover Sport L494	2013 on
RANGE ROVER EVOQUE MODEL LINE	
Range Rover Evoque L538 UK Build	2012 on
Range Rover Evoque L538 China Build	2014 on

At Rimmer Bros, we opt to use the best carriers in the business to ensure your order is delivered safely, securely, and on time.

Orders are despatched as soon as practically possible. If your parts are required urgently and you want an express delivery service, please tell us.

We use Royal Mail's first class post service or international standard (formerly air mail) service for small packages and DPD, UPS and Fedex for most of our domestic and the majority of our overseas parcels. Larger domestic orders are sent via DX Freight, and for customers in Europe we also utilise DPD (as an alternative to UPS) for a cost effective, economy delivery service by road.

These options provide our customers with a choice of the best services available.

Guide prices for shipping (including packaging and handling), are shown below.

Shipping charges for export of oversize parcels outside the UK may need to be quoted once the order is picked and packed. Please also see below for further details.

Once your order is shipped and providing we have your email address, we will email confirmation to you, including tracking information if applicable.

Please note that as a security measure, your first order with us must be delivered to the credit card holders registered address.



United Kingdom

We utilise Royal Mail's first class post service, DPD or UPS Standard Service, depending upon size, weight and urgency. Larger domestic orders are sent via DX Freight or Pallet couriers.

We aim to despatch all UK orders within 24hrs, subject to stock availability and payment being received. Orders containing items which are advertised as "available to order", or are temporarily out of stock will take longer, depending on stock availability from our suppliers.

The majority of UK orders are delivered within 1-3 working days. Certain off-shore, remote, Scottish Highland and Northern Ireland destinations may take longer. Bulky and very heavy items may also take longer. If you require your parts urgently, a UK Mainland next working day express option is available for orders placed by 3pm except for oversize parcels where the order must be placed by 10am. You can also choose to have your order sent to an alternative work address or direct to your garage. A nominated delivery day option is also available, as is a same day service for very urgent items. All orders sent by carrier or Royal Mail Special Delivery / DPD pre Noon will require a signature on delivery. We will send you an order despatch confirmation email and tracking number providing we have your email address. Order tracking is not available for Royal Mail first class post deliveries, so please wait a full 3-5 working days for your order to arrive. Royal Mail will only accept claims for loss after 10 working days from due date on first class post and 5 working days on Special Delivery.

Shipping charges (including packaging & handling) are calculated on the weight of the consignment and the desired shipping method.

Please note that our minimum postage charge reflects our cost of processing, picking, packing and despatching your order and may sometimes appear disproportionate with an order of very low value. An order of £10 or less will usually attract the minimum postage charge, so we recommend you add some other items to increase the order value to make the postage charge more cost effective.

The UK chart on the opposite page is a guide to our shipping charges and transit times.

Supplements apply to out of area rural destinations including Highlands, Scottish Islands, Northern Ireland, Isle of Man, Isle of Wight, and the Channel Islands and for certain 'hazardous' products, such as aerosols, paints, fluids and chemicals. Please enquire for shipping to BFPO addresses. Any quoted delivery times are for 'working days' from despatch and exclude weekends and bank holidays. All delivery times are guides. Certain large or bulky items may incur an additional packing charge. Please note that the delivery driver may need assistance to unload large/heavy items - Please advise if special delivery arrangements are required.

EU Countries

We utilise Royal Mail Airmail for small parcels and DPD Classic for an economy, larger parcel delivery service by road for most European destinations at a low, fixed price box rate up to 31.5Kg (not exceeding 175cm length and 300cm girth which is length cm + 2 x width cm + 2 x height cm) - meaning that it costs no more to include extra parts! We also use UPS Road and Air services. Large European orders are sent by air or road freight by alternate carriers, depending upon destination and speed of service required.

We aim to despatch all export orders within 48 hours of receipt, subject to stock availability and payment for goods and shipping charges being received. Orders containing items which are advertised as "available to order", or are temporarily out of stock will take longer depending on stock availability from our suppliers. To keep shipping charges as low as possible, we may hold orders until all stock is available to ship as one consignment.

Delivery times will be dependent on location and delivery method selected. See guide below for estimated times. Bulky and very heavy items may take longer. If you require your parts urgently, an Express option is available. A Next Day service is available for very urgent orders to certain European locations. All orders sent by Carrier will require a signature on delivery. You can choose to have your order sent to an alternative work address or direct to your garage. We will send you an order despatch confirmation email and tracking number providing we have your email address. Order tracking is not available for Royal Mail Air Mail deliveries and we cannot accept a claim for loss unless at least 20 working days have passed from the due delivery date.

Shipping charges (including packaging & handling) are based on weight and volume. Our order system automatically calculates the shipping charge based only on the weight of the goods.

For orders that include oversize, large / bulky parts (e.g. body panels), an additional shipping charge may be incurred, which may not be reflected at the time of ordering. This is because the charge is calculated on physical weight, rather than volumetric weight. This can not be calculated until the order is packed, measured and weighed. If the volumetric weight exceeds the physical weight, we will notify you by email prior to despatch if the estimated shipping charge is insufficient and inform you of the new shipping total, seeking your authorisation to proceed.

Certain large or bulky items may also incur an additional packing charge.

The EU chart on opposite page is a guide to our shipping charges and transit times for EU destinations

Any quoted delivery times are for 'working days' from despatch and exclude weekends and bank holidays. All delivery times are guides. Small orders are sent via Royal Mail Air Mail service and will usually arrive within 5-15 days depending on location. Large and bulky or heavy items and orders, will be sent using international freight services. We will contact you to advise on prices and service speeds available to your destination.

VAT at the ruling rate will be applied to the order if shipped within the EU. Please note that there may be shipping restrictions for overseas destinations for certain 'hazardous' products, such as aerosols, paints, fluids and chemicals. Please enquire for shipping to BFPO addresses. Orders cannot be sent to American Forces Post Offices (APO's).

OTHER THINGS TO NOTE

Please check your parcels

When you sign for a parcel being delivered, please inspect it carefully. If it has suffered in transit, you can mark the delivery note 'Parcel Damaged', before signing, or even refuse delivery in serious cases. We do of course pack carefully to help avoid these problems! Some deliveries involve more than one parcel - please check that all have been received. We must be advised within 48 hours of delivery of any shortages or damaged goods.

Loss In Transit

If your parcel does not arrive, we have to establish our claim with the carriers concerned before we can send a replacement consignment. This can sometimes be a lengthy process, and if your part is needed urgently, a second order can be paid for to save time. We refund one of your orders as soon as the carriers clear our claim.

Worldwide (Non EC Countries)

We utilise Royal Mail Airmail and a combination of UPS and Fedex services. Larger overseas orders are sent by air or sea freight by alternate carriers, depending upon destination and speed of service required.

We aim to despatch all export orders within 48 hours of receipt, subject to stock availability and payment for goods and shipping charges being received. Orders containing items which are advertised as "available to order", or are temporarily out of stock will take longer depending on stock availability from our suppliers. To keep shipping charges as low as possible, we may hold orders until all stock is available to ship as one consignment.

Delivery times will be dependent on location and delivery method selected. See guide below for estimated times. Bulky and very heavy items may take longer. If you require your parts urgently, an Express option is available. All orders sent by Carrier will require a signature on delivery. You can choose to have your order sent to an alternative work address or direct to your garage. We will send you an order despatch confirmation email and tracking number providing we have your email address. Order tracking is not available for Royal Mail Air Mail deliveries and we cannot accept a claim for loss unless at least 25 working days have passed from the due delivery date.

Shipping charges (including packaging & handling) are based on weight and volume.

Our order system automatically calculates the shipping charge based only on the weight of the goods.

For orders that include oversize, large / bulky parts (e.g. body panels), an additional shipping charge may be incurred, which may not be reflected at the time of ordering. This is because the charge is calculated on physical weight, rather than volumetric weight. This can not be calculated until the order is packed, measured and weighed. If the volumetric weight exceeds the physical weight, we will notify you by email prior to despatch if the estimated shipping charge is insufficient and inform you of the new shipping total, seeking your authorisation to proceed.

Certain large or bulky items may also incur an additional packing charge.

The Worldwide chart opposite is a guide to our shipping charges and transit times for Worldwide (Non UK/EU) destinations

Any quoted delivery times are for 'working days' from despatch and exclude weekends and bank holidays. All delivery times are guides. Small orders are sent via Royal Mail Airmail service and will usually arrive within 5-15 days depending on location. Large and bulky or heavy items and orders, will be sent using international freight services. We will contact you to advise on prices and service speeds available to your destination.

We do not charge VAT on orders despatched directly outside the EU however, any local import duty, taxes or customs clearance are not included in our prices and must be paid for by you, usually at the time of delivery by the Carrier. Please note that there may be shipping restrictions for overseas destinations for certain 'hazardous' products, such as aerosols, paints, fluids and chemicals. Please enquire for shipping to BFPO addresses. Orders cannot be sent to American Forces Post Offices (APO's)

UNITED KINGDOM SHIPPING CHARGES AND TRANSIT TIMES

Service	Transit Times From Despatch*	Price ex VAT
Royal Mail First Class Post	Usually 1 - 3 working days - Excludes Hazardous Goods	From £2.50
Royal Mail Special Delivery / DPD Pre Noon	Order By 3pm Next working day from despatch Mon - Fri (not inc Saturday)	From £6.95
Standard Carrier Delivery	Usually 2 - 3 working days Mon- Fri	From £7.95
Next Day Express Carrier	Order by 3pm for Next working day Mon - Fri delivery from despatch	From £10.95
Pre-12 Carrier Delivery	Order by 3pm Before 12 o'clock the following day	From £18.95
Nominated Day Delivery	Any week day of your choice (minimum 48hr notice)	From £10.95
Saturday Delivery	Order by Phone by 3pm on Friday for Saturday delivery	From £9.75
Sunday Delivery	Order by Phone by 10am on Saturday for Sunday delivery	From £12.95
Collection in person from our Lincoln Showroom	Open weekdays 08:30 - 17:30, Saturday 08:30 - 13:00	FREE
Delivery to classic car shows and meetings	See which UK and international shows we are attending on our events page	FREE
Same-Day	Location restrictions apply Contact us - 01522 568000	

*We aim to despatch all UK orders within 24hrs. Prices shown exclude VAT.

EC SHIPPING CHARGES AND TRANSIT TIMES

Area	STANDARD Delivery via DPD Up to 31.5kg Box		EXPRESS Delivery via UPS Express Saver Based on Weight / Size	
	Price ex VAT	Transit Time From Despatch* Approx	Price ex VAT From 1kg	Transit Time From Despatch* Approx
Austria	£14.95	3 days	£24.80	1 day
Belgium	£12.95	2 days	£22.46	1 day
Bulgaria	£24.95	4-6 days	£27.05	2-3 day
Croatia	UPS Only	UPS Only	£42.38	2-3 day
Czech Republic	£17.95	3-4 days	£26.95	1-2 day
Denmark	£14.95	3 days	£24.80	1 day
Estonia	£19.95	4-5 days	£27.05	1-2 day
Finland	£19.95	4-5 days	£24.80	1-2 day
France	£12.95 (Chronopost / Exapaq)	2 days	£22.81	1 day
Germany	£12.95	2 days	£22.81	1 day
Greece	From £14.35 (UPS Only)	6-10 days	£24.80	1-2 day
Hungary	£19.95	4-6 days	£26.95	2-3 day
Iceland	UPS Only	UPS Only	£42.38	2-3 day
Italy	£17.95 (BRT Corriere Espresso)	3-4 days	£24.80	1 day
Latvia	£24.95	4-6 days	£27.05	2-3 day
Lithuania	£24.95	4-6 days	£27.05	2-3 day
Luxembourg	£12.95	2 days	£22.46	1 day
Netherlands	£12.95	2 days	£22.46	1 day
Norway	From £20.28 (UPS Only)	4-6 days	£39.73	1-2 day
Poland	£19.95	4-5 days	£26.95	1-2 day
Portugal**	£19.95 (Chronopost)	4-5 days	£24.80	1-2 day
Republic of Ireland	£12.95	2 days	£22.46	1 day
Romania	£24.95	4-6 days	£27.05	2-3 day
Russia	Enquire	Enquire	Enquire	Enquire
Slovak Republic	£17.95	3-4 days	£26.95	1-2 day
Slovenia	£19.95	4-5 days	£26.95	1-2 day
Spain***	£17.95 (Seur)	3-4 days	£24.80	1 day
Sweden	£19.95	4-5 days	£24.80	1-2 day
Switzerland	From £20.28 (UPS Only)	4-6 days	£39.73	1-2 day

*We aim to despatch all export orders within 48 hours. Prices shown exclude VAT.

Excludes Madeira and the Azores. *Excludes Balearic and Canary Islands

WORLDWIDE (NON UK/EC) SHIPPING CHARGES AND TRANSIT TIMES

Area	UPS Express Saver		FedEx Int Economy	
	Transit Time From Despatch* Approx	Prices From 1kg	Transit Time From Despatch* Approx	Prices From 1kg
Africa / Middle East	2-5 days	From £28.12	6-7 days	From £25.00
Asia	2-5 days	From £28.12	5-7 days	From £20.50
Australia	2-5 days	From £28.12	5-7 days	From £20.50
Canada	2 days	From £23.71	5-6 days	From £16.50
New Zealand	2-5 days	From £35.49	5-7 days	From £20.50
North America	2 days	From £23.71	5-6 days	From £15.00
South and Central America	3-4 days	From £53.74	5-7 days	From £25.00

*We aim to despatch all export orders within 48 hours

RETURNS & EXCHANGE OLD UNITS

All returns must be pre-authorized with a returns authorisation (RA) number. Returned products without an RA number will be subject to delay and possible return to sender. All returns are subject to a physical inspection.

We must have received and inspected the product before an exchange or credit can be issued (see also Warranty & Legal Info). Defective items are backed 100% and after 30 days can be returned for exchange only.

Returns of Parts Not Required - within 14 days

All goods sold by Mail Order are covered by the Consumer Contracts Regulations, which allow for a fourteen day 'cooling off' period during which you may cancel your order (in writing) by sending us a letter, fax or e-mail at any time up to and including the fourteenth working day after the day on which you received your purchase.

If you exercise your statutory right to cancel you must immediately return to us (at your own cost), the item(s) that you do not wish to keep. Return carriage charges are non-refundable. We will acknowledge receipt of your written cancellation by issuing a 'Returns Authorisation Number' which should be quoted and accompanied by a proof of purchase or invoice when returning the goods.

Please ensure all goods are adequately packed to avoid damage, that you insure them accordingly with the carrier used and obtain a proof of shipment. Please note that all goods must be in the condition supplied at the point of sale and with their original, undamaged packaging. Returns are not permitted on parts specially ordered by Rimmer Bros on customer's behalf.

Returns of parts not required - within 14 - 28 days

As an added benefit to Rimmer Bros customers and in addition to your statutory cancellation right (as detailed above), returns may be considered outside the 14 day cooling off period up to and including 28 days after you receive your purchase, subject to the following criteria. Please note that any offset, credit or refund will be at the sole discretion of Rimmer Bros Ltd.

A 'Returns Authorisation Number' must be applied for within the 14 to 28 day period. Where goods have been correctly supplied, it may be possible to offset the full value of the return against another order of the same or higher value. Alternatively, a credit note (for the full value) could be offered. Please note that any cash refund will be subject to a handling charge (typically 15% min £5) to cover administration and re-stocking costs. Return carriage charges are non-refundable.

All goods returned for a credit or exchange must be accompanied by our invoice quoting the 'Return Authorisation Number'. Please complete the form on the reverse side of the invoice. Goods must be adequately packed to avoid damage. You should insure them accordingly with the carrier and obtain a proof of shipment. No responsibility can be accepted for goods received by us, damaged. Goods must be in the condition supplied at the point of sale and with their original, undamaged packaging. Returns are not permitted on parts specially ordered by Rimmer Bros on customer's behalf.

Returns of Parts Not Required - Outside 28 days

No returns will be considered after 28 days unless covered by the terms and conditions of our Warranty.

Returns of Exchange 'Old Units'

There is no specific time limit for the return of exchange old units except for Genuine Land Rover parts, where old core must be returned within 80 days. Please contact us prior to returning the old unit for a 'Return Authorisation Number'. This speeds up the process of returning the surcharge refund. See reverse of invoice for full details of returns procedure.

Please note that old core must be complete and serviceable and drained of fluids where applicable. We reserve the right to retain all or part of the surcharge if the unit is irreparable, damaged or not identical to the type supplied.

Old core parts should NOT be disassembled for inspection purposes.

The core parts returned MUST be the same as the original part supplied and MUST be returned in the packaging used for the supply of the original part, AND must be safely fixed/fastened in that packaging – failure to comply may result in a charge being levied for any resulting or consequential costs incurred.

Returned core parts should NOT be cleaned by abrasive methods such as sandblasting or glass beading. If such cleaning methods have been used and damage has occurred the return core will be rejected and no credit will be issued.

Other Returns

Other returns will be dealt with in accordance with your statutory rights, if applicable, or our warranty.

Returns Processing

Please note that returns are processed as quickly as possible. During busy periods, especially in the Spring and Summer, returns may take up to 14 days to process. Your statutory rights remain unaffected.



WARRANTY & LEGAL INFO

Parts Warranty

All new and reconditioned parts are covered by a 12 month manufacturer's warranty unless specifically stated. You should notify us immediately if a potential warranty situation arises. We will then advise a course of action. Any suspected faulty part must be returned to us together with the original invoice or proof of purchase and with as much information relating to the problem as possible. **Please note that a defective part must be returned and received by us before it can be exchanged.** All warranty parts are subject to a physical inspection. This may involve returning the part to our supplier to verify the fault before it can be exchanged. Defective items are backed 100% and after 30 days can be returned for exchange only. For warranty claims please state vehicle chassis number, date fitted & mileage, date failed & mileage and exact nature of fault.

The warranty period commences from our invoice date not from the date of installation or first use. This warranty covers defects to the part when fitted and used correctly for normal, everyday vehicle use but does not apply to parts used for any extraordinary or unusual uses such as competition, racing, rallying or parts subsequently stripped down, altered, modified or adapted etc. in any way from their original design or intended use.

Although we are, by law, liable for death or personal injury caused by our proven negligence and by the Consumer Rights Act 2015, our warranty only covers the parts in question and not to any consequential loss or cost, eg garage labour, recovery, car hire, re-delivery, parking fines etc. No claim will be validated if the failure is caused by misuse, neglect, overheating, incorrect installation or failure of a related component.

Any part replaced or repaired under warranty, will only benefit from the balance of the cover remaining from the original purchase date. Warranties are not transferable. Acceptance of goods is deemed as acceptance of these terms. The warranties are in addition to, and do not affect your statutory consumer rights.

Legal Info

Errors & Omissions Excepted. Please tell us if you think something is wrong in this Catalogue. All parts offered subject to availability.

All part numbers, illustrations and photographs used are intended for reference and identification purposes only and are not necessarily an exact representation of the goods supplied. Photographs of parts should be considered indicative of what we supply rather than an exact representation as sources of supply and manufacture can change.

Whilst we make every effort to ensure the accuracy of product descriptions, illustrations and photographs, they are based upon information supplied by the manufacturer or distributor at the time.

There may be occasions - due to circumstances beyond our control - when specifications are changed, or when goods become temporarily unavailable.

Certain part numbers may have been superseded to an alternative number when a later version or updated specification is offered.

© Copyright Rimmer Bros Ltd. All rights reserved. No part of this publication may be copied, reproduced, stored in any retrieval system, communicated or transmitted in any form or by any means, including Photocopying, Electronic, Mechanical or otherwise, without prior written permission from Rimmer Bros Ltd.



Insurance solutions*
for classics and more.



- CLASSIC + MODERN CAR
- CLASSIC + MODERN BIKE
- MULTI VEHICLE
- COLLECTORS
- KIT CAR
- COMPETITION CAR
- CLASSIC MOTOR TRADE
- MOTORSPORT SUPPORT VEHICLE



At FJ we understand every classic vehicle owner is different.
With FJ+ you can build your classic vehicle policy from a range
of cover options* including **breakdown**, **agreed value**, **salvage
retention** and **spare parts**.

Call our friendly UK team for a quote.

0333 207 6256

or visit:

footmanjames.co.uk



Part of the Towergate Group

PROUD PARTNERS OF:

*All cover is subject to insurers terms and conditions, which is available upon request.

Footman James is a trading name of Towergate Underwriting Group Limited. Registered in England No. 4043759. Registered Address: Towergate House, Eclipse Park, Sittingbourne Road, Maidstone, Kent ME14 3EN. Authorised and regulated by the Financial Conduct Authority. Telephone calls may be monitored or recorded. Sign up to our newsletter at footmanjames.co.uk to receive updates on all the latest news, events, offers and competitions.FP ADGE674.9.16

SIDE STEPS/SIDE TUBES

Side Steps

- Made from UK steel, powder coated to a high specification gloss black
- Plastic runners run along the steps to prevent wear, but also provide a non-slip covering
- Instructions and fittings make these steps easy to fit

Defender 90
Rubber Tread (pair)
VPLDP0067P
 PRICE EX VAT (OUTSIDE EU) **£209.95** PRICE INC VAT (UK @ 20%) **£251.94**

Defender 110
Rubber Tread (pair)
VPLDP0068P
 PRICE EX VAT (OUTSIDE EU) **£159.95** PRICE INC VAT (UK @ 20%) **£191.94**

Defender 90

Side Steps

Aluminium Chequer Plate Tread (pair)
LL1257BMALI
 PRICE EX VAT (OUTSIDE EU) **£130.83** PRICE INC VAT (UK @ 20%) **£157.00**

Aluminium Tread (pair)
LL1257BM
 PRICE EX VAT (OUTSIDE EU) **£205.83** PRICE INC VAT (UK @ 20%) **£247.00**

Black Chequer Plate Tread (pair)
LL1257BMBLK
 PRICE EX VAT (OUTSIDE EU) **£165.00** PRICE INC VAT (UK @ 20%) **£198.00**

Defender 90

Tomb Raider Style Side Steps

Chequer Plate (pair)
LL1313BP
 PRICE EX VAT (OUTSIDE EU) **£119.50** PRICE INC VAT (UK @ 20%) **£143.40**



Available in Black or Stainless Steel

Stainless Steel (pair)

LL1313BPSS
 PRICE EX VAT (OUTSIDE EU) **£165.00** PRICE INC VAT (UK @ 20%) **£198.00**

Fire & Ice Style Side Steps (pair)



Available in Black or Stainless Steel

Defender 90 (2003 on)
Defender 110 (2 Door Pick Up)

Black with Rubber & Anodised Aluminium Top
LR008379BP
 PRICE EX VAT (OUTSIDE EU) **£225.83** PRICE INC VAT (UK @ 20%) **£271.00**

Stainless Steel
LR008379BPSS
 PRICE EX VAT (OUTSIDE EU) **£358.33** PRICE INC VAT (UK @ 20%) **£430.00**

Defender 110 (Not 2 Door Pick Up)

Black with Rubber & Anodised Aluminium Top
LR008375BP
 PRICE EX VAT (OUTSIDE EU) **£279.17** PRICE INC VAT (UK @ 20%) **£335.00**

Stainless Steel
LR008375BPSS
 PRICE EX VAT (OUTSIDE EU) **£495.83** PRICE INC VAT (UK @ 20%) **£595.00**

'Fire & Ice' Tubular Side Steps



- Heavy Duty Steel and Zinc Galvanised
- Black Powder Coat
- Masai Tread Plate
- Rubber/Brushed Aluminium
- Easy to Fit
- Supplied as a pair



Defender 90
LL1854
 PRICE EX VAT (OUTSIDE EU) **£225.00** PRICE INC VAT (UK @ 20%) **£270.00**

Defender 110 (2 Door)
LL1852
 PRICE EX VAT (OUTSIDE EU) **£299.99** PRICE INC VAT (UK @ 20%) **£359.94**

Defender 110 (4 Door)
LL1853
 PRICE EX VAT (OUTSIDE EU) **£299.99** PRICE INC VAT (UK @ 20%) **£359.94**

Defender 110 Side Steps



Chequer Plate Tread (pair)
LL1259BM
 PRICE EX VAT (OUTSIDE EU) **£189.50** PRICE INC VAT (UK @ 20%) **£227.40**

Defender 110 Side Steps



Black with Rubber Top (pair)
STC8015AABP
 PRICE EX VAT (OUTSIDE EU) **£225.83** PRICE INC VAT (UK @ 20%) **£271.00**

Defender 110 Side Tubes



Stainless Steel (pair)
LL1314BPSS
 PRICE EX VAT (OUTSIDE EU) **£220.00** PRICE INC VAT (UK @ 20%) **£264.00**

Defender Folding Side Steps



Genuine
STC7631
 PRICE EX VAT (OUTSIDE EU) **£81.48** PRICE INC VAT (UK @ 20%) **£97.78**

Britpart
STC7631BP
 PRICE EX VAT (OUTSIDE EU) **£29.58** PRICE INC VAT (UK @ 20%) **£35.50**



Rubber Tread for Side Step Tyre Tread Pattern
STC7631BPTREAD
 PRICE EX VAT (OUTSIDE EU) **£13.12** PRICE INC VAT (UK @ 20%) **£15.74**

SIDE STEPS/SIDE TUBES

Series Ila, 88 & 109

Side Step



Spring Loaded Action

LL1583BM

PRICE EX VAT (OUTSIDE EU) **£58.33** PRICE INC VAT (UK @ 20%) **£70.00**

Discovery 1

Side Steps

Rubber Tread Chevron (pair)

RTC9507ABPC

PRICE EX VAT (OUTSIDE EU) **£172.33** PRICE INC VAT (UK @ 20%) **£206.80**



Discovery 2

Side Steps

Not compatible with mudflaps

Chequer Plate (pair)

STC50030P

PRICE EX VAT (OUTSIDE EU) **£173.33** PRICE INC VAT (UK @ 20%) **£208.00**



Discovery 2

Side Steps

(inc. Mudflaps)

Stainless Steel (pair)

STC50032BP

PRICE EX VAT (OUTSIDE EU) **£175.83** PRICE INC VAT (UK @ 20%) **£211.00**



Discovery 3 & 4 Alloy Finish Edge, Rubber Anti-Slip Treads (pair)

Side Steps

VPLAP0035P

PRICE EX VAT (OUTSIDE EU) **£163.33** PRICE INC VAT (UK @ 20%) **£196.00**



Discovery 3 & 4

Side Tubes

Black (pair)

VTD500010BM

PRICE EX VAT (OUTSIDE EU) **£105.83** PRICE INC VAT (UK @ 20%) **£127.00**

75mm Diameter Tube with Rubber Foot Mouldings

Available in Black or Stainless Steel

Stainless Steel (pair)

VTD500020BM

PRICE EX VAT (OUTSIDE EU) **£175.83** PRICE INC VAT (UK @ 20%) **£211.00**



Discovery Sport

Side Steps

Black (pair)

VPLCP0210

PRICE EX VAT (OUTSIDE EU) **£572.05** PRICE INC VAT (UK @ 20%) **£686.46**

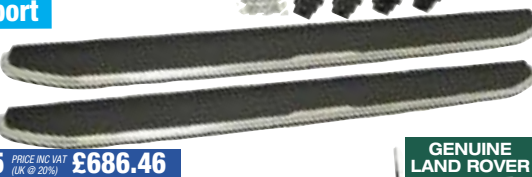

GENUINE LAND ROVER

Discovery Sport

Side Tubes

GENUINE LAND ROVER

VPLCP0209

PRICE EX VAT (OUTSIDE EU) **£525.24** PRICE INC VAT (UK @ 20%) **£630.29**

75mm Diameter Tube with Rubber Foot Mouldings, Black (pair)

STC7945AABM

Aftermarket

PRICE EX VAT (OUTSIDE EU) **£97.25** PRICE INC VAT (UK @ 20%) **£116.70**



Freelander 1

Side Steps

75mm Diameter Tube with Rubber Foot Mouldings, Stainless Steel (pair)

STC7943AABM

PRICE EX VAT (OUTSIDE EU) **£170.83** PRICE INC VAT (UK @ 20%) **£205.00**



Freelander 1

Side Steps

Galvanised Steel Encased in Rubber (pair)

STC53077GBM

PRICE EX VAT (OUTSIDE EU) **£155.83** PRICE INC VAT (UK @ 20%) **£187.00**



Freelander 2

Side Steps

Thermo Plastic Elastomer Tops & Brushed Aluminium Side Trim (pair)

LR002773P

PRICE EX VAT (OUTSIDE EU) **£145.83** PRICE INC VAT (UK @ 20%) **£175.00**



Range Rover Classic

Side Steps

Rubber Tread Chevron (pair)

RTC9507ABPC

PRICE EX VAT (OUTSIDE EU) **£172.33** PRICE INC VAT (UK @ 20%) **£206.80**



Range Rover P38

Side Steps

Rubber Encased (pair)

STC8505AAP

PRICE EX VAT (OUTSIDE EU) **£167.50** PRICE INC VAT (UK @ 20%) **£201.00**



Range Rover L322

Side Protection Tubes

Stainless Steel (pair)

VUB001230P

PRICE EX VAT (OUTSIDE EU) **£308.33** PRICE INC VAT (UK @ 20%) **£370.00**



Range Rover L322

Side Steps

Thermo Plastic Elastomer Tops (pair)

VUB503660P

PRICE EX VAT (OUTSIDE EU) **£195.00** PRICE INC VAT (UK @ 20%) **£234.00**

Insert Moulding for above

RH **VUB001300BP** 50.83 61.00

LH **VUB001310BP** 50.83 61.00



Range Rover Sport (2005-2013)

Side Steps

VPLSP0040P

PRICE EX VAT (OUTSIDE EU) **£175.83** PRICE INC VAT (UK @ 20%) **£211.00**

Alloy Finish Edge, Rubber Anti Slip Treads (pair)



Range Rover Sport (2014 on)

Side Steps (pair)

VPLGP0226P

PRICE EX VAT (OUTSIDE EU) **£295.83** PRICE INC VAT (UK @ 20%) **£355.00**



Range Rover Evoque

Side Steps

Brushed Stainless Steel (pair)

VPLVP0184BP

PRICE EX VAT (OUTSIDE EU) **£230.83** PRICE INC VAT (UK @ 20%) **£277.00**



ORDER

BY PHONE: 01522 568000 / ON LINE: www.rimmerbros.co.uk / E-MAIL: lrsales@rimmerbros.co.uk

*Prices include UK VAT @ 20%.



ROCK GUARDS/ TREE SLIDERS

Made from Galvanised box section (unless stated) designed especially for the off-road enthusiast. Replaces aluminium sill & bolts directly onto chassis and is more than able to support the weight of the whole vehicle. Can be painted to match the colour of your vehicle (supplied as a pair).

Defender 90 - All models
Rock Guards - Black

LL1164
PRICE EX VAT (OUTSIDE EU) **£125.83** PRICE INC VAT (UK @ 20%) **£151.00**

Defender 110 - All models
Rock Sliders - Galvanised inc jacking points

LL1167BMT
PRICE EX VAT (OUTSIDE EU) **£175.83** PRICE INC VAT (UK @ 20%) **£211.00**

Defender 90 - All models
Rock Sliders - Black inc jacking points

LL1164BMT
PRICE EX VAT (OUTSIDE EU) **£138.33** PRICE INC VAT (UK @ 20%) **£166.00**

Defender 110 - All models
Rock Sliders - Black & Orange

LL1856
PRICE EX VAT (OUTSIDE EU) **£230.00** PRICE INC VAT (UK @ 20%) **£276.00**

Defender 90 - All models
Rock Sliders - Galvanised inc jacking points

LL1165BMT
PRICE EX VAT (OUTSIDE EU) **£160.83** PRICE INC VAT (UK @ 20%) **£193.00**

Defender 130 - All models
Rock Guards - Black

LL1168
PRICE EX VAT (OUTSIDE EU) **£199.17** PRICE INC VAT (UK @ 20%) **£239.00**

Defender 90
Rock Sliders - Black & Orange

LL1857
PRICE EX VAT (OUTSIDE EU) **£189.50** PRICE INC VAT (UK @ 20%) **£227.40**

Defender 130 - All models
Rock Sliders

LL1168T
PRICE EX VAT (OUTSIDE EU) **£210.83** PRICE INC VAT (UK @ 20%) **£253.00**

Defender 110 - All models
Rock Guards - Black

LL1166
PRICE EX VAT (OUTSIDE EU) **£149.17** PRICE INC VAT (UK @ 20%) **£179.00**

Range Rover Classic & Discovery 1
Rock Guards - Black Nylon Coated

RD1124BBM
PRICE EX VAT (OUTSIDE EU) **£113.33** PRICE INC VAT (UK @ 20%) **£160.00**

Defender 110 - All models
Rock Sliders - Black inc jacking points

LL1166BMT
PRICE EX VAT (OUTSIDE EU) **£150.83** PRICE INC VAT (UK @ 20%) **£181.00**

Range Rover Classic & Discovery 1
Rock Guards - Galvanised

RD1124GBM
PRICE EX VAT (OUTSIDE EU) **£158.50** PRICE INC VAT (UK @ 20%) **£190.20**

Defender 110 - All models
Rock Sliders - Galvanised

LL1167BM
PRICE EX VAT (OUTSIDE EU) **£150.83** PRICE INC VAT (UK @ 20%) **£181.00**

Range Rover Classic & Discovery 1 - 5 door
Rock Guards - Black

RD1124TF5
PRICE EX VAT (OUTSIDE EU) **£249.00** PRICE INC VAT (UK @ 20%) **£298.80**

Range Rover Classic & Discovery 1 - All models
Rock Sliders - Black Nylon Coated



RD1264BBM
 PRICE EX VAT (OUTSIDE EU) **£182.50** PRICE INC VAT (UK @ 20%) **£219.00**

Discovery 3 **Rock Sliders - Black**



RD1264TFD3
 PRICE EX VAT (OUTSIDE EU) **£250.00** PRICE INC VAT (UK @ 20%) **£300.00**

Range Rover Classic & Discovery 1 - All models
Rock Sliders - Galvanised



RD1264GBM
 PRICE EX VAT (OUTSIDE EU) **£205.00** PRICE INC VAT (UK @ 20%) **£246.00**

Discovery 3 & 4 - All models
Rock Slider/Side Step - Black



RD1284BP
 PRICE EX VAT (OUTSIDE EU) **£458.33** PRICE INC VAT (UK @ 20%) **£550.00**

Range Rover Classic & Discovery 1 - 3 door
Rock Sliders - Black



RD1264TF3
 PRICE EX VAT (OUTSIDE EU) **£299.00** PRICE INC VAT (UK @ 20%) **£358.80**

Discovery 3 & 4 - All models
Rock Guards - Aluminium (6mm)



RD1285BPA
 PRICE EX VAT (OUTSIDE EU) **£258.33** PRICE INC VAT (UK @ 20%) **£310.00**

Range Rover Classic & Discovery 1 - 5 door
Rock Sliders - Black



RD1264TF5
 PRICE EX VAT (OUTSIDE EU) **£299.00** PRICE INC VAT (UK @ 20%) **£358.80**

Discovery 3 & 4 - All models
Rock Guards - Black Aluminium (6mm)



RD1285BPAB
 PRICE EX VAT (OUTSIDE EU) **£258.33** PRICE INC VAT (UK @ 20%) **£310.00**

Discovery 2
Rock Guards - Black



RD1124TFD2
 PRICE EX VAT (OUTSIDE EU) **£249.00** PRICE INC VAT (UK @ 20%) **£298.80**

Range Rover P38
Rock Guards - Black



RA2106TF
 PRICE EX VAT (OUTSIDE EU) **£222.00** PRICE INC VAT (UK @ 20%) **£266.40**

Discovery 2
Rock Sliders - Black



RD1264TFD2
 PRICE EX VAT (OUTSIDE EU) **£275.00** PRICE INC VAT (UK @ 20%) **£330.00**

Range Rover P38
Rock Sliders - Black



RA2107TF
 PRICE EX VAT (OUTSIDE EU) **£349.00** PRICE INC VAT (UK @ 20%) **£418.80**



TREE FENDER

Easily fitted to the rear side panels of the Defender models. Offering protection from those annoying scratches and dents.



Tree Fender - Black

Defender 90
LL1612S PRICE EX VAT (OUTSIDE EU) **£99.50** PRICE INC VAT (UK @ 20%) **£119.40**

Defender 110
LL1612L PRICE EX VAT (OUTSIDE EU) **£199.17** PRICE INC VAT (UK @ 20%) **£239.00**

REAR STEPS



Rear Tow Ball Step

Will also fit any vehicle with a drop plate tow hitch.

Defender - All models



Black Finish

LL1256BPBLACK

PRICE EX VAT (OUTSIDE EU) £19.37 PRICE INC VAT (UK @ 20%) £23.24



Zinc Plated

LL1256BP

PRICE EX VAT (OUTSIDE EU) £17.50 PRICE INC VAT (UK @ 20%) £21.00

Rear Tow Bar & Step



Defender 90 - All models

This NAS rear step is also a tow bar and is securely bolted to the rear cross member & chassis on all Defender 90 models. Made from black powder coated steel tube and stylishly fabricated to include an alloy tread plate step. The position of the towing bracket also allows for easier hitching when towing as it is less obscured by the door mounted spare wheel.

STC50269AATF

PRICE EX VAT (OUTSIDE EU) £329.17 PRICE INC VAT (UK @ 20%) £395.00

Defender 110 - From 1999 on

Same style as STC50269AATF but fits the Defender 110 from 1999 on (VIN XA159807 on)



STC50301BP

PRICE EX VAT (OUTSIDE EU) £280.00 PRICE INC VAT (UK @ 20%) £336.00

Rear Folding Steps

Discovery 1 - All models



Hydraulic Step

RTC9505ACP

PRICE EX VAT (OUTSIDE EU) £98.33 PRICE INC VAT (UK @ 20%) £118.00

Discovery 2 - All models to VIN 1A298103

Genuine Land Rover



STC50290

PRICE EX VAT (OUTSIDE EU) £198.84 PRICE INC VAT (UK @ 20%) £238.61



Defender - All models



Folding Rear Step with Rubber Top

STC7632BP

PRICE EX VAT (OUTSIDE EU) £29.58 PRICE INC VAT (UK @ 20%) £35.50

Defender - All models

Folding Rear Step Support Bracket



OEM - MXC1624P1

PRICE EX VAT (OUTSIDE EU) £11.14 PRICE INC VAT (UK @ 20%) £13.25

GENUINE - MXC1624

PRICE EX VAT (OUTSIDE EU) £11.11 PRICE INC VAT (UK @ 20%) £13.33

Defender - All models

Folding Rear Step with Rubber Tyre Tread Top



STC7632BPMT

PRICE EX VAT (OUTSIDE EU) £32.08 PRICE INC VAT (UK @ 20%) £38.50

SPARE WHEEL CARRIERS

Spare Wheel Carrier Swingaway (Hard Top)
Sturdily mounted to the chassis to ensure minimum strain on the rear door hinges.



Series III - All models
Defender 90 & 110 - to VIN 1A622423

LL1226BM PRICE EX VAT (OUTSIDE EU) £138.33 PRICE INC VAT (UK @ 20%) £166.00

Defender 90 & 110 - from VIN 1A622424

LL1226BM02 PRICE EX VAT (OUTSIDE EU) £158.33 PRICE INC VAT (UK @ 20%) £190.00

Series III - All models
Defender 90 & 110 - to VIN 1A622423

LL1226BP PRICE EX VAT (OUTSIDE EU) £173.33 PRICE INC VAT (UK @ 20%) £208.00

Spare Wheel Carrier Swingaway (Soft Top)
Suitable for drop down/side opening tailgates.



Series III - All models
Defender 90 & 110 - to VIN 1A622423

LL1227BM PRICE EX VAT (OUTSIDE EU) £192.50 PRICE INC VAT (UK @ 20%) £231.00

Defender - Models with half door tailgate

LL1227BP PRICE EX VAT (OUTSIDE EU) £129.50 PRICE INC VAT (UK @ 20%) £155.40

Series & Defender - All models

Fixed Spare Wheel Rear Door Mount



ALR4125BP PRICE EX VAT (OUTSIDE EU) £33.75 PRICE INC VAT (UK @ 20%) £40.50

Series or Military Models

Spare Wheel Strap
Replacement strap for fixing your Series or Military spare wheel to the bonnet.



345510BP PRICE EX VAT (OUTSIDE EU) £9.79 PRICE INC VAT (UK @ 20%) £11.75

Defender 90 & 110 - All models

Mantec's legendary swing away wheel carrier removes the weight of the spare wheel from the door and transfers it to the chassis. Opening in conjunction with the normal door operation using a patent piston design.

The swing away is phosphate & powder coated providing a durable & great looking finish. For vehicles with alloy wheels an additional fitting kit is required (215SWC-DEF).



LL122602MANTEC PRICE EX VAT (OUTSIDE EU) £210.00 PRICE INC VAT (UK @ 20%) £252.00

Defender 90 & 110 - Soft Top or Pick Up

Swingaway Spare Wheel Carrier - Square or Tubular

- High strength steel construction, laser cut for superior clean welding
- High quality zinc plating & black powder coated finish
- Robust catch mechanism to allow swing function
- Complete with fitting kit



Square Section

LL1861 PRICE EX VAT (OUTSIDE EU) £99.50 PRICE INC VAT (UK @ 20%) £119.40

Tubular Section

LL1862 PRICE EX VAT (OUTSIDE EU) £120.00 PRICE INC VAT (UK @ 20%) £144.00



Series or Military Models

Bonnet Mounted Spare Wheel Carrier



GENUINE LAND ROVER

STC7633 PRICE EX VAT (OUTSIDE EU) £320.87 PRICE INC VAT (UK @ 20%) £385.04

ORDER

BY PHONE: 01522 568000 / ON LINE: www.rimmerbros.co.uk / E-MAIL: lrsales@rimmerbros.co.uk

*Prices include UK VAT @ 20%.

EXTERIOR STYLING - SPARE WHEEL CARRIERS

CHEQUER PLATE

Add some heavy duty protection to your Land Rover with this aluminium chequer plate. As well as offering protection it also looks great!

Proudly manufactured in the UK.



LL1209P-3



LL1335



LL1207P-3B



LL1207-3LHD

Bonnet Protection Set

Model	Material	Part Number	Price Ex VAT	Price Inc VAT*
Defender 90 & 110 to (VIN) 6A999999				
	2mm Aluminium	LL1209	40.00	48.00
	2mm Aluminium Black	LL1210	48.50	58.20
	3mm Aluminium	LL1209P-3	49.58	59.50
	3mm Aluminium Black	LL1209P-3B	55.83	67.00
Defender 90 & 110 from (VIN) 7A000001				
	2mm Aluminium (2 piece)	LL1368	90.00	108.00
	2mm Aluminium Black (2 piece)	LL1369	110.00	132.00
	3mm Aluminium (2 piece)	LL1209-3	115.83	139.00
	3mm Aluminium Black (2 piece)	LL1369-3	125.83	151.00



LL1374



LL1263-3

Sill Protectors (pair)

Model	Material	Part Number	Price Ex VAT	Price Inc VAT*
Series II 88, IIa 88 & Series III 88				
	2mm Aluminium	LL1374	29.58	35.50
	3mm Aluminium	LL1338PSWB	34.58	41.50
Series II 109, IIa 109 & Series III 109				
	2mm Aluminium	LL1375	29.58	35.50
Series II 109, IIa 109 & Series III 109 (Station Wagon)				
	3mm Aluminium	LL1338PLWB	34.58	41.50
Defender 90 all models				
	2mm Aluminium	LL1260P	25.00	30.00
	3mm Aluminium	LL1260-3	34.58	41.50
	2mm Aluminium Black	LL1261B	32.08	38.50
	3mm Aluminium Black	LL1261-3B	38.33	46.00
Defender 110 all models				
	2mm Aluminium	LL1262P	28.75	34.50
	3mm Aluminium	LL1262-3	34.58	41.50
	2mm Aluminium Black	LL1263	42.08	50.50
	3mm Aluminium Black	LL1263-3	39.50	47.50

Front Wing Protectors - Long (pair)

Model	Material	Part Number	Price Ex VAT	Price Inc VAT*
Series III all models				
	2mm Aluminium (long no vent hole)	LL1335	31.67	38.00
	2mm Aluminium Black (long no vent hole)	LL1335B	42.92	51.50
Defender 90 & 110 to (VIN) 6A999999				
	2mm Aluminium	LL1207	36.67	44.00
	3mm Aluminium Black	LL1207P-3B	44.58	53.50
	2mm Aluminium Black	LL1208	45.00	54.00
	3mm Aluminium Black	LL1208-3B	60.00	72.00
Defender 90 & 110 from (VIN) 7A000001				
	2mm Aluminium (RHD vehicles)	STC7667P	39.58	47.50
	3mm Aluminium (RHD vehicles)	LL1207P-3	49.58	59.50
	3mm Aluminium Black (RHD vehicles)	LL1208P-3B	48.50	58.20
	3mm Aluminium (LHD vehicles)	LL1207-3LHD	55.00	66.00
	3mm Aluminium Black (LHD vehicles)	LL1208P-3BLHD	49.58	59.50

Front Wing Protectors - Short (pair)

Model	Material	Part Number	Price Ex VAT	Price Inc VAT*
Defender 90 & 110 all models				
	2mm Aluminium	LL1335S	24.58	29.50

EXTERIOR STYLING - CHEQUER PLATE



Rear Wing Protectors (pair)

Model	Material	Part Number	Price Ex VAT	Price Inc VAT*
Series II, IIa & III all models				
	2mm Aluminium	LL1334	11.67	14.00
	2mm Aluminium Black	LL1334B	14.58	17.50
Defender 90 all models				
	2mm Aluminium	LL1211	19.58	23.50
	2mm Aluminium Black	LL1264	21.67	26.00
	3mm Aluminium	LL1211-3	22.71	27.25
	3mm Aluminium Black	LL1264-3B	29.58	35.50
Defender 110 all models				
	2mm Aluminium	LL1211P-2	24.58	29.50
	2mm Aluminium Black	LL1264P-2B	26.67	32.00
	3mm Aluminium	LL1211P-3	32.92	39.50
	3mm Aluminium Black	LL1264P-3B	39.58	47.50

LL1366

Door Protectors (pair)

Model	Material	Part Number	Price Ex VAT	Price Inc VAT*
Series III all models (bottom of front door)				
	2mm Aluminium	LL1336	8.96	10.75

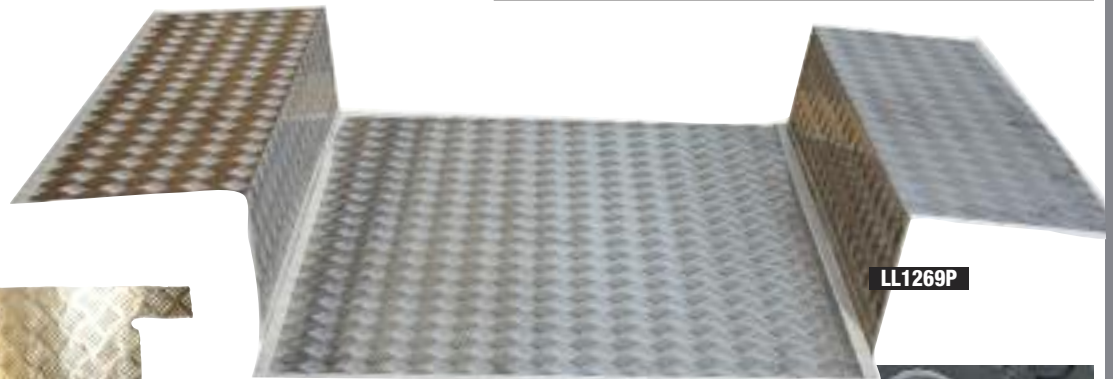

LL1269P

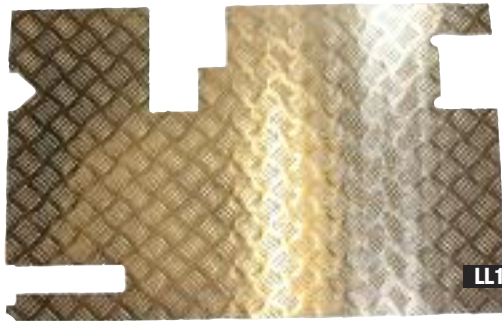

LL1268P

Rear Door (loadspace)

Model	Material	Part Number	Price Ex VAT	Price Inc VAT*
Defender without rear wiper				
	2mm Aluminium	LL1266P	39.58	47.50
Defender with rear wiper				
	2mm Aluminium EARLY	LL1267P	45.00	54.00
	2mm Aluminium LATE	LL1268P	42.92	51.50



Load Area Floor

Model	Material	Part Number	Price Ex VAT	Price Inc VAT*
Series III 88				
	2mm Aluminium	LL1337	115.83	139.00
Defender 90				
	2mm Aluminium	LL1269P	99.17	119.00
Defender 110				
	2mm Aluminium	STC61840P	95.83	115.00
Defender 110 Station Wagon load area sides				
	2mm Aluminium (pair)	STC61838P	95.83	115.00

Cross Member/Bumper

Model	Material	Part Number	Price Ex VAT	Price Inc VAT*
Series III all models				
	2mm Aluminium	LL1372P	29.58	35.50
Defender all models Bumper Top				
	2mm Aluminium	LL1265	8.33	10.00
Defender 90 Rear Cross Member				
	2mm Aluminium	LL1366P	25.83	31.00
Defender 90 & 110 Rear Cross Member all TD5 models				
	2mm Aluminium	LL1822	29.58	35.50
	2mm Aluminium Black	LL1822B	34.58	41.50
Defender all models tread plate bumper end covers				
	2mm Aluminium (pair)	STC61842P	14.58	17.70

Miscellaneous

Model	Material	Part Number	Price Ex VAT	Price Inc VAT*
Rivet for Chequer Plate				
All models 3/16" diameter (monobolt)			AFU1843	1.49 1.79
Mudflap Brackets (pair)				
Defender all models			LL1365	12.71 15.25
2mm Aluminium Chequer Plate Sheet				
1200mm x 2500mm			LL1376	120.83 145.00

AFU1843

STC61842P

WINCH BUMPERS

Terrafirma Pro Taper Bumper

When strength, functionality and good looks are the ultimate goal the Terrafirma Pro Taper bumper range will be your choice. With these bumpers the winch is raised above the chassis rails and, with the tapered and swept back wings, approach angle and styling are optimised even with air conditioned models. With large, high capacity winches becoming more and more popular for commercial and recreational use these bumpers for big and powerful winches are unmatched in the market place. Air cooling slots, built in recovery and jacking points complete these superb winch bumpers.

Defender - All models without air conditioning



LL1710TF
 PRICE EX VAT (OUTSIDE EU) **£295.83** PRICE INC VAT (UK @ 20%) **£355.00**

Defender - All models with air conditioning



LL1710TFAC
 PRICE EX VAT (OUTSIDE EU) **£295.00** PRICE INC VAT (UK @ 20%) **£354.00**

Also available
 TUV APPROVED LL1710TFACTUV 453.33 550.00

Winch Bumper with Bash Plate

Manufactured in heavy gauge tubular and plate steel and black powder coated, these bumpers offer superb value for money. Manufactured in the UK they all feature integral bash plate and jacking points to take standard hi-lift jacks. The mounting plate will take the majority of modern winches with no further drilling, however some cutting of the grille may be required. Includes interal A bar.

Defender 90 & 110 (non-air con)

To VIN 6A999999
BLACK with silver bash plate.



LL1449ABS
 PRICE EX VAT (OUTSIDE EU) **£262.50** PRICE INC VAT (UK @ 20%) **£315.00**

Also available
 As above but air-con models LL1449ABSAC 262.50 315.00

Defender 90 & 110 (non-air con)

To VIN 6A999999
Silver with black bash plate.

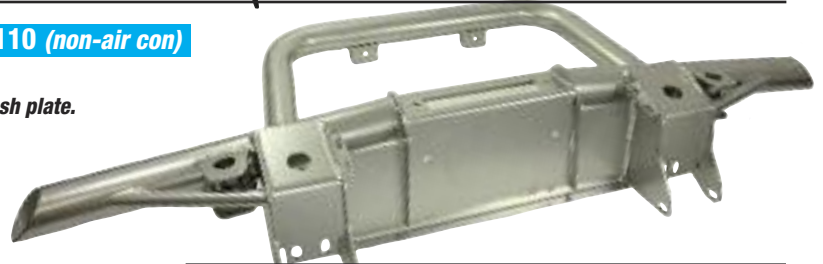

LL1449ASB
 PRICE EX VAT (OUTSIDE EU) **£249.17** PRICE INC VAT (UK @ 20%) **£299.00**

Also available
 As above but air-con models LL1449ASBAC 262.50 315.00

See page 112 for Winches and Winching Accessories

Defender 90 & 110 (non-air con)

To VIN 6A999999
Black with silver bash plate.

Suitable for BD1200i, DB5900i, DB9000c, DB800 winches



LL1449B
 PRICE EX VAT (OUTSIDE EU) **£249.17** PRICE INC VAT (UK @ 20%) **£299.00**

Also available
 As above but air-con models LL1449AC 215.00 298.44

Defender 90 & 110 (non-air con)

To VIN 6A999999
Silver with black bash plate.
 Suitable for BD1200i, DB5900i, DB9000c, DB800 winches



LL1449S
 PRICE EX VAT (OUTSIDE EU) **£249.17** PRICE INC VAT (UK @ 20%) **£299.00**

Defender 90 & 110

Suitable for BD1200i, DB5900i, DB9000c, DB800 winches



LL1449
 PRICE EX VAT (OUTSIDE EU) **£185.00** PRICE INC VAT (UK @ 20%) **£222.00**

Winch Bumper only

Winch frame and integral bumper. Replaces the original bumper, Black powder coated. No drilling or modifications required. Incorporates jacking points. Made from 6mm steel plate will fit air-con models as well.

Defender 90 & 110 (models with air con)

Suitable for Warn 9000 & 9.5 series winches.



LL1450ACWARN
 PRICE EX VAT (OUTSIDE EU) **£195.83** PRICE INC VAT (UK @ 20%) **£235.00**

Discovery 1 - All models

Black powder coated.



RD1245 PRICE EX VAT (OUTSIDE EU) **£205.00** PRICE INC VAT (UK @ 20%) **£246.00**

Discovery 2 - All models

Black powder coated.
(Manufactured from 5mm steel).
Fixed to standard mounting points,
grille will need trimming to fit winch.



RD1246BP PRICE EX VAT (OUTSIDE EU) **£195.83** PRICE INC VAT (UK @ 20%) **£235.00**

Discovery 1 - All models

Black with silver bash plate.



RA1521BM

PRICE EX VAT (OUTSIDE EU) **£283.33** PRICE INC VAT (UK @ 20%) **£340.00**

Range Rover P38 - All models

Black with silver bash plate.



RA1560

PRICE EX VAT (OUTSIDE EU) **£330.00** PRICE INC VAT (UK @ 20%) **£396.00**

Discreet Winch Bumpers

- Suitable for any low line winch
- Made from 6mm & 8mm steel
- Discreetly fits behind the existing bumper
- Bolts directly onto the front cross member using existing holes
- Modifications to the bumper are required (full instructions included)
- Excludes fairlead

Note – low line winch needs to have a removable solenoid, solenoid needs to be removed and relocated.

Discovery 3 & 4 - TDV6 engine
Range Rover Sport - TDV6 engine



LR015274BPWTDV6

PRICE EX VAT (OUTSIDE EU) **£320.83** PRICE INC VAT (UK @ 20%) **£385.00**

Range Rover Sport - 3.6 TDV8 engine
Range Rover Sport - 4.2 V8 Supercharged engine
Range Rover Sport - 4.4 V8 engine



LR015274BPWTDV8

PRICE EX VAT (OUTSIDE EU) **£320.83** PRICE INC VAT (UK @ 20%) **£385.00**

ORDER

BY PHONE: 01522 568000 / ON LINE: www.rimmerbros.co.uk / E-MAIL: lrsales@rimmerbros.co.uk

*Prices include UK VAT @ 20%.



GRILLES & AIR INTAKE SETS



Hi-Force Wing Top Air Intake Sets (Pairs)

Defender 90 & 110 - All models



Satin Black
AWR2214-5BMHFSB
PRICE EX VAT (OUTSIDE EU) **£42.99** PRICE INC VAT (UK @ 20%) **£51.59**

Zambezi Silver
AWR2214-5BMHFZS
PRICE EX VAT (OUTSIDE EU) **£56.99** PRICE INC VAT (UK @ 20%) **£68.39**

Santorini (gloss) Black
AWR2214-5BMHFGB
PRICE EX VAT (OUTSIDE EU) **£56.99** PRICE INC VAT (UK @ 20%) **£68.39**

Brunel Silver
AWR2214-5BMHFBS
PRICE EX VAT (OUTSIDE EU) **£56.99** PRICE INC VAT (UK @ 20%) **£68.39**

Sport Side Air Intakes (Right Hand)

Defender 90 & 110 - 200Tdi, 300Tdi, TD5 & TDci models

Standard versions include black fins & mesh.
Premium versions include silver fins & mesh.



Satin Black Premium
BTR6188BMSPBLKPREM
PRICE EX VAT (OUTSIDE EU) **£42.99** PRICE INC VAT (UK @ 20%) **£51.59**



Satin Black Standard
BTR6188BMSPBLKSTD
PRICE EX VAT (OUTSIDE EU) **£39.99** PRICE INC VAT (UK @ 20%) **£47.99**

Zambezi Silver Premium
BTR6188BMSPZSPREM
PRICE EX VAT (OUTSIDE EU) **£46.99** PRICE INC VAT (UK @ 20%) **£56.39**



Zambezi Silver Standard
BTR6188BMSPZSSTD
PRICE EX VAT (OUTSIDE EU) **£43.99** PRICE INC VAT (UK @ 20%) **£52.79**

Santorini Black Standard
LL1840
PRICE EX VAT (OUTSIDE EU) **£46.99** PRICE INC VAT (UK @ 20%) **£56.39**



Santorini Black Premium
LL1841
PRICE EX VAT (OUTSIDE EU) **£46.99** PRICE INC VAT (UK @ 20%) **£56.39**

Brunel Silver Premium
BTR6188BMSPBSPREM
PRICE EX VAT (OUTSIDE EU) **£46.99** PRICE INC VAT (UK @ 20%) **£56.39**



Brunel Silver Standard
BTR6188BMSPBSSTD
PRICE EX VAT (OUTSIDE EU) **£43.99** PRICE INC VAT (UK @ 20%) **£52.79**

Face Lift Grille and Light Surround Kits

Defender 90 & 110 - incl. air-con models



As well as offering stylish good looks, these three piece grille & lamp surround kits offer maximum airflow and rugged strength. Manufactured in tough injection moulded ABS to OEM standards they are easy to fit with no drilling (or specialist tools) required. Standard versions include black fins & mesh. Premium versions include silver fins & mesh.

Satin Black Premium
LL1349BM
PRICE EX VAT (OUTSIDE EU) **£175.00** PRICE INC VAT (UK @ 20%) **£210.00**

Satin Black Standard
LL1348BM
PRICE EX VAT (OUTSIDE EU) **£156.50** PRICE INC VAT (UK @ 20%) **£187.80**

Zambezi Silver Premium
LL1351BM
PRICE EX VAT (OUTSIDE EU) **£219.00** PRICE INC VAT (UK @ 20%) **£262.80**

Zambezi Silver Standard
LL1350BM
PRICE EX VAT (OUTSIDE EU) **£199.99** PRICE INC VAT (UK @ 20%) **£239.99**

Santorini Black Premium
LL1837
PRICE EX VAT (OUTSIDE EU) **£225.00** PRICE INC VAT (UK @ 20%) **£270.00**

Santorini Black Standard
LL1836
PRICE EX VAT (OUTSIDE EU) **£199.99** PRICE INC VAT (UK @ 20%) **£239.99**

Brunel Silver Premium
LL1351BMBS
PRICE EX VAT (OUTSIDE EU) **£219.00** PRICE INC VAT (UK @ 20%) **£262.80**

Brunel Silver Standard
LL1351BMBS
PRICE EX VAT (OUTSIDE EU) **£199.99** PRICE INC VAT (UK @ 20%) **£239.99**

Signature Grille and Light Surround Kits

As above but with full mesh grille



Santorini Black Premium
LL1839
PRICE EX VAT (OUTSIDE EU) **£345.00** PRICE INC VAT (UK @ 20%) **£414.00**

Santorini Black Standard
LL1838
PRICE EX VAT (OUTSIDE EU) **£249.00** PRICE INC VAT (UK @ 20%) **£299.99**

Wing Vents

Defender 90 & 110 - all models

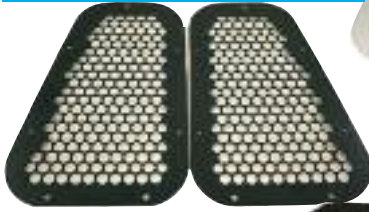

Wing Top Vents
Stainless Steel - Pair

AWR2214-BSS
PRICE EX VAT (OUTSIDE EU) £29.50 PRICE INC VAT (UK @ 20%) £35.40

Wing Top Vents
Black - Pair

AWR2214-BLK
PRICE EX VAT (OUTSIDE EU) £29.50 PRICE INC VAT (UK @ 20%) £35.40



Wing Side Vent
(RH or LH)

BTR6188BMBLKUNIV
PRICE EX VAT (OUTSIDE EU) £17.29 PRICE INC VAT (UK @ 20%) £20.75

Raised Air Intake Grilles

Defender 90 & 110 - all models



Black Steel,
Right Hand Side

AWR2214RAISED
PRICE EX VAT (OUTSIDE EU) £9.79 PRICE INC VAT (UK @ 20%) £11.75

Stainless Steel,
Left Hand Side

AWR2215BPRAISEDSS
PRICE EX VAT (OUTSIDE EU) £29.58 PRICE INC VAT (UK @ 20%) £35.50

(Includes stainless steel screw kit)

Black Steel,
Left Hand Side

AWR2215RAISED
PRICE EX VAT (OUTSIDE EU) £9.79 PRICE INC VAT (UK @ 20%) £11.75

Snow Cowls

Defender 90 & 110 - all models

Manufactured from ABS plastic these cowls will help prevent snow, mud & leaves from entering the heater intake and reducing the Defender heater performance. The cowl fits over the existing grille & follows the profile of the Defender wing.



Right Hand Drive

LL1826RHD PRICE EX VAT (OUTSIDE EU) £19.37 PRICE INC VAT (UK @ 20%) £23.24

Left Hand Drive

LL1826LHD PRICE EX VAT (OUTSIDE EU) £19.37 PRICE INC VAT (UK @ 20%) £23.24

Front Grille

Defender 90 & 110

Will not fit Td5 vehicles with air-con fitted



Stainless Steel

LR038615BPSS
PRICE EX VAT (OUTSIDE EU) £65.83 PRICE INC VAT (UK @ 20%) £79.00

Black

LR038615BPBLK PRICE EX VAT (OUTSIDE EU) £65.83 PRICE INC VAT (UK @ 20%) £79.00

Front Grilles

Range Rover Classic



Front Grille

BTR451P PRICE EX VAT (OUTSIDE EU) £53.33 PRICE INC VAT (UK @ 20%) £64.00



Front Spoiler Grille

BTR7929P1 PRICE EX VAT (OUTSIDE EU) £95.17 PRICE INC VAT (UK @ 20%) £114.20

Air Intake Grilles

Discovery 3



Right Hand Wing
Discovery 3 - BRITPART
JAK000065MMMBP
PRICE EX VAT (OUTSIDE EU) £34.58 PRICE INC VAT (UK @ 20%) £41.50

Right Hand Wing
Discovery 3 - Genuine

JAK000065MMM
PRICE EX VAT (OUTSIDE EU) £30.00 PRICE INC VAT (UK @ 20%) £36.00



Right Hand Wing
Discovery 3

DISCOVERY 4 STYLE, SILVER

LR008051PSILVER
PRICE EX VAT (OUTSIDE EU) £37.92 PRICE INC VAT (UK @ 20%) £45.50

Right Hand Wing
Discovery 3

DISCOVERY 4 STYLE, CHROME

LR008051PCHROME
PRICE EX VAT (OUTSIDE EU) £37.92 PRICE INC VAT (UK @ 20%) £45.50

Radiator Grille

Discovery 3



Supercharged Style **RD1278**

PRICE EX VAT (OUTSIDE EU) £135.00 PRICE INC VAT (UK @ 20%)

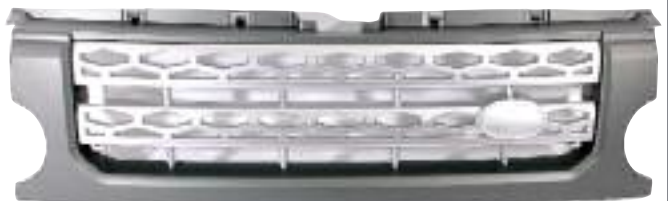

Discovery 4 Style **RD1278D4**

PRICE EX VAT (OUTSIDE EU) £125.00 PRICE INC VAT (UK @ 20%)

Grille Inserts

Discovery 2

Satin Black (2 PIECES)



RD1383 PRICE EX VAT (OUTSIDE EU) £105.00 PRICE INC VAT (UK @ 20%) £126.00

Discovery 3

Titan Silver (3 PIECES)

With plinth mounted number plate



RD1384 PRICE EX VAT (OUTSIDE EU) £189.99 PRICE INC VAT (UK @ 20%) £227.99

ORDER

BY PHONE: 01522 568000 / ON LINE: www.rimmerbros.co.uk / E-MAIL: lrsales@rimmerbros.co.uk

*Prices include UK VAT @ 20%.

GRILLES & AIR INTAKE SETS

Supercharged Style Wing Vents (pair)

Range Rover L322



Range Rover L322 - 2002-2009 models

RA2088 PRICE EX VAT (OUTSIDE EU) £88.33 PRICE INC VAT (UK @ 20%) £106.00



Range Rover L322 - All models

RA2100 PRICE EX VAT (OUTSIDE EU) £90.83 PRICE INC VAT (UK @ 20%) £109.00

Side Air Intake Grilles (pair)

Range Rover L322 - All models



Plastic-chrome

VUB503650BP

PRICE EX VAT (OUTSIDE EU) £118.33 PRICE INC VAT (UK @ 20%) £142.00

Air Intake Grilles

Range Rover Sport
2005-2009 models



RA2090 *Pair*

PRICE EX VAT (OUTSIDE EU) £123.33 PRICE INC VAT (UK @ 20%) £148.00

Supercharged Style Front Grille Conversion

Range Rover L322

All models to (VIN) 5A999999



RA2099

PRICE EX VAT (OUTSIDE EU) £153.33 PRICE INC VAT (UK @ 20%) £184.00

Supercharged Style Front Grille

Range Rover L322

All models from (VIN) 6A000001



RA2087

PRICE EX VAT (OUTSIDE EU) £180.00 PRICE INC VAT (UK @ 20%) £216.00

Front Grille - Brunel Metallic/Chrome

Range Rover L322

All models from (VIN) 6A000001



DHB500550LQVBP

PRICE EX VAT (OUTSIDE EU) £143.33 PRICE INC VAT (UK @ 20%) £172.00

Mesh Grille Insert - Lower

Range Rover Sport - 2005-2009 models

Stainless steel with hand polished mirror finish.

Not compatible with adaptive cruise control system.



RA2084BP

PRICE EX VAT (OUTSIDE EU) £103.33 PRICE INC VAT (UK @ 20%) £124.00

Radiator Grille

Range Rover Sport
2005-2009 models



RA2089

2010 on Style

PRICE EX VAT (OUTSIDE EU) £208.33 PRICE INC VAT (UK @ 20%) £250.00

Right Hand Side
Tungsten/Titan finish

JAK500320WWHBP

PRICE EX VAT (OUTSIDE EU) £20.62 PRICE INC VAT (UK @ 20%) £24.74



Left Hand Side
Tungsten/Titan finish

JAK500330WWHBP

PRICE EX VAT (OUTSIDE EU) £13.12 PRICE INC VAT (UK @ 20%) £15.74



Front Grilles

Range Rover Evoque - All models



Genuine Style

Gloss Red

LR043648RED

PRICE EX VAT (OUTSIDE EU) **£125.00** PRICE INC VAT (UK @ 20%) **£150.00**

Enhance the front of your Range Rover Evoque by fitting one of these "Autobiography" style grilles similar to those used on the top of the range "Autobiography" models. This grille differs from the standard grille in that it has a "U" shape trim around the edge of the grille.



Autobiography Style

Black/Chrome/Silver

LR043648CHRSIL

PRICE EX VAT (OUTSIDE EU) **£125.00** PRICE INC VAT (UK @ 20%) **£150.00**

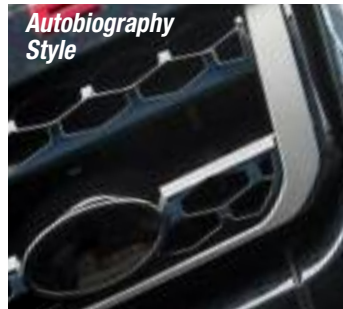

Autobiography Style

Black Gloss/Grey

LR043648BLKGRY

PRICE EX VAT (OUTSIDE EU) **£125.00** PRICE INC VAT (UK @ 20%) **£150.00**



Autobiography Style

Black Gloss

LR043648RGLOSSB

PRICE EX VAT (OUTSIDE EU) **£91.67** PRICE INC VAT (UK @ 20%) **£110.00**



Autobiography Style

Black Gloss/Red

LR043648BLKRED

PRICE EX VAT (OUTSIDE EU) **£125.00** PRICE INC VAT (UK @ 20%) **£150.00**

Side Vents

Defender - All models

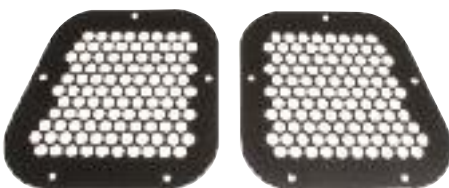

Stainless Steel Black (pair)

BTR6188BLK

PRICE EX VAT (OUTSIDE EU) **£21.50** PRICE INC VAT (UK @ 20%) **£25.80**



Brushed Stainless Steel

BTR6188BRU

PRICE EX VAT (OUTSIDE EU) **£21.50** PRICE INC VAT (UK @ 20%) **£25.80**



Stainless Steel Polished

BTR6188POL

PRICE EX VAT (OUTSIDE EU) **£21.50** PRICE INC VAT (UK @ 20%) **£25.80**

Radiator Grille Frame

Defender 2007 on - All models



Matt Black

ASJ710060PMB

PRICE EX VAT (OUTSIDE EU) **£83.00** PRICE INC VAT (UK @ 20%) **£99.60**

Gloss Black

ASJ710060PGB

PRICE EX VAT (OUTSIDE EU) **£83.00** PRICE INC VAT (UK @ 20%) **£99.60**

Lower Grille Mesh for above

Defender 2007 on - All models



Brushed Stainless Steel

ASJ710060GBRU

PRICE EX VAT (OUTSIDE EU) **£39.00** PRICE INC VAT (UK @ 20%) **£46.80**

Stainless Steel Polished

ASJ710060GPOL

PRICE EX VAT (OUTSIDE EU) **£39.00** PRICE INC VAT (UK @ 20%) **£46.80**

Stainless Steel

ASJ710060GBSS

PRICE EX VAT (OUTSIDE EU) **£39.00** PRICE INC VAT (UK @ 20%) **£46.80**

High Profile Raised Air Intake Grilles

Defender - All models



Without grille, right hand

AWR2214HPRAISED

PRICE EX VAT (OUTSIDE EU) **£8.95** PRICE INC VAT (UK @ 20%) **£10.74**

Without grille, left hand

AWR2215HPRAISED

PRICE EX VAT (OUTSIDE EU) **£8.95** PRICE INC VAT (UK @ 20%) **£10.74**

ORDER

BY PHONE: 01522 568000 / ON LINE: www.rimmerbros.co.uk / E-MAIL: lrsales@rimmerbros.co.uk

*Prices include UK VAT @ 20%.

Wheel Arch Set - Plastic

Series III, 88 & 109 - 2 Door
Short Wheelbase (Not Station Wagon)



Set of 4

LL1352
PRICE EX VAT (OUTSIDE EU) **£69.17** PRICE INC VAT (UK @ 20%) **£83.00**

Wheel Arch Extension 50mm

Defender - All Models

These 'Plus 50mm' wheel arch extensions are made from high impact plastic and almost unbreakable.



Set of 4

LL1391
PRICE EX VAT (OUTSIDE EU) **£150.83** PRICE INC VAT (UK @ 20%) **£181.00**

Wheel Arch Flares

Defender - All Models



Wheel Arch Flares - OEM

Model	Part Number	Price Ex VAT	Price Inc VAT*
Defender 90 & 110 (all models)			
Front RH Gloss Black	MRC9378P1	42.08	50.50
Front LH Gloss Black	MRC9377P1	42.08	50.50
Rear Left & Right Hand Gloss Black	AL0710010P1	42.08	50.50
Front RH Matt Black	MRC9378MP1	42.08	50.50
Front LH Matt Black	MRC9377MP1	42.08	50.50
Rear Left & Right Hand Matt Black	AL0710010MP1	42.08	50.50

Wheel Arch Kit

Discovery 1 - 3 Door
Without body mouldings



Set of 4

STC8497P
PRICE EX VAT (OUTSIDE EU) **£87.50** PRICE INC VAT (UK @ 20%) **£105.00**

Discovery 1 - 5 Door
Without body mouldings



Set of 6

STC8498P
PRICE EX VAT (OUTSIDE EU) **£87.50** PRICE INC VAT (UK @ 20%) **£105.00**

Discovery 1 - 3 Door
With body mouldings



Set of 4

STC8497PM
PRICE EX VAT (OUTSIDE EU) **£87.50** PRICE INC VAT (UK @ 20%) **£105.00**

Discovery 1 - 5 Door
With body mouldings



Set of 6

STC8498PM
PRICE EX VAT (OUTSIDE EU) **£87.50** PRICE INC VAT (UK @ 20%) **£105.00**

Wheel Arch Kit

Discovery 1 - 3 Door



Set of 4
50mm wide - cutting required

RA1531WIDE
PRICE EX VAT (OUTSIDE EU) £139.17 PRICE INC VAT (UK @ 20%) £167.00

Discovery 2 - 5 Door



Set of 6
50mm wide
No cutting required

RA1573
PRICE EX VAT (OUTSIDE EU) £139.50 PRICE INC VAT (UK @ 20%) £167.40

Discovery 1 - 3 Door



Set of 4
75mm wide - cutting required

RA1498P3
PRICE EX VAT (OUTSIDE EU) £179.19 PRICE INC VAT (UK @ 20%) £215.00

Discovery 1 & 2 - 5 Door

Set of 6
50mm wide - cutting required



STC8498P50
PRICE EX VAT (OUTSIDE EU) £139.17 PRICE INC VAT (UK @ 20%) £167.00

Discovery 1 & 2 - 5 Door



Set of 4
50mm wide

RA1498P5
PRICE EX VAT (OUTSIDE EU) £179.19 PRICE INC VAT (UK @ 20%) £215.00



Rubber Bumper End Cap

Defender - All Models

Single (not handed)



Model	Part Number	Price Ex VAT	Price Inc VAT*
Defender - all models	Genuine	DPT100070	18.61 22.33
	Aftermarket	DPT100070BP	12.50 15.00

Bumper Corners

Discovery 1



Discovery 1 - OEM			
RH Front	LR013411RHP1	31.25	37.50
LH Front	LR013411LHP1	31.25	37.50
RH Rear	LR013410RHP1	25.75	30.90
LH Rear	LR013410LHP1	25.75	30.90

ORDER

BY PHONE: 01522 568000 / ON LINE: www.rimmerbros.co.uk / E-MAIL: lrsales@rimmerbros.co.uk

*Prices include UK VAT @ 20%.

Sliding Side Window Kits

Series IIa 88 & 109, Series III 88 & 109, Defender 90 & 110

- Clear Glass
- Plastic Catch
- E Marked

Size 41.5" x 16.75" (105 x 43cm)

LL1136BMLWB*
 PRICE EX VAT (OUTSIDE EU) **£147.50** PRICE INC VAT (UK @ 20%) **£177.00**

Size 36" x 15" (91 x 38cm)

LL1136BMSWB*
 PRICE EX VAT (OUTSIDE EU) **£295.00** PRICE INC VAT (UK @ 20%) **£354.00**

* Some modification may be required.



Sliding Side Window Kits

Series IIa 88 & 109, Series III 88 & 109, Defender 90 & 110

- Standard Side Window Kit
- Clear Glass
- Metal Catch
- Glass is Toughened to EII CER-43

LL1136BP
 PRICE EX VAT (OUTSIDE EU) **£145.83** PRICE INC VAT (UK @ 20%) **£175.00**



- Standard Size Deluxe Side Window Kit
- Clear Glass
- Plastic Catch
- Rubber Mounting Strips to Cover Rivets
- Glass is Toughened to EII CER-43

LL1136BPD
 PRICE EX VAT (OUTSIDE EU) **£185.00** PRICE INC VAT (UK @ 20%) **£222.00**



Sunroof

All Models

This sunroof has a variety of uses where increased access, light & ventilation is needed but not at the expense of security. Includes rubber seal & internal bezel trim. The bezel trim can be used as a template to cut out the aperture. The sun roof can be opened completely by unscrewing the gas strut brackets from the frame. 70% no light transmission factory tint. Two handle locking with keys.

Size 963 x 419mm.

LL1851 PRICE EX VAT (OUTSIDE EU) **£279.00** PRICE INC VAT (UK @ 20%) **£334.80**



Door Repair Channel

Series II, IIa, III & Defender - All Models

This channel is the part of the frame that is prone to rust. Weld this channel in place instead of replacing the complete frame and you have as good as new, secure, door skin. Fits Series II, IIa, III & Defender (all models).

LL1602 PRICE EX VAT (OUTSIDE EU) **£13.96** PRICE INC VAT (UK @ 20%) **£16.75**

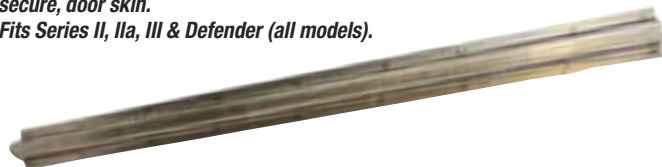

Window Seal

All Models

Replacement window seal for both standard & deluxe side window kits. Each kit does one window.

LL1136BPSEAL
 PRICE EX VAT (OUTSIDE EU) **£16.87** PRICE INC VAT (UK @ 20%) **£20.24**





Masai Bonded, Tinted Panoramic Windows

Stylish, minimalist & durable. Whether you are looking to update your old glass or convert your panel van workhorse into a family vehicle this exclusive design is the kit for you!
 70% no light transmission factory tint.
 High quality fleck runners.

Sliding Window Kit

Defender 90

LL1868 PRICE EX VAT (OUTSIDE EU) £395.50 PRICE INC VAT (UK @ 20%) £474.60

Defender 110

LL1866 PRICE EX VAT (OUTSIDE EU) £395.50 PRICE INC VAT (UK @ 20%) £474.60

Fixed Window Kit

Defender 90

LL1867 PRICE EX VAT (OUTSIDE EU) £312.50 PRICE INC VAT (UK @ 20%) £375.00

Defender 110

LL1865 PRICE EX VAT (OUTSIDE EU) £312.50 PRICE INC VAT (UK @ 20%) £375.00

Tinted Panoramic Quarter Lights

Defender 90 & 110 - All Models

Installed along with LL1868, LL1866, LL1867 & LL1865, or as a standalone accessory, these panoramic quarter lights are guaranteed to dramatically enhance the look of your Defender. Available in standard version which leaves a 1cm gap around the glass edge & bodywork or maxi version which takes the glass to the edge of the vehicle. 70% no light transmission factory tint.



Standard - LL1863

PRICE EX VAT (OUTSIDE EU) £99.50 PRICE INC VAT (UK @ 20%) £119.40

Maxi - LL1864

PRICE EX VAT (OUTSIDE EU) £99.50 PRICE INC VAT (UK @ 20%) £119.40

Tinted Panoramic Side Windows

Defender 110 - Hardtop

These panoramic windows feature a 70% no light transmission factory tint and lockable sliding windows. High quality fleck runners.

LL1855 PRICE EX VAT (OUTSIDE EU) £495.83 PRICE INC VAT (UK @ 20%) £595.00

Double Sliding Side Windows

Defender 90 & 110 with Td5, 300Tdi & 200Tdi power units

Using unique design aluminium profile that is rattle & leak proof these windows are the perfect replacement for your existing windows. 70% no light transmission factory tint and high quality fleck runners.

LL1869 PRICE EX VAT (OUTSIDE EU) £249.50 PRICE INC VAT (UK @ 20%) £299.40

Tinted Zeppelin Windows

Defender 90 & 110 - All Models

New style bonded, tinted with 70% no light transmission factory tint, these superb windows are lockable & slide opening. High quality fleck runners.

LL1860 PRICE EX VAT (OUTSIDE EU) £395.90 PRICE INC VAT (UK @ 20%) £475.08

Slide Opening Blind Spot Windows

Defender 90 & 110 - All Models

Designed for panel van Defenders to provide the driver with extra visibility where it counts they will also fit most flat sided vans or trucks. 70% no light transmission factory tint, guaranteed to be leak and draft proof.

LL1870 PRICE EX VAT (OUTSIDE EU) £149.50 PRICE INC VAT (UK @ 20%) £179.40

WINDOW KITS

- All glass is factory style tint - NOT stick-on film.
- 4mm 43R toughened safety glass.

Tinted Front Door Windows

Defender 90, 110 & 130 - All Models

The perfect finishing touch for a set of Masai's tinted, panoramic or zeppelin windows. Feature a factory 15% grey tint. Polished edges. LH & RH Pair.

LL1846 PRICE EX VAT (OUTSIDE EU) £89.95 PRICE INC VAT (UK @ 20%) £107.94

ORDER

BY PHONE: 01522 568000 / ON LINE: www.rimmerbros.co.uk / E-MAIL: lrsales@rimmerbros.co.uk

*Prices include UK VAT @ 20%.

DOOR MIRRORS

Door Mirror Cover Sets



These are the genuine replacement mirror covers from Land Rover supplied primed & ready to paint. Discovery 3 (all models), Freelander 2 (all models), Range Rover L322 to (VIN) 9A999999 & Range Rover Sport to (VIN) 9A999999.

	Part Number	Price Ex VAT	Price Inc VAT*
Door Mirror Cover Sets			
Upper (pair)	LR004867	93.42	112.10
Lower (pair)	LR004866	51.38	61.66

These mirror covers are designed to fit early 2002 to 2005, to (VIN) 4A999999, Range Rover L322 models but look like the later (2005 to 2009) 'facelift' models. Gloss Black.

	Part Number	Price Ex VAT	Price Inc VAT*
Door Mirror Cover Sets			
(pair)	RA2102	70.83	85.00

Mirror Arms

Defender - All Models



	Part Number	Price Ex VAT	Price Inc VAT*
Mirror Arm - Defender			
7" Standard Genuine	MTC5083	27.87	33.44
Britpart	MTC5083BP	7.92	9.50
Allmakes	MTC5083P	10.75	12.90
OEM	MTC5083P1	16.87	20.24
11 1/2" Large Britpart	RRC8443BP	37.08	44.50
Rubber Plug for MTC5083 mirror arm	MTC5083PLUG	0.37	0.44

Unbreakable Mirror

These mirrors are awesome, Bearmach claim that they drove a Defender 90 over these mirrors & they did not break, even the casing remained intact - perfect for off road driving (each).



Series III & Defender - All Models

Model	Part Number	Price Ex VAT	Price Inc VAT*
Unbreakable Mirror - Series III & Defender			
Unbreakable	LL1604BM	42.08	50.50
Unbreakable Heated	LL1604BMHEAT	47.08	56.50

Blind Spot Mirrors

This retro fit mirror incorporates a wide angle convex mirror to eliminate potentially dangerous blind spots, making lane manoeuvre changes much safer. The large surface area (198mm x 124mm) consists of a blind spot convex section of 52mm x 127mm. The mirrors are a straight swap for the original Defender mirrors.

Defender - All Models

Model	Part Number	Price Ex VAT	Price Inc VAT*
Blind Spot Mirror - Defender			
Right hand side	MTC5084BPBRH	32.92	39.50
Left hand side	MTC5084BPBLH	32.92	39.50

These replacement UPPER mirror covers will fit: Discovery 3 (all models), Freelander 2 (all models), Range Rover L322 to (VIN) 9A999999 & Range Rover Sport to (VIN) 9A999999.



	Part Number	Price Ex VAT	Price Inc VAT*
Upper Door Mirror Covers			
Chrome (pair)	VUB503880MMMP	35.83	43.00
Charbon Fibre (pair)	VUB503880MMMTFCF	55.83	67.00

These replacement LOWER mirror covers will fit: Discovery 3 (all models), Freelander 2 (all models), Range Rover L322 to (VIN) 9A999999 & Range Rover Sport to (VIN) 9A999999.



	Part Number	Price Ex VAT	Price Inc VAT*
Lower Door Mirror Covers			
Chrome (pair)	LR003905P	40.83	49.00

Mirror Heads

Defender - All Models

	Part Number	Price Ex VAT	Price Inc VAT*
Mirror Head - Defender			
5x8" Standard			
Genuine	MTC5084	49.73	59.68
Aftermarket	MTC5084P	6.46	7.75
Britpart	MTC5084BP	5.75	6.90
6x10 1/2" Large			
Britpart	MTC5084BPLARGE	37.08	44.50

Door Handle Sets



Stainless Steel, bright chrome plated. Fits into position with the double sided tape fixed to the reverse side.

Discovery 3 - All Models

	Part Number	Price Ex VAT	Price Inc VAT*
Door Handle Sets - Discovery 3			
Stainless Steel	RD1084BM	65.83	79.00



Easily fitted using double sided tape that is fixed on the reverse side. Available in Black Gloss or Stainless Steel, chrome plated.

Range Rover L322 - 2002-2012

	Part Number	Price Ex VAT	Price Inc VAT*
Door Handle Sets - Range Rover L322 (2002-2012)			
Stainless Steel	RA2076BM	38.33	46.00
Black Gloss	RA2101	60.00	72.00

Mirror Assemblies

Defender - All Models

Model	Part Number	Price Ex VAT	Price Inc VAT*
Mirror Assy (Britpart) - Defender			
Complete - Standard	MTC5217BP	10.62	12.74

Series III & Defender - 1987 on

Model	Part Number	Price Ex VAT	Price Inc VAT*
Mirror Assy - Series III & Defender 1987 on			
Complete (Fits vehicles with drilled hinges)	LL1141BM	14.17	17.00

Heated Mirror Kit

These heated mirror elements are unlike any other heated mirror elements. They use the same carbon impregnated Glasscloth technology found in underfloor heating. This results in a larger 'heated' surface area and avoids the striping effect of traditional elements. Simply peel off the self-adhesive backing from the heating elements & apply to the back of the mirror glass. Comes complete with cable, terminals and a relay. Wiring can be concealed within the arm of the mirror. Switch not included (enables you to match existing switches for seamless installation).

Defender - All Models

Model	Part Number	Price Ex VAT	Price Inc VAT*
Heated Mirror Kit (pair)	MTC5084BPHTR	30.42	36.50

Elements measure 115mmx167mm.

Headlamp Surrounds



Defender - All Models

Model	Part Number	Price Ex VAT	Price Inc VAT*
Headlamp Surround - Defender (all models)			
RH, Black	Aftermarket BTR7850PUCP	7.08	8.50
LH, Black	Aftermarket BTR7849PUCP	7.08	8.50
Headlamp Surround - Defender XS Style			
RH, Graphite	Genuine LR051109	50.71	60.85
	Aftermarket LR051109P	5.62	6.74
LH, Graphite	Genuine LR051110	50.71	60.85
	Aftermarket LR051110P	7.08	8.50
RH, Brunel	Genuine LR051107	50.71	60.85
	Aftermarket LR051107P	28.33	34.00
LH, Brunel	Genuine LR051108	50.71	60.85
	Aftermarket LR051108P	28.33	34.00

Fog Lamp Bezels



Chrome Fog Lamp Bezels (pair).
Freelander 1 - All Models

DXB50026070BMC
PRICE EX VAT (OUTSIDE EU) **£40.42** PRICE INC VAT (UK @ 20%) **£48.50**

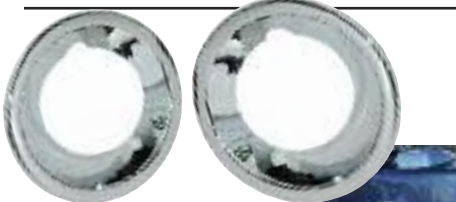

Chrome Fog Lamp Bezels (pair).
Discovery 3 - All Models

RD1261BP
PRICE EX VAT (OUTSIDE EU) **£14.58** PRICE INC VAT (UK @ 20%) **£17.50**



Black Fog Lamp Bezels.
Discovery 3 - All Models

RH - DXB500041PCL
PRICE EX VAT (OUTSIDE EU) **£7.06** PRICE INC VAT (UK @ 20%) **£8.47**

LH - DXB500051PCL
PRICE EX VAT (OUTSIDE EU) **£7.06** PRICE INC VAT (UK @ 20%) **£8.47**



Chrome Fog Lamp Bezels (pair).
L322 - 2006-09 (From VIN 6A000001)

DXB500310-30BPC
PRICE EX VAT (OUTSIDE EU) **£18.12** PRICE INC VAT (UK @ 20%) **£21.74**

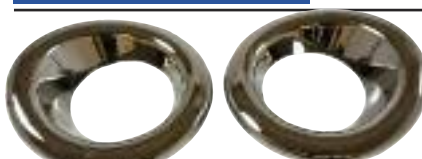

Chrome Fog Lamp Bezels (pair).
Range Rover Sport - 2005-2009

DXB000221-31BMC
PRICE EX VAT (OUTSIDE EU) **£38.33** PRICE INC VAT (UK @ 20%) **£46.00**

Stainless Steel Screw & Bolt Kits

Defender

Using these smart stainless steel replacement bolt & screw kits will prevent rust from spoiling your Defender's bodywork - ideal for smartening up your vehicle or a restoration project.



Front & rear door, 4 door bolt kit
Defender up to 2007.

LL1541BP
PRICE EX VAT (OUTSIDE EU) **£22.29** PRICE INC VAT (UK @ 20%) **£26.75**

Front door, 2 door bolt kit.
Defender up to 2007.

LL1542BP
PRICE EX VAT (OUTSIDE EU) **£10.83** PRICE INC VAT (UK @ 20%) **£13.00**

Rear door Safari bolt kit.
Defender up to 2007.

LL1543BP
PRICE EX VAT (OUTSIDE EU) **£6.87** PRICE INC VAT (UK @ 20%) **£8.24**

Rear cross member to body bolt kit.
Defender - all models.

LL1546BP
PRICE EX VAT (OUTSIDE EU) **£5.62** PRICE INC VAT (UK @ 20%) **£6.74**

Front grille screw kit.
Defender - all models.

LL1548BP
PRICE EX VAT (OUTSIDE EU) **£2.08** PRICE INC VAT (UK @ 20%) **£2.50**

Bonnet hinge bolt kit.
Defender - all models.

LL1544BP
PRICE EX VAT (OUTSIDE EU) **£2.08** PRICE INC VAT (UK @ 20%) **£2.50**

Bumper bolt kit.
Defender - all models.

LL1545BP
PRICE EX VAT (OUTSIDE EU) **£6.87** PRICE INC VAT (UK @ 20%) **£8.24**

Door Hinge Kits



Series III & Defender
Front door hinge kit (4 hinges, pins & fixings in aluminium).

LL1527BPALLY
PRICE EX VAT (OUTSIDE EU) **£188.33** PRICE INC VAT (UK @ 20%) **£226.00**

Defender - 2007 on
but can be used on earlier vehicles

Front door hinge kit with Torx head bolts & all fixings.

LL1527BP
PRICE EX VAT (OUTSIDE EU) **£40.83** PRICE INC VAT (UK @ 20%) **£49.00**



Defender - All Models

Rear end door hinge kit, supplied with stainless steel fitting kit.



LR075817BPK
PRICE EX VAT (OUTSIDE EU) **£37.08** PRICE INC VAT (UK @ 20%) **£44.50**

Defender - 2007 on
but can be used on earlier vehicles

Rear end door hinge kit, supplied with stainless steel Torx head bolts & all fixings.

LR075817BPKPUMA
PRICE EX VAT (OUTSIDE EU) **£45.42** PRICE INC VAT (UK @ 20%) **£54.50**



Bonnet Hinges

Defender - All Models

Replace your corroded Defender bonnet hinges with a pair of CNC machined aluminium billet hinges which won't tarnish like the standard hinges.



Kits include hinges, hinge bushes & stainless steel bolts.

Black anodised finish (pair)

AHU710010BPALIBLK PRICE EX VAT (OUTSIDE EU) **£50.83** PRICE INC VAT (UK @ 20%) **£61.00**

Silver anodised finish (pair)

AHU710010BPALI PRICE EX VAT (OUTSIDE EU) **£50.83** PRICE INC VAT (UK @ 20%) **£61.00**

Windscreen Brackets

Defender - All Models

Replace your corroded Defender windscreen brackets with a pair of these CNC machined aluminium billet brackets which won't tarnish like the standard brackets. Kits include gaskets & bolts. Fits vehicles with hinge type windscreen (2 reinforcement straps are required LR016671).



Black anodised finish (pair)

MUC7911-2BPBK PRICE EX VAT (OUTSIDE EU) **£53.33** PRICE INC VAT (UK @ 20%) **£64.00**

Silver anodised finish (pair)

MUC7911-2BPSK PRICE EX VAT (OUTSIDE EU) **£53.33** PRICE INC VAT (UK @ 20%) **£64.00**

ORDER

BY PHONE: 01522 568000 / ON LINE: www.rimmerbros.co.uk / E-MAIL: lrsales@rimmerbros.co.uk

*Prices include UK VAT @ 20%.

REAR BUMPERETTE

Series II 88, IIa 88 & 109
Series III 88 & 109
Defender 90 & 110

Steel folded section,
black nylon coated.
Bolts directly in
place of the existing
grab handles.



Sold in pairs

LL1212BMBOX
PRICE EX VAT (OUTSIDE EU) £45.50 PRICE INC VAT (UK @ 20%) £54.60

Series III - All models
Defender - All models

Black powder coated
with chequer plate protection.



Sold in pairs

LL1603BMPC
PRICE EX VAT (OUTSIDE EU) £82.50 PRICE INC VAT (UK @ 20%) £99.00

Also available
Galvanised as above

Part Number	Price Ex VAT	Price Inc VAT*
LL1603BMGAL	77.50	93.00

Series III - All models
Defender - All models

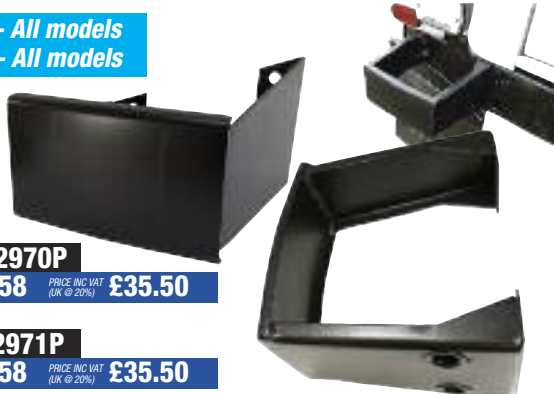

RH - RRC2970P
PRICE EX VAT (OUTSIDE EU) £29.58 PRICE INC VAT (UK @ 20%) £35.50

LH - RRC2971P
PRICE EX VAT (OUTSIDE EU) £29.58 PRICE INC VAT (UK @ 20%) £35.50

Series II & III - All models
Defender 90 & 110 - All models

Tubular black.



Sold in pairs

LL1212BLACK
PRICE EX VAT (OUTSIDE EU) £49.58 PRICE INC VAT (UK @ 20%) £59.50

Also available
Galvanised as above
Stainless steel as above

Part Number	Price Ex VAT	Price Inc VAT*
LL11212BMGAL	49.15	58.98
LL11212BMSS	116.67	140.00

FRONT BUMPER



Defender - All models

Black Military style front bumper.

Also available
Galvanised as above

Part Number	Price Ex VAT	Price Inc VAT*
DPB000270PG	79.17	95.00

DPB000270P
PRICE EX VAT (OUTSIDE EU) £69.17 PRICE INC VAT (UK @ 20%) £83.00

Defender - All models

Front bumper and
day running lights kit.

Includes integrated LED day running lights.



LR062058BMLED
PRICE EX VAT (OUTSIDE EU) £192.50 PRICE INC VAT (UK @ 20%) £231.00

Series III - All models
Defender - All models

Galvanised
front bumperette
(each)



RTC4769BP
PRICE EX VAT (OUTSIDE EU) £36.67 PRICE INC VAT (UK @ 20%) £44.00

REAR BUMPER

Discovery 2 - All models

- One-piece rear heavy-duty bumper manufactured from 4mm steel with incorporated steel end caps & 2 recovery points, finished in black

- Two recovery points & 2 hi-lift jacking points included
- Fixes to standard mounting points & for added strength, extra fixings in centre where tow bar mounts.

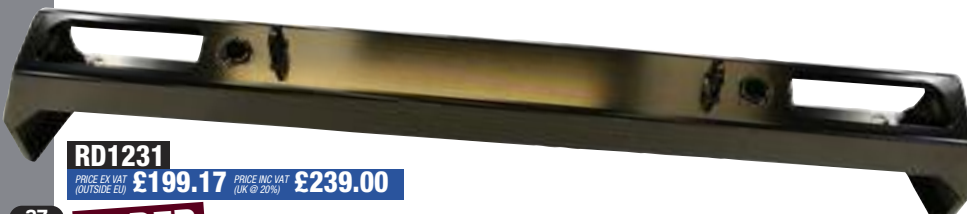

RD1231
PRICE EX VAT (OUTSIDE EU) £199.17 PRICE INC VAT (UK @ 20%) £239.00

Series III - All models
Defender - All models

Front Bumper Fitting Kit



LR062058BMFK
PRICE EX VAT (OUTSIDE EU) £12.50 PRICE INC VAT (UK @ 20%) £15.00

Wind Deflectors



Why purchase Climair Wind Deflectors?

- Precision made in Germany
- TUV approved
- 2 year guarantee
- Tailor made for each vehicle
- Easy to install, no drilling required
- Fit inside the door window channel, they do not stick on the outside
- Come right down the front of the window down to the frame
- Stops rain penetration when on the move
- Reduces drafts, allows ventilation when driving with the window open
- Reduces buffeting & wind noise
- Climair is an OEM supplier to the world's finest car manufacturers

Wind Deflectors (pair)

Model	Part Number	Price Ex VAT	Price Inc VAT*
Defender (3 door) 2004 on	Front RX1906	44.40	53.28
	Rear N/A		
Defender (5 door) 1983 on	Front RX1906	44.40	53.28
	Rear RX1922	39.00	46.80
Discovery 1 1989 to 1998	Front RX1907	44.40	53.28
	Rear RX1923	39.00	46.80
Discovery 2 1998 to 2004	Front RX1908	44.40	53.28
	Rear RX1924	39.00	46.80
Discovery 3 2005 to 2009	Front RX1909	44.40	53.28
	Rear RX1925	39.00	46.80
Discovery 4 2010 on	Front RX1909	44.40	53.28
	Rear RX1925	39.00	46.80
Discovery Sport 2014 on	Front RX1910	44.40	53.28
	Rear RX1926	44.40	53.28
Freelander 1 (3 door) 1996 to 2006	Front RX1911	44.40	53.28
	Rear N/A		
Freelander 1 (5 door) 1996 to 2006	Front RX1912	44.40	53.28
	Rear RX1927	39.00	46.80
Freelander 2 2006 to 2014	Front RX1913	44.40	53.28
	Rear RX1928	39.00	46.80
Range Rover Classic 1970 to 1996	Front RX1914	44.40	53.28
	Rear RX1930	39.00	46.80
Range Rover Classic (LWB) 1972 to 1996	Front RX1914	44.40	53.28
	Rear RX1929	39.00	46.80
Range Rover P38 1994 to 2001	Front RX1915	44.40	53.28
	Rear RX1931	39.00	46.80
Range Rover L322 2002 to 2012	Front RX1919	44.40	53.28
	Rear RX1934	39.00	46.80
Range Rover L405 2012 on	Front RX1916	44.40	53.28
	Rear RX1932	39.00	46.80
Range Rover Sport L320 2005 to 2013	Front RX1920	44.40	53.28
	Rear RX1935	39.00	46.80
Range Rover Sport L494 2014 on	Front RX1921	44.40	53.28
	Rear RX1936	39.00	46.80
Range Rover Evoque (3 door) 2012 on	Front RX1917	47.70	57.24
Range Rover Evoque (5 door) 2012 on	Front RX1918	44.40	53.28
	Rear RX1933	39.00	46.80



RX1922



RX1906

Gift Certificates

Certificates can also be ordered on-line, personalised and either e-mailed or posted to the recipient!



Gift Certificates make Ideal Presents!

Part Number	Price Ex VAT	Price Inc VAT*
Rimmer Bros 'Gift Certificates':		
£10 value GIFTCERTIFICATE10	10.00	10.00
£25 value GIFTCERTIFICATE25	25.00	25.00
£50 value GIFTCERTIFICATE50	50.00	50.00
£100 value GIFTCERTIFICATE100	100.00	100.00
£250 value GIFTCERTIFICATE250	250.00	250.00

Union Jack Badges

30 x 50mm accessory type enamel badge, choice of screw-on or self-adhesive types.



Enamel badge (each), screw on

RX1299 PRICE EX VAT (OUTSIDE EU) **£10.42** PRICE INC VAT (UK @ 20%) **£12.50**



Enamel badge (pair), self adhesive

RX1299SE PRICE EX VAT (OUTSIDE EU) **£13.71** PRICE INC VAT (UK @ 20%) **£16.45**



Resin badge (pair), self adhesive

RX1299SR PRICE EX VAT (OUTSIDE EU) **£6.87** PRICE INC VAT (UK @ 20%) **£8.24**

SIDE MOULDING KITS



RA1219BM

These rubber strips are easily fitted to your vehicle & aid protection against minor dings & scrapes. Complete with chrome insert to enhance the look of your vehicle.

Side Moulding Kits

Model	Part Number	Price Ex VAT	Price Inc VAT*
Range Rover Classic			
2 Door	RA1217BM	50.83	61.00
4 Door up to 1991 (VIN) HA610293	RA1218BM	49.58	59.50
4 door from 1992 (VIN) JA610294	RA1219BM	53.33	64.00
Discovery 1			
3 & 5 Door models	RD1151BM1	68.33	82.00
Discovery 2			
	RD1151BM2	53.33	64.00
Discovery 3			
	VPLAP0013BM	88.33	106.00
Freelander 1 (1996 to 2006)			
3 Door models	STC7912BM	45.83	55.00
5 Door models	STC7913BM	47.08	56.50



Range Rover Classic 'Brooklands Type' Body Styling

Body Styling Kit

Remanufactured in GRP. Includes front & rear aprons, side sills & fittings. Also includes self adhesive chrome edge strips

Range Rover Classic

2 Door Models	RA1410	PRICE EX VAT (OUTSIDE EU) £591.67	PRICE INC VAT (UK @ 20%) £710.00
4 Door Models	RA1411	PRICE EX VAT (OUTSIDE EU) £591.67	PRICE INC VAT (UK @ 20%) £710.00
Type LSE (LWB)	RA1412	PRICE EX VAT (OUTSIDE EU) £604.16	PRICE INC VAT (UK @ 20%) £724.99

Side Sills (pair)

Range Rover Classic - 2 Door Models



RA1415 PRICE EX VAT (OUTSIDE EU) £175.00 PRICE INC VAT (UK @ 20%) £210.00

Range Rover Classic - 4 Door Models (Standard Wheelbase)



RA1416 PRICE EX VAT (OUTSIDE EU) £175.00 PRICE INC VAT (UK @ 20%) £210.00

Range Rover Classic - 4 Door Models (Long Wheelbase)



'LSE Type' RA1417 PRICE EX VAT (OUTSIDE EU) £195.00 PRICE INC VAT (UK @ 20%) £234.00

Front Spoiler

Range Rover Classic - All Models



RA1413 PRICE EX VAT (OUTSIDE EU) £262.50 PRICE INC VAT (UK @ 20%) £315.00

Rear Apron

Range Rover Classic - All Models



RA1414 PRICE EX VAT (OUTSIDE EU) £262.50 PRICE INC VAT (UK @ 20%) £315.00

Bonnet Protector

Freelander 1 - All Models

Bonnet protector in dark smoke, protects leading edge of bonnet against stone chips.

Smoked Acrylic

LF1034 PRICE EX VAT (OUTSIDE EU) £70.83 PRICE INC VAT (UK @ 20%) £85.00



Upper Tailgate Assembly

Range Rover Classic



- Heated, tinted glass
- Aluminium frame (not steel)
- Will not rust
- Pre-assembled
- Black powder coat frame
- Fitting kit included

Fits all Range Rover Classic models with or without central locking from 1970 to 1995.

Note: You will need to re-use the door handle and locking mechanism from your old window frame or you can purchase them separately.

RA1423ASSY
PRICE EX VAT (OUTSIDE EU) **£365.00** PRICE INC VAT (UK @ 20%) **£438.00**



Handle with Lock Barrel and 2 Keys

All models from FA351847 on, and may also be fitted to some earlier vehicles.

Range Rover Classic
MWC8656
PRICE EX VAT (OUTSIDE EU) **£90.17** PRICE INC VAT (UK @ 20%) **£108.20**

Puma GRP Bonnet

Defender 90 (1984 on)
 Defender 110 (1983 on)

This Puma GRP Bonnet is half the weight of the original Land Rover Bonnet.

Fits Defender 90 (1984 on) and Defender 110 (1983 on).

The bonnet has return edges on all four sides underneath for strength and to make it more rigid. It also has strengthened hinge points and is supplied with stainless steel hinge bolts and screws.



LL1560 PRICE EX VAT (OUTSIDE EU) **£308.33** PRICE INC VAT (UK @ 20%) **£370.00**

Exterior Sun Visor Kit

Series II 88 & 109
 Series IIa 88 & 109
 Series III 88 & 109



Aluminium Folded Sun Visor with Steel Plated Brackets

Fits Series II 88 & 109, Series IIa 88 & 109, Series III 88 & 109.



Supplied as a complete kit ready for installation. All fixtures and fittings plated. Visor supplied in bright finish, suitable for spraying (if required) to match the colour of your vehicle (see page 139 for paint colours).

LL1605 PRICE EX VAT (OUTSIDE EU) **£50.83** PRICE INC VAT (UK @ 20%) **£61.00**

MUDFLAPS

Series

Model	Part Number	Price Ex VAT	Price Inc VAT*
Series IIa 88 - Mudflaps			
Flexible high density rubber. (Fixings not included)			
Front, Pair	Aftermarket	LL1607BM	12.50 15.00
Rear, Pair	Aftermarket	LL1606BM	8.33 10.00
With Land Rover logo			
Rear, Pair	Genuine	320590	36.40 43.68
Series IIa 109 - Mudflaps			
Flexible high density rubber. (Fixings not included)			
Front, Pair	Aftermarket	LL1607BM	12.50 15.00
Rear, Pair	Aftermarket	LL1606BM	8.33 10.00
Series III 88 - Mudflaps			
Flexible high density rubber. (Fixings not included)			
Front, Pair	Aftermarket	LL1607BM	12.50 15.00
Rear, Pair	Aftermarket	LL1606BM	8.33 10.00
Series III 109 - Mudflaps			
Flexible high density rubber. (Fixings not included)			
Front, Pair	Aftermarket	LL1607BM	12.50 15.00
Rear, Pair	Aftermarket	LL1606BM	8.33 10.00



Defender 90

Model	Part Number	Price Ex VAT	Price Inc VAT*
Defender 90 - Mudflaps			
With Bracket, from VIN AA792971			
RH Front, Single	Genuine	LR055323	26.18 31.42
	Aftermarket	LR055323P	9.50 11.40
LH Front, Single	Genuine	LR055333	26.18 31.42
	Aftermarket	LR055333P	9.50 11.40
RH Rear, Single	Aftermarket	LR055332P	16.87 20.24
No Brackets, from (VIN) BA266790			
Front, Pair	Aftermarket	RTC4685P	8.54 10.25
With Brackets, from (VIN) BA266790			
Front, Pair	Genuine	RTC9479	65.87 79.04
	Aftermarket	RTC9479P	36.67 44.00
With Land Rover logo, no exhaust cut-out			
LH Rear, Single	Genuine	CAT500450PMA	25.97 31.16
No exhaust cut-out			
LH Rear, Single	Aftermarket	CAT500450MAP	15.62 18.74
With Land Rover logo, with Bracket, from (VIN) AA792971			
RH Rear, Single	Genuine	LR055332	24.79 29.75
With Land Rover logo, with exhaust cut-out, from (VIN) AA792971			
LH Rear, Single	Genuine	LR055340	24.79 29.75
No Bracket, from (VIN) 3A650368 to (VIN) 5A690309			
RH Rear, Single	Aftermarket	MUC2344P	11.04 13.25
No Bracket, Hard & Soft Top, from (VIN) AA232011 to (VIN) FA414686			
Rear, Single	Genuine	MUC3990	10.40 12.48
	Aftermarket	MUC3990P	5.62 6.74

Model	Part Number	Price Ex VAT	Price Inc VAT*
Defender 90 - Mudflap Brackets			
All models from (VIN) BA26670 to (VIN) 6A999999			
RH Front, Single	Aftermarket	MTC3000P	7.29 8.75
LH Front, Single	Aftermarket	MTC3001P	7.29 8.75
Galvanised, All models from (VIN) BA26670 to (VIN) 6A999999,			
RH & LH Front, Pair	Aftermarket	MTC3000-1BP	10.42 12.50
Support Stiffener, All models from (VIN) BA26670 to (VIN) 6A999999			
Front, Single	Genuine	MTC3874	3.79 4.55
	Aftermarket	MTC3874P	2.33 2.80
Support Stiffener, angled, All models from (VIN) BA26670 to (VIN) 6A999999			
Rear, Single	Genuine	MUC1512	4.34 5.21
Bracket, all Soft Top models from (VIN) BA26670 to (VIN) AA232010			
RH Rear, Single	Aftermarket	MUC3984P	18.54 22.25
LH Rear, Single	Aftermarket	MUC3985P	23.54 28.25
Bracket, all Soft Top models from (VIN) AA232011 to (VIN) WA138479			
RH Rear, Single	Genuine	MUC3986	6.27 7.52
	Aftermarket	MUC3986P	5.63 6.76
LH Rear, Single	Genuine	MUC3987	6.03 7.24
Bracket, all Hard Top models from (VIN) AA253495 to (VIN) WA138479			
RH Rear, Single	Genuine	MUC3986	6.27 7.52
	Aftermarket	MUC3986P	5.63 6.76
LH Rear, Single	Genuine	MUC3987	6.03 7.24
Bracket, all Soft Top models from (VIN) AA232011 to (VIN) WA138479			
LH Rear, Single	Aftermarket	MUC3987P	5.42 6.50
Bracket, all Hard Top models from (VIN) AA253495 to (VIN) WA138479			
LH Rear, Single	Aftermarket	MUC3987P	5.42 6.50
Galvanised Bracket, all Soft Top models from (VIN) AA232011 to (VIN) WA138479			
Rear, Pair	Aftermarket	MUC3986-7BP	13.33 16.00
Galvanised Bracket, all Hard Top models from (VIN) AA253495 to (VIN) WA138479			
Rear, Pair	Aftermarket	MUC3986-7BP	13.33 16.00



LR055323



MUC1512



MTC3000-1BP





BTR277P



LR055333P

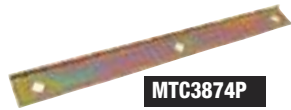

MTC3874P

Defender 110

Model	Part Number	Price Ex VAT	Price Inc VAT*
Defender 110 - Mudflaps			
With Bracket, from VIN AA792971			
RH Front Single	Genuine LR055323	26.18	31.42
	Aftermarket LR055323P	9.50	11.40
LH Front Single	Genuine LR055333	26.18	31.42
	Aftermarket LR055333P	9.50	11.40
No Brackets, from (VIN) BA266790			
Front, Pair	Aftermarket RTC4685P	8.54	10.25
With Brackets, from (VIN) BA266790			
Front, Pair	Genuine RTC9479	65.87	79.04
	Aftermarket RTC9479P	36.67	44.00
Ribbed rubber, from (VIN) FA414616 on			
RH or LH Rear, Single	Genuine BTR277	23.40	28.08
	Aftermarket BTR277P	4.50	5.40
With Bracket, Soft top, Pick up, Crew Cab, Hard Top, Station Wagon, from (VIN) AA792971			
RH Rear, Single	Genuine LR055330	26.18	31.42
	Aftermarket LR055330P	18.33	22.00
LH Rear, Single	Genuine LR055334	26.18	31.42
	Aftermarket LR055334P	15.83	19.00
With Bracket, High Capacity Pick-up, from (VIN) AA792971			
RH Rear, Single	Genuine LR055331	26.18	31.42
LH Rear, Single	Genuine LR055339	26.18	31.42
Defender 110 - Mudflap Brackets			
All models from (VIN) BA26670 to (VIN) 6A99999			
RH Front, Single	Aftermarket MTC3000P	7.29	8.75
LH Front, Single	Aftermarket MTC3001P	7.29	8.75
RH Rear, Single	Aftermarket MTC8358P	13.54	16.25
LH Rear, Single	Aftermarket MTC8357P	13.54	16.25
Galvanised, All models from (VIN) BA26670 to (VIN) 6A99999			
RH & LH Front, Pair	Aftermarket MTC3000-1BP	10.42	12.50
Support Stiffener, All models from (VIN) BA26670 to (VIN) 6A99999			
Front, Single	Genuine MTC3874	3.79	4.55
	Aftermarket MTC3874P	2.33	2.80



Dirt D-Fenders

Defender 90, 110 & 130

Dirt D-Fenders are a great solution to the annoying problem of mud which splashes through the gap which exists between the bottom of the wheel arch and the mudflap of your Defender.

They are an especially useful addition if you have wider tyres fitted.

The Dirt D-Fenders attach with rivets into the underside of the sill and wheel arch flare.

Supplied in pairs with fitting kit.



LL1751BP



RTC9479BP

Defender 130

Model	Part Number	Price Ex VAT	Price Inc VAT*
Defender 130 - Mudflaps			
With Bracket, from VIN AA792971			
RH Front, Single	Genuine LR055323	26.18	31.42
	Aftermarket LR055323P	9.50	11.40
LH Front, Single	Genuine LR055333	26.18	31.42
	Aftermarket LR055333P	9.50	11.40
No Brackets, from (VIN) BA266790			
Front, Pair	Aftermarket RTC4685P	8.54	10.25
With Brackets, from (VIN) BA266790			
Front, Pair	Genuine RTC9479	65.87	79.04
	Aftermarket RTC9479P	36.67	44.00
Ribbed rubber, from (VIN) FA414616 on			
RH or LH Rear, Single	Genuine BTR277	23.40	28.08
	Aftermarket BTR277P	4.50	5.40
With Bracket, Chassis Cab from, (VIN) AA792971			
RH Rear, Single	Genuine LR055330	26.18	31.42
	Aftermarket LR055330P	18.33	22.00
LH Rear, Single	Genuine LR055334	26.18	31.42
	Aftermarket LR055334P	15.83	19.00
With Bracket, High Capacity Pick-up, from (VIN) AA792971			
RH Rear, Single	Genuine LR055331	26.18	31.42
LH Rear, Single	Genuine LR055339	26.18	31.42
No Brackets, ribbed rubber, up to (VIN) 1A622423			
Rear, Pair	Aftermarket LL1388BMUNIV	4.58	5.50
Defender 130 - Mudflap Brackets			
All models from (VIN) BA26670 to (VIN) 6A99999			
RH Front, Single	Aftermarket MTC3000P	7.29	8.75
LH Front, Single	Aftermarket MTC3001P	7.29	8.75
RH Rear, Single	Aftermarket MTC8358P	13.54	16.25
LH Rear, Single	Aftermarket MTC8357P	13.54	16.25
Galvanised, All models from (VIN) BA26670 to (VIN) 6A99999			
RH & LH Front, Pair	Aftermarket MTC3000-1BP	10.42	12.50
Support Stiffener, All models from (VIN) BA26670 to (VIN) 6A99999			
Front, Single	Genuine MTC3874	3.79	4.55
	Aftermarket MTC3874P	2.33	2.80

Defender 90/110/130 - Dirt D-Fenders

All models, Rear of Front Wheel (will not fit vehicles with rock/tree sliders fitted)			
Front, Pair	Aftermarket	LL1751BP	38.33 46.00

Defender 90/110 - Dirt D-Fenders

All models, Front of Rear Wheel (will not fit vehicles with rock/tree sliders fitted)			
Rear, Pair	Aftermarket	LL1752BP	38.33 46.00

Defender 90 - Dirt D-Fenders

All models, Rear of Rear Wheel			
Rear, Pair	Aftermarket	LL1753BP	38.33 46.00

Defender 110 - Dirt D-Fenders

All models, Rear of Rear Wheel			
Rear, Pair	Aftermarket	LL1754BP	38.33 46.00

ORDER

BY PHONE: 01522 566000 / ON LINE: www.rimmerbros.co.uk / E-MAIL: lrsales@rimmerbros.co.uk

*Prices include UK VAT @ 20%.

MUDFLAPS



STC7978AB



LR003324P



LR003322P

Freelander

Model	Part Number	Price Ex VAT	Price Inc VAT*
Freelander 1 - Mudflaps			
Hatton Grey, with Land Rover logo, all models up to (VIN) 1A999999			
Front, Pair	Genuine STC7978AB	38.13	45.76
Black, with Land Rover logo, all models from (VIN) 2A000001			
Front, Pair	Genuine STC53075AA	40.74	48.89
	Aftermarket STC53075AABM	33.33	40.00
Black, with Land Rover logo, all models from (VIN) 2A000001 to (VIN) 3A999999			
Rear, Pair	Genuine STC53076AA	38.13	45.76
Black, all models from (VIN) 2A000001 to (VIN) 3A999999			
Rear, Pair	Aftermarket STC53076AABM	33.33	40.00
Black, with Land Rover logo, all models from (VIN) 4A000001			
Rear, Pair	Genuine CAT50006PMA	40.74	48.89
Freelander 2 - Mudflaps			
All models, not compatible with body styling pack			
Front, Pair	Genuine LR003324	58.12	69.74
	Aftermarket LR003324P	37.08	44.50
Rear, Pair	Genuine LR003322	58.12	69.74
	Aftermarket LR003322P	29.58	35.50



RTC6820



MXC6509P



CAS500010PCLP



CAT500010PCLP

Discovery

Model	Part Number	Price Ex VAT	Price Inc VAT*
Discovery 1 - Mudflaps			
With 'mountain' logo, all models			
Pair, Front	Genuine RTC6820	45.20	54.24
	Aftermarket RTC6820P	7.95	9.54
Pair, Rear	Genuine RTC6821	39.97	47.96
All models, Pair, Rear	Aftermarket RTC6821P	8.12	9.74

Discovery 1 - Mudflap Brackets

Model	Part Number	Price Ex VAT	Price Inc VAT*
All models			
RH, Single, Front	Genuine 392678	15.25	18.30
RH, Single, Rear	Aftermarket MXC6509P	15.21	18.25
LH, Single, Front	Genuine 392679	13.67	16.40
LH, Single, Rear	Aftermarket MXC6510P	15.21	18.25

Discovery 2 - Mudflaps

Model	Part Number	Price Ex VAT	Price Inc VAT*
With Land Rover logo, all models			
RH side, Pair	Genuine CAS100900	21.45	25.74
LH side, Pair	Genuine CAS100910	21.45	25.74
Pair, Front	Genuine STC50067	83.21	99.85
RH, Single, Rear	Genuine CAT101140	38.62	46.34
LH, Single, Rear	Genuine CAT101150	30.08	36.10

Splash Shield for Air Suspension Compressor

Model	Part Number	Price Ex VAT	Price Inc VAT*
RH, Single	Genuine CAT101080	20.80	24.96
LH, Single	Genuine CAT101090	20.80	24.96

Discovery 2 - Mudflap Brackets

Model	Part Number	Price Ex VAT	Price Inc VAT*
All models			
RH, Single, Rear	Genuine CAX100200	44.98	53.98
	Aftermarket CAX100200P	33.33	40.00
LH, Single, Rear	Genuine CAX100210	44.98	53.98
	Aftermarket CAX100210P	33.33	40.00

Stay Bracket, All models

Model	Part Number	Price Ex VAT	Price Inc VAT*
RH, Single, Rear	Genuine CNG100020	17.33	20.80
	Aftermarket CNG100020PG	13.50	16.20
LH, Single, Rear	Genuine CNG100030	16.90	20.28
	Aftermarket CNG100030PG	12.50	15.00

Discovery 3 - Mudflaps

Model	Part Number	Price Ex VAT	Price Inc VAT*
Anthracite, All models			
Pair, Front	Genuine CAS500010PCL	59.58	71.50
	Aftermarket CAS500010PCLP	29.58	35.50
Anthracite, All models - unpainted bumper			
Pair, Rear	Genuine CAT500010PCL	59.58	71.50
	Aftermarket CAT500010PCLP	25.83	31.00
Anthracite, All models - partially painted bumper			
Pair, Rear	Genuine VPLAP0017	59.58	71.50
	Aftermarket VPLAP0017P	29.17	35.00

Discovery 4 - Mudflaps

Model	Part Number	Price Ex VAT	Price Inc VAT*
Anthracite, All models			
Pair, Front	Genuine CAS500010PCL	59.58	71.50
	Aftermarket CAS500010PCLP	29.58	35.50
Anthracite, All models - unpainted bumper			
Pair, Rear	Genuine CAT500010PCL	59.58	71.50
	Aftermarket CAT500010PCLP	25.83	31.00
Anthracite, All models - partially painted bumper			
Pair, Rear	Genuine VPLAP0017	59.58	71.50
	Aftermarket VPLAP0017P	29.17	35.00

Discovery Sport - Mudflaps

Model	Part Number	Price Ex VAT	Price Inc VAT*
All models, Pair, Front	Genuine VPLCP0203	57.20	68.64
All models, Pair, Rear	Genuine VPLCP0277	56.08	67.30

Range Rover

Model	Part Number	Price Ex VAT	Price Inc VAT*
Range Rover Classic - Mudflaps			
No Bracket, Fits models from 1986 to 1994, RH or LH			
Front or Rear, Single	Genuine	MXC5587	16.17 19.40
	Aftermarket	MXC5587P	4.08 4.90
Includes fitting kit, Fits models from 1986 to 1994			
Front, Pair	Aftermarket	RTC9562P	26.67 32.00
Includes fitting kit, Fits all models			
Rear, Pair	Aftermarket	RA1434BM	27.08 32.50
Range Rover Classic - Mudflap Brackets			
All models 1986 to 1994			
RH, Front, Single	Genuine	392678	15.25 18.30
LH, Front, Single	Genuine	392679	13.67 16.40
All models 1986 to 1994			
RH, Rear, Single	Aftermarket	BTR432P	15.21 18.25
LH, Rear, Single	Aftermarket	BTR433P	15.62 18.74
Range Rover P38 - Mudflaps			
Fits all models from (VIN) XA428522			
RH, Front, Single	Genuine	CAS100920	54.61 65.53
	OEM	CAS100920P1	54.17 65.00
LH, Front, Single	Genuine	CAS100930	33.32 39.98
Includes fitting kit, Fits all models			
Front, Pair	Genuine	STC8535	130.02 156.02
	OEM	STC8535P1	88.33 106.00
Fits all models from (VIN) XA428522			
RH, Rear, Single	Genuine	CAT101160	52.00 62.40
	OEM	CAT101160P1	23.12 27.74
LH, Rear, Single	Genuine	CAT101170	52.00 62.40
	OEM	CAT101170P1	28.33 34.00
Fits all twin exhaust models			
Rear, Pair	Genuine	STC7703	93.60 112.32
Range Rover L322 - Mudflaps			
Fits all models to (VIN) 5A999999			
Front, Pair	Genuine	CAS000150PMA	65.87 79.04
Rear, Pair	Genuine	CAT000180PMA	65.87 79.04
	Aftermarket	CAT000180PMABP	60.83 73.00
Fits all models from (VIN) 6A000001			
Front, Pair	Genuine	CAS500060PMA	65.87 79.04
	Aftermarket	CAS500060PMAP	45.83 55.00
Rear, Pair	Genuine	CAT500070PMA	61.03 73.24
	Aftermarket	CAT500070PMAP	35.83 43.00
Range Rover L405 - Mudflaps			
All models, not compatible with power deployable steps			
Front, Pair	Genuine	VPLGP0109	63.93 76.72
All models with power deployable steps			
Front, Pair	Genuine	VPLGP0111	63.93 76.72
All models,			
Rear, Pair	Genuine	VPLGP0110	63.93 76.72
Range Rover Sport L320 - Mudflaps			
Anthracite, all models to (VIN) DA999999			
Front, Pair	Genuine	CAS500070PCL	61.03 73.24
	Aftermarket	CAS500070PCLP	35.83 43.00
All models to (VIN) 9A999999 with sport bumper protection			
Rear, Pair	Genuine	CAT500120PCL	65.00 78.00
	Aftermarket	CAT500120PCLP	29.58 35.50
All models from (VIN) AA000001			
Rear, Pair	Genuine	VPLSP0016	61.03 73.24
Range Rover Sport L494 - Mudflaps			
All models except SVR, not compatible with power deployable steps			
Front, Pair	Genuine	VPLWP0165	63.93 76.72
All models except SVR, with power deployable steps			
Front, Pair	Genuine	VPLWP0167	63.93 76.72
All models except SVR			
Rear, Pair	Genuine	VPLWP0166	63.93 76.72
Range Rover Evoque - Mudflaps			
All models with Pure or Prestige Trim Pack			
Front, Pair	Genuine	VPLVP0065	59.58 71.50
	Aftermarket	VPLVP0065P	38.33 46.00
Rear, Pair	Genuine	VPLVP0069	59.58 71.50
	Aftermarket	VPLVP0069P	38.33 46.00
All models with Dynamic Trim Pack			
Front, Pair	Genuine	VPLVP0066	59.58 71.50
	Aftermarket	VPLVP0066P	38.33 46.00
Rear, Pair	Genuine	VPLVP0070	59.58 71.50
	Aftermarket	VPLVP0070P	49.58 59.50



ALLOY ROAD WHEELS



Nothing improves the look of your Land Rover like a new set of Alloy Wheels!

Defender & Discovery 1

Deep Dish Alloy
16" x 7



ANR3631MNHBP
PRICE EX VAT (OUTSIDE EU) **£100.83** PRICE INC VAT (UK @ 20%) **£121.00**

Defender (VIN) TA977538 on & Discovery 1

Tornado Alloy
16" x 7



ANR5307MNHBP
PRICE EX VAT (OUTSIDE EU) **£93.33** PRICE INC VAT (UK @ 20%) **£112.00**

Defender (VIN) LA930456 on

Boost Alloy Silver
16" x 7



LR023391BP
PRICE EX VAT (OUTSIDE EU) **£87.50** PRICE INC VAT (UK @ 20%) **£105.00**

Defender (VIN) LA930456 on

Boost Alloy Black
16" x 7



LR023391BPBLK
PRICE EX VAT (OUTSIDE EU) **£102.50** PRICE INC VAT (UK @ 20%) **£123.00**

Defender (VIN) LA930456 on

Sawtooth Silver
16" x 7



LR025862BPMNH
PRICE EX VAT (OUTSIDE EU) **£105.83** PRICE INC VAT (UK @ 20%) **£127.00**

Defender (VIN) LA930456 on

Sawtooth Black
16" x 7



LR025862P
PRICE EX VAT (OUTSIDE EU) **£92.50** PRICE INC VAT (UK @ 20%) **£111.00**

Defender (VIN) LA930456 on

Sawtooth Silver
18" x 8



LR025862BPMNH18
PRICE EX VAT (OUTSIDE EU) **£160.83** PRICE INC VAT (UK @ 20%) **£193.00**

Defender (VIN) LA930456 on

Sawtooth Black
18" x 8



LR025862P18
PRICE EX VAT (OUTSIDE EU) **£119.95** PRICE INC VAT (UK @ 20%) **£143.94**

Defender (VIN) LA930456 on

Boost Alloy Silver
18" x 7.5



RA2126
PRICE EX VAT (OUTSIDE EU) **£149.00** PRICE INC VAT (UK @ 20%) **£178.80**

Defender (VIN) LA930456 on

Boost Alloy Matt Black
18" x 7.5



RA2127
PRICE EX VAT (OUTSIDE EU) **£149.00** PRICE INC VAT (UK @ 20%) **£178.80**

Defender (VIN) LA930456 on

Boost Alloy Gloss Black
18" x 7.5



RA2128

PRICE EX VAT (OUTSIDE EU) **£149.00** PRICE INC VAT (UK @ 20%) **£178.80**

Defender (VIN) LA930456 on

VBS Nemesis Black
18" x 7.5



RA2129

PRICE EX VAT (OUTSIDE EU) **£199.00** PRICE INC VAT (UK @ 20%) **£238.80**

Defender All Models

VBS Encore Black
16" x 7



RA2130

PRICE EX VAT (OUTSIDE EU) **£149.00** PRICE INC VAT (UK @ 20%) **£178.80**

Discovery 2 & RR P38

Hurricane Silver
18" x 8



RCC501470MCMBP

PRICE EX VAT (OUTSIDE EU) **£108.33** PRICE INC VAT (UK @ 20%) **£130.00**

Discovery 3 & 4

Twin Spoke Black & Polished
20" x 8.5



RA2123

PRICE EX VAT (OUTSIDE EU) **£145.00** PRICE INC VAT (UK @ 20%) **£174.00**

Discovery 3 & 4

Twin Spoke Silver
19" x 9



RA2124

PRICE EX VAT (OUTSIDE EU) **£140.00** PRICE INC VAT (UK @ 20%) **£168.00**

RR L322 & RR Sport

Stormer Alloy Black
20" x 9.5



RA2097

PRICE EX VAT (OUTSIDE EU) **£145.00** PRICE INC VAT (UK @ 20%) **£174.00**

RR L322 & RR Sport

Stormer Alloy Silver
20" x 9.5



RA2097P

PRICE EX VAT (OUTSIDE EU) **£145.00** PRICE INC VAT (UK @ 20%) **£174.00**

RR L322 & RR Sport

Stormer Alloy Black & Polished
20" x 9.5



RA2120

PRICE EX VAT (OUTSIDE EU) **£145.00** PRICE INC VAT (UK @ 20%) **£174.00**



RR L322 & RR Sport

HST Alloy Silver
20" x 9.5



RA2121

PRICE EX VAT (OUTSIDE EU) **£145.00** PRICE INC VAT (UK @ 20%) **£174.00**

RR L322 & RR Sport

HST Gunmetal Polished
20" x 9.5



RA2122

PRICE EX VAT (OUTSIDE EU) **£145.00** PRICE INC VAT (UK @ 20%) **£174.00**

ORDER

BY PHONE: 01522 568000 / ON LINE: www.rimmerbros.co.uk / E-MAIL: lrsales@rimmerbros.co.uk

*Prices include UK VAT @ 20%.

STEEL ROAD WHEELS

Defender, Series & RR Classic

8 Spoke White
15" x 8



LL1674BM15X8WHT

PRICE EX VAT (OUTSIDE EU) £39.50 PRICE INC VAT (UK @ 20%) £47.50

Defender, Series, RR Classic & Discovery 1

8 Spoke White
16" x 7



LL1674BM16X7WHT

PRICE EX VAT (OUTSIDE EU) £42.50 PRICE INC VAT (UK @ 20%) £51.00

Defender, Series, RR Classic & Discovery 1

8 Spoke Black
16" x 7



LL1674TF7X16B

PRICE EX VAT (OUTSIDE EU) £44.58 PRICE INC VAT (UK @ 20%) £53.50

Defender, Series, RR Classic & Discovery 1

8 Spoke Silver
16" x 7



LL1674TF7X16S

PRICE EX VAT (OUTSIDE EU) £44.58 PRICE INC VAT (UK @ 20%) £53.50

Defender, Series, RR Classic & Discovery 1

Modular Black
16" x 7



LL1675BM7X16BLK

PRICE EX VAT (OUTSIDE EU) £34.50 PRICE INC VAT (UK @ 20%) £41.40

Defender, Series, RR Classic & Discovery 1

Modular Grey
16" x 7



LL1675BM7X16GRY

PRICE EX VAT (OUTSIDE EU) £34.50 PRICE INC VAT (UK @ 20%) £41.40

Defender, Series, RR Classic & Discovery 1

Modular Black
16" x 8



LL1675BM8X16BLK

PRICE EX VAT (OUTSIDE EU) £38.50 PRICE INC VAT (UK @ 20%) £46.20

Defender, Series, RR Classic & Discovery 1

Modular Silver
16" x 8



LL1675BM8X16SIL

PRICE EX VAT (OUTSIDE EU) £38.50 PRICE INC VAT (UK @ 20%) £46.20

Defender (Welded tubeless)

Wolf Style Black Gloss
16" x 6.5



ANR4583P

PRICE EX VAT (OUTSIDE EU) £45.00 PRICE INC VAT (UK @ 20%) £54.00

Defender (Welded tubeless)

Wolf Style Silver
16" x 6.5



ANR4583SILVERBP

PRICE EX VAT (OUTSIDE EU) £58.33 PRICE INC VAT (UK @ 20%) £70.00

Defender (Welded tubed)

Wolf Style Primed
16" x 6.5



ANR5593PMBP

PRICE EX VAT (OUTSIDE EU) £85.00 PRICE INC VAT (UK @ 20%) £102.00

Defender 1987 on (Welded tubeless)

Steel Wheel Primed
16" x 5.5



LR053845BP

PRICE EX VAT (OUTSIDE EU) £71.67 PRICE INC VAT (UK @ 20%) £86.00

Defender (Standard welded tube)

**Steel Wheel Primed
16" x 5.5**



ANR4636PMBP
PRICE EX VAT (OUTSIDE EU) **£67.50** PRICE INC VAT (UK @ 20%) **£81.00**

Discovery 1

**Steel Wheel Primed
16" x 7**



NTC5193PMBP
PRICE EX VAT (OUTSIDE EU) **£188.33** PRICE INC VAT (UK @ 20%) **£226.00**

Discovery 1

**Steel Wheel White
16" x 7**



NTC5193PMBPW8
PRICE EX VAT (OUTSIDE EU) **£44.17** PRICE INC VAT (UK @ 20%) **£53.00**

Freelander 1

**Lemertz Silver
15" x 5.5J**



RR503430MUWBP
PRICE EX VAT (OUTSIDE EU) **£55.83** PRICE INC VAT (UK @ 20%) **£67.00**

**Inner Tube
205 x 16**



LL1565BP205
PRICE EX VAT (OUTSIDE EU) **£11.87** PRICE INC VAT (UK @ 20%) **£14.24**

**Inner Tube
750 x 16**



LL1565BP750
PRICE EX VAT (OUTSIDE EU) **£11.87** PRICE INC VAT (UK @ 20%) **£14.24**

Wheel Spacers

30mm Alloy wheel spacers give an additional 60mm track width to all Land Rovers. The benefits are improved handling, cornering and stability as well as increased steering lock. The opportunity to fit larger tyres due to the increased steering lock is a bonus not to mention the improved 'planted' look to the vehicle.



**Kit of 4 Spacers
in Alloy
30mm wide
(includes all nuts & studs)**

**Defender, Discovery 1
& RR Classic**
RD1069BM
PRICE EX VAT (OUTSIDE EU) **£153.33** PRICE INC VAT (UK @ 20%) **£184.00**



Discovery 2 & RR P38
RD1294TF
PRICE EX VAT (OUTSIDE EU) **£97.50** PRICE INC VAT (UK @ 20%) **£117.00**



Freelander 1
LF1129
PRICE EX VAT (OUTSIDE EU) **£254.17** PRICE INC VAT (UK @ 20%) **£305.00**

WHEEL ADAPTOR KITS

Wheel adaptor sets enable you to convert your existing stud pattern to allow the fitment of a different style of wheel.



To fit Range Rover P38 wheels to Defender, Discovery 1 or Range Rover Classic. Set of 4. Boss Height is 66.65mm.

RA1389BP
PRICE EX VAT (OUTSIDE EU) **£383.33** PRICE INC VAT (UK @ 20%) **£460.00**



To fit Discovery 2 wheels to Defender, Discovery 1 or Range Rover Classic. Set of 4. Boss Height is 58mm.

RA1389BPDEF
PRICE EX VAT (OUTSIDE EU) **£383.33** PRICE INC VAT (UK @ 20%) **£460.00**



Wheel Conversion Rings
To fit Range Rover L322 or Range Rover Sport Wheels to a Discovery 2 or Range Rover P38

RA1389BPP38
PRICE EX VAT (OUTSIDE EU) **£48.33** PRICE INC VAT (UK @ 20%) **£58.00**

SPARE WHEEL COVERS

Vinyl Spare Wheel Covers

**Plain Black
Easy Fit**



All Models

Tyre Size	Part Number	Price Ex VAT	Price Inc VAT*
205x16	RD1113-205BP	11.87	14.24
235x85x16	RD1113-235BP	11.87	14.24
235x70x16 & 255x55x18	RD1113-255BP	11.87	14.24
6.0x16 & 195x80x15	RD1113-600BP	11.87	14.24
7.5x16	RD1113-750BP	11.87	14.24

Rigid Spare Wheel Covers

Plain Black



All Models

Tyre Size	Part Number	Price Ex VAT	Price Inc VAT*
205x16	RD1114-205	32.08	38.50
17" wheel	LF1059-17	45.00	54.00



**Freelanders 1
illustration**

Freelanders 1

Wheel Size	Part Number	Price	Price
15" wheel	LF1059-15	43.33	52.00
16" wheel	LF1059-16	43.33	52.00

Stainless Steel, Lockable Spare Wheel Covers

**Black with
Stainless Steel
Rim**



All Models

Tyre Size	Part Number	Price Ex VAT	Price Inc VAT*
195x80xR15	STC50275P	92.50	111.00
215x65xR16	RD1143215	80.83	97.00

**Defender &
Discovery 1
illustration**



Defender & Discovery 1

Tyre Size	Part Number	Price Ex VAT	Price Inc VAT*
235x16	RD1114-235	28.33	34.00

Genuine Land Rover Spare Wheel Covers

Defender

Model	Tyre Size	Part Number	Price Ex VAT	Price Inc VAT*
(VIN) FA414687 to (VIN) HA906580	750x16	MXC6405	182.84	219.41
(VIN) BA267064 on	235x16	STC7665AA	98.81	118.57
(VIN) BA267064 on	265x16	STC8487AA	98.81	118.57
(VIN) 7A000001 on	205x16 & 600x16	STC8485AA	98.81	118.57

Discovery 2

Spec	Tyre Size	Part Number	Price Ex VAT	Price Inc VAT*
Moulded	235x16	STC50042	104.88	125.86
Moulded	255x18 & 255x16	STC50043	104.88	125.86
Vinyl	255x18 & 255x16	STC50069AA	77.14	92.57
Vinyl	235x16	STC8486AB	77.14	92.57

Freelanders 1

Spec	Tyre Size	Part Number	Price Ex VAT	Price Inc VAT*
Rigid, fluted style	15"	STC7980	96.21	115.45
Rigid, fluted style	16"	STC7982	108.69	130.43
Vinyl	16"	STC7983AA	98.81	118.57
Rigid, fluted style	17"	STC7984	96.21	115.45
Vinyl	17"	STC7985AA	104.01	124.81



LOCKING WHEEL NUTS

TRILOCK



PRECISION ENGINEERING

The original locking wheel nut system that has been used by 20 different car companies during the course of its life.

- Hardened Lock Body
- Stainless Steel 360 degree Rotary Ring
- Hardened Pins
- Stainless Steel Cap

evo^{Mk5}

This lock was developed to combat the ever increasing determination of wheel and tyre thieves. It is an evolution of the original Trilock and offers the highest level of wheel and tyre security that money can buy!



ENGINEERED TO CAR MANUFACTURER QUALITY STANDARDS

Alloy Wheels Locking Wheel Nuts

	Part Number TRILOCK	Part Number evo^{Mk5}	Price Ex VAT	Price Inc VAT*
90, 110, 127, 130 (1983 to 1989) (set of 4) (set of 5)	RA1390 STC8843AAP		30.59 32.40	36.71 38.88
Defender 1990 on (set of 4) (set of 5)	RA1390 STC8843AAP		30.59 32.40	36.71 38.88
Discovery 1 (set of 4) (set of 5)	RA1390 STC8843AAP		30.59 32.40	36.71 38.88
Discovery 2 (set of 4) (set of 5)	RRB100510P ANR6091P		28.50 29.90	34.20 35.88
Discovery 3		LR078545P1	31.50	37.80
Discovery 4		LR078545P1	31.50	37.80
Freelander 1 (M14 thread size) (set of 5) (M12 thread size) (set of 5)	ANR6091P LF1057M12		29.90 27.50	35.88 33.00
Freelander 2		RX1881	28.50	34.20
Range Rover Classic (set of 4) (set of 5)	RA1390 STC8843AAP		30.59 32.40	36.71 38.88
Range Rover P38A (set of 4) (set of 5)	RRB100510P ANR6091P		28.50 29.90	34.20 35.88
Range Rover Evoque		RX1881	28.50	34.20
Range Rover L322 (2002 to 2012) (18" wheels) (20" wheels)		RX1882 LR078545P1	29.90 31.50	35.88 37.80
Range Rover L405 (2012 on)		LR078545P1	31.50	37.80
Range Rover Sport (2005 to 2013) (2014 on)		LR078545P1 LR078545P1	31.50 31.50	37.80 37.80

Steel Wheels Locking Wheel Nuts

	Part Number TRILOCK	Price Ex VAT	Price Inc VAT*
Series I	RX1883	28.50	34.20
Series II	RX1883	28.50	34.20
Series IIa (set of 4) (set of 5)	RA1391 RTC9535P	29.99 29.90	35.99 35.88
Series III (set of 4) (set of 5)	RA1391 RTC9535P	29.99 29.90	35.99 35.88
90, 110, 127, 130 (1983 to 1989) (set of 4) (set of 5)	RA1391 RTC9535P	29.99 29.90	35.99 35.88
Defender 1990 on (set of 4) (set of 5)	RA1391 RTC9535P	29.99 29.90	35.99 35.88
Discovery 1 (set of 4) (set of 5)	RA1391 RTC9535P	29.99 29.90	35.99 35.88
Freelander 1 (M14 thread size) (set of 5) (M12 thread size) (set of 5)	ANR6091P LF1057M12	29.99 27.50	35.88 33.00
Range Rover Classic (set of 4) (set of 5)	RA1391 RTC9535P	29.99 29.99	35.99 35.99

Full set of Wheel Nuts Kit
(4 locking nuts, 4 spare caps, 18 normal nuts inc, caps, 1 key, 1 remover tool.



Discovery 2

STC50080BP
PRICE EX VAT (OUTSIDE EU) **£79.50** PRICE INC VAT (UK @ 20%) **£95.40**

Locking Wheel Nuts Set for Terraforma Beadlock Wheels

LL1714TFLNUT
PRICE EX VAT (OUTSIDE EU) **£38.33** PRICE INC VAT (UK @ 20%) **£46.00**

Spare Wheel Anti-Theft Device

Discovery 3 & 4
Range Rover Sport (2005-13)



Aftermarket

LR064520ATD
PRICE EX VAT (OUTSIDE EU) **£85.83** PRICE INC VAT (UK @ 20%) **£103.00**

OEM

LR064520P1
PRICE EX VAT (OUTSIDE EU) **£60.00** PRICE INC VAT (UK @ 20%) **£72.00**

ORDER

BY PHONE: 01522 568000 / ON LINE: www.rimmerbros.co.uk / E-MAIL: lrsales@rimmerbros.co.uk

*Prices include UK VAT @ 20%.

LOCKING WHEEL NUTS

90

	Part Number	Price Ex VAT	Price Inc VAT*
Wheel Centre Cap			
All models with Alpine White (NUC) 5 spoke steel wheels			
Alpine White, features Land Rover Logo			
Genuine	ANR3861	3.23	3.88

90 & 110

Wheel Nut			
All models with alloy spare wheel - Alloy spare wheel only			
Genuine	ANR4914	8.67	10.40
All models with alloy wheels - Without stainless steel cap			
Aftermarket	NRC7415P	2.00	2.40
OEM	NRC7415P1	2.75	3.30
Genuine	NRC7415	3.06	3.67
All models with steel wheels			
Aftermarket	RRD500010P	0.79	0.95
Genuine	RRD500010	1.88	2.26

Wheel Nut Set			
All models with alloy wheels - Set of 20.			
Without stainless steel cap			
Aftermarket	NRC7415KP	38.33	46.00
Genuine	NRC7415K	58.50	70.20
All models with steel wheel - Set of 20			
Aftermarket	RRD500010KP	11.04	13.25
Genuine	RRD500010K	35.00	42.00

Wheel Stud			
All models - Front and rear hubs			
Aftermarket	FRC6137P	0.46	0.55
Genuine	FRC6137	4.38	5.26
All models - For alloy or steel wheels			
Aftermarket	RUF500010P	1.33	1.60
Genuine	RUF500010	2.16	2.59
All models - Extended, 60mm (original fitment for Defender Wolf/XD). Allows fitment of certain alternative wheels			
OEM	FRC7577P1	5.83	7.00
Genuine	FRC7577	20.00	24.00

Defender 90 & 110

Wheel Centre Cap			
All Defender 90 models with Alpine White (NUC) 5 spoke steel wheels			
Alpine White, features Land Rover Logo			
Genuine	ANR3861	3.23	3.88
Tomb Raider limited edition - Pewter, features Land Rover logo			
Genuine	ANR2391LAL	5.52	6.62
All models with Silver Sparkle (MNH) colour alloy wheels			
Silver Sparkle, features Land Rover logo			
Genuine	ANR2391MNH	7.43	8.92
All models with Quicksilver (MUE) colour alloy wheels			
Quicksilver, features Land Rover logo			
Genuine	ANR2391MUE	5.29	6.35
All models up to (VIN) 5A999999 with Black colour alloy wheels			
Black, features Land Rover logo			
Genuine	STC7248	10.49	12.59
All models with 16" dual finish alloy wheels from (VIN) 7A000001 on			
Polished finish, Land Rover green/silver badge			
Aftermarket	LR023301P	5.42	6.50
Genuine	LR023301	6.84	8.21
All models with polished shadow chrome alloy wheel centre caps with green/gold Land Rover badge			
Polished shadow chrome finish with Land Rover green/gold badge			
Genuine	RRJ500060MUZ	8.67	10.40

Wheel Nut			
All models with steel wheels			
Aftermarket	RRD500010P	0.79	0.95
Genuine	RRD500010	1.88	2.26
All models with alloy wheels up to (VIN) 6A999999 except Tomb Raider - Without stainless steel cap			
Aftermarket	NRC7415P	2.00	2.40
OEM	NRC7415P1	2.75	3.30
Genuine	NRC7415	3.06	3.67

All models with stainless capped wheel nuts for alloy wheels from (VIN) 7A000001 on - Without stainless steel cap			
Aftermarket	RRD500560P	2.33	2.80
Britpart	RRD500560BP	2.08	2.50
OEM	RRD500560P1	4.38	5.26
Genuine	RRD500560	11.77	14.12
All models with alloy spare wheel up to (VIN) 4A999999			
Alloy spare wheel only	Genuine	ANR4914	8.67
All models with alloy spare wheel from (VIN) 7A000001 on	Alloy spare wheel only	Genuine	RRD500520
		5.12	6.14

Wheel Nut Set			
All models with steel wheels - Set of 20			
Aftermarket	RRD500010KP	11.04	13.25
Genuine	RRD500010K	35.00	42.00
All models with alloy wheels up to (VIN) 6A999999 except Tomb Raider - Set of 20. Without stainless steel cap			
Aftermarket	NRC7415KP	38.33	46.00
Genuine	NRC7415K	58.50	70.20

All models with stainless capped wheel nuts for alloy wheels from (VIN) 7A000001 on - Set of 20. With stainless steel cap			
Aftermarket	RRD500560KP	38.33	46.00
OEM	RRD500560KP1	77.50	93.00
Genuine	RRD500560K	215.00	358.00

Wheel Nuts, Centre Caps & Studs



Discovery 1

	Part Number	Price Ex VAT	Price Inc VAT*
Wheel Centre Cap			
All models fitted with 5 spoke Pewter colour (LAL) alloy wheels from (VIN) WA746542 on			
Pewter, features Land Rover logo			
Genuine	ANR2391LAL	5.52	6.62
All models with Silver Sparkle (MNH) colour alloy wheels			
Silver Sparkle, features Land Rover logo			
Genuine	ANR2391MNH	7.43	8.92
All models with Quicksilver (MUE) colour alloy wheels			
Quicksilver, features Land Rover logo			
Genuine	ANR2391MUE	5.29	6.35
All models with Black colour alloy wheels			
Black, features Land Rover logo			
Genuine	STC7248	10.49	12.59

Wheel Nut			
All models with steel wheels			
Aftermarket	RRD500010P	0.79	0.95
Genuine	RRD500010	1.88	2.26
All models with alloy wheels up to (VIN) KA052252			
Without stainless steel cap			
Aftermarket	NRC7415P	2.00	2.40
OEM	NRC7415P1	2.75	3.30
Genuine	NRC7415	3.06	3.67
All models with alloy spare wheel			
Alloy spare wheel only	Genuine	ANR4914	8.67

Wheel Nut Set			
All models with steel wheels - Set of 20			
Aftermarket	RRD500010KP	11.04	13.25
Genuine	RRD500010K	35.00	42.00
All models with alloy wheels up to (VIN) KA052252 - Set of 20.			
Without stainless steel cap			
Aftermarket	NRC7415KP	38.33	46.00
Genuine	NRC7415K	58.50	70.20

Wheel Stud			
All models with alloy wheels - For alloy or steel wheels			
Aftermarket	RUF500010P	1.33	1.60
Genuine	RUF500010	2.16	2.59
All models - Extended, 60mm (original fitment for Defender Wolf/XD). Allows fitment of certain alternative wheels			
OEM	FRC7577P1	5.83	7.00
Genuine	FRC7577	20.00	24.00

Discovery 2

Badge Wheel Centre Cap			
All models - Green/Gold			
Genuine	DAG100310	14.65	17.58

Wheel Centre Cap			
All models with steel spare wheel - Features Land Rover logo.			
Covers spare wheel centre and wheel nuts			
Genuine	DTC100810	44.01	52.81

Wheel Nut			
All models with steel wheels			
Genuine	ANR4851	4.38	5.26
All models with alloy wheels - Alloy wheel type, with washer			
Aftermarket	ANR3679P	2.10	2.52
Britpart	ANR3679BP	2.08	2.50
OEM	ANR3679P1	3.00	3.60
Genuine	ANR3679	5.81	6.97
All models with steel spare wheel - Steel spare wheel only			
Genuine	RRD100640	6.78	8.14
All models with alloy spare wheel - Alloy spare wheel only			
Genuine	RRD100630	6.17	7.40

Wheel Nut Set			
All models with alloy wheels - Set of 20.			
Alloy wheel type, with washer			
Aftermarket	ANR3679KP	35.00	42.00
Genuine	ANR3679K	102.50	123.00



Discovery 3

	Part Number	Price Ex VAT	Price Inc VAT*
Wheel Nut			
All models with stainless steel finish wheel nuts			
Stainless steel finish	OEM	LR068126P1	3.25
	Genuine	LR068126	5.43
			6.52

Wheel Nut Set			
All models with stainless steel finish wheel nuts			
Stainless steel finish			
set of 16			
OEM	LR068126P1K16	40.00	48.00
Genuine	LR068126K16	80.83	97.00
set of 20			
OEM	LR068126P1K20	50.00	60.00
Genuine	LR068126K20	97.50	117.00

Discovery 4

Wheel Centre Cap			
All models with polished finish alloy wheel centre caps from (VIN) BA000001 on - Polished finish, Land Rover green/silver badge			
Aftermarket	LR023301P	5.42	6.50
Genuine	LR023301	6.84	8.21
All models with bright black alloy wheel centre caps from (VIN) DA690512 on - Bright black finish, Land Rover badge			
Aftermarket	LR069899P	7.50	9.00
Genuine	LR069899	10.76	12.91
All models with satin silver/bright aluminium alloy wheel centre caps from (VIN) DA690512 on			
Satin silver/bright aluminium finish, Land Rover badge			
Genuine	LR069900	6.02	7.22

Wheel Nut			
All models with stainless steel finish wheel nuts			
Stainless steel finish	OEM	LR068126P1	3.25
	Genuine	LR068126	5.43
			6.52

Wheel Nut Set			
All models with stainless steel finish wheel nuts			
Stainless steel finish			
set of 16			
OEM	LR068126P1K16	40.00	48.00
Genuine	LR068126K16	80.83	97.00
set of 20			
OEM	LR068126P1K20	50.00	60.00
Genuine	LR068126K20	97.50	117.00

Discovery Sport L550

Wheel Centre Cap			
All models with bright black alloy wheel centre caps			
Bright black finish, Land Rover badge			
Aftermarket	LR069899P	7.50	9.00
Genuine	LR069899	10.76	12.91
All models with satin silver/bright aluminium alloy wheel centre caps			
Satin silver/bright aluminium finish, Land Rover badge			
Genuine	LR069900	6.02	7.22

Wheel Nut			
All models with bright finish wheel nuts - Stainless steel finish			
Genuine	LR001381	2.00	2.40
All models with black finish wheel nuts - Black finish			
Genuine	LR066225	8.32	9.98

Wheel Nut Set			
All models with gloss black wheels & wheel nuts			
Gloss black chrome, set of 20			
Genuine	VPLVW0070	180.15	216.18

Wheel Nuts, Centre Caps & Studs

Range Rover Classic

	Part Number	Price Ex VAT	Price Inc VAT*
Wheel Centre Cap			
All models with Quicksilver (MUE) colour alloy wheels Quicksilver, features Land Rover logo			
	Genuine ANR2391MUE	5.29	6.35
All models with black alloy wheel centre caps Black, Range Rover badge			
	Genuine NRC8254	8.71	10.45
All models with Black colour alloy wheels and Land Rover logo on centre cap - Black, features Land Rover logo			
	Genuine STC7248	10.49	12.59
Wheel Nut			
All models with steel wheels			
	Aftermarket RRD500010P	0.79	0.95
	Genuine RRD500010	1.88	2.26
All models with alloy wheels up to (VIN) KA635839 Without stainless steel cap			
	Aftermarket NRC7415P	2.00	2.40
	OEM NRC7415P1	2.75	3.30
	Genuine NRC7415	3.06	3.67
Wheel Nut Set			
All models with alloy wheels up to (VIN) KA635839 - Set of 20. Without stainless steel cap			
	Aftermarket NRC7415KP	38.33	46.00
	Genuine NRC7415K	58.50	70.20
All models with steel wheels - Set of 20			
	Aftermarket RRD500010KP	11.04	13.25
	Genuine RRD500010K	35.00	42.00
Wheel Stud			
All models from 1984 on, will fit earlier models For alloy or steel wheels			
	Aftermarket RUF500010P	1.33	1.60
	Genuine RUF500010	2.16	2.59
All models - Extended, 60mm (original fitment for Defender Wolf/XD). Allows fitment of certain alternative wheels			
	OEM FRC7577P1	5.83	7.00
	Genuine FRC7577	20.00	24.00

Range Rover P38

Wheel Centre Cap			
All models with Silver Sparkle (MNH) colour alloy wheels Silver Sparkle, features Land Rover logo			
	Genuine ANR3522MNH	3.45	4.14
Badge Wheel Centre Cap			
All models from (VIN) XA410482 on - Green/Gold			
	Genuine DAG100310	14.65	17.58
Wheel Nut			
All models - Alloy wheel type, with washer			
	Aftermarket ANR3679P	2.10	2.52
	Britpart ANR3679BP	2.08	2.50
	OEM ANR3679P1	3.00	3.60
	Genuine ANR3679	5.81	6.97
Wheel Nut Set			
All models - Set of 20. Alloy wheel type, with washer			
	Aftermarket ANR3679KP	35.00	42.00
	Genuine ANR3679K	102.50	123.00
Wheel Stud			
All models - Front hubs			
	Genuine FTC2057	5.73	6.88

Range Rover L322

	Part Number	Price Ex VAT	Price Inc VAT*
Wheel Centre Cap			
All Autobiography Ultimate models from (VIN) BA344356 on Polished finish, Land Rover green/silver badge			
	Aftermarket LR023301P	5.42	6.50
	Genuine LR023301	6.84	8.21
All models with shadow chrome finish wheel centre caps from (VIN) 6A000001 on			
Shadow chrome with Land Rover green/gold badge			
	Genuine RRJ500030MNL	8.67	10.40
All models with Silver Sparkle wheel centre caps with Land Rover black/silver badge from (VIN) 6A000001 on			
Silver Sparkle with Land Rover black/silver badge			
	Genuine RRJ500030WYT	9.03	10.84
All models with polished shadow chrome alloy wheel centre caps with green/gold Land Rover badge up to (VIN) 9A999999			
Polished shadow chrome finish with Land Rover green/gold badge			
	Genuine RRJ500060MUZ	8.67	10.40
All models with polished silver/black alloy wheel centre caps with black/silver Land Rover badge from (VIN) 7A000001 on			
Polished silver/black finish with Land Rover black/silver badge			
	Genuine LR021626	8.29	9.95
Wheel Nut			
All models up to (VIN) 5A999999			
	Aftermarket RRD000011P	3.25	3.91
	Britpart RRD000011BP	3.50	4.20
	Genuine RRD000011	3.88	4.66
All models with stainless steel finish wheel nuts from (VIN) 6A000001 on - Stainless steel finish			
	OEM LR068126P1	3.25	3.90
	Genuine LR068126	5.43	6.52
Wheel Nut Cap			
All models up to (VIN) 5A999999 - Locking wheel nut			
	Genuine RRJ000030	2.05	2.46
Wheel Nut Set			
All models up to (VIN) 5A999999 - Set of 20			
	Aftermarket RRD000011PK	56.67	68.00
	Genuine RRD000011K	72.50	87.00
All models with stainless steel finish wheel nuts from (VIN) 6A000001 on - Stainless steel finish			
	set of 16	OEM LR068126P1K16	40.00 48.00
		Genuine LR068126K16	80.83 97.00
	set of 20	OEM LR068126P1K20	50.00 60.00
		Genuine LR068126K20	97.50 117.00

Range Rover L405

Wheel Centre Cap			
All models with bright black alloy wheel centre caps with Land Rover logo from (VIN) EA134627 on			
Bright black finish, Land Rover badge			
	Aftermarket LR069899P	7.50	9.00
	Genuine LR069899	10.76	12.91
All models with satin silver/bright aluminium alloy wheel centre caps with Land Rover logo from (VIN) EA134627 on			
Satin silver/bright aluminium finish, Land Rover badge			
	Genuine LR069900	6.02	7.22
Wheel Nut			
All models with stainless steel finish wheel nuts			
Stainless steel finish			
	OEM LR068126P1	3.25	3.90
	Genuine LR068126	5.43	6.52
All models with Stealth Pack from (VIN) EA000001 on with 7 spoke or 9 spoke alloy wheels - Black chrome finish			
	Genuine LR056214	13.04	15.65
Wheel Nut Set			
All models with stainless steel finish wheel nuts			
Stainless steel finish			
	set of 16	OEM LR068126P1K16	40.00 48.00
		Genuine LR068126K16	80.83 97.00
	set of 20	OEM LR068126P1K20	50.00 60.00
		Genuine LR068126K20	97.50 117.00
All models with grey/black or gloss black alloy wheels from (VIN) EA000001 on - Gloss black chrome, set of 20			
	Genuine VPLWW0078	210.04	252.05

Range Rover Sport L320

	Part Number	Price Ex VAT	Price Inc VAT*
Wheel Centre Cap			
All models with polished shadow chrome alloy wheel centre caps with green/gold Land Rover badge up to (VIN) 9A999999			
Polished shadow chrome finish with Land Rover green/gold badge			
	Genuine RRJ500060MUZ	8.67	10.40
All non-supercharged models with shadow chrome finish wheels from (VIN) 9A000001 to 9A999999			
Shadow chrome finish, Land Rover green/gold badge			
	Genuine LR089424	5.45	6.54
All models with polished silver/black alloy wheel centre caps with black/silver Land Rover badge from (VIN) 9A000001 on			
Polished silver/black finish with Land Rover black/silver badge			
	Genuine LR021626	8.29	9.95
All supercharged models with shadow chrome finish wheels from (VIN) 9A000001 to 9A999999			
Shadow chrome finish, Land Rover black/silver badge			
	Genuine LR011487	9.95	11.94
All models with bright black alloy wheel centre caps from (VIN) CA000001 on - Bright black finish, Range Rover badge			
	Genuine LR089428	8.76	10.51
All models with Silver Sparkle wheel centre caps with Land Rover black/silver badge - Silver Sparkle with Land Rover black/silver badge			
	Genuine RRJ500030WYT	9.03	10.84
All models with Titan Silver wheel centre caps with Land Rover black/silver badge - Titan Silver with Land Rover black/silver badge			
	Genuine RRJ500030WYT	9.03	10.84
Wheel Nut			
All models with stainless steel finish wheel nuts - Stainless steel finish			
	OEM LR068126P1	3.25	3.90
	Genuine LR068126	5.43	6.52
Wheel Nut Set			
All models with stainless steel finish wheel nuts - Stainless steel finish set of 16			
	OEM LR068126P1K16	40.00	48.00
	Genuine LR068126K16	80.83	97.00
	set of 20	OEM LR068126P1K20	50.00 60.00
		Genuine LR068126K20	97.50 117.00

Range Rover Sport L494

Wheel Centre Cap			
All models with bright black alloy wheel centre caps with Land Rover logo from (VIN) EA309592 on			
Bright black finish, Land Rover badge			
	Aftermarket LR069899P	7.50	9.00
	Genuine LR069899	10.76	12.91
All models with satin silver/bright aluminium alloy wheel centre caps with Land Rover logo from (VIN) EA309592 on			
Satin silver/bright aluminium finish, Land Rover badge			
	Genuine LR069900	6.02	7.22
Wheel Nut			
All models with Stealth Pack from (VIN) FA000001 on with 5 spoke or 9 spoke alloy wheels - Black chrome finish			
	Genuine LR056214	13.04	15.65
All models with stainless steel finish wheel nuts			
Stainless steel finish			
	OEM LR068126P1	3.25	3.90
	Genuine LR068126	5.43	6.52
Wheel Nut Set			
All models with stainless steel finish wheel nuts			
Stainless steel finish			
	set of 16	OEM LR068126P1K16	40.00 48.00
		Genuine LR068126K16	80.83 97.00
	set of 20	OEM LR068126P1K20	50.00 60.00
		Genuine LR068126K20	97.50 117.00
All models with grey/black or gloss black alloy wheels			
Gloss black chrome, set of 20			
	Genuine VPLWW0078	210.04	252.05

Range Rover Evoque L538

Wheel Centre Cap			
All models with bright black alloy wheel centre caps up to (VIN) CH999999 - Bright black finish, Range Rover badge			
	Genuine LR089428	8.76	10.51
All models with bright black alloy wheel centre caps with Land Rover logo from (VIN) EH000001 on			
Bright black finish, Land Rover badge			
	Aftermarket LR069899P	7.50	9.00
All models with bright black alloy wheel centre caps with Land Rover logo from (VIN) EH000001 on			
Bright black finish, Land Rover badge			
	Genuine LR069899	10.76	12.91
All models with satin silver/bright aluminium alloy wheel centre caps with Land Rover logo from (VIN) EH000001 on			
Satin silver/bright aluminium finish, Land Rover badge			
	Genuine LR069900	6.02	7.22
Victoria Beckham limited edition only - Requires VIN to order			
	Genuine LR043647	17.16	20.59
Wheel Nut			
All models with bright finish wheel nuts - Stainless steel finish			
	Genuine LR001381	2.00	2.40
Wheel Nut Set			
All models with gloss black wheels & wheel nuts			
Gloss black chrome, set of 20			
	Genuine VPLWW0070	180.15	216.18



ANR2391MUE



NRC8254



DAG100310



LR023301P



RRD000011P



LR027409

ORDER

BY PHONE: 01522 568000 / ON LINE: www.rimmerbros.co.uk / E-MAIL: lrsales@rimmerbros.co.uk

*Prices include UK VAT @ 20%.

Wheel Nuts, Centre Caps & Studs

Freelander 1

	Part Number	Price Ex VAT	Price Inc VAT*
Wheel Centre Cap			
All models with steel wheels			
Features Land Rover logo. Covers wheel centre and wheel nuts			
Genuine	ANR3976	16.65	19.98
Wheel Nut			
All models with steel wheels			
Aftermarket	ANR6089P	1.25	1.50
Genuine	ANR6089	2.00	2.40
All models with alloy wheels			
Alloy wheels including alloy spare wheel			
Aftermarket	RRD100660P	1.83	2.20
Genuine	RRD100660	3.66	4.39
Wheel Nut Set			
All models with steel wheels - Set of 20			
Aftermarket	ANR6089KP	17.50	21.00
Genuine	ANR6089K	37.08	44.50
All models with alloy wheels - Set of 20			
Alloy wheels including alloy spare wheel			
Aftermarket	RRD100660KP	27.08	32.50
Genuine	RRD100660K	67.50	81.00
Wheel Stud			
All models - Front or rear			
Aftermarket	CLP9037LP	1.50	1.80
Genuine	CLP9037L	2.95	3.54

Freelander 2

Wheel Centre Cap			
All models with shadow chrome finish wheels from (VIN) 8H057881 on			
Shadow chrome finish, Land Rover green/gold badge			
Genuine	LR089424	5.45	6.54
All models with Silver Sparkle (MNH) colour alloy wheels up to (VIN) AH999999			
Silver Sparkle, Land Rover green/silver badge			
Genuine	LR089424	5.45	6.54
All models with polished shadow chrome alloy wheel centre caps with green/gold Land Rover badge up to (VIN) AH999999			
Polished shadow chrome finish with Land Rover green/gold badge			
Genuine	RRJ500060MUZ	8.67	10.40
All models with polished finish alloy wheel centre caps from (VIN) BH000001 on			
Polished finish, Land Rover green/silver badge			
Aftermarket	LR023301P	5.42	6.50
Genuine	LR023301	6.84	8.21
Wheel Nut			
All models with bright finish wheel nuts - Stainless steel finish			
Genuine	LR001381	2.00	2.40

Series I & II

	Part Number	Price Ex VAT	Price Inc VAT*
Wheel Nut			
All models - Tapered both ends			
Aftermarket	217361P	0.42	0.50
Genuine	217361	1.39	1.67
Wheel Stud			
All models			
Screw-in type	Aftermarket	561590P	0.75 0.90
	Genuine	561590	3.62 4.34
Pull-in type	Aftermarket	561886P	0.58 0.70

Series IIA

Wheel Nut			
All models up to 1969 with 9/16 BSF studs - Tapered both ends			
Aftermarket	217361P	0.42	0.50
Genuine	217361	1.39	1.67
All models 1968 to 1969 with 9/16 BSF studs			
Tapered one end, 59/64" across flats			
Genuine	561254	2.08	2.50
All models from 1969 to 1971 with 9/16 BSF studs			
Tapered one end, 1 1/16" across flats			
Aftermarket	576103P	0.35	0.42
Genuine	576103	6.39	7.67
All models with 16mm wheel nuts from 1970 on			
Aftermarket	RRD500010P	0.79	0.95
Genuine	RRD500010	1.88	2.26
Wheel Nut Set			
All models with 16mm wheel nuts from 1970 on - Set of 20			
Aftermarket	RRD500010KP	11.04	13.25
Genuine	RRD500010K	35.00	42.00
Wheel Stud			
All models up to 1969 with 9/16 BSF studs			
Screw-in type	Aftermarket	561590P	0.75 0.90
	Genuine	561590	3.62 4.34
Pull-in type	Aftermarket	561886P	0.58 0.70

Series III

Wheel Nut			
All models			
Aftermarket	RRD500010P	0.79	0.95
Genuine	RRD500010	1.88	2.26
Wheel Nut Set			
All models - Set of 20			
Aftermarket	RRD500010KP	11.04	13.25
Genuine	RRD500010K	35.00	42.00
Wheel Stud			
Extended, 60mm (original fitment for Defender Wolf/XD).			
Allows fitment of certain alternative wheels			
OEM	FRC7577P1	5.83	7.00
Genuine	FRC7577	20.00	24.00



ANR3976



LR089424

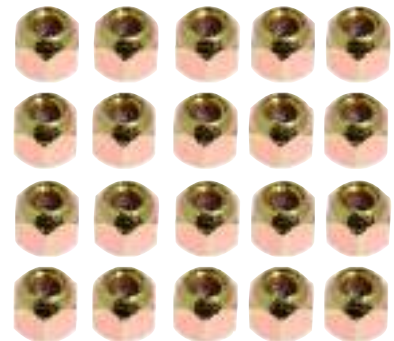

ANR6089



See page 128 for Wheel Wrenches and Wheel Chocks



LR027664



LR027666



LR027560

Set of four valve caps, genuine Land Rover accessory, available with alternative coloured Union Jack emblems or Land Rover logo.

Tyre Valve Cap Sets

	Part Number	Price Ex VAT	Price Inc VAT*
Union Jack Emblem			
Red, white & blue	LR027664	22.22	26.66
Black, white & grey	LR027666	16.83	20.20
Land Rover logo	LR027560	16.83	20.20

WINDOW MESH

Defender

Side Window Guards (pair)

- Precision laser cut steel
- Zinc plated and powder coated in black
- Includes rivets
- Pre-assembled
- Easy to fit

Fits all Defenders with factory fitted windows.



LL1858

PRICE EX VAT (OUTSIDE EU) **£175.00** PRICE INC VAT (UK @ 20%) **£210.00**

Rear Window Mesh Guard Kit (3 piece)

For added security this set of window guards is constructed from a sturdy metal grid.

The kit covers the rear door window & the two rear quarter panels. Black nylon coated.



Series II 88 & 109
Series IIa 88 & 109
Series III 88 & 109
Defender up to (VIN) 1A622423

LL1225

PRICE EX VAT (OUTSIDE EU) **£59.17** PRICE INC VAT (UK @ 20%) **£71.00**

Defender 90 & 110

Exterior Window Mesh Grille Kit (5 piece)

These window grilles are the ideal answer if you need serious protection to your vehicles back windows for extreme off-roading or security reasons (looks cool too!)

Manufactured from pressed steel these grilles are easily screwed into position or riveted for a more permanent solution.

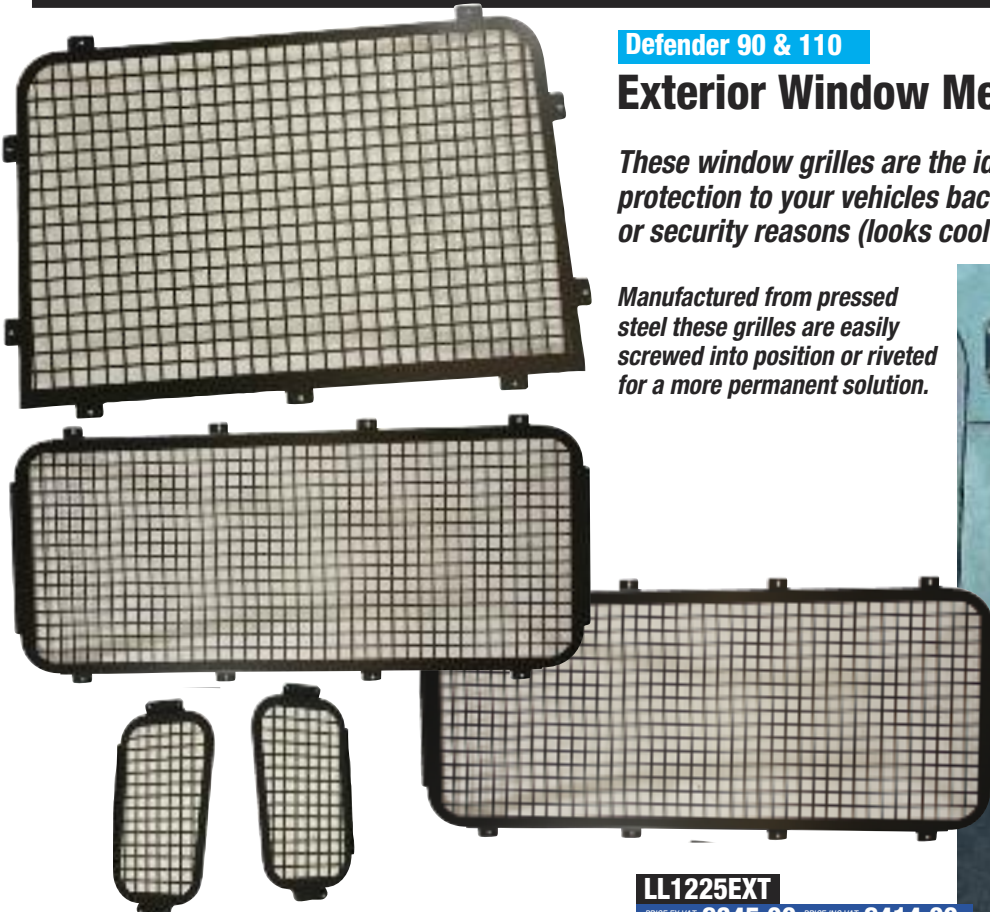

LL1225EXT

PRICE EX VAT (OUTSIDE EU) **£345.00** PRICE INC VAT (UK @ 20%) **£414.00**

ORDER

BY PHONE: 01522 568000 / ON LINE: www.rimmerbros.co.uk / E-MAIL: lrsales@rimmerbros.co.uk

*Prices include UK VAT @ 20%.

LAMP GUARDS & PROTECTORS

Defender Lamp Guards



LL1378BP



RTC8860AABP



LL1379BP

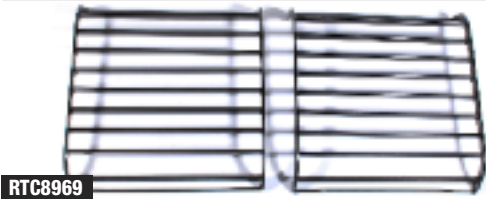

RTC8969



STC53157BP

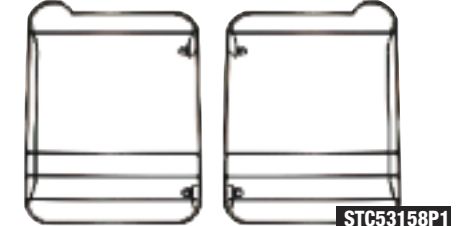

STC53158P1

Defender

Model	Part Number	Price Ex VAT	Price Inc VAT*
Defender Headlamp Protectors, Acrylic			
All models (Defender Puma all models except RAW, Fire & Ice, SIX)			
Front, Pair	Aftermarket STC7561BM	23.54	28.25
Defender Lamp Guards			
All models			
Front, Pair	Aftermarket LL1378BP	30.83	37.00
Up to (VIN) 1A622423 without headlamp wash, hinged			
Front, Pair	Genuine RTC8969	129.15	154.98
(VIN) 2A622424 on, rectangular, hinged			
Front, Pair	Aftermarket STC53161BP	73.33	88.00
	Genuine STC53161	136.11	163.33
All models, hinged			
Front, Pair	Aftermarket RTC8969P	30.83	37.00
Up to (VIN) 1A622423 (1 square, 1 L Shape), hinged			
Rear, Pair	Aftermarket RTC8860AABP	50.83	61.00
	Genuine RTC8860AA	126.57	151.88
(VIN) 2A622424 on, (1 square, 1 L Shape), hinged			
Rear, Pair	Aftermarket STC53157BP	73.33	88.00
	Genuine STC53157	126.57	151.88
Td5 models			
rectangular, Rear, Single	Aftermarket LL1381BP	11.87	14.24
round, Rear, Single	Aftermarket LL1382BP	11.87	14.24
2003 on, Wolf style, rectangular & round			
Rear, Pair	Aftermarket LL1379BP	35.83	43.00
All models, square hinged			
Rear, Pair	OEM STC53158P1	39.95	47.94
	Genuine STC53158	126.57	151.88
All models, round mesh type			
Rear, Pair	Aftermarket VUB504110BP	29.17	35.00
110 high capacity pick-up only to (VIN) 1A612403			
Rear, Pair	Aftermarket LL1204BM	29.17	35.00
For NAS spec lamps 95mm diameter			
Java Black, Rear, Pair	KBX LL1844	25.99	31.19
Brunel Silver, Rear, Pair	KBX LL1845	25.99	31.19
All models, except high capacity pick-up			
Set of 4	Aftermarket LL1205BM	113.33	136.00
Td5 2003 on, Wolf style			
Set of 4	Aftermarket LL1380BP	65.83	79.00



VUB504110BP

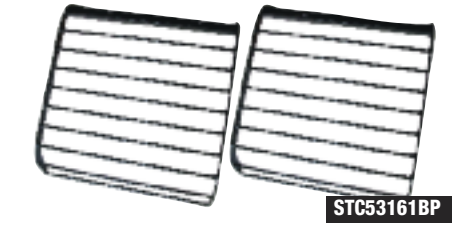

STC53161BP



LL1381BP



LL1204BM

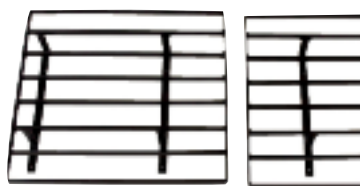

RTC8969P



STC7561BM



LL1844



LL1845



LL1382BP



LL1380BP

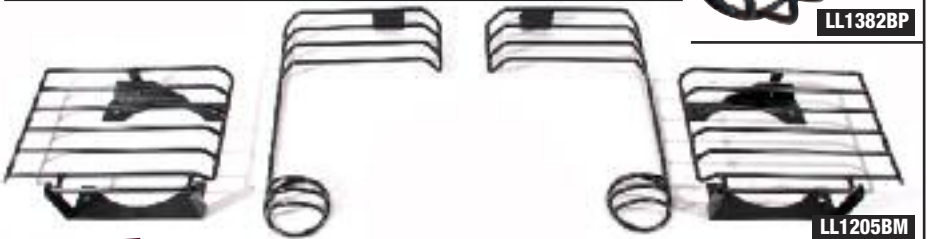

LL1205BM

Discovery Lamp Guards & Protectors



STC8932AABP



STC50026BP



STC50027BP



STC8453P1



STC53193BP



RTC9503AABP

Discovery

Model	Part Number	Price Ex VAT	Price Inc VAT*
Discovery 1 Headlamp Protectors, Acrylic			
300Tdi, Front, Pair	Aftermarket STC8932AABP	47.08	56.80
	Genuine STC8932AA	54.98	65.98
Discovery 1 Lamp Guards			
Rear wing (upper)			
Rear, Pair	Aftermarket RTC9503AABP	49.58	59.50
Rear bumper (no drill fit)			
Rear, Pair	Aftermarket STC8453P1	29.95	35.94
Discovery 2 Headlamp Protectors, Acrylic			
Up to (VIN) 2A499999			
Front, Pair	Aftermarket STC50064BP	48.33	58.00
	Genuine STC50064	57.70	69.24
Discovery 2 Lamp Guards			
Up to (VIN) 2A499999			
Front, Pair	Aftermarket STC50026BP	65.83	79.00
	Genuine STC50026	121.69	146.03
(VIN) 3A000001 on			
Front, Pair	Aftermarket STC53193BP	80.83	97.00
	Genuine STC53193	103.66	124.39
All models (upper & lower set)			
Rear, Set of 4	Aftermarket STC50027BP	70.00	84.00
	Genuine STC50027	133.61	160.33
All models rear wing (upper)			
Rear, Pair	Genuine STC53194	86.54	103.85
From (VIN) 3A000001 (lower set)			
Rear, Pair	Genuine VUB500520	77.08	92.50
Discovery 3 Lamp Guards			
All models			
Front, Pair	Aftermarket VUB501200BP	50.83	61.00
All models (except Canada, Mexico & USA)			
Front, Pair	Genuine VUB501200	136.11	163.33
All models (except Canada, Mexico & USA)			
Front, Right Hand	Genuine VUB503080	75.73	90.88
Front, Left Hand	Genuine VUB503070	75.73	90.88
Rear, Pair	Aftermarket VUB501380BP	50.83	61.00
	Genuine VUB501380	140.64	168.77
Rear, Right Hand	Genuine VUB503040	135.21	162.25
Rear, Left Hand	Genuine VUB503030	135.21	162.25
Discovery 4 Lamp Guards			
From (VIN) AA000001 to (VIN) DA999999			
Front, Pair	Genuine VPLAP0008	133.61	160.33
Rear, Pair	Genuine VPLAP0009	136.18	163.42
Front, Right Hand	Genuine VPLAP0028	104.13	124.96
Front, Left Hand	Genuine VPLAP0029	79.91	95.89
Rear, Right Hand	Genuine VPLAP0030	104.13	124.96
Rear, Left Hand	Genuine VPLAP0027	104.13	124.96



STC53194



VUB500520



VUB501200BP

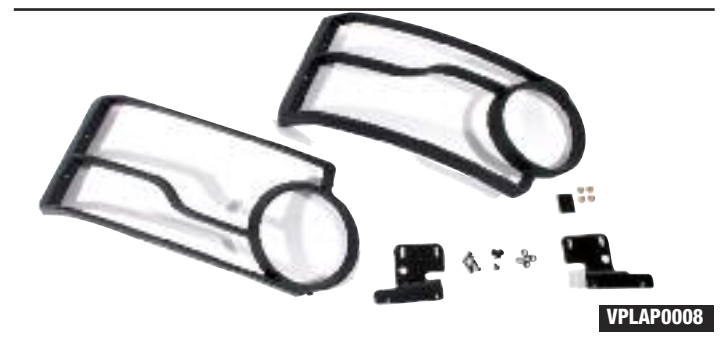

VPLAP0008



VUB501380BP



VPLAP0009

ORDER

BY PHONE: 01522 568000 / ON LINE: www.rimmerbros.co.uk / E-MAIL: lrsales@rimmerbros.co.uk

*Prices include UK VAT @ 20%.

LAMP GUARDS & PROTECTORS

Freelander Lamp Guards & Protectors



VPLFP0077

Freelander

Model	Part Number	Price Ex VAT	Price Inc VAT*
Freelander 1 Headlamp Protectors, Acrylic			
To (VIN) 3A999999			
Front, Pair	Aftermarket STC7917P	37.08	44.50
Freelander 1 Lamp Guards			
From (VIN) 4A000001 to (VIN) 6A999999			
Front, Pair	Aftermarket VUB501390BP	37.08	44.50
Freelander 2 Lamp Guards			
From (VIN) BH000001 to (VIN) CH999999			
Front, Pair	Genuine VPLFP0076	42.47	50.96
Front, Right Hand	Genuine VPLFP0077	72.88	87.46
Front, Left Hand	Genuine VPLFP0078	72.88	87.46
All models, Rear, Pair	Genuine LR003685	17.87	21.44



VUB501390BP



VPLFP0076



LR003685

Series Lamp Guards



345985BP



345985P

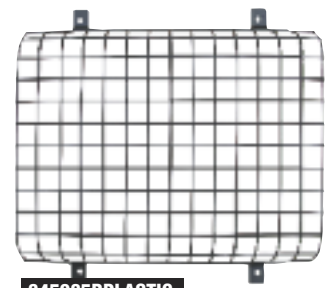

345985BPLASTIC

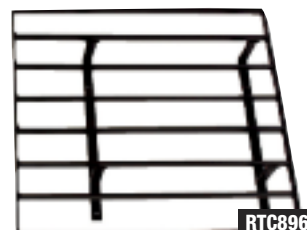
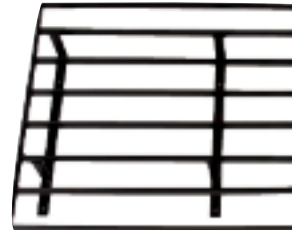

RTC8969P

Series

Model	Part Number	Price Ex VAT	Price Inc VAT*
Series Lamp Guards			
All models, natural finish			
Front, Single	Aftermarket 345985P	6.87	8.24
	Genuine 345985	34.67	41.60
Rear, Single	Aftermarket MRC316BP	5.62	6.74
All models, plastic coated			
Front, Pair	Aftermarket 345985BPLASTIC	6.04	7.25
IIa 88 & 109 models from 1969 on, hinged			
Front, Pair	Aftermarket RTC8969P	30.83	37.00
III 88 & 109 all models, hinged			
Front, Pair	Aftermarket RTC8969P	30.83	37.00
III 88 & 109 late models			
Rear, Set of 4	Aftermarket LL1582BM	37.08	44.50
III 109 high capacity pick up models			
Rear, Pair	Aftermarket LL1204BM	29.17	35.00



LL1204BM

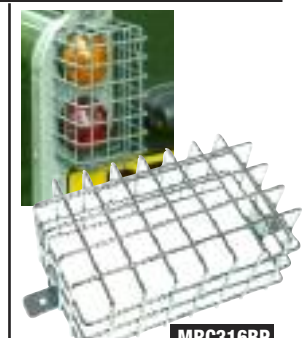

MRC316BP



LL1582BM

Range Rover Lamp Guards & Protectors



STC8027



STC7608AA



VUB001070



RA2067BP



VPLSP0010



VPLTP0064



VUB501920BP



VUB501920BP

Range Rover

Model	Part Number	Price Ex VAT	Price Inc VAT*
Range Rover Classic Lamp Guards			
Hinged, Rear, Pair	Genuine	STC8027	121.71 146.05
Range Rover P38 Headlamp Protectors, Acrylic			
Up to 1999, Front, Pair	Aftermarket	RA2067BP	40.83 49.00
Range Rover P38 Lamp Guards			
All models outer			
Rear, RH	Genuine	STC7607AA	58.13 69.76
Rear, LH	Genuine	STC7608AA	58.13 69.76
All models inner			
Rear, RH	Genuine	STC7609AA	16.66 19.99
Rear, LH	Genuine	STC7610AA	58.13 69.76
Range Rover L322 Lamp Guards			
From (VIN) 2A000001 to (VIN) 9A999999			
Front, Pair	Genuine	VUB001070	161.75 194.10
Rear, Pair	Genuine	VUB001080	161.75 194.10
Range Rover Sport Lamp Guards			
Up to (VIN) 9A999999			
Front, Pair	Aftermarket	VUB501930BP	39.50 47.40
Rear, Pair	Aftermarket	VUB501920BP	55.83 67.00
From (VIN) AA000001 to (VIN) DA999999			
Front, Pair	Genuine	VPLSP0010	161.75 194.10
Rear, Pair	Genuine	VPLTP0064	35.03 42.04
Rear, RH	Genuine	VPLTP0062	91.43 109.72
Rear, LH	Genuine	VPLTP0063	91.43 109.72

ORDER

BY PHONE: 01522 568000 / ON LINE: www.rimmerbros.co.uk / E-MAIL: lrsales@rimmerbros.co.uk

*Prices include UK VAT @ 20%.

SUMP GUARDS

Sump Guards

These sump guards are manufactured from high quality, hard wearing & corrosion resistant materials. All fixings are supplied and the guards fit into the vehicle's pre-existing holes. Each guard has holes at the front to allow for water drainage & to help with ventilation for the cooling system.

Defender - 1985 on

LL1182BPALLY

PRICE EX VAT (OUTSIDE EU) **£120.00** PRICE INC VAT (UK @ 20%) **£144.00**



Discovery 1, Range Rover Classic, RHD & LHD

RA1225ABP

PRICE EX VAT (OUTSIDE EU) **£112.00** PRICE INC VAT (UK @ 20%) **£134.40**

An essential purchase for any off road use as they prevent damage to the underside of the engine & intercooler at the front of the vehicle. Manufactured from 8mm 5083 aluminium supplied completely machined & drilled ready to bolt directly to the 4 pre-drilled holes in the chassis with supplied galvanised fixings. The guard requires no additional drilling just unscrewing & unclipping of the plastic OEM parts. Fitting should take 5 minutes shorter than it takes to decide on Black or Silver finish!



Discovery 3 - all models

Silver - LR007483BPALI

PRICE EX VAT (OUTSIDE EU) **£260.00** PRICE INC VAT (UK @ 20%) **£312.00**

Black - LR007483BPALIB

PRICE EX VAT (OUTSIDE EU) **£258.33** PRICE INC VAT (UK @ 20%) **£310.00**

Discovery 4 - all models

Silver - VPLAP0094BPALI

PRICE EX VAT (OUTSIDE EU) **£270.83** PRICE INC VAT (UK @ 20%) **£325.00**

UJ Silicone Sleeves

Suitable for Series, Defender, Discovery 1, Discovery 2 & Range Rover Classic. By adding one of these silicone sleeves you will reduce debris from building up in the universal joint which, in time, will increase the life span of the joint.



51mm dia propshaft - LL1600BP

PRICE EX VAT (OUTSIDE EU) **£24.58** PRICE INC VAT (UK @ 20%) **£29.50**

63mm dia propshaft - LL1599BP

PRICE EX VAT (OUTSIDE EU) **£27.08** PRICE INC VAT (UK @ 20%) **£32.50**

Made from heavy duty 7mm aluminium plate & with 6mm fixing brackets which are zinc coated for extra corrosion resistance. The aluminium plate has 9 vent holes (38mm diameter) to allow for ventilation & excess water to drain. Complies with EU regulation.



Defender - 1983 to 2006 RHD & LHD

LR008247P

PRICE EX VAT (OUTSIDE EU) **£117.50** PRICE INC VAT (UK @ 20%) **£141.00**

As well as protecting the sump this guard will also look after your front steering & drag links. Manufactured from 6mm, very high grade aluminium, it is easy to fit with no drilling required. Compatible if the vehicle has Nudge Bars or Winch Plate fitted too.

Discovery 2 - all models

RD1265P

PRICE EX VAT (OUTSIDE EU) **£85.83** PRICE INC VAT (UK @ 20%) **£103.00**



Sump Plate

This sump plate protects the underside of the engine & allows the car to slide over objects, forward & backwards due to the rear lip. With a natural finish the plate is made from 6mm 5083 grade aluminium & has been water jet cut to a precise finish. The plate bolts directly into existing holes & bulkheads already in the chassis, using the standard Land Rover fixings.



Discovery 3 & 4 - all models

RD1282BPD3

PRICE EX VAT (OUTSIDE EU) **£148.33** PRICE INC VAT (UK @ 20%) **£178.00**

Swivel Housing Gaiter Kits

Permanent Protection!

- Bond in place under existing flange
- Completely seals against dust, water & grit
- Moulded in high performance neoprene rubber
- No special tools required
- 2 year guarantee
- Kit includes 2 gaiters, metal straps, bonding agent, gloves & full instructions



Series - all models

LL1392BP

PRICE EX VAT (OUTSIDE EU) **£35.83** PRICE INC VAT (UK @ 20%) **£43.00**

Defender, Discovery 1 & Range Rover Classic

LL1393BP

PRICE EX VAT (OUTSIDE EU) **£29.58** PRICE INC VAT (UK @ 20%) **£35.50**

Additional bonding agent for easier fitment of gaiter without dismantling the axle assembly

LL1393BPGLUE

PRICE EX VAT (OUTSIDE EU) **£3.33** PRICE INC VAT (UK @ 20%) **£4.00**



DIFF GUARDS

Diff Guards

Easy to fit, no drilling required, zinc plated for corrosion resistance.

Series II, IIa, III, Defender, Range Rover Classic, Discovery 2.

RA1354P

PRICE EX VAT (OUTSIDE EU) £21.50 PRICE INC VAT (UK @ 20%) £25.80

Simple to fit, no drilling required, electroplate finish for corrosion resistance.

Defender, Discovery 1, Range Rover Classic

RA1354BP

PRICE EX VAT (OUTSIDE EU) £17.50 PRICE INC VAT (UK @ 20%) £21.00

Series II, IIa, III, Defender with Salisbury type axle

RA1354BMSALS

PRICE EX VAT (OUTSIDE EU) £50.00 PRICE INC VAT (UK @ 20%) £60.00

Made from 5mm steel & finished in zinc & yellowed to resist corrosion. This heavy duty diff guard wraps entirely around the diff giving maximum protection.

Defender 110 front - 2002 on (VIN) 2A6z2424.
Defender 110 rear - up to 2001 (VIN) YA999999
Range Rover Classic - all models
Discovery 1 & 2 - RHD only

RA1354-BM-WRAP

PRICE EX VAT (OUTSIDE EU) £38.33 PRICE INC VAT (UK @ 20%) £46.00

Slider type diff guard made from heavy duty 4mm steel to offer sturdy protection. Zinc plated to resist corrosion. Bolts directly to the diff mounting bolts to protect case as well as acting like a slider.

Defender 110 rear - 2007 on

RA1354BMS90

PRICE EX VAT (OUTSIDE EU) £43.33 PRICE INC VAT (UK @ 20%) £52.00

Defender 110 rear - 2007 on
Range Rover P38 rear

RA2091BM

PRICE EX VAT (OUTSIDE EU) £47.08 PRICE INC VAT (UK @ 20%) £56.50

These diff guards produced by Terraforma are manufactured in 6mm steel. They are gold zinc passivated to resist corrosion. Easy to fit with all necessary fixings supplied, they mount onto existing pre-drilled holes.

Discovery 2 front

RD1227TF

PRICE EX VAT (OUTSIDE EU) £69.17 PRICE INC VAT (UK @ 20%) £83.00

Discovery 2 rear

RD1227RTF

PRICE EX VAT (OUTSIDE EU) £65.00 PRICE INC VAT (UK @ 20%) £78.00

Steering Guards

These steering guards offer additional protection to the steering components while off roading.

Defender

NRC7009P

PRICE EX VAT (OUTSIDE EU) £35.83 PRICE INC VAT (UK @ 20%) £43.00

Discovery 1, Range Rover Classic

NRC8239P

PRICE EX VAT (OUTSIDE EU) £60.83 PRICE INC VAT (UK @ 20%) £73.00

Fuel Tank Guards

These fuel tank guards are finished in very high grade aluminium and are complete with drain & ventilation holes. Lightweight & strong - easy to fit.

LL1185BMEARLY

LL1185BMLATE

LL1186BMEARLY

RA1519BM

RA1518BM

LF1122

Model	Material	Part Number	Price Ex VAT	Price Inc VAT*
Defender 90				
to (VIN) VA999999	Aluminium	LL1185BMEARLY	100.83	121.00
from (VIN) WA000001	Aluminium	LL1185BMLATE	75.83	91.00
Defender 110				
to (VIN) VA999999	Aluminium	LL1186BMEARLY	108.33	130.00
from (VIN) WA000001	Aluminium	LL1186BMLATE	118.33	142.00
Discovery 1, Range Rover Classic				
	Aluminium	RA1518BM	68.50	82.20
Plastic fuel tank	Aluminium	RA1519BM	85.00	102.00
Discovery 2	Aluminium	RD1293BM	119.50	143.40
Freelander 1 Will not fit with tow bar. (Steel not aluminium) 1.5" heavy gauge tube, 4 point fixing				
	Steel	LF1122	105.00	126.00

ORDER

BY PHONE: 01522 568000 / ON LINE: www.rimmerbros.co.uk / E-MAIL: lrsales@rimmerbros.co.uk

*Prices include UK VAT @ 20%.

There are many more Roll Cage options available from Safety Devices, too many to list here. For your specific needs please call our sales Hotline on 01522 568000.

ROLL CAGES

Safety Devices

Defender 90 - Soft Top 2 Door (1983 on)

8 Point, Multi-Point, Bolt-In, Full Roll Cage

Safety Devices offer design excellence and unrivalled quality.

Safety Devices are the UK's original designers and manufacturers of roll cages and roof racks for Land Rover. Originally designed for the British Army and the Camel Trophy, today an extensive range of designs are available. The quality is exceptional - cold drawn seamless steel, grit blasted, zinc primed and black powder coated roll cages will stand up to the sort of challenges you expect your Land Rover to cope with.



NOTE: - Utilises existing hood which will need modification, front legs are NAS style.



RBL1887SSS

PRICE EX VAT (OUTSIDE EU) £1199.00 PRICE INC VAT (UK @ 20%) £1438.80

Defender 110 PUMA - (2007 on)

4 Point, Bolt-In, Internal, Rear 'Half' Roll Cage - Black



Suitable for high back/bench seats.

RBL2557SSS

PRICE EX VAT (OUTSIDE EU) £675.00 PRICE INC VAT (UK @ 20%) £810.00

Defender

External Style Roll Bar

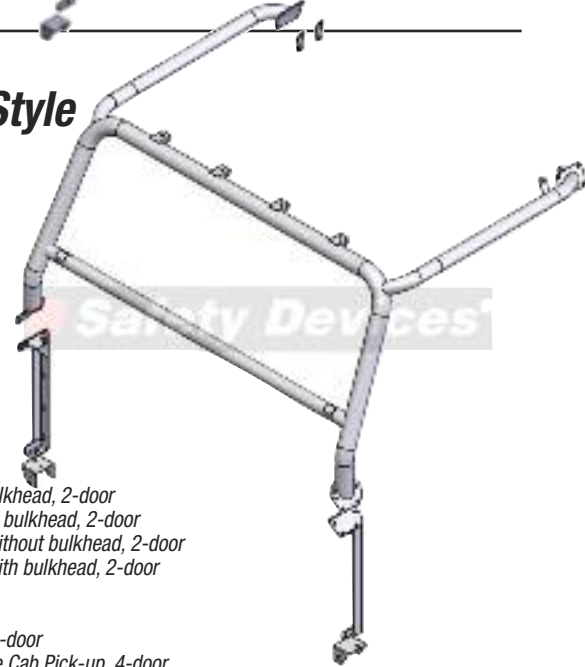

Fits:

Defender 90

- Hard Top with bulkhead, 2-door
- Hard Top without bulkhead, 2-door
- Station Wagon without bulkhead, 2-door
- Station Wagon with bulkhead, 2-door

Defender 110

- Hard Top, 2-door
- Station Wagon, 4-door
- Crew Cab/Double Cab Pick-up, 4-door

Defender 130

- Station Wagon, 4-door
- High Capacity Crew Cab Double Cab Pick-up, 4-door

Silver RBL2303SSS

PRICE EX VAT (OUTSIDE EU) £539.95 PRICE INC VAT (UK @ 20%) £647.94

Black RBL2303SSSBLK

PRICE EX VAT (OUTSIDE EU) £539.95 PRICE INC VAT (UK @ 20%) £647.94

Defender 110 PUMA - (2007 on)

Padding Kit

For RBL2557SSS internal roll cage
Specially formulated polyurethane flame retardant padding kit.
Kit covers all internal roll cage components above shoulder height.

RBL255PAD

PRICE EX VAT (OUTSIDE EU) £320.00 PRICE INC VAT (UK @ 20%) £384.00

Roll Bar

Series II, IIa & III - (88 & 109 models)

Standard Roll Bar (not competition)



Manufactured in 2" (50mm) diameter tubular steel with 3.2mm wall thickness. Body mounted (bolted onto cappings). Supplied unpainted. Will not fit with hardtop.

STC7014BM

PRICE EX VAT (OUTSIDE EU) £128.75 PRICE INC VAT (UK @ 20%) £154.50

TREAD PLATES

Sill Tread Plate Sets

4 Piece Set
Self Adhesive
Stainless Steel



Discovery 3 & 4 (All Models)

Sill Tread Plate Set			
	Part Number	Price Ex VAT	Price Inc VAT*
Aftermarket	EBN500041BP	125.83	151.00
Genuine	EBN500041	227.24	272.69

4 Piece Set
Self Adhesive
Polished
Stainless
Steel



Freelander 2 (All Models)

Sill Tread Plate Set			
	Part Number	Price Ex VAT	Price Inc VAT*
Aftermarket	LR002525BP	118.33	142.00



8 Piece Set
Self Adhesive
Stainless
Steel

Range Rover Sport (VIN) 6A000001 to DA999999

Sill Tread Plate Set			
	Part Number	Price Ex VAT	Price Inc VAT*
Aftermarket	VPLSS0042BP	133.33	160.00

Loadspace Mat Retainer



Stainless Steel

Discovery 3 & 4 (All Models)

Loadspace Mat Retainer			
	Part Number	Price Ex VAT	Price Inc VAT*
Genuine	LR006874	287.91	345.49

Defender (All Models)

Loadspace Mat Retainer			
	Part Number	Price Ex VAT	Price Inc VAT*
OEM	AFP710120P1	6.87	8.24
Stainless Steel*	AFP710120PSS	20.83	25.00
Genuine	AFP710120	14.13	16.96

Rear Bumper Cover Scuff Plate



Stainless Steel

Range Rover L322 (All Models)

Rear Bumper Cover Scuff Plate			
	Part Number	Price Ex VAT	Price Inc VAT*
Aftermarket	RA2073BP	133.33	160.00

Rear Door Scuff Plate



Stainless Steel

Range Rover Evoque From (VIN) EH894484

Rear Door Scuff Plate			
	Part Number	Price Ex VAT	Price Inc VAT*
Genuine	LR061593	132.24	158.69

Stainless Steel
or Chrome



Range Rover Sport

All Models up to (VIN) DA999999

Rear Bumper Cover Scuff Plate			
	Part Number	Price Ex VAT	Price Inc VAT*
Chrome	LR007321BM	75.83	91.00
Stainless Steel	LR007321	301.63	361.96

Glove Box



Neat storage solution for your Defender which utilises the available dashboard space. Ideal for storing all the usual small items you carry with you. Robust construction & easy to fit with all the necessary parts supplied. Suitable for both right & left hand drive vehicles.

Defender (VIN) 7A000001 on

Glove Box			
	Part Number	Price Ex VAT	Price Inc VAT*
Aftermarket	LL1564	48.33	58.00

ORDER

BY PHONE: 01522 568000 / ON LINE: www.rimmerbros.co.uk / E-MAIL: lrsales@rimmerbros.co.uk

*Prices include UK VAT @ 20%.

CUBBY BOXES



The Defender cubby box will fit all models unless they have been fitted at the factory with a box mounted subwoofer.

The Exmoor Trim box has been the subject of a facelift & has been updated after many years of production.

4 x ABS plastic moulding feet & alternate internal mounting points for either Series or Defender (including Puma) that bring the box away from the high/low gear shift position. The inside of the box is lined and features the original black hinges & a check strap for the lid stop.

All boxes are supplied with nut & bolt fixings rather than self-tapping screws & the hole positions correspond to the Defender & Puma mounting points without the need for any drilling (if factory installed) – this will hold the box firmly in place.

The cubby box also includes a new ABS plastic twin cup holder that has been designed to allow for easy removal of hot or cold drinks without any suction occurring – so no spills!

Defender & Series (All Models)

Material	Part Number	Price Ex VAT	Price Inc VAT*
Cubby Box			
Black Leather	EXT015-BL	69.34	83.21
Black Vinyl	EXT015-BV	59.95	71.94
Dark Grey Vinyl	EXT015-DGV	61.90	74.28



The Premium Cubby will fit all Defenders & Series vehicles.

The Premium Cubby box is part of the Exmoor Trim premium range of seating & has been designed for those looking to make their Defender more luxurious.

It has a 50mm padded lid which is at the correct height for improved comfort & arm support. 4 x ABS plastic moulding feet will fit straight into the pre-drilled Land Rover fixings on most Defender models, the inside of the box is fully carpet lined for a luxury look & has a clip catch to help prevent lifting & rattling. Supplied complete with ABS plastic twin cup holder & all fixings required.

Defender & Series (All Models)

Material	Part Number	Price Ex VAT	Price Inc VAT*
Cubby Box			
Black Leather black stitching	EXT015PREM-BL	166.63	199.96
Black Vinyl white stitching	EXT015PREM-XS	115.00	138.00
Diamond XS - Vinyl	EXT015PREM-DXS	135.00	162.00
Black Rack - Vinyl	EXT015PREM-XSBR	129.00	154.80



The Cubby Boxes are available in many other trim options, if your preferred option is not shown please call 01522 568000.

The LocBox will fit all Defenders & Series vehicles.

This box is incredibly secure with a heavy-duty locking bolt that neatly locks when the lid closes shut.

Finished in tough powder coat, a padded lid, neat rear map pocket & twin cup holders.

Also includes a front pocket tray for pens, mobile phone etc.

4 x ABS plastic moulding feet will fit straight into the pre-drilled Land Rover fixings on most Defender (including Puma) & Series models.



Twin Cup Holder

Defender & Series (All Models)

Material	Part Number	Price Ex VAT	Price Inc VAT*
LocBox			
Black Leather	EXT016-BL	182.84	219.41
Black Vinyl	EXT016-BV	175.13	210.16

All Models

Material	Part Number	Price Ex VAT	Price Inc VAT*
Twin Cup Holder			
Black	EXT015-2	11.29	13.55



BRITPART



Defender & Series (All Models)

Material	Part Number	Price Ex VAT	Price Inc VAT*
Cubby Box Black Vinyl	LL1223BLACKBP	51.67	62.00



Freelander 2 (All Models)

*Includes adjustable sliding top.

Material	Part Number	Price Ex VAT	Price Inc VAT*
Freelander 2 to (VIN) BH999999 with no factory fitted armrests			
Black leather, RHD	LF1102BLACKBP*	88.33	106.00
Black eco leather RHD	LF1102BLACKCOBP*	78.33	94.00
Alpaca leather RHD	LF1102ALPACABP*	90.83	109.00
Almond leather RHD	LF1102ALMONDBP*	90.83	109.00
Black leather, LHD	LF1103BLACKBP*	90.83	109.00
Black eco leather LHD	LF1103BLACKCOBP*	78.33	94.00
Alpaca leather LHD	LF1103ALPACABP*	93.33	112.00
Almond leather LHD	LF1103ALMONDBP*	93.33	112.00
Freelander 2 to (VIN) BH999999 with factory fitted armrests			
Black leather RHD & LHD	LF1104BLACKBP	90.83	109.00
Black eco leather RHD & LHD	LF1104BLACKCOBP	78.33	94.00
Alpaca leather RHD & LHD	LF1104ALPACABP	99.50	119.40
Almond leather RHD & LHD	LF1104ALMONDBP	93.33	112.00



Gear Lever Knob & Gaiter Set

Discovery 4



Fits Discovery 4 with manual gearbox

LR012184
PRICE EX VAT (OUTSIDE EU) **£68.23** PRICE INC VAT (UK @ 20%) **£81.88**

Improve your driving position in a Range Rover Evoque with an additional armrest.



Manufactured from real leather & simple to fit, it can easily be moved to suit your driving position & still gives access to the cubby box.

Range Rover Evoque (All Models)

Material	Part Number	Price Ex VAT	Price Inc VAT*
Evoque vehicles with non-adjustable armrests			
Black leather	LR054857BPAR	80.83	97.00
Almond leather	LR054858BPAR	80.83	97.00
Lunar leather	LR054860BPAR	80.83	97.00
Evoque vehicles with adjustable armrests			
Black leather	RA2114BPE	79.17	95.00
Almond leather	RA2114BPA	79.17	95.00
Lunar leather	RA2114BPL	79.17	95.00

ORDER BY PHONE: 01522 568000 / ON LINE: www.rimmerbros.co.uk / E-MAIL: lrsales@rimmerbros.co.uk

*Prices include UK VAT @ 20%.

GEAR KNOBS & TRIM FINISHES

Gear Knob Sets

Anodised Aluminium



Defender R380 Gearbox

STC60508-9R380
PRICE EX VAT (OUTSIDE EU) £29.50 PRICE INC VAT (UK @ 20%) £35.40



Defender LT77 Gearbox

STC60508-9LT77
PRICE EX VAT (OUTSIDE EU) £16.67 PRICE INC VAT (UK @ 20%) £20.00

Gear Knobs

Anodised Aluminium



Defender LT77 Gearbox

FRC8722ALILT77
PRICE EX VAT (OUTSIDE EU) £16.87 PRICE INC VAT (UK @ 20%) £20.24



Defender R380 Gearbox

STC60508BM
PRICE EX VAT (OUTSIDE EU) £16.87 PRICE INC VAT (UK @ 20%) £20.24



Defender LT77 Transfer Box

STC60509BM
PRICE EX VAT (OUTSIDE EU) £16.87 PRICE INC VAT (UK @ 20%) £20.24

Aluminium Door Locking Peg

Defender



JRC1775ALIS
PRICE EX VAT (OUTSIDE EU) £22.50 PRICE INC VAT (UK @ 20%) £27.00

Aluminium Vent Knob

Defender Up to (VIN) 6A999999



AIT710030ALIS
PRICE EX VAT (OUTSIDE EU) £11.50 PRICE INC VAT (UK @ 20%) £13.80

Aluminium Interior Door Handle

Defender



Y00451ALIS
PRICE EX VAT (OUTSIDE EU) £29.50 PRICE INC VAT (UK @ 20%) £35.40

X-Trouser Catch

Defender



Lost a pair of trousers getting in & out of your Defender?

Here is the simple solution. Not only does it protect your trousers, in many cases it makes the door close more reliably & helps (though it does not entirely stop) the seat belt getting caught in the latch. If the seat belt does become caught as you close the door, it suffers less damage due to the smooth profile, if your belt loop or pocket runs over it, it will slide off freely. The X-trouser catch is reversible so it will fit both driver & passenger doors, left & right hand drive. It will also fit the rear side doors of 110 Station

FQB500130XT
PRICE EX VAT (OUTSIDE EU) £24.17 PRICE INC VAT (UK @ 20%) £29.00

Demister (pair)

Defender

An amazing product that will fit all Defenders with wide demist vents (approx 1983 on).

Fitted in 30 seconds using 2 self tapping screws (supplied) - no drilling required.



LL1886
PRICE EX VAT (OUTSIDE EU) £79.50 PRICE INC VAT (UK @ 20%) £95.40

INTERIOR TRIM

SPECIAL PURCHASE LIMITED STOCKS

Interior Trim Kit

Freelander 2 (RHD - All Models)

7 Piece Interior Trim Kit
Aluminium Finish



Genuine LAND ROVER

SPECIAL PURCHASE LIMITED STOCKS

LR002463
PRICE EX VAT (OUTSIDE EU) £99.95 PRICE INC VAT (UK @ 20%) £119.94

Air Vent Surround Kits

Range Rover Sport
(VIN) 5A000001 to 9A999999



4 Piece Air Vent Surround Kit
Self Adhesive
American Cherry Finish

SPECIAL PURCHASE LIMITED STOCKS

LR003872
PRICE EX VAT (OUTSIDE EU) £59.95 PRICE INC VAT (UK @ 20%) £71.94

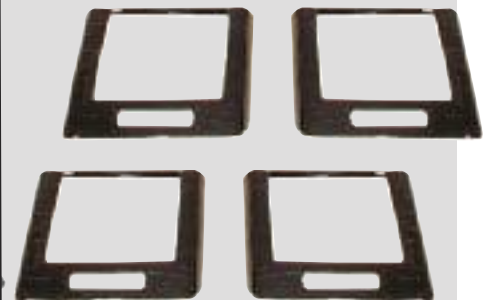

4 Piece Air Vent Surround Kit
Self Adhesive
Lined Oak/Ebony Finish

SPECIAL PURCHASE LIMITED STOCKS

LR003873
PRICE EX VAT (OUTSIDE EU) £49.95 PRICE INC VAT (UK @ 20%) £59.94

Gear Lever Gaiters

Defender LT77 & R380 Gearbox To (VIN) 6A999999



Gear Lever Gaiter Fabric

Exmoor Trim - EXT014-2
 PRICE EX VAT (OUTSIDE EU) **£20.17** PRICE INC VAT (UK @ 20%) **£24.20**



Gear Lever Gaiter Rubber

Aftermarket - BTR1698P
 PRICE EX VAT (OUTSIDE EU) **£9.17** PRICE INC VAT (UK @ 20%) **£11.00**

Genuine - BTR1698
 PRICE EX VAT (OUTSIDE EU) **£29.77** PRICE INC VAT (UK @ 20%) **£35.72**



Gear Lever Gaiter Fabric

Aftermarket - BTR1698BPBLACK
 PRICE EX VAT (OUTSIDE EU) **£14.79** PRICE INC VAT (UK @ 20%) **£17.75**



Discovery 1 & 2 (All Models)

3 Piece Gaiter Kit (Handbrake, Gear & Hi/Low)

Exmoor Trim - EXT014-3
 PRICE EX VAT (OUTSIDE EU) **£17.33** PRICE INC VAT (UK @ 20%) **£20.80**

Door Trim Panels

Range Rover Classic 2 Door Models



Door Trim Panel Upper Pair - Leather Cloth

Other options available, call 01522 568000 for details.



RA1290BEIGE
 PRICE EX VAT (OUTSIDE EU) **£129.17** PRICE INC VAT (UK @ 20%) **£155.00**



Door Trim Panel Lower Pair - Leather Cloth



RA1292BEIGE
 PRICE EX VAT (OUTSIDE EU) **£79.17** PRICE INC VAT (UK @ 20%) **£95.00**



Side Trim Rear Pair - Leather Cloth



RA1297BEIGE
 PRICE EX VAT (OUTSIDE EU) **£94.17** PRICE INC VAT (UK @ 20%) **£113.00**

Door Pillar Trim Set of 4 Leather Cloth



RA1299BEIGE
 PRICE EX VAT (OUTSIDE EU) **£93.33** PRICE INC VAT (UK @ 20%) **£112.00**

Range Rover Classic Headlining

All headlinings are made to order by our supplier and take 6-8 weeks for delivery.

Many options are available and we need to know the following information:

Does your vehicle have a sunroof fitted, if so what type (metal, glass, manual or electric)?

Does your vehicle have rear speakers fitted?

What model year is your vehicle?



Range Rover Classic

Headlining

2 Piece, 2 Door Models	RA1303BEIGE	308.33	370.00
2 Piece, 4 Door Models	RA1304BEIGE	337.50	405.00
1 Piece, 4 Door Models	RA1305GREY	416.67	500.00

Discovery 1 Dashboard Repair Kits

Does your Discovery 1 suffer from the dreaded dashboard curl?

It is a common problem with earlier Discovery models. This is the simple answer, a neat plastic trim, supplied as a two-part kit with self tapping screws, to give the dashboard edge a better than original finish.

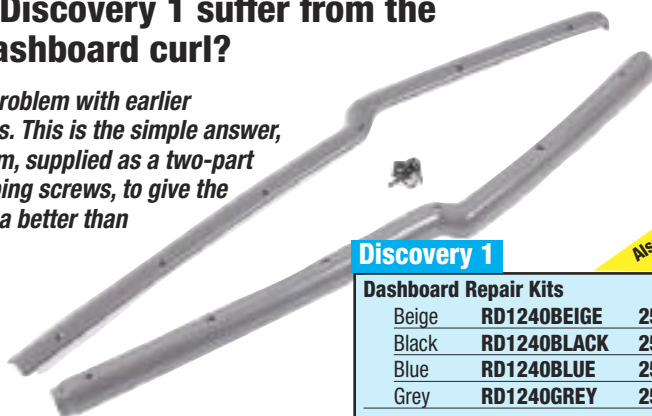

Discovery 1

Dashboard Repair Kits

Beige	RD1240BEIGE	25.42	30.50
Black	RD1240BLACK	25.42	30.50
Blue	RD1240BLUE	25.42	30.50
Grey	RD1240GREY	25.42	30.50

Also available in Beige, Black, Blue or Grey



ORDER

BY PHONE: 01522 568000 / ON LINE: www.rimmerbros.co.uk / E-MAIL: lrsales@rimmerbros.co.uk

*Prices include UK VAT @ 20%.

FRONT

DEFENDER DOOR CASINGS

Front Door Casings - Manual Windows

Defender



Dark Grey,
Right Hand

LL1416GREY
PRICE EX VAT (OUTSIDE EU) **£60.00** PRICE INC VAT (UK @ 20%) **£72.00**



Light Grey,
Right Hand

LL1416LGREY
PRICE EX VAT (OUTSIDE EU) **£60.00** PRICE INC VAT (UK @ 20%) **£72.00**



Lift Up Handle,
Black,
Right Hand

LL1416BLKLU
PRICE EX VAT (OUTSIDE EU) **£60.00** PRICE INC VAT (UK @ 20%) **£72.00**



Dark Grey,
Left Hand

LL1417GREY
PRICE EX VAT (OUTSIDE EU) **£60.00** PRICE INC VAT (UK @ 20%) **£72.00**



Light Grey,
Left Hand

LL1417LGREY
PRICE EX VAT (OUTSIDE EU) **£60.00** PRICE INC VAT (UK @ 20%) **£72.00**



Lift Up Handle,
Black,
Left Hand

LL1417BLKLU
PRICE EX VAT (OUTSIDE EU) **£60.00** PRICE INC VAT (UK @ 20%) **£72.00**



Push Button Entry,
Black,
Right Hand

LL1416BLKPB
PRICE EX VAT (OUTSIDE EU) **£60.00** PRICE INC VAT (UK @ 20%) **£72.00**



Push Button Entry,
Black,
Left Hand

LL1417BLKPB
PRICE EX VAT (OUTSIDE EU) **£60.00** PRICE INC VAT (UK @ 20%) **£72.00**

Trim Clip Assortment



280 pieces

RX1966 PRICE EX VAT (OUTSIDE EU) **£36.00** PRICE INC VAT (UK @ 20%) **£43.20**

Front Door Casings - Electric Windows

Defender



Dark Grey
Right Hand

LL1416GREYE
PRICE EX VAT (OUTSIDE EU) **£60.00** PRICE INC VAT (UK @ 20%) **£72.00**



Light Grey
Right Hand

LL1416LGREYE
PRICE EX VAT (OUTSIDE EU) **£60.00** PRICE INC VAT (UK @ 20%) **£72.00**



Black
Right Hand

LL1417BLACKE
PRICE EX VAT (OUTSIDE EU) **£60.00** PRICE INC VAT (UK @ 20%) **£72.00**



Dark Grey
Left Hand

LL1417GREYE
PRICE EX VAT (OUTSIDE EU) **£60.00** PRICE INC VAT (UK @ 20%) **£72.00**



Light Grey
Left Hand

LL1417LGREYE
PRICE EX VAT (OUTSIDE EU) **£60.00** PRICE INC VAT (UK @ 20%) **£72.00**



Black,
Left Hand

LL1416BLACKE
PRICE EX VAT (OUTSIDE EU) **£60.00** PRICE INC VAT (UK @ 20%) **£72.00**

REAR

DEFENDER DOOR CASINGS

INTERIOR STYLING - DOOR CARDS

2nd Row Door Casings - Manual Windows

Defender



Dark Grey,
Right Hand

LL1416GREYREAR
PRICE EX VAT (OUTSIDE EU) **£58.33** PRICE INC VAT (UK @ 20%) **£70.00**



Light Grey,
Right Hand

LL1416LGREYREAR
PRICE EX VAT (OUTSIDE EU) **£58.33** PRICE INC VAT (UK @ 20%) **£70.00**



Black,
Right Hand

LL1416BLACKREAR
PRICE EX VAT (OUTSIDE EU) **£58.33** PRICE INC VAT (UK @ 20%) **£70.00**



Dark Grey,
Left Hand

LL1417GREYREAR
PRICE EX VAT (OUTSIDE EU) **£58.33** PRICE INC VAT (UK @ 20%) **£70.00**



Light Grey,
Left Hand

LL1417LGREYREAR
PRICE EX VAT (OUTSIDE EU) **£58.33** PRICE INC VAT (UK @ 20%) **£70.00**



Black,
Left Hand

LL1417BLACKREAR
PRICE EX VAT (OUTSIDE EU) **£58.33** PRICE INC VAT (UK @ 20%) **£70.00**

2nd Row Door Casings - Electric Windows



Dark Grey,
Right Hand

LL1416GREYREARE
PRICE EX VAT (OUTSIDE EU) **£58.33** PRICE INC VAT (UK @ 20%) **£70.00**



Light Grey,
Right Hand

LL1416LGREYREARE
PRICE EX VAT (OUTSIDE EU) **£58.33** PRICE INC VAT (UK @ 20%) **£70.00**



Black,
Right Hand

LL1416BLACKREARE
PRICE EX VAT (OUTSIDE EU) **£58.33** PRICE INC VAT (UK @ 20%) **£70.00**



Dark Grey,
Left Hand

LL1417GREYREARE
PRICE EX VAT (OUTSIDE EU) **£58.33** PRICE INC VAT (UK @ 20%) **£70.00**



Light Grey,
Left Hand

LL1417LGREYREARE
PRICE EX VAT (OUTSIDE EU) **£58.33** PRICE INC VAT (UK @ 20%) **£70.00**



Black,
Left Hand

LL1417BLACKREARE
PRICE EX VAT (OUTSIDE EU) **£58.33** PRICE INC VAT (UK @ 20%) **£70.00**

Rear Door Casings

Defender



Dark Grey

BTR9712LOYP
PRICE EX VAT (OUTSIDE EU) **£59.17** PRICE INC VAT (UK @ 20%) **£71.00**



Light Grey

BTR9712LCSP
PRICE EX VAT (OUTSIDE EU) **£59.17** PRICE INC VAT (UK @ 20%) **£71.00**



Black

BTR9712PMAP
PRICE EX VAT (OUTSIDE EU) **£59.17** PRICE INC VAT (UK @ 20%) **£71.00**

ORDER

BY PHONE: 01522 568000 / ON LINE: www.rimmerbros.co.uk / E-MAIL: lrsales@rimmerbros.co.uk

*Prices include UK VAT @ 20%.

STEERING WHEELS

Steering Wheels (Boss sold separately)

Defender, Series, Range Rover Classic



14" Vinyl Steering Wheel with Black Centre (Semi-Dished)

43SBVB

PRICE EX VAT (OUTSIDE EU) **£54.17** PRICE INC VAT (UK @ 20%) **£65.00**



14" Vinyl Steering Wheel with Polished Centre (Semi-Dished)

43SPVB

PRICE EX VAT (OUTSIDE EU) **£54.17** PRICE INC VAT (UK @ 20%) **£65.00**



15" Leather Steering Wheel with Black Centre (Semi-Dished)

53SBLB

PRICE EX VAT (OUTSIDE EU) **£59.50** PRICE INC VAT (UK @ 20%) **£71.40**



15" Leather Steering Wheel with Polished Centre (Semi-Dished)

53SPLB

PRICE EX VAT (OUTSIDE EU) **£59.50** PRICE INC VAT (UK @ 20%) **£71.40**



340mm M Range Steering Wheel Black Centre Moulded with Semi-Dish Horn Push Included

M34M3PB

PRICE EX VAT (OUTSIDE EU) **£66.67** PRICE INC VAT (UK @ 20%) **£80.00**



340mm M Range Steering Wheel Polished Centre Moulded with Semi-Dish Horn Push Included

M34M3PS

PRICE EX VAT (OUTSIDE EU) **£66.67** PRICE INC VAT (UK @ 20%) **£80.00**



Heated Steering Wheel

Range Rover L322 (2002 to 2012)



Heated Leather Steering Wheel

Many of the early L322 Range Rovers still look as good as new but steering wheels on some models have gone all shiny & have lost the leather appearance & started to sag. Range Rover improved the specification of the wheel on later models and this wheel has the grained leather surface (not the smooth finish) which was used on later models & is much more durable.

Spoke covers are not supplied with this wheel, you need to retain your original airbag/switch assembly.

LR022687BP

PRICE EX VAT (OUTSIDE EU) **£123.33** PRICE INC VAT (UK @ 20%) **£148.00**

Steering Wheel Boss

Defender, Series, Range Rover Classic



Model	Part Number	Price Ex VAT	Price Inc VAT*
Suitable for the following steering wheels 43SBVB, 43SPVB, 53SBLB, 53SPLB			
Series II, IIa & III	SB111A	23.25	27.90
Defender			
36 Spline (17.20mm column)	SB115	20.62	24.74
48 Spline (18.55mm column)	SB088	20.62	24.74
Range Rover Classic			
Black centre	SB015	20.62	24.74

Suitable for the following steering wheels
M34M3PB, M34M3PS

Model	Part Number	Price Ex VAT	Price Inc VAT*
Defender			
36 Spline (17.20mm column)	KK807X	45.83	55.00
48 Spline (18.55mm column)	KK810X	45.83	55.00

Door Stays

Does your Defender's rear door sometimes close on you unexpectedly?

This neat & easily installed gas strut kit will solve that problem & replaces the original door stopper. The gas strut will hold the door in place when open, even with a spare wheel in place, and will assist in the opening of the rear door too with a smoother & more controlled movement. Complete with all fittings and instructions.



Defender 90 & 110 - up to (VIN) 1A622423

LR016708E
 PRICE EX VAT (OUTSIDE EU) £48.33 PRICE INC VAT (UK @ 20%) £58.00

Defender 90 & 110 - (VIN) 2A622424 on

LR016708L
 PRICE EX VAT (OUTSIDE EU) £63.33 PRICE INC VAT (UK @ 20%) £76.00



Pedal Set

**Range Rover Sport - up to (VIN) 9A999999
 Discovery 3**



Stainless Steel & Rubber

LR008713P PRICE EX VAT (OUTSIDE EU) £89.50 PRICE INC VAT (UK @ 20%) £107.40

Extended Seat Rails

Defender (including 2007 onwards)

Ideal for the taller driver



Give your Defender (including 2007 onwards model) seats 3" (75mm) of extra slide with a pair of these seat rails. Ideal for the taller driver to give a more practical & comfortable driving position. One pair of rails is suitable for one seat.

LL1402BP PRICE EX VAT (OUTSIDE EU) £43.33 PRICE INC VAT (UK @ 20%) £52.00

Bulkhead Bars

Defender

Need more leg room & seat adjustment in your Defender?

These bulkhead bars alleviate that problem without compromising strength.

The bulkhead bars allow for extra seat recline & travel on the seat base – giving you a more comfortable seating position & more space in the front foot wells.

The bars create a rigid bracing for the front of the Defender tub as well as the added benefit of extra room in the vehicle due to the seats being more manoeuvrable, access to the rear of the Defender is now not compromised by a higher bulkhead.

Black powder coated & supplied complete with all the necessary fixings & instructions.



OEM Bulkhead Removal Kit

LL1196 PRICE EX VAT (OUTSIDE EU) £123.33 PRICE INC VAT (UK @ 20%) £148.00

Bulkhead Reduction Bar Kit

LL1403BP PRICE EX VAT (OUTSIDE EU) £115.83 PRICE INC VAT (UK @ 20%) £139.00



ORDER

BY PHONE: 01522 568000 / ON LINE: www.rimmerbros.co.uk / E-MAIL: lrsales@rimmerbros.co.uk

*Prices include UK VAT @ 20%.



SEAT BELTS



Exmoor Seat Belts

Defender, Series



Exmoor Trim offers an exclusive range of seat belts, specifically designed to fit your Land Rover using OEM parts only, they will not supply any belt that isn't type approved.



Defender - 2 Door

Model	Part Number	Price Ex VAT	Price Inc VAT*
Front 2 Door Inertia Reel & Buckle			
<i>Fits: Defender 2 Door - All models</i>			
RH	EXT001-5	47.75	57.30
LH	EXT001-6	47.75	57.30



Series

Model	Part Number	Price Ex VAT	Price Inc VAT*
Static Lap Belt (each) (equivalent to MXC5497)			
<i>Fits: Series Front - All models</i>			
<i>Front Centre - All models</i>			
<i>2nd Row Seats - All models</i>			
<i>Load Area Side Facing seats</i>			
	EXT001-1	20.90	25.08



Includes anti-rub plastic sleeve on belt to help keep the belt in position and protect the webbing against movement in the seats when tilted.

109 & 110

Model	Part Number	Price Ex VAT	Price Inc VAT*
Second Row Lap Belt (each)			
<i>Fits: 2nd Row Centre Seat - 109 & 110 (Will not fit Series I)</i>			
	EXT001-2	27.71	33.25



Series II, III 88 & 109 - 2 & 4 Door Defender 110 - 4 Door

Model	Part Number	Price Ex VAT	Price Inc VAT*
Front 4 Door Inertia Reel & Buckle			
<i>Fits: Series II, III 88 & 109 2 Door or 4 Door, Defender 110 4 door</i>			
RH	EXT001-7	47.75	57.30
LH	EXT001-8	47.75	57.30

Includes 'Butterfly' clip system

If you are using these belts for the rear forward facing load area seats then you will require the top mounting brackets (see below).



All Models

Model	Part Number	Price Ex VAT	Price Inc VAT*
4 Point Inertia (LH or RH fit)			
<i>Fits: 2nd Row Seats - All models</i>			
<i>Forward Facing Fold-up seats*</i>			
	EXT001-10	49.88	59.86

*Mounting Bracket required for Forward Facing Fold-up seats.



All Models

Model	Part Number	Price Ex VAT	Price Inc VAT*
Top Mounting Bracket			
RH	EXT001-11	8.38	10.06
LH	EXT001-12	8.38	10.06



Complete with protective rubber boot covering reel and buckle to prevent dirt and dust entering the mechanism.

All Models

Model	Part Number	Price Ex VAT	Price Inc VAT*
ALR Retractable Lap Belt (each)			
<i>Fits: Rear Side Facing Seating - All models</i>			
	EXT001-4	29.75	35.70



SEAT BELTS



Securon Seat Belts

Defender, Series

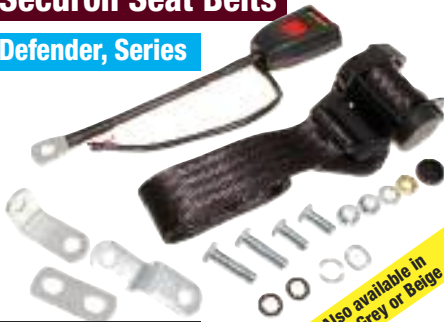

KXC2528-30BLACK

Also available in Red, Grey or Beige



RB7355-30BLACK

Also available in Red, Grey, Beige or Blue



R01086BLACK

Also available in Red, Grey or Beige



719918A30BLACK

Also available in Red or Beige



RS1394SBLACK

Also available in Red, Grey or Beige

RX1937
still waiting for pic

RX1937

Securon Safety Harnesses

Defender, Series

Ideal for off-road use



Model	Part Number	Price Ex VAT	Price Inc VAT*
3 Point Harness 'E' Approved			
Black	LL1172	32.08	38.50
Push Button Reflex Buckle			
Black	LL1172R	93.33	112.00



Model	Part Number	Price Ex VAT	Price Inc VAT*
4 Point Harness 'E' Approved			
Black	RX1500BLACK	80.00	96.00
Red	RX1500	80.00	96.00
Blue	RX1500BLUE	80.00	96.00



Model	Part Number	Price Ex VAT	Price Inc VAT*
Crotch Harness			
Black	RX1501BLACK	18.96	22.75
Red	RX1501	18.96	22.75



Model	Part Number	Price Ex VAT	Price Inc VAT*
Pair of Eye Bolts			
	RX1503	9.99	11.99



Model	Part Number	Price Ex VAT	Price Inc VAT*
Pair of Bolt & Spacer Set			
	RX1505	5.34	6.41

	Defender to 2007	Defender 2007 on	Series II 88 & 109	Series IIa 88 & 109	Series III 88 & 109	Part Number	Price Ex VAT	Price Inc VAT*
3 Point Inertia Reel Seat Belt 30cm Stalk (each)								
Black	Yes	Yes	Yes	Yes	Yes	KXC2528-30BLACK	36.67	44.00
Red		Yes	Yes	Yes	Yes	KXC2528-30RED	46.25	55.50
Grey		Yes	Yes	Yes	Yes	KXC2528-30GREY	46.25	55.50
Beige		Yes	Yes	Yes	Yes	KXC2528-30BEIGE	46.25	55.50
3 Point Angled Inertia Reel Seat Belt 30cm Stalk (each)								
Black		Yes	Yes	Yes	Yes	RB7355-30BLACK	43.33	52.00
Red		Yes	Yes	Yes	Yes	RB7355-30RED	51.67	62.00
Grey		Yes	Yes	Yes	Yes	RB7355-30GREY	51.67	62.00
Beige		Yes	Yes	Yes	Yes	RB7355-30BEIGE	51.67	62.00
Blue		Yes	Yes	Yes	Yes	RB7355-30BLUE	51.67	62.00
3 Point Inertia Reel Seat Belt 32cm Webbed Stalk (each)								
Black	Yes		Yes	Yes	Yes	R01086BLACK	44.17	53.00
Red	Yes		Yes	Yes	Yes	R01086RED	56.67	68.00
Grey	Yes		Yes	Yes	Yes	R01086GREY	56.67	68.00
Beige	Yes		Yes	Yes	Yes	R01086BEIGE	56.67	68.00
3 Point Static Seat Belt 30cm Stalk (each)								
Black			Yes	Yes	Yes	719918A30BLACK	25.42	30.50
Red			Yes	Yes	Yes	719918A30RED	33.75	40.50
Beige			Yes	Yes	Yes	719918A30BEIGE	33.75	40.50
Static Lap Belt 45cm Webbed Stalk (each)								
Black	Yes		Yes	Yes	Yes	RS1394SBLACK	21.67	26.00
Red	Yes		Yes	Yes	Yes	RS1394SRED	37.50	45.00
Grey	Yes		Yes	Yes	Yes	RS1394SGREY	37.50	45.00
Beige	Yes		Yes	Yes	Yes	RS1394SBEIGE	37.50	45.00
Inertia Lap Belt (black only) (each)								
Black	Yes					RX1937	24.58	29.50

ORDER

BY PHONE: 01522 568000 / ON LINE: www.rimmerbros.co.uk / E-MAIL: lrsales@rimmerbros.co.uk

*Prices include UK VAT @ 20%.

Roof Console

Defender 1983 on (not truck cab)

Storage in the cabin area of a Defender is minimal with very few places to put things. Any additional space that can be created is a real bonus especially if it does not cramp the driving space. This roof console is the perfect solution for tucking away maps, pens, glasses etc., even small binoculars & a folding saw can be stashed away in the reversible trap door storage tray.



NOTE – Truck cab versions are available please call 01522 568000 for details

LL1770TF

PRICE EX VAT (OUTSIDE EU) **£115.83** PRICE INC VAT (UK @ 20%) **£139.00**

Front Parcel Shelf

Defender 1983 on



Another great idea to maximise storage space in your Defender, this full width shelf secures into the door openings & spans the width of all Defenders & includes provision to add another or relocate the original interior light. The sun visors fit neatly & tidily into recesses.

LL1769TF

PRICE EX VAT (OUTSIDE EU) **£83.50** PRICE INC VAT (UK @ 20%) **£100.20**

Rear Parcel Shelf Kits

Remanufactured in GRP and covered in original materials. Comprises 2 side trim panels and centre shelf.



Range Rover Classic

Model	Part Number	Price Ex VAT	Price Inc VAT*
Rear Parcel Shelf Kit			
2 Door, Beige	RA1313BEIGE	362.50	435.00
4 Door, Beige	RA1314BEIGE	362.50	435.00
4 Door, Grey	RA1314GREY	362.50	435.00

**Other Options Available
Please Call
01522 568000**

Electric Window Kit - Front

Defender 2002 on

Fed up with winding windows down?



Add electric front windows to your Defender with this comprehensive kit (pair).

CUH000101CONVK

PRICE EX VAT (OUTSIDE EU) **£185.83** PRICE INC VAT (UK @ 20%) **£223.00**

Electric Window Kit - Rear

Defender 110/130



Everything you need is included in this kit (pair).

CUH000101REARKIT

PRICE EX VAT (OUTSIDE EU) **£299.00** PRICE INC VAT (UK @ 20%) **£358.80**

SEATING



Series Seating

Hi-Back Extreme Seat

Will install straight into the existing mountings

- Large rear pockets
- Other colours available, RH or LH

Series

EXT370-BV Black Vinyl
 PRICE EX VAT (OUTSIDE EU) £186.45 PRICE INC VAT (UK @ 20%) £223.74



Hinged Rear Bench Seat

- Side Facing
- Elephant Hide Grey
- Galvanised frame
- Complete with all fixings & retaining straps

Series

EXT003-EHG
 PRICE EX VAT (OUTSIDE EU) £104.48 PRICE INC VAT (UK @ 20%) £125.38



Outer Front Seat Back

- Standard (Bolt type)
- Elephant Hide Grey

Series

EXT372-EHG
 PRICE EX VAT (OUTSIDE EU) £58.80 PRICE INC VAT (UK @ 20%) £70.56



3 Man Bench Cushion

- Elephant Hide Grey
- Attaches to the frame with webbing tape ties

Series

EXT008-DGV
 PRICE EX VAT (OUTSIDE EU) £33.00 PRICE INC VAT (UK @ 20%) £39.60



This is just a small selection of the vast array of products available. The style of seating from front to rear is almost certainly available in a variety of materials & colours. If you cannot find what you are looking for then please ring our sales line for help - 01522 568000

Deluxe Front Full Seat Set

- Black vinyl
- Complete with new pivot bolts, washers & locking bolts

Also available as backs or bases on their own, see below.

Series

EXT378-1
 PRICE EX VAT (OUTSIDE EU) £197.00 PRICE INC VAT (UK @ 20%) £236.40



Deluxe Front Seat Backs & Bases

Black vinyl

Series

	Part Number	Price Ex VAT	Price Inc VAT*
Deluxe Front Outer			
Seat Back	EXT378-2	38.95	46.74
Seat Base	EXT378-3	29.85	35.82
Deluxe Front Centre			
Seat Back	EXT378-4	35.71	42.85

Defender Seating

2 Man Bench Seat

Defender

EXT002-BV Black Vinyl, Black frame
 PRICE EX VAT (OUTSIDE EU) £79.95 PRICE INC VAT (UK @ 20%) £95.94



Defender

EXT003-BV Black Vinyl, Galvanised frame
 PRICE EX VAT (OUTSIDE EU) £98.00 PRICE INC VAT (UK @ 20%) £117.60



2 Man Bench Cushion

Defender

EXT005-BV Black Vinyl
 PRICE EX VAT (OUTSIDE EU) £19.37 PRICE INC VAT (UK @ 20%) £23.24



Second Row Seats Classic High Back

- Impact Tested
- Meet all EEC Regulations
- Perfect for replacing the original little square back seats, RH or LH.

Defender

EXT350-BV Black Vinyl
 PRICE EX VAT (OUTSIDE EU) £103.37 PRICE INC VAT (UK @ 20%) £124.04



Hinged Rear Bench Seat (Side Facing)

- Farm Green
- Galvanised frame
- Complete with all fixings & retaining straps

Defender

EXT003-GNV
 PRICE EX VAT (OUTSIDE EU) £99.75 PRICE INC VAT (UK @ 20%) £119.70



Inward Facing Tip-up Seat, Pre-assembled



Series III

Colour	Part Number	Price Ex VAT	Price Inc VAT*
Black Leather	EXT050-BL	193.50	232.20
Denim Twill	EXT050-DT	87.68	105.22
Techno	EXT050-TC	94.45	113.34
XS Half Leather	EXT050-XSBR	145.13	174.16
Black Vinyl	EXT050-BV	83.95	100.74

Series & Defender

Forward Facing Fold Up-Seat



Black Vinyl

Series & Defender

EXT056-BV Right Hand
 PRICE EX VAT (OUTSIDE EU) £244.13 PRICE INC VAT (UK @ 20%) £292.96

EXT055-BV Left Hand
 PRICE EX VAT (OUTSIDE EU) £244.13 PRICE INC VAT (UK @ 20%) £292.96

ORDER

BY PHONE: 01522 568000 / ON LINE: www.rimmerbros.co.uk / E-MAIL: lrsales@rimmerbros.co.uk

*Prices include UK VAT @ 20%.

Replacement Front Outer Base or Seat Back Covers

Easy to fit. Using an Exmoor Trim cover is a perfect opportunity to upgrade your seats from vinyl to cloth or even XS, half leather, with the twin white stitching. It is also an opportune time to fit the seat heater & lumbar support kits.



Outer Base Defender

Colour	Part Number	Price Ex VAT	Price Inc VAT*
Dark Grey Vinyl	EXT318-DGV	19.76	23.71
Denim Twill	EXT318-DT	20.74	24.89
Techno	EXT318-TC	22.65	27.18
Black Vinyl	EXT318-BV	17.79	21.35
XS Half Leather	EXT318-XSBR	43.00	51.60
LR Logo Black	EXT318-LRBK	32.22	38.66

Seat Back Defender

Colour	Part Number	Price Ex VAT	Price Inc VAT*
Dark Grey Vinyl	EXT319-DGV	22.77	27.32
Denim Twill	EXT319-DT	24.44	29.33
Techno	EXT319-TC	26.51	31.81
Black Vinyl	EXT319-BV	20.86	25.03
XS Half Leather	EXT319-XSBR	57.00	68.40
LR Logo Black	EXT319-LRBK	41.84	50.21

Front Seat Internal Foams

Exmoor Trim foams are made with a cold cure process ensuring that they will wear better than the original. A coravine strip is encapsulated into the wearing parts to ensure the foam cannot split.



Defender

Model	Part Number	Price Ex VAT	Price Inc VAT*
Outer Back Internal Foam			
RH or LH up to (VIN) 6A999999	EXT321-1	25.99	31.19
from (VIN) 7A000001 on	EXT321-9	31.45	37.74
Outer Base Internal Foam			
RH or LH all models	EXT321-2	22.00	26.40
Front Headrest Internal Foam			
RH or LH up to (VIN) 6A999999	EXT321-3	11.55	13.86

Front Outer Seat Base - Assembly

Exmoor Trim manufacture a high-quality base to last as long as possible for this type of base. The welded covers always crack & give along the seams first, therefore Exmoor sew all of the joins. The seat base will fit both sides of the vehicle & is simply removed by lifting the front & releasing the retention bar from the plastic front clips. The rear of the seat base fits within locating pins at the back of the seat frame.

Defender from 1985 on

Colour	Part Number	Price Ex VAT	Price Inc VAT*
Dark Grey Vinyl	EXT310-DGV	48.83	58.60
Denim Twill	EXT310-DT	49.95	59.94
Techno	EXT310-TC	52.45	62.94
Black Vinyl	EXT310-BV	48.83	58.60



Complete Seat Trim Kits

Put life back into your old seats with these superb trim kits, which are supplied with all you need to complete the job including new foam, adhesive, trim pins & a comprehensive fitting guide. These kits are designed to be better than the original seat's comfort levels



Standard Front Seat Outer Base

Defender to 1985

EXT374-BV Black Vinyl	
PRICE EX VAT (OUTSIDE EU) £23.57	PRICE INC VAT (UK @ 20%) £28.28

Seat Risers

The Exmoor Trim seat riser & rail protector with the Land Rover grille incorporated into the design.

Quick & easy to install - 3 positions to bolt your seat to. Made from 2.5mm steel for maximum strength with a black graphite finish.

Fits all Defenders



Defender

EXT010-5RH Right Hand	
PRICE EX VAT (OUTSIDE EU) £48.50	PRICE INC VAT (UK @ 20%) £58.20

EXT010-5LH Left Hand	
PRICE EX VAT (OUTSIDE EU) £48.50	PRICE INC VAT (UK @ 20%) £58.20

Seat Handle



Defender

	Part Number	Price Ex VAT	Price Inc VAT*
Complete Seat Mechanism Kit			
Pair	EXT324-4	17.00	20.40
Mechanism Cover			
RH	EXT324-2	5.90	7.08
LH	EXT324-1	5.90	7.08
Seat Mechanism Handle			
Each	EXT324-3	2.90	3.48

2 Seat Re-Trim Kits

Defender Front up to (VIN) 6A999999

Colour	Part Number	Price Ex VAT	Price Inc VAT*
Dark Grey Vinyl	EXT316-DGV	144.32	173.18
Techno	EXT316-TC	149.36	179.23
Black Vinyl	EXT316-BV	144.32	173.18

Single Outer Seat Re-Trim Kits

Defender up to (VIN) 6A999999

Colour	Part Number	Price Ex VAT	Price Inc VAT*
Denim Twill	EXT315-DT	75.68	90.82
Black Vinyl	EXT315-BV	69.81	83.77

Lumbar Support Kit

1 Seat Kit



Defender

EXT010-1	
PRICE EX VAT (OUTSIDE EU) £29.95	PRICE INC VAT (UK @ 20%) £35.94

Seat Heater Kit

2 Seat Kit



Defender

EXT010-2	
PRICE EX VAT (OUTSIDE EU) £76.13	PRICE INC VAT (UK @ 20%) £91.36

Single Outer Seat Re-Trim Kits

Defender from (VIN) 7A000001 on

Colour	Part Number	Price Ex VAT	Price Inc VAT*
Denim Twill	EXT317-1DT	79.00	94.80
Black Span/Mondus	EXT317-1BSM	99.75	119.70
XS, Half Leather Black	EXT317-1DBXS	231.00	277.20
XS, Half Leather Red	EXT317-1DRXS	231.00	277.20

Discovery 1 Trim Kits

Many Discovery 1 seats have seen better days, with the drivers & passenger base foams collapsed & the cloth trim covers badly worn or split & the rear seat carpet panels hanging off.

This kit is available as a 2 seat or 5 seat kit & has been clearly thought out to make what could be a very difficult job quite easy for the average person to complete. All the front covers have rear pockets & the 60/40 seat covers are carpet backed & bound on the rear boot panels.



Trim Kits Discovery 1

Model	Material	Part Number	Price Ex VAT	Price Inc VAT*
Early Type Front Seat				
	Black vinyl 2 seat trim kit	EXT317-DE1-2BV	154.88	185.86
	Brown Land Rover logo 2 seat trim kit	EXT317-DE1-2LRB	175.88	211.06
	Black Land Rover logo 2 seat trim kit	EXT317-DE1-2LRBK	175.88	211.06
	Black vinyl 5 seat trim kit	EXT317-DE1-5BV	303.45	364.14
	Brown Land Rover logo 5 seat trim kit	EXT317-DE1-5LRB	351.75	422.10
	Black Land Rover logo 5 seat trim kit	EXT317-DE1-5LRBK	351.75	422.10
Late Type Front Seat				
	Black vinyl 2 seat trim kit	EXT317-DL1-2BV	154.88	185.86
	Brown Land Rover logo 2 seat trim kit	EXT317-DL1-2LRB	175.88	211.06
	Black Land Rover logo 2 seat trim kit	EXT317-DL1-2LRBK	175.88	211.06
	Black vinyl 5 seat trim kit	EXT317-DL1-5BV	303.45	364.14
	Brown Land Rover logo 5 seat trim kit	EXT317-DL1-5LRB	351.75	422.10
	Black Land Rover logo 5 seat trim kit	EXT317-DL1-5LRBK	351.75	422.10

Will not fit rear 60/40 seats with a centre armrest
Will not fit V8's with front seats that do not have the grab handle incorporated into the headrest
If you are not sure if you have early or late seats please call 01522 568000 for help.

Discovery Seat Diaphragms

Seat base replacements for both driver & passenger seats. Helps improve the ride & stop saggy base foams.



This is just a small selection of the vast array of products available. The style of seating from front to rear is almost certainly available in a variety of materials & colours. If you cannot find what you are looking for then please ring our sales line for help -
01522 568000

Discovery Seat Foam Base

Replacement foam for the Drivers or passenger seats.



Discovery

Discovery Seat Diaphragm (each)			
Discovery 1 all models	EXT317-D1-DIA	41.48	49.78
Discovery 2 all models	EXT317-D2-DIA	41.48	49.78

Discovery

Discovery Seat Foam (each)			
Discovery 1 all models	EXT321-4	48.50	58.20
Discovery 2 all models	EXT321-10	50.35	60.42

Range Rover Classic - Seat Diaphragms



These seat base replacement diaphragms have been exclusively reproduced by Exmoor Trim & improved from the original design, they simply clip back into the original mountings in the frame. These simple parts will make a huge difference to the ride & seating position of your vehicle & are fitted by removing the trim cover, base foam & old diaphragm & then reversing the procedure to complete the task

Range Rover Classic

Range Rover Classic Seat Diaphragm (each)			
all models	EXT317-RR1-DIA	41.48	49.78

Trim Adhesive

RX1353 1 Litre
PRICE EX VAT £12.92 PRICE INC VAT £15.50
(OUTSIDE EU) (UK @ 20%)



RX1353A Aerosol 500ml
PRICE EX VAT £5.95 PRICE INC VAT £7.14
(OUTSIDE EU) (UK @ 20%)

please note

AEROSOLS

Please note: Aerosols are classed as hazardous and that shipping restrictions apply. Aerosols cannot be exported and can only be sent via carrier (not post) to UK mainland destinations. Touch-in pencils and aerosols are non-returnable.

ORDER

BY PHONE: 01522 568000 / ON LINE: www.rimmerbros.co.uk / E-MAIL: Irsales@rimmerbros.co.uk

*Prices include UK VAT @ 20%.

WATERPROOF SEAT COVERS



BRITPART

A FANTASTIC WAY TO PROTECT YOUR LAND ROVER SEATS WITH THESE BRITPART WATERPROOF SEAT COVERS

- Quality & stylish waterproof seat cover sets
- Front & rear sets available with headrests & armrests included in the Discovery, Range Rover & Freelander ranges
- Rear inward facing sets also available for the Discovery 7 seater models
- Made from waterproof woven polyester with a PVC backing
- Hard wearing & washable
- Snug fit & available in a range of colours
- Easy to put on the seats & just as easy to remove again



Defender

Model	Colour	Part Number	Price Ex VAT	Price Inc VAT*
Defender up to (VIN) 6A999999				
3 Seats Front - 3 x full seat covers (excludes headrests)				
	Black	LL1224BPBLACK	34.58	41.50
	Blue	LL1224BPBLUE	39.58	47.50
	Green	LL1224BPGREEN	39.58	47.50
	Grey	LL1224BPGREY	39.58	47.50
Defender (VIN) 7A000001 on				
Front - 2 x full seat covers, 2 x headrest covers				
	Black	LL1224BP07	49.50	59.40
	Grey	LL1224BP07GREY	55.83	67.00
	Sand	LL1224BP07SAND	55.83	67.00
Defender 110 Station Wagon up to (VIN) 6A999999				
Rear forward facing 2nd row 60/40*				
1 x two seat back & base, 1 x one seat back & base				
	Black	LL1224BPPEARBLACK	47.08	56.50
	Blue	LL1224BPPEARBLUE	47.08	56.50
	Grey	LL1224BPPEARGREY	47.08	56.50
Rear inward facing bench seat				
2 x bench seat back & base, for 1200mm long seat				
	Blue	LL1224BPBENCHBLUE	29.58	35.50
	Grey	LL1224BPBENCHGREY	32.08	38.50
Defender 90/110 (VIN) 7A000001 on				
Rear forward facing 2nd row				
2 x full seat covers, 2 x headrest covers				
	Black	VPLDS0013BP	53.33	64.00
Rear forward facing 2nd row 60/40				
3 x full seat covers, 3 x headrest covers				
	Black	VPLDS0012BP	75.83	91.00

*Will fit 110 Crew Cab with minor modification to seat covers.



Discovery

Model	Colour	Part Number	Price Ex VAT	Price Inc VAT*
Discovery 1				
Front* - 2 x full seat covers				
	Black	RD1223BPBLACK	37.08	44.50
	Blue	RD1223BPBLUE	37.08	44.50
	Green	RD1223BPGREEN	37.08	44.50
	Grey	RD1223BPGREY	37.08	44.50
Rear* - 1 x two seat back & base, 1 x one seat back & base				
	Black	RD1224BPBLACK	45.83	55.00
	Blue	RD1224BPBLUE	45.83	55.00
	Green	RD1224BPGREEN	45.83	55.00
	Grey	RD1224BPGREY	45.83	55.00
Boot* - 2 x full seat covers				
	Blue	RD1225BPBLUE	20.83	25.00
	Green	RD1225BPGREEN	20.83	25.00
	Grey	RD1225BPGREY	39.58	47.50
Discovery 2				
Front - 2 x full seat covers, 2 x headrest covers, 2 x armrest				
	Black	RD1236BPBLACK	53.33	64.00
	Blue	RD1236BPBLUE	53.33	64.00
	Green	RD1236BPGREEN	53.33	64.00
	Grey	RD1236BPGREY	53.33	64.00
	Sand	RD1236BPSAND	53.33	64.00
Rear 1 x full seat, 1 x two seat back & base, 1 x armrest, 3 x headrest				
	Black	RD1237BPBLACK	63.33	76.00
	Blue	RD1237BPBLUE	63.33	76.00
	Green	RD1237BPGREEN	63.33	76.00
	Grey	RD1237BPGREY	63.33	76.00
	Sand	RD1237BPSAND	63.33	76.00
Boot - 2 x full seat, 2 x roof headrest				
	Green	RD1238BPGREEN	39.58	47.50
	Grey	RD1238BPGREY	39.58	47.50
Discovery 3				
Front** - 2 x full seat covers, 2 x headrest covers, 2 x armrest				
	Black	RD1239FRONTBP	58.33	70.00
	Sand	RD1239FRONTBPSAND	58.33	70.00
Rear 35/30/35 split - 3 x full seat covers, 3 headrest covers				
	Black	RD1239REARBP	53.33	64.00
	Black	LR005218P	52.50	63.00
Discovery 4				
Front** - 2 x full seat covers, 2 x headrest covers, 2 x armrest				
	Black	RD1380BP	62.50	75.00
Discovery Sport				
Front - 2 x full seat covers, 2 x headrest covers				
	Black	VPLCS0291PVJ ♦	166.42	199.70
	Black	VPLCS0291SVA ♦	121.18	145.42

*Will not fit vehicles with leather seats & 200Tdi's with pocket on rear seat.
 **Suitable for vehicles with side airbags.
 ♦ Genuine Land Rover Item.

Freelander

Model	Colour	Part Number	Price Ex VAT	Price Inc VAT*
Freelander 1				
3 door, Front* - 2 x back, base & headrest covers				
	Black	LF1055BPBLACK	48.33	58.00
	Grey	LF1055BPGREY	44.50	53.40
5 door, Front* - 2 x back, base & headrest covers				
	Black	LF1029BPBLACK	42.08	50.50
	Grey	LF1029BPGREY	42.08	50.50
3 & 5 door, Rear 60/40 split without armrest*				
1 x two seat back & base, 1 x one seat back & base, 3 headrest covers				
	Black	LF1030BPBLACK	39.58	47.50
	Green	LF1030BPGREEN	39.58	47.50
	Grey	LF1030BPGREY	39.50	47.50
3 & 5 door, Rear 60/40 split with armrest*				
1 x two seat back & base, 1 x one seat back & base, 3 headrest covers				
	Blue	LF1030BPBLUEAR	33.33	40.00
	Grey	LF1030BPGREYAR	33.33	40.00
3 door Sport, 2 rear seats* - 2 x back, base & headrest covers				
	Blue	LF1056BPBLUESPORT	33.33	40.00
	Green	LF1056BPGREENSPORT	33.33	40.00
	Grey	LF1056BPGREYSPORT	33.33	40.00
Freelander 2				
Front** - 2 x full seat covers, 2 x headrest covers, 2 x armrest				
	Black	LF1098BLACKBP	58.33	70.00
Rear*** - 1 x two seat back & base, 1 x one seat back & base, 3 headrest & 3 armrest covers				
	Black	LF1098BLACKBPPEAR	58.33	70.00

*Not suitable for face lift models (VIN) 4A000001 on
 **Suitable for vehicles with airbags
 ***Not suitable for vehicles with leather seats

BRITPART



LF1055BPBLACK

Range Rover

Model	Colour	Part Number	Price Ex VAT	Price Inc VAT*
Range Rover Classic				
4 door, Front - 2x back & base, 2 headrest, 2 x armrest				
	Black	RA1316BPBLACK	54.17	65.00
	Blue	RA1316BPBLUE	54.17	65.00
	Green	RA1316BPGREEN	33.33	40.00
	Grey	RA1316BPGREY	54.17	65.00
4 door, Rear - 1 x two seat back & base, 1 x one seat back & base & 3 armrest covers				
	Blue	RA1318BPPEARBLUE	50.83	61.00
	Green	RA1318BPPEARGREEN	50.83	61.00
	Grey	RA1318BPPEARGREY	50.83	61.00

Range Rover P38

Front* - 2 x full seats, 2 headrest & armrest covers				
	Grey	RA1575	47.08	56.50
	Green	RA1574	47.08	56.50

Range Rover Sport

up to (VIN) 9A999999 - Front				
2 x full seat covers, 2 x headrest covers, 2 x armrest				
	Black	RA1504BP	55.83	67.00
	Sand	RA1504BPSAND	55.83	67.00
up to (VIN) 9A999999 - Front, vehicles with electric headrests				
2 x full seat covers, 2 x headrest covers, 2 x armrest				
	Sand	RA1576	63.33	76.00
up to (VIN) 9A999999 - Rear - 1 x two seat back & base, 1 x one seat back & base, 3 headrest & 3 armrest covers				
	Black	RA1504BPPEAR	55.83	67.00
(VIN) AA000001 to (VIN) DA999999 - Front				
2 x full seat covers, 2 x headrest covers, 2 x armrest				
	Black	RA1551BPBLACK	55.83	67.00
	Sand	RA1551BPSAND	55.83	67.00

Range Rover L322

(VIN) 7A000001 to (VIN) 9A999999 - Front**				
2 x full seat covers, 2 x headrest covers, 2 x armrest				
	Black	RA1505BP	65.83	79.00
(VIN) AA000001 on - Front				
2 x full seat covers, 2 x headrest covers, 2 x armrest				
	Black	VPLMS0085PVJ ❖	211.02	253.22
	Black	VPLMS0085SVA ❖	211.02	253.22
Rear - 1 x one seat base, 1 x two seat base, 2 x back, 1x middle back, 2 headrest				
	Black	RA1505BPPEAR	55.83	67.00

Range Rover Evoque

3 door without rear entertainment - Front				
2 x full seat covers, 2 x headrest covers				
	Black	VPLVS0070PVJ ❖	126.23	151.48
5 door without rear entertainment - Front				
2 x full seat covers, 2 x headrest covers				
	Black	VPLVS0071PVJ ❖	185.44	222.53

*Not suitable for vehicles with rear airbags mounted in the front seats or seats with electric headrests.
 **Non-power assisted headrests only.
 ❖ Genuine Land Rover Item.



RA1316BPBLACK



RA1318BPPEARGREY



RA1316BPGREY

BRITPART

NYLON WATERPROOF SEAT COVERS



Nylon waterproof seat covers from Exmoor Trim are manufactured from an exclusive waterproof material that is totally non slip.

This means that you won't slide off the seat and the cover won't slide on the seating fabric.

All Exmoor waterproof seat covers are specifically tailored to fit each seat. This guarantees they will enhance the interior unlike a baggy seat cover.

The seat cover for the base fits separately from the seat back so you can remove the seat base for storage/ battery access without taking the protective covers off.

Defender -
All models up to 2007
(VIN) 6A999999



Front Seat Outer Cover, Single

EXT018-1 PRICE EX VAT (OUTSIDE EU) **£20.10** PRICE INC VAT (UK @ 20%) **£24.12**

Defender -
All models 2007 on
(VIN) 7A000001 on



Front Seats, Pair

EXT018-18 PRICE EX VAT (OUTSIDE EU) **£48.28** PRICE INC VAT (UK @ 20%) **£57.94**



Front Seat Outer Cover, Pair, Black

EXT018-2 PRICE EX VAT (OUTSIDE EU) **£39.39** PRICE INC VAT (UK @ 20%) **£47.27**

Front Seat Outer Cover, Pair, Grey

EXT018-2GRY PRICE EX VAT (OUTSIDE EU) **£39.39** PRICE INC VAT (UK @ 20%) **£47.27**



2nd Row Set, 60/40 Split Seats, includes 3 Headrest Covers.

EXT018-19 PRICE EX VAT (OUTSIDE EU) **£77.50** PRICE INC VAT (UK @ 20%) **£93.00**



Tip-Up Seat Cover, Single

EXT018-7 PRICE EX VAT (OUTSIDE EU) **£17.79** PRICE INC VAT (UK @ 20%) **£21.35**



Rear 2 Man Bench Seat Cover - Grey

EXT018-8GRY PRICE EX VAT (OUTSIDE EU) **£21.37** PRICE INC VAT (UK @ 20%) **£25.64**

CANVAS WATERPROOF SEAT COVERS



Canvas Seat Covers from Exmoor Trim in Quality Seating Canvas

Defender - All models up to 2007 (VIN) 6A999999



Front Seat Outer Cover, Pair, Grey

EXT019-2
 PRICE EX VAT (OUTSIDE EU) **£129.50** PRICE INC VAT (UK @ 20%) **£155.40**



Front Seat Outer Cover, Pair, Black

EXT019-45
 PRICE EX VAT (OUTSIDE EU) **£129.50** PRICE INC VAT (UK @ 20%) **£155.40**

Defender - All models 2007 on (VIN) 7A000001 on



Front Seat Outer Cover, Pair, Black

EXT019-46
 PRICE EX VAT (OUTSIDE EU) **£139.50** PRICE INC VAT (UK @ 20%) **£167.40**



Front Seat Outer Cover, Pair, Sand

EXT019-5
 PRICE EX VAT (OUTSIDE EU) **£139.50** PRICE INC VAT (UK @ 20%) **£167.40**



2nd Row Set, 60/40 Split Seats, Black

EXT019-49
 PRICE EX VAT (OUTSIDE EU) **£156.98** PRICE INC VAT (UK @ 20%) **£188.38**

Supplied as a front pair of covers for 2 seats that are easy to fit, hard wearing whilst protecting your seats.

The seat cover for the base fits separately from the seat back so you can remove the seat base for storage/battery access without taking the protective covers off.

- Airbag Compatible (model dependent)
- Heavy Duty Seams - double stitched and over-locked
- Leatherette Piping - double stitched on borders
- Rear Pockets
- Tailor Made
- Waterproof
- Washable

Sets include all headrests & armrests and separate backs and bases where required for 2 front seats

Discovery 3 All models except with TV in headrests.



Front Seat Covers, Pair, Sand

EXT019-31 PRICE EX VAT (OUTSIDE EU) **£162.75** PRICE INC VAT (UK @ 20%) **£195.30**

Front Seat Covers, Pair, Black

EXT019-32 PRICE EX VAT (OUTSIDE EU) **£162.75** PRICE INC VAT (UK @ 20%) **£195.30**

Premium OE PUMA 2013 Seats



Front Seat Covers, Pair, Black

EXT019-69
 PRICE EX VAT (OUTSIDE EU) **£162.75** PRICE INC VAT (UK @ 20%) **£195.30**

Discovery 4

All models except with TV in headrests.



Front Seat Covers, Pair, Grey

EXT019-43
 PRICE EX VAT (OUTSIDE EU) **£162.75** PRICE INC VAT (UK @ 20%) **£195.30**



Front Seat Covers, Pair, Black

EXT019-44
 PRICE EX VAT (OUTSIDE EU) **£162.75** PRICE INC VAT (UK @ 20%) **£195.30**

ORDER

BY PHONE: 01522 568000 / ON LINE: www.rimmerbros.co.uk / E-MAIL: lrsales@rimmerbros.co.uk

*Prices include UK VAT @ 20%.

RUBBER OVERMATS

Series

Model	Part Number	Price Ex VAT	Price Inc VAT*
Series - Rubber Overmats			
Series I 80			
Front Pair	Aftermarket	EXT017-32	31.50 37.80
Series II & III - Will fit RHD & LHD (not suitable for Lightweight or 6 cylinder vehicles)			
Front Pair	Aftermarket	331392-3P	33.33 40.00
All models			
2nd Row Pair	Aftermarket	EXT017-3	30.83 37.00
Series - Moulded Matting System			
All models - Not V8, Lightweight or 6 cylinder vehicles			
Front 3 piece	Exmoor	EXT009-11	380.00 456.00
Series - Hardura Tunnel Interior Kit			
Series II & III - Plastic coated felt with bound edges			
RHD - Front 7 piece	Exmoor	EXT020-20	98.85 118.62
LHD - Front 7 piece	Exmoor	EXT020-21	94.05 112.86
Series - Insulation Matting Kit			
Series II, IIa & III Includes a pair of moulded floor mats, will fit RHD & LHD vehicles			
Front Kit	Exmoor	EXT023-1	146.48 175.78
All models Covers floor & wheel arches			
Rear 3 piece	Exmoor	EXT009-14	140.45 168.54



Defender

Model	Part Number	Price Ex VAT	Price Inc VAT*
Defender - Rubber Overmats			
All models - Pre marked, cut to fit			
Front Pair	Aftermarket	STC50172P	43.33 52.00
All models to (VIN) BA999999			
Front Pair	Aftermarket	LR005039P	32.92 39.50
All models to (VIN) BA999999 - Feature embossed Land Rover logo			
Front Pair	Genuine	LR005039	57.49 68.99
All models from (VIN) CA000001 - Feature embossed Land Rover logo			
Front Pair	Genuine	VPLDS0147	57.49 68.99
All models to (VIN) WA159806 - Feature embossed Land Rover logo			
Front Pair	Genuine	RTC8098AB	67.61 81.13
All models (VIN) XA159807 on			
Front Pair	Aftermarket	BTR7895-6BP	33.33 40.00
All models (VIN) XA159807 on - Feature embossed Land Rover logo			
Front Pair	Genuine	STC50172	54.46 65.35
All models with LT77 gearbox			
Front Pair	Aftermarket	BTR7895-6HDBP	60.83 73.00
Front Right Hand	Aftermarket	BTR7896BP	29.58 35.50
Front Left Hand	Aftermarket	BTR7895BP	33.33 40.00
All models (VIN) KA918810 on			
Front Pair	Aftermarket	BTR7897-8BP	73.33 88.00
Front Right Hand	Aftermarket	BTR7898BP	38.75 46.50
Front Left Hand	Aftermarket	BTR7897BP	38.75 46.50
110, CSW & Crew Cab from (VIN) 7A000001 - Feature embossed Land Rover logo			
Front Pair	Genuine	LR005041	49.40 59.28
All models			
2nd Row Pair	Aftermarket	EXT017-3	30.83 37.00
All models to (VIN) XA162004 - Feature embossed Land Rover logo			
2nd Row Pair	Genuine	RTC8099	65.87 79.04
110 CSW - Feature embossed Land Rover logo			
2nd Row Single	Genuine	STC50173	65.87 79.04
Crew Cab, HCPU & 130 - Feature embossed Land Rover logo			
2nd Row Single	Genuine	LR005042	65.87 79.04
Defender - Moulded Matting System			
All models with LT77 gearbox - drastically reduces noise levels			
Grey - Front Kit	Exmoor	EXT009-12	340.00 408.00
All models with R380 gearbox - drastically reduces noise levels			
Black - Front Kit	Exmoor	EXT009-13BK	380.00 456.00
All models (VIN) 7A000001 on (Puma) with 2.4 engine - drastically reduces noise levels			
Black - Front Kit	Exmoor	EXT009-25	380.00 456.00
Defender - Hardura Insulation Matting Kit			
All models with LT77 gearbox			
LHD - Front 4 piece	Exmoor	EXT022-2-LH	31.45 37.74
Complete vehicle set - Full Kit	Exmoor	EXT023-2	156.98 188.38
All models with R380 gearbox			
Complete vehicle set - Full Kit	Exmoor	EXT023-3	156.98 188.38
All TDci & Puma models			
Complete vehicle set - Full Kit	Exmoor	EXT023-4	135.75 162.90
Defender 90, 110 & CSW - Covers floor & wheel arches			
Rear 3 piece	Exmoor	EXT009-14	140.45 168.54



Freelander

Model	Part Number	Price Ex VAT	Price Inc VAT*
Freelander 1 - Rubber Overmats			
All models			
Front Pair - Will fit RHD & LHD	Aftermarket	EXT017-14	30.83 37.00
2nd Row Pair	Aftermarket	EXT017-15	30.83 37.00
Full 4 piece - RHD	Genuine	STC7973AB	65.00 78.00
Full 4 piece - LHD	Genuine	STC50402AA	65.00 78.00
Freelander 2 - Rubber Overmats			
All models			
Front Pair - RHD	Aftermarket	LF1136FR	43.33 52.00
2nd Row - Pair	Aftermarket	LF1136RR	42.08 50.50
Full 4 piece - RHD	Aftermarket	VPLFS0233P	37.49 44.99



EXT017-8

Discovery

Model	Part Number	Price Ex VAT	Price Inc VAT*
Discovery 1 - Rubber Overmats			
All models			
Front Pair - Will fit RHD & LHD	Aftermarket	EXT017-8	30.83 37.00
2nd Row Pair	Aftermarket	EXT017-9	30.83 37.00
Set of 4 mats, feature 'mountain' logo			
Full 4 piece	Genuine	STC8188AB	104.88 125.86
Discovery 2 - Rubber Overmats			
All models			
Front Pair - Will fit RHD & LHD	Aftermarket	EXT017-11	30.83 37.00
Front Pair, feature Land Rover logo	Genuine	STC50049AA	60.67 72.80
2nd Row Pair	Aftermarket	EXT017-12	30.83 37.00
Set of 4 mats, feature Land Rover logo			
Full 4 piece	Genuine	STC50048AA	79.74 95.69
Discovery 3 - Rubber Overmats			
All models			
Front Pair	Aftermarket	LR006237FR	35.42 42.50
2nd Row Pair	Aftermarket	LR006238RR	45.42 54.50
All models to (VIN) 7A999999			
Front Pair - RHD	Genuine	EAH500058PMA	71.07 85.28
Front Pair - LHD	Genuine	EAH500057PMA	70.21 84.25
Set of 4 mats - Full 4 piece			
RHD	Genuine	EAH500052PMA	109.21 131.05
LHD	Genuine	EAH500050PMA	109.21 131.05
All models from (VIN) 8A000001			
Front Pair - RHD	Genuine	LR006240	73.01 87.61
Front Pair - LHD	Genuine	LR006239	73.91 88.69
Set of 4 mats - RHD vehicles			
Full 4 piece	Aftermarket	LR006237P	49.95 59.94
	Genuine	LR006237	100.73 120.88
Set of 4 mats - LHD vehicles			
Full 4 piece	Aftermarket	LR006238BP	83.33 100.00
	Genuine	LR006238	100.73 120.88
All models with 7 seats			
3rd Row 1 piece	Genuine	EAH500100PMABP	44.17 53.00
	Aftermarket	EAH500100PMA	53.32 63.98
Discovery 4 - Rubber Overmats			
All models			
Front Pair	Aftermarket	LR006237FR	35.42 42.50
2nd Row Pair	Aftermarket	LR006238RR	45.42 54.50
Set of 4 mats - RHD			
Full 4 piece	Aftermarket	LR006237P	49.95 59.94
	Genuine	LR006237	100.73 120.88
Set of 4 mats - LHD			
Full 4 piece	Aftermarket	LR006238BP	83.33 100.00
	Genuine	LR006238	100.73 120.88
All models with 7 seats			
3rd Row 1 piece	Genuine	EAH500100PMABP	44.17 53.00
	Aftermarket	EAH500100PMA	53.32 63.98
Discovery Sport - Rubber Overmats			
All models			
Set of 4 mats - RHD			
Full 4 piece	Aftermarket	VPLCS0278P	37.49 44.99

Range Rover

Model	Part Number	Price Ex VAT	Price Inc VAT*
Range Rover Classic - Rubber Overmats			
All models			
Front Pair - Will fit RHD & LHD	Aftermarket	STC8053AAFR	42.08 50.50
2nd Row Pair	Aftermarket	STC8053AARR	42.08 50.50
Full 3 piece	Genuine	STC8053AA	66.74 80.09
Range Rover P38 - Rubber Overmats			
All models			
Front Pair - Will fit RHD & LHD	Aftermarket	EXT017-16	30.83 37.00
Front Pair	Genuine	STC8890AA	58.93 70.72
2nd Row Pair	Aftermarket	EXT017-17	30.83 37.00
Full 4 piece	Aftermarket	STC8520AABP	60.83 73.00
Range Rover L322 - Rubber Overmats			
All models			
Front Pair - RHD	Aftermarket	EXT017-18	30.83 37.00
2nd Row Pair	Aftermarket	EXT017-19	30.83 37.00
All models up to (VIN) 6A999999			
Full 4 piece - RHD	Aftermarket	EAH000261PMABP	95.83 115.00
	Genuine	EAH000261PMA	110.94 133.13
Full 4 piece - LHD	Aftermarket	EAH000271PMABP	95.83 115.00
All models from (VIN) 7A000001			
Full 4 piece - RHD	Aftermarket	EAH500320PMABP	88.33 106.00
	Genuine	EAH500320PMA	123.49 148.19
Full 4 piece - LHD	Aftermarket	EAH500330PMABP	88.33 106.00
	Genuine	EAH500330PMA	105.53 126.64
Range Rover L405 - Rubber Overmats			
All models			
Full 4 piece - RHD	Aftermarket	VPLGS0189P	37.49 44.99
Range Rover Sport - Rubber Overmats			
All models to (VIN) CA999999			
Front Pair - RHD	Aftermarket	VPLSS0103P	45.42 54.50
2nd Row Pair	Aftermarket	VPLSS0103RP	43.33 52.00
Front Pair - LHD	Genuine	LR006244	70.21 84.25
All models from (VIN) 7A555556 to (VIN) 7A999999			
Full 4 piece - RHD	Genuine	VPLSS0104	118.08 141.70
All models from (VIN) AA000001 to (VIN) CA999999			
Full 4 piece - RHD	Genuine	VPLAS0197	105.53 126.64
All models from (VIN) DA0000001			
Full 4 piece - RHD	Aftermarket	VPLGS0189P	37.49 44.99
Full 4 piece - LHD	Genuine	VPLAS0198	110.34 132.41
Range Rover Evoque - Rubber Overmats			
All models - RHD vehicles			
Front Pair - RHD	Aftermarket	RA2119FR	43.33 52.00
2nd Row Pair	Aftermarket	RA2119RR	42.08 50.50
Full 4 piece - LHD	Aftermarket	LR045096P	37.49 44.99



EXT017-16



VPLCS0278P

CARPET OVERMATS

Defender

Model		Part Number	Price Ex VAT	Price Inc VAT*
Defender - Carpet Overmats				
All models - 2 Piece Front				
Black	Aftermarket	LL1143BP	38.33	46.00
All models (VIN) 7A000001 on - 4 Piece Set - RHD/LHD				
Black	Aftermarket	LL1884BLACK	39.95	47.94
Grey	Aftermarket	LL1884GREY	39.95	47.94



Discovery

Model		Part Number	Price Ex VAT	Price Inc VAT*
Discovery 1 - Carpet Overmats				
3 & 5 door models - 3 Piece Set				
Beige - RHD	Aftermarket	RD1072BEIGE	35.00	42.00
Black - RHD	Aftermarket	RD1072BLACK	35.00	42.00
Blue - RHD	Aftermarket	RD1072BLUE	35.00	42.00
Grey - RHD	Aftermarket	RD1072GREY	35.00	42.00

Discovery 2 - Carpet Overmats

All models - 3 Piece Set				
Slate Grey - RHD	features Land Rover logo. Genuine	STC50046	132.51	159.01
Black - RHD/LHD	Aftermarket	RD1386BLACK	39.95	47.94
Grey - RHD/LHD	Aftermarket	RD1386GREY	39.95	47.94

Discovery 3 - Carpet Overmats

All models - 4 Piece Set				
Black - RHD	Aftermarket	RD1388BLACK	39.95	47.94
Grey - RHD	Aftermarket	RD1388GREY	39.95	47.94
Black - LHD	Aftermarket	RD1389BLACK	39.95	47.94
Grey - LHD	Aftermarket	RD1389GREY	39.95	47.94

All models to (VIN) 7A999999 - 4 Piece Set without chrome strip, features Land Rover logo				
Ebony Black - RHD	Genuine	EAH500010PVJ	160.45	192.54
Ebony Black - LHD	Genuine	EAH500080PVJ	22.89	27.47
Bahama Beige - LHD	Genuine	EAH500081SUC	49.95	59.94

with chrome strip, features Land Rover logo				
Ebony Black - LHD	Genuine	EAH500019MMM	162.25	194.70

All models from (VIN) 8A000001 - 4 Piece Set features Land Rover script				
Ebony Black - LHD	Genuine	VPLAS0192PVJ	135.93	163.12

Discovery 4 - Carpet Overmats

All models - 4 Piece Set, features Land Rover script				
Ebony Black - RHD	Genuine	LR026384	161.36	193.63
Ebony Black - LHD				
from (VIN) BA557111 to (VIN) CA651574	Genuine	LR026386	149.63	179.56
from (VIN) DA000001				
	Genuine	VPLAS0192PVJ	135.93	163.12

Black - RHD	Aftermarket	RD1390BLACK	39.95	47.94
Black - LHD	Aftermarket	RD1391BLACK	39.95	47.94
Grey - RHD	Aftermarket	RD1390GREY	39.95	47.94
Grey - LHD	Aftermarket	RD1391GREY	39.95	47.94

Discovery Sport - Carpet Overmats

All models - 4 Piece Set				
Black - RHD	Aftermarket	RD1392BLACK	39.95	47.94
Black - LHD	Aftermarket	RD1393BLACK	39.95	47.94
Grey - RHD	Aftermarket	RD1392GREY	39.95	47.94
Grey - LHD	Aftermarket	RD1393GREY	39.95	47.94



EAH500080PVJ

Range Rover

Model		Part Number	Price Ex VAT	Price Inc VAT*
Range Rover Classic - Carpet Overmats				
All 2 door models - 3 Piece Set				
Black - RHD	Aftermarket	RA1428BLACK	39.95	47.94
All 4 door models - 3 Piece Set				
Beige - RHD	Aftermarket	RA1426BEIGE	39.95	47.94
Black - RHD	Aftermarket	RA1426BLACK	39.95	47.94
Blue - RHD	Aftermarket	RA1426BLUE	39.95	47.94
Grey - RHD	Aftermarket	RA1426GREY	39.95	47.94
All LSE models - 3 Piece Set				
Black - RHD	Aftermarket	RA1427BLACK	35.00	42.00
Range Rover P38 - Carpet Overmats				
All models - 3 Piece Set				
Black - RHD	Aftermarket	RA1431BLACK	30.00	36.00
Range Rover L322 - Carpet Overmats				
All models to (VIN) 6A999999 - 4 Piece Set, combination of Rubber/Carpet				
Sand - RHD	Aftermarket	EAH500280SUNP1	143.33	172.00
Aspen - LHD	Genuine	EAH000320LUP	49.95	59.94
All models from (VIN) 7A000001 - 4 Piece Set, combination of Rubber/Carpet				
Sand - RHD	Genuine	EAH500280PVA	105.53	126.64
Navy - RHD	Genuine	EAH500290JMN	39.57	47.48
Aspen - LHD	Genuine	EAH500310LUP	49.95	59.94
All models to (VIN) 6A999999 - 4 Piece Carpet Set				
Black - RHD	Aftermarket	RA1565BLACK	39.95	47.94
Black - LHD	Aftermarket	RA1566BLACK	39.95	47.94
Grey - RHD	Aftermarket	RA1565GREY	39.95	47.94
Grey - LHD	Aftermarket	RA1566GREY	39.95	47.94
Range Rover L405 - Carpet Overmats				
All models - 4 Piece Set				
Black - RHD	Aftermarket	RA1567BLACK	39.95	47.94
Black - LHD	Aftermarket	RA1568BLACK	39.95	47.94
Grey - RHD	Aftermarket	RA1567GREY	39.95	47.94
Grey - LHD	Aftermarket	RA1568GREY	39.95	47.94
Range Rover Sport - Carpet Overmats				
All models to (VIN) 7A999999 - 4 Piece Set				
Black - RHD	Aftermarket	EAH500012PVJP	39.95	47.94
Ebony Black - RHD	Genuine	EAH500012PVJ	172.17	206.60
All models to (VIN) 7A999999 - 4 Piece Set				
Black - LHD	Aftermarket	EAH500011PVJP	39.95	47.94
Alpaca - LHD	Genuine	EAH500015SMS	171.27	205.52
All models AA000001 to DA999999 - 4 Piece Set				
Black - LHD	Aftermarket	RA1562BLACK	39.95	47.94
Grey - LHD	Aftermarket	RA1562GREY	39.95	47.94
All models (VIN) 8A000001 to (VIN) CA999999 - 4 Piece Set				
Ebony Black - RHD	Genuine	VPLAS0195PVJ	141.32	169.58
Black - RHD	Aftermarket	RA1561BLACK	39.95	47.94
Grey - RHD	Aftermarket	RA1561GREY	39.95	47.94
All models (VIN) DA000001 on - 4 Piece Set				
Black - RHD	Aftermarket	RA1563BLACK	39.95	47.94
Black - LHD	Aftermarket	RA1564BLACK	39.95	47.94
Grey - RHD	Aftermarket	RA1563GREY	39.95	47.94
Grey - LHD	Aftermarket	RA1564GREY	39.95	47.94
Range Rover Evoque - Carpet Overmats				
All models - 4 Piece Set				
Black - RHD	Aftermarket	RA1569BLACK	39.95	47.94
Black - LHD	Aftermarket	RA1570BLACK	39.95	47.94
Grey - RHD	Aftermarket	RA1569GREY	39.95	47.94
Grey - LHD	Aftermarket	RA1570GREY	39.95	47.94



Freelander

Model		Part Number	Price Ex VAT	Price Inc VAT*
Freelander 1 - Carpet Overmats				
All models - 4 Piece Set				
Black - RHD	Aftermarket	LF1020BLACK	30.00	36.00
Black - LHD	Aftermarket	LF1143BLACK	30.00	36.00
All 3 door models except V6 engine - 4 Piece Set				
Teal - RHD	Genuine	STC50152HAU	102.76	123.31
Teal - LHD	Genuine	STC50403HAU	49.58	59.50
All V6 engine models - 4 Piece Set				
Ash Grey - LHD	Genuine	STC50403LNF	81.13	97.36
All models from (VIN) 4A000001 - 4 Piece Set				
Alpaca - RHD	Genuine	EAH500020SMS	79.32	95.18
Light Tundra - LHD	Genuine	EAH500030HPP	79.32	95.18
Black - LHD	Genuine	EAH500030PUY	52.28	62.74
Alpaca - LHD	Genuine	EAH500030SMS	29.95	35.94
Freelander 2 - Carpet Overmats				
All models - 4 Piece Set				
Black - RHD	Aftermarket	LF1138BLACK	39.95	47.94
Black - LHD	Aftermarket	LF1139BLACK	39.95	47.94
Grey - RHD	Aftermarket	LF1138GREY	39.95	47.94
Grey - LHD	Aftermarket	LF1139GREY	39.95	47.94

LOADSPACE MATS

Series

Model		Part Number	Price Ex VAT	Price Inc VAT*
Series - Acoustic Load Mat				
80 Features spare wheel cut out	Exmoor	EXT009-2	57.13	68.56
86, 88 & 109	Exmoor	EXT009-1	59.89	71.87
Series - Loadspace Mat Rubber				
88	Aftermarket	331401BP	27.08	32.50
Series - Commercial Load Mat				
109 (3 door) 6mm heavy duty rubber	Exmoor	EXT009-10	63.34	76.01

EXT009-10



STC7619BP



STC7899

Defender

Model		Part Number	Price Ex VAT	Price Inc VAT*
Defender - Acoustic Load Mat				
90 & 110 Station Wagon	Exmoor	EXT009-1	59.89	71.87
Defender - Commercial Load Mat				
110 (3 door) - 6mm heavy duty rubber	Exmoor	EXT009-10	63.34	76.01
Defender - Loadspace Mat Rubber				
90 all models	Aftermarket	STC7619BP	60.83	73.00
90 to (VIN) 6A999999	Genuine	STC4629	133.03	159.64
<i>Features Land Rover logo</i>				
90 Station Wagon to (VIN) 6A999999	Genuine	STC7898	153.41	184.09
<i>Features Defender logo</i>				
90 Hard top models				
from (VIN) 7A000001	Genuine	LR005614	121.83	146.20
<i>Features Defender logo, will not fit SVX soft top models.</i>				
90 Station Wagon (3 door)				
from (VIN) 7A000001	Genuine	LR005615	89.76	107.71
<i>Features Defender logo, will not fit SVX soft top models.</i>				
110 Station Wagon				
to (VIN) 6A999999	Genuine	STC7899	155.14	186.17
<i>Features Defender logo</i>				
110 Hard Top & truck cab				
Includes 6mm foam backing	Aftermarket	STC7620P	60.83	73.00
Features Defender logo	Genuine	STC7620	143.88	172.66
110 with 5 seats from (VIN) 7A000001	Genuine	LR005613	121.83	146.20
<i>Features Defender logo, will not fit SVX soft top models.</i>				
110 with 7 seats from (VIN) 7A000001	Genuine	LR005040	123.21	147.85
<i>Features Defender logo, will not fit SVX soft top models.</i>				

Discovery

Model		Part Number	Price Ex VAT	Price Inc VAT*
Discovery 1 - Loadspace Mat Rubber or Velour				
All models without rear A/C	Aftermarket	STC8465P	76.67	92.00
Features Discovery logo	Genuine	STC8465	97.35	116.82
Black (Velour)	Aftermarket	RD1073BLACK	30.00	36.00
All models with rear A/C				
Black (Velour)	Aftermarket	RD1073BLACKAC	30.00	36.00
Discovery 2 - Loadspace Mat Rubber				
All models - Half length	Genuine	STC50052AA	97.94	117.53
Discovery 3 - Loadspace Mat Rubber				
All models				
Rear luggage compartment	Aftermarket	LR006401P	45.83	55.00
	Genuine	LR006401	100.12	120.14
All Commercial models with 2 seats				
Half length, forward section	Genuine	LR006400	106.61	127.93
Discovery 4 - Loadspace Mat Rubber				
All models				
Rear luggage compartment	Aftermarket	LR006401P	45.83	55.00
	Genuine	LR006401	100.12	120.14
All Commercial models with 2 seats				
Half length, forward section	Genuine	LR006400	106.61	127.93
Discovery Sport - Loadspace Mat Rubber				
All models with 7 seats	Aftermarket	VPLWS0225P	45.83	55.00
All models				
Rear luggage compartment	Genuine	VPLCS0279	124.81	149.77
Half length, forward section	Genuine	VPLCS0273	62.41	74.89



STC8465P

LR006401



Range Rover

Model		Part Number	Price Ex VAT	Price Inc VAT*
Range Rover Classic - Loadspace Mat Velour				
All 2 door models				
Black	Aftermarket	RA1369BLACK	35.00	42.00
All 4 door models				
Beige	Aftermarket	RA1370BEIGE	35.00	42.00
Black	Aftermarket	RA1370BLACK	35.00	42.00
Blue	Aftermarket	RA1370BLUE	35.00	42.00
Grey	Aftermarket	RA1370GREY	35.00	42.00
Range Rover P38 - Loadspace Mat Velour				
All models - Black	Aftermarket	STC8526PVBLACK	30.00	36.00
Range Rover P38 - Loadspace Mat Polyurethane				
All models	Genuine	STC8526	159.55	191.46
<i>Features Range Rover logo.</i>				
Range Rover L322 - Loadspace Mat Rubber				
All models	Aftermarket	LR003894P	45.83	55.00
	Genuine	LR003894	113.50	136.20
Range Rover L405 - Loadspace Mat Rubber				
All models	Aftermarket	VPLGS0260P	45.83	55.00
Range Rover Sport - Loadspace Mat Rubber				
All models				
to (VIN) CA999999	Aftermarket	VPLSS0043P	45.83	55.00
	Genuine	VPLSS0043	119.00	142.80
from (VIN) DA000001	Aftermarket	EBF500020P	45.83	55.00
Range Rover Evoque - Loadspace Mat Rubber				
All models except Convertible	Aftermarket	VPLVS0089P	45.83	55.00
<i>Features Range Rover logo</i>	Genuine	VPLVS0091	99.97	119.96



RA1370GREY



VPLGS0260P



VPLVS0089P



LR003894



VPLVS0091



STC50435P

Freelander

Model		Part Number	Price Ex VAT	Price Inc VAT*
Freelander 1 - Loadspace Mat Rubber				
All models (5 door)	Aftermarket	STC50435P	45.83	55.00
	Genuine	STC50435	62.41	74.89
All Commercial models with 2 seats				
<i>Features Land Rover logo</i>	Genuine	STC60631	202.44	242.93
Freelander 2 - Loadspace Mat Rubber				
All models	Aftermarket	LR002424P	45.83	55.00
	Genuine	LR002516	99.02	118.82

FULL CARPET SETS

Defender

Model	Part Number	Price Ex VAT	Price Inc VAT*
Defender - Front Carpet Sets, Standard Quality <i>Will fit RHD or LHD vehicles, includes gear & handbrake gaiters</i>			
All models with LT77 gearbox - Front set	Exmoor EXT020-2	102.30	122.76
All models with R380 gearbox - Front set	Exmoor EXT020-1	102.30	122.76
Defender - Front Carpet Sets, Premium Quality <i>Will fit RHD or LHD vehicles, includes gear & handbrake gaiters</i>			
All 110 models with LT77 gearbox - Front set	Exmoor EXT021-17	151.20	181.44
All 110 models with R380 gearbox - Front set	Exmoor EXT021-16	151.20	181.44
All models from (VIN) 7A000001 on (Puma) - Front set	Exmoor EXT021-15	158.55	190.26
Defender - Full Carpet Sets, Premium Quality <i>Will fit RHD or LHD vehicles, includes gear & handbrake gaiters</i>			
All 90 models with R380 gearbox - Complete vehicle set	Exmoor EXT021-3	283.80	340.56
All 110 models with LT77 gearbox - Complete vehicle set	Exmoor EXT021-4	299.25	359.10
All 110 models with R380 gearbox - Complete vehicle set	Exmoor EXT021-5	299.25	359.10



Discovery

Model Colour	RHD Part Number	LHD Part Number	Price Ex VAT	Price Inc VAT*
Discovery 1 - Full Carpet Sets				
All 3 door models - Complete vehicle set				
Beige Aftermarket	RD1081BEIGE	RD1081BEIGELHD	362.50	435.00
Blue Aftermarket	RD1081BLUE	RD1081BLUELHD	362.50	435.00
Grey Aftermarket	RD1081GREY	RD1081GREYLHD	362.50	435.00
All 5 door models - Complete vehicle set				
Beige Aftermarket	RD1150BEIGE	RD1150BEIGELHD	362.50	435.00
Blue Aftermarket	RD1150BLUE	RD1150BLUELHD	362.50	435.00
Grey Aftermarket	RD1150GREY	RD1150GREYLHD	362.50	435.00

RD1081GREY

Range Rover

Model Colour	RHD Part Number	LHD Part Number	Price Ex VAT	Price Inc VAT*
Range Rover Classic - Full Carpet Sets (RHD or LHD)				
All 2 door models - Complete vehicle set				
Beige Aftermarket	RA1306BEIGE	RA1306BEIGELHD	362.50	435.00
Black Aftermarket	RA1306BLACK	RA1306BLACKLHD	362.50	435.00
Light Brown Aftermarket	RA1306BROWN	RA1306BROWNLHD	362.50	435.00
Grey Aftermarket	RA1306GREY	RA1306GREYLHD	362.50	435.00
All 2 door models - Vogue Spec - Complete vehicle set				
Beige Aftermarket	RA1307BEIGE	RA1307BEIGELHD	362.50	435.00
Black Aftermarket	RA1307BLACK	RA1307BLACKLHD	362.50	435.00
Light Brown Aftermarket	RA1307BROWN	RA1307BROWNLHD	362.50	435.00
Grey Aftermarket	RA1307GREY	RA1307GREYLHD	362.50	435.00
4 door models to (VIN) BA999999 - Complete vehicle set				
Beige Aftermarket	RA1308BEIGE	RA1308BEIGELHD	362.50	435.00
Light Brown Aftermarket	RA1308BROWN	RA1308BROWNLHD	362.50	435.00
Grey Aftermarket	RA1308GREY	RA1308GREYLHD	362.50	435.00
4 door models to (VIN) BA999999 - Vogue Spec - Complete vehicle set				
Beige Aftermarket	RA1309BEIGE	RA1309BEIGELHD	362.50	435.00
Light Brown Aftermarket	RA1309BROWN	RA1309BROWNLHD	362.50	435.00
Grey Aftermarket	RA1309GREY	RA1309GREYLHD	362.50	435.00
4 door models from (VIN) CA000001 on - Vogue Spec - Complete vehicle set				
Beige Aftermarket	RA1310BEIGE	RA1310BEIGELHD	362.50	435.00
Light Brown Aftermarket	RA1310BROWN	RA1310BROWNLHD	362.50	435.00
Grey Aftermarket	RA1310GREY	RA1310GREYLHD	362.50	435.00
Light Stone Aftermarket	RA1310LIGHTSTONE	RA1310LIGHTSTONELHD	362.50	435.00
4 door models from (VIN) CA000001 on - Wilton - Complete vehicle set				
Beige Aftermarket	RA1311BEIGE	RA1311BEIGELHD	608.33	730.00
Black Aftermarket	RA1311BLACK	RA1311BLACKLHD	608.33	730.00
Brown Aftermarket	RA1311BROWN	RA1311BROWNLHD	608.33	730.00
Grey Aftermarket	RA1311GREY	RA1311GREYLHD	608.33	730.00
Range Rover Classic - Seat Base Covers				
All 2 & 4 door models - Seat Base Covers, Pair				
Beige Aftermarket	RA1312BEIGE	RA1312BEIGELHD	61.67	74.00
Black Aftermarket	RA1312BLACK	RA1312BLACKLHD	61.67	74.00
Brown Aftermarket	RA1312BROWN	RA1312BROWNLHD	61.67	74.00
Grey Aftermarket	RA1312GREY	RA1312GREYLHD	61.67	74.00



RA1308BEIGE

LOAD LINERS

Defender

Model	Part Number	Price Ex VAT	Price Inc VAT*
Defender - Loadspace Liner Rigid			
90 to (VIN) 6A999999 <i>Features Land Rover logo.</i>	Genuine RTC8936AA	172.48	206.98
90 from (VIN) 7A000001 <i>Station Wagon without 2nd row seats. Features Land Rover logo. Hard Top depending on internal equipment, may need small modifications to fit.</i>	Genuine LR005081	136.98	164.38
110 Station Wagon to (VIN) 6A999999 <i>Features Land Rover logo.</i>	Genuine RTC8935	167.28	200.74
110 from (VIN) 7A000001 on <i>Station Wagon without 3rd row seats. 5 Door hard top utility. Features Land Rover logo</i>	Genuine LR005081	136.98	164.38



Discovery

Model	Part Number	Price Ex VAT	Price Inc VAT*
Discovery 1 - Loadspace Liner Semi-rigid			
All models			
75mm (3") deep sides	Aftermarket RD1146BP	50.83	61.00
Discovery 2 - Loadspace Liner Semi-rigid			
All 7 Seater models			
100mm (4") deep sides	Aftermarket STC50050P	49.58	59.50
Discovery 3 - Loadspace Liner Semi-rigid			
All models			
75mm (3") deep sides, not compatible with cargo barrier			
	Aftermarket EBF500010BP	43.33	52.00
	Genuine EBF500010	138.35	166.02
75mm (3") deep sides, compatible with cargo barrier			
	Genuine EBF500080	134.22	161.06
All models, Black			
Waterproof Load Liner	Genuine VPLAS0015	121.41	145.69
Discovery 4 - Loadspace Liner Semi-rigid			
All models			
75mm (3") deep sides, not compatible with cargo barrier			
	Aftermarket EBF500010BP	43.33	52.00
	Genuine EBF500010	138.35	166.02
75mm (3") deep sides, compatible with cargo barrier			
	Genuine EBF500080	134.22	161.06
All models, Black			
Waterproof Load Liner	Genuine VPLAS0015	121.41	145.69
Discovery Sport - Loadspace Liner Semi-rigid			
All models, 50mm (2") deep sides, not compatible with cargo barrier			
	Genuine VPLCS0274	115.35	138.42

Range Rover

Model	Part Number	Price Ex VAT	Price Inc VAT*
Range Rover P38 - Loadspace Liner Semi-rigid			
All models, 100mm (4") deep sides	Aftermarket STC8525BM	43.33	52.00
Range Rover L322 - Loadspace Liner Semi-rigid			
All models, 50mm (2") deep sides	Aftermarket EBF000040BP	36.67	44.00
	Genuine EBF000040	137.72	165.26
All models, Black			
Waterproof Load Liner	Genuine VPLMS0017	108.12	129.74
Range Rover L405 - Loadspace Liner Semi-rigid			
All models, 50mm (2") deep sides	Genuine VPLGS0263	118.96	142.75
Range Rover Sport - Loadspace Liner Semi-rigid			
All models to (VIN) CA999999			
100mm (4") deep sides	Genuine EBF500020	138.35	166.02
All models from (VIN) DA000001			
100mm (4") deep sides	Genuine VPLWS0224	121.12	145.34
All models to (VIN) CA999999, Black			
Waterproof Load Liner	Genuine VPLSS0016	52.77	63.32
Range Rover Evoque - Loadspace Liner Rigid			
All models <i>Features Land Rover logo</i>	Genuine VPLVS0089	116.36	139.63
All models, Black			
Waterproof Load Liner	Genuine VPLVS0090	105.47	126.56



Freelander

Model	Part Number	Price Ex VAT	Price Inc VAT*
Freelander 1 - Loadspace Liner Semi-rigid			
All 3 door models			
100mm (4") deep sides	Aftermarket LF10183DR	55.83	67.00
Freelander 1 - Loadspace Liner Rigid			
All models	Genuine STC7935	114.41	137.29
<i>Features Land Rover logo, compatible with dog guard</i>			
Freelander 2 - Loadspace Liner Rigid			
All models <i>Features Land Rover logo</i>	Genuine LR002424	108.07	129.68

CANVAS HOODS



All Exmoor Trim Hoods feature:

- Deep weave canvas, hand made to the highest standard
- Tighter weave giving superior water proofing and durability characteristics



Model	Colour	Part Number	Price Ex VAT	Price Inc VAT*
Full Canvas Hood				
Defender 90				
with side windows				
	Sand	EXT202-11SAC	272.25	326.70
	Black	EXT202-14BKC	283.50	340.20
without side windows				
	Black	EXT202-6BKC	273.00	327.60
Defender 90 Td4/Td5 Puma				
with side windows				
	Sand	EXT202-12SAC	272.25	326.70
Series I (80)				
Rigid perspex twin rear windows				
	Khaki	EXT274-3KHC	318.17	381.80
Series 88				
with side windows				
	Khaki	EXT250-6KHC	284.50	341.40
	Sand	EXT250-7SAC	284.50	341.40
without side windows				
	Khaki	EXT250-1KHC	269.50	323.40
	Sand	EXT250-2SAC	269.50	323.40
Bikini Canvas Hood				
Defender 90 & 110				
	Black	EXT206-6BKC	96.33	115.60
Series 88 & 109				
	Khaki	EXT253-1KHC	88.00	105.60
	Sand	EXT253-2SAC	88.00	105.60
	Black	EXT253-4BKC	88.00	105.60
Full Stick Set				
Defender 90				
	call 01522 568000 for full details		EXT220-1	369.30 443.16
Series 88				
	call 01522 568000 for full details		EXT262-1	339.00 406.80
Drain Channel Clip				
Defender				
	6 required (3 each side)		EXT221-33	1.35 1.62
U Bracket				
All models				
	For securing hood stick		EXT263-23	3.10 3.72

*Prices include UK VAT @ 20%.

- Accurate colour matching to the original archived canvas samples
- Vat dyed ensuring the colour has penetrated all the way through the cotton canvas
- Improved colour fastness rating, ensuring that the natural UV fading is prolonged especially in hot climates
- Cold water shrinkage of the natural cotton fibre is greatly reduced.

This is just a selection of hoods that are available, with over 300 different options to choose from we will have something that suits your vehicle, call 01522 568000 for details.

ROOF RACKS

Specially sourced for Rimmer Bros, these roof racks are a sleek, slimline design manufactured from lightweight but strong aluminium with a tough high quality satin black powder coat finish. They weigh in at just 25kg.

Rimmer Bros have created a design - the extrusion is more rounded to give a better aerodynamic look and feel to cause less drag. These Racks cause little wind resistance..... at over 70mph it is very quiet!!

Easy fitting using a robust clamping system for Land Rover Defender 90. This rack will also fit a Discovery 2.

These roof racks are made from heat treated aluminium extrusions to ensure the optimum degree of flexibility and rigidity.

They have a modular construction with an anodised powder coated aluminium frame mounted on powder coated feet.

The modular construction, with horizontal slats, allows the slats to be removed for sunroof access etc.

The bars have a T slot system allowing a host of available accessories to be securely fitted to them, such as tents, lights, O-rings and a host of other items.

Sleek slimline construction makes them ideal for expeditions, overlanding, roof tents, camping etc not forgetting they look spot on!

They arrive flat packed for easy & cost effective delivery and have all holes drilled for easy assembly (normally less than an hour).

Defender 90 & 110 Discovery 1 & 2



Rimmer Bros Roof Racks

Model	Size	Part Number	Price Ex VAT	Price Inc VAT*
Defender 90 & Discovery 2		LL1888	555.00	666.00
<i>Dimensions when assembled: 2200mm x 1400mm.</i>				
Defender 110		LL1889	595.00	714.00
<i>Dimensions when assembled: 2800mm x 1400mm.</i>				
Discovery 1		RD1394	575.00	690.00
<i>Dimensions when assembled: 2200mm x 1400mm.</i>				

Defender 90 & 110

Aluminium Curved Luggage Roof Rack for Land Rover Defender.

Masai have designed and developed a wide range of robust Defender roof racks manufactured from high grade, light-weight, aluminium profiles using stainless steel fittings. Masai aluminium Defender roof racks are a practical, stylish and lighter-weight alternative to steel roof racks. Manufactured in three lengths.



Masai Roof Racks

Model	Size	Part Number	Price Ex VAT	Price Inc VAT*
1.5 Metre Roof Rack		LL1850	595.95	715.14
<i>Fits 90, 110 and full length of crew cab. (Will also fit Discovery 1 and 2 with height extension kit - special order only)</i>				
2.15 Metre Roof Rack		LL1848	695.95	835.14
<i>Fits full length of Defender 90, also fits 110.</i>				
2.8 Metre Roof Rack		LL1849	795.95	955.14
<i>Fits full length of 110 Station Wagon and hard top.</i>				

ORDER BY PHONE: 01522 568000 / ON LINE: www.rimmerbros.co.uk / E-MAIL: lrsales@rimmerbros.co.uk

*Prices include UK VAT @ 20%.

Defender

ROOF RACKS & BARS

Roof Bars (pairs)

Defender

Non-Lockable
High Foot



STC8057ACBMHD
PRICE EX VAT (OUTSIDE EU) **£203.33** PRICE INC VAT (UK @ 20%) **£244.00**



Lockable
High Foot

STC8057ACBMLOCK
PRICE EX VAT (OUTSIDE EU) **£254.17** PRICE INC VAT (UK @ 20%) **£305.00**

Non-Lockable
Standard Foot
Height



STC8057ACBMSTD
PRICE EX VAT (OUTSIDE EU) **£90.00** PRICE INC VAT (UK @ 20%) **£108.00**

Mont Blanc

Premium
Lockable
High Foot



STC7582BPPREM
PRICE EX VAT (OUTSIDE EU) **£133.33** PRICE INC VAT (UK @ 20%) **£160.00**



GENUINE
LAND ROVER

STC7582
PRICE EX VAT (OUTSIDE EU) **£160.89** PRICE INC VAT (UK @ 20%) **£193.07**

Roof Racks

Galvanised Flat Floor
Roof Rack

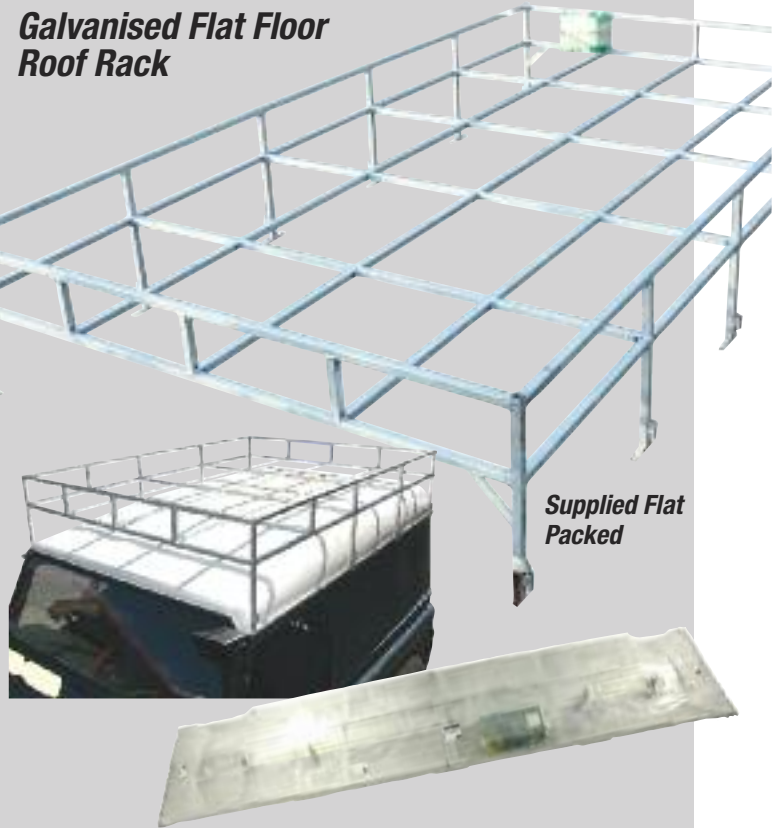

Supplied Flat Packed

Defender 90

L - 1990mm (78")
H - 420mm (16")
W - 1460mm (57")

LL1396BPFLAT
PRICE EX VAT (OUTSIDE EU) **£195.00** PRICE INC VAT (UK @ 20%) **£234.00**

Defender 110

L - 2800mm (110")
H - 420mm (16")
W - 1460mm (57")

LL1397BPFLAT
PRICE EX VAT (OUTSIDE EU) **£230.83** PRICE INC VAT (UK @ 20%) **£277.00**

Folding Tyre Step

All Models



- Adjustable tyre step for most light commercials and 4x4 vehicles.
- Adjustment pins must be locked in place.
- Ideal for windscreen repair / mechanical repair / roof rack loading / vehicle cleaning etc.
- Time saver.
- Sturdy steel construction.
- Internal dimensions of uprights = 490mm, Internal dimensions of adjustable width = 230mm to 350mm.

RX1970
PRICE EX VAT (OUTSIDE EU) **£32.50** PRICE INC VAT (UK @ 20%) **£39.00**



Discovery ROOF RACKS, RAILS & BARS

Roof Bars (pairs)

Discovery 1 Non-Lockable High Foot



STC8057ACBMHD
PRICE EX VAT (OUTSIDE EU) **£203.33** PRICE INC VAT (UK @ 20%) **£244.00**

Discovery 1

Lockable High Foot



STC8057ACBMLOCK
PRICE EX VAT (OUTSIDE EU) **£254.17** PRICE INC VAT (UK @ 20%) **£305.00**

Discovery 2

To (VIN) 2A499999

Raised Foot Fitment



RD1234BPDISC02
PRICE EX VAT (OUTSIDE EU) **£117.50** PRICE INC VAT (UK @ 20%) **£141.00**

Discovery 2

From (VIN) 3A000001

Raised Foot Fitment



VPLAR0001BP
PRICE EX VAT (OUTSIDE EU) **£136.67** PRICE INC VAT (UK @ 20%) **£164.00**

Discovery 3 & 4



VPLAR0001
PRICE EX VAT (OUTSIDE EU) **£225.26** PRICE INC VAT (UK @ 20%) **£270.31**

GENUINE LAND ROVER

Discovery 3 & 4

GENUINE LAND ROVER



CAP500090
PRICE EX VAT (OUTSIDE EU) **£195.12** PRICE INC VAT (UK @ 20%) **£234.14**

Discovery 3 & 4

Black Finish. Side Rail Kit Pair.



CAB500120PVJ
PRICE EX VAT (OUTSIDE EU) **£195.12** PRICE INC VAT (UK @ 20%) **£234.14**

GENUINE LAND ROVER

Side Rail Kit (pairs)

Discovery 3 & 4

GENUINE LAND ROVER

Black Finish Extended Side Rail Kit



VPLAR0074
PRICE EX VAT (OUTSIDE EU) **£365.84** PRICE INC VAT (UK @ 20%) **£439.01**

Discovery 3 & 4

Black Finish



GENUINE LAND ROVER

CAB500120PVJ
PRICE EX VAT (OUTSIDE EU) **£195.12** PRICE INC VAT (UK @ 20%) **£234.14**

Discovery 3 & 4

Extended Black Finish



VPLCR0131

PRICE EX VAT (OUTSIDE EU) **£197.61** PRICE INC VAT (UK @ 20%) **£237.13**

GENUINE LAND ROVER

Roof Racks

Discovery 3 & 4

This roof rack is manufactured from aluminium with a smart black powder coated finish.

Fully welded, they are extremely strong, versatile & easy to use. The floor planks are orientated longitudinally which results in a reduction of wind noise. There are nut channels on all the extrusions to allow for easy fitment of accessories.

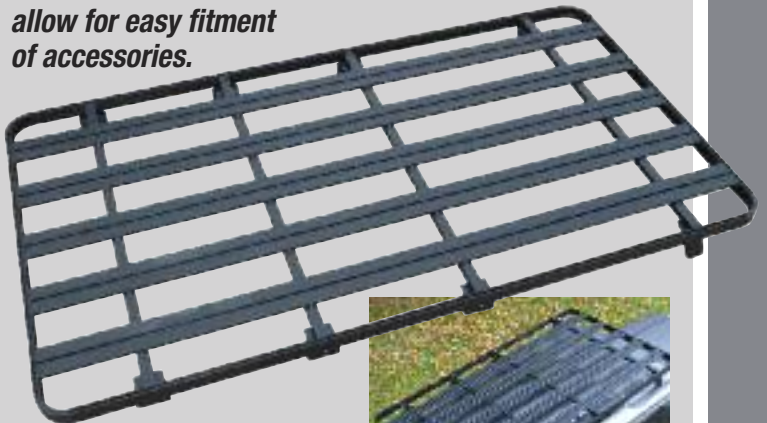

NOTE: May need roof rail kit (CAB500120PVJ or CAP500090) to be fitted to vehicle prior to roof rack installation.



2300mm long
1260mm wide
120mm roof to top of rack

CAB500021PMABP
PRICE EX VAT (OUTSIDE EU) **£675.00** PRICE INC VAT (UK @ 20%) **£810.00**

Freelander ROOF BARS & ROOF RACKS

Roof Bars (pairs)

Freelander 1

Clamp style fitment for vehicles up to (VIN) 3A999999



LF1026BP

PRICE EX VAT (OUTSIDE EU) **£155.83** PRICE INC VAT (UK @ 20%) **£187.00**

Freelander 1

For vehicles fitted with roof rails



CAC100162BPSTD

PRICE EX VAT (OUTSIDE EU) **£65.83** PRICE INC VAT (UK @ 20%) **£79.00**



Freelander 2

For vehicles fitted with roof rails



LR002417BP

PRICE EX VAT (OUTSIDE EU) **£115.83** PRICE INC VAT (UK @ 20%) **£139.00**

Freelander 2

Clamp style



LR002417BPNORAIL

PRICE EX VAT (OUTSIDE EU) **£170.83** PRICE INC VAT (UK @ 20%) **£205.00**

Freelander 1

For vehicles fitted with roof rails



CAC100162BP

PRICE EX VAT (OUTSIDE EU) **£105.83** PRICE INC VAT (UK @ 20%) **£127.00**

Roof Rail Kit

Freelander 2



GENUINE LAND ROVER

LR006608

PRICE EX VAT (OUTSIDE EU) **£265.19** PRICE INC VAT (UK @ 20%) **£318.23**

Series ROOF BARS & ROOF RACK

Roof Bars (pairs)



Series

Non-Lockable High Foot

STC8057ACBMHD

PRICE EX VAT (OUTSIDE EU) **£203.33** PRICE INC VAT (UK @ 20%) **£244.00**



Series

Lockable High Foot



STC8057ACBMLOCK

PRICE EX VAT (OUTSIDE EU) **£254.17** PRICE INC VAT (UK @ 20%) **£305.00**



Roof Racks

Galvanised Flat Floor Roof Rack

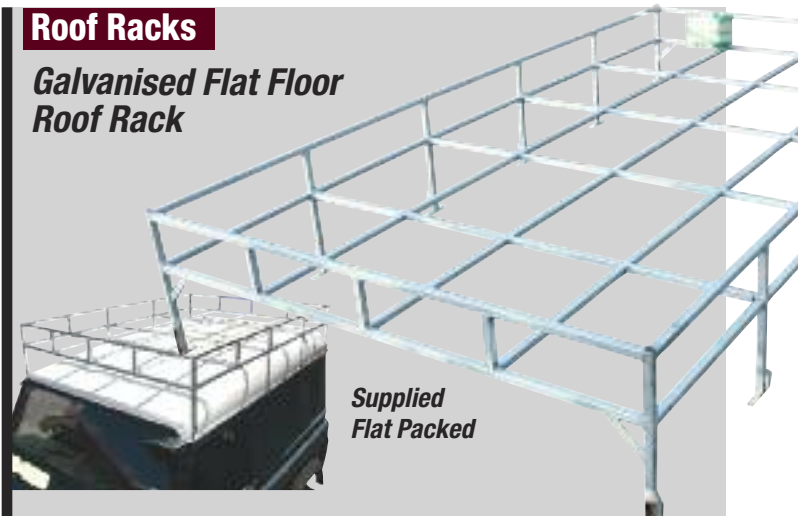

Supplied Flat Packed

Series 88" Wheelbase

L - 1990mm (78")
H - 420mm (16")
W - 1460mm (57")

LL1396BPFLAT

PRICE EX VAT (OUTSIDE EU) **£195.00** PRICE INC VAT (UK @ 20%) **£234.00**

Series 109" Wheelbase

L - 2800mm (110")
H - 420mm (16")
W - 1460mm (57")

LL1397BPFLAT

PRICE EX VAT (OUTSIDE EU) **£230.83** PRICE INC VAT (UK @ 20%) **£277.00**

Range Rover ROOF BARS & ROOF RACKS

Roof Bars (pair)

Range Rover Classic

Non-lockable



RTC9475BM

PRICE EX VAT (OUTSIDE EU) **£85.83** PRICE INC VAT (UK @ 20%) **£103.00**

Range Rover P38

Lockable



STC50252BPREM

PRICE EX VAT (OUTSIDE EU) **£110.83** PRICE INC VAT (UK @ 20%) **£133.00**

Range Rover P38 Fixed Points Fitment



STC50252BP

PRICE EX VAT (OUTSIDE EU) **£148.33** PRICE INC VAT (UK @ 20%) **£178.00**

Range Rover L322

Clamp Style Fitment



VUB502790BP

PRICE EX VAT (OUTSIDE EU) **£150.83** PRICE INC VAT (UK @ 20%) **£181.00**

Range Rover 2013 on (L405)

Range Rover Sport 2014 on (L494)



Lockable

For vehicles fitted with roof rails



VPLGR0102

PRICE EX VAT (OUTSIDE EU) **£290.07** PRICE INC VAT (UK @ 20%) **£348.08**

Range Rover Evoque

Lockable
For vehicles fitted with roof rails



VPLAR0001BP

PRICE EX VAT (OUTSIDE EU) **£136.67** PRICE INC VAT (UK @ 20%) **£164.00**



VPLVR0073

PRICE EX VAT (OUTSIDE EU) **£187.71** PRICE INC VAT (UK @ 20%) **£225.25**

Roof Rack Rail Kits

Kit includes raised roof side rails, locking cross rail assemblies & keys. The cross rails, easily removed when not in use, accepts all roof stowage accessories.

Range Rover Sport - 2005-2013



VUB502130

PRICE EX VAT (OUTSIDE EU) **£437.21** PRICE INC VAT (UK @ 20%) **£524.65**



Range Rover Sport - 2005-2013

Roof bars only (Pair)
Clamp style fitment



VUB502130BP

PRICE EX VAT (OUTSIDE EU) **£150.00** PRICE INC VAT (UK @ 20%) **£180.00**

Range Rover Sport - 2005-2013

Roof Bars only
(3 part kit)



VUB502130BPPREM

PRICE EX VAT (OUTSIDE EU) **£145.83** PRICE INC VAT (UK @ 20%) **£175.00**



Roof Racks

Range Rover L322 - All Models



Expedition Roof Rack finished in Black. Contoured to fit the roof line of your Range Rover. Fits all models 2002 to 2012.



CAB500070PMA

PRICE EX VAT (OUTSIDE EU) **£771.37** PRICE INC VAT (UK @ 20%) **£925.64**



ORDER BY PHONE: 01522 568000 / ON LINE: www.rimmerbros.co.uk / E-MAIL: lrsales@rimmerbros.co.uk

*Prices include UK VAT @ 20%.

BIKE RACKS /CYCLE CARRIERS

Bike Racks/Carriers

All Models

**Holds 2 bikes.
Mounts on the spare wheel.**

Includes number plate holder & straps.



RD1110
PRICE EX VAT (OUTSIDE EU) £57.00 PRICE INC VAT (UK @ 20%) £68.40

All Models

**Holds 1 bike.
Mounts to roof rail crossbars.
Lockable.**

The smartest, most elegant solution for loading & transporting a bike on a roof.

- The self-adjusting & upright frame holder into which the bike automatically slides makes bike loading easy
- Adjusting & securing is done comfortably & quickly, with a turning knob at roof height
- Quick release straps, adjustable for different wheel sizes, hold the wheels securely in place
- Light & convenient aluminium design
- Can be easily fitted on either side of the car roof
- Fits frame dimensions up to 100mm



VPLFR0091BP
PRICE EX VAT (OUTSIDE EU) £95.83 PRICE INC VAT (UK @ 20%) £115.00

All Models

**Holds 1 bike.
Mounts to roof rail crossbars.
Lockable**



Stable easy-to-use roof mounted bike holder

- Takes frame diameters from 30mm up to 80mm
- Lockable to roof rack as well as bike
- Frame holder with quick attachment for easy fitting without tools
- Wheels rest in adjustable wheel holders & are fastened with strong security straps

RX1596BPSCOTT
PRICE EX VAT (OUTSIDE EU) £48.33 PRICE INC VAT (UK @ 20%) £58.00

Freelander 1

**Holds 3 bikes.
Mounts to spare wheel carrier.**



LF1100BP
PRICE EX VAT (OUTSIDE EU) £70.83 PRICE INC VAT (UK @ 20%) £85.00

Discovery 2, 3 & 4 Range Rover Sport (2005-2013)

**Holds 2 bikes.
Fits to multi-height tow bar.**



STC50063BP
PRICE EX VAT (OUTSIDE EU) £225.00 PRICE INC VAT (UK @ 20%) £270.00



**Holds 4 bikes.
Mounts to spare wheel carrier.**

Discovery 1

RD1110-BP PRICE EX VAT (OUTSIDE EU) £75.83 PRICE INC VAT (UK @ 20%) £91.00

Discovery 2

RD1280BP PRICE EX VAT (OUTSIDE EU) £65.50 PRICE INC VAT (UK @ 20%) £78.60

Ski/Snowboard/Canoe Carriers

Land Rover offer various options to hold skis etc for use in conjunction with roof cross bars:

Please call to confirm compatibility with your vehicle.

Part Number	Price Ex VAT	Price Inc VAT*
1 pair of ski or snowboard holders LR006849	141.37	169.64
1 pair of ski holders CAN500020	60.74	72.89
Canoe/Sailboard carrier STC8435	95.34	114.41



Ratchet Strap - Tie Down

All Models

**5m long
20mm wide**



**GENUINE
LAND ROVER**

CAR500010
PRICE EX VAT (OUTSIDE EU) £13.46 PRICE INC VAT (UK @ 20%) £16.15

BungeeClic

All Models

BungeeClic, a complete system for securing loads & objects.

It can be customised in a variety of ways to build the correct length ties needed for securing a variety of objects. It can be used to secure loads at work, at home or at leisure.

Kit contains:

- 2 x J-Hooks
- 2 x Locking hooks
- 1 x Straight connector
- 1 x 30-45cm bungee cord
- 1 x 60-90cm bungee cord
- 1 x 90-135cm bungee cord



It's as easy as click & connect



The BungeeClic is an adaptable system to suit your needs.



Description	Part Number	Price Ex VAT	Price Inc VAT*
BUNGEELIC ADDITIONAL ACCESSORIES			
J-HOOKS (twin pack)	RX1742JHOOK	3.00	3.60
LOCKING HOOKS (twin pack)	RX1742LOCHOOK	2.83	3.40
STRAIGHT CONNECTORS	RX1743STRAIGHT	2.83	3.40
<i>Twin pack - precision length for every job.</i>			
Y-CONNECTOR	RX1743YCON	2.83	3.40
<i>Single pack - allows you to build netting shapes.</i>			
WALL MOUNTS (twin pack)	RX1744	2.83	3.40
ADJUSTABLE HOOKS	RX1742ADJHOOK	2.83	3.40
<i>Twin pack - sets the cord to the required length.</i>			
BUNGEE CORDS, twin pack			
30cm extends to 45cm	RX1745-30	3.83	4.60
60cm extends to 90cm	RX1745-60	4.50	5.40
90cm extends to 135cm	RX1745-90	4.50	5.40
120cm extends to 160cm	RX1745-120	4.58	5.50

RX1741
PRICE EX VAT (OUTSIDE EU) £9.17 PRICE INC VAT (UK @ 20%) £11.00

ROOF ACCESS LADDERS & ROOF BOXES

Roof Ladders *Rear Mounted Ladders for Easy Access to your Roof Rack*

Defender & Series



Galvanised
Ideal for
LL1396BPFLAT
& LL1397BPFLAT
Roof Racks
(see pages 81).

Defender



Black

Aftermarket - STC50417BP

PRICE EX VAT (OUTSIDE EU) **£65.83** PRICE INC VAT (UK @ 20%) **£79.00**

Genuine Land Rover - STC50417

PRICE EX VAT (OUTSIDE EU) **£111.81** PRICE INC VAT (UK @ 20%) **£134.17**

Aftermarket - LL1395BPGALV

PRICE EX VAT (OUTSIDE EU) **£42.08** PRICE INC VAT (UK @ 20%) **£50.50**



Black

Discovery 2

Aftermarket - STC50134BP

PRICE EX VAT (OUTSIDE EU) **£43.33** PRICE INC VAT (UK @ 20%) **£52.00**

Genuine Land Rover - STC50134

PRICE EX VAT (OUTSIDE EU) **£84.89** PRICE INC VAT (UK @ 20%) **£101.87**



Black

Discovery 3 & 4

Genuine Land Rover - VPLAR0164

PRICE EX VAT (OUTSIDE EU) **£230.98** PRICE INC VAT (UK @ 20%) **£277.18**

Roof Boxes

All Models



Mont
Blanc

380 litres
Half Width
L2000 x W650 x H450
75Kg capacity,
Weight 15Kg.

RX1655BP380

PRICE EX VAT (OUTSIDE EU) **£191.50** PRICE INC VAT (UK @ 20%) **£229.80**

GENUINE LAND ROVER



*Picture used for illustration purposes only and is not representative of the box size.

410 litres
L1750 x W820x H450
75Kg capacity
Black Gloss

VPLVR0062

PRICE EX VAT (OUTSIDE EU) **£370.26** PRICE INC VAT (UK @ 20%) **£444.31**

Tie Down Points

All Models



GENUINE
LAND ROVER

Luggage Tie Down Loop

E0Z100000

PRICE EX VAT (OUTSIDE EU) **£4.15** PRICE INC VAT (UK @ 20%) **£4.98**

SVX Style Cargo Tie Down Point



E0Z100000BP

PRICE EX VAT (OUTSIDE EU) **£21.25** PRICE INC VAT (UK @ 20%) **£25.50**

Luggage Nets

Land Rover offer a huge variety of load retention & luggage nets – this is just a selection of what is available, please give us a call for your specific requirements.

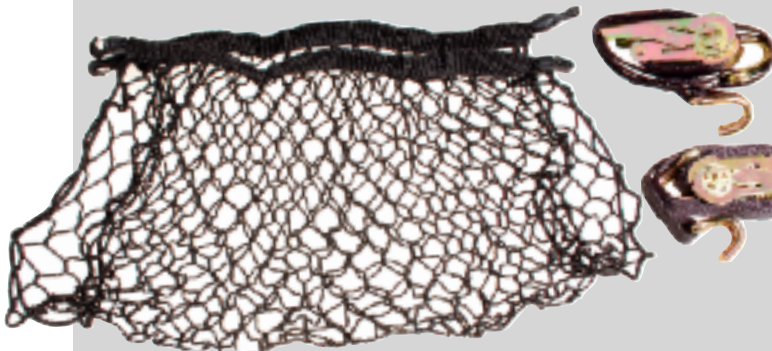

Model	Part Number	Price Ex VAT	Price Inc VAT*
Discovery 2			
Pair of side envelope nets	STC50133	99.67	119.60
Discovery 3 & 4			
Elasticated luggage net	E00500010PVJ	7.72	9.26
Discovery 4, Discovery Sport & Evoque			
Loadspace net	VPLCS0269P1	32.92	39.50
Discovery Sport & Evoque			
Rear of second row seat envelope net	VPLCS0271	67.61	81.13
Range Rover L322			
Pair of side envelope nets	LR017770	42.93	51.52
Freelander 1			
5 door rear door stowage net	STC7952	32.07	38.48
Loadspace net	STC7954	85.80	102.96
5 door pair of side envelope nets	STC7955	86.67	104.00
3 door rear door stowage net	STC7953	32.07	38.48

DOG GUARDS / CARGO BARRIERS

Travall is a UK manufacturer supplying many vehicle manufacturers and all the dog guards are:

- OEM quality parts from a Land Rover OEM supplier
- Manufactured in the UK
- Nylon powder coated steel
- Scratch resistant
- Dark Grey
- Laser cut & precision welded
- Supplied with easy to follow fitting guides
- Lifetime warranty against manufacturing defects

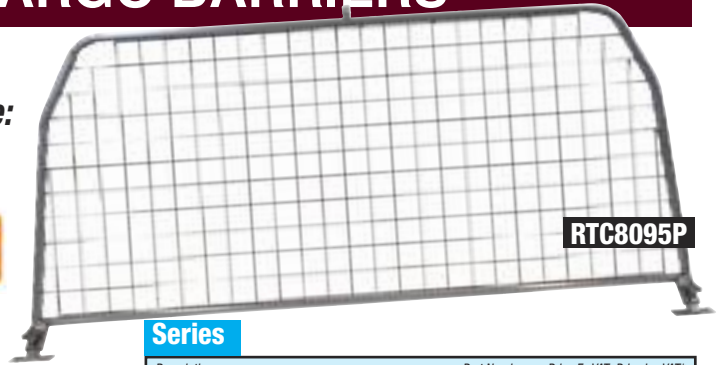

RTC8095P



Series & Defender



RTC8095P



Series

Description	Part Number	Price Ex VAT	Price Inc VAT*
Series II & III Upper half			
Mesh type - Aftermarket	LL1333BM	131.67	158.00
88 & 109 hardtop with bulkhead			
Travall	RTC8095P	95.83	115.00

Defender

90 & 110 hardtop with bulkhead 1983 on			
Mesh Type - Travall	RTC8095P	95.83	115.00
110 Station Wagon 1987 to 2006, 5 door, Commercial 90 & 110 1987 to 2006 with bulkhead removal bar fitted			
Mesh type - Genuine	STC50479	109.56	131.47
110 Station Wagon 2007 on, 5 door, less bulkhead			
Mesh type - Travall	LR006447P	174.99	209.99
Mesh type - Genuine	LR006447	209.71	251.65
90 Station Wagon 2007 on, 3 door, less bulkhead			
Mesh type - Genuine	LR006448	209.71	251.65

Defender 90 & 110



STC50479



Defender 110



LL006447P



Discovery 2



STC50323P



Discovery Sport



VPLCS0300P



Discovery 3 & 4



RD1229

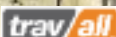

Discovery Sport



VPLCS0300PL



Discovery 3 & 4



RD1229D



Discovery Sport



VPLCS0301P



Discovery

Discovery 1			
Upper half. Mesh type			
Aftermarket	STC8414BP	75.00	90.00
Discovery 2			
Upper half. Bar type			
Travall	STC50323P	95.83	115.00
Genuine	STC50082AA	96.94	116.33
Upper half. Mesh type			
Aftermarket	STC50082AABP	70.00	84.00
Discovery 3			
Upper half. Mesh type			
Travall	RD1229	91.66	109.99
Boot space divider. Mesh type. Requires RD1229			
Travall	RD1229D	99.99	119.99
Full width, full length centre divider. Mesh type			
Genuine	VUB501170	244.67	293.60
Fitting kit for VUB501170			
Genuine	VUB503000	74.54	89.45
Boot space divider. Mesh type			
Genuine	EOH500040	151.46	181.75
Discovery 4			
Upper half. Mesh type			
Travall	RD1229	91.66	109.99
Boot space divider. Mesh type. Requires RD1229			
Travall	RD1229D	99.99	119.99
Full width, full length centre divider. Mesh type			
Genuine	VUB501170	244.67	293.60
Fitting kit for VUB501170			
Genuine	VUB503000	74.54	89.45
Boot space divider. Mesh type			
Genuine	EOH500040	151.46	181.75
Discovery Sport			
<i>NOTE: 7 seater vehicles only.</i>			
<i>Parcel shelf cannot be used when dog guard is in place.</i>			
Upper half. Mesh type			
Travall	VPLCS0300P	116.66	139.99
Lower half. Mesh type. Requires VPLCS0300P			
Travall	VPLCS0300PL	91.66	109.99
Boot space divider. Mesh type. Requires VPLCS0300P.			
Travall	VPLCS0301P	91.66	109.99

DOG GUARDS / CARGO BARRIERS

TOURING - DOG GUARDS / CARGO BARRIERS

Freelander 1

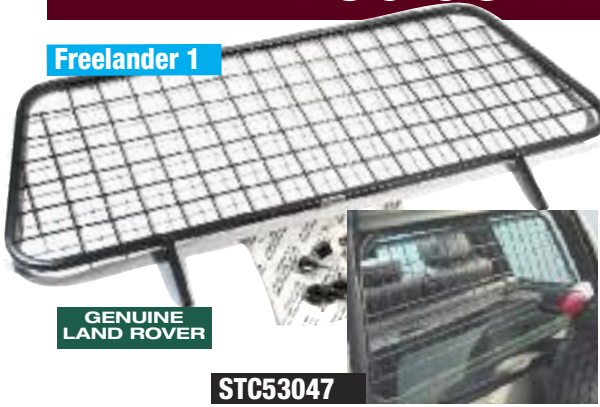

GENUINE LAND ROVER

STC53047

Freelander 1



STC7939ABP

trav all

Freelander 2



VPLVS0222P

trav all

Freelander

Description	Part Number	Price Ex VAT	Price Inc VAT*
Freelander 1			
Full height, upper half bar type, lower half mesh Travall	STC7939ABP	91.66	109.99
Rear window, allows rear window to be left open when pets are left in the vehicle Genuine	STC53047	91.01	109.21
Freelander 2			
Upper half. Mesh type Travall	VPLVS0222P	83.33	100.00
Full width, full height. Mesh type Genuine	LR002521	233.03	279.64
Boot space divider. Mesh type Genuine	LR002522	155.35	186.42

Range Rover L322

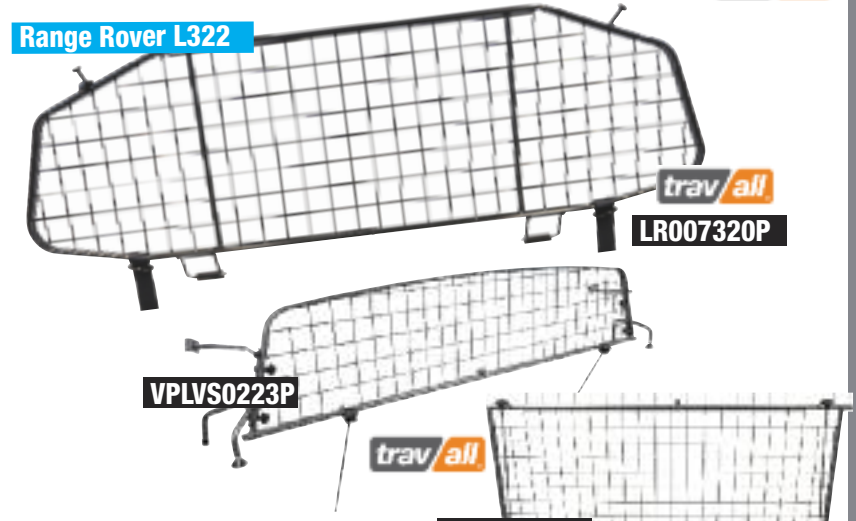

LR007320P

VPLVS0223P

trav all

VPLVS0224P

Range Rover

Range Rover Classic			
Upper half. Mesh type Aftermarket	RTC8092BP	73.33	88.00
Range Rover P38			
Upper half. Bar type Aftermarket	STC8524BP	151.67	182.00
Range Rover L322 (2002 to 2012)			
Upper half. Mesh type Travall	LR007320P	104.17	125.00
Genuine	LR007320	170.88	205.06
Range Rover L405 (2012 on)			
<i>NOTE parcel shelf cannot be used when dog guard is in place.</i>			
Upper half. Mesh type. Travall	VPLVS0223P	133.33	160.00
Lower half. Mesh type. <i>Requires VPLVS0223P.</i> Travall	VPLVS0224P	91.66	109.99
Boot space divider. Mesh type. <i>Requires VPLVS0223P.</i> Travall	VPLVS0225P	99.99	119.99
Range Rover Sport L320 (2005 to 2013)			
Upper half. Mesh type Travall	VPLSS0205P	112.49	134.99
Boot space divider. Mesh type. <i>Requires VPLSS0205P.</i> Travall	EOH500140PMAP	104.16	124.99
Range Rover Sport L494 (2013 on)			
Upper half. Mesh type Travall	VPLWS0236P	116.66	139.99
Boot space divider. Mesh type. <i>Requires VPLWS0236P.</i> Travall	VPLWS0237P	83.33	100.00
Range Rover Evoque			
5 door upper half. Mesh type Travall	VPLVS0218P	99.00	118.80
Boot space divider for VPLVS0218P Travall	VPLVS0218PDIV	91.66	109.99
3 door upper half. Mesh type Genuine	VPLVS0219	239.22	287.06
5 door full height. Mesh type Genuine	VPLVS0220	244.67	293.60
3 door full height. Mesh type Genuine	VPLVS0221	280.82	336.98

Range Rover Sport L320



VPLSS0205P

trav all

Range Rover Sport L320



EOH500140PMAP

trav all

Range Rover Sport L494

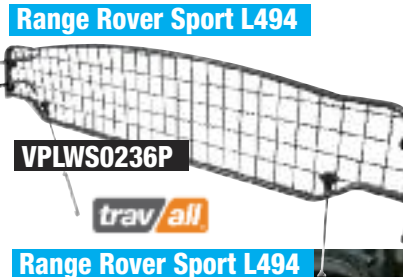

VPLWS0236P

trav all

Range Rover Sport L494

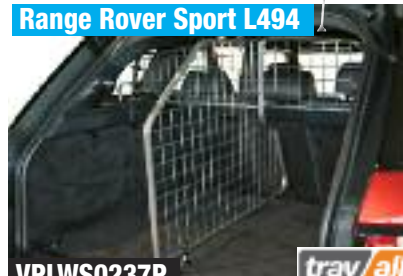

VPLWS0237P

trav all

Range Rover L405



VPLVS0225P

trav all

Range Rover Evoque



VPLVS0218P

trav all

Range Rover Evoque

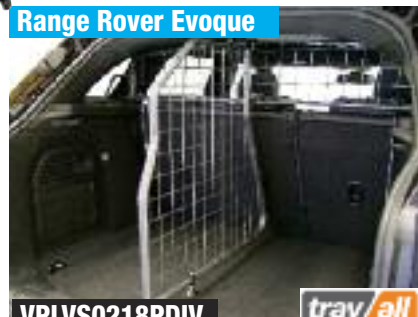

VPLVS0218PDIV

trav all

ORDER BY PHONE: 01522 568000 / ON LINE: www.rimmerbros.co.uk / E-MAIL: lrsales@rimmerbros.co.uk

*Prices include UK VAT @ 20%.

TOW BARS

TOW BARS – there is a vast array of tow bars on the market for Land Rover & Range Rover vehicles.

Here we have selected the most popular applications and tried to make it as clear as possible as to what is included within each kit.

The range is selected from specialists in the towing industry such as Witter, Bosal, Thule and, of course, Genuine products from Land Rover themselves.

If you cannot find what you are looking for, or are in any doubt about the fitment to your vehicle please give us a call on 01522 568000 and we will be able to help you with the correct application.

Series

Description	Part Number	Price Ex VAT	Price Inc VAT*
Series			
Tow Hitch Kit - Height adjustable (Tow ball not included)			
All models	Dixon Bate	RTC7042P	83.33 100.00
Lightweight models	Dixon Bate	RTC7042BPLW	86.67 104.00
Tow Hitch Front - Simply slips over front bumper (Tow ball not included)			
Series III - All models	Aftermarket	LL1608BM	73.33 88.00
Drop Plate & Bracket (Tow ball not included)			
Long - All models	Aftermarket	508412PL	18.96 22.75
Standard - All models	Aftermarket	508412PS	11.50 13.80

Defender

Defender

Tow Bar Assembly only

Height adjustable (Tow ball not included)			
Defender 90 & 110 to (VIN) WA159806			
	Dixon Bate	RTC8828AAP	113.33 136.00
	Genuine	RTC8828AA	184.62 221.54
Height adjustable (with tools) (Tow ball not included)			
Defender 90 from (VIN) WA000001 on			
	Aftermarket	LR006309BP	103.33 124.00
Height adjustable (Tow ball not included)			
Defender 90 all TD5 models & from (VIN) 7A000001 on (not suitable for HCPU)			
	Dixon Bate	LR007221P	147.50 177.00
	Genuine	LR007221	178.57 214.28
Defender 110/130 from (VIN) WA000001 on			
	Dixon Bate	LR007223P	192.50 231.00
	Genuine	LR007223	205.89 247.07
Height adjustable (with tools) (Tow ball included)			
Defender 110 from (VIN) WA000001 on			
	Aftermarket	VPLDT0085P	123.33 148.00
Height adjustable (Tow ball not included)			
Defender 110 all TD5 models & from (VIN) 7A000001 on (not suitable for HCPU)			
	Dixon Bate	LR007222P	126.67 152.00
	Genuine	LR007222	159.77 191.72
2" Receiver Hitch - Height adjustable (with tools) (Tow ball not included)			
Defender 90 & 110 to (VIN) WA159806			
	Terrafirma	RTC8828AARECTF	169.50 203.40
Defender 110 all TD5 models & from (VIN) 7A000001 on (not suitable for HCPU)			
	Terrafirma	LR007222RECTF	175.83 211.00
Tow Hitch Front - Simply slips over front bumper (Tow ball not included)			
Defender 90 & 110 all models Aftermarket			
		LL1608BM	73.33 88.00
Centre Pin For Bumper			
Defender all models			
	Aftermarket	RRC6681BP	23.12 27.74



Discovery

Description	Part Number	Price Ex VAT	Price Inc VAT*
Discovery 1			
Tow Bar Kit inc electrics - Height adjustable (with tools) (Tow ball not included) All models to (VIN) KA064754	Aftermarket	STC8816BP	105.83 127.00
Tow Bar Assembly only - Height adjustable (Tow ball not included) All models from (VIN) LA064755 on	Dixon Bate	STC8060ABP	120.83 145.00
2" Receiver Hitch - Height adjustable (with tools) (Tow ball not included) All models	Terrafirma	STC8060ABRECTF	175.83 211.00
Discovery 2			
Tow Bar Kit inc electrics Swan neck, fixed (Tow ball included)	Aftermarket	ANR6643P	155.83 187.00
Height adjustable (Tow ball not included)	Aftermarket	ANR6643BP	143.33 172.00
Tow Bar Assembly only Height adjustable (Tow ball not included)	Dixon Bate	STC50287ABP	138.33 166.00
All coil suspension models Dixon Bate	Dixon Bate	STC50289ABP	133.33 160.00
All air suspension models Dixon Bate	Dixon Bate	STC50319BP	135.00 162.00
Multi height - None sliding adjuster (Tow ball included)	Terrafirma	STC80319RECTF	175.83 211.00
2" Receiver Hitch - Height adjustable (with tools) (Tow ball not included) All models	Terrafirma	STC80319RECTF	175.83 211.00
Discovery 3			
Tow Bar Assembly only - Height adjustable (Tow ball included) All models (except Canada, Mexico & USA)	Aftermarket	LR070497P	217.50 261.00
	OEM	LR070497P1	245.83 295.00
Towing Hook Assembly - Quick disconnect, fixed height All models (except Canada, Mexico & USA)	OEM	LR071295P1	307.50 369.00
	Genuine	LR071295	429.91 515.89
Discovery 4			
Towing Hook Assembly - Quick disconnect, fixed height All models (except Canada, Mexico & USA)	OEM	LR071295P1	307.50 369.00
	Genuine	LR071295	429.91 515.89
All New Discovery			
Tow Bar Assembly only - Fixed multi-height (Tow ball included) All models (except Canada, Mexico & USA)	Genuine	VPLRT0175	569.80 683.76
Tow Bar Kit inc electrics - Swan neck, detachable (Tow ball included) All models (except Canada, Mexico & USA)	Genuine	VPLRT0171	584.10 700.92
Discovery Sport			
Tow Bar Assembly only Tow ball included			
All 5 seat models (except Canada, Mexico & USA)	Genuine	VPLCT0140	399.40 479.28
All 7 seat models without spare wheel (except Canada, Mexico & USA)	Genuine	VPLCT0140	399.40 479.28
All 7 seat models with spare wheel (except Canada, Mexico & USA)	Genuine	VPLCT0142	468.04 561.65
Includes quick release swan neck All 5 seat models (except Canada, Mexico & USA)	OEM	VPLCT0147P1	295.83 355.00
	Genuine	VPLCT0147	686.47 823.76
All 7 seat models without spare wheel (except Canada, Mexico & USA)	OEM	VPLCT0147P1	295.83 355.00
	Genuine	VPLCT0147	686.47 823.76
All 7 seat models with spare wheel (except Canada, Mexico & USA)	Genuine	VPLCT0148	707.27 848.72
Requires draw bar (VPLCT0160) All 5 seat models, Canada, Mexico & USA	Genuine	VPLCT0141	399.40 479.28
Requires draw bar (VPLCT0161) All 7 seat models, Canada, Mexico & USA, without spare wheel	Genuine	VPLCT0141	399.40 479.28
All 7 seat models, Canada, Mexico & USA, with spare wheel	Genuine	VPLCT0143	499.25 599.10

Range Rover

Description	Part Number	Price Ex VAT	Price Inc VAT*
Range Rover Classic			
Tow Bar Kit inc electrics - Height adjustable (with tools) (Tow ball not included) All models to (VIN) KA637567	Aftermarket	STC8816BP	105.83 127.00
Tow Bar Assembly only - Height adjustable (Tow ball not included) All models from (VIN) LA0637568 on	Dixon Bate	STC8060ABP	120.83 145.00
Range Rover P38			
Tow Bar Assembly only (Tow ball not included) All models	Aftermarket	STC8543AABP	120.83 145.00
Tow Bar Kit inc electrics (Tow ball not included) All models	Aftermarket	STC8543AAP	155.83 187.00
Range Rover L322			
Tow Bar Armature only All models to (VIN) 5A999999	Genuine	KNI000014	273.89 328.67
All models to (VIN) 5A999999 (European Spec)	Aftermarket	VUB000740P	225.83 271.00
All models from (VIN) 6A000001 on	Aftermarket	VUB503960BP	275.00 330.00
	Genuine	KNI500020	436.33 523.60
Range Rover L405			
Tow Bar Assembly only (Includes 50mm tow ball) All models (except Canada, Mexico & USA)	Genuine	VPLGT0082	603.26 723.91
Range Rover Sport			
Towing Hook Assembly - Quick disconnect, fixed height All models (except Canada, Mexico & USA) to (VIN) DA999999	OEM	LR071295P1	307.50 369.00
	Genuine	LR071295	429.91 515.89
Tow Bar Assembly only Fixed multi-height includes swan neck All models (VIN) DA000001 on (L494)	OEM	VPLWT0165P1	391.67 470.00
Includes swan neck, fixed All models (except Canada, Mexico & USA)	Genuine	VPLVT0065	290.71 348.85
Includes quick release swan neck All models (except Canada, Mexico & USA)	Genuine	VPLVT0069	463.71 556.45
Includes 50mm tow ball All models (except Canada, Mexico & USA)	Genuine	VPLVT0078	240.47 288.56

Freelander

Freelander 1			
Tow Bar Kit inc electrics Includes 50mm tow ball and plug connection to vehicle loom	Aftermarket	KNK500070BPDIX	140.83 169.00
Includes swan neck, detachable and plug-in electrics	Aftermarket	KNK500080BP	283.33 340.00
Includes Euro style fixed swan neck	Aftermarket	KNK500060BP	208.33 250.00
Tow Bar Assembly only - Includes swan neck, detachable All models	Bosal	LF1024	199.17 239.00
Freelander 2			
Tow Bar Assembly only Tow ball included	Aftermarket	VPLFT0118P	150.83 181.00
Includes swan neck, detachable	Aftermarket	VPLFT0119P	230.83 277.00
Includes swan neck, fixed All models from (VIN) DH000001 on	Thule	VPLFT0120P	158.33 190.00

TOW BALLS & FITTINGS



**50mm Tow Ball
E Approved**

Aftermarket - RTC8891P
PRICE EX VAT (OUTSIDE EU) **£7.71** PRICE INC VAT (UK @ 20%) **£9.25**

Genuine Land Rover - RTC8891AA
PRICE EX VAT (OUTSIDE EU) **£17.33** PRICE INC VAT (UK @ 20%) **£20.80**



**50mm Full
Tow Ball
Cover**

GTT308
PRICE EX VAT (OUTSIDE EU) **£2.33** PRICE INC VAT (UK @ 20%) **£2.80**

50mm Tow Ball Covers

**Spun
Aluminium
Polished**



ANR3635POLISHED
PRICE EX VAT (OUTSIDE EU) **£4.17** PRICE INC VAT (UK @ 20%) **£5.00**

**GENUINE
LAND ROVER**

ANR3635
PRICE EX VAT (OUTSIDE EU) **£5.64** PRICE INC VAT (UK @ 20%) **£6.77**

**Spun
Aluminium
Black**

ANR3635P
PRICE EX VAT (OUTSIDE EU) **£4.17** PRICE INC VAT (UK @ 20%) **£5.00**

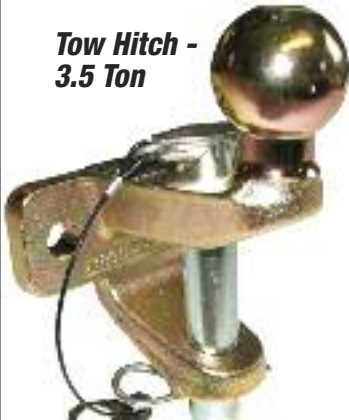

**Tow Hitch -
3.5 Ton**

Aftermarket - LR008244BP
PRICE EX VAT (OUTSIDE EU) **£33.33** PRICE INC VAT (UK @ 20%) **£40.00**



Ball, Jaw & Pin

Dixon Bate - LR008244BPDIX
PRICE EX VAT (OUTSIDE EU) **£44.58** PRICE INC VAT (UK @ 20%) **£53.50**

Dixon Bate Spare Parts



**Replacement Pin for
LR008244BPDIX**



LR008244BPDIXPIN
PRICE EX VAT (OUTSIDE EU) **£14.37** PRICE INC VAT (UK @ 20%) **£17.24**

**Saddle Slider - Fits all
Dixon Bate Kits**



STC50259AABP
PRICE EX VAT (OUTSIDE EU) **£38.33** PRICE INC VAT (UK @ 20%) **£46.00**

**Ball, Jaw & Pin - Heavy Duty
(Ball 3.5 Ton/Jaw 5 Ton)
4 Bolt Mounted**



Dixon Bate - LR008244BPHD
PRICE EX VAT (OUTSIDE EU) **£105.83** PRICE INC VAT (UK @ 20%) **£127.00**



**Tow Ball
Universal
Coupling**

Dixon Bate - LR008244P
PRICE EX VAT (OUTSIDE EU) **£53.33** PRICE INC VAT (UK @ 20%) **£64.00**

**Universal Coupling Pin,
Heavy Duty**



LR008244BPHDPIN
PRICE EX VAT (OUTSIDE EU) **£20.83** PRICE INC VAT (UK @ 20%) **£25.00**

**Replacement Slider
Bracket - 1 Pin**



STC50259AABP1
PRICE EX VAT (OUTSIDE EU) **£31.67** PRICE INC VAT (UK @ 20%) **£38.00**

**Replacement Chain,
Tag & Clip**



LR008244BPCHAIN
PRICE EX VAT (OUTSIDE EU) **£3.33** PRICE INC VAT (UK @ 20%) **£4.00**

**Replacement Slider
Bracket - 2 Pin**



STC50259AABP2
PRICE EX VAT (OUTSIDE EU) **£42.50** PRICE INC VAT (UK @ 20%) **£51.00**



**Tow Jaw -
3.5 Ton**

Dixon Bate - KNB100640BP
PRICE EX VAT (OUTSIDE EU) **£44.58** PRICE INC VAT (UK @ 20%) **£53.80**



Nato Tow Hitch

Aftermarket - NRC2051BP
PRICE EX VAT (OUTSIDE EU) **£231.67** PRICE INC VAT (UK @ 20%) **£278.00**

Replacement Slider Pin



STC50259AABPPIN
PRICE EX VAT (OUTSIDE EU) **£11.46** PRICE INC VAT (UK @ 20%) **£13.75**

Replacement R Clip



STC50259AABPCLIP
PRICE EX VAT (OUTSIDE EU) **£1.25** PRICE INC VAT (UK @ 20%) **£1.50**

TOW BALL - VEHICLE SPECIFIC OPTIONS

Description	Part Number	Price Ex VAT	Price Inc VAT*
Defender			
2" Receiver Drop Plate			
All models to (VIN) VA999999			
Terrafirma	STC8828AARECDPTF	58.33	70.00
All models from (VIN) WA000001 on			
Terrafirma	LR007221RECDPTF	57.50	69.00
2" Receiver Hitch Plate			
All models from (VIN) WA000001 on			
Terrafirma	LR007221RECTF	175.83	211.00
2" Receiver Recovery Point			
All models			
Terrafirma	STC8828AARECRPTF	55.83	67.00
Spare Retaining Pin for Receiver			
All models			
Terrafirma	STC8828AARECPINTF	19.58	23.50
Discovery 1			
Spare Retaining Pin for Receiver			
All models			
Terrafirma	STC8828AARECPINTF	19.58	23.50
Discovery 2			
Spare Retaining Pin for Receiver			
All models			
Terrafirma	STC8828AARECPINTF	19.58	23.50
Discovery 3			
Protective Cap - Tow bar socket			
All models			
Genuine	KNG500013	3.89	4.67
Discovery 4			
Protective Cap - Tow bar socket			
All models			
Genuine	KNG500013	3.89	4.67
Discovery Sport			
Draw Bar			
All 5 seat models (Canada, Mexico & USA spec) (Includes integral tow ball)			
Genuine	VPLCT0160	187.22	224.66
All 7 seat models (Canada, Mexico & USA spec) (Includes integral tow ball)			
Genuine	VPLCT0161	187.22	224.66
All 5 seat models (Australia spec) (Includes integral tow ball)			
Genuine	VPLCT0162	178.45	214.14
All 7 seat models (Australia spec) (Includes integral tow ball)			
Genuine	VPLCT0163	178.45	214.14
Range Rover L322			
Multi Height Tow Ball Assy			
All models (except Canada, Mexico & USA) (Includes carry bag)			
Aftermarket	VUB000720BP	250.00	300.00
Quick Release Tow Ball Assy			
All models (except Canada, Mexico & USA)			
Aftermarket	VUB000730BP	265.00	318.00
Range Rover Sport			
Protective Cap - Tow bar socket			
All models to (VIN) DA999999			
Genuine	KNG500013	3.89	4.67

TOWING ANCILLARY PARTS

**Trailer Socket
12N 7 Pin
Plastic**



STC4286P
PRICE EX VAT (OUTSIDE EU) **£2.08** PRICE INC VAT (UK @ 20%) **£2.50**

**Trailer Socket
12N 7 Pin
Aluminium**



STC4286BMALI
PRICE EX VAT (OUTSIDE EU) **£4.08** PRICE INC VAT (UK @ 20%) **£4.90**

**Single
Socket
Mounting Plate**



LL1668 Suitable for both 12N 7 pin & 13 pin sockets
PRICE EX VAT (OUTSIDE EU) **£2.00** PRICE INC VAT (UK @ 20%) **£2.40**

**12N 7 Pin
Plastic Plug**



579408PN
PRICE EX VAT (OUTSIDE EU) **£2.83** PRICE INC VAT (UK @ 20%) **£3.40**

**12N 7 Pin
Aluminium
Plug**



579408PNALI
PRICE EX VAT (OUTSIDE EU) **£3.33** PRICE INC VAT (UK @ 20%) **£4.00**

**12S 7 Pin
Plastic Plug**



579408PS
PRICE EX VAT (OUTSIDE EU) **£4.00** PRICE INC VAT (UK @ 20%) **£4.80**

**Pre-Wired 12N Socket Assembly
7 Pin with 2 Metres of 12N Cable
& Mounted on a Mounting Plate
(No fog cut-out)**



LL1667
PRICE EX VAT (OUTSIDE EU) **£8.96** PRICE INC VAT (UK @ 20%) **£10.75**

**Pre-Wired 12N 8 Core Socket
Assembly with Audible Relay & Fog
Cut-Out
7 Pin with 2 Metres of 12N Cable
& Mounted on a Mounting
Plate**



RTC3834AP
PRICE EX VAT (OUTSIDE EU) **£19.50** PRICE INC VAT (UK @ 20%) **£23.40**

**Angled Socket
Mounting Plate
Freelander 2**



VPLFT0017
PRICE EX VAT (OUTSIDE EU) **£87.55** PRICE INC VAT (UK @ 20%) **£105.06**

**1 x Pair Amber Reflectors
E Approved**

51mm H
x 106mm W
x 8mm D

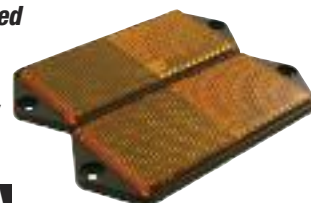

LL1672A
PRICE EX VAT (OUTSIDE EU) **£3.00** PRICE INC VAT (UK @ 20%) **£3.60**

**1 x Pair Red
Reflectors
E Approved**

51mm H
x 106mm W
x 8mm D



LL1672R
PRICE EX VAT (OUTSIDE EU) **£3.00** PRICE INC VAT (UK @ 20%) **£3.60**

**Trailer Board
122cm (48") wide
Complete with 4 Metres of Cable.**



RX1513 PRICE EX VAT (OUTSIDE EU) **£16.50** PRICE INC VAT (UK @ 20%) **£19.80**

ORDER BY PHONE: 01522 568000 / ON LINE: www.rimmerbros.co.uk / E-MAIL: lrsales@rimmerbros.co.uk

*Prices include UK VAT @ 20%.

TOWING ELECTRICS

Defender

Description	Part Number	Price Ex VAT	Price Inc VAT*
Defender Towing Electrics Kit			
13 Pin			
Defender 90 from (VIN) 1A000001 Genuine	YWJ500040	117.88	141.46
Defender 110 from (VIN) 1A000001 Genuine	YWJ500050	117.88	141.46
Defender 130 from (VIN) 1A000001 Genuine	YWJ500060	117.88	141.46
All models from (VIN) 7A000001 on			
Aftermarket	LR005919BP	105.00	126.00
Genuine	LR005919	117.19	140.63
N Type			
All TD5 models			
Aftermarket	YWJ101500P	45.83	55.00
Genuine	YWJ101500	78.01	93.61
All models from (VIN) 7A000001 on			
Aftermarket	LR005920BP	45.83	55.00
Genuine	LR005920	78.87	94.64
S Type, front			
All models from (VIN) 7A000001 on			
Aftermarket	LR005921BP	79.50	95.40
Genuine	LR005921	88.77	106.52



YWJ500050



LR005919BP



LR005920BP



YWJ500201P

Discovery

Description	Part Number	Price Ex VAT	Price Inc VAT*
Discovery 1			
Towing Electrics Kit - 7 Pin			
All models	Genuine	YWJ500110	224.48 269.38
Discovery 2			
Towing Electrics Kit - 7 Pin			
All models	Genuine	YWJ500120	224.48 269.38
Towing Socket, Split Charge			
S Type, post 99 caravan - All models			
	Aftermarket	STC50389BP	83.33 100.00
	Genuine	STC50389	93.94 112.73
Towing Socket - N Type			
All models	Aftermarket	STC50081BP	37.08 44.50
Discovery 3			
Towing Electrics Kit			
N & S Type - All Great Britain & Ireland models			
	Aftermarket	YWJ500201P	83.33 100.00
	Genuine	YWJ500201	174.56 209.47
13 Pin			
All European models	Genuine	YWJ500211	187.13 224.56
Canada, Mexico & USA models			
	Genuine	YWJ500220	149.66 179.59
Discovery 4			
Towing Electrics Kit			
7 Pin 12N & 12S			
All models to (VIN) DA999999			
	Genuine	VPLAT0011	131.06 157.27
All models from (VIN) EA000001			
	Genuine	VPLAT0135	117.95 141.54
13 Pin			
All models to (VIN) DA999999			
	Genuine	VPLAT0012	101.93 122.32
All models from (VIN) EA000001			
	Genuine	VPLAT0136	145.61 174.73
Canada, Mexico & USA models			
to (VIN) DA999999	Genuine	VPLAT0013	101.93 122.32
from (VIN) EA000001	Genuine	VPLAT0137	131.06 157.27
Towing Socket Harness			
7 Pin 12N - All models to (VIN) DA999999			
(except Canada, Mexico & USA)			
	Genuine	LR011190	47.02 56.42
7 Pin 12S - All models to (VIN) DA999999			
(except Canada, Mexico & USA)			
	Genuine	LR011192	29.13 34.96
13 Pin - All models to (VIN) DA999999			
(except Canada, Mexico & USA)			
	Genuine	LR011211	69.69 83.63
All New Discovery			
Towing Socket Adaptor			
7 Pin 12N & 12S			
All models	Genuine	VPLHT0060	79.10 94.92
Discovery Sport			
Towing Electrics Kit			
13 Pin - All 7 seat models			
without spare wheel (except Canada, Mexico, USA & Australia)			
	Genuine	VPLCT0182	109.21 131.05
without spare wheel & all 5 seat models (Canada, Mexico & USA only)			
	Genuine	VPLCT0183	111.67 134.00
without spare wheel & all 5 seat models (Australia only)			
	Genuine	VPLCT0184	111.67 134.00
with spare wheel (except Canada, Mexico, USA & Australia)			
	Genuine	VPLCT0185	80.78 96.94
with spare wheel (Canada, Mexico & USA only)			
	Genuine	VPLCT0186	85.09 102.11
with spare wheel (Australia only)			
	Genuine	VPLCT0187	85.09 102.11

Range Rover

Description	Part Number	Price Ex VAT	Price Inc VAT*
Range Rover L322			
Towing Electrics Kit			
13 Pin - All models up to (VIN) 5A999999 includes control unit module	Aftermarket VUH000020BP	148.33	178.00
excludes control unit module	Genuine VUH000020	112.68	135.22
7 Pin 12N & 12S - All models from (VIN) 6A000001 to (VIN) 9A999999 (except Canada, Mexico & USA)	Genuine YWJ500450	137.99	165.59
13 Pin - All models from (VIN) 6A000001 to (VIN) 9A999999 (except Canada, Mexico & USA)	Aftermarket YWJ500460BP	125.00	150.00
	Genuine YWJ500460	137.99	165.59
4 Pin - All models from (VIN) 5A000001 to (VIN) 9A999999 (Canada, Mexico, USA only)	Genuine YWJ500012	152.55	183.06
Combined 7 Pin & 4 Pin - All models from (VIN) 5A000001 to (VIN) 9A999999 (Canada, Mexico, USA only)	Genuine YWJ500480	222.56	267.07
Towing Control Unit Module -			
All models	Aftermarket YWC000840BP	60.83	73.00
	Genuine YWC000840	71.86	86.23

Range Rover L405

Towing Electrics Kit - 13 Pin - All models (except Canada, Mexico & USA)			
	Genuine VPLGT0073	115.80	138.96

Range Rover Sport

Towing Electrics Kit			
7 Pin 12N & 12S - All models from (VIN) 5A000001 to (VIN) 9A999999	Aftermarket YWJ500150P	80.83	97.00
	Genuine YWJ500150	98.87	118.64
13 Pin - All models from (VIN) 5A000001 to (VIN) 9A999999	Aftermarket YWJ500160BP	78.50	94.20
	Genuine YWJ500160	168.92	202.70
Combined 7 Pin & 4 Pin - All models from (VIN) 5A000001 to (VIN) 9A999999 (Canada, Mexico & USA models)	Genuine YWJ500170	182.21	218.65
13 Pin			
All models from (VIN) DA000001 on (L494)	OEM VPLWT0114P1	68.33	82.00
	Genuine VPLWT0114	115.80	138.96
All models from (VIN) DA000001 on (L494) (Canada, Mexico & USA models)	Genuine VPLWT0115	115.80	138.96
All models from (VIN) DA000001 on (L494) (Australia models)	Genuine VPLWT0116	119.61	143.53

Towing Socket Harness

7 Pin 12N - All models from (VIN) AA000001 to (VIN) DA999999 (except Canada, Mexico & USA)	Genuine LR011190	47.02	56.42
7 Pin 12S - All models from (VIN) AA000001 to (VIN) DA999999 (except Canada, Mexico & USA)	Genuine LR011192	29.13	34.96
13 Pin - All models from (VIN) AA000001 to (VIN) DA999999 (except Canada, Mexico & USA)	Genuine LR011211	69.69	83.63

Range Rover Evoque

Towing Electrics Kit - 13 Pin			
All models (except Canada, Mexico, USA & Australia)	Genuine VPLHT0061	145.61	174.73
All models (Canada, Mexico & USA)	Genuine VPLHT0062	145.61	174.73
All models (Australia)	Genuine VPLHT0063	101.93	122.32
Towing Socket Adaptor - 7 Pin 12N & 12S			
All models	Genuine VPLHT0060	79.10	94.92



YMZ101030BP

Freelander

Description	Part Number	Price Ex VAT	Price Inc VAT*
Freelander 1			
Towing Electrics Kit			
7 Pin 12N - All models	Aftermarket YMZ101030BP	17.08	20.50
	Genuine YMZ101030	30.77	36.92
13 Pin - All models	Genuine YWJ500070	112.68	135.22
12S caravan auxiliary electrics			
All models	Aftermarket STC50460BP	75.83	91.00
	Genuine STC50460	81.13	97.36

Freelander 2

Towing Electrics Kit			
7 Pin 12N & 12S			
All models up to (VIN) CH999999	Aftermarket VPLFT0001BP	133.33	160.00
	Genuine VPLFT0001	148.54	178.25
All models from (VIN) DH000001 on	OEM VPLFT0105P1	85.83	103.00
	Genuine VPLFT0105	98.19	117.83
13 Pin			
All models from (VIN) CH000001 to (VIN) CH999999	Aftermarket VPLFT0077BP	130.83	157.00
	Genuine VPLFT0077	146.77	176.12
All models from (VIN) DH000001 on	Genuine VPLFT0106	98.19	117.83
All models from (VIN) 9H000001 to (VIN) CH999999 (Canada, Mexico & USA only)	Genuine VPLFT0003	167.81	201.37
All models from (VIN) DH000001 on (Canada, Mexico & USA only)	Genuine VPLFT0107	138.68	166.42



LR011190

? **WE'RE HERE TO HELP**
 Can't find or not sure of the right part for your car, contact our technical sales team for help and advice.
01522 568000



VPLAT0012

LED HEADLAMP CONVERSION KITS (All models where fitted)

7" LED Headlamp Conversion Kit

- High & Low Beam including Position Light
- Clear Lens
- 25w Main, 28w Dip & 1.5w Position Light
- H4 Connector Included
- Long Life & Low Power
- 12 & 24 Volt
- E Marked
- 100 Metre Forward Vision
- 178mm x 175mm x 113mm



RHD LED Headlamp Conversion Kit (pair)

RB7129LE PRICE EX VAT (OUTSIDE EU) **£265.00** PRICE INC VAT (UK @ 20%) **£318.00**

LHD LED Headlamp Conversion Kit (pair)

RB7082LE PRICE EX VAT (OUTSIDE EU) **£279.17** PRICE INC VAT (UK @ 20%) **£335.00**

ECE 7" LED Headlamp Conversion Kit

- ECE & ROHs Compliant
- Up to 50x Longer Life than Halogen Headlamps
- Produces Pure White Light
- Includes Built in Position Lamp
- H4 Connector System
- 12 & 24 Volt



RHD ECE LED Headlamp Conversion Kit (pair)

RB7129BPLED PRICE EX VAT (OUTSIDE EU) **£370.83** PRICE INC VAT (UK @ 20%) **£445.00**

LHD ECE LED Headlamp Conversion Kit (pair)

RB7082BPLED PRICE EX VAT (OUTSIDE EU) **£379.17** PRICE INC VAT (UK @ 20%) **£455.00**

Xenon Ultima 7" Headlamp Conversion Kit

- 2 x Xenon H4 Ultima Lamps from Ring
- 120% More Light on the Road than Halogen Bulbs
- 2 x Ice Blue Sidelight Bulbs
- 2 x 7" Headlamp Aluminium Housings with Glass Lens
- E Marked



RHD Xenon Ultima Headlamp Conversion Kit (pair)

RB7129X PRICE EX VAT (OUTSIDE EU) **£60.42** PRICE INC VAT (UK @ 20%) **£72.50**

LHD Xenon Ultima Headlamp Conversion Kit (pair)

RB7082X PRICE EX VAT (OUTSIDE EU) **£75.83** PRICE INC VAT (UK @ 20%) **£91.00**

7" Headlamp Conversion Kit with LED Halo

- RHD only
- Non E Marked



Headlamp Conversion Kit with LED Halo (pair)

RB7129BMHC PRICE EX VAT (OUTSIDE EU) **£35.50** PRICE INC VAT (UK @ 20%) **£42.60**

Defender

WIPAC 73mm Light Kits

- E Marked and SAE Approved - Road Legal in Europe and America
- Waterproof to IP67
- AMP style connectors fitted - plug and play, fit and forget
- Stainless steel screws - rust resistant
- Multi-voltage 9-33W
- Wipac LED flasher unit included

Contents

- 2 x front sidelights
- 2 x front indicators
- 2 x rear indicators
- 2 x stop & tail
- 1 x LED flasher unit



Wipac Clear LED 73mm Lamp Kit

LL1780DELUXE
 PRICE EX VAT (OUTSIDE EU) £100.00 PRICE INC VAT (UK @ 20%) £120.00



Wipac Colour LED 73mm Lamp Kit

LL1781DELUXE PRICE EX VAT (OUTSIDE EU) £100.00 PRICE INC VAT (UK @ 20%) £120.00

Aftermarket 73mm Lamp Kits



Aftermarket Clear LED 73mm Lamp Kit

LL1780BM PRICE EX VAT (OUTSIDE EU) £95.75 PRICE INC VAT (UK @ 20%) £114.90

Aftermarket Coloured LED 73mm Lamp Kit

LL1781BM PRICE EX VAT (OUTSIDE EU) £120.00 PRICE INC VAT (UK @ 20%) £144.00

INDIVIDUAL 73mm LED LAMPS

- E Marked
- Waterproof



Indicator Lamp Amber

LR048188PLED
 PRICE EX VAT (OUTSIDE EU) £12.71 PRICE INC VAT (UK @ 20%) £15.25

Indicator Lamp Clear

LR047798PLED
 PRICE EX VAT (OUTSIDE EU) £12.71 PRICE INC VAT (UK @ 20%) £15.25

Side Lamp Clear

LR048189LED
 PRICE EX VAT (OUTSIDE EU) £12.71 PRICE INC VAT (UK @ 20%) £15.25

Stop/Tail Lamp Red

LR048200LED
 PRICE EX VAT (OUTSIDE EU) £12.71 PRICE INC VAT (UK @ 20%) £15.25

Stop/Tail Lamp Clear

LR048200LEDCL
 PRICE EX VAT (OUTSIDE EU) £12.71 PRICE INC VAT (UK @ 20%) £15.25

NAS SPEC 95mm LED LAMPS

- E Marked
- IP67 Waterproof



Stop/Tail Lamp Clear

AMR6526LEDCLR
 PRICE EX VAT (OUTSIDE EU) £16.67 PRICE INC VAT (UK @ 20%) £20.00

Indicator Lamp Amber

AMR6527LED
 PRICE EX VAT (OUTSIDE EU) £16.67 PRICE INC VAT (UK @ 20%) £20.00

Stop/Tail/Indicator Lamp Clear

RX1866
 PRICE EX VAT (OUTSIDE EU) £16.67 PRICE INC VAT (UK @ 20%) £20.00

Indicator Lamp Clear

AMR6527LEDCLR
 PRICE EX VAT (OUTSIDE EU) £16.67 PRICE INC VAT (UK @ 20%) £20.00

Reversing Lamp Clear

LR048202LED
 PRICE EX VAT (OUTSIDE EU) £16.67 PRICE INC VAT (UK @ 20%) £20.00

Side Lamp Clear

RX1865
 PRICE EX VAT (OUTSIDE EU) £16.67 PRICE INC VAT (UK @ 20%) £20.00

Rear Fog Lamp Red

LR048201LED
 PRICE EX VAT (OUTSIDE EU) £16.67 PRICE INC VAT (UK @ 20%) £20.00

Stop/Tail Lamp Red

AMR6526LED
 PRICE EX VAT (OUTSIDE EU) £16.67 PRICE INC VAT (UK @ 20%) £20.00

Rear Fog Lamp Clear

LR048201LEDCL
 PRICE EX VAT (OUTSIDE EU) £16.67 PRICE INC VAT (UK @ 20%) £20.00

MOUNTING PLINTH

NAS Spec Mounting Plinth (each)

AMR3850P1
 PRICE EX VAT (OUTSIDE EU) £2.08 PRICE INC VAT (UK @ 20%) £2.50



SMART LOAD DEVICE

12 Volt

LL157612
 PRICE EX VAT (OUTSIDE EU) £14.37 PRICE INC VAT (UK @ 20%) £17.24

24 Volt

LL157624
 PRICE EX VAT (OUTSIDE EU) £14.37 PRICE INC VAT (UK @ 20%) £17.24

FLASHER UNIT FOR LED LAMPS

PRC8876PLED
 PRICE EX VAT (OUTSIDE EU) £8.12 PRICE INC VAT (UK @ 20%) £9.74



DRIVING LAMPS

HALO LED Driving Lamps

- 55watt
- E Marked
- Stainless Steel
- Available in 6" or 8" Dia

High Quality Aftermarket Lamps
from OEM Suppliers



WIPAC 8" Driving Lamps

- Complete with Grille
- Black Body
- 100w Bulbs

Superb Lamp for Off-Road!

8" Round Driving Lamps (pair)
RX1512 PRICE EX VAT (OUTSIDE EU) **£54.58** PRICE INC VAT (UK @ 20%) **£65.50**



Product Dimensions:
160mm diameter,
75mm depth

6" Dia

6" Round Driving Lamps (pair)

RX1869 PRICE EX VAT (OUTSIDE EU) **£47.92** PRICE INC VAT (UK @ 20%) **£57.50**

Replacement Grille for RX1512



RX1512GRILLE
PRICE EX VAT (OUTSIDE EU) **£7.08** PRICE INC VAT (UK @ 20%) **£8.50**

WIPAC Driving Lamps



Rectangular Driving Lamps (pair)
PRC8238P PRICE EX VAT (OUTSIDE EU) **£27.92** PRICE INC VAT (UK @ 20%) **£33.50**



Product Dimensions:
210mm diameter, 89mm depth

8" Dia

8" Round Driving Lamps (pair)

RX1870 PRICE EX VAT (OUTSIDE EU) **£58.33** PRICE INC VAT (UK @ 20%) **£70.00**

LED Driving Lamp

- Aluminium Housing
- Black Powder Coated
- 15 Hi-Power LEDs for Driving Beam
- 6 LEDs for Front Position



Product Dimensions:
198mm diameter, 132mm depth



LED Driving Lamp (each)

RX1871 PRICE EX VAT (OUTSIDE EU) **£110.83** PRICE INC VAT (UK @ 20%) **£133.00**

5" Round Driving Lamps (pair) Chrome

RX1556 PRICE EX VAT (OUTSIDE EU) **£39.95** PRICE INC VAT (UK @ 20%) **£47.94**

5" Round Driving Lamps (pair) Stainless Steel

RX1556SS PRICE EX VAT (OUTSIDE EU) **£49.95** PRICE INC VAT (UK @ 20%) **£59.94**



WIPAC 5" Driving Lamps

- Classic Style
- Available in Chrome or Stainless Steel

RING Roadrunner 6" Driving Lamps

- E Marked
- Mounts above or below the Bumper
- Stone Guards included

6" Round Driving Lamps (pair)

RX15565-5 PRICE EX VAT (OUTSIDE EU) **£19.58** PRICE INC VAT (UK @ 20%) **£23.50**

RING Sportsline 7" Driving Lamps

- Multi Function Bracket for Maximum Fitting Flexibility
- Lamp Covers included



7" Round Driving Lamps (pair)

RX1512-180 PRICE EX VAT (OUTSIDE EU) **£41.63** PRICE INC VAT (UK @ 20%) **£49.96**



All Models

Auxiliary Driving Lamps

- E Marked
- Clear Lens
- Long Range Beam

Auxiliary Driving Lamps

RX1880 PRICE EX VAT (OUTSIDE EU) **£32.92** PRICE INC VAT (UK @ 20%) **£39.50** Product Dimensions: 71mm x 58mm x 100mm

Lucas Square 8 Driving Lamps

- The Original Classic Lamp
- Chrome with Black Lens Cover & Strap
- E Marked



Square 8 Driving Lamps (pair)

RX1701 PRICE EX VAT (OUTSIDE EU) **£84.95** PRICE INC VAT (UK @ 20%) **£101.94** Product Dimensions: 180mm x 105mm x 60mm

Britpart Round Driving Lamps

BRITPART



- 100w Bulbs
- Complete with Stone Guards

8" Round Driving Lamps (pair)

RX1512BP PRICE EX VAT (OUTSIDE EU) **£33.33** PRICE INC VAT (UK @ 20%) **£40.00**

Replacement Cover for above

RX1512GRILLEBP PRICE EX VAT (OUTSIDE EU) **£2.83** PRICE INC VAT (UK @ 20%) **£3.40**

HELLA Rallye 1000 Long Range Driving Lamps

- Black Body



1000 Round Driving Lamps (each)

STC7644BP PRICE EX VAT (OUTSIDE EU) **£70.83** PRICE INC VAT (UK @ 20%) **£85.00**

Solid Guard for above

STC7643BPGSOLID PRICE EX VAT (OUTSIDE EU) **£9.37** PRICE INC VAT (UK @ 20%) **£11.24**



Discovery 3 Driving Lamps

These Britpart lamps have been produced for above the bumper fit to Discovery 3's. Includes electrics (pair).

XQB500080BP PRICE EX VAT (OUTSIDE EU) **£199.00** PRICE INC VAT (UK @ 20%) **£238.80**

Pro-Comp 6" Round Driving Lamps

Specially fluted lens delivers long range brightness.



Stainless Steel
130w Bulb

Black
100w Bulb

Stainless Steel 130w Bulb Driving Lamp (each)

RX1556BM130 PRICE EX VAT (OUTSIDE EU) **£39.58** PRICE INC VAT (UK @ 20%) **£47.50**

Black 100w Bulb Driving Lamp (each)

RX1556BM100 PRICE EX VAT (OUTSIDE EU) **£32.08** PRICE INC VAT (UK @ 20%) **£38.50**

Safari 5000 Driving Lamp

Safari 5000 Driving Lamp (each)

STC8480 PRICE EX VAT (OUTSIDE EU) **£120.47** PRICE INC VAT (UK @ 20%) **£144.56**



GENUINE
LAND ROVER

Replacement Lens (each)

STC8811 PRICE EX VAT (OUTSIDE EU) **£49.40** PRICE INC VAT (UK @ 20%) **£59.28**

Don't Forget

Accessory Lighting Wiring Kit

Provides all you need to fit a pair of lamps quickly and effectively. Includes 30amp relay, in-line fuse, wiring, switch & bracket.

Lighting Wiring Kit

RX1512WK PRICE EX VAT (OUTSIDE EU) **£12.71** PRICE INC VAT (UK @ 20%) **£15.25**

Lamp Steady Bars (pair)

For Hella Rallye 1000 & Safari 5000 Lamps.



Lamp Steady Bars (pair)

STC8814 PRICE EX VAT (OUTSIDE EU) **£33.80** PRICE INC VAT (UK @ 20%) **£40.56**

ORDER

BY PHONE: 01522 568000 / ON LINE: www.rimmerbros.co.uk / E-MAIL: lrsales@rimmerbros.co.uk

*Prices include UK VAT @ 20%.

DAY RUNNING LIGHTS

LED Day Running Lights

- 12 volt
- 6 x Mini LED
- Includes Mounting Plate



LED Day Running Lights (pair)

RX1867 PRICE EX VAT (OUTSIDE EU) **£19.58** PRICE INC VAT (UK @ 20%) **£23.50**

Product Dimensions: 60mm x 10mm x 10mm

LED Day Running Lights

- 12/24 volt
- E Marked
- 23 x Mini LED
- Slim design, simple installation & adj brackets



LED Day Running Lights (pair)

RX1868 PRICE EX VAT (OUTSIDE EU) **£49.58** PRICE INC VAT (UK @ 20%) **£59.50**

Product Dimensions: 203mm x 30mm x 23mm

SIDE REPEATER LAMPS

Side Repeater Lamp

- Smoke



Side Repeater Lamp (each)

LR007954SMOKE PRICE EX VAT (OUTSIDE EU) **£13.54** PRICE INC VAT (UK @ 20%) **£16.25**

Side Repeater Lamps Conversion Kit

- Clear or Smoke



Clear Side Repeater Lamps Conversion Kit (pair)

RD1378CLEAR PRICE EX VAT (OUTSIDE EU) **£25.42** PRICE INC VAT (UK @ 20%) **£30.50**

Smoke Side Repeater Lamps Conversion Kit (pair)

RD1378SMOKE PRICE EX VAT (OUTSIDE EU) **£22.50** PRICE INC VAT (UK @ 20%) **£27.00**

Side Repeater Lamp Kit

- Clear



Side Repeater Lamp Kit (pair)

XGB000012CLEAR PRICE EX VAT (OUTSIDE EU) **£32.92** PRICE INC VAT (UK @ 20%) **£39.50**

NUMBER PLATE LAMPS



LED Number Plate Lamp (each)

XFC100550LEDP1 PRICE EX VAT (OUTSIDE EU) **£8.75** PRICE INC VAT (UK @ 20%) **£10.50**

Number Plate Lamp (each)

XFC100550CHR PRICE EX VAT (OUTSIDE EU) **£24.58** PRICE INC VAT (UK @ 20%) **£29.50**

FOG LAMPS

RING Roadrunner Fog Lamps

- E Marked
- Mounts above or below the Bumper
- Stone Guards included



Ring Roadrunner Fog Lights (pair)

RX1370 PRICE EX VAT (OUTSIDE EU) **£24.48** PRICE INC VAT (UK @ 20%) **£29.38**

Product Dimensions: 183mm x 94mm x 97mm



Lucas Square 8 Fog Lamps

- E Marked
- Chrome with Black Lens Cover & Strap

The Original Classic Lamp

Lucas Square 8 Fog Lights (pair)

RX1700 PRICE EX VAT (OUTSIDE EU) **£79.17** PRICE INC VAT (UK @ 20%) **£95.00**

Product Dimensions: 180mm x 105mm x 60mm

Genuine Land Rover Replacement Fog Lamp Unit

Fits Discovery 4 & Freelander 2



GENUINE LAND ROVER

Genuine Fog Lamp Unit (each)

LR057400 PRICE EX VAT (OUTSIDE EU) **£61.11** PRICE INC VAT (UK @ 20%) **£73.33**

Also available as Aftermarket or OEM item

Aftermarket Fog Lamp Unit (each)

LR057400P PRICE EX VAT (OUTSIDE EU) **£33.33** PRICE INC VAT (UK @ 20%) **£40.00**

OEM Fog Lamp Unit (each)

LR057400P1 PRICE EX VAT (OUTSIDE EU) **£36.00** PRICE INC VAT (UK @ 20%) **£43.20**



Rear Fog Lamp

Rear Fog Light (each)

RB7092 PRICE EX VAT (OUTSIDE EU) **£13.36** PRICE INC VAT (UK @ 20%) **£16.03**

LIGHTING - DAY RUNNING LIGHTS, FOG LAMPS & NUMBER PLATE LAMPS

7" LAMP UPGRADE KITS

Crystal Clear Lens

- E Marked
- Includes H4 Bulbs
- RHD or LHD

RHD Crystal Clear Lens (pair)

RB7129CB PRICE EX VAT (OUTSIDE EU) £40.00 PRICE INC VAT (UK @ 20%) £48.00

LHD Crystal Clear Lens (pair)

RB7082CA PRICE EX VAT (OUTSIDE EU) £40.00 PRICE INC VAT (UK @ 20%) £48.00



Halogen Conversion Set

- E Marked
- RHD only

Halogen Conversion Kit (pair)

RB7129H PRICE EX VAT (OUTSIDE EU) £20.00 PRICE INC VAT (UK @ 20%) £24.00



Halogen Conversion Set

- Non E Marked
- RHD or LHD

RHD Halogen Conversion Kit (pair)

RB7129BP PRICE EX VAT (OUTSIDE EU) £19.58 PRICE INC VAT (UK @ 20%) £23.50

LHD Halogen Conversion Kit (pair)

RB7082BP PRICE EX VAT (OUTSIDE EU) £27.08 PRICE INC VAT (UK @ 20%) £32.50



Crystal Light Conversion Set

- Non E Marked
- RHD only

Crystal Conversion Kit (pair)

RB7129BMC PRICE EX VAT (OUTSIDE EU) £29.50 PRICE INC VAT (UK @ 20%) £35.40



The Original Quadoptic Conversion Sets

- Metal Reflectors
- Includes Sidelight
- E Marked

RHD Quadoptic Conversion Kit (pair)

RB7129PILOT PRICE EX VAT (OUTSIDE EU) £39.50 PRICE INC VAT (UK @ 20%) £47.40

LHD Quadoptic Conversion Kit (pair)

RB7082PILOT PRICE EX VAT (OUTSIDE EU) £45.00 PRICE INC VAT (UK @ 20%) £54.00



As above except...

- Without Sidelights

RHD Quadoptic Conversion Kit (pair)

RB7129 PRICE EX VAT (OUTSIDE EU) £40.83 PRICE INC VAT (UK @ 20%) £49.00

LHD Quadoptic Conversion Kit (pair)

RB7082 PRICE EX VAT (OUTSIDE EU) £45.00 PRICE INC VAT (UK @ 20%) £54.00



INDICATOR LENS

Give your vehicle a more up-to-date appearance with these clear indicator lenses. Coupled with orange bulbs (included) these kits directly replace the existing orange lens & satisfy all legal requirements.

Front Indicator



Discovery 1 - 300Tdi from (VIN) MA081992 on

RH Front Indicator (each)

XBD100760WBM PRICE EX VAT (OUTSIDE EU) £20.62 PRICE INC VAT (UK @ 20%) £24.74

LH Front Indicator (each)

XBD100770WBM PRICE EX VAT (OUTSIDE EU) £12.75 PRICE INC VAT (UK @ 20%) £15.30



Discovery 1 - All 200Tdi models

RH Front Indicator (each)

PRC9306WBM PRICE EX VAT (OUTSIDE EU) £12.92 PRICE INC VAT (UK @ 20%) £15.50

LH Front Indicator (each)

PRC9307WBM PRICE EX VAT (OUTSIDE EU) £12.92 PRICE INC VAT (UK @ 20%) £15.50

Rear Indicator

Discovery 1 - 300Tdi from (VIN) MA081992 on

RH Rear Indicator (each)

AMR6510WBM PRICE EX VAT (OUTSIDE EU) £11.87 PRICE INC VAT (UK @ 20%) £14.24

LH Rear Indicator (each)

AMR6509WBM PRICE EX VAT (OUTSIDE EU) £11.87 PRICE INC VAT (UK @ 20%) £14.24



PUDDLE LAMP KIT

LED Logo Puddle Lamp Kit

LED puddle lamps, with Land Rover logo embedded in the beam, ideal for adding that personal touch to your Land Rover vehicle. The lamps are designed to operate when you open the door of your vehicle to illuminate the floor below. These lamps may also be installed internally to illuminate the interior footwell of the vehicle. Flush fitting, for discreet installation.

Kit includes two puddle lamps with wiring, plus core cutter to make mounting holes.

Puddle Lamp Kit with LED logo

RX1267 PRICE EX VAT (OUTSIDE EU) £53.33 PRICE INC VAT (UK @ 20%) £64.00



LIGHTING - LAMP UPGRADE KITS, INDICATOR LENS & PUDDLE LAMP KIT

BULBS

Performance Upgrade Bulbs



xenon130

Puts up to 130%* more light on the road

- Improve night vision with up to 130% more light on the road for a safer & more comfortable journey
- Maximum performance is achieved through micro filament technology & 100% xenon gas
- See & be seen more clearly with up to a 60 metre longer beam than a standard bulb
- Better visibility of road markings & signs is produced through a whiter light that is closer to daylight
- A stylish finish is achieved through the silver tip
- Plug and go – no changes to vehicle wiring required

Standard H7 Beam



Xenon 130 Beam



+130%

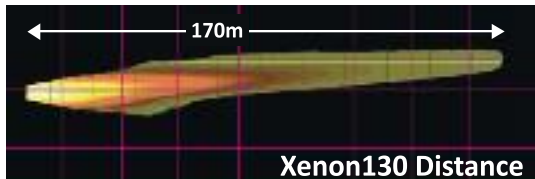

+60m

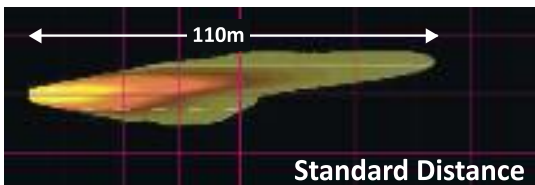

*Compared to a standard halogen bulb

Part Number	Voltage	Wattage	ECE	Cap	Kelvin	Upgrades
RX1950	12v	55w	H1	P14.5s	3700k	448
RX1951	12v	60/55w	H4	P43t	3700k	472
RX1952	12v	55w	H7	Px26d	3700k	477



LIGHT MOUNTING BARS

Roof Light Mounting Bar

Defender



- Rugged Looks & Finished in Satin Black Powder Coat
- 2" Section Tubing with Laser Cut Mounting Plates
- Four mounting Plates are Welded to the Bar to fix most popular makes of Driving Lamps Securely

LL1575 PRICE EX VAT (OUTSIDE EU) £40.83 PRICE INC VAT (UK @ 20%) £49.00

Spot Light Mounting Bar

Defender



Suits Winch Bumpers



LL1735TFAC PRICE EX VAT (OUTSIDE EU) £61.50 PRICE INC VAT (UK @ 20%) £73.80

Roof Light Mounting Bar

Defender

- No Drilling Required
- Clamps on to Gutter Rail
- Powder Coated Textured Black



Four light mounting tabs & pre-drilled holes to feed cable inside bar - much better than untidy cable and cable ties!



LL1887 PRICE EX VAT (OUTSIDE EU) £82.50 PRICE INC VAT (UK @ 20%) £99.00



Spot Light Mounting Bar

Discovery 1



- Suitable for the early Discovery 1 models
- Made from UK Steel
- Powder Coated Matt Black



STC50243P PRICE EX VAT (OUTSIDE EU) £43.75 PRICE INC VAT (UK @ 20%) £52.50

ORDER

BY PHONE: 01522 568000 / ON LINE: www.rimmerbros.co.uk / E-MAIL: lrsales@rimmerbros.co.uk

*Prices include UK VAT @ 20%.

LED WORK LAMPS

All lamps need to be hard wired unless stated.



- 9-32V
- Flood Beam
- IP68 Waterproof

Product Dimensions:
83mm diameter, 76mm depth

LED Round Flood Beam Work Lamp

RX1646 PRICE EX VAT (OUTSIDE EU) £42.95 PRICE INC VAT (UK @ 20%) £51.50



- 12-24V
- Polycarbonate Lens
- 1 to 4 pieces can be linked together

Product Dimensions:
52mm square, 61mm depth

Polycarbonate Lens Work Lamp

RX1873 PRICE EX VAT (OUTSIDE EU) £37.92 PRICE INC VAT (UK @ 20%) £45.50



- 2 x 3W LEDs
- Product Dimensions:
93mm wide, 66mm high,
49mm depth

2 x 3W LED Round Work Lamp

RX1876 PRICE EX VAT (OUTSIDE EU) £37.92 PRICE INC VAT (UK @ 20%) £45.50

- 9-56V
- Low current draw
- Polycarbonate Lens
- Polymer Housing
- IP66 Waterproof



- 4 x 3W LEDs
- Product Dimensions:
107mm diameter,
47mm depth

4 x 3W LED Round Work Lamp

RX1877 PRICE EX VAT (OUTSIDE EU) £39.58 PRICE INC VAT (UK @ 20%) £47.50

Medium flood beam pattern.
Tough and heat resistant hardened glass lens.
Stainless steel mounting bracket with bolt fixing.
3 year warranty.

Product Dimensions: H 150mm x W 120mm x D 84mm

LED Round Flood Beam Work Lamp

RX1263LED PRICE EX VAT (OUTSIDE EU) £52.08 PRICE INC VAT (UK @ 20%) £62.50



- 9-32V
- Flood Beam
- IP67 Waterproof

Product Dimensions:
110mm square, 51mm depth

LED Square Flood Beam Work Lamp

RX1878 PRICE EX VAT (OUTSIDE EU) £29.58 PRICE INC VAT (UK @ 20%) £35.50

High Quality LED Lighting from OEM Suppliers



- 12-78V
- 4 LEDs Round Work Lamp
- IP66 Waterproof
- Multi-voltage
- Extreme long life up to 50,000 hrs
- 800 lumens light output

LED Light Bars (Superb for light mounting bars)



- 6 LED Light Bar
- 9-32V 6x1W LED's, Waterproof

Product Dimensions: 135mm wide, 83mm high, 85mm depth.

6 LED Light Bar

RX1874 PRICE EX VAT (OUTSIDE EU) £39.58 PRICE INC VAT (UK @ 20%) £47.50

- 8 LED Light Bar
- 9-32V 8x1W LED's, Waterproof

Product Dimensions: 175mm wide, 83mm high, 85mm depth.

8 LED Light Bar

RX1783-175 PRICE EX VAT (OUTSIDE EU) £48.75 PRICE INC VAT (UK @ 20%) £58.50



- 14 LED Light Bar
- 9-32V 14x1W LED's
- Waterproof

Product Dimensions:
285mm wide, 83mm high, 85mm depth.

14 LED Light Bar

RX1875 PRICE EX VAT (OUTSIDE EU) £75.00 PRICE INC VAT (UK @ 20%) £90.00

LED Rechargeable & Portable Flood Light



- 12-24V LED Rechargeable & Portable Flood Light

Product Dimensions:
75mm x 95mm x 100mm.
LED luminous flux - 900.

- Charging time - 3-4hr.
- Working time - 4-5hr.

LED Flood Light (12/24 volt)

RX1872 PRICE EX VAT (OUTSIDE EU) £34.58 PRICE INC VAT (UK @ 20%) £41.50

HALOGEN WORK LAMPS

- 12-24V
- H3 Bulb
- With Handle, Switch & Grille

Product Dimensions:
137mm diameter, 97mm depth



- 12-24V
- Dual Voltage
- Round Switched Work Lamp
- H3 Bulb

Wide flood light output.
Polycarbonate lens - Clear.
Impact and heat resistant polypropylene housing.
Protected switch.
1 year warranty.

Product Dimensions: H 253mm x W 168mm x D 119mm

Round Work Lamp

RX1263R PRICE EX VAT (OUTSIDE EU) **£13.75** PRICE INC VAT (UK @ 20%) **£16.50**

Round Work Lamp

RX1879 PRICE EX VAT (OUTSIDE EU) **£15.00** PRICE INC VAT (UK @ 20%) **£18.00**



- 12-24V
- H3 Bulb
- With Handle, Switch & Grille

Wipac Round Work Lamp

RX1675 PRICE EX VAT (OUTSIDE EU) **£12.29** PRICE INC VAT (UK @ 20%) **£14.75**



- 12-24V
- H3 Bulb, Spot Beam

Product Dimensions:
130mm wide, 70mm high, 68mm deep.



Spot Beam Work Lamp

RX1678 PRICE EX VAT (OUTSIDE EU) **£14.58** PRICE INC VAT (UK @ 20%) **£17.50**

- 12-24V
- Dual Voltage
- Rectangular
- Switched Work Lamp
- H3 Bulb

Handle for repositioning lamp, can be rotated through 270° and angled through 90°.
Polycarbonate lens - Clear.
Impact and heat resistant polypropylene housing.
Heavy duty zinc plated bracket.
1 year warranty.



Rectangular Work Lamp

RX1263S PRICE EX VAT (OUTSIDE EU) **£13.75** PRICE INC VAT (UK @ 20%) **£16.50**

Tyre Pressure Monitor System



New generation system for cars and vans

TB99 is for cars and vans with a small dashboard mounted monitor that displays the pressure of four tyres up to 99psi simultaneously and can be set up to monitor the spare tyre as well.

- Neat system, reliable and very easy to install
- Clear visible and audible alerts
- User set alert levels for low pressure, high pressure and high temperature
- Automatic back light
- Rechargeable monitor battery

The TB99 monitor continuously displays the pressure of four tyres. If there is a fifth sensor, it alternately displays the four tyres and then the spare. Tyre temperatures are shown at the press of a button.

New generation sensors simply screw on to the tyre valves in place of the normal dust caps, and they have an integral anti-theft design. They are smaller and lighter than previous models and improved electronics give up to 2 year life from the replaceable CR1632 batteries

Box contents

- 1 Monitor
- 1 Charging lead
- 4 Locking screws
- 1 Pair sensor tools
- 1 Monitor mounting pad
- 4 Sensors with batteries fitted
- 2 Locking keys

Tyre Pressure Monitor

RX1595TP PRICE EX VAT (OUTSIDE EU) **£110.83** PRICE INC VAT (UK @ 20%) **£133.00**

Mirror Mounted Search Light

Defender (Vin) 7A000001 on

Includes switch, cables & brackets



Mirror Mounted Search Light

RTC8921AA PRICE EX VAT (OUTSIDE EU) **£96.22** PRICE INC VAT (UK @ 20%) **£115.46**

GENUINE LAND ROVER

AIR COMPRESSORS

Double Pump Air Compressor

- Air flow - 150ltr/min
- 12 volt / 50 amp



BRITPART

Single Pump Air Compressor

- Air flow - 72ltr/min
- 12 volt / 30 amp



Features for both air compressors:-

- Max. pressure - 150psi
- Automatic cut off to prevent overheating
- Integrated sand tray
- Blow moulded carrying case
- 10 metre air hose with heavy-duty gauge and brass fittings
- Also great for camping and outdoor use.



Great Features...



	Part Number	Price Ex VAT	Price Inc VAT*
Double Pump Air Compressor	RX1599DOUBLE	70.83	85.00
Single Pump Air Compressor	RX1599SINGLE	44.58	53.50
Replacement Cap and Filter (fits both models)	RX1599FILTER	3.33	4.00

Standard Air Compressor

- 12 volt (plugs into cigarette lighter)
- 300PSI
- Fitted with fused cigarette lighter plug
- 3 mtrs of cable
- Flexible air hose with tyre valve locking mechanism
- Includes 3 piece adaptor kit

RX1580 PRICE EX VAT (OUTSIDE EU) **£12.92** PRICE INC VAT (UK @ 20%) **£15.50**



Heavy Duty Air Compressor

- Ideal for 4x4 use
- Pressure gauge in PSI, kg/cm2, bar
- Fitted with fused cigarette lighter plug
- Flexible air hose with tyre locking mechanism
- Anti-vibration rubber feet to prevent excessive movement
- Includes handy storage case
- Carry handle

RX1580HD PRICE EX VAT (OUTSIDE EU) **£40.00** PRICE INC VAT (UK @ 20%) **£48.00**



Draper, Double Cylinder Footpump

- Pressure gauge is marked 0-100psi & 0-7 bar
- All metal design with robust 4mm thick steel base.
- Complete with special nozzle for air beds, footballs etc.



GAT347 PRICE EX VAT (OUTSIDE EU) **£14.37** PRICE INC VAT (UK @ 20%) **£17.24**

Draper, Digital Tyre Pressure Gauge



XPT000006ACAP PRICE EX VAT (OUTSIDE EU) **£10.42** PRICE INC VAT (UK @ 20%) **£12.50**

Draper Tyre Tread Depth Gauge



27298 PRICE EX VAT (OUTSIDE EU) **£4.08** PRICE INC VAT (UK @ 20%) **£4.90**

Temporary Tyre Repair Kit

For off-road /agricultural vehicles. Not to be used for permanent repair for road vehicles.

- Repair tools:
- 1 x T handle insert tool,
 - 1 x T handle rasp tool,
 - 1 x tyre pressure gauge 5-50lbs,
 - 2 dust caps

- Consumables included:
- 1 x tube Rubber Solution 20ml
 - Plus 15 x tyre plugs (10.16cm)

RX1971 PRICE EX VAT (OUTSIDE EU) **£16.90** PRICE INC VAT (UK @ 20%) **£20.28**



Jerry Cans



	Part Number	Price Ex VAT	Price Inc VAT*
JERRY CAN, 20 litre:			
green	LL1423	20.00	24.00
red	LL1423RED	20.00	24.00
stainless steel	LL1423SS	150.00	180.00
JERRY CAN HOLDER, holds 20 litre Jerry Can			
	LL1423HOLDER	19.58	23.50
JERRY CAN SPOUT:			
rigid, green	LL1423SPOUT	8.54	10.25
flexible, green	LL1423SPOUTFLEXI	7.08	8.50
semi flexible, green	LL1423SPOUTSFLEXI	10.62	12.74
rigid, red	LL1423SPOUTRED	8.54	10.25
rigid, stainless steel	LL1423SSPOUT	26.67	32.00
JERRY CAN SEAL	LL1423SEAL	0.87	1.04



Vehicle Number Plates



Number plates can only be sold directly to the owner of the vehicle together with proof of ownership and personal identification.

We will need sight of the following three original documents:-

- Vehicle registration document (V5)
- Driving Licence or utility bill.
- Passport or credit card (with photo ID), or travel/works pass (with photo ID).

Number plates are made to special order.

Please note that it is also now mandatory in the UK for all new number plates to bear the originating suppliers name, postcode and telephone number (i.e. Rimmer Bros).

	Part Number	Price Ex VAT	Price Inc VAT*
VEHICLE NUMBER PLATE - Front			
Standard	NPF	10.83	13.00
Standard with 'GB' logo	NPFGB	12.08	14.50
Deluxe			
3D effect	NPF3D	11.04	13.25
3D effect with 'GB' logo	NPF3DGB	12.08	14.50
VEHICLE NUMBER PLATE - Rear (oblong)			
Standard	NPR	10.83	13.00
Standard with 'GB' logo	NPRGB	12.08	14.50
Deluxe -			
3D effect	NPR3D	11.04	13.25
3D effect with 'GB' logo	NPR3DGB	12.08	14.50
VEHICLE NUMBER PLATE - Rear (square)			
Standard	NPRS	12.08	14.50
Deluxe			
3D effect	NPRS3D	13.12	15.74
3D effect with 'GB' logo	NPRS3DGB	14.37	17.24
VEHICLE NUMBER PLATES (pair)			
with 'Euro' logo	NPPRRC	20.62	24.74
FITTING KIT - number plates	NPK	2.33	2.80
<small>Universal kit including 4 self tap screws, 2 white cups, 2 yellow cups & 8 double sided adhesive pads.</small>			

Outdoor Covers

Freelander, Discovery, Range Rover etc



Galaxy Outdoor Car Cover

The Galaxy premium outdoor car cover is manufactured from heavy duty polyester with a superior satin finish. The resultant material has a very high tear strength combined with excellent water repellency and UV protection. This is enhanced by a waterproof membrane and heat sealed seams. The excellent waterproofing and breathability of the outer shell is combined with a soft moisture resistant fleece lining to provide the ultimate protection.

Eclipse Outdoor Car Cover

The Eclipse outdoor car cover is made from polypropylene with a breathable membrane. The four-layer construction consists of two non-woven top layers which gives good UV protection and water repellency. The third layer is a breathable/ waterproof film, and the fourth is a non-woven soft inner lining for scratch resistance.

Eclipse Outdoor Car Cover

RA2113E

PRICE EX VAT £139.17 PRICE INC VAT (UK @ 20%) £167.00

Galaxy Outdoor Car Cover

RA2113G PRICE EX VAT (OUTSIDE EU) £209.17 PRICE INC VAT (UK @ 20%) £251.00

Jump Start Kit

Small and lightweight high capacity nano lithium polymer portable power pack with the latest battery technology. Supports fast charging with low self-discharge cycle. Charging cycles can reach more than 1,000 times.

Supports 12V jump starts as well as back up charging for many brands of mobile phones, laptops, tablets, portable refrigerators etc.

Support 3 different types of charging modes.

Built in redundant electronic control safety protection for jump starter over-charging and over-discharging.



Jump Start Kit - XD Model (600Amp)

RX1410BPXD PRICE EX VAT (OUTSIDE EU) **£42.08** PRICE INC VAT (UK @ 20%) **£50.50**



Jump Start Kit - XS Model (400Amp)

RX1410BPXS PRICE EX VAT (OUTSIDE EU) **£77.50** PRICE INC VAT (UK @ 20%) **£93.00**

Multi-function jump starter & charger for electronic products...

- Lap tops
- Mobile phones
- Portable games
- Tablets
- Portable DVD
- Music players
- Not much larger than a mobile phone
- Plus much more...

Battery Charger

Conventional battery charger, ideal for charging a flat battery quickly or overnight charging.



6 & 12 volt Battery Charger

GAC7106 PRICE EX VAT (OUTSIDE EU) **£41.50** PRICE INC VAT (UK @ 20%) **£49.80**

Battery Acid Tester



CONS295230 PRICE EX VAT (OUTSIDE EU) **£6.25** PRICE INC VAT (UK @ 20%) **£7.50**

Twin Car Air Horns



- Penetrating safety sound, increasing awareness to others around you
- E approved, suitable for road use
- Maintenance free, no need to worry about your car horn once fitted
- Universal fit, fits all makes and models

RX1381 PRICE EX VAT (OUTSIDE EU) **£20.00** PRICE INC VAT (UK @ 20%) **£24.00**

Power Source Inverter

Great for in car entertainment and leisure use!

A power source inverter converts car battery voltage (12v) into a 240v output. You can plug in a variety of mains voltage appliances into the standard UK socket. Three different inverters are available to suit a range of power requirements. There is overload, overheat and short circuit protection on all models.



150 Watt Model

Continuous power: 150w. Peak power: 300w
Cigar lighter plug connection. 15A fuse.
Suitable applications: TV, DVD, Video, Computer Consoles, Lights (not fluorescent) Phone charger etc.

RX1551-150 PRICE EX VAT (OUTSIDE EU) **£20.00** PRICE INC VAT (UK @ 20%) **£24.00**

300 Watt Model

Continuous power: 300w. Peak power: 660w
Cigar lighter or battery clip connection.
40A fuse.
Suitable applications: as 150w model plus small power tools, small fridges, stereo etc.

RX1551-300 PRICE EX VAT (OUTSIDE EU) **£30.00** PRICE INC VAT (UK @ 20%) **£36.00**

500 Watt Model

Continuous power: 500w. Peak power: 800w
Battery clip connection only. 70A fuse.
Suitable applications: as 300w model plus medium power tools, colour TV's with DVD's, battery chargers etc.

RX1551-500 PRICE EX VAT (OUTSIDE EU) **£40.00** PRICE INC VAT (UK @ 20%) **£48.00**

Battery Conditioner

The battery conditioner is a battery charger that turns on and off automatically.



This superb product is suitable for all 12 volt batteries (from 5ah to 100ah) and constantly revitalises the battery cells - helping to extend cell life, without the danger of overcharging.

Look at these benefits:

- Designed to be left connected for long periods.
- Use without disconnecting vehicle electrics.
- L.E.D. battery condition display.
- Thermal cut-out facility.
- 12 month guarantee.

It can also be used for the following applications, providing they use a 12 volt battery: caravans, lawn mowers, motorbikes, motor boats, wheel chairs and general leisure use. The kit is supplied complete with all fittings and operating instructions.

0.8 Amp Version

RX1410CTEK PRICE EX VAT (OUTSIDE EU) **£42.50** PRICE INC VAT (UK @ 20%) **£51.00**

3.8 Amp Version

RX1410CTEK3800 PRICE EX VAT (OUTSIDE EU) **£63.83** PRICE INC VAT (UK @ 20%) **£76.60**

Multisockets



Fastcharge 12v Twin Can Multisocket with Twin USB Socket

- 10amp
- Battery analyser
- Width adjusting fitment collar
- 3 guide light rings and coiled cable

2T89283 PRICE EX VAT (OUTSIDE EU) **£13.12** PRICE INC VAT (UK @ 20%) **£15.74**

12v Twin Multisocket with Battery Analyser



- 8amp
- 2 guide light rings, mounting arms and coiled cable

RX1661 PRICE EX VAT (OUTSIDE EU) **£8.12** PRICE INC VAT (UK @ 20%) **£9.74**

12v Triple Multisocket with Battery Analyser



- 8amp
- 3 guide light rings, mounting arms and coiled cable

RX1662 PRICE EX VAT (OUTSIDE EU) **£9.17** PRICE INC VAT (UK @ 20%) **£11.00**

12v Twin Multisocket



- 10amp
- 0° to 90° adjustable plug
- 2 guide light rings

RX1660 PRICE EX VAT (OUTSIDE EU) **£5.62** PRICE INC VAT (UK @ 20%) **£6.74**

USB Port



Compact 1amp USB Port

- Compatible with 12v & 24v
- Powered by cigarette lighter socket
- Suitable for smart phones & MP3 players

RX1664 PRICE EX VAT (OUTSIDE EU) **£5.00** PRICE INC VAT (UK @ 20%) **£6.00**

Torches



Cyba-lite Lightstar 15 Keyring Torch

LED aluminium keyring torch. DC-2DC circuit provides optimum light output for the life of the battery. High strength machine crafted aluminium body. 15 lumens. Product Dimensions; H 75mm x W 16mm x D 16mm 1 x AAA Batteries included

RX1680 PRICE EX VAT (OUTSIDE EU) **£10.00** PRICE INC VAT (UK @ 20%) **£12.00**



Cyba-lite LED Head Torch

Lightweight and sturdy. 5 ultra bright high intensity LED's. Virtually indestructible LED, burn time up to 100,000 hours. 4 mode operating for energy saving. Lamp adjusts through 90°. Adjustable head strap with padded front section. 3 x AAA batteries included.

RX1683 PRICE EX VAT (OUTSIDE EU) **£16.04** PRICE INC VAT (UK @ 20%) **£19.25**



High Power Mechanics Headlamp

3W Cree LED provides 320 lumens of light output. Operating times: 2.5hrs (high); 8hrs (med) & 18hrs (low). Lamp adjusts through 50° to focus on work area. Tough & robust impact resistant aluminium construction, ideal for a workshop environment. Weatherproof design for outdoor use. Adjustable headstrap with padding for comfortable usage. 4 x AAA batteries included.

RX1263HL PRICE EX VAT (OUTSIDE EU) **£29.17** PRICE INC VAT (UK @ 20%) **£35.00**

Cyba-lite Vega Lantern

- 3 x 1 watt Nichia LEDs up to 300 lumens output.
- Removable lens provides forward area light.
- 3 mode electronic switch with instant off at any mode.
- Green LED indicator shows lantern in darkness.
- Recessed hook in lantern base
- Battery life up to 6 days.

Product Dimensions: H 184mm x W 98mm x D 88mm

RX1682 PRICE EX VAT (OUTSIDE EU) **£30.00** PRICE INC VAT (UK @ 20%) **£36.00**

Inspection Lamps

Rechargeable and cordless multi-position inspection lamps

Standard (15 LEDs) or heavy duty (21 LEDs) formats.

Compact and robust, both designs include an integral belt clip and a virtually unbreakable polycarbonate lens with wide angle light output.

The standard lamp features a hook/stand for multi-positional use while the heavy duty lamp is supplied with a charging station.



21 LEDs Heavy Duty Inspection Lamp
Rechargeable. Plugs into the mains.

RX1424LEDHD PRICE EX VAT (OUTSIDE EU) **£45.83** PRICE INC VAT (UK @ 20%) **£55.00**



15 LEDs Standard Inspection Lamp
Rechargeable. Plugs into the mains.

RX1424LED PRICE EX VAT (OUTSIDE EU) **£35.00** PRICE INC VAT (UK @ 20%) **£42.00**



Reversing Camera Kit

Rear Facing Camera Kit - includes Monitor

Seeing exactly what is behind a Land Rover is not easy using conventional mirrors.

This kit is a practical driver assistance device with the primary objective of helping the driver to see things that they may not otherwise see when reversing.



Features of the kit with monitor:

- Waterproof rear view or reverse camera.
- Small, discreet, MicroBlock™ colour camera.
- Slimline 3½ LCD monitor.
- Typically installed above number plate to include the rear bumper in the field of view.
- Outstanding image quality both day & night.
- Panoramic view.
- Instant image on.
- Single cable installation technology - easy to install. IP68 rated so 100% water and dust proof.

Reversing Camera Kit

RX1710 PRICE EX VAT (OUTSIDE EU) **£100.00** PRICE INC VAT (UK @ 20%) **£120.00** See below to add a forward facing camera

Additional Forward Facing Camera Kit

Front Facing Camera Kit - no Monitor

An additional camera to add to RX1710 above.



Easy to install camera kit.

The camera is the only external part and much like the vehicle it will be installed on it can be submerged in water, it can be blasted by a jet wash, sprayed with mud.

Effectively there is very little that can be done to damage the camera, short of hitting it with a solid object. But even then it can withstand some abuse.

Forward Facing Camera Kit (to add to RX1710)

RX1710FFCAM PRICE EX VAT (OUTSIDE EU) **£49.58** PRICE INC VAT (UK @ 20%) **£59.50**

Automatic Reversing Camera Kit

This is a high performance, fully automatic, practical driver assistance device.

The primary objective is very simple: to help a driver to see things that they may not otherwise see when reversing.



With the patented cable technology, installation should take around 30 - 45 minutes. No other system in the market is as quick and easy to install.

Features of the kit with monitor:

- Small, discreet, camera.
- Typically installed above number plate to include the rear bumper in the field of view.
- Outstanding image quality both day and night.
- Panoramic view.
- Instant image on.
- Single cable installation technology.
- IP68 rated (100% water and dust proof).
- Works seamlessly with supplied LCD monitor.

Reversing Camera Kit (Fully Automatic)

RX1710AUTO PRICE EX VAT (OUTSIDE EU) **£170.00** PRICE INC VAT (UK @ 20%) **£204.00**



Compact Dashboard Camera



Record your off-road adventures.

- Complete with 2.7 dash cam screen and a 120° lens
- Camera automatically turns on when you start the vehicle and will switch off once the engines turned off
- Installation is easy, just plug in and you are ready to go.
- Continuous loop recording
- If you need to keep footage, lock the file
- 12/14 volt
- H 55mm, W 86mm, D 37mm
- Rechargeable batteries included



Compact Dashboard Camera

RX1784 PRICE EX VAT (OUTSIDE EU) **£43.25** PRICE INC VAT (UK @ 20%) **£51.90**

Parking Distance Control Kit



- Sensors neatly integrate into the vehicle's bumper and will detect obstacles behind or in front of your vehicle whilst manoeuvring into position.
- As an obstacle is approached, the sensors trigger the acoustic alarm which rises in frequency the closer the vehicle gets.
- Quick and easy to install - fits any vehicle including all Land Rover models.
- 3 level buzzer alarm to indicate obstacles.
- 12 or 24v power supply.
- Sensors can be painted to match vehicle.

Parking Distance Control Kit

RX1559 PRICE EX VAT (OUTSIDE EU) **£60.00** PRICE INC VAT (UK @ 20%) **£72.00**

Jackall

Built with a patented 'Safety Link' the Maasdam Jackall is the 'Jack with More'!

Larger base for greater stability.

'Safety Link' mechanism that prevents abuse, misuse & makes operations safer.

Jacks come with a lifetime warranty & are built to current ANSI/ASME specifications.

When safety & dependability matter most, continue to rely on Jackall.

- Patented 'Safety Link' mechanism which prevents abuse & misuse
- Heavy ribbed, extra large base which provides strength & greater load stability
- Cast components assures long life, trouble free operation
- Hot roll-formed, alloy steel beam which is strong & reliable
- Steel handle locks against beam for convenient storage
- Powder coated through & through resisting corrosion.

48" Jack (4ft) -
8,000lbs capacity

LL1425BP48 £48.33 £58.00



Top Clamp

LL1425BPCLAMP £21.75 £26.10

Jacking Point Adaptor

LL1425BPADAPTOR £16.87 £20.24

Mounting Kit
Jack Rack

LL1425BPMOUNT £14.37 £17.24

60" Jack (5ft) -
8,000lbs capacity

LL1425BP60 £53.33 £64.00

Bottle Jacks

Top Bottle Jack & Handle
Defender only

ANR4489BP £126.67 £152.00

Handle Only (Replacement)

KAH500060BP £14.95 £17.94

Draper 6 Tonne Bottle Jack
with 2 Piece Handle

ANR4489P £25.83 £31.00

Heavy Duty Bottle Jack
(Handle not included)
Defender from (VIN) BA405609

LR031924BP £99.50 £119.40

Handle Only

KAH500060BP £14.95 £17.94

Farm Jacks

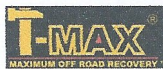

48" Farm Jack (4ft)

LL1177BMTMAX £44.50 £53.40

60" Farm Jack (5ft)

LL1178BMTMAX £51.50 £61.80

Large Foot for T-Max Jack

LL1177BMTMLF £10.86 £13.00

Jack Adaptor (15mm)

LL1179BMTMAX £18.12 £21.74

Heavy Duty Ground Anchor

Pull yourself out of trouble using your Farm Jack and this Heavy Duty Ground Anchor

Heavy Duty Ground Anchor

LL1471BPHE £155.83 £187.00

Ground Anchor Set

Ground Anchor Set -
600mm Pins

LL1471BP £93.33 £112.00

Trolley Jack

Draper 2 Tonne Trolley Jack

RX1649 £42.08 £50.50

Ratchet Axle Stands

Draper 2 Tonne Ratchet
Axle Stands (pair)

RX1650 £28.33 £34.00

Anti-Rattle Jack Clamp

LL1427BPBLACK

£5.62 £6.74

Ground Anchor Bag Set

2 x Pulling Power Bags
(Ground Anchor not included)

Ground Anchor Bag Set

LL1471BPBAG £18.12 £21.74

WINCHES

If you are serious about off-roading then a winch is an essential piece of kit. They are indispensable when getting yourself, and others, out of the mire!
The Britpart Pulling Power range of powerful & reliable electric winches all feature a planetary gear system for fast line speed, free spooling, power in & power out & low electric current.



LL1437BP12000
PRICE EX VAT (OUTSIDE EU) **£455.00** PRICE INC VAT (UK @ 20%) **£546.00**



LL1437BP8000
PRICE EX VAT (OUTSIDE EU) **£289.00** PRICE INC VAT (UK @ 20%) **£346.80**



LL1437BP9500
PRICE EX VAT (OUTSIDE EU) **£320.00** PRICE INC VAT (UK @ 20%) **£384.00**



LL1437BP6000
PRICE EX VAT (OUTSIDE EU) **£255.00** PRICE INC VAT (UK @ 20%) **£270.00**

- Most models feature:
- 24 Month guarantee
 - Available in steel cable or Dyneema rope
 - Weather & dustproof contactor controls
 - Planetary gear system for fast line speed
 - Automatic load holding brake
 - Free spooling
 - Power in & power out
 - Low electric current
 - Hardened drum

For full specification information see table below.

A full range of replacement component parts are available for all Britpart Winches. Please call 01522 568000 with your requirements.



LL1437BP9000
PRICE EX VAT (OUTSIDE EU) **£289.00** PRICE INC VAT (UK @ 20%) **£346.80**



LL1437BP2000
PRICE EX VAT (OUTSIDE EU) **£76.50** PRICE INC VAT (UK @ 20%) **£91.80**

Winches Specifications

Part Number	LL1437BP12000	LL1437BP9500	LL1437BP9000	LL1437BP8000	LL1437BP6000	LL1437BP2000
Motors	3.6kw (4.8hp) Heavy-duty series wound DC motor	3.6kw (4.8hp) Heavy-duty series wound DC motor	3.3kw (4.5hp) Permanent magnetic DC motor	3.0kw (4.1hp) Permanent magnetic DC motor	2.7kw (3.6hp) Permanent magnetic DC motor	1.0kw (1.5hp) Permanent magnetic DC motor
Models available	12 volts & 24 volts*	12 volts & 24 volts*	12 volts	12 volts	12 volts	12 volts
Steel cable or Dyneema rope	Steel cable or Dyneema rope**	Steel cable or Dyneema rope**	Steel cable or Dyneema rope**	Steel cable	Steel cable	Steel cable
Weather & rustproof contractor controls	✓	✓	✓	✓	✓	
Planetary gear for fast line speed	✓	✓	✓	✓	✓	✓
Automatic load holding brake	✓	✓	✓	✓	✓	
Free spooling	✓	✓	✓	✓	✓	✓
Power in & power out	✓	✓	✓	✓	✓	✓
Low electric current	✓	✓	✓	✓	✓	✓
Hardened drum	✓	✓	✓	✓		
Rated line pull - single line	5,443kgs (12,000lbs)	4,309kgs (9,500lbs)	4,082kgs (9,000lbs)	3,632kgs (8,000lbs)	2,722kgs (6,000lbs)	907kgs (2,000lbs)
Gear reduction ratio	294:1	212:1	212:1	210:1	210:1	153:1
Drum size - Dia x length	67 x 228mm (2.64 x 9")	67 x 228mm (2.64 x 9")	63 x 228mm (2.5 x 9")	63 x 228mm (2.5 x 9")	63 x 140mm (2.5 x 5.51")	32 x 71mm (1.26 x 2.8")
Steel cable - size	9.53mm x 30.5mtr (0.38" x 100')	9.53mm x 30.5mtr (0.38" x 100')	9.53mm x 30.5mtr (0.38" x 100')	9.53mm x 30.5mtr (0.38" x 100')	7.94mm x 26mtr (0.31" x 85')	4.0mm x 15.2mtr (0.16" x 50')
Dyneema rope - size	11mm x 28mtr (0.43" x 91.9')	11mm x 28mtr (0.43" x 91.9')	11mm x 28mtr (0.43" x 91.9')	Not available	Not available	Not available
Overall dimensions - LxWxH	548x167x299mm (21.57x6.57x11.77")	548x167x299mm (21.57x6.57x11.77")	560x160x280mm (22.0x6.3x11.0")	570x180x280mm (22.4x7.0x11.0")	438x158x185mm (17.24x6.22x7.28")	320x105x111mm (12.6x4.13x4.35")
Steel cable - net weight	43.0kgs (94.8lbs)	43.0kgs (94.8lbs)	38.0kgs (84.0lbs)	36.0kgs (80.0lbs)	31.8kgs (70.0lbs)	6.6kgs (14.6lbs)
Dyneema rope - net weight	33.0kgs (72.8lbs)	33.0kgs (72.8lbs)	31.0kgs (68.3lbs)	Not available	Not available	Not available
Mounting bolt pattern	254x114.3mm (10x4.5")	254x114.3mm (10x4.5")	254x114.3mm (10x4.5")	254x114.3mm (10x4.5")	166x114.3mm (6.54x4.5")	48x76mm (1.89x3.0")

Shackles & Pulleys

Shackle 4.7 Ton

LL1462BP4-7
 PRICE EX VAT (OUTSIDE EU) **£4.16** PRICE INC VAT (UK @ 20%) **£4.99**

Forged Jate Ring

LL1463BPFORGED
 PRICE EX VAT (OUTSIDE EU) **£14.25** PRICE INC VAT (UK @ 20%) **£17.10**

Jate Ring Welded Steel

LL1463P
 PRICE EX VAT (OUTSIDE EU) **£12.50** PRICE INC VAT (UK @ 20%) **£15.00**

Snatch Block
 High Quality Tempered Steel.
 Max Head Load 9,000kgs (each)

RA1377BP
 PRICE EX VAT (OUTSIDE EU) **£19.50** PRICE INC VAT (UK @ 20%) **£23.40**

Shackle 1.4 Ton

LL1462BP1-4
 PRICE EX VAT (OUTSIDE EU) **£3.95** PRICE INC VAT (UK @ 20%) **£4.74**

Swivel Shackle

LL1193BP
 PRICE EX VAT (OUTSIDE EU) **£39.95** PRICE INC VAT (UK @ 20%) **£47.94**

D-Shackle 1.4 Ton

LL1462BP1-4D
 PRICE EX VAT (OUTSIDE EU) **£3.95** PRICE INC VAT (UK @ 20%) **£4.74**

Pulley Hook
 SWL Loads -
 Pulley 1.500kgs
 Lifting 750kgs

LL1461BP
 PRICE EX VAT (OUTSIDE EU) **£15.95** PRICE INC VAT (UK @ 20%) **£19.14**

Fairleads

LL1452BPSTEEL

PRICE EX VAT (OUTSIDE EU) **£11.25** PRICE INC VAT (UK @ 20%) **£13.50**

LL1451BPSTEEL215

PRICE EX VAT (OUTSIDE EU) **£31.50** PRICE INC VAT (UK @ 20%) **£37.80**

LL1451BPSTEEL130

PRICE EX VAT (OUTSIDE EU) **£6.95** PRICE INC VAT (UK @ 20%) **£8.34**

Fairlead Specifications

125mm Mounting Holes			
LL1452BPSTEEL	Hawse Fairlead	Steel	80mm aperture
255mm Mounting Holes			
LL1451BPSTEEL215	Hawse Fairlead	Steel	215mm aperture
LL1451BPSTEEL130	Hawse Fairlead	Steel	130mm aperture
LL1451BPALLY	Hawse Fairlead	Aluminium	205mm aperture
LL1451BPSS	Hawse Fairlead	Stainless steel	205mm aperture
LL1451BPSSROLLER	Roller Fairlead	Stainless steel	180mm aperture
LL1441BP1	Roller Fairlead	Zinc coated	180mm aperture
LL1441BP2	Roller Fairlead	Zinc coated	105mm aperture

LL1451BPALLY

PRICE EX VAT (OUTSIDE EU) **£27.43** PRICE INC VAT (UK @ 20%) **£32.92**

LL1451BPSS

PRICE EX VAT (OUTSIDE EU) **£52.50** PRICE INC VAT (UK @ 20%) **£63.00**

LL1451BPSSROLLER

PRICE EX VAT (OUTSIDE EU) **£52.50** PRICE INC VAT (UK @ 20%) **£63.00**

LL1441BP1

PRICE EX VAT (OUTSIDE EU) **£31.50** PRICE INC VAT (UK @ 20%) **£37.80**

LL1441BP2

PRICE EX VAT (OUTSIDE EU) **£32.50** PRICE INC VAT (UK @ 20%) **£39.00**

Ropes & Straps

Tree Strop 1.6 mtr x 120mm

LL1460BP
 PRICE EX VAT (OUTSIDE EU) **£34.90** PRICE INC VAT (UK @ 20%) **£41.88**

Tow Strap 9mtr x 60mm

LL1454BP
 PRICE EX VAT (OUTSIDE EU) **£42.50** PRICE INC VAT (UK @ 20%) **£51.00**

High Elasticity Tow Sling
 9mtr x 60mm

LL1455BP
 PRICE EX VAT (OUTSIDE EU) **£39.50** PRICE INC VAT (UK @ 20%) **£47.40**

Pair of Wheel Chocks



Wheel Chocks (pair)

LL1464BP
 PRICE EX VAT (OUTSIDE EU) £29.99 PRICE INC VAT (UK @ 20%) £35.99

Safety Gloves



Safety Gloves

LL1465BP
 PRICE EX VAT (OUTSIDE EU) £4.25 PRICE INC VAT (UK @ 20%) £5.10

12 Volt Winch Remote Control

Operate your winch from a safe distance with this wireless remote control.

- High frequency circuit
- FM Technology for frequency stability and greater control distance
- Receiver output is protected against voltage spikes.



LL1467BP PRICE EX VAT (OUTSIDE EU) £42.50 PRICE INC VAT (UK @ 20%) £51.00

Winch Blanket

Manufactured from heavy-duty vinyl, the blanket will absorb most of the recoil in the unlikely event of the cable breaking. Can also be used to kneel on in the mud!!

LL1466BP PRICE EX VAT (OUTSIDE EU) £11.95 PRICE INC VAT (UK @ 20%) £14.34

Winch Kit Bag



LL1468BP PRICE EX VAT (OUTSIDE EU) £34.50 PRICE INC VAT (UK @ 20%) £41.40

Dyneema Rope

12 strand synthetic fibre replacement winch rope



11mm x 28mtr
 Breaking point 25,800lbs

- Very strong
- Very light
- Easily spliced
- Highly visible
- Easy to handle
- Floats
- Does not kink

For use with LL1437BP1200, LL1437BP9500 & LL1473BP9000 winches

LL1470BP PRICE EX VAT (OUTSIDE EU) £145.00 PRICE INC VAT (UK @ 20%) £174.00

Replacement Winch Cables with Hook



Winch Cable with Hook - 9.5mm x 30.5mtr
 Suitable for LL1437BP12000, LL1437BP9500 & LL1473BP9000

LL1445BP1 PRICE EX VAT (OUTSIDE EU) £54.50 PRICE INC VAT (UK @ 20%) £65.40

Winch Cable with Hook - 8mm x 26mtr
 Suitable for LL1437BP6000

LL1445BP2 PRICE EX VAT (OUTSIDE EU) £46.50 PRICE INC VAT (UK @ 20%) £55.80

Winch Cable with Hook - 4mm x 15.2mtr
 Suitable for LL1437BP2000

LL1437BP2000CAB PRICE EX VAT (OUTSIDE EU) £13.90 PRICE INC VAT (UK @ 20%) £16.68

Extended Winch Wiring Kit

Kit Contains:
 1 x red & 1 x black cable.
 Both 1.8mtr in length with end connectors and cut-off switch.
 Defender vehicles.



LL1469BP
 PRICE EX VAT (OUTSIDE EU) £49.50 PRICE INC VAT (UK @ 20%) £59.40

Split Charge Relay

With all the demands on the battery that off-roading can produce, an auxiliary battery is a sensible option, to run that battery you will need a split charge relay.



ASU1151BPHD PRICE EX VAT (OUTSIDE EU) £11.95 PRICE INC VAT (UK @ 20%) £14.34

Winching Accessory Kits

All the basic items you need to ensure your winch can be used to the best effect.

Deluxe Kit Contains:

- 1 x LL1464BP Wheel Chocks (pair)
- 1 x LL1468BP Winch Kit Bag
- 1 x RA1377BP Snatch Block
- 1 x LL1454BP Tow Strap
- 1 x LL1460BP Tree Strap
- 1 x LL1465BP Safety Gloves
- 1 x LL1455BP Snatch Tow Sling
- 2 x LL1462BP4-7 Shackle 4.75 Ton
- 1 x LL1466BP Winch Blanket



Deluxe Winch Accessory Kit

RA1376BPDELUXE PRICE EX VAT (OUTSIDE EU) **£119.50** PRICE INC VAT (UK @ 20%) **£143.40**

Standard Kit Contains:

- 1 x LL1468BP Winch Kit Bag
- 1 x RA1377BP Snatch Block
- 1 x LL1454BP Tow Strap
- 1 x LL1460BP Tree Strap
- 1 x LL1465BP Safety Gloves
- 2 x LL1462BP4-7 Shackle 4.75 Ton



Standard Winch Accessory Kit

RA1376BPSTD PRICE EX VAT (OUTSIDE EU) **£99.50** PRICE INC VAT (UK @ 20%) **£119.40**

T-Max Hand Operated Winch



Hand Operated Winch - 1,600kgs

LL1645BM

PRICE EX VAT (OUTSIDE EU) **£145.00** PRICE INC VAT (UK @ 20%) **£174.00**



Brush & Holder Set



For LL1437BP12000 & LL1437BP9500

LL1446BP1 PRICE EX VAT (OUTSIDE EU) **£12.99** PRICE INC VAT (UK @ 20%) **£15.59**

Heavy Duty Ground Anchor

Pull yourself out of trouble using a Farm Jack (not included)



Heavy Duty Ground Anchor

LL1471BPHD PRICE EX VAT (OUTSIDE EU) **£155.83** PRICE INC VAT (UK @ 20%) **£187.00**

Ground Anchor Set



Ground Anchor Set - 600mm Pins

LL1471BP PRICE EX VAT (OUTSIDE EU) **£93.33** PRICE INC VAT (UK @ 20%) **£112.00**

Ground Anchor Bag Set

2 x Pulling Power Bags (Ground Anchor not included)



Ground Anchor Bag Set

LL1471BPBAG PRICE EX VAT (OUTSIDE EU) **£18.12** PRICE INC VAT (UK @ 20%) **£21.74**



A full range of replacement component parts are available for all Britpart Winches
Please call 01522 568000 with your requirements

WINCH BUMPERS

WINCH ACCESSORIES - WINCH BUMPERS

Terrafirma Pro Taper Bumper

When strength, functionality and good looks are the ultimate goal the Terrafirma Pro Taper bumper range will be your choice. With these bumpers the winch is raised above the chassis rails and, with the tapered and swept back wings, approach angle and styling are optimised even with air conditioned models. With large, high capacity winches becoming more and more popular for commercial and recreational use these bumpers for big and powerful winches are unmatched in the market place. Air cooling slots, built in recovery and jacking points complete these superb winch bumpers.

Defender - All models without air conditioning



LL1710TF
 PRICE EX VAT (OUTSIDE EU) £295.83 PRICE INC VAT (UK @ 20%) £355.00

Defender - All models with air conditioning



LL1710TFAC
 PRICE EX VAT (OUTSIDE EU) £295.00 PRICE INC VAT (UK @ 20%) £354.00

Also available
 TUV APPROVED Part Number LL1710TFACTUV Price Ex VAT 458.33 Price Inc VAT* 550.00

Winch Bumper with Bash Plate

Manufactured in heavy gauge tubular and plate steel and black powder coated, these bumpers offer superb value for money. Manufactured in the UK they all feature integral bash plate and jacking points to take standard hi-lift jacks. The mounting plate will take the majority of modern winches with no further drilling, however some cutting of the grille may be required. Includes integral A bar.

Defender 90 & 110 (non-air con)

To VIN 6A999999
 BLACK with silver bash plate.



LL1449ABS
 PRICE EX VAT (OUTSIDE EU) £262.50 PRICE INC VAT (UK @ 20%) £315.00

Also available
 As above but air-con models Part Number LL1449ABSAC Price Ex VAT 262.50 Price Inc VAT* 315.00

Defender 90 & 110 (non-air con)

To VIN 6A999999
 Silver with black bash plate.

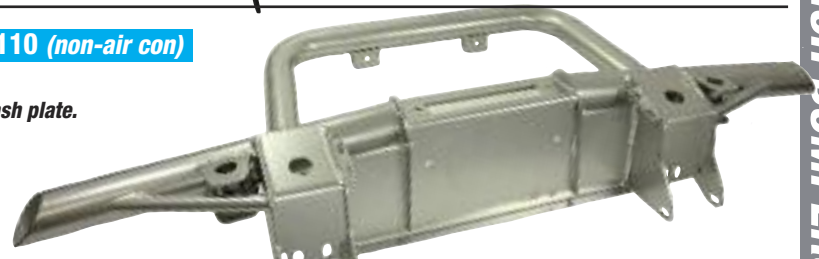

LL1449ASB
 PRICE EX VAT (OUTSIDE EU) £262.50 PRICE INC VAT (UK @ 20%) £315.00

Also available
 As above but air-con models Part Number LL1449ASBAC Price Ex VAT 262.50 Price Inc VAT* 315.00

Defender 90 & 110 (non-air con)

To VIN 6A999999
 Black with silver bash plate.

Suitable for BD12000i, DB9500i, DB9000c, DB8000 winches



LL1449B
 PRICE EX VAT (OUTSIDE EU) £240.00 PRICE INC VAT (UK @ 20%) £288.00

Also available
 As above but air-con models Part Number LL1449AC Price Ex VAT 240.00 Price Inc VAT* 288.00

Defender 90 & 110 (non-air con)

To VIN 6A999999
 Silver with black bash plate.
 Suitable for BD12000i, DB9500i, DB9000c, DB8000 winches



LL1449S
 PRICE EX VAT (OUTSIDE EU) £240.00 PRICE INC VAT (UK @ 20%) £288.00

Winch Bumper only

Winch frame and integral bumper. Replaces the original bumper, Black powder coated. No drilling or modifications required. Incorporates jacking points. Made from 6mm steel plate will fit air-con models as well.

Defender 90 & 110

Suitable for BD12000i, DB9500i, DB9000c, DB8000 winches.



LL1449
 PRICE EX VAT (OUTSIDE EU) £185.00 PRICE INC VAT (UK @ 20%) £222.00

Defender 90 & 110 (models with air con)

Suitable for Warn 9000 & 9.5 series winches.



LL1450ACWARN
 PRICE EX VAT (OUTSIDE EU) £195.83 PRICE INC VAT (UK @ 20%) £235.00

LAND ROVER ACCESSORIES

WINCH ACCESSORIES - WINCH BUMPERS

Discovery 1 - All models

Black powder coated.



RD1245 PRICE EX VAT (OUTSIDE EU) **£205.00** PRICE INC VAT (UK @ 20%) **£246.00**

Discovery 2 - All models

*Black powder coated.
(Manufactured from 5mm steel).
Fixed to standard mounting points,
grille will need trimming to fit winch.*

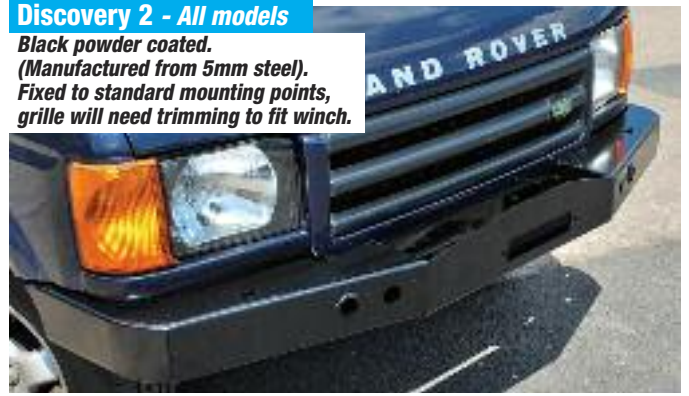

RD1246BP PRICE EX VAT (OUTSIDE EU) **£195.83** PRICE INC VAT (UK @ 20%) **£235.00**

Discovery 1 - All models

Black with silver bash plate.



RA1521BM PRICE EX VAT (OUTSIDE EU) **£283.33** PRICE INC VAT (UK @ 20%) **£340.00**

Range Rover P38 - All models

Black with silver bash plate.



RA1560 PRICE EX VAT (OUTSIDE EU) **£330.00** PRICE INC VAT (UK @ 20%) **£396.00**



Discreet Winch Bumpers

- Suitable for any low line winch
- Made from 6mm & 8mm steel
- Discreetly fits behind the existing bumper
- Bolts directly onto the front cross member using existing holes
- Modifications to the bumper are required (full instructions included)
- Excludes fairlead

Note – low line winch needs to have a removable solenoid, solenoid needs to be removed and relocated

Discovery 3 & 4 - TDV6 engine
Range Rover Sport - TDV6 engine

Range Rover Sport - 3.6 TDV8 engine
Range Rover Sport - 4.2 V8 Supercharged engine
Range Rover Sport - 4.4 V8 engine



LR015274BPWTDV6 PRICE EX VAT (OUTSIDE EU) **£320.83** PRICE INC VAT (UK @ 20%) **£385.00**



LR015274BPWTDV8 PRICE EX VAT (OUTSIDE EU) **£320.83** PRICE INC VAT (UK @ 20%) **£385.00**

Defender

The special tools you need to give your Defender the care it deserves.

Oil Pump Alignment Tool



- The tool has been developed to correctly align the engine oil pump in the sump after an engine rebuild etc
- OEM Codes: 303-705/303-1093
- Defender 2.4 TD4/2006-2015

RX1846
PRICE EX VAT (OUTSIDE EU) **£9.50** PRICE INC VAT (UK @ 20%) **£11.40**

Propshaft Socket



- 1/2"D
- Size: 9/16"x 150mm
- Manufactured from impact quality Chrome Molybdenum
- Designed for access
- Black finish
- Defender

BA3138
PRICE EX VAT (OUTSIDE EU) **£10.95** PRICE INC VAT (UK @ 20%) **£13.14**

Clutch Alignment Tool

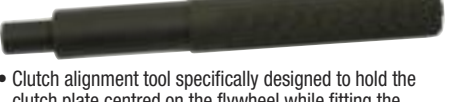

- Clutch alignment tool specifically designed to hold the clutch plate centred on the flywheel while fitting the clutch cover plate
- Equivalent to OEM No. 308-419
- 200mm long x 14mm diameter with knurled grip
- Defender 2.4 TD4

LL1663P
PRICE EX VAT (OUTSIDE EU) **£11.50** PRICE INC VAT (UK @ 20%) **£13.80**

Engine Timing Tool Kit



- This kit has been developed to fit the 2.4 Land Rover TDCi (common rail) engines to allow cambelt, camchain replacement. It also includes 2 locking plates to allow the fuel pump to be removed without disturbing the timing drive chain
- Supplied in foam tray
- Defender 2004 (244 DT).

RX1823
PRICE EX VAT (OUTSIDE EU) **£105.00** PRICE INC VAT (UK @ 20%) **£126.00**



Impact Hub Nut Socket - 52mm



- Air impact deep socket
- 52mm 6pt (single hex)
- 1/2"D
- 46mm drive depth, 56mm internal depth 69mm external diameter
- Defender (83 on) and most post 1970 models.

RTC639PSOCKET
PRICE EX VAT (OUTSIDE EU) **£13.95** PRICE INC VAT (UK @ 20%) **£16.74**

Crankshaft Seal Remover/Installer



- Crankshaft rear oil seal removal and installation tool
- Equivalent to OEM No. 303-538
- Complete with punch to assist seal removal
- Defender (07 on)

RX1840
PRICE EX VAT (OUTSIDE EU) **£49.50** PRICE INC VAT (UK @ 20%) **£59.40**

Timing Pins - TD5



- Designed specifically for the iconic TD5 engine found across the Land Rover range
- Camshaft/Crankshaft Timing pins OEM ref LRT 12-058
- Flywheel locking pin OEM ref LRT 12-158
- Defender 1999-2007, engine codes: 10P, 15P, 16P

RX1861
PRICE EX VAT (OUTSIDE EU) **£8.50** PRICE INC VAT (UK @ 20%) **£10.20**



Engine Timing Tool Kit



- A 12 piece kit consisting of the components required to lock the crankshaft and camshafts in their timed position to allow the removal and replacement of the cam belt and the associated components
- Comprehensive tool kit for early Land Rover engines
- Supplied in metal storage case with instructions and application list
- Defender 2.5, 200TDi 1990-94, 300TDi 1994-98.

RX1610
PRICE EX VAT (OUTSIDE EU) **£199.50** PRICE INC VAT (UK @ 20%) **£239.40**



GENERAL TOOLS

General tools for getting your hands dirty!

Alloy Wheel Nut Socket - Air Impact - 22mm



- 1/2"D x 22mm
- Nylon outer sleeve to protect alloy wheel
- Manufactured from Chrome Molybdenum
- Range Rover, Discovery, Freelander

RX1820
PRICE EX VAT (OUTSIDE EU) **£10.50** PRICE INC VAT (UK @ 20%) **£12.60**

Fuel Tank Sender Wrench



- 19mm Hex Drive
- To remove/replace the fuel pump locking ring
- External diameter 140mm, Internal diameter 115mm
- Equivalent to OEM No. 310-118
- V8 petrol, TD5 diesel, V6 petrol, TD4 diesel, 4 cyl petrol, TD6 diesel, 2.4L diesel

RX1838
PRICE EX VAT (OUTSIDE EU) **£38.95** PRICE INC VAT (UK @ 20%) **£46.74**

Universal Clutch Alignment Tool



All Models

RX1702
PRICE EX VAT (OUTSIDE EU) **£10.95** PRICE INC VAT (UK @ 20%) **£13.14**

Cooling System Pressure Test Kit



- 24 pieces including 16 individually sized adaptors, pressure testing pump with gauge, 2 connectors for use with no. 3 adaptor and handle
- Suitable for a large range of vehicles
- Thermometer included
- Also checks the leakage on original radiator cap
- Discovery 1 & 2 / 3 & 4, Freelander

RX1829
PRICE EX VAT (OUTSIDE EU) **£249.50** PRICE INC VAT (UK @ 20%) **£299.40**

Discovery 1 & 2

The special tools you need to give your Discovery the care it deserves.

Diesel Injection Pump Puller



- Specifically designed for holding the sprocket chain in place when disassembling the VP44 injection pump and high pressure pump common rail
- Specialist timing tool
- OEM Codes: 12-178

Discovery 1 & 2, 2.5 TD diesel engines

RX1825

PRICE EX VAT (OUTSIDE EU) **£34.95** PRICE INC VAT (UK @ 20%) **£41.94**

Diesel Injection Pump Puller



- Full engine locking tool kit also available
- Equivalent to OEM No. LRT12-119

Discovery 1 & 2, 2.5 TD diesel engines

RX1822

PRICE EX VAT (OUTSIDE EU) **£14.50** PRICE INC VAT (UK @ 20%) **£17.40**

Timing Pins - TD5



- Designed specifically for the iconic TD5 engine found across the Land Rover range
- Camshaft/Crankshaft Timing pins OEM ref LRT 12-058
- Flywheel locking pin OEM ref LRT 12-158

Discovery 1999-2007

RX1861

PRICE EX VAT (OUTSIDE EU) **£8.50** PRICE INC VAT (UK @ 20%) **£10.20**



Made in Sheffield

Impact Hub Nut Socket - 52mm

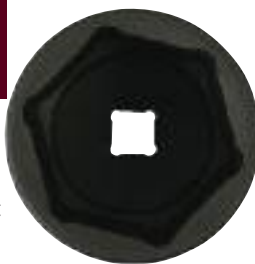

- Air impact deep socket
- 52mm 6pt (single hex)
- 1/2" D
- 46mm drive depth, 56mm internal depth 69mm external diameter

Discovery (83 on) plus most post 1970 models

RTC639PSOCKET

PRICE EX VAT (OUTSIDE EU) **£13.95** PRICE INC VAT (UK @ 20%) **£16.74**



Diesel Injector Socket Set (6pc)

- 1/2" D
- A set of six sockets specifically designed for removing diesel injectors
- Contents: 21mm/22mm x 2 lengths/27mm/28mm/28mm with location collar for 2.4, 2.5D on Land Rover engines
- Manufactured from Chrome Molybdenum for strength and finished in black to prevent corrosion

Discovery 2.4/2.5D engines

RX1821

PRICE EX VAT (OUTSIDE EU) **£64.50** PRICE INC VAT (UK @ 20%) **£77.40**

Propshaft Socket



- 1/2" D
- Size: 9/16" x 150mm
- Manufactured from impact quality Chrome Molybdenum
- Designed for access
- Black finish

Discovery 1 & 2

BA3138

PRICE EX VAT (OUTSIDE EU) **£10.95** PRICE INC VAT (UK @ 20%) **£13.14**

Gunsons EEZ1-BLEED



This system sets the standard for affordable brake and clutch bleeding systems. Using air pressure from a spare wheel it will effortlessly bleed hydraulic systems.

- Suitable for one man operation
- Uses the air pressure from a spare tyre to effortlessly bleed hydraulic systems
- The Eezibleed kits contains a special pressure vessel to hold the new fluid, spare bottle seal part number G4062/80
- Can be used successfully on the following systems: Tandem master cylinders without sensors Tandem reservoirs, Slave servos, Vacuum Servos
- Easy to follow instructions

RX1855

PRICE EX VAT (OUTSIDE EU) **£22.50** PRICE INC VAT (UK @ 20%) **£27.00**



Engine Timing Tool Kit

- A 12 piece kit consisting of the components required to lock the crankshaft and camshafts in their timed position to allow the removal and replacement of the cam belt and the associated components
- Comprehensive tool kit for early Land Rover engines
- Supplied in metal storage case with instructions and application list

Discovery (1990-94) 200TDi engines
Discovery (1994-98) and with 300TDi engines
Discovery (1993-97) with 20T
and 2.0L 16v MPI engines

RX1610

PRICE EX VAT (OUTSIDE EU) **£199.50** PRICE INC VAT (UK @ 20%) **£239.40**



Made in Sheffield

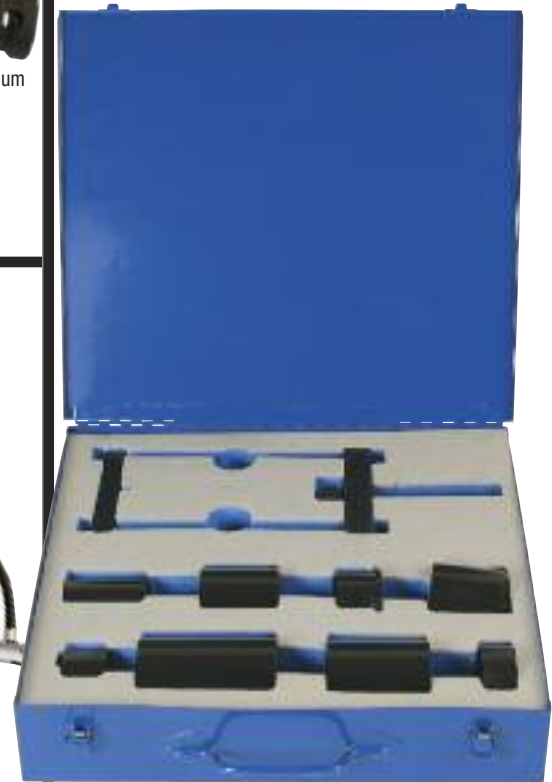

Knuckle Ball Joint Tool

- This kit has been designed to allow the top and bottom steering ball joints fitted to the Land Rover model listed below to be replaced with the axle casing attached to the vehicle
- Upper and lower ball joints
- On vehicle solution
- Equivalent to OEM No. 205-718, 205-732, 205-733, 205-719

Discovery 2 (1998-04)

RX1847

PRICE EX VAT (OUTSIDE EU) **£349.50** PRICE INC VAT (UK @ 20%) **£419.40**



Made in Sheffield

Discovery 3 & 4

Crankshaft Pulley Holding Tool



- This tool provides the required components to hold the crankshaft vibration damper (crankshaft pulley) still while undoing the often very tight pulley mounting bolt found on the Land Rover vehicles listed
- Equivalent to OEM No. 303-191
- Designed to be used with a 1/2" D power bar

Discovery 3, 4.2, 4.4 V8 petrol engines
RX1854
 PRICE EX VAT (OUTSIDE EU) **£99.50** PRICE INC VAT (UK @ 20%) **£119.40**

Front Lower Arm Rear Bush Tool



- Front lower arm rear bush removal/insertion tool
- Equivalent to OEM No. 204-535A
- For use on the OEM Hydro bush RBX500291

Discovery 3 & 4 (2005 on)
RX1841
 PRICE EX VAT (OUTSIDE EU) **£164.50** PRICE INC VAT (UK @ 20%) **£197.40**  Made in Sheffield

Engine Timing Tools



- This tool kit is a complete kit that allows the valve timing to be maintained during camchain replacement
- Timing pins for Range Rover Sport 2.7 TDV6 with automatic and manual transmissions

Discovery 3 & 4 2004-09
RA1549
 PRICE EX VAT (OUTSIDE EU) **£52.50** PRICE INC VAT (UK @ 20%) **£63.00**

Diesel Fuel Pump Locking Tool



- Used to lock the high pressure fuel pump in its timed position when changing the high pressure pump drive belt
- Equivalent to OEM No. 310-212
- Also use in conjunction with Viscous Fan Coupling tools - Part No. RX1839 & RX1831

Discovery 4, SDV6/TDV6
RX1842
 PRICE EX VAT (OUTSIDE EU) **£25.95** PRICE INC VAT (UK @ 20%) **£31.14**  Made in Sheffield

Hub Bush Remover/installer



- Bush remover installer on Range Rover Sport
- Application for rear suspension top knuckle bush
- Can be used in situ which reduces the dismantling required
- Equivalent to OEM No. 204-530

Discovery 3 & 4 (2005 on)
RX1843
 PRICE EX VAT (OUTSIDE EU) **£80.95** PRICE INC VAT (UK @ 20%) **£97.14**  Made in Sheffield

Engine Timing Tools



- Specifically introduced for pre 2010 4.2, 4.4 V8 petrol engines fitted with timing chains
- The crankshaft locking pin has been especially designed to combine 2 OEM designs into one tool
- Supplied in metal case with EVA foam

Discovery 3, 4.4 V8 (2004-2010)
RA1548
 PRICE EX VAT (OUTSIDE EU) **£154.95** PRICE INC VAT (UK @ 20%) **£185.94**  Made in Sheffield

Crankshaft Seal Remover/installer



- Crankshaft rear oil seal removal and installation tool
- Equivalent to OEM No. 303-538
- Complete with punch to assist seal removal

Discovery 3
RX1840
 PRICE EX VAT (OUTSIDE EU) **£49.50** PRICE INC VAT (UK @ 20%) **£59.40**

Rear Suspension Bush Tool



- Lower Hub Bush
- Equivalent to OEM No. 204-516

Discovery 3, Discovery 4 (2005 on)
RX1834
 PRICE EX VAT (OUTSIDE EU) **£89.95** PRICE INC VAT (UK @ 20%) **£107.94**  Made in Sheffield

Oil Filter Remover



- Oil filter removal of the paper filter from the canister on 2.7 TDV6 diesel engines fitted to Land Rover vehicles
- Equivalent to OEM No. 303-1128
- Prevents damage to the filter housing
- 32mm socket required for filter housing

Discovery 3 (2.7 TDV6 engines)
 Made in Sheffield
RX1827
 PRICE EX VAT (OUTSIDE EU) **£12.95** PRICE INC VAT (UK @ 20%) **£15.54**

Front Lower Arm Front Bush Tool



- This tool has been developed to allow the user to remove and refit the front suspension bush of the front lower arm with the minimum of dismantling
- Designed specifically to work with OEM bushes
- Equivalent to OEM No. 204-536

Discovery 3, Discovery 4 (2005 on)
RX1848
 PRICE EX VAT (OUTSIDE EU) **£109.50** PRICE INC VAT (UK @ 20%) **£131.40**  Made in Sheffield

Engine Timing Tools

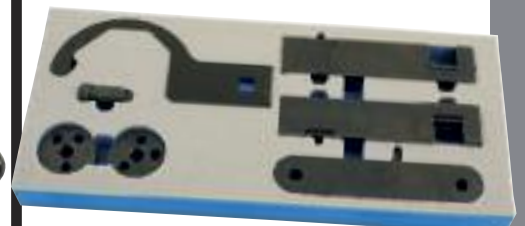

- This kit provides the required timing tools to lock the camshaft and crankshaft in their timed position on the post 2010 V8 5.0 petrol engines in the Land Rover ranges

Discovery 4, 5.0 V8 (2010 on)
RX1845
 PRICE EX VAT (OUTSIDE EU) **£199.00** PRICE INC VAT (UK @ 20%) **£238.80**  Made in Sheffield

Range Rover

The special tools you need to give your Range Rover the care it deserves.

Engine Timing Tools

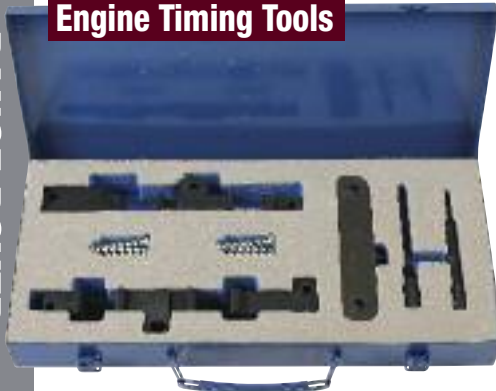

- Designed to lock the camshafts and crankshafts in their timed position for engine rebuilds and timing chain replacement on the Land Rover 3.6 TDV8 diesel engine
- Equivalent to OEM No. 303-1236, 303-1243, 303-1239, 303-1238
- Packed in a foam tray and metal tin

Range Rover Sport, Range Rover 3.6 TDV8 (2006 on)

RX1844

PRICE EX VAT (OUTSIDE EU) **£215.00** PRICE INC VAT (UK @ 20%) **£258.00**



Knuckle Ball Joint Tool



- This kit has been designed to allow the top and bottom steering ball joints fitted to the Land Rover and Range Rover models listed below to be replaced with the axle casing attached to the vehicle
- Upper and lower ball joints
- On vehicle solution
- Equivalent to OEM No. 205-718, 205-732, 205-733, 205-719

Range Rover P-38 (1995-02)

RX1847

PRICE EX VAT (OUTSIDE EU) **£349.50** PRICE INC VAT (UK @ 20%) **£419.40**



Engine Timing Tool Kit



- A specialised timing tool kit for Range Rover (02) 4.4
- OEM numbers and instructions included
- Also fits Morgan with M62 engine

Range Rover 4.4 V8, 44 8S 2 2003-05

RX1828

PRICE EX VAT (OUTSIDE EU) **£385.00** PRICE INC VAT (UK @ 20%) **£462.00**

Engine Timing Tool

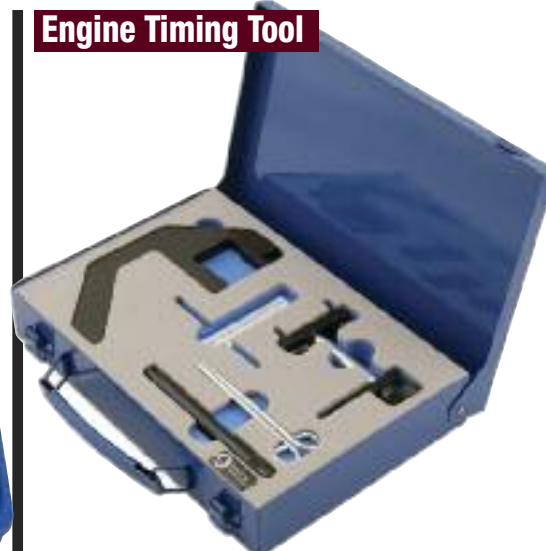

- Designed for the TD4 and TD6 engines found in Range Rover
- Upgrade component for M57, M47S available separately
- Supplied in metal case with EVA foam

Range Rover 2.0D/3.0D TD6 2000-06

LF1123

PRICE EX VAT (OUTSIDE EU) **£80.95** PRICE INC VAT (UK @ 20%) **£97.14**

Engine Timing Tools



- Specifically introduced for pre 2010 4.2, 4.4 V8 petrol engines fitted with timing chains
- The crankshaft locking pin has been especially designed to combine 2 OEM designs into one tool
- Supplied in metal case with EVA foam

Range Rover 4.2 V8 (2004-2010)

RX1548

PRICE EX VAT (OUTSIDE EU) **£154.95** PRICE INC VAT (UK @ 20%) **£185.94**



Engine Timing Tool Kit



- A 12 piece kit consisting of the components required to lock the crankshaft and camshafts in their timed position to allow the removal and replacement of the cam belt and the associated components
- Comprehensive tool kit for early Range Rover engines
- Supplied in metal storage case with instructions and application list

Range Rover 2.5 200TDi, 300TDi 1985-98

RX1610

PRICE EX VAT (OUTSIDE EU) **£199.50** PRICE INC VAT (UK @ 20%) **£239.40**



Engine Timing Tools

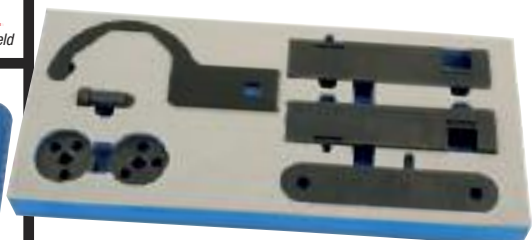

- This kit provides the required timing tools to lock the camshaft and crankshaft in their timed position on the post 2010 V8 5.0 petrol engines in the Range Rover range

Range Rover 5.0 V8 (2010 on)

RX1845

PRICE EX VAT (OUTSIDE EU) **£199.00** PRICE INC VAT (UK @ 20%) **£238.80**



Engine Timing Tool Kit

- Designed specifically for the popular chain driven 2.5 turbo diesel engine used in the Range Rover
- Supplied in blow moulded storage case



Range Rover 2.5D (1994-2002)

RX1824

PRICE EX VAT (OUTSIDE EU) **£117.50** PRICE INC VAT (UK @ 20%) **£141.00**

Crankshaft Pulley Holding Tool



- This tool provides the required components to hold the crankshaft vibration damper (crankshaft pulley) still while undoing the often very tight pulley mounting bolt found on the Range Rover vehicle listed
- Equivalent to OEM No. 303-191
- Designed to be used with a 1/2"D power bar

RX1854
PRICE EX VAT (OUTSIDE EU) **£99.50** PRICE INC VAT (UK @ 20%) **£119.40**

Crankshaft Seal Remover/installer



- Crankshaft rear oil seal removal and installation tool
- Equivalent to OEM No. 303-538
- Complete with punch to assist seal removal

RX1840
PRICE EX VAT (OUTSIDE EU) **£49.50** PRICE INC VAT (UK @ 20%) **£59.40**

Diesel Fuel Pump Locking Tool



- Used to lock the high pressure fuel pump in its timed position when changing the high pressure pump drive belt
- Equivalent to OEM No. 310-212
- Also use in conjunction with Viscous Fan Coupling tools - Part No. RX1839 & RX1831

RX1842
PRICE EX VAT (OUTSIDE EU) **£25.95** PRICE INC VAT (UK @ 20%) **£31.14**  Made in Sheffield

Propshaft Socket



- 1/2"D
- Size: 9/16"x 150mm
- Manufactured from impact quality Chrome Molybdenum
- Designed for access
- Black finish

BA3138
PRICE EX VAT (OUTSIDE EU) **£10.95** PRICE INC VAT (UK @ 20%) **£13.14**

Crankshaft Pulley Holding Tool

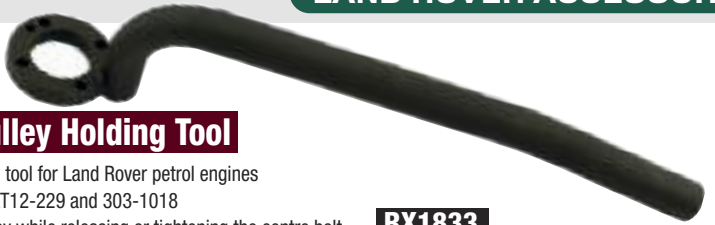

- Crankshaft pulley holding tool for Land Rover petrol engines
- Equivalent to OEM No. LRT12-229 and 303-1018
- For holding the front pulley while releasing or tightening the centre bolt

RX1833
PRICE EX VAT (OUTSIDE EU) **£42.50** PRICE INC VAT (UK @ 20%) **£51.00**

Impact Hub Nut Socket - 52mm



- Air impact deep socket
- 52mm 6pt (single hex)
- 1/2"D
- 46mm drive depth, 56mm internal depth 69mm external diameter

RTC639PSOCKET
PRICE EX VAT (OUTSIDE EU) **£13.95** PRICE INC VAT (UK @ 20%) **£16.74**

Upper Hub Bush Tool



- Lower Hub Bush
- Equivalent to OEM No. 204-516

RX1834
PRICE EX VAT (OUTSIDE EU) **£89.95** PRICE INC VAT (UK @ 20%) **£107.94**

Rear Suspension Bush Tool



- Upper Hub Bush
- For use in situ

RX1835
PRICE EX VAT (OUTSIDE EU) **£73.95** PRICE INC VAT (UK @ 20%) **£88.74**

Oil Filter Wrench 90mm x 15 Flats



- Powder coated finish
- 3/8" Drive

RX1860
PRICE EX VAT (OUTSIDE EU) **£8.50** PRICE INC VAT (UK @ 20%) **£10.20**

Diesel Injector Extractor



- Mechanical extractor that removes the injector in one piece
- Equivalent to OEM 303-1127

RX1858
PRICE EX VAT (OUTSIDE EU) **£62.50** PRICE INC VAT (UK @ 20%) **£75.00**  Made in Sheffield

Battery Conditioner



The battery conditioner is a battery charger that turns on and off automatically.
This superb product is suitable for all 12 volt batteries (from 5ah to 100ah) and constantly revitalises the battery cells - helping to extend cell life, without the danger of overcharging.

- Look at these benefits:**
- Designed to be left connected for long periods.
 - Use without disconnecting vehicle electrics.
 - L.E.D. battery condition display.
 - Thermal cut-out facility.
 - 12 month guarantee.

All models
It can also be used for the following applications, providing they use a 12 volt battery: caravans, lawn mowers, motorbikes, motor boats, wheel chairs and general leisure use. The kit is supplied complete with all fittings and operating instructions.

0.8 amp version
RX1410CTEX
PRICE EX VAT (OUTSIDE EU) **£42.50** PRICE INC VAT (UK @ 20%) **£51.00**

3.8 amp version
RX1410CTEX3800
PRICE EX VAT (OUTSIDE EU) **£63.83** PRICE INC VAT (UK @ 20%) **£76.60**

Misfuel Reset Key



- Resets the misfuelling safety device in the fuel filter after it has been activated.

LR014047
PRICE EX VAT (OUTSIDE EU) **£13.08** PRICE INC VAT (UK @ 20%) **£15.70**

Freelander

The special tools you need to give your Freelander the care it deserves.

Fuel Pump Removal Tool



- Use with or without ring dependent on application
- OEM Codes: 12-178, 303-976 short

Freelander 2.0 TD4 (Short version tool)

RX1826

PRICE EX VAT (OUTSIDE EU) **£46.95** PRICE INC VAT (UK @ 20%) **£56.34**

Diesel Injection Pump Puller



- Full engine locking tool kit also available
- Equivalent to OEM No. LRT12-119

Freelander 2.5 TD diesel engine

RX1822

PRICE EX VAT (OUTSIDE EU) **£14.50** PRICE INC VAT (UK @ 20%) **£17.40**

Engine Timing Tools



- Designed for the KV6 petrol engine. The kit is a comprehensive kit for these belt driven engines
- For KV6 engines
- Supplied in metal case with EVA foam

Freelander 2000-06

RX1609

PRICE EX VAT (OUTSIDE EU) **£249.00** PRICE INC VAT (UK @ 20%) **£298.80**



Made in Sheffield

Engine Timing Tools



- Designed for the TD4 and TD6 engines found in Freelander upgrade component for M57, M47S available separately.
- Supplied in metal case with EVA foam

Freelander 2.0 TD4 2000-06

LF1123

PRICE EX VAT (OUTSIDE EU) **£80.95** PRICE INC VAT (UK @ 20%) **£97.14**



Made in Sheffield

Diesel Timing Kit



- A set of timing pins for Rover vehicles with 20T diesel engines

Freelander 2.0 TD (20 T engine) 1997-2000

RX1818

PRICE EX VAT (OUTSIDE EU) **£14.49** PRICE INC VAT (UK @ 20%) **£17.39**



Made in Sheffield

Diesel Injection Pump Puller



- Specifically designed for holding the sprocket chain in place when disassembling the VP44 Injection pump and high pressure pump common rail
- Specialist timing tool
- OEM Codes: 12-178

Freelander 2.0 TD4 diesel engine

RX1825

PRICE EX VAT (OUTSIDE EU) **£34.95** PRICE INC VAT (UK @ 20%) **£41.94**



Freelander 2 & Evoque

The special tools you need to give your Freelander or Evoque the care it deserves.

Crankshaft Seal Remover/Installer



- Crankshaft rear oil seal removal and installation tool
- Equivalent to OEM No. 303-538
- Complete with punch to assist seal removal

Freelander 2 (05-10)

RX1840

PRICE EX VAT (OUTSIDE EU) **£49.50** PRICE INC VAT (UK @ 20%) **£59.40**

Ratchet Wrench Oil Wrench - 27mm



- 27mm x 1/2"D with switchable Bi-hex ratchet head
- Application: Euro 6 compliant engines from 2010 onwards
- Chrome plated Chrome Vanadium
- Equivalent to OEM No. 303-1579

Evoque, Freelander 2.2 TDi

RX1837

PRICE EX VAT (OUTSIDE EU) **£44.50** PRICE INC VAT (UK @ 20%) **£53.40**

Diesel Fuel System Bleeder Kit

- Hand pressure pump and 4 adaptors
- For bleeding the system after fitting new filter or other maintenance on the fuel system



Freelander 2 (2.2 TDCi - DW)

RX1830

PRICE EX VAT (OUTSIDE EU) **£109.50** PRICE INC VAT (UK @ 20%) **£131.40**

Fuel Tank Sender Wrench



- To remove/replace the fuel pump locking ring
- 19mm Hex Drive
- External diameter 140mm, Internal diameter 115mm
- Equivalent to OEM No. 310-118

Freelander TD4, TD5 diesel models

RX1838

PRICE EX VAT (OUTSIDE EU) **£38.95** PRICE INC VAT (UK @ 20%) **£46.74**

Oil Filter Socket - 27mm



- Removes paper filters without damage to the filter housing
- 27mm face drive, 3/8"D
- Manufactured from Chrome Vanadium

Evoque, Freelander 2.2 TDi

RX1819

PRICE EX VAT (OUTSIDE EU) **£6.95** PRICE INC VAT (UK @ 20%) **£8.34**

Timing Pin Set



- Specific kit supplied for DOHC common rail diesel engines

Freelander 2 2.2 TD4 2006-2015, Evoque 2011-2015 (224DT)

LF1109

PRICE EX VAT (OUTSIDE EU) **£49.95** PRICE INC VAT (UK @ 20%) **£59.94**

Adjustable EPB Brake Adaptor 3 Pin - 2 Pin Drive



- Adjustable 3 pin adaptor with standard 2 pin drive
- Adjustable to fit many modern vehicles
- Registered design

Evoque (with EPB)

RX1836

PRICE EX VAT (OUTSIDE EU) **£23.95** PRICE INC VAT (UK @ 20%) **£28.74**

GEN2 Wheel Bearing Kit - 82mm



- For 82mm diameter front wheel bearings

Freelander

RX1832

PRICE EX VAT (OUTSIDE EU) **£220.00** PRICE INC VAT (UK @ 20%) **£264.00**

Timing Tool Kit 2.0 Engine



- Engine code 204PT
- Equivalent to the following OEM numbers: 303-1600, 303-1595, 303-1521, 303-1521, 303-1594, 303-748

Freelander 2 2012>2015 Si4, Range Rover Evoque 2011>2016 Si4, *also fits Discovery Sport 2015>2016, Si4.

RX1859

PRICE EX VAT (OUTSIDE EU) **£129.50** PRICE INC VAT (UK @ 20%) **£155.40**



Made in Sheffield

Misfuel Reset Key



- Resets the misfuelling safety device in the fuel filter after it has been activated.

Freelander 2, Range Rover Evoque (all models)

Also fits Discovery 3 & 4, Discovery Sport, Range Rover Sport (all models) & Range Rover L405 (2012 on)

LR014047

PRICE EX VAT (OUTSIDE EU) **£13.08** PRICE INC VAT (UK @ 20%) **£15.70**

ORDER

BY PHONE: 01522 568000 / ON LINE: www.rimmerbros.co.uk / E-MAIL: lrsales@rimmerbros.co.uk

*Prices include UK VAT @ 20%.

GENERAL TOOLS

Viscous Fan Wrench Set - 3pc



- Use in pairs according to application
- Slim fit design to allow for limited under bonnet access.
- Equivalent to OEM No. 303-1142, 303-1143, 303-1167

Land Rover models post 2006 (V8 petrol & diesel)

RX1839
PRICE EX VAT (OUTSIDE EU) £89.50 PRICE INC VAT (UK @ 20%) £107.40
Made in Sheffield

Viscous Fan Wrench Set - 2pc



- Viscous fan spanner set for Land Rover
- 1 x 36mm open ended and 1 x 5 holed 'horse shoe' design
- Equivalent to OEM No. 303-904

Land Rover models pre 2006 (V8 petrol & TD5 diesel)

RX1831
PRICE EX VAT (OUTSIDE EU) £69.95 PRICE INC VAT (UK @ 20%) £83.94
Made in Sheffield

Sump Ket Set - 5pc



All Models
RX1515
PRICE EX VAT (OUTSIDE EU) £12.95 PRICE INC VAT (UK @ 20%) £15.54

Valve Spring Compressor



Overhead Cam

All Models
RX12260HC
PRICE EX VAT (OUTSIDE EU) £31.50 PRICE INC VAT (UK @ 20%) £37.80



Overhead Valve

All Models
RX12260HV
PRICE EX VAT (OUTSIDE EU) £26.25 PRICE INC VAT (UK @ 20%) £31.50

Classic Leather Tool Bag

- 150mm x 145mm x 380 mm
- Heavy Duty Oiled Leather
- 3 Buckle Straps

All Models
RX1856
PRICE EX VAT (OUTSIDE EU) £44.95 PRICE INC VAT (UK @ 20%) £53.94

Coil Spring Compressor



All Models
RX1328
PRICE EX VAT (OUTSIDE EU) £31.50 PRICE INC VAT (UK @ 20%) £37.80

Oil Filter Socket

- 3/8" Drive
- Defender Puma, Freelander 1 (TD4), Range Rover L322 (M57 3.0Ltr Diesel & M62 4.4 V8 Petrol).



LL1738P
PRICE EX VAT (OUTSIDE EU) £7.95 PRICE INC VAT (UK @ 20%) £9.54

Strap Oil Filter Wrench

- 1/2" Drive
- Carbon Steel
- Zinc Plated
- 120mm Capacity



All Models
RX1514
PRICE EX VAT (OUTSIDE EU) £6.75 PRICE INC VAT (UK @ 20%) £8.10

14mm Flexible Spark Plug Wrench

All Models
GAT140
PRICE EX VAT (OUTSIDE EU) £6.25 PRICE INC VAT (UK @ 20%) £7.50

Diesel Injector Socket

- 1/2" Drive
- 27mm with Window
- Chrome Vanadium
- Bi-Hex 12 Point



All Models
RX1864
PRICE EX VAT (OUTSIDE EU) £12.90 PRICE INC VAT (UK @ 20%) £15.48

Radius Arm Bush Removal Tool

Required for front arm radius bush.



Range Rover Classic, P38, Discovery 1 & 2 & Series

LRT-60-004P
PRICE EX VAT (OUTSIDE EU) £99.50 PRICE INC VAT (UK @ 20%) £119.40

Grease Gun



All Models
RX1423
PRICE EX VAT (OUTSIDE EU) £21.50 PRICE INC VAT (UK @ 20%) £25.80
500cc Lever Action

Pop Rivet Gun



Includes 30 Assorted Rivets

All Models
RX1647
PRICE EX VAT (OUTSIDE EU) £16.99 PRICE INC VAT (UK @ 20%) £20.39

Brake Pipe Corrosion Tool



All Models
BA4873
PRICE EX VAT (OUTSIDE EU) £9.50 PRICE INC VAT (UK @ 20%) £11.40

Radiator Comb Cleaner

Removes debris from radiator fans as well as reshaping damaged or bent grille fins.



All Models
RX1817
PRICE EX VAT (OUTSIDE EU) £5.95 PRICE INC VAT (UK @ 20%) £7.14

Flywheel Locking Tool



Defender from (VIN) 7A00001 on
303-698P
PRICE EX VAT (OUTSIDE EU) £6.25 PRICE INC VAT (UK @ 20%) £7.50

Double Ended Viscous Fan Spanner



All Models
RX1645P
PRICE EX VAT (OUTSIDE EU) £12.50 PRICE INC VAT (UK @ 20%) £15.00
32m x 36mm

Magnetic Parts Tray

Keep small steel parts, screws & bolts where you need them.



All Models
CONS8500
PRICE EX VAT (OUTSIDE EU) £8.49 PRICE INC VAT (UK @ 20%) £10.19

Steering Drop Arm Puller 57.5mm

- Using this puller will ensure the steering box shaft and oil seal remain intact
- Application: Land Rover Series II, Series IIA, Series III
- Over time the steering drop arm and the steering box splines corrode together making it difficult to remove the drop arm
- Always grease threaded bar.

RX1973 PRICE EX VAT (OUTSIDE EU) £37.95 PRICE INC VAT (UK @ 20%) £45.54

Steering Drop Arm Puller 43mm

- Using this puller will ensure the steering box shaft and oil seal remain intact
- Application: Land Rover Defender, 90, 110, 130 1987-2006
- Over time the steering drop arm and the steering box splines corrode together making it difficult to remove the drop arm
- Always grease threaded bar.

RX1974 PRICE EX VAT (OUTSIDE EU) £42.50 PRICE INC VAT (UK @ 20%) £51.00

Heat Torch Kit with Heat Shrink Tube (162 piece)

- Assorted coloured tubing and sizes: 1 x 15mm x 500mm Black Tube, Tubes supplied in Red, Green, Blue, Yellow, White and Clear: 1.5mm x 60pc, 2.5mm x 35pc, 3mm x 25pc, 5mm x 20pc, 6mm x 10pc, 10mm x 10pc
- Heat Shrink Tubing meet ROHS directive.
- Operating temperature range: -55°C to +125°C,
- Manufactured from G5 general purpose, polyolefin tubing
- Characteristics: shrinkage ratio 2:1, very flexible, highly flame retardant, resistant to common fluids and solvents
- Mini Butane gas torch supplied with full instructions. Capacity 6ml, Operating time 20mins, Approximate temperature <1300°C, GS/TUV certificated

Heat shrink tubing is the ideal way to repair and refurbish worn and cracked insulation of vehicle wiring or to insulate new wiring connections when adding accessories. This new kit from Laser Tools includes a butane gas powered heat torch as well as a useful and generous selection of heat shrink tubing.

It can be tempting to use a flame on heat shrink tubing, but this heat is uncontrolled and unless great care is taken the tubing can burn and become damaged. The butane powered gas torch in the kit provides a very soft, even heat that is ideal for heat shrink work. The heat shrink tubing supplied has a shrinkage ratio of 2:1 and remains very flexible after shrinkage. A selection of tube sizes and colours is supplied from 1.5 mm diameter up to 15 mm. All you need for quick and professional repairs with everything required in one convenient box.

RX1968 PRICE EX VAT (OUTSIDE EU) £22.90 PRICE INC VAT (UK @ 20%) £27.48

Alignment Tool for Automatic Gearboxes

- Alignment tool for JLR Auto gearbox selector
- Applications include Land Rover V8 Defender, Land Rover Discovery 1 and 2(1990 to 2005), Range Rover Classic and P38 (1994 to 2002) where fitted with ZF4HP22, ZF4HP24, ZF4HP44 automatic gearboxes
- An essential tool for the correct setting and alignment of the XYZ switch (gear selector position and starter inhibitor switch) on the automatic gear boxes
- Equivalent to OEM 307-498 and LRT-44-011
- Made in Sheffield

RX1972 PRICE EX VAT (OUTSIDE EU) £31.50 PRICE INC VAT (UK @ 20%) £37.80

Polarity Circuit Tester - Cordless



This tool tests the polarity instantly, locating short circuits without wasting fuses and finds bad ground/earth contacts. Test polarity without connecting jumper wires. Tests include: Cooling fans, window regulator motors, electronic fuel pumps, relays, lamps etc. Computer safe for use around sensitive engine management systems

- Locates short circuits.
- Finds bad ground/earth contacts.
- Test polarity without connecting the jumper wires.
- Instant testing saving time.
- CE and RoHS compliant.

The Gunson Polarity Tester is suitable for 6, 12, 24 volts.

RX1959 PRICE EX VAT (OUTSIDE EU) £1.95 PRICE INC VAT (UK @ 20%) £2.34

Temperature Sensor Socket

Modern Land Rover Diesel engines are equipped with exhaust particulate filtration systems (DPF). In order for the systems to perform correctly the engine control system must know the exhaust temperature. This makes the EGT sensor an important and integral part of the system

- Applications: Range Rover L322-2011-2012, Range Rover L405-2013-2014, 2015, 2016, 2017, Range Rover Sport L494 -2014, 2015, 2016 ,2017
- Required to remove/install the exhaust gas temperature sensor
- Equivalent to OEM No: 303-1573
- 13mm Bi Hex x 6mm deep. Socket equipped with a 13mm hex to use with appropriate spanner or wrench
- Manufactured in Sheffield

RX1976 PRICE EX VAT (OUTSIDE EU) £20.95 PRICE INC VAT (UK @ 20%) £25.14

Crankshaft Trigger Wheel Installer

- Required to install the crankshaft position Sensor Ring on Discovery 3/4, Range Rover Sport when fitted with TDV6 engine (3 Powertrain)
- Equivalent to OEM 303-1130
- Overall dimension: 125mm
- Specifically requested to repair sensor wheel dropping off or cracking

RX1975 PRICE EX VAT (OUTSIDE EU) £59.95 PRICE INC VAT (UK @ 20%) £71.94

Automotive Fuse Tester 4in1

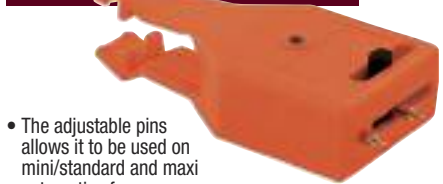

- The adjustable pins allows it to be used on mini/standard and maxi automotive fuses.
- The battery is DC15V and can last more than 100,000hrs with LED bulb.
- Ideal glove box tool.
- Space saver.

Ideal for both the toolbox and the glovebox, this handy automotive fuse tester from Gunson quickly and conveniently checks for blown fuses. The adjustable pins allow it to be used on mini, standard and maxi sized automotive fuses. If the fuse is 'good' the LED illuminates. If the fuse needs replacing then the reverse of the tester is used to unclip and remove the fuse.

RX1967 PRICE EX VAT (OUTSIDE EU) £7.90 PRICE INC VAT (UK @ 20%) £9.48

Hog Ring Pliers (Auto Feed Type)



- Complete with automatic feed.
- Ideal for continuous connections.
- Single handed operation.
- Ideal for seating on classic cars, fencing, bird pens, sealing bags and particularly car upholstery restoration
- Compatible with C Ring G616 and 16G.

The preformed strips of 50 Hog Rings (Size 07) feed easily into the tool.

RX1964 PRICE EX VAT (OUTSIDE EU) £31.50 PRICE INC VAT (UK @ 20%) £37.80

Hog Rings (Box of 500) for RX1964 above

Galvanised Hog Rings suitable for use with the Laser Hog Ring Pliers 500 per pack 17.4mm>7mm closed Compatible with C Ring G616 and 16G

RX1965 PRICE EX VAT (OUTSIDE EU) £4.95 PRICE INC VAT (UK @ 20%) £5.94

Brake Fluid Tester

A simple and effective tester shows the condition of the brake fluid with a coloured response.

- Test percentage of water in the brake fluid
- Immerse the probe end of the tester into the brake fluid - use regularly for brake maintenance
- Green indicates <1.5%water = ok
- Yellow indicates 1.5>3%water = marginal
- Red indicates 3%



RX1960 PRICE EX VAT (OUTSIDE EU) **£19.50** PRICE INC VAT (UK @ 20%) **£23.40**

Adjustable Thread Restorer M4-M45



- Quick-adjustable Thread Restorer - 55-60 angle blade
- Adjustable cuts: M4-M45, Capacity: 5/32" to 1-3/4"(4-45mm)
- Angled blades manufactured from HSS steel to 55-60 hardness (HSS blade, HRc62(+/-2))
- Zinc body, Chrome plated
- Quick and easy to use

RX1969 PRICE EX VAT (OUTSIDE EU) **£25.50** PRICE INC VAT (UK @ 20%) **£30.60**

Hose Clamp (set of 3)



- Ideal for use on flexible hose lines on brakes / fuel / heater and radiators.
- Lightweight, non-conductive material.
- High viz colour for easy location.
- Single handed use.
- With jaws of 1/2" to 3/4" diameter.
- Plastic construction reduces risk of shorting electrical systems.

RX1961 PRICE EX VAT (OUTSIDE EU) **£13.25** PRICE INC VAT (UK @ 20%) **£15.90**

Hose Clamp Tool (Bar type)



- Clamps any hose simply and effectively.
- Chrome plated bars.
- Use on brake, fuel and heater hoses.
- No sharp edges.
- Ensures complete clamp.

RX1962 PRICE EX VAT (OUTSIDE EU) **£7.95** PRICE INC VAT (UK @ 20%) **£9.54**

Oil Change Kit (5 Piece)



- Contents include: 6L oil drain pan - 370mm dia x 115mm deep
- Plus: Funnel 140mm dia x 130mm long
- Plus: oil absorption mat 400mm x 500mm (will soak up oil only)
- Blue bag for disposing of hazardous waste 500mm x 600mm and 2x cable ties 200mm long
- Oil waste should be disposed of responsibly in line with local regulations

If you're planning on changing the engine oil on your pride and joy over the weekend, then make the job easier on yourself by picking up one of these Oil Drain Kits.

RX1955 PRICE EX VAT (OUTSIDE EU) **£9.50** PRICE INC VAT (UK @ 20%) **£11.40**

Drip Tray - Plastic



- Size: 24" x 18" x 3/4" (609mm x 457mm x 19mm)
- Manufactured from Plastic
- Pouring spout in corner
- Protect your drive and garage floors from oil drips
- Also useful when transferring fluids to avoid workshop floor contamination

RX1956 PRICE EX VAT (OUTSIDE EU) **£4.29** PRICE INC VAT (UK @ 20%) **£5.15**

Canvas Tool Rolls

A great bit of kit with plenty of storage slots and a large front pocket for nuts and bolts, spare spark plugs etc. Keeps those essential maintenance tools to hand whilst stopping them from rattling around behind the seats. With handy carry strap and heavy duty traditional roll up straps, made from very hard wearing Land Rover canvas.

In keeping with earlier Land Rovers and Defenders with traditional straps and buckles. Available to match your hood colour in Khaki, Sand or Blue canvas.



Please note, tools not included.

Khaki EXT294-7 PRICE EX VAT (OUTSIDE EU) **£29.50** PRICE INC VAT (UK @ 20%) **£35.40**

Sand EXT294-8 PRICE EX VAT (OUTSIDE EU) **£29.50** PRICE INC VAT (UK @ 20%) **£35.40**

Blue EXT294-9 PRICE EX VAT (OUTSIDE EU) **£29.50** PRICE INC VAT (UK @ 20%) **£35.40**

WHEEL WRENCHES



LR011870SPIN



LR011870P1

Wheel Wrenches

Model	Part Number	Price Ex VAT	Price Inc VAT*
15/16" Wheel Wrench	537179P	10.21	12.25
27mm Heavy Duty Wheel Wrench	595336HDBP	5.62	6.74
27mm Wheel Wrench			
Aftermarket	LR011870BP	2.95	3.54
OEM	LR011870P1	9.37	11.24
Genuine	LR011870	12.64	15.17
27mm Spinner Wheel Wrench	LR011870SPIN	16.87	20.24

Wheel Chocks



Defender, Discovery 1, Range Rover P38

Each

ANR3052 PRICE EX VAT (OUTSIDE EU) £7.27 PRICE INC VAT (UK @ 20%) £8.72



Discovery 3 & 4, Freelander 1, Range Rover Sport (2010-13)

Each

ANR5449 PRICE EX VAT (OUTSIDE EU) £5.72 PRICE INC VAT (UK @ 20%) £6.86

Wheel Nut Cap Remover Tool



Defender, Discovery 1 & 2, Range Rover P38

ANR5436P1 **OEM**

PRICE EX VAT (OUTSIDE EU) £4.58 PRICE INC VAT (UK @ 20%) £5.50

ANR5436 **Genuine**

PRICE EX VAT (OUTSIDE EU) £5.54 PRICE INC VAT (UK @ 20%) £6.65



Freelander 1

KBP10001P **Aftermarket**

PRICE EX VAT (OUTSIDE EU) £2.83 PRICE INC VAT (UK @ 20%) £3.40

KBP10001 **Genuine**

PRICE EX VAT (OUTSIDE EU) £2.95 PRICE INC VAT (UK @ 20%) £3.54



All Models

Pair

LL1464BP PRICE EX VAT (OUTSIDE EU) £29.99 PRICE INC VAT (UK @ 20%) £35.99

ORDER

BY PHONE: 01522 568000 / ON LINE: www.rimmerbros.co.uk / E-MAIL: lrsales@rimmerbros.co.uk

*Prices include UK VAT @ 20%.

DIAGNOSTIC TOOLS

HawkEye Total

A powerful diagnostic tool for Land Rovers

Benefits:

- Ready to use out of the box
- No batteries required
- Unlocked for Land Rover vehicles
- Comes with handy carry pouch
- Simple to use
- Identifies faults quickly and accurately
- Fits in glove compartment or cubby box
- No laptop required



Est. UK1958
Bearthmach
PARTS FOR LAND ROVERS



Bearthmach's HawkEye Total diagnostic tool is truly portable and simple to use by the home mechanic and professionals alike. The HawkEye Total will assist you in fixing the problem and getting your Land Rover back on the road as soon as possible. It has the complete Land Rover package installed, and all models (year dependent) are unlocked and ready to use on this unit.

The diagnostic tool is robust and comes with its own storage pouch. The keypad has well defined buttons and is powered directly from the vehicle. The clear graphical display is easy to read and features on-screen prompts.

The specific applications will allow you to access information from your vehicle. Functionality includes READ and CLEAR fault codes, LIVE DATA, ACTUATORS, Electronic Control Module data.

All Models

BA5068 PRICE EX VAT (UK/SIDE EU) **£249.17** PRICE INC VAT (UK & 20%) **£299.00**

Lynx Evo - Ideal for the workshop & home user*



What is Lynx Evo?

Lynx Evo is the next generation diagnostic tool for Land Rover vehicles. Offering market leading diagnostics from a powerful and mobile design. Lynx Evo provides full vehicle servicing and in depth diagnostic capability for all Land Rover models from 1990 through to current day. Ideal for the workshop and home user.

Live data can also be displayed using numerics and graphics making it easier to read time based events on your Land Rover. This small but powerful Dongle requires no batteries as it uses the vehicles power. For the enthusiast home user, using Lynx Evo will mean no more trips to your local main dealer to clear any faults on your Land Rover.

Lynx Evo is compatible with iOS and Android mobile devices with apps available for download from the Apple App Store and Android Play Store. As the software is App Store based and is loaded onto your mobile device, updates are as easy to do as any other mobile app, simply click the update icon. Lynx Evo is manufactured by the company who supply Land Rover with their T4H Legacy diagnostic product.

*Not suitable for USA, Australia or New Zealand.

Key Features:

- Read & display live data
- Mobile device based
- Easy to use
- Unlocked ready to cover an entire Land Rover model family
- Upgrade software over app store
- Quickly checks your Land Rover for faults
- Small enough to store in glove box

What does Lynx Evo do?

- Read fault codes
- Clear fault codes
- Read & display live data
- Test actuators
- Programming - such as alarm settings, key fobs etc. on selected models
- Service reset



All Models

DA1500 PRICE EX VAT (UK/SIDE EU) **£255.83** PRICE INC VAT (UK & 20%) **£307.00**

Terrafirma
Serious 4x4 Accessories

Terrafirma Hand Held Diagnostic Tool

Professional multi-system scanner TF930 for Land Rover



- Full system diagnosis tool enabling DIY problem solving - all at a bargain price!
- Read and clear diagnostic trouble codes, read live data stream.
- Multi-language.
- Test modes include: CANBUS, ISO9141, KWP2000 AND J1850.

Key Features:

- 1 Fast full colour screen
- 2 USB 2.0 high speed upgrades
- 3 Support of multi-language
- 4 Read and clear Diagnostic Trouble Codes
- 5 Read live data stream
- 6 Full System Diagnosis
- 7 Pre-programmed for Land Rover

The Kit Includes:
Handheld scanner, OBDII connector, USB 2.0 cable, User manual, Protective case, 12-month warranty, Free updates

All Models

TF930 PRICE EX VAT (UK/SIDE EU) **£95.83** PRICE INC VAT (UK & 20%) **£115.00**

LAND ROVER ACCESSORIES

FLUIDS - ANTIFREEZE, SCREENWASH & WINTER ACCESSORIES

Anti-Freeze

The inclusion of a glycol based Anti-Freeze in winter helps prevent the engine coolant from freezing up and blowing a hose or radiator core (or worse!).

However, it's not just during the winter that you need protection for your engine and radiator. Using anti-freeze during the summer improves the effectiveness of the coolant by helping to remove the heat from the block and dispersing it more efficiently, even in the worst traffic jam! It also protects from corrosion damage.



GENUINE LAND ROVER

Anti-Freeze

Description	Part Number	Price ex VAT (Outside EU)	Price inc VAT (UK @ 20%)
XPart Anti-Freeze			
1 Litre	GAC2018X	4.58	5.50
5 Litre	GAC2019	19.98	23.98
Genuine Land Rover (Extended Life) Anti-Freeze			
1 Litre	STC50529	11.42	13.70
5 Litre	STC50530	42.31	50.77
20 Litre	8510373	125.08	151.08
Genuine Land Rover Anti-Freeze			
<i>Suitable for Range Rover Classic (1976 to 1995), Range Rover P38 to (VIN) XA159811, Range Rover L322 to (VIN) 6A99999, Discovery 1, Defender 200TDi, 300 TDi & V8, Freelander 1 (1996 - 1999).</i>			
1 Litre	PDA500300	9.36	11.23
XPart Oat Anti-Freeze			
1 Litre	XP1LL	4.00	4.80
5 Litre	XP5LL	19.13	22.96
20 Litre	XP20LL	70.14	84.17

The Xpart OAT Antifreeze Concentrate has a 5 year life and is suitable for all year use as a coolant and anti-freeze. The silicate free, organic acid technology (OAT) provides superior engine protection and is compatible with all vehicle manufacturers' colours of OAT coolants.

- 5 Year Life
- Suitable for all year round - anti freeze / summer coolant
- Temperature range from +108C / -34C
- Suitable for most vehicles manufactured after 1998
- Silicate free, organic acid technology (OAT) for superior engine protection
- Compatible with all vehicle manufacturers' colours of OAT coolants
- Enhanced corrosion protection

* If in any doubt, always refer to manufacturers recommendations & handbooks.



De-Icer



500ml Trigger
S3SGD1520

PRICE EX VAT (OUTSIDE EU) **£1.96**

PRICE INC VAT (UK @ 20%) **£2.35**



300ml Aerosol
RX1586

PRICE EX VAT (OUTSIDE EU) **£1.83**

PRICE INC VAT (UK @ 20%) **£2.20**

Screenwash



Summer & Winter
1 Litre
XP1SW

PRICE EX VAT (OUTSIDE EU) **£1.78**

PRICE INC VAT (UK @ 20%) **£2.14**

Ice Scraper Mitt



RX4090

PRICE EX VAT (OUTSIDE EU) **£2.58**

PRICE INC VAT (UK @ 20%) **£3.10**

Folding Snow Shovel



- Heavy duty forged steel
- Serrated blade
- Folded length 235mm
- Open length 580mm
- Easy to assemble
- Soft storage pouch with belt loop

2T839280

PRICE EX VAT (OUTSIDE EU) **£13.12**

PRICE INC VAT (UK @ 20%) **£15.74**

Masai Vehicle Shovel



- Supplied with mounting brackets
- Aluminium/plastic construction
- Ideal for Defender, but can be fitted to many vehicles
- Rubber mounting points
- Easy to fit

LL1859

PRICE EX VAT (OUTSIDE EU) **£5.94**

PRICE INC VAT (UK @ 20%) **£7.14**

Waterless Coolants



Life Time Cooling

No Water - No Overheating

Classic Cool 180° has a boiling point of 180°C and will not boil over.

No Water - No Corrosion

Water contains oxygen, oxygen allows corrosion. Classic Cool 180° eliminates corrosion.

No Water - No Pressure

Classic Cool 180° allows your cooling system to run at a lower pressure, reducing the strain on engine components.

No Water - No Liner Pitting

Classic Cool 180° generates significantly less pitting when compared with all water based coolants.

No Water - More BHP

Classic Cool 180° eliminates premature detonation associated with overheating.



Waterless Coolants

Description	Part Number	Price ex VAT (Outside EU)	Price inc VAT (UK @ 20%)
Evans Classic Cool 180 - Waterless Coolant			
2 Litre	RX1673	25.00	30.00
5 Litre	RX1672	54.17	65.00
Evans Power Cool 180 - Waterless Coolant <i>Formulated specifically for use with modern alloy/performance Engines.</i>			
2 Litre	RX1704	25.00	30.00
5 Litre	RX1703	54.17	65.00
Evans Auto Cool 180 - Waterless Coolant <i>Auto Cool 180 has the same characteristics as Classic Cool 180 but is formulated specifically for use in modern applications from about 1993 onwards.</i>			
2 Litre	RX1716	25.00	30.00
5 Litre	RX1715	54.17	65.00
Evans Vintage Cool 180 - Waterless Coolant <i>Formulated specifically for use with vintage Engines.</i>			
2 Litre	RX16972	25.00	30.00
5 Litre	RX1697	54.17	65.00
Evans Prep Fluid <i>Actively removes the loose dirt and scale from your cooling system which can cause inefficient heat transfer.</i>			
2 Litre	RX16742L	13.33	16.00
5 Litre	RX1674	33.33	40.00

Radiator Relief

Cooling System Additive

Radiator relief allows your radiator to transfer heat more efficiently, reducing your engines operating temperature (which is obviously controlled by the thermostat) by up to 30°F. You therefore have 'a little bit in hand' for those hot days stuck in traffic. This proven coolant additive will also cut engine warm-up time in half which will reduce engine wear which is most extreme when the engine is cold. Fully compatible with water and anti-freeze and is safe with cast iron and all alloys.

- 30°F lower operating temperature
- 50% quicker warm up time
- Safe with water/anti-freeze mixture
- Safe with cast iron, alloy engines and heads
- Increased engine life!
- 100% biodegradable, non corrosive, non toxic
- For use in all water cooled engines

473ml

Treats one engine

RX1461-473

PRICE EX VAT (OUTSIDE EU) **£16.49** PRICE INC VAT (UK @ 20%) **£19.75**



Grease



Holts Radweld



- Seals leaks in minutes
- Simply pour & fix
- No clogging or damaging effect
- Prevent future leaks

250ml

RX1508

PRICE EX VAT (OUTSIDE EU) **£4.25**

PRICE INC VAT (UK @ 20%) **£5.10**

Kalimex K-Seal Permanent Coolant Leak Repair

The simple to use and permanent cooling system repair **GUARANTEED to last for the life of your engine!** Mixes with all types of anti-freeze & coolant.

DON'T WASTE MONEY ON QUICK FIX 'GET YOU HOME' PRODUCTS. K-SEAL REALLY IS PERMANENT FOR THE LIFE OF YOUR ENGINE.

Save Time & Money

Avoid time consuming and expensive mechanical repairs which could cost you hundreds of pounds. Repairs most leaks in the engine block or cooling system.

Just shake - pour in - and go!

K-Seal® is specially formulated to permanently seal most cracks in the engine block and head. This unique product is guaranteed to mix with all types of glycol based coolant and anti-freeze. K-Seal® can also be used to seal holes and cracks in the head gasket, radiator, heater core, freeze plugs, water pump casing and other metal components of the cooling system in both petrol and diesel engines.

RX1554

PRICE EX VAT (OUTSIDE EU) **£10.42** PRICE INC VAT (UK @ 20%) **£12.50**



Description	Part Number	Price ex VAT (Outside EU)	Price inc VAT (UK @ 20%)
Rubber Grease Sachet			
50gms	514578P	1.50	1.80
Lithium EP2 Grease			
500g (Tin)	CONSF081160	5.95	7.14
Copper Grease			
70g	RX1345	4.67	5.60
500g	RX1585	8.96	10.75
Water Pump Grease			
500gms	RX1793	6.04	7.25
Red Rubber Grease			
500gms	RX1794	7.08	8.50
Castrol Classic Multi-Purpose High Temp			
400gms	RX1796	6.67	8.00
Swivel Housing Grease			
Genuine	STC3435	7.85	9.42
Britpart			
Bottle	STC3435BPBOTTLE	4.79	5.75
Sachet	STC3435BPSACHET	4.38	5.26
OEM	STC3435P1	5.00	6.00



Castrol Classic XL 20W/50

For Pre-1980 classic cars and motorcycles. A conventional multigrade engine oil of good all round performance, formulated with high quality mineral oils plus selected additives ideally suited to older technology engines. Castrol Classic XL 20W/50 offers excellent oil consumption and very high level of engine wear protection.



RX1363 4.55 Litres
 PRICE EX VAT (OUTSIDE EU) **£21.87** PRICE INC VAT (UK @ 20%) **£26.24**

RX13631L 1 Litre
 PRICE EX VAT (OUTSIDE EU) **£6.87** PRICE INC VAT (UK @ 20%) **£8.24**



Castrol Classic XL30 Monograde

For pre 1950 veteran, vintage and classic cars. A high quality monograde engine oil which is also used in most types of manually operated gearboxes fitted to vintage and classic cars. Offers excellent cold temperature starting and improved oil pressure at high operating temperatures.

RX15701L 1 Litre
 PRICE EX VAT (OUTSIDE EU) **£6.67** PRICE INC VAT (UK @ 20%) **£8.00**

RX1570 4.55 Litres
 PRICE EX VAT (OUTSIDE EU) **£24.37** PRICE INC VAT (UK @ 20%) **£29.24**

Castrol Oil Jugs



RX1395 Half Pint
 PRICE EX VAT (OUTSIDE EU) **£8.96** PRICE INC VAT (UK @ 20%) **£10.75**

RX1396 One Pint
 PRICE EX VAT (OUTSIDE EU) **£11.04** PRICE INC VAT (UK @ 20%) **£13.25**

RX1397 Two Pint
 PRICE EX VAT (OUTSIDE EU) **£12.71** PRICE INC VAT (UK @ 20%) **£15.25**

RX1398 Set of Three
 PRICE EX VAT (OUTSIDE EU) **£27.50** PRICE INC VAT (UK @ 20%) **£33.00**

Castrol Classic Umbrella



RX1811
 PRICE EX VAT (OUTSIDE EU) **£26.25** PRICE INC VAT (UK @ 20%) **£31.50**

Castrol Classic Tin Mug



RX1395MUG
 PRICE EX VAT (OUTSIDE EU) **£6.04** PRICE INC VAT (UK @ 20%) **£7.25**

Castrol Windscreen Sticker



RX1807W
 PRICE EX VAT (OUTSIDE EU) **£0.42** PRICE INC VAT (UK @ 20%) **£0.50**

Castrol Body Stickers



RX18075 5" Sticker
 PRICE EX VAT (OUTSIDE EU) **£1.67** PRICE INC VAT (UK @ 20%) **£2.00**

RX180710 10" Sticker
 PRICE EX VAT (OUTSIDE EU) **£2.17** PRICE INC VAT (UK @ 20%) **£2.60**

Large Oil Drip Tray



See page 127 for plastic option

GAC9905X
 PRICE EX VAT (OUTSIDE EU) **£25.71** PRICE INC VAT (UK @ 20%) **£30.85**

635mm x 1200mm Galvanised steel.

Oil Drip Absorbent Mat



Absorbs Oil only (not water)
 Plastic Film backing for floor protection
 100% Polypropylene
 1000mm x 800mm x 2mm (including film)
 Weight: 50gms
 Absorbency 2.6L per mat

RX1857
 PRICE EX VAT (OUTSIDE EU) **£3.95** PRICE INC VAT (UK @ 20%) **£4.74**

Top-Up Oil Bottle Holder

Designed to take Castrol 1 Litre Oil

GENUINE LAND ROVER



RX1813
 PRICE EX VAT (OUTSIDE EU) **£8.12** PRICE INC VAT (UK @ 20%) **£9.74**



AutoGlym Body Care

AutoGlym Car Care Products

Description	Part Number	Price ex VAT (Outside EU)	Price inc VAT (UK @ 20%)
Silicone Resin Polish 325ml	RX1312	9.78	11.74
Bodywork Shampoo/Conditioner 500ml	RX1313	6.49	7.79
Car Interior Shampoo 500ml	RX1314	6.49	7.79
Glass Polish 325ml	RX1315	6.49	7.79
Paint Renovator 325ml	RX1316	6.46	7.75
Ultra Deep Shine 500ml	RX1558	11.67	14.00
Extra Gloss Protection 325ml	RX1317	9.17	11.00
Bumper Care 325ml	RX1318	6.46	7.75
Vinyl & Rubber Care 500ml	RX1319	6.69	8.03
Leather Care Balm 500ml	RX1320	10.00	12.00
Insect Remover 450ml	RX1567	6.46	7.75
Clean Wheels 500ml	RX1322	6.85	8.22
Clean Machine Engine Cleaner 1 Litre	RX1325	8.54	10.25
Fabric Hood Care & Maintenance Kit Twin Pack	RX1433	20.95	25.14
Instant Tyre Dressing 500ml	RX1368	6.26	7.51
Intensive Tar Remover 325ml	RX1367	6.04	7.25
Surface Detailing Clay Kit Four Pack	RX1630	27.08	32.50
Alloy Wheel Seal (Silicone Spray) 450ml	RX1698	8.54	10.25
Rapid Aqua Wax Kit Triple Pack	RX1699	11.25	13.50
Bird Dropping Wipes Pack of 10	RX1693	5.00	6.00
Jumbo Sponge	RX1415	0.99	1.19
Aqua Dry (Synthetic Wash Leather)	RX1324	8.50	10.20
Hi-Tec Drying Blade	RX1684AG	18.75	22.50
Basic Car Care Kit	RX4079	16.25	19.50

Contents include: BODYWORK SHAMPOO, RESIN POLISH, SPONGE.



LAND ROVER ACCESSORIES

Silicone Car Drying Blade

Turtle Wax



RX1684TW

PRICE EX VAT (OUTSIDE EU) £5.83

PRICE INC VAT (UK @ 20%) £7.00

Renovo Vinyl Top Cleaner

500ml



RX1529

PRICE EX VAT (OUTSIDE EU) £9.76

PRICE INC VAT (UK @ 20%) £11.71

Microfibre Cloth Set

Brookstone
9 Piece Set



RX4089

PRICE EX VAT (OUTSIDE EU) £8.33

PRICE INC VAT (UK @ 20%) £10.00

Microfibre 2in1 Noodle Wash Mitt

Brookstone
Twin sided



RX4089W

PRICE EX VAT (OUTSIDE EU) £3.33

PRICE INC VAT (UK @ 20%) £4.00

Wheel Polish

Rimwax, wheel polish & protector
For alloy wheels



RX1262

PRICE EX VAT (OUTSIDE EU) £16.17

PRICE INC VAT (UK @ 20%) £19.40

Wheel Cleaning

MWS WHEEL
CLEANING AND
PROTECTION SYSTEM

This specialist wheel cleaning system will help you care for your wheels.

Suitable for all Steel, Alloy and Wire wheels (including painted & chromed), this wheel cleaning system uses a unique 2-stage process that not only cleans, but gives wheels a superb lasting finish that helps to protect them, making them easier to care for and clean in the future.

Kit includes;

- Special cleaning solution (580ml).
- Wooden handled cleaning brush & dispenser.
- Finishing/protection solution (180ml)
- 2 pair of disposable gloves.

Cleaning solution breaks down brake dust & road grime. Brush & dispenser gets into all those awkward places. Finishing/protection solution leaves wheels like new.

RX1405

PRICE EX VAT (OUTSIDE EU) £22.42

PRICE INC VAT (UK @ 20%) £26.90

ORDER

BY PHONE: 01522 568000 / ON LINE: www.rimmerbros.co.uk / E-MAIL: lrsales@rimmerbros.co.uk

*Prices include UK VAT @ 20%.

CHEMICALS - CAR CARE

General Consumables

Description	Part Number	Price ex VAT (Outside EU)	Price inc VAT (UK @ 20%)
WD-40			
Large 400ml	GAC111	4.15	4.98
Wonderweld			
Holts, 250ml	RX1539-250ML	10.83	13.00
Easystart (Bradex)			
280ml	RX1511	3.74	4.49
Silicone Sealant			
Tube 80ml	GHF6093	6.46	7.75
Hylomar (Gasket Sealant)			
100g	GGC102	4.58	5.50
Exhaust Joining Compound			
140gm	GCH112	3.17	3.80
Copper Ease (Tube) (Anti-Seize Grease)			
70g	RX1345	4.67	5.60
500g	RX1585	8.96	10.75
Brake Rubber Grease			
50gms	514578P	1.50	1.80
Brake Cleaner			
Aerosol	GBF901	5.21	6.25
Loctite			
24ml	GAC10024ML	18.54	22.25
3ml	GAC100	7.92	9.50
Silverhook Thread Locker			
7gm	GAC100SH	2.30	2.76
Adhesive (Trim/Carpets)			
1 Litre Tin	RX1353	12.92	15.50
370g Aerosol	RX1353A	5.95	7.14
Latex/Rubber Gloves			
<i>Ideal for those really dirty maintenance jobs</i>			
Pack of 100	RX1406	6.87	8.24
Rear View Mirror Adhesive			
0.5ml	RX1740	4.42	5.30
Castrol Valvemaster Lead Additive			
250ml	RX1407VM	8.33	10.00
Castrol Valvemaster plus with Octane Booster			
250ml	RX1407VMP	11.87	14.24
QuikTape			
25mm x 3m	RX1479	5.42	6.50
Fuel Tank Slushing Compound			
US quart	608591A	31.67	38.00



GAC111



RX1539-250ML



RX1511



GHF6093



GGC102



RX1345



GCH112



514578P



GBF901



RX1353A



GAC100



RX1353



RX1406



RX1740



RX1407VM



RX1407VMP



RX1479

QuikTape Silicone Rubber Tape
 A self-adhering and fusing, curing into a solid rubber insulator in less than 24 hours. Resists moisture and temperatures up to 260°C. Gives a tough, permanent insulation seal around electrical connections, hoses, pipes (including exhaust) etc.
 Roll is 25mm x 3m long approx.



608591A

Fuel Tank Slushing Compound
 This tacky fluid sticks to the inner walls of the fuel tank and prevents rusting problems which normally lead to leaks. It is even efficient at filling minor rust holes and leaking seams. Easy to use and long lasting. Ideal for renovating older tanks, or prior to installing replacements.

Waxoyl Body Care



Anti-Corrosion Waxoyl

Description	Part Number	Price ex VAT (Outside EU)	Price inc VAT (UK @ 20%)
Waxoyl:			
5 litre can			
clear	RX1027	29.50	35.40
Black	RX1027BLACK	29.50	35.40
2.5 litre cartridge			
clear	RX1028	24.50	29.40
black	RX1036	24.50	29.40
400ml aerosol			
clear	RX1026	9.00	10.80
black	RX1035	9.00	10.80
Underbody Seal:			
1 litre	RX1024	7.50	9.00
500ml	RX1023	5.00	6.00



Protective Coatings

- Easy to use, simply fill-shake-shoot
- Easy to clean
- Provides excellent UV protection
- Waterproof – provides a water tight seal, keeping water out & protects new surfaces against rust
- Sound deadener – reduces noise & vibrations
- Abrasion & stain resistant
- Dries rapidly, is flexible

Suggested application areas:-

- Chequer plate & grilles
- Loading area
- Underbody protection
- Bumpers & bull bars
- Sills. Side rails & steps
- Wheels & wheel arches
- Etc, etc.

Raptor is a highly durable protective coating that ensures protection against mechanical damage, fuels, hydraulic oils, rust, corrosion, salt water, damp, extreme temperatures & off-road muddy good fun!



Raptor is available in black & tintable versions. The tintable version can be altered to suit the colour of your vehicle by adding a small amount of automotive solvent paint.

Raptor can be applied as a smooth finish through to a very coarse finish.

Raptor Protective Coating

Description	Part Number	Price ex VAT (Outside EU)	Price inc VAT (UK @ 20%)
Raptor:			
4 litre kit – black finish (contains 4 x 750ml Raptor, 1 x 1ltr hardener)	DA6382	69.17	83.00
1 litre kit – black finish (contains 1 x 750ml Raptor, 1 x 250ml hardener)	DA6497	19.50	23.40
5 litres – black finish	DA6370	75.00	90.00
4 litre kit – tintable finish (contains 4 x 750ml Raptor, 1 x 1ltr hardener)	DA6384	69.17	83.00
1 litre kit – tintable finish (contains 1 x 750ml Raptor, 1 x 250ml hardener)	DA6498	19.50	23.40
5 litres – tintable finish	DA6436	75.00	90.00
5 litres – hardener	DA6371	75.00	90.00
Application gun – screws directly on to plastic bottle	DA6386	16.04	19.25

Brake & Clutch Fluid



Description	Part Number	Price ex VAT (Outside EU)	Price inc VAT (UK @ 20%)
Brake & Clutch Fluid - 4 DOT			
500ml	S3SHE05	2.69	3.23
1 Litre	S3SHE1	5.62	6.74
4.54 Litres	S3SHE5	20.22	24.26

Series Books



Workshop/Repair Operation Manuals

- Contain comprehensive instructions on repair & maintenance
- Fully illustrated
- Detailed engine data & work instructions
- Invaluable to help with maintenance, service & repair

GENUINE LAND ROVER



Workshop Manuals - Series

Key	Description	Part Number	Price ex VAT (Outside EU)	Price inc VAT (UK @ 20%)
Land Rover Genuine Workshop Manuals				
1	Series I Workshop Manual (384 pages)	LL1021	27.95	27.95
2	Series II & IIIa Repair Operation Manual (966 pages)	LL1022	54.95	54.95
3	Series III (4 & 6 Cyl) Repair Operation Manual (378 pages)	LL1024	36.96	36.96
4	Series III V8 Repair Operation Manual Supplement (116 pages)	LL1025	14.96	14.96
5	Series II/IIIa/III 59-83 Owners Workshop Manual (259 pages)	LL1023	21.96	21.96
Haynes Workshop Manuals				
6	Series II/IIIa/III Owners Workshop Manual 4 cylinder petrol & diesel models	LL1677	17.95	17.95



Parts Books

- Contains full listings of part numbers & detailed illustrations

GENUINE LAND ROVER

Part Books - Series

Key	Description	Part Number	Price ex VAT (Outside EU)	Price inc VAT (UK @ 20%)
Land Rover Genuine Parts Books				
7	Series I 48-53 Parts Book (448 pages)	LL1032	27.96	27.96
8	Series II 54-58 Parts Book (444 pages)	LL1033	29.96	29.96
9	Series II & Early IIIa Bonneted Control Parts Book (326 pages)	LL1034	27.95	27.95
10	Series IIIa Bonneted Control Parts Book (336 pages)	LL1035	27.95	27.95
11	Series IIIa/III & 109 V8 Optional Equipment Parts Book (176 pages)	LL1037	24.96	24.96
12	Series III 88, 109 & 109 V8 Parts Book (396 pages)	LL1036	35.96	35.96



Owners Handbooks

- Original books that are supplied with a new vehicle

GENUINE LAND ROVER

Owners Handbooks - Series

Key	Description	Part Number	Price ex VAT (Outside EU)	Price inc VAT (UK @ 20%)
Land Rover Genuine Owners Handbooks				
13	Series I Owners Handbook (60 pages)	LL1040	14.96	14.96
14	Series I & Series II Diesel Owners Handbook (58 pages)	LL1041	14.96	14.96
15	Series IIIa & IIIb Owners Handbook (80 pages)	LL1042	14.96	14.96
16	Series III 71-81 Owners Handbook (168 pages)	LL1043	14.96	14.96
17	Series III 81-85 Owners Handbook (172 pages)	LL1044	14.96	14.96



Reference & Information Books - Series

Key	Description	Part Number	Price ex VAT (Outside EU)	Price inc VAT (UK @ 20%)
Land Rover Genuine Gold Portfolio				
18	Series I/II/IIIa 48-71 (168 pages) Off-road tests, buyers guides, new model updates, tech data.	LL1078	18.95	18.95
Haynes Restoration Manual				
19	Series I/II/III (288 pages)	LL1054	22.99	22.99
Practical Classics Restoration Book				
20	Series I (92 pages)	LL1020	12.00	12.00
Veloce Essential Buyers Guide				
21	Series I/II/IIIa (64 pages) Key checks, inspection guide, support organisations etc	9781845843489	10.50	10.50
22	Series III (64 pages) Key checks, inspection guide, support organisations etc	9781845844424	10.50	10.50

Military Books

Owners Handbooks & Parts Books - Military

Key	Description	Part Number	Price ex VAT (Outside EU)	Price inc VAT (UK @ 20%)
Land Rover Genuine - Owners Handbook - Military				
23	90 & 110 (234 pages)	LL1361	17.95	17.95
24	101 Forward Control 1 Ton (178 pages)	LL1046	14.96	14.96
25	Series III LWB (208 pages)	608179P	17.95	17.95
26	Series III Lightweight (162 pages)	LL1047	14.96	14.96
Land Rover Genuine - Parts Book - Military				
27	101 Forward Control 1 Ton (226 pages)	LL1038	29.96	29.96
28	Series III Lightweight (184 pages)	LL1039	24.96	24.96
Land Rover Genuine - Repair Manual - Military				
29	101 Forward Control 1 Ton (168 pages)	LL1031	34.96	34.96



GENUINE LAND ROVER

Defender Books

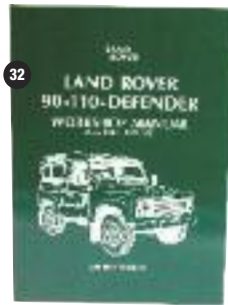
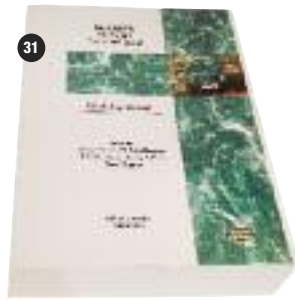

GENUINE LAND ROVER



Workshop/Repair Operation Manuals

- Contain comprehensive instructions on repair & maintenance
- Fully illustrated
- Detailed engine data & work instructions
- Invaluable to help with maintenance, service & repair

Electrical Workshop Manuals

- Electrical circuit diagrams
- Fully illustrated
- Draws together information to maintain & repair all electrical needs

Workshop Manuals - Defender

Key	Description	Part Number	Price ex VAT (Outside EU)	Price inc VAT (UK @ 20%)
Land Rover Genuine Workshop Manuals				
30	Defender 83-92 Workshop Manual (842 pages)	LL1027	47.95	47.95
31	Defender 93-95 Workshop Manual (1,008 pages)	LL1028	54.95	54.95
32	Defender 83-95 Owners Workshop Manual (228 pages)	LL1026	25.96	25.96
33	Defender 300Tdi 96-98 Workshop Manual (1,008 pages)	LL1030	49.96	49.96
34	Defender Td5 99-05 Workshop Manual (548 pages) Excludes electrical section, ideally use with part number LL1332.	LL1329	52.95	52.95
35	Defender Td5 99-05 Electrical Workshop Manual (272 pages) Use with part number LL1329.	LL1332	80.90	80.90
Haynes Workshop Manuals				
36	Defender Diesel 83-07 Workshop Manual (Paperback)	LL1049	22.99	22.99



Parts Books

- Contains full listings of part numbers & detailed illustrations

Part Books - Defender

Key	Description	Part Number	Price ex VAT (Outside EU)	Price inc VAT (UK @ 20%)
Land Rover Genuine Parts Books				
37	110 83 To Aug 86 Parts Book (384 pages)	RTC9863CEP	36.70	36.70
38	Defender 87-01 Parts Book (824 pages)	STC9021CC	59.95	59.95



Owners Handbooks

- Original books that are supplied with a new vehicle

Owners Handbooks - Defender

Key	Description	Part Number	Price ex VAT (Outside EU)	Price inc VAT (UK @ 20%)
Land Rover Genuine Owners Handbooks				
39	90 & 110 83-90 Owners Handbook (148 pages)	LL1045	14.96	14.96
40	Defender 91-94 Owners Handbook (192 pages)	LDAHBN93P	14.95	14.95
41	Defender 94-98 Owners Handbook (192 pages)	LRLO087ENGP	14.95	14.95

Reference & Information Books - Defender

Key	Description	Part Number	Price ex VAT (Outside EU)	Price inc VAT (UK @ 20%)
Haynes Manuals				
42	Defender Restoration Manual (208 pages)	LL1053	24.00	24.00
43	Defender Modifying Manual (232 pages) Includes off-road & cosmetic upgrades	LL1579	25.00	25.00



Discovery Books



GENUINE LAND ROVER

Workshop/Repair Operation Manuals

- Contain comprehensive instructions on repair & maintenance
- Fully illustrated
- Detailed engine data & work instructions



Workshop Manuals - Discovery

Key	Description	Part Number	Price ex VAT (Outside EU)	Price inc VAT (UK @ 20%)
Land Rover Genuine Workshop Manuals				
44	Discovery 1 89-94 (Vin LA) Workshop Manual (416 pages)	RD1019	49.96	49.96
45	Discovery 1 95-98 (Vin MA On) Workshop Manual (768 pages)	RD1021	64.96	64.96
46	Discovery 2 Workshop Manual (824 pages)	RD1155	57.95	57.95
Haynes Workshop Manuals				
47	Discovery 1 & 2 Maintenance & Upgrade Manual (160 pages)	RD1375	19.95	19.95
48	Discovery 1 Workshop Manual <i>Does not include 2.0 litre Mpi engine.</i>	RD1015	22.99	22.99
49	Discovery 2 Diesel Workshop Manual (paperback)	RD1201	22.99	22.99
50	Discovery 3 Diesel Workshop Manual (paperback) <i>Excludes petrol models</i>	RD1330	22.99	22.99



GENUINE LAND ROVER

Owners Handbooks

- Original books that are supplied with a new vehicle

Owners Handbooks - Discovery

Key	Description	Part Number	Price ex VAT (Outside EU)	Price inc VAT (UK @ 20%)
Land Rover Genuine Owners Handbooks				
51	Discovery 1 89-90 (256 pages)	RD1017-90	17.95	17.95
52	Discovery 2 (248 pages)	RD1219	17.95	17.95



GENUINE LAND ROVER

Parts Books

- Contains full listings of part numbers & detailed illustrations

Part Books - Discovery

Key	Description	Part Number	Price ex VAT (Outside EU)	Price inc VAT (UK @ 20%)
Land Rover Genuine Parts Books				
53	Discovery 1 Parts Book (612 pages)	RTC9947CFP	47.95	47.95
54	Discovery 2 Parts Book (252 pages)	STC9049CAP	29.95	29.95



Reference & Information Books - Discovery

Key	Description	Part Number	Price ex VAT (Outside EU)	Price inc VAT (UK @ 20%)
55	The Story Of Discovery 1 (128 pages)	RD1025	12.25	12.25
56	25 Years Of The Discovery (240 pages) <i>Covers 1989 to 2014 models.</i>	RD1369	31.00	31.00
57	Discovery 1 & 2 Performance Portfolio (140 pages) <i>Off-road tests, buyers guides, new model updates, tech data</i>	RD1018	15.96	15.96

Freelander Books

GENUINE LAND ROVER



Workshop Manuals - Freelander

Key	Description	Part Number	Price ex VAT (Outside EU)	Price inc VAT (UK @ 20%)
Land Rover Genuine Workshop Manuals				
58	Freelander 1 98-00 Workshop Manual (586 pages)	LRL0144ENGP	56.96	56.96
59	Freelander 1 01-03 on Workshop Manual (616 pages)	LF1094	54.95	54.95
Haynes Workshop Manuals				
60	Freelander 1 Workshop Manual <i>Covers all models 1996 to 2006.</i>	LF1101	22.99	22.99
61	Freelander 2 Diesel Workshop Manual (paperback) <i>Excludes petrol models.</i>	LF1121	17.95	17.95



Owners Handbooks - Freelander

Key	Description	Part Number	Price ex VAT (Outside EU)	Price inc VAT (UK @ 20%)
Land Rover Genuine Owners Handbooks				
62	Freelander 1 Owners Handbook Literature Pack	VDC100680	53.98	53.98

Range Rover Books

GENUINE LAND ROVER



Workshop/Repair Operation Manuals

- Contain comprehensive instructions on repair & maintenance
- Fully illustrated
- Detailed engine data & work instructions
- Invaluable to help with maintenance, service & repair

Electrical Workshop Manuals

- Electrical circuit diagrams
- Fully illustrated
- Draws together information to maintain & repair all electrical needs

Workshop Manuals - Range Rover

Key	Description	Part Number	Price ex VAT (Outside EU)	Price inc VAT (UK @ 20%)
Land Rover Genuine Workshop Manuals				
63	RR Classic 70-85 Workshop Manual (508 pages)	RA1365	39.96	39.96
64	RR Classic 86-89 Workshop Manual (1,024 pages)	RA1366	59.95	59.95
65	RR Classic 90-94 Workshop Manual (1,184 pages)	RA1367	57.95	57.95
66	RR P38 Workshop Manual (756 pages)	VDR100370P	59.96	59.96
67	RR P38 Electrical Trouble Shooting Manual	YVB101760	70.58	70.58
68	RR L322 02-05 Workshop Manual (538 pages)	RA1495	49.95	49.95
69	RR L322 UK 02-05 Electrical Workshop Manual (240 pages)	RA1496UK	27.95	27.95
70	RR L322 USA 02-05 Electrical Workshop Manual (224 pages)	RA1496USA	27.95	27.95
Haynes Workshop Manuals				
71	RR Classic Workshop Manual (317 pages) 1970 to 1992, excludes 4.2 litre engine	RA1007	22.99	22.99



Owners Handbooks - Range Rover

Key	Description	Part Number	Price ex VAT (Outside EU)	Price inc VAT (UK @ 20%)
Land Rover Genuine Owners Handbooks				
72	RR Classic 2 Door Owners Handbook (140 pages)	RA14002D00R	14.96	14.96
73	RR Classic 81-82 Owners Handbook (188 pages)	RA140081	14.96	14.96
74	RR Classic 83-85 Owners Handbook (182 pages) up to facelift	RA140083	14.96	14.96
75	RR Classic 86-88 Owners Handbook (168 pages)	RA140086	14.96	14.96
76	RR P38 Owners Handbook (208 pages)	VDC000010P	17.95	17.95
77	RR L322 2002MY Owners Handbook	LRL0448ENG	35.83	35.83



Part Books - Range Rover

Key	Description	Part Number	Price ex VAT (Outside EU)	Price inc VAT (UK @ 20%)
Land Rover Genuine Parts Books				
78	RR Classic 70-85 Parts Book (410 pages) To (VIN) BA999999.	RTC9846CHP	32.40	32.40
79	RR Classic 86-92 Parts Book (364 pages) (VIN) CA00001 to (VIN) HA610293.	RTC9908CBP	34.96	34.96
80	RR Classic 92-95 Parts Book (958 pages) (VIN) JA610294 to (VIN) MA999999.	RTC9961CBP	38.95	38.95
81	RR P38 Parts Book (784 pages)	RTC9970CEP	56.95	56.95



Reference & Information Books - Range Rover

Key	Description	Part Number	Price ex VAT (Outside EU)	Price inc VAT (UK @ 20%)
Land Rover Genuine Gold Portfolio				
82	RR Classic 70-85 Gold Portfolio (172 pages) Off-road tests, buyers guides, new model updates, tech data.	RA1401	18.96	18.96
83	RR Classic 85-95 Gold Portfolio (172 pages) Off-road tests, buyers guides, new model updates, tech data.	RA1402	18.96	18.96
Performance Portfolio				
84	RR P38 Performance Portfolio (136 pages) Off-road tests, buyers guides, new model updates, tech data.	RA1447	15.96	15.96



Miscellaneous Books



GENUINE
LAND ROVER

Information Manuals

Key	Description	Part Number	Price ex VAT (Outside EU)	Price inc VAT (UK @ 20%)
Land Rover Genuine Publications				
85	V8 Engine Overhaul Manual (132 pages) 3.5, 3.9, 4.0, 4.2 & 4.6 litre engines.	RD1024	19.96	19.96
86	300Tdi Engine & Transmission Overhaul Manual (202 pages) Includes R380 & LT230T transfer gearbox, ideal aid when converting to a 300Tdi engine	RD1023	24.96	24.96
87	Driving Techniques (32 pages) Official Land Rover booklet to enable you, with practice, to get maximum benefit from your vehicle.	RA1404	3.96	3.96
88	Working In The Wild Manual For Africa (232 pages) This book will enable you to make the most of the vehicle's capacity for hard work in hostile conditions.	LL1019	16.96	16.96
89	Winching In Safety (104 pages) How to use winches safely.	RA1405	11.96	11.96
Haynes Manuals				
90	Manual On Bodywork (160 pages) The definitive guide on car bodywork repair.	RX1771	17.00	17.00
91	Manual On Welding (176 pages) The definitive DIY manual on welding.	RX1782	17.00	17.00
92	Manual On Engine Management (336 pages) The definitive guide on engine management systems.	RX1773	17.00	17.00
93	Manual On Electrical Systems Practical (160 pages) The definitive DIY guide to diagnostic & repair information.	RX1774	17.00	17.00
94	Manual On Electrical Systems Theory (256 pages) An essential theory guide to electronic systems.	RX1776	17.00	17.00
95	Manual On Brakes (192 pages) The definitive DIY manual on vehicle braking systems.	RX1772	17.00	17.00
96	On Air Con Systems (160 pages) Covers theory for fault finding & repair of your A/C system.	RX1777	17.00	17.00
97	On Diesel Engines (168 pages) The definitive DIY guide for Diesel engine & injection systems.	RX1781	17.00	17.00
98	Off-Road Driving Manual (208 pages) Learn to drive safely & successfully off-road	LL1742	25.99	25.99
99	Wheeler Dealer Restoration Manual (176 pages) Spin off from the popular TV show.	RX1768	20.00	20.00
100	Track Day Manual (168 pages) Helps you to enjoy track days to the maximum.	RX1770	16.50	16.50
101	Highway Code (160 pages)	RX1769	2.50	2.50
102	Range Rover Takes On The Competition	RA1403	15.96	15.96

Manuals



Electrical Workshop Manuals

- Electrical circuit diagrams
- Fully illustrated
- Draws together information to maintain & repair all electrical needs

Engine Overhaul Manuals

- Essential reference for any engine rebuild
- Covers engine but not bolt-on equipment



Every driver needs a copy of the Highway Code!!



Diagnostic Manuals

Diagnostic Fault Codes Manuals

Key	Description	Part Number	Price ex VAT (Outside EU)	Price inc VAT (UK @ 20%)
103	Haynes Diagnostic Fault Codes Manual (328 pages) Includes fault code tables (including EOBD codes).	RX1779	17.00	17.00
104	Code Breaker Diagnostic Fault Codes Manual Covers over 2,700 EOBD/ISO fault codes.	BA5070CB	55.00	55.00



Now also available on Handy Portable USB Sticks.

GENUINE LAND ROVER



Land Rover Original Technical Publications DVDs or USBs

Carefully reproduced from extensive historical archives in the U.K. and the U.S.A., the original Land Rover and Range Rover publications help you to run and maintain your classic Land Rover or Range Rover, including parts catalogues, service manuals, technical information and owners literature. (Depending upon model please refer to our website for detailed contents of each DVD).

What's more, you can find information and links to Land Rover, Land Rover Heritage and Original Technical Publications. Discover more about the history of Land Rover, Land Rover and Range Rover Models and get the latest Heritage News and Information. From here you can also find Genuine Classic Parts and links to local Land Rover and Range Rover Clubs.

Product Features:

- Printable - Print only the pages you need. (Windows Only)
- Searchable - Search the entire section in seconds.
- Zoom - Zoom in to see the exact details.
- Bookmarked - Manuals are bookmarked to quickly locate sections
- USB requires Windows 2000 or later, USB port and Safeguard Windows PDC viewer

Technical Publications - DVD & USB

Description	Part Number	Price ex VAT (Outside EU)	Price inc VAT (UK @ 20%)
DVD - Land Rover Original Technical Publications			
Land Rover Series Models (1948-1985)	LTP3001	41.67	50.00
Land Rover 90,110 & 130 (1983-2011)	LTP3003	41.67	50.00
Land Rover Discovery Series 1 (1989-1999)	LTP3004	41.67	50.00
Land Rover Discovery Series II (1999 to 2004)	LTP3006	41.67	50.00
Land Rover Discovery 3 (2004-2009)	LTP3016	41.67	50.00
Land Rover Discovery 4 (2009-2012)	LTP3017	41.67	50.00
Range Rover Classic (1970-1995)	LTP3002	41.67	50.00
Range Rover (P38A) (1994-2001)	LTP3005	41.67	50.00
Range Rover (L322) (2002 to 2006)	LTP3008	41.67	50.00
Range Rover Sport (2005-2009)	LTP3015	41.67	50.00
Land Rover Freelander Series I (1998 to 2006)	LTP3007	41.67	50.00
USB - Land Rover Original Technical Publications			
Land Rover Series Models (1948-1985)	LTP3001-USB	62.50	75.00
Land Rover 90,110 & 130 (1983-2011)	LTP3003-USB	62.50	75.00
Land Rover Discovery Series 1 (1989-1999)	LTP3004-USB	62.50	75.00
Land Rover Discovery Series II (1999 to 2004)	LTP3006-USB	62.50	75.00
Land Rover Discovery 3 (2004-2009)	LTP3016-USB	62.50	75.00
Land Rover Discovery 4 (2009-2012)	LTP3017-USB	62.50	75.00
Range Rover Classic (1970-1995)	LTP3002-USB	62.50	75.00
Range Rover (P38A) (1994-2001)	LTP3005-USB	62.50	75.00
Range Rover (L322) (2002 to 2006)	LTP3008-USB	62.50	75.00
Range Rover Sport (2005-2009)	LTP3015-USB	62.50	75.00
Land Rover Freelander Series I (1998 to 2006)	LTP3007-USB	62.50	75.00
Land Rover Collection Set (1948 to 2012)	LTP3010	166.67	200.00



LTP3001



LTP3003



LTP3004



LTP3006

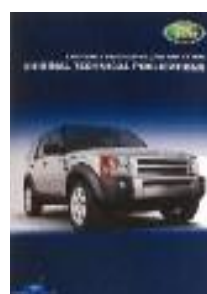

LTP3016

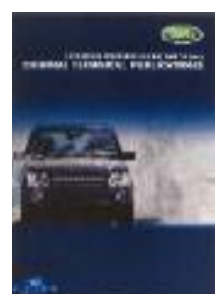

LTP3017

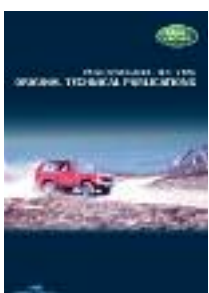

LTP3002



LTP3005



LTP3008

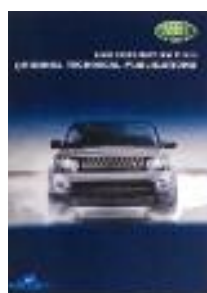

LTP3015



LTP3007



LTP3010-USB

ORDER BY PHONE: 01522 568000 / ON LINE: www.rimmerbros.co.uk / E-MAIL: lrsales@rimmerbros.co.uk

*Prices include UK VAT @ 20%.

UPDATED BRAKE DISCS

Why fit Uprated Discs?

- Wide slots help brakes run up to 150° cooler
- Reduces brake fade under load
- Removes dirt, dust & debris from braking zone
- Great for off-road applications
- Manufactured to British Standard BS1453 Grade 220 & DIN1691 GG20



Sold in Pairs

BRITPART

90 & 110 - Performance Brake Discs (pair)

Model	Part Number	Price Ex VAT	Price Inc VAT*
90 (1983 to 1989) All models Front	LR017951URBP	39.58	47.50
110 (1983 to 1989) All models Front	LR017951URBP	39.58	47.50

Defender - Performance Brake Discs (pair)

Defender 90 (1989 on)			
Non vented disc brake models up to (VIN) 9A777776			
Front	LR017951URBP	39.58	47.50
Vented disc brake models from (VIN) LA930456 to 9A777776			
Front	LR017952URBP	50.00	60.00
All models from (VIN) LA930456 to 9A777776			
Rear	LR017953URBP	45.00	54.00
Defender 110 (1989 on)			
Non vented disc brake models from (VIN) XA159807 to (VIN) 9A777776			
Front	LR018026URBP	45.00	54.00
Non vented disc brake models up to (VIN) 9A777776			
Front	LR017951URBP	39.58	47.50
Vented disc brake models from (VIN) LA930456 to 9A777776			
Front	LR017952URBP	50.00	60.00

Freelander - Performance Brake Discs (pair)

Freelander 1 (1996 to 2006)			
All models up to (VIN) YA999999			
Front	SDB100830URBP	39.17	47.00
All models from (VIN) 1A000001 on			
Front	SDB101070URBP	45.00	54.00
Freelander 2 (2006 to 2014)			
All models with 2.0L TIVCT turbocharged petrol engine			
Front	LR027107URBP	65.83	79.00
Rear	LR001019URBP	50.00	60.00
All models with 2.2L diesel engine			
Front	LR007055URBP	59.17	71.00
Rear	LR001018URBP	55.00	66.00
All models with 3.2L petrol engine			
Front	LR027107URBP	65.83	79.00
Rear	LR001019URBP	50.00	60.00
All models from (VIN) DH000001			
Rear	LR039935BPUR	40.00	48.00

Discovery - Performance Brake Discs (pair)

Model	Part Number	Price Ex VAT	Price Inc VAT*
Discovery 1 (1989 to 1998)			
All non vented disc brake models			
Front	LR017951URBP	39.58	47.50
All vented disc brake models			
Front	LR017952URBP	50.00	60.00
All models			
Rear	LR017953URBP	45.00	54.00
Discovery 2 (1998 to 2004)			
All models			
Front	SDB000380URBP	58.33	70.00
Rear	SDB000470URBP	49.99	59.99
Discovery 3 (2005 to 2009)			
All models with 2.7L Lion V6 diesel engine,			
All models with 4.0L Cologne V6 petrol engine			
Front	SDB000604URBP	60.00	72.00
Rear	SDB000636URBP	60.00	72.00
All models with 4.4L AJ V8 petrol engine			
Front	SDB000614URBP	60.00	72.00
Rear	SDB000646URBP	65.00	78.00
Discovery 4 (2010 on)			
All models with 2.7L Lion V6 diesel engine			
Front	SDB000604URBP	60.00	72.00
Rear	SDB000636URBP	60.00	72.00
All models with 3.0L AJ133 diesel engine to (VIN) CA999999			
Front	SDB000624URBP	70.00	84.00
Rear	SDB000646URBP	65.00	78.00
All models with 4.0L Cologne V6 petrol engine			
Front	SDB000604URBP	60.00	72.00
Rear	SDB000636URBP	60.00	72.00
All models with 5.0L SGDI NA V8 petrol engine to (VIN) CA999999			
Front	SDB000624URBP	60.00	72.00
Rear	SDB000646URBP	70.00	84.00
All Coil sprung models from (VIN) DA000001 on			
Front	SDB000604URBP	60.00	72.00
Rear	SDB000636URBP	60.00	72.00
All air sprung models from (VIN) DA000001 on			
Front	SDB000624URBP	60.00	72.00
Rear	SDB000646URBP	70.00	84.00
Discovery Sport L550 (2014 on)			
All models with 6 speed manual or 9 speed auto gearbox			
Front	LR059122BPUR	59.17	71.00
Rear	LR061388BPUR	37.50	45.00

PERFORMANCE ENHANCEMENT - BRAKE DISCS

ORDER

BY PHONE: 01522 568000 / ON LINE: www.rimmerbros.co.uk / E-MAIL: lrsales@rimmerbros.co.uk

*Prices include UK VAT @ 20%.

PERFORMANCE BRAKE DISCS *cont'd*

PERFORMANCE ENHANCEMENT - BRAKE DISCS & BRAKE KITS

Range Rover - Performance Brake Discs (pair)

Model	Part Number	Price Ex VAT	Price Inc VAT*
Range Rover Classic (1970 to 1996)			
All models from (VIN) CA to FA399972			
Front	LR017951URBP	39.58	47.50
All models from (VIN) GA399973 on			
Front	LR017952URBP	50.00	60.00
All models from (VIN) CA (1986) on			
Rear	LR017953URBP	45.00	54.00
Range Rover P38 (1994 to 2001)			
All models			
Front	NTC8780URBP	47.50	57.00
Rear	SDB000470URBP	49.99	59.99
Range Rover L322 (2002 to 2012)			
All models up to (VIN) 5A999999			
Front	SDB000201URBP	65.83	79.00
Rear	SDB000211URBP	44.17	53.00
3.0L M57 D30 Diesel from (VIN) 6A228067 to 9A999999			
Front	SDB500182URBP	65.83	79.00
All models with 3.6L V8 diesel engine			
Front	LR031843URBP	60.00	72.00
4.2L AJ V8 supercharged petrol engine from (VIN) 6A228067 to 9A999999			
Front	LR031843URBP	60.00	72.00
4.4L AJ V8 Petrol from (VIN) 6A228067 to 9A999999			
Front	SDB500182URBP	65.83	79.00
All 4.4L DOHC Diesel V8 DITC models from (VIN) AA000001			
Front	LR031845URBP	80.00	96.00
5.0L SGDI NA V8 petrol engine from (VIN) AA000001 on			
Front	LR031843URBP	60.00	72.00
All 5.0L OHC SGDI V8 petrol models from (VIN) BA356997			
Front	LR031845URBP	80.00	96.00
All models from (VIN) 6A228067 to 9A999999			
Rear	LR031844URBP	54.17	65.00
All 3.6L TDV8 diesel models (VIN) AA000001 on			
Rear	LR031844URBP	54.17	65.00
4.4L TDV8 diesel models (VIN) AA000001 on			
Rear	LR031846URBP	60.00	72.00
All 5.0L NA V8 petrol models from (VIN) AA000001 on			
Rear	LR031844URBP	54.17	65.00
5.0L V8 supercharged petrol models (VIN) AA000001 on			
Rear	LR031846URBP	60.00	72.00
Range Rover L405 (2012 on)			
All models from (VIN) EA000001			
Front	LR038934BPUR	65.00	78.00
Rear	LR033302BPUR	55.00	66.00



Range Rover - Performance Brake Discs (pair)

Model	Part Number	Price Ex VAT	Price Inc VAT*
Range Rover Sport L320 (2005 to 2013)			
2.7L Lion V6 diesel engine up to (VIN) 9A999999			
Front	SDB000604URBP	60.00	72.00
Rear	SDB000636URBP	60.00	72.00
2.7L Lion V6 diesel engine up to (VIN) 9A999999 with dynamic brake pack			
Rear	SDB000646URBP	65.00	78.00
All models with 3.0L V6 diesel engine			
Front	SDB000624URBP	70.00	84.00
Rear	SDB000646URBP	65.00	78.00
All models with 3.6L V8 diesel engine			
Front	SDB000624URBP	70.00	84.00
Rear	SDB000646URBP	65.00	78.00
4.2L AJ V8 supercharged petrol engine up to (VIN) 9A999999			
Front	SDB000624URBP	70.00	87.00
Rear	SDB000646URBP	65.00	78.00
4.4L AJV8 petrol engine up to (VIN) 9A999999			
Front	SDB000614URBP	60.00	72.00
4.4L AJV8 petrol engine up to (VIN) 9A999999 with dynamic brake pack			
Front	SDB000604URBP	60.00	72.00
Rear	SDB000646URBP	65.00	78.00
5.0L SGDI NA V8 petrol engine from (VIN) AA000001 on			
Front	SDB000624URBP	70.00	84.00
Rear	SDB000646URBP	65.00	78.00
All 5.0L supercharged V8 petrol models from (VIN) AA000001 on			
Rear	LR016192BPUR	57.50	69.00
Range Rover Sport L494 (2014 on)			
All models except V8 engine & SVR models			
Rear	LR033302BPUR	55.00	66.00
All V8 Engine models & SVR			
Rear	LR033303BPUR	57.50	69.00
Range Rover Evoque L538 (2012 on)			
All models			
Front	LR007055URBP	59.17	71.00
Rear	LR027123BPUR	32.50	39.00
All models with 17" disc brakes from (VIN) GH000001			
Front	LR059122BPUR	59.17	71.00

UPDATED BRAKE KITS



These kits will improve the braking ability of your Discovery 1 or Range Rover Classic.

All of the kits contain slotted & grooved brake discs (matched pair), the discs for the front brakes are also ventilated. EBC Green Stuff brake pads compliment the discs and, where required, pin fitting kits are also included. The front kits also include a pair of 4-pot brake calipers

Discovery 1 - Updated Brake Kits

Discovery 1 (1989 to 1998)			
Converts Solid discs to vented (inc calipers, pads, discs & retaining kit)			
Front	RA1357	166.67	200.00
Upgrades existing vented discs (inc calipers, pads, discs & retaining kit)			
Front	RA1358	82.50	99.00
All models (inc discs & pads)			
Rear	RA1359	77.50	93.00

Range Rover Classic - Updated Brake Kits

Range Rover Classic (1970 to 1996)			
Converts Solid discs to vented up to Oct 1989 3.5V8 & 2.4TD (inc calipers, pads, discs & retaining kit)			
Front	RA1357	166.67	200.00
Upgrades existing vented discs from Oct 1989 on 3.9V8 & 2.5TD (inc calipers, pads, discs & retaining kit)			
Front	RA1358	82.50	99.00
All models (inc discs & pads)			
Rear	RA1359	77.50	93.00

Terrafirma

SHOCK ABSORBER & SPRING KITS



Most of these kits are available with TUV Approval - please call for details

Terrafirma shock absorber & spring kits have been created for convenience, ensuring that the correct parts are matched.

The kits on this page have been specially selected to produce the ideal upgrade options.



All Terrain Shocks

- 35mm internal bore & piston
- 16mm double chromed shaft
- Nitrogen charged
- High temperature fluid
- 1.2mm outer shock tube wall
- 14mm mounting pins



Terrafirma

Pro-Sport Shocks

- Up to 3" (75mm) longer than standard
- 40mm internal bore & piston
- 20mm double chromed shaft
- Velocity sensitive valving
- Nitrogen charged
- High temperature fluid
- 1.5mm outer shock tube wall
- 14mm mounting pins



Shock Absorber & Spring Kits

All kits include 2 front & 2 rear shock absorbers and 4 coil springs

Model	Part Number	Price Ex VAT	Price Inc VAT*
Defender 90 - All models from (VIN) HA455946			
All terrain Shock Absorbers			
light load, plus 50mm lift	LL1700TFATL	247.50	297.00
medium load, plus 50mm lift	LL1700TFATM	195.00	234.00
heavy load, plus 50mm lift	LL1700TFATH	240.00	288.00
Pro-Sport Shock Absorbers			
light load, plus 50mm lift	LL1700TFPSLE	295.00	354.00
medium load, plus 50mm lift	LL1700TFPSME	295.00	354.00
heavy load, plus 50mm lift	LL1700TFPSHE	315.00	378.00
Defender 110 - All models from (VIN) HA455946			
All terrain Shock Absorbers			
light load, plus 50mm lift	LL1701TFATL	255.00	306.00
medium load, plus 50mm lift	LL1701TFATM	240.00	288.00
heavy load, plus 50mm lift	LL1701TFATH	265.00	318.00
Pro-Sport Shock Absorbers			
light load, plus 50mm lift	LL1701TFPSLE	291.50	349.80
medium load, standard travel	LL1701TFPSM	295.00	354.00
medium load, plus 50mm lift	LL1701TFPSME	295.00	354.00
heavy load, plus 50mm lift	LL1701TFPSHE	350.00	420.00
Defender 130 - All models from (VIN) HA455946			
All terrain Shock Absorbers			
light load, plus 50mm lift	LL1701TFATL	255.00	306.00
medium load, plus 50mm lift	LL1701TFATM	240.00	288.00
heavy load, plus 50mm lift	LL1701TFATH	265.00	318.00
Pro-Sport Shock Absorbers			
light load, plus 50mm lift	LL1701TFPSLE	291.50	349.80
medium load, standard travel	LL1701TFPSM	295.00	354.00
medium load, plus 50mm lift	LL1701TFPSME	295.00	354.00
heavy load, plus 50mm lift	LL1701TFPSHE	350.00	420.00
Discovery 1 - All models			
All terrain Shock Absorbers			
light load, plus 50mm lift	LL1700TFATL	249.50	297.00
medium load, plus 50mm lift	LL1700TFATM	195.00	234.00
heavy load, plus 50mm lift	LL1700TFATH	240.00	288.00
Pro-Sport Shock Absorbers,			
light load, plus 50mm lift	LL1700TFPSLE	295.00	354.00
medium load, plus 50mm lift	LL1700TFPSME	295.00	354.00
heavy load, plus 50mm lift	LL1700TFPSHE	315.00	378.00
Range Rover Classic - All models			
All terrain Shock Absorbers			
light load, plus 50mm lift	LL1700TFATL	247.50	297.00
medium load, plus 50mm lift	LL1700TFATM	195.00	234.00
heavy load, plus 50mm lift	LL1700TFATH	240.00	288.00
Pro-Sport Shock Absorbers			
light load, plus 50mm lift	LL1700TFPSLE	295.00	354.00
medium load, plus 50mm lift	LL1700TFPSME	295.00	354.00
heavy load, plus 50mm lift	LL1700TFPSHE	315.00	378.00

BILSTEIN

GAS SHOCK ABSORBERS

BILSTEIN®



SUSPENSION UPGRADES

Driving a vehicle equipped with Bilstein Gas shock absorbers is an exhilarating experience. There is, quite literally, nothing like it. Superb control & stability, precise handling and incredible comfort.

The mono-tube gas shock absorber developed by Bilstein has become the norm for automotive construction. The oil is kept in the shock absorber under pressure and the use of nitrogen ensures that the oil is permanently under pressure. This means that full damping is experienced even when the system is placed under extreme stress.

Shock Absorber Kits

Includes 2 front & 2 rear heavy duty gas shock absorbers

Model	Part Number	Price Ex VAT	Price Inc VAT*
Defender 90			
All models up to (VIN) WA159806	RA1344BILSTEIN	262.50	315.00
All models from (VIN) XA159807 on	LL1112	291.67	350.00
Defender 110			
All models up to (VIN) WA159806	RA1344BILSTEIN	262.50	315.00
Defender 130			
All models up to (VIN) WA159806	RA1344BILSTEIN	262.50	315.00
Discovery 1 All models	RA1344BILSTEIN	262.50	315.00
Discovery 2 All models	RD1200BILSTEIN	287.50	345.00
Range Rover Classic			
All coil spring models	RA1344BILSTEIN	262.50	315.00
Range Rover P38 All models	RA2006BILSTEIN	291.67	350.00

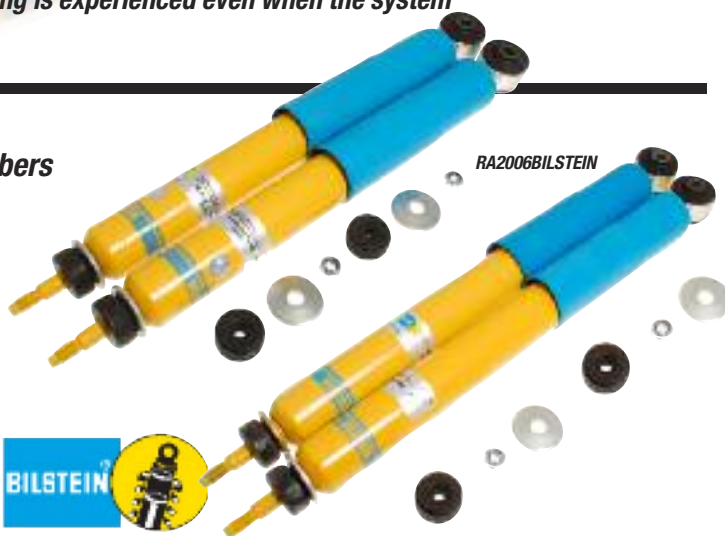

Shock Absorber & Spring Kits

Includes 2 front & 2 rear heavy duty gas shock absorbers and 4 uprated coil springs.

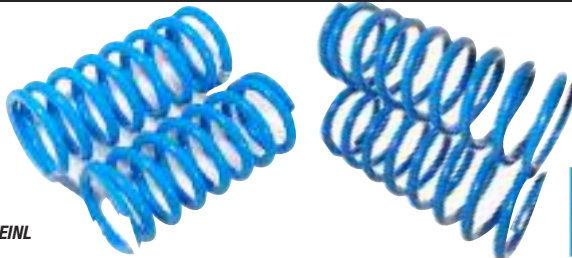

Raises ride height by 50mm

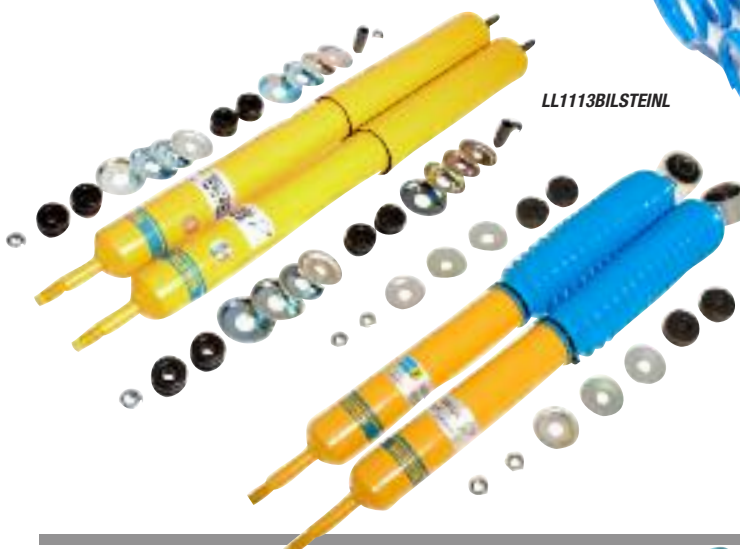

Model	Part Number	Price Ex VAT	Price Inc VAT*
Defender 90 All models			
from (VIN) HA455946 to (VIN) WA159806	LL1113BILSTEINE	330.00	396.00
from (VIN) XA159807	LL1113BILSTEINL	405.00	486.00
Defender 110 All models (unless fitted with self levelling suspension)			
from (VIN) HA455946 to (VIN) WA159806	LL1114BILSTEINE	350.00	420.00
from (VIN) XA159807	LL1114BILSTEINL	410.00	492.00
Defender 130 All models (unless fitted with self levelling suspension)			
from (VIN) HA455946 to (VIN) WA159806	LL1114BILSTEINE	350.00	420.00
from (VIN) XA159807	LL1114BILSTEINL	410.00	492.00

Shock Absorber Kit

Pair gas, standard height shocks



Range Rover Classic - All air suspension models			
Front, gas, standard height	RA1347BILSTEIN	157.50	189.00
Rear, gas, standard height	RA1348BILSTEIN	152.50	183.00

ORDER

BY PHONE: 01522 568000 / ON LINE: www.rimmerbros.co.uk / E-MAIL: lrsales@rimmerbros.co.uk

*Prices include UK VAT @ 20%.



The Electronic Air Suspension systems fitted to Range Rover P38A and the rear of the Discovery 2 can be expensive to repair and are considered to be not that reliable.

The following kits offer a cost effective solution to these issues by eliminating the costly electronic components (air springs & Compressor) by offering replacement coil spring conversions that are reliable and economical to maintain. Significant increased load carrying capacity is also achieved.

Air to Coil Spring Conversion Kits

Model & Application	Brand	Part Number	Price Ex VAT	Price Inc VAT*
Discovery 2 - All models with air suspension				
Rear, car kit inc. 2 coil springs & fitting kit, standard	Britpart	RD1206BP	63.33	76.00
	Bearmach	RD1206BM	89.50	107.40
Car kit inc. 4 coil springs & fitting kit, raises vehicle by 50mm	Terraforma	RD1206TFA	155.00	186.00
	Terraforma	RD1206TFB	275.00	330.00
Car kit inc. 4 All Terrain shock absorbers, 4 heavy load plus 2" coil springs, raises vehicle by 50mm	Terraforma	RD1206TFC	305.00	366.00
	Terraforma	RD1206TFD	355.00	426.00
Car kit inc. 4 Pro Sport plus 3" shock absorbers, 4 heavy load coil springs, raises vehicle by 75mm	Terraforma	RD1206TFE	240.00	288.00
	Terraforma	RD1206TFF	295.83	355.00
Car kit inc. 4 All Terrain plus 2" shock absorbers, 4 medium load plus 2" coil springs, raises vehicle by 50mm	Terraforma	RD1206TFG	395.00	474.00
	Terraforma	RD1206TFH	395.00	474.00
Range Rover P38A - All models				
Car kit inc. 4 coil springs & fitting kit <i>Required EAS Override Module RA1449BPMOD.</i>	Britpart	RA1449BP	295.83	355.00
	Terraforma	RA1449TFR	333.33	400.00
Car kit inc. 4 shock absorbers, 4 coil springs & fitting kit <i>Required EAS Override Module RA1449BPMOD.</i>	Terraforma	RA1449TFAT	445.00	534.00
	Terraforma	RA1449TFATR	399.50	479.40
Electronic Air Suspension (EAS) Override Module	Britpart	RA1449BPMOD	57.50	69.00
Range Rover Classic - All models				
Car kit inc. 4 coil springs & fitting kit	Bearmach	RA1448BM	160.00	192.00
	Britpart	RA1448BP	145.83	175.00
Car kit inc. 4 coil springs & fitting kit, plus 25mm lift	Britpart	RA1448BPRAISED	180.83	217.00
	Britpart	RA1448BPRAISED	180.83	217.00
Discovery 3 - All models				
Car kit inc. 2 front & 2 rear strut & coil spring assemblies plus dis-arm kit	Aftermarket	RD1367	600.00	720.00



BRITPART



Bearmach



Terraforma

50mm Lift Pro-Sport Mini Dislocation Kits

Kits include 4 Pro-Sport shock absorbers, 4 dislocation cones and all required fittings

Model	Part Number	Price Ex VAT	Price Inc VAT*
Defender 90 - All models from (VIN) HA455946 plus 50mm lift	LL1702TF	275.00	330.00
Defender 110 - All models from (VIN) HA455946 plus 50mm lift	LL1702TF110	275.00	330.00
Defender 130 - All models from (VIN) HA455946 plus 50mm lift	LL1702TF110	275.00	330.00
Discovery 1 - All models plus 50mm lift	LL1702TF	275.00	330.00
Range Rover Classic - All models plus 50mm lift	LL1702TF	275.00	330.00



50mm Lift Pro-Sport Maxi Dislocation Kits

Kits include 4 Pro-Sport shock absorbers, 4 dislocation cones and all required fittings

Plus
**50mm
LIFT**



TerrafirMa

Model	Part Number	Price Ex VAT	Price Inc VAT*
Defender 110 All models from (VIN) HA455946	LL1703TF110	725.00	870.00
Defender 130 All models from (VIN) HA455946	LL1703TF110	725.00	870.00

125mm Extreme Lift Dislocation Kits

Kits include 4 Pro-Sport shock absorbers, 4 dislocation cones and all required fittings

Plus
**125mm
LIFT**



Model	Part Number	Price Ex VAT	Price Inc VAT*
Defender 90 All models from (VIN) HA455946	LL1704TF	908.33	1090.00
Defender 110 All models from (VIN) HA455946	LL1704TF110	975.00	1170.00
Discovery 1 All models	LL1704TF	908.33	1090.00
Range Rover Classic All models	LL1704TF	908.33	1090.00

Hydraulic Bump Stop & Mounting Kit

Kit contains everything you need to convert to hydraulic bump stops front & rear



Model	Part Number	Price Ex VAT	Price Inc VAT*
Defender 90 All models from (VIN) HA455946	LL1707TF	695.00	834.00
Defender 110 All models from (VIN) HA455946	LL1707TF110	695.00	834.00
Defender 130 All models from (VIN) HA455946	LL1707TF110	695.00	834.00
Discovery 1 All models	LL1707TF	695.00	834.00
Range Rover Classic All models	LL1707TF	695.00	834.00



Est. UK 1958
Bearthmach
LAND ROVER PARTS

The legendary Beearthmach Blue Springs are designed as a superior performance replacement part for OEM coil springs.

They exceed original ratings by 10% to 15% (depending on the application) - the bi-product of this? A dramatically improved ride!

Made to the highest standard in micro alloy steel each spring is individually hot coiled on a variable speed coiling machine.

The springs are then shot peened ready for protective surface finishing, prior to powder coating.

Front Springs - Pairs

Model	Part Number	Price Ex VAT	Price Inc VAT*
90 (1983 to 1989) All models			
plus 45mm ride height, 380lb rate	LL1106	79.50	95.40
110 (1983 to 1989) All models			
plus 45mm ride height, 380lb rate	LL1106	79.50	95.40
Defender 90 All models			
plus 45mm ride height, 380lb rate	LL1106	79.50	95.40
Defender 110 All models			
plus 45mm ride height, 380lb rate	LL1106	79.50	95.40
Defender 130 All models			
plus 45mm ride height, 380lb rate	LL1106	79.50	95.40
Discovery 1 All models			
plus 30mm ride height, 195lb rate	RA1350RAISED	61.50	73.80
Discovery 2 All models			
plus 30mm ride height, 195lb rate	RA1350RAISED	61.50	73.80
Discovery 3 All models			
plus 30mm ride height, 18mm wire	RD1341	65.00	78.00
Discovery 4 All models			
plus 30mm ride height, 18mm wire	RD1341	65.00	78.00
Range Rover Classic All models			
plus 30mm ride height, 195lb rate	RA1350RAISED	61.50	73.80

Rear Springs - Pairs

Model	Part Number	Price Ex VAT	Price Inc VAT*
90 (1983 to 1989) All models			
plus 0mm ride height, 195.5lb rate	RA1351	74.50	89.40
plus 20mm ride height, 240lb rate	RA1351R20	68.33	82.00
plus 40mm ride height, 295lb rate	RA1351R40	78.33	94.00
Defender 90 All models			
plus 0mm ride height, 195.5lb rate	RA1351	74.50	89.40
plus 20mm ride height, 240lb rate	RA1351R20	68.33	82.00
plus 40mm ride height, 295lb rate	RA1351R40	78.33	94.00
Defender 130 All models			
plus 40mm ride height, 510lb rate	LL1107	115.00	138.00
Discovery 1 All models			
plus 0mm ride height, 195.5lb rate	RA1351	74.50	89.40
plus 20mm ride height, 240lb rate	RA1351R20	68.33	82.00
plus 40mm ride height, 295lb rate	RA1351R40	78.33	94.00
Discovery 2 All models			
plus 0mm ride height, 195.5lb rate	RA1351	74.50	89.40
plus 20mm ride height, 240lb rate	RA1351R20	68.33	82.00
plus 40mm ride height, 295lb rate	RA1351R40	78.33	94.00
Range Rover Classic All models			
plus 0mm ride height, 195.5lb rate	RA1351	74.50	89.40
plus 20mm ride height, 240lb rate	RA1351R20	68.33	82.00
plus 40mm ride height, 295lb rate	RA1351R40	78.33	94.00

Vehicle Springs Set

Model	Part Number	Price Ex VAT	Price Inc VAT*
Discovery 1 All models			
Standard ride height	RA1349	125.83	151.00
Front +30mm 195lb rate, rear +40mm ride height, 295lb rate	RA1349RAISED	122.50	147.00



Terrafirma
 Serious 4x4 Accessories

COIL SPRING UPGRADES

Terrafirma coil springs are made from the highest quality steel, formed on accurate computer controlled mandrels and precisely heat treated to ensure consistent manufacture.

All springs are shot peened to relieve stress and 'scragged' to ensure long spring life and prevent sagging.

Finally they are powder coated silver for long lasting good looks.



Front Springs - Pairs

Model	Part Number	Price Ex VAT	Price Inc VAT*
Defender 90 All models from (VIN) HA455946			
light load, plus 50mm lift	LL1684TF	60.00	72.00
medium load, plus 50mm lift	LL1687TF	62.50	75.00
heavy load, plus 50mm lift	LL1685TF	79.50	95.40
lowered, minus 25mm drop	LL1694TF	75.00	90.00
Defender 110 All models from (VIN) HA455946			
light load, plus 50mm lift	LL1684TF	60.00	72.00
medium load, plus 50mm lift	LL1687TF	62.50	75.00
heavy load, plus 50mm lift	LL1685TF	79.50	95.40
lowered, minus 25mm drop	LL1694TF	75.00	90.00
Defender 130 All models from (VIN) HA455946			
medium load, plus 50mm lift	LL1687TF	62.50	75.00
light load, plus 50mm lift	LL1684TF	60.00	72.00
heavy load, plus 50mm lift	LL1685TF	79.50	95.40
lowered, minus 25mm drop	LL1694TF	75.00	90.00
Discovery 1 All models			
light load, plus 50mm lift	LL1684TF	60.00	72.00
medium load, plus 50mm lift	LL1687TF	62.50	75.00
heavy load, plus 50mm lift	LL1685TF	79.50	95.40
Discovery 2 All models			
medium load, plus 50mm lift	LL1698TF	65.00	78.00
heavy load, plus 50mm lift	LL1699TF	69.96	83.95
Range Rover Classic All models			
light load, plus 50mm lift	LL1684TF	60.00	72.00
medium load, plus 50mm lift	LL1687TF	62.50	75.00
heavy load, plus 50mm lift	LL1685TF	79.50	95.40

Rear Springs - Pairs

Model	Part Number	Price Ex VAT	Price Inc VAT*
Defender 90 All models from (VIN) HA455946			
medium load, plus 50mm lift	LL1688TF	85.00	102.00
heavy load, plus 50mm lift	LL1690TF	105.00	126.00
lowered, minus 25mm drop	LL1695TF	80.00	96.00
Defender 110 All models from (VIN) HA455946			
light load, plus 50mm lift	LL1686TF	85.00	102.00
medium load, plus 50mm lift	LL1689TF	99.96	119.25
heavy load, plus 50mm lift	LL1691TF	121.50	145.80
lowered, minus 25mm drop	LL1696TF	105.00	126.00
lowered, minus 50mm drop	LL1697TF	117.50	141.00
Defender 130 All models from (VIN) HA455946			
light load, plus 50mm lift	LL1686TF	85.00	102.00
medium load, plus 50mm lift	LL1689TF	99.96	119.25
heavy load, plus 50mm lift	LL1691TF	121.50	145.80
lowered, minus 25mm drop	LL1696TF	105.00	126.00
lowered, minus 50mm drop	LL1697TF	117.50	141.00
Discovery 1 All models			
medium load, plus 50mm lift	LL1688TF	85.00	102.00
heavy load, plus 50mm lift	LL1690TF	105.00	126.00
Discovery 2 All models			
medium load, plus 50mm lift	LL1688TF	85.00	102.00
heavy load, plus 50mm lift	LL1690TF	105.00	126.00
Range Rover Classic All models			
medium load, plus 50mm lift	LL1688TF	85.00	102.00
heavy load, plus 50mm lift	LL1690TF	105.00	126.00
Range Rover P38 All models			
	LL1693TF	95.00	114.00

Light load = no additional equipment fitted.

Medium load = with some additional weight such as a roof rack, winch and bumper.

Heavy load = with significant off road or expedition equipment fitted.



Panhard Rods

Terraforma Adjustable Panhard Rods

Lateral stability on the front end of coil sprung Land Rovers fitted with live axles is controlled by a tie rod called a Panhard Rod which is fitted between the front axle & the chassis, typically mounted in parallel with the drag link connecting the steering box to the axle. When these vehicles are lifted (raised suspension) the axle is pulled off-centre due to the fixed length of the Panhard Rod. Terraforma Adjustable Panhard Rods allow the axle to be adjusted back to centre restoring the steering geometry. They are manufactured from 30mm diameter, 5mm wall thickness high tensile steel tube with a 20mm precision machined threaded adjuster, also included is a lock nut part way along its length. Supplied complete with polyurethane bushes they are ready to fit



Terraforma Adjustable Panhard Rods

Model	Part Number	Price Ex VAT	Price Inc VAT*
90 - RHD or LHD			
All models	RBI500020TFADJ	100.83	121.00
110 - RHD or LHD			
All models	RBI500020TFADJ	100.83	121.00
Defender 90 - RHD or LHD			
All models up to (VIN) 2A626645	RBI500020TFADJ	100.83	121.00
All models from (VIN) 2A626646 on	RBI100041TFADJ	103.33	124.00
Defender 110 - RHD or LHD			
All models up to (VIN) 2A626645	RBI500020TFADJ	100.83	121.00
All models from (VIN) 2A626646 on	RBI100041TFADJ	103.33	124.00
Defender 130 - RHD or LHD			
All models up to (VIN) 2A626645	RBI500020TFADJ	100.83	121.00
All models from (VIN) 2A626646 on	RBI100041TFADJ	103.33	124.00
Discovery 1 - RHD or LHD			
All models	RBI500020TFADJ	100.83	121.00
Discovery 2 - RHD or LHD			
All models up to (VIN) 2A999999	RBI000090TFADJ	103.33	124.00
All models (VIN) 3A000001 on	RBI000090TFADJ	103.33	124.00
Range Rover Classic - RHD or LHD			
All models	RBI500020TFADJ	100.83	121.00

Britpart Panhard Rods
Supplied complete with yellow polyurethane bushes.



Britpart Panhard Rods

Defender up to 2002	RBI100041ADJBP	46.67	56.00
Defender Td5 & 2007 onwards	RBI100041ADJBP	46.67	56.00
Discovery 1	RBI100041ADJBP	46.67	56.00
Range Rover Classic	RBI100041ADJBP	46.67	56.00

Body Lift Kit

Freelander 1

Fits all Freelander 1* Will raise vehicle by 50mm (2"). Gives your Freelander the ground clearance for better off-road ability. *Must be fitted with LF111BM Camber Pins.



LF1106BM
PRICE EX VAT £205.00 PRICE INC VAT (UK @ 20%) £246.00

Dislocation Cones

When longer than standard rear shock absorbers are fitted the coil spring can part company with the chassis becoming dislodged on full suspension drop out, sometimes failing to relocate correctly when the suspension compresses again. Fitting dislocation cones in conjunction with coil spring retaining plates (see chart below) will ensure the spring re-seats correctly every time.



Model	Qty Req.	Part Number	Price Ex VAT	Price Inc VAT*
Defender 90				
Dislocation Cone (pair)				
Rear	Terraforma	1 LL1363TF	44.17	53.00
Rear, extra long travel	Terraforma	1 LL1363TFELT	49.58	59.50
Rear, stainless steel	Britpart	1 LL1363BPSS	47.08	56.50
Coil Spring Retaining Plates (pair)				
Rear, holds single rear springs	Terraforma	1 NTC6106TF	7.08	8.50
Plate, Spring Retainer (pair)				
Rear, holds single rear springs	Britpart	1 NTC6106BP	6.25	7.50
Inverse Relocation Cones (pair)				
Rear	Terraforma	1 LL1363TFINV	50.00	60.00
Defender 110				
Dislocation Cone (pair)				
Rear	Terraforma	1 LL1362TF	49.58	59.50
Rear, stainless steel	Britpart	1 LL1362BPSS	60.83	73.00
Coil Spring Retainer				
Rear, holds double rear springs	Aftermarket	2 NRC4318P	2.50	3.00
	Terraforma	1 NRC4318TF	8.12	9.74
Discovery 1				
Dislocation Cone (pair)				
Rear	Terraforma	1 LL1363TF	44.17	53.00
Rear, extra long travel	Terraforma	1 LL1363TFELT	49.58	59.50
Rear, stainless steel	Britpart	1 LL1363BPSS	47.08	56.50
Plate, Spring Retainer (pair)				
Rear, holds single rear springs	Terraforma	1 NTC6106TF	7.08	8.50
	Britpart	1 NTC6106BP	6.25	7.50
Inverse Relocation Cones (pair)				
Rear	Terraforma	1 LL1363TFINV	50.00	60.00
Range Rover Classic				
Dislocation Cone (pair)				
Rear	Terraforma	1 LL1363TF	44.17	53.00
Rear, extra long travel	Terraforma	1 LL1363TFELT	49.58	59.50
Rear, stainless steel	Britpart	1 LL1363BPSS	47.08	56.50
Plate, Spring Retainer (pair)				
Rear, holds single rear springs	Terraforma	1 NTC6106TF	7.08	8.50
	Britpart	1 NTC6106BP	6.25	7.50
Inverse Relocation Cones (pair)				
Rear	Terraforma	1 LL1363TFINV	50.00	60.00

An alternative to the dislocation cones, Inverse Relocation Cones retain the coil spring at the top rather than the bottom & allow for a shorter cone to be used providing a reliable location regardless of shock travel. Supplied with all necessary fittings.

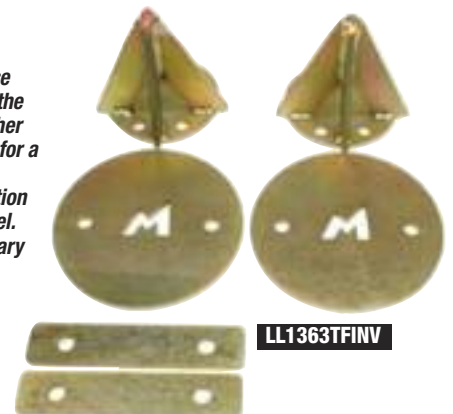

SHOCK ABSORBER MOUNTING TURRETS

Model	Application
90 (1983 to 1989) - All models	Front spring, upper
110 (1983 to 1989) - All models	Front spring, upper
Defender 90 - All models	Front spring, upper
Defender 110 - All models	Front spring, upper
Discovery 1 - All models	Front spring, upper
Range Rover Classic - All models	Front spring, upper

Mounting Bracket Galvanised

Standard Height - Galvanised

Aftermarket (Each)

NRC6372PG

PRICE EX VAT (OUTSIDE EU) **£16.67** PRICE INC VAT (UK @ 20%) **£20.00**

Fits all models listed above



Mounting Bracket Extended

Standard Height - manufactured from heavy duty steel. The original mounts are susceptible to corrosion, this design enables easy cleaning of the dirt that can build up inside.

Pair - Terrafirma

NRC6372TFELT

PRICE EX VAT (OUTSIDE EU) **£102.50** PRICE INC VAT (UK @ 20%) **£123.00**

Fits all models listed above

Terrafirma



Mounting Bracket

These strong stylish turrets are ideally suited for long travel shock absorbers and prevent bottoming out (50mm extended).

Pair - Britpart

NRC6372URBP

PRICE EX VAT (OUTSIDE EU) **£65.00** PRICE INC VAT (UK @ 20%) **£78.00**

Fits all models listed above



Twin Mounting Bracket

Twin shock turrets allows for fitment of an additional shock absorber.

Pair - Britpart

NRC6372URTWINBP

PRICE EX VAT (OUTSIDE EU) **£75.83** PRICE INC VAT (UK @ 20%) **£91.00**

Fits all models listed above



Twin Mounting Bracket - 50mm Lift

Enables fitting of additional shock absorber and 50mm lift.

Fits all models listed above

Pair - Britpart

NRC6372URTWINBP50

PRICE EX VAT (OUTSIDE EU) **£75.83** PRICE INC VAT (UK @ 20%) **£91.00**



Spring Spacer Blocks - 50mm Lift

These 50mm spring spacer blocks are manufactured from 6mm plate with a powder coated finish.



RA2086BPFRONT

The spacers fit between the axle and the spring seats on the front and rear giving you that extra 50mm of lift.



Plus 50mm LIFT

RA2086BPREAR

Model	Part Number	Price Ex VAT	Price Inc VAT*
90 (1983 to 1989) - All models	Front pair RA2086BPFRONT	32.08	38.50
	Rear pair RA2086BPREAR	32.08	38.50
110 (1983 to 1989) - All models	Front pair RA2086BPFRONT	32.08	38.50
	Rear pair RA2086BPREAR	32.08	38.50
Defender 110 - All models	Front pair RA2086BPFRONT	32.08	38.50
	Rear pair RA2086BPREAR	32.08	38.50
Defender 90 - All models	Front pair RA2086BPFRONT	32.08	38.50
	Rear pair RA2086BPREAR	32.08	38.50
Discovery 1 - All models	Front pair RA2086BPFRONT	32.08	38.50
	Rear pair RA2086BPREAR	32.08	38.50
Range Rover Classic - All models	Front pair RA2086BPFRONT	32.08	38.50
	Rear pair RA2086BPREAR	32.08	38.50

Terrafirma



RD1250TFRT

RD1250TFREAR

Lift Kit

For Discovery 2's with rear air suspension this simple lift kit will increase ground clearance and tyre to body clearance. Both kits come complete and ready to fit and require no resetting of the air suspension.

Discovery 2 - All models with rear air suspension			
Front pair	RD1250TFRT	39.58	47.50
Rear pair	RD1250TFREAR	39.58	47.50

ORDER

BY PHONE: 01522 568000 / ON LINE: www.rimmerbros.co.uk / E-MAIL: lrsales@rimmerbros.co.uk

*Prices include UK VAT @ 20%.



PERFORMANCE FILTERS

THE WORLDS BEST AIR FILTERS

K&N Air Filters

Designed to increase horsepower, this original high-flow air filter invented by K&N is made with layers of woven cotton for a washable filter that offers high airflow that can increase your vehicles horsepower & acceleration.

Economical - by using the washable air filter you will save money in the long run, one K&N direct replacement air filter costs far less than replacing disposable air filters over & over again. K&N air filters only require cleaning every 50,000 miles under normal driving conditions.

- Thousands of microscopic cotton gauze fibres naturally hold specially designed oil in suspension to create a powerful filtering medium
- Easy to fit just directly replaces your original air filter
- Washable & re-usable
- Multiple layers of premium cotton gauze help maintain high airflow
- Made in the USA



NTC6660K-N

ESR1445K-N

RTC4683K-N

PHE000112K-N

LR007478K-N

K&N Induction Kit

Specifically designed for Range Rover Classic 3.5 litre V8 EFI 1985-1990 & V8 EFI with flap type air flow meter & will free your vehicle from the size restriction that comes with the factory air box.

These economical kits will provide extra power throughout the RPM range & the larger air filter will capture & hold more dirt increasing the service life before cleaning is required.

RA1063I

PRICE EX VAT (OUTSIDE EU) **£95.00** PRICE INC VAT (UK @ 20%) **£114.00**



K&N Air Filter Cleaning Fluid

For cleaning K&N Air Filters Elements 1 Litre

RX1346

PRICE EX VAT (OUTSIDE EU) **£8.96** PRICE INC VAT (UK @ 20%) **£10.75**



K&N Air Filter Oil

For re-oiling K&N Air Filter Elements



Sachet 57cc

RX1347 PRICE EX VAT (OUTSIDE EU) **£5.21** PRICE INC VAT (UK @ 20%) **£6.25**

Bottle 250ml

RX1348 PRICE EX VAT (OUTSIDE EU) **£4.58** PRICE INC VAT (UK @ 20%) **£5.50**

Aerosol 400ml

RX1349 PRICE EX VAT (OUTSIDE EU) **£7.08** PRICE INC VAT (UK @ 20%) **£8.50**

K&N Air Filters

Model	Part Number	Price Ex VAT	Price Inc VAT*
Defender 90 & 110			
All TD5 diesel models up to (VIN) 6A999999	LR027408K-N	40.42	48.50
All 200TDi diesel models	NTC6660K-N	65.83	79.00
All V8 EFI petrol models	RTC4683K-N	42.50	51.00
All models from (VIN) 7A000001 on	PHE500060KN	50.00	60.00
Discovery 1			
All 200TDi diesel models up to (VIN) JA018272	NTC1435K-N	80.00	96.00
All 2.0 Mpi petrol models	ESR1445K-N	43.33	52.00
All 300TDi diesel models	ESR1445K-N	43.33	52.00
All V8 EFI petrol models up to (VIN) LA081991	RTC4683K-N	42.50	51.00
All V8 Efi petrol models from (VIN) MA081992 on	ESR1445K-N	43.33	52.00
Discovery 2			
All TD5 diesel models	LR027408K-N	40.42	48.50
All V8 EFI petrol models	LR027408K-N	40.42	48.50
Discovery 3 - All models			
PHE000112K-N 39.58 47.50			
Discovery 4			
All 2.7L TDV6 diesel engine models	PHE000112K-N	39.58	47.50
All 3.0L V6 diesel models	PHE000112K-N	39.58	47.50
All 4.0 V6 Cologne petrol models	PHE000112K-N	39.58	47.50
All 5.0L normally aspirated V8 petrol models from (VIN) AA000001 on	LR011593KN	71.50	85.80
Discovery Sport L550			
All 2.0L TIVCT turbo petrol models	LR029078KN	42.50	51.00
All 2.2L diesel models	LR029078KN	42.50	51.00
Range Rover Classic			
All 300TDi diesel models	ESR1445K-N	43.33	52.00
All 2.4L VM turbo diesel models	NTC1435K-N	80.00	96.00
All 2.5L VM turbo diesel models	NTC1435K-N	80.00	96.00
All V8 EFI petrol models up to (VIN) LA647644	RTC4683K-N	42.50	51.00
from (VIN) MA647645 on	ESR1445K-N	43.33	52.00
Range Rover P38			
All 2.5L 6 cyl diesel models up to (VIN) VA376579	ESR341K-N	46.67	56.00
from (VIN) WA376580 on	LR027408K-N	40.42	48.50
All V8 EFI petrol models up to (VIN) TA346793 and from WA376580 to WA385948	ESR341K-N	46.67	56.00
from (VIN) VA346794 to VA376579 and from WA385949 on	LR027408K-N	40.42	48.50
Range Rover L322			
All 3.0L 6 cyl BMW M57 diesel engine models	PHE000040K-N	62.50	75.00
All 3.6L V8 diesel engine models	PHE500021KN	42.50	51.00
All 4.4L V8 AJ petrol engine models	PHE500021KN	42.50	51.00
Range Rover Sport L320			
All models to (VIN) 9A999999	PHE000112K-N	39.58	47.50
All 3.0L V6 diesel models	PHE000112K-N	39.58	47.50
All 3.6L TDV8 diesel engine models	PHE000112K-N	39.58	47.50
All 5.0L V8 normally aspirated petrol models from (VIN) AA000001 on	LR011593KN	71.50	85.80
All 5.0L V8 supercharged petrol models from (VIN) AA000001 on	LR011593KN	71.50	85.80
Range Rover Sport L494 - All models			
LR011593KN 71.50 85.80			
Range Rover Evoque L538			
All 2.0L TIVCT turbo petrol models	LR029078KN	42.50	51.00
All 2.2L diesel models	LR029078KN	42.50	51.00
Freelander 1			
All models with 1.8L petrol engine	ESR4103K-N	30.83	37.00
All models with KV6 petrol engine	LR027408K-N-FL	46.67	56.00
All models with 2.0L L Series diesel	ESR4103K-N	30.83	37.00
All 2.0L TD4 diesel models	LR007478K-N	52.50	63.00
Freelander 2			
All 2.0L TIVCT turbo petrol models	LR029078KN	42.50	51.00
All 2.2L diesel models	LR005816K-N	45.00	54.00
All 3.2L 6 cyl petrol models	LR005816K-N	45.00	54.00

PERFORMANCE FILTERS



PERFORMANCE FILTERS

Britpart Peak Performance Air Filters

These filters, tailored to fit your Land Rover, will give maximum breathing efficiency for your engine meaning increased power or better fuel mileage. The engine will get more air and the dirt particles are trapped by quality filters.

- Easy fit, directly replaces standard air filter
- Ideal for use in hot, dusty conditions
- Compatible with snorkels
- Does not require pre-oiling
- Clean using air, water or detergent



Britpart Air Filters

Model	Part Number	Price Ex VAT	Price Inc VAT*
90 & 110			
All 2.5L petrol models up to (VIN) FA375497	NRC9238BP	23.33	28.00
All diesel models up to (VIN) FA375497	NRC9238BP	23.33	28.00
Defender 90 & 110			
All TD5 diesel models up to (VIN) 6A999999	LR027408BP	19.38	23.26
All 200TDi diesel models	NTC6660BP	29.58	35.50
All V8 EFI petrol models	RTC4683BP	17.08	20.50
All models from (VIN) 7A000001 on	PHE500060BP	21.50	25.80
Discovery 1			
All 200TDi diesel models up to (VIN) JA018272	NTC1435BP	33.75	40.50
(VIN) JA018273 to LA081991	ESR1049BP	33.75	40.50
All 2.0 Mpi petrol models	ESR1445BP	19.17	23.00
All 300TDI diesel models	ESR1445BP	19.17	23.00
All V8 carburettor models 2 filters required	605191BP	15.62	18.74
All V8 EFI petrol models up to (VIN) LA081991	RTC4683BP	17.08	20.50
from (VIN) MA081992 on	ESR1445BP	19.17	23.00
Discovery 2			
All TD5 diesel models	LR027408BP	19.38	23.26
All V8 EFI petrol models	LR027408BP	19.38	23.26
Discovery 3 - All models	PHE000112BP	18.54	22.25
Discovery 4			
All 2.7L TDV6 diesel engine models	PHE000112BP	18.54	22.25
All 3.0L V6 diesel models	PHE000112BP	18.54	22.25
All 4.0 V6 Cologne petrol models	PHE000112BP	18.54	22.25
All 5.0L normally aspirated V8 petrol models from (VIN) AA000001 on	LR011593BP	57.50	69.00
Discovery Sport L550			
All 2.0L TIVCT turbo petrol models	LR029078BP	37.50	45.00
All 2.2L diesel models	LR029078BP	37.50	45.00
Range Rover Classic			
All 200TDi diesel models	ESR1049BP	33.75	40.50
All 300TDI diesel models	ESR1445BP	19.17	23.00
All 2.4L VM turbo diesel models	NTC1435BP	33.75	40.50
All 2.5L VM turbo diesel models	NTC1435BP	33.75	40.50
All V8 carburettor models 2 filters required	605191BP	15.62	18.74
????	RB7296BP	18.12	21.74
Cone type style, extreme power	RB7296BPEX	21.04	25.25
All V8 Efi petrol models up to (VIN) LA647644	RTC4683BP	17.08	20.50
rom (VIN) MA647645 on	ESR1445BP	19.17	23.00
Range Rover P38			
All 2.5L 6 cyl diesel models up to (VIN) VA376579	ESR341BP	19.17	23.00
from (VIN) WA376580 on	LR027408BP	19.38	23.26
All V8 Efi petrol models up to (VIN) TA346793	ESR341BP	19.17	23.00
and from WA376580 to WA385948	ESR341BP	19.17	23.00
from (VIN) VA346794 to VA376579 and from WA385949 on	LR027408BP	19.38	23.26
Range Rover L322			
All 3.0L 6 cyl			
BMW M57 diesel engine models	PHE000040BP	25.83	31.00
All 3.6L V8 diesel engine models	PHE500021BP	32.08	38.50
All 4.4L V8			
BMW M62 petrol engine models	PHE000050BP	39.58	47.50
AJ petrol engine models	PHE500021BP	32.08	38.50
diesel models from (VIN) BA000001 on	LR011593BP	57.50	69.00
All 5.0L V8 normally aspirated petrol models from (VIN) AA000001 on	LR011593BP	57.50	69.00
All 5.0L V8 supercharged petrol models from (VIN) AA000001 on	LR011593BP	57.50	69.00
Range Rover L405 - All models	LR011593BP	57.50	69.00
Range Rover Sport L320			
All models to (VIN) 9A999999	PHE000112BP	18.54	22.25
All 3.0L V6 diesel models	PHE000112BP	18.54	22.25
All 3.6L TDV8 diesel engine models	PHE000112BP	18.54	22.25
All 5.0L V8 normally aspirated petrol models from (VIN) AA000001 on	LR011593BP	57.50	69.00
supercharged petrol models from (VIN) AA000001 on	LR011593BP	57.50	69.00
Range Rover Sport L494 - All models	LR011593BP	57.50	69.00
Range Rover Evoque L538			
All 2.0L TIVCT turbo petrol models	LR029078BP	37.50	45.00
All 2.2L diesel models	LR029078BP	37.50	45.00

Britpart Air Filters

Model	Part Number	Price Ex VAT	Price Inc VAT*
Freelander 1			
All models with 1.8L petrol engine	ESR4103BP	18.54	22.25
All models with KV6 petrol engine	LR027408BP	19.38	23.26
All models with 2.0L L Series diesel	ESR4103BP	18.54	22.25
All 2.0L TD4 diesel models	LR007478BP	31.75	38.10
Freelander 2			
All 2.0L TIVCT turbo petrol models	LR029078BP	37.50	45.00
All 2.2L diesel models	LR005816BP	33.33	40.00
All 3.2L 6 cyl petrol models	LR005816BP	33.33	40.00
Series			
All 4 cylinder models with Zenith & Weber Carbs fitted	LL1475BP	19.37	23.24
Series III 109			
All V8 petrol engine models 2 filters required	605191BP	15.62	18.74

PERFORMANCE FILTERS

K&N Cartridge Oil Filters

Provide outstanding filtration levels & a high oil flow rate. They are able to handle heavy duty applications & block 99% of foreign material. Suitable for both synthetic & conventional oils.

- High flow rates
- Exceptional filtration
- Strong & durable



K&N Cartridge Oil Filters

Model	Part Number	Price Ex VAT	Price Inc VAT*
90 & 110 - All models			
with 2.25L petrol engine	ERR3340KN	5.83	7.00
with 2.5L petrol engine	ERR3340KN	5.83	7.00
with 2.5L normally aspirated diesel engine	ERR3340KN	5.83	7.00
with 2.5L turbo diesel engine	ERR3340KN	5.83	7.00
with V8 petrol engine	ERR3340KN	5.83	7.00
Defender 90 & 110 - All models			
with 200TDi diesel engine	ERR3340KN	5.83	7.00
with 300TDi diesel engine	ERR3340KN	5.83	7.00
with V8 petrol engine	ERR3340KN	5.83	7.00
Discovery 1 - All models			
with 200TDi diesel engine	ERR3340KN	5.83	7.00
with 300TDi diesel engine	ERR3340KN	5.83	7.00
with V8 petrol engine	ERR3340KN	5.83	7.00
Discovery 2 - All models			
with V8 petrol engine	ERR3340KN	5.83	7.00
Discovery 3 - All models			
with 4.4L V8 AJ petrol engine	LR031439KN	12.50	15.00
Discovery Sport L550			
All 2.0L TIVCT turbo petrol models	LR096524KN	6.04	7.25
Range Rover Classic - All models			
with 200TDi diesel engine	ERR3340KN	5.83	7.00
with 300TDi diesel engine	ERR3340KN	5.83	7.00
V8 engines from (engine) suffix F on (1976 on)	ERR3340KN	5.83	7.00
Range Rover P38 - All models			
with V8 petrol engine	ERR3340KN	5.83	7.00
Range Rover L322 - All models			
with 4.2L supercharged V8 petrol engine	LR031439KN	12.50	15.00
with 4.4L V8 AJ petrol engine	LR031439KN	12.50	15.00
Range Rover Sport L320 - All models			
with 4.2L supercharged V8 petrol engine	LR031439KN	12.50	15.00
with 4.4L V8 AJ petrol engine	LR031439KN	12.50	15.00
Range Rover Evoque L538			
All 2.0L L4 petrol engine	LR096524KN	6.04	7.25
Freelander 2			
All 2.0L L4 petrol engine	LR096524KN	6.04	7.25
Series III 109 - All models			
with 3.5L V8 petrol engine	ERR3340KN	5.83	7.00

Britpart Filter Guard

The filter guard removes potential engine damaging metal particles from your oil. Britpart's filter guard is a cost effective way of removing the harmful contaminants that conventional oil filters can miss. The contaminants are fine metal particles which act like an abrasive on the fast moving parts in your vehicles engine - dramatically shortening engine life. The filter guard will never clog or restrict the all important oil flow. **NOTE** - filter not included with filter guard, please ensure that there is sufficient room for the addition of the filter guard.



- Extends engine life
- No vehicle modification required
- Added protection for stop & go driving & towing
- Improves fuel economy
- Cleans engine oil for 50,000 miles



Britpart Filter Guard

Model	diameter & height	Part Number	Price Ex VAT	Price Inc VAT*
90 & 110 - All models				
with 2.25L petrol engine	95mm x 30mm	ERR3340FGBP	45.00	54.00
with 2.5L petrol engine	95mm x 30mm	ERR3340FGBP	45.00	54.00
with 2.5L normally aspirated diesel engine	95mm x 30mm	ERR3340FGBP	45.00	54.00
with 2.5L turbo diesel engine	95mm x 30mm	ERR3340FGBP	45.00	54.00
with V8 petrol engine	95mm x 30mm	ERR3340FGBP	45.00	54.00
Defender 90 & 110 - All models				
with 200TDi diesel engine	95mm x 30mm	ERR3340FGBP	45.00	54.00
with 300TDi diesel engine	95mm x 30mm	ERR3340FGB	45.00	54.00
with V8 petrol engine	95mm x 30mm	ERR3340FGBP	45.00	54.00
Discovery 1 - All models				
with 200TDi diesel engine	95mm x 30mm	ERR3340FGBP	45.00	54.00
with 300TDi diesel engine	95mm x 30mm	ERR3340FGBP	45.00	54.00
with V8 petrol engine	95mm x 30mm	ERR3340FGBP	45.00	54.00
Discovery 2 - All models				
with V8 petrol engine	95mm x 30mm	ERR3340FGBP	45.00	54.00
Discovery 3 - All models				
with 4.4L V8 AJ petrol engine	77mm x 30mm	LR031439FGBP	47.50	57.00
Range Rover Classic - All models				
with 200TDi diesel engine	95mm x 30mm	ERR3340FGBP	45.00	54.00
with 300TDi diesel engine	95mm x 30mm	ERR3340FGBP	45.00	54.00
with V8 engine up to 1975	95mm x 30mm	RTC3186FGBP	47.50	57.00
V8 engines from (engine) suffix F on (1976 on)	95mm x 30mm	ERR3340FGBP	45.00	54.00
Range Rover P38 - All models				
with V8 petrol engine	95mm x 30mm	ERR3340FGBP	45.00	54.00
Range Rover L322 - All models				
with 4.2L supercharged V8 petrol engine	77mm x 30mm	LR031439FGBP	47.50	57.00
with 4.4L V8 AJ petrol engine	77mm x 30mm	LR031439FGBP	47.50	57.00
Range Rover Sport L320 - All models				
with 4.2L supercharged V8 petrol engine	77mm x 30mm	LR031439FGBP	47.50	57.00
with 4.4L V8 AJ petrol engine	77mm x 30mm	LR031439FGBP	47.50	57.00
Freelander 1 - All models				
with 1.8L petrol engine	77mm x 30mm	LPW100181FGBP	46.67	56.00
Series III 109 - All models				
with 3.5L V8 petrol engine	95mm x 30mm	ERR3340FGBP	45.00	54.00

See Oil Application Table on page 130 to select the correct grade oil for your vehicle



The HEARTBEAT of your ENGINE

Universal Air Filters

PERFORMANCE FILTERS



K&N Universal Air Filters

	Height	Outside dia.	Inside Dia	Flange Length	Flange offset	Finish	Inner wire	Part Number	Price Ex VAT	Price Inc VAT*
Round Straight	76mm	127mm	62mm	16mm	not applicable	Chrome	No	Base outside dia. 130mm	LL1085	53.33 64.00
	51mm	152mm	65mm	22mm	21mm	Chrome	No	Base has optional 13mm vent	LL1331	48.33 58.00
	150mm	125mm	74mm	18mm	not applicable	Chrome	No	Base outside dia. 125mm	RA1063-73	38.75 46.50
Round Tapered	165mm	89mm	84mm	16mm	not applicable	Rubber	No	Base outside dia. 121mm	RA1060	42.50 51.00
	152mm	51mm	70mm	25mm	Angled	None	No	Base outside dia. 102mm	RA1063-70	34.58 41.50
	127mm	76mm	73mm	16mm	not applicable	Chrome	No	Base outside dia. 102mm	RB7296	40.00 48.00
Custom Pancake (4 barrel carbs)	recessed	70mm	356mm (14")			Chrome	No	Neck flange 130mm	RA1397	98.33 118.00
	flat	98mm	356mm (14")			Chrome	No	Neck flange 130mm, includes vent kit	RA1398	115.00 138.00
X-Stream Pancake (4 barrel carbs)		25mm	356mm (14")			Black	No		RA1399BLACK	70.83 85.00
		25mm	356mm (14")			Polished	No		RA1399POLISHED	78.33 94.00
		25mm	356mm (14")			Red	No		RA1399RED	85.83 103.00
Pancake Element Only	59mm	356mm (14")	305mm			None	No		RB7439ELK-N	58.33 70.00
	78mm	356mm (14")	305mm			None	No		RB7438ELK-N	54.17 65.00



Edelbrock Universal Air Filters (4 Barrel Carbs)

	Height	Outside dia.	Finish	Inner wire	Part Number	Price Ex VAT	Price Inc VAT*
Custom Pancake, flat	75mm	356mm (14")	Chrome	No	RB7438	40.83	49.00
	50mm	356mm (14")	Chrome	No	RB7439	69.97	83.60
Replacement Element for RB7438					RB7438EL	19.58	23.50
for RB7439					RB7439EL	18.54	22.25
Breather Pipe Adaptor - Air cleaner base to flame trap					RB7654EDL	11.00	13.20



*Prices include UK VAT @ 20%.



LL1174

If you are likely to be driving your Land Rover in circumstances which could mean wading deep water or driving in very dusty conditions then you should consider fitting a raised air intake to your vehicle. Our aftermarket versions are a great cost effective solution!



LR008383EARLY



LL1174MET



LL1174M2



Established in 1989 the Mantec name has become synonymous with a quality & safety 'built for the job' reputation. All Mantec products are conceived, designed & engineered specifically for the off road work that Land Rovers are built for and all products are manufactured in Warwickshire, England.



RD1241



Pioneered in Australia in the early 1980's, Safari snorkels were born out of a need to protect 4WD engines from the hazards of dust & water.

Manufactured to the highest standards in durable, UV stable polyethylene material, using stainless steel

hardware where appropriate, you can be sure that a Safari snorkel will deliver a continuous & cooler supply of air for maximum engine performance.



LL1433

Snorkels

Model	Part Number	Price Ex VAT	Price Inc VAT*
Defender 200Tdi - left hand side	Safari	LL1173	172.50 207.00
	poly		
Defender 200Tdi, Td - left hand side	poly	Aftermarket	LL1173P 119.00 142.80
		Mantec	LL1173M 155.00 186.00
Defender 300Tdi - right hand side	poly	Safari	LL1174 185.59 222.71
		Aftermarket	LL1174P 125.00 150.00
	poly		
	3 piece	Mantec	LL1174M3 152.00 183.00
2 piece (not roll cage compatible)			
	Mantec	LL1174M2 125.00 150.00	
metal pipe	Britpart	LR008383EARLY	73.33 88.00
	Mantec	LL1174MET	167.50 201.00
Defender Td5 - right hand side	poly	Safari	LL1432 169.50 203.40
		Aftermarket	LL1174P 125.00 150.00
	poly		
	2 piece (not roll cage compatible)	Mantec	LL1174M2 125.00 150.00
3 piece	Mantec	LL1174M3 152.00 183.00	
metal pipe	Britpart	LR008383EARLY	73.33 88.00
	Mantec	LL1174MET	167.50 201.00
Defender (VIN) 7A000001 on - right hand side	poly	Safari	LL1432 169.50 203.40
	poly		
	2 piece (not roll cage compatible)	Mantec	LL1174M2 125.00 150.00
	3 piece	Mantec	LL1174M3 152.00 183.00
metal pipe	Britpart	LR008383LATE	73.33 88.00
	Mantec	LL1174MET	167.50 201.00
Defender V8 1984 to 1994 - right hand side	poly	Safari	LL1176 167.50 201.00
Discovery 1 200Tdi 1990 to 1994 - left hand side	poly	Safari	RD1137 197.50 237.00
Discovery 1 300Tdi (non EGR) - left hand side	poly		
	non ABS models	Safari	RD1074 220.00 264.00
	ABS models	Safari	RD1120 245.00 294.00
Discovery 1 V8 1990 to 1994 - left hand side	poly	Safari	RD1121 235.00 282.00
Discovery 1 V8 1994 to 1999 - left hand side	poly		
	non ABS models	Safari	RD1074 220.00 264.00
	ABS models	Safari	RD1120 245.00 294.00
Discovery 2 Td5 - left hand side	poly	Safari	RD1202 249.00 298.80
Discovery 2 V8 1999 on - left hand side	poly	Safari	RD1202 249.00 298.80
Discovery 3 TDV6 - right hand side	poly	Safari	RD1241 195.00 234.00
Discovery 3 all models - right hand side	poly		
	Aftermarket	RD1356	99.00 118.80
	Genuine	VPLAP0018	410.84 493.01
Discovery 4 TDV6 - right hand side	poly	Safari	RD1241 195.00 234.00
Discovery 4 all models - right hand side	poly		
	Aftermarket	RD1356	99.00 118.80
Discovery 4 all models (elbow LR020024 also required to fit 3.0L diesel) - right hand side, poly	Genuine	VPLAP0018	410.84 493.01
Range Rover Classic (all models except VM Turbo Diesel) - left hand side	metal pipe	Mantec	RA1373 285.00 342.00

Stainless Steel Air Ram Grille (will not fit LL1432BP)			
Safari	LL1433	9.50	11.40
Replacement Air Ram			
75mm (3")	Safari	LL1434	35.00 42.00
Fits LL1173, RD1137, RD1121, RD1074, RD1120 & RD1202.			
87mm (3.5")	Safari	LL1435	47.50 57.00
Fits LL1176, LL1174300TDI, LL1432 & RD1241.			

Wading Kits

If fitting a snorkel is high up on your 'must have' list then a breather kit should be higher.

The likelihood of water being deep enough to require a snorkel is far less than the 18" of water that could do serious damage to the differential. Plunging a hot axle into cold water will cause it to contract & it will suck in air, if the axle is submerged it will suck water past the seals (designed to keep oil in not water out) which will mix with the oil, dirty water will quickly wear seals, bearings & gears.



RD1122

Kits consist of breather pipes for axles, gearbox & timing cover.

Defender 90, 110 & Discovery 1	200/300Tdi engine	Aftermarket	RD1122	63.33 76.00
Defender 90 & 110	Td5 engine	Aftermarket	RD1123	30.83 37.00
	(VIN) 7A000001 on 2.4 Tdci engine	Aftermarket	RD1123PUMA	44.58 53.50

Silicone Turbo Hose Kits

Direct replacement hoses, ideal to replace standard perished items and essential with a tuned engine running higher boost pressure.

- Will not rot
- Withstand higher temperatures
- Oil resistant

All hoses are guaranteed for 2 years (will last much longer!) and are TS16949 approved.

They are manufactured from the highest quality silicones & reinforcement fabrics and will operate at temperatures from -50°C up to +180°C & at operating pressures of 2.5 to 4 bar. Hoses are constructed using 3, 4 or 5 ply fabric (depending on diameter) and have a minimum wall thickness of 4.5mm.

Defender - Silicone Hoses



Defender 200TDi
LL1614BLUE
 PRICE EX VAT (OUTSIDE EU) £29.50 PRICE INC VAT (UK @ 20%) £35.40
Also available in Black



Defender 300TDi
LL1615BLACK
 PRICE EX VAT (OUTSIDE EU) £37.50 PRICE INC VAT (UK @ 20%) £45.00
Also available in Blue



Defender TD5
LL1616BLUE
 PRICE EX VAT (OUTSIDE EU) £49.50 PRICE INC VAT (UK @ 20%) £59.40
Also available in Black



Defender TD4 Puma
PNH500660KITBLUE
 PRICE EX VAT (OUTSIDE EU) £69.50 PRICE INC VAT (UK @ 20%) £83.40



Also available in Blue
Defender TD4 2.2 Puma to 2011
LL1726BLACK
 PRICE EX VAT (OUTSIDE EU) £49.50 PRICE INC VAT (UK @ 20%) £59.40

Discovery - Silicone Hoses



Discovery 200TDi
ESR2263KITBLUE
 PRICE EX VAT (OUTSIDE EU) £37.50 PRICE INC VAT (UK @ 20%) £45.00



Discovery 300TDi
ESR3025KITBLUE
 PRICE EX VAT (OUTSIDE EU) £37.50 PRICE INC VAT (UK @ 20%) £45.00



Discovery TD5
RD1346BLACK
 PRICE EX VAT (OUTSIDE EU) £48.50 PRICE INC VAT (UK @ 20%) £58.20
Also available in Blue



Also available in Black
Discovery TDV6
RD1347BLUE
 PRICE EX VAT (OUTSIDE EU) £69.50 PRICE INC VAT (UK @ 20%) £83.40

Freelander - Silicone Hoses



Also available in Blue
Freelander TD4
LL1725BLACK
 PRICE EX VAT (OUTSIDE EU) £69.50 PRICE INC VAT (UK @ 20%) £83.40



Freelander TD4
LL1725BLUE2
 PRICE EX VAT (OUTSIDE EU) £49.50 PRICE INC VAT (UK @ 20%) £59.40

Silicone Coolant Hose Kits

Will not rot or perish!



Defender 90/110 200 TDi
LL1570
 PRICE EX VAT (OUTSIDE EU) £99.50 PRICE INC VAT (UK @ 20%) £119.40



Defender 90/110 300 TDi
ESR2298SBKIT
 PRICE EX VAT (OUTSIDE EU) £115.00 PRICE INC VAT (UK @ 20%) £138.00

ORDER

BY PHONE: 01522 568000 / ON LINE: www.rimmerbros.co.uk / E-MAIL: Irsales@rimmerbros.co.uk

*Prices include UK VAT @ 20%.

EGR BLANKING KITS & TUBES

EGR Blanking Kits

Model	Part Number	Price Ex VAT	Price Inc VAT*
Defender 90 & 110			
All 300 TDi diesel models <i>Includes blanking plate, insulator/gasket & screws</i>	LL1473	5.00	6.00
All 2.5L TD5 diesel models <i>Includes blanking plate, bypass tube & gasket</i>	LL1474	29.58	35.50
Discovery 1			
All 300 TDi diesel models <i>Includes blanking plate, insulator/gasket & screws</i>	LL1473	5.00	6.00
Discovery 2			
All 2.5L TD5 diesel models <i>Includes blanking plate, bypass tube & gasket</i>	LL1474	29.58	35.50
Discovery 3			
All 2.7L TDV6 diesel models with EU2 emissions (non-DPF) <i>Includes blanking plates & seals for both EGR valves</i>	RD1340	35.00	42.00
Range Rover Classic			
All 300 TDi diesel models <i>Includes blanking plate, insulator/gasket & screws</i>	LL1473	5.00	6.00
Range Rover Sport L320			
All 2.7L TDV6 diesel models with EU2 emissions (non-DPF) <i>Includes blanking plates & seals for both EGR valves</i>	RD1340	35.00	42.00



EGR Blanking & Silicone Hose Kits

Model	Part Number	Price Ex VAT	Price Inc VAT*
Defender 90 & 110			
All 300 TDi diesel models <i>Includes blanking plate, insulator/gasket, 3 hoses, screws & clips.</i>	LL1473KIT	42.50	51.00
All 2.5L TD5 diesel models <i>Includes blanking plate, insulator/gasket, 3 hoses & clips.</i>	LL1474KITDEF	80.00	96.00
Discovery 1			
All 300 TDi diesel models <i>Includes blanking plate, insulator/gasket, 3 hoses, screws & clips.</i>	LL1473KIT	42.50	51.00
Discovery 2			
All 2.5L TD5 diesel models <i>Includes blanking plate, insulator/gasket, 4 hoses, screws & clips..</i>	LL1474KITDIS	90.00	108.00
Range Rover Classic			
All 300 TDi diesel models <i>Includes blanking plate, insulator/gasket, 3 hoses, screws & clips.</i>	LL1473KIT	42.50	51.00
Freelander 1			
All 2.0L TD4 BMW M47 diesel models <i>Includes blanking plate, 2 hoses & clips.</i>	LF1110KIT	90.00	108.00



LL1473KIT



LL1474KITDEF



LL1474KITDIS



LF1110KIT



LL1829



RA2085

Bypass Tube EGR Valve

Range Rover P38			
All 2.5L 6 cyl BMW M51 diesel models	LL1829	35.00	42.00
Range Rover L322			
All 3.0L TD6 diesel models	RA2085	27.08	32.50
Freelander 1			
All 2.0L TD4 BMW M47 diesel models	LF1110	27.08	32.50

Performance Intercoolers

These high performance & robust units are constructed from polished aluminium & are 30% larger than the standard intercooler. As a result air has a chance to cool before entering the engine. This cooler air can increase engine power by up to 25bhp (subject to application).

Other benefits include better throttle response & reduction in fuel consumption depending on driving conditions.

Ideal for on or off road use all units are FULLY PRESSURE TESTED, CAPPED & SEALED.



Discovery 3 & Range Rover Sport
2.7 TDV6 engines

PML500011UR
PRICE EX VAT (OUTSIDE EU) £475.00 PRICE INC VAT (UK @ 20%) £570.00

The original Land Rover intercooler design can have problems due to the blocking up of the core with mud when the vehicles are used off road, as the intercooler is mounted at the lowest point in the front of the vehicle. This uprated oil cooler is designed to be easier to clean & less prone to blockage due to coarser, less dense fin design whilst dramatically improving flow, performance & economy, even without any further tuning. Tests have shown a minimum improvement of 12-15%. Power & throttle response in the lower & mid-range engine revs particularly are noticeably improved.

The intercooler is designed to be simple to install without major modifications to the vehicle. The performance intercooler makes full use of the space available behind the bumper. It is designed with an integral fan cowl extension to ensure no loss of cooling efficiency & is supplied with mounting brackets & fitting guide.



Discovery 2 - TD5
Manual without transmission
oil cooler 1999-2004.

60mm deep x 300mm high.

PCM100220URMAN
PRICE EX VAT (OUTSIDE EU) £385.00 PRICE INC VAT (UK @ 20%) £462.00



Defender 90 & 110 TD5
(1998-2006) inc aircon models.

60mm deep x 300mm high.

LR017950URTD5
PRICE EX VAT (OUTSIDE EU) £305.00 PRICE INC VAT (UK @ 20%) £366.00



Discovery 2 - TD5
Automatic & manual with
transmission oil cooler 1999-2004.

60mm deep x 235mm high.

PCM100220URAUTO
PRICE EX VAT (OUTSIDE EU) £379.17 PRICE INC VAT (UK @ 20%) £455.00



Defender 90 & 110
(2007 on) inc aircon models.

60mm deep x 300mm high.

LR017950URPUMA
PRICE EX VAT (OUTSIDE EU) £305.00 PRICE INC VAT (UK @ 20%) £366.00



Range Rover P38 - DSE/DT

60mm deep x 280mm high.

RA1466UR
PRICE EX VAT (OUTSIDE EU) £380.00 PRICE INC VAT (UK @ 20%) £456.00

Radiator Muffs

The radiator muffs are black with edging colour detailed below.

Radiator Muffs

Model	Part Number	Price Ex VAT	Price Inc VAT*
Defender			
Black edging	LL1229BLACKBP	25.83	31.00
Blue edging	LL1229BLUEBP	25.83	31.00
Green edging	LL1229GREENBP	25.83	31.00
All Black (Exmoor Trim)	EXT244-1	41.48	49.78
Series II & IIa (early)			
Black edging	LL1552BLACKBP	25.83	31.00
Blue edging	LL1552BLUEBP	25.83	31.00
Brown edging	LL1552BROWNP	25.83	31.00
Green edging	LL1552GREENBP	25.83	31.00
Series IIa (late) & Series III			
Black edging	LL1553BLACKBP	25.83	31.00
Blue edging	LL1553BLUEBP	25.83	31.00
Green edging	LL1553GREENBP	25.83	31.00
Discovery 1 (VIN) MA081992 on -			
Black edging	RD1262BP	33.33	40.00
Discovery 2			
Black edging			
square headlights	RD1263BPSQUARE	33.33	40.00
facelift headlights	RD1263BPROUND	33.33	40.00

LL1229BLACKBP



LL1553BLUEBP



LL1229BLUEBP



RD1262B



EXT244-1



RD1263BPROUND



LL1552GREENBP



RD1263BPSQUARE



ORDER

BY PHONE: 01522 568000 / ON LINE: www.rimmerbros.co.uk / E-MAIL: lrsales@rimmerbros.co.uk

*Prices include UK VAT @ 20%.



FAN CONVERSION KITS

Revotec Electronic Fan Conversion Kits

- Custom engineered to fit & cool your Land Rover perfectly
- Supplied complete with all necessary fittings & fixings to complete an electronic fan conversion on your vehicle.
- Engineered to fit without any permanent modifications & utilising original radiator mountings
- Easy to install – no special tools required
- Latest fan & controller technology for the ultimate cooling package.

Revotec offer a huge array of spare parts and accessories, please call **01522 568000** if you are looking for a specific item not shown here.



Radiator Fan Conversion Kits

Model		Part Number	Price Ex VAT	Price Inc VAT
90 - All 2.5L petrol models	Fan with brackets, temperature controller & all fixings	LL1354RTA	169.17	203.00
110 - All 2.25L & 2.5L petrol models	Fan with brackets, temperature controller & all fixings	LL1354RTA	169.17	203.00
90 & 110				
All 2.5L N/A diesel & Turbo Diesel models	Fan with brackets, temperature controller & all fixings	LL1354RETA	169.17	203.00
All V8 carb petrol models	Twin fans with brackets, temperature controller & all fixings	LL1083RT	231.95	278.34
Defender 90 & 110				
All V8 carb petrol models	Twin fans with brackets, temperature controller & all fixings	LL1083RT	231.95	278.34
All 2.5L TD5 diesel models	Fan with brackets, temperature controller & all fixings	LL1084RTA	210.00	252.00
All 200 TDi & 300 TDi diesel models	Fan with alloy brackets, temperature controller & all fixings	LL1354RTC	169.17	203.00
	Fan with black anodised alloy brackets, temperature controller & all fixings	LL1354RTB	183.60	220.32
All 2.4L & 2.2L Puma TDCi diesel models	Fan with alloy brackets, temperature controller & all fixings	LL1830	210.00	252.00
Discovery 1				
All 200 TDi & 300 TDi diesel models	Fan with alloy brackets, temperature controller & all fixings	LL1354RTC	169.17	203.00
	Fan with black anodised alloy brackets, temperature controller & all fixings	LL1354RTB	183.60	220.32
Discovery 2				
All 2.5L TD5 diesel models	Fan with brackets, temperature controller & all fixings	LL1084RTA	210.00	252.00
Range Rover P38				
All diesel models	Fan with brackets, temperature controller & all fixings	LL1084RTB	169.95	203.94
All petrol models	Fan with brackets, temperature controller & all fixings	LL1084RTC	169.95	203.94
Series II 88 - All models	Fan with powder coated steel brackets, temperature controller & all fixings	LL1831	166.00	199.20
Series II 109 - All models	Fan with powder coated steel brackets, temperature controller & all fixings	LL1831	166.00	199.20
Series IIA 88 - All models	Fan with powder coated steel brackets, temperature controller & all fixings	LL1831	166.00	199.20
Series IIA 109 - All models	Fan with powder coated steel brackets, temperature controller & all fixings	LL1831	166.00	199.20
Series III 88 - All models	Fan with powder coated steel brackets, temperature controller & all fixings	LL1832	166.00	199.20
Series III 109				
All models except V8 petrol	Fan with powder coated steel brackets, temperature controller & all fixings	LL1832	166.00	199.20
All V8 petrol models	Twin fans with brackets, temperature controller & all fixings	LL1833	231.95	278.34
Condenser Fan Assembly				
Discovery 2 - All models with air cond	Up-rated specification	JRP100060RT	108.00	129.60

ELECTRONIC FAN CONVERSION KITS

Long Range Fuel Tank - Plastic

The best way of getting more fuel into your Defender without compromising valuable space!



30 litre Plastic Tank

- Lightweight
- Supplied as a kit
- Easy to install
- Requires no pumps or added filters
- Does not interfere with storage or clearance
- Compatible with standard Defender fuel filler cap.

Defender 90, Td5 & Tdci
up to (VIN) 7A999999

LL1558EARLY
PRICE EX VAT (OUTSIDE EU) £270.83 PRICE INC VAT (UK @ 20%) £325.00

Defender 90, Tdci
from (VIN) 8A000001

LL1558LATE
PRICE EX VAT (OUTSIDE EU) £270.83 PRICE INC VAT (UK @ 20%) £325.00

Long Range Fuel Tank - Metal

Rear Arch Metal Spare Fuel Tank - right hand side

- 45 litre metal tank
- Supplied with all necessary fittings.



Defender 110
up to 1999 (pre Td5 models)

LL1422EARLY
PRICE EX VAT (OUTSIDE EU) £258.33 PRICE INC VAT (UK @ 20%) £310.00

Defender 110
1999 on (Td5 & Puma models)

LL1422LATE
PRICE EX VAT (OUTSIDE EU) £320.83 PRICE INC VAT (UK @ 20%) £385.00

Including a replacement filler neck and specifically engineered bulkhead fitting for the balance pipe.



Programmable Wiper Relay

Fed up with your Defender's intermittent wipers not being intermittent enough?



Does it drive you mad when you give the screen a quick spray and it wipes for ages?

Fit this new relay in place of the standard LR057366 to your vehicle to solve this problem. Once fitted you press the stalk down so that the wiper wipes & then back off again, now count/wait until you want another swipe, switch the stalk down & leave it on, this timing will now remain constant until you set another timing the same way or turn off the ignition at which point the relay returns to the standard 6 second wipe interval. Another bonus is that the wipers will now only wipe once following a short burst of washer fluid or 3 times after a long burst.

This will work on all Defenders with the latching intermittent wiper stalk PRC7370 or AMR6106 (VIN) HA onwards (stays down when pressed) but it will also work on 300TDi & TD5 although on post 2002 TD5's the relay LR057366 is located behind the speedo. Will not work with early stalk PRC3900 up to (VIN) GA models.

Defender
LR057366PROG
PRICE EX VAT (OUTSIDE EU) £35.83 PRICE INC VAT (UK @ 20%) £43.00

Alternator Upgrade Kits

Upgrades the Alternator to 100AMP



Kits include uprated cable

Defender 200Tdi
RTC5682PKUR
PRICE EX VAT (OUTSIDE EU) £100.00 PRICE INC VAT (UK @ 20%) £120.00

Discovery 1 200Tdi
STC233P-KUR
PRICE EX VAT (OUTSIDE EU) £100.00 PRICE INC VAT (UK @ 20%) £120.00



Battery Isolator Switch

	Part Number	Price Ex VAT	Price Inc VAT*
Standard Switch, with key	LL1171	6.46	7.75
Race Type Switch, FIA approved	LL1171RACE	17.71	21.25
Spare Key			
standard isolator switch	LL1171KEY	2.00	2.40

How Does 'Dis-Car-Nect' Work?

When leaving your car, simply remove the knob to isolate the starter circuit. The 16 amp fuse will maintain current supply to all other electrical circuits (central locking, stereo memory, alarm etc.). Because the starter motor draws over 150 amps, any attempt to connect (hot-wire) the starter motor will instantly cause the fuse to blow. This immobilises the car until the knob is replaced. If this should happen, simply replace the 16 amp fuse at a convenient time.

As an added advantage, the 'Dis-Car-Nect' will also prevent battery drain if you intend to store your car: simply unscrew the knob and remove the fuse. For extra security, unscrew and remove the immobiliser knob completely.

'Dis-Car-Nect' fits all vehicles and is easily fitted to any battery terminal. Full installation instructions are supplied with the kit.



Dis-Car-Nect

	Part Number	Price Ex VAT	Price Inc VAT*
Dis-Car-Nect Immobiliser Kit	RX1356	12.71	15.25
Replacement Knob	RX1356KNOB	3.92	4.70
Replacement Fuse	RX1356FUSE	2.92	3.50

Heater Plug Upgrade Kit



Series - 2.25 Diesel
LL1530
PRICE EX VAT (OUTSIDE EU) £22.50 PRICE INC VAT (UK @ 20%) £27.00

Replacement Heater Plug Set for LL1530

Series - 2.25 Diesel
LL1530PLUG
PRICE EX VAT (OUTSIDE EU) £17.50 PRICE INC VAT (UK @ 20%) £21.00



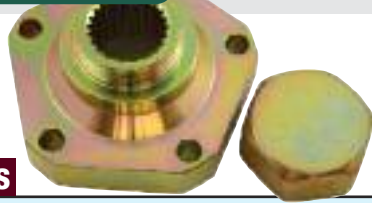

Heavy Duty Driving Members

These heavy-duty drive flange kits have been engineered to out perform many of the inferior products on the market – they are much stronger than an OE drive flange.

The Britpart product is profiled to follow the shape of the standard part rather than the simple pentagon design, this does mean that wheels such as Rostyle and some alloy's will fit without issue.

Also the cap on the Britpart design is sealed at the base of the thread preventing water ingress into the thread.



Driving Members

Model	Part Number	Price Ex VAT	Price Inc VAT*
90 - All models			
24 spline, front or rear (each)			
Bearmach	FRC5806HDBMDEF	13.33	16.00
Britpart	FRC5806HDBPDEF	25.83	31.00
Kit, inc. driving members, bolt & gaskets (pair)			
Britpart	FRC5806HDKBPDEF	60.00	72.00
110 - All models			
24 spline, front or rear (each)			
Bearmach	FRC5806HDBMDEF	13.33	16.00
Britpart	FRC5806HDBPDEF	25.83	31.00
Kit, inc. driving members, bolt & gaskets (pair)			
Britpart	FRC5806HDKBPDEF	60.00	72.00
Defender 90 - All models			
24 spline, front or rear (each) (to (VIN) KA930455)			
Bearmach	FRC5806HDBMDEF	13.33	16.00
Britpart	FRC5806HDBPDEF	25.83	31.00
Kit, inc. driving members, bolt & gaskets (pair) (to (VIN) KA930455)			
Britpart	FRC5806HDKBPDEF	60.00	72.00
24 spline, front or rear (each) ((VIN) LA930456 on)			
Terraforma	RUC105200HDTF	16.88	20.26
Britpart	RUC105200HDBP	25.83	31.00
Bearmach	RUC105200HDBM	16.88	20.26
Kit, inc. driving members, bolt & gaskets (pair (VIN) LA930456 on)			
Britpart	RUC105200HDKBP	62.50	75.00
Defender 110 - All models (VIN) LA930456 on			
24 spline, front or rear (each)			
Terraforma	RUC105200HDTF	16.88	20.26
Britpart	RUC105200HDBP	25.83	31.00
Bearmach	RUC105200HDBM	16.88	20.26
Kit, inc. driving members, bolt & gaskets (pair)			
Britpart	RUC105200HDKBP	62.50	75.00
Discovery 1 - All models (VIN) JA032851 on			
24 spline, front (each)			
Terraforma	RUC105200HDTF	16.88	20.26
Britpart	RUC105200HDBP	25.83	31.00
Bearmach	RUC105200HDBM	16.88	20.26
Kit, inc. driving members, bolt & gaskets (pair)			
Britpart	RUC105200HDKBP	62.50	75.00
Range Rover Classic - All ABS fitted models			
24 spline, front or rear (each)			
Terraforma	RUC105200HDTF	16.88	20.26
Britpart	RUC105200HDBP	25.83	31.00
Bearmach	RUC105200HDBM	16.88	20.26
Kit, inc. driving members, bolt & gaskets (pair)			
Britpart	RUC105200HDKBP	62.50	75.00

Driving Members Spare Parts

Model	Part Number	Price Ex VAT	Price Inc VAT*
Bolt Kit, Heavy Duty Driving Members, Includes 10 bolts (one axle set)			
90	Britpart RUC105200BPKBOLT	10.00	12.00
110	Britpart RUC105200BPKBOLT	10.00	12.00
Defender 90	Britpart RUC105200BPKBOLT	10.00	12.00
Defender 110	Britpart RUC105200BPKBOLT	10.00	12.00
Discovery 1	Britpart RUC105200BPKBOLT	10.00	12.00
Range Rover Classic	Britpart RUC105200BPKBOLT	10.00	12.00
Dust Cap, Screw On, Heavy duty driving member			
90	Britpart RUC105200HDBPCAP	8.75	10.50
	Bearmach RUC105200HDBMNUT	3.33	4.00
110	Britpart RUC105200HDBPCAP	8.75	10.50
	Bearmach RUC105200HDBMNUT	3.33	4.00
Defender 90	Britpart RUC105200HDBPCAP	8.75	10.50
	Bearmach RUC105200HDBMNUT	3.33	4.00
Defender 110	Britpart RUC105200HDBPCAP	8.75	10.50
	Bearmach RUC105200HDBMNUT	3.33	4.00
Discovery 1	Britpart RUC105200HDBPCAP	8.75	10.50
	Bearmach RUC105200HDBMNUT	3.33	4.00
Range Rover Classic	Britpart RUC105200HDBPCAP	8.75	10.50
	Bearmach RUC105200HDBMNUT	3.33	4.00

Sand Ladder & Waffle Boards

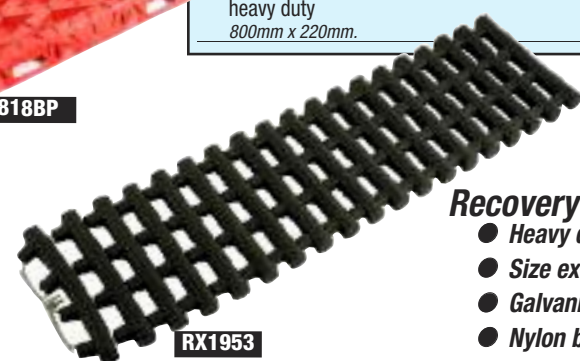

Model	Part Number	Price Ex VAT	Price Inc VAT*
Sandtracks, aluminium (pair)			
	LL1429	135.83	163.00
Waffle Boards, fibreglass (pair):			
Grey with gritted surface for extra traction.			
size 1			
1220mm long x 260mm wide x 50mm deep.	LL1430BP1	83.33	100.00
size 2			
1220mm long x 270mm wide x 38mm deep.	LL1430BP2	77.50	93.00
Recovery tracks,:			
plastic (pair)	LL1818BP	57.50	69.00
1210mm long x 325mm wide x 60mm deep. Maximum load 3.5 tons.			
heavy duty	RX1953	29.50	35.40
800mm x 220mm.			

Recovery Track

- Heavy duty
- Size extended 800mm x 220mm
- Galvanised steel cable and fittings
- Nylon bag for handy storage

AVM Free Wheeling Hubs

Ideal economy measure when four wheel drive is not required.

Saves wear and tear on front axle.



- Ultra reinforced nodular iron body
- Salt-spray tested epoxy enamel finish
- Die cast aluminium cap, corrosion resistant gloss finish
- Internal components: CNC machined and heat treated.

AVM Free Wheeling Hubs (pair)

Model	Part Number	Price Ex VAT	Price Inc VAT*
Series IIa & Series III			
10 Spline	LL1610BM10	159.50	191.40
Series III			
24 Spline	LL1610BM24	142.50	171.00
Defender up to 1993			
<i>Will only fit vehicles with LT230 & LT230T Transfer case</i>			
24 Spline	LL1620BME	208.33	250.00
Defender 1994 on & Discovery 1 1994 on			
<i>Will not fit vehicles with factory alloy wheels</i>			
24 Spline	LL1620BML	210.00	252.00

Handbrake Conversion Kits

Driving off-road you will know how easy it is for the standard Land Rover handbrake to get bunged up with dirt & once the mechanism gets clogged up it does not work as efficiently as it should.

Britpart now offer a solution to that problem – a drum to disc conversion kit.

These kits use powerful calipers whose mechanism is sealed to prevent the ingress of mud.

Parts are supplied coated with a tough corrosion resistant coating of gold zinc passivate to ensure a long life.

Fitting is easy requiring only simple tools. Full fitting instructions are included as well as advice on adjustment & use.

Series I, II & III

This will fit any Land Rover fitted with a standard Series transfer box, including those fitted with PTO's under or overdrive units. The new brake replaces the original transmission brake drum. It is supplied with a new adjustable actuator rod which connects from your original handbrake lever, direct to the caliper, reducing the amount of slack in the linkages.

The disc transmission brake uses an industrial open-frame caliper with simple adjustment & easy cleaning. The new caliper is mounted on a laser cut steel back-plate with a folded gusset for added strength & incorporates a built-in skid plate to protect the disc.

The disc is manufactured from robust 10mm thick mild steel plate which bolts directly to your original gearbox output flange with 6 new bolts (supplied).

The system is very light weight, offering a saving of almost 10kg compared to the original drum brake.



Handbrake Conversion Kits

Model	Part Number	Price Ex VAT	Price Inc VAT*
Series I, II & III			
<i>All models with standard Series transfer box.</i>			
	LL1664	188.33	226.00
Defender 90 & 110			
<i>For anything post 1993 (300Tdi, TD5 & Puma) you will need to change the cable - NRC5088.</i>			
	LL1472	325.00	390.00
Discovery 1, Discovery 2, Range Rover Classic			
<i>Will not fit a Borg Warner or LT95 transfer box.</i>			
	RD1247	270.83	325.00
Replacement Disc			
for LL1472 & RD1247	LL1472DISC	38.33	46.00
Replacement Pads			
for LL1472 & RD1247	LL1472PAD	48.33	58.00

Defender/Discovery/Range Rover Classic

The disc transmission brake uses a state of the art monster sized mechanical caliper designed for agricultural vehicles & earth moving equipment – so using it on a Land Rover is easy work for it.

The mechanism is sealed so it will not seize up due to the ingress of mud or water & it uses special 'sintered' pads which are resistant to abrasion from mud as well as providing greater friction against the disc than a standard pad.

The disc has been specially designed for Land Rovers & manufactured from tough 10mm thick steel. It has a smaller diameter than a standard drum & so does not dangle below the transfer box which helps to protect it from whatever you are driving over. The caliper mechanism sits in a well protected area at the top, away from most of the mud & water.



ARB DIFF AIR LOCKERS

Air Locker Locking Differentials allow you to tackle the toughest terrain.

As the world's premier traction aid, ARB Air Lockers keep you moving in all conditions.

- Provides 100% traction on demand without affecting on road driveability or driveline wear
- Vastly improved traction means less reliance on momentum, thus reducing the likelihood of vehicle damage & environmental impact
- Easy, convenient operation allows the driver to concentrate on the terrain without leaving the comfort & safety of their seat
- Ultra durable & extremely strong – only the highest quality materials are used in construction
- Incredibly simple yet effective design that employs minimal moving parts, thereby ensuring maximum reliability
- Thoroughly tested & proven design – trusted & used in over 80 countries around the world
- Easy installation & maintenance – no special tools, skills or additives required
- Two year warranty guarantees the Air Locker will be free of defects in materials



Notes Key	
1	If vehicle was manufactured during 1993, check spline count
2	Air Locker not available for vehicles equipped with high load option
3	Ring gear spacer required. Longer ring gear bolts (not supplied) are also necessary 3/8 BSF x 1.1/2" (no longer available from LR)
4	When an LL1159 Air Locker is to be installed in Range Rovers manufactured prior to 1980 (approx.), special carrier bearings may also be necessary. RTC3426P (aftermarket) RTC3426 (Genuine)
5	Some vehicles have crown wheel bolts which cannot be reused & must be replaced. Consult service manual
6	Type P38A is most commonly found in traction control equipped vehicles. Identify P38A type diff by large 205mm (8.07") flange diameter. P38A was not used on North American delivered Discoverys – use LL1160
7	Check diff ratio before ordering this part

ARB Air Lockers

Model & Year	Axle Location	Notes	Shaft Description	Shaft Diameter	Spline	Ratio	Part Number	Price Ex VAT	Price Inc VAT*
Series I, II & III									
1948 - 1985	Front	2 & 3	Rover type	28.2mm (1.11")	10	4.7	LL1159	633.33	760.00
	Rear	2 & 3	Rover type	28.2mm (1.11")	10	4.7	LL1159	633.33	760.00
Defender 90									
1984 - 1993	Front	1	Rover type	28.2mm (1.11")	10	3.54	LL1159	633.33	760.00
	Rear	1 & 2	Rover type	28.2mm (1.11")	10	3.54	LL1159	633.33	760.00
1993 on	Front	1 & 5	Rover type	31.5mm (1.24")	24	3.54	LL1160	608.33	730.00
	Rear	1 & 6	Rover type	31.5mm (1.24")	24	3.54	LL1160	608.33	730.00
2002 on	Rear	6	Rover type, P38A	31.5mm (1.24")	24	3.54	LL1162	699.00	838.80
2007 on (with 2 pin rear diff) (with 4 pin rear diff)	Front	1 & 6	Rover type	31.5mm (1.24")	24	3.54	LL1160	608.33	730.00
	Rear	1 & 6	Rover type	31.5mm (1.24")	24	3.54	LL1160	608.33	730.00
2007 on (with 4 pin rear diff)	Rear	6	Rover type, P38A	31.5mm (1.24")	24	3.54	LL1162	699.00	838.80
	Rear	6	Rover type, P38A	31.5mm (1.24")	24	3.54	LL1162	699.00	838.80
Defender 110/130									
1983 - 1993	Front	1	Rover type	28.2mm (1.11")	10	3.54	LL1159	633.33	760.00
1983 - 2002	Rear		Salisbury type	31.5mm (1.24")	24	3.54	LL1161	733.33	880.00
1993 on	Front	1 & 5	Rover type	31.5mm (1.24")	24	3.54	LL1160	608.33	730.00
2002 on	Rear	6	Rover type	31.5mm (1.24")	24	3.54	LL1160	608.33	730.00
2007 on	Rear	6	Rover type, P38A	31.5mm (1.24")	24	3.54	LL1162	699.00	838.80
	Front	1 & 6	Rover type	31.5mm (1.24")	24	3.54	LL1160	608.33	730.00
2007 on	Rear	6	Rover type, P38A	31.5mm (1.24")	24	3.54	LL1162	699.00	838.80
	Rear	6	Rover type, P38A	31.5mm (1.24")	24	3.54	LL1162	699.00	838.80
Discovery 1									
up to 1993	Front	1	Rover type	28.2mm (1.11")	10	3.54	LL1159	633.33	760.00
	Rear	1	Rover type	28.2mm (1.11")	10	3.54	LL1159	633.33	760.00
1993 - 1998	Front	1 & 5	Rover type	31.5mm (1.24")	24	3.54	LL1160	608.33	730.00
	Rear	1 & 5	Rover type	31.5mm (1.24")	24	3.54	LL1160	608.33	730.00
Discovery 2									
All models	Front	1 & 5	Rover type	31.5mm (1.24")	24	3.54	LL1160	608.33	730.00
	Rear	6	Rover type	31.5mm (1.24")	24	3.54	LL1160	608.33	730.00
2002 on	Rear	6	Rover type, P38A	31.5mm (1.24")	24	3.54	LL1162	699.00	838.80
Discovery 3									
All models	Front	7	IRS, Clamshell type	31.5mm (1.24")	29	All	LL1890	625.25	750.30
	Rear		IRS, Clamshell type	33.6mm (1.32")	31	All	RD1368	641.67	770.00
Discovery 4									
All models	Front		IRS, Clamshell type	31.5mm (1.24")	29	All	LL1890	625.25	750.30
Range Rover Classic									
up to 1992	Front	1 & 4	Rover type	28.2mm (1.11")	10	3.54	LL1159	633.33	760.00
	Rear	1 & 4	Rover type	28.2mm (1.11")	10	3.54	LL1159	633.33	760.00
1993 - 1996	Front	1 & 5	Rover type	31.5mm (1.24")	24	3.54	LL1160	608.33	730.00
	Rear	1 & 5	Rover type	31.5mm (1.24")	24	3.54	LL1160	608.33	730.00
Range Rover P38									
1996 - 2002	Front	5	Rover type, P38A	31.5mm (1.24")	24	3.54	LL1162	699.00	838.80
	Rear	5	Rover type, P38A	31.5mm (1.24")	24	3.54	LL1162	699.00	838.80
Range Rover Sport									
2005 - 2013	Front		IRS, Clamshell type	31.5mm (1.24")	29	All	LL1890	625.25	750.30

Detroit Locker

The legendary Detroit Locker began the revolution in performance differentials & still leads the industry today as an Eaton brand. The Detroit Locker is the most durable & dependable locking differential available. The Detroit Locker maximises traction by delivering 100% of the torque to both drive wheels. It is engineered to keep both wheels in a constant drive mode & has the ability to automatically allow wheel speed differentiation when required.

No other performance differential has the reputation for delivering traction in mud, snow, rocks & on the track. The choice of professional racers & off-road enthusiasts around the world! The durability of Detroit Locker is unmatched!

- 100% locking differential
- Legendary traction
- Ultimate performance



Detroit Locker

Model	Part Number	Price Ex VAT	Price Inc VAT*
Series III, Defender, Discovery 1 & Range Rover Classic			
Rear 10 spline	LL1152	535.00	642.00
24 spline	LL1153	495.83	595.00
Defender - Salisbury axle			
Rear 24 spline	LL1154	491.67	590.00

Detroit Truetrac

The Detroit Truetrac was the first helical gear differential ever introduced into the automotive aftermarket as an Eaton brand. It remains the leading helical gear-type limited slip differential in the industry. Detroit Truetrac's proven helical gear design eliminates the need for wearable parts, resulting in maintenance free traction.

Recognised not only for its toughness but also its smooth & quiet operation. Engineered to work efficiently in front & rear axles, semi-floating (C-clip axles) & transfer cases. Power transfer is so smooth, it literally goes unnoticed by the driver – even in front wheel drive axles.

Proven design, low cost & effective performance, all make the Detroit Truetrac limited slip differential the ideal choice for a wide variety of vehicle applications.

- No maintenance – just traction!
- Smooth operation
- Performs open until needed
- Fully automatic limited slip



Detroit Truetrac

Model	Part Number	Price Ex VAT	Price Inc VAT*
Series III, Defender, Discovery 1 & Range Rover Classic			
Rear 10 spline	LL1157	458.33	550.00
Series III, Defender, Discovery 1, Discovery 2 & Range Rover Classic			
Front 10 spline	LL1155	449.00	538.80
24 spline	LL1156	459.00	550.80
Rear 24 spline	LL1158	479.00	574.80
Defender - Salisbury axle			
Rear 24 spline	LL1421	555.00	666.00

Land Inclinometers

- Independent twin meter
- Perfect for seeing the pitch and roll of the vehicle body or terrain
- Transparent illumination for easy-to-see reading at night



Black
LL1431BLACK
 PRICE EX VAT (OUTSIDE EU) £14.37 PRICE INC VAT (UK @ 20%) £17.24



Carbon Fibre Effect
LL1431CARBON
 PRICE EX VAT (OUTSIDE EU) £16.87 PRICE INC VAT (UK @ 20%) £20.24



4 Barrel Carb Conversion

The simple, cost effective, bolt-on performance upgrade that is a direct replacement for the twin Stromberg or SU carbs, offering easy starting, smooth running, transformed drive-ability and enhanced fuel economy. A 4 barrel conversion will work well on its own, or in conjunction with an uprated cam or cylinder heads and can be re-jetted to suit if required.

We offer several conversion kits for just about all applications and engine sizes, utilising either the Holley 390 or Edelbrock 500 carb paired with an inlet manifold and air cleaner to suit your requirements. Our conversion kits also include accelerator / choke cable kits and thermostat housing, please see below. To decide on what suits, select a carb, inlet manifold and air cleaner from the options below, then refer to the list of kits on the opposite page. Also, refer to the list of optional parts below, to include fuel pump, heater hose connector etc.



4 Barrel Carb Conversion Options

Choose a Carb:

Holley 390 cfm - RB7254

The legendary Holley is an ideal choice for all engines up to 4.6 litres. Supplied jetted to suit the standard 3.5 litre engine (primary jet 51, secondary equivalent to 53 jet), it can be re-jetted to suit modified engines (cam and/or heads) or larger capacities (see options under Holley carb components). Supplied with manual choke, vacuum secondary, power valve blow-out protection and polished body finish. Adaptor plate kit also available for enlarging secondary jets. Accelerator and choke cable kits available separately (supplied if purchasing conversion kit). Recommended: Facet 'Red Top' fuel pump kit RB7259.



Edelbrock 500 cfm - RA1335

Previously marketed as Weber, this increased capacity 4 barrel carb is best suited to larger capacity engines (4.6 litres +) but can be fitted to any Rover V8. Supplied jetted to suit the standard 3.5 / 3.9 litre engine (primary jet .086, secondary .095, metering rods .065x.052 jet), a tuning / calibration kit is also available for larger capacity and / or modified engines, which includes assorted jets and metering rods (see options under Edelbrock carb components). Supplied with manual choke and polished body finish. Accelerator / choke cable kits and fuel feed banjo / bolt available separately (supplied if purchasing conversion kit). Recommended: Facet 'Red Top' fuel pump kit RB7259.



Choose an Inlet Manifold:

Both the Holley and Edelbrock carbs will fit any of the inlet manifolds listed below, as they have the same footprint. However, the height of the manifold affects the performance proportionally, and this will be dictated by the available clearance under the bonnet.

Edelbrock Performer Dual Plane Inlet Manifold - RA1337

Due to its design, this manifold offers up to 10 BHP over other 4 barrel manifold options at high mid-range, with increased torque over a wide RPM range, especially from idle to to mid-range. It also offers excellent throttle response. Due to its height, it may not offer sufficient under bonnet clearance where space is tight. Select the correct air cleaner to ensure sufficient under bonnet clearance when suitable. A spacer may also be required to allow clearance for the pancake filter and carb throttle linkages. A thermostat housing, air cleaner and carb levelling plate (for 4x4 and certain other applications), are all available separately (supplied if purchasing conversion kit).



Offenhauser 360 Dual Plane Inlet Manifold - RB7314

Sitting slightly lower than the Edelbrock manifold, this unit is a compromise between the Offenhauser JWR manifold (which offers the lowest profile) and the Edelbrock. Select the correct air cleaner to ensure under bonnet clearance. A thermostat housing, air cleaner and carb levelling plate (for 4x4 and certain other applications), are all available separately (supplied if purchasing conversion kit).



Offenhauser JWR Dual Port Inlet Manifold - RA1336

This manifold offers the lowest profile where under bonnet clearance is restricted. The dual ports design offers increased efficiency due to the primaries using the lower port (increasing gas speed) and since the secondaries use the upper port (which is shielded by the primaries), the gas is cooler, meaning a better fuel burn. These benefits help to offset the efficiency lost due to the low profile design. Select the correct air cleaner to ensure under bonnet clearance. A thermostat housing, air cleaner and carb levelling plate (for 4x4 and certain other applications), are all available separately (supplied if purchasing conversion kit).



Choose an Air Cleaner:

Dependent on the height available under the bonnet, select the most suitable air cleaner for your application. If clearance is not an issue, the 3" deep filter will offer the best performance, as will the K&N (at extra cost) air cleaner and X-Stream air flow lid - see listings for details.

14" Chrome Pancake Air Cleaner Kit

Included in conversion kits.

- 3" Deep (standard applications) **RB7438**
- 2" Deep (for extra bonnet clearance) **RB7439**



Conversion Kits also include (where relevant):



Optional Parts:



Camshaft - Performance



Kent Cams

Kent Cams are renown for their range of performance enhancing cams, and have been manufacturing in the UK since the early '60s. No other single modification will result in a greater increase in performance, than by fitting a performance cam.

Rimmer Bros stock a range of Kent hydraulic cams and also offer a selection of cam kits for the Rover V8 engine. Depending on whether you want a straightforward bolt-in cam to improve bottom end power and torque, or are looking for a competition spec set-up which involves modified heads, enhancing the bottom end, fuel and exhaust systems (and perhaps an upgraded distributor), we can help!

Essentially, there are 2 different types of cam for the V8. Non GEMS (to 1995), and GEMS type(1995 on, ie 4.0 & 4.6 litre Range Rover 2, 4.0 Discovery 2 & Defender 4.0 Efi).

GEMS refers to the electronic engine management system, where there is a sensor pick-up on the rear of the block. GEMS engines are distributor-less and have a crank driven (as opposed to distributor driven) oil pump. This then dictates the type of cam installed.



We offer 4 different types of cam / cam kits, ranging from the Sports Torque to Competition.

Our cam kits include the minimum of parts required to install the cam chosen.

Our Kent cam installation kit should also be purchased separately (RB7488KENT), along with a head gasket set (since valve springs will need to be changed) - see our website or contact us.

There are also a few other options to consider depending on your requirements, such as upgraded timing chain set, or upgraded head studs, main and big end stud & bolt kits.

Finally, you may also wish to consider a K+N Filter or even a 4 barrel carb / re-chipped engine management, or performance enhancing extractor manifolds. (Please see relevant sections).

If you have any specialised requirements such as high-end competition/racing (solid lifer) cams or cam kits, please enquire.

Kent Cams & Kits

Model	Part Number	Price Ex VAT	Price Inc VAT*
Kent Sports Torque H180			
Designed using the latest in cam design technology, low overlap and minimal duration to help create a package that is unbeatable when installed in a standard production road car or 4x4. Straight swap for standard cam. Improves low-rev and mid range torque with up to 22 BHP increase in power (1000-4500rpm power band), and retains smooth idle characteristics and fuel economy. Also suitable for automatics. No modifications are necessary to ensure straightforward installation. Upgraded cam followers and upgraded single valve springs are required. A K+N air filter is a worthy and easy upgrade to also enhance performance with this cam. Valve lift: inlet 11.20mm, exhaust 11.20mm. Timing: inlet 23/59, exhaust 59/23			
Cam H180 only;			
Non Gems (to'95)	RB7444	265.00	318.00
Gems type ('95 on)	RB7444GEMS	260.00	312.00
Cam H180 Kit;			
Inc H180 cam, cam lube, upgraded followers & upgraded single type valve springs.			
Non Gems (to'95)	RB7441	555.00	666.00
Gems type ('95 on)	RB7441GEMS	555.00	666.00

Kent Fast Road H218			
Fast road cams are designed specifically for the spirited driver. Utilising maximum valve acceleration technology, this cam will benefit more with other modifications, such as performance exhaust, K+N air filter and/or fuel system / engine management chip. Improves power by up to 26 BHP (1500-5000rpm power band), with further gains available depending on mods. Boosts top end power whilst retaining low end torque and fuel economy. The benefit with this cam, is that it uses upgraded single valve springs, and does not require machining of valve spring platforms. Upgraded cam followers and upgraded single valve springs are required. Valve lift: inlet 11.38mm, exhaust 11.78mm. Timing: inlet 27/71, exhaust 74/30			
Cam H218 only			
Non Gems (to'95)	RB7718	262.33	314.80
Gems type ('95 on)	RB7718GEMS	258.33	310.00
Cam H218 Kit			
Inc H218 cam, cam lube, upgraded followers & upgraded single type valve springs.			
Non Gems (to'95)	RB7719	555.00	666.00
Gems type ('95 on)	RB7719GEMS	555.00	666.00

Kent Fast Road H214			
Fast road cams are designed specifically for the spirited driver. Utilising maximum valve acceleration technology, this cam will benefit more with other modifications, such as performance exhaust, K+N air filter and/or fuel system / engine management chip. Improves power by up to 30 BHP (1500-5000rpm power band), with further gains available depending on mods. This kit requires machining of the valve spring platforms to enable fitting of the double springs, and also the top of the valve guides depending upon application. Upgraded cam followers and upgraded double valve springs and retaining caps are required. Also consider fitting an upgraded timing chain kit (RB7449), upgraded main and big end studs/bolts (RB7456/RB7500) and upgraded head stud kit (RB7680). Valve lift: inlet 11.90mm, exhaust 12.44mm. Timing: inlet 31/73, exhaust 78/40			
Cam H214 only			
Non Gems (to'95)	RB7445	250.00	300.00
Gems type ('95 on)	RB7445GEMS	250.00	300.00
Cam H214 Kit			
Inc H214 Cam, cam lube, upgraded followers, upgraded double type valve springs & special spring retainers.			
Non Gems (to'95)	RB7442	540.00	648.00
Gems type ('95 on)	RB7442GEMS	540.00	648.00

Kent Competition H224			
Specifically designed for motor sport/competition use, and not generally recommended for road use. This hydraulic cam delivers a power increase dependent upon modifications to heads, fuelling and exhaust (2000-5500rpm power band). This kit requires machining of the valve spring platforms to enable fitting of the double springs, and also the top of the valve guides depending upon application. Upgraded cam followers and upgraded double valve springs and retaining caps are required. An upgraded timing chain kit (RB7449) should also be fitted. Also consider fitting upgraded main and big end studs/bolts (RB7456/RB7500) and upgraded head stud kit (RB7680). Valve lift: inlet 12.49mm, exhaust 13.08mm. Timing: inlet 41/83, exhaust 86/44			
Cam H224 only			
Non Gems (to'95)	RB7446	250.00	300.00
Gems type ('95 on)	RB7446GEMS	250.00	300.00
Cam H224 Kit			
Inc H224 Cam, cam lube, upgraded followers, upgraded double type valve springs & special spring retainers.			
Non Gems (to'95)	RB7443	540.00	648.00
Gems type ('95 on)	RB7443GEMS	540.00	648.00

Camshaft Components

Model	Part Number	Price Ex VAT	Price Inc VAT*
Cam Follower , hydraulic,uprated, set of 16, high rev, Kent,	ERC4949KENT	147.50	177.00
Installation Kit - Kent camshaft	RB7488KENT	18.33	22.00
As it is necessary to purchase a head gasket set when installing a Kent cam, this kit includes the additional parts required i.e. standard timing chain, timing cover gasket & oil seal. Includes mix of components to suit all engines.			
Cam Lube , 250ml	RX1358	7.29	8.75
Essential when installing a new cam & followers.			
Timing Disc (Protractor)	RX1359	8.75	10.50
Non-gems only.			



Timing Chains

All parts listed are suitable for saloon, sports and 4x4 applications unless otherwise stated.			
Upgraded Timing Chain Kit	RB7449	172.93	207.52
Non-gems applications. This adjustable kit includes vernier camshaft sprocket, crank sprocket and double roller chain; also includes timing protractor and Allen key. The fully adjustable cam sprocket allows extremely accurate cam timing whilst eliminating stretch common in original parts. Instructions included.			
Upgraded Timing Chain	RB7450	32.50	39.00
Replacement double roller type chain, for use only with upgraded timing chain kit RB7449.			





RB7680-28

Upated Cylinder Head Fixings

	Part Number	Price Ex VAT	Price Inc VAT*
Upated Head Stud Kit, cylinder head: Engine set of ARP cylinder head studs, washers and nuts to replace original bolts. Studs improve cylinder head sealing & prevent damage to block threads.			
20 stud kit	RB7680-20	132.10	158.52
28 stud kit	RB7680-28	212.65	255.18

Upated Valves, Guides & Springs

Various different valves have been used since the Rover V8's introduction, most having the standard "Rover SD1" head diameters: 40mm inlet and 34mm exhaust. However, early engines (pre 1976) were fitted with smaller diameter valves - 38mm inlet and 33mm exhaust - which are less efficient. In order to benefit from the larger valve sizes, it would be more practical to fit a pair of later cylinder heads than to attempt to fit the larger valves to early heads.

The largest valves that can be fitted to the existing valve seats on later heads only, without extensive machining, are our Big Valves (41.4mm inlet and 35.5mm exhaust, with waisted stems). These valves are particularly suited to large capacity engines, but note that some machining is still required to the guides and seats to fit them.

Finally, the latest factory valves, as fitted to 3.9 and 4.2 engines since 1993, as well as the P38 Range Rover (4.0 and 4.6 engines), feature the same head diameter as SD1-type valves.

Note: all parts supplied are suitable for unleaded applications.

	Part Number	Price Ex VAT	Price Inc VAT*
Inlet Valve			
Big Valve (8 required) Head diameter: 41.4mm. With waisted stem. Machining required to valve guide and seat.	RB7460	8.90	10.68
Exhaust Valve			
Big Valve (8 required) Head diameter: 35.5mm. With waisted stem. Machining required to valve guide and seat.	RB7461	10.20	12.24
Valve Guide, performance: Shortened & bulletted, for use with performance cam. Suitable for all valves.			
car set (inlet/exhaust)	RB7453	35.00	42.00
individual			
inlet (8 required)	RB7463	2.67	3.20
exhaust (8 required)	RB7464	2.67	3.20
Valve Spring, upated, engine set:			
single spring set	RB7454	170.67	204.80
Suitable for all engines with mild road camshaft. Uses standard retaining caps (ERC573A).			
double spring set	RB7455	93.33	112.00
Suitable for all engines with fast road camshaft. Special retaining caps required (ERC573S).			
Note: machining may be required to spring platform when fitting double valve springs to engines previously fitted with singles.			
Retaining Cap, valve springs:			
upated double springs	ERC573S	6.67	8.00
16 required.			



RB7460



RB7453



RB7454



RB7455



ERC573S

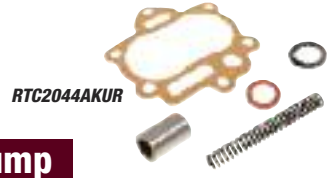

RTC2044AKUR

Oil Pump

	Part Number	Price Ex VAT	Price Inc VAT*
Oil Pump Service Kit (with upated spring). For all engines without crank driven oil pump (pre-1994). Includes pressure relief valve, spring, sealing washers and gasket.			
	RTC2044AKUR	12.29	14.75
Upated Spring relief valve			
	RB7457	5.00	6.00
For all pre crank driven oil pump models (pre-1994). Increases oil pressure by approx. 10 psi.			
Upating Kit, oil pump			
	RB7480	76.67	92.00
Pre-'76 engines with original short oil pump gears only. Kit includes spacer plate and longer gears to upate early pumps to later specification. Increases idle & high RPM pressure. Raises oil volume by 40%.			



RB7480



Rocker Cover Bolt Set

Chrome 'T'-Bolt Set	RB7440	21.04	25.25
American style rocker cover hold-down bolts, supplied as set of 4 (2 sets required per engine).			



Crankshaft

Upated Stud Kit main bearing caps	RB7456	120.18	144.22
All engines, engine set. Used instead of standard main bearing bolts, these ARP studs provide superior clamping for main bearing caps, preventing them from working loose. Suitable for non cross-bolted blocks only.			

These pages refer to Upgrade Components only, for a full list of all V8 Engine Parts please refer to our Rover V8 Engine Catalogue or our website.

If you are in any doubt of the suitability of these parts please call 01522 568000 for technical assistance.

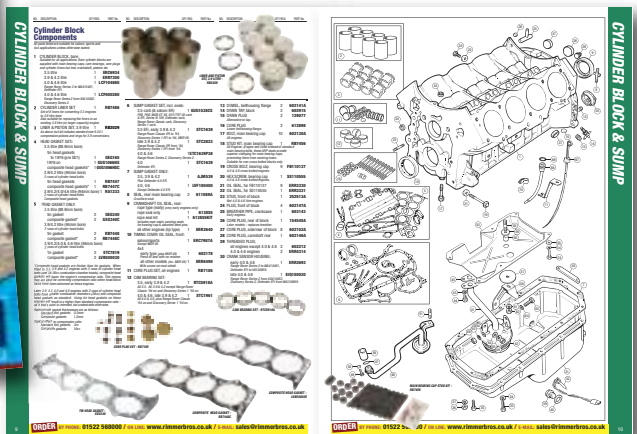



Pertronix Distributor



Mallory Distributor

Model	Qty Req	Part Number	Price Ex VAT	Price Inc VAT*
Distributor Assembly				
Late type ('76 on) Pertronix With slot in distributor shaft for oil pump drive ("Flexible shaft"). electronic type				
	1	RB7459EP	250.00	300.00
Use with RB7475E Accel chrome coil and RB7476E Ballast resistor.				

Lumination

Electronic Ignition



V8 Lumination Ignition Kits

Lumination Ignition Kit				
Includes all parts and instructions necessary to convert V8 Lucas 35D8 points type distributor to breakerless electronic ignition, or to improve 35DE8 electronic distributor. Benefits include better starting/reliability, reduced maintenance and improved performance/mpg. (Distributor can also be converted back if so desired).				
for 35D8 points type distributor	1	RB7270	177.50	213.00
for 35DE8 electronic distributor	1	RB7323	177.50	213.00
Lumination Performance Ignition Kit				
As above kit but also offers constant maximum spark energy at coil through the whole rev range. Supplied complete with low resistance coil.				
for 35D8 points type distributor	1	RB7270P	241.67	290.00
for 35DE8 electronic distributor	1	RB7323P	241.67	290.00

123ignition.nl Distributors

ignition systems for classic cars



Replacement USB programmable, electronic distributor for the V8, with versions suitable for pre 1976 (Rover P6 type) and 1976 onward applications. Features include selectable fine tune advance curves (enables switching between two advance curves, ideal or example, for alternating between petrol and LPG fuels), automatic Dwell spark balancing, gearshift retard and more. The unit will optimise engine ignition performance once installed correctly (advance curve is selected manually) and are available only in the "Tune" form. Can be used with either a standard or 'sports' coil. Silicone HT leads are recommended. "Tune" software is updated from time to time and can be downloaded from www.123ignition.nl

V8 123 Ignition Distributors

Model	Qty Req	Part Number	Price Ex VAT	Price Inc VAT*
Distributor Assembly (programmable):				
Early type (Pre '76, Rover P6 type) With oil pump drive tooth on distributor shaft ("Rigid shaft").				
	1	RB7458-E123	430.00	516.00
Late type ('76 on) With slot in distributor shaft for oil pump drive ("Flexible shaft").				
	1	RB7459E123	385.00	462.00
Please enquire for replacement components.				

Also from 123 Ignition...

Programmable wirelessly with Bluetooth 4 technology.

Control your 123\TUNE+ with your iOS/Android smart phone or tablet. The App makes it possible to adjust the ignition curve and shows an electronic dashboard. Main features: REV-counter, Anti-theft system by a PIN code, Bluetooth 4.0, Real time tuning, Vacuum advance, Boost retard, Soft REV-limiter, etc. The TUNE+ will run on all iOS devices with Bluetooth 4.0 and on Android devices with Bluetooth 4.0 in the future. The Android App is under construction.

Here are all the features offered :

- rotation CW and CCW (autodetect)
- for 6 Volt and/or 12 Volt cars (autodetect)
- variable dwell constant current, fully autom. (autodetect)
- coil current protection time-out after 1 second (autodetect)
- for positive and negative earthed cars (123\TUNE-8 is for neg.earth ONLY)
- programmable centrifugal advance curve (500 to 8000 rpm)
- programmable vacuum-advance and boost-retard curve (0 to 200 kPa or 3 0 inHg to +15 psi)
- rev.limiters (advanced random spark stealing)
- real-time tuning (ideal for working on a rolling road)

Electronic "dashboard" with :

- temperature gauge (selectable in degrees Celsius or Fahrenheit)
- manifold pressure (selectable in Bar or inches Hg / Psi)
- rev. counter (0 to 8000 rpm crankshaft)
- spark-energy gauge (primary coil current)
- total-advance gauge (in degrees crankshaft)

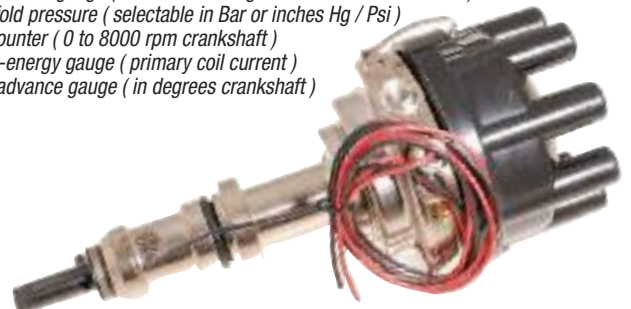

V8 123 Ignition Bluetooth Distributors

Distributor Assembly (programmable):				
Early type (Pre '76, Rover P6 type) With oil pump drive tooth on distributor shaft ("Rigid shaft").				
	1	RB7458-E123BT	415.00	498.00
Late type ('76 on) With slot in distributor shaft for oil pump drive ("Flexible shaft").				
	1	RB7459E123BT	395.00	474.00
Please enquire for replacement components.				

BRITPART Electronic Ignition Conversion Kits

ETC5835KBP

The Britpart electronic ignition conversion kit replaces the existing points & condenser with a new reliable electronic module. For 4 cylinder petrol engines it has been developed to work with the standard ignition coil & provides service free & accurate ignition timing.



ETC4536KBP

This electronic ignition conversion kit is for V8 points and has built in dwell adjustment with RPM protection when not running



Britpart Electronic Ignition Conversion Kits

Model	Part Number	Price Ex VAT	Price Inc VAT*
Series II 88 & 109 All 4 cyl petrol models <i>Fitted with non-original Lucas 45D/59D type distributor</i>	ETC5835KBP	22.95	27.50
Series IIA 88 & 109 All 4 cyl petrol models <i>Fitted with non-original Lucas 45D/59D type distributor</i>	ETC5835KBP	22.95	27.50
Series III 88 & 109 All 4 cyl petrol models <i>Fitted with Lucas 45D/59D type distributor</i>	ETC5835KBP	22.95	27.50
Series III 109 All V8 petrol models <i>With points type distributors</i>	ERC4536KBP	19.79	23.75
90 & 110 All 4 cyl petrol models <i>Fitted with Lucas 45D/59D type distributor</i>	ETC5835KBP	22.95	27.50
All V8 petrol models <i>With points type distributors</i>	ERC4536KBP	19.79	23.75
Defender 90 & 110 All V8 petrol models <i>with points type distributors</i>	ERC4536KBP	19.79	23.75
Range Rover Classic All V8 petrol models <i>with points type distributors</i>	ERC4536KBP	19.79	23.75

Lumenition

Optronic Performance Ignition Kit

The Performance Optronic system is suited to high speed engines and is ideal for all performance drivers, particularly race and rally applications. This system includes all the benefits of the Optronic System and comes with Lumenition's own Constant Energy coil electronically matched to the power module, to give an added kick.



Features:

- High energy ignition coil electronically matched to power module.
- Microcircuit control of the coil current giving optimum performance across speed and voltage range, ensuring constant maximum spark energy at the coil.
- Variable dwell angle, optimising energy use to prevent low speed coil over heat.
- Automatic switch off, preventing electrical damage in the event of ignition being on.
- Fully compatible with Lumenition Rev Limiters for complete engine protection.

Fits: Land Rover Series with negative earth (originally late Series IIA and Series III only, but earlier Series are ok if converted to negative earth) and Lucas 22D4, 25D4 or DMS2P4 distributors. It will require a fitting kit (FK116 for 22D4 or 25D4 distributors, FK125 for the DMS2P4).

NOTE: It will not fit all Series III - some have Ducellier distributors and later Series III have Lucas 45D distributors - neither will accept this kit.

Optronic Performance Ignition Kit

GEK150 PRICE EX VAT (OUTSIDE EU) £262.50 PRICE INC VAT (UK @ 20%) £315.00

Fitting Kit	Part Number	Price Ex VAT	Price Inc VAT*
for 22D4 or 25D4 distributors	FK116	20.42	24.50
for the DMS2P4 distributors	FK125	19.79	23.75

Distributor Waterproofing Kit



Everything you need to protect the distributor from damp conditions. Includes boots for coil and distributor.

Fits: Land Rover Series II 88 & 109, Series IIA 88 & 109, Series III 88 & 109; Defender 90 & 110, Discovery 1

GDC117BMWPKIT PRICE EX VAT (OUTSIDE EU) £30.83 PRICE INC VAT (UK @ 20%) £37.00

Ignition Lead Sets - Silicone Red

These silicone HT leads are designed to meet or exceed the original equipment specification. The silicone cable has minimal interference with maximum suppression, it is also resistant to water, oils, chemicals & high temperatures.

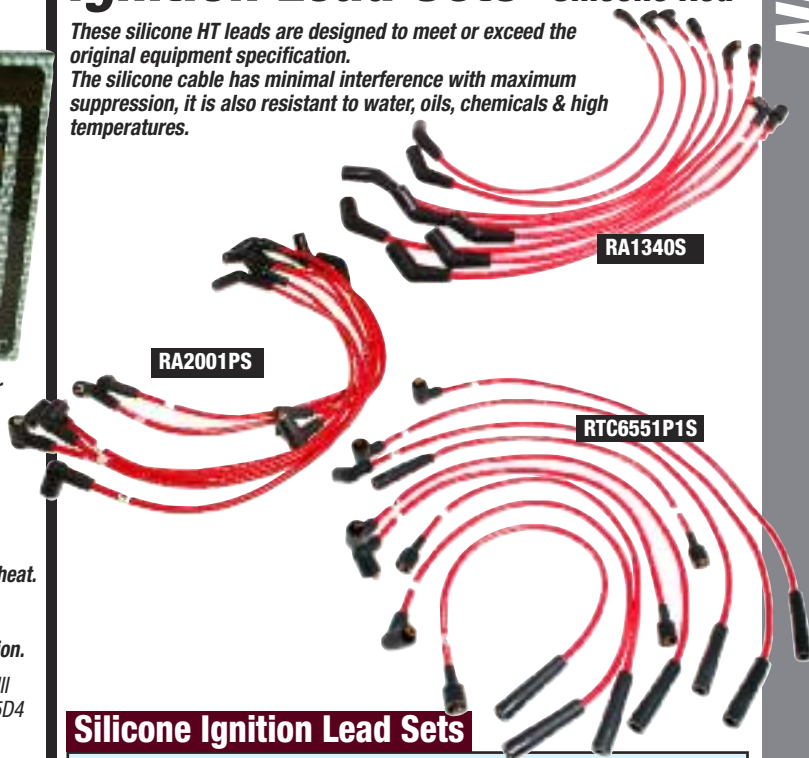

Silicone Ignition Lead Sets

Series III 109 All V8 carb petrol engine models	OEM	RTC6551P1S	32.50	39.00
90 & 110 All V8 carb petrol engine models	OEM	RTC6551P1S	32.50	39.00
Defender 90 All 4.0L V8 EFi petrol models	Aftermarket	RA1340S	25.83	31.00
Defender 90 & 110 All V8 carb petrol engine models	OEM	RTC6551P1S	32.50	39.00
Discovery 1 All V8 carb petrol engine models	OEM	RTC6551P1S	32.50	39.00
All V8 EFi petrol engine models with distributor ignition	OEM	RTC6551P1S	32.50	39.00
Discovery 2 All V8i petrol models	Aftermarket	RA2001S	25.83	31.00
Range Rover Classic All V8 carb petrol engine models	OEM	RTC6551P1S	32.50	39.00
All V8 EFi petrol engine models up to (VIN) MA647644	OEM	RTC6551P1S	32.50	39.00
Range Rover P38 All V8 petrol models				
up to (VIN) WA410481	Aftermarket	RA1340S	25.83	31.00
from (VIN) XA410482 on	Aftermarket	RA2001S	25.83	31.00

ORDER

BY PHONE: 01522 568000 / ON LINE: www.rimmerbros.co.uk / E-MAIL: Irsales@rimmerbros.co.uk

*Prices include UK VAT @ 20%.

WIDE ANGLE PROPSHAFTS

Wide Angle Propshafts

Model	Part Number	Price Ex VAT	Price Inc VAT*
Defender 90 200Tdi - (VIN) HA455946 to (VIN) LA939975			
Front	Terrafirma LL1717ETF	193.33	232.00
	Britpart FRC8390BPWA	155.00	186.00
Rear	Terrafirma LL1718ETF90	193.33	232.00
	Britpart FRC8392BPWA	155.00	186.00
Defender 90 300Tdi - (VIN) MA939976 to (VIN) VA999999			
Front	Terrafirma LL1717LTF	193.33	232.00
	Britpart TVB100610BPWA	153.33	184.00
Rear	Terrafirma LL1718LTF90	193.33	232.00
	Britpart FRC8393BPWA	155.00	186.00
Defender 90 V8 - (VIN) MA939976 to (VIN) VA999999			
Front	Terrafirma LL1717LTF	193.33	232.00
	Britpart TVB100610BPWA	153.33	184.00
Rear	Terrafirma LL1718LTF90	193.33	232.00
	Britpart FRC8393BPWA	155.00	186.00
Defender 90 TD5 - (VIN) WA000001 to (VIN) 6A999999			
Front	Terrafirma LL1717LTF	193.33	232.00
	Britpart TVB100610BPWA	153.33	184.00
Rear	Terrafirma LL1718LTF90	193.33	232.00
	Britpart FRC8393BPWA	155.00	186.00
Defender 90 - (VIN) 7A000001 on			
Front	Terrafirma LL1718LTF90	193.33	232.00
Rear	Terrafirma LR044296TFWA	193.33	232.00
Defender 110 200Tdi - (VIN) HA455946 to (VIN) LA939975			
Front	Terrafirma LL1717ETF	193.33	232.00
	Britpart FRC8390BPWA	155.00	186.00
Rear	Terrafirma LL1718ETF110	193.33	232.00
Defender 110 300Tdi - (VIN) MA939976 to (VIN) VA999999			
Front	Terrafirma LL1717LTF	193.33	232.00
	Britpart TVB100610BPWA	153.33	184.00
Rear	Terrafirma LL1718ETF110	193.33	232.00
Defender 110 V8 - (VIN) MA939976 to (VIN) VA999999			
Front	Terrafirma LL1717LTF	193.33	232.00
	Britpart TVB100610BPWA	153.33	184.00
Rear	Terrafirma LL1718ETF110	193.33	232.00
Defender 110 TD5 - (VIN) WA000001 to (VIN) 1A622423			
Front	Terrafirma LL1717LTF	193.33	232.00
	Britpart TVB100610BPWA	153.33	184.00
Rear	Terrafirma LL1718ETF110	193.33	232.00
Defender 110 TD5 - (VIN) 2A622424 to (VIN) 6A999999			
Front	Terrafirma LL1717LTF	193.33	232.00
	Britpart TVB100610BPWA	153.33	184.00
Rear	Terrafirma LL1718LTF110	193.33	232.00
Defender 110 - (VIN) 7A000001 on			
Front	Terrafirma LL1718LTF90	193.33	232.00
Rear	Terrafirma LR010463TFWA	193.33	232.00
Discovery 1 200Tdi - (VIN) FA393361 to (VIN) KA064754			
Front	Terrafirma LL1717ETF	193.33	232.00
Rear	Terrafirma TVB000150TFWA	193.33	232.00
	Britpart FRC8387BPWA	155.00	186.00
Discovery 1 300Tdi - (VIN) LA064755 to (VIN) WA567426			
Front	Terrafirma LL1717LTF	193.33	232.00
	Britpart TVB100610BPWA	153.33	184.00
Rear	Terrafirma TVB000150TFWA	193.33	232.00
Discovery 1 V8 - (VIN) LA064755 to (VIN) WA567426			
Front	Terrafirma LL1717LTF	193.33	232.00
	Britpart TVB100610BPWA	153.33	184.00
Rear	Terrafirma FRC8387TFWA	193.33	232.00
	Britpart FRC8387BPWA	155.00	186.00
Discovery 2			
Rear	Terrafirma TVB000150TFWA	193.33	232.00

Terrafirma Wide Angle Propshafts

Lifting a vehicle by raising the suspension alters the propshaft angles which often causes severe vibration. Aggressive mud tyres, noisy engine & transmission & the slower speeds associated with off-roading usually masks this vibration but a more road biased lifted Land Rover owner will likely find the noise & vibration too obtrusive & will be keen to rectify it.

- 20% stronger than standard Land Rover propshafts
- Double seal arrangement on slip coupling
- RILSAN coated 100mm spline slip coupling for smoother operation
- Metal shield greasable universal joints
- 32 degree wide angle yoke & joints
- Gun metal grey finish.



Terrafirma

The most effective way to eliminate vibration is to fit a propshaft with a double cardan joint** at the gearbox end. Even Land Rover found this essential on the Discovery 2. Double cardan propshafts are a successful vibration cure on vehicles lifted to around 2", beyond that even the double cardan joint cannot always accommodate the angle without vibrating.

It is a common misconception that fitting a wide angle propshaft will cure vibrations caused by raised suspension, the vibration is caused by the angle of the shaft in relation to its end flanges, fitting a wide angle shaft does not change the angles. The vibration may seem reduced but this will be coincidental with a new heavier shaft in perfect condition. Wide angle propshafts are necessary for vehicles fitted with very long travel suspension where on full axle drop out the original propshaft yoke will bind up straining the joints and ultimately locking the shaft solid which, in extreme cases, can literally tear the shaft in half.

A 32 degree yoke and joint will accommodate typical long travel suspension set ups on Land Rover based chassis using around 11" travel shocks.

**Double cardan joints have 2 universal joints joined by an intermediate shaft, the joints are phased or synchronised with each other which overcomes the speeding up and slowing down of a single joint thus reducing vibration

Britpart Propshafts

Britpart Wide Angle Propshafts allow drivetrain angles of up to 32 degrees which reduces vibration, universal joint bind up & premature wear on the joints.

All Britpart wide angle propshafts have greaseable universal joints.



BRITPART

Double Cardan Propshafts

Defender 90 & 110 300Tdi - (VIN) LA930456 to (VIN) VA999999			
Front	Terrafirma LL1719LTF	395.83	475.00
Defender 90 & 110 V8 - (VIN) LA930456 to (VIN) VA999999			
Front	Terrafirma LL1719LTF	395.83	475.00
Defender 90 & 110 TD5 - (VIN) WA000001 to (VIN) 6A999999			
Front	Terrafirma LL1719LTF	395.83	475.00
Defender 90 & 110 - (VIN) 7A000001 on			
Front	Terrafirma LL1719TD4TF	395.83	475.00
Discovery 1 300Tdi - (VIN) LA064755 to (VIN) WA567426			
Front	Terrafirma LL1719LTF	395.83	475.00
Discovery 1 V8 - (VIN) LA064755 to (VIN) WA567426			
Front	Terrafirma LL1719LTF	395.83	475.00

LL1566BP

FRC8393BPWA

Propshaft Parts

Model	Part Number	Price Ex VAT	Price Inc VAT*
Replacement Universal Joint for Wide Angle			
Terrafirma	LL1566TF	20.83	25.00
Britpart	LL1566BP	24.37	29.34
Bolt Kit for Wide Angle Propshafts			
Britpart	LL1567BP	1.33	1.60



LL1567BP

STAINLESS STEEL EXHAUSTS



For many years Rimmer Bros have been supplying stainless steel exhaust systems for Land Rover & Range Rover applications. The next 13 pages include all of the detailed applications so you can be sure that you are getting the correct fitment for your vehicle.

Carefully selected from our specialist suppliers, the systems reflect the high quality engineering & manufacturing processes that we demand our suppliers work to and provide a purpose designed product to reduce long term running costs & enhanced vehicle re-sale value.

Why fit a Stainless Steel Exhaust?

All the stainless steel exhausts featured in this catalogue are made from high quality stainless steel. For the technical, this is a generic term for a group of corrosion-resistant steels containing a minimum of 10.5% chromium.

Standard exhausts made from aluminised mild steel are prone to rust, so they are likely to need replacing after several years of service. Corrosion is caused by salt spread on the roads during winter and, if vehicles are used mainly for short journeys, the exhaust gases condense within the system and do not have time to dry out leaving moisture inside the system.

Stainless steel exhaust systems will also help to maximise gas flow – this reduces the effort required by the engine and can save money on fuel costs.

The system will cost a little more than replacing with a standard system but the small additional outlay is far outweighed by the advantages of trouble free motoring. If you are planning to keep your vehicle for any length of time, it is a first class investment:

- **Tough, reliable, long-lasting**
- **Designed to outlast vehicle lifetime**
- **Quiet in operation**
- **Cost-effective choice**
- **Vehicle re-sale value enhanced**



Exhaust Fitting Kits
Available for most systems -
refer to website
or enquire

ORDER

BY PHONE: 01522 568000 / ON LINE: www.rimmerbros.co.uk / E-MAIL: lrsales@rimmerbros.co.uk

*Prices include UK VAT @ 20%.

Exhaust Fitting Kits
Available for most systems - refer to website or enquire

STAINLESS STEEL EXHAUST SYSTEMS - SERIES I & II 88 & 109

Series I SWB

Model	Part Number	Price Ex VAT	Price Inc VAT*
Stainless Steel Exhaust System			
All 1.6L & 2.0L 80 models up to 1954 - 2 piece			
RHD	LR1151	279.17	335.00
All 1.6L & 2.0L petrol models 80 models up to 1954 - 3 piece			
RHD	LR1084	187.50	225.00
LHD	LR1084LHD	229.95	275.94
All 88 models, 1954 to 1958 - 3 piece			
RHD	LR1001	150.00	180.00
RHD, large bore 2" (50mm) inside diameter	LR1001LB	206.67	248.00
LHD	LR1001LHD	175.00	210.00

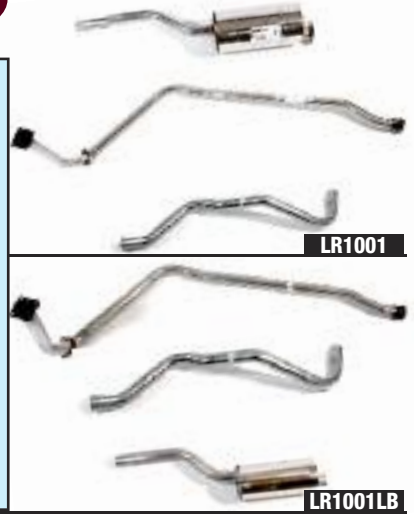

Series I LWB

Model	Part Number	Price Ex VAT	Price Inc VAT*
Stainless Steel Exhaust System			
All 109 models, 1954 to 1958 - 3 piece			
RHD	LL1893	179.95	215.94
LHD	LL1893LHD	179.95	215.94



Series II 88

Model	Part Number	Price Ex VAT	Price Inc VAT*
Stainless Steel Exhaust System			
All models, 1958 to 1961 - 3 piece			
RHD	LR1001	150.00	180.00
RHD large bore, 2" (50mm) inside diameter	LR1001LB	206.67	248.00
LHD	LR1001LHD	175.00	210.00



Series II 109

Model	Part Number	Price Ex VAT	Price Inc VAT*
Stainless Steel Exhaust System			
All 2.25L 4 cylinder petrol models, 1958 to 1961 - 3 piece			
RHD	LR1013	155.00	186.00
LHD	LR1013LHD	205.00	246.00
All 2.25L 4 cylinder diesel models, 1958 to 1961 - 3 piece			
RHD	LR1012	155.00	186.00
LHD	LR1012LHD	195.00	234.00



Exhaust Fitting Kits
Available for most systems -
refer to website
or enquire

STAINLESS STEEL EXHAUST SYSTEMS - SERIES IIA 88 & III 88

Series IIA 88

Model	Part Number	Price Ex VAT	Price Inc VAT*
Stainless Steel Exhaust System			
All 2.25L 4 cylinder petrol models except Lightweight, 1961 to 1971 - 3 piece			
RHD	LR1002	150.00	180.00
RHD, large bore, 2" (50mm) inside diameter	LR1002LB	204.17	245.00
<i>Includes clamps & flange bolts.</i>			
LHD	LR1002LHD	170.00	204.00
All 2.25L 4 cylinder diesel models, 1961 to 1971 - 3 piece			
RHD	LR1001	150.00	180.00
RHD, large bore, 2" (50mm) inside diameter	LR1001LB	206.67	248.00
LHD	LR1001LHD	175.00	210.00

Series III 88

Model	Part Number	Price Ex VAT	Price Inc VAT*
Stainless Steel Exhaust System			
All 2.25L 4 cylinder petrol models except Lightweight, 1971 to 1976 - 3 piece			
RHD	LR1002	150.00	180.00
RHD, large bore 2" (50mm) inside diameter	LR1002LB	204.17	245.00
<i>Includes clamps & flange bolts.</i>			
LHD	LR1002LHD	170.00	204.00
1976 to Nov 1986 - 3 piece			
RHD	LR1004	150.00	180.00
RHD, large bore 2" (50mm) inside diameter	LR1004LB	198.33	238.00
<i>Includes clamps & flange bolts.</i>			
LHD	R1004LHD	170.00	204.00
All 2.25L 4 cylinder diesel models 1971 to Oct. 1973- 3 piece			
RHD	LR1001	150.00	180.00
RHD, large bore 2" (50mm) inside diameter	LR1001LB	206.67	248.00
LHD	LR1001LHD	175.00	210.00
Oct. 1973 to Jul. 1974- 3 piece			
RHD	LR1071	155.00	186.00
RHD, large bore 2" (50mm) inside diameter	LR1071LB	212.50	255.00
<i>Includes clamps & flange bolts.</i>			
LHD	LR1071LHD	175.00	210.00
Jul. 1974 to Nov. 1986- 3 piece			
RHD	LR1003	155.00	186.00
RHD, large bore 2" (50mm) inside diameter	LR1003LB	203.75	244.50
LHD	LR1003LHD	175.00	210.00



LR1002



LR1002LB



LR1002LHD



LR1004



LR1004LB



LR1004LHD



LR1071



LR1071LB

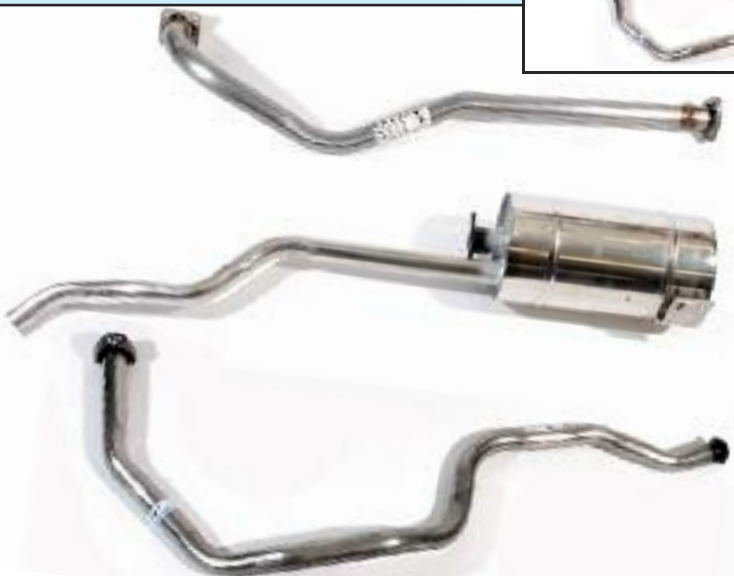

LR1003LHD



LR1071LHD



LR1001



LR1001LB



LR1001LHD



LR1003



LR1003LB

ORDER

BY PHONE: 01522 568000 / ON LINE: www.rimmerbros.co.uk / E-MAIL: lrsales@rimmerbros.co.uk

*Prices include UK VAT @ 20%.

Exhaust Fitting Kits
Available for most systems - refer to website or enquire

STAINLESS STEEL EXHAUST SYSTEMS - SERIES IIA 109, III 109 & FORWARD CONTROL



LR1013



LR1013LHD



LR1014



LR1016



LR1012



LR1012LHD

Series IIA 109

Model	Part Number	Price Ex VAT	Price Inc VAT*
Stainless Steel Exhaust System			
All 2.25L 4 cylinder petrol models, 1961 to 1971 except Station Wagon - 3 piece			
RHD	LR1013	155.00	186.00
LHD	LR1013LHD	205.00	246.00
Station Wagon models - 3 piece			
	LR1014	155.00	186.00
All 2.25L 4 cylinder diesel models, 1961 to 1971 except Station Wagon - 3 piece			
RHD	LR1012	155.00	186.00
LHD	LR1012LHD	195.00	234.00
Station Wagon models - 3 piece			
	LR1015	173.00	208.00
All 2.6L 6 cylinder petrol models, 1967 to 1971			
4 piece	LR1020	225.00	270.00

Series III 109

Model	Part Number	Price Ex VAT	Price Inc VAT*
Stainless Steel Exhaust System			
All 2.25L 4 cylinder petrol models, 1971 to 1974, except Station Wagon - 3 piece			
RHD	LR1013	155.00	186.00
LHD	LR1013LHD	205.00	246.00
All 2.25L 4 cylinder petrol Station Wagon models, 1971 to 1974			
3 piece, single box	LR1014	155.00	186.00
All 2.25L 4 cylinder petrol models, 1974 to 1986, including Station Wagon			
3 piece, single box alternative	LR1016	157.50	189.00
1971 to 1973, except Station Wagon - 3 piece			
RHD	LR1012	155.00	186.00
LHD	LR1012LHD	95.00	234.00
All 2.25L 4 cylinder diesel models, 1973 to 1974 (Suffix C), except Station Wagon			
3 piece	LR1105	167.50	201.00
All 2.25L 4 cylinder diesel Station Wagon models, 1971 to 1974			
3 piece, single box	LR1015	173.00	208.00
All 2.25L 4 cylinder diesel models, 1974 to 1986, including Station Wagon			
3 piece, single box alternative	LR1017	167.50	201.00
All 2.6L 6 cylinder petrol models, 1971 to 1980 - 4 piece			
	LR1020	225.00	270.00
All 3.5L V8 petrol models, 1979 to 1986 - 5 piece			
	LR1021	320.83	385.00



LR1105



LR1015



LR1017



LR1020



LR1021

Forward Control

Model	Part Number	Price Ex VAT	Price Inc VAT*
Stainless Steel Exhaust System			
All V8 engine models			
5 piece			
RHD	LR1029	300.00	360.00
LHD	LR1030	310.00	372.00
5 piece, large bore, 2" (50mm) inside diameter			
RHD	LR1029LB	400.00	480.00
LHD	LR1030LB	410.00	492.00



LR1029LB

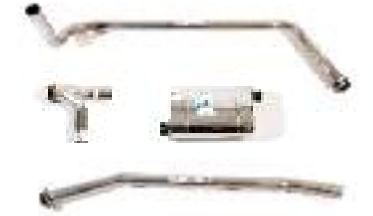

LR1030LB



LR1029



LR1030

Exhaust Fitting Kits
Available for most systems -
refer to website
or enquire

STAINLESS STEEL EXHAUST SYSTEMS - 90

90

Model Part Number Price Ex VAT Price Inc VAT*

Stainless Steel Exhaust System

All 2.25L petrol models up to (VIN) AA232010 4 piece	LR1006SS	287.50	345.00
All 2.5L petrol Hardtop & Station Wagon models up to (VIN) AA253495 4 piece	LR1007SS	291.00	349.50
All 2.5L petrol models from (VIN) AA253496 to (VIN) AA267063 5 piece	LR1008SS	277.50	333.00
from (VIN) AA267064 on 4 piece	LR1009SS	266.67	320.00
All 2.5L petrol Soft Top models up to (VIN) AA232010 4 piece	LR1007SS	291.00	349.50
All 2.5L N/A diesel Hardtop & Station Wagon models up to (VIN) AA253495 4 piece	LR1032SS	287.50	345.00
from (VIN) AA253496 to (VIN) AA267063 5 piece	LR1034SS	291.67	350.00
All 2.5L N/A diesel engine models from (VIN) AA267064 to (VIN) GA455945 4 piece	LR1031SS	255.00	306.00
All 2.5L N/A diesel Soft Top models up to (VIN) AA232010 4 piece	LR1032SS	287.50	345.00
from (VIN) AA232011 to (VIN) AA267063 5 piece	LR1034SS	291.67	350.00
All 2.5L turbo diesel engine models from (VIN) AA267064 to (VIN) FA450140 4 piece	LR1037SS	375.00	450.00
from (VIN) FA450141 on 4 piece	LR1063SS	355.00	426.00
All V8 engine Hardtop & Station Wagon models up to (VIN) AA253495 5 piece	LR1010SS	329.17	395.00
from (VIN) AA253496 to (VIN) AA267063 6 piece	LR1035SS	304.17	365.00
All V8 Carburettor models from (VIN) AA267064 to (VIN) AA267907 6 piece	LR1036SS	295.83	355.00
All V8 engine models from (VIN) AA267908 to (VIN) FA404321 6 piece	LR1011SS	362.50	435.00
from (VIN) FA404322 on 6 piece	LR1061SS	330.00	396.00
All V8 engine Soft Top models up to (VIN) AA232010 5 piece	LR1010SS	329.17	395.00
from (VIN) AA232011 to (VIN) AA267063 6 piece	LR1035SS	304.17	365.00

Stainless Steel Sports Exhaust System

All 3.5L V8 engine models
5 piece including manifolds
Includes clamps, bolts & gaskets.

LR1039 **525.00** **630.00**



LR1006SS



LR1007SS



LR1008SS



LR1009SS



LR1032SS



LR1034SS



LR1031SS



LR1037SS



LR1063SS



LR1010SS



LR1035SS



LR1036SS



LR1061SS



LR1011SS



LR1039

ORDER

BY PHONE: 01522 568000 / ON LINE: www.rimmerbros.co.uk / E-MAIL: lrsales@rimmerbros.co.uk

*Prices include UK VAT @ 20%.

Exhaust Fitting Kits
Available for most systems - refer to website or enquire

Defender 90

Model Part Number Price Ex VAT Price Inc VAT*

Stainless Steel Exhaust System

All 200Tdi diesel engine models
3 piece **LR1057SS 425.00 510.00**

All 300TDi engine models without catalyst
from (VIN) MA939976 to (VIN) MA951235
3 piece **LR1089SS 395.00 474.00**

from (VIN) MA951236 to (VIN) TA997521
3 piece (inc. 2 x exhaust olives) **LR1090SS 412.50 495.00**

from (VIN) TA997522 on
3 piece (inc. 2 x exhaust olives) **LR1093SS 337.50 405.00**

All 2.5L N/A diesel engines models
from (VIN) HA455946 to (VIN) JA911705
4 piece **LR1031SS 255.00 306.00**

from (VIN) JA911706 on
4 piece **LR1062SS 255.00 306.00**

from (VIN) HA455946 on
4 piece **LR1063SS 355.00 426.00**

All TD5 engine models without catalyst
3 piece **LR1135SS 525.00 630.00**

All 3.9L V8 engine models without catalyst
5 piece **LR1141SS 320.00 384.00**

All 4.0L V8 engine models without catalyst
5 piece **LR1141SS 320.00 384.00**

Stainless Steel 'Cat Back' System

All 300TDi engine models with catalyst
from (VIN) MA939976 to (VIN) MA951235
2 piece, Cat Back **LR1095SS 275.00 330.00**

from (VIN) MA951236 to (VIN) TA997521
2 piece, Cat Back **LR1087SS 325.00 390.00**

from (VIN) TA997522 on
2 piece, Cat Back **LR1091SS 225.00 270.00**

All TD5 engine models with catalyst
2 piece, Cat Back **LR1127SS 395.00 474.00**

All 3.9L V8 50th anniversary models with catalyst 1998 on
2 piece, Cat Back **LR1126SS 370.83 445.00**

All 2.2 & 2.4 Tdci (PUMA) engine models with catalyst
2 piece, Cat Back **LR1156SS 350.00 420.00**

Stainless Steel Exhaust System including CAT

All 300TDi engine models with catalyst
from (VIN) MA939976 to (VIN) MA951235
3 piece (includes mild steel CAT) **LR1088SS 395.00 474.00**

from (VIN) MA951236 to (VIN) TA997521
3 piece (includes mild steel CAT) **LR1096SS 412.50 495.00**

from (VIN) TA997522 on
3 piece (includes mild steel CAT) **LR1097SS 307.50 369.00**

All TD5 engine models with catalyst
3 piece (includes mild steel CAT) **LR1136SS 575.00 690.00**

All 3.9L V8 engine models with catalyst
3 piece (includes mild steel CAT) **LR1142SS 550.00 660.00**

All 4.0L V8 engine models with catalyst
3 piece (includes mild steel CAT) **LR1142SS 550.00 660.00**

Stainless Steel Sports Exhaust System

All 3.9L V8 engine models without catalyst
5 piece including manifolds **LR1072 525.00 630.00**

Includes mild steel CAT.

All 4.0L V8 engine models without catalyst
5 piece including manifolds **LR1072 525.00 630.00**

Includes clamps, bolts & gaskets.

Stainless Steel 'Cat Back' Sports System

All 3.9L V8 50th anniversary models with catalyst 1998 on
2 piece, Cat Back **LR1126SSUTILITY 250.00 300.00**

Main silencer replaced by straight pipe.

All 2.2 & 2.4 Tdci (PUMA) engine models with catalyst
2 piece, Cat Back. **LR1156SSSPORT 195.00 234.00**

Main silencer replaced by straight pipe.



LR1089SS



LR1090SS



LR1093SS



LR1031SS



LR1062SS



LR1063SS



LR1135SS



LR1141SS



LR1095SS



LR1126SSUTILITY



LR1087SS



LR1091SS



LR1127SS



LR1126SS



LR1088SS



LR1096SS



LR1097SS



LR1142SS



LR1072

Exhaust Fitting Kits
Available for most systems -
refer to website
or enquire

STAINLESS STEEL EXHAUST SYSTEMS - 110 & 127

110



LR1022SS



LR1023SS



LR1025SS



LR1024SS



LR1026SS

Model	Part Number	Price Ex VAT	Price Inc VAT*
Stainless Steel Exhaust System			
All 2.25L petrol models up to (VIN) AA266789 - 4 piece	LR1022SS	262.50	315.00
from August 1985 to (VIN) AA266789 4 piece	LR1023SS	267.50	321.00
from (VIN) AA266790 to (VIN) GA455945 3 piece	LR1025SS	275.00	330.00
All 2.25L diesel models to (VIN) AA266789 - 4 piece	LR1024SS	262.50	315.00
All 2.5L N/A diesel models from (VIN) AA266790 to (VIN) GA455945 3 piece	LR1026SS	283.33	340.00
All 2.5L turbo diesel engine models from (VIN) AA266790 to (VIN) FA450078 4 piece	LR1033SS	366.67	440.00
from (VIN) FA450079 on 4 piece	LR1050SS	354.17	425.00
All 3.5L V8 petrol models to (VIN) AA267907 - 5 piece	LR1027SS	312.50	375.00
from (VIN) AA267908 to FA403996 5 piece	LR1028SS	362.50	435.00
All V8 Carburettor models from (VIN) FA403997 on - 5 piece	LR1046SS	362.50	435.00

Stainless Steel Sports Exhaust System			
All 3.5L V8 engine models 6 piece including manifolds	LR1040	575.00	690.00
<i>Includes clamps, bolts & gaskets.</i>			



LR1033SS



LR1050SS



LR1027SS



LR1028SS



LR1046SS



LR1040

127



LR1148SS



LR1107SS



LR1149SS



LR1150SS

Model	Part Number	Price Ex VAT	Price Inc VAT*
Stainless Steel Exhaust System			
All 2.5L petrol models from August 1985 to (VIN) AA266789 6 piece	LR1148SS	430.00	516.00
from (VIN) AA267064 on 4 piece	LR1107SS	412.50	495.00
All 2.5L N/A diesel models from (VIN) AA266790 to GA455945 5 piece	LR1149SS	420.00	504.00
All 2.5L turbo diesel engine models from (VIN) AA266790 to (VIN) FA450078 6 piece	LR1150SS	512.50	615.00
from (VIN) FA450079 on 6 piece	LR1144SS	470.00	564.00
All V8 Carburettor models to (VIN) AA267907 6 piece	LR1145SS	340.00	408.00
from (VIN) AA267908 to (VIN) FA403996 6 piece	LR1146SS	375.00	450.00
from (VIN) FA403997 on 6 piece	LR1147SS	371.25	445.50



LR1144SS



LR1145SS



LR1146SS



LR1147SS

Exhaust Fitting Kits
Available for most systems - refer to website or enquire

Defender 110



LR1092SS



LR1026SS



LR1048SS



LR1050SS



LR1137SS

Model	Part Number	Price Ex VAT	Price Inc VAT*
Stainless Steel Exhaust System			
All 200TDi diesel engine models 3 piece	LR1054SS	395.00	474.00
All 300TDi engine models without catalyst 3 piece (includes 2 x flange olives)	LR1092SS	341.67	410.00
All 2.5L N/A diesel models from (VIN) HA455945 to JA911705 3 piece	LR1026SS	283.33	340.00
from (VIN) JA911706 on 3 piece	LR1048SS	255.00	306.00
All 2.5L turbo diesel engine models from (VIN) HA455946 on 4 piece	LR1050SS	354.17	425.00
All TD5 engine models without catalyst 3 piece	LR1137SS	495.00	594.00
All 3.9L V8 engine models without catalyst 3 piece	LR1143SS	295.00	354.00
All 4.0L V8 engine models without catalyst 5 piece	LR1143SS	295.00	354.00
Stainless Steel Exhaust System including CAT			
All 300TDi engine models with catalyst 3 piece (includes mild steel CAT)	LR1094SS	385.00	462.00
All TD5 engine models with catalyst 3 piece (includes mild steel CAT)	LR1138SS	595.00	714.00
Stainless Steel 'Cat Back' System			
All 300TDi engine models with catalyst 2 piece, Cat Back	LR1098SS	316.67	380.00
All TD5 engine models with catalyst 2 piece, Cat Back	LR1128SS	375.00	450.00
All 2.2 & 2.4 Tdci (PUMA) engine models with catalyst 2 piece, Cat Back	LR1157SS	365.00	438.00
Stainless Steel Sports Exhaust System			
All 3.9L V8 engine models without catalyst 6 piece including manifolds Includes clamps, bolts & gaskets.	LR1073	575.00	690.00
All 4.0L V8 engine models without catalyst 6 piece including manifolds Includes clamps, bolts & gaskets.	LR1073	575.00	690.00
Stainless Steel 'Cat Back' Sports System			
All 2.2 & 2.4 Tdci (PUMA) engine models with catalyst 2 piece, Cat Back Main silencer replaced by straight pipe.	LR1157SSSPORT	195.00	234.00



LR1143SS



LR1094SS



LR1098SS



LR1128SS



LR1073

Defender 130



LR1107SS



LR1149SS



LR1108SS



LR1144SS

Model	Part Number	Price Ex VAT	Price Inc VAT*
Stainless Steel Exhaust System			
All 2.5L petrol engine models 4 piece	LR1107SS	412.50	495.00
All 200TDi diesel engine models 4 piece	LR1103SS	525.00	630.00
All 300TDi engine models without catalyst from (VIN) MA939976 on 4 piece	LR1099SS	416.67	500.00
All 2.5L N/A diesel models from (VIN) HA455946 to (VIN) JA911705 5 piece	LR1149SS	420.00	504.00
from (VIN) JA911706 on - 4 piece	LR1108SS	400.00	480.00
All 2.5L turbo diesel engine models from (VIN) HA455946 on 6 piece	LR1144SS	470.00	564.00
All TD5 engine models without catalyst - 3 piece	LR1139SS	512.50	615.00
All V8 Carburettor models - 6 piece	LR1147SS	371.25	445.50
Stainless Steel 'Cat Back' System			
All 300TDi engine models with catalyst 3 piece, Cat Back	LR1101SS	340.00	408.00
All TD5 engine models with catalyst 2 piece, Cat Back	LR1129SS	375.00	450.00
All 2.2 & 2.4 Tdci (PUMA) engine models with catalyst 3 piece, Cat Back	LR1158SS	395.00	474.00
Stainless Steel Exhaust System including CAT			
All 300TDi engine models with catalyst 4 piece (includes mild steel CAT)	LR1100SS	415.50	495.00
All TD5 engine models with catalyst 3 piece (includes mild steel CAT)	LR1140SS	625.00	750.00
Stainless Steel Sports Exhaust System			
All 3.5L V8 engine models 7 piece including manifolds Includes clamps, bolts & gaskets.	LR1124	575.00	690.00



LR1147SS



LR1101SS



LR1100SS



LR1124

*Prices include UK VAT @ 20%.

Exhaust Fitting Kits
Available for most systems -
refer to website
or enquire

STAINLESS STEEL EXHAUST SYSTEMS - DISCOVERY 1

Discovery 1

Model	Part Number	Price Ex VAT	Price Inc VAT*
Stainless Steel Exhaust System			
All 200 TDi engine models to (VIN) GA460229			
4 piece, sleeve jointed	RD1004SSALT	325.00	390.00
from (VIN) GA460230 to KA064754			
3 piece, sleeve jointed	RD1005SSALT	325.00	390.00
with manual gearbox from (VIN) LA064755 to LA081991			
4 piece, sleeve jointed	RD1006SSALT	325.00	390.00
with auto gearbox from (VIN) LA064755 to LA081991			
3 piece, sleeve jointed	RD1014SSALT	395.00	474.00
All 300 TDi engine models without catalyst from (VIN) MA081992 on			
4 piece	RD1013SS	470.00	564.00
up to (VIN) GA467181			
5 piece	RD1002SS	325.00	390.00
All 3.5L V8 EFI models without catalyst from (VIN) GA467182 on			
3 piece, twin tailpipes	RD1010SS	475.00	570.00
Stainless Steel Part System			
All 200 TDi engine models to (VIN) LA081991			
3 piece (intermediate pipe back)	LR1110	237.50	285.00
All 3.5L V8 EFI models without catalyst from (VIN) GA467182 on, part system			
2 piece	LR1122	291.25	349.50
Stainless Steel 'Cat Back' System			
All 2.0L MPI engine models -			
2 piece, Cat Back	LR1086	289.50	347.40
All 300 TDi engine models with or without catalyst from (VIN) MA081992 on			
2 piece, Cat or downpipe back	LR1104	240.00	288.00
All 3.5L V8 EFI models with catalyst from (VIN) GA467182 on			
2 piece, Cat Back	LR1085	295.83	355.00
All 3.9L V8 engine models -			
2 piece, Cat Back	LR1085	295.83	355.00
Stainless Steel Exhaust System including CAT			
All 2.0L MPI engine models with catalyst			
3 piece (includes mild steel CAT)	RD1003SS	360.00	432.00
All 300 TDi engine models with catalyst from (VIN) MA081992 on			
4 piece (includes mild steel CAT)	RD1001SS	312.50	375.00
All 3.5L V8 EFI models with catalyst from (VIN) GA467182 on - single tailpipe			
3 piece, (includes mild steel CAT)	RD1011SS	400.00	480.00
All 3.9L V8 models with catalyst up to (VIN) VA703296			
3 piece (includes mild steel CAT)	RD1012SS	425.00	510.00
from (VIN) VA703297 on			
3 piece (includes mild steel CAT)	RD1034SS	600.00	720.00
Stainless Steel Sports Exhaust System			
All 3.5L V8 carburettor models up to (VIN) GA467181			
6 piece including manifolds	RD1007F	575.00	690.00
<i>Includes clamps, bolts & gaskets.</i>			
All 3.5L V8 EFI models from (VIN) HA000001 (from intro of tubular gearbox xmember)			
6 piece including manifolds	RD1009F	650.00	780.00
<i>Includes clamps, bolts & gaskets.</i>			
All 3.9L V8 models (For UK Vehicles, only suitable to August 1995.)			
6 piece including manifolds	RD1009F	650.00	780.00
<i>Includes clamps, bolts & gaskets.</i>			
Stainless Steel Part Sports System			
All 200 TDi engine models to (VIN) LA081991			
3 piece	LR1110SPORT	185.00	222.00
<i>Intermediate pipe back. Main silencer replaced by straight pipe.</i>			
Stainless Steel 'Cat Back' Sports System			
All 300 TDi engine models with or without catalyst from (VIN) MA081992 on			
3 piece	LR1104SPORT	206.67	248.00
<i>Cat or downpipe back. Main silencer replaced by straight pipe.</i>			



RD1004SSALT



RD1006SSALT



RD1013SS



RD1002SS



RD1010SS



LR1110



LR1122



LR1104SPORT



LR1110SPORT



LR1085



RD1001SS



RD1011SS



RD1012SS



RD1034SS



RD1007F



RD1009F



*Prices include UK VAT @ 20%.

Exhaust Fitting Kits
Available for most systems - refer to website or enquire



RD1194SS



RD1198SS



RD1199SS



RD1195SS

Discovery 2

Model	Part Number	Price Ex VAT	Price Inc VAT*
Stainless Steel Exhaust System			
All TD5 engine models without catalyst 3 piece	RD1194SS	515.00	618.00
All V8 engine models without catalyst 3 piece <i>Includes Genuine mild steel Front Y section</i>	RD1196SS	995.00	1194.00
Stainless Steel 'Cat Back' System			
All TD5 engine models 2 piece, Cat back	RD1198SS	395.00	474.00
All V8 engine models 2 piece, Cat back	RD1199SS	425.00	510.00
Stainless Steel Exhaust System including CAT			
All TD5 engine models with catalyst 3 piece (<i>includes mild steel CAT</i>)	RD1195SS	625.00	750.00
All V8 engine models with catalyst - 3 piece, <i>includes non OE mild steel CAT</i>	RD1197SSP	575.00	690.00
<i>includes Genuine mild steel CAT</i>	RD1197SS	2385.00	2862.00
Stainless Steel 'Cat Back' Sports System			
All TD5 engine models - 2 piece, Cat back. <i>Main silencer replaced by straight pipe & rear silencer/tail pipe has 3" rolled end.</i>	RD1198SSSPORT	204.43	245.32
All V8 engine models - 2 piece, Cat back. <i>Main silencer replaced by straight pipe, tailpipe has 3" rolled end</i>	RD1199SSSPORT	225.00	270.00



RD1197SSP



RD1198SSSPORT



RD1199SSSPORT



RD1379

Discovery 3

Model	Part Number	Price Ex VAT	Price Inc VAT*
Stainless Steel Sports Rear Silencers only (pair)			
All 2.7 TDV6 engine models 2 piece, rear sports silencers	RD1379	170.00	204.00



LF1006SS



LF1007SS



LF1142SS



LF1006SSSPORT



LF1081

Freelander 1

Model	Part Number	Price Ex VAT	Price Inc VAT*
Stainless Steel 'Cat Back' Standard System			
All 1.8L petrol engine models up to (VIN) YA999999 2 piece, Cat back	LF1006SS	250.00	300.00
All 2.0L TCIE diesel engine models 2 piece, Cat back	LF1007SS	220.00	264.00
All 2.5L KV6 petrol engine models 2 piece, Cat back	LF1142SS	350.00	420.00
Stainless Steel 'Cat Back' Sports System			
All 1.8L petrol engine models up to (VIN) YA999999 2 piece, Cat back with sports rear silencer	LF1006SSSPORT	265.00	318.00
Stainless Steel 'Cat Back' Transplex Sports System			
All 1.8L petrol engine models up to (VIN) YA999999 2 piece, Cat back <i>With Transplex Rear silencer and 3" RH & LH roll tailpipes.</i>	LF1081	350.00	420.00
Stainless Steel Exhaust System including CAT			
All 1.8L petrol engine models up to (VIN) YA999999 4 piece (<i>with 4 downpipe studs</i>). <i>Includes mild steel CAT</i>	LF1004SS	410.00	492.00
All 2.0L TCIE diesel engine models 4 piece. <i>Includes mild steel CAT</i>	LF1005SS	325.00	390.00
Stainless Steel Rear Silencer			
All 2.0L TD4 BMW M47 diesel models 1 piece, rear silencer only with single tail pipe	WCG000032SS	184.57	221.48
Stainless Steel 'Cat Back' Transplex Sports System			
All 2.5L KV6 petrol engine models - 2 piece, Cat back with Transplex <i>Rear silencer and 3" RH & LH roll tailpipes</i>	LF1142SSSPORT	375.00	450.00



LF1005SS



LF1142SS



WCG000032SS



LF1142SSSPORT



LF1004SS

Exhaust Fitting Kits
Available for most systems -
refer to website
or enquire

Range Rover Classic

Model Part Number Price Ex VAT Price Inc VAT*

Stainless Steel Exhaust System

All 200 TDi diesel models without catalyst
from Nov 1992 to March 1994
3 piece (excludes downpipe) **RA1067SS 371.25 445.50**

All 2400TD engine models
from April 1986 to (VIN) FA399772
4 piece **RA1017SS 255.00 306.00**

All 2500TD engine models
from (VIN) GA399973 on
3 piece **RA1016SS 237.50 285.00**

All 3.5L V8 engine models
1970 to 1977
5 piece - single pipe/single tailpipe
RA1015SS 337.50 405.00

1977 to 1982
5 piece - early twin pipe system
with oblique-cut tailpipes **RA1003SS 320.83 385.00**

1982 to 1986
5 piece - early twin pipe system with
rolled-end twin tailpipes **RA1004SS 316.67 380.00**

All 3.5L V8 carb engine models without catalyst 1986 on
5 piece - single pipe system/twin tailpipes
RA1019SS 329.17 395.00

All 3.5L V8 efi engines without catalyst
5 piece - twin downpipes & twin tailpipes
RA1005SS 387.50 465.00

All 3.9L V8 engine models
with manual gearbox without catalyst up to (VIN) HA610293
3 piece **RA1029SS 525.00 630.00**

with auto gearbox without catalyst up to (VIN) HA610293
3 piece **RA1018SS 490.00 588.00**

Stainless Steel Part System

All 200 TDi diesel models
2 piece (centre silencer & tail pipe section)
RA1086SS 329.17 395.00

All 2400TD engine models from April 1986 to (VIN) FA399772
2 piece (centre silencer & tail pipe section)
RA1017SSPART 162.50 195.00

All 2500TD engine models from (VIN) GA399973 on
2 piece (centre silencer & tail pipe section)
RA1084SS 176.25 211.50

Stainless Steel 'Cat Back' System

All 300 TDi engine models with catalyst,
engine nos. 17L/18L/19L/20L
2 piece, Cat back **LR1112SS 300.00 360.00**

engine nos. 21L/22L
2 piece, Cat back **LR1113SS 300.00 360.00**

All 3.9L V8 engine models
from (VIN) GA399973 to (VIN) HA610293
2 piece, Cat back (centre & rear assembly)
RA1081 300.00 360.00

from (VIN) JA610294 on
2 piece, Cat back (centre & rear assembly)
RA1082 300.00 360.00

All 4.2L V8 engine LSE models 1992 to 1995
2 piece, Cat back (centre & rear assembly)
RA1082 300.00 360.00



RA1067SS



RA1016SS



RA1015SS



RA1003SS



RA1004SS



RA1019SS



RA1029SS



RA1018SS



LR1112SS



LR1113SS



RA1081



RA1082



RA1005SS



*Prices include UK VAT @ 20%.

STAINLESS STEEL EXHAUST SYSTEMS - RANGE ROVER CLASSIC

Exhaust Fitting Kits
Available for most systems - refer to website or enquire

Range Rover Classic

Model Part Number Price Ex VAT Price Inc VAT*

Stainless Steel Exhaust System including CAT

All 300 TDi engine models with catalyst, engine nos. 17L/18L/19L/20L from Mar 1994

3 piece (inc. mild steel CAT) **RA1085SSUTILITY 272.50 327.00**

Main silencer replaced by straight pipe.

3 piece (includes mild steel CAT) **RA1085SS 375.00 450.00**

engine nos. 21L/22L (EGR) from Mar 1994 on

3 piece (inc. mild steel CAT) **RA1087SSUTILITY 272.50 327.00**

Main silencer replaced by straight pipe.

3 piece (inc. mild steel CAT) **RA1087SS 375.00 450.00**

All 3.9L V8 engine models with manual gearbox with catalyst up to (VIN) HA610293

3 piece (inc. mild steel CAT) **RA1073SS 455.00 546.00**

from (VIN) JA610294 on

3 piece (inc. mild steel CAT) **RA1077SS 400.00 480.00**

All 3.9L V8 engine models with auto gearbox with catalyst up to (VIN) HA610293

3 piece (incl. mild steel CAT) **RA1072SS 469.00 562.80**

from (VIN) JA610294 on

3 piece (inc. mild steel CAT) **RA1076SS 469.00 562.80**

All 4.2L V8 engine LSE models 1992 to 1995, with catalyst

3 piece (incl. mild steel CAT) **RA1083SS 475.00 570.00**

Stainless Steel Sports Exhaust System

All 3.5L V8 engine models to 1990

Not suitable for 3.5L manual with optional oil cooler.

6 piece including manifolds **RA1014F 575.00 690.00**

Includes clamps, bolts & gaskets.

All 3.9L V8 engine models with manual gearbox 1990 on

6 piece including manifolds (includes clamps, bolts & gaskets).

with or without lambda sensors **RA1028SSDS 513.18 615.82**

Supplied with lambda provisions and blanking plugs if not required.

no lambda sensors **RA1069F 575.00 690.00**

All 3.9L V8 engine models with auto gearbox 1990 on

6 piece including manifolds (includes clamps, bolts & gaskets).

lambda type **RA1069FWS 608.33 730.00**

All 4.2L V8 engine LSE models, RHD (lambda type)

6 piece including manifolds **RA1080F 591.67 710.00**

Includes clamps, bolts & gaskets.

Stainless Steel 'Cat Back' Sports System

All 300 TDi engine models with catalyst,

engine nos. 17L/18L/19L/20L

2 piece, Cat back. **LR1112SSUTILITY 200.00 240.00**

Main silencer replaced by straight pipe.

engine nos. 21L/22L

2 piece, Cat back. **LR1113SSUTILITY 200.00 240.00**

Main silencer replaced by straight pipe.



RA1085SS



RA1087SS



RA1073SS



RA1077SS



RA1072SS



RA1076SS



RA1083SS



RA1014F



RA1069F



RA1069FWS



LR1112SSUTILITY



LR1113SSUTILITY



RA1080F

Exhaust Fitting Kits
Available for most systems -
refer to website
or enquire

STAINLESS STEEL EXHAUST SYSTEMS - RANGE ROVER P38

Range Rover P38

Model Part Number Price Ex VAT Price Inc VAT*

Stainless Steel Exhaust System including CAT

All 2.5TD engine models
up to (VIN) TA346793, 3 piece including mild steel CAT
RH exit tailpipe **RA1078SS 425.00 510.00**
RH exit tailpipe **RA1078SSUTILITY 277.50 333.00**
Main silencer replaced by straight pipe.

from (VIN) VA346794 on, 4 piece including mild steel CAT
twin exit tailpipes **RA1420SS 537.50 645.00**
twin exit tailpipes **RA1420SSUTILITY 395.00 474.00**
Main silencer replaced by straight pipe.

All V8 engine models
up to (VIN) TA346793, 3 piece including mild steel CAT
RH exit tailpipe **RA1074SS 430.00 516.00**

from (VIN) VA346794 to (VIN) WA410481
4 piece including mild steel CAT
twin tailpipes **RA1418SS 545.00 654.00**
from (VIN) XA410482 on, 4 piece including mild steel CAT
twin tailpipes **RA1453SS 650.00 780.00**

Stainless Steel Tailpipes Quad Exit (Pair)

All 2.5TD engine models, quad exit tailpipes only
2 piece, tailpipes **RA1088QTP 330.00 396.00**
Includes clamps, bolts & mountings.
Note; Early RH exit cars will need minor mod to rear valance for LH tailpipe.

All V8 engine models, quad exit tailpipes only
2 piece, tailpipes **RA1088QTP 330.00 396.00**
Includes clamps, bolts & mountings.
Note; Early RH exit cars will need minor mod to rear valance for LH tailpipe.

Stainless Steel Tailpipes Twin Exit Large Bore (Pair)

All 2.5TD engine models, twin exit large bore tailpipes only
2 piece, tailpipes **RA1088LBT 355.00 426.00**
Includes clamps, bolts & mountings.
Note; Early RH exit cars will need minor mod to rear valance for LH tailpipe.

All V8 engine models, twin exit large bore tailpipes only
2 piece, tailpipes **RA1088LBT 355.00 426.00**
Includes clamps, bolts & mountings.
Note; Early RH exit cars will need minor mod to rear valance for LH tailpipe.

Stainless Steel 'Cat Back' System

All 2.5TD engine models
up to (VIN) TA346793, 2 piece, Cat back
RH exit tailpipe **RA1079SS 350.00 420.00**
RH exit tailpipe **RA1079SSUTILITY 195.00 234.00**
Main silencer replaced by straight pipe.

from (VIN) VA346794 on, twin exit tailpipes
3 piece, Cat back **RA1421SS 425.00 510.00**
from (VIN) VA346794 on, twin exit tailpipes
3 piece, Cat back **RA1421SSUTILITY 311.25 373.50**
Main silencer replaced by straight pipe.

All V8 engine models
up to (VIN) TA346793, 2 piece, Cat back
RH exit tailpipe **RA1075SS 335.00 402.00**
from (VIN) VA346794 on, 3 piece, Cat back
twin tailpipes **RA1419SS 450.00 540.00**

Stainless Steel 'Cat Back' Sports System

All 2.5TD engine models,
quad exit tailpipes
3 piece, Cat back **RA1088DQ 535.00 642.00**
Includes clamps, bolts & gaskets.
Note; Early RH exit cars will need minor mod to rear valance for LH tailpipe.

3 piece, Cat back **RA1088DQUTILITY 395.00 474.00**
Includes clamps, bolts & gaskets.
Main silencer replaced by straight pipe.
Note; Early RH exit cars will need minor mod to rear valance for LH tailpipe.

twin exit large bore tailpipes
3 piece, Cat back **RA1088DLB 570.00 684.00**
Includes clamps, bolts & gaskets.
Note; Early RH exit cars will need minor mod to rear valance for LH tailpipe.
3 piece, Cat back **RA1088DLBUTILITY 420.00 504.00**
Includes clamps, bolts & gaskets.
Main silencer replaced by straight pipe.
Note; Early RH exit cars will need minor mod to rear valance for LH tailpipe.

All V8 engine models,
quad exit tailpipes
3 piece, Cat back **RA1088Q 550.00 660.00**
Includes clamps, bolts & gaskets.
Note; Early RH exit cars will need minor mod to rear valance for LH tailpipe.

twin exit large bore tailpipes
3 piece, Cat back **RA1088LB 575.00 690.00**
Includes clamps, bolts & gaskets.
Note; Early RH exit cars will need minor mod to rear valance for LH tailpipe.

Stainless Steel Sports Catalysts - Free Flow

All V8 engine models (*Enhanced power output at all revs*)
to (VIN) WA410481 **WCD000860SPORT200 437.50 525.00**
from (VIN) XA410482 on **WCD105350SPORT200 437.50 525.00**



RA1078SS



RA1420SS



RA1074SS



RA1418SS



RA1088QTP



RA1088LBT



RA1079SS



RA1421SS



RA1075SS



RA1419SS



RA1088DQ



RA1088DQUTILITY



RA1088DLB



RA1088DLBUTILITY



RA1088Q



RA1088LB

ORDER

BY PHONE: 01522 568000 / ON LINE: www.rimmerbros.co.uk / E-MAIL: Irsales@rimmerbros.co.uk

*Prices include UK VAT @ 20%.

Exhaust Fitting Kits
Available for most systems - refer to website or enquire



RA1455DS



RA1533DS

Range Rover L322

Model	Part Number	Price Ex VAT	Price Inc VAT*
Stainless Steel Part System			
All TD6 engine models to (VIN) 5A999999	4 piece (rear silencer, 2 link pipes, Y piece)	RA1455DS 495.00	594.00
All 4.4L BMW M62 Petrol V8 models to (VIN) 5A999999	3 piece (rear silencer & 2 link pipes)	RA1589 495.00	594.00
All TD6 engine models from (VIN) 6A000001 on	4 piece (rear silencer, 2 link pipes, Y piece)	RA1533DS 495.00	594.00
All 4.4L AJV8 Petrol V8 models (VIN) 6A000001 on	3 piece (rear silencer & 2 link pipes)	RA1584 495.00	594.00
All 4.2L V8 supercharged models from (VIN) 6A000001 on	3 piece (rear silencer & 2 link pipes)	RA1584 495.00	594.00
All 3.6L TDV8 models from (VIN) 7A000001 on	3 piece (rear silencer & 2 link pipes)	RA1584 495.00	594.00
All 5.0L V8 N/A models from (VIN) AA000001 on	3 piece (rear silencer & 2 link pipes)	RA1584 495.00	594.00
All 5.0L V8 supercharged models from (VIN) AA000001 on	3 piece (rear silencer & 2 link pipes)	RA1584 495.00	594.00
All 4.4L TDV8 models from (VIN) AA000001 on	3 piece (rear silencer & 2 link pipes)	RA1590 495.00	594.00



RA1584



RA1590



RA1589



Range Rover Sport L320

Model	Part Number	Price Ex VAT	Price Inc VAT*
Stainless Steel 'Cat Back' System			
All 2.7L TDV6 models up to (VIN) 9A999999	5 piece, Cat back, Standard system	RA1468STD 550.00	660.00
	Sports system	RA1468SPORT 495.00	594.00
	<i>With carbon tipped straight through rear pipes.</i>		
All 4.2L AJV8 supercharged models up to (VIN) 9A999999	5 piece, Cat back, Standard system	RA1468STD 550.00	660.00
	Sports system	RA1468SPORT 495.00	594.00
	<i>With carbon tipped straight through rear pipes.</i>		
All 4.4L AJV8 N/A models up to (VIN) 9A999999	5 piece, Cat back, Standard system	RA1468STD 550.00	660.00
	Sports system	RA1468SPORT 495.00	594.00
	<i>With carbon tipped straight through rear pipes.</i>		
All 5.0L V8 supercharged models from (VIN) AA000001 to (VIN) DA999999	5 piece, Cat back, Standard system	RA1585STD 650.00	780.00
	Sports system	RA1585SPORT 595.00	714.00
	<i>With carbon tipped straight through rear pipes.</i>		
All 5.0L V8 N/A models from (VIN) AA000001 to (VIN) DA999999	5 piece, Cat back, Standard system	RA1585STD 650.00	780.00
	Sports system	RA1585SPORT 595.00	714.00
	<i>With carbon tipped straight through rear pipes.</i>		
SS Sports Rear Silencers only (Pair)			
All 2.7 TDV6, 3.6 TDV8, 4.2 & 5.0 SC, 4.4 & 5.0 N/A engine models	2 piece, rear sports silencers	RD1379 170.00	204.00



RA1468STD



RA1585STD



RD1379



RA1468SPORT



RA1585SPORT

*Prices include UK VAT @ 20%.

All New Discovery

As we were nearing completion of the catalogue the All New Discovery (Discovery 5) accessory range was launched - here is a selection of Genuine Land Rover items.

If you cannot find what you are looking for then please give us a call on 01522 568000 and we will be pleased to help.

Bright Side Tubes (pair)



VPLRP0270 PRICE EX VAT (OUTSIDE EU) £579.15 PRICE INC VAT (UK @ 20%) £694.98

Mudflap Set



Front (pair) VPLRP0283
PRICE EX VAT (OUTSIDE EU) £49.50 PRICE INC VAT (UK @ 20%) £59.40



Rear (pair) VPLRP0282
PRICE EX VAT (OUTSIDE EU) £49.25 PRICE INC VAT (UK @ 20%) £59.10

Rear Seat Centre Arm Rest/ Cooler/Warmer Box



A rear seat centre arm rest that doubles up as a cooler/warmer box.

VPLVS0176
PRICE EX VAT (OUTSIDE EU) £348.90 PRICE INC VAT (UK @ 20%) £418.68

Mirror Covers (pair)



Chrome VPLAB0132
PRICE EX VAT (OUTSIDE EU) £99.77 PRICE INC VAT (UK @ 20%) £119.72



Noble Chrome VPLGB0073
PRICE EX VAT (OUTSIDE EU) £147.02 PRICE INC VAT (UK @ 20%) £176.42

Stainless Steel Pedal Covers



Stainless steel bright finish sports pedal covers. Easy to fit & feature hidden fixings for a clean finish. Automatic transmission vehicles only.

VPLGS0160
PRICE EX VAT (OUTSIDE EU) £91.64 PRICE INC VAT (UK @ 20%) £109.97

Wind Deflectors - Tinted



Complete Vehicle Set (front & rear)
 VPLRP0284
PRICE EX VAT (OUTSIDE EU) £89.10 PRICE INC VAT (UK @ 20%) £106.92

Outer Door Sill Treadplates



Front (pair) VPLRS0368
PRICE EX VAT (OUTSIDE EU) £178.20 PRICE INC VAT (UK @ 20%) £213.84

Side Vents Gloss



Narvik Black
 RH - LR083009
 LH - LR083010
PRICE EX VAT (OUTSIDE EU) £79.86 PRICE INC VAT (UK @ 20%) £95.83



Bright Atlas
 RH - LR083013
 LH - LR083014
PRICE EX VAT (OUTSIDE EU) £55.56 PRICE INC VAT (UK @ 20%) £66.67

Gearshift Paddles

Complete the look & feel of your steering wheel with premium aluminium gearshift paddles. Machine polished, anodised & hand brushed to provide exceptional wear resistance with a premium finish.



Aluminium Red VPLVS0187CAY
PRICE EX VAT (OUTSIDE EU) £315.06 PRICE INC VAT (UK @ 20%) £378.07



Aluminium VPLVS0187MMU
PRICE EX VAT (OUTSIDE EU) £315.06 PRICE INC VAT (UK @ 20%) £378.07

ORDER

BY PHONE: 01522 568000 / ON LINE: www.rimmerbros.co.uk / E-MAIL: Irsales@rimmerbros.co.uk

*Prices include UK VAT @ 20%.

Luxury Carpet Mat Sets - RHD

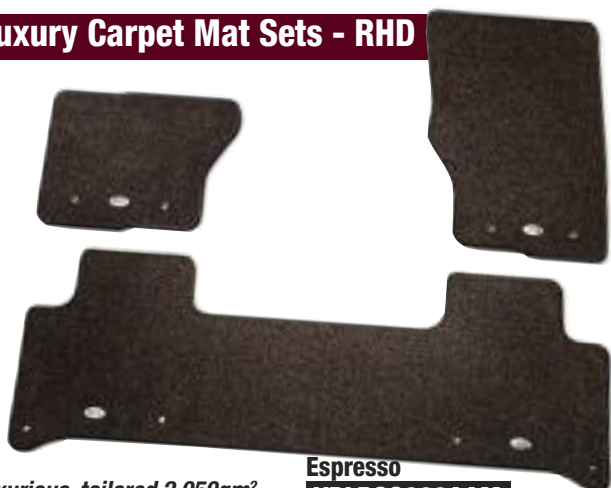

Luxurious, tailored 2,050gm² deep pile carpet mat set with Land Rover ingot branding and waterproof backing.

Espresso

VPLRS0330AAM

PRICE EX VAT (OUTSIDE EU) **£168.30** PRICE INC VAT (UK @ 20%) **£201.96**

Ebony

VPLRS0330PVJ

PRICE EX VAT (OUTSIDE EU) **£168.30** PRICE INC VAT (UK @ 20%) **£201.96**

Rubber Mat Sets - RHD



Espresso

VPLRS0332AAM

PRICE EX VAT (OUTSIDE EU) **£99.00** PRICE INC VAT (UK @ 20%) **£118.80**

Ebony

VPLRS0332PVJ

PRICE EX VAT (OUTSIDE EU) **£99.00** PRICE INC VAT (UK @ 20%) **£118.80**

Waterproof Seat Covers

Waterproof protective seat cover helps protect seats from mud, dirt, wear and tear. Easily fitted and easy to wipe clean.

Front Row Seats (pair)

Ebony

VPLRS0335PVJ

PRICE EX VAT (OUTSIDE EU) **£183.15** PRICE INC VAT (UK @ 20%) **£219.78**

Nimbus

VPLRS0337LKP

PRICE EX VAT (OUTSIDE EU) **£183.15** PRICE INC VAT (UK @ 20%) **£219.78**



Second Row Seats (set)

Ebony

VPLRS0336PVJ

PRICE EX VAT (OUTSIDE EU) **£198.00** PRICE INC VAT (UK @ 20%) **£237.60**

Nimbus

VPLRS0338LKP

PRICE EX VAT (OUTSIDE EU) **£198.00** PRICE INC VAT (UK @ 20%) **£237.60**

Loadspace Rubber Mats



Land Rover branded waterproof rubber mat, with retaining lip, helps to protect the rear loadspace carpet from general dirt. Applicable with loadspace rails, luggage dividers and luggage partition.

Model	Colour	Part Number	Price Ex VAT	Price Inc VAT*
Load Space Rubber Mat				
for vehicles without rear air conditioning				
	Espresso	VPLRS0373AAM	103.95	124.74
	Ebony	VPLRS0373PVJ	103.95	124.74
for vehicles with rear air conditioning				
	Espresso	VPLRS0375AAM	103.95	124.74
	Ebony	VPLRS0375PVJ	103.95	124.74
Extension Mat (covers the back of the rear seats when folded down)				
	Espresso	VPLRS0374AAM	49.50	59.40
	Ebony	VPLRS0374PVJ	49.50	59.40

Loadspace Liner Tray



Semi-rigid waterproof loadspace liner tray with a raised lip on three sides to protect loadspace floor and side wall carpets from dirt or wet equipment. Not compatible with luggage retention kit.

VPLRS0386 PRICE EX VAT (OUTSIDE EU) **£158.40** PRICE INC VAT (UK @ 20%) **£190.08**

Loadspace Protection Liner



The loadspace full protection liner covers sides, roof and loadspace floor and provides full protection from wet or muddy items like boots, garden waste, or leisure equipment. When loading, the padded panel drops down and acts as a bumper protector. The liner anchors securely to the lashing eyes to keep it in place and is designed to keep bulky objects hidden from view. A side zip allows easy access to the loadspace area.

VPLRS0410 PRICE EX VAT (OUTSIDE EU) **£153.45** PRICE INC VAT (UK @ 20%) **£184.14**

Alloy Wheels

Style 5021



5 Split Spoke

19" Silver

LR081580

PRICE EX VAT (OUTSIDE EU) **£415.80** PRICE INC VAT (UK @ 20%) **£498.96**

Style 5025



5 Split Spoke

22" Machine Polished

VPLRW0117

PRICE EX VAT (OUTSIDE EU) **£633.60** PRICE INC VAT (UK @ 20%) **£760.32**



Style 5011
5 Split Spoke

Available in 20" or 22", Silver or Black Gloss



Style 9002



9 Spoke

21" Silver

LR081582

PRICE EX VAT (OUTSIDE EU) **£544.50** PRICE INC VAT (UK @ 20%) **£653.40**

Style 1012



10 Split Spoke

21" Silver

LR081584

PRICE EX VAT (OUTSIDE EU) **£564.92** PRICE INC VAT (UK @ 20%) **£677.90**

Style 1011



10 Split Spoke

20" Silver

LR081589

PRICE EX VAT (OUTSIDE EU) **£475.20** PRICE INC VAT (UK @ 20%) **£570.24**

20" Silver

LR081581

PRICE EX VAT (OUTSIDE EU) **£475.20** PRICE INC VAT (UK @ 20%) **£570.24**

20" Gloss Black

LR081587

PRICE EX VAT (OUTSIDE EU) **£524.70** PRICE INC VAT (UK @ 20%) **£629.64**

22" Silver

LR082901

PRICE EX VAT (OUTSIDE EU) **£683.10** PRICE INC VAT (UK @ 20%) **£819.72**

22" Gloss Black

LR082900

PRICE EX VAT (OUTSIDE EU) **£683.10** PRICE INC VAT (UK @ 20%) **£819.72**

Wheel Centre Caps

Black

LR069899

PRICE EX VAT (OUTSIDE EU) **£10.76** PRICE INC VAT (UK @ 20%) **£12.91**

Satin Silver

LR069900

PRICE EX VAT (OUTSIDE EU) **£6.02** PRICE INC VAT (UK @ 20%) **£7.22**



Locking Wheel Nuts



Set of 5

Silver

LR078545

PRICE EX VAT (OUTSIDE EU) **£85.88** PRICE INC VAT (UK @ 20%) **£103.06**

Black

VPLWW0093

PRICE EX VAT (OUTSIDE EU) **£92.42** PRICE INC VAT (UK @ 20%) **£110.90**

Black (Aftermarket)

LR078545BLACK

PRICE EX VAT (OUTSIDE EU) **£45.00** PRICE INC VAT (UK @ 20%) **£54.00**

Wheel Nuts



Set of 20

Black Chrome

VPLWW0078

PRICE EX VAT (OUTSIDE EU) **£210.04** PRICE INC VAT (UK @ 20%) **£252.05**

UV Windscreen Sun Shield

UV windscreen sun shield, reflects the sun's rays & helps to keep the interior of the vehicle cool.



VPLRS0366

PRICE EX VAT (OUTSIDE EU) **£79.20** PRICE INC VAT (UK @ 20%) **£95.04**

Sun Blinds

Easy to install or remove these sun blinds provide increased comfort helping to protect passengers from heat & glare of the sun.



Second Row Side Windows

VPLRS0367

PRICE EX VAT (OUTSIDE EU) **£69.30** PRICE INC VAT (UK @ 20%) **£83.16**

Third Row Side Windows

VPLRS0363

PRICE EX VAT (OUTSIDE EU) **£59.40** PRICE INC VAT (UK @ 20%) **£71.28**

Rear Tailgate

VPLRS0364

PRICE EX VAT (OUTSIDE EU) **£79.20** PRICE INC VAT (UK @ 20%) **£95.04**

Smoker's Pack

Option to fit a smoker's pack with front cigarette lighter & ash tray receptacle in a vehicle produced with non-smoker's pack.



VPLRS0365

PRICE EX VAT (OUTSIDE EU) **£84.15** PRICE INC VAT (UK @ 20%) **£100.98**

iPhone Connect & Charge Dock

The iPhone connect and charge dock has been designed to allow visibility of the phone whilst charging, utilising the cup holder space in the central console. When connected the iPhone media is accessible and has the ability to be controlled via the integrated infotainment/audio system. The 'cut-out' design of the holder is such that the home button is also accessible for use when parked. The iPhone USB charger can be easily disconnected if the USB connection is required for other use. For use with iPhone 5, 5c, 5s, 6, 6s and SE. Not suitable for use with 6 Plus. iPhone® is a registered trademark of Apple Inc., registered in the US and other countries.



VPLRV0119

PRICE EX VAT (OUTSIDE EU) **£64.35** PRICE INC VAT (UK @ 20%) **£77.22**

ORDER

BY PHONE: 01522 568000 / ON LINE: www.rimmerbros.co.uk / E-MAIL: lrsales@rimmerbros.co.uk

*Prices include UK VAT @ 20%.

CLICK and GO!

The Click and Go range is a multi-purpose seat-back system for second row passengers. The versatile Click and Go Base fixes between the headrest mountings and further attachments can be added to hold tablets, bags and shirts or jackets. Each attachment is sold separately.

Click and Go Base



The base can be easily removed when not in use. Required for fitment of all Click & Go attachments.

VPLRS0388

PRICE EX VAT (OUTSIDE EU) **£17.82** PRICE INC VAT (UK @ 20%) **£21.38**

Click and Play



iPad 2-4 Holder

The Click and Play holder is part of the Click and Go range. These removable tablet holder attachments can easily be positioned at multiple angles for in-cabin comfort and rear entertainment. Click & Go base required for fitment.

For iPad 2-4. **VPLRS0391**

PRICE EX VAT (OUTSIDE EU) **£85.01** PRICE INC VAT (UK @ 20%) **£102.01**



iPad Air Holder

For iPad Air **VPLRS0392**

PRICE EX VAT (OUTSIDE EU) **£85.01** PRICE INC VAT (UK @ 20%) **£102.01**



Samsung 10.1" Holder

For Samsung 10.1"

VPLRS0394

PRICE EX VAT (OUTSIDE EU) **£85.01** PRICE INC VAT (UK @ 20%) **£102.01**

Click and Hook



The Click and Hook is part of the Click and Go range. This universal hook creates extra storage space for items to be hung, especially useful for handbags or groceries. Click & Go base required for fitment.

VPLRS0389

PRICE EX VAT (OUTSIDE EU) **£25.08** PRICE INC VAT (UK @ 20%) **£30.10**

Click and Hang



The Click and Hang is part of the Click and Go range. This removable coat hanger allows shirts or jackets to be kept crease-free whilst transporting. Also includes an integral hook for use outside the vehicle.

Not compatible with rear seat entertainment. Click & Go base required for fitment.

VPLRS0390

PRICE EX VAT (OUTSIDE EU) **£43.56** PRICE INC VAT (UK @ 20%) **£52.27**

Click and Work



The Click and Work is part of the Click and Go range. This folding table offers the rear passengers a practical surface from which to work, particularly useful on long journeys. It also has a cup holder and is height and angle adjustable for in-cabin comfort.

Click & Go base required for fitment.

VPLRS0395

PRICE EX VAT (OUTSIDE EU) **£74.25** PRICE INC VAT (UK @ 20%) **£89.10**

This is a selection of Click and Go accessories, if you cannot find what you are looking for call 01522 568000 for help.

Seat Back Stowage Standard



Convenient stowage system for the rear of the front seats provides multiple compartments for stowing small items.

VPLVS0181

PRICE EX VAT (OUTSIDE EU) **£63.62** PRICE INC VAT (UK @ 20%) **£76.34**

Seat Back Stowage Premium



Convenient stowage system manufactured from Windsor leather. For the rear of the front seats provides multiple compartments for stowing small items. The premium seat back stowage also features a soft touch interior lining and magnetic clasps.

VPLVS0182

PRICE EX VAT (OUTSIDE EU) **£162.46** PRICE INC VAT (UK @ 20%) **£194.95**

Security Box



Offered as an accessory for the loadspace rail system, this convenient security box offers sufficient space for laptops up to 15" screen or similar sized items.

VPLVS0183

PRICE EX VAT (OUTSIDE EU) **£364.37** PRICE INC VAT (UK @ 20%) **£437.24**

Cross Bars



Elegant, durable Bright finish aluminium cross bars, with compact design which utilises the full length of the bars, providing space to mount multiple accessories.

The cross bars are easy to attach or remove with a simple clamp down with handle operation and are also lockable for security. Aerodynamic profile minimises drag and wind noise. The combined incremental height of roof rails and cross bars when fitted is up to 110mm. When fitted maximum load capacity is 74kg. Roof rails required for fitment. Objects placed above the roof mounted satellite antenna may reduce the quality of the signal received by the vehicle and could have a detrimental effect on the navigation and satellite radio systems, if fitted.

VPLRR0154 PRICE EX VAT (OUTSIDE EU) **£168.30** PRICE INC VAT (UK @ 20%) **£201.96**

Roof Mounted Bike Carrier



Roof mounted cycle carrier provides a simple and secure fitting with the bicycle front wheel removed. Ideally suited to lightweight bikes and 'racing' wheels. A separate carrier is included for the front wheel. Easy to fit, lockable cycle carrier carries one bicycle per holder. Three bike holders can fit on the vehicle.

VPLWR0101 PRICE EX VAT (OUTSIDE EU) **£188.83** PRICE INC VAT (UK @ 20%) **£226.60**

Tow Bar Mounted Bike Carrier



Tow Bar mounted Bicycle carrying modules. Features rear lights and number plate holder. Supplied complete with bike tie-down straps. When fitting either of these cycle carriers it is recommended that you fit heat shield pack – VPLWR0124.

2 bike cycle carrier RHD only

VPLVR0066 PRICE EX VAT (OUTSIDE EU) **£438.42** PRICE INC VAT (UK @ 20%) **£526.10**

3 bike cycle carrier RHD only

VPLVR0068 PRICE EX VAT (OUTSIDE EU) **£506.58** PRICE INC VAT (UK @ 20%) **£607.90**

Luggage Carrier



Flexible rack system to facilitate roof carrying. When fitted maximum load capacity is 61kg. Roof rails and cross bars are required for all Land Rover roof mounted accessories. Objects placed above the roof mounted satellite antenna may reduce the quality of the signal received by the vehicle and could have a detrimental effect on the navigation and satellite radio systems, if fitted.

VPLRR0159 PRICE EX VAT (OUTSIDE EU) **£346.50** PRICE INC VAT (UK @ 20%) **£415.80**

Roof Storage Accessories



	Part Number	Price Ex VAT	Price Inc VAT*
Canoe/Surfboard Carrier Kit	VPLGR0107	242.35	290.82
Ski Bag	VPLGS0166	100.98	121.18
Roof Box Ski/Snowboard Inserts	VPLRR0151	54.45	65.34
Roof Box Ski/Snowboard Inserts	VPLRR0152	54.45	65.34
Aqua Sport Carrier – 2 Kayaks	VPLWR0099	65.64	78.77
Collapsible Luggage Carrier	VPLVS0175	50.49	60.59
Universal Lift & Load System for roof box	VPLVR0096	90.75	108.90

Luggage Partition - Full Height



Designed to prevent luggage from entering the passenger compartment. The design of the luggage partition has been optimised to second row seating featuring tilt functionality. Complies with ECE-17 regulation. Features a useful integral ski hatch which allows longer items such as skis to be carried where a suitable rear seat option is fitted. Can be fitted with loadspace rubber mat and loadspace liner tray, loadspace rail system and parcel shelf roller blind.

VPLRS0374 PRICE EX VAT (OUTSIDE EU) **£237.60** PRICE INC VAT (UK @ 20%) **£285.12**

Luggage Partition - Half Height



Designed to prevent luggage from entering the passenger compartment. The design of the luggage partition has been optimised to second row seating featuring tilt functionality. Can be fitted with loadspace rubber mat and loadspace liner tray, loadspace rail system and parcel shelf roller blind. The half height option is suitable for use when folding second row seats.

VPLRS0375 PRICE EX VAT (OUTSIDE EU) **£188.10** PRICE INC VAT (UK @ 20%) **£225.72**

ORDER

BY PHONE: 01522 568000 / ON LINE: www.rimmerbros.co.uk / E-MAIL: Irsales@rimmerbros.co.uk

*Prices include UK VAT @ 20%.

Loadspace Retention Kit



The loadspace retention kit consists of a pack of attachments that fix into the loadspace rails via a quick lock/quick release system to help provide a comprehensive and flexible solution for retaining luggage and other items within the loadspace. The attachment pack includes a retractable strap with inertia reel and telescopic rod. For 5 seat only. Requires loadspace rails for fitment.

VPLCS0324 PRICE EX VAT (OUTSIDE EU) **£135.19** PRICE INC VAT (UK @ 20%) **£162.23**

Loadspace Mounting Rails



Loadspace mounted rails to help increase the flexibility of loadspace stowage, also allowing the fitment of the luggage retention kit stowage system. For 5 seat only. Required for use with loadspace retention kit.

VPLRS0357 PRICE EX VAT (OUTSIDE EU) **£237.60** PRICE INC VAT (UK @ 20%) **£285.12**

Loadspace Organiser



Convenient loadspace organiser provides segregated compartments to stow wet, dirty or delicate items or separate shopping/luggage. The front and rear compartments also have flexible dividers to create smaller compartments within them. Featuring two lockable lids, it is secured via loadspace 'D' loops. Cannot be used in conjunction with other loadspace accessories and where specified third row seats must be stowed.

VPLRS0355 PRICE EX VAT (OUTSIDE EU) **£222.75** PRICE INC VAT (UK @ 20%) **£267.30**

Loadspace Partition



Loadspace Partition, full height (incorporates luggage net). Convenient loadspace partition net helps protect passengers from stowed items. The net fits to the loadspace D-loops and fixings in roof lining. Easily detachable for when carrying longer loads. Applicable for use with loadspace cover, loadspace mats and loadspace liner.

VPLRS0360 PRICE EX VAT (OUTSIDE EU) **£84.15** PRICE INC VAT (UK @ 20%) **£100.98**

Loadspace Retention Net



Secure small items and luggage within loadspace. Utilises loadspace tie-down points. Includes floor net and two ratchet straps which are approximately two metres long.

VPLMS0302 PRICE EX VAT (OUTSIDE EU) **£92.09** PRICE INC VAT (UK @ 20%) **£110.51**

Side Luggage Net



Keep smaller items safely stowed away - but easy to find - with a loadspace side net. Not available for vehicles with 2 zone air conditioning.

VPLRS0361 PRICE EX VAT (OUTSIDE EU) **£44.55** PRICE INC VAT (UK @ 20%) **£53.46**

Electrically Deployable Tow Bar



The electrically deployable tow bar is operated via a switch in the rear loadspace or by the infotainment system in the cabin. It is sensitive to obstruction encountered during deploying/stowing and will stow automatically if necessary. The electrically deployable tow bar is stowed discreetly behind the rear bumper when not in use providing a clean attractive finish. The towing electrics are included and are also hidden until deployed. Approved for up to 3,500kg* maximum towing capacity and 350kg* nose weight.

*Towing capability varies by powertrain. Towing nose weight dependent upon powertrain and wheels fitted. Requires tow bar module, switch and harness kit VPLRT0192 for fitment.

VPLRT0172 PRICE EX VAT (OUTSIDE EU) **£1584.00** PRICE INC VAT (UK @ 20%) **£1900.80**

A tow eye cover must also be ordered when fitting electrically deployable tow bar.

Colour	Part Number	Price Ex VAT	Price Inc VAT*
Tow Eye Covers			
Indus Silver	LR082880	100.79	120.95
Dark Techno	LR083036	62.17	74.60
White Silver	LR083037	62.17	74.60
Anthracite	LR083038	62.17	74.60

Multi-Height Tow Bar

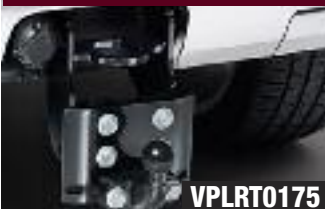

The multi-height tow bar contains a towing armature and slider plate. 50mm tow ball. Three different towing heights. Approved for up to 3,500kg* maximum towing capacity and 350kg* nose weight.

* Towing capability varies by powertrain. Towing nose weight dependent upon powertrain and wheels fitted.

VPLRT0175 PRICE EX VAT (OUTSIDE EU) **£569.80** PRICE INC VAT (UK @ 20%) **£683.76**

A tow eye cover must also be ordered when fitting multi-height tow bar.

Colour	Part Number	Price Ex VAT	Price Inc VAT*
Tow Eye Covers			
Indus Silver	LR082881	100.79	120.95
Dark Techno	LR083033	56.62	67.94
White Silver	LR083034	56.62	67.94
Anthracite	LR083035	56.62	67.94

Towing Electrics Adaptors



Part Number	Price Ex VAT	Price Inc VAT*
Towing Electrics Adaptor		
13 pin to 12N/12S	VPLHT0060	79.10 94.92
13 pin to 12N	VPLVT0064	37.87 45.44

Trailer Lighting Board



A robust lighting board with a 13 pin ISO rated socket and 8 metres of cable. Neatly designed, it includes reverse and rear fog lights, 2 tail lamps, indicator and brake lights. This lighting board is primarily designed for use with a trailer.

VPLCV0109 PRICE EX VAT (OUTSIDE EU) **£115.52** PRICE INC VAT (UK @ 20%) **£138.62**

Car Cover



All weather tailored cover protects your Discovery from the elements including showers, frost, snow and dust. Quick and easy to fit.

VPLRP0278 PRICE EX VAT (OUTSIDE EU) **£237.60** PRICE INC VAT (UK @ 20%) **£285.12**

Snow Traction System

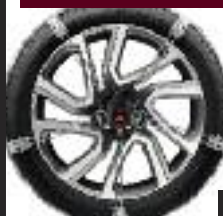

Snow traction system is designed to give improved steering and braking control on snow and ice, when fitted to front wheels. Easy-fit design, manufactured from high quality hardened galvanised steel, the chains are supplied in a tough vinyl carry bag for storage when not in use. Suitable for fitment to 19"-21" wheels only.

VPLGW0081 PRICE EX VAT (OUTSIDE EU) **£540.24** PRICE INC VAT (UK @ 20%) **£648.29**

If you know what you want why wait until office hours?

Visit our website and order online anytime!



HOME PAGE, WITH NAVIGATION MENU



CURRENT PRICE AND AVAILABILITY IS DISPLAYED

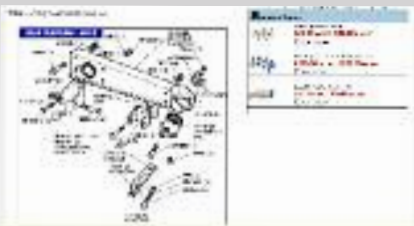

DETAILED PARTS INFORMATION MAKES SELECTION EASY



SIMPLY ENTER WHAT YOU WANT TO ORDER, AND PROCEED TO CHECK OUT FOR SECURE ORDERING!

Featuring:-

- Live Catalogues for all models
- Stock Availability
- Current Prices
- Special Offers
- Clearance Bargains
- Competitors Price Match
- Live Chat Facility
- Wish List
- Multiple Currency Pricing
- Shipping Charges

Ordering on-line is easy, secure, fast and efficient. Visit our website today.

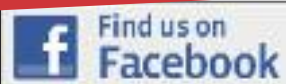

SIGN UP ON OUR WEBSITE TODAY FOR THE LATEST NEWS AND OFFERS!

Join our email list to ensure you don't miss out on new products and promotions, whether you own a Triumph, Land Rover, MG Rover, Jaguar '98 on or Mini!

CLEARANCE BARGAINS

HUGE SAVINGS

ITEMS ADDED DAILY! LIMITED SUPPLIES!

Visit our website to pick up a bargain today on our heavily discounted Clearance Bargain parts.

- First come first served.
- Limited quantities of product available.
- Parts will no longer be available once sold.
- Product selection changes regularly.
- Shipped anywhere worldwide.

Click on the Clearance Tag on our home page to see some amazing bargains...

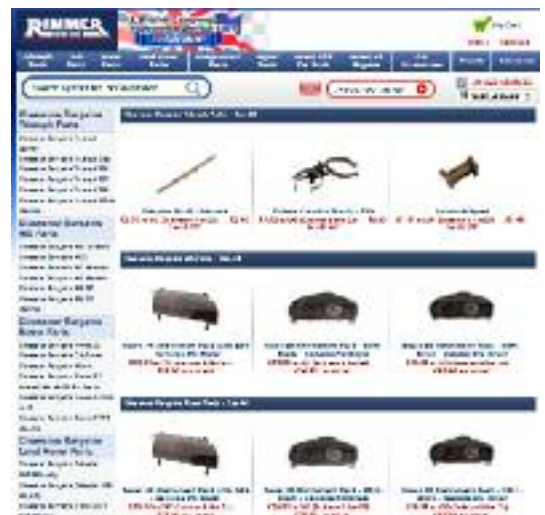

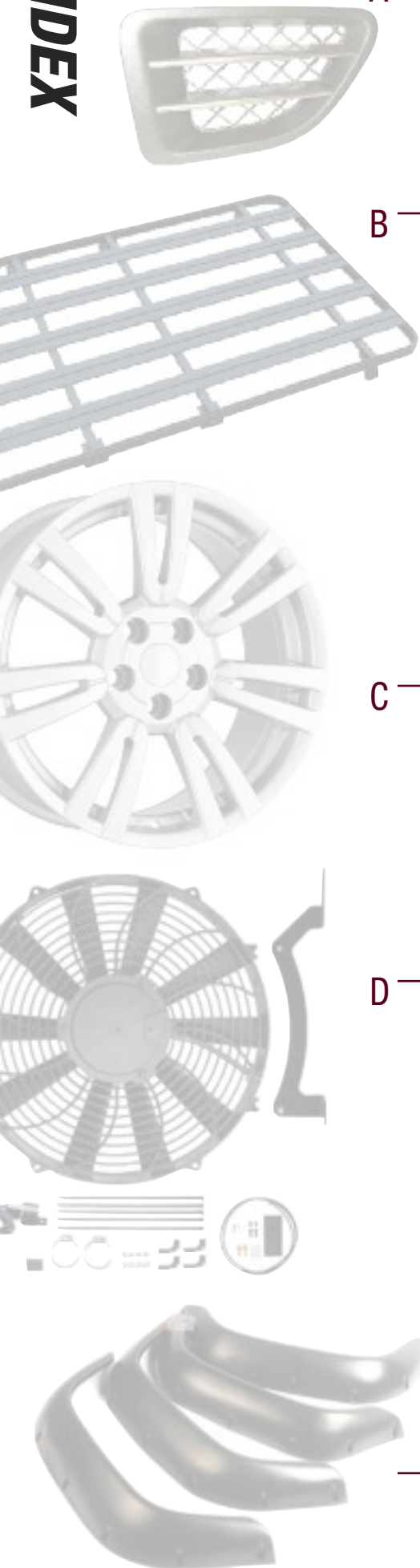

A	Air Compressors	105	E	EBC Brake Pads	155
	Air Horns	107		Eezi-Bleed	119
	Air Intake Grilles	17		EGR Blanking Kits	179
	Air Suspension Conversion Kits	167		Electric Window Kits	63
	All New Discovery Accessory Range	208		Electrics Towing	93
	Alloy Wheels	35		Electronic Ignition Kits	191
	Alternator Upgrade Kit	182		Engine Oil Application Table	130
	Anti-Freeze	133		Engine Upgrades	189
	Armrests	54		Evans Waterless Coolant	134
	Autoglym	136		Exhausts Stainless Steel	194
	AVM Free Wheeling Hubs	184		Exterior Styling	7
	Axle Stands	111	F	Fairleads	113
B	Battery Chargers	107		Fan Conversion Kits (Revotec)	181
	Bike Carriers	85		Farm Jacks	111
	Bilstein Shock Absorber Kits	166		Filter Guard	175
	Blind Spot Mirrors	25		Fire Extinguisher	110
	Blind Spot Windows	24		First Aid Kits	110
	Body Styling Kits	29		Flood Light	103
	Bolt Kits Stainless Steel	26		Fog Lamp Bezels	26
	Bonnet GRP	30		Fog Lamps	99
	Books & Publications	149		Folding Tyre Step	81
	Bottle Jacks	111		Footpump	105
	Brake & Clutch Hoses Goodridge	158		Free Wheeling Hubs	184
	Brake Cleaner	137		Fuel Tank Guards	50
	Brake Discs (uprated)	156		Fuel Tanks (long range)	182
	Brake Fluid	131		Full Carpet Sets	77
	Brake Pads	155	G	Gear Knob Sets	55
	Bulb Kits	110		Gear Lever & Gaiter Set	54
	Bulbs (upgrade)	101		Gear Lever Gaiters	56
	Bulkhead Bars	60		Gearbox Oil Application Table	131
	Bump Stop Hydraulic Conversion Kit	168		Gift Certificates (Vouchers)	28
	Bumper Corners	22		Glove Box	52
	Bumper End Caps	22		Glow Plug Heater Kit	182
	Bumperettes	27		Goodridge Hoses	158
	Bumpers Front	27		Grilles & Air Intakes	17
	BungeeClic	85		Ground Anchors	111
C	Camera Kits	109	H	Hand Operated Winch	115
	Car Covers	106		Handbrake Conversion Kits	184
	Carburettor Conversions	187		Hawkeye Total	129
	Cargo Barriers	87		Headlamp Conversions	95
	Carpet Mats	73		Headlamp Surrounds	26
	Carpet Sets (full)	77		Headlamp Upgrade Kits	100
	Carpets & Mats	71		Headlining	56
	Castrol Classic Oil	135		Heated Mirror Kits	25
	Chequer Plate	13		Hinge Kits Stainless Steel	26
	Climair	28		Hoods	79
	Coil Springs (uprated)	169		How to order	1
	Compressors	105	I	Indicator Lenses	100
	Cubby Boxes	53		Inspection Lamps	108
	Cup Holder	53		Intercoolers (uprated)	180
	Cycle Carriers	85		Interior Hardware Aluminium	55
D	Dashboard Camera	109		Interior Styling	52
	Dashboard Repair Kits	56		Interior Trim Kits	55
	Day Running Lights	99	J	Inverters	107
	De-Icer	133		Jacking	111
	Demister Vents	55		Jerry Cans	106
	Diagnostic Tools	129		Jump Start Kits	107
	Diaphragms (seat)	66	K	K & N Filters	173
	Diff Guards	50		K & N Oil Filters	175
	Diff Lockers	185		K-Seal Leak Repair	134
	Diff Oil Application Table	131		Kent Cams	189
	Dirt D-Fenders	32	L	Ladders (roof access)	86
	Discovery 5 Accessory Range	208		Lamp Guards	45
	Dislocation Kits	171		Lamp Mounting Bars	102
	Dog Guards	87		Lamp Steady Bars	98
	Door Cards Front	57		Land Inclometers	186
	Door Cards Rear	58		Land Rover Original Tech Publications	154
	Door Casings Front	57		LED Headlamp Conversions	95
	Door Casings Rear	58		LED Lamp Conversions	96
	Door Handle Sets	25		LED Light Bars	103
	Door Locking Peg	55		LED Work Lamps	103
	Door Mirrors	25		Light Guards	45
	Door Repair Channel	23		Light Mounting Bars	102
	Door Stays	60		Lighting	95
	Driving Lamps	97		Load Liners	78
	Driving Members	183		Loadspace Mats	75
				Locking Wheel Nuts	40
				Luggage Boxes	86
				Luggage Nets	86
				Lumbar Support Kit	65
				Lynx Evo	129

M	Mats & Carpets	71
	Mirror Arms	25
	Mirror Covers	25
	Mirrors	25
	Mudflaps	31
	Mudflaps Defender 110/130	32
	Mudflaps Defender 90	31
	Mudflaps Discovery	33
	Mudflaps Freelander	33
	Mudflaps Range Rover	34
	Mudflaps Series	31
	Multi socket Chargers	108
N	NAS Spec LED Lamps	96
	Number Plate Lamps	99
	Number Plates	106
O	Oil Application Table	130
	Oil Change Kit	127
	Overseas Travel	110
	Owners Handbooks	149
P	Panoramic Side Windows	24
	Parcel Shelf Kits	63
	Parking Distance Kit	109
	Parts Books	149
	Peak Performance Air Filters	174
	Pedal Set (aluminium)	60
	Performance Enhancement Accessories	155
	Performance Filters	173
	Polybush Kits	159
	Polyurethane Bush Kits	159
	Power Inverters	107
	Power Steering Fluid	131
	Propshafts (wide angle)	193
	Protection	44
	Puddle Lamp Kit	100
Q	Quadoptic Conversion Kits	100
	Quarter Light Windows	23
R	Radiator Muffs	180
	Raised Air Intakes (snorkels)	177
	Raptor	138
	Rear Fog Lamp	99
	Rear Parcel Shelf Kits	63
	Rear Steps	11
	Reversing Bleeper Kit	109
	Reversing Camera Kits	109
	Revotec Fan Conversion Kits	181
	Rock Guards/Sliders	9
	Roll Bar	51
	Roll Cages	51
	Roof Boxes	86
	Roof Console	63
	Roof Ladders	86
	Roof Racks	80
	Ropes & Straps	113
	Rubber Mats	71
S	Sand Ladder	183
	Screenwash	133
	Scuff Plates	52
	Seat Belts	61
	Seat Heater Kits	65
	Seat Rails (extended)	60
	Seat Re-Trim Kits	65
	Seat Re-Trim Kits (Discovery)	66
	Seating	64
	Shackles & Pulleys	113
	Shipping details	3
	Side Moulding Kits	29
	Side Repeater Lamps	99
	Side Steps/Side Tubes	7
	Silicone Hose Kits	178
	Ski Holders	85
	Snorkels	177
	Snow Cowles	18
	Spare Wheel Anti-Theft Device	40
	Spare Wheel Carriers	12
	Spare Wheel Covers	39
	Stainless Steel Exhausts	194
	Stainless Steel Screw & Bolt Kits	26
	Steel Wheels	37
	Steering Guards	50
	Steering Wheels	59
	Steps Rear	11

	Stone Chip Touch-In Paint	139
	Sump Guards	49
	Sun Visor Kit	30
	Sunroof	23
	Suspension Hardware	171
	Suspension Upgrade Kits	165
	Swingaway Wheel Carriers	12
	Swivel Housing Gaiter Kits	49
T	Tailgate Assembly	30
	Technical Publications (DVD & USB)	154
	Tools	118
	Torches	108
	Touch-Up Paints	139
	Touring	80
	Tow Balls	91
	Tow Bars	89
	Towing	89
	Towing Accessories	92
	Towing Electrics	93
	Trailer Board	92
	Transmission Oil Application Table	131
	Tread Plates	52
	Tree Fender	10
	Tree Sliders/Rock Guards	9
	Trolley Jack	111
	Trouser Catch	55
	Tyre Pal Tyre Pressure Monitor	104
	Tyre Pressure Gauge	105
	Tyre Pressure Monitor	104
	Tyre Repair Kit	105
	Tyre Step	81
	Tyre Valve Cap Sets	43
U	UJ Silicone Sleeves	49
	Union Jack Badges	28
	Upgrade Bulbs	101
	Uprated Brake Kits	157
	USB Port	108
V	Valve Cap Sets	43
W	Wading Kits	177
	Warning Triangles	110
	Waterless Coolant	134
	Waterproof Seat Covers	67
	Waxoyl	138
	WD-40	137
	Wheel Adaptor Kits	38
	Wheel Arch Kits	21
	Wheel Arches	21
	Wheel Carriers	12
	Wheel Centre Caps	41
	Wheel Covers (spare wheel)	39
	Wheel Nuts Locking	40
	Wheel Nuts, Centre Caps & Studs	41
	Wheel Spacer Kits	38
	Wheel Studs	41
	Wheel Wrenches	128
	Wheels Alloy	35
	Wheels Steel	37
	Winch Blanket	114
	Winch Bumpers	15
	Winch Cables	114
	Winches	112
	Winching	112
	Winching Accessories	113
	Wind Deflectors	28
	Window Kits	23
	Window Mesh Kits	44
	Wing Vents	18
	Wiper Relay (programmable)	182
	Work Lamps	103
	Workshop Manuals	149
X	Xenon Bulbs	101
Z	Zeppelin Windows	24

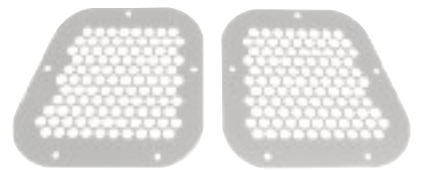
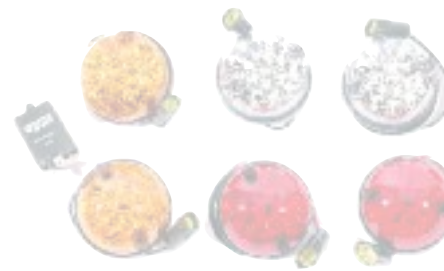

Large empty rectangular area for notes.

LAND ROVER & RANGE ROVER ACCESSORIES



All the parts you need
1948 to present day



RIMMER BROS

A BRITISH COMPANY SUPPORTING BRITISH CARS

Triumph House, Sleaford Road, Bracebridge Heath, Lincoln LN4 2NA, England
T: 01522 568000 F: 01522 567600 E: lrsales@rimmerbros.co.uk

TRADE ENQUIRIES WELCOME

Call us on **01522 567111** or email us trade@rimmerbros.co.uk

QUALITY PARTS AND ACCESSORIES



www.rimmerbros.co.uk