

BOATS & HARBORS®

THIRD FEBRUARY ISSUE 2018 VOLUME 60 NO. 29
Covering The East Coast, Gulf Coast, West Coast & Inland Waterways



www.boats-and-harbors.com

PH: (931) 484-6100 • FAX: (931) 456-2337 • Email: gdonnelly@boats-and-harbors.com • "The" Marine Marketplace



ACCOMMODATION BARGE

Cash Price:
Steal It At \$5.95M!!!



POOL



MOVIE THEATER



70' MARINA

MOTIVATED SELLER

MUST SELL!



STAIR WELL



11,000LB HELIDECK



FULL RESTAURANT



WINE CELLAR

370' Long x 85' Wide x 55' Tall

Features: 38 Rooms, Up To 300 People • Pool • Movie Theater • Bar • Full Restaurant • Aquarium • 11,000 lb Helideck
Boat Crane For Lifting 32' Boats • 70' Marina • 2 Water Makers • 4 CAT Generators • 14,000 sq ft Unused Space Ready For
Casino Or More Accommodation Rooms • Perfect For Oil Rig Support, Fishing / Gaming Lodge, Private Island, Floating Hotel.

Ready For Immediate Delivery! • Contact Us At: 727-441-3474



As I Told You Before Betty, Our Marketing Strategy Has Been Like a Viking Raid, Just Here And There. All This Will Change When You Get Our Ad In Boats And Harbors!!!



Contents of this publication either in whole or in part may not be reproduced without the express permission of the publisher.
Copyright © 2018 Donnelly Advertising & Publishing.



BOATS & HARBORS is Published 3 Times Each Month and Each Issue Goes by Direct Mail and Internet to Thousands of Individual Boat Owners, Builders and Operators, Tug, Pushboat and Barge Owners and Builders, Boat Yards, Commercial Fishermen, Packers and Processors, Divers and Diving Companies, Docks, Dredgers, Exporters, Ferryman, Freighters, Harbor Personnel, Longshoremen, Marinas, Steamship Companies, Marine Contractors, Off-Shore and Inland Oil Exploration Firms, Pile Drivers, Marine Salvage Firms, Ship Yards, Terminals, Towing Companies, Marine Warehouses, Government Agencies & other Related Businesses in the U. S. Possessions, Canada, Mexico & most other Foreign Countries. Boats and Harbors is Published in Crossville TN 38557.



Jeanerette, LA – Louisiana based shipbuilder Metal Shark has partnered with design firm Incat Crowther to develop an entirely new line of passenger vessels. The welded-aluminum, high-speed, low-wake, catamaran Endurance PV-X models are touted by Metal Shark as "next-generation passenger vessels" and feature thoroughly proven Incat Crowther hull designs well-regarded among passenger vessel operators for their efficiency and performance. The new models have been optimized for comfort, safety, and operational efficiency, offering a range of configurations and optional features designed to suit individual operator requirements. The Endurance PV-X vessels stand out with chiseled, modern lines derived from Metal Shark's latest military patrol boat designs. In addition to a design that enhances comfort, efficiency, performance and safety, one of the Endurance PV-X's most important benefits to customers is availability. "The development of the Endurance PV-X line is the latest step in our ongoing quest to support clients with high-quality vessels delivered in the shortest timeframe possible," explained Metal Shark's CEO Chris Allard. "We offer a smart alternative for operators who do not want to wait for two years or more for a new passenger vessel. With these standardized production-ready platforms, combined with our proven serialized production methodologies, we can deliver the 150-pax vessel in eight months and the 350-pax vessel in ten months from contract signing." For more info contact: Carl Wegener Sales (251) 610-3111, cwegener@metalsarkboats.com, www.metalsarkboats.com

BOATS & HARBORS®
P. O. Drawer 647
Crossville, Tennessee 38557-0647 • USA

www.FRANTZMARINE.com

2018 NEW YEAR VESSELS FOR SALE EXCLUSIVELY IN MY HANDS!!

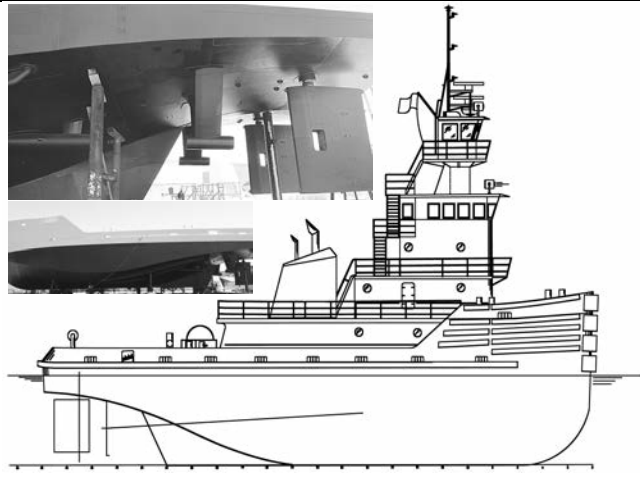

5,000 BHP - 2108 NEW CONSTRUCTION
110' x 38' x 19'



US Flag 4-Point DSV, 180' ABS Fully Classed
Exclusively in My Hands

ABS Class Certificate +A1, AMS valid thru June 30 2021, USCG Certificate of Inspection valid thru May 30, 2010.

OSV / Utility & Crewboats



320' x 60' x 28 Built 1995, 222' x 50' clear deck; U.S. Flag. Class: ABS +A1 +DP2.

280' L x 60' B x 24' D x 19' loaded draft. Built in 2004, US Flag, Class 1, +AMS, +DPS-2. Sub Ch. L & I. 203' x 50' clear deck.

272' L x 56' B x 18' D x 6' light draft x 15' loaded draft. Built in 1998, Class: ABS +A1, +AMS, DPS-2.

AHTS: 262' L x 58' B x 23' depth x 19' loaded draft. Built in 1998, Class: ABS + A1, Towing Vessel, AH (E) + AMS, DPS-2, SOLAS, US Flag.

260 L x 56 B x 18D x 6.60' light draft x 15.20' loaded draft. Built in 1997, Class: ABS +A1, +AMS, (E); USCG Sub Ch. L. US Flag.

260 L x 56' B x 18D x 6.60' light draft x 15.20' loaded draft. Built in 1996, Class: ABS +A1, +AMS, (E); USCG Sub Ch. L. US Flag.

260' L x 56 B x 21' D x 6.60' light draft x 18.00' loaded draft. Built in 2002, Class: ABS +A1, +AMS; USCG Sub Ch. L. US Flag.

260' L x 56' B x 21' D x 6.60' light draft x 18.00' loaded draft. Built in 2001, U.S. Flag. Class: ABS +A1, +AMS; USCG Sub Ch. L.

260' L x 56' B x 19' D x 16.14' loaded draft. Built in 1997, US Flag. Class: ABS +A1, +AMS, DPS-2. SOLAS.

240' L x 56' B x 21' D x 6' light draft x 18' loaded draft. Blt 1999, US Flag. Class: ABS +A1, +AMS; USCG Sub Ch. L, DP2.

240' L x 56' B x 21' D x 17' loaded draft. Built in 1998, **AHTS:** 240' L x 52' B x 18' D x 15' loaded draft. Built in 1986, US Flag. Class: ABS + A1 AMS Towing.

250' L x 56' B x 19' D x 16' loaded draft. Built in 2007, US Flag. Class: ABS +A1, +AMS, +DPS-2 Unrestricted Service.

AHTS: 225' L x 52' B x 22' D. Built in 1997, U.S. Flag. Class: ABS + A1.

220' L x 46' B x 16' D x 9' light draft x 13' loaded draft. Built in 1999, US Flag. Class: ABS Loadline. USCG SubCh "I" & "L". No SOLAS.

220' L x 46' B x 16' D x 9' light draft x 13' loaded draft. Built in 2000, US Flag. Class: ABS Loadline. USCG SubCh "I" & "L". No SOLAS.

220' L x 46' B x 16' D x 9' light draft x 13' loaded draft. Built in 1998, US Flag. Class: ABS Loadline. USCG SubCh "I" & "L". No SOLAS.

220' L x 48' B x 16' D x 6' light draft x 13' loaded draft. Built in 1995, US Flag. Class: ABS + A1 Oceans + AMS (E), DPS-1.

220.0' L x 56' B x 18' D x 16' loaded draft. Built in 1998, US Flag. Class: ABS + A1 +AMS, DPS-2, SOLAS, U.S. Domestic Service.

220' L x 40' B x 14' D x 11' loaded draft. Built in 1989, US Flag. Class: ABS +A1 AMS (exp. Dec 6, 2019. Next DD due Dec. 23, 2017).

AHTS: 220' L x 42' B x 14' D x 13' loaded draft. Built in 1982, US Flag. GRT: 490. Class: ABS loadline exp. 18 April 2017. Laid up. USCG Subch. I.

205' L x 46' B x 17' D x 9' light draft x 14' loaded draft. Built in 1999, US Flag. Class: ABS + A1 U.S. Domestic Service + AMS, DPS-1. USCG Sub Ch. L, OSV.

205' L x 46' B x 17' D x 9' light draft x 14' loaded draft. Built in 1998, US Flag. Class: ABS + A1, U.S. Domestic Service + AMS, DPS-1.

190' L x 54' B x 16' D x 13' loaded draft. Built in 1998, US Flag. Class: ABS +A1 +AMS, DPS-1, Loadline, SOLAS, SIP, USCG Sub. Ch. "L".

199' L x 44' B x 19' D x 16' loaded draft. Built in 1999, Rebuilt: 2014. U.S. Flag. Class: ABS + A1, OSV, + AMS, DPS-1, Unrestricted.

150' L x 36' B x 12' D x 12' loaded draft. Built in 2007, U.S. Flag. Class: ABS Loadline only.

150' L x 26' B x 10' D. Built in 1981 U.S. Flag. For sale without US Registry. U.S. Gulf Coast.

150' L x 26' B x 10' D. Built in 1981, U.S. Flag. For sale without US Registry. U.S. Gulf Coast.

145' L x 34' B x 9' D x 9' loaded draft. Built in 1982, U.S. Flag. U.S. Gulf Coast.

Utility Boat: 120' L x 26' B x 8' D. U.S. Flag. GRT: 99. 55'x18' clear deck. FO: 30,000g. FW: 40,000g. Main Engines: 2 x GM. Quarters: 16 in 3 rooms. U.S. Gulf.

Utility Boat: 115' L x 26' B x 6.8' D x 8' loaded draft. Built in 1980 U.S. Flag. GRT: 93. Class: USCG Sub T, OSV. Deck Cargo: 68LT on 55' x 22' clear deck. Last drydocked March 2014. Idle. Owner did a major rebuild at drydock and has invoices over US \$700K (owner will produce all invoices upon request). Owner is inviting serious interest. U.S. Gulf Coast.

Supply Boat: 110' L x 28' B x 4' D x 7' light draft x 9' loaded draft. Built in 1980. U.S. flag. Deck Cargo: 142LT on 50' x 20' clear deck. Quarters: 20 berths (4 crew, 16 pax). Utility vessel for sale. U.S. Gulf Coast.

Utility Boat: 110' L x 26' B x 7' D. Built in 1981, U.S. Flag. Class: USCG Cert. "T" 40 persons. ABS loadline exp. Deck Cargo: 67T on 48'x22' clear deck. U.S. Gulf

Utility Boat: 110' L x 28' B x 8' loaded draft. Built in 1982, U.S. Flag. Deck Cargo: 60LT on 62' x 22' clear deck. U.S. Gulf Coast.

CARIBBEAN TUGS



2,200 BHP



2,200 BHP



1,700 BHP

TUGS



800 HP - Vivian
60' x 22'

6' Draft, Blt 1975, Twin Screw GM 12V71's, MG 514 (5.16:1), Steel In Subchapter M Condition



2,600 BHP
Lucinda Smith 90' x 28'

Twin Cummins QSK 38M's Tier II, With ZF 4610W, 5.63:1, Korts, Upper House, ABS International Loadline Valid



4,000 BHP - William
115' x 32'

Twin EMD 16-645 E6's, Reintjes, Korts, ABS Full Class Hull and Machinery Valid, Intercon Double Drum Winch, Rent Ready



5,750 BHP - Costal 303
128' x 35'

Twin Alco 16-251 E's, Built Main, Upper House With Elevator, ABS Laidup Status.

PUSHBOATS



1,350 BHP Miss Laurie
65' x 24'

Twin QSK Cummins (Tier II); MG 5170 (6:1), Flanking Rudders, Fleeting Deck, Elect. Winches



1,800 BHP Warren
65' x 26'

Twin CAT C-32's (Tier II), MG 5222 (6:1), Flanking Rudders, Fleeting Deck, Elect Winches



1,000 BHP
Hayden - 60' x 22'

Twin CAT 3408's, MG518 (6.5:1) Flk. Rudders, Fleet Deck, Elect., Winches, MMBumpers.

SUPER BARGAIN!



2,600 BHP
Capt. Vince - 78' x 30'

Blt. 1982, Rebuilt 2015 Dravo, Twin CAT 3512's, MG 5600 (7:1), 78' x 68", RCP Cert. & SubM 2,600 Profile



DB350

All Oceans; heavy lift derrick crane barge; 250' x 78'; upgraded 4 point RB-97 mooring system; quarters for 64 people; Manitowoc 3900; (3) 224 kw gen sets. (Priced To Sell)

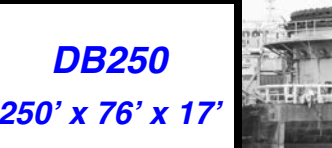

DB250
250' x 76' x 17'

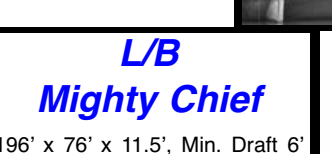

L/B
Mighty Chief

196' x 76' x 11.5', Min. Draft 6' USCG COI, ABS +A1 Barge Classed, Fuel: 49,920 gal, Water: 109,824 gal., Ballast 65,208 gal., Generators: (3) 350 KW, (1) 125 KW, Deck Crane: Manitowoc 3900

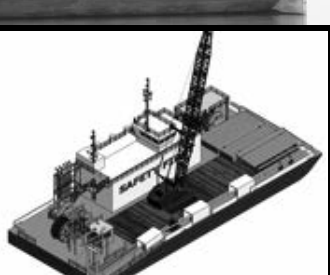

DENNIS FRANTZ FRANTZ MARINE CORPORATION, INC.

CELLULAR (504) 430-7117

Email: Dennis@Frantzmarine.com

Email: Tugmaninmandeville@charter.net

(ALL SPECIFICATIONS AS PER OWNER AND NOT GUARANTEED BY BROKER)

Two Certified Landing Crafts For Sale



76 x 22.5 Landing Craft. Over 500k spent in refurbished and extensively modified in 2010, including new Tier 2 John Deere 6125 engines w/ low hrs. & Twin Disc gears, 20kw and 40kw gen sets, 12T RO Stinger crane w/ 60' boom, widened 22 x 56 cargo area, galley/accommodations, full electronics, stern anchor winch, two stern mooring winches and lots more. Legal to haul freight for hire. Feb 2017 100k drydocking incl complete blast/paint, new gate, new wheelhouse main deck, much more" **Reduced \$100,000 to \$485,000**



76 x 22.5 Aluminum Coast Guard certified Landing Craft. Refurbished and extensively modified in 2003 including Twin Detroit Series 60 engines. (2) 30kw gen sets, 10T crane w/ 60' boom, galley/accommodations, full electronics, stern anchor winch, and lots more..... **Reduced \$100,000 to \$485,000**

To Duplicate Modification/Conversion Work done on these vessels would run several hundred thousand dollars. **619-533-7932 • Located West Coast • Delivery Available** "Special Delivery Price on freighter to FL or Bahamas - \$75k, (About 1/2 the normal rate)" grant@pacifictugboats.com



DON'T LET MOTHER NATURE AFFECT YOUR BOTTOM LINE

Our custom-built fabric structures are designed to withstand the harshest conditions, while ensuring that your business needs are met. Everything from covering large refit projects to storing equipment and cargo is a cinch with a Big Top Fabric Structure.

The high clearance and open design of our shelters make them ideal for the marine industry.

- Boat Fabrication/Refit
- Paint & Blasting
- Warehouse
- Equipment Storage

BIGTOPSHELTERS.COM
1.800.277.8677



P C Industries

www.powerlinecomponents.com

Specializing in Detroit Diesel 2 Cycle Engines

Complete Line of Remanufactured Subassemblies
Blowers, Con Rods, Cylinder Heads, Injectors,
Fuel Pumps, Oil Pumps, Water Pumps and More!



Large Inventory of New Parts

Pistons, Cylinder Liners, Ring Sets, Gasket Sets, Bearings



North West Distributor
Kocsis Hydraulic Starting Systems

New Water Cooled Exhaust Manifolds & Accessories
for Caterpillar, Cummins & Detroit Diesel Engines



P C Industries, LLC

1088 N. Washington, P.O. Box 490
Afton, Wyoming 83110 USA
Phone # (307) 885-4724
Fax # (307) 885-3215
Toll Free # (877) 885-4724

Remanufactured & Dynamometer
Tested Detroit Diesel Engines



LOOKING AHEAD

AHEAD TANK™

WILL BE THE **LAST** SEWAGE TREATMENT SYSTEM YOU WILL EVER BUY

USCG Certified Type II
Marine Sanitation Device

In Compliance with Title 33 CFR
159.015 for Inspected and
Non Inspected Vessels

Also Accepted Worldwide in
accordance with the NEW 2016
IMO Resolution MEPC.227 (64)



Model AT-12T

#1 in the #2 Business

NEXT GENERATION TECHNOLOGY

Sewage Treatment Systems, Products, Parts & Supplies



FOR MORE INFORMATION

Phone: 337-330-4407

Email: headflusher@aheadtank.com

VISIT US ONLINE:

www.aheadsanitationsystems.com

facebook.com/aheadsanitationsystems

Kubota

1800 RPM Standard Equipment:

- Kubota Diesel Engine
- 12 Volt Electric Starter
- 12 Volt Battery Charging Alternator
- Automatic Engine Shutdown for Low Oil Pressure / High Coolant Temperature
- Fuel Filter
- Built in Fuel Transfer Pump
- Dry Air Cleaner
- Heavy Duty Steel Frame with Isolation Mounts
- High Ambient Radiator Cooling
- MeccAlte Industrial Generator
- Brushless Exciter
- Unit Mounted Solid State Voltage Regulator
- Ship-loose Muffler with Raincap
- Toggle Switch Start
- Engine Hour Meter
- 3 Year Kubota Engine Warranty
- EPA Tier 4i Compliant

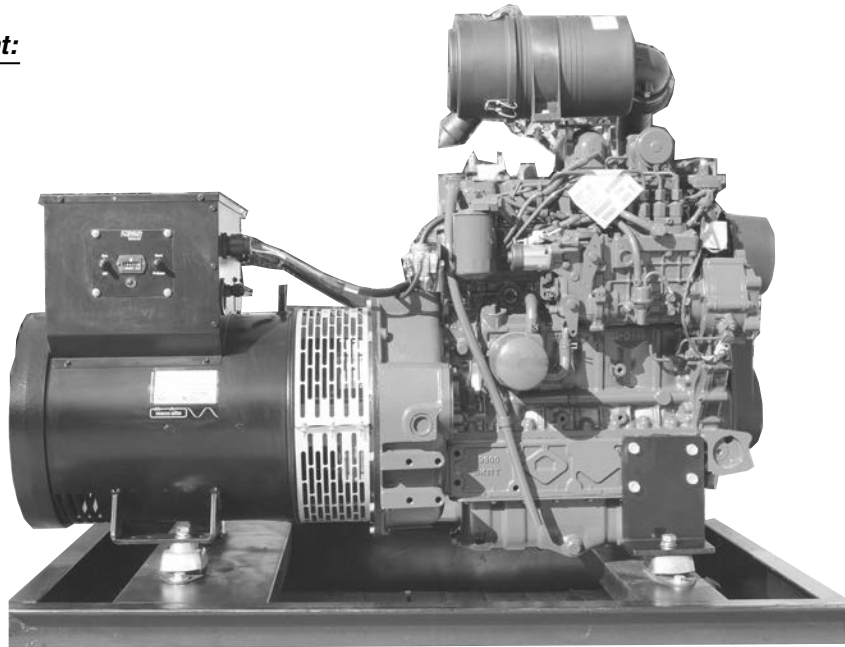

KK4-50.0 kW

Optional Equipment:

- Sound / Weather Enclosures
- Auto Start / Stop
- ATS
- Fuel Tanks
- Block Heater
- Critical Silencers
- Gauge Panels
- RACOR Filters
- Circuit Breakers

KEEL COOLED MODELS

| MODEL | PRICE | MODEL | PRICE |
|----------------------|----------|------------|----------|
| DRY EXHAUST MANIFOLD | | | |
| KK3-7.0KW | \$ 5,891 | KK4-21.0KW | \$ 9,634 |
| KK3-8.5KW | 6,321 | KK4-25.0KW | 9,955 |
| KK3-9.5KW | 6,542 | KK4-30.0KW | 10,406 |
| KK4-12.5KW | 7,245 | KK4-40.0KW | 14,506 |
| KK4-15.0KW | 8,306 | KK4-50.0KW | 15,708 |
| KK4-17.5KW | 8,511 | JD4-60.0KW | 17,627 |

Southeastern Power Products is the Authorized KUBOTA Industrial Engine America Distributor for the State of Florida, Bahamas and the Caribbean.

Supplying Genuine KUBOTA Parts and factory Remanufactured components.

WE SHIP GENERATORS WORLDWIDE
RADIATOR COOLED GENERATORS

| Model | KW Rating | Net Price |
|-----------|-----------|-----------|
| SEP 7.0I | 7.0 KW | 6,285 |
| SEP 8.5I | 8.5 KW | 6,631 |
| SEP 9.5I | 9.5 KW | 6,925 |
| SEP 12.5I | 12.5 KW | 7,686 |
| SEP 15.0I | 15.0 KW | 8,474 |
| SEP 17.5I | 17.5 KW | 8,973 |
| SEP 21.0I | 21.0 KW | 9,755 |
| SEP 25.0I | 25.0 KW | 10,353 |
| SEP 30.0I | 30.0 KW | 10,983 |
| SEP 40.0I | 40.0 KW | 12,579 |
| SEP 50.0I | 50.0 KW | 13,934 |

LOWBOY

GL SERIES

GL7000 - USA \$4,600
GL11000 - USA \$5,800
GL14000 - USA \$8,950



COMPONENTS AVAILABLE

SOUTHEASTERN POWER PRODUCTS

2880 Hammondville Road,
Pompano Beach, FL 33069
Phone: (954) 979-5899
Fax: (954) 979-4349

www.southeasternpower.com

Prices and Specifications
Subject to Change



**Quality Custom Built Aluminum Workboats & Pleasure Craft
Located In Harvey, Louisiana Just South Of New Orleans.**



27' Harbor Patrol Vessel



75' Quick Response Fire Fighting Vessel



35' Collar Style Supply Vessel



38' In Shore Supply Vessel



30' Aluminum Supply Vessel



30' Collar Style Supply Vessel

Aluminum Never Looked So Good!

We Also Offer A Variety Of Services Including:

- Repairs
- Conversions
- Sandblasting & Painting
- Aluminum & Steel Fabrication
- Dockside Service Including A 65 Ton Crane
- Experience With State & Local Government

Let Us Build A Boat For You!

Contact Darren or Chad at (504) 347-7898

Visit us on the web at WWW.ALUMAMARINE.COM. For further info, contact us by email at chad@alumamarine.com or darren@alumamarine.com

BAIER



Hatch Company, Inc.

**THE STRONGEST
HATCH TO EVER
HIT THE DECK!**



ROUNDS



OVALS



**MULTI-BOLT
MANHOLES**



SQUARES

Hatches Available in Cast Aluminum & Cast Steel

TO ORDER

800 - 455 - 3917

Seattle, WA • Costa Mesa, CA
www.baiermarine.com

PINE HILL EQUIPMENT



655 Pine Hill Rd. - Westport, MA 02790 • E-mail: sales@pinehillequipment.com
"Pictures of all equipment can be emailed upon request. Dimension sheets also available"

**NEW AND USED PULLMASTERS
IN STOCK**

See pinehillequipment.com or call for inventory

Used Double Drum Marco Winch

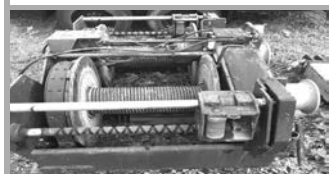

Used take off with control valves. Foot acuated band brakes. Holds Approx. 1,800 feet of 3/4" wire on each drum. Call for price

Available For Immediate Dispatch:

- (1) M12-3-97-1 - For Sale or Rent
- (1) H25-3-86-2 - For Sale or Rent
- (2) H25-3-86-3 - For Rent Only
- (1) H50-3-207-2 - For Rent Only

Almond Johnson LST Anchor Winch

It makes a strong towing winch. Carries 1500 ft of 1 1/2 wire rope and has 60,000 lb. bare drum line pull. The winch has been converted to hydraulic and air operated brake/clutch. The winch appears to never have been used. Hydraulics are new, installed by Pine Hill Equipment. Includes level wind.



Call ex 215 for pricing

**(1) ZF IRM 320 PL-1
REVERSE GEAR**

1-12:1, SAE No. 1 Bell Housing, serial no. 320-672, new never used cond. Call for price.

**200 TON SHACKLE
LIKE NEW • \$1,250**

Marine Cranes | Spare Parts

Pine Hill Equipment is proud to offer marine products by:



CRANES - Off-shore, ship-mounted & dock mounted cranes • Knuckle boom, telescopic boom, and stiff boom configurations • Cranes from 2.5 mt to 400 mt • Heavy Lift cranes to 3000 mt • Certified for ABS, DNV & others.

PARTS - Spare parts for all things Palfinger Marine and Palfinger NedDeck Many in stock. Fast reliable ordering service.

PACKAGES - Power units, winches, radio remote controls, anti-2-block systems, scales & weight systems, platforms, seats, cabs & crane skids. Spare parts, pipes & hoses. After sales & service.



NEW MARINE CRANES IN STOCK

**PALFINGER MARINE MODELS IN STOCK
PK4501MC - 4.2 MT/29,500 FT-LBS**

(1) 1996 Used HIAB 080 SeaCrane



Will pick 2300 LBS at a full stick of 23' & 4800 LBS @ 11' 400 degree rotation Includes used Gearmatic winch As-Is Where Is

NEW Kawasaki "STAFFA" Radial Piston Motor



Brand New - Take Off Hydraulic Radial Piston Motor. Heavy Duty, High Torque, Low Speed. Model: HMHDB200/T/FM4 /30/PL130, Serial: 01A10151 • 188 Cubic Inch, Max Continuous Speed: 175 RPM, Max Continuous Output: 174 HP, Max Cont. Pressure: 3625 PSI. Full specs & price upon request.

Custom Hydraulic Power Units! Rent or Own!

Any HP, wireless control capabilities, any GPM, any size! They are fully customizable and marine tested and proven. Below are the pictures of our standard 80HP!

DIESEL POWER UNITS FOR SALE OR RENT



Available quickly. Standard diesel HPUs up to 173 HP. Built to spec. Buy or rent. We can deliver to your jobsite. Call for availability.

Available For Immediate Dispatch:

- (2) 99 HP John Deere Units - For Sale or Rent
- (2) 85 HP Kubota Units - For Rent Only

WIRELESS RADIO REMOTE CONTROLS



Wirelessly control all of your hydraulic equipment. Don't be stuck behind a console! Safely run your equipment with the ability to be in a better line of sight. Push button stop features allow you to remotely shut down equipment in case of machinery failure or other emergency. Remotely control your cranes, winches, deck equipment, power units and motor starters, etc. We can safely and remotely control just about anything. Call with your specifications.

MR 375 HYDROSTAR RADIAL PISTON MOTOR CURRENTLY BEING REBUILT

Once reconditioned this unit will be - Spline shaft 85%, motor clean inside. Supplied blasted and in zinc primer. Motor will be entirely disassembled, inspected & resealed with shaft saver on shaft. Motor has six bolt flange connections. Single Speed, Heavy Duty, High torque, Low speed., 374.2 Cubic Inch, Max Continuous Speed: 90 RPM, Max Continuous Output: 165 HP, Max Continuous Pressure: 3000 PSI, Max Continuous Output torque: 13,750 FT/LBS, Dry Weight: 1444 LBS. **POR**

DESIGN & CONSTRUCTION OF HYDRAULICALLY POWERED WINCHES AND LINE/MATERIAL HANDLING MACHINERY FOR ALL APPLICATIONS

Often Times It Is More Cost Effective To Replace Old Mechanically Driven Winch Systems With NEW Hydraulic Winches and Power Units!

WE ARE DISTRIBUTORS OF



PLANETARY WINCHES AND PLANEMATIC PLANETARY DRIVES FROM 1,000 LBS. TO 75,000 LBS. LINE PULL

CALL OR FAX US FOR A QUOTE ON YOUR NEXT WINCH REQUIREMENT!

Website: www.PineHillEquipment.com

PHONE (508) 636-5971 x212
FAX: (508) 636-9067

MIDSHIP MARINE INC.

MIDSHIP MARINE

OUR QUALITY SAYS IT ALL!
WHEN IT COMES TO BUILDING ALUMINUM BOATS
WE HAVE NO LIMITATIONS

• Passenger Vessels • Crew Boats • Pilot Boats • Patrol Boats • Dive Boats • Water Taxis • Fishing Boats



210' x 32' HIGH SPEED CREWBOAT



65' SAILING CAT - 120 PASS



95' OIL SPILL FRV



42' CREWBOAT



97' EXCURSION VESSEL



70' x 21' PASSENGER FERRY



90' CATAMARANS - 250 PASS



55' PASSENGER HEADBOAT - 49 PASS



55' SEMI SUB - 49 PASS



58' ALUMINUM VESSEL

MIDSHIP MARINE ALSO SPECIALIZES IN CONVERSIONS OF CREW BOATS INTO: DIVE VESSELS, CHARTER YACHTS, PASSENGER FERRIES, ETC. W/LOW PRICING & HIGH QUALITY. LET US DESIGN & QUOTE YOUR NEXT VESSEL.

MIDSHIP MARINE will quote on building any vessel to meet your specific needs. All work is done at our yard in Harvey.

CONTACT MIKE or RANDY - PHONE (504) 341-4359 • FAX (504)-340-8997

Email: Midboats@aol.com • Website: www.MidshipMarine.net

MAILING ADDRESS: P.O. BOX 125, HARVEY, LOUISIANA 70059

KOHLER Commercial Marine Generators

Open - Frame and Keel Cooled Units

| MODEL | COST |
|---------|-------------|
| 9EKOZD | \$8,250.00 |
| 11EKOZD | \$8,785.00 |
| 13EKOZD | \$9,990.00 |
| 15EKOZD | \$11,100.00 |
| 20EKOD | \$12,800.00 |
| 23EKOD | \$13,725.00 |

24 Hour Emergency Service!!
Monmouth Marine Engines, Inc.
536 Union Lane • Brielle, NJ 08730
Phone: (732) 988-0245 • Fax: (732) 988-0246

65' Mississippi Like River Boat - 78' Overall, Incl. Stern Paddle. USCG Lic. For 150 + 10 Crew. Full Electronics, USCG Insp. Both Decks Heat & A/C. 2 - 671 GM Diesels. 2-371 - 50 KW GM Gens @ 1200 RPM. Brielle, NJ.
\$450,000 • (732) 245-1592

The most advanced. The most reliable.

- RATED "BEST" BY POWERBOAT REPORTS
- REPLACES STUFFING BOX
- DRIPLESS
- ELIMINATES SHAFT WEAR
- PROTECTS ENVIRONMENT
- ELIMINATES POLLUTION FINES
- UTILIZED BY THE U.S. COAST GUARD

- MAINTENANCE FREE
- 3 YEAR WARRANTY
- SINCE 1975
- METRIC AND CUSTOM SIZES AVAILABLE
- FROM 3/4" TO 8" SHAFT SIZES
- MADE IN USA
- 3 MODELS TO CHOOSE FROM
- COMPLETE LINE OF RUDDER SEALS
- **PRICES STARTING AT \$95**

Ask about our fall specials!

Lasdrop

SHAFT-SEAL

nautical 11x 1-800-940-SEAL

3615 Dove St., Port Huron, Michigan 48060 USA
Phone: 810.388-9718 • Fax: 810.388-9753
Visit Us Online At: lasdrop.com

WATER COOLED EXHAUST MANIFOLDS

For 3-71, 4-71, & 6-71 Detroit Diesel

DD-1-6710

| | |
|---------------------------------------|----------|
| 3-71 & 6V71 | \$225.00 |
| 4-71 & 8V71 | \$250.00 |
| 6-71 & 12V71 | \$325.00 |
| 4" NPT EXHAUST END PLATE | \$40.00 |
| Water Cover Plate (Specify Pipe Size) | \$9.00 |

BARR MARINE BY EDM
100 Douglas Way, P.O. Box 190
Natural Bridge Station, VA 24579
Toll Free (866) 255-9265 Fax (540) 291-4185

LEE FELTERMAN & ASSOCIATES MARINE SALES

www.leefelتمان.com Patterson, Louisiana 70392 USA
lee@leefelتمان.com Office: (985) 399-7222

MARINE EQUIPMENT FOR SALE

OWNER - BROKER - BUY - SELL - REPAIR • EXPERT SERVICES • MARINE SURVEYING



OFFSHORE SUPPLY BOATS



CREWBOATS



PUSHBOATS & TUGBOATS



LIFT BOATS



UTILITY BOATS

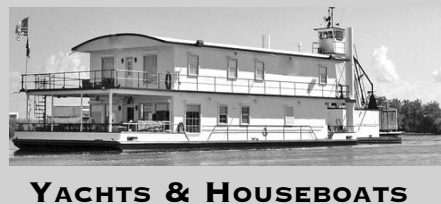

YACHTS & HOUSEBOATS



DIVE BOATS



BARGES

FISHING BOATS, PROPS, SHAFTS, AND MUCH MORE..
For Specs And Prices See Our Website:
www.leefelتمان.com
"Over 35 Years in the Marine Industry"

ST. JOHNS SHIP BUILDING

New Builds
Repairs
Dry Dockage

FULL SERVICE SHIP BUILDING AND REPAIR CENTER

Why Choose Us:
Quality Workmanship
Over 30 Years Experience • U.S. Ship Builder
Certified ABS, USCG
Accessible to East Coast

DECK BARGE SALE / LEASE

2016, 150 x 60 x 8, 9,000 sq. Ft. Deck, 3200 PSF Uniform Dry Load.
\$1.25 Million USD

2017 TRUCKABLE TUG

Heavy Duty or Built To Class
Sale / Lease

25' 10" x 13' 6", 2 Cummins 6.7L 305 HP Ea., 2 Twin Disc Gears 3:1 Ratio, 8' Push Knee, 400 Gal. Fuel Capacity, up to 17' Height of Eye, Electronics, Deck Winch Cables, 34" x 19" Props. SALE / LEASE
\$298,000 USD

40' x 12' x 3.5' BARGE

\$31,500

54' PUSH TUG

\$355,000.00 • Great Condition Available For Purchase/Lease

LANDING CRAFT

Cummins 660 HP, Twin Screw, Schottel Z-Drive Availability
Double Ended Car Ferry

Drydocking & Repairs

We service local and international customers!
For info. on sales, new builds or repairs please call **386-972-3413**
560 Stokes Landing Rd, Palatka, FL 32177

Opdyke Inc.
Specialized Trucks & Equipment Sales
3123 Bethlehem Pike, Hatfield P.A. 19440
Sales@Opdykes.com
DESDE MEXICO: 001-215-721-4446
866-204-2545

www.Trucks123.com

100+ SPECIALIZED TRUCKS IN STOCK!
20 TANDEM KNUCKLEBOOM TRUCKS IN STOCK!! \$34K-\$100K

199,500 **16 TON** 8899
82' SIDE REACH
197,615 mi.

2003 KENWORTH T800 TRACTOR-CAT C-126 CYL (385 HP); FULLER 911L; A/C; 58,740 GVW. 2002 PALFINGER PK50002 KNUCKLEBOOM; 16 TON; RADIO REMOTES.

UNMOUNTED KNUCKLEBOOMS
199,500 & up

HIAB • PALFINGER • EFFER • FASSI • ETC.

199,500 **23.5 TON** 8930
83,647 mi.

1999 INTERNATIONAL 2574; 530E 6 CYL (300 HP); SPICER 10 SP; A/C; 58K GVW. TEREX TC4792 CRANE; 23.5 TON; 128' TOTAL HOOK HT; 21' WOOD FLATBED. FOR EXPORT - HAS DENT ON CRANE. WILL NOT PASS CRANE CERTIFICATION.

10+ FUEL TRUCKS IN STOCK!
BROKERS WANTED
we pay competitive commissions on sales!

SCRAP NINJA!



**WE PUSH 'EM
WE SUCK 'EM
AND WE SHUCK 'EM
EPA Compliant
ALL SCRAP METALS
New Orleans LA
(504) 458-1222**

1200 HP DECK LUGGER FOR SALE
Triple Screw - 65' x 26' x 9' - Built 1998



Waterways Equipment Exchange, Inc.
Paul Legeay III (888) 416-9303
paul@legeay.com • WaterwaysEquipment.com



Island Hopper 30'x12', Excellent, stable 6 pack sport fishing and crabbing boat, built by Island Hopper of Florida in 2005 and powered by a 440 horse Yanmar Diesel with trolling valve. Extensive equipment list including live bait well and jet bow thruster. Price reduced to \$89,000
Call 360 738 8099 For Details

For Sale: 2003 Zodiac H920 Fireboat



Powered by Twin Yanmar 440 Diesel engines and Twin Disc water jets. 200 gallon fuel capacity. Features include generator, 1750 GPM fire pump, roof-mounted deck gun, 30 gallon foam tank, air conditioning and heat, remote ACR searchlights, Whelen hailer, Raytheon electronics package, and numerous other extras.

For more information contact Dean at (561) 909-9788

125' Ex-Coast Guard Cutter Morris



1927/2010
\$2 Million Overhaul. Low hour KTA's & gens, new wiring, piping, decks, hull, plating, electronics & more.
Rio Vista, CA

**Must Go
Only \$110K!**

(916) 715-0563 • See: www.libertymaritime.org

JW FISHERS In the darkness...comes clarity
with a JW Fishers SCAN-650 Sector Scan Sonar

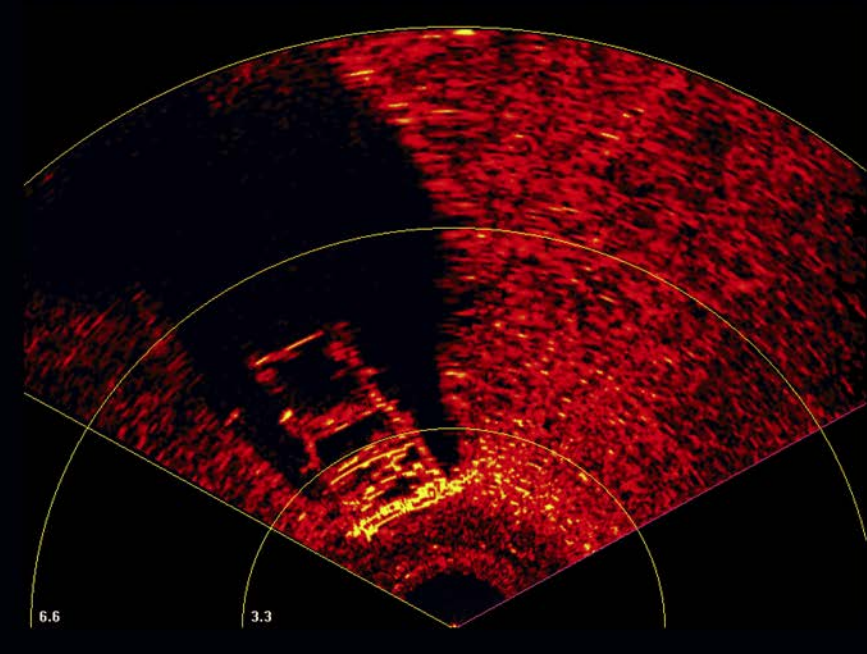

- Target sizing capability
- Depth range of 1,000' (300m)
- High resolution imagery
- Sweep 360 degrees
- ROV, pole or tripod mountable
- User friendly software
- Fast imaging
- Commercial grade

JW Fishers Mfg., Inc.
1953 County Street
East Taunton MA 02718 USA
(800) 822-4744 or (508) 822-7330
Email: info@jwfishers.com
www.jwfishers.com

f YouTube in Pinterest

Vogel Equipment LLC

OFFSHORE FIRE RESCUE 1 **NAVATEK I SWATH Excursion Vessel**

**\$595K
FOB Honolulu**
Financing Available
w/30% Deposit



**A RAPID RESPONSE 27+ KNOTS
FIRE RESCUE VESSEL**

**\$595K
FOB Honolulu**
Financing Available
w/30% Deposit



**For Additional Information visit:
<http://www.vogelequipment.com/project/navatek-i/>**

Vogel Equipment LLC announces the sale of the Offshore Fire Rescue 1 vessel. Builder Halter Moss Point Marine, Inc., Escatawpa, Miss., a member of the Trinity Marine Group. The vessel is equipped with four water monitors or nozzles with a collective capacity of up to 12,000 gallons per minute of water and foam. One of the fire monitors is located atop a telescoping tower which can rise 50 feet above the water to allow placement of a stream on the deck of a large ship in ballast. The vessel was designed by Guido Perla & Associates, Inc., Seattle. Propulsion and pumping power is provided by two Detroit Diesel 16V92TA engines developing 1,100 horsepower at 2,100 rpm. The Generators are 2 x Detroit 353 Generator @ 180 KW. They drive fixed-pitch propellers through two Twin Disc marine transmissions. 2 x 6,000-gpm fire pump is driven off of each propulsion engine through a front mounted pump with Fawick air clutch. Fire suppressant foam is supplied from stainless steel tanks located below decks. The vessel's four fire monitors include one 5,000-gpm remote operated unit mounted on the foredeck, two 2,500-gpm manually operated water monitors on the bridge deck aft, and one 2,000-gpm remote operated foam/water monitor on top of the pilothouse. Starting, operating, and stopping of the propulsion, electrical, and firefighting systems is automated for control from the wheelhouse, and the vessel and all systems can be operated by a crew of two. This great vessel from Hawaii was made for rapid intervention response is a very special made vessel with towing capacity capabilities. Vessel formally known as Moku Ahi. There is an Additional \$300,000 Spare Parts Package available at additional cost, All Offers Considered.
FOB Honolulu, Delivery to West Coast Port Available at Additional Cost.

Certified by the U.S. Coast Guard to carry as many as 430 passengers and crew on an ocean route, the Navatek I was the first SWATH in the world to be classed by ABS, +A1 Ferry, Hawaiian interisland service, +AMS. A SWATH ship is designed to radically reduce ship motions—pitch, heave and roll—caused by waves. The SWATH ship's most unique market advantage is the virtual elimination of seasickness. Compared to a conventional mono-hull or catamaran, it also offers greater maneuverability, more usable deck space, and can maintain greater speed through rough waters. Despite operating in rough ocean seas of 4-12 feet all year long, the passenger seasickness rate has maintained at being less than 1 percent. The hull of Navatek I was built by Thompson Metal Fab, Vancouver, Wash.; she was outfitted by Northwest Marine, Portland, Ore.; and Trinity Marine Group, Gulfport, Miss., built her superstructure. The structural design of the vessel consists of two demi-hulls, connected by a cross-structure consisting of two box beams. There are two vertical struts per side which connects the lower hulls to the upper structure. The lower hulls have hemispherical endcaps at the bow. Aft of this are two cylindrical lengths of hull of circular cross section. The deckhouse is mounted on flexible mounts. Navatek I is 140 feet long, has a beam of 53 feet, displacement of about 365 tons, and variable draft ranging from 8 to 12 feet. She is powered by two Deutz MWM 16V- 816CR diesel engines, rated at 1,350 hp each, fitted with Ulstein reduction gears driving Ulstein controllable-pitch, four-bladed propellers. Auxiliary power is provided by two GM 6-71-powered generators rated at 99 kw each. There is a complete spare parts package, including spare engine at additional cost.
FOB Honolulu, Delivery to West Coast Port Available at Additional Cost.

Contact: Marc Vogel, Director, Vogel Equipment LLC • marc@vogelequipment.com
Office: (415) 576-9007 • Cell: (415) 828-2848 • Web: www.VogelEquipment.com

TheGPSStore.com

Automotive ■ Outdoor ■ Marine Electronics

Toll Free 1-800-477-2611 • Check Out Our Weekly Web Specials

Furuno FCV-588 Dual Frequency Fishfinder



Furuno FCV-588
#FU588 **\$1195⁰⁰**

Features RezBoost Technology on a bright, 8.4" color display. A 600/1kW Sonar, RezBoost improves resolution and enhances target separation when paired with a narrowband transducer.

Transducer Sold Separately



Furuno NavNet TZtouch2 Network FURUNO® 12" Combo Chartplotter Fishfinder - Refurbished



Furuno 12" TZtouch2
#FUTZTL12FR **\$2449⁰⁰**

Bright 12" touchscreen display with built-in 56 Channel GPS Receiver and 600w/1kW Dual Frequency RezBoost Fishfinder with Bottom Discrimination and Accu-Fish.

Two-Year Warranty.

Garmin GPSMAP 1242xsv Chartplotter / Sounder



- Sensitive 10Hz GPS/GLONASS Receiver.
- Preloaded BlueChart g2 Charts and LakeVu HD.
- Compatible with g2 Vision HD Charts + LakeVu HD Ultra.
- Dual MicroSD Card Slots.
- WiFi and Bluetooth Wireless Connectivity to compatible Tablet or Smartphone.
- 5000 Waypoints / 100 Routes.
- Built-in Garmin CHIRP sonar, CHIRP ClearVü and CHIRP SideVü scanning sonar and Panoptix™ support.
- QuickDraw Contours.

GPSMAP 1242xsv
without Transducer
#GA0174103

\$2199⁹⁹

GPSMAP 1242xsv
with All-in-One Transducer
#GA0174111

\$2499⁹⁹



NEW LOWER PRICE!

Si-Tex T-760 Radar



Si-Tex T-760 Radar
#SIT760 **\$1459⁰⁰**

Small in Size - Powerful in features. 7" Color LCD Touchscreen, 4kW, 24NM, 18" Radome. Built-in MARPA & AIS tracking. Simple and intuitive interface.



McMurdo SmartFind Plus G5 Cat II EPIRB



McMurdo SmartFind Plus G5 Cat II EPIRB
#MC82800001A2 **\$419⁹⁵**

The McMurdo Smartfind Plus G5 Category 2 EPIRB is a Manual Bracket Emergency Position Indicating Radio Beacon that can send a signal to Search and Rescue with your location with accuracy of less than 62 meters. The G5 offers a Bright, flashing LED light, 6 Year Battery Storage Life and Minimum 48hr continuous operation.

Standard Horizon HX870 VHF with GPS



Standard Horizon HX870
#STHX870 **\$209⁹⁵**

PLUS \$40 MAIL-IN REBATE
until 7/31/18

Floating Handheld VHF Radio with 6 Watts of Transmit power, a built in 66 Channel WAAS GPS receiver with DSC Calling and Water Activated SOS Light.



Icom IC-M506 VHF Radio

Icom IC-M506
Black Case
#IC50601
\$329⁹⁵

Icom IC-M506 AIS
Black Case
#IC50621
\$499⁹⁵



A large dot matrix display, built-in DSC, clear audio and Command Mic IV second station compatibility. The M506 is also available with an integrated AIS receiver and NMEA 0183/2000 Protocols.



PLUS \$50 MAIL-IN REBATE
until 2/28

TheGPSStore.com

Your Best Source for Discount Marine Electronics!



Call for our Latest Catalog!

Or check out **TheGPSStore.com** to see our complete selection of marine electronics from all the major manufacturers.



TheGPSStore.com
Automotive ■ Outdoor ■ Marine Electronics

The GPS Store, Inc.
6899 Beach Drive
Ocean Isle Beach, NC 28469

Same Day Shipping!

Order by 4 PM Eastern

Friendly Customer Service

1-800-477-2611



SECTIONAL BARGES & TUGS FOR LEASE



5 Jones Street, Dubuque, IA 52001
 Office: (563) 583-0556 • Fax: (563) 556-2293
sunflower-enterprises.com



| BARGE DIMENSIONS: |
|--|
| 30' x 10' x 3' 14,000 Lbs: Truck Three Per Load |
| 40' x 8' x 4' 20,000 Lbs: Truck Two Per Load |
| 41' x 10' x 5' 27,000 Lbs: Truck One Per Load |
| 41' x 10' x 7' 35,000 Lbs: Truck One Per Load |



330-660 HP

Deck (Party Barge)

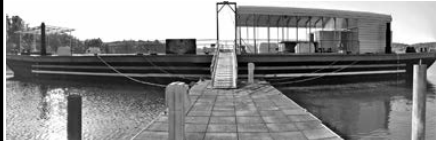

144' x 32'. Wired for generator and shore-power. Two bathrooms, ramp, galley and retractable spuds.

\$150,000.00
 (270) 860-5826

FOR SALE OR CHARTER

Coming Off Charter Feb. 2018

(6) 2017 · 45 x 11.5 x 5
 SECTIONAL SPUD BARGES

(1) 2010 · 25.9 x 16 x 5
 TRUCKABLE TUG

Equipment In Great Condition

251-599-5906

EQUIPMENT

- ✓ TUGS
- ✓ ABS UNRESTRICTED HOPPER BARGES

SERVICES

- ✓ MARINE TRANSPORTATION
- ✓ PROJECT CARGO
- ✓ SHIP ASSISTS
- ✓ ICE BREAKING
- ✓ SALVAGE

OPERATING ON THE GREAT LAKES AND INLAND RIVER SYSTEM

FOR MORE INFORMATION, CONTACT **SETH ANDRIE** AT
 (231) 220-5530 OR SETH@ASHTONTUGS.COM
 OR VISIT ASHTONTUGS.COM

M/V Global Explorer



Brochure and additional pictures available at www.MVGlobalExplorer.tk

- CAMCRAFT complete refit 2016-2017
- Vessel Speed WOT 26.5 Kts @ 2300 rpm
- 115' x 24' x 6'
- Cruise 21 Kts @ 1800 rpm
- 3 decks / 5 cabins / 2 heads
- Range at Cruise 600 Nautical Miles
- Triple CAT 3412 @ 3750 Hp
- Capacity 150 PAX + 6 Crew

Asking \$1,700,000.00 USD

Contact Info: Tel: (321) 454-4185 | Cell: (321) 480-9555 | E-mail: IMSE1@aol.com

CASH MAKER



Old Port 26' - 1990 - Totally Renewed Presently
20 PP+1 Captain - No Deckhand - 4/5 GPH
COI Till 2019 - 77 HP Yanmar
\$85,000 - Text (561) 628-3830

SCRATCH & DENT SALE

High Tensile Galvaluma Steel



100% U.S. Made No Drilling Required

Military Spec. Quonsets SAVE \$\$\$\$

| | | |
|---------|---------|----------|
| 20 x 30 | 40 x 60 | 55 x 120 |
| 25 x 40 | 45 x 72 | 60 x 150 |
| 30 x 50 | 51 x 96 | 70 x 200 |

Archway Steel Buildings
1-800-344-2724
Fax (412) 771-4191

Successful TN Marina
Price: \$2,000,000 • Great Cash Flow









Please Contact: **George Ash**
Marina Investment and Marketing Adviser
ash1@simplymarinas.com
352-262-5784 • www.simplymarinas.com

Jet Boat For Sale



USCG certified 25 passenger. (2) Yanmar 8LV. (2) Hamilton jet drive. Under 400 hours. Comes with trailer.
\$225,000 OBO
Contact Billy (361) 443-4687

J & B BOAT RENTAL LLC
Has Crew Boats, Work Boats, Tug Boats and Living Quarters for Hire.
J & B MANUFACTURING
J & B Manufacturing Builds Work Boats and Crew Boats to Your Specifications
We also have Coast Guard Plans to choose from, tell us what you want and we can build it
Below are a few vessels built by J & B Manufacturing.
You can contact us @ (985) 594-5831 or
Visit our website: www.jbboatrentals.com

VESSELS FOR SALE

150' Aluminum Welded Crew Boat



150' Aluminum Crew Boat with 5 Cummins K19, Very Clean, New COI
65' Aluminum Crew with Cummins Diesel Engines, Clean & Fast, New COI
(4) 50 Aluminum Crew Boats with Cummins Diesel Engines, Clean & Fast, All New COI
68' 3 Level Steel Push Boat, with Cummins Diesel Engines, New COI
(10) Aluminum Deck Boats from 20' - 47'

47' Neuville Crew Boat



COI until 2020 for 22 pass. 2 crew. Twin Cummins 8.3 L Diamond series. 450 HP. ZF 280 A gears. 9 KW Onan. Turn Key. \$190,000
Call (252) 728-9611 • asmith7@ec.rr.com

41' Coast Guard Utility Boat



1975 Twin 903 Cummins Diesel Aluminum hull and decks
Set up for towing
Handyman special
\$50,000.00 USD
(727) 542-3800



OIL PADS
Only \$19.95 Per Bale
Five Stocking Locations
We Have The Best Prices On Oil Absorbents, Booms, Pads and Socks.
800-9-BUYNET
www.buyingnetwork.com

Southern Marine Services Inc.
Email: southernmarineservicesinc@gmail.com
Website: www.Southernmarineservices.com
(321) 536-4855 / (321) 501-5200 / (321) 613-0458
SE HABLA ESPANOL WE WANT YOUR BUSINESS
1980 Built US Flagged Container Ship
295' x 45' x 17'



155 TEU or (62) 40' containers and (31) 20' containers, (20) reefers. New main engine, 2665 HP Man B+W Alpha model installed in 1999. (6) Cargo holds totaling 128,187 Sq. Ft., (2) Caterpillar 400KW Gens. ABS, USCG COI.
Don't Miss The Boat Priced to Sell Quickly!
Located: FL • \$295,000.00 USD

Scully's Customized Boats



MDL 2072VWB, T-Top



MDL 2284VWB, T-Top



MDL 2284DVWB, Cabin, AC5



MDL 2484VWB, T-Top



MDL 2484VWB, Cabin, Survey



MDL 2684DVWB, Cabin

Scully's Constructs Up To 100 Foot Vessels USCG Certified



MDL 2884DVWB, Cabin



MDL 2896BS, T-Top



MDL 3410BV, Cabin



MDL 4012BV, Cabin, AC



MDL 4518 Crane Barge



MDL 2684LC, T-Top

Boats Are Available IN STOCK Up To 40 Feet Long • Mercury, Honda, and Yamaha Packages Also Available
Offers: Jet Drives, Diesel Applications, Shaft Logs Applications
Phone: 1-866-238-8353 • Fax: 1-985-384-5146 • 1015 Stephenville Road • Morgan City, LA 70380
Email: info@scullyboats.com • www.scullyboats.com
Available On GSA Contract

MASTER MECHANIC MARINE™

A Certified Power Business

www.mastermechanicmarine.com

For ALL of your Hydraulic Systems & Components Needs

Thousands of Items in Stock

Se habla español!

TO ORDER CALL: 800-877-8350 ISSUE # BHQ118
OR EMAIL: mmmsales@certifiedpower.com

MASTER DESIGNED GAS & DIESEL POWER UNITS

ALL UNITS IN-STOCK! SHIPS WITHIN 24-48 HOURS!

Power units include: roll cage, engine, pump adapter, love-joy couplings, pump, relief valve, reservoir, return filter, pressure gauge, hose, fittings and battery cage. Optional oil cooler and directional control valves mounted to structure are available upon request. **Power units come assembled and ready to work upon arrival.**

Custom Power Units are also Available!

GAS MODELS

| ITEM # | HP | GPM |
|----------|-------|------------------|
| BH-GX200 | 5.5HP | 11 GPM @ 800PSI |
| BH-GX390 | 13HP | 10 GPM @ 1500PSI |
| BH-GX630 | 20HP | 15 GPM @ 1500PSI |

DIESEL MODELS

| ITEM # | HP | GPM |
|----------|--------|-----------------|
| BH-KD625 | 22.1HP | 20GPM @ 1500PSI |

• IF A HIGHER HP IS REQUIRED PLEASE CALL FOR PRICING!
 • STAND ALONE POWER UNITS ARE AVAILABLE! •

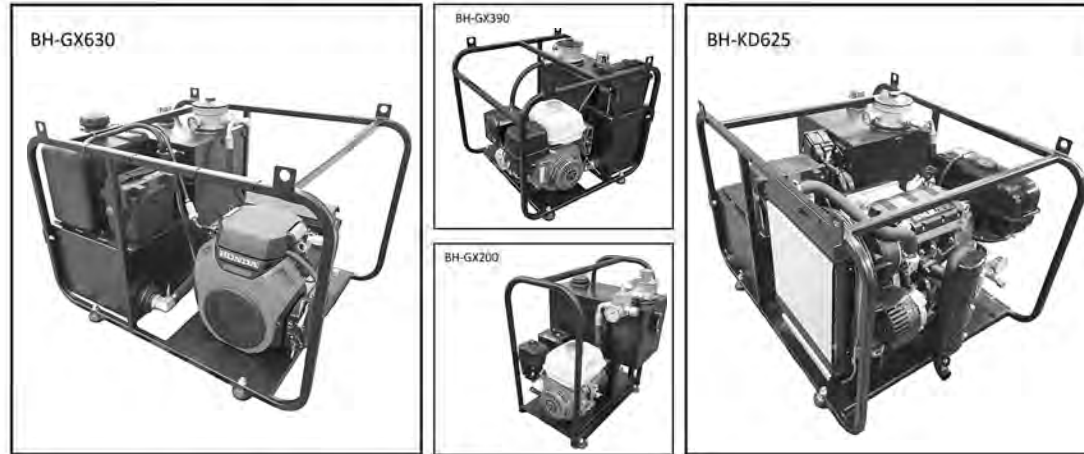

MARINE CLUTCH PUMP KITS

Drive off truck or equipment engines. Drive-shaft or belt driven options.

Clutch pump kits come with: Bi-Rotational Pump, Clutch, Switch and Mounting Bracket.

| ITEM # | MAX PRESSURE | GPM@1200 | GPM@2000 | GPM@3000 | PRICE |
|----------|--------------|----------|----------|----------|----------|
| BH119 | 3000 | 9.6 | 16 | 24.1 | \$429.00 |
| BH119X | 3000 | 12.8 | 21.5 | 32.2 | \$429.00 |
| BH119XX | 3000 | 17 | 26 | 43.4 | \$589.00 |
| BH119XXX | 3000 | 23 | 34.8 | N/A | \$729.00 |



STAINLESS STEEL BOOM WINCHES, PLANETARY WINCHES & ANCHOR HOISTS

Planetary winches can hold up to 300 ft. of 1/2" cable.

Boom winches hold up to 230 ft. 5/16" cable.

| ITEM # | MAX CONT. FLOW | LINE PULL | MAX LINE SPEED | PRICE |
|--------------|----------------|------------|----------------|------------|
| BHPSVH-10000 | 15.9 GPM | 10,000 LBS | 46 FPM | \$1,200.00 |
| BHPSVH-15000 | 15.9 GPM | 15,000 LBS | 30 FPM | \$1,575.00 |
| BHPSVH-18000 | 15.9 GPM | 18,000 LBS | 23 FPM | \$1,826.00 |



| ITEM # | DESC. | RPM @ RATED FLOW | LINE PULL | PRICE |
|--------|--------------|------------------|-----------|----------|
| BH1008 | ANCHOR HOIST | 300RPM @ 12GPM | 900 LBS | \$795.00 |

HYDRAULIC VALVES

Perfect for operating winches, cylinders, reels, pot haulers and more.

Gresen SPW4 Rotary Spool



SS Rotary Spool Valve



SS Rotary Spool Valve



Hydraulic Control Valve



Hydraulic Control Valve (Spring to Neutral)



Hydraulic Control Valve (Power Beyond)



2-Spool Hydraulic Control Valve (Power Beyond)



3-Spool Hydraulic Control Valve (Power Beyond)



Flow Control Valve

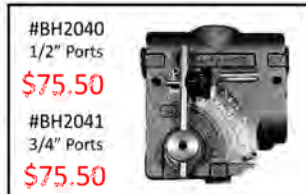

Gresen Selector Valve



Cushion Valve



LOW SPEED, HIGH TORQUE HYDRAULIC MOTORS

Master Mechanic Marine provides you with today's leading manufactured hydraulic motors. **NO TAG? NO PROBLEM!**

Our hydraulic specialists can get you a replacement motor with little dimensional data from your motor. (Imports are available).

PRICES STARTING AT\$239.00

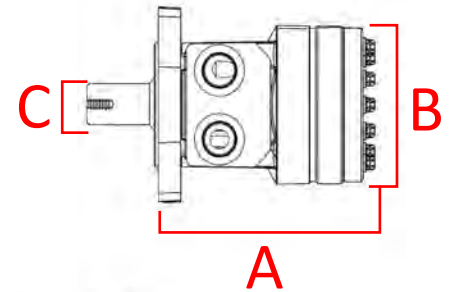

VANE PUMPS

GRESEN TC24, TB12, V10, V20, 25VQ & VTM42

- 500 PSI - 3000 PSI
- 3 GPM - 55 GPM
- Up to 3,000 RPM
- Straight Key Shafts
- Splined Shafts

| ITEM # | PRICE |
|--------|----------|
| V10 | \$233.23 |
| V20 | \$250.79 |
| VTM42 | \$325.99 |
| TB12 | \$429.78 |
| TC24 | \$489.50 |



POT HAULERS - 8", 10", 12", 14", 17"

- Completely Stainless Steel Options
- Top-Performing Hydraulic Motors
- Higher Speed or Higher Torque Options
- Line Speeds from 275-350 ft/min.
- Line Pulls from 310-1750 lbs.



PRICES STARTING AT.....\$699.00

HYDRAULIC HOSE AND FITTINGS

All lengths, sizes, hose ends and adapters available.

| LENGTH | SIZE | HOSE ENDS | PRICE |
|--------|------|------------------|----------|
| 15' | 1/2" | Male Pipe Swivel | \$61.42 |
| 20' | 1/2" | Male Pipe Swivel | \$73.92 |
| 30' | 1/2" | Male Pipe Swivel | \$101.52 |
| 50' | 1/2" | Male Pipe Swivel | \$153.92 |
| 15' | 3/4" | Male Pipe Swivel | \$96.74 |
| 20' | 3/4" | Male Pipe Swivel | \$116.24 |
| 30' | 3/4" | Male Pipe Swivel | \$155.24 |
| 50' | 3/4" | Male Pipe Swivel | \$233.24 |
| 15' | 1" | Male Pipe Swivel | \$149.74 |
| 20' | 1" | Male Pipe Swivel | \$179.84 |
| 30' | 1" | Male Pipe Swivel | \$240.04 |
| 50' | 1" | Male Pipe Swivel | \$360.44 |

Hydraulic Cylinder Special

Types of Cylinders: Tie-Rod and Welded • ALL sizes available!
 Application Examples: Steering, A-Frames, Log Splitters



| BORE | STROKE | PRICE |
|------|--------|-------|
| 3 | 8 | \$100 |
| 3 | 10 | \$115 |
| 3 | 12 | \$120 |
| 4 | 8 | \$130 |
| 4 | 10 | \$143 |
| 4 | 12 | \$158 |
| 2.5 | 8 | \$79 |
| 2.5 | 10 | \$89 |
| 2.5 | 12 | \$103 |



JOHNSON DIESEL SERVICE

Dealer for Cummins, Detroit, & Volvo Marine & Industrial Engines, Power Units and Generator sets. New, exchanges and used engines. We carry exchange and new Twin Disc and ZF Marine transmission and all parts necessary for overhaul's.

Phone (228) 392-1311 Fax (228) 392-0096

Email: johnsondiesel@cableone.net • Website: JohnsonDiesel.com



The World's Safest Underwater Cleaning System

Welcome to the Next Level In Underwater Cleaning Efficiency... CaviBlaster!



BEST SELLER

- ✓ Easy to Set Up and Use
- ✓ Gas, Diesel or Electric
- ✓ Cleans All Surfaces
- ✓ Fresh or Sea Water
- ✓ Compact, Easy to Transport

CaviBlaster-1228-G for Rent or Sale

For more information please email sales@cavidyne.com

Or Call Us at (352) 275-5319, Sarasota, FL 34234

visit www.cavidyne.com to see more products



CS Marine Constructors Inc.

CS MARINE CONSTRUCTORS, INC.
425 15TH Street Vallejo, CA 94592
WWW.CSMARINE.COM

Rental/Services: Mark@csmarine.com
Sales: Terry@csmarine.com
(707) 562-4100

Barges for Charter

- Hopper Barge 3000 Ton
- Jackup Barge, Portable
- Spud Barges
- Deck Barges

Services

- Dockside Mobilization
- Floating Crane Service



Equipment for Rent

- Anchors
- Buoys
- Fairleads
- Ramps, Fenders
- Concrete Buckets
- Bardex Jacking System

For Sale - Good running 2900 Manitowoc Truck Crane, outriggers bad, makes good pedestal mount \$15K



For Sale

5 yd
Escob
Digging
Bucket
\$25,000



For Sale - 18 Ton Drott Hyd. Crane.....\$10K



ISLAND WIDE MARINE INSURANCE

Superior Service Since 1977

CUSTOMIZED POLICIES

Designed Specifically For:

- Passenger Vessels**
- Sightseeing - Dinner Cruise**
- Headboats - 6 Packs - Ferry**
- Dolphin - Whale Watch**

FEATURING:

- ★ **Basic & Enhanced Policies**
- ★ **Competitive Pricing**
- ★ **Easy Payment Terms**
- ★ **Discounts For Seasonal Operations**



Marine Insurance is Our ONLY Business
1-800-635-6097

110' x 34' 1943 STEEL • EX-NAVY REPAIR BARGE



All steel construction Appears to be in Very Good or better condition throughout! CLEAN: Used for Electronics repair. 96' two-story house w/ 7' 2" ceiling height. 7' open deck at each end. Approx. 3,250 sq. ft. on each of two decks & below main deck which has refrigerated storage & water integral tank approx. 2500 gal. Fully plumbed w/heads & showers on 2 decks, 500 cu. ft. holding tank. Fully MODERNIZED electrical w/480/240/110 shore power & transformers. Fire suppression sys., Fiber optic wired thruout, vapor proof DOANE lighting. No propulsion or gen set. All interior walls on upper decks removed, totally open space ready for your EASY reconfiguration. Perfect conv. to camp, quarters barge, shops, display, retail, floating residence, etc. Loc. in fresh water at Seattle, WA.

\$249,500.00

ALL Details • Photos: www.PacificMarine.org
Email: david@pacificmarine.org • (206) 225-3360



Tug & Barge Service Coastal Towing

Servicing East Coast
Inland and Offshore Tugs / ASD Pushboats
350 - 2,400HP
Equipment For Sale / Rent • Barges For Rent

Contact: info@burnhammarine.com
(978) 745-1788 • burnhammarine.com

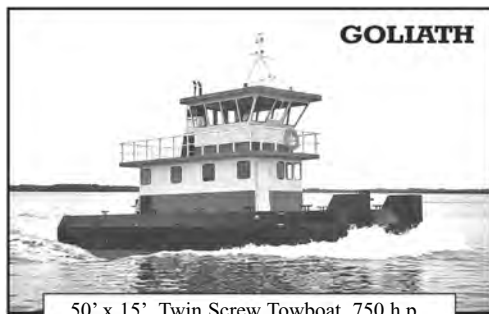

50' x 15', Twin Screw Towboat, 750 h.p., 5:1 Gears, 46" Props, 20 K.W. Gen.



25.5' x 14', Twin Screw Towboat, 450 h.p., with Deckhouse, 3.5' Draft.



25.5' x 14', Twin Screw Towboat, 450 h.p., 3.5' Draft.

AMERICA'S PREMIER TRUCKABLE BOAT BUILDER

IS OFFERING SUPERIOR BOATS AT PRICES LOWER THAN YOU'VE SEEN IN YEARS



FULLY EQUIPPED

THIS BOAT AND OTHER MODELS ARE IN STOCK FOR DELIVERY TODAY!



25.5' x 12', Single Screw Towboat, 225 h.p., Flanking Rudders.

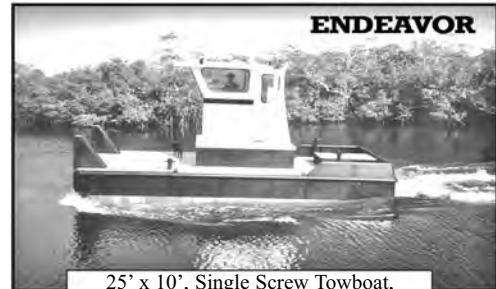

25' x 10', Single Screw Towboat, 225 h.p., Flanking Rudders.

Just Turn the Key. Everything is Included.

- Towing Bitt and Four Cleats
- Running Lights
- Lockable Pilot House and Engine Room
- Non-skid Deck
- Engine Room and Pilot House Lights
- Opening Front Window in Pilot House
- Coolant Tanks with Level Indicators
- Large-Capacity Fuel Tank
- Full Instrumentation
- 1200 G.P.M Bilge Pump



BORN TOUGH



PROGRESSIVE INDUSTRIAL, INC.
PALMETTO, FL

(941) 723-0201

PUSHBOATS-BARGES.COM

Sectional Barges
8' x 20' to 15' x 60' per section pin together to form as large a platform as needed.

Fast Delivery!
Call Now for a Quote!

PHASOR MARINE

Powered By Kubota

Phasor Marine, has begun delivering EPA Tier IV compliant marine generators. These machines are not utilizing EPA flex credit engines as are other marine generator manufacturers, which is illegal. The Kubota diesel engines utilized by **Phasor** are either Tier IV Final or EPA Tier IV Marine Certified up to and including the K4-30.0 kw model. All standard machines continue to utilize the Kubota or John Deere diesel engines coupled to the electrical ends. These engines approved for use with Bio-Diesel B5. New for the 2014 model year are two Ignition Protection Certified models rated at 4.5 kw and 7.0 kw operating at 1800 rpm. These machines are certified for use in gasoline powered boats. All **Phasor's** continue to offer a 5 year limited warranty.



K3 - 9.5 KW

Kubota
WE SHIP GENERATORS WORLDWIDE

Standard Equipment: 1800 RPM Sets

- Kubota or John Deere Diesel Engine
- Single Bearing Generator With Epoxy Coated Stator Windings
- ± 1% Solid-State Voltage Regulation
- Low 1,800 RPM Operating Speed
- Four Point Isolation Mounts
- Automatic Low Oil Pressure and High Water Temperature Safety Shutdown Systems
- Fresh Water Heat Exchanger Cooling
- Water Cooled Manifold and Stainless Steel Exhaust Elbow
- Direct Driven raw Water Pump
- Spin On Fuel Filter
- Electric Fuel Transfer Pump
- Toggle Switch Start with Preheat, Start, Run, & Stop Positions
- Awl-Craft 2000 Urethane Finish
- Oil Drain Valve
- Zinc Anode in Heat Exchanger
- Air Intake Silencer
- Spin On Oil Filter
- 5 Year Limited Warranty

BOATS & HARBORS SPECIALS

| MODEL | PRICE | MODEL | PRICE |
|---------------|-------------|--------------|-------------|
| K2 - 4.5 IPC | \$ 7,518.00 | K4 - 12.5 KW | \$11,829.00 |
| K3 - 7.0 IPC | 9,011.00 | K4 - 15.0 KW | 12,458.00 |
| K3 - 6.5 KWC | 8,436.00 | K4 - 17.5 KW | 13,572.00 |
| K3 - 7.0 KW | 8,642.00 | K4 - 21.0 KW | 14,685.00 |
| K3 - 8.0 KWC | 9,161.00 | K4 - 30.0 KW | 20,160.00 |
| K3 - 8.5 KW | 8,998.00 | K4 - 34.0 KW | 22,234.00 |
| K3 - 9.5 KW | 9,986.00 | J4 - 65.0 KW | 32,367.00 |
| K3 - 10.0 KWC | 10,679.00 | J4 - 80.0 KW | 40,688.00 |
| K4 - 12.0 KWC | 11,954.00 | J4 - 99.0 KW | 41,187.00 |

SOUTHEASTERN POWER PRODUCTS

2880 Hammondville Road,
Pompano Beach, FL 33069
Phone: (954) 979-5899
Fax: (954) 979-4349

www.phasormarine.com

Prices and Specifications Subject to Change

www.Sightseerboats.com

Quality and Affordability

All Boats Built To USCG Partially Protected Criteria
Eco-Tour, City Tour, Party Cruise, Water Taxi's Boats
30', 35', 40', 45' & 50' Lengths x 10, 12, 13 & 14 Ft. Widths



All Aluminum Construction Means Lower Operational Costs & Requires Smaller HP Motors.
Up to 49 Passenger • Multiple Route COI's Available

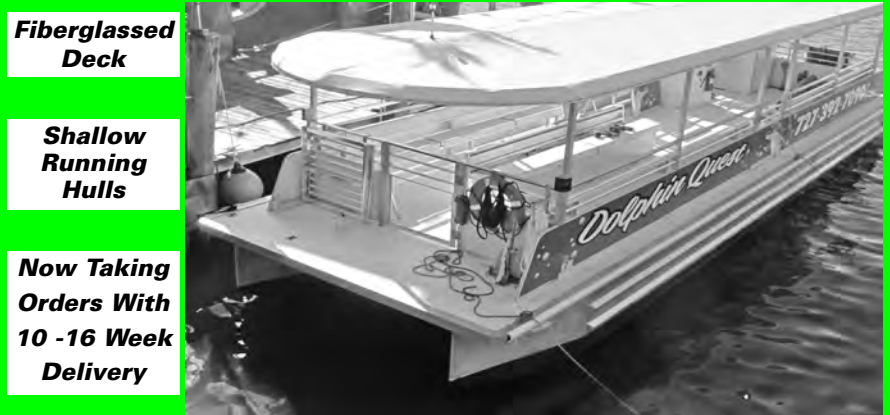

Fiberglassed Deck

Shallow Running Hulls

Now Taking Orders With 10 -16 Week Delivery



40' • 42 Passenger 35' • 36 Passenger

"V" Bottomed Catamaran Hulls
FACTORY DIRECT SERVICE & PRICING
BUILT TO MEET YOUR SPECIFIC APPLICATION & SITUATION
Full Turnkey Boats Starting Under \$100K
Call to Discuss Your Project & For Free Quotation

727.856.6900

BUYING OR SELLING?

New & pre-owned vessels, Pinnacle Marine Corporation can help.



Majestic Princess 131 Passenger Yacht



Mystere 88 Passenger Yacht



Black-Eyed Susan 149 Pass. Sternwheeler



Lil Diamond III 149 Passenger Catamaran

PINNACLE MARINE CORPORATION

We are the only brokerage service specializing in the passenger vessel industry. We also provide assistance locating financing, vessel transportation, securing insurance, marketing and business consulting, and auction services.

608-788-3210 • email: info@pinnaclemarine.com • www.pinnaclemarine.com

JEMISON MARINE SHIPYARD

New Constructions,
Repairs And Conversions

(NEW) BOATS FOR SALE

251-824-7878 • 251-824-4575 (Fax)
9315 Little River Rd • PO Box 645
Bayou La Batre, Alabama 36509

Contact: **Tim Jemison**
website: www.jemisonmarine.com

NEW FLUSH HATCHES

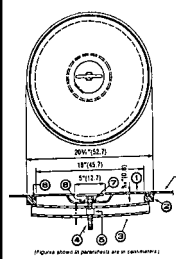

| PIECE NUMBER | NAME | MATERIAL |
|--------------|----------------|-----------------|
| 1 | COVER ASSEMBLY | MILD STEEL |
| 2 | DECK RING | MILD STEEL |
| 3 | STRONG BACK | MILD STEEL |
| 4 | TEE HANDLE | STAINLESS STEEL |
| 5 | NUT | BRASS |
| 6 | GASKET | NEOPRENE |
| 7 | WASHER | BRASS |
| 8 | WASHER | NEOPRENE |

PRICE ON REQUEST

NEW 18" & 24" HATCH COVERS



Flush mounting watertight hatch with machined steel mounting ring. T-handle is recessed and hand tightens against a strongback across mounting ring: 18" 90lbs. - 24" 120lbs.

6-Dog Watertight ABS Steel Doors

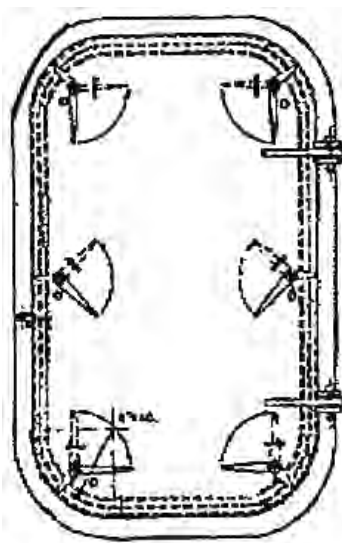

1/4" Panel
5/16" Frame
Righthand & Lefthand
Clear Opening Sizes:
26 x 60
30 x 60
30 x 66
30 x 72
Available in either Manual or Quick-Acting Operation (4-Dog doors also available)
Other sizes available by special order.



NEW 7" RADIUS PANAMA CHOCKS

(Meet Panama regulations)
14" x 10" CLEAR OPENING
With extended legs for welding to deck.
14" Wide on base - 28" Length - 27-1/4" High
In Stock Immediate • Delivery

FACTORY NEW - SIZE 15x23 RAISED BOLTED PLATE MAN HOLE OR TANK TOP COVER

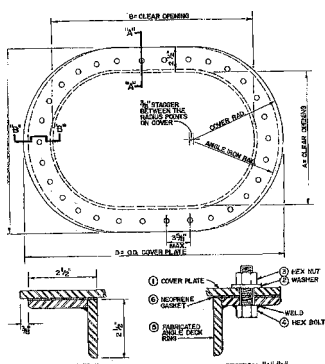

1/2" Thick-Cover 3/8" Thick Coaming 2-1/2" High Overall dims. of cover 20" x 28-3/4" Overlap for lifting No handles necessary



NEW 15" x 23" TANK TOP COVERS

3/8" COVER & 3/4" DECK RING
Complete with Neoprene Gasket w/Brass Washers & S.S. Nuts 20 Bolts - Wt. 95 lbs.



24"- 36"- 48" KEVEL CHOCKS

4-DOG GENERAL PURPOSE 15" x 23" x 5" HATCH

ALSO AVAILABLE

Open and Closed Chocks
Single and Double Bitts
All types of Marine Equipment

POLI MARITIME

(formerly of Maritime Power Corporation) 79 West 33rd Street, Bayonne, New Jersey 07002
PHONE: (201) 243-6387 • (201) 858-2675 • Fax: (888)491-4731 • Email: claire@polimaritime.com



Turnbuckles

Qty 24 | Crosby 2.5 in x 24 in Eye & Jaw | \$750 ea
 Qty 12 | Crosby 2 in x 24 in Jaw & Jaw | \$475 ea
 Qty 18 | Crosby 2 in x 24 in Eye & Eye | \$500 ea
 Qty 24 | Crosby 1 in x 24 in Eye & Eye | \$100 ea



Steamboat Ratchets

Qty 6 | 20 ton | 42 in Barrel | \$600 ea
 Qty 4 | 20 ton | 30 in Barrel | \$500 ea
 Qty 14 | 20 ton | 24 in Barrel | \$500 ea
 Qty 14 | 20 ton | 18 in Barrel | \$450 ea



Heavy Duty Marine Deck Mount Fairleads

Qty 5 | Appleton Marine SF-38-2.25
 2.25 in Rope Groove | Very Good Condition
 Harrison, OH, USA | \$18,750 ea



Manitowoc 4100W S-II Crawler and X-Tender
 For sale | Used | Gulf Coast, USA

X-TENDER



Clyde Frame 6 27262
 2,150 ft of 7/8 in rope
 36,000 lbs SLP
 For Sale | Used



Clyde Frame 6 26862
 2,150 ft of 7/8 in rope
 36,000 lbs SLP
 For Sale | Used



The Powerful Solutions People!

TOLL-FREE 866.883.7221 | WORLD-WIDE 513.202.8901
 bhsales@fmmafco.com | www.fmmafco.com

Winches

AVAILABLE NOW



Manitowoc 4100 S-II Crawler and X-Tender
 For sale | Used | Gulf Coast, USA



Skagit G160 MAF2581
 2,640 ft of 1-1/2 in wire rope
 165,000 lbs SLP
 For Sale | Used

FMM169

65' Paddle Wheel



1983 • Beam: 24'
Hull Material: Steel 3/16
Annabelle Lee with Single Engine
150HP John Deere Diesel Engine 1998 I6
Onan 16.0 KW Diesel Generator
Fuel Capacity: 100 US Gallons
Builder: Joilet Boat Builder
Displacement: 65GRT 52 NET
Passengers: 122



info@stjohnsms.com • (386) 626-3364



COOPERCAPITAL
 SPECIALTY SALVAGE, LLC

www.cooperss.com



2013 90' New World Yacht Builders
 CAT C18 Acert's 454hp.
 Saltwater damage. -WA



Great opportunity to re-fit a large expedition style yacht. 11 knot max speed and 4000 mile range at 9.5 knots. Stabilized, fully loaded 147 LT. Northern Marine NA designed boat and interior. Fully customized displacement Cruiser with very gracious headroom, passageway width storage throughout. Guest accommodations for 8 including owner's suite.



Licensed, FL Yacht & Ship Sales Person

119' x 34' Army LCU Landing Craft



180 Ton Deck Capacity w/ 5' Draft
Hauled 2015 New Shafts/Props
\$795,000 w/ Partial Trade for LCM-8
California Delta
(415) 686-0907 • John

Acadian
Allison Marine Gear Specialist
Marine Transmission & Electrical
217 Burgess Dr., Broussard, LA 70518
PH: (337) 837-3636
Fax: (337) 837-3633
www.acadianmarinetransmission.com

Repair / Exchange / Outright
Allison M & MH Transmissions
M, MH, Twin & Quad Units
Repair / Parts
Twin Disc & ZF Transmissions
Repair / Exchange
New Hydreco Pump & Eaton Pumps



"They build a good product."

"The camaraderie of the yard workers at Gladding-Hearn makes you feel that you're part of the team, not just an outsider. They include you in decisions, and when you ask a question, you get an answer; there's no hidden agenda. They build a good product."

Frederic "Skip" Scudder, President
Hyannis Harbor Tours, Dba Hy-Line Cruises

Gladding-Hearn all-aluminum construction, Incat Crowther design, LOA 154', beam 35', draft 8', 493 passengers, top speed 34+ knots. It takes experience to integrate custom details and guaranteed performance, backed by dependable customer service. All at a price you can afford.

If you are looking to build a new boat or upgrade an old one, we can offer complete design and construction, from port security vessels and pilot boats to high-speed ferries. To learn more call Peter Duclos at 508 676-8596 or visit: www.gladding-hearn.com.

GLADDING-HEARN
SHIPBUILDING
Duclos Corporation



INCINOLET® electric incinerating toilets

PROBLEM SOLVED!

Need a toilet in "no discharge" zones?

For boat or dock, home or cabin – INCINOLET, your best solution!

SIMPLE to install, maintain.
120 or 240 volts

US Coast Guard Certified

ULTRA CLEAN: waste reduced to sterile ash. As little as a cupful weekly. Dump in garbage.

TOP QUALITY: stainless steel, platinum odor control, quality controls assure long life.



1-800-527-5551
www.incinolet.com

RESEARCH PRODUCTS/Blankenship • 2639 Andjon • Dallas, TX 75220

Standard 12' Aluminum Gangways
\$2200.00 • 12' x 30"

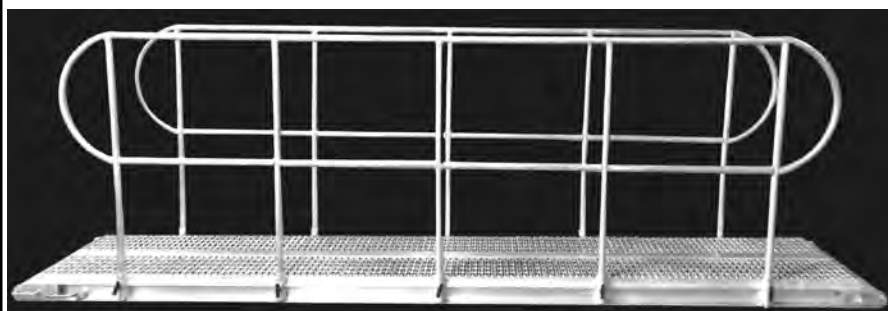

Grip Strut Grating • Removable Handrails
Handles and Retractable Wheels for easy one man use
Contact for more information and pics:
bwyble@sup-us.com / 409-985-2448
Sabine Universal Products, Port Arthur, TX



VISIT OUR SHIPYARD
ORANGE, TEXAS

CALL (409) 988-0005
for SPECS OR QUOTE
www.inlandboats.com
Email:
inlandboatworks@gmail.com

The ORIGINAL
Truckable Boat Builders

CUSTOM BUILT PUSHBOATS AND
DECK BARGES YOUR DESIGN OR OURS

STANDARD MODELS • CONTINUOUS PRODUCTION OVER 45 YEARS BUILDING BOATS & BARGES



MODEL 2516
25'9" x 16'0" x 5'6"
650-750 H.P. Twin Engine



MODEL 2510
25'9" x 10'0" x 4'0"
200 H.P. Single Engine



MODEL 2512
25'9" x 12'0" x 4'6"
400 H.P. Twin Engine



MODEL 2514
25'9" x 14'0" x 4'6"
600 H.P. Twin Engine



DECK BARGES
120'0" x 30' 0" x 7'0"
Double or Single Rake



MODEL 2520
25'9" x 20'0" x 6'0"
750 H.P. Twin Engine



NEW MODEL
MODEL 2523 with Quarters
25'9" x 23'0" x 6'8"
1125 H.P. Triple Engine



MODEL 2520 with Quarters
25'9" x 20'0" x 6'0"
750 H.P. Twin Engine

NEW ENGINES WITH FACTORY WARRANTY
JOHN DEERE & CUMMINS TIER III COMPLIANT
EXTENDED WARRANTY AVAILABLE

NEW TWIN DISC TRANSMISSIONS
AQUAMET 17 PROPELLER SHAFTS
NEW BRONZE 4-BLADE PROPS
HEAVY DUTY QUALITY CONSTRUCTION

Questions to ask before ordering your sectional barge:

1. Will my barge be designed by experienced engineers?
2. Will my barge be built to my exact requirements?
3. Will my complete satisfaction be guaranteed?

If it's important that the answer to these questions is "YES", then contact us at:

RPS Barge Co.

Built to your requirements.
Built to last. Guaranteed.

877-826-2617 502-747-5540

www.rpsbarge.com

bill@rpsbarge.com



Specify PITTS Heavy Duty Electric Clutches & Mounts

Adaptable, Dependable... Easy to Install & Maintain
SHAFT OR V-BELT DRIVEN MARINE CLUTCHES

- 75 to 1500 lbs - ft • 12 or 24 VDC power supply • Compact
- Zinc plated-meets ASTM B-117 salt spray test
- SAE pump mount-several options available

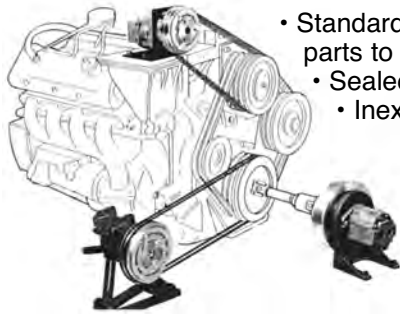

- Standard drive shaft flange input requires fewer parts to connect to drive train
- Sealed bearings-no lubrication required
- Inexpensive

PITTS

The Clutch People
Distributed/Represented
in Canada and the East Coast by:

Coastal Hydraulics

28 Route 286, Seabrook, NH 03874
(603) 474-1914 • FAX (603) 474-1902



Southern Marine Services Inc.

Email: southernmarineservicesinc@gmail.com

Website: www.Southernmarineservices.com

(321) 536-4855 / (321) 501-5200

SE HABLA ESPANOL



WE WANT YOUR BUSINESS

FOR SALE: 2 HIGH SPEED PASS FERRIES CATS



All Alum. Construction Fjellstrand • 1990 Cadillac Vessels • 132' x 32' x 6' Loaded
Great for Island Service • 282 Pass • Speed 25-36 Kts. • Jets • Zero Hrs. on Engines
Totally Rebuilt DNV Classed • Have Crew Will Travel

These Two Vessels Are The Best Deal on the Market

ONLY \$595,000 Each

Located USA East Coast • See Our Web Site



CONSOLIDATED SHIP REPAIR & MARINE FABRICATION

SALES@CSRTX.COM
(281) 740-1340

We Are Located Just 200-ft Off The Texas Ship Channel In
Port Arthur TX And Offer:

- Deep Water Access • 24 Hour Service
- USCG & ABS Certified Welders
- Vessel & Barge Fleeting
- Certified Crane Operators And Crane Service 24/7
- Heavy Crane Service
- 3,200' of Dock Space
- 7,000' of Water Front Access
- 50,000 Sq-Ft Fabrication Shop





1-800-960-0068 CALL TODAY!
 2845 Hwy 311, Schriever, LA 70395
www.mlengine.com sales@mlengine.com

Gas Inboard / Mud boat Power train
 Up to 44 Horsepower!
 Electronic Fuel Injection
 ZF Transmission
 Air Cooled



KOHLER engines **ZF**

Marine Diesel Generators
 6kW up to 200kW
 Keel Cooled
 Heat Exchanger Cooled

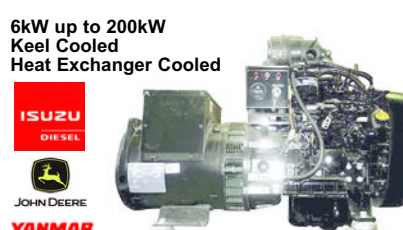

ISUZU DIESEL
JOHN DEERE
YANMAR

Gas and Diesel Pumps
 2" - 48" Pumps
 Skid Mounted
 Trailer Mounted
 Dry Prime
 Wet Prime



YANMAR
KOHLER
CORNELL
LoLift
GR
PUMPS

Packaged Generators
 6kW up to 800kW
 Sound Enclosures
 Fuel Tanks
 Trailer Mounted
 Panels and Accessories



YANMAR
KOHLER
kwjet
GILLETTE GENERATORS

Replacement Engines
 Tier 2 Mechanical in Stock!
 Tier 3 & Tier 4 Available



ISUZU DIESEL
JOHN DEERE
YANMAR **KOHLER**

Pressure Washers



FAT
KOHLER
YANMAR
 Heavy Duty Diesel and Electric

Generator Alternator Ends



MARATHON ELECTRIC
STAMFORD
meccalte

Custom Power Units
 6hp up to 400hp
 Diesel
 Natural Gas
 Gasoline
 Propane
 Accessories



ISUZU DIESEL
YANMAR **KOHLER**

PRICE MATCH GUARANTEE
 We will match or beat any competitors



FOR RENT

FLEXIFLOAT JACK-UP BARGE
 - Truckable, Maximum 100 Ton Crane
TUGS
HIGH SPEED CREW BOAT
CRANES
OTHER MISC. EQUIPMENT



Contact Stan Andrie At: (231) 332-9227 Or srandrie@andrie.com
www.andrietg.com

2002 50' EVANS
 Twin 3196 Cats 660 HP each. Twin Disc, 1,500 hrs since rebuild. 10.5 Westerbeke Generator, Northstar Loran, Ray Marine radar, 2 VHF, autopilot, large salon. 6 bunks. 600 gallon fuel tank. Well maintained.



Asking \$239,900
 Call Rick (609) 425-0391
missandreasportfishing.com

WEEKS MARINE

W18
 110 X 34 X 11'
 Deck Barge

Location: Hawaii
 Asking: \$110,000



W68
 105 X 70 X 12'
 Deck Barge

Location: Hawaii
 Asking: \$150,000



W33
 120 X 30 X 7'
 Deck Barge

Location: Hawaii
 Asking: \$95,000

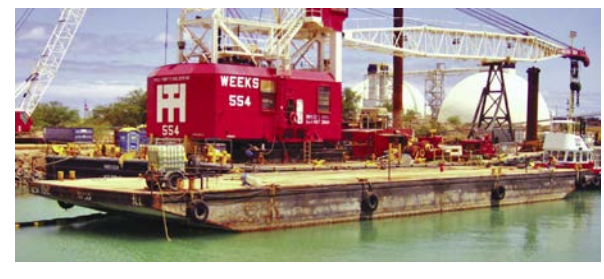

W190
 190 X 54 X 11'
 Deck Barge

Location: Hawaii
 Asking: \$75,000



W40
 106 X 26 X 8'
 Deck Barge

Location: Hawaii
 Asking: \$85,000



W538
 160 X 50 X 12'
 Floating Crane

Location: Hawaii
 Asking: \$1.25 M



Please visit our website to view more equipment for sale.

Boats & Harbors

CLASSIFIEDS

Experience
The Selling Power of The
Yellow Sheet!Place Your Ad (931) 484-8708 or Email: Tlewis@boats-and-harbors.com • Fax: (931) 456-2337 • Submit Online: www.boats-and-harbors.com

★ BOATS FOR SALE

'85 TORRES 43' SF, single 12V71 turbo, equipped for charter fishing. Boat, or boat and business. (727) 403-6714 or (727) 441-9084

50'x15' CUSTOM BUILT Fiberglass Tri-toon workboat, 1.5' draft (operates in 2' of water), (2) 20' L spuds, (2) 12,000 lb. 12 volt (Ramsey) winches, (1) IMT 2.5 knuckle boom crane (2,800 lb. max), (2) 70 hp. Suzuki outboards (480 hrs.), hydraulic steering, radar, GPS, VHS, head, storage closet, cuddly cabin. Was used for commercial diving. Asking \$60,000. Seadrift, TX. (361) 920-0585

180x52 CENTER ISLAND CAR FERRY, built 1956. 2x 12V149's with 10K hours. Located Florida. \$100K. Call: (386) 937-4902

1971 40' TD VINETTE Steel Cabin Cruiser, twin Perkins diesels. \$30K. Call (715) 779-9581.

1984 WILLARD 50 FT NAVY Utility Boat, 671 Detroit Diesel engine, Serial: 50UB847. Engine shows 48 hours and has been started and checks out good. Asking \$20,000 OBO. (270) 535-2886
ebogle4@gmail.com

30 PASSENGER US Coast Guard certified tour boat for sale. 35x10 Sightseer 6 years old. Available immediately; 2 yr old triple axle trailer included. \$110,000. Contact Shelly @ Punta Gorda Marina (941) 639-2750.

32' LUHRS GILLNETTER 1974, twin Yanmar diesels 4LHDE 9,000 hrs. All electronics and safety gear. Turnkey, \$15,000. Freeport, NY. (516) 705-6148

OPPORTUNITY KNOCKS: Advertising your vessels or equipment in Boats and Harbors will put your business ahead of the game! With Both Print and Online Editions Boats and Harbors can place your classified ad in front of thousands of loyal buyers. Call Now 931-484-6100 or
Email: tlewis@boats-and-harbors.com

34' GLEN MARINE Union Jack Trawler, steel hull, 11'6" beam, 70 HP Westerbeke, ZF gear, transport trailer, located MT. Asking \$40K. More info, call Jim (406) 207-0902.

35FT FG LOW CAT HR, needs cabin cosm. Very good shape otherwise. Reduced from \$35K to \$27K. (843) 385-2301

36' LCVF 1965 FG 671. \$2,000. (415) 601-7858

37' ENSEN MONTAUK Charter Boat, 1977, fiberglass hull, 3208 Cat, 310 hp, 9,000 hours, fighting chair, hard top, some electronics. \$32,000. Call (631) 668-5275.

37' FIBERGLASS FISHING BOAT, Detroit 471N, all safety up to date, Furuno electronics. \$27,000. Call (813) 361-4403

38 FT DELTA, 12 FT Wide. Has twin 220 John Deere with around 8,000 hrs. Boat is in process of over haul. Has two new fuel tanks and all deck beams are in. Boat needs to be finished. \$25,000 OBO. Email or text for pics. Cell (609) 675-0384
lobsterboy17@icloud.com

38' CHRIS CRAFT Commander, 1972 Sedan, fiberglass. Twin 454's. Fully equipped & operational. Lake Superior, Michigan, boat \$25,000.
nomadrh@chartermi.net

45' HATTERAS SPORTS FISHING 1969, 41 years of updates and maintenance. Great condition, runs great. Many above and under water modifications. She is loaded with many extras. This boat is nearly bullet proof. Must be seen to appreciate. \$69K. (561) 747-7733

48 PASSENGER TOUR BOAT, in operation now, twin outboards for sale. Palm Beach. (561) 723-2028

50 EVANS Inspected Vessel Plus All Commercial Gear. Net reel and a wide variety of nets. Great condition. Low hours. Recent survey on file. \$500K. Call (252) 453-9500.

55'x16' STEEL DOUBLE RIG Freezer Trawler with brine tank, new Simrad electronics with Autopilot. Federal shrimp permit included. \$110K. (985) 226-2467

65'x22' 2014 SKIPPERLINER Passenger Vessel Sub Chapter T, USCG inspected and certified for 120 passengers. Two 305 HP Cummins engines, Konrad outdrives, generator is a Cummins, Onan 32 kilowatts. Dinner cruise vessel with open main cabin, open wet bar area forward open seating in main salon. Galley aft with a pass through to the main salon. Enclosed half bath to port and a handicap accessible bath to Stbd. Open upper deck with steel framework for canvas cover over forward end of the deck including Eisenglass for protection against inclement weather. Wet bar on upper deck. Excellent condition. For details
Email: skipperlinervesselinfo@gmail.com

ALUMINUM WORKBOATS & Landing Crafts. Custom designed to your specifications & requirements. Call for more information. (860) 526-2227

26'x8' CUSTOM BUILT fiberglass catamaran (Bayliner hull) alum. cuddly cabin, hydraulic steering, jack plate, (1) 200 hp. Evinrude e-tec. outboard, 40 gal. alum. fuel tank, custom built alum. trailer, radar, GPS, VHS. Asking \$35,000. Seadrift, TX. (361) 920-0585

34' UNIFLITE GEOLOGICAL Survey Boat, 3208T Caterpillar diesel engine, 255 HP, 9 beam. \$18,000 OBO. Eddie Bogle (270) 535-2886
ebogle4@gmail.com

BOSTON WHALER, Commercial, foam collared 21', Mercury Optimax 225, <200 hrs on powerhead, aluminum double axle trailer. Located Long Island, NY.
BERTRAMP1@aol.com

BREAUX CREWBOATS - Three 65 ft, built in 1970's, twin 12-71 GM engines, M-514 Twin Disc gears well maintained, USCG certified. One 65 ft Swiftship. Two 42 ft Lafco crewboats. Texas. (361) 438-9742
www.coastalcrewboats.com

C-HAWK 1988 24FT with forward cabin fiberglass workboat hull, only \$5,000 (negotiable). Clamming, fishing, towing and commercial uses. Bring truck, trailer, and money. New York. Call John (516) 527-4951

CHESAPEAKE BAY BUILT Classic 110 Passenger Vessel. 65 LOA, 60 ton, two 6-71 Detroit, current COI. Business and / or boat for sale, ready to cruise this season. (240) 463-1510
www.WestRiverCruises.com

(1) CUSTOM BUILT TRI-TOON workboat (Wilson plastic pontoons), (1) 90 hp. Suzuki outboard (280 hrs.), hydraulic steering, alum. deck, handrails, T-top and trailer. A-frame for lifting. Asking \$25,000. Seadrift, TX. (361) 920-0585

GOOD STEEL BOATS Made for Work, Self-Bailing Assist, Utility and Bridge Construction Boats. (508) 264-6863
www.americanworkboat.com

34' PREMIUM PARASAIL / DIVE Boat with Trailer, 12 ft beam, good shape, 2 rebuilt 300 HP 6B Cummins diesel engines, has room for toilet under steering console. Refurbishing, 90% done. Asking \$60,000 OBO. (270) 535-2886
ebogle4@gmail.com

★ BOAT AND BUSINESS FOR SALE

1989 34' KEYWEST #1 / Neptune - Term lease my SG1 & KM1 permits. Great boat, versatile. 3,300 hrs. 3208 Natural. Complete turnkey with permit leases under \$45K. Mark (904) 219-5976.

SANDY HOOK, NJ - Successful established seasonal sailing excursion charter and sailing school for sale w/ vessels. Established 2003. Includes 22' Seaward monohull and custom Maine Cat 30. Brand new, hurricane hardened, upscale marina. Contact Captain Tracey (732) 546-4103.

CLEAN OUT YOUR STORAGE TODAY! Sell it in Boats & Harbors! Call us today at (931) 484-6100 or place your ad online at www.boats-and-harbors.com

★ FISHING EQUIPMENT FOR SALE

CHARTER BOAT Off Shore Equipment For Sale. Reels from 6/0 to 80W's, all single speed. Rods, reels, gaffs and tackle. All charter boat quality, in excellent condition. (609) 226-6002

COMMERCIAL FISHING GEAR: Shrimp & fish nets, turtle excluder, doors, deck winches, cable, steel wire rope cable, towing blocks, have one tower with outriggers. Call Capt. Ron Diamond in Oriental, NC. (518) 294-6181

HAVE MARINE PARTS YOU NEED to sell? Let Boats & Harbors help you! (931) 484-6100 or place your ad online at www.boats-and-harbors.com

★ BOATS FOR LEASE

1988 48' OCEAN YACHT, 671TIB, \$60,000. PH: (443) 553-4249

CREWBOATS / SAFETY Boats For Lease. Truckable aluminum crewboats 22' - 44', 6-15 pax, up to 40 knts., available bareboat or w/ crew. Can deliver anywhere. Contact Kevin @ (410) 977-0028
Email: smithequipment@verizon.net

★ BOAT SLIPS FOR RENT

PARTY BOAT SLIP 70-80', looking for owner / operated party boat to handle existing fishing traffic in Ocean City, NJ. For May-October season. At an established marina. Email for inquiries:
ocfishingcenter@gmail.com

★ GANGWAYS FOR SALE

MARINE GANGWAYS & RAMPS. Custom designed to your specifications & requirements. Call for more information. (860) 526-2227

★ TANKS FOR SALE

SINGLE WALL and DOUBLE WALL steel above ground oil/fuel storage tanks. For details, visit:
www.abovegroundtanksforsale.com

★ VESSELS FOR CHARTER

VESSELS AVAILABLE FOR CHARTER. Spud, crane, deck, hopper, ABS, dumpscow, flexifloat barges. Eastern seaboard. Crane barge service available New York and Boston Harbor. Marine project mobilization. Call (888) MRBARGE
www.sterlingequipment.com

★ BUMPERS FOR SALE

NEW PRODUCT Distributor Opportunity! Inflatable Boat & Dock Bumpers, (404) 401-1154, Multiple Sizes.
cal@bigbumpercompany.com
www.bigbumpercompany.com

★ SAILBOAT HULLS FOR SALE

CARGO / TRADE SCHOONER Under Construction as T-boat, steel, 48 GRT, 61' LOA. <1 year to complete. \$225K OBO. Seller exiting. For info, call Matt (252) 626-1699.

★ BOAT DELIVERIES

100 TON CAPTAIN, with towing available, for boat deliveries. Call (251) 656-6592.

EXPERIENCED PROFESSIONAL. Worldwide, licensed masters and crews. Bayfront Marine, Inc. Mel or Diane Longo. (904) 824-8970
www.bayfrontmarineinc.com

★ PERMITS FOR SALE

32 PASSENGER Gulf of Mexico Charter / Headboat, Reef & Pelagic Federal Fisheries Permits. \$40K. (727) 656-4434

CAN LOCATE ANY PERMIT, Commercial or Charter. 28, 33, 48 Passenger charter permits available now. (361) 356-1172
permits@greatsageinc.com

★ PERMITS WANTED

FULL PERMIT SERVICES: Buy, Sell, Renew, Transfer, Broker your federal fisheries permits. File no fish reports, vessel documentation, VMS activation. Expired permit solutions. (361) 356-1172

I BUY AND SELL South Atlantic Snapper / Grouper, Gulf Reef Comm. & Charter, King Mac, others. Dave (904) 708-0893, (904) 262-2869

★ PUSHBOATS FOR SALE

1997 30' STEEL PUSHBOAT, heavy duty, shallow water vessel, 871 engine recently overhauled, recently painted and gone through. Located on Long Island. Truckable. \$53,000. (516) 250-3190

★ TUGBOATS FOR SALE

'LEONA B' Model Bow 1972, Twin V12 149 DT. 1,450 hp, 30 kW & 40 kW. Towing machine, 63x24x10, GT99. Great Lakes. (414) 588-7784

1910 STEEL TUGBOAT. Asking \$45K. 45' length. Documented. 120 HP Kahlenberg, oil, engine excellent condition. Full spares, tools. Tug in good running condition, ready to go. Heat exchanger, always in fresh water. Two bunks, stove, diesel generator, air compressor. (707) 333-8863

85' HARBOR TUG For Sale, Pensacola, FL. (2) Caterpillar D-398's. 2,000 HP with one new. Over \$100K spent. (813) 404-9867
traver@worldwideyachts.net

110' TUG MUST SELL! 3,000 HP. Currently working. Current survey is over 1 million dollars! Pensacola, FL. (813) 404-9867
traver@worldwideyachts.net

★ BARGES FOR SALE

110'x34' 1943 STEEL Ex-Navy. Very Good Overall, two-story, electronics repair. Always clean, in & out. \$249,500. Seattle. (206) 225-3360
Details: www.PacificMarine.org
E-mail: david@pacificmarine.org

42'x14.5' TRUCKABLE self propelled crane barge, new epoxy paint, folds to 8.5', road legal. (2) 150 HP Mercury, 4 strokes, low hours. 35 HP Vanguard powerpack motor, reaches almost 50' plumbed for accessories at end of PM13 series Knuckle boom 20' hydraulic actuated spuds. \$95,000. Call (262) 949-5828.

ALUMINUM WORK OR MOORING BARGE, 12x32x3 ft, 1/4 inch plate, 1/2 pipe, rub rails, (2) hatches, raked one end. (860) 526-2227

MATERIAL DECK BARGE 110x35 with spud holes, bottom good, deck needs works, usable as is. \$50,000. Located Boston. (781) 925-2404, (617) 908-1006

MOTORIZED BARGE 65 ft by 25 ft. Twin 871's. 20 KW generator. Comes with oyster planting and harvesting equipment. \$60K OBO. Call (804) 758-5640 or
Email: saracook2002@hotmail.com

SECTIONAL BARGES Built. Any Truckable Size. Portable pushboats. Madison Boat and Barge, Madison Indiana, (812) 265-6255.
www.madisonboatandbarge.com

SMALL STEEL BARGES: (1) 32 x 16 x 7 @ \$25,000.00; (1) 48 x 17 x 8 @ \$55,000.00; (1) 52 x 20 x 8 @ \$55,000.00. Located: S.E. Massachusetts
Email: Lynchmarine@comcast.net

SPUD BARGE 30x80x9. With or without American 399 crawler. Located in NE. \$35,000. Call (508) 274-5298
chipshultz@gmail.com

ECONOMY GETTING YOU DOWN? Sell that unused marine item through Boats & Harbors. Call us today (931) 484-6100 or place ad online
www.boats-and-harbors.com

★ BARGES FOR CHARTER

NEW 10K & 30K Double-Skin Rank Barges. Central Boat Rentals, Inc. (985) 384-8200
www.centralboat.com

SPUD, CRANE, HOPPER, Material, Car-floats, Sectionals, Oceangoing and Inland. Services include floating crane, Brooklyn NY loading berth, transportation and project cargo, marine construction support, etc. Equipment located throughout the east coast. Call or email us for a free quote: Hughes Marine Firms. (800) 357-7744 or
info@hughesmarine.com
www.hughesmarine.com

★ BARGE SPUDS FOR SALE

LARGE SPUDS good condition, (3) @ 59 ft, (1) @ 42 feet, all 26" Dia. (305) 942-6335
coastaldocks@gmail.com

CONTINUED ON PAGE 22

GOOD STEEL BOATS



**Made For Work
Self-Bailing Assist
Utility & Bridge Construction Boats**
www.AMERICANWORKBOAT.com
(508) 264-6863

CENTURY ROPE CO. SINCE 1976

**TWISTED NYLON ROPE
MED. LAY - PREMIUM GRADE WHITE
100% USA - 600' REELS**

| | |
|-----------------|---------------------|
| 1/2" @ \$158.00 | 1" @ \$651.00 |
| 5/8" @ \$269.00 | 1-1/4" @ \$899.00 |
| 3/4" @ \$389.00 | 1-1/2" @ \$1,315.00 |
| 7/8" @ \$589.00 | 2" @ \$1,989.00 |

MONTHLY SPECIALS: Feb./March 2018
1-1/4" x 90Ft. Stud Link Chain, A.B.S. GR-2 @ \$1,355/Ea. PC
50 Ton Deck D-Ring w/Strap @ \$18.55/Set
8920 S.W. 129th St., Miami, FL 33176-5810
Tel: 305-238-1640 • Fax: 305-232-4372
Email: mmainc2012@gmail.com • MC/Visa No Checks



Smithwick & Mariners Insurance, Inc

Specializing in Inspected Passenger Vessels, Marinas, Boatyards, Boat Dealers,
Mobile Marine Repairers & Various Commercial Marine Businesses
as well as Yachts & Private Pleasure Boats

- ✓ Commercial Fishing, P&I, Lobsterboats
- ✓ Pollution Coverages
- ✓ NHCFA: Fishboat Program (New Hampshire)
- ✓ Charter Vessels
- ✓ Loss Free Credit/Loss of Income
- ✓ Payment Term Options

Call to customize a program for your needs:

603-394-7008

www.blackadarmarine.com

Dames Point Workboats, Jacksonville, FL

(904) 757-0407 • www.damespointworkboats.com



Truckable Hopper Barge: 50' x 14' x 6' Hopper Barge. Can hold 50 c.y. and is ready to work! More pictures available on "For Sale" page of website.
.....\$32,500.00

Aluminum Push Boat: Aluminum Ex-Army Bridge Boat, 353 Detroit with fresh rebuilds. 3:1 gears. Aluminum tri-axle trailer included to easily pull with 3/4 ton pick-up. Boat was shortened to 25' 3". \$29,500.00

100' 1994 Custom Built Lydia



Pristine. Current COI 150 passenger. Yacht and business. Charleston, SC. Serious inquiries only!
843.270.2100 • captbob1951@gmail.com

New Price - 48' Chesapeake Bay Deadrise



1970 48' x 14' x 3', New Detroit 671, Hull just re-glassed & painted, Dual Steering. Crab/Lobster/Shrimp, has new 671, new glass over. Lying Oriental, NC. See article on "sister ship" in Soundings June 2016 Page 82. Price \$35,000. Capt. Ron (518) 294-6181

INDUSTRIAL DIESEL, INC.

8705 HARMON • FORT WORTH, TX 76177 • Ph: 817-232-1071 • FAX: 817-232-0354 • WATS: 800-323-3659

WORLD WEB WEBSITE • http://www.industrialdiesel.net • EMAIL: sales@industrialdiesel.net

SEE OUR COMPLETE INVENTORY ON THE WORLD WIDE WEB

NO C.O.D'S PLEASE
WE ACCEPT VISA AND MASTERCARD
Se Habla Español

POWER UNITS



Caterpillar C4.4 Power Unit
Tier III, 100 HP RTO - Call For Pricing



Perkins 1104 Tier IV Power Unit
100-117 HP RTO, Low Hours
Call For Pricing



Caterpillar 3126 Tier II Power Unit
200 HP RTO, Low Hours - \$7,500

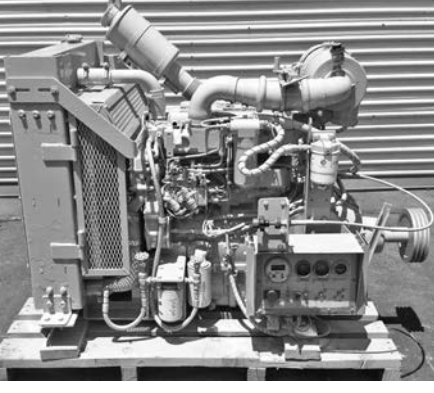

3054C Caterpillar Power Unit
160 HP, Low Hours
\$6,000

INVENTORY & COMPONENTS!



KT38 Cummins Engine
950-1200 HP, Rebuilt
\$65,000

Rebuilt Detroit Diesel Marine Engines

| Keel Cooled | Exch Price US | Outright Price US |
|-------------|---------------|-------------------|
| 3-71 | \$ 7,000 | \$ 10,500 |
| 4-71 | \$ 8,200 | \$ 11,700 |
| 6-71 | \$ 10,000 | \$ 13,500 |
| 8V71 | \$ 12,200 | \$ 16,000 |
| 8V92 N | \$ 14,000 | \$ 19,700 |
| 12V71 N | \$ 20,500 | \$ 28,550 |
| 16V92 N | \$ 36,000 | \$ 46,000 |

Exchange Price Includes New Air Silencer.
Outright Price Includes Exhaust Manifold, Flywheel, Tank Silencers.

| Heat Exchanger | Exch Price US | Outright Price US |
|----------------|---------------|-------------------|
| 3-71 | \$ 9,500 | \$ 12,500 |
| 4-71 | \$ 10,000 | \$ 14,000 |
| 6-71 | \$ 11,500 | \$ 15,000 |
| 8V71 | \$ 14,500 | \$ 18,500 |
| 8V92 N | \$ 16,500 | \$ 24,500 |
| 12V71 N | \$ 22,500 | \$ 32,000 |
| 16V92 N | \$ 38,000 | \$ 47,500 |

Exchange Price Includes New Air Silencer.
Outright Price Includes Exhaust Manifold, Flywheel, Tank W/P, Pipes For Raw W/P, Air Silencers.

Rebuilt Cummins Diesel Engines

| | Exchange | Outright |
|--------------------|------------|----------------|
| KT19 / 1150 / 450 | \$ 28,000 | \$ 38,000 |
| KTA19 / 1150 / 525 | \$ 32,000 | \$ 42,000 |
| QSK19 | \$ 47,500 | \$ 60,000 |
| KTA38 High Profile | \$ 75,000 | \$ 95,000 |
| KTA38 Low Profile | \$ 102,000 | \$ 137,000 |
| KTA50 High Profile | \$ 90,000 | \$ 125,000 |
| KTA50 Low Profile | \$ 105,000 | \$ 145,000 |
| QSK50 Engine | \$ 185,000 | Includes Swing |

Prices are for standard industrial engines.
Prices subject to change for non-standard engines.

CALL NOW!!

Inquire about our used DDA parts inventory & components

CUMMINS

| | | |
|------------|--|-----------|
| KT 19/1150 | BLOCK NEW STYLE 12 BOLT FRONT..... | \$ 5,000 |
| KT 19/1150 | BLOCK NEW STYLE 11 BOLT FRONT..... | \$ 4,500 |
| KT 19/1150 | CRANKSHAFT NEW STYLE STD/STD..... | \$ 4,500 |
| KV 50/3067 | CRANKSHAFT NEW STYLE STD/STD..... | \$ 10,000 |
| VT 28/1710 | CRANKSHAFT NEW STYLE STD/STD..... | \$ 5,000 |
| KV 38/2300 | CRANKSHAFT NEW STYLE STD/STD..... | \$ 8,000 |
| QSK 19 | CRANKSHAFT NEW STYLE STD/STD..... | \$ 5,000 |
| KV 38/2300 | BLOCK NEW STYLE VALLEY COOLED STD..... | \$ 8,500 |
| QSK 19 | FRONT COVER NEW STYLE NEW TAKE OFF..... | \$ 500 |
| QSK 19 | AFTER COOLER ASSY. NEW STYLE NEW TAKE OFF..... | \$ 3,000 |
| QSK 19 | OIL PANS NEW STYLE NEW TAKE OFF..... | \$ 350 |

NEW MARINE PARTS

| | | |
|------------|------------------------------------|----------|
| NT 855 | WET EXHAUST MANIFOLD NEW..... | \$ 950 |
| NT 855 | MARINE THERMOSTAT HOUSING NEW..... | \$ 350 |
| NT 855 | MARINE FLYWHEEL SAE #1 NEW..... | \$ 750 |
| NT 855 | MARINE BELL HOUSING NEW..... | \$ 1,000 |
| KT 19/1150 | WET EXHAUST MANIFOLD NEW..... | \$ 1,100 |
| KT 19/1150 | 3003657 CONNECTOR NEW..... | \$ 105 |
| KT 19/1150 | 3004718 CONNECTOR NEW..... | \$ 115 |
| KT 19/1150 | 3003662 TUBE NEW..... | \$ 80 |
| KT 19/1150 | 3004716 TUBE NEW..... | \$ 85 |

REBUILT BLOWERS

3-53, 4-53, 6V53, 4-71, 3-71, 2-71, 6-71, 12V71, 6V92T & 8V92T
EXCHANGED - \$600.00 • OUTRIGHT - \$800.00 - \$1,000.00

NEW SURPLUS • NEW SURPLUS



SPM 3000 HP Pump
BAS3000, G0214-10000
3000BHP, 12 Stroke, 7.68 Gear Ration, MFG 2/2014,
*No Fluid End - \$295,000



FMCWT2450 Pump 4.5 FLUID END
WT2450, Part# P540619,
2400HP, Speed 1950, Gear Ration: 6:39:1 - \$110,000



OFS 4700 Transmission
SN# 6610392590, 600HP,
Pyroban Equipment,
Cert# PYROBAN06ATEX0121X
\$40,000



Pacemaker Pumps 700BHP
BS# 322656, 141111PTL7/576
Fluid End BSPAR# 322690
SN: F0914-25960, MFG 2014
\$105,000



Cummins QSK19 800HP
800HP @2100RPM, Marine
Application ABS Certified,
4 Available - \$50,000 Ea.



SPM QWS 1000 Pump
SN# F0613-21599, 60514-10175
1000BHP, 4.61 Gear Ration
MFG 12/2012
2 Available, 1 Left and 1 Right
\$105,000



QSB 6.7 Cummins Power Unit
260HP, SN# 46941797, CPL 8611
260HP @2200RPM, MFG 2008
\$20,000



Cummins QSX15 Power Unit
Tier IV Compliant, CPL 3350,
600HP @2100, MFG 4/2012
7 Available - \$55,000

NEW SURPLUS NEW SURPLUS CALL NOW!!

WOOD DOCK HARDWARE

MADE WITH 1/4" HIGH STRENGTH STEEL THEN HOT DIPPED GALVANIZED

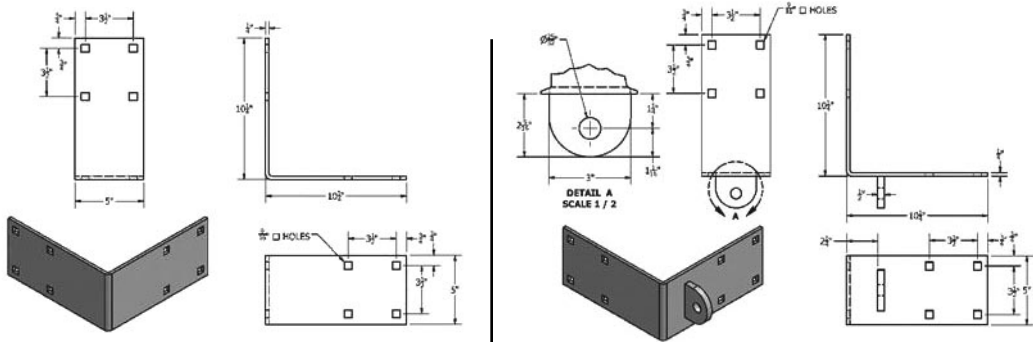

Outside Corner End (H-OCE) is used at the ends of fingers, ends of dock or for swim platforms.

H-OCE Ship#7 \$12.98

Outside Corner Male (H-OCM) has one 1/2" tab and a hole for a 3/4" bolt or B-PIN. Would be used with an Outside Corner Female (H-OCF) or with a Single "T" Female (H-SF). **H-OCM Ship#8 \$18.71**

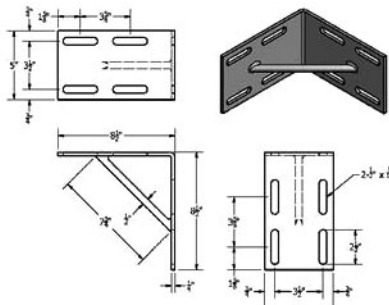

Inside Corner (H-IC) has slots and can be used with 1-1/2" - 3" thick wood. The inside corner sandwiches the wood between the opposite outside corner, keeping bolts from burying themselves in the wood. A corner gusset gives the unit a lot of strength and helps from racking the dock. **H-IC Ship#7 \$13.95**

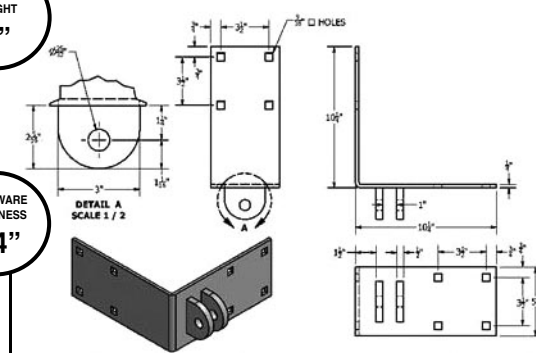

Outside Corner Female (H-OCF) has two 1/2" tabs and a hole for a 3/4" bolt or B-PIN. Would be used with an Outside Corner Male (H-OCM) or with a Single "T" Male (H-SM). **H-OCF Ship#9 \$22.23**

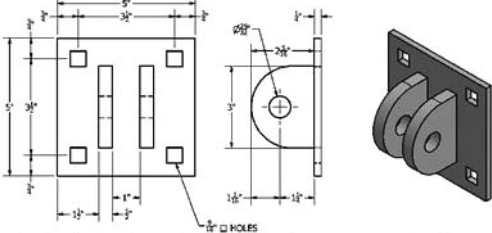

Single "T" Female (H-SF) has two 1/2" tabs and is used with an Outside Corner Male (H-OCM) or a Single "T" Male (H-SM). Both male and female singles can be bolted to the side of a dock to make finger attachments. They can also be bolted to seawalls to make ramps.

H-SF Ship#4 \$13.04

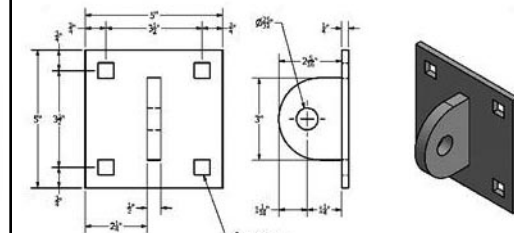

Single "T" Male (H-SM) has one 1/2" tab and is used with an Outside Corner Female (H-OCF) or Single "T" Female (H-SF). **H-SM Ship#3 \$9.22**

WOOD DOCK HARDWARE WWW.MERCOMARINE.COM 1-304-737-3006

WOOD DOCK HARDWARE

MADE WITH 1/4" HIGH STRENGTH STEEL THEN HOT DIPPED GALVANIZED

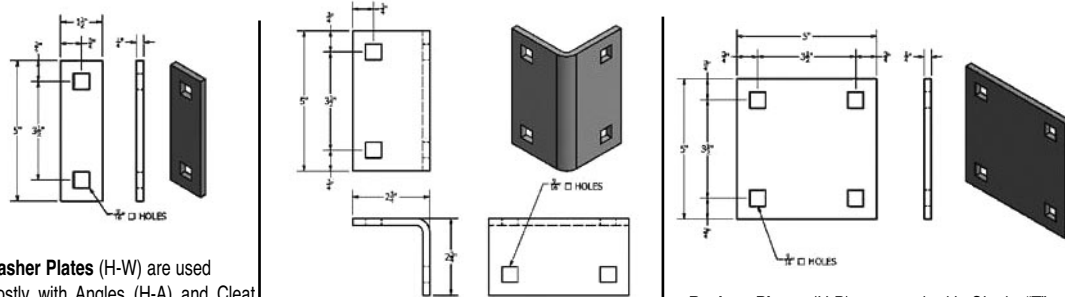

Washer Plates (H-W) are used mostly with Angles (H-A) and Cleat Angles (H-CA). The square hole in the plate keeps the carriage bolts from turning when the bolts are tightened. **H-W Ship#1 \$1.24**

Angles (H-A) used to hold all cross stringers to side stringers using a Washer Plate (H-W). The wood is sandwiched between the steel and creates a solid corner. **H-A Ship#2 \$3.45**

Backup Plates (H-B) are used with Single "T" Males (H-SM) and Single "T" Females (H-SF) for additional strength and to keep bolts from pulling through the wood. **H-B Ship#2 \$3.30**

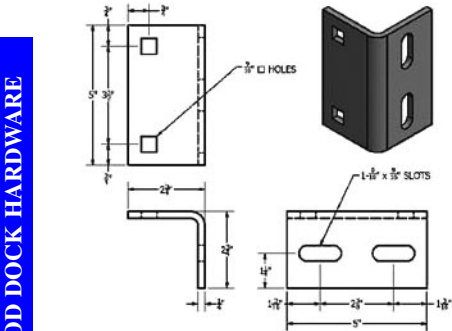

Cleat Angles (H-CA) have slots for various sizes of cleats. The cleat angle is bolted to the side stringer using a Washer Plate (H-W). The cleat is then bolted through the deck into the cleat angle. This keeps the cleat from pulling out of the deck. **H-CA Ship#2 \$4.88**

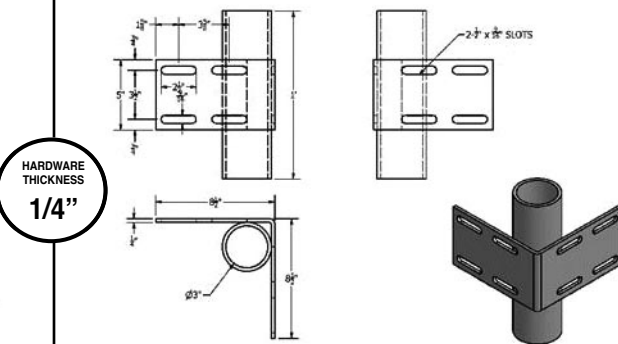

Inside Corners/3" I.D. Pipe Holder (H-IC3) has a 3" I.D. pipe holder welded in place. It can be used to replace a regular inside corner. It will accommodate a 2" I.D. pipe. **H-IC3 Ship#13 \$26.31**

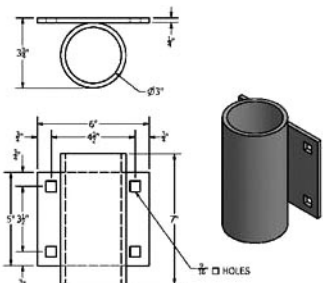

3" Pipe Holder (P-3) can bolt to the side stringer and uses 2" standard pipe to anchor docks in place. **P-3 Ship# 6 \$16.41**

3" Pipe Holder (H-OCEP3) outside corner end with a pipe holder welded to the end. 3" opening for 2" pipe. Save money by getting 2 pieces of hardware in one. **H-OCEP3 Ship#11 \$23.19**

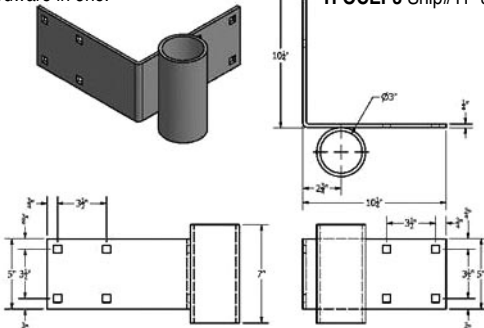

MERCO MARINE

Merco Marine is a manufacturer of boat dock building components and accessories. We were established in 1979. Everything we manufacture is made in the United States, with US Steel, and US workers.

The products shown here are only a small portion of the over 2000 items that we manufacture and keep in inventory for boat dock building and marinas.

For a complete list of our products check us out on the web at www.mercoboatdocks.com or give us a call at 304-737-3006. You can also request a free copy of our 65 page catalog.

Merco Marine can provide simple parts and pieces for your small pond or lake dock to build on site, or we can build entire marinas from start to finish.

We also stock

PILE GUIDES

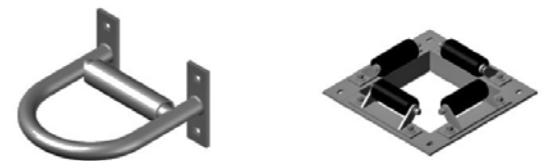

DOCK EDGING

Our **DE-40W** 40' Dock Edging (Shown above) comes 40' per box in easy to install 4' sections (10 per box) and includes 180 stainless ring shank nails.

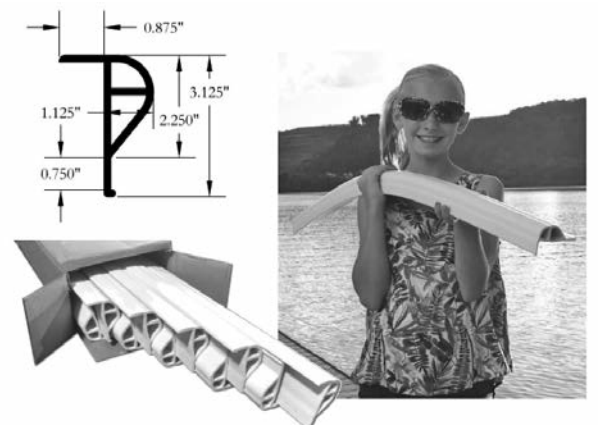

DE-40W White 40' Length 31 Lbs. \$89.95

FLOAT DRUMS

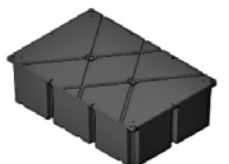

CLEATS



WOOD DOCK HARDWARE

WOOD DOCK HARDWARE

We also stock

SQUARE INTERNAL PILE GUIDES

For replacement roller assembly or parts see page 17.

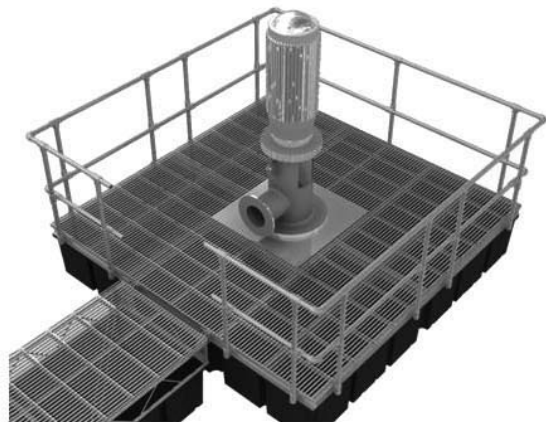

PUMP PLATFORMS



PILE CAPS



CORNER BUMPERS

View our complete product line on our website...

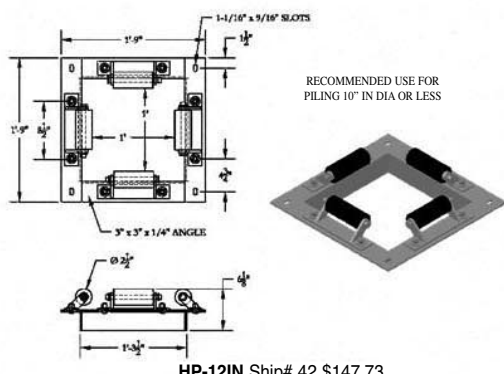

HP-12IN Ship# 42 \$147.73

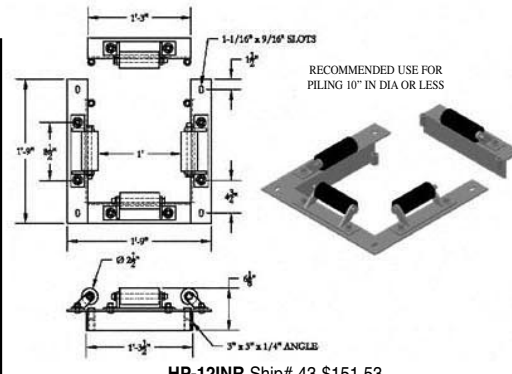

HP-12INR Ship# 43 \$151.53

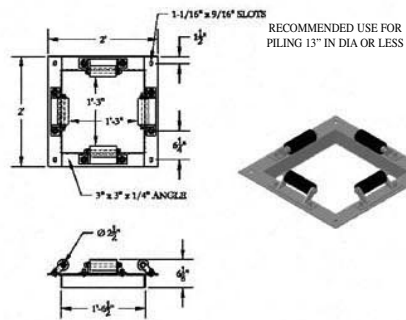

HP-15IN Ship# 53 \$162.37

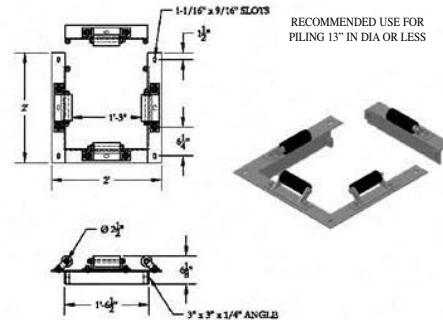

HP-15INR Ship# 54 \$167.11

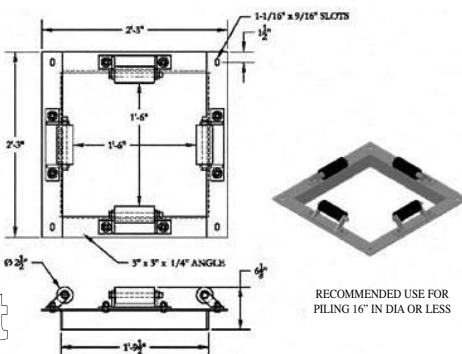

HP-18IN Ship# 58 \$170.98

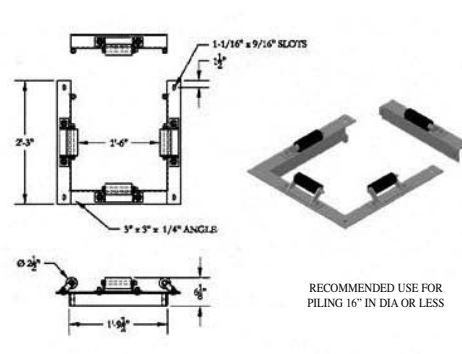

HP-18INR Ship# 59 \$175.26

PILE GUIDES

WWW.MERCOMARINE.COM 1-304-737-3006

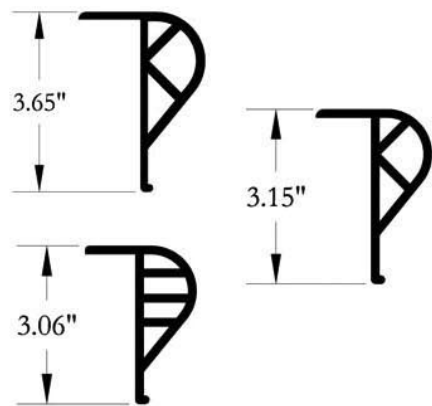

RUBRAIL

HOOP PILE HOLDERS

Our convertible Hoop Pile Holders have 3 basic pieces, a deck plate, a hoop and a roller assembly. This allows you to have a hoop pile holder the way you want it, whether it be a permanent hoop, a removable hoop or a hoop with a roller. You can use the roller assembly on the deck plate or bolt it directly to the dock. All parts are hot dipped galvanized. Add a UHMW Roller to any assembly as shown at the bottom of page 19. All assemblies include a deck plate, hoop, roller assembly, and 6 carriage bolts. Fasteners required to bolt to your dock sold separately on page 28.

| Assembly Number | Assembled Weight | □ | L | L2 | W | BH | BM | Hoop Number | Hoop Weight | Deck Plate Number | Deck Plate Weight |
|-----------------|------------------|-----|---------|---------|---------|---------|---------|-------------|-------------|-------------------|-------------------|
| HP-H8R | 25 lbs | 8" | 8 3/4" | 10" | 15 3/4" | 9-3/4" | 13 3/4" | HP-H8 | 8 lbs | HP-DP8 | 12 lbs |
| HP-H10R | 28 lbs | 10" | 10 1/8" | 11 3/8" | 18 1/2" | 12-1/2" | 16 1/2" | HP-H10 | 8 lbs | HP-DP10 | 14 lbs |
| HP-H12R | 30 lbs | 12" | 11 1/2" | 12 3/4" | 20 1/2" | 14-1/2" | 18 1/2" | HP-H12 | 10 lbs | HP-DP12 | 15 lbs |
| HP-H14R | 32 lbs | 14" | 13 1/2" | 14 3/4" | 22 1/2" | 16-1/2" | 20 1/2" | HP-H14 | 10 lbs | HP-DP14 | 16 lbs |
| HP-H16R | 35 lbs | 16" | 15 3/4" | 17" | 24" | 18-1/2" | 22" | HP-H16 | 12 lbs | HP-DP16 | 18 lbs |
| HP-H18R | 37 lbs | 18" | 17 1/4" | 18 1/2" | 26" | 20-1/2" | 24" | HP-H18 | 13 lbs | HP-DP18 | 19 lbs |
| HP-H20R | 38 lbs | 20" | 19 5/8" | 20 7/8" | 27 1/4" | 21-7/8" | 25 1/4" | HP-H20 | 13 lbs | HP-DP20 | 20 lbs |

NOTES: ALL DIMENSIONS NOMINAL. DIAMETER TOLERANCE IS +/- 1/4". □ = DIAMETER

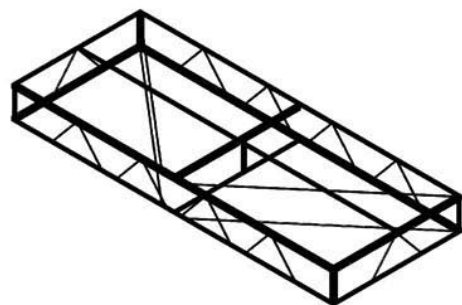

TRUSS FRAMES



MERCO MARINE™

1-1/2" HOOP PILE HOLDERS



| Circumference | □ |
|---------------|-----|
| 9.42 | 3" |
| 12.56 | 4" |
| 15.7 | 5" |
| 18.84 | 6" |
| 21.98 | 7" |
| 25.12 | 8" |
| 28.26 | 9" |
| 31.4 | 10" |
| 34.54 | 11" |
| 37.68 | 12" |
| 40.82 | 13" |
| 43.96 | 14" |
| 47.1 | 15" |
| 50.24 | 16" |
| 53.38 | 17" |
| 56.52 | 18" |
| 59.66 | 19" |
| 62.8 | 20" |

□ - DIAMETER

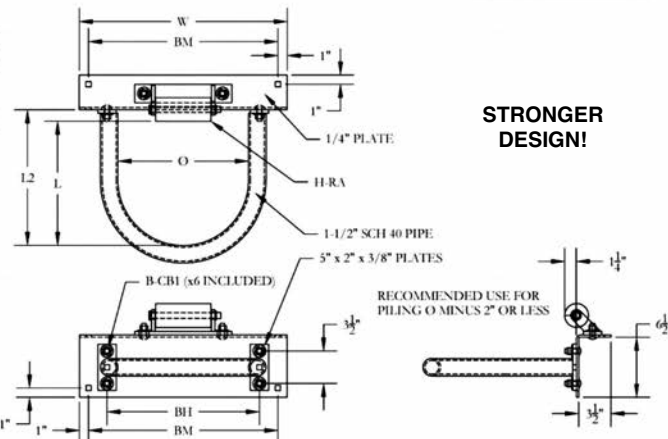

STRONGER DESIGN!

Our mounting plates are 5" x 2" x 3/8" which are welded to the hoop and are used to mount the hoop to the deck plate. Our mounting plates are 33% thicker and 25% wider than most other hoop mounting plates on the market.

An easy way to determine the diameter of your existing pipe or piling is to measure the circumference and divide by 3.14. We've done the math for you with our Circumference chart to the left.

| Part Number | Assembled Price | Hoop Number | Hoop Price | Deck Plate Number | Deck Plate Price |
|-------------|-----------------|-------------|------------|-------------------|------------------|
| HP-H8R | \$94.88 | HP-H8 | \$35.93 | HP-DP8 | \$33.28 |
| HP-H10R | \$99.53 | HP-H10 | \$38.55 | HP-DP10 | \$35.31 |
| HP-H12R | \$106.43 | HP-H12 | \$43.42 | HP-DP12 | \$37.34 |
| HP-H14R | \$111.31 | HP-H14 | \$47.34 | HP-DP14 | \$38.30 |
| HP-H16R | \$119.62 | HP-H16 | \$51.91 | HP-DP16 | \$42.04 |
| HP-H18R | \$125.87 | HP-H18 | \$56.26 | HP-DP18 | \$43.94 |
| HP-H20R | \$132.16 | HP-H20 | \$60.61 | HP-DP20 | \$45.88 |

Kubota

Tier 4 Final Kubota Powered Industrial Diesel Generators

1800 RPM Standard Equipment:

- Kubota Tier 4 Final Diesel Engine
- Epoxy-coated, brushless 1800 rpm generator
- 12VDC starting and charging system
- Murphy starting and monitoring system
- DOC-only aftertreatment
- Fuel filtration system
- Fuel priming system with transfer pump
- High ambient charge air cooling system
- Heavy-duty steel frame
- Vibration isolators
- Dry-type air cleaner
- Industrial muffler – S/L
- Solid state AVR

Southeastern Power Products is the Authorized KUBOTA Industrial Engine Distributor for the state of Florida, the Bahamas and the Caribbean.

Supplying genuine Kubota parts and factory remanufactured components.

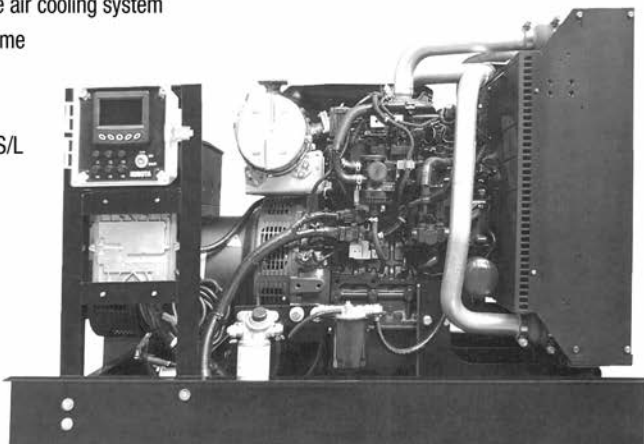

20 kW – \$14,480
Kubota D1803BGCR

30 kW – \$15,730
Kubota V2403BGCR

Optional Equipment:

- Enclosures
- Fuel tanks
- Auto start/stop
- Transfer switches
- Circuit breakers
- Critical silencers
- Battery, rack, cables

SOUTHEASTERN POWER PRODUCTS

2880 Hammondville Road Pompano Beach, FL 33069
Phone: (954) 979-5899
Fax: (954) 979-4349

www.southeasternpower.com

1953 65' Blount Built T-boat

22' beam, dinner / tours. Licensed 150 pass. Rebuilt 1993. Operating on NYS Canal System since 1975. COI expires spring 2022. Drydock inspection expires spring 2021. Detroit 8-V71 300 hp rebuilt spring 2017. (1) Yanmar / Kohler 20kw. (1) Yanmar / Kohler 16kw. Includes safety and serving equipment.
\$190,000 • (315) 685-8500 or sarah@midlakesnav.com

SAMS®
Society of Accredited Marine Surveyors®
An International Organization of Professional Marine Surveyors
Use SAMS® Surveyors in your area
www.marinesurvey.org
1-800-344-9077

Central Boat Rentals, Inc.

Morgan City, LA

Ocean 2000 HP Push Boat
Towing: 10K & 30K BBL Double Skin Oil Barges

(985) 384-8200 www.centralboat.com

The Pressure Is On Board!

Clean traps catch more • Our pressure washers are proven.

19" W x 10" H x 12.5" L
Hydraulic Pressure Washer

12.5" W x 10" H x 12.5" L
Belt-driven Pressure Washer w/ Electric Clutch

Coastal Hydraulics Pressure Washers
Hydraulic Operated or Belt Driven with Electric Clutch

- Triplex Plunger Pump • Forged Brass Head
- Ceramic Plungers • For use with fresh or salt water
- Hydraulic Requirements 12 GPM @ 1,500 PSI
- Pressure Washer Output 4.5 GPM @ 3,000 PSI

Basic System Includes:

- (1) Hydraulic operated plunger pump
- (1) SS Pressure Gauge
- (1) Pressure Relief Valve
- (1) Bronze & SS water inlet strainer (Cleanable)
- (1) 24" Wand with Dirt Killer Turbo Nozzle
- (1) 50' High Pressure Hose
- (2) Brass Quick Disconnects
- (1) Hydraulic Flow Regulator (Hydraulic only)
- (1) Check Valve (Hydraulic only) Electric Clutch (Belt Driven only)

Coastal Hydraulics, Inc.
28 Route 286 • Seabrook, NH • 03874
(603) 474-1914 Fax (603) 474-1902
Please visit our shopping cart website at: www.coastalhyd.com

CLOSING DATES • FIRST MARCH ISSUE 2018

• To Be Mailed February 28th, 2018 •

For Display February 23rd, 2018 **For Classified** February 27th, 2018
(9:00 A.M. C.S.T) (10:00 A.M. C.S.T)

AHOY PROPELLERS
QUALITY & PERFORMANCE THROUGH FLUID INNOVATION

2614 OAK DRIVE, HARVEY, LA 70058
504-367-5710
AHOYPROPELLERS.COM

trak
ACCELERATE TO DOMINATE

TÖRKING
EXPERIENCE THE POWER OF TORQUE

BRONZE - NIBRAL - STAINLESS
SIZES 24 INCH AND UP

Phone: 504-367-5710
Fax: 504-367-5733

Vessels, Barges, & Cranes For Sale

32' x 40' x 4' Sectional Spud Barge and Crane.

20' x 8' x 4' Truck-Able Push Boat, (1) GM 471, Flanking Rudder, Keel Cooled.

Dry Dock 220' x 70' x 6', Capacity 2800 Tons, Reported to be in excellent working condition.

New Shugart Compatible Sectional Barges. Call today for a quote, and lead time.

| | |
|--|----------------------|
| (30) Crewboats 22' to 150' | Starting at \$18,000 |
| (110) Inland and Ocean Deck Barges 30' to 400' | Starting at \$15,000 |
| (31) Spud Barges 40' to 250' | Starting at \$22,000 |
| (45) Inland & Ocean Hopper Barges 175' to 600' | Starting at \$45,000 |
| (7) Landing Crafts 40' to 250' | Starting at \$22,000 |
| (6) Travel Lifts 25 ton & Up | Starting at \$25,000 |
| (29) Utility / Supply Vessels | Starting at \$95,000 |
| (65) Pushboats 200hp & Up | Starting at \$25,000 |
| (70) Model Bow Tugboats 200hp & Up | Starting at \$65,000 |

New & Used Truckable Pushboats & Sectional Barges
Used Cranes and Draglines
OVER 600 ITEMS LISTED ON OUR WEBSITE

WWW.TMT-LLC.COM

MONEY MAKER



1996 Built / Commissioned 1999
56' Steel Hull Sternwheel Boat
Rotten Wood on Housing and Hand Railing
Mechanically Sound • Truck-able
Just needs a remodel and ready to put to work

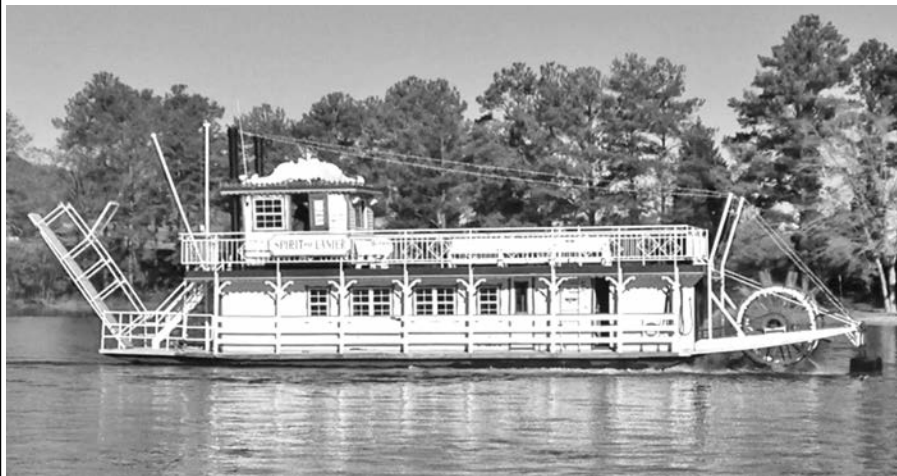

\$20,000 OBO As Is

MIKE WILLIAMS
7000 Lanier Islands Parkway, Buford, GA 30518
(404) 585-1818
mike@lanierislands.com • www.LanierIslands.com

"WHEN YOU NEED TO GET THINGS MOVING!"

VALUE FOR YOUR ADVERTISING DOLLAR?



OUR BUSINESS IS TO GET YOUR ADVERTISING PROGRAM RUNNING IN THE RIGHT DIRECTION!

CALL, FAX, WRITE OR E-MAIL:
BOATS & HARBORS

P.O. DRAWER 647 - CROSSVILLE, TN 38557

PHONE: (931) 484-6100 • FAX: (931) 456-2337 • gdonnelly@boats-and-harbors.com

MAINE BOATBUILDERS' SHOW

March 23, 24, 25, 2018

512 Warren Avenue • Portland, ME 04103

Hours: 10-6 Friday & Saturday, 10-4 Sunday

A gathering of the finest fiberglass and wooden custom boat builders on the East Coast. Also exhibiting numerous manufacturers of boating equipment. Sailboats, powerboats, canoes, kayaks, and rowing boats with the builders there to discuss and sell their work.

Produced by:
Portland Yacht Services
 207-774-1067



New Location
 512 Warren Ave
 Portland Sports Complex

For More Updated Information Go To:

www.portlandyacht.com

TOUGH
Kubota
PARTS

LARGE INVENTORY
 SAME DAY SHIPPING

KUBOTA
Reman

STARTERS / ALTERNATORS / TURBO'S

LIST OF SPECIFICATIONS

| |
|--|
| Kubota Diesel Engine |
| 1800 RPM Generator Single or 3 Phase |
| Brushless Exciter |
| Automatic Voltage Regulator |
| High Temp and Low oil shutdown system |
| Air Cleaner |
| Belt Guard |
| Hour Meter |
| Key Switch |
| Stable Flex Neoprene Vibration Isolators |
| Fuel Filter |
| Mechanical Fuel Transfer Pump |

OPTIONAL EQUIPMENT ACCESSORIES

| |
|--|
| Weather Proof Enclosures |
| Drip Pan For Skid |
| Fuel Tanks |
| Circuit Breakers |
| 110/220 Outlets |
| Fuel Water Separators |
| Deluxe Gauge Panels |
| Extended Deluxe Gauge Panels to 50 ft. |

Kubota

AUTHORIZED DISTRIBUTOR
ENGINES / GENERATORS / PARTS

(800) 925-4966

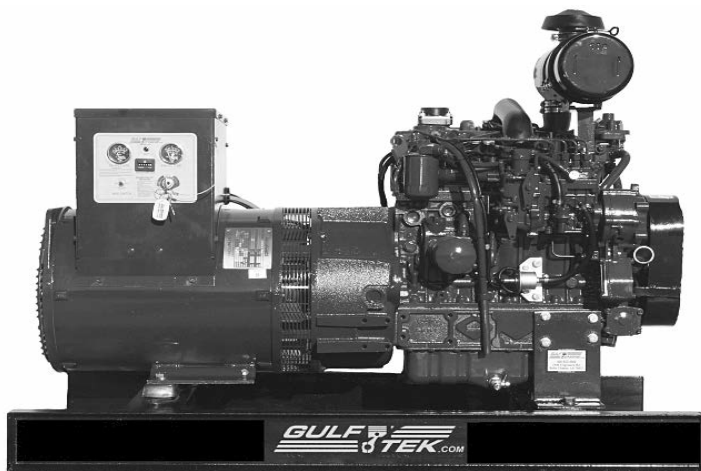

Marine and Industrial Generators

KEEL COOLED MODELS

| MODEL | KW | PRICE |
|--------------|----|-------------|
| KG8KWKC-ECS | 8 | \$5,920.00 |
| KG10KWKC-ECS | 10 | \$6,130.00 |
| KG12KWKC-ECS | 12 | \$6,800.00 |
| KG15KWKC-ECS | 15 | \$7,810.00 |
| KG17KWKC-ECS | 17 | \$8,050.00 |
| KG21KWKC-ECS | 21 | \$9,075.00 |
| KG25KWKC-ECS | 25 | \$9,355.00 |
| KG30KWKC-ECS | 30 | \$9,810.00 |
| KG40KWKC-ECS | 40 | \$12,715.00 |
| KG50KWKC-ECS | 50 | \$13,860.00 |

TIER 4 GENERATORS AVAILABLE

GL SERIES

LOWBOY II

| | |
|-------------|------------|
| GL7000-USA | \$4,650.00 |
| GL11000-USA | \$5,750.00 |



Pressure Washer
 3K to 10K Cold Water
 3K to 5K Hot Water



Trash Pumps 3 to 6 Inch



HPU Units

GULF ENGINE.COM

GULF & TEK.COM

CAVI & TEK.COM

HYDRA & COMP.COM

RE & RENT

2306 Engineers Road, Belle Chasse, LA 70037

Office: (504) 393-1701 * Fax: (504) 393-1627 * Toll Free: (800) 925-4966

LIFETIME CUSTOM ALUMINUM BOATS



25' LANDING CRAFT WORK BOAT 20', 24' - IN STOCK



DECK BARGE 24' HYDRAULIC CRANE 24' PATROL LANDING CRAFT - IN STOCK



30' LANDING CRAFT - IN STOCK PILOTHOUSE 40'

~ Stock Workboats Available ~
Workboats and Landing Craft in Stock

LIFETIME BOATS, INC.

14104 Hwy 84, Jonesville, LA 71343

Phone (318) 339-4007

bodie@lifetymeboats.com

www.lifetymeboats.com

CLOSING DATES • FIRST MARCH ISSUE 2018

• To Be Mailed February 28th, 2018 •

For Display February 23rd, 2018 (9:00 A.M. C.S.T.) For Classified February 27th, 2018 (10:00 A.M. C.S.T.)

ELLICOTT 370HP



Needs New Pump,
Motor Has 2,000 Hours,
Gear Box, Service Water Pump,
Has a 20' Dredging Depth,
Newly Painted
Priced to Sell - \$140,000
Cape Mining • (609) 374-2995 - NJ



28' ALMAR RAIV 2006 Aluminum
Towing Vessel
Twin 375/377 Mag Mercruiser Motors
Turnkey ready to go! \$135,000
Contact Woody (772) 286-8123
Email: towboatusstuart1@gmail.com

50 x 14 Push



Cargo steel hull twin 671 with 400 hr, cargo area
12 x 22. Very good condition, located in MS.
\$60K OBO • (228) 617-8699

BARGES FOR RENT



Sectional Barges • Located In Florida
40 x 10 x 5 & 60 x 11 x 4
Contact: (305) 965-8852
Email: barge@bargerent.com

BUY NOW!



Cat 3412 Marine
Propulsion Engines
Qty (6)
Stk #: P170223A,
720 HP
\$99,700 USD Each
Email or call for
more info

NEW SURPLUS
2010 Cat 3412
Marine Gensets
Qty (7)
Stk #P170294A,
590kW
\$154,800 USD Each
Email or call for
more info



MARK REZA

858.376.6840 | mreza@hawthornecat.com

Units located in San Diego, CA. Email for a complete inventory.

www.hawthornecat.com

RENTALS & SALES



Hydraulic Winches & Power Units
For Sale & For Rent



Diesel Mechanical Winches
For Sale & For Rent

Seattle, WA
Tel: 206-762-3700
Info@rasmussenco.com

RASMUSSEN EQUIPMENT COMPANY

New, Used, & Reconditioned Sales ~ Rentals

Belle Chasse, LA
Tel: 504-392-0442
www.rasmussenco.com

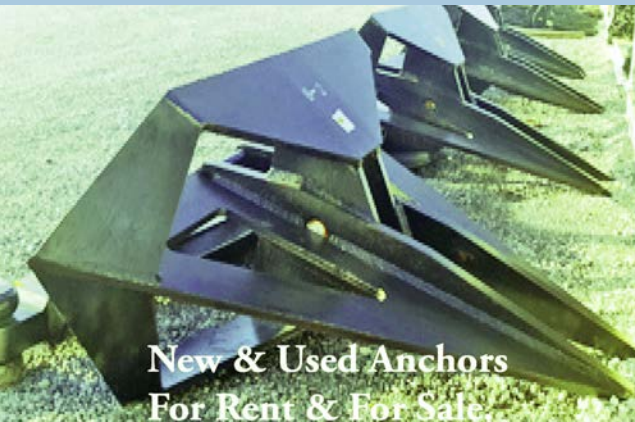

New & Used Anchors
For Rent & For Sale

5' x 7' x 5' Surplus Used Steel Tanks
Located: Seattle, WA



Large Inventory of Poseidon & Flexifloat
Barges For Rent & For Sale: Seattle, WA;
Belle Chasse, LA; & Anderson, CA



Used 6x12 Foam filled Fenders
\$2500.00 each; As Is, Seattle, WA

Diesel Mechanical Winches,
Hydraulic Winches, Hydraulic
Power Units, Air Winches

Please call, or email for a quote.
Seattle: 206-762-3700 Belle Chasse: 504-392-0442
info@rasmussenco.com ~ www.rasmussenco.com

Portable Barges, Anchors, Chain,
Wire Rope, Rigging Hardware, Deck
Sheaves, Fairleads, Buoys, Blocks, etc.



MARINE EXHAUST SYSTEMS
OF ALABAMA INC.



Silicon 90's, 45's, Bellows, Humps, Hose, Clamps, Connectors, Mufflers
Silencers, Fittings
Exhaust Manifolds,
Marinizing Kits,
Heat Exchangers,
Turbos, Crossovers,
Risers, Custom Ells,
Pumps, Duplications,
Prototyping and more.



Please call for Pricing 1-251-928-1234 ask for Mark <http://www.mesamarine.com>

HIGH SPEED CATAMARANS FOR CHARTER



**New 150 Passenger
Ava Pearl**
Trim Tab Ride
Control System

These two state-of-the-art Gladding-Hearn "INCAT" ferries are available for Charter with Crew beginning **September 2017 through May 2018** and **September 2018 through May 2019**.

AVA PEARL - for Charter, 150 Passengers, two levels, 2 restrooms, 5 Flat Screen TV's, Business-class interiors, the latest MDI Trim Tab Ride-Control System. Powered by (2) MTU 12V4000 M53 engines and (2) ZF Propellers. Top Speed 30 knots.

MILLENNIUM - for Charter or For Sale, 400 Passengers, three levels, two bars, 3 restrooms, powered by (4) KTA-38 Cummins engines & (4) MJP Waterjets. Top Speed 34 knots. Both have AC/Heated interiors and have a COI to operate up to 20 miles offshore.

If you are looking for a reliable fast ferry that has a proven track record to supplement your fleet or start up a new service call Rhode Island Fast Ferry. We also offer various fast ferry Consulting Services as well. www.RhodeIslandFastFerry.com

400 Passenger Millennium



Charles A. Donadio 401.255.9118 or email charlie@vineyardfastferry.com

CLOSING DATES • FIRST MARCH ISSUE 2018

For Display
February 23rd, 2018
9:00 A.M. C.S.T

To Be Mailed
February 28th, 2018

For Classified
February 27th, 2018
10:00 A.M. C.S.T

**SERVING THE MARINE AND OIL INDUSTRY
FOR OVER 50 YEARS**

**ANCHORS
CHAIN
CONN. LINKS**

**FENDERS
CHOCKS
BITTS**

**KEVELS
DOORS
HATCHES**

**FAIRLEADS
CAPSTANS
WINCHES
WINDLASSES**

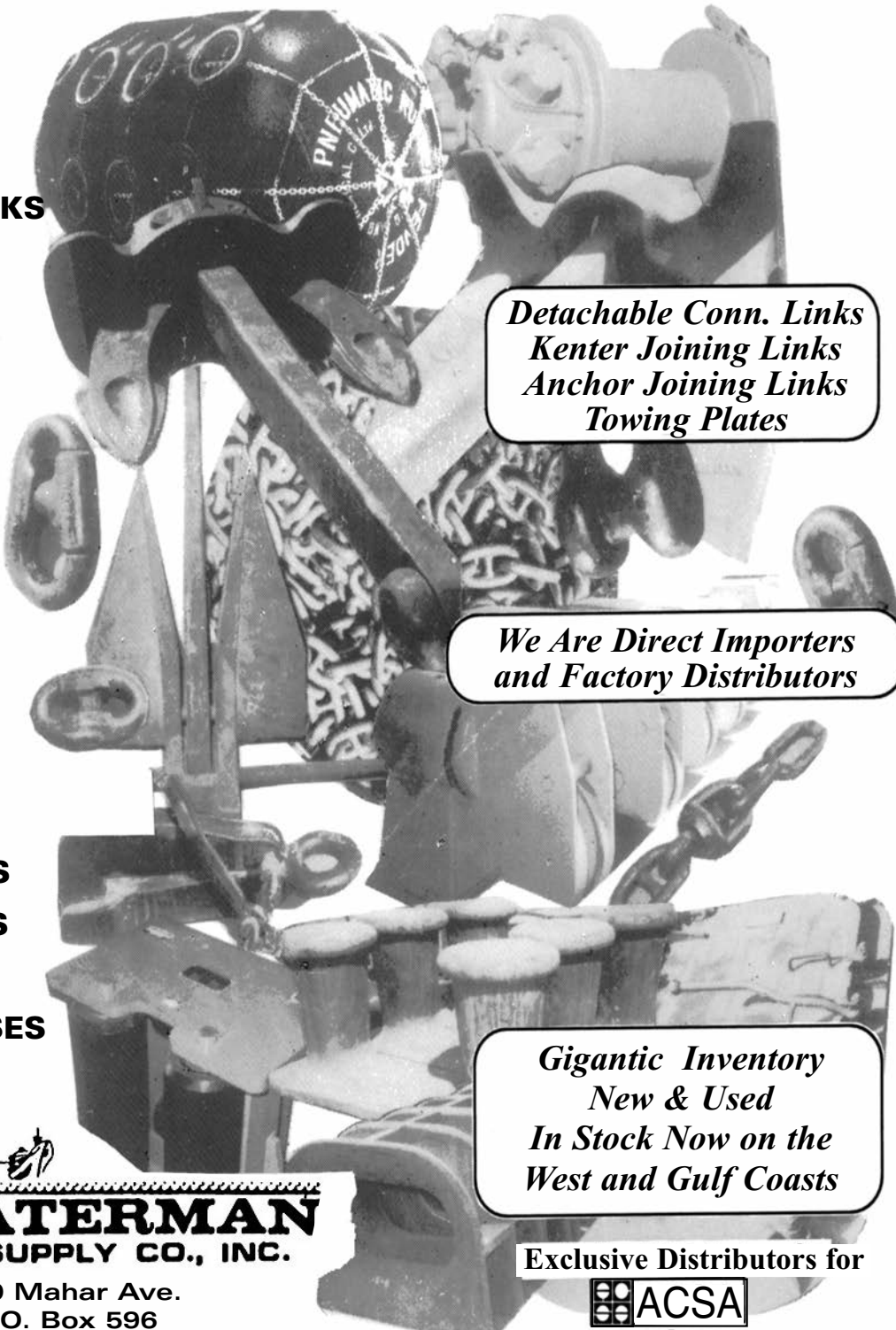

*Detachable Conn. Links
Kenter Joining Links
Anchor Joining Links
Towing Plates*

*We Are Direct Importers
and Factory Distributors*

*Gigantic Inventory
New & Used
In Stock Now on the
West and Gulf Coasts*

Exclusive Distributors for



Products

Anchors • Chain • Hardware • Fittings

www.watmansupply.com

**Call Toll-Free
(800) 322-3131**



910 Mahar Ave.
P.O. Box 596

Wilmington, CA 90748

800-322-3131 • (310) 522-9698

Fax: (310) 522-1043

PILOT HOUSES



- Custom Built
- No Minimum Qty
- Carbon
- Stainless
- Aluminum

Est. 1992
Lake Superior Cabs, Inc.
800-328-1823
www.lakesuperiorcabs.com

Campins Custom Boats
campinscustomboats.co



Available at
Any Stage of
Completion!

(239) 784-5451

**"EQUIPMENT
DETAILS ARE ON
WEBSITE"**

www.triplecmarine.com



1, 2 & 3 Drum Friction Winches,
2 Ea. Clyde Frame & Double Drum,
American 55B, 70B, 90B, 120B.



2 Ea., 38" Westec Power Blocks
\$30,000 Ea.

TRIPLE "C" MARINE

PO Box 885

Morgan City, LA 70381-0885

Phone: 985-384-9517
www.triplecmarine.com



Manufacturer of Marine Air Conditioning Systems, Chillers, Water and Air Cooled Package Units, Refrigeration, Explosion Proof

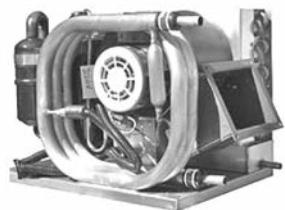

6,000 to 40,000 BTU



16k to 320k BTU Air Cooled Heavy Duty, Explosion Proof



Air Conditioning Condenser Unit / Ref. Unit up to 50 HP



60,000 to 360,000 BTU Self Contained

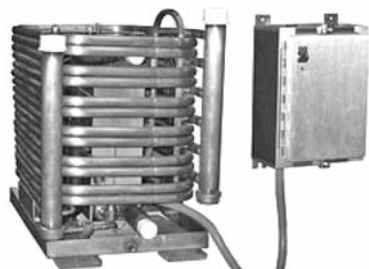

Chiller 60,000-180,000 BTU

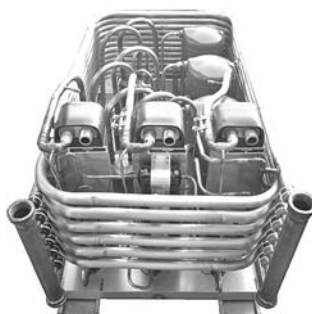

Triple Compressor up to 500,000 BTU

- Custom Engineering On Site
- Fast Delivery
- We ship world wide
- Water Cooled Self Contained Units for boats from 24 feet to Cargo Vessels
- Specialist to the Military, Shipbuilders
- Air-Cooled Marine Package AC for Pilot Houses
- Oil Rigs
- Marine Load Bank

On Site Manufacturing since 1993
Contact Us Now Toll Free 1 866 227 7773

Phone: 772 220 0038 Fax: 772 220 0260

Email us at: obr@oceanbreezeac.com

Visit us online at: <http://www.oceanbreezeac.com>

Quorum Marine and Electronics Inc.

D / B / A Ocean Breeze 3920 SE Commerce Avenue
 Stuart, Florida 34997

★★★ REQUEST FOR PROPOSAL ★★★

The Beaver Island Transportation Authority (BITA) owner of the Ferry M/V Emerald Isle is requesting proposals/qualifications for design and modifications to the vessel.

To request a copy of the RFP contact:

Mary Cook, Executive Director
 Beaver Island Transportation Authority
 PO Box 426
 Beaver Island, Michigan 49782

231-448-3049

bitrans@tds.net

A copy of the RFP is also listed on the operator's, Beaver Island Boat Co (BIBCO), Website.
<http://www.bibco.com/bitanaengineerrfp/>

Proposals will be accepted by US Mail, other similar carrier or hand delivered. Proposals must be received by February 28, 2018 at 12 noon EST.

BITA reserves the right to reject any and all bids.

FOR SALE
BLOUNT PASSENGER VESSEL

PRICE REDUCTION to: \$2.7 million



Built: 1994
 LOA: 177.3 ft.
 Beam: 40 ft. (Extreme Beam)
 Draft: 06.3 ft.
 Gross tons: 99GRT
 Net tons: 67NRT
 Class Society: U.S. Coast Guard Certification

DWT: 340t
 Air Draft: 57 ft. max
 Main Eng: MAN - Total HP 1142
 Fuel Burn: 55 gal. hr. 2 engs. 1 gen.
 Pax Cap: 76
 Total Persons: 93
 Lying: Eastern Seaboard, USA
 Flag: U.S.A.

FOR MORE INFORMATION CONTACT

1-800-556-7450

or email operations@blountadventure.com

RATES, ETC.

DISPLAY ADVERTISING

(3 ISSUES)

RATES:

Based on the column inch which is 1" deep and 2 1/4" (14 picas) wide

| SIZE | RATE | SIZE | RATE | SIZE | RATE | SIZE | RATE |
|------|----------|------|-----------|------|-----------|---------------|-----------|
| 1" | \$73.00 | 12" | \$552.00 | 27" | \$1161.00 | 48" | \$1728.00 |
| 2" | \$118.00 | 13" | \$585.00 | 28" | \$1204.00 | 52" | \$1820.00 |
| 3" | \$174.00 | 14" | \$630.00 | 30" | \$1260.00 | 56" | \$1960.00 |
| 4" | \$232.00 | 15" | \$675.00 | 32" | \$1344.00 | 60" | \$2040.00 |
| 5" | \$290.00 | 16" | \$688.00 | 33" | \$1353.00 | | |
| 6" | \$348.00 | 18" | \$774.00 | 36" | \$1404.00 | | |
| 7" | \$406.00 | 20" | \$960.00 | 39" | \$1521.00 | | |
| 8" | \$432.00 | 21" | \$903.00 | 40" | \$1560.00 | Double Page | \$4224.00 |
| 9" | \$450.00 | 22" | \$946.00 | 42" | \$1596.00 | Center Spread | \$4608.00 |
| 10" | \$480.00 | 24" | \$1032.00 | 44" | \$1628.00 | Cover Page | \$2144.00 |
| 11" | \$506.00 | 26" | \$1188.00 | 45" | \$1665.00 | | |

Full Page \$2,176.00 1/2 Page \$1,344.00
 1/3 Page \$903.00 1/4 Page \$688.00

CLASSIFIED ADVERTISING

88 cents per word, minimum 20 words for \$17.60 (charge covers two consecutive issues), \$1.32 per word, minimum 20 words for \$26.40 (covers three consecutive issues), \$1.76 per word, minimum 20 words for \$35.20 (covers four consecutive issues). Each additional consecutive issue .44 cents per word. For "Blind" ads (B&H Box No. replies) add \$4.00 for 2 issues or \$6.00 for 3 issues. Include in count words in name, address, (phone numbers count as 2 words), & count each initial or number as a separate word unless considered good style to group, as P.O., H.P., 16-278A, etc. but if more than seven characters count as two words. Email & Web addresses count as 3 words. **BOLD TYPE** - \$1.20 per word 20 word minimum for \$24.00 (charge covers two consecutive issues), \$1.80 per word 20 word minimum for \$36.00 (covers three consecutive issues), \$2.40 per word 20 word minimum for \$48.00 (covers four consecutive issues), etc. **RED BOLD TYPE** - \$1.20 per word + \$10.00 Color Charge, 20 word minimum for \$34.00 (charge covers two consecutive issues), \$1.80 per word + \$15.00 Color Charge, 20 word minimum for \$51.00 (covers three consecutive issues), \$2.40 per word + \$20.00 Color Charge, 20 word minimum for \$68.00 (covers four consecutive issues), etc.

• TERMS: Payment With Order
 • CLOSING DATES: 8th, 18th, 28th, 10:00AM C.S.T. (Unless Otherwise Published)
 We Reserve The Right To Reject Any or All Advertising.

ADDRESSES - (MAILING) Boats & Harbors, P.O. Drawer 647, Crossville, TN 38557
 Physical Delivery Address: Boats & Harbors, 175 4th St. Crossville, TN 38555-4302
 Phone: (931) 484-6100 • (931) 484-8708 • Fax: (931) 456-2337
 Email: gdonnelly@boats-and-harbors.com • www.boats-and-harbors.com

MECHANICAL REQUIREMENTS FOR DISPLAY ADVERTISING

1. Printing process: Web offset.
2. Binding method: Saddle stitched.
3. Trim size 10-1/4" wide by 17" deep
4. 4 column page format.
5. Width of single column: 2-1/4" (14 picas)
 Width of two columns: 4-3/4" (28-1/2 picas)
 Width of three columns: 7-1/4" (43 picas)
 Width of four columns: 9-3/4" (58-1/2 picas)
6. Depth of column: 16-1/4"
7. Minimum size space unit; one column in. (2-1/4"W x 1"D)
8. All display ads must be full inches (no fractions).
9. Ad must be as many inches in depth as it is columns wide.
10. Publisher accepts: Negatives (right reading emulsion side down); repro proofs; camera-ready art; copy to be set in type. For best results, we recommend the submissions of quality white proofs rather than negatives. (Mail repro proofs flat or in mailing tube).
11. Black and white halftones: 80 to 100 line screen.
12. For best quality, submit clear sharp photos.
13. Page number or position on page not guaranteed.
14. Contract advertisers are entitled to one complete change of copy every three issues. When change of copy is not received by closing date, copy run in previous issue will be inserted.
15. The publisher assumes no liability if for any reason it becomes necessary to omit any advertisement.
16. No cancellations or changes in orders will be accepted after closing dates.

SUBSCRIPTION ORDER FORM

- * Standard Mail - (One Year - 36 Issues - 3 Per Month).....**\$39.95**
- * Standard Mail - (Two Years - 24 Issues - 1 per month).....**\$35.90**
- * Standard Mail - (One Year - 12 Issues - 1 per month).....**\$17.95**

***USA & POSSESSIONS ONLY**

- * First Class Mail - (One Year - 36 Issues - 3 Per Month).....**\$81.95**
- * First Class Mail - (Six Months - 18 Issues - 3 Per Month).....**\$41.95**
- * First Class Mail - (One Year - 12 Issues - 1 Per Month).....**\$31.95**

Remittance Enclosed \$ _____

Foreign (Send For Rates)

PH: (931) 484-6100

FAX: (931) 456-2337

Email: gdonnelly@boats-and-harbors.com • www.boats-and-harbors.com

BOATS & HARBORS

P.O. Drawer 647
 Crossville, TN 38557

2 Rip Rap Barges on Norris Lake



Excellent Condition



Contact (865) 617-4290

50' Fiberglass N.E. Dragger



New 671 Detroit Diesel with 2:1 gear. New wiring Pitts, electric PTO w/ hydraulic split winches, w/ 2 deck winches. Full electronics hauled in November, fully painted. Call for additional photos.

\$70,000 OBO • Bob (516) 982-6090

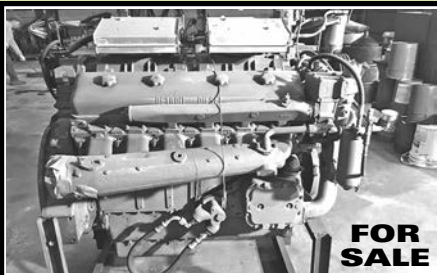

FOR SALE

12V71 Complete Engine - New Old Stock N65 Injectors, 12VA-15866, 7123-7300. Also have a spare machined 12V71 block. (508) 776-9759

TO REDUCE, RECOVER AND SAVE ON ELECTRICITY COSTS, JUST CALL LEAH.



Leah, the Hialeah Meter Maid

Remanufactured meters with everything you need to install on existing power box or pedestal* now only **\$37.99**

- Meter (Single Phase) with 2 Year Guarantee
- New Meter Socket
- New Nipple
- New Mounting Hub
- Security Seal
- New Sealing Ring

*We have power boxes and pedestals should you need them as well.



120/208V meters also available

HIALEAH METER

Meters you can believe in since 1954.

www.hialeahmeter.com • 800-654-0821 • 800-521-9925

"WHEN YOU NEED TO GET THINGS MOVING!"

VALUE FOR YOUR ADVERTISING DOLLAR?



OUR BUSINESS IS TO GET YOUR ADVERTISING PROGRAM RUNNING IN THE RIGHT DIRECTION!

CALL, FAX, WRITE OR E-MAIL: BOATS & HARBORS

P.O. DRAWER 647 - CROSSVILLE, TN 38557

PHONE: (931) 484-6100 • FAX: (931) 456-2337 • gdonnelly@boats-and-harbors.com



140' x 40' x 7' Crane Barge With LS318
100' x 30' x 5' Spud Barge with 80T Grove Truck Crane
(2) Conex Buildings with Tools and Quarters
650HP Truckable Tug
Call Tommy @ 504-450-8332



McDermott Light & Signal

Our LED Floodlights provide durability with a low amperage draw that maintains the lifespan of your alternator. Avoid Damaging your charging system by replacing your high power consumption halogen with our green, low-energy consumption LED lights.



30 Watt



10 Watt



50 Watt



100 Watt



140 Watt

*Most models available in Spot or Flood type



BARGE LIGHTS



TUGBOAT NAVIGATION LIGHTS



DREDGE LIGHTS



BUOYS



SOLAR ANCHOR LIGHTS



McDermott Light & Signal

718.456.3606 - www.mcdermottlight.com

fishing@mcdermottlight.com



www.YachtSalvage.com



52' Shannon 2017 (Brokerage) YS170149



47' Fountain 1997 (Private Liquidation) YS170101



41' Beneteau 1999 (Donation) YS170286



23' Trophy 2007 (Brokerage) YS170344



40' Formula 2008 (Private Liquidation) YS170162



45' Carver 2000 (Donation) YS170211

Hundreds Of Boats For Sale

For More Information Please Call One Of Our Offices
Warwick, RI (401) 732-6300 • Charleston, SC (843) 789-0357
Mendon, MA (508) 478-0200 • St. George, SC (843) 563-9199

Boats & Harbors

CLASSIFIEDSExperience
The Selling Power of The
Yellow Sheet!Place Your Ad (931) 484-8708 or Email: Tlewis@boats-and-harbors.com • Fax: (931) 456-2337 • Submit Online: www.boats-and-harbors.com

★ PROPELLERS WANTED

PROPELLERS WANTED 20" and Up, Any Condition or Metals. (337) 839-2468 or Email: ken@spiritmarine.org

WE BUY PROPELLERS. Any Material or Condition. 20" and up. Johnny's Propeller Shop. (985) 384-6940

★ PROPELLER SHAFTING FOR SALE

ABSOLUTE BEST PRICING: Aquamet HS Shafting & Dynotorc Props. (781) 837-5424 twindiscgears@aol.com

BOAT SHAFTING 3/4" to 29" Diameter, various lengths and metals. (337) 839-2468

BOAT SHAFTING, Up to 6", Bar Stock or Machined as Required, will ship worldwide. Lauderdale Propeller, deep discounts. (800) 329-7767

★ DIVING EQUIPMENT FOR SALE

HULL SCRUBBERS & Dive Compressors. We manufacture, you save. Armada Systems. USA. Phone (850) 912-8962, Fax (850) 912-8965
Email: armadahull@aol.com
Website: armadahull.com

★ BOAT HANDLING EQUIPMENT FOR SALE

1975 MODEL MARINE TRAVEL Lift AMO 50. \$25,000. Steel in excellent shape. Call Jr at (985) 969-2657.

1981 ACME MARINE Travel Lift For Sale. In great operating condition currently in use at Dana Point Shipyard. 300 cubic inch, 6 cylinder, gasoline Ford engine. Inside clear height is 26'. Inside clear width is 25.9' with a 76.5" removable center beam. Without center beam, inside clear width is 19.5'. Lifting capacity is 50GT. Asking \$50,000 OBO. Lift will be available on February 10th. For additional information, please call Steve Morris at (949) 542-3368 or call our office at (949) 661-1313 and ask for Steve.

35 BFM BOAT HOIST 2,000. 35 ton capacity 77,000 lbs. 17'1" inside width, 18' inside height. Ford engine, front & rear powered slings. Located in Maine. Call Jack (781) 347-1201

or sales@walterco.com
Pics at www.walterco.com

CLEAN OUT YOUR STORAGE TODAY! Sell it in Boats & Harbors! Call us today at (931) 484-6100 or place your ad online at www.boats-and-harbors.com

MARINE TRAVELIFT FOR SALE. 35 BFM Boat Hoist 1988, 35 ton capacity 70,000 lbs., 17' inside width, 18' inside height, Ford engine, front & rear powered slings, located in Massachusetts. Call Jack (781) 347-1201. Pics at: www.walterco.com or sales@walterco.com

GOOD CONDITION, 490.8 hours. Re-manufactured 6.354 Perkins engine installed (from Taylor). Recent paint. Six new tires, 4 new rims, all replaced within the past year. New mast cylinder. New lift chain. New fork coverings. Up-to-date service. Currently used only in boatyard, not in rack storage, for service only. (954) 567-2628

HOSTAR - HYDRAULIC TRAILERS - New and Used, road / yard. Boat stands, dollies. (800) 783-9303, (508) 295-2900, Fax (508) 295-2922

www.hostarmarine.com

MARINE FORK TRUCK Fork Replacement. Starting at \$18,000 installed. (239) 309-9238

MARINE TRAVELIFT For Sale. 1990 70 BFM with Ford 300 C.I. gas engine \$100,000. Well maintained with 18'-8" ICW. For additional details, call (251) 987-1696 or Email: charlesj@gulfnet.com

MARINE TRAVELIFT FOR SALE. 69 AMO Boat Hoist 1982, 69 ton capacity, 138,000 lbs., 24' inside width, 22' inside height., Ford engine, spreaders, located in Rhode Island. Call Jack (781) 347-1201.

Pics at: www.walterco.com or sales@walterco.com

USED MARINE TRAVELIFT Boat Hoists For Sale. Call (781) 347-1201 or go to www.walterco.com for listings.

★ BOAT HANDLING EQUIPMENT WANTED

TRAVEL HOIST WANTED: 15 to 100 Ton Needed. Any brand. Call Mike Mazzeo. (609) 263-6900 mikemazzeo@gantrytrading.com

WANTED: 100 TON TRAVEL LIFT, In Good Condition. East coast preferred. Dave Allan. (207) 841-7257

★ MARINE EQUIPMENT FOR SALE

(2) DETROIT DIESEL 671. (2) Fuel oil deep well pumps, 16 ft. (2) Angle drives for deep well pumps. (1) Hydraulic anchor winch. (2) Oil barge anchors. (2) Hand winches. (2) Diesel generators, 26 Kw @ 1,800 RPM's. Pictures are available upon request. BNG-NY@hotmail.com

★ PILING FOR SALE

STEEL PIPE For Piling, Spuds, Dredging, Etc. See our display ad in this issue. (800) 238-7473. www.crestwoodtubulars.com

★ AIRCRAFT TIRES FOR SALE

USED FOR FENDERS or Bumpers. All sizes of aircraft and special service tires for marine uses. Tire Traders Inc. Cell phone: (516) 526-6363. Fax: (516) 897-7426. Email: tiremw@aol.com

★ ROPE FOR SALE

2,050 PHILLYSTRAN POLYESTER Marine Winch Line or general use rope, 1.82" diameter, 175,000 lb break strength. Price: \$14,000. Call Michael (334) 799-4149

★ CRANES FOR SALE

380 TON STIFF LEG mounted on a barge. Texas. Call (281) 635-7151.

BUCYRUS ERIE Super 30-B Crawler, set up with generator for magnet operation, 471 engine air controls. \$10,000. (516) 527-4951

MARINE CONSTRUCTION CRANE. Bucyrus Erie Hydro Crane 20 Ton prepped for barge mount. Free fall Hydro, everything new / re-built, ready to work. Over \$90K invested. Only 9' tall. \$49,000.00 OBO. (239) 571-7074 or info@naplesdockbuilders.com

LINKBELT LS 78 CRAWLER. 371 Diesel, 50' boom, independent swing and travel, both lines power lowering. \$38,000. (631) 264-3522

★ HOIST/WINCHES FOR SALE

AMERICAN 120-B 2-Drum Deck Winch \$10,500.00. 1(514) 386-7507 sergeharrison2@gmail.com

★ HELP WANTED

200T AND UP CAPTAINS with Master of Tow Wanted. San Diego and Long Beach, CA. Pacific Tugboat Service. Ask for Bob. (619) 533-7932

HAVE MARINE PARTS YOU NEED to sell? Let Boats & Harbors help you! (931) 484-6100 or place your ad online at www.boats-and-harbors.com

DECKHANDS, Party Fishing Boat fleet, Myrtle Beach, SC. area. Nice boats, good pay, plenty of work. Call Capt. Larry (910) 367-6417.

MATES, DECKHANDS, CAPTAINS, and Servers Needed for Dinner Cruise Boat in Ft. Lauderdale, Fla. Call (954) 448-1044

★ INSTRUCTION

BECOME A PROFESSIONAL Marine Surveyor, commercial and recreational courses. Navtech US surveyors nationwide home study guide. Survey forms, check lists, USCG NVCS, accreditation. USCG approved for fishing vessels. Advertise your boating business with us on the web! Toll-free: 1-(800) 245-4425.

CAPTAIN'S LICENSE PREP GUIDE For 6 Passenger and 100 Ton Master's Licenses. 2018 Edition. Actual exam questions, answers, Flashcards, Rules of the Road, Chart Lessons. Guaranteed! Still \$37.50. Best nationwide prices on Rules CD, DVD's. Other DVD's and CD's available. Renewal test assistance. National Captain's Institute, Box 11834-H, St. Petersburg, FL 33733. Order online at

www.Captains.com
or Toll Free at 1-(800) 345-6901.
Immediate Shipment!

★ MISCELLANEOUS FOR SALE

(2) VERINALIFT DUAL Stage Mufflers. 12 inch exhaust, new, never used. \$1,200.00 each. (757) 287-4153

USED GM ENGINES For Sale. Used 671's, 8V71's, V12's, V16's, and used pumps & generators. Large or small starting @ \$2,000. For pictures and specs & more marine misc. equipment, call (956) 943-2648 or visit our

website: www.marineservice.us

★ NAUTICAL JEWELRY FOR SALE

FISHHOOK PENDANT NECKLACES on 18" black cord. Free shipping after check clears. Send order and check for \$20 each to Virginia Koetzner, PO Box 260, Bellport, NY 11713. (631) 475-5479.

ADVERTISING WITH US is easy as 1, 2, 3. Give us a call! (931) 484-6100 or see us on the web at

www.boats-and-harbors.com
to place display or classified ad.

★ BUSINESSES FOR SALE

BURTON SHIPYARD, Bridge City, Texas. (Near Beaumont, Texas) Established in 1985. Dry-dock, 30 acres, 800x100x11' slip. Offices, storage buildings. Protected waterway and slip. 100 Ton Crawler crane. Call Stephen Wilson (281) 635-7151.

FLORIDA BLUE CRAB restricted species license for sale. Comes with boat, hauler and some traps. \$25,000 or best reasonable offer. Call Dave (508) 527-2562.

MARINE CONTRACTOR / Dock Builder in booming SC coastal market. Highly successful 27+ year operation. Extensive equipment, including 3 barges and cranes. Current client contracts in hand. 3 months waiting list for new projects and growing! Owner ready to retire but will negotiate transition contract. No Brokers! For more information, Email: info@marinedockcontractor.com

NUMBER 1 OFFSHORE Charter Fishing Company in Key West. Since 1994, we have grown this business from one to four boats. This is a great opportunity to own the most popular offshore charter boat business in Key West. Grossing approximately \$1,000,000.00 per year. All federal, state licenses and top of the line tackle included. Our boats range in size from 34FT to 39FT. These boats are turnkey, diesel powered, fishing machines. Call (954) 798-7764.

TOWBOAT BUSINESS For Sale. Owner of very successful South Florida towing & salvage company wants to retire. Selling entire company; vessels, oil spill equipment, and boat trailers for sale. Protected area. No brokers need to call. Call (772) 465-0709.

★ BUSINESS OPPORTUNITIES

HAVE A BUSINESS and Live in Oriental Harbor, NC. in large marina. Boat repair yard? Marine Contracting? Yacht Brokerage? Rack-N-Stack? Towing? Salvage? On Intracoastal Channel. Steel dredge barge with pile driver, on one acre deep water commercial parcel, with newly renovated house & rental cottage. 500 boats within walking distance. Financing available. \$560,000. Call Capt. Ron Diamond (518) 294-6181.

COLLEGE FOR SELL or Interested Partner. Joint venture underwater certification for a Scuba College. Veteran's approved for sell. Air compressors. School has a # of patents. Underwater spearguns / powerheads / dive regulators. (229) 200-4777 califanoadvanced@aol.com

★ MARINAS FOR SALE

NORTHERN OCEAN COUNTY, New Jersey, marina for sale. There are 200+/- slips on 9+/- acres on wide river frontage close to Barnegat Bay. There are two travel lifts, 15 & 40 ton plus numerous yard equipment. There is a swimming pool & 13 buildings, including restaurant. Plans are approved to build eight new structures, including a two and a half story restaurant directly on the water. This would create sixteen income producing units. \$8,500,000. Owner financing available. Phone (732) 604-2376

YOUR AD LOOKS GOOD IN PRINT! Whether it is Boats For Sale, Engines For Sale, Gears For Sale or a Wanted Ad your advertising can be more effective by placing your vessels and equipment with us! Call Now: 931-484-6100 or Email: tlewis@boats-and-harbors.com

★ SHIPYARDS

BURTON SHIPYARD FOR SALE, Bridge City, Texas. 30 acres. Dry dock. Equipment included. Stephen Wilson, Marine International LLC (281) 635-7151 marineone1st@yahoo.com

NEXT CLOSING DATES

First March Issue 2018

• Mailed February 28th, 2018 •

For Display - Feb. 23rd, 2018 • (9:00 A.M. C.S.T.)

For Classified - Feb. 27th, 2018 • (10:00 A.M. C.S.T.)



REMOVE
paint, rust, scale
& barnacles
from steel ships

800.823.4670
www.swirloff.com

PROVEN RESULTS

THE ONLINE DIGITAL EDITION AND OUR PRINT EDITION OF

BOATS & HARBORS®

Buy and sell anything connected to the commercial marine industry using our time proven print edition and the power of the internet!

To View Our DIGITAL EDITION or Contact Us Online Go To:

www.boats-and-harbors.com

For More Information Call:
(931) 484-6100

"MARINE INDUSTRY SALES AND CHARTERS"

DAMCO MARINE MANAGEMENT, INC.

MORGAN CITY + NEW ORLEANS

PHONE (985) 384-2614 + FAX (985) 384-3741

BRITT CELL: (985) 714-0974 + DON CELL: (985) 397-1941



BOATS

Crew Boats • Lugger Boats
Tug Boats • Push Boats
Supply Boats
Utility Boats • Lift Boats

BARGES

Deck Barges • Hopper Barges
Living Quarters Barges
Spud Barges • Tank Barges
Crane Barges

CRANES

American Cranes
Lima Cranes • Terex Cranes
Manitowoc Cranes
Linkbelt Cranes

NEW CONST.

DRYDOCKS

MISC. EQUIP.

WE ARE LOOKING FOR NEW LISTINGS IF ANYONE IS LOOKING TO SELL.
PLEASE CONTACT US ON INFO ABOUT HOW TO LIST WITH US.



OUR INVENTORY IS GROWING DAILY,
PRICES ARE STARTING TO DROP, AND IT'S A BUYERS' MARKET.

COME VISIT OUR WEBSITE AND SEE WHAT'S NEW.



DAMCO MARINE MANAGEMENT, INC., with over 30 years in the marine brokerage & consulting business, offers quality marine equip., including new & used Boats, Barges, Cranes, & Dry Docks, & many other miscellaneous equip. available under U.S. or foreign flags. We have financing options available, we will arrange for NAMS Surveys and Valuations, we can help you ship, transport domestically or internationally, help with refloating, redocumenting, transferring ownership, we also have charter and bareboat options. We will facilitate the purchase/sale transaction from start to finish.

••• IF IT FLOATS WE CAN HELP YOU BUY OR SELL IT •••

• Call For Details And Additional Pictures •

E-mail: britt@damcomarine.com • don@damcomarine.com • www.DAMCOMARINE.com

CLOSING DATES • FIRST MARCH ISSUE 2018

• To Be Mailed February 28th, 2018 •

For Display February 23rd, 2018 For Classified February 27th, 2018
(9:00 A.M. C.S.T) (10:00 A.M. C.S.T)



Hydraulic Thruster Manufacturer



Self-propel your barges & sectional Floats

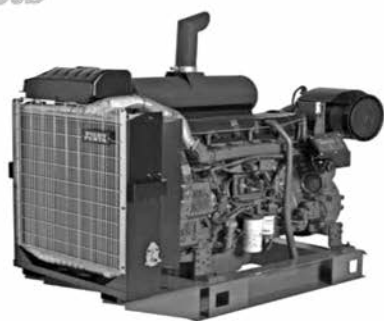

Featuring

VOLVO PENTA®

Available Now Refurbished / Used Thrusters

See Website For Details

1-386-734-0020

www.hydraulicmarinesystems.com

ISLAND WIDE MARINE INSURANCE

Superior Service Since 1977

CUSTOMIZED POLICIES

Designed Specifically For:

**Passenger Vessels
Sightseeing - Dinner Cruise
Headboats - 6 Packs - Ferry
Dolphin - Whale Watch**

FEATURING:

- ★ **Basic & Enhanced Policies**
- ★ **Competitive Pricing**
- ★ **Easy Payment Terms**
- ★ **Discounts For Seasonal Operations**



Marine Insurance is Our ONLY Business
1-800-635-6097



2001 Zodiac LRI
Great Shape - 2 Ea. Available



2001 Sea Ark
Yanmar Diesel, Excellent Cond. • \$89,000 OBO



2005 36 Sea Ark Patrol Fire Boat
Excellent Condition • Reduced Price



25' SafeBoat Defender
Great Shape, NO POWER
Reduced Price • 11 Available



1997 23' Sea Ark Little Giant
Diesel Powered, Fresh Paint, Just Serviced
Call For Pricing



2001 21' Sea Ark
Twin Four Stroke Outboards
2 Ea. to Choose From • Call For Pricing



41 UTB 41446 "Detroit"
Freshwater Boat, Nicest Original 41 Around.
Price Reduced on all 41's, 6 Ea. to Choose From



50' UTB Utility Boat
3 Ea. to Choose From • Price Reduced

ALL VESSELS ARE IN STOCK AND AVAILABLE FOR IMMEDIATE PURCHASE

For More Information On All These Boats Please Call:

Mike (850) 221-5138 Or

Visit Our Website: www.kclmsales.com

**WELLS
FARGO**

Accommodation / Work Barge

Now available from Wells Fargo



For sale, lease or long term charter. Financing available to qualified buyers.

To view the photo gallery, visit the Wells Fargo Asset Seller Marine Showcase at assetseller.wf.com/marine

1994 Trinity - Steel Barge

Dimensions: 250' x 72' x 16'
Deck space: 110' x 52' - 2,000 sq ft

Deck: 9/16"
Side: 1/2"
Bottom: 1/2"

4 Point Mooring System

Winch Control Tower

- 4 - Intercon Winches 12V71 300,000# capacity
- 4 - 5,000' x 2" wire rope
- 4 - 10,000# Anchors - Delta Flippers
- 4 - Pennant Buoys
- Each drum can hold up to 9,200' wire rope, currently has 5,000' rope

Below Deck Machinery Space

Satellite Communications / Internet Access

Heliport: 62' x 50' - 12,000 lb capacity

US FLAG, USCG Cert (expired), ABS Classed A1 (expired)

15 Ton (Man Rated) Pedestal Crane

Fire Pumps

Internal Ballast System - 335,124 gallons

Freshwater - 394,330 gallons

Sewage Treatment System

Generators:

- 2 - 300 KW Electric Generators
- 1 - 99 KW Std-by Generator

60 Person Living Quarters

- Client Offices / Accommodations
- Safety Office
- Recreation Room
- Weight Room
- 32 Person Galley Capacity

Freshwater under scheduled maintenance program

Located in Morgan City, Louisiana

* Specifications subject to change without notice

For more details, and to schedule your inspection, contact us today!

Joe DiSalvo

Marine Remarketing Manager, Wells Fargo Equipment Management Group

Tel: 203-616-2016 | joseph.disalvo@wellsfargo.com



Scan this to see our complete inventory and comprehensive equipment details.

If you do not have a smartphone visit assetseller.wf.com/marine to learn more.





METAL SHARK
METALSHARKBOATS.COM



36' Courageous



38' Defiant



75' Endurance

337.364.0777 • sales@metalsarkboats.com

**FRASER
MARINE
PRODUCTS**



**MANUFACTURING QUALITY
ALUMINUM & BRONZE HARDWARE
TO THE BOAT BUILDING INDUSTRY
SINCE 1965**



WWW.FRASERBRONZE.COM

5625-48th Dr. NE Unit D Marysville, WA 98270
Toll Free: 877-264-1064 Made In USA

**Heartland Barge
MARINE BROKERS**
618-281-4503
www.HL-Barge.com

STEEL PIPE

NEW & USED STEEL PIPE

FOR: Piling, Spuds, Dredging,
Ballards, Floats, Casing, Etc.

CURRENT SPECIALS

- 30,000' 8-5/8" O.D. x .188"/.500" wall pipe
- 15,000' 10-3/4" O.D. x .250"/.500" wall pipe
- 20,000' 11-3/4" O.D. x .534" wall pipe
- 40,000' 12-3/4" O.D. x .250"/.750" wall pipe
- 10,000' 16" O.D. x .250"/.500" wall pipe
- 15,000' 24" O.D. x .312"/.750" wall pipe
- 30,000' 36" O.D. x .375"/.750" wall pipe

Plus many more sizes!

Call Anytime on 2"-46" Dia pipe

DELIVERY ANYWHERE IN:

US/CANADA/MEXICO/CARIBBEAN

CRESTWOOD TUBULARS, INC

Phone: (314) 842-8604

Fax: (314) 842-9064

Toll Free (US) 800-238-7473

Email: info@crestwoodtubulars.com

www.crestwoodtubulars.com



UNDERWATER LIFT BAGS
ENGINEERED FROM THE BOTTOM UP!

- OPEN BOTTOM AND ENCLOSED LIFT BAGS FROM 100 LBS TO 50 TONS
- CABLE AND PIPELINE FLOATS
- WATER LOAD TEST BAGS
- LIFE BOAT TEST DAVIT TEST KITS
- PIPE PLUGGERS - INFLATABLE PIPE STOPPERS
- INFLAT-A-TANK - LIQUID STORAGE BLADDERS
- FEND-AIR™ - INFLATABLE MARINE FENDERS
- RENTALS AVAILABLE

• MADE IN USA • ALL MAJOR CREDIT CARDS ACCEPTED • IMCA COMPLIANT

P.O. Box 2030 • North Kingstown, Rhode Island 02852 USA

Phone: (401) 884-8801 • Toll Free: (800) 466-6962 • Fax: (401) 884-8868

Website: www.SUBSALVE.com • E-mail: Richard@Subsalve.com

FOR SALE

**Used Travel Lifts
70 BFM**



Travel Lift 70 BFM

Year: 2000
Capacity: 154,000 LB.
Engine: John Deere Diesel
Inside Clear Width: 20'
Inside Clear Height: 26'
Wheel Base: Standard
Tires: Good
Available: Now!

- * Newly reconditioned
- * 3 ft. extra height



Travel Lift 70 BFM

Year: 1991
Capacity: 140,000 LB.
Engine: John Deere Diesel
Inside Clear Width: 27'
Inside Clear Height: 22'
Wheel Base: Standard
Tires: Good
Available: Now!

- * Good, strong running machine
- * Extra wide machine



**International
Boatlift
Exchange**

James Alfieri (813)653-4390 ibe@tampabay.rr.com

www.ibeglobal.com

© International Boatlift Exchange, Inc.

5 MILLION LBS. IN STOCK
RENT - SELL - LEASE - TRADE

Anchors, Chain, Buoys, Yokohamas,
Sea Cushions, Wire Rope and Fittings,
Deck and Dock Hardware, Oil Boom,
Towing and Salvage Equipment

NEW

USED

A.B.S.



**Anchor Marine
& Industrial Supply, Inc.**

P.O. Box 58645
Houston, TX 77258

1-800-233-8014

(713) 644-1183

24 Hour Service

Fax: (713) 644-1185

WEBSITE: www.anchormarinehouston.com
email: sales@anchormarinehouston.com

Modular Plastic Pontoons
The Best Idea Since the Indian Canoe
36 and 24-inch Diameter Sizes



Wilson pontoons are used for pontoon boats, houseboats,
barges, work boats, party boats, pumping stations—they're
perfect for any application that uses pontoons.

- Molded from sturdy, medium density polyethylene (MDPE)
- **Heavy-Duty:** filled with closed cell polyurethane foam
- **Modular:** separate bow, middle, and stern modules allow for configurations of the most popular application sizes
- **Maintenance Free:** bottom painting recommended if left in saltwater full time. Otherwise, just pressure wash to clean.
- UV protected



Pontoons, Inc.

2869 Charlevoix St.

The Villages, FL 32163-2019

phone: 419-675-0002 • toll free: 877-456-2531

email: info@wilsonpontoons.com

www.plasticpontoon.com

MERTON'S

FIBERGLASS AND MARINE SUPPLY

- Complete hand lay-up fiberglass supplies for light & heavy fiberglass or wood boat repair & construction.
- Polyester, Epoxy, Vinylester Marine Grade Resins.
- Marine Topside Enamels & Antifouling Bottom Paint.
- Silicon Bronze & Stainless Steel Fasteners

Quality Brand Name Products
Competitive Pricing
All items in stock for Immediate shipment

Online catalog
www.mertons.com
Call 800-333-0314
P.O. Box 399
East Longmeadow, MA 01028

Supplying Quality Products To Boat Owners.
Hull Finishers & Boatyards for over 20 years

800-333-0314



Scruton Marine Services

Peggy or Mike Scruton
MARINE BROKERS
49 John Street
Port Dover Ontario,
NOA 1N7

Website:
www.scrutonmarine.com
Email:
sms@scrutonmarine.com
Ph: (519) 583-1636
Fax: (519) 583-2189

1981 SWIFTSIP



91 x 19.6' Crew / OSV Triple V1271T, 2,600 fuel cap. Located Galveston, TX. \$209K OBO. Call Richard:
(713) 705-0037



COI 37 PASSENGER DINNER BOAT

1988, 64 x 14 Tri Hull, Great Condition, 4 Cylinder Turbo 2 - Volvo Engines. 1 Kohler Generator, Full Galley And Bar, Chairs And Tables.
\$125,000.00
Gordy - (612) 802-2072

Turnkey Charter Boat

For Sale Established 1971



Busy South Florida Marina. Gross is \$125K+ a year. Family owned and operated. Hatteras 41', V-6 Detroit Diesels, Onan genset, Pompanette chair, Rupp riggers, Furuno color sounder, 1 year old A/C.
Asking \$100K
Capt. Brad (561) 732-1980

Landing Craft

Available for Charter

(2) LCM-8 - 74' x 21' x 4'
Capacity 50 Tons

(1) LCM-6, 56' x 14' x 3.5'
Capacity 25 Tons

All Equipped w/ Hydraulic Cranes
DAVE ALLAN • (207) 882-5400

50' EX-NAVY DIVE BOAT

Asking \$35,000



Twin 671N (Approx. 1,000 Hours)
30 KW 3 Phase Generator
Contact: Ryan or Doug (757) 898-5060
Will Email Pictures Upon Request

WWW.BOATWINDOWS.BIZ

B & J Aluminum Windows Inc
1-800-621-1381
sillycajun@aol.com
Made In USA

CLOSING DATES • FIRST MARCH ISSUE 2018

• To Be Mailed February 28th, 2018 •

For Display February 23rd, 2018 For Classified February 27th, 2018
(9:00 A.M. C.S.T) (10:00 A.M. C.S.T)

Available for Monthly or Yearly Lease



Manitowoc 4100W Series II Heavy Lift Crane Barge • Price: \$1,200,000.00
1992, 230 Ton Crawler Manitowoc 4100W Series II sitting on a 155' x 54' x 10' Steel Barge. Barge also equipped with Generator, Welding Machine, Air Compressor, Sewage Treatment System, Office Building and Equipment Shed. Crane has 200' of boom and a 60' jib.
Contact: Troy Lombardo - 1414 River Road, Berwick, LA 70342 • Of: (985) 384-8770 • Cell: (985) 637-8775

Central Boat Rentals, Inc.

Morgan City, LA

Ocean Barges: 180 x 54 x 12 260 x 72 x 16

Tank Barges: 10K & 30K bbl Double Skin

Ocean Towing **Barge Fleeting**

Shipyard Services

(985) 384-8200 centralboat.com

WANTED

Marine Boat Service Manager

Star Island Yacht Club, Long Island's #1 Marina Destination, located in Montauk, seeks a marine boat service manager. Manage service department, complete work orders, experience in troubleshooting and repairing boats and engines, winterizing, hauling & launching, etc. Boat repair skills required, 10+ years of boat experience required, computer experience a must. This year-round position is an excellent career opportunity with a highly competitive salary and benefits. Email resume and salary history to resume@starislandyc.com or call Scott at 631-767-6891.





STAR ISLAND

YACHT CLUB & MARINA

STARISLANDYC.COM • PHONE: (631) 767-6891
RESUME@STARISLANDYC.COM

COMMERCIAL MARINE SUPPORT SALVAGE, DIVING & CONSTRUCTION

Cranes, Barges, Tugs, Ferry & Dredging Services • Crew, Tow, Film, Spill Security & Safety Boats.
Sales & Equipment Rentals • Meet The Fleet At www.CustomMarine1.com
Capt. Dwayne Reith • 646-235-9546 Tel. • 914-930-8907 Fax. • 710 Washington St., Peekskill, NY 10511

| | | | | |
|---|---|---|---|---|
|  <p>95' Warping Tug, Twin Detroit Diesel 8 Cyl. Engines, Winch Power Assisted Drum Allison MH30L Transmissions, 360 Degree Water Jet Propulsion. Asking \$99k W/O Winch</p> |  <p>2004 46' Dauntless Sea Ark, Twin Diesel Cummins (QSM-11) Engines. 580 HP @ 2300 RPM. Transmission is ZF Marine (ZF 325-1A). Fuel Capacity 500 Gallons (200 FWD Saddle Tank, 300 AFT Saddle Tank). 25 Knot Cruise.....\$295K</p> |  <p>2 - LCM-8, 1987, Freshwater Only, 700 Hrs., 80 Ton Capacity. \$329,000</p> |  <p>1985 American 9220, 125 Ton, 100' Boom, Cummins, 4 1/2 Yard Clam Bucket. On Bulkhead In NY Barge Accessible For Pickup. - \$149,000</p> |  <p>2004 Nautica Rib, 42'. Cost \$500K New. A/C, Genset, 440 Yanmar w/Jets. - \$119,000</p> |
|---|---|---|---|---|

| | | |
|--|--|--|
|  <p>1991 Thomas, 28' Pilothouse, Inboard Cummins, 6 Cylinder 6BTA 250 HP, Keel Cooled, 1,200 Hours. All Aluminum. - \$34,000</p> |  <p>2003 23' Rescue Boat, BH-HR7 Steyr 236 Diesel, 30 Hrs. \$50,000</p> |  <p>2000 32' Aluminum Breaux Brothers Work Boat, Mercruiser 454 FWC, Bravo 2, Fast Fuel Efficient. - \$44,000</p> |
|  <p>3- 1- 25' Steel Push/Work Boat, 1993, Twin 453, Both Diesels & Trans. Rebuilt Last Season, 24" 4 Blade Props. - \$64,000</p> |  <p>24' Henley Aluminum Work Boat, 4 Cyl Gas Volvo I/O, Just Rebuilt. - \$19,000</p> |  <p>1999 Metal Craft King Fisher 22', 150 HP Volvo I/O Penta Diesel, Trailer Included. - \$49,000</p> |
|  <p>Shugart (4) 40' x 12' x 5'3, 25 Ton Capacity Ea. 2- 20' Spud Wells, 2- 40-80' Spuds Avail. - For Lease</p> |  <p>2003 Sea Ark 28' Enforcer, Aluminum, Twin Yanmar 200 HP, Genset. - \$78,000</p> |  <p>Flat Deck Bin Wall Barge 130' x 38' x 11' x 1/2" Sides Mostly Freshwater. - \$120,000</p> |

FOR LEASE:

(2) 2007 25' x 12
TRUCKABLE PUSH BOATS -
(1) FOR SALE - \$159K FIRM

15' Eye Level, Twin Screw John Deere's, Flanking Rudders, Used Only In Fresh Water, Excellent Condition, Very Low Hours.



FOR LEASE OR SALE

(2) 2015 Marine Inland Truckable Push Tugs • \$275K

25'11" x 14'

2 - 300 H.P. John Deere 6068 turbo tier 3 diesels 700 hrs. Flanking rudders with 21' eye level upper station and 15' from house 10 kW Genset. Fire pump, diesel mounted on deck 2- 10 ton winches 3/4 cable.
2 - 36" x 24" x 2.5" work horse props. 9' Push knees. Very Low Hours





DIESEL GENERATORS

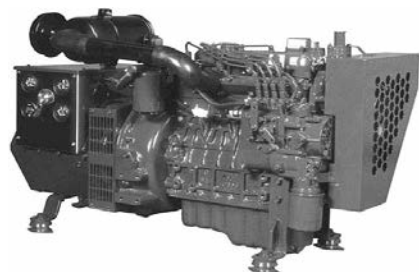
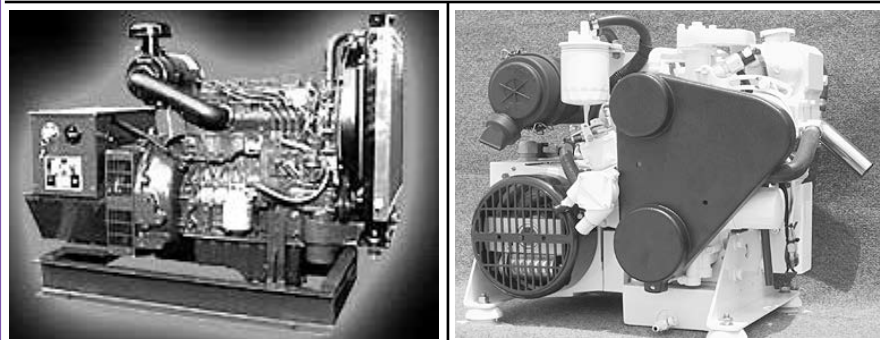

Kybo

1800 RPM Generators

| | Heat Exchange Cooled | Keel Cooled | Radiator Cooled Remote Radiator Only | |
|------|----------------------|-------------|--------------------------------------|---|
| 1cyl | 3.5kw \$ 5,775.00 | \$ n/a | \$ 4,525.00 | |
| 2cyl | 5.5kw 6,975.00 | 5,400.00 | 5,575.00 | |
| 3cyl | 7.0kw 8,642.00 | 6,050.00 | 6,465.00 | Prices include ISO mounts, switch start with hour meter, other accessories and options available. |
| 3cyl | 8.5kw 8,998.00 | 6,250.00 | 6,575.00 | |
| 3cyl | 9.5kw 9,986.00 | 6,475.00 | 6,935.00 | |
| 4cyl | 12.5kw 11,829.00 | 7,200.00 | 7,600.00 | |
| 4cyl | 15kw 12,458.00 | 8,200.00 | 8,525.00 | |
| 4cyl | 17.5kw 13,572.00 | 8,600.00 | 9,125.00 | |
| 4cyl | 21kw 14,685.00 | 9,450.00 | 9,675.00 | |
| 4cyl | 25kw n/a | 10,100.00 | 10,450.00 | |
| 4cyl | 30kw 20,160.00 | 10,500.00 | 11,120.00 | |
| 4cyl | 40kw n/a | 14,475.00 | 12,500.00 | |
| 4cyl | 50kw n/a | 15,600.00 | 13,950.00 | |

1732 St. Johns Bluff Road, Jacksonville, FL 32246
www.nextgenerationpower.com

904-642-8555

Marine Equipment Rentals

S-70 Flexi Floats & Accessories



Spud Barges
Jack Up Barges
Truckable Twin Screw Pushboats
Truckable Dinnys
Harbor Masters
Manitowoc Crawler Cranes
Construction Equipment For Sale



Chris Jarvais
207 679 2359
cjarvais@cianbro.com

CIANBRO



VECLOADER® 616 DOUBLE DUMP

Performance Proven Vacuum Solutions™
The VecLoader® 616 Double Dump offers 2,400 CFM & 28" Hg vacuum for greater job flexibility when conveying longer distances or handling dense material. The VecLoader® self-pulsing baghouse represents a 40-year legacy of proven safety and performance! All VecLoaders® are easily maintained and simple to use without complicated set-up. Call us today at 1-800-832-4010 or email us at inquiry@vector-vacuums.com to learn more!



The Original Since 1976
Vector Technologies Ltd.

8301 W Parkland Court | Milwaukee WI, USA 53223
Toll Free: (800) 832-4010 | Main: (414) 247-7100 | Fax: (414) 354-4314
web site: www.vector-vacuums.com
Email: inquiry@vector-vacuums.com

*2 year warranty applies to the engine and the blower; 1 year structural excluding wear parts

Continuous Duty

170HP John Deere

2,400 CFM/
28" Hg

54" Baghouse

100 Gal Fuel Tank

Heavy Duty Trailer

Four Point Lift

2 Year Warranty*

33% More Efficient

PROUDLY MADE IN THE

USA



WORLD LEADER IN ALUMINUM LANDING CRAFT



MUNSON & YAMAHA
A Winning Combination



WWW.MUNSONBOATS.COM

(360)707-2752 | jesse@munsonboats.com | 15806 Preston Place, Burlington, WA 98233



33 x 66 x 5 Clubhouse

With Ramps and Spuds.

trident677@aol.com For Details

65' Gillikin



75 pass, 2-8 / 71's, 2 gens, large cabin with booths, large wheelhouse, extra large framing and strong tight hull.

\$25,000 OBO • (732) 615-7531

36' Fiberglass Custom Built Sport Fishing, Commercial, & Dive Boat

Transom 11'3" and 14' beam. Twin 260 diamond series Cummins, 5,200 hours. New Awlgrip paint, hydraulics, shore power, battery charger, full electronics, and autopilot. Two insulated fish boxes below deck, 4,000 & 1,000 lbs., head, and sleeps 2, top speed 30 knots.

Located in NC

For More Pics and Info

Call (252) 423-0451

or email Tillett6@gmail.com



\$98,900

M/V Valcour For Sale



Length: 190' Overall, 177' Waterline • Power: Twin 425 HP CAT D-353 • Gross Tons R446, Net Tons R87 • Fresh Water Boat • Galvanized Hull • COI - Lakes, Bays, and Sounds • Lifesaving (4) 50 Man IBA's • Co2 Fixed Fire Extinguishing • Very Clean Solid Vessel • Accepting Reasonable Offers • heathers@ferries.com

Brand New Vertical Deck Mounted Capstans 2 Units Available



Complete with reversing starter and foot control. 18" diameter head for maximum 2 3/4" diameter rope. 20,000 lbs initial line pull and 10,000 lbs running pull. Electric release break and fully lubricated sealed bearings. Removable motor guard. More information and drawing on request. Available for immediate shipment.



P.O Box 596 • 910 Mahar Avenue
Wilmington, CA 90748
Phone (310) 522-9698 • Fax (310) 522-1043
E-mail: sales@watermansupply.com
Website: www.watermansupply.com

1,200 BHP MODEL Bow Tug



(Rebuilt 2007) • Length: 65', Beam: 22', Depth: 8'

Draft: Min operating draft 6'; Max 7'

Eye Level: 21' Lower Wheelhouse (26'Upper)

Fuel Capacity: 10,000 gallons • Water Capacity: 8,000 gallons

Engines: Caterpillar C-18's repower in 2006 • Gears: ZF F350

Wheels: Torking-HD 5 Blade 59"x 55" • Shafts: 6"

Generators: 40 kw Caterpillar x 2 • State Rooms: 2 • Heads: 1 • Berths: 4

Tow Winch: Pullmaster Rapid Reverse Model H-25-7-86-4

P: 912-313-3347 • F: 912-964-0771

E: 1200HPTUGBOAT@gmail.com



Celebrating 30 Years

CAILLOU ISLAND TOWING CO., INC.

TUGS - DECK BARGES - SHALE BARGES - SPUD BARGES - KEYWAY BARGES
RIG MOVES, RIG SERVICE, DREDGE SUPPORT, CONSTRUCTION PROJECTS,
HEAVY HAUL, FLEET SERVICE, ALL OF YOUR WATERWAY TOWING NEEDS

CALL FOR COMPETITIVE QUOTE FOR YOUR MARINE PROJECTS

985-876-1731

1211 BAYOU LACARPE ROAD HOUMA, LA 70363
WWW.CAILLOUISLANDTOWING.COM

MARINE EQUIPMENT FOR SALE

3-120' x 30' DECK BARGES / 2- 120' x 30' Shale Barges / 1- 135' x 35' Power Spud Barge
1-10,000 BBL Double Skin Tank Barge / 3- Deck Luger Tugs



MV Joan Cenac
900hp Deck Luger Tug
2006
66' x 24' x 7'
2 - QSM11 Cummins
2 - 4B Cummins 35KW
2 - Twin Disc
MGX5114DC Ratio 5:1
10,800 Fuel / 24,000
Potable Water / 100 Lube
Loran, Auto Pilot, VHF,
GPS, AIS



MV Labelle
900hp Deck Luger Tug
1998
54' x 24' x 8'
2 - NTA855 Cummins
2 - 4B Cummins 35KW
2 - Twin Disc
MG5114DC Ratio 4.5:1
10,000 Fuel / 16,000
Potable Water / 100 Lube
Loran, Auto Pilot, VHF,
GPS, AIS



MV Annette Cenac
1,200hp Deck Luger Tug
2004
60' x 24' x 8'
2 - KTA19 Cummins
2 - 4B Cummins 35KW
2 - Twin Disc TD516
Ratio 5:1
10,000 Fuel / 15,000
Potable Water / 300 Lube
Loran, Auto Pilot, VHF,
GPS, AIS

**For Further Information and Pricing
Contact Billy (985) 665-0631**

www.WaterTaxiMarine.Com Ph: 513-557-6936

WATER TAXI MARINE

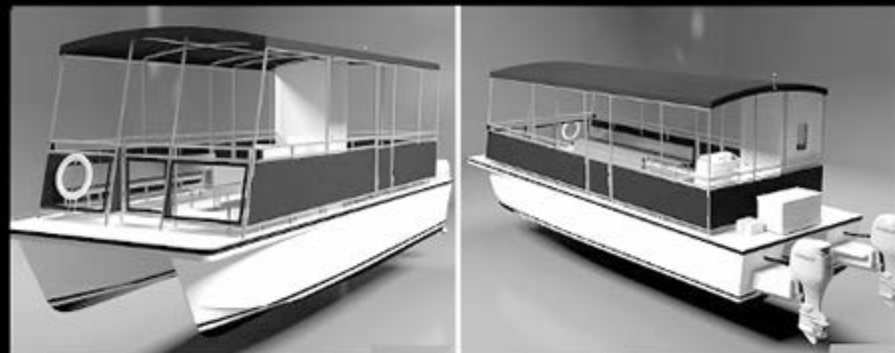

(Above)

33' x 11' 35 Passenger Water Taxi with Twin 90 HP. O.B.

From \$139,000.00 ** Call For Details

38' x 12' 49 Passenger with Twin 150 HP. O.B.

From \$189,000.00 ** Call For Details

Blank Catamaran Open Hulls From \$75,000.00

** Call For Details

(Below)

NON C.O.I. High Speed Enclosed 40 Passenger Water Taxi

From \$259,000.00 Includes Restroom, Twin 250 HP. O.B.,

Gen.; A/C, Global Shipping To Most Cargo Ports.

(C.O.I. Enclosed 40 Passenger From \$350,000.00)

** Call For Details



WaterTaxiMarine@Gmail.Com

WaterTaxiMarine.Com 513-557-6936

HYDRO-SLAVE

★ SAME DAY SERVICE ★

QUALITY MARINE HYDRAULIC EQUIPMENT

STANDARD BOOM WINCH

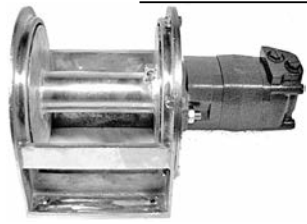

SPECIFICATIONS

PULL - EMPTY SPOOL - 24 CID MOTOR
 12 GPM @ 1500 PSI - 3580 LBS
 12 GPM @ 2000 PSI - 4730 LBS
 PULL - FULL SPOOL - 24 CID MOTOR
 12 GPM @ 1500 PSI - 1375 LBS
 12 GPM @ 2000 PSI - 1813 LBS

BRAKE BOOM WINCH

WIRE CAPACITY

5/16" WIRE - 321 FEET • 3/8" WIRE - 223 FEET
 1/2" WIRE - 125 FEET



Available in Both Powder Coated Steel and Stainless Steel

BUY THE BEST - BUY THE ORIGINAL BUY HYDRO-SLAVE

HYDRAULIC PUMP WITH ELECTRIC CLUTCH

2 Bolt B Auxilliary Drive Assembly

2 BOLT B 13 TOOTH MOUNTING FLANGE

- Precision Machined Aluminum 2 Bolt B Mounting Flange
- Precision Machined Steel Pump-Clutch Mounting Bracket
- 250 Ft. Lb. 2 Bolt B 13 Tooth Clutch
- 25VQC High Performance Vane Pump 2 Bolt B 13 Tooth Spline 21 GPM @ 3000 PSI, 1200 RPM
- Dimensions: 13" Long, 8-1/2" Wide



THIS ASSEMBLY IS SUITABLE FOR INSTALLATION ON ANY 2 BOLT B 13 TOOTH DRIVE ADAPTER SUCH AS A TWIN DISC OR ZF TRANSMISSION

WORLD'S LARGEST POT HAULER MFG. FOR OVER 40 YEARS

For more information call: 1-800-747-7550 or visit us on the internet: www.marine-hydraulic-engineering.com

MARINE HYDRAULIC ENGINEERING CO., INC.

17 Gordon Drive Rockland Maine 04841 Fax: 207-594-9721
 Email: marinhyd@midcoast.com

YOUR BUSINESS ANCHOR

Buying or Selling a Passenger Vessel or Business?



Fort Warren 150 Passenger Charter Yacht



Mark Twain 149 Passenger Sternwheel



Andrews 42 Passenger Water Taxi



Catfish Bend 1,389 Passenger Paddlewheeler

PINNACLE MARINE CORPORATION

We are the only brokerage service specializing in the passenger vessel industry. We also provide assistance locating financing, vessel transportation, securing insurance, marketing and business consulting, and auction services.

608-788-3210 • email: info@pinnaclemarine.com • www.pinnaclemarine.com

74' 1974 Gulf Craft



Aluminum Head Boat. Twin 1271, 550 Turbo engines. 72 passenger, easily increased. 100 mile COI. (2) 20KW generators.

\$695,000.00 • All Inquires (E-mail Only)
office@flyingfishfleet.com

BUY SELL RENT

CLAMSHELL BUCKETS HOISTS & WINCHES PILE DRIVING EQUIPMENT

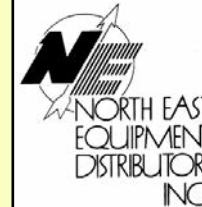

GREG DUNN

(724) 228-5560

FAX (724) 228-8776

www.neequipdist.com

400 Country Club Road
 P.O. Box 358
 Meadow Lands, PA 15347-0358

Marine Travelifts For Sale



1988 35BFMII - 70,000 lb. Capacity, 17' Inside Clear Width, 18' Inside Clear Height, Ford Gas Engine, Front & Rear Powered Slings. Loc. - Fall River MA



2000 35BFMII - 77,000 lb. Capacity, 17' Inside Clear Width, 18' Inside Clear Height, Ford Gas Engine, Front & Rear Powered Sling. Location - Vinalhaven ME



1982 69AMO
 138,000 lb. Capacity
 24' Inside Clear Width
 22' Inside Clear Height
 Ford Gas Engine
 Front & Rear Powered Sling Spreaders.
 Location
 Rhode Island

Call Martin Walter Company

Sales Direct at
781-347-1201
 or Email

sales@walterco.com
 For more information and to see more pics at
www.walterco.com



CALL FOR PRICING

Johnson Stevens
 (843) 889-2254 Office

j.stevens@stevens-towing.com

For over 100 years, Stevens Towing has conducted business in marine towing, barge charter, and marine repair. Located 25 miles south of Charleston, SC, (mile marker 490 ICW) the shipyard is equipped with 2 Marine Railways, a 150-ton Marine Travel Lift, as well as 500' of dock space for topside marine repairs.

Equipment For Charter

Deck Barges

- (3) 120 x 30 x 7
- (2) 120 x 33 x 10
- (1) 150 x 55 x 8
- (1) 162 x 52 x 10
- (1) 175 x 39 x 9
- (1) 260 x 50 x 10.5
- (1) 250 x 54 x 13 ABS

US FLAG JONES ACT SHIP "M/V Coastal Venture" For Charter

Length Overall: 247' • Draft: 11'
 Speed At Sea Loaded: 12 KTS • GT: 497
 Capacities: Hold 1 Cubic Capacity 8,640 FT+, Hold 2 Cubic Capacity 30,800 FT+, Hold 3 Cubic Capacity 45,760 FT+.
 Capable of carrying a wide variety of cargo from Break Bulk to Containers as well as Hazardous Goods Class 1-9



Equipment For Sale

Hopper Barge

- (1) 260 x 52.5 x 12

Crane Barge

- (1) 199 x 52 x 14 w/ 28 ton Crane at 90' Intercon Hydraulic Crane w/Cat Engines



Cranes

We have two 500 ton barge mounted cranes that are strategically placed in Savannah, GA and Charleston, SC. These cranes have the ability to move via the Intercoastal Waterway or Offshore to any job. We also have a barge mtd Clyde 32 which is a rotating 140 ton crane at

Savannah Giant

Crane Capacity: 500 Tons
 Barge Dimensions: 180' x 80' x 10'

Ocean Ranger

Crane Capacity: 500 Tons
 Barge Dimensions: ABS 200' x 72' x 14'

Stevens 1401

Crane Capacity: 140 Tons
 Barge Dimensions: 142' x 58' with spuds

Stevens Towing Shipyard

Railways

We Have Two Large Marine Railways With A Weight Capacity Up To 1650 ST And Dimension Up To 300' Long x 80' Wide.

Travel Lift

Weight Capacity: 150 ST • Length Unlimited x 37' Wide

STEVENS TOWING - A RESPECTED NAME IN THE MARITIME INDUSTRY FOR OVER 100 YEARS.

FOR SALE M/V HORIZON'S EDGE



MOTIVATED SELLER
\$2,950,000.00

Length: 161.3' (registered) - LOA: 186'
 Year Built: 2000

For more information visit

www.horizonsedgeboston.com or contact
 Owner's attorney David S. Smith at 978-744-8918

INLAND MARINE, INC.

CONTACT: ALLEN CUTLER
(757) 754-0767
ACUTLER@INLANDMARINEVA.COM



BAY SURVEYOR – CREW BOAT
45'x15'x3.5'
CONVERTED TO ACCOMADATE DIVE CREWS AND SURVEY EQUIPMENT



LIFT BOAT "CAPT RAY"
64'x32'x7'
THRU-DECK DRILL WELL
70' – 15 TON DECK CRANE
8-71 DETROITS
13,000 GAL FUEL CAPACITY
BERTHING FOR 8
GALLEY
450 GAL FRESH WATER TANK
35 GPH FRESH WATER MAKER

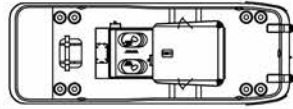
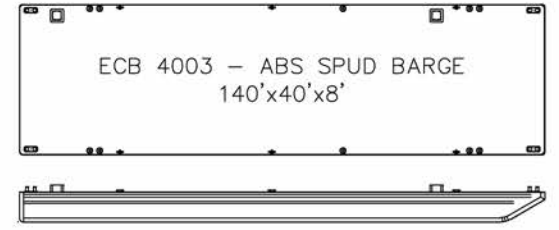
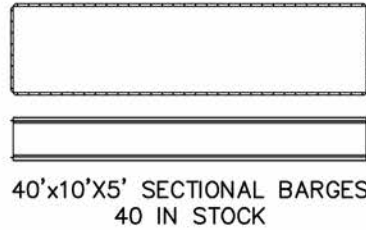

39' TRUCKABLE TUGS

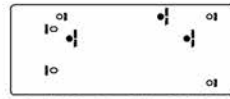
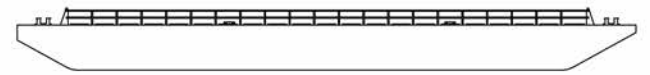

CAPT JACK SPUD BARGE
60'x24'x4'

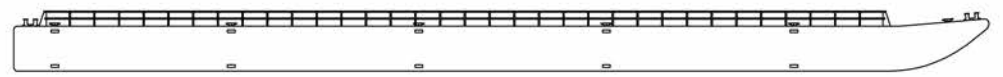
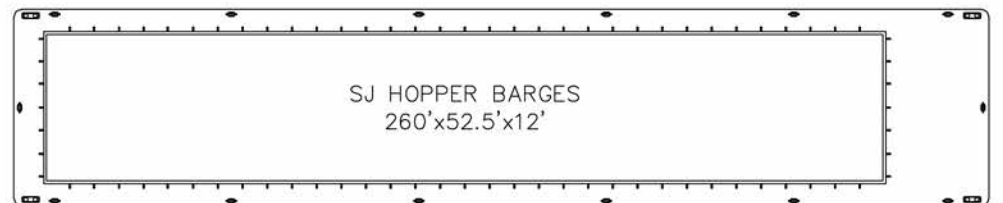
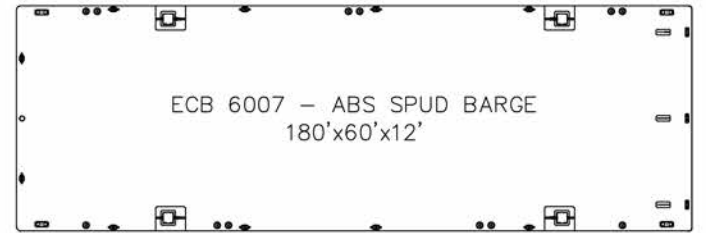

TO SEE OTHER AVAILABLE EQUIPMENT PLEASE VISIT:
PRECONMARINE.COM/EQUIPMENT



SEA FORCE IX

45' ALUMINUM COMMERCIAL VESSELS

6
AVAILABLE
NOW

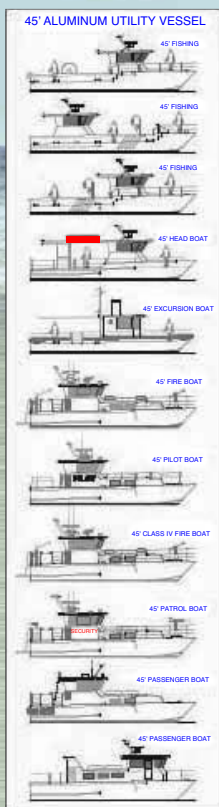

Originally constructed as a crew/supply vessels, these aluminum commercial crafts were built to U.S. Coast Guard specs and are available for purchase. They are customizable with 2 vessels capable of being ready for delivery in 45 days.

Sea Force IX, Inc. has extensive experience in large power vessel design and construction. Competitive pricing, certified welders and heavy lifting capability, we will build to your design or ours.

- 2 Boats Available in 45 days
- 28 Person Capacity
- Fully Customizable
- Twin Engine
- Dive/Fire Boat
- Sub Chapter T Certified

SPECIFICATIONS:

- LOA: 45'-4" - Over Rails
- BEAM: 14' - 6" Over Rails
- Draft: 5'-0"
- Fuel: 300 Gals
- Speed: 2X 300HP = 21K
- 2X 410HP = 24K

Contact
Chris Mackenzie or Todd Albrecht
For More Information.



1227 North U.S. Highway 41 | Palmetto, Florida 34221 | (941) 721-9009

(3) EA. 55' Derecktor Ex-USCG Workboats



All three boats are a matched set and are in good operational condition. Surveys Available. For more information please contact Mike Majewski 850-221-5138 or majewski4@bellsouth.net • For photos please go to www.kclmsales.com

USED & REBUILT DIESEL ENGINES

Eugene & David Evans of Evans Boats, Inc.

Engines Available Include:

3208 210HP Rebuilt • 3208 320HP Rebuilt • 375 Rebuilt
375 Takeout Runs Great • 453 Detroit's • 353 Detroit's
Volvo Sterndrive Package Takeout

CALL FOR PRICING AND AVAILABILITY... GROWING INVENTORY!

CALL EUGENE EVANS @ (443) 783-0529

100% Stainless Steel Construction

This Muffler can go to HELL and take the HEAT!!!

www.the-flex.com

Exhaust System Silencers Style 1-2

| PART # | A | B | C | D | PRICE |
|--------|--------|--------|-----|-----|---------|
| AIM-03 | 3.5" | 6.625" | 15" | 9" | \$400 |
| AIM-04 | 4.5" | 8.625" | 18" | 12" | \$450 |
| AIM-05 | 5.563" | 10.75" | 21" | 15" | \$500 |
| AIM-06 | 6.625" | 12.75" | 24" | 18" | \$600 |
| AIM-08 | 8.625" | 16.00" | 30" | 24" | \$785 |
| AIM-14 | 4.5" | 8.625" | 22" | 16" | \$575 |
| AIM-15 | 5.563" | 10.75" | 26" | 20" | \$675 |
| AIM-16 | 6.625" | 12.75" | 30" | 24" | \$900 |
| AIM-18 | 8.625" | 16.00" | 38" | 32" | \$1,150 |
| AIM-24 | 4.5" | 8.625" | 46" | 40" | \$1,000 |
| AIM-25 | 5.563" | 10.75" | 56" | 50" | \$1,350 |
| AIM-26 | 6.625" | 12.75" | 66" | 60" | \$1,750 |
| AIM-28 | 8.625" | 16.00" | 86" | 80" | \$2,500 |
| AIM-34 | 4.5" | 8.625" | 46" | 40" | \$1,295 |
| AIM-35 | 5.563" | 12.75" | 56" | 50" | \$1,710 |
| AIM-36 | 6.625" | 16.00" | 66" | 60" | \$3,345 |
| AIM-38 | 8.625" | 20.00" | 86" | 80" | \$5,500 |

Call for price of Style 3

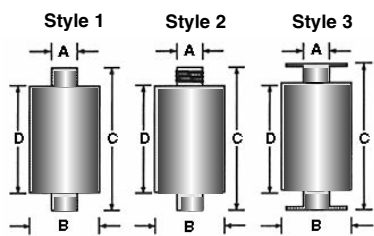

CUSTOM FABRICATION AVAILABLE

NOTE: Above is styles 1 & 2 only!

Carbon Steel Flanged Pipe Stainless Flexible Exhaust



| Part # | HOSE I.D. | Flange Outside Dia. | Flange Inside Dia. | Number of Bolt Holes | Bolt Hole Dia. | Bolt Circle | Price |
|--------|-----------|---------------------|--------------------|----------------------|----------------|-------------|-------|
| FF-1 | 1.0" | 4 1/4" | 1.36" | 4 | 5/8" | 3 1/8" | \$60 |
| FF-125 | 1.25" | 4 5/8" | 1.70" | 4 | 5/8" | 3 1/2" | \$65 |
| FF-150 | 1.5" | 5" | 1.95" | 4 | 5/8" | 3 7/8" | \$75 |
| FF-2 | 2.0" | 6" | 2.44" | 4 | 3/4" | 4 3/4" | \$100 |
| FF-250 | 2.5" | 7" | 2.94" | 4 | 3/4" | 5 1/2" | \$130 |
| FF-3 | 3.0" | 7 1/2" | 3.57" | 4 | 3/4" | 6" | \$150 |
| FF-4 | 4.0" | 9" | 4.60" | 8 | 3/4" | 7 1/2" | \$240 |
| FF-4L | 4.0" | 9" | 4.60" | 8 | 3/4" | 7 1/2" | \$295 |
| FF-5 | 5.0" | 10" | 5.66" | 8 | 7/8" | 8 1/2" | \$295 |
| FF-5L | 5.0" | 10" | 5.66" | 8 | 7/8" | 8 1/2" | \$350 |
| FF-6 | 6.0" | 11" | 6.72" | 8 | 7/8" | 9 1/2" | \$300 |
| FF-6L | 6.0" | 11" | 6.72" | 8 | 7/8" | 9 1/2" | \$375 |
| FF-8 | 8.0" | 13 1/2" | 8.72" | 8 | 7/8" | 11 3/4" | \$380 |
| FF-8L | 8.0" | 13 1/2" | 8.72" | 8 | 7/8" | 11 3/4" | \$470 |
| FF-10 | 10.0" | 16" | 10.88" | 12 | 1" | 14 1/4" | \$500 |
| FF-10L | 10.0" | 16" | 10.88" | 12 | 1" | 14 1/4" | \$615 |
| FF-12 | 12.0" | 19" | 12.88" | 12 | 1" | 17" | \$540 |
| FF-12L | 12.0" | 19" | 12.88" | 12 | 1" | 17" | \$685 |

Carbon Steel Beveled Pipe Stainless Flexible Exhaust



| PRODUCT # | HOSE I.D. | PIPE O.D. | PRICE | GASKETS (FULL FACE, 1/16" THICK UP TO 6", 1/8" THICK ABOVE) | PART # | PRICE |
|-----------|-----------|-----------|-------|---|----------|-------|
| WW-1 | 1.0" | 1.315" | \$40 | 1" | \$12.00 | |
| WW-125 | 1.25" | 1.660" | \$45 | 2" | \$18.00 | |
| WW-150 | 1.5" | 1.900" | \$50 | 3" | \$22.00 | |
| WW-2 | 2.0" | 2.375" | \$55 | 4" | \$26.00 | |
| WW-250 | 2.5" | 2.875" | \$70 | 4" CAT | \$24.00 | |
| WW-3 | 3.0" | 3.500" | \$90 | 5" | \$29.00 | |
| WW-4 | 4.0" | 4.500" | \$120 | 5" CAT | \$26.00 | |
| WW-4L | 4.0" | 4.500" | \$160 | 5" CUMMINS | \$26.00 | |
| WW-5 | 5.0" | 5.563" | \$130 | 6" | \$35.00 | |
| WW-5L | 5.0" | 5.563" | \$190 | 6" CAT | \$34.00 | |
| WW-6 | 6.0" | 6.625" | \$140 | 8" | \$40.00 | |
| WW-6L | 6.0" | 6.625" | \$210 | 8" CAT | \$38.00 | |
| WW-8 | 8.0" | 8.625" | \$200 | 10" | \$85.00 | |
| WW-8L | 8.0" | 8.625" | \$300 | 10" CAT | \$85.00 | |
| WW-10 | 10.0" | 10.750" | \$310 | 12" | \$99.00 | |
| WW-10L | 10.0" | 10.750" | \$440 | 12" CAT | \$96.00 | |
| WW-12 | 12.0" | 12.750" | \$450 | 14" | \$112.00 | |
| WW-12L | 12.0" | 12.750" | \$600 | 16" | \$148.00 | |
| | | | | 18" | \$165.00 | |

L SERIES IS RECOMMENDED FOR ENGINES WITH TURBO

MUFFLER WRAP

| PART # | PRICE |
|-----------|---------|
| TIBAIM-03 | \$120 |
| TIBAIM-04 | \$155 |
| TIBAIM-05 | \$230 |
| TIBAIM-06 | \$265 |
| TIBAIM-08 | \$420 |
| TIBAIM-14 | \$185 |
| TIBAIM-15 | \$285 |
| TIBAIM-16 | \$345 |
| TIBAIM-18 | \$550 |
| TIBAIM-24 | \$275 |
| TIBAIM-25 | \$550 |
| TIBAIM-26 | \$695 |
| TIBAIM-28 | \$1,105 |
| TIBAIM-34 | \$475 |
| TIBAIM-35 | \$640 |
| TIBAIM-36 | \$995 |
| TIBAIM-38 | \$1,505 |

THERMAL INSULATION BLANKET

| PART # | PRICE |
|--------|-------|
| TIB-3 | \$80 |
| TIB-4 | \$80 |
| TIB-5 | \$90 |
| TIB-6 | \$105 |
| TIB-8 | \$120 |

BULK THERMAL INSULATION BLANKET 18" WIDE X RUNNING FOOT ***\$55.00 PER FT.***



We Stand by our work!

AIM APPLIGATE INDUSTRIAL MATERIALS INC.

P. O. Box 428, Baton Rouge, LA 70821-0428
1-225-336-4116 • fax 1-225-336-4317
1-800-843-3539 • www.the-flex.com
E-mail: info@The-flex.com

AIM has set the standard for reliability, durability & service for over 35 years! Run silent, Run deep.

MARINE FUEL TANKS

www.speedytanks.com

ANY SIZE - ANY SHAPE

ALUMINUM TANKS FOR GAS OR DIESEL

TESTED & BUILT TO U.S.C.G. SPEC.

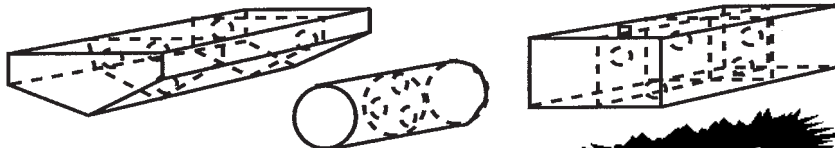

UPS DAILY

5 DAY TURNAROUND

ATLANTIC COASTAL WELDING INC.

[800] 434-TANK (8265)

OR FAX A DRAWING 1-732-269-7992

Alumatec Marine Docks and Gangways

Custom design and fabrication of commercial and residential dock systems, gangways, beach-access stairs, piers, walkways. We also have commercial grade dock float tubs in all sizes. We deliver from Plymouth Massachusetts throughout North East & Ship Nationwide.

(508) 746-7774

Ron Cooper Catamarans THE MONEY MAKERS

WE BUILD ONE OF THE MOST FUEL EFFICIENT PASSENGER VESSELS IN THE WORLD

63' x 24' Catamaran, base price \$399,000 plus power, stability test for 200

The perfect vessels for:

- Day/Snorkel Trips
- Sightseeing
- Booze Cruises
- Cruise Ship Tenders
- Over 130 Built

All New 47' x 15.5' Catamaran • USCG Stability test for up to 70 passengers • Introductory base price \$139,000 plus power • Economical and very stable • Glass bottom available • Set up for beach loading • Fast delivery

Call Ron Cooper (727) 804-6389 www.coopermarine.com

1-800-THE FLEX

90' Model Bow Coastal Tug



2400 hp, 12 cyl. EMD 645 E-7 turbo single screw. 3-1 Falk Gear. (2) 4-71 75KW gen sets, fully equipped. East Coast U.S.
Reduced To \$50,000 USD For Quick Sale
(443) 324-6457

110' x 29' ALUMINUM
\$1,250,000



All Aluminum, Derecktor Built. (2) Deutz TBD 616, 818 hp ea., (2) John Deere 6135SFM85, 650 hp ea. Top speed 20.5 knots. 40Kw Gen & 55Kw Northern Lights. Full electronics, USCG inspected. Presently fishing Brielle, NJ, Lic. 150 passengers, 100 miles.
Day: (732) 245-1592

Looking for Marine parts?

Save time and money!
 We will find marine parts from around the world including engines, generators, & oil platform cranes.

OVER 25 YEARS EXPERIENCE

MyMarineTracker.com
 Marine Purchasing Services

1-866-717-2053
 or 608-783-2766

Sandpiper Air Powered Double Diaphragm Pump



Model SA2-A type DB-4-A. New old stock.
 10 Available • \$800 Each
(804) 514-4266 • poddj@yahoo.com

119' Navy Landing Craft



\$700K + In Recent Upgrades.
 200T Cargo Capacity. Excellent Condition. Very Shallow Draft - 3'9", Freshwater Docked, Fresh Rebuilds, Electronics.
Location - US Gulf • \$900K
(228) 918-6090
gulfstreamcorp.com

46' 1988 Trojan Int'l 14 Meter Conv.
 Twin 750 hp wet turbo diesels 900 orig. hrs., 12.5 Onan 1600 hrs., 16' 3" beam 2 SR 2 head layout

Health Forces Sale
Make All Offers
(813) 641-8886
valbelle@tampabay.rr.com



For Sale SunCruz VII Casino Vessel

Name Reserved: Yes, Ex-Name Diamond Royale, Andrew Fletcher. Manufacture: Offshore Shipbuilding, Inc. Model Year: 1985, MFG. Year: 1985, Boat Type: Casino Vessel, Boat Is: Used, Length Overall: 184', Beam: 40', Weight (Displ): Gross tons ITC: 1,314 REG: 99/NT, ITC: 413 REG: 67, Hull Material: Welded steel, Hull Configuration: Traverse, Speed (knots) Cruise@ RPM 10 Speed (knots) Max@RPM 10 Fuel Tank (Gal / Mtr) 7,500 total gal. Certification & Class: K Class. Boat just had \$327,000 worth of work done by the Detyens Shipyard. At time of work the boat was seized by the U.S. Marshal's Office for taxes. The boat is sail-able per U.S. Coast Guard. The keel & hull below water line have been repaired. The decks & pilot house need some blasting & painting. The boat has around 175-180 Slot machines, 20 Black Jack tables, 4 Roulette wheels, 2 Craps tables & 2 Texas holdem tables. There are three bars on board. The ship has set for the last eight months so it needs to be cleaned out. The main propulsion is (2) 3812 CAT motors which are working, Generators are 3408 CAT motors (3). This vessel has very good Reef Possibilities.

Can be viewed any time with appointment in the Port of Charleston, SC, USA
Price: \$265,000.00
For More Information Call: Mike Bruce
(864) 270-4945

100' (149) Passenger Triple Screw Aluminum Tour Boat / Ferry



1971 Camcraft conversion. 3412 Caterpillar powered with two 30 KW 3-71 Gensets. Currently working in Hawaii but will deliver to West Coast. May partial finance to approved party. \$225K. This is our vessel and will give courtesy to brokers. New 5 year COI for USCG haul inspection and dry dock 2-1-17.
Email: maucaptaindave@yahoo.com
For Details

Craftsman Marine ALUMINUM BOATS

WE BUILD BOATS FOR PLEASURE, DOCK BUILDERS, POLICE & FIRE DEPT, PARKS DEPT AND CREW BOATS

We Fabricate Fuel Tanks, T-Tops, Bow Rails, Radar Mounts and Arches



179 Frowein Road • East Moriches, NY 11940
P: 631.400.9118 E: Craftsmanmarinealumin@gmail.com
Like us on Facebook • Follow us on Instagram

TRUCKABLE WORK BOATS AND BARGES



WE PUT WHAT WE BUILD TO THE TEST WE KNOW WHAT WORKS
EAGLE HOLLOW MARINE
(812) 599-4629
www.EagleHollowMarineConstruction.com

NATIONAL / ALTEC CRANE BODIES FOR SALE
3 Available (10-15 Tons) - \$4,500-\$9,500



2006 10 Ton National 400B Crane with 56' Sheave
 Here at Cassone Truck Sales, we sell a variety of used Crane Bodies. All bodies are tested rigorously before removal to ensure quality. This unit is perfect to put on a Cab & Chassis or for docks and barges.
(631) 585-7800 • trucks@cassone.com • www.cassonetruks.com

COMMERCIAL MARINE EXPO

2018 | Providence, RI



October. 17 & 18, 2018

REGISTER TO ATTEND FOR FREE & ENTER TO WIN \$100 AMAZON GIFT CARD!
 Monthly Prize Drawings start October 2017
USE CODE BHNV17

Register at CommercialMarineExpo.com

BOOK YOUR EXHIBIT SPACE TODAY!



FOR SALE

32' Aluminum Hull Survey / Excavation Vessel

\$49,000



Length - 32' • Beam - 9'
 Mains - 2 Detroit 8.2 Turbo Four Strokes • Fuel Cap. - 160 Gal.
 Gears - Twin Disc MG504's Engines Rebuilt in 2016
 Hydraulic Seastar Steering System
 20' Aluminum Outriggers
 1/4" Aluminum Blowers
 Small Deck Crane with 3,500 lb Winch
 Hummingbird GPS, VHF Radio

Formerly US Navy PTF-23 Osprey Class Patrol Boat

\$225,000



Length - 98' • Beam - 24'
 Mains - 2 Detroit 12V71's Generators - 2 Detroit 371's Mako Scuba Tank Compressor
 Fuel Cap. - 6,281 Gal.
 Water Cap. - 1,800 Gal.
 Speed: 12 Knots
 Built: 1968 • Sleeps 17
 2 Hiab Deck Cranes
 Vessel is Located at Port Canaveral, FL

For More Info Please Contact:
Bill (813) 255-3620 • wildbill@seliger.org • Ron (813) 777-1356



Scarano 65' x 14' Water Ferry Launch



Scarano 80' x 16' Motor Launch



115' PV Adirondack
350 Passenger Capacity



Adirondack 65 LOD

SCARANO BOATBUILDING, INC.

Port of Albany, Albany NY 12202

Custom Design Construction

518-463-3401 • FAX 463-3403 • www.scaranoboot.com

MARINE CONTRACTORS

All-In-One Package Policies Available NOW!

- Tugs & Barges
- Charter Boats
- Marine Contractors
- Marinas
- Workers Comp.
- Equipment
- General Liability
- Fishing Vessels
- Live Aboards
- Diving Contractors
- ROVs
- Jones Act
- USL&H
- Bonds

Ryen Marine Insurance Group, Inc.
Insurance Consultants & Agents

221 South Ocean Dr., Ste C, Ft. Pierce, FL 34949
Telephone (772) 242-1045 Fax: (772) 882-9856
info@insuremarine.com www.insuremarine.com

14" ELICOTT BOOSTER PUMP

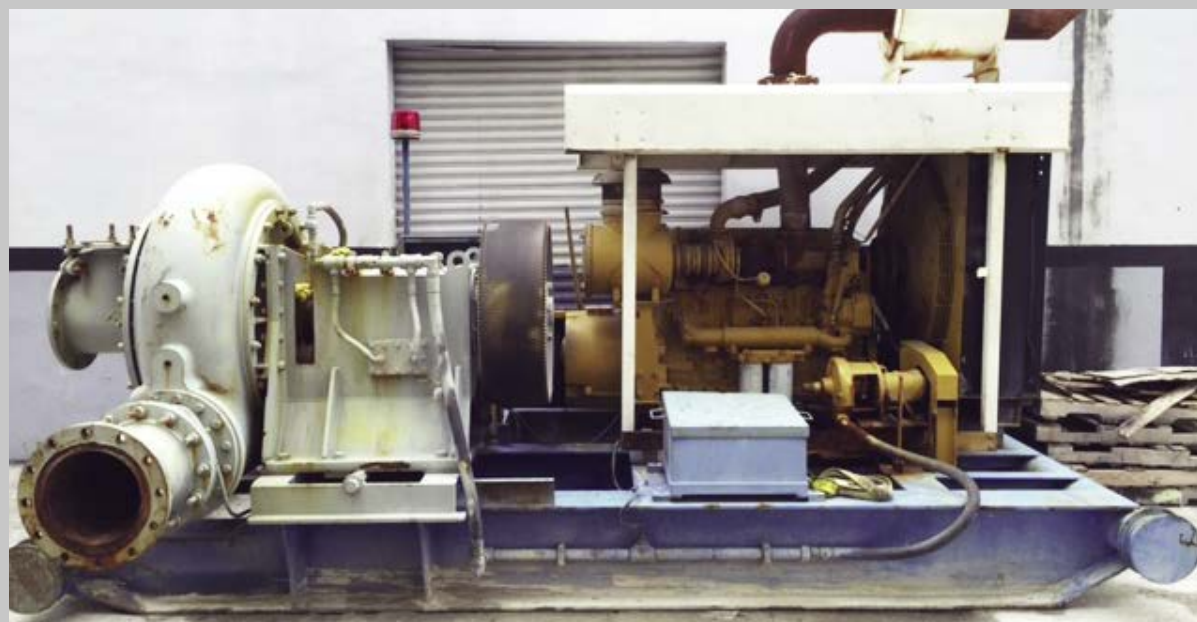

**3,000 Hours
With
Caterpillar C18**

**\$100,000.00
Accepting Best Offers**

**Call:
(305) 206 9090
or Email:
Ahernan124@icloud.com
Carl@09-tech.com**

600 Ton Manitowoc 4600 S3/S2 Ringer



Your Trusted Resource for
Heavy Marine Equipment

24 Hour Response | Portsmouth, VA



200 Ton Manitowoc 4000W Ringer

350 Ton Heavy Lift Derrick "Samson"



85 Ton Derrick



Truckable Push Tug "Teddi C"

Visit our website: www.crofton.com | Sales and Rentals: Mike Frohnapfel mikef@crofton.com | Office: 757-397-1131

Heavy Lift Capacity up to 600 Tons | Hydraulic | Conventional | Barge Mounted

Tug Rental: Truckables | Up to 1100 HP | Single & Twin Screw Engines

Barge Rental: Sectional, Spud, & Deck Barges | 20' -185' Lengths | 10' - 55' Widths | 4' - 12' Heights



70' Fiberglass Party Boat
 90 Passenger Certified. Dry Dock 2018
 (3) Detroit Diesel Motors 615 HP
 \$215,000 OBO
 Contact Danny (786) 897-4458

**A & D SHIPYARD
 BROOKLYN NY
 718-404-4285 (HAUL)**

**7
1
8
4
0
4**



*Brooklyn's
 First
 120 Ton Lift
 Servicing
 Your Complete
 Shipyards Needs*

**H
A
U
L**

*Hauling
 Painting
 Welding
 Shaft & Prop Work
 50 Years of Experience*

**MARINE PILOT HOUSE
 CHAIRS**



Adjustable
 Swivel Seat
 Aluminum
 Inland and
 Offshore
 Bases
\$780.00
 F.O.B.
 Port Arthur, TX

Texas Wheel Works, Inc
 PO Box 1276 • Port Arthur, TX 77641-1276
PHONE: (800) 238-9402
FAX: (409) 984-5690

**Portable Pushboats
 For Charter**

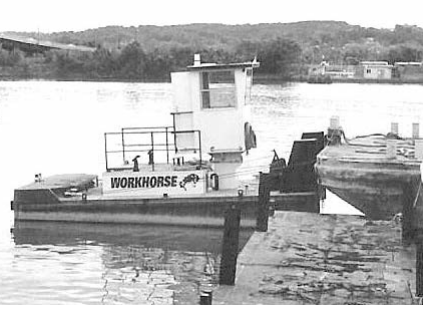

**430/330 HP Twin Screw
 25' x 12' x 5', 3.5' Draft**
J-Way Leasing & Marine, LLC
(440) 934-1020

MARINA EQUIPMENT FOR SALE

1987 70 Ton Marine Travelift
 140,000 lb. Capacity
 ICW: 23'
 ICH: 22'
 Spreader Beams Inc.
 2 Available Units:
 1 Gas
 1 Diesel



2006 Wiggins W230M2
 23,000 lb. Cap.
 38' Positive Lift
 12' Negative Lift
 20' Forks
 Diesel Engine



2007 75 BFMII Marine Travelift
 150,000 Lb. Capacity
 ICH: 26'
 ICW: 19' 8"
 John Deere Diesel (2,065 hrs.)
 Remote Control Included
 Immediately Available



(305) 882-7000
gwork@wejohnson-fl.com • www.wej-fl.com

Northeast Industrial & Marine Equipment Supplies
 661 Route 9 Cape May, NJ 08204
 1-800-884-3152 609-884-3152 609-884-3510
 Fax: 609-884-3170, Check Us Out @www.northeastindustrialnj.com

EQUIPMENT SUPPLIES FOR ALL PHASES OF THE FISHING, DREDGING, MARINE CONSTRUCTION, AND TRANSPORTATION INDUSTRIES





- Custom Winch Systems 1,000 to 300,000 Line Pulls
- Custom Built Winches - 1,000 lb. to 200,000 lb. Line Pull & Diesel HPU Units
- Electric HPU Units
- Spud Handling Systems & Barge Anchoring Systems
- Used Equipment Refurbishing
- Equipment Rentals - Winches, Power Units
- Custom Built Barges

John Deere / Yanmar Industrial Engines

- Pullmaster, Superwinch, Lantec, Kinematic
- Custom Built Power Units
- Winches - Planetary, Worm Gear
- Control Valves 4 GPM - 400 GPM
- Hydraulic Pumps - Gear, Piston
- Hydraulic Motors - Staffa, KYB, Char-lynn
- Free Fall Winches - 5,000 lb. to 75,000 lb.
- Wintech Winches - Electric, Air, Hand Cranked
- Transmissions - ZF, Twin Disc

National & International Services
 Hydraulic, Welding, Machine Shop Service
 Email us @ neindustrial@hotmail.com or contact@northeastindustrialnj.com





VIKING FENDER

VIKING ENHANCED SOFTLOOP FENDER

*When Push Comes to Shove
 Have a Viking on Your Side*

- The softest, most forgiving ship assist fender on market
- Designed for greater energy absorption and gripping ability
- Ideal for tractor tugs, bow, stern and side fenders
- Side hip fenders for tug and barge units
- Pier cell fenders



Quality Recycled Materials  

a division of Viking Marine Products, Inc.
 977 New Durham Rd, Edison, NJ 08817
 Tel: +1 732-826-4552 • Fax: +1 732-826-5533
 Complete Brochure at: www.vikingfender.com

CLOSING DATES • FIRST MARCH ISSUE 2018

| | | |
|--|--|--|
| For Display February 23rd, 2018 9:00 A.M. C.S.T | To Be Mailed February 28th, 2018 | For Classified February 27th, 2018 10:00 A.M. C.S.T |
|--|--|--|

FLOATING DOCKS, GANGWAYS, SEAWALLS
RAVENS MARINE, INC.

**3295 ORANGE AVENUE
 KISSIMMEE, FL 34744
 PH: 407-935-9799
 TOLL FREE: 800-676-3023
 FAX: 407-935-9436
www.ravensmarine.com
ravens@ravensmarine.com**

AT RAVENS MARINE, QUALITY IS #1

FROM THE BACKYARD DOCK TO THE FULL SCALE MARINA, WE MANUFACTURE THE COMPLETE "PICTURE"

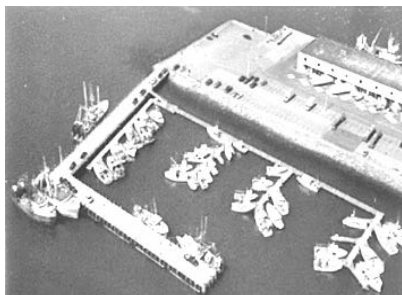

Portable Housing For 20



Generator, water maker, sewage plant, totally self contained other options for up to 100 people.

\$105,000

(206) 465-7981
(985) 258-3266

tridentllc@me.com • www.tridentllc.net

65' Sewart Sea Craft For Sale



Very Good Condition
\$165,000.00 • (504) 329-0451
gauthierboat@aol.com

Buy • Sell • Trade • Rent • Lease

Place An Ad In

Boats And Harbors Today!!

931.484.6100

THE RIGHT CHOICE WHEN YOU NEED TO POWER UP



DF-356 WINCH **DF-629 SIDEWINDER**

nabrico-marine.com
615.442.1300

NABRICO

FENDERTEAM SPC 1600 GR 2.6 FENDER SYSTEM



4 Fenders Total
2 - New
2 - Used



C/W One Cone Element Per System Panel
Size: 6300 mm x 3100 mm x 322 mm
(20'-8" x 10'-2" x 1'-1")

Includes all mounted UHMW-PE, Chains, Hardware, and Incidentals Required for Complete Installation.

Located in Charleston, South Carolina
Seller: S.J. Hamill Construction Company
Phone: (843) 872-8000



ATLANTIC
YACHT & SHIP INC.

SHIPS FOR SALE



33.5M High-Speed Cutter Patrol
2012 CAT engines / 22 knot cruise



65M Landing Craft Cargo 2007 RINA
809t Capacity - 15 days at 8 knots

Atlantic Yacht & Ship has a variety of commercial ships to choose from. This ad depicts a small selection of vessels available. Contact us for any commercial vessel including patrol vessels, double ended ferries, fast ferries, and landing crafts, tankers, ANYTHING. We have ships available in every age from old to brand new, and a broad range of prices to suite your requirements.

 **Doug Hoogs**
+1-954-643-6386
doug@ayssales.com

 **Brent de Sellier**
+1-954-662-6241
brent@ayssales.com

This is a 425 Passenger Paddle Wheel Boat Built in 1985



Coast Guard Certified



Presently in Use in New York City

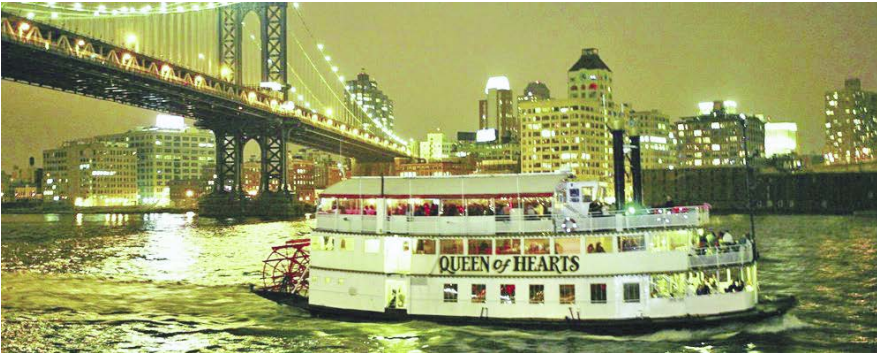

\$750,000
(914) 338-4692
peter@finonewyork.com



COOPERCAPITAL
SPECIALTY SALVAGE, LLC

860-395-4745
info@cooperss.com

*The complete salvage management company
Building relationships, not transactions*

www.cooperss.com

Register to bid and receive information via email



BUYING OR SELLING?
What Are You Doing With Your Boat?

List your vessel with us today...for free

Our website is viewed by thousands daily. Buying? We have hundreds of vessels to choose from.

THIS MONTH'S FEATURE
ICEBERG BAY

Iceberg Bay is a fully operational 161.8' x 48.1' steel barge with ice production and delivery facilities, an aluminum fish buying station and accommodations for 12. Fully self contained with water, fuel, and machinery to output up to 53 tons of ice in 24 hours.

Stock #F3508 • Reduced To \$1,800,000 (USD)

Head Office Toll Free: 1-877-448-0010
Email: sales@pacificboatbrokers.com

WWW.PACIFICBOATBROKERS.COM

1997 30' STEEL PUSH BOAT



Heavy Duty Shallow Water Vessel
871 Engine Recently Overhauled
Recently Painted and Gone Through
Located on Long Island Truckable

\$53,000
(516) 250-3190

CLOSING DATES • FIRST MARCH ISSUE 2018

• To Be Mailed February 28th, 2018 •

For Display February 23rd, 2018 For Classified February 27th, 2018
(9:00 A.M. C.S.T) (10:00 A.M. C.S.T)

PROCK MARINE COMPANY

Specializing In Residential & Custom Docks, Commercial Work, and Shore Stabilization, Mainly Along the Coast of Maine
Barge Rental Also Available



Rockland, Maine
207-594-9565
www.prockmarinecompany.com

FOR SALE
127 x 28 Dinner Cruise/Party Boat



Current USCG Certified For 150 + 16 Crew. Built 1978 Palatka, Florida. Steel Hull and Aluminum Super Structure. 3 GM V 12 T1. 2 Northern Lights Gen Sets 40 KW Each. Both decks have heat and A/C. Currently operating in NY Harbor. Well maintained. Turn Key Operation. Hull inspection good for 2 years. 5 years new inspection & yearly done.

\$665,000.00

Contact: Fred Ardalino (917) 453-3171 • amberjack@live.com

VESSELS FOR SALE



2002 OSV

Certified: I & L, USCG Inspection: Yes, ABS Loadline: Yes
DP System: DP-1, Length: 185', Beam: 46'
Clear Deck: 120' x 39'
Deck Cargo: 850 Long Tons, Main Engines: Caterpillar
Bow Thruster: (1) Schottel
Fuel Capacity: 58,540 / 119,440 Gals
Liquid Mud/Fuel: 1,450 Barrels
Dry Bulk Capacity: 3,300 Cu. Ft.
Potable Water: 15,000 Gals, Fire Monitor: 4" Elkhart
Anchor: (2) 1,500 Lbs, Certified To Carry: 40
Berth: 17, Two (2) 99 Kw: Cat 3304
Radars: (2) Furuno, Radios: (3) VHF (1) SSB / ICOM
Fathometer: (Yes) Furuno, GPS: (2) Interfaced CP Plotter
Beier: Model IVCS4000 DP-1
Complete C.G. & ABS Dry Docking May 2017

2007 MINI SUPPLY

USCG Inspected: I & L, ABS Loadline, ABS: ADP11...DP1
Length: 150', Beam: 36', Depth: 12', Clear Deck: 90' x 30'
Deck Cargo: 335 Long Tons, Main Engines: Caterpillar
Speed: 12 Knots, Bow Thruster: 300 HP
Fuel Capacity: 43,000 / 95,920 Gals, Liquid Mud: 1,260 BBLs
Potable Water: 10,000 Gals, Fire Monitor: 4" Elkhart,
Certified To Carry: 20, Berth: 20, Two (2) 150 KW: Cat C-9
Radars: (2) Furuno, Radios: (3) VHF (1) SSB / ICOM
Fathometer: Yes, GPS: (2)
Navtec: Yes, Plotter: Yes
Can Be Classed



Please Call (337) 319-8123
If Interested Or Need More Information



BYRNE Rentals and Sales, LLC.

Marine & Construction Supplies
24 HR Phone (985) 702-9500
Toll Free 1 (800) 99-BYRNE
Trusted Over 30 years



SMATCO 66 DOUBLE DRUM WINCH



YOKOHAMA BOAT FENDERS - All Sizes



NEW AND USED ANCHORS



NEW AND USES ANCHOR CHAIN

BUILT TO ORDER CUSTOMIZED WINCHES AND PEDESTAL CRANES



**SEAHORSE
4 DRUM
DIESEL POWERED WINCH
MODEL WDW-100**

100,000 Lbs. S.L.P. 1 St Layer
Holds 3,000 Ft. of 1-1/8" Cable
READY TO GO



- | | | | |
|------------------|------------------|----------------|-----------------|
| Snatch Blocks | Swivels | Pulling Blocks | Marine Fittings |
| Yokohama Fenders | Headache Balls | Capstans | Air Tuggers |
| Shackles | Marine Fairleads | Windlasses | Winches |
| Buckets | Tow Plates | Buoys | Anchor |
| Deck Blocks | Generators | Crane Blocks | Ship's Chain |

www.BYRNERENTALS.com

SALES@BYRNERENTALS.com

WELD-ON D-GUARD FENDERS

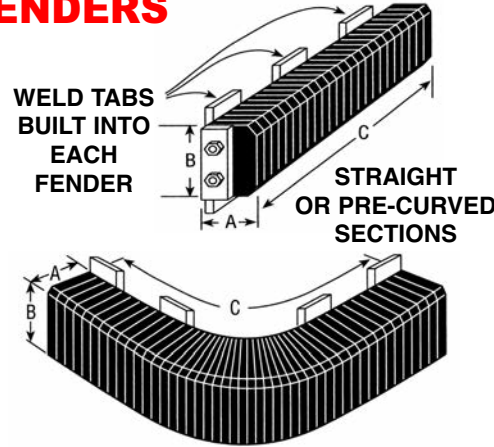

| 1 1/4" RODS | | DIMENSIONS | | |
|-------------|-----|------------|------|----|
| PART NO. | A | B | C | |
| SR114D 0606 | 6" | 6" | 12" | to |
| SR114D 0609 | 6" | 9" | | |
| SR114D 0707 | 7" | 7" | | |
| SR114D 0808 | 8" | 8" | 240" | |
| SR114D 0810 | 8" | 10" | | |
| SR114D 0909 | 9" | 9" | | |
| SR114D 1010 | 10" | 10" | | |

| 3/4" RODS | | DIMENSIONS | | |
|-------------|------|------------|------|----|
| PART NO. | A | B | C | |
| SR114D 0404 | 4" | 4" | 12" | to |
| SR114D 0405 | 4" | 5" | | |
| SR114D 0406 | 4" | 6" | | |
| SR114D 0408 | 4" | 8" | 240" | |
| SR114D 0410 | 4" | 10" | | |
| SR114D 4510 | 4.5" | 10" | | |
| SR114D 4512 | 4.5" | 12" | | |
| SR114D 0606 | 6" | 6" | | |
| SR114D 0610 | 6" | 10" | | |
| SR114D 0612 | 6" | 12" | | |

WELD TABS BUILT INTO EACH FENDER

16901 Wood-Red Rd.
Woodinville, WA 98072
1-800-426-3917
Fax: 425-488-2424
sales@schuylerubber.com
www.schuylerubber.com



1036 Vicky Lane
Broussard, LA 70518
1-866-347-9445
Fax: 337-321-4276
sales@schuylermaritime.com
www.schuylermaritime.com



Flagship Marine - Keep It Simple Stupid - the KISS principal has guided us since 1995!

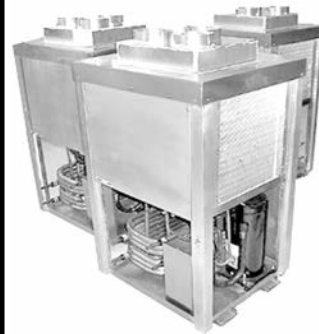

NO EXPENSIVE, PROPRIETARY PRINTED CIRCUIT BOARDS!
A CHILD CAN FOLLOW OUR SCHEMATICS!



CHILLERS • SELF - CONTAINED AIR COOLED - EXPLOSION PROOF EXTREME DUTY FOR UP TO 105°F SEAWATER!

OVER-THE-COUNTER COMPONENTS SLOWLY EVOLVED DESIGN AND COMPONENT SELECTION OVER MANY YEARS OF EXPERIENCE.



Air Cooled Rooftop Units By RVP Coleman 13,500 BTUs With Heat, Install Kit And Ceiling Assembly For Only \$929.95

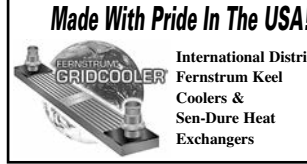

Phone: 772-283-1609
Fax: 772-283-4611
Watts: 800-316-6426
Flagship Marine, Inc.
2427 SE Dixie Hwy.
Stuart, FL 34996
flagshipmarine.com
sales@flagshipmarine.com



Donations Make a Difference:

- Annual gifts
- Planned giving
- Memorials
- Tributes to honor a birthday, anniversary or other special event
- Employer matching gifts

The Passenger Vessel Foundation, Inc is a 501(c)(3) nonprofit corporation. The Foundation was begun to ensure that the passenger vessel industry continues its dedication to furthering education and development of safety resources.

For More Information and to Donate Online Please Visit: pvfoundation.com/donate/

Supporting the passenger vessel industry through education and safety resources.



PASSENGER VESSEL FOUNDATION
Passenger Vessel Safety and Education.

Contact Us At:
Email: info@pvfoundation.com • Website: pvfoundation.com



Barge Propulsion Units

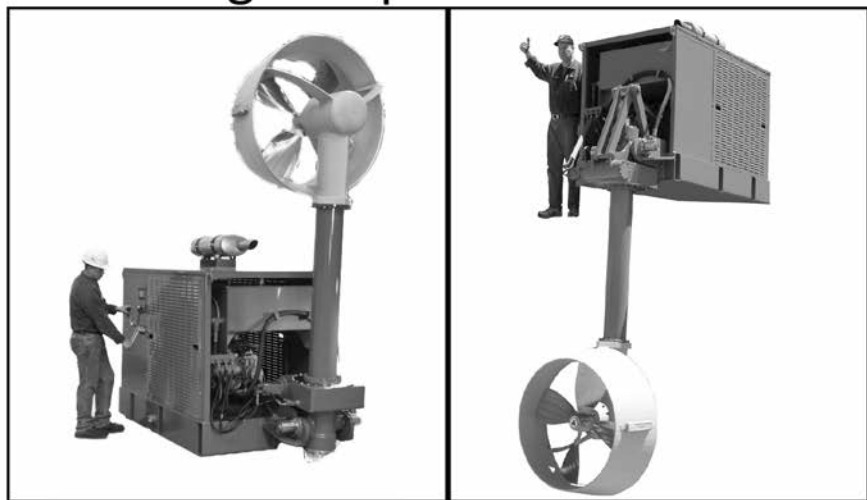

Available for rental

For over 30 years, Thrustmaster of Texas has been building outboard propulsion units for propulsion and maneuvering of barges used in brown water for marine construction projects. Powered by a Cummins QSB6.7 diesel engine, the Thrustmaster barge propulsion unit is a completely self-contained, hydraulic unit that can quickly be installed on the deck of any barge to provide pinpoint maneuverability and propulsion. Thrustmaster outboard drives freely azimuth through 360 degrees of steering range making them extremely responsive and ideal for tight quarter maneuvering and positioning applications. The units are extremely robust and equipped with a hydraulic power tilt system capable of elevating the outboard drive assembly through an arc of 180 degrees to allow instant access for clearing ropes or logs fouling the propeller. Thrustmaster units are ideal for your construction project and available for immediate shipment.

Contact: Bert Ault - International Sales Manager Phone: 713-937-6295
bert@thrustmastertexas.com Mobile: 713-249-2375
www.Thrustmaster.net

SPECIAL! BEST DEALS ON ROPE!

3-Strand Nylon

High-tenacity white nylon multifilament fiber. Four-stage construction produces a torque-balanced rope with medium lay. Meets or exceeds Cordage Institute, US and Canadian Military standards.



600 ft Spools

| Size | Order# | Tensile Strength | Ft Price per Reel | 600' Reel |
|--------|--------|------------------|-------------------|-----------|
| 3/8" | 118628 | 3700 lbs | 0.17 | 104.46 |
| 7/16" | 118630 | 5000 lbs | 0.22 | 131.75 |
| 1/2" | 118631 | 6400 lbs | 0.31 | 184.86 |
| 5/8" | 118632 | 10400 lbs | 0.49 | 292.72 |
| 3/4" | 118633 | 14200 lbs | 0.69 | 416.43 |
| 7/8" | 118634 | 17280 lbs | 0.96 | 578.97 |
| 1" | 118635 | 25000 lbs | 1.16 | 711.45 |
| 1-1/8" | 118636 | 33000 lbs | 1.43 | 856.64 |
| 1-1/4" | 118637 | 37500 lbs | 1.75 | 1047.76 |
| 1-1/2" | 118639 | 53000 lbs | 2.43 | 1457.77 |

Poly Plus Rope

High-tenacity polyester with polypropylene core, medium lay, good strength/low stretch, good abrasion resistance, excellent UV resistance. White with orange tracers.



600 ft Spools

| Size | Order# | Tensile Strength | Ft Price per Reel | 600' Reel |
|--------|--------|------------------|-------------------|-----------|
| 3/8" | 118655 | 3200 lbs | 0.15 | 91.46 |
| 7/16" | 118656 | 3900 lbs | 0.18 | 118.58 |
| 1/2" | 118657 | 5400 lbs | 0.25 | 149.66 |
| 5/8" | 118658 | 7200 lbs | 0.39 | 231.61 |
| 3/4" | 118659 | 9800 lbs | 0.54 | 326.50 |
| 7/8" | 118660 | 13500 lbs | 0.76 | 455.27 |
| 1" | 118661 | 17000 lbs | 0.88 | 526.06 |
| 1-1/8" | 118662 | 21000 lbs | 1.09 | 654.11 |
| 1-1/4" | 118663 | 25000 lbs | 1.34 | 806.39 |
| 1-1/2" | 118664 | 41000 lbs | 1.89 | 1135.01 |

HAMILTON MARINE

800-639-2715
hamiltonmarine.com

Anti-Fatigue Mats

2-Sided Interlocking Design, 1/2" thick, 3' x 3' mat. 100% re-vulcanized rubber.

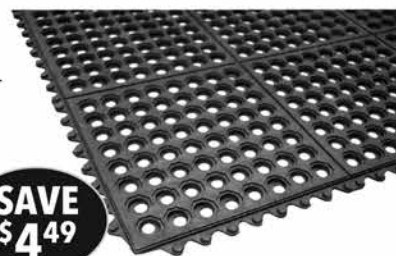

\$14.50

SAVE \$4.49

Reg 18.99
HTV-179873
Order# 754535



Cast Aluminum Commercial Hatches

Fast acting, flush, watertight. Easily installed in any deck style.

15" x 24"
\$649⁹⁹

SAVE \$170

Reg 819.99
FMN-2433-0002
Order# 754527



24" x 24"
\$1149⁹⁹

SAVE \$250

Reg 1399.99
FMN-2424-0002
Order# 754529



Anchor Inspection Hatches



Anodized Aluminum with Stainless Steel Flange

Many Sizes Available!

Search HM-H

FROM **\$339⁹⁹**

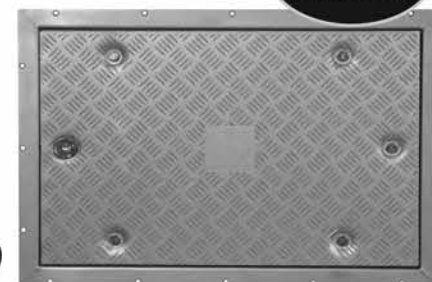

Cast Aluminum Commercial Hatches

Flush, watertight, 4-dog system, opens from the outside only.

15" x 24"
\$529⁹⁹

SAVE \$90

Reg 619.99
BOM-C41524-0
Order# 104612



24" x 24"
\$899⁹⁹

SAVE \$130

Reg 1029.99
BOM-C42424
Order# 104619

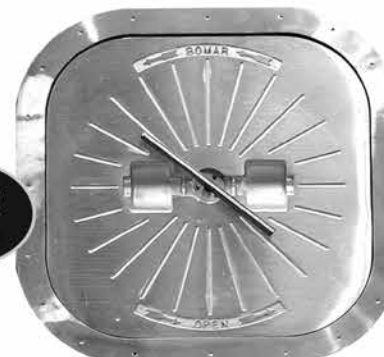

Tread Plate Access Hatch

High quality 5-bar marine grade, anodized aluminum tread plate with 12-gauge 316 stainless steel frames. Wrench sold separately. Search# BOM-S4

FROM **\$539⁹⁹**



Commercial Bumper

Black. Up to 60 ft lengths.

2-1/8" Base Width, 2" High, 7/16" Wall Thickness

DAM-DB-50 **\$7⁹⁹ FT**
Order# 107117

3-1/8" Base Width, 2-7/8" High, 11/16" Wall Thickness

DAM-DB-75 **\$15⁹⁹ FT**
Order# 107128

Insert Strips and Molded Corners Available



Strip inserts here. Sold in lengths up to 10'



Fan Nose Bumper

Black. Up to 60 ft lengths.



2-1/2"W x 3" OD, 5/8" Wall Thickness

DAM-DB-503 **\$16⁹⁹ FT**
Order# 148198

3-3/4"W x 4-1/2" OD, 3/4" Wall Thickness

DAM-DB-504 **\$23⁹⁹ FT**
Order# 147124



Composite Panels

Use in place of plywood!

High density, polyurethane foam, reinforced with layers of fiberglass strands throughout. Lightweight, non-rotting.

SEARCH# CSA-

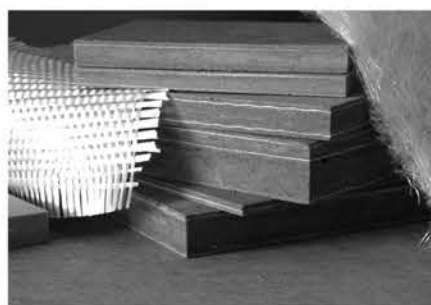

Extren® Fiberglass Structural Shapes & Plates

GET THE WOOD OUT!

Corrosion and UV resistant, lightweight, high-strength, low maintenance!

SEARCH# SGW-



COMMERCIAL SUPPLIES

PORTLAND ROCKLAND SEARSPORT SOUTHWEST HARBOR JONESPORT

Typographical errors are unintentional and subject to correction.

HAMM MAINE HAMILTON MARINE

800-639-2715
hamiltonmarine.com

KENT Premium Adult Universal Survival Suit

High visibility yellow inflatable head pillow, face mask, mitts and ankle adjustments. Removable head pillow. Articulated arms for easier donning. Includes buddy line and whistle.

USCG APPROVED
\$249⁹⁹

KNT-1540-AU
Order# 753274



IMPERIAL Adult Universal Cold Water Immersion Suit

Three fingered mitt. Wide legs for easy donning. Includes whistle and storage bag.

USCG APPROVED
\$269⁹⁹

RVS-1409A
Order# 743829



KENT Type I Offshore Life Vest

USCG Approved with reflective tape, light loop and whistle attachment.

\$32⁹⁹

Adult Universal
PFD-1A
Order# 748930



GME ACCUSat™ EPIRBs

406 MHz. 6 Year Non-Haz Mat battery, 6 Year warranty. Featuring a stainless steel antenna. USCG/GMDSS Approved.

6 Year Battery!

Cat II Manual
Order# 731676
\$349⁹⁹

Cat I Auto
Order# 731678
\$469⁹⁹



KENT In-Sight Offshore Automatic/Manual Inflatable PFD

USCG APPROVED Type V with Type II Performance Heavy-duty 420 denier nylon shell. Neoprene comfort collar. SOLAS grade reflective tape. In-Sight window shows armed status. Full 35 lbs buoyancy.

LIMITED QUANTITIES!

\$99⁹⁹

SAVE \$50

Reg 149.99
Color Order#
Orange 752862
Red 761645



Cyalume PML



USCG APPROVED

Carries its own energy source, the safe, sure power of chemiluminescence. Illuminates up to 8 hours, no batteries necessary.

\$14⁹⁹

OLI-899
Order# 150937



C-Light™ H2O

Waterproof steady-on light with 20 lumen LEDs that operate typically for 30 hours continuously. Two activation methods; manual push On/Off button or auto-activated when immersed in water. The slim, lightweight and versatile design fits easily in a pocket or hangs discreetly when attached to a life jacket or backpack. Requires two AA batteries (not included).



USCG & SOLAS APPROVED
ACR-3962-1 **\$19⁹⁹**
Order# 761836



RIGID High Performance LED Lights

Patented specter and hybrid optics allow for multiple combinations of flood and spot lighting. High purity aluminum housing. Superior light with ultra low power consumption.

Search# RIL-

Starting At
\$113⁹⁹



Polyurethane Steel Toe Boots

14" High. Very comfortable and light weight polyurethane boots with steel toe cap. Green. GYC-GCT-GR

\$142⁹⁹



pair

Order# Size
755534 9
755535 10
755536 11
755537 12
755707 13



GRUNDÉNS Foul Weather Gear HUGE SELECTION IN STOCK!

Search# GRD-



GRUNDÉNS Grundies Base Layer Long Underwear

Made from a super comfy and high performing merino wool, polyester hollow core, spandex blend, guaranteed to keep you warm and toasty under Grundéns rain gear. Dark Slate. S-3XL.

Shirt or Pants
\$44⁹⁹

Search# GRD-GB



Exhaust Wrap

Manufactured from fiberglass. Contains no asbestos. Sold in 100' rolls.

Best Seller!



| Part# | Size | Order# | SELL |
|--------|------------|--------|-------|
| HM-EW2 | 2" x 1/16" | 117646 | 24.49 |
| HM-EW3 | 3" x 1/16" | 117648 | 35.99 |
| HM-EW4 | 4" x 1/16" | 117649 | 46.99 |

Electric Rope Cutting Guns

100 Watts
\$32⁹⁹

PUR-15463
Order# 127675

Heavy Duty
120 Watts
\$39⁹⁹

PUR-15463HD
Order# 735613



WE MARK AND SWAGE WIRE!

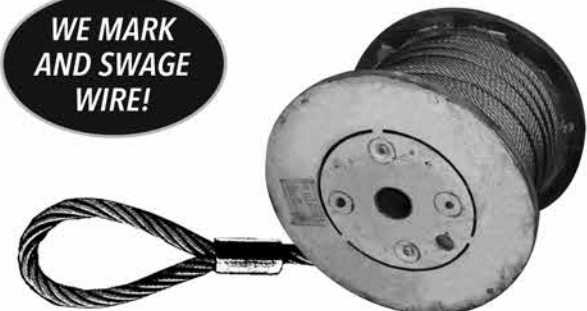

Galvanized or Stainless Steel wire, from 1/4" to 1" diameter. We hand and machine (commercial) swage wire and mark wire for fishermen the old fashioned way.

Marine Oil Stoves



Rugged marine grade heavy gauge stainless steel. Runs on diesel oil or kerosene. Reliable, efficient, and safe heat.

Search# REF-



FREE HEAT from your engine's closed cooling system!

MARINE HEAT

Flush mount or ducted models. Available in 28,000 to 40,000 BTUs.



Search# MH-

Noise Reduction Sheets

Engine room noise control. Reinforced metallized polyester film facing with adhesive backing. 32" x 54" sheets.

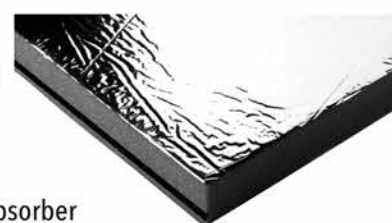

1" Thick Sound Absorber
HMQ-SA3254M1 **\$84⁹⁹**
Order# 154807

1" Thick Sound Barrier Composite
HMQ-SBC3254M1 **\$102⁹⁹**
Order# 154810

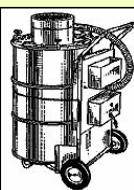

Get a "WiseASH" attitude!
 #RM-97 incinerator for burning Non-Haz oily wastes, oil filters, boxes, sorbents/rags, waste oil etc.
Burns Clean & Smoke Free!
 "The SuperCharged Burn Barrel!"
 SkimOil Inc. www.wiseash.com
 (314) 579-9755 • fax (314) 558-9253

MARINE SANITATION DEVICE Economy Type II MSD

USCG Approved Modular Design
 4/12/16/32 man sizes compact/low profile
 Fits anywhere In STOCK Now!!
Economy Type II MSD Got Poop?
 EZ Install & EZ Ops
"The Poop Plant"
www.thetankMSD.com • SkimOil Inc. (314) 579-9755



Offshore Oil Rigs & Marina WINDSOCKS
FACTORY DIRECT
 IN STOCK AND READY FOR IMMEDIATE SHIPMENT
AIRPORT WINDSOCK CORPORATION
 1-800-579-5135 952-890-9214
www.airportwindsocks.com

FOR SALE OR RENT

Army Bridge Boats
 27' x 8' Twin Diesel GM 353,
 3-1 Trans, 25 x 19 Prop.
For Location & Price
(916) 539-8199 or
osmsinc@gmail.com
 Trailers May Be Available Separate

COMMERCIAL ALUMINUM JETBOATS
SMOKY MOUNTAIN JETBOATS
 12 passenger COI - PARTIALLY PROTECTED
 25 passenger COI - LIMITED COASTWISE
smokymountainjetboats.com
 1828 488 0522 - 1888 900 9091



NYS MARINE HIGHWAY TRANSPORTATION CO., LLC
WWW.NYSMARINEHIGHWAY.COM
SHIP BY CANAL



FABRICATED PRODUCTS



DREDGES, DEAD SHIPS & CONTRACTORS EQUIPMENT



PROJECT CARGO

WE CAN TOW YOUR EQUIPMENT BETWEEN THE EAST COAST & GREAT LAKES VIA THE NYS CANAL SYSTEM
QUOTES ROB (518) 365-3305 rob@nysmarinehighway.com



Commercial-Duty Walker AIRSEPS®

The NEW Standard for Diesel Breathing Systems Used in Today's Workboats.
Fleet Supply Warehouse, Inc.
 205 Venture Blvd., Houma, LA 70360
 Tel: 985.868.0430 Fax: 985.868.0436
Your Louisiana Headquarters for Walker Air Filters and New CCE Replacement Elements.

Walker Engineering
www.walkerairsep.com

TWIN DISC
Marine Gears, Torque-Converters - ALL Supplier & Rebuilder "Since 1982"
www.RMIservices.com
 (504) 347-4361

NO DISCHARGE ZONE? Got Bilge water? No problem! BilgeVAP eliminates your water!

ZERO LIQUID DISCHARGE
Bubba Proof
 No moving parts
 Electric / 4-12 GPH
 SkimOil Inc.
 Call (314) 579-9755
 BilgeVAP evaporates your water away
www.NoDischargeZone.com

FIBERGLASS SUPPLIES

Epoxy, Vinylester, Polyester Gelcoats, Barrier Coats
 FG Laminate Angle & Panels
 Carbon Fiber, Kevlar
 Fairing & Bonding Compounds
 Marine Plywood, Core & More!

CARBON CORE
 HONEYCOMB CORE
 Technical Assistance
 800-231-6537
lbiadmin@lbicorp.com
office@lbicorp.com
www.lbifiberglass.com

Ever Get Bad Fuel? Get The Fuel Purifier Simply Removes Bulk Free Water Heavy Particulates
How About Just Cleaner Fuel? FILTERLESS FILTER - BUBBA PROOF
 EZ to install and use - sizes for ALL diesel engines
 SkimOil Inc. (314) 579-9755 - www.thefuelpurifier.com

Oily Bilge Filters

 Sizes for all boats
 Simple Inline Filter
 Works With Any Pump
 Overboard oil prevention system
 1/10 the size and cost of oil water separator
www.TheBilgeFilter.com - (314) 579-9755
Check Out Our Classified Ads
Starting on Page 18

Automatic Pot Line Coilers

FREE SHIPPING

The Extra Deckhand®
 Hydraulic Line Coilers
 The patented 40# wonder that's Made in Alaska to be Alaskan Tough
WWW.EXTRADECKHAND.COM
 E.D. Industries LLC - 10006 Crazyhorse Drive
 Juneau, Alaska 99801
 Tel./Fax - (907) 789-9164

Serving Both Coasts Of The United States And The Gulf Of Mexico



Vessels Built Over 70 Years Of Fabrication Include: Double Hull Tank Barges, Hydraulic Dump Scows, Deck Cargo Barges, ATB Barges, Ro-Ro Barges And Many Custom Vessels.
GUNDERSON MARINE
 Call Chuck Garman At Gunderson Marine (800) 253-4350
 A GREENBRIER COMPANY
 4350 NW Front Avenue, Portland, Oregon 97210
 Call Chris Cole At Our Gulf Coast Office (504) 722-3526

LED FLOODLIGHTS
 Commercial Duty • Marine Grade
 10Watt, 30Watt, 50Watt & 80Watt

GREEN GENERATION LEADING-EDGE TECHNOLOGY
 Low Maintenance and Low Power Consumption
 Up to 85% less power when compared to Halogen Lights
 Low Operating Temperature and Low UV Output
 Vibration and Shock Resistant Design
 Grey or White Double Power Coated Aluminum Housing
 Marine Grade 316 Stainless Steel Hardware and Bracket
 Water Resistant IP 67 Rating UL/CE and SAA Compliant
 2 Year Limited Warranty
 3900 Kelvin Natural White LED Color Temperature
 >80 CRI - Color Rendering Index
 130 Lumens per Watt
 100v-305vac 50-60Hz or 10-30vdc Input Power
NEW FLHQ SERIES
 80Watt & 120Watt LED FLOOD LIGHTS 130 lumens per Watt
 Simple to change 50°, 90° & 120° Beam Angle Lenses

The LED Robust Tri-Proof Light is designed to replace fluorescent fixtures in applications where long life and low power consumption are important considerations.
 Available in 600mm, 2ft 30Watt and 1200mm, 4ft 60Watt
 Large Beam Angle 230°
 CRI - Color Rendering Index of >85CRI provides excellent color rendering and natural light appearance
 Long service life ensures low operating costs and reduces maintenance costs
 Low profile fitting
 High impact cover IK10
 5 years limited warranty

OCEANUS - LED MARINE UTILITY LIGHT
 The Oceanus LED Utility light fixture is designed to replace fluorescent light fixtures in applications where long life, minimal maintenance, and low power consumption are important considerations.
 A 3900K Natural White color is used to achieve the best CRI and there are versions with an added red or blue color circuit for night time illumination.
 The fixture can be flush mounted or surface mounted with the supplied bezel.
 Available in 85v-265vac, 10v-30vdc and a dual circuit 85v-265vac + 10v-30vdc.
 2520 Lumens in Total
E-LED LIGHTING Inc.
 PHONE: (561) 845-7460, FAX: (561) 214-4928
info@E-LEDLighting.com, www.E-LEDLighting.com