

2020

Mid Fifties

F-100 Parts

www.midfifty.com

1953-56 CATALOG

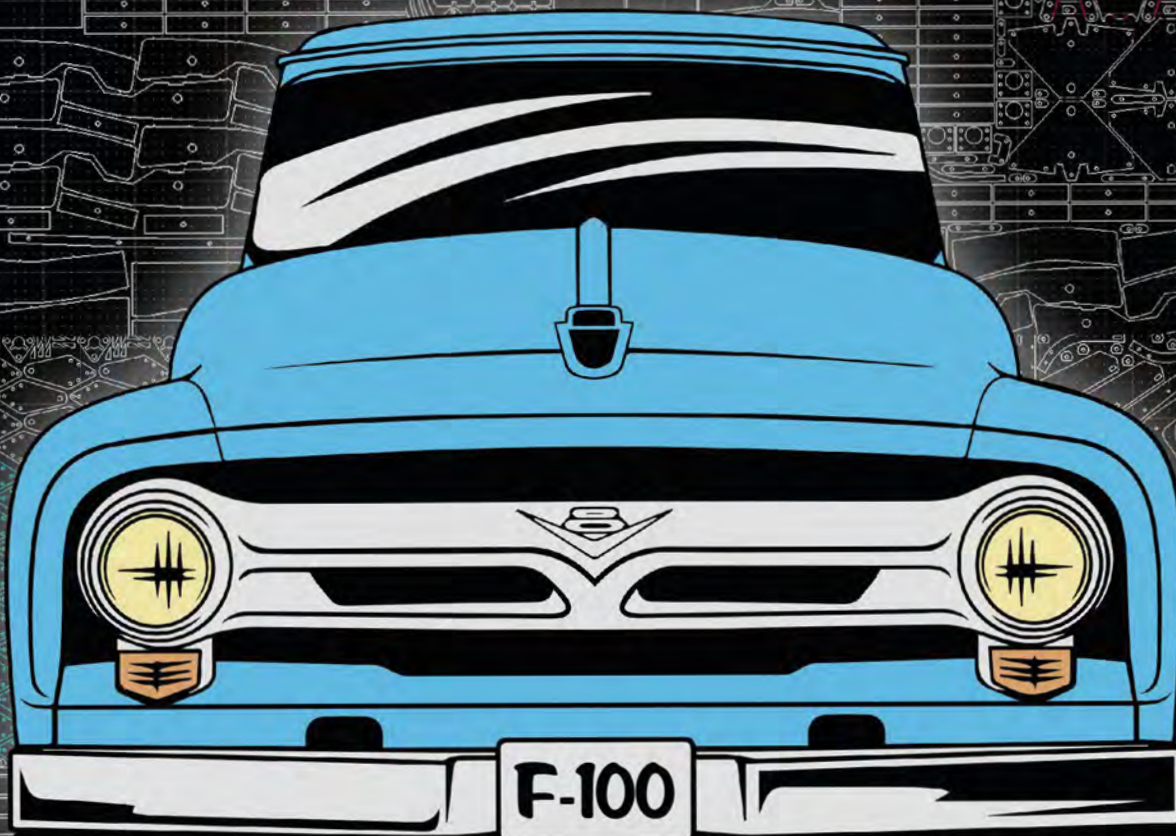

1-800-252-1956



Loretta Smallwood

04-01-56 02-25-04

Life, Love, Laughter, Longing and Loss
Daughter, Sister, Mother, Partner & Friend

Forever with us in spirit, Sy's sister Loretta, who was an integral part of Mid Fifty, was taken from us much too soon. She is terribly missed and will remain in our hearts forever. May her smile, enthusiasm, command of life, spirit and drive continue to inspire and comfort us.



Jodi Ward

12-18-60 01-02-06

Jodi was our right hand for 8 years, she loved these old trucks, her customers, vendors and going to the Super-nationals, this picture was taken "after the show" in Gatlinburg. What Fun she was! We loved her and miss her terribly. She never met a problem or an idea she could not handle. May her Optimism, Kindness, Sharp Wit and Can-do attitude live on in our memories of her.



This pin is designed in honor of our Ford truck extended family. Let it stand for ALL our loved ones gone before us. May it be a small symbol of our united fellowship, and silently say what we sometimes cannot.

We are honored to offer the pin as our gift. Please ask for and display it.



Joe Donaldson

4-29-1953 8-25-2012

Joe was a kind, loving, and a tremendously giving soul. His favorite pastime was sailing the waters of Calif., and helping others. He enjoyed working at Mid Fifty's, and was knowledgeable in all that he did. He left us with fun memories that will be in our hearts forever, and we miss him every day.



Gina Hanks

9-9-1955 3-16-2012

Gina took on our office and paperwork flow with poise and determination for a job well done. She worked tirelessly with the best of humor and grace. She will forever be in our hearts. Memories of her quick wit and wonderful laugh comfort us throughout the days. The Best of Friends and a fearless 4-wheeler. May her true goodness and strong, honest, positive spirit stay with us and guide us.



**WINGED TRUCK
MEMORY WINDOW DECALS**
Personalized, call for details
Black or White
add your loved ones name & dates



CORE CHARGES

We chrome or rebuild some original pieces which means we must exchange stock parts for the chromed or rebuilt part. Core charge will be refunded as soon as we receive your chrome-able or rebuild-able part. It MUST be in acceptable condition.

CORE CHARGES Listed in this catalog are NOT an estimate of value. They are an INCENTIVE (scare tactic perhaps) for the return of the original part. Core charges are in ADDITION to the price of the product. Parts like steering boxes have a low value (\$25.00 for instance) but a high Core Charge (\$100.00) because they are difficult to return, heavy, messy, etc

INSTRUCTIONS FOR RETURNING YOUR CORES: **MAKE SURE YOUR NAME, ADDRESS AND PHONE NUMBER IS INSIDE THE BOX**

STEERING BOX CORES, cut shaft off 2" above box, drain oil, wrap in plastic (oil is never completely gone) send without shaft, then box is only about a square foot. Steering boxes must have outer plates. Cores that are damaged or have been previously rebuilt may not be acceptable.

DEFROST DEFLECTORS, Must be in a box that will not bend, 53-55's can go in a carpet tube or piece of large sewer pipe. 1956's should be taped to piece of paneling, Masonite, wide board, etc

VENT FRAMES, we no longer rebuild vent frames as they are now available reproduced.

SEND CORE PART TO: **MID FIFTY F-100 PARTS**
5221 US HIGHWAY 68
GOLDEN VALLEY, AZ 86413

DUE TO COST OF HANDLING & STORAGE UNACCEPTABLE PARTS WE RECEIVE MUST BE DISCARDED.

If you are lucky enough to have extras, let us know, we may buy, trade or pass on the information to someone who has none.

SHIPPING

Shipping costs are calculated based on your location and the size/weight of your order and we charge as close as possible to our cost to give you the best possible rate. Next Day, 2 and 3 day shipping is available for an additional charge. We are committed to the environment and hate to waste good boxes so you may receive your parts in a recycled box, the image on the outside may not be what is inside.

RUSH ORDERS

Rush service is available on most items and is an extra \$20. Rush orders must be placed by 11AM Arizona time, and does not mean you are paying for a faster shipping method, it just means your order will ship the same day if received before the cutoff time

COD

We accept COD orders and all major charge cards, American Express, VISA, Master Card & Discover, Cash is nice too.

TRUCK FREIGHT

Truck lines charge \$20.00 to call before delivery, a minimum of \$90.00 to \$180.00 to deliver to a residence, so we need a business address. Some locations are remote, and extra charges might apply. Never ship by Truck COD (as in collecting for item at delivery, truck lines charge hundreds of dollars to collect other people's money). UPS cod is much less, about \$10.00 at time of printing. NEVER accept a truck freight shipment without examining it closely first, OPEN it up to inspect for hidden damage If you have any questions, or notice any damage, WRITE IT ON THE BILL OF LADING, ask the driver to wait and CALL US!! 1-800-252-1956. Do not be intimidated, you do not have to accept a questionable shipment! Common sense must be your guide, Shipping companies assume when they deliver something to you it is your responsibility. If you accept a damaged shipment without inspecting inside and out, and writing any damage on the bill of lading there is NOTHING WE CAN DO!!!! If someone else is accepting your shipment, make sure they NOTE ANY DAMAGE ON THE BILL OF LADING, if they do not, THERE IS NO RECOURSE. Accepting a freight shipment is YOUR RESPONSIBILITY

PHONES

Our phones are toll free to you for both ordering and technical questions. We do NOT have automated menu driven mail box phone systems and we NEVER will, 'cause I hate them. We try to spend as much time as needed with each caller, therefore you may get a busy signal or recording during business hours. Just give us a few minutes and try again. Our phones are answered by living, breathing, interested and helpful people. If we are unable to help, most likely we know someone who can and will refer you.

FIRST-SERVE WAITING LIST

New parts, improved parts, new fixes, ideas and such are being worked on every day. Some are listed in this catalog or on our website. If you are interested in one, or any part for that matter, let us know. We will keep your name on a waiting list and notify you when its available.

RETURN POLICY

Mid Fifty F-100 parts will always stand behind our parts, with regard to defects or damage that we are responsible for. To help us maintain this policy, please open and inspect all parts upon receipt. Parts returned for defect will not be subject to a restocking fee. For returns at customer discretion, a flat restocking fee of 5% will be applied. NO restocking fee if you want store credit for your return. Items returned that were part of a kit will have a 15% restocking fee, (10% if you want store credit) since the return amount is based off retail price, and items in kits are already discounted.

IN ADDITION, note below exceptions, some products not returned in a timely fashion may incur additional restocking charges:

- Un-installed electrical items are not returnable after 90 days. Installed electrical items are NON-returnable.
- Electrical items are ineligible for replacement after 1 year from date of purchase.
- Wood products are not returnable after 30 days.
- Rubber and Raw Steel are not returnable after one year.
- Polished Stainless, Chrome and Polished Aluminum are not returnable after one year.
- Of course items that have been modified, painted, installed, etc. are not returnable.
- SPECIAL ORDER ITEMS ARE NON-RETURNABLE

Excluding defective products, aged products that are not the current part revision that we stock (Discontinued, obsolete or redesigned items) are not returnable.

We stock, and/or are dealers for any and all manufactures of any F-100 product, as well as our own. We ship what Sy considers best at any given time, we research this stuff constantly, what we consider best sometimes changes. Rubber compounds change, Stampings change, molds & dies age and need constant care, manufacturing can be off just because one person is off.

If you have a question, information, advice or a preference, give us a call.



Photo courtesy of East Bay Ford F-100 Elites, Hayward, CA

ABS INTERIOR	12-13	DIP STICK	88
AIR CONDITIONING	80-81-82	DISC BRAKE KITS	176
AIR DEFLECTOR	122	DOG HOUSE	121
ALTMANS EASY LATCH	105	DOME LIGHT	35
ANTENNA	30	DOOR HANDLE REGULATOR	103
ANTI-RATTLE KIT	97	DOOR HARDWARE	99
ARM RESTS	14	DOOR HINGE	105
ASH TRAY	38	DOOR LATCH	105
AWESOME ASSEMBLY KITS	65	DOOR LOCKS	104
AXLE, FRONT	165	DOOR PANELS	12-15
AXLE, REAR STOCK	184-185	DOOR REPAIR	98
BATTERY BOX	56-57	DOOR WEATHERSTRIPPING	96
BATTERY FLOOR HOLE LID	57, 117	DOOR & WINDOW HANDLES	103
BED BOLTS	139	DRAG LINK	166
BED COVERS	147	DRIP RAIL	120
BED, CUSTOM, PROS PICK	148	DROPPED AXLE	165
BED FLOOR	137	EMBLEMS	32-33
BED KITS	132-135	EMERGENCY BRAKE	183
BED MAT	26	ENGINE	87-89
BED PARTS	138-141 148-149	ENGINE MOUNTS	90-91
BED ROLL PLUGS	141	EXHAUST	88-89
BED STRIPS	136	FAN	83
BED STRIP, BULL NOSE	133	FENDER ALIGNMENT	113
BEZELS	39	FENDER & FRONT END COVER	26
BIG BACK WINDOW CONVERSION	120	FENDERS, FRONT	124
BODY REPAIR PANELS	117-130	FENDERS, REAR	130-131
BOOKS	10	FENDER WELT	131
BOXING PLATES	179	FIREWALL	115
BRAKES	176-183	FIREWALL COVERS	115
BULBS, HEADLIGHT	59	FLOOR	116-117
BUMPERS	28	FLOOR MAT	21
CAB, COMPLETE	120	FRAME BOXING PLATES	179
CAB MOUNTS	126-127	FRAME HORN COVERS	28
CAB REPAIR PANELS, CORNERS	116-121	FUN FORD STUFF	6-7-8
CAB SKIRTING	128	GAS CAPS	73
CARPET	18-19	GAS/FUEL LINES	70
CENTER CONSOLES	14	GASKETS	88-89
CHOKE OR THROTTLE CABLE	39	GAS SENDERS	68
CHOP TOP	121	GAS STUFF	68-72
CHRISTMAS CARDS	7	GAS TANK	71-72
CIGAR LIGHTER	38	GAUGES, AFTERMARKET	48-49
CLUTCH PARTS	180	GAUGES, STOCK	42-43, 57
COLUMN DROPS	171	GIFT CERTIFICATES	6
COURTESY LIGHT	35	GIFTS	6-8
COVERS, TRUCK	27	GLASS	92-93
COWL VENT	114	GLASS KITS	93
CUP HOLDERS	37-38	GLOVE BOX	37
CUSTOM CAB EMBLEMS	33	GRAVEL PAN	123
DASH COVER	26	GRILLE	32
DASH FRAME	41	HEADERS	86
DASH PANELS	44-47	HEADLIGHT	59-61
DASH REPAIR	119	HEADLINER	22
DASH TRIM, DEFLECTOR	78-79	HEATER	78-79
DECALS	9	HEAT SHIELD, HOOD	26
DEFROST	78-79	FLOOR	24
DIMMER SWITCH	61	HINGE, DOOR	105
		HINGE, HOOD	111
		HOOD EMBLEM	33
		HOOD & HOOD PARTS	110-113



HOOD TILT KITS	112	SHOP MANUALS	10
HORN	34	SHORT & SMOOTH LEAF SPRING	158
HUB CAPS	186	SHROUDS	83
ID PLATE	36	SIDE WINDOW ANTI-RATTLE	97
IFS SUSPENSION	175	SIGNS	7
IGNITION	58	SLIDING REAR WINDOW	192
INNER FENDER	125	SOLID SIDE WINDOW	106-107
INSULATION	19, 24, 25	SPARE TIRE CARRIER	185
KEYS	104	SPEEDOMETER CABLE	40
KICK PANELS	20	SPRINGS, LOWERING	158-159, 162
KING PINS	165	SPRINGS, STOCK	160-161-163
KNOBS	39	STAKE POCKET	138
LATCH, DOOR	105	STARTER SOLENOID	53, 58
LATCH, HOOD	110	STEERING, STOCK	167
LOCKS & KEYS	104	STEERING COLUMN, CUSTOM	166-169, 172-174
LONG BED	150-155	STEERING CONVERSIONS	169-170, 174
LOWERING KITS	157-159, 162	STEP PLATES	129, 150
LOWERING TIPS	156	SUN VISORS, OUTSIDE	29
MANUALS	10	SWAY BARS	157
MASKS	26	TAILGATES & PARTS	133, 142-145, 148, 153
MASTER CYLINDER	179	TAIL LIGHT	64-67
MIRRORS	31	TANK, GAS	71-72
MMB HOOD TILT KIT	112	TEMPERATURE SENDERS	50
MOLDING	120	TIE ROD	165
MONO LEAF SPRINGS	158	TONNEAU COVER	147
MOTOR MOUNTS	91	TOYOTA STYLE STEERING	169
MUSTANG II IFS	175	TRANSMISSION COVERS	117
OIL FILTER, SENDER ORIGINAL	87	TRANSMISSION MOUNTS	91
OVERDRIVE PARTS	50	TRIM, WINDOW	29
PANEL TRUCK PARTS	187-191	TRUCK COVERS	27
PARKING BRAKE	183	TURN SIGNALS	62
PARKING LIGHT	63	U-JOINTS	168
PATCHES	8	UNDER-BED GAS TANK	77-72
PATCH PANELS	116-119	UNDER DASH COVERS	21
PIN & BUSHING KIT	159	UPHOLSTERY	14-15
POWER STEERING	169-170	VALANCE, GRAVEL PAN	123
POWER WINDOWS	108-109	VALANCE, RADIATOR	83
RADIATOR & PARTS	83-85	VALVE COVER DECALS	9
RADIO	30	VENT WINDOW	100-101
RAG JOINT	168	VISORS, INSIDE	23
RATING PLATE	36	VISORS, OUTSIDE	29
REAR AXLE	184-485	VOLTAGE REDUCERS	53
REAR VIEW MIRROR	31	VOLTAGE REGULATORS	58
REAR WALL	12	WEATHERSTRIPPING	94-96
REMOTE KEYLESS ENTRY	109	WHEELS	186
ROCKER PANELS	118	WHEEL TUBS	131
ROLL PANS	146	WINDOW REGULATORS	102
ROOF, steel and fiberglass	120	WINDOW RUBBERS	94-95
RUBBER SEALS	94-95	WINDOW TRIM	120
RUNNING BOARD	129, 150	WINDOW VISORS, INSIDE	23
SAMPLES	11	WINDSHIELDS	92
SEAT BELTS	17	WINDSHIELD WASHER	74
SEAT COVERS	15-16	WIPERS	75-77
SEAT FOAM	16	WIRING, 6 VOLT	53
SEAT PARTS	16	WIRING ACCESSORIES	54-55
SENDING UNITS	50	WIRING HARNESSSES	51-52
SHIRTS	6	WRAP AROUND WINDOW	120
SHOCKS	164-165		



A



B



C



D

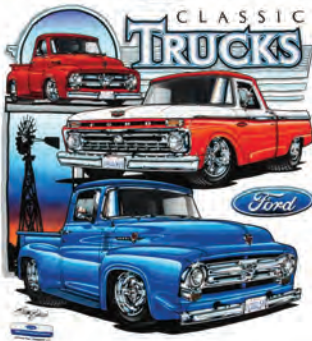

E



CHILD SIZES T-SHIRT

F



Onezy 12 or 24 month size

F-1



G

SHIRTS, Order by size, available in small, medium, large x-large, 2x-large and 3x-large, 3x sizes are \$3.00 extra

- (a) VINTAGE SIGN A-TS-VS1..... \$15.00 ea
On a dark gray shirt
- (b) BROWN PANEL A-TS-VS2.... \$15.00 ea
On a brown shirt
- (c) WHITE W/ RED TRUCK...A-TS-VS3.. \$15.00 ea
- (d) HOOD EMBLEM & 56.....A-TS-HD.... \$15.00 ea

- (e) CLASSIC FORD A-TS-CL..... \$15.00 ea
- (f) CHILD'S SHIRT A-TS-C..... \$10.00 ea
Reads "I do the haulin' around here". Child sizes are 2T, 4T, 6-8, 10-12 and 14-16
- (f-1) ONEZY A-TS-Z \$12.50 ea
Available in 12 months and 24 months
- (g) NEON LOGO A-TSL-B \$15.00 ea
Available in black and pink



GIFT CERTIFICATES A-0101..... You choose \$\$

Does not have to be returned. A great gift.
Comes with free Christmas card If ordered as a Christmas gift.
We fill in the recipients name, gift givers name, event,
or anything of your choice.



A-CLOCK1



A-CLOCK2



A-CLOCK3



A-CLOCK4



A-CLOCK5



A-CLOCK6

CLOCKS, Order style and state color..... A-CLOCK(#) \$22.00 ea

Add a name +\$3.00 ea



GIFTS & FUN STUFF

1-800-252-1956



HAT PINS

Check website as we have some left overs engine badges, 289, 302 etc and a few misc other Ford styles, as we find them they will show up on website. (USA)

- Taillight with script & blue dotA-9508 \$4.50 ea
- Front hood emblemA-9510 \$4.50 ea
- Side hood emblem 1956.....A-9511 \$4.50 ea
- V8 hat pin with ford ovalA-9505 \$3.50 ea

MANY HAT PINS AVAILABLE SEE WEBSITE

DECALS

You just knew I could not resist making these, the truck is part of the family and a dependent, right? WHITE, as shown in photo of truck window so they show up 48-56 trucks available. (USA)

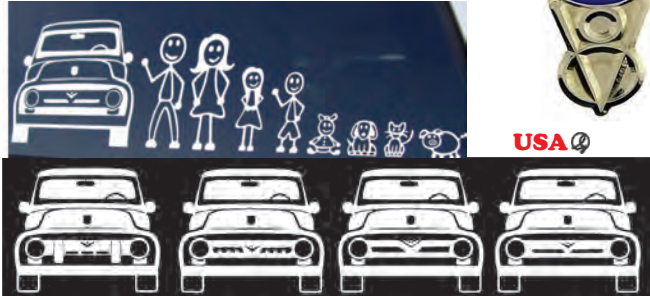

- People & petsD-520-(type) \$1.00 ea
- Truck front 1953D-520-53W \$5.00 ea
- 1954.....D-520-54W \$5.00 ea
- 1955.....D-520-55W \$5.00 ea
- 1956.....D-520-56W \$5.00 ea

MOST COLORS AVAILABLE, Call for help with colors

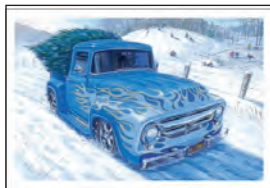

A



B



C



D



E



F

CHRISTMAS CARDS With envelopes.

- A..** BLUE With Flames (10)A-10018-BF\$13.50 set
- B..** BLUE on Country road.....A-10014-EA..... \$1.50 ea
Pack of 12.....A-10014.....\$15.00 set
- C..** RED 56 With GiftsA-10011-EA \$1.50 ea
Pack of 12A-10011.....\$15.00 set
- D..** RED 53-55 Santa's Delivery.....A-10017-EA..... \$1.50 ea
Pack of 12.....A-10017..... \$15.00 ea
- E..** RED 55 Santa's Shop (10)A-10019.....\$13.50 set
- F..** RED 53 Seasons GreetingsA-10016-EA..... \$1.50 ea
Pack of 12.....A-10016.....\$15.00 set

VINTAGE LOOKING METAL SIGNS

Made of nice heavy aluminum

- BROWN PANEL TRUCKA-0200-2..... \$29.99 ea
 - BLUE & WHITEA-0200-1..... \$39.99 ea
 - PINK & TEALA-0200-3..... \$29.99 ea
 - Ford Calendar, Red 1954 blue calendar
Includes date magnets A-0217.....\$24.95 ea
 - Ford Parking Only, Blue background,
Red and Black 1955 A-0216.....\$15.00 ea
 - Wood with 60 blue truckA-0218.....\$12.95 ea
- I'm going to drive a Ford when I grow up





- F-100 PARKING SIGNS
Choice of name & year
Gloss Red A-10021\$39.99 ea
Reflective Red A-10021-R.....\$27.99 ea
- METAL TOOTSIE ROLL SIGN..... A-10033\$16.95 ea



- STRESS SQUEEZE TOY..... SALE...A-0111....\$4.50 ea**
GONE WHEN GONE
- REGISTRATION HOLDER..... A-0410\$9.95 ea
Goes on steering column



- PATCHES, Embroidered, very nice quality, vibrant!!
Mid Fifty logo A-9400\$3.00 ea
- 1956 Pick-up A-9402\$5.00 ea
- 1955 Panel..... A-9403\$5.00 ea



- FORD COOLER, Blue A-0114-BLU... \$104.50 ea
Black.....A-0114-BLK... \$104.50 ea
Built-in bottle opener & snack tray. 18"x8 3/4"x12" tall

In memory of

LORETTA SMALLWOOD
1956 - 2004

- PERSONALIZED MEMORY DECAL**
Personalize with your lettering, White usually, shown in black for print, or most any color. Nice in back window.
..... D-550-5356.....\$15.00 ea

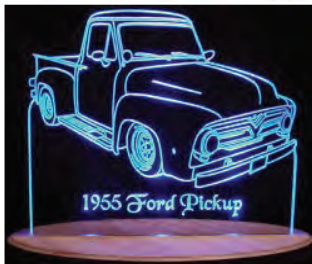

- LIGHTED ACRYLIC SIGN A-10401-(year)..\$99.95 ea
Order color and year, can be personalized, see website for additional information, comes with stand.





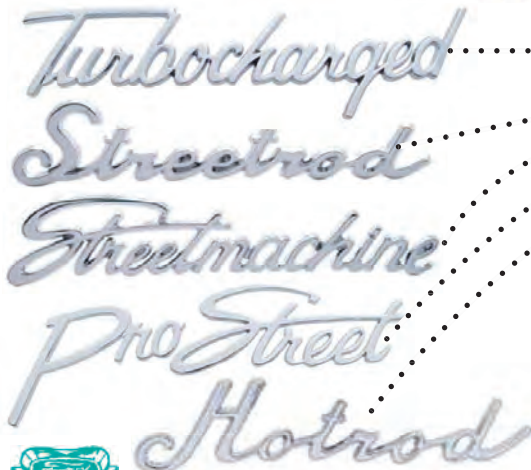





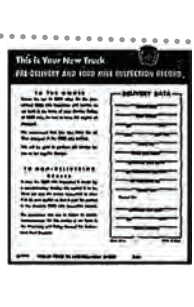
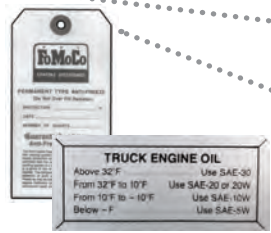
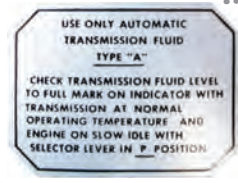







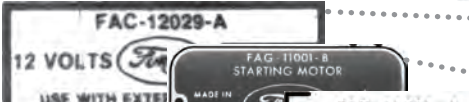
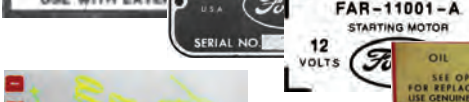
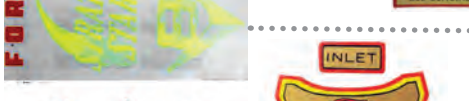

- FORD OVAL DECAL 3.5" D-001\$3.50 ea

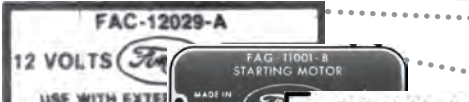
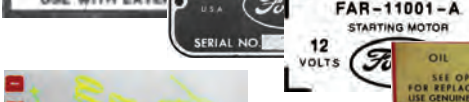
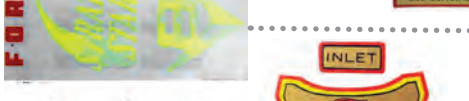

- EMBLEMS, Chrome Die Cast, include clips.**
- CRUISIN..... A-1205-CR\$8.95 ea
- BLOWN (4 x 2) A-1205-BN\$8.95 ea
- TURBO CHARGED A-1205-TC\$8.95 ea
- STREET ROD A-1205-SR\$7.95 ea
- STREET MACHINE A-1205-SM.....\$7.95 ea
- PRO STREET..... A-1205-PS\$8.95 ea
- HOT ROD A-1205-HR\$7.95 ea
- FORD SCRIPT 2220-A.....\$8.00 ea
- V6, approx. 4 X 1.5" 1205-M6.....\$9.50 ea
- V8, approx. 4 X 1.5..... 1205-M.....\$6.99 ea



	BATTERY WARRANTY CERTIFICATE Green on parchment, 53-55D-009.....	\$3.50 ea
	PRE-DELIVERY SHEET & 1000 MILE INSPECTION RECORD Green on parchment, 53-56D-679.....	\$4.25 ea
	FOMOCO ANTI-FREEZE TAG Red printing, 53-64D-120.....	\$4.75 ea
	GLOVE BOX ENGINE OIL DECAL Silver background, 53-56D-390.....	\$6.75 ea
	AUTOMATIC TRANS. GLOVE BOX DECAL Silver background, 55-56.....D-081.....	\$4.90 ea
	GENERATOR METAL TAG FAA-10001-C, 1953.....D-101.....	\$6.50 ea
	GENERATOR WARNING TAG Green, 1956.....D-125.....	\$4.75 ea
	GENERATOR DECAL Red, 1953-55.....D-134.....	\$6.50 ea
	DISTRIBUTOR METAL TAG Silver on clear, 1956.....D-068.....	\$4.95 ea
	DISTRIBUTOR METAL TAG Cast distributorD-106.....	\$6.50 ea
	DISTRIBUTOR METAL TAG Aluminum distributor.....D-105.....	\$6.50 ea
	VALVE COVER DECALS 272 cubic in 1956-60D-070.....	\$10.90 pr
	V8 power king 130 hp. 1954.....D-642.....	\$11.95 pr
	V8 power king 132 hp. 1955.....D-892.....	\$10.00 pr
	6 cyl. "I" block 1955-56D-050.....	\$7.50 ea
	Cost clipper 6 '52-53 & '55-56D-108.....	\$5.50 ea
	Mileage maker 6 cyl 1953-54D-793.....	\$7.95 ea
	VOLTAGE REGULATOR METAL TAG (FAC-A1) 1953.....D-104.....	\$5.90 ea
	VOLTAGE REGULATOR DECALS (FAC) 1953-54, silver on clear.....D-109.....	\$6.50 ea
	(B5AF) 1955, silver on clearD-084.....	\$3.95 ea
	(FAP) 1956-57, silver on clear.....D-022.....	\$4.95 ea
	COIL DECAL 1956-64, silver on clearD-033.....	\$6.95 ea
	STARTER MOTOR Metal tag, FAG-11001-B 53-55 ..D-103.....	\$5.90 ea
	Decal, 1956-57 (FAR).....D-131.....	\$6.50 ea
	OIL FILTER DECAL 1954-56D-082.....	\$7.95 ea
	6cyl 1953 (3 pcs).....D-375.....	\$10.50 set
	<i>Ford strato star is clear with yellow lettering</i> 1953, red on gold (2 pcs)D-064.....	\$6.95 set
	WINDSHIELD WASHER JAR DECAL 1948-55D-686.....	\$4.95 ea
	WIPER MOTOR DECAL, 12V 1956, blue.....D-300.....	\$6.50 ea
	AIR CLEANER SERVICE INSTRUCTIONS 1954, blue & white.....D-124.....	\$6.50 ea
	OIL BATH AIR CLEANER 1948-53D-357-4853...	\$6.50 ea
	TAILGATE LETTERING <i>We can do almost any color, just ask. See page need</i> Chrome.....D-0265.....	\$10.00 set
	Colors, black, white etc.....D-0266-Color.....	\$9.00 ea
	SEE PAGE	

BOOKS & MANUALS

2020 Mid Fifty
1953-56 Catalog

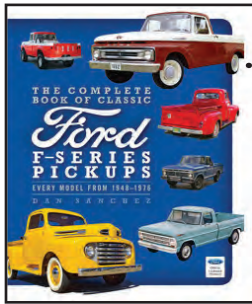

THE COMPLETE BOOK OF FORD PICKUPS
240 pages..... B-11195..... \$40.00 ea

THE ULTIMATE ENCYCLOPEDIA OF PICKUPS
by Peter Henshaw B-11803 \$12.95 ea

STEERING WHEEL B11705
Restoration how to book,

BASIC AUTO ELECTRICITY
48 pages..... B-11167 \$7.95 ea



SALES BROCHURES \$16.50 ea
B-11150-53 B-11150-54 B-11150-55 B-11150-56

ILLUSTRATED PARTS CATALOG
CD, 48-56 B-11149-CD \$35.00 ea

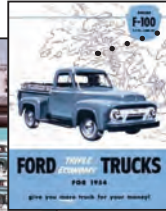

OPERATOR GLOVE BOX MANUALS \$10.95 ea
B-11163-53 B-11163-54 B-11163-55 B-11163-56

FORD SHOP MANUALS
The best investment you will make in rebuilding your truck. Covers body, doors, trim, chassis & engine. 53 and 55 book also cover 54
1953-54 B-11160-5354 .. \$49.95 ea
1954-55 B-11160-5455 .. \$29.90 ea
1956 B-11160-56 \$31.95 ea

SHOP MANUALS ON CD
1953, 54-55 or 56 B-250-53 \$45.95 ea

COLORING BOOK B-11000 \$1.50 ea

INSTRUCTIONS & SAMPLES FREE

SPECIFICATIONS FEATURES MANUAL
1953, 54, 55 or 56 \$10.00 ea
B-11164-53 B-11164-54 B-11164-55 B-11164-56

TRUCK & CAR ACCESSORY CATALOG
1956, reproduction of orig..... B-11268-56 \$12.50 ea

RADIO MANUAL B-11169 \$3.50 ea
53-55 with installation template No longer available, but we have ONE that we will copy for you. It is 11 pages and all the information is there, just not original printed book form.

ILLUSTRATED FACTS & FEATURES MANUAL
Reproduction of original, nice if you like to have all the original stuff. \$12.95 ea
B-11166-53 B-11166-54 B-11166-55 B-11166-56

BODY, TRIM & SEALANT MANUAL
1953 blue..... B-11161-53 \$24.50 ea
1954 maroon B-11161-54 \$24.50 ea

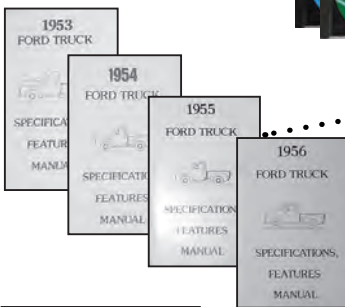
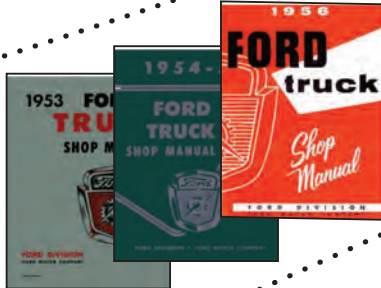
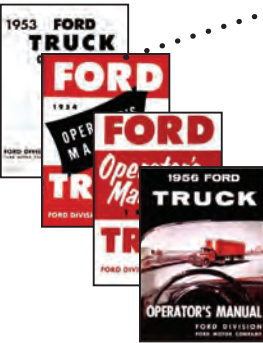

SAMPLES & UPHOLSTERY TOOLS

JUST A FEW, Many colors not shown, Ask for FREE SAMPLES. The colors here are just to get your creative juices flowing as it is not possible to accurately reproduce fabric colors on paper, so call for a real sample before you do anything wild. Even blacks and greys have variations. If in doubt we are happy to help. Original fabric is expensive, Check current price, last was \$95.00 yard! Keep in mind you may be a teensy bit color blind, please, let one of us, or another favorite lady, help with color matching.

Tweed Colors	75T Red	79T Burgundy	44T Tannette	41T Tan	35T Green	25T Blue
Tweed Greys	05T Black	19T Charcoal	18T Grannete	15T Grey		
Velour Colors	25E Blue	29E Navy	26E Ocean	41E Tan	47E Brown	79E Burgundy 75E Red
Velour Greys	05E Black	19E Grey	15T Grey			
	29C Navy	28C Royal Blue	25C Blue	43C Sand	41C Tan	65C Rust 44C Mocha
Carpet Colors	47C Brown	79C Burgundy	75L Red	75C Red		
Carpet Greys	05C Black	05L Black	19C Charcoal	19L Salt Pepper	16C Med Grey	15C Grey
Vinyl	05V Black	Kiwi Black	Basketweave	Carbon Fiber	Embossed Perf	20V Cinder 15V Grey
Tonneau Cover	Navy	White	Light Grey	Charcoal	Black	

FABRICS BY THE YARD

Vinyl.....	\$20.00 yd
Velour	\$22.00 yd
Tweed.....	\$24.00 yd
Carpet.....	\$19.00 yd

YARDAGES NEEDED

Headliner	3 yds
Seat, all fabric.....	4 yds
Door panels, lower..	2.5 yds
Seat and back.....	2 yds
Door panels, top	3/4 yds
Vinyl sides	2 yds
Rear wall.....	2 yds
Seat, closed back	2 yds



Seat belt colors



FREE SAMPLES

Bed cover, tonneau.....	SMP-T	FREE
Carpet colors	SMP-CC	FREE
Carpet greys.....	SMP-GC	FREE
Upholstery, gray vinyl	SMP-GY	FREE
Upholstery, gray tweed.....	SMP-GT	FREE
Upholstery, gray velour.....	SMP-GV	FREE
Upholstery, colors vinyl.....	SMP-CY	FREE
Upholstery, colors tweed	SMP-CT	FREE
Upholstery, colors velour	SMP-CV	FREE
Dash cover materials	SMP-DC	FREE
Seat belt colors.....	SMP-SB	FREE
Most any sample of anything.....		FREE

UPHOLSTERY TOOLS & ACCESSORIES

DIE CUT FORD LOGO

Just peel & stick to any surface, glue and smooth fabric over shape and Ta-Da, custom!!

Inny and outie	2119-FD	\$13.50 ea
SALE buy 2 save \$\$\$		\$9.99
V8	2119-V8.....	\$14.95 ea
HI-TEMP SPRAY ADHESIVE.....	2103	\$14.95 ea
Use on firewall, roof, floor, any place temps will get high		
UPHOLSTERY ADHESIVE	2102	SALE \$9.99
WEATHER-STRIP TOOL.....	83124	\$14.95 ea

DAMPENER KITS

Strips of self adhesive material, does both doors

Inner door	92180	\$25.00 kit
Behind door panel	92181	\$25.00 kit
ALUMINUM TAPE	2101	\$4.95 rl
SEAM ROLLER.....	2101-RLR.....	\$4.95 ea
DUAL-LOCK TAPE KIT Do not order with any items (except flat door panels), as they are included.		
6 pieces	82149-6	\$6.90 kit
16 pieces	82149-16	\$18.40 kit



These are one of the best things to come along for our trucks. Makes doing your own interior a pleasure. Professional looking results at a fraction of the cost and the truck stays home. ABS is surprisingly easy to cover, just spray glue your choice of fabric, and we are happy to send you free samples of fabrics and colors we stock or if you find something you like locally see previous page for yardage requirements for each piece. **DON'T FORGET INSULATION** see page 24

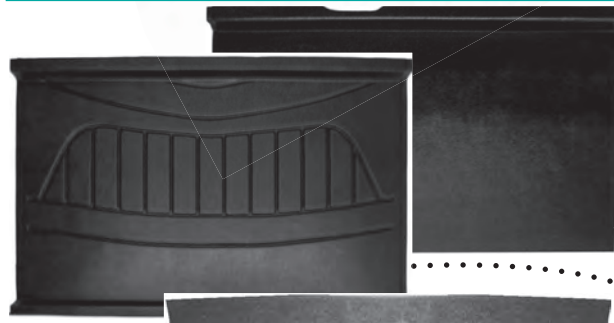

All ABS parts made in the **USA**

COMPLETE ABS INTERIOR KIT

Includes choice of embossed or smooth ,door panels with armrests, kick panels, rear wall and headliner. (Headliners are smooth in all kits) Oversize shipping,

*Kit rear wall is no tank style. Let us know if you have a in-cab tank we will include the correct rear wall that goes over tank.

ABS INTERIOR KIT

53-55 embossed	92143-5355	\$795.00
53-55 embossed, no arm rests ...	92144-5355	\$795.00
53-55 smooth with arm rests	92142-5355	\$795.00
53-55 smooth, no arm rests.....	92142-5355NA	\$795.00
1956 embossed *	92143-56	\$795.00
1956 embossed, no arm rests *	92144-56	\$795.00
1956 smooth*	92142-56	\$795.00
1956 smooth, no arm rests.....	92142-56NA	\$795.00
56 big window, embossed*Shown	92143-56BB	\$795.00
56 big window, smooth*	92142-56BB	\$795.00

COMPLETE KIT WITH PRECUT INSULATION, Also includes floor fillers, precut insulation, glue, tape & seam roller.

53-55 embossed	92146-5355	\$1,149.00
53-55 smooth.....	92145-5355	\$1,149.00
1956 embossed*	92146-56	\$1,149.00
1956 Smooth*	92145-56	\$1,149.00
56 big window, embossed*	92146-56BB	\$1,149.00
56 big window, smooth*	92145-56BB	\$1,149.00

*Kit rear wall is no tank style. Tell us if you have in cab tank.

ABS REAR WALL Sides are contoured to fit. Also see stock and flat style rear wall covers on page 14. Tip: Slide panels in from top

SMOOTH

1953-55 & 56 without gas tank, ...	2145-SM	\$275.00 set
1956, Smooth, big back glass ...	2145-BBSM	\$275.00 set

EMBOSSSED

1953-55 & 56 without gas tank	2146-E	\$275.00 set
1956 with big back glass	2146-BBE	\$275.00 set

1956 TANK COVER

2139-TNK	\$275.00 set
----------------	--------------

Fits 1956 with in cab tank, trim to fit big window cab.

UPHOLSTERY TOOLS & ACCESSORIES

UPHOLSTERY ADHESIVE	2102	\$13.95 ea
HI-TEMP SPRAY ADHESIVE.....	2103	\$14.95 ea

Use on firewall, roof, floor, any place temps will get high

DIE CUT FORD LOGO, *Just peel & stick to any surface, glue .. and smooth fabric over shape and Ta-Da, custom!!*

FORD INNY AND OUTIE	2119-FD	\$13.50 ea
V8 EMBOSSSED	2119-V8	\$14.95 ea

DAMPENER KITS *Self adhesive material, does both doors*

Inner door	92180	\$25.00 kit
Behind door panel	92181	\$25.00 kit

ALUMINUM TAPE

2101	\$4.95 rl
------------	-----------

REPAIR TABS...Center hump

82148-HB	\$4.50 set
----------------	------------

Clip style, for Headliner

82148-H	\$4.50 set
---------------	------------

SEAM ROLLER.....

2101-RLR	\$4.95 ea
----------------	-----------

DUAL-LOC TAPE KIT *Do not order with any items (except flat door panels), as they are included with all our kits*

6 pieces	82149-6	\$6.90 kit
16 pieces	82149-16	\$18.40 kit



ABS KICK PANELS *Nice rolled edge. Attaches with Velcro tabs*

- With Speaker Pod, 1953-552117-5355SPK.....\$109.00 pr
- With Speaker Pod, 1956.....2117-56SPK.....\$109.00 pr
- With Round AC Louver installed.....2114-RND\$139.95 pr
- 1953-55 embossed pattern.....2117-5355RD\$99.00 pr
- 1953-55 smooth.....2117-5355SM.....\$99.00 pr
- 1956 embossed pattern.....2117-56RD\$99.00 pr
- 1956 smooth.....2117-56SM.....\$99.00 pr

DOOR PANELS

Door panels come with or without arm rests. Arm rests are hollow for power window switches, etc. Goes on easy with duo-lock tape pieces

EMBOSSED

- No arm rest.....53-55.....2140-5355
-562140-56\$249.00 pr
- With arm rest ..53-55.....2141-5355A
-562141-56A\$275.00 pr

SMOOTH

- No arm rest.....53-55.....2142-5355
-562142-56\$249.00 pr
- With arm rest ..53-55.....2142-5355A
-562142-56A.....\$275.00 pr

- FLAT like original...53-552144-5355
-562144-56\$95.00 pr

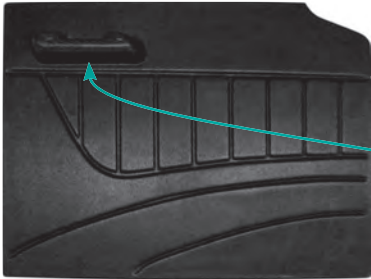

Self Adhesive



- **INSPECTION PLATE, ABS**...2126-ABS.....\$57.50 ea
- Countersunk holes, rolled edge*
- Steel, not shown*.....2126-STL\$47.50 ea

INSPECTION PLATE GASKETS

- Pair.....2126-GSKT\$21.50 pr

NEW SELF ADHESIVE,

Inner section is used as insulation for heat and sound.

- Outer gaskets2126-GSA\$18.85 pr
- Inner insulators.....2126-CS.....\$14.50 pr
- Combo, inner & outer ...2126-CMB.....\$24.50 set



- **DOOR POCKET INSERT** *Can be used with or behind ABS door panels, with any upholstered panel or alone. Trim ring can be covered, painted or left black. Can not be used with power window kits that need a straight bar across center of inspection hole.*

- Insert.....2127-IN.....\$55.00 ea
- Trim ring.....2127-T\$55.00 ea
- Set, does one door2127.....\$129.00 set



USA

USA

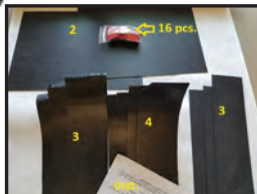

ABS HEADLINERS, see also page 23

Doesn't use rubber retainer. Installs in an hour, honest ! BEST BUY!! Smooth only. High shipping cost. Also see page 22 for more headliner options

- 1953-55 smooth.....2148-5355SM.. \$275.00 set
- 1956 smooth.....2148-56SM.....\$275.00 set
- 1956 big back window, smooth.....2148-BBSM.....\$275.00 set

ABS CHOP TOP HEADLINER CONVERSION KIT, also page

- Headliner chop expansion kit2123-CTK.....\$89.00 kit

DYI ABS FLAT SHEET KIT, 48 x 68 inches. can be rolled for shipping. Comes with 30 Dual-loc tabs and weatherstripping.

- Kit2143-46\$129.80 kit
- Extra ABS sheets 48 x 68"2143-461\$110.00 ea



UPHOLSTERY

2020 Mid Fifty
1953-56 Catalog

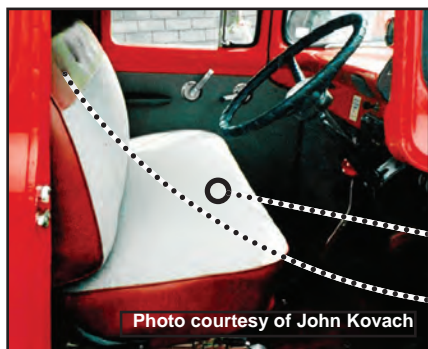

Photo courtesy of John Kovach

STOCK STYLE SEAT COVERS

Some original woven vinyl type fabric is available but price is outrageous! Tweed fabrics look similar to original however, especially the two tone with vinyl sides and top accent in dark maroon, blue or charcoal. We can also do it up in all vinyl, again gray with contrasting sides & accents is "stock" looking.

- Stock style..... 92100-STK-5356 ...\$149.95 ea
Order your color choice
- Buttons, go across top accent..... 82141\$18.50 set
Extra large buttons, covered in top area material, were only on 56 deluxe.



ARM RESTS

Trucks came with or without, many with just one for on driver side.

- Not covered, pair..... 2125..... \$50.00 pr
- Covered, Vinyl, Black..... 2125-BLK \$85.00 pr
- Covered, Vinyl, Grey..... 2125-GRY \$85.00 pr
- Covered, Colors and other Fabrics..... Special order
- Installation kit..... 82125..... \$5.00 kit
- Mounting clips, original 2124-ELK.....\$2.50 ea
2 clips needed for each arm rest, goes in the rectangular holes in the door.



STOCK STYLE DOOR PANELS

- Grey panel-board
- 1953-55..... 2107-5355..... \$55.00 pr
- 1956..... 2107-56..... \$49.95 pr
- Imperfects, perfect for upholstering \$20.00 pr

- Flat ABS door panels, like original
- 1953-55 pair, ABS black..... 2144-5355..... \$95.00 pr
- 1956 pair, ABS black..... 2144-56..... \$95.00 pr
- Pattern kit, door & kick panels, 1953-55 B-2107-5355.....\$9.99 ea
- 1956..... B-2107-56\$9.99 ea

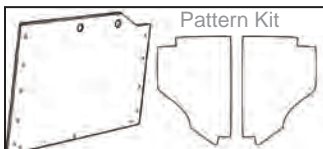

Pattern Kit

- Door panel button clips, gray..... 82123.....\$14.95 set
Works on flat ABS panels, very strong, little too strong for cardboard.
- Clips for upholstered panels 82122.....\$7.50 kit
Clip in from backside and are hidden from front.



CENTER CONSOLES

King size drink holders, storage compartment, armrest.

Ask for special console colors and samples.

For bench seats Fits stock style seat, has a securing strap

- Black..... A-0130-B.....\$109.95 ea
- Graphite (dark Grey)..... A-0130-GG\$109.95 ea
- Two tone, color matched..... A-0132\$119.95 ea

For bucket seats Fits between bucket seats.

- Black A-0135-BK\$159.95
- Graphite (dark gray)..... A-0135-GG\$159.95 ea
- Special Colors..... A-0135\$159.95 ea

COMPLETE CUSTOM INTERIOR KIT, YOU PICK

For color and fabric choices see page 11, for styles see next page

Choose from the styles on next few pages, then take 10% off for "kit" price

- Seat cover..... pg 16 & 17
- Door panels..... pg 15
- Door panel fabric, if ABS pg 17
- Carpet kit..... pg 20
- Headliner..... pg 14
- Headliner fabric if ABS..... pg 14
- Visors..... pg 17
- Arm rest pg 17

Insulation does not have to be in the kit for the savings but don't forget it
See page 24

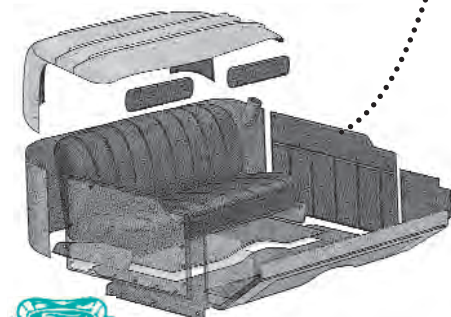

UPHOLSTERY

1-800-252-1956
Direct 928-565-2763



USA

CHANNEL DESIGN SEAT KIT

Choose materials and colors for seat, back rest and sides
See page 11 for color choices and fabric samples

- Seat cover, Channel design..... 92100-CNL.....\$184.95 ea
- EXTRAS**
- Buttons, will match seat fabric..... ADD-BUT-CD..... \$30.00 set
- Closed back rest, need for big back window . ADD-CLOSED \$20.00 ea
- Visors, covered to match 2106-(add color)
- Door panels, Channel design, 1953-55 92101-CNL-5355 \$189.95 pr
- Door panels, Channel design, 1956 92101-CNL-56 \$189.95 pr
- Arm rests, covered to match, pair..... 2125-CVR \$98.50 pr
- Headliner in matching vinyl..... see page 22

Order your visors covered in matching vinyl or fabric. Headliners made in matching vinyl see page 23 for more information on headliners. If using our ABS headliner it can be covered in matching vinyl or fabric. See page 11 for some color and fabric options and any yardage needed. Headliners typically need about 3 yards.

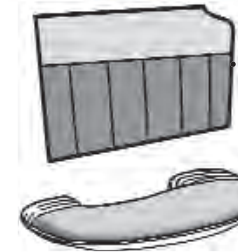

VINTAGE SQUARES DESIGN SEAT KIT

Choose materials and colors for Inserts, seat, back rest, sides and center
See page 11 for color choices and fabric samples

- Seat cover
- Vintage square, 92100-VNT-5356.....\$179.95 ea
- Extras**
- Buttons, will match seat fabric..... ADD-BUT-VS \$20.00 kit
- Closed back rest, need for big back window . ADD-CLOSED \$20.00 ea
- Visors, covered to match 2106-(add color)
- Door panels, Vintage square, 1953-55 92101-VNT-5355.....\$189.95 ea
- Door panels, Vintage square, 1956 92101-VNT-56 \$189.95 pr
- Arm rests, covered to match, pair..... 2125-CVR \$98.50 pr
- Headliner in matching vinyl..... see page 22

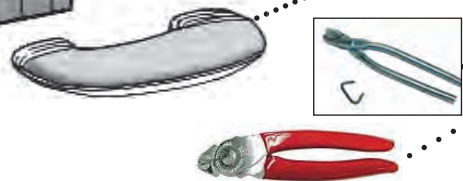
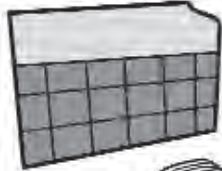

- HOG RING PLIERS..... 82142 \$9.50 set
With hog rings, these are included in all seat cover kits
- HOG RING PLIERS, nicer set..... 82143 \$28.95 ea

All upholstery kits made in the **USA**

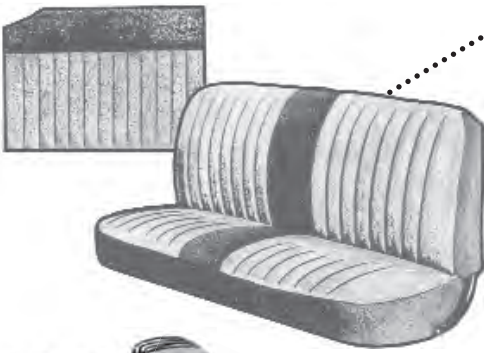

DESIGNER SEAT KIT

Choose colors combination for inserts, seat, sides, center & back rest
See page 11 for color choices and fabric samples

- Seat cover, Designer 92100-DSN-5356 \$179.95 ea
what is sometimes called yardstick channels, very nice finished look.
- EXTRAS**
- Buttons, sold each..... ADD-BUT-DS \$2.50 ea
- Closed back rest, need for big back window . ADD-CLOSED \$20.00 ea
- Door panels, designer, 1953-55 92101-DSN-5355 \$189.95 ea
- Door panels, designer, 1956..... 92101-DSN-56 \$189.95 pr
- Arm rests, covered to match..... 2125-CVR \$98.50 pr
- Visors, covered to match, sold in pairs..... 2106-(add color).....
- Headliner in matching vinyl..... see page 22



Sy says: Always use closed back rests for big window cab. Seat back has a piece that goes all the way down back of seat. Regular style shows springs on back through window.

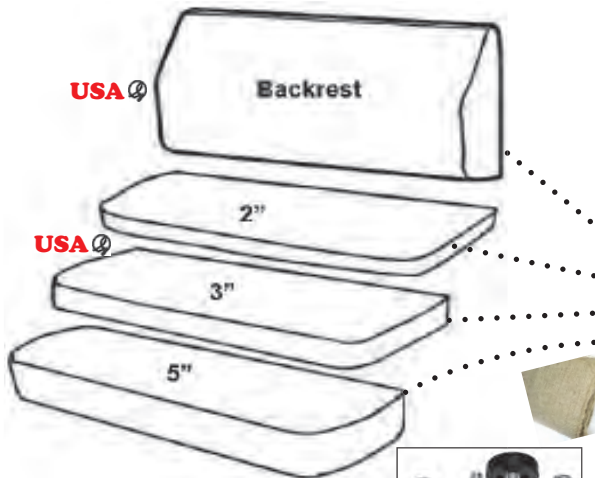

1953-54 Seat and some 1955's had 3" foam over a spring base. Late 55's and the 56 "driverized" seat was a 5" foam base. Our back rest fits both seats and is tapered. We have found on most 53-55's we like a 2" seat base better than 3" and on 56's the 3" seat base gives us larger folks a little extra room. Foam pieces have higher than normal shipping costs

SEAT FOAM

- Tapered back rest.....2171.....\$85.00 ea
- 2" Seat foam.....2172-2\$60.00 ea
- 3" Seat foam.....2172-3\$65.00 ea
- 5" Seat foam.....2172-5\$87.00 ea
- Burlap backing, 60".....2176.....\$16.50 ea
You need one backing for each piece of foam

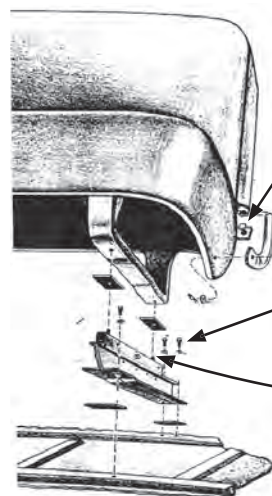

- SEAT FRAME BUMPER82146..... \$5.50 pr
This bumper adjusts backrest and clangs each time you move the seat back, so replacing it with rubber head, nice and quiet

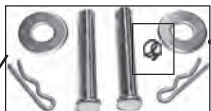

- SEAT SWIVEL CLEVIS PIN82145..... \$3.90 pr
Holds back on, back swivels on pin, does both sides

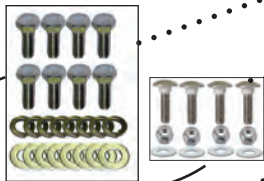

- SEAT TRACK TO FLOOR BOLTS.....82140.....\$6.90 kit
Note: 53-55 only uses one hole in front. 56 uses 2
- SEAT TRACK TO SEAT BOLTS.....82140-TS.....\$4.85 set

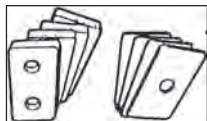

- SEAT TRACK FLOOR INSULATOR2179.....\$1.50 ea
Note: 53-55 only uses one hole in front. 56 uses 2



FLOOR BRACES

*Includes seat track mounting plate and taps. Also see page 117
Some trucks did not have, Ford added as it helps with sagging and twisting in the cab*

- LEFT OR RIGHT7787.....\$26.50 ea
- CENTER BRACE7788.....\$28.50 ea



CUSTOM & ADJUSTABLE SEAT RISER

Pair, does one seat. Universal, adjusts up and down, back and forth. Powder coated. Includes hardware

- 2" (2.25" lowest, 2.5" highest).....2177-2**SALE** \$74.95
- 4" to 6" (3 7/8" lowest, 6 5/8" highest).....2177-46\$74.95 set
- Riser hardware, polished.....82177.....\$7.75 ea
The heads show so of course we polished. Included in our kits, shown in slider & riser kit below, also includes bolts to floor, not polished. Does ONE riser



SEAT TRACK SLIDER SET

Handle releases seat to slide back and forth. Easy install and adjustment, cable pull. One set does one seat, bucket seats need two sets. Includes hardware

- Slider2178-H \$70.00 pr
- Slider and riser kit, 2".....2178-H2...\$135.00 set
- Slider and riser kit, 4"-6"2178-H4...\$135.00 set



SLIDER CABLE,

do not order with our sliders, are included, if you bought sliders elsewhere you need this.....82178-CBL ...\$6.00 kit





BOLT IN SEAT BELT SHOULDER MOUNTS

Utilizes strength of upper cab for safety by going behind both sides.

- Standard window, with hardware..... 2180..... \$95.00 pr
- Big Back Window, must be welded in..... 2181..... \$20.00 pr

New Improved Belts made Exclusively for Mid Fifty, with correct Lengths for our Classic 1953-56 Ford Trucks. LOWER PRICES TOO.

NEW COLORS:

ANTELOPE=A.....Blue=B.....CHARCOAL=C.....MAROON=M.....SILVER=S.....TAN=T



BENCH SEAT BELTS

SHOULDER BELTS, 3 POINT

Includes retracting 3 point harness with soft buckle side & mounting hardware. You will need the above seat belt mounts or equivalent.

- Chrome lift lid, "Aircraft" black 2190-3R..... \$89.00 ea
- Chrome lift lid, in SPO colors..... 2190-3R(color)..... CALL

We have a bunch of colors being discontinued, at BIG discounts.

- PUSH BUTTON Black..... 2185-BLK..... \$76.95 kit
Colors \$76.95 ea
Colors...2185-BLU 2185-CHR 2185-MRN 2185-SLV 2185-TAN

- **COMPLETE KIT, RETRACTABLE, Black..... 92130-BLK..... \$165.00 kit**
Comes with 2 shoulder belts, center lap belt and all needed hardware

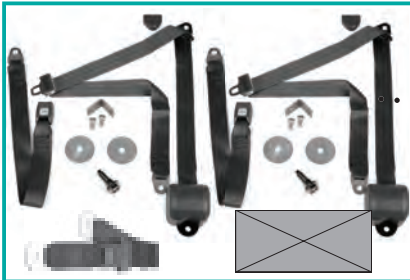

BENCH SEAT LAP BELTS, 2 POINT

Use for driver, passenger or center belt. Includes all mounting hardware

- CENTER NON RETRACTING, PUSH BUTTON,
Black..... 2189..... \$26.95 ea
Colors \$29.95 ea
Colors...2189-BLU 2189-C 2189-M 2189-S 2189-TAN

- CHROME LIFT LID, "aircraft" Black.....2190-C..... \$35.00 ea
special order colors.....2190-C(color) Call

- RETRACTING, PUSH BUTTON, Black.....2183-BLK..... \$54.95 ea
Colors...2183-BLU 2183-CHR 2183-MRN 2183-SLV 2183-TAN

- CHROME LIFT LID, "aircraft" Black.....2190-2R..... \$70.00 ea
- CHROME LIFT LID belt in SPO Colors.....2190-2R(color) CALL



NEW IMPROVED BELTS, NEW LOWER PRICES

BUCKET SEAT BELTS

SHOULDER BELTS

Set includes retracting 3 point harness with hardware and buckle side with stand up sleeve. You will need the above seat belt mounts or equivalent.

- Push button black 2184-BLK..... \$76.95 ea
- 2184-BLU...2184-CHR...2184-MRN...2184-SLV...2184-TAN. \$79.95 ea

LAP BELTS

With stand up plastic buckle holder. Includes hardware.

- Push button black 2182-BLK..... \$55.95 ea
- 2182-BLU...2182-CHR...2182-MRN...2182-SLV...2182-TAN. \$69.95 ea



SEAT BELT HARDWARE

DO NOT ORDER with our belts, needed hardware is included.

- Hardware set for mounting 2 belts (save \$)..... 2188..... \$8.00 kit
- Floor mounting L bracket..... 2187-LB..... \$2.75 ea
- Floor mounting large washer..... 2187-FW \$2.50 ea
- Grade 8 floor mounting bolt (1 inch)..... 2187-FB1 \$2.00 ea
- Grade 8 floor mounting bolt (1.5 inch)..... 2187-FB15..... \$2.50 ea
- Shoulder bolt, upper mount, 1"..... 2187-SB..... \$4.95 ea
- Shoulder bolt, upper mount, 1.5"..... 2187-SB15..... \$7.50 ea
- Seat belt extender, fits any vehicle..... 2199..... \$19.99 ea
- Plastic bolt cover, not included..... 2187-CVR..... \$10.00 ea

Expensive little things, cover bolt heads at L brackets.



Sy says: See page 11 for color samples
But note: colors printed on page are not actual color. We are happy to send you free color samples and help in any way.

Custom made from Sy's patterns using the highest quality automotive carpet in cut pile. Covers floor completely, not just universal.

- *TALLER TRANY COVER? If so, ask for ADD-T for taller tranny cover.
- *DOUBLE DENSITY: super plush, double thick, black only.
- *LOOP: un-cut carpet, very retro look but remember if a loop pulls it can show, use caution if a screw goes through carpet. Colors are limited

CARPET PIECES

Note: this group is pieces, keep in mind *Kits are cheaper*

- Color samples.....SMP-C.....FREE
- *Rear wall
 - Black..... 2152-BK \$57.50 ea
 - Colors 2152-(color) \$57.00 ea
- *Kick panels, bound edge for retainers see page 20
 - Black..... 2115-CBL \$55.00 pr
 - Colors 2115-(color) \$65.00 pr
- *Seat curtains, covers sides of bench seat.
 - Black..... 2153-BK \$38.00 pr
 - Colors 2153-(color) \$43.00 pr
- *Under seat, bench
 - Black..... 2151-BK \$39.95 ea
 - Colors 2151-(color) \$45.00 ea
- Gas pipe or steering column cover..... 2154-BK \$20.00 ea

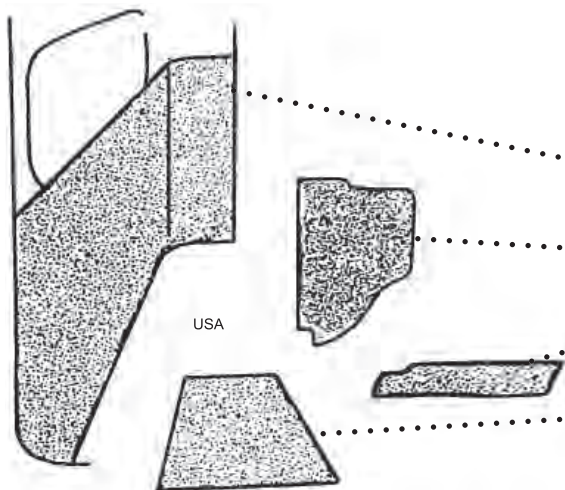

FRONT FLOOR KITS

Includes glue, snaps & instructions, goes up toe board and firewall and down over rockers, (with carpet keepers, trim excess at rocker)

- BENCH SEAT**
 - Black..... 2161-BLK \$129.00 kit
 - Double density black 2161-DDBK \$179.00 kit
 - Cut pile colors, order sample #..... 2161-(color) \$139.00 kit
 - Taller tranny cover ADD-T \$15.00 ea
 - Loop style, order sample # 2161-(color)L \$149.00 kit

- BUCKET SEATS**

One piece, middle is covered without seam all the way to back rear wall.

 - Black..... 2165-BLK \$159.00 kit
 - Double density black 2165-DDBK \$285.00 kit
 - Colors, order by sample # 2165-(color) \$169.00 kit
 - Taller tranny cover ADD-T \$15.00 ea
 - Loop style, order sample # 2165-(color)L CALL

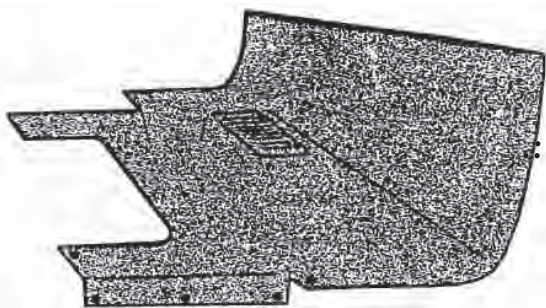

The glue spray cans that come in these kits can not be shipped air

FOR BEST SMOOTH INSTALLATION CHECK OUT OUR FLOOR FILLERS AND INSULATION ON NEXT PAGE & 24

COMPLETE KIT

Floor, firewall, rear wall, under seat, kick panels, and rockers. Has snaps for access to under floor areas, like battery. Large heel pad, bound along all visible edges. Glue, hardware and instructions included.

- BENCH SEAT**
 - Black..... 2160-BLK \$259.00 kit
 - Colors 2160-(color) \$275.00 kit
 - Double density black 2160-DDB \$365.00 kit
 - Taller tranny cover ADD-T \$15.00 ea
 - Loop style, order sample # 2160-(color)L \$300.00 kit

- BUCKET SEATS**
 - Black..... 2164-BLK \$279.00 kit
 - Colors 2164-(color) \$289.00 kit
 - Double density black 2164-DDBK \$356.00 kit
 - Taller tranny cover ADD-T \$15.00 ea
 - Loop style, order sample # 2165-(color)L \$169.00 kit

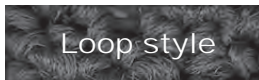
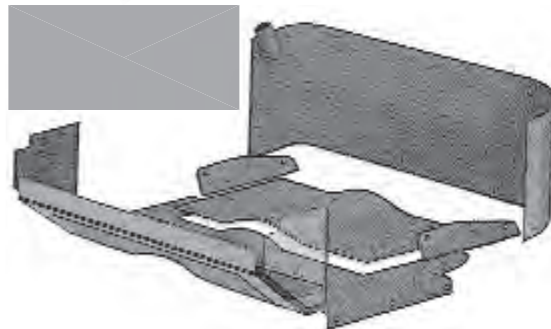



CARPET KEEPERS

••••• POLISHED STAINLESS.....	2130.....	\$47.50 pr
<i>Very nice smooth bend, carpet grip edge and countersunk holes.</i>		
SCREWS, Polished	82130.....	\$5.00 kit
••••• BRUSHED STAINLESS	2130-BR	\$29.00 pr
SCREWS, Polished	82130.....	\$5.00 kit

ROCKER COVER & CARPET KEEPER COMBO

Mirror polished stainless, covers rocker panel and top edge with room for carpet, inside edge for grip & finish, countersunk screw holes.
Polished stainless.....2128.....\$79.50 pr

• CARPET KEEPER AND ROCKER COVER SCREW KIT

Does both sides of all keepers or combos.
Polished stainless.....82130..... \$5.00 kit

• FLOOR SILL ROCKER COVERS

2129.....\$65.00 pr
Mirror polish stainless, nice tight fit over rocker panel, no screw holes. Use double sided tape or screws for installation, does not go over carpet



• FLOOR DEPRESSION FILLER & INSULATOR

Pour formed for perfect fit. Self adhesive backing. No more old sticky, gummy, gook. Solid, smooth, high tech for a perfect level floor. Made these just because I hate the old sticky stuff and wanted to start with a nice even, flat, smooth, clean surface. Included in the complete floor kit below and the complete insulation kit, also see page 24
Set does 53-55 or 56.....2100.....\$53.95 set

• FLOOR HOLE PLUGS.....

87722..... \$1.00 set

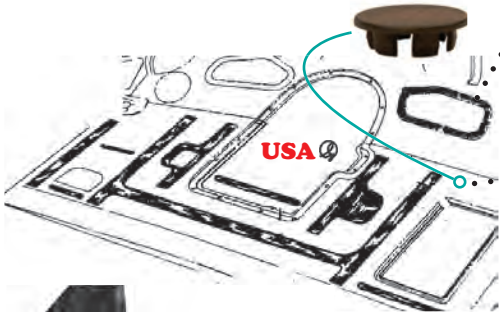

• FLOOR INSULATION KITS

Kits include all pieces including above poured fillers, dampener kit for under seat and rear floor, high temp adhesive, tape & instructions.
1953-5592170-5355 \$149.00 kit
1956.....92170-56 \$149.00 kit

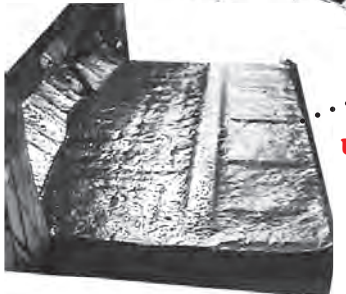

1. Start with sound damper kit, self adhesive high density floor depression filler and sound dampener pads go in all indents on floor.
2. Then add precut floor pieces made from aluminum faced heat and sound absorber-barrier material.

Note you simply can NOT over-do the sound dampener, I like to go over the entire area, on top of the kits above with an additional smooth layer. Not necessary but really quiets and helps with cooling in our hot areas. Takes 2 extra rolls to completely "over-do" the cab also see page 24.

SOUND DAMPENER2166.....\$38.00 rl

• REAR WALL KIT

Kits include all pieces shown, dampener (not shown) & instructions, does not include adhesive or tape.
1953-5592173-5355 \$79.00 kit
1956.....92173-56 \$79.00 kit



See page 24 for complete kits and additional insulation.

STICK ON EMBLEMS *Great for rockers, 3M backing*

••••• FORD SCRIPT.....	2220-A.....	\$8.00 ea
V8	1205-M	\$6.99 ea
V6	1205-M6	\$9.50 ea

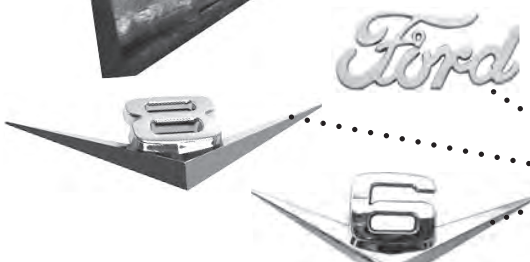

KICK PANELS

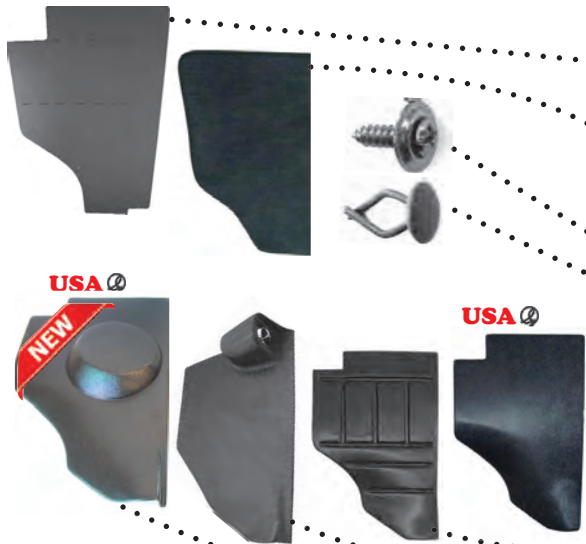

- STOCK GRAY PANEL-BOARD KICK PANELS
 - 1953-55 2114-5355 \$24.95 pr
 - 1956 2114-56 \$24.95 pr
- CARPETED KICK PANELS. *Can not be used with retainers*
 - Black 2115-CBL \$55.00 pr
 - Color, ask for carpet color samples 2115-(color) \$65.00 pr
 - Covered fabric or vinyl 2115-SPECIAL \$65.00 pr
- KICK PANEL TRIM SCREWS 82114-S \$0.95 pr
- KICK PANEL TRIM BUTTONS 82114-B \$1.50 pr
One button or screw for each panel, original was button

ABS KICK PANELS

Order 1953-55 or 1956, needs no retainer, nice rolled edge, paint, cover or leave as is, attaches with Velcro tabs.

- 1953-55 embossed pattern 2117-5355RD \$99.00 pr
- 1953-55 smooth 2117-5355SM \$99.00 pr
- 1956 embossed pattern 2117-56RD \$99.00 pr
- 1956 smooth 2117-56SM \$99.00 pr
- ABS kick panel with ac vent 2114-RND \$139.95 pr
- 1953-55 With speaker pod 2117-5355SPK... \$109.00 pr
- 1956 With speaker pod 2117-56SPK \$109.00 pr

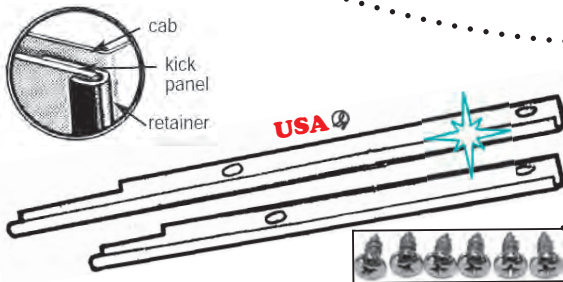

- KICK PANEL RETAINER STRIPS... 2116-PS \$39.50 pr
Made like originals but to fit better, go completely top to bottom.
- RETAINER SCREW SET 82116 \$1.50 set
Screws are hidden behind kick panel.

REAR WALL



- REAR WALL TRIM SCREW CHROME.. 82138 \$5.50 set
- REAR WALL INSULATION Also see pg. 20
 - 1953-55 92173-5355 \$79.00 kit
 - 1956 92173-56 \$79.00 kit
- REAR WALL PANEL BOARD SET 2137 \$79.00 set
Grey, 2 piece set, oversized shipping
- REAR WALL UPPER EXTENSION 2138 \$15.00 ea
Small flap that holds top of stock panel-board to rear window rubber. Not needed if you are covering the panels with fabric or carpet.
- FLAT ABS REAR WALL 2136-F \$109.00 ea
Use without in cab tank, easier to use & holds up better than panel board, one flat piece, curves into corners nicely, can paint, cover or leave black, nice pebble texture. Oversized shipping

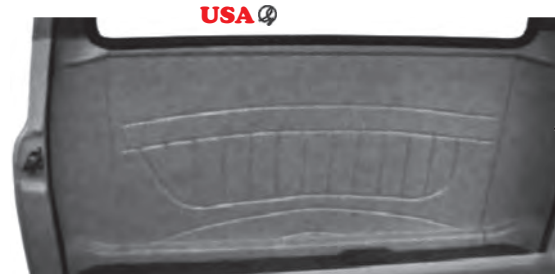

- CARPET REAR WALL *No backing, just carpet piece, not bound.*
 - Black 2152-BK \$57.50 ea
 - Colors 2152-(color) \$57.00 ea

ABS FORMED 3 PIECE, NEW STYLE

No rubber retainer needed. Easy install, 3 pieces, sides are contoured to fit and simply clip in. Oversized shipping.

Tip: slide panels in from top.

- 1953-56, smooth 2145-SM \$275.00 set
- 1956, smooth, with big back glass 2145-BBSM \$275.00 set
- 1953-56, embossed pattern 2146-E \$275.00 set
- 1956, embossed, with big back glass. 2146-BBE \$275.00 set



- 1956 TANK COVER REAR WALL .. 2139-TNK \$275.00 set
Molded to create a small shelf over tank. Oversized shipping. Can be trimmed to fit big window.





USA



USA

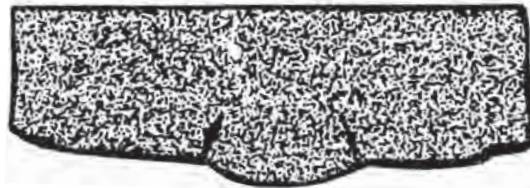

USA

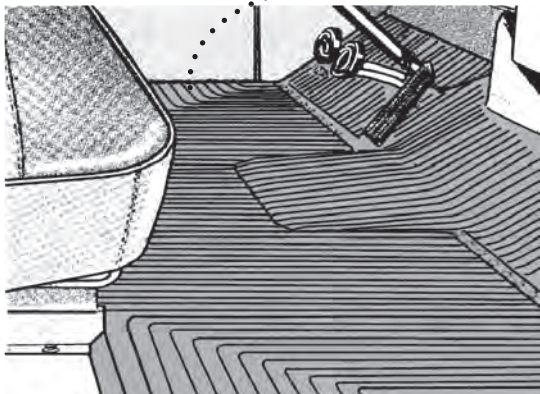
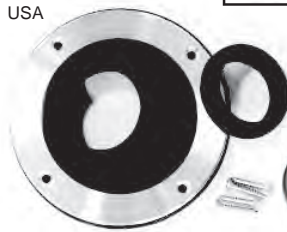

UNDER-DASH FIREWALL COVERS

Order with holes only if your truck has stock Heater, etc If not, order without holes, we have a handy dandy full size hole pattern blueprint showing any stock holes you might need. Fasten with clips or bolts. The ends of fasteners show under the hood on firewall, check out our bolt and acorn nut set so polished acorns will show on firewall side.

ABS

These are the best! Textured black ABS with ribbed edge, easy installation. Can be left as is for nice stock look or covered. 1956 trucks "without" wiper motors in stock location use 53-55

- PRE-CUT HOLES, 1953-55..... 2133-5355W\$199.00 ea
- PRE-CUT HOLES, 1956..... 2133-56W\$199.00 ea
- NO HOLES..... 2134-NO\$199.00 ea

Order this one if not using stock heater.

•• **CARPET**, With padding. Glue to firewall with high temp glue or fasten with bolts or clips. Carpet floors cover this area so not needed if ordering our carpet kits, see page 18.

- Black carpet..... 2135-BLK.....\$50.00 ea
- Colors, see color samples..... ADD.....\$3.50 ea

PRECUT UNDER-DASH INSULATION

UNDER-DASH INSULATION..... 2167-FD.....\$24.00 ea
precut insulation for under any of the above covers

- UNDER-DASH DAMPENER..... 2166-FD.....\$24.00 ea
- UNDER-DASH OVERDONE DAMPENER..... 2166-BFD.....\$24.00 ea
- UNDER-DASH HOLE PATTERN..... B-2134.....\$9.75 ea

UNDER-DASH COVER MOUNTING CLIPS

- Clip, black plastic, one only..... 82136.....\$0.90 ea
- Clips, black plastic set of 10..... 82136-10.....\$4.85 set

BOLT & ACORN NUT KIT

- Set of 10 (20 pcs)..... 82134.....\$17.50 kit

STEERING COLUMN TRIM RINGS

MACHINED ALUMINUM WITH RUBBER SEAL

- Split & pinned..... 4663.....\$42.95 kit

BRAKE OR CLUTCH MATCHING TRIM

- With rubber, does one arm..... 4664.....\$19.95 ea

See additional column mounts and trim rings on page 170.

STOCK FLOOR MAT

Reproduction of original rubber floor mat. This is all the truck came with originally, covers from seat across floor up toe board to firewall. Has punch outs on back for brake, gas pedal, etc Punch out holes as needed. New lower price..... 2132.....\$94.95 ea

HORSE HAIR JUTE INSULATION BACKING

- Yucky stuff but original
Cut to fit, 1/2" X 36" X 72"..... 2132-JT.....\$19.95 rl

Carpet floor covering see page 18
Floor repair panels see page 116





To cover the headliner with material you would need 3 Yards

Panel truck headliner, see page 188

STOCK PANEL-BOARD HEADLINER, Stock headliners are made of stiff panel board, and can be VERY difficult. You are working upside down & backwards, and making a straight piece into a curve so please see our ABS headliners. Oversize shipping

1953-55	2109-5355.....	\$119.95 ea
1956 standard rear window	2109-56.....	\$119.95 ea
1956 wraparound rear window	2109-BB.....	\$120.00 ea

HEADLINER TRIM SCREW SET 82110 \$1.00 set

HEADLINER RETAINER CLIP

Each	2113-EA	\$0.60 ea
Complete set of 16	2113-SET	\$6.45 set

HEADLINER RUBBER RETAINER

Replace this, the newer & softer the easier it is to get headliner in.
Use with flat "old style" ABS headliners and stock panel-board headliners.
If covering headliner, do not overlap material to back side of panel as it will be too thick to go inside rubber, just bring material to edge and trim.
178" Stock, goes to bottom of headliner.. 2112-OR..... \$18.50 ea
196" goes to floor 2112 \$18.50 ea



NOTE: molded abs does not use retainer and is easiest to install.

ABS HEADLINERS

Installs in an hour, honest ! BEST BUY!! Smooth only. Can be painted, covered or customize with sculpting foam for your own unique design.
Oversized shipping.

1953-55 smooth.....	2148-5355SM	\$275.00 set
1956 smooth.....	2148-56SM	\$275.00 set
1956 big back window, smooth.....	2148-BBSM.....	\$275.00 set

• CHOP TOP Headliner expansion kit.....

ABS HEADLINERS Save a ton of work, last forever, do not sag, and save dollars in the long run.

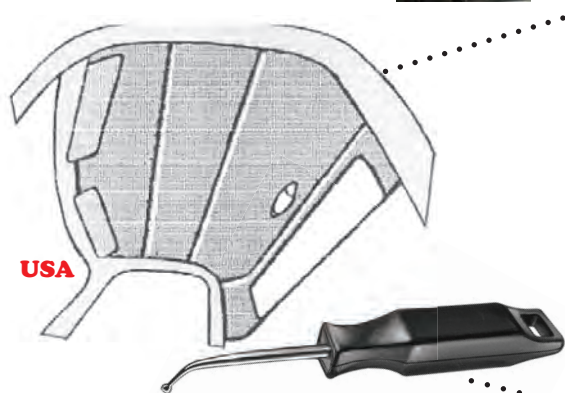

SUSPENDED HEADLINER KITS Complete kit includes sewn headliner, steel bows and bow mounting brackets, hide-em trim welting, die cut tack strips, hardware and instructions.

Order standard or wrap around window and color.
Call for free color and fabric samples

Vinyl

Black.....	2120-05B	\$165.00 kit
Grey.....	2120-15VG.....	\$165.00 kit
Colors, see color samples	2120-(color).....	\$179.00 kit

Velour

Colors, see color samples	2121-(color).....	\$189.00 kit
---------------------------------	-------------------	--------------

Tweed

Colors, see color samples	2122-(color).....	\$189.00 kit
---------------------------------	-------------------	--------------

WEATHER-STRIP TOOL 83124 \$14.95 ea

Handy when stuffing headliner edge under weatherstrip

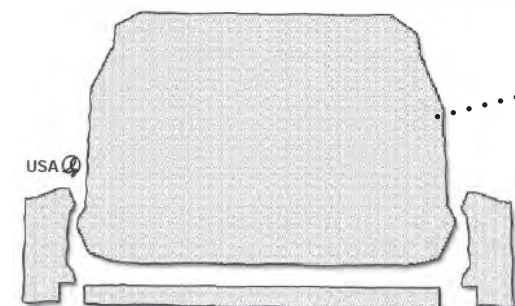

HEADLINER INSULATION KIT

Includes pre-cut sound dampeners, roof insulation and side of window insulation, high temp adhesive, aluminum tape & Instructions

1953-55 STANDARD WINDOW	92176-5355.....	\$89.00 kit
1956 STANDARD WINDOW	92176-56.....	\$89.00 kit
1956 BIG WRAP AROUND WINDOW ..	92177-56BB.....	\$89.00 kit
OVERDONE DAMPENERS KIT 53-55 ...	92166-5355.....	\$66.00 kit
OVERDONE DAMPENERS KIT 1956.....	92166-56.....	\$66.00 kit

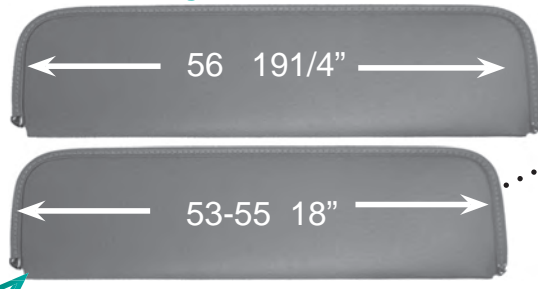

SUN VISORS

STOCK GRAY PANEL-BOARD

- 1956, slightly longer 2106-56 \$24.95 ea
- 1953-55 2106-5355 \$24.95 ea

UPHOLSTERED & PADDED

Complete spring loaded inner core, covered. Order material and color

- Vinyl, black, pair 2106-V-05V \$70.00 pr
- Velour, order color, pair 2106-L(color) \$90.00 pr
- Tweed, order color, pair 2106-T(color) \$90.00 pr

SUCH NICE DETAIL!!

NEW !! Finally Finished, Great look, I hate putting parts together metal to metal, love little trim. Made for Front 56 grille V8 and 56 side hood emblems too!!! see on those pages. Thanks Daniel !!!



VISOR BRACKETS

- 1953-55 Visor Bracket Trim Pads 2105-5355T \$7.95 pr
- 1953-55 stock gray 2105-5355 \$17.50 ea
- 1953-55 chrome 2105-5355CH \$29.50 ea

- VISOR BRACKET SCREWS, polished . 82105 \$2.95 set

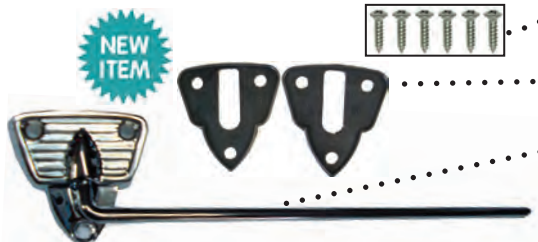

- 1956 Visor Bracket Trim Pads 2105-5660T \$7.85 pr
- 1956 stock gray 2105-56 \$17.50 ea
- 1956 chrome 2105-56CH \$29.95 ea

VANITY MIRROR W/ SERVICE RECORD

- Nostalgic clip-on visor mirror, spot to enter, gas, oil, battery, grease. Polished 2106-VM \$15.00 ea

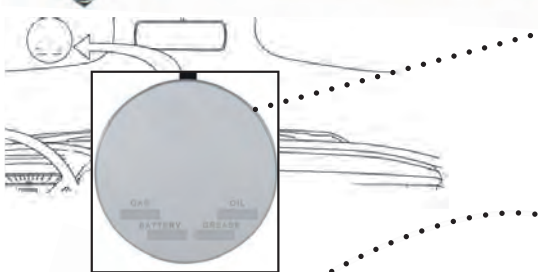

ABS OVERHEAD CONSOLE

Trim to fit, can be installed with fiberglass or ABS headliners. Faceplate fits standard radios, gauges, etc room for lights, power window switches, etc Paint with standard vinyl dye or upholster. Requires trimming to fit. Shown upholstered..... 2118-RD \$99.00 ea



- HI-TEMP SPRAY ADHESIVE 2103 \$14.95 ea
Use on firewall, roof, floor, any place temps will get high

- UPHOLSTERY ADHESIVE 2102 \$13.95 ea

DIE CUT FORD LOGO

Just peel & stick to any surface, glue and smooth fabric over shape and ta-da, custom!! very cool on headliners,

- FORD oval, Inny and outie 2119-FD \$13.50 ea
- V8 2119-V8 **SALE** \$10.00



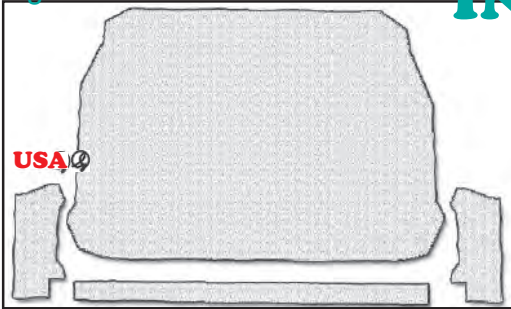

HEADLINER INSULATION

HEADLINER INSULATION KIT

Includes pre-cut sound dampeners, roof insulation and side of window insulation, high temp adhesive, aluminum tape & Instructions

1953-55 standard window	92176-5355	\$89.00 kit
1956 standard window.....	92176-56	\$89.00 kit
1956 big wrap around window.....	92177-56BB	\$89.00 kit



OVERDONE ROOF KIT

Complete precut self adhesive sound deadener and heat barrier. Super high-density, high heat insulator. Goes against sheet metal, then insulation above. Tap the roof and all you will hear is a dull thud, really nice!

53-55	92166-5355	\$66.00 kit
1956.....	92166-56	\$66.00 kit

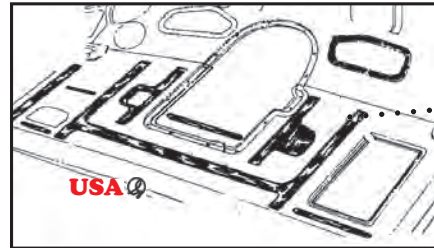

FLOOR INSULATION

FLOOR DEPRESSION FILLER.....2100

\$53.95 set
Pour formed for perfect fit. Self adhesive backing. No more old sticky, gummy, gook. Solid, smooth, high tech for a perfect level floor. Made these just because I hate the old sticky stuff and wanted to start with a nice even, flat, smooth, clean surface.

FLOOR INSULATION KITS

Kits include all pieces including above poured fillers, dampener kit for under seat and rear floor, high temp adhesive, tape & instructions.

1953-55	92170-5355	\$149.00 kit
1956.....	92170-56	\$149.00 kit

OVERDONE FLOOR INSULATOR

92166-F.....\$92.50 kit
Precut high density heat and sound deadener. I like to cover entire surface, over the indent fillers, with this. Complete quiet, ultimate insulation.

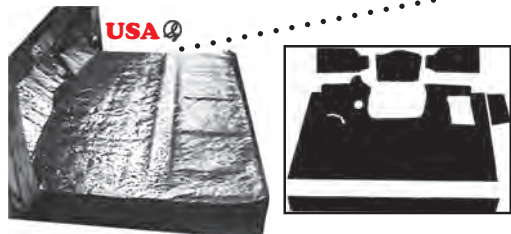

REAR WALL KITS

Kits include dampener (not shown) does not include adhesive or tape.

1953-55	92173-5355	\$79.00 kit
1956	92173-56	\$79.00 kit



OTHER INSULATION

DASH, COWL & KICK PANELS KIT

Does not include adhesive or tape. (Included in complete insulation kits)

1953-55	92174-5355	\$49.95 kit
1956.....	92174-56	\$49.95 kit

PRECUT UNDER-DASH INSULATION

UNDER-DASH INSULATION

2167-FD.....\$24.00 ea

UNDER-DASH DAMPENER

2166-FD.....\$24.00 ea

UNDER-DASH OVERDONE DAMPENER.....

2166-BFD

\$24.00 ea
Do not order with any kits, is included.

DOOR DAMPENER KIT Self adhesive material, does both doors

Inside of outer skin

92180

\$25.00 kit

Outside of inner skin, behind door panels.....

92181

\$25.00 kit

COMPLETE INSULATION KITS

Includes, headliner kit, complete floor kit, dash & cowl kit, rear wall kit & door dampener kit, glue, aluminum tape & instructions. Now includes our new floor filler kit at no additional charge.

1953-55

92190-5355

\$349.00 kit

1956 with stock in cab tank

92191-56

\$349.00 kit

1956, stock tank, big window.....

92192-BB

\$349.00 kit

1956, no tank in cab

92193-56N

\$349.00 kit

1956, no tank, big window

92194-BBN.....

\$349.00 kit

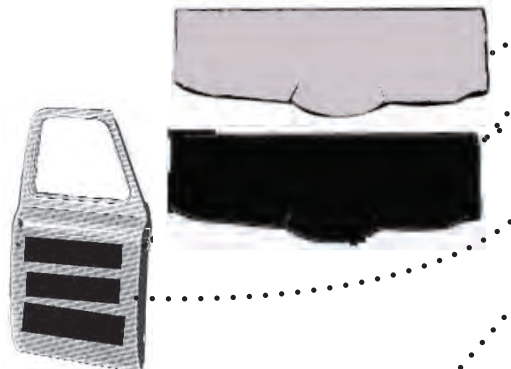



INSULATION INFO: Many aluminum faced insulation instructions show the aluminum side facing the steel and the product used inside doors, this is misleading. The Shiny side should always be facing you, with the insulation material between it and the metal to form a barrier. Never use this type of insulation inside doors as it will retain moisture.
GLUE: We prefer high temp glue on most areas as summer surface temperatures on floor, roof and firewall can easily reach the normal 160° "release" temperature of standard glues.

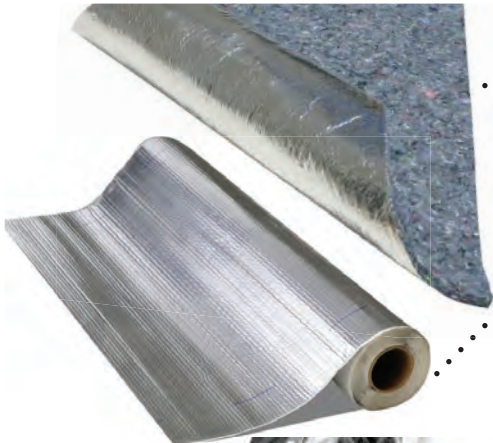

HEAT SHIELD & INSULATOR

Aluminum laminated to 3/8" fiber tech padding, (do not use inside doors, is not water proof) precut kits are made from this material. Apply with high temp glue and seal all seams with aluminum tape. Usually need 3-4 rolls of insulation, 2 tape & 2 glue for complete cab
 Single sided foil, 48" x 72" rolls..... 2167 \$32.00 rl
 Double sided, 48" x 72" 2167-AA \$35.00 rl
 We often use this in headliner and under-dash areas.

SELF ADHESIVE SOUND & HEAT DAMPER

Heat reflective, waterproof, mold-able. Good for any place that might get wet, inside doors, etc. High density, use in indents or sheet metal areas to dampen vibrations. Foil over mold-able rubber compound with aluminum on one side and self adhesive on the other.
 Roll, 36" x 48" 45mm thick..... 2166 \$38.00 rl
 18" x 32" sheet..... 2166-D12 \$28.50 ea

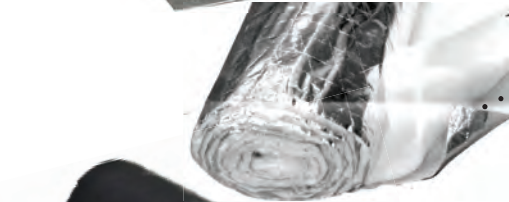

FIBERGLASS MAT SELF ADHESIVE INSULATION

Bright foil side acts as temperature barrier, inner quarter inch fiberglass mat as sound deadener, fiberglass will not absorb water like fiber filled, self adhesive. Easy to install, best everywhere but heavy wear (smashing) area like floor. Layers stitched together making it easy to form, and cut.
 40" x 96" roll..... 2168 \$32.50 rl

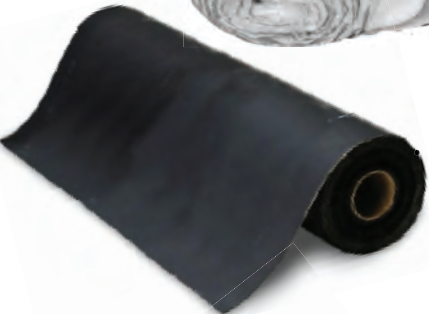

OVERDONE MAT

Super dense self adhesive matting. This is stuff I like to go over all the sheet metal with, on top of indent fillers but under jute insulation. Super high adhesion, stick it down and heat it up, contours perfect, great for inside doors. Completely quiets cab, pop your knuckle on the metal after this and all you get is a satisfyingly dull thump.
 Roll 36" x 48" 2166-B..... \$22.00 ea
 See precut kits as well, previous page and individual applications

UNSURE? CALL FOR HELP AND SAMPLES SMP-2167



HI-TEMP SPRAY ADHESIVE, WILL NOT SHIP VIA AIR

Holds at temps over 160°, most adhesive lets go at 160° so we use this at firewall, roof & floor. Does about two 4 x 6 rolls, or 48 sq ft
 14oz..... 2103 \$14.95 ea

UPHOLSTERY ADHESIVE..... 2102 \$13.95 ea

Use for material to insulation, plastic, panel-board or steel



ALUMINUM TAPE..... 2101 \$4.95 rl



PATTERN KIT Cut the insulation out yourself with our patterns.

Lower cab, floor, rear wall & kicks B-2110 \$35.00 kit
 Headliner 1953-55 and 1956 B-2116 \$15.00 ea



SEAM ROLLER 2101-RLR..... \$4.95 ea

HORSE HAIR JUTE INSULATION..... 2132-JT \$19.95 rl
 Yucky stuff but original, close to same matting as the 2167 with aluminum on one side. Used under floor mat originally 1/2" X 36" X 72"



FRONT MASK

Highest quality padded vinyl, with soft paint protecting felt underside and felt covered attachments. Includes vinyl storage pouch. Also available with Velcro opening to open hood without removing mask. Works with stock or flip hoods.

MASK FOR USE WITH BUMPER

Custom made to go around frame behind bumper.
 Black.....0140-WB\$275.00 ea
 With Velcro closure.....0141-VB\$289.50 ea

MASK FOR USE WITHOUT BUMPER

Black.....0140-NB\$296.00 ea
 With Velcro closure.....0141-VNB.....\$299.50 ea
 No park light openings.....0141-VNBP\$280.00 ea

FELT COVERED ATTACHING TABS

For replacing worn tabs.....0142\$6.50 ea

Bumper Mask is held on with bendable tabs



BUMPER MASK

Matches front mask, good looking and great protection. Sewn with center contour for perfect fit. Covers front, top & bottom.

Black.....0143\$75.00 ea

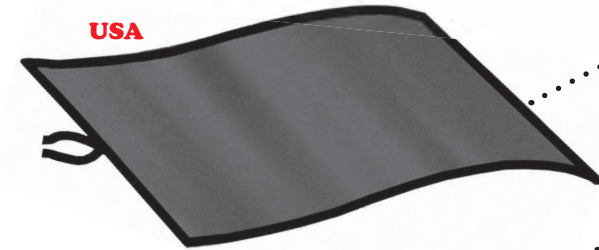

BED MAT

Bound edges, newer style dash cover type carpet. Quick protection of fine bed wood and strips, rolls up with attached Velcro strap for storage

Charcoal bed mat0154-CH.....\$39.95 ea



DASH COVER, Velour

Attach with Velcro tabs or magnets for easy on and off without leaving behind tell-tale Velcro squares. Only made for 56 at this time. Made in soft sponge backed Velour. Attachments included

Black.....0157-56BK\$39.95 ea
 Grey.....0157-56GY\$42.50 ea
 Charcoal0157-56CR\$45.00 ea
 Blue0157-56BL.....\$45.00 ea
 Tan.....0157-56TAN\$45.00 ea
 Colors made individually, may take 4 weeks....\$45.00 ea.



DASH COVER, Carpet

Black only0156-56BK\$65.00 ea



UNDER HOOD ABS COVER, With insulation

Smooth7750-5356\$169.95 ea
 Ford Script.....7752-001\$239.95 ea
 Ford Oval & Script.....7752-002\$259.50 ea
 289 embossed7752-289\$239.95 ea
 302 embossed7752-302\$239.95 ea
 351 embossed7752-351\$239.95 ea

INSULATION ONLY.....7753-5356\$37.50 ea



7752-001



7752-002



7752-289



7752-302



7752-351



Remember this? “Covers are now made overseas, it is a nightmare! Material being cut in Mexico, sewn in China, go figure! We continue searching for a better way, well, **I FOUND IT**, I have been on a quest for a GOOD truck cover manufacturer. We have been dealers for Covercraft, Coverking and California Car Cover for years, but I have not been happy with them for some time. Quality going down, prices going UP, way up!!! But we found a company that will make our cover my way, with reinforcement at those sharp bed corners, long enough to cover bumpers and running boards, enough room for mirrors and just a tad cheaper than building a garage!!

Photo courtesy of Dennis McBride



Our truck covers are long enough to cover the running boards

SILVER-TECH

3 layers The most exciting one, Sy's exclusive design with DOOR ZIPPER, on driver side. What a great cover for shows. Keeps interior cooler, we are in Arizona so very aware of how important UV resistant sun reflective covers are for protection. Lightest weight, so easy on and off. Super slick inner side pampers paint. No comparison anywhere, Sy's pattern and yes, it really does have a door zipper!!! “Chevy guys will be green with envy” Not available for Panel truck, if interested in panel, get on first serve list. Must do up a “roll” at a time, so, to invest in a panel cover we need some “reassurance”. Color: LIGHT METALLIC SILVER

1953-56 Pick-up TC-5301-SZ \$159.00 ea

STORM-BOND

4 layers. Best long term storage and protection from dings, hail, kids, garages with family traffic. Two breathable and protective layers inside & soft luxurious fleece inner layer. Outer layer has highest UV (sun) protection available. Ultrasonic sealed seams to avoid stitches and punctures. Color: LIGHT GREY

1953-56 pick-up TC-5300-PG \$169.95 ea

1953-56 panel TCP-5356-SW \$395.00 ea

SOFT-BOND

3 layers, very soft without the “fuzz” that we worry about in flannel fabrics. Highly water resistant, seams are heat sealed to avoid stitches and punctures. This is the cover for newer paint and babied finishes. Very UV resistant, good for high sun areas. Cover is comparable to but exceeds competitor covers costing way over \$200.00. Color: TAN

1953-56 pick-up TC-5300-FT \$115.00 ea

1953-56 panel TCP-5356-DX \$280.00 ea

HONEYCOMB

Single layer, very breathable and thin, lightweight, water resistant, economical, indoor and outdoor mild weather or short term storage, good dirt, dust and UV ray protection. Easy on & off. Color: LIGHT GREY

1953-56 pick-up TC-5300-BG \$79.95 ea

1953-56 panel TCP-5356-HC \$369.00 ea

ECONOMY, PLASTIC Clear, 3 mil plastic cover with elastic band, temporary cover that will not scratch surface. Like a rain coat, even in heavy rain or wind elastic band holds it on. Does not cover truck completely to running board but is handy for quick cover up, good for quick protection over a cloth cover Universal TC-5309-EC \$15.00 ea

ECONOMY MATERIAL, Not Sy's design but decent cover, Inside storage only TC-5303-1B \$59.95 ea

Same basic cover but heavier Tan material, temporary outside storage TC-5303-3FT \$99.95 ea

LONG BED COVERS OUTSIDE STORAGE Water Proof TC2-5305-LB \$178.50 ea
 INSIDE STORAGE Water Resistant TC2-5306-LB \$138.50 ea
 1000 FABRIC SERIES, Gray, inside storage, TC2-5303-1000 \$59.95 ea
 3000 FABRIC SERIES, Tan, outside temporary storage TC2-5303-3000 \$99.95 ea

ALL COVERCRAFT AND STYLES AVAILABLE , call for prices



COVER GROMMET FOR ANTENNA... TC-9112 \$1.75 ea

STORAGE BAG, DRAWSTRING TC-9110 \$12.00 ea

TRUCK COVER WIND GUARD KIT. TC-9108 \$19.95 ea



COVER CABLE AND LOCK TC-9109 \$12.50 ea



USA

Original license plate holes are in chrome bumper NOT in stainless bumper. Lower wing brackets attach to bottom of bumper, 3 bolts on each side, with offset of wing pointing up. Wing bolts to bottom of frame. Top of bumper has 2 holes on each side, over the years some originals had 3 holes, as same bumper fit larger trucks.



- FRONT BUMPER** Fits pickup & panel. Bumper mask see page 26
- Polished stainless, with brackets, USA.....0600-PS\$324.50 ea
 - Plain steel, with brackets, USA.....0600-A.....\$142.50 ea
 - Black (China) with brackets, with lic holes.....0600-BL.....\$128.50 ea
 - Black, no brackets, with license holes.....0600-BLNB.....\$115.00 ea
 - Chrome, with license holes....**NEW**.....0600-CHNL.....\$189.95 ea
 - Chrome, with brackets, with license holes.....0600-CH.....\$249.50 ea
 - Chrome, without brackets, with lic. holes.....0600-CHNB.....\$165.00 ea
- Triple plated chrome guaranteed, the steel under the chrome is not as perfect as we would like, imported, but best available anywhere.*
- NO BOLT HOLES, polished, USA.....0600-NH.....\$325.00 ea

FRONT BUMPER BOLT SETS

- Polished stainless. Top bolts, should be only finger tight allowing a little movement on impact. Only 2 are used on each side, do not over-tighten.*
- Button head80600-PB\$12.00 set
 - Capped head make hole square80601-PS\$11.50 set
 - Hex head, was original80602-PX\$9.50 set

- LIGHTED LICENSE PLATE BOLTS.....2223-LD.....\$12.50 pr

FRONT BUMPER BRACKETS

- Chrome.....0601-CH.....\$89.50 pr
- Black.....0601-BL.....\$56.50 pr
- Polished stainless.....0601-PS\$59.95 pr

FRONT BUMPER BRACKET TO FRAME BOLT SET

- Bolts for bracket to underside of frame, these hold bumper to truck.*
- Hex head stainless80606-SS\$6.50 set
 - Hex head zinc.....80606-Z.....\$4.50 set

FRAME HORN COVERS0606\$39.50 pr

Covers frame showing behind bumper. Polished stainless

- FRAME HORN REPAIR PIECE, Left**.....0608-L.....\$29.50 ea
- Right**.....0608-R.....\$29.50 ea

REAR BUMPER (Panel truck rear bumper & brackets see page 188)

- Polished stainless, USA.....0602-PS\$324.95 ea
 - Black, Imported.....0602-BL.....\$128.50 ea
 - Plain Steel, USA.....0602-A.....\$124.80 ea
 - Chrome, Imported, Triple plated.....0602-CH.....\$219.00 ea
 - Chrome, SECONDS, tiny imperfections.....0602-CH-2 Usually available
- Beautiful chrome, steel not as perfect as we like, but best anywhere*
- NO BOLT HOLES, Polished Stainless.....0602-NH.....\$324.95 ea

Special order, only make a few a year.

ADJUSTABLE REAR BUMPER BRACKETS

Fits 1955-up frame, hits spring bracket on 48-54, cut ends back or use Sy's snuggers below. Made in USA.

- 0603-ADJ\$125.00 set
- SNUGGER REAR BUMPER BRACKETS, BEST BUY**
- Brings bumper up 2", in 3", closes gap between bed & bumper.*
- Black or plain steel, set of 4.....0603\$100.00 set

REAR BUMPER BRACKETS, STOCK

- Black, set of 4, China.....0604-BC\$99.00 set
 - Polished,.....0604-A.....\$244.50 set
 - Chrome, set of 4, Import.....0604-CH.....\$129.95 set
- Nice chrome, but edge that shows not as smooth as should be.*

REAR BUMPER BRACKET TO FRAME BOLT KIT

- Polished stainless.....80615-PS\$26.75 kit
- Zinc.....80615-Z.....\$6.00 kit

REAR BUMPER BOLT SET

- 1/2" Bolts, polished stainless heads.....80612-PS\$19.50 set
- Original bumper used 9/16" bolts, newer ones use 1/2" bolts*

GROOVED ALUMINUM BRIZ BUMPERS

- FRONT, 5 RIBS0600-53A5.....\$265.00 ea
- FRONT, 3 RIBS0600-53A3.....\$265.00 ea
- REAR, 5 RIBS0602-48A5.....\$265.00 ea
- REAR, 3 RIBS0602-48A3.....\$265.00 kit
- SPECIAL CURVED HEAD BOLT80602-A.....\$8.50 ea

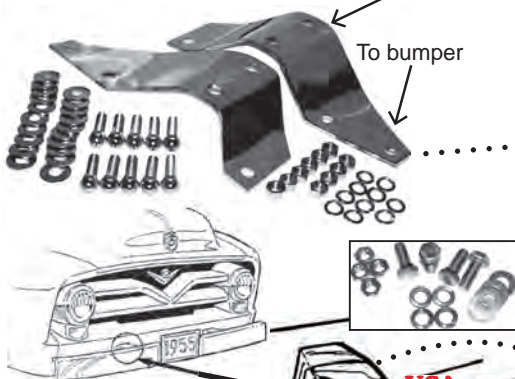

Individual pieces available, ask



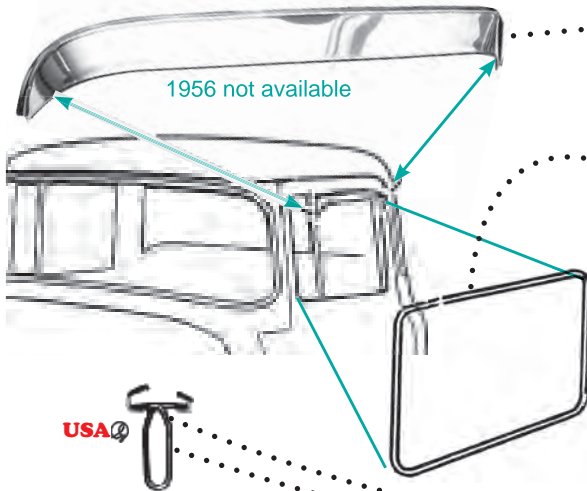

••••• **SIDE WINDOW SUN VISORS**

Polished stainless, with hardware, 1953-55 Only available. No 1956.
1953-550125-5355 \$59.50 pr

••••• **STAINLESS SIDE WINDOW TRIM MOLDING SET**

Was on custom cabs, does both sides, includes replacement style clips, for original clips see below.
1956 reproduction with clips1215..... \$159.50 pr

••••• **SIDE WINDOW TRIM CLIPS**

The only replacements available are too heavy and require a larger hole in the door as well as some grinding on trim. We have now reproduced the correct clip, but it's pricey! Got the price down a little on this new run. They are worth the price as any other clip available requires enlarging holes in door & grinding trim.



- Reproduction, one81215..... \$2.90 ea
- Reproduction, set, does both doors.....81215-20 \$49.80 set
- Replacement, set.....81214-R..... \$6.00 set
Requires drilling larger holes and opening up trim channel, not good for already painted trucks, if painted use Sy's reproduction clips 81215.



••••• **JOINT CLIP, STAINLESS**1218-RP \$8.00 ea

We reproduced these, still expensive but a lot cheaper than before

••••• **WINDSHIELD MOLDING TRIM**1220..... \$250.00 set

Includes clips, new reproductions, chromed aluminum.



••••• **BIG BACK WINDOW MOLDING**1226..... \$250.00 set

Long time in the making, long story. Originals were stainless, these reproductions are chrome over aluminum. They are beautiful and guaranteed. They fit like originals, use stock rear window weatherstrip with groove and even come with all the clips.



••••• **WINDOW INSTALL KIT**93126..... \$25.00 kit

Includes Rope and install tool, plastic razor blades, butyl & gloves.



••••• **OUTSIDE SUN VISOR**

Complete Steel Sun Visor with brackets, Polished Trim & Side mounts
1953-55 outside visor kit, shown7990-5355..... \$550.00 ea
1956 outside visor kit.....7990-56..... \$550.00 ea



Beautiful Truck, Thanks
Charlie Edmond

- VISOR TRIM Polished stainless.....1260 \$95.00
Trim only, do not order with visor it is included, This trim is for original visors only.



ROOF PANEL SEE PAGE 120

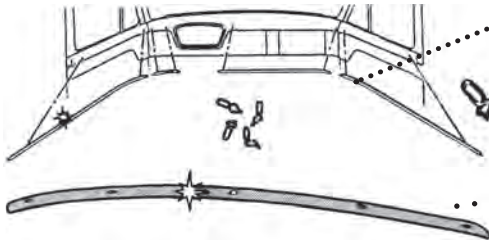

DASH & DOOR INTERIOR CUSTOM CAB TRIM

If you have tiny holes in door and across dash this is what was there

53-55, all 4 pieces with clips.....1216..... \$79.50 set

CAB TRIM CLIPS

One individual clip81217-1\$0.60 ea

Set of 2081217-20\$9.95 set

DEFROST DEFLECTOR

Goes across dash at windshield. Ship core to us taped to a piece of wood, can be damaged very easily, will be un-chromeable and unusable. If damaged core charge cannot be refunded. Oversized shipping

1953-55 Chrome exchange1940-5355\$100.00 ea

1956 Chrome exchange1940-56\$110.00 ea

Core charge.....53-55.....\$50.00 ea. 1956.....\$75.00 ea

1956 defrost deflectors are hard to find these days, die to do them is way to expensive, I am thinking of making them in chrome plastic, what do you think?

DEFROST DEFLECTOR SCREW SET

Polished stainless

1953-5581940-5355\$4.00 set

1956.....81940-56\$4.50 set

RADIO PIECES

OVERHEAD SPEAKER

SPEAKER.....**SALE**.....0185.....\$12.95

Speaker bolts.....80177.....\$3.90 set

Speaker wing nuts.....80178.....\$2.50 set

GRILLE SCREEN AND PATTERN.....0184-5356\$8.50 ea

RADIO TRIM RING.....0171-PA.....\$75.00 ea

Polished aluminum replacement, looks perfect, hand made.

RADIO INSTALL SCREWS80170.....\$3.90 set

ABS KICK PANEL WITH SPEAKER POD2117-5355SPK\$109.00 pr

ROUND REPLACEMENT RADIO, not stock but is ROUND and fits.

BOSS Stereo, Blue-tooth, MP3.....0170.....\$125.55 ea

TRICKLE LEAD, keeps radio settings.....0172-CP\$3.49 ea

RADIO ADAPTER, Redirad

Use your MP3 player or phone with your existing radio

AM0172-12VAM....\$99.00 ea

FM/AM.....**SALE**.....0172-12V\$89.95

ELECTRONIC ANTENNA

Completely concealed. NO external mast means no drilling, no damage, no vandalism. Install as close to glass as possible, self stick. 3 1/2" X 3/4"

Long Cable, 9 ft0177-A1\$49.95 ea

RADIO MAST ASSEMBLY ONLY0176.....\$20.00 ea

ORIGINAL ANTENNA

Hole is 1 1/8" at angle on cowl. Complete exact of original reproduction assembly, includes instructions.

1953-550175-5355\$89.95 ea

1956.....0175-56\$89.95 ea

RADIO MANUALB-11169\$3.50 ea

53-55 with template. No longer available, but have one we will copy for you. 11 pages, charge is just for paper

ADD ON SIDE ANTENNA

Perfect high quality reproduction, includes lead wire. Popular 50's add-on.

Retro-red ball on top.....0178\$39.95 ea

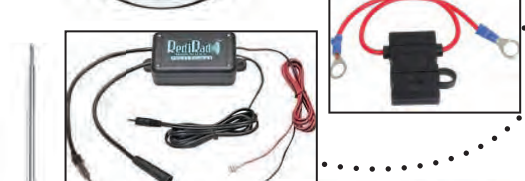

MIRRORS



• **OUTSIDE MIRROR KIT**91150..... \$109.00 kit
Best mirror on market and best price. Plus parts are interchangeable and mirror head can be tightened if ever necessary, (glass must be replaced to do this) Includes both mirrors, grommets and install bolts

• **OUTSIDE MIRROR KIT PIECES**

- Mirror assembly, head, arm and base, one1150.....\$54.99 ea
- Mirror assembly, has FOMOCO stamp1150-FMC **SALE** \$59.50
- Mirror arm grommet.....1152.....\$2.95 ea
- Mirror head replacement, NON-FORD1159-HD\$37.50 ea
- Mirror head replacement, FOMOCO1159-HDFMC.....\$24.95 ea
- Mirror arm replacement1159-ARM.....\$22.00 ea
- Mirror acorn nut.....81150-AC.....\$1.95 ea



- **MIRROR BULLET NUT**, polished, neat!1151-CVR\$39.95 pr
- Mirror head Allen wrench.....81158.....\$0.75 ea
- Mirror head set screw.....81159.....\$0.75 pr
- Mirror replacement glass.....1159.....\$9.85 ea



• **MIRROR INSTALL BOLTS**

Coarse thread, heads show with door open

- Zinc.....80202-Z.....\$2.00 set
- Polished stainless hex head.....80202-PX.....\$7.90 set
- Polished stainless button head.....80202-PB.....\$8.90 set



• **MIRROR HOLE PLUG** Use without mirrors .1153.....\$2.95 ea

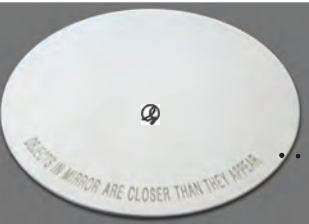

• **WIDE ANGLE MIRROR GLASS**1157.....\$9.00 ea
Says (Items in mirror are closer than they appear)

• **MIRROR GLUE**1159-GLU\$2.98 ea



• **MIRROR VISOR**, Chrome.....1151-V\$16.50 pr
 Smoke1151-S **SALE** ~~16.50~~ **13.50** ea
 Blue1151-B\$7.50 ea



• **MIRROR BASE ARM CHOICES**

Guaranteed against breakage. Extended arms are so you can see past division bar on passenger side.

- Chrome, solid, stock length, NICEST ONE1151-5356 **SALE** \$18.00
- Chrome, Ford FOMOCO1151-FMC.....\$25.50 ea
- Smooth polished aluminum, extended 1"1155-SX.....\$32.50 ea
- Grooved polished aluminum, extended 1".....1155-GX\$32.50 ea



• **PEEP MIRROR**

New higher quality peep mirrors, street rod style, attaches to top or side angle of door. New wide angle view

- 4" curved arm, wide angle glass.....1157-XC4.....\$45.00 ea
- 4" straight arm, wide angle glass.....1157-XS4.....\$45.00 ea
- 3" plain glass, curved arm1157-3.....\$20.00 ea
- 4" plain glass, curved arm1157-4.....\$20.00 ea
- 4" plain glass, straight arm1157-S4\$23.00 ea
- 4" with turn arrow light, curved arm1157-TS\$26.50 ea
- 4" with turn arrow, curved arm, wide angle.....1157-XTS.....\$28.50 ea
- Peep mirror arm extension1157-EXT.....\$14.50 ea



• **INSIDE REAR VIEW MIRROR**

New dies for a better reproduction. Note all holes in cab are in a triangular pattern. Rectangular base was used on 53-55's, some 56's & with speaker grille, but triangular base mirror swivels at top & bottom for better adjustment, can be used in both cabs by re-drilling mounting holes & may need little ding for ball clearance. Triangular base mirror is better mirror.

- **RECTANGULAR** base1154-RCT\$49.80 ea
- **TRIANGULAR** base1154-TRI.....\$49.50 ea
- Mirror screws, polished stainless.....81154.....\$1.75 set
- **UNIVERSAL, GLUE ON**1154-UNI\$40.00 ea



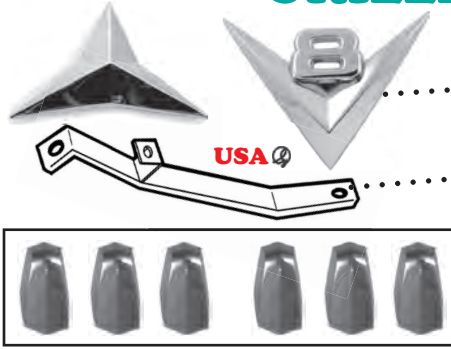

1953 Original grille was painted "ivory"

- GRILLE EMBLEM, V8..... 1205-53..... \$59.95 ea
- GRILLE EMBLEM, 6 CYL. STAR 1206-53..... \$52.50 ea
- V8 & STAR HARDWARE *Included above*..... 81205..... \$0.65 ea
- GRILLE & EMBLEM SUPPORT Stainless... 1210-53SS **SALE** \$29.95
- GRILLE & EMBLEM SUPPORT, POLISHED .. 1210-53PS \$59.95 ea
- SUPPORT BOLT KIT *Polished stainless* 81210-53..... \$10.00 kit
- "TEETH" DELUXE GRILL TRIM 1207-53..... \$219.50 set
- 3 left and 3 right with template for drilling holes in grille if necessary.
- TEETH HARDWARE 81207-53..... \$5.00 set

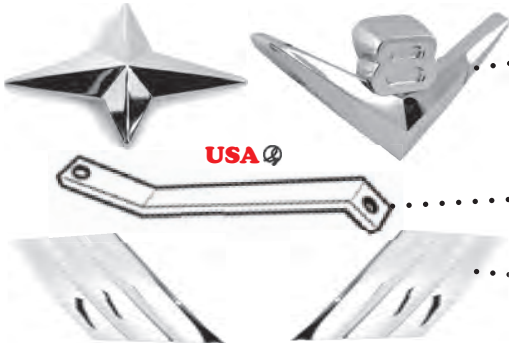

1954 Original grille was painted "ivory"

- GRILLE EMBLEM, V8
- NEW improved dies!!!..... 1205-54..... \$59.95 ea
- GRILLE EMBLEM, 6 CYL. STAR 1206-54..... \$52.50 ea
- V8 & STAR HARDWARE *Included above*..... 81205..... \$0.65 ea
- GRILLE TO GRAVEL PAN LOWER BOLTS..... 81257-54..... \$3.25 ea
- GRILLE & EMBLEM SUPPORT, stainless 1210-54SS \$29.50 ea
- GRILLE & EMBLEM SUPPORT, POLISHED .. 1210-54PS \$45.00 ea
- SUPPORT BOLT KIT *Plain stainless*..... 81210-5456..... \$4.50 kit
- "HASH MARKS" DELUXE TRIM..... 1207-54... **SALE** \$149.95
- 3 left and 3 right with template for drilling holes in grille if necessary.
- HASH MARKS HARDWARE 81207-54..... \$4.00 kit



1955 Original grille was painted "off white"

- GRILLE EMBLEM, V8 1205-55..... \$59.95 ea
- GRILLE EMBLEM, 6 CYL. STAR 1206-55..... \$52.50 ea
- V8 & STAR HARDWARE *Included above*..... 81205..... \$0.65 ea
- EMBLEM SUPPORT, Stainless..... 1210-53SS \$69.80 ea
- **NEW**..Powder Coated black 1210-55BK..... \$38.85 ea
- SUPPORT BOLT KIT *Plain stainless*..... 81210-5456..... \$4.50 kit
- "GULL WINGS" DELUXE TRIM..... 1207-55..... \$199.80 set
- GULL WINGS HARDWARE 81207-55..... \$5.00 kit



1956 GRILLE REPRODUCTION

- Black primer, with emblem support..... 1256-BK..... \$445.00 ea
- Chrome, with emblem support..... 1256-CH..... \$599.80 ea
- *Top picks, grilles with little defects are marked as 2's or 3's, passed on and picked up by competitors, or discounted as #2 \$30.00 off or #3 \$90.00 off*
- *To use 56 Grille in 1953-55 truck change air deflectors & buckets. 6 cyl had no emblem. 1956 Deluxe was only chrome grille in series*
- GRILLE EMBLEM, V8 1205-56..... \$59.95 ea
- EMBLEM PAD, molded edge, perfect!!..... 1205-56T..... \$9.75 ea
- GRILLE & EMBLEM SUPPORT
- Polished SS..... 1210-56PS..... \$32.00 ea
- Black..... **SALE** 1210-56BK..... \$12.00
- SUPPORT BOLT KIT *Polished stainless*..... 81210-5456..... \$4.50 kit
- 'HEADLIGHT RING CLIP, 1956 82238..... \$6.85 ea



BOLTS AND CLIPS FOR ABOVE GRILLES

- GRILLE BOLTS USE WITH ORIGINAL FINE THREAD J-NUTS
- Black set of 6..... 87003-Z..... \$5.50 set
- Polished hex..... 87003-PX..... \$14.50 set
- Polished button..... 87003-PB..... \$16.50 set
- BOLTS WITH J-NUTS Black set of 6 81256-Z..... \$7.50 set
- Polished hex 81256-PX..... \$14.50 set
- Polished button..... 81256-PB..... \$15.50 set
- One j-nut & bolt only 87004..... \$1.50 set
- GRILL TO BUCKET CLIP & screws..... 82230..... \$4.50 kit

Emblems, like many things, have been reproduced many times, and in various qualities over the years. We have them all of course, as we are dealers for everyone as well as manufacturers, but, we only ship what Sy considers best available at the time. If you have questions, or a preference on something, please give us a call. We price match, see our price match policy.



55-56 CUSTOM CAB EMBLEMS

- Chrome, no paint. not shown..... 1213..... \$30.00 pr
- Painted cream 1213-PNT..... \$37.50 pr
- Emblem clips 81213-5556..... \$1.50 set
- **EMBLEM PAD**, molded edge**NEW**... 1213-T..... \$12.95 pr



1953-54 SIDE HOOD EMBLEM

- Block lettering with dot, pair..... 1204-53..... \$47.50 pr
- Dot only 1202..... \$20.00 ea
- Emblem clips 81202-5354..... \$3.25 set
- Our kit includes both styles.....



1954 DELUXE BOOMERANGS

- Emblem with hardware 1203..... \$207.00 pr
- Round cup washer, like original, set of 4... 81209-5456..... \$8.75 set
- Use 4 for 55 and 56 side emblems use 2 sets of 4 for 1954 boomerang



1955 SCRIPT SIDE HOOD EMBLEMS

- Painted, red circle, Pair 1204-55PT \$79.95 pr
- Painted red circle, One Only..... 1204-55PT-1 \$50.00 ea
- Clip & hardware kit 81202-55..... \$2.95 kit



1956 HOOD EMBLEMS *Paint is now better, color corrected.*

- Painted, red circle and letters 1204-56P \$99.95 pr
- Clip & hardware kit 81202-56..... \$2.50 kit
- Clips, flat washers, lock washers & nuts.
- Round cup washer, like original..... 81209-5456..... \$8.75 set
- Use 4 for 55 and 56 side emblems use 2 sets of 4 for 1954 boomerang



- **EMBLEM PAD**, Molded raised edge, very nice, sets off emblems. See also V8 pad, Custom Cab and Mirror Trim Pads. Finally finished after Years of work and waiting. **NEW** 1204-56T..... \$19.85 pr



HOOD BIRD BEAUTIFUL, Rarely seen, very expensive, this is bling!

- Ford shows it in the 1956 book "Ford accessories passenger car & truck" we include free with each 'bird'. Ford described it in 1956 as "Fleet looking, distinctive design, adds a sparkling personal touch to your truck"
- Cast Polished Stainless, best fit 1209..... \$450.00 ea
- Die Cast Polished Stainless 1209-5356..... \$575.00 ea



FRONT HOOD EMBLEM

- Painted red in body, black around Ford.
- Emblem, with hardware 1200 \$44.50 ea
- Emblem stud mounting nuts 81212.....
- Fits all threaded emblem studs on this page, includes washers.*
- Front hood emblem pad, flat..... 1201 \$2.95 ea
- Front hood emblem pad, molded edge..... 1201-MD \$7.90 ea
- With fancy raised bead around edge. Helps cover gap at top center
- Kit with emblem hardware & molded pad.. 91200..... \$49.95 ea



OVERDRIVE EMBLEM

- Emblem 1211 \$25.00 ea
- Emblem mounting nuts 81212..... \$1.15 kit



FORDOMATIC EMBLEM

- Emblem 1212-5556..... \$24.50
- Emblem mounting nuts 81212... **SALE** .. \$1.15 kit



- **EMBLEM REMOVAL TOOLS**..... 80107..... \$23.95 ea
- Handy for a multitude of things, especially for removing emblems. so helpful, plastic.

HORN

2020 Mid Fifty
1953-56 Catalog

HORN BUTTONS *All include black plastic mounting base*

50TH ANNIVERSARY

Includes stainless ring, plastic insert and black plastic backing. This button celebrated the Ford trucks 50th year in 1953

- Button 2781-53A \$74.95 ea
- Plastic anniversary insert only 2737-ANV \$49.95 ea

5 STAR

- 54-56 polished stainless 2785-PS \$45.00 ea
- 54-56 black center 2784 \$45.00 ea

BOLT & GEAR

- Silver with red center 2783-56 \$49.95 ea
- All polished stainless 2782-PS \$49.95 ea

Steering wheels see page 167

HORN BUTTON PARTS

- CONTACT SPRING 2733 \$5.95 ea

Looks like a piece of grapefruit, it is what makes contact with wire

- WIRE, INSULATOR & CONTACT 2730 \$15.50 ea

Not included in any wire harness, goes inside steering shaft, Bakelite piece not available separately, is installed on wire along with special contact end.

- BRASS CONTACT CAP 2732 \$6.50 ea

This is cap that must be removed to access shaft nut, make sure Bakelite insulator on horn wire is properly seated in center indent

- RETAINER BELL SPRING 2734 \$6.50 ea

Slips into slots in cup, makes ears that hold button on, push button down and turn clockwise to install, counter clockwise to remove

- SUPPORT CUP 2735 \$12.00 ea

Some buttons have different height cups Measure area between spring slot and top, short one (2735-SHT) is 1/8" and was used in 48-52 trucks and many 57-60 trucks, correct one (2735) is 1/4"

- HORN BUTTON KIT *All above pieces.* 92730 \$33.50 kit

HORN

- REPLACEMENT, CHROME, pair 2793-CH \$44.50 pr

- REPLACEMENT, SMALL UNIVERSAL, order by tone.

- Low, driver side 2793-L \$20.00 ea

- High, passenger side 2793-R \$20.00 ea

- HORN, ORIGINAL REPRODUCTION**, steel housing with correct shape.

Most trucks had only one horn, but both are reproduced.

- Passenger, LOW 2790-LW \$44.50 ea

- Driver, HIGH 2790-HI \$44.50 ea

- HORN WIRE From relay to horn 3209-H \$4.50 ea

HORN MOUNTING BRACKET

- 1956 driver side 2796-56L \$13.50 ea

- 1956 passenger side 2796-56R \$13.50 ea

- 1953-55 driver side 2795-5355L \$13.50 ea

- 1953-55 passenger side 2795-5355R \$13.50 ea

HORN BRACKET TO SADDLE BOLTS

- Zinc 82795-Z \$4.90 ea

- Polished hex 82795-PX \$7.90 ea

- Polished button 82795-PB \$8.90 ea

- HORN TO BRACKET TABS 2798-K \$10.85 set

Mounts horn to bracket and prevents "dull" sound

- HORN BODY TO TAB BOLTS 82798 \$1.10 pr

- BODY TO TAB SPACERS *Replacements* 82799 \$1.65 pr

HORN RELAY

- 12 volt 3229 **SALE** \$15.00

Note Gm, Ididit & Flaming River Columns use GM Relay, not this one

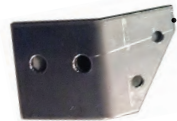

Yellow/Green
HORNS
Pass. Side



Blue/Yellow
HORN BUTTON
Driver side

Yellow
BATTERY



HORN

1-800-252-1956
Direct 928-565-2763



- DOME LIGHT FRAME ONLY (see kits at bottom of page)
 - Chrome, with switch hole..... 2250-CH.....\$35.57 ea
 - Painted gray 2250-PNT.....\$35.00 ea
 - Chrome, no switch hole 2250-NO\$34.50 ea



- DOME LIGHT FRAME SCREWS 82250 \$1.00 kit
Screws that hold frame to cab brace, inside bulb area.



- DOME LIGHT LENS 2251 \$7.00 ea
Remember dome lens in colors? Ahh-the 70's, we do have color bulbs tho.



- DOME LIGHT SOCKET & PIGTAIL 2253 \$9.95 ea
Includes wire, insulator, contact & spring (not included in frame)



- SOCKET REPAIR 2254 \$2.50 kit
Wire, insulator, contact & spring. Use with existing socket only.



- DOME LIGHT BULB
 - 12 volt 2269\$1.25 ea
 - Colors available, ask
 - 12 volt Amber..... 2269-AMB\$3.95 pr
 - 6 volt 6V-2269.....\$1.50 ea



- DOME LIGHT FUSE 82903\$2.00 pr
This special fuse goes in the back of the headlight switch.



- DOME LIGHT SWITCH 2256 \$14.95 ea
Reproduction of original but with chrome handle and bright nickel plating on part that shows through rectangle hole in frame.



- DOME LIGHT SWITCH SCREWS 82257\$0.50 set
Mounts switch to center brace, frame then goes over it.



- WIRE ENDS & SCREWS 82256 \$1.50 kit

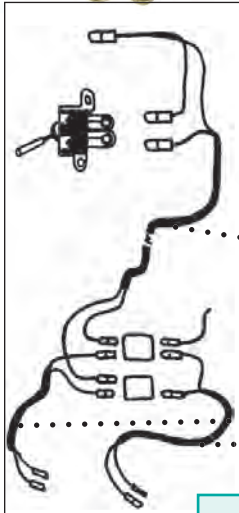

Dome light wiring is a pain to do. Both doors, headlight switch & dome light switch at light all control on and off. The kits below make it much easier



- 4 WAY CONNECTORS 3205 \$8.50 pr
Use one pair for dome light circuit as shown. Pricy but correct.



- DOME LIGHT HARNESS 3203-DM\$25.00 ea
Door switch junctions to dome switch and socket pigtail, goes from under dash, up and over driver door to dome light with connectors

- DOME LIGHT DOOR SWITCH HARNESS
 - Driver, left 3204-L\$8.50 ea
 - Passenger, right..... 3204-R\$14.00 ea

- **COMPLETE DOME LIGHT WIRING KIT** 93204 \$55.00 kit
Wiring kits for both doors, connectors, dome light harness, socket, wire, fuse and instructions

DOME LIGHT SUPPORT See pg 120



- DOOR JAM BUTTON *Stainless face* 2252-SS\$5.95 ea



- BUTTON INSTALLATION KIT 82252 \$1.50 kit
Switch contacts & instructions for switches, this kit not needed with ha R



- JAM HOLE PLUG For NO switch 82253 \$9.95 ea



- **DOME LIGHT KIT, CHROME, BASIC**..... 92250-B \$39.00 kit
Includes chrome frame, lens, socket pigtail, and bulb

- **DOME LIGHT KIT, CHROME** 92250 \$77.50 kit
Includes switch, chrome frame, lens, socket, pigtail, bulb, 2 door jam buttons, button connectors and instructions.

- **DOME LIGHT KIT WITH WIRING THIS IS THE BEST BUY!**
Complete with wiring 92251 \$108.00 kit
Includes complete dome light kit above and complete wiring kit.

- CUSTOM DOME LIGHT C-2250 \$62.50 kit



- DOME LIGHT DIMMER MODULE 2259-DM\$47.50 ea
Delays & dims dome light 2.5 seconds after door closes.



Perfect reproduction. We offer plates stamped correctly as exact reproduction of original. For stamped plate we need copy of proof of ownership, and all plate information. VIN number must be correct and verified, but engine, trans, rear axle, etc information can reflect your changes. If you need help with the codes, give us a call. Processing this plate takes 18 to 24 weeks, for rush 7 to 10 business day service Add \$40.00. I know it is expensive but that's what they charge us, only two stampers and long backlog. 1953-55 Rating plate is installed on glove box door facing passenger when door is open. 1956 plate was on door post.

Locating the VIN number: Start on passenger side just in front of cab mount, under inner fender, Is on top of frame rail but can be anywhere along frame up to front x-member. 1953 can be on front x-member instead of frame.

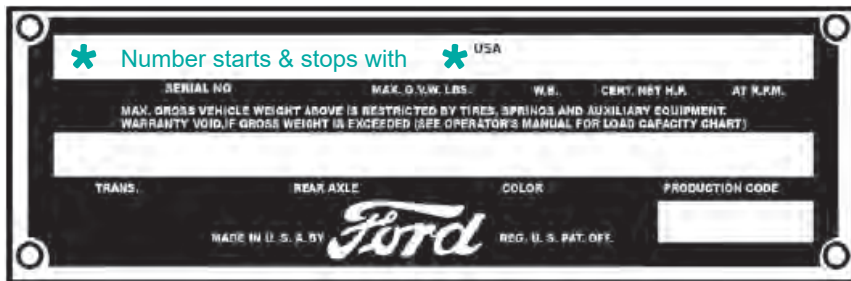

CODE	1953	1954	1955	1956
A	Black	Black	Black	Black
B	Sheridan Blue	Sheridan Blue	Banner Blue	Nocturne Blue
C			Aquatone Blue	
D	Woodsmoke	Glacier Blue	Waterfall Blue	Diamond Blue
E			Snowshoe White	Colonial White
G	Seafoam Green		Sea Sprite Green	Meadow Mist
H		Sea Haze		
N	Vermilion Red			
R	Meadow Green	Vermilion Red	Torch Red	Torch Red
U		Meadow Green	Meadow Green	Meadow Green
V		Goldenrod	Goldenrod Yellow	Golden Glow
P	Prime	Prime	Prime	Prime
S-SS	Special	Special	Special	Special

RATING PLATE HELP

GVW: GROSS VEHICLE WEIGHT

1953-54 4800 pounds
1955-56 5000 pounds

WHEELBASE

Standard pick-up 6-1/2' box..... 110"
Express with 8' box..... 118"
Express with 9' box 130"
Panel body 110"

HP @ RPM & ENGINE LETTER CODE

1953 15.D=101 @ 3500
..... 239.R=118 @ 3500
1954..... 223.D=115 @ 3900
..... 239.V=130 @ 4200
..... 256.Z=138 @ 3900
1955..... 223.D=118 @ 3900
..... 239.V=132 @ 4200
..... 256.Z=140 @ 3900
1956..... 223.D=133 @ 4000
..... 272.V=167 @ 4400
..... 272.R=158 @ 3800

TRANSMISSION CODE

Standard 3 speed 3
Heavy duty 3 speed..... 3HD
Overdrive 3OD
Synchronized 4 sp..... 4SYN
Fordomatic..... AUTO

REAR AXLE

1953-54 3.91..... 4.09..... 4.27
1955-56 3.92..... 4.09..... 4.27

ASSEMBLY PLANT CODES

A..... Atlanta 53-55
B..... Buffalo 53-55
C..... Chester 53-55
G..... Chicago 53-55 56
D..... Dallas 53-55 56
F..... Dearborn 53-55
E..... Edgewater 53-55
E..... Mahwah 56
H..... Detroit Truck 53-55 56
K..... Kansas City 53-55 56
L..... Long Beach 53-55 56
U..... Louisville 53-55 56
M..... Memphis 53-55 56
N..... Norfolk 53-55 56
R..... San Jose 56
S..... Somerville 53-55
SP..... Saint Paul 53-55

1953-56 STAMPED PLATE B-10091-STMP \$145.00 ea
RUSH SERVICE B-10091-RUSH \$40.00 ea
INSTALLATION SCREWS
Stainless 80091 \$1.00 set
Polished stainless 80091-PS \$3.00 set
MERCURY RATING PLATE B-10092-STMP \$175.00 ea

1953	1954	1955	1956
PICKUP 116,437 PANEL 9,951	PICKUP 101,202 PANEL 8,078	PICKUP 124,842 PANEL 11,198	PICKUP 127,581 PANEL 14,023



GLOVE BOX

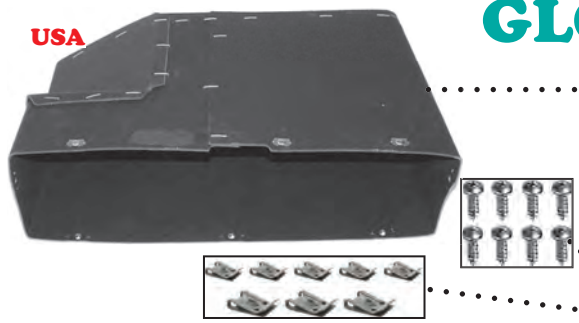

USA

GLOVE BOX Stock panel board with factory installed clips. Install from back side, do not attempt to push through opening. Note, we often have S&D (scratch & dent) glove boxes available. Perfect if cutting down for AC clearance or repair with a little tape.

When available they are \$8.00, just ask.

1953-55	1023-5355	\$24.50 ea
1956.....	1023-56.....	\$24.50 ea

GLOVE BOX SCREW SET 81024 \$1.75 set
GLOVE BOX CLIPS & SCREWS 81025 \$5.00 kit
 Do not order with our boxes, clips are installed, just order screws above. We offer in case you got box elsewhere, that'll teach ya.



USA

REDUCED ABS GLOVE BOX, Use with AC, etc Sy's is deeper than any others available, 3.5" and has correct edge shape, easy install.

1953-55 ABS reduced box.....	1024-M5355	\$25.50 ea
1956 ABS reduced box.....	1024-M56.....	\$26.50 ea



USA

GLOVE BOX HINGE

1953-55 driver side.....	1020-5355L.....	Call
1953-55 passenger side, with spring.....	1020-5355R	Call
1956 driver side.....	1020-56L.....	Call
1956 passenger side, with spring.....	1020-56R	Call

HINGE SPRING 81029 \$2.50 ea
 Goes on passenger, far right, side hinge only.

HINGE BUMPER 1021 \$1.50 ea
 Small bumper goes around hinge arm on right side hinge, Jodi discovered this in 1999, first time we ever found original still intact

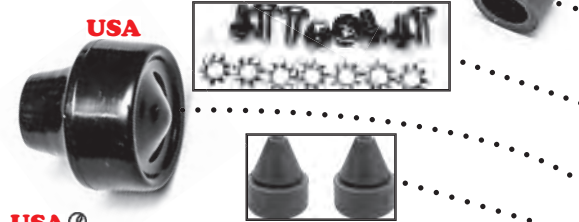

USA

MOUNTING BOLTS, Mounts hinge to door & dash
 Stainless..... 81028-SS \$2.50 set
 Polished stainless..... 81028-PS \$5.00 set



USA

GLOVE BOX KNOB, 53-56 1005 \$5.95 ea
GLOVE BOX DOOR BUMPERS..... 1022 \$2.00 pr

GLOVE BOX LOCK KNOB,
 for original lock only, Black..... 1027-MB..... \$9.50 ea
 White, made in error, can be painted..... 1027-MW..... \$7.00 ea



NEW!

GLOVE BOX LOCK REPLACEMENT, Not exact of original but looks and works correctly, does not use original Ford Key, Includes Knob..... 1027-5355 \$29.50 kit
 Note, you can add a lock to 1956 glove door 1027-56..... \$29.50 kit
 Template available with special lock tab. not shown



NEW!

GLOVE BOX DOORS
 1953-55 With Lock Hole 1070-5355..... \$74.50 ea
 1953-55 Door With Lock and Knob 1071-5355..... \$95.00 kit
 1956 Door..... 1070-56..... \$74.50 ea

GLOVE BOX DOOR CUP HOLDER, Nifty idea. Machined aluminum with magnetic base, holds tight to glove box door, can stay in place with the door shut or be removed for storage. Includes inner plastic cup to catch condensation and for easy clean up
 * 3" ID 2 1/8" deep..... 1026 \$38.80 ea



USA

GLOVE BOX DOOR DECALS
 • Engine oil, passenger side, door open..... D-390 \$6.75 ea
 • Automatic trans, driver side, door open..... D-081 \$4.90 ea



GLOVE LIGHT KIT 1029-K..... \$32.95 ea
 LED. Turns on when you tilt your door, with tilt sensor

CIGAR LIGHTER

2020 Mid Fifty
1953-56 Catalog

USA



•CUP HOLDERS, 1956

Slides into ash tray opening. Very trick!! Pops out quick & easy to go back to original ash tray. Holds two of todays large cups. Covered in high quality automotive vinyl. BLACK..... A-0126-BK.....\$44.95 ea
Standard colors, GREY..... A-0126-GR\$45.95 ea
Red A-0126-RD ... \$45.95 ea

Flag style as shown.... A-0126-FG\$45.95 ea

Match your interior or paint color A-0126-SPO.....\$49.95 ea

Bench seat consoles with cup holders see page 14

NEW

USA



•ASH TRAY Used housings, bases, covers etc available if needed.

•KNOB 1953-55..... 1005\$5.95 ea

ASH TRAY COVER, 53-55 1052-5355\$25.00 ea

•Body Installation screws 1953-55..... 81020\$1.50 set



•POWER PORT PLUG Billet aluminum 1010-P.....\$20.00 ea

Add your choice of Knobs

•Stock black knob for power port only..... 1004\$5.95 ea

•Billet alum bushed knob 1000-ABT\$12.00 ea

Polished knob..... 1000-APT\$12.00 ea

•Power point socket only..... 1003-WELL\$5.50 ea

USA



USA



•CIGARETTE LIGHTER Complete assembly with correct knob and wiring, wire directly to accessory side of Ignition switch, fuse wire.

•CIGARETTE LIGHTER, 12-VOLT..... 1003-A.....\$19.75 ea

..... 6-VOLT..... 6V-1003.....\$27.00 ea

LIGHTER ASSEMBLY without knob 1003-NO.....\$17.00 ea

•ELEMENT ONLY..... 1003-EL. \$8.50 ea \$27.00 ea

•WITH LIGHTED TRIM RING..... 1003-L.....\$26.50 ea

Ring wires to dash lights and may require enlarging original hole

•WIRING 6 or 12V, fused..... 1003-W.....\$10.00 ea

•CIGARETTE LIGHTER KNOB..... 1003\$6.95 ea

For Original lighter, includes polished trim



Stock Knob Locations

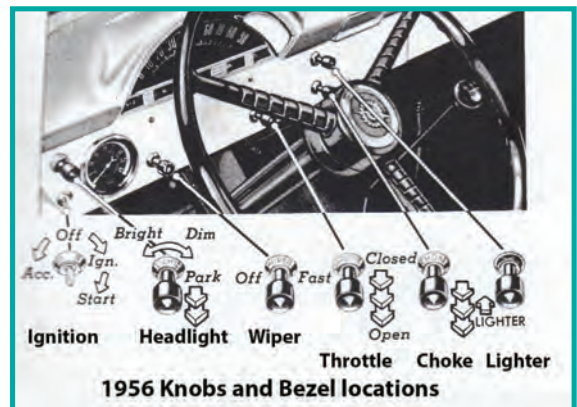
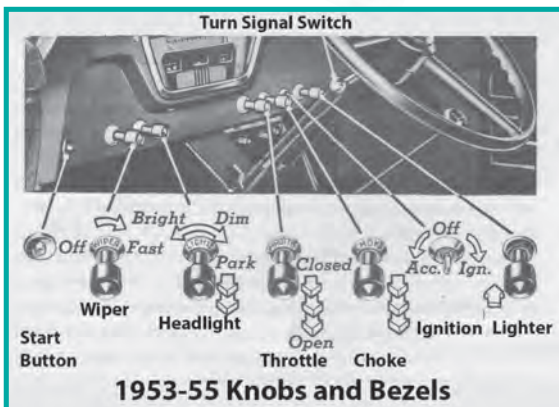

CIGAR LIGHTER

1-800-252-1956
Direct 928-565-2763



- BEZELS** See individual switch applications before ordering
- COMPLETE KIT, 7 pcs as shown.....91013.....\$49.95 set
 - THROTTLE.....1036.....\$7.50
 - CHOKE.....1035.....\$7.95
 - WIPER.....1032.....\$7.95
 - WIPER INSERT.....2911.....\$7.95
 - LIGHTS.....1031.....\$7.95
 - LIGHTS INSERT.....2902.....\$7.00
 - IGNITION.....1033.....\$7.95
- HEATER, Not available, Sy made back in 70's but are gone
 PLAIN, ALUMINUM.....coming soon
 POLISHED ALUMINUM.....coming soon



- KNOBBS**, Stock black plastic, exact of original
- LIGHTS.....1001.....\$8.80
 - LIGHTS-6V LONGER SHAFT.....6V-1001.....\$7.50
 - WIPERS, with set screw.....1002.....\$6.50
 - HEATER, threaded.....1004.....\$5.95
 - SET OF 4 heater or cable knobs...1004-4.....\$22.95 set
 - CIGAR LIGHTER, with trim.....1003.....\$6.95
 - GLOVE BOX,with screw.....1005.....\$5.95
 - ASH TRAY or glove box, w/screw...1005.....\$5.95
 - COWL VENT, with rivet.....1008.....\$6.00
 - SHIFT BALL, FLOOR SHIFT.....1006-4.....\$5.95
 - SHIFT BALL COLUMN, 53-55.....1006-B.....\$6.00
 - SHIFT SPEAR SHAPE, 56.....1006-S.....\$6.95
 - TURN SIGNAL BALL.....1007.....\$5.50
 - TURN SIGNAL SPEAR (56).....1007-56.....\$5.95



- FAUX (FAKE) KNOB, use with any bezel to fill hole.....91001.....\$6.50 set
 - GLOVE BOX LOCK KNOB, See glove box page # for original lock.....1027-MB...\$9.50 ea
- IGNITION KEY KNOB** Key in knob, pop in ignition and looks like just another knob. Neat! Blank key or we can cut to match
- Stock knob, stock key.....1009.....\$10.00 ea
 - Aluminum, stock key, polished.....1009-AP.....\$18.00 ea
 - Aluminum, stock key, brushed.....1009-AB.....\$18.00 ea



- BILLET ALUMINUM KNOBS**, Order glove box or ash tray (G) Wiper, has set screw (S) Or threaded (T) for headlight, heater, cables, etc
- BILLET ALUMINUM KNOBS, BRUSHED.....\$12.00 ea
 - G** Glove Box.....1000-ABG
 - S** Set Screw.....1000-ABS
 - T** Threaded.....1000-ABT
 - BILLET ALUMINUM KNOBS, POLISHED.....\$12.00 ea
 - G** Glove Box.....1000-APG
 - S** Set Screw.....1000-APS
 - T** Threaded.....1000-APT



- **CABLE WITH KNOB**, 60".....1014.....\$19.50 ea
Cut to fit, includes correct 53-56 knob
- Cables with no knobs, Threaded to accept threaded knob.
 - 36 inch.....1014-36.....\$14.85 ea
 - 48 inch.....1014-48.....\$16.50 ea
 - 60 inch.....1014-60.....\$16.50 ea
 - 66 inch.....1014-66.....\$16.50 ea
- BACKING NUTS for cables.....81014....\$1.00 kit



All our cables include inner drive cable, outer housing, 5/8" speedo head screw on end and transmission end. They fit most all aftermarket mechanical speedo heads like Motorsport, Dolphin, VDO, Autometer, etc as well as stock.



FORD AUTO • C4 • C6 • FM • AOD and 3 & 4 Speed Late Model.

- SPEEDO CABLE, 71" (normal) 2601 \$45.80 ea
Late model manual and C4-C6, FMX, AOD automatic transmission
Normally the truck uses 71" but just in case we also make 67 and 76.
- SPEEDO CABLE, 67" 2601-67 \$33.50 ea
- SPEEDO CABLE, 76" 2601-76 \$49.50 ea
- SPEEDO CABLE GROMMET 1617-G \$2.95 ea
- SPEEDO CABLE "O" RING 2604-B \$0.75 ea
- SPEEDO GEAR CLIP 2604-A \$3.50 ea
- SPEEDO GEARS, C4 & C6 TRANS
Most trucks need 18 teeth.
- 18 teeth, yellow, most common 2603-Y \$11.95 ea
- 19 teeth, pink 2603-P \$12.50 ea
- 16 teeth, maroon 2603-M \$11.50 ea
- SPEEDO CABLE LUBE 2607 \$6.95 tb
- SPEEDO CABLE CLAMP 2605 \$6.90 ea
Clamp is included with our cables, do not order separately
- SPEEDO CLAMP BOLT & LOCK 82604 \$0.95 ea

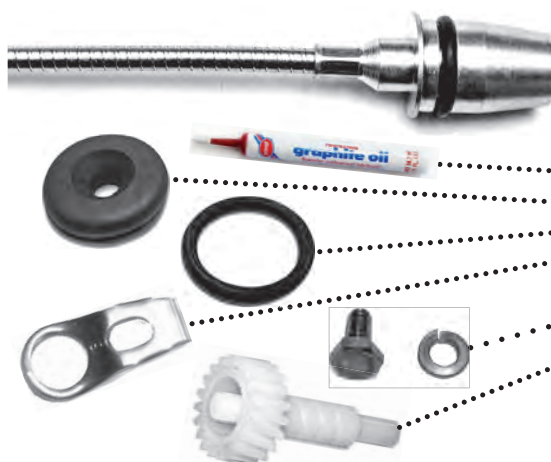

ORIGINAL 3 SPEED MANUAL & AUTOMATIC

- SPEEDO CABLE
Stock 3 speed manual, automatic & overdrive
With both ends & clamp 2600 \$17.95 ea
- Stock 4 speed manual 2602 \$21.50 ea
- SPEEDO CABLE LUBE 2607 \$6.95 tb
- SPEEDO CABLE GROMMET 1617-G \$2.95 ea
- SPEEDO CABLE "O" RING 2604-B \$0.75 ea
- SPEEDO CABLE CLAMP 2605 \$6.90 ea
This clamp is included with our cables, do not order separately
- SPEEDO BOLT & LOCK 82604 \$0.95 ea
- SPEEDO GEARS
- 19 teeth 2603-W19 \$15.00 ea
- 20 teeth (most likely needed) 2603-W20 \$11.95 ea
- 21 teeth 2603-W21 \$15.00 ea
- 22 teeth 2603-W22 \$15.00 ea



CHEVY TRANSMISSIONS

- SPEEDO CABLE 1947-72 69" 2602 \$21.50 ea
- SPEEDO CABLE LUBE 2607 \$6.95 tb
- SPEEDO GEAR, CHEVY 350 2603-C350 **SALE** \$12.50
- SPEEDO CABLE GROMMET 1617-G \$2.90 ea

Examples: Numbers inside () are samples only, Fill in your findings this is just a rule of thumb, trans, tires, etc. effect it.

Truck faster (50 mph) than speedometer (45 mph) Subtract 1 tooth per 5 miles. If current gear is (20) you need 19 teeth
Truck slower (45 mph) than speedometer (50 mph) Add 1 tooth per 5 miles. If current gear is (20) you need 21 teeth



SPEEDO HEAD CONVERTER

Converts an electronic transmission signal to stock mechanical speedo head. Newer transmissions have electronic pulse senders and would need drive gears installed to use cable driven stock style speedo heads. This reads electronic signal and converts it to cable drive, cable then operates stock (or other mechanical) style speedo heads.
Complete ready to install 2609 **SALE** \$339.80





DASH FRAME

Reproduction is very nice, chromed stainless steel, & guaranteed.

- 1956 REPRODUCTION, stainless..... 2610-56SS.....\$59.95 ea
- 1956 CHROME ORIGINAL, exchange, . 2610-56.....\$88.88 ea
\$50 core charge. For best results leave backing can on frame.
- 1953-55, CHROMED ORIGINAL..... 2610-5355.....\$99.00 ea
Working on reproduction hope for spring 2020

DASH FRAME SCREW SET

- 1956 polished stainless 82610-56.....\$2.95 set
- 1953-55, polished stainless 82610-5355.....\$2.95 set



- 53-55 MOUNTING TAB CLIP NUTS 82611-5355.....\$1.50 ea



- 1956 DASH FRAME RUBBER 2611-56.....\$6.00 ea



DASH FRAME GLASS

- 1956 clear..... 2613-56C.....\$14.00 ea
- 1956 smoke..... 2613-56S.....\$14.00 ea
- 1953-55 clear..... 2613-5355C.....\$14.00 ea
- 1953-55 smoke..... 2613-5355S.....\$14.00 ea



GLASS INSULATOR & DUST SEAL

- 1956..... 2614-56.....\$6.50 ea
- 1953-55 2614-5355.....\$2.50 ea



DASH CLUSTER BULB (high beam, turn indicators & dash lighting)

- 12 volt, cluster takes 5 bulbs 2618-12V\$1.50 ea
- 6 volt, cluster takes 5 bulbs 6V-2269\$1.90 ea



REPAIR CONTACT & PIGTAIL 2619.....\$1.50 ea

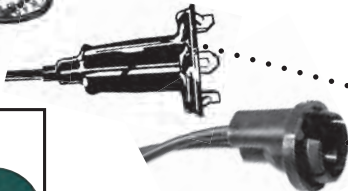

DASH BULB SOCKETS Single wire 2620.....\$2.75 ea

DASH BULB SOCKETS Double wire 2620-2.....\$4.75 ea

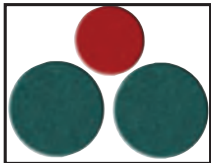

JEWEL SET 2616.....\$10.00 set

Tiny plastic color circles for turn signal and high beam indicator lights, all we could find, same as for t-bird

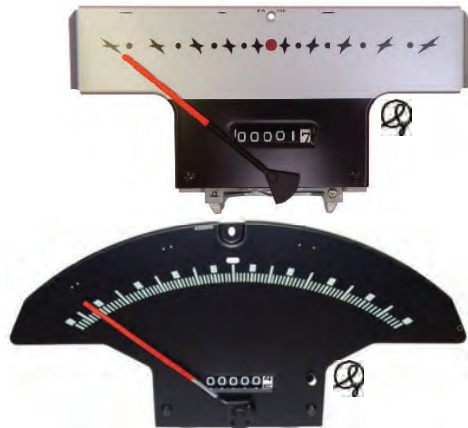

SPEEDO HEAD, reproductions,

There are 2 reproductions on the market of gauges and speedo heads. One is made for Mid Fifty in India and we stand behind it 100% One is made in China and we have experienced some problems with those so far. We offer them both of course as we are dealers for all things 53-56 Truck. Should you have any concerns please give us a call for help.

- 1953-55 Speedo Head 2606-M5355 **SALE**.....\$145.00
- 1956 Speedo Head..... 2606-M56.....\$175.00 ea

ORIGINAL GAUGES, not available new

Were Bi-metal type and require Original style sending units, not listed on this page, listed with individual applications. Sending units are Volt Specific and Must match gauge Ohms.

MID FIFTY REPRODUCTION GAUGES:

Look and Install like original;
made in India exclusively for Mid Fifty. Modern Technology Ohms are 240-33. Have ground posts for electrical ground.

CHINA GAUGES:

Look and Install like original, are Bi-metal & use original style sending units. Dash ground.
Bi-metal type gauges are not as accurate however and Speedos we tested are not working correctly.
We do stock these gauges, but not stocking speedometers until problems are corrected.



• MID FIFTY GAUGES

- Gauges have same modern technology as new aftermarket gauges but look and fit like original. Ohms 240-33
- All gauges, including ours, require matching sending units.
- Gauges and senders are 12 volt, negative ground
- Battery gauges are voltmeters. Ammeters are not advised.
- Fuel senders include adapter kit #1605-ADPT
- Temperature gauge mid point is 160 degrees,
- Oil gauge mid point is 40 PSI.

COMPLETE GAUGE AND SENDER KIT

Includes all Mid Fifty Gauges, matching senders & hardware.
1953-55 set of 4 with senders 92690-5355.....\$269.95 kit
1953-55 set with Speedo Head 92691-5355.....\$399.95 kit
(not shown, does not include speedo cable)

INDIVIDUAL GAUGES 1953-55 (STARS)

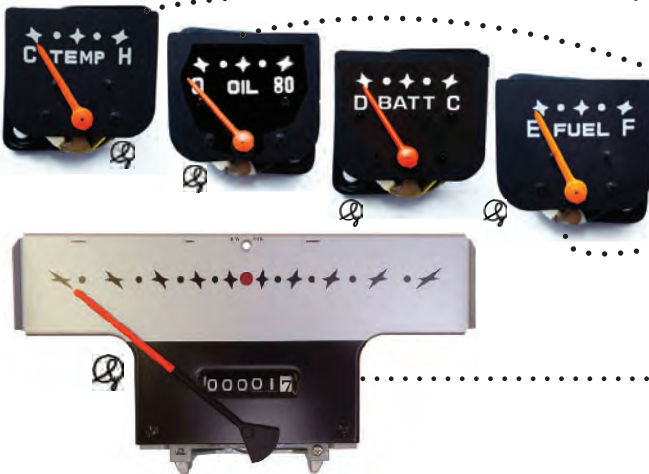

- TEMP GAUGE
Gauge only 2695-5355..... \$55.00 ea
Gauge, & sender kit..... 2692-5355.....\$70.00 kit
- OIL GAUGE
Gauge only 2696-5355..... \$55.00 ea
Gauge & sender 2693-5355.....\$75.00 kit
- BATTERY GAUGE
Gauge only, voltmeter..... 2690-5355..... \$45.00 ea
- FUEL GAUGE
Gauge only 2694-5355..... \$60.00 ea
Gauge, & sender kit..... 2691-5355.....\$95.00 kit

SPEEDOMETER HEAD

1953-55 2606-M5355.... \$175.00 ea
SALE SALE.....\$145.00

Mid Fifty Speedometer head, will not start at .0 as are all tested.
Uses stock type Speedo cables found on page 40.

BI-METAL REPRODUCTION GAUGES, China.

Original ohms, Ford 78-10 1953-55 are 6 Volt.
Bi-metal, use original style sending units. Dash ground.
Temp rests on H, goes to C with power. Battery follows current through 14 gauge Yellow wire going to Headlight switch, B post. Speedos we tested are not quite right. We do stock these gauges, but not stocking speedometers until corrected.
For info or help with this please call.
Senders listed with individual applications.

STOCK STYLE 1953-55 GAUGES (Stars)

53-55 Fuel gauge 2690-R5355 \$75.00 ea
53-55 Battery gauge, ammeter..... 2690-R5355 \$75.00 ea
53-55 Oil gauge 2690-R5355 \$75.00 ea
53-55 Temp gauge..... 2690-R5355 \$75.00 ea

Speedo Head..... 2606-R5355
Call for info at this time.



ORIGINAL GAUGES, not available new

Were Bi-metal type and require Original style sending units, not listed on this page, listed with individual applications. Sending units are Volt Specific and Must match gauge Ohms.

MID FIFTY REPRODUCTION GAUGES:

Look and Install like original;

made in India exclusively for Mid Fifty. Modern Technology Ohms are 240-33. Have ground posts for electrical ground.

CHINA GAUGES:

Look and Install like original, are Bi-metal & use original style sending units. Dash ground.

Bi-metal type gauges are not as accurate however and Speedos we tested are not working correctly.

We do stock these gauges, but not stocking speedometers until problems are corrected.



MID FIFTY GAUGES

- Gauges have same modern technology as new aftermarket gauges but look and fit like original. Ohms 240-33
- All gauges, including ours, require matching sending units.
- Gauges and senders are 12 volt, negative ground
- Battery gauges are voltmeters. Ammeters are not advised.
- Fuel senders include adapter kit #1605-ADPT
- Temperature gauge mid point is 160 degrees,
- Oil gauge mid point is 40 PSI.

COMPLETE GAUGE AND SENDER KIT

1956 set of 4 with senders.....	92690-56.....	\$269.95 kit
..... 1956 set with speedo head.....	92691-56.....	\$399.95 kit

1956 GAUGES (SQUARES)

TEMP GAUGE		
Gauge only	2695-56.....	\$55.00 ea
Gauge & sender kit.....	2692-56.....	\$70.00 kit
OIL GAUGE		
Gauge only	2696-56.....	\$55.00 ea
Gauge & sender kit.....	2693-56.....	\$75.00 kit
BATTERY GAUGE		
Gauge only	2690-56.....	\$45.00 ea
FUEL GAUGE		
Gauge only	2694-56.....	\$60.00 ea
Gauge & sender kit.....	2691-56.....	\$95.00 kit



SPEEDO HEAD

1956.....	2606-M56.....	\$175.00 ea
-----------	---------------	-------------



BI-METAL REPRODUCTION GAUGES, China.

Original ohms, Ford 78-10 1956 are 12 Volt. Bi-metal, use original style sending units. Dash ground. Temp rests on H, goes to C with power. Battery follows current through 14 gauge Yellow wire going to Headlight switch, B post. Speedos we tested are not quite right. We do stock these gauges, but not stocking speedometers until corrected. For info or help with this please call. Senders listed with individual applications.

STOCK STYLE 1956 GAUGES (Squares)

56 Fuel gauge.....	2690-R56.....	\$75.00 ea
56 Battery gauge, ammeter.....	2690-R56.....	\$75.00 ea
56 Oil gauge.....	2690-R56.....	\$75.00 ea
56 Temp gauge.....	2690-R56.....	\$75.00 ea
Speedo Head.....	2606-R5355.....	

Call for info at this time.

WHITE GAUGE & SPEEDO DECAL,

Computer printed vinyl, pre-cut precise fit, install easily over stock gauge faces without removing needles, use stock gauge lighting to change color. Will not wrinkle or bubble in hot or cold temperatures can be removed. instructions

1956.....	D-2615-56.....	\$34.50 ea
-----------	----------------	------------



COLOR DASH BULBS

1953-55 DASH PANELS

2020 Mid Fifty
1953-56 Catalog



USA

CAST ALUMINUM, SATIN FINISH

Leave as is or paint to match dash, fancy gauges pop out & dash disappears. Cast aluminum difficult to polish, not as smooth as billet, for brightest finish see polished billet panels. Mounts in original holes.
3 3/8" speedo.....2622-5355 \$95.00



USA

ABS 5 HOLE 3 3/8" SPEEDO, black ABS plastic, can be painted or left black.2622-A5355 SALE ..\$69.99

DASHES ARE STOCKED POLISHED, Unless specifically listed as SATIN. Pictures are Satin so would show up on paper.



USA

6 GAUGE PANEL, HOLDS A TACH

Small gauges on Outside,

AUTOMETER or MOTORSPORT GAUGES
3 1/8" Polished2641-A6P \$122.50
3 1/8" Satin, Shown2641-A6S \$114.50
VDO GAUGES 3 1/8" Satin.....2646-16 \$112.50
3 1/8" Polished.....2629-PA..... \$135.00



USA

CLASSIC or DOLPHIN GAUGES,

Installed from rear, bezels do not show, 3 piece kit, ← Backing holds gauges recessed behind panel.
3 3/8" Speedo recessed2647-RM \$155.00

Panel only, shown with Red Steeles



USA

Small gauges on Inside, for CLASSIC or DOLPHIN

Gauges installed from front with gauge bezels showing
3 3/8" Polished with ball mills2645-D6 \$122.50
3 3/8" Polished Smooth2645-D6SM \$122.50

Panel only, shown with Red Steeles



USA

.5 GAUGE BILLET ALUMINUM PANELS

For AUTOMETER or MOTORSPORT gauges
3 1/8" Satin finish.....2621-T1 \$112.50
3 1/8" Polished finish2621-T1A..... \$120.00
For CLASSIC or DOLPHIN
3 3/8" gauges2621-D5P \$112.50
For VDO
3 1/8" gauges only, Polished2621-T1P \$109.95
3 3/8" gauges only, Satin2621-T3..... \$112.50
3 3/8" gauges only, Polished2621-T3P \$112.50

USA



EXTRA BALL MILLED GROOVES, SALE

For 3 1/8" Speedo,**SALE**..... 2621-T1EX....**SALE**....\$109.95



USA

Panel only, shown with Old Tyme

Panels are made to fit the listed gauges perfectly but also fit many other brands that are similar. Most are made with 3 1/8" or 3 3/8" speedos.

TWO HOLE PANEL

For AUTOMETER 3 3/8" speedo-tach combo & quad gauge
3 3/8" Polished.....2645-D23 \$122.50

For CLASSIC OR DOLPHIN, 5" speedo and 5" quad gauge,
5" Polished2645-D5 \$120.00



USA

Panel only, shown with Red Steeles

DASH ACCESSORIES SEE NEXT PAGE

POLISHED BOLT KITS, 1953-55

Mounts cast dashes or just to fill original dash mounting holes when using billet aluminum clip in dashes.82622-5355PS ... \$5.90 set



CLIPS FOR BILLET DASHES82623.....\$8.90 kit
These hold the dash in place, and are included with our dashes.



DASHES ARE STOCKED POLISHED, Unless specifically listed as SATIN. Pictures are Satin so would show up on paper.





CAST ALUMINUM, SATIN FINISH

3 1/8" speedo.....2622-56\$89.50 ea
 3 3/8" speedo.....2622-56M\$115.00 ea
*Looks neat painted to match dash, disappears, gauges "pop".
 Good deals on scratch & dent and discontinued cast panels.*



POLISHED PANEL INSTALL BOLT KITS

1956.....82622-56PS\$5.90 set

ABS PANEL, NO holes.....2625-56NH **SALE** \$68.50

With 5 holes.....2625-56WH special order

We have a few sets of 1956 dash panels that are discontinued and-or "scratch & dent". Call for details



2626



2626-BGG



LED INDICATOR LIGHTS

1 Red & 2 Green.....2626\$10.95 set
 1 Blue & 2 Green.....2626-BGG\$11.95 set
 Individual, Red.....2626-R
 Green.....2626-G\$3.95 ea
 Amber.....2626-A\$4.95 ea
 Blue.....2626-B.....\$4.95 ea



ADAPTER RING

Reduces 3 3/8" hole to 3 1/8"2627\$18.50 ea

GAS SENDER ADAPTER KIT, 5 hole aftermarket sender to 6 hole

Original tank bolt pattern.1605-ADPT\$19.50 kit



ELECTRIC SPEEDO SENDER

FORD C4-C6.....2651\$119.50 ea
 GM2652-G\$59.95 ea
*Electric speedos need this & corresponding adapter if Trans mechanical.
 Most Transmissions made after about 1991 are electric.
 Check for wires coming out instead of cable or hole for cable.*



ADAPTER, Original, manual & automatic....2639-STK.....\$144.50 ea

ADAPTER, C4-C6, FMX, Ford.....2639-C4C6.....\$39.50 ea

ADAPTER, GM.....2639-CHVY\$19.00 ea

Chevy trans does not need adapter for most applications.



ELECTRONIC TO MECHANICAL SPEED CONVERTER

*Converts electronic transmission to cable drive for stock and any
 mechanical style speedo head.....2609\$75.00 ea*

AUTO METER GAUGE WIRE KIT3278-AM\$195.50 ea

CLASSIC GAUGE WIRE KIT3278-CG\$75.00 ea



53-55 DASH & GAUGE PANELS, ELECTRICAL

ELECTRIC GAUGE SETS IN POLISHED ALUMINUM DASH

Kits are as shown with Polished Billet Aluminum Dash Insert and pictured gauge set.

CLASSIC KITS include sending units for FORD Engine & Trans, 240-33 ohm fuel *Chevy engines Order 92640-GM.

AUTO METER KITS include sending units for GM Engine and Transmissions. *For Ford engines order 92640-FD

Individual Dash Inserts and Gauge sets are available. MECHANICAL gauges, see next page



92653-E2A \$775.00
CLASSIC INSTRUMENTS
 All American Tradition 5" gauges
ELECTRIC Speedo, Ford senders
 DASH ONLY2645-D5
 GAUGE SET ONLY92642-ATB



92653-E2V..... \$575.00
CLASSIC INSTRUMENTS
 Vintage 5" gauges
ELECTRIC Speedo, Ford senders
 DASH ONLY2645-D5
 GAUGE SET ONLY92642-VB



92653-E2VT \$898.50
CLASSIC INSTRUMENTS
 Vintage 5" gauges & TACH
ELECTRIC Speedo, Ford senders
 DASH ONLY2645-D5
 GAUGE SET ONLY 92642-VBT



92653-E2R \$838.50
CLASSIC INSTRUMENTS
 Red Stealie 5" gauges
ELECTRIC Speedo, Ford senders
 DASH ONLY2645-D5
 GAUGE SET ONLY92642-RT



92653-E2T..... \$565.00
AUTOMETER 3 3/8"
 Old Tyme 3 3/8" gauges
ELECTRIC Speedo, GM senders
 DASH ONLY2645-D23
 GAUGE SET ONLY 92642-ATW



92653-E2TT..... \$645.00
AUTOMETER 3 3/8"
 Old Tyme 3 3/8" gauges & TACH
ELECTRIC Speedo, GM senders
 DASH ONLY2645-D23
 GAUGE SET ONLY 92642-ATWT



92653-E5A \$698.50 kit
AUTOMETER 5 GAUGE SET
 American Muscle
ELECTRIC Speedo, GM Senders
 DASH ONLY 2621-T1AP
 GAUGE SET ONLY 92645-AM



92653-E5R \$788.50
CLASSIC 5 GAUGE SET
 Red Stealie gauges
ELECTRIC Speedo, Ford Senders
 DASH ONLY 2643-D5P
 GAUGE SET ONLY 92645-RS



92653-E5V8..... \$795.95
CLASSIC 5 GAUGE SET
 V8 Speedster gauges
ELECTRIC Speedo, Ford Senders
 DASH ONLY 2643-D5P
 GAUGE SET ONLY92645-V8



92653-E6M..... \$668.50
AUTOMETER 6 GAUGE SET
 Masterpiece Gauges & Tach
ELECTRIC Speedo, Ford senders
 DASH ONLY2641-A6P
 GAUGE SET ONLY 92646-MS



92653-E6C \$998.50
AUTOMETER 6 GAUGE SET
 Cruiser Gauges & Tach
ELECTRIC Speedo, GM senders
 DASH ONLY 2647-RM
 GAUGE SET ONLY 92646-CR



92653-E6AX..... \$829.95
CLASSIC 6 GAUGE SET
 Auto Cross Yellow Gauges & Tach
ELECTRIC Speedo, Ford senders
 DASH ONLY2647-RM
 GAUGE SET ONLY 92646-AY



53-55 DASH & GAUGE PANELS, MECHANICAL

MECHANICAL GAUGE SETS IN POLISHED ALUMINUM DASH

Kits are as shown with Polished Billet Aluminum Dash Panel and pictured gauge set.

CLASSIC KITS include sending units for FORD Engine & Trans, 240-33 ohm fuel *Chevy engines Order 92640-GM.

AUTO METER KITS include sending units for GM Engine and Transmissions. *For Ford engines order 92640-FD

Individual Dash Inserts and Gauge sets are available. **MECHANICAL gauges use SPEEDO CABLE, see page 38**



92653-M5M \$558.50 kit
AUTOMETER 5 GAUGE SET
Masterpiece Gauges
MECHANICAL Speedo, Ford senders
 DASH ONLY 2621-T1AP
 GAUGE SET ONLY 92645-MS



92653-M5TB..... \$425.00 kit
AUTOMETER 5 GAUGE SET
Old Tyme Black Gauges
MECHANICAL Speedo, GM senders
 DASH ONLY 2621-T1AP
 GAUGE SET ONLY92645-ATB

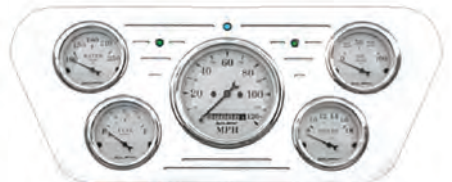

92653-M5TW..... \$425.00 kit
AUTOMETER 5 GAUGE SET
Old Tyme White Gauges
MECHANICAL Speedo, GM senders
 DASH ONLY 2621-T1AP
 GAUGE SET ONLY 92645-ATW

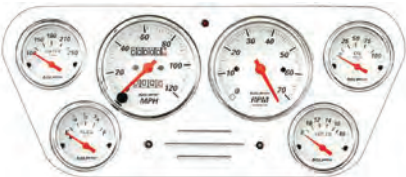

92653-M6AW..... \$549.95 kit
AUTOMETER 6 GAUGE SET
Arctic White
MECHANICAL Speedo, ELECT Tach
 GM senders
 DASH ONLY2641-A6P
 GAUGE SET ONLY92646-AAW



92653-M6TB..... \$545.00 kit
AUTOMETER 6 GAUGE SET
Old Tyme Black Gauges
MECHANICAL Speedo, ELECT Tach
 GM senders
 DASH ONLY2641-A6P
 GAUGE SET ONLY92646-ATB



92653-M6TW..... \$545.00 kit
AUTOMETER 6 GAUGE SET
Old Tyme White Gauges
MECHANICAL Speedo, ELECT Tach
 GM senders
 DASH ONLY2641-A6P
 GAUGE SET ONLY 92646-ATW



LED INDICATOR LIGHTS, Red for Headlight, 2 Green for Turn signals.
 • 3 Piece, 2 green & 1 red2626..... \$10.95 set
 • 3 Piece, 2 green & 1 blue.....2626-BGG \$11.95 set
 • Amber.....2626-A..... \$3.95 ea
 • Blue.....2626-B..... \$4.95 ea



• **AUTO METER WIRE KIT** 3278-AM..... \$164.00 ea
 • **CLASSIC GAUGE WIRE KIT** 3278-CG..... \$75.00 ea



• **GAS SENDER ADAPTER KIT**1605-ADPT.....\$19.50 kit
 5 hole sender to Stock Ford tank

NOTE THESE THINGS WHEN CONTEMPLATING GAUGES:



- ___ GAUGE SIZE, This is actually the speedo size, It will be 3 1/8" or 3 3/8" across the part that goes in the hole
- ___ GAUGE TYPE Mechanical or electric, referring to speedo. Electric costs more but more accurate & easy to change.
- ___ DASH CLUSTER INSERT Dash clusters come with gauge holes for 3 1/8" or 3 3/8" speedos.
- ___ TRANSMISSION Speedo senders do not come with most gauges, cables never come with mechanical gauges.
 Cables sold on page 40 will fit all mechanical speedos sold in this book. For electrical speedo see page 45.
- ___ GAS TANK Gas sending units are included in gauge sets and fit most all under bed and reproduction tanks.
 Aftermarket gas senders will NOT fit stock 1953-55 or 1956 gas tank without adapter, use our #1605-ADPT
 NOT ALL GAUGES WE STOCK ARE SHOWN, DUE TO SPACE



CARBON FIBER



SILVER ALLOY

BLUE



BLACK



RED



WHITE



KILOMETERS AVAILABLE
see website or call.

DIGITAL VHX GAUGES

Fit directly into the stock dash without modification. Fully lit needles, back-lit faces, highly visible LCD message centers set VHX Series apart from yesterday's traditional approach to instrumentation. Plus micro-controlled stepper motors, solid state sensors for accuracy, and user-customizable display feedback, limited lifetime warranty. Features: speedo, tach, water temp, oil pressure, voltmeter, fuel, odometer, trip odometer (2), clock, gear indicator, hour meter, resettable service meter, 0-60 timer, 1/4 mile timer/speed, high speed/rpm recall, turn signals, high beam, park brake, cruise control indication & check engine.

Colors are silver with red or blue, or carbon fiber with red or blue

1953-55 VHX CLUSTER Includes beautiful aluminum frame \$795.00 ea

CARBON FIBER...Blue.....	2685-CFB.....	\$795.00 ea
Red	2685-CFR.....	\$795.00 ea
SILVER ALLOY.....Blue.....	2685-SB	\$795.00 ea
Red	2685-SR	\$795.00 ea
BLACK.....Blue.....	2685-BKB.....	\$795.00 ea
Red	2685-BKR.....	\$795.00 ea
White.....	2685-BKW.....	\$795.00 ea



Stock color



Black



Grey



White



Tan

KILOMETERS AVAILABLE

RETRO DIGITAL GAUGES

BEZEL NOT INCLUDED. LED lighting, LED turn signal indicators, blue LED high beam indicator, molded plastic back housing. Ultimate speedometer and tachometer technology, push button calibration, another time and money saver. USA made. Everything plugs in and connectors are included. Dual layer design features red pointers on all colors to maintain originality. The gauges included are a speedometer, tachometer, fuel, temp, volt, and oil gauges. Our favorite is the stock look. Colors: Stock, black, gray, tan and white

1953-55 RETRO CLUSTER

STOCK Salt & Pepper.....	2680-ST	\$959.95 ea
BLACK.....	2680-BK	\$959.95 ea
GREY	2680-GR.....	\$959.95 ea
WHITE.....	2680-WH.....	\$959.95 ea
TAN	2680-TN	\$959.95 ea



SMOOTH DIGITAL DASH

Comes with all sending units except fuel. See bottom of page. For original frames *Ready to install in your original Frame.*

1953-55, Blue DD-2600-5355..... \$629.00 kit

Senders for Dakota Digital dashes

Note most digitals will read almost any most aftermarket sender.
Fuel sender..... 2697

This is the simplest and cheapest one if you do not have a sending unit that works, stock Ford units do not work.
Sender will need adapter 1605-ADPT if using original gas tank.



UNIVERSAL ROUND GAUGES

Also available with black trim rings, fit most our aluminum dash inserts with 3 3/8" speedo holes.

3 3/8" speedo 6 gauge set..... DD-2606-3..... \$695.00 set
3 3/8" speedo 5 gauge set..... DD-2605-3..... \$595.00 set





1956 VHX



CARBON FIBER



SILVER ALLOY

BLACK



BLUE



RED



WHITE



KILOMETERS AVAILABLE

1956 HDX CLUSTER

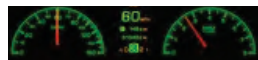
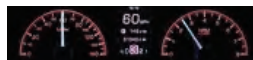

Couple examples of Illumination colors, White, Blue, Emerald, Pink, Red, Aqua, Yellow.

KILOMETERS AVAILABLE

RETRO ELECTRONIC GAUGES



DIGITAL GAUGES

Fit directly into the stock dash without modification. Fully lit needles, back-lit faces, highly visible LCD message centers set VHX Series apart from yesterday's traditional approach to instrumentation. Plus micro-controlled stepper motors, solid state sensors for accuracy, and user-customizable display feedback, limited lifetime warranty. Features: speedo, tach, water temp, oil pressure, voltmeter, fuel, odometer, trip odometer (2), clock, gear indicator, hour meter, resettable service meter, 0-60 timer, 1/4 mile timer/speed, high speed/rpm recall, turn signals, high beam, park brake, cruise control indication & check engine.

1956 VHX CLUSTER

Includes beautiful aluminum frame

CARBON FIBER...	Blue.....	2686-CFB.....	\$795.00 ea
	Red	2686-CFR.....	\$795.00 ea
SILVER ALLOY.....	Blue.....	2686-SB	\$795.00 ea
	Red	2686-SR	\$795.00 ea
	White.....	2686-SW	\$795.00 ea
BLACK.....	Blue.....	2686-BKB.....	\$795.00 ea
	Red	2686-BKR.....	\$795.00 ea
	White.....	2686-BKW.....	\$795.00 ea

USA

1956 HDX CLUSTER

HDX system allows selection of independent illumination colors for gauge readings, needles & message centers. Illumination colors include, White, Emerald, Red, Pink, Blue, Aqua, Yellow. Cluster is Black or White without illumination.

SILVER ALLOY HDX	2687-56XS	\$1295.00 ea
BLACK ALLOY HDX.....	2687-56XB	\$1295.00 ea

Senders for Dakota Digital dashes

Note that most digitals will read most aftermarket sending units. Fuel sender.....2697 \$38.00 ea
This is the simplest and cheapest one if you do not have a sending unit that works, stock Ford units do not work. Sender will need adapter 1605-ADPT if using original gas tank.

RETRO ELECTRONIC GAUGES

1956 Frame not included. LED lighting, LED turn signal indicators, blue LED high beam indicator, molded plastic back housing. Ultimate speedometer and tachometer technology, push button calibration, another time and money saver. Everything plugs in and connectors are included. Dual layer design features red pointers on all colors to maintain originality. The gauges included are a speedometer, tachometer, fuel, temp, volt, and oil gauges.

1956 RETRO CLUSTER

STOCK Salt & Pepper.....	2680-ST	\$959.95 ea
BLACK.....	2680-BK	\$959.95 ea
GREY	2680-GR.....	\$959.95 ea
WHITE.....	2680-WH.....	\$959.95 ea
TAN	2680-TN	\$959.95 ea

SMOOTH DIGITAL DASH

Comes with all sending units except fuel. For original frames Ready to install in your original Frame. 1956.....DD-2600-56.....\$659.00 kit

USA



NOTE THESE THINGS WHEN CONTEMPLATING GAUGES:



- ___ GAUGE SIZE, This is actually the speedo size, It will be 3 1/8" or 3 3/8" across the part that goes in the hole
 - ___ GAUGE TYPE Mechanical or electric, referring to speedo. Electric costs more but more accurate & easy to change.
 - ___ DASH CLUSTER INSERT Dash clusters come with gauge holes for 3 1/8" or 3 3/8" speedos.
 - ___ TRANSMISSION Speedo senders do not come with most gauges, cables never come with mechanical gauges.
Cables sold on page 40 will fit all mechanical speedos sold in this book. For electrical speedo senders see below.
 - ___ GAS TANK Gas sending units are included in gauge sets and fit most all under bed and reproduction tanks.
Aftermarket gas senders will NOT fit stock 1953-55 or 1956 gas tank without adapter, use our #1605-ADPT
- NOT ALL GAUGES WE STOCK ARE SHOWN, DUE TO SPACE



Be sure to check what ohm your gauges need. Gauges we sell come with sending units unless noted otherwise. Sold here for replacements or those that bought gauges elsewhere and discovered senders were not included.

TEMPERATURE SENDERS

240-30 ohm	2698	\$18.00 kit
10-180 ohm (VDO)	2659-180	\$25.00 ea
10-90 ohm (Dolphin).....	2659-90	\$28.50 ea
Adapters, 1/4, 3/8 & 1/2.....	82698-ALL.....	\$5.75 set
Sender for original old stock gauges	2940	\$58.00 ea



OIL SENDERS, Stock

Stock Ford Engines, 1942-1955	2658-4853	\$39.95 ea
240-30 ohm, 80 psi.....	2699	\$37.50 ea
0-90 ohm	2699-90	\$24.95 ea
240-30 ohm, 100 psi	2699-100	\$44.50 kit

GAS SENDER ADAPTER PLATE & GASKET, 5 hole aftermarket sender to 6 hole Original tank bolt pattern.....

1605-ADPT.....	\$19.50 kit
----------------	-------------



GAS SENDERS, AFTERMARKET

Empty-0, Full-30 ohms (GM pre 65)	1608-30	\$50.00 ea
E-0, F-90 ohms (GM after 65)	1608-90	\$37.50 ea
E-0, F-180 VDO.....	1608-180	\$62.95 ea
E-78, F-10 ohms (Ford pre 87) (Chrysler).....	1605	\$64.80 ea
E-240, F-33 ohms (aftermarket gauges)	2697	\$38.00 ea

OVERDRIVE PARTS



Overdrive Emblem.....	1211	\$25.00 ea
-----------------------	------------	------------



Overdrive book, Borg-warner	B-11176	\$16.50 ea
-----------------------------------	---------------	------------



Overdrive kick-down switch	2913	\$24.95 ea
Overdrive switch wire ends kit.....	82913	\$1.50 kit



Overdrive relay	0820	SALE \$149.50
Overdrive relay 6 Volt	0820-6V.....	\$150.00 ea



Overdrive wiring (use with start button).....	3276-OD	\$42.95 ea
---	---------------	------------



Overdrive cable, with Chrome handle	2913-CH	\$50.00 ea
Overdrive cable Handle Knob only	2913-H.....	\$19.99 ea



Overdrive cable grommet	1011-G.....	\$4.95 ea
-------------------------------	-------------	-----------



Overdrive solenoid.....	0822	\$399.80 ea
Overdrive solenoid, 6 Volt.....	0822-6V.....	\$399.80 ea



Overdrive solenoid oil seal	0823	\$12.00 ea
-----------------------------------	------------	------------





CUSTOM 21 CIRCUIT KIT

Easy to install, adapts to most steering columns, ignition key locations, or charging systems.

These kits use GXL 125 high temp cross linked polyethylene jacketed wire that is grease, oil, gas, and acid resistant. Each wire is labeled every 5" Its entire length so checking a circuit is easy!

Radio, coil, dome light, backup/cruise, horn, cigarette lighter, fuel pump, ac/heat, radio, turn signal, accessories, wiper, gauges, hazard, fan, power window, power door locks, brake, headlights

EZ WIRE, Color wires..... 3260-EZC \$234.00 kit



CUSTOM BUILT RON FRANCIS KITS

Built by Ron Francis Wire Works to Mid Fifty specs. Unique serial number and any modifications, engine changes and the like can be ordered custom made ready to fit. In rare case of trouble, a simple phone call can usually detect, and fix problem. 23 fused circuit panel and color coded wires with matching color instructions. Connects directly to stock switches so dash looks original, but behind dash and under hood, well, lets just say thats the only thing that is original.

Some neat Mid Fifty features are: wiring for built in anti-theft systems, choice of power accessories (window, radio) operating with ignition on or off. Front park lights will operate alone or with headlights like original. Front park lights are also turn signals in this and in all our other harnesses for safety, even though it was not original. Harnesses are set up for after-market steering columns (like Ididit).

Each kit includes: wiring for engine (note choices) alternator, distributor, neutral safety switch, starter, coil, stock ignition switch, turn signals, horn button, 4 way flashes, dimmer, headlights, tail lights, parking lights, third brake light provision just in case, horns, wiper, radio, all gauges and sending units, (note different gauge wiring choices). Accepts electronic fuel injection harness.

Ford engine, with one wire alternator

Harness kit.....3250-F \$498.80 kit

Ford engine w/ externally regulated alternator & electronic regulators

Harness kit.....3251-F \$509.80 kit

Add electronic ford regulator3252-FR \$40.00 kit

Chevy engine, with standard gauge wiring and one wire alternator

Harness kit.....3255-C..... \$499.80 set

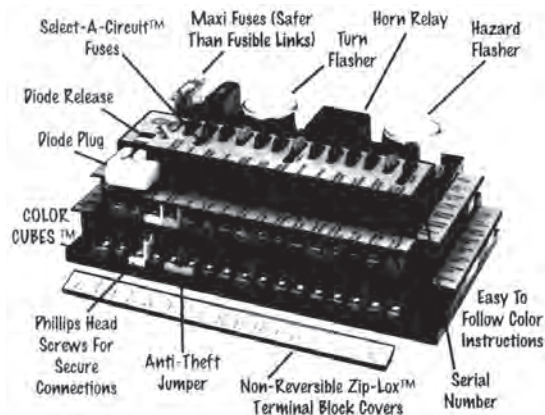

Quick connect dash wiring

Add to any kit, allows disconnecting the entire instrument cluster at a single location, VERY NICE

For VDO gauges.....3259-7 \$79.95 ea

For other gauges3259-5 \$79.95 ea



GROUND
Engine to Frame to body

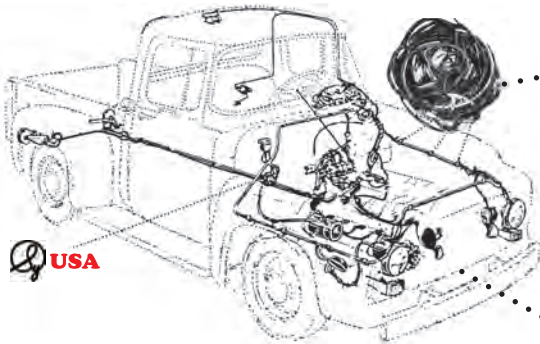

USA

ORIGINAL STYLE WIRING HARNESS

•EASY INSTALL!! Includes all main body wiring, instrument cluster wiring for stock gauges (also works with most aftermarket gauges), dash light sockets, temp sender wire, gas sender wire, oil sender wire, battery gauge wire, grille crossover harness, including headlights, park lights and turn signals, generator to regulator wiring, horn, tail light harness from turn signal pigtail to tail lights including master cylinder wiring and both brake and turn signals with crossover wiring. Can be modified for late model engines, alternator, etc. add socket kit below, not included because tail lights and park lights have sockets & pigtails installed. For a 1956 with late model engine, use alternator connection kit #3271 shown below

1953-56.....3200\$325.00 ea



NEW USA

ALTERNATOR WIRING HARNESS, FORD With External Regulator

For Voltmeter or Warning light.....3270-FX..... \$27.52 ea
For Ammeter.....3270-FXA \$22.50 ea

•GM, ONE or TWO WIRE Alternator With DA Plug, For FORD truck with Original ignition & headlight switch 3271 \$55.00 kit

•DA PLUG Use with alternator & stock ignition switch to eliminate engine run-on after switch is off 3269.....\$13.50 ea



USA

•LIGHT SOCKETS & CONNECTORS KIT.....93203 \$49.95 kit

Includes 2 headlight sockets with pigtails & grommets, 4 sockets & pigtails that fit park lights & tail lights and accept double filament bulbs for turn signals front & rear and 4 double connector ends.



BEST BUY

NEW USA

DYI FORD COLORS HARNESS, USA BEST BUY, EASY INSTALL, EXTRA LONG WIRES

Flexible mounting and routing. Extra heavy gauge and long enough to hide wiring. Follows Ford colors, detailed instructions. 24 circuit panel, with 2 extra, 22 pre-wired, fuses included. Connections for turn signal, emergency flasher, horn relay & 2 fusible links. Fuse block & relay/flasher connectors are configurable & expandable and can be mounted almost anywhere. Cut wires to length and terminate with terminals is provided.

COMPLETE3202 **SALE** \$299.00

LIGHT SOCKETS & CONNECTORS KIT.....93203..... \$49.95 kit

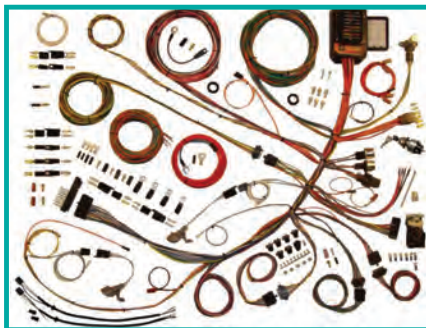

USA

CUSTOM HARNESS WITH SWITCHES

Custom kit, includes original ignition switch with retainer & bezel, aftermarket headlight switch. Wiper & heater switches not included.

1953-563264 \$679.00 ea



ORIGINAL STYLE EVERYTHING KIT

Includes harness for most alternators & regulators including GM, stock and late model engines, most gauges, including originals, replacements and after-market, includes sockets & pigtails, park lights, tail lights and headlights. Plugs in, no end crimping. Does not include switches or fuses, uses stock switches.

1953-55, Import3263 \$499.00 ea

1956, Import3263-5660\$575.00 ea



THIS PAGE IS FOR 6 VOLT TRUCKS ONLY, IF YOU ARE LOOKING AT 6 VOLT AND ARE UNDECIDED, ANSWER THIS QUESTION:

Are you striving for exact, or as close to exact of original as possible? NO? Then don't even mess with 6v, go 12v. All 1953, 1954 and 1955 trucks were originally 6 volt, positive ground. The following pieces are cloth bound, proper color, correct wire size and include instructions.

6 VOLT TO 12 VOLT SYSTEMS. Changing to 12 volt will require a 12 volt generator or alternator (alternator is best choice). The bulbs need changed to 12 volt. Stock gauges, 6v heater motor and 6v wiper motors will work with an electronic voltage reducer. 6v starter will run a little fast and maybe not last as long so may not be worth changing. Battery, solenoid, & coil need updated.

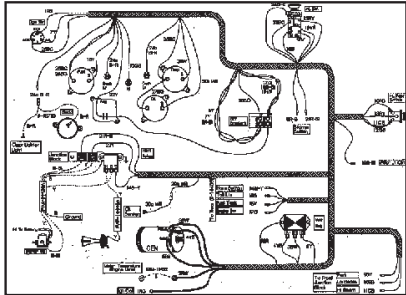

USA



USA

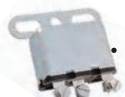
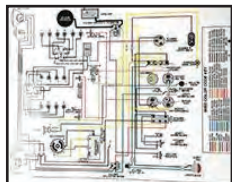

DASH/COWL WIRING		
1953, 6 cylinder	6V-14401-FAL	\$299.95 ea
1953, 8 cylinder	6V-14401-FAK	\$339.95 ea
1954, 8 cylinder	6V-14401-FDE	\$315.00 ea
1955, 6 cylinder	6V-14401-E	\$385.00 ea
1955, 8 cylinder	6V-14401-B5C	\$399.50 ea

RETRO HARNESS	6V-3200	\$299.95 kit
1953 COIL TO DISTRIBUTOR	6V-14302-7RA	\$5.50 ea

GENERATOR TO REGULATOR WIRING		
1953-54, 6 cylinder	6V-14305-FAJ	\$18.50 ea
1954, 8 cylinder	6V-14305-FDE	\$21.95 ea
1955, 8 cylinder	6V-14305-FDM	\$19.95 ea

HEADLIGHT CROSSOVER WIRING, Stock	6V-13006-BTZ	\$45.95 ea
WITH PARK LIGHTS, AND HORN WIRES	6V-3207	\$39.52 ea

HEADLIGHT SOCKET & PIGTAIL	6V-2235	\$28.95 ea
---	---------------	------------

53-54 HORN RELAY TO HORN	6V-14440-FA	\$19.00 ea
1955 HORN RELAY TO HORN	6V-14440-B5C	\$17.50 ea

53-54 SOLENOID TO JUNCTION BOX	6V-14439-FAA	\$49.50 ea
TAIL LIGHT CROSS OVER WIRES	6V-14405-B5C	\$85.50 ea

<i>Harness comes from steering column with both brake lights</i>		
CONNECTOR Needed for 6V ends		
4-way	3205	\$8.50 pr
Single	3205-1	\$2.25 pr

NEUTRAL SAFETY SWITCH WIRES		
54-55	6V-14476-FDE	\$32.00 ea

6V TEMP SENDER, single post	6V-2941	\$58.50 ea
6V TEMP SENDER, double post	6V-2942-2	\$54.00 ea

FLAT HEAD TEMP X-OVER WIRE, 53-54	6V-14432-7RA	\$8.75 ea
---	--------------------	-----------

RADIATOR FAN 6V 16" SuperFlo	6V-5031	\$99.00 ea
---	---------------	------------

6V CIGAR LIGHTER	6V-1003	\$27.00 ea
6V FLASHER	6V-2920	\$9.50 ea

SCHEMATIC Color, 11 x 17, laminated, close up of tiny piece shown.		
Order year (1953-4) (1955) or (1956)	B-3203 (yr)	\$15.50 ea

6 VOLT BULBS		
Tail or park light with turn signals	6V-2260	\$1.95 ea
Park light, no turn signals	6V-2269	\$1.50 ea
Dome light	6V-2269	\$1.50 ea
Dash cluster	6V-2618	\$1.90 ea

ELECTRONIC VOLTAGE REDUCERS		
For single gauges, one per gauge	3222	\$15.95 ea
For multiple gauges up to 1.5 Amps	3223	\$68.50 ea
For motors, heater & wiper	3223-4	\$85.00 ea

VOLTAGE REDUCER, CERAMIC, 4 Amp	3220	\$17.00 ea
6 Amp	3221	\$35.50 ea

6 VOLT HEADLIGHT RELAY	6V-3268	\$34.50 ea
6 VOLT ALTERNATOR	6V-3266	\$275.00 ea
6 VOLT HORN RELAY	6V-3229	\$18.25 ea
6 VOLT STARTER SOLENOID	6V-3225	\$22.50 ea



- HARNESS FIREWALL GROMMET 3210 \$3.95 ea
- HARNESS FIREWALL CLIP
 - Stock..... 3211 \$9.95 set
 - Chrome..... 3211-CH \$18.00 set

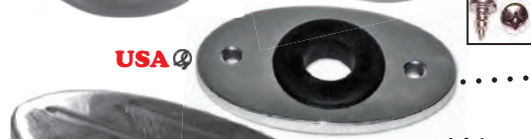

- HARNESS CLIP BOLTS
 - Stock..... 83211-Z \$0.75 pr
 - Polished stainless..... 83211-PS \$1.95 pr



- FIREWALL GROMMET & TRIM 3211-T \$29.95 ea
Polished aluminum oval trim and grommet, with polished button head bolts, fits flush with firewall
- FIREWALL HOLE COVER, OVAL 3211-V \$49.95 ea
Polished aluminum oval cover, hidden bolts thread into back using stock holes, wires exit straight down



- WIRE CLIP FOR INNER FENDER, one..... 3212 \$3.65 ea
Made correctly
- WIRING FRAME CLIPS *Set of 10* 83214 \$4.00 set



- HEADLIGHT PIGTAIL..... 2235 \$19.95 ea
- GROMMET 2234 \$1.95 ea
Do not order with pigtail, Included on our pigtails



- WIRING GROMMETS, REPLACEMENTS *Use in various places*
 - Goes in hole size 5/8" 2321-M \$2.50 pr
 - Goes in hole size 3/4" all grille holes HAG-4428 \$1.25 ea
 - Goes in hole size 7/8" HAG-4432 \$1.25 ea
 - Goes in hole size 1 1/16" air deflector hole 2320-L \$2.50 pr



- WIRING GROMMET, EXACT OF ORIGINAL *Vinyl covered steel*
 - Goes in 11/16" hole, larger one 2233 \$3.95 ea
Fits all 4 grille holes and rear panel truck doors
 - Goes in 25/32" hole, smaller one..... 2233-S \$3.95 ea
Fits air deflector & panel truck body driver side



- WIRE RETAINER, on column, Chrome..... 2919-CH \$12.90 ea
- Black 2919-BL \$4.85 ea

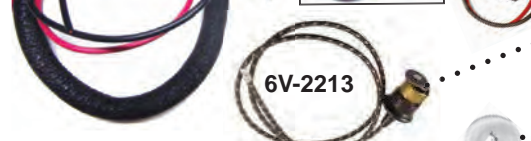

- DOUBLE FILAMENT SOCKETS, for use with Turn Signals.
 - Socket & pigtail, 18 Gauge 2213 \$4.95 ea
 - Socket & pigtail, 12 or 6 Volt, heavy duty 2213-16 \$15.00 ea
Best choice, made at Mid Fifty, sealed, 25" long
 - Socket & pigtail, sealed end to end 2213-MD \$16.95 ea



- DOUBLE CONNECTOR *For 2 wire pigtail*..... 82215 \$1.99 ea
- SINGLE WIRE Park socket & wire 6-12V 6V-2213-1 \$16.95 ea



- BULBS, 12V
 - Dash cluster..... 2618-12V \$1.50 ea
 - Dome light bulb..... 2269 \$1.25 ea
 - Clear double filament for turn signals 2260 \$1.00 ea
 - Clear high power for turn signals..... 2262-HPC \$3.50 ea
 - Amber for turn signals 2261-AMB \$2.95 ea
 - Amber high power for turn signals..... 2263-HPA \$8.75 ea
 - Quartz halogen for turn signals 2267 \$7.99 ea
 - LED, High Power..... White 2265-W \$9.50 ea
 - Amber 2265-A \$9.50 ea
 - Red 2265-R \$9.50 ea
 - 6 Volt double filament (with turn signal)..... 6V-2260 \$1.95 ea



- WIRE CONNECTORS *Packs of 5, order by letter, all for 18 gauge wire*
A-B-C-D-E-F-G 83216-(choice) ... \$1.75 set



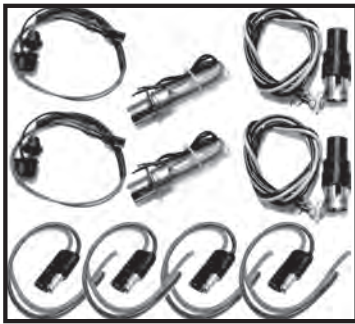

WIRING HARNESS EXTRAS

LIGHT SOCKETS & CONNECTORS KIT ... 93203..... \$49.95 kit
Includes 2 headlight sockets with pigtails & grommets, 4 sockets & pigtails that fit park lights & tail lights and accept double filament bulbs for turn signals front & rear and 4 double connector ends.



• WIRING HARNESS CLIP, back of Cluster..... 3214-D\$5.75 ea



ALTERNATOR WIRING HARNESS,

• FORD With External Regulator
For Voltmeter or Warning light 3270-FX \$27.52 ea
For Ammeter..... 3270-FXA.....\$22.50 ea

• DA PLUG Use with alternator & stock ignition switch to eliminate engine run-on after switch is off 3269.....\$13.50 ea

• GM, ONE or TWO WIRE Alternator With DA Plug, For FORD truck with Original ignition & headlight switch 3271 \$55.00 kit



• ALTERNATOR BRACKET, Y BLOCK..... 4350-B\$114.80 ea

GROUND Engine-Frame-body, Scrape into paint & ground again.

**GROUND EVERYTHING
GROUND IT AGAIN!!!!**

GROUND STRAP *Paint does not ground, go to bare metal!!*

Use at least three of these, battery to block, body to block, frame to block

• WITH ROUND END BOTH ENDS

Both round ends, 8"..... 3224-08.....\$12.50 ea

Both round ends, 12"..... 3224-12.....\$14.50 ea

Both round ends, 18"..... 3224-18.....\$16.50 ea

• WITH BATTERY TERMINAL END,

order by length goes from battery to frame.

6.5" 3224-B06\$17.50 ea

9" 3224-B09\$17.50 ea

13" 3224-B13\$17.50 ea

16.5" 3224-B16\$17.50 ea

19.5" 3224-B19\$17.50 ea

• GROUNDING TERMINAL STRIP..... 3224-TS.....\$33.50 ea

Absolute must for fiberglass front ends, roll and gravel pans and fiberglass cabs, or just to be sure.



• WIRE LOOM INSTALLING TOOL, Neat little gadget runs wires

Inside of wire loom tubing..... 83222.....\$9.95 ea

• WIRE LOOM SPLIT TUBING, 10 foot roll (40 & 50 foot rolls available)

1/4 INCH.....83220-1/4 \$4.95 rl

3/8 INCH.....83220-3/8 \$4.95 rl

1/2 INCH.....83220-1/2 \$4.95 rl

3/4 INCH.....83220-3/4 \$5.95 rl



DASH LIGHT SOCKETS

• SINGLE WIRE SOCKET2620-2\$4.75 ea

• DOUBLE WIRE SOCKET.....2620\$2.75 ea

• Dash socket repair contact and wire..... 2619.....\$1.50 ea

BATTERY BOX

2020 Mid Fifty
1953-56 Catalog

NEW!

1956
SHOWN



BATTERY TRAYS For newer common batteries

With top & studs. Die stamped fits in original spot holds common (10 1/2" x 7") group 24, 34, 65, or Optima battery. This is the best one, best buy, fits, Sy's design, made in USA.

NOW IN BLACK POWDER COATED

1953-55 with top & J bolts.....0112-5355PC\$96.50 ea

1956 with top & J bolts0112-56PC\$96.50 ea

Installation bolts, stainless hex head.....80112-SX\$6.00 kit

Installation bolts, polished ss button.....80112-PB\$12.00 kit

PLAIN STEEL

1953-55 with top & J bolt.....0112-5355\$83.50 ea

1956 with top & J bolt0112-56\$85.00 ea

Installation bolts, stainless hex head.....80112-SX\$6.00 kit

Installation bolts, polished ss button.....80112-PB\$12.00 kit

1953-55
SHOWN



J-HOOK STUD WITH WING NUT0124\$4.25 ea

Correct flat J, includes Wing nut. see close up end.

J-HOOK, round shallow J..universal.....0124-568... **sale \$1.85 ea.**



BATTERY TOP & HOLD DOWN KIT90123\$28.50 kit

REPLACEMENT TOP.....0123\$16.50 ea

Wing nut80124\$0.95 ea

Hold down kit0124-HD.....\$3.85 kit

J-hook stud with wing nut0124\$4.25 ea

BILLET ALUMINUM.....0105-TP\$116.50 ea



ORIGINAL STYLE TRAYS BELOW. Caution, note diminsions, as Original battery trays are not compatable with most modern batteries.

53-55 ORIGINAL SIDE TO SIDE POST

Top only, hold down, without tray, USA...0107-SPT\$27.50 ea

Battery tray, no top, China.....0107-5355\$64.45 ea

1956 FOR ORIGINAL LONG BATTERIES

Order ONLY IF EXACT of original, and have long thin battery

Battery tray, no top, China.....0108-56.....\$69.95 ea

Top for long battery.....0108-56T\$23.00 ea

1953-55



1956



1956



DROP DOWN BATTERY BOX, HINGED

Does not separate into two pieces, very nice set up, spring loaded hinge and self locking, drops down for easy access.

Stainless, group 24 batteries.....0122-HBS.....\$140.00 ea

Black, group 24 batteries.....0122-HNG.....\$125.00 ea

Install bolts, polished80125-PB\$11.50 ea

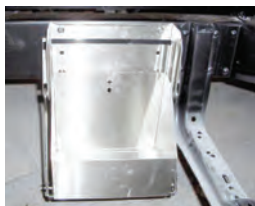

installed and dropped down



BATTERY BOX

1-800-252-1956
Direct 928-565-2763

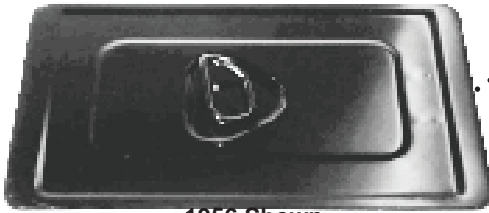

1956 Shown

BATTERY FLOOR HOLE LID

- 1953-55 lid with handle, 13.25" Long 0117-5355 \$46.50 ea
- 1956 lid with handle 15.50" Long 0117-56 \$44.95 ea



1956



1953-55

BATTERY LID GASKET

- 1956 lid gasket (9 1/4 x 15 1/2) 0115-56 \$10.50 ea
- 1953-55 lid gasket (9 1/4 x 13 3/16) 0116-5355 \$10.50 ea



USA



BATTERY SPLASH SHIELD

Original rubber seal was stapled on, causing a potential rust area. Paint panel before installing rubber seal regardless of how installed

- SPLASH SHIELD, plain steel 0118 \$24.00 ea
- Splash shield, polished stainless 0120-PLSS \$35.00 ea
- Shield bolts, stainless hex 80118-SS \$4.00 kit
- Shield bolts, polished stainless button 80118-PB \$5.90 kit
- RUBBER SEAL 0114 \$3.50 ea
- *Retaining clips 80114 \$1.00 set

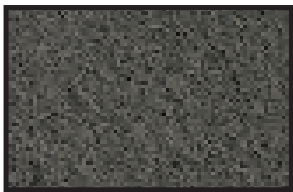

USA



SALE

- BATTERY MAT, Black 0114-BM \$7.95 ea
- POST CORROSION ARRESTERS 0113-CA SALE \$1.95

GROUND Engine-Frame-body, Then ground it again.

GROUND STRAP Paint does not ground, go to bare metal!!

Use three of these, battery to block, body to block, frame to block

WITH 2 ROUND ENDS

- Both round ends, 8" 3224-08 \$12.50 ea
- Both round ends, 12" 3224-12 \$14.50 ea
- Both round ends, 18" 3224-18 \$16.50 ea

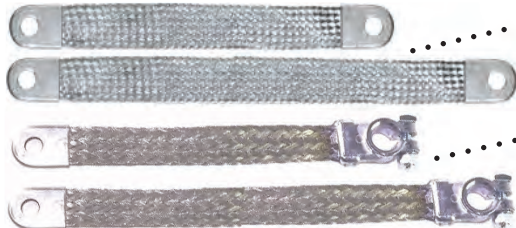

WITH BATTERY TERMINAL END,

order by length goes from battery to frame.

- 6.5" 3224-B06 \$17.50 ea
- 9" 3224-B09 \$17.50 ea
- 13" 3224-B13 \$17.50 ea
- 16.5" 3224-B16 \$17.50 ea
- 19.5" 3224-B19 \$17.50 ea



GROUNDING TERMINAL STRIP 3224-TS... \$33.50 ea

Absolute must for fiberglass front ends, roll and gravel pans and fiberglass cabs, or just to be sure.

GROUND EVERYTHING
battery to frame, body to block,
body to Frame, Frame to block



1953-55

BATTERY GAUGES

**Original gauge is an AMMETER it feels the "flow" going through 14 gauge Yellow wire that loops through back hoops.

- 1953-55 Original reproduction, Ammeter 2690-5355B \$75.00 ea



1956



**Mid Fifty Original Looking Gauges are VOLTMETERS which measure the actual Voltage being produced. Voltmeters are more accurate and a better measure of what your electrical system is actually doing.

- 1953-55 Original Face, Voltmeter 2690-5355 \$45.00 ea
- 1956 Original Face, Voltmeter 2690-56 \$45.00 ea



BATTERY DISCONNECT SWITCHES

- 350A, plastic 3228-3 \$12.50 ea
- 250A, metal 3228-2 \$25.00 ea

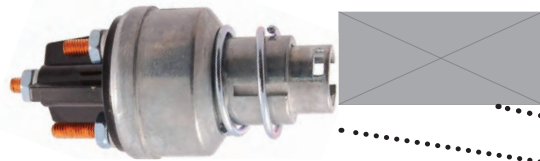

IGNITION SWITCH

1953 will need a new bezel and hole may need enlarged. Assemble like this, Switch, Spring, Retainer, Dash, Bezel. Original bezel had no lettering.

- Complete kit.....92904 \$54.50 kit
Includes switch, retainer, bezel, key cylinder, keys and instructions
- Switch.....2904 \$17.95 ea
- Switch retainer.....2905 \$9.80 ea
- Bezel.....1033 \$7.95 ea
- Switch wire ends kit.....82904 \$2.50 kit
Wire connectors, switch nuts & wiring instructions



IGNITION KEYS

- Keys.....1138..... \$3.55 ea
- Key cylinder and keys.....2906 \$18.50 ea
This set is included in some door lock sets see page 104

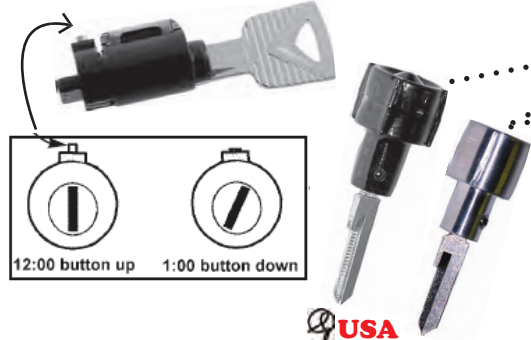

- Knob key, stock knob.....1009 \$10.00 ea
- Knob key, aluminum satin knob.....1009-AB \$18.00 ea
- Knob key, aluminum polished knob.....1009-AP \$16.00 ea
Key goes in knob, pop it in the ignition and it looks like just another knob. Neat! Blank key or we can cut to match existing keys

INSTALLATION: Check small spring in center of angled slot in bottom of key way. Make sure it is not sideways. Adjust slot slightly if necessary insert key cylinder, push in and turn key from 1 o'clock position to 12 o'clock. Button should pop up into hole in top of switch. Remove key.
REMOVAL: Turn key to 1 o'clock position and push button down. Key should lock in that position, pull complete cylinder out.



STARTER BUTTON

Starter button can also be used with 12 volt switch above is a good momentary deterrent for unknowing would be thieves.

- 12 volt 2 terminals, negative ground.....2907 \$17.50 ea
- 6 volt, chrome, positive ground.....2907-PG \$8.50 ea
- Wire ends kit.....82907 \$1.00 kit

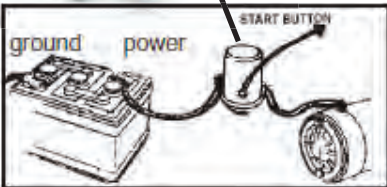

- STARTER SOLENOID 12 volt 3225 \$13.50 ea
- STARTER AND SOLENOID KIT 12 volt ... 92907 \$45.00 kit

- IGNITION RESISTOR 3227-F \$9.00 ea
Firewall mount, keeps coil from overheating at low RPM by limiting voltage at coil, but still allows enough voltage at coil at high RPM

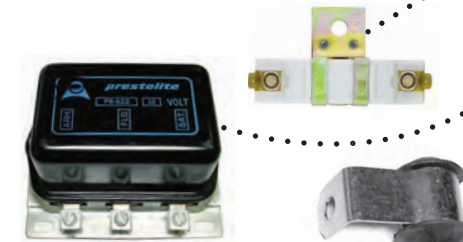

VOLTAGE REGULATORS

- 12 volt.....3219 **SALE** \$65.50
- 6 volt.....6V-3219..... \$59.95 ea

STARTER, BATTERY CABLE BRACKET & GROMMET

- Bracket & grommet set (zinc plate)3215 \$10.00 ea
- Zinc bracket only3217 \$8.85 ea
- Grommet only3216 \$3.50 ea
- Hardware, bolt & acorn for firewall83215-F \$2.50 set
- Polished screw for inner fender.....83215-I \$1.00 ea
Bolt and acorn can also be used on inner fender, enlarge hole slightly.



IGNITION COIL

- Chrome.....3280 \$24.00 ea
- Bracket3280-BRK..... \$5.00 ea

- FORD SCRIPT COIL, 6 V, Steel3280-F6 \$64.50 set
- 12 V, Polished Stainless3280-FP..... \$76.50 set



Headlights are getting Fancy and Cool, not to mention much better night vision!

Some combine Running and-or Turn Signals. Few things to keep in mind when changing headlights in our Trucks.

- 1...Turn Signals. Original was NO Turn Signals or Running Lights in front, Park lights only.
- 2...Turn Signals. Combined Headlight & Turn Signals require Color (Amber usually)
- 3...Headlights with White accents are used for Running Lights only, The accent part is on during the day.
- 4...Power, Most all High Power headlights need a "boost". Relays are needed get the best illumination and color.
- 5...All headlights shown in this book are 7".

We do not offer some styles as they do not set straight or correctly in a Ford truck bucket and ring assembly.

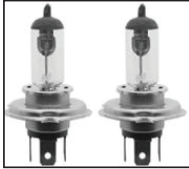

2264

HEADLIGHT BULBS

Sold each, one bulb. There are so many new bulbs on the market, many do not fit truck just right because of thickness of bulb edge and depth of retainer ring, some are a little off center, etc. If having trouble installing check how bulb sits in retainer and that nothing hits bucket edges.



2268

•H4 bulb, push-in, white, Pair.....2264.....\$15.00 pr
Replacement bulbs, these are sold in pairs, fit all halogens below.

•Halogen, stock look, flat face.....2268.....\$21.80 ea



2268-E

•Halogen, euro style, smooth crystal face.....2268-E.....\$39.50 ea



•Halogen, with SIDE LED lights, amber.....2268-AA.....\$59.50 ea

•Halogen, with SIDE LED lights, white.....2268-AW.....\$59.50 ea

Side lights can be used as turn signals or running lights.



2268-TS

2268-AA

•Halogen, with BOTTOM LED light, amber.....2268-TS.....\$36.80 ea
Use LED's as blinkers or running lights.



2268-LA

•Halogen, with LED accent, blue.....2268-LA.....\$32.50 ea



2268-L58A

•Light with center LED amber accent.....2268-L58A.....\$154.50 ea
Light bar can be used as Running Light, Turn Signal or accent.



2268-L55C

Halogen, with LED accent lights, Replaceable LED's in 6 colors
Comes in Black or Chrome

••• Chrome.....2268-L55C.....2268-L55C

••• Black.....2268-L53B.....\$278.50 ea



2268-L53B

HEADLIGHT RELAY

Gives the headlights power from the battery instead of from the switch

12 volt relay3268.....\$29.95 ea



6 VOLT BULBS

••6 VOLT standard stock bulb.....6V-2268.....\$19.50 ea

••6 VOLT, Halogen, 7" Bulb with insert.....6V-2268-H.....\$16.95 ea



HEADLIGHT

2020 Mid Fifty
1953-56 Catalog

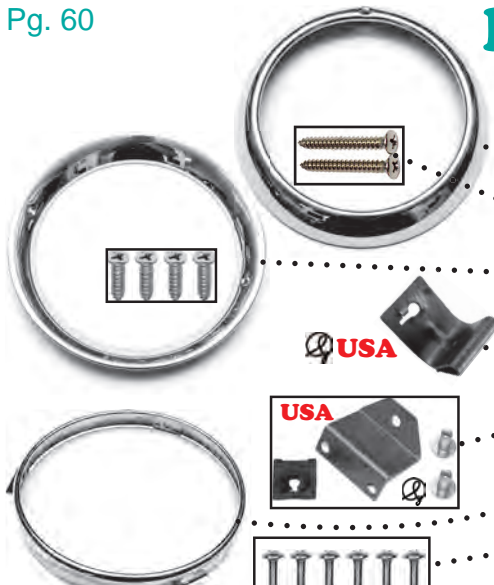

HEADLIGHT DOOR RING, POLISHED STAINLESS

1953-55 outer headlight rings on the market are a bit too small, can be forced on sometimes but then impossible to remove, If you are having this problem, its not your truck, the darn things just don't work. Ours fit!!!!

- 1953-55 door ring (outty)2237-4855\$25.00 ea
- 1953-55 screw set82237-5355\$1.25 pr
- 1956 door ring (inny)2237-56\$27.50 ea
- 1956 screw set82237-56\$2.00 set
- 1956 DOOR RING GRILLE CLIP, 4 per truck82238..... \$6.85 ea
Fits 1956, holds outer trim to grille, fits on grille
Set of 4, SAVE \$\$82238-4\$24.50 set
- 1953-55 DOOR RING TAB, with rivets82239-5355\$5.50 ea
Fits 1948-53, holds outer trim on.

HEADLIGHT RETAINER RING

- Plain stainless.....2236.....\$12.00 ea
- Hardware kit, stainless, for both sides.....82236-SS.....\$2.90 set
- Hardware kit, zinc, for both sides82236-Z\$2.00 set



**KIT IS
BEST BUY**

HEADLIGHT INSTALL KIT

Includes: 2 polished stainless outer trim rings & screws, 2 polished retainer rings & screws, 2 gaskets, 1 bucket to grille installation kit, 2 socket pigtails with grommet, 4 retaining springs & 4 adjusting screws.

- 1953 -55 all stainless.....92237-5355\$125.00 kit
- 1956 all stainless.....92237-56\$125.00 kit

HEADLIGHT BUCKET

- 1953-55 bucket.....2230-4855\$75.95 ea
- 1956 bucket.....2230-56M\$84.95 ea
- Bucket to grill hardware, stainless, does both82230.....\$4.50 kit



GASKET

-2239.....\$7.90 pr
- Used adjusting retainer collarU-13041\$20.00 ea

- ADJUSTING SCREW, use 2 per bucket.....82231.....\$1.25 ea
- ADJUSTING NUT & KEEPER, with rivet82232.....\$1.50 ea
- RETAINER SPRING, use 2 per bucket2232.....\$1.95 ea
Each bucket needs 2 springs, 2 adjusting screws & 2 keepers.

HEADLIGHT WIRING

- Headlight socket & pigtail2235.....\$19.95 ea
Includes light socket, pigtail, end connector and installed grommet.
- Headlight pigtail grommet, included above.....2234.....\$1.95 ea
- Crossover harness
Wiring from fender across grille for headlights & park lights with turn signals, plugs into headlight and park light pigtails..
- 12 volt (Heavy wire will work for 6V).....3207.....\$32.00 ea



HEADLIGHT WIRING GROMMETS

- 11/16" grommets are used in the grille uses 4, and air deflector used 1 each side. The smaller one, 25/32" is used in the small air deflector holes. Reproduction grommets are vinyl coated metal like original.
- Reproduction, 11/16"2233.....\$3.95 ea
 - Reproduction, 25/32"2233-S\$3.95 ea
 - Replacements, 11/16".....2320-L\$2.50 pr
 - Replacements, 25/32"2321-M\$2.50 pr

- HEADLIGHT VISORS2238.....\$15.95 pr
- HEADLIGHT HALF MOON SHIELDS2231..... **SALE**\$7.95
- HEADLIGHT CAT EYE SHIELDS.....2230.....\$15.00 pr



HEADLIGHT

1-800-252-1956
Direct 928-565-2763

12 VOLT HEADLIGHT SWITCH, 1953-56

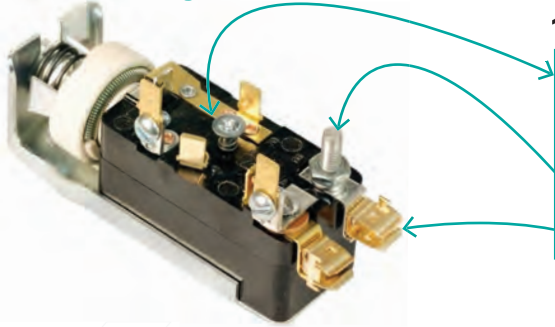

To remove Knob, Push button mid-switch, turn knob while pulling, gently. Some bad switches are out there that do not hold knob shaft in. Watch also for knob shaft that is very pointed, grind off very tip, it will interfere with spring. Not if you bought here!! Allen tests EVERY SWITCH.
 ALL power goes through headlight switch post B.
 Fuse is for dome light. Internal circuits protect entire wiring harness.

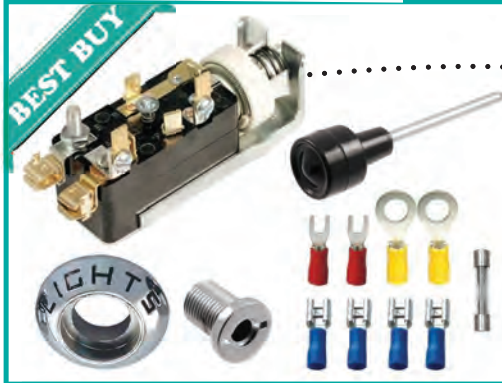

COMPLETE KIT,

12V HEADLIGHT SWITCH KIT	92901.....	\$71.00 kit
SWITCH.....	2901.....	\$44.50 ea
Fuse for switch	82903.....	\$2.00 pr
Wire connector ends and instructions	82901.....	\$3.90 kit
BEZEL.....	1031.....	\$7.95 ea
SWITCH INNER SCREW.....	2902.....	\$7.00 ea
SWITCH KNOB & SHAFT.....	1001.....	\$8.80 ea

We carry lots of fancy new headlight bulbs.
See page 59.

6 VOLT HEADLIGHT SWITCHES

Trucks going from 6 volt to 12 volt will need a new bezel, 12-v knob, and 12-v inner screw, and the original dash hole will need slightly enlarged

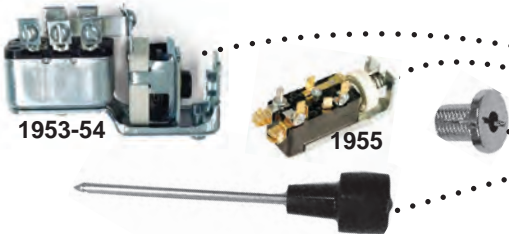

• 53-54 6 Volt switch, uses 6 volt knob	2901-5154	\$45.00 ea
• 1955 6 Volt switch, uses 12 volt knob.....	6V-2901-55	\$79.50 ea
• Matching inner screw.....	6V-2902	\$6.90 ea
• 6 Volt Knob Shaft is 3" long.....	6V-1001	\$7.50 ea

DIMMER SWITCH

• SWITCH, 6 or 12 volt.....	2914	\$15.85 ea
• Switch to plate bolts.....	82915	\$1.00 set

SWITCH WIRE ENDS KIT,

• for stock screw terminals.....	82914	\$2.00 kit
• for spade terminals.....	82914-PF	\$2.00 set



• SWITCH COVER, Black Rubber.....	2914-RC	\$4.50 ea
• Chrome and Rubber.....	2914-SR	\$27.50 ea

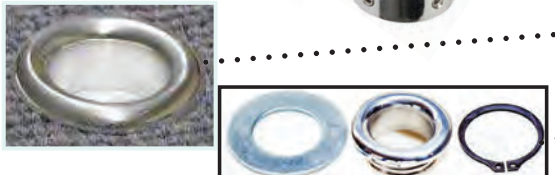

• SWITCH TRIM, Aluminum, Satin	4664-DAS	\$24.50 ea
• Polished.....	4664-DAP	
• Black.....	4664-DAB	\$28.50 ea

DIMMER SWITCH FLOOR PLATE

• FLOOR PLATE for switch.....	2914-FP.....	\$15.00 ea
• FLOOR DELETE PLATE, for No floor switch ...	2914-FPD	\$10.00 ea
Floor plate screws	82912.....	\$0.95 set
• Hole plug, if not using switch.....	82911	\$0.55 ea



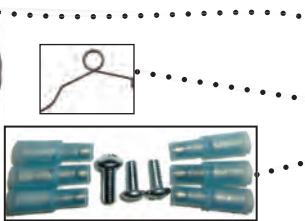

TURN SIGNAL SWITCH

- Internal switch, for stock column, 12 Volt ... 2916.....\$73.95 ea
- Repair Spring..... 2918-SP.....\$7.80 ea
- Turn signal switch install kit 82916..... \$2.25 kit
Wire connectors, switch screws, handle screw & instructions.

USA



- TURN SIGNAL CANCEL CLIP** 2918.....\$9.75 ea
Installation, turn wheel upside down, with spokes at 10, 2 & 6 o'clock (should be a small X on 6 o'clock spoke) place the clip like a "C"

SWITCH WIRING RETAINER,

- Painted black, use 2 2919-BL.....\$3.95 ea
- Chrome, use 2 2919-CH.....\$12.90 ea

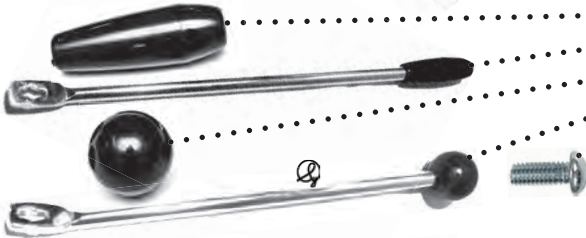

TURN SIGNAL HANDLE

- Spear style knob (56) knob only 1007-56.....\$5.95 ea
- Chrome with spear knob..... 2917-56C.....\$17.50 ea
- Ball knob, 53-55..... 1007.....\$5.50 ea
- Chrome with round knob 2917-CH.....\$17.50 ea
- Handle attaching screw 82917.....\$0.50 ea

ADD ON TURN SIGNAL UNITS

Clamps to steering column.

- LIGHTED CHROME,**
green light on handle 2916-A.....\$25.00 ea
- HEAVY DUTY,** with 4 way flasher..... 2915-HD.....\$29.50 ea

FLASHER UNIT

- 12 volt 2920.....\$8.00 ea
- Flasher for LED bulbs 2921-S2\$10.95 ea
Use if running LED in both tail and park lights
- Or with sequential tail lights 2921-S2\$10.95 ea
- Flasher with hazards, 3 prong 2921-3.....\$15.00 ea
- 6 volt 6V-2920\$9.50 ea
- Flasher clip 2922-CLP.....\$7.85 ea
- FLASHER CLIP, Original Rectangular**..... 2922-A.....\$14.00 ea

WIRING

- Headlight crossover harness, with turn signals. goes across grille
Heavy wire will carry 6 or 12 volt 3207.....\$32.00 ea
Wiring from fender across grille for headlights & park lights with turn signals, plugs into headlight and park light pigtail.
- Tail light harness 3208.....\$40.00 ea
- Tail light harness for long bed 3208-LB.....\$45.00 ea
From main harness back to tail light pigtail, includes stop switch (red wires, does not matter which is which) and turn signal connections.
- Light socket & pigtail, use double filament bulbs to add turn signals
- 1953-55 park light, single filament 2213.....\$4.95 ea
- Park Light and Tail Light 2213-MD\$16.95 ea
- Double connectors 82215.....\$1.99 ea

BULBS

- Clear double filament 2260.....\$1.00 ea
- Clear high power 2262-HPC.....\$3.50 ea
- Amber 2261-AMB.....\$2.95 ea
- Amber high power 2263-HPA.....\$8.75 ea
- Quartz halogen 2267.....\$7.99 ea
- 6 volt double filament 6V-2260\$1.95 ea

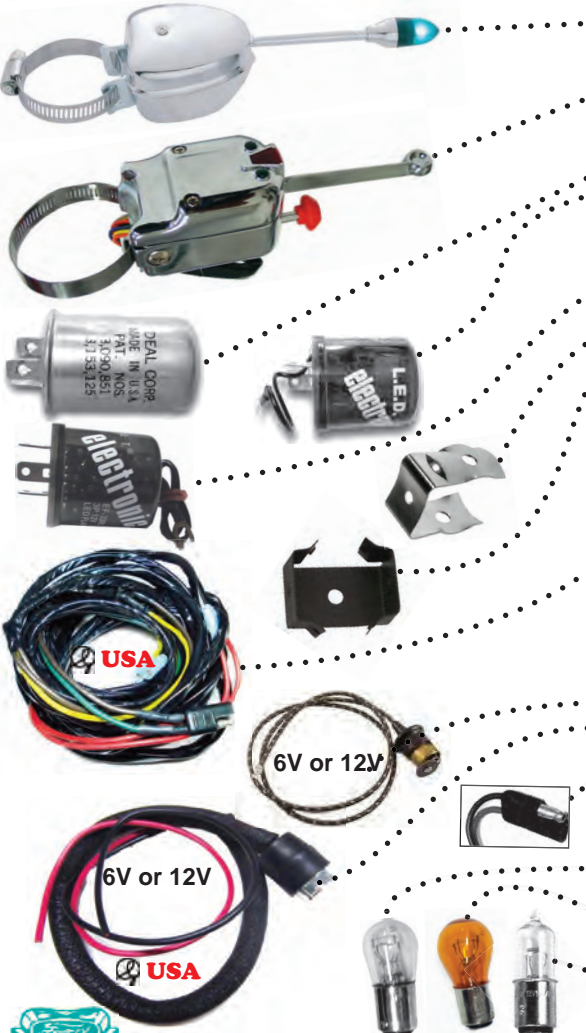

Original park lights were clear with clear bulbs and no turn signals, our wiring includes turn signals. 1955 & 56 park light bases will interchange by drilling new holes. Match with grille, and gravel pan for best results, lights must be grounded on fiberglass pans



PARK LIGHT ASSEMBLIES

Complete with base, lens, frame and wiring. All are 12v with double filament bulbs for park & turn signals. If 6-volt please specify 6 volt with or without turn signals. Does not come with mounting bolts, see below.

1953-54 with polished frame	2240-5354PS	\$44.80 ea
1955 with correct polished frame.....	2240-55PS	\$49.50 ea
1956 with polished frame.....	2240-56PS	\$48.95 ea
1953-54 with painted frame.....	2240-5354CM	\$39.80 ea
1956 with painted frame	2240-56CM	\$40.00 ea
1956 with painted frame, amber lens	2240-56ACM	\$43.00 ea
With amber lens, 1953-54	2243-5354A.....	\$50.00 ea
With amber lens, 1955.....	2243-55A.....	\$50.00 ea
With amber lens, 1956.....	2243-56A.....	\$50.00 ea
With high power bulbs	Add.....	\$5.00 ea

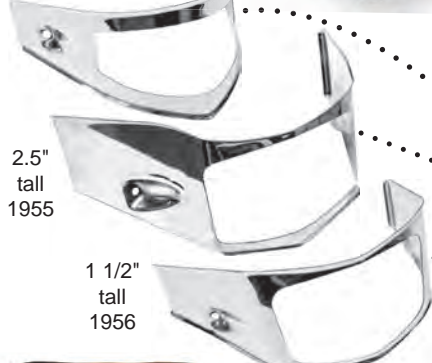

PARK LIGHT FRAMES

Polished stainless 1953-54.....	2241-5354PS	\$20.00 ea
Polished stainless 1955.....	2241-55PS	\$20.00 ea
Polished stainless 1956.....	2241-56PS	\$24.50 ea
Painted cream 1953-4	2241-5354PNT.....	\$15.00 ea
Painted cream 1956	2241-56PNT	\$15.00 ea
Park light frame screws, does both	82241	\$2.90 set
Frame trim	2248	\$6.88 pr

Does both top and bottom of one light or just one side of both lights



PARK LIGHT BASE Includes socket & wiring pigtail for turn signals.

1953-54, not shown.....	2242-5354	\$29.00 ea
1955, shown	2242-55	\$29.00 ea
1956, not shown, widest hole pattern	2242-56	\$29.00 ea

Park light base mounting screw, both lights

Steel gravel pan.....	82242	\$1.50 set
Fiberglass gravel pan	82243	\$2.00 set

PARK LIGHT SOCKET & PIGTAIL 12 Volt, for double filament bulb.

original was single filament, to add turn signals change to double.

1953-54 and 55	2213	\$4.95 ea
12 or 6 Volt, double filament socket.....	2213-16	\$15.00 ea
Double connector	82215	\$1.99 ea

BULBS, 12V, see also previous page, these are for turn

Clear single filament, original	2269	\$1.25 ea
Amber single filament.....	2269-AMB	\$3.95 pr
Clear double filament, for turn signals	2260	\$1.00 ea
Clear high power, for turn signals.....	2262-HPC SALE	\$2.75
Amber, for turn signals.....	2261-AMB	\$2.95 ea
Amber, high power for turn signals.....	2263-HPA.....	\$8.75 ea
Quartz halogen, for turn signals	2267	\$7.99 ea
6 Volt double filament, for turn signals.....	6V-2260.....	\$1.95 ea

Note if using LED bulbs in both tail lights and park lights you will need LED Flasher..... see previous page for flasher

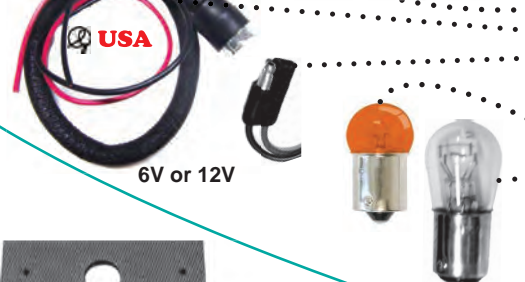

PARK LIGHT GASKET

1953-54 both lights.....	2246-5354	\$5.95 pr
1955-56 both lights	2246-5556	\$5.75 pr

PARK LIGHT LENS Original was clear but amber looks nice.

Clear 1953 & 54.....	2244-5354	\$9.50 ea
Clear 1955 & 56.....	2244-5556	\$9.95 ea
Amber 1953 & 54.....	2245-5354	\$8.00 ea
Amber 1955 & 56.....	2245-5556	\$10.00 ea

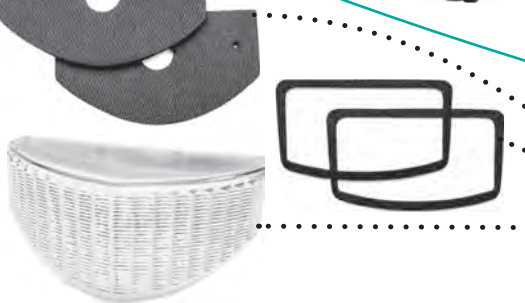

PEDESTAL TURN SIGNAL & BRAKE LIGHTS

Amber Front, Red Back. Super bright 24 LED bulbs Chrome housing,
One Light with LED Bulbs

2249.....	\$32.50 ea	
Standard blinking turn will work for Fender or Cab mount.		
SEQUENTIAL TURN PATTERN, Pair	2249-ARS	\$98.95 pr
Sequential pattern for Fender only as goes right & left.		



TAIL LIGHT

2020 Mid Fifty
1953-56 Catalog

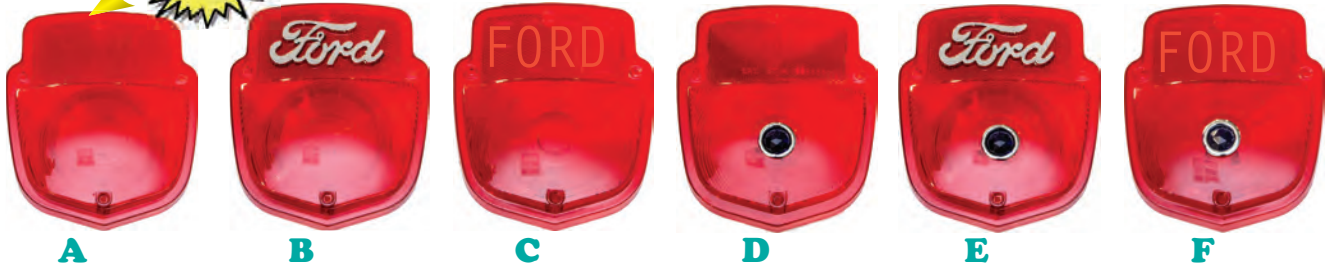

TAIL LIGHT LENS Choices

A.) Plain lens	2209 ..	SALE	\$5.00
B.) Script.....	2208		\$14.95 ea
C.) Ford block.....	2207		\$10.00 ea
D.) Blue dot.....	2210		\$12.75 ea
E.) Script & dot	2211		\$18.00 ea
F.) Ford block & dot	2207-D		\$16.00 ea



• LED LENS,	2209-LED	\$47.50 ea
with License lens	2209-CMB.....	\$57.50 set
• LED FLASHER, 3 prong-for hazards.....	2921-3.....	\$15.00 ea

NEW

One of Sy's Favorite Things!!

LED SEQUENTIAL LENS

- Switch on back of lens changes blinking
Right or Left or Standard (not sequential)
- No license lens..... 2209-SL
- With License lens

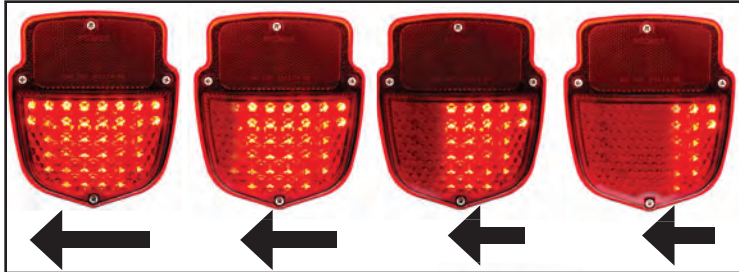

• LED SEQUENTIAL FLASHER, Includes polarity.	2921-S2	\$10.95 ea
--	---------------	------------

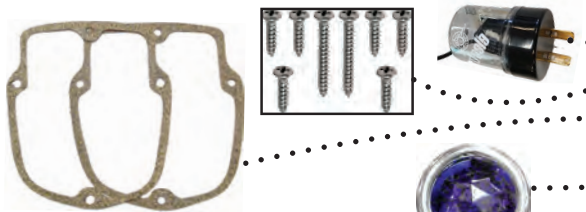

• LENS SCREWS, Black, does 2 lens	82207	\$1.50 set
• LENS SCREWS, Polished, does 2 lens	82208	\$4.50 set
• LENS GASKET	2212	\$5.75 pr

LENS ADD-ONS

• Glass blue dots, 2 w/chrome rings	2217-GL.....	\$10.00 set
• Ford script emblem, studs on back.....	2220	\$7.50 ea
• Ford script emblem, stick on.....	2220-A.....	\$8.00 ea



TAIL LIGHT BODY ASSEMBLY

No lens, includes: body, socket & pigtail, license light lens if necessary.

• Black, solid	2200-BL	\$20.00 ea
• Black with license light.....	2201-BL	\$21.50 ea
• Chrome, solid	2200-CH.....	\$34.50 ea
• Chrome, with license light.....	2201-CH.....	\$30.00 ea
• Polished stainless, solid	2200-PS	\$34.50 ea
• Polished stainless, with license light.....	2201-PS	\$32.80 ea



LICENSE LIGHT

• Gasket	2218	\$2.00 ea
• License light lens	2219	\$5.00 ea
• Clips and screws	82219	\$2.50 set

BULBS, 12V

Clear double filament.....	2260	\$1.00 ea
Clear high power	2262-HPC	\$3.50 ea



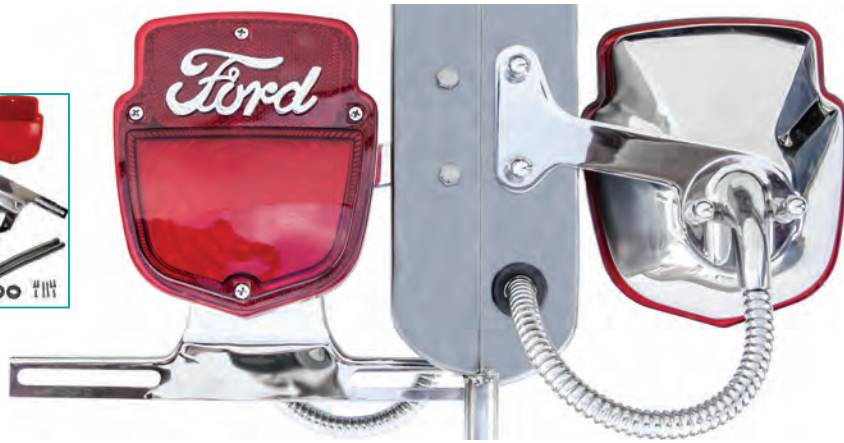

Kits Include:

- Lens (unless noted)
- Ford script emblem
- Lens gaskets
- Mounting brackets
- Socket & pigtails
- Double connectors
- Socket shields
- Flex wire covers
- Wire grommets
- Polished hardware

POLISHED STAINLESS AWESOME ASSEMBLIES

- Plain lens with script
- No license light92200-PS..... \$155.00 pr
 - With license light.....92202-PS..... \$159.95 pr
 - With lens, script & blue dot
 - No license light92201-PBD \$165.00 pr
 - With license light.....92202-PBD \$185.00 pr
 - With LED lens and script
 - No license light92209-PLED \$237.75 kit
 - With license light.....92208-PLED \$257.75 pr

CHROME AWESOME ASSEMBLIES

- No license light92200-CH \$145.00 pr
- With license light.....92202-CH \$169.00 pr
- No license light, LED92209-CLED..... \$235.55 pr
- With license light, LED.....92208-CLED..... \$237.75 pr

BLACK AWESOME ASSEMBLIES

- No license light92200-BL \$105.00 pr
- With license light.....92202-BL \$115.00 pr

ADD-ONS

- Add blue dots to both lightsADD-BD..... \$16.00 pr



ULTIMATE AWESOME ASSEMBLY
With
HIDE A WIRE BRACKETS
And **LED LIGHTS**

Ultimate Awesome
assembly on truck



ULTIMATE AWESOME ASSEMBLY TAIL LIGHTS
INCLUDES: HIDE-A-WIRE BRACKETS, 2 polished stainless lights, 2 LED lens with chrome script & all hardware

- No license light** (2 solid lights).....92212..... \$327.75 pr
 - 1 With license light & 1 solid**.....92213..... \$357.75 pr
- Includes license plate bracket & hardware



SEQUENTIAL AWESOME ASSEMBLY

INCLUDES: HIDE-A-WIRE BRACKETS, 2 polished stainless lights, 2 LED lens with chrome script & all hardware

- No license light** (2 solid lights).....92219 \$267.50 kit
 - 1 With license light & 1 solid**.....92218..... \$297.50 kit
- Includes license plate bracket & hardware

- **SEQUENTIAL CONVERSION KIT**.....92209-S..... \$145.95 ea
- 1 with License lens, 1 without, Sequential controller



NEW

TAIL LIGHT SOCKET SHIELD

- Polished stainless..... 2215..... \$9.50 ea
- Black..... 2215-BL \$8.00 ea

- **BRAKE PULSATER** 2922..... \$15.00 ea
- 300 pulses per minute. Simple, goes in brake light wire, use standard or LED bulbs, no additional power.
- Added safety!!



ROUND TAIL LIGHTS

2020 Mid Fifty
1953-56 Catalog



1953-54 STYLE ROUND TAIL LIGHTS

- 1953-54, sometimes 55 as well. Often was only on driver side. Correct Plastic lens
- Black solid body..... 2200-5354.....\$34.50 ea
 - With License Lens, Right..... 2201-5354.....\$34.50 ea

PLASTIC ROUND TAIL LIGHT LENS, Correct for 1953-54

- Plastic round lens..... 2203.....\$5.95 ea
- Plastic lens with Script..... 2203-5354FD..\$10.95 ea
- Lens gasket..... 2203-GSK.....\$2.95 ea
- Lens screws, polished stainless..... 82206-PS.....\$2.50 set
- License Light Gasket..... 2218-RG.....\$2.00 ea



1933-52 STYLE ROUND TAIL LIGHTS

Original for 1948-52,

Shown here as some 53-56 builders like them.

COMPLETE LIGHT WITH STAINLESS TRIM

With **GLASS** Lens, USA made, 6 Volt double filament bulbs.

- Polished Stainless, Solid..... 2200-APRU.....\$32.95 ea
- Polished with license light..... 2200-APLU.....\$31.80 ea
- Black, Solid..... 2200-ABRU.....\$34.95 ea
- Black, with license light..... 2200-ABLU.....\$32.50 ea
- 12 Volt double filament bulb.....

With **LED** Lens, 12 Volt, Import, may need LED Flasher

- Polished with license light & LED's.... 2200-APLD.....\$65.00 ea
- Polished Solid with LED's..... 2200-APRD.....\$60.00 ea
- Black, solid with LED's..... 2200-ABRD.....\$60.00 ea
- Black, with license light & LED's..... 2200-ABLD.....\$65.00 ea

ROUND TAIL LIGHT BODY

Includes pigtail, NO lens, order 6V or 12V bulbs separately

- Black, no license lens..... 2204-B.....\$24.00 ea
- Black, with license lens..... 2204-BLT.....\$25.00 ea
- Polished stainless, no license lens..... 2204-PS.....\$28.00 ea
- Polished stainless, with license lens.... 2204-BLT.....\$29.00 ea

LENS CHOICES

LED LIGHTS PLASTIC ROUND LENS

Lens is plastic, but uses same retainer as glass lens

- Lens, LED..... 2203-LED.....\$32.50 ea
- Lens, LED with license light..... 2203-RW.....\$38.50 ea

SMOKE, New smoke lens, comes with license lens only, but can be removed to use on a solid body..... 2203-RSL.....\$49.95 ea

GLASS ROUND TAIL LIGHT LENS, Original for pre 53

Plain Glass is dark, consider high power bulbs or better yet, LEDs.

- Lens, glass..... 2203-GLS.... **SALE**..... \$4.50
- Lens, glass, with blue dot..... 2203-RD.....\$17.00 ea
- Lens gasket..... 2203-GSK.....\$2.95 ea
- Lens retainer, polished stainless..... 2203-SR.... **SALE**..... \$8.50
- Lens, retainer, & gasket set..... 92203.... **SALE**..... \$19.50
- CHROME LENS GRILLE COVER..... 2203-CH.....\$19.95 ea
- Blue dots, glass, with chrome rings..... 2217-GL.....\$10.00 set
- High power bulb..... 2262-HPC.... **SALE**..... \$2.75



ROUND TAIL LIGHTS

1-800-252-1956
Direct 928-565-2763

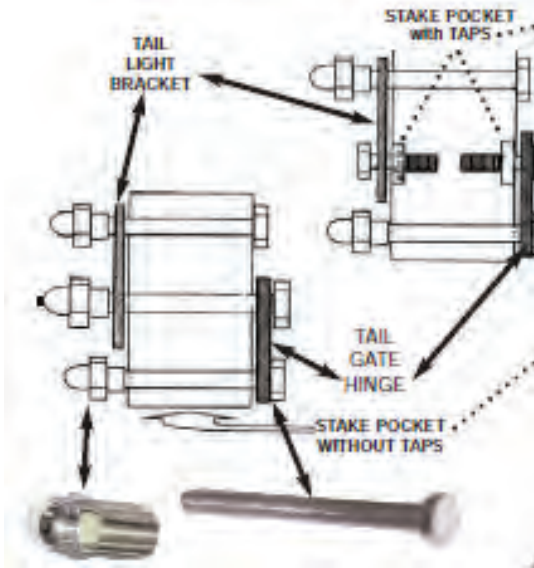

MOUNTING BOLTS

Tail light brackets are mounted behind the post on the top two bolts, one goes through top of gate hinge. License plate is actually partially hidden by the bumper in the original location. All kits to both sides

BOLTS FOR BEDS THAT HAVE TAPS

- Both tail light and gate hinge
 - Polished hex head with acorn.....80242-PX.....\$16.75 kit
 - Polished button with acorn80242-PB.....\$18.50 kit
- Light only or hinge only
 - Polished hex with acorns.....80246-PX.....\$10.00 kit
 - Polished button with acorn80246-PB.....\$12.00 kit
 - Plain zinc plate with hex nuts80246-Z.....\$4.00 kit

BOLTS FOR BEDS THAT DO NOT HAVE TAPS

- Both tail light and gate hinge
 - Polished hex head with acorn.....80243-PX.....\$19.25 kit
 - Polished button with acorn80243-PB.....\$19.25 kit
- Light only or gate hinge only
 - Polished hex head with acorns.....80245-PX.....\$12.85 kit
 - Polished button with acorns.....80245-PB.....\$14.50 kit

DEEP ACORN NUTS (4)82203.....\$7.25 set
Chrome, covers threads on back of tail light



LICENSE PLATE

LICENSE PLATE BRACKET

- Black.....2206-BL.....\$10.00 ea
- Polished stainless.....2206-PS.....\$18.00 ea

LICENSE PLATE BACK COVER

- Smooth, polished stainless.....2226.....\$10.95 ea
- Louvered, polished stainless2226-LV.....\$15.95 ea
- Clear plastic.....2226-CLR.....\$15.95 ea



LICENSE PLATE HARDWARE

- License plate bolt & acorns82229.....\$8.95 set
- License plate bullet bolt set2229.....\$10.00 set
- Lighted license plate bolts2223-LD.....\$12.50 pr
Has small LEDs built into the head of the bolt, use when you want to use tail lights without license lens, or relocate plate.



TAIL LIGHT BRACKETS

TAIL LIGHT BRACKETS, HIDE A WIRE *Tail light wires go inside bracket and are "hidden".*

- ANGLED, smooth polished.....2202-PA.....\$157.75 pr

STOCK TAIL LIGHT BRACKETS, according to original service bulletin, 1956 #9, tail light bracket could be installed upside down with bumper, drawing also shows bracket on hinge side, however they came from factory angled down on opposite, front side of hinge and stake pockets only had 3 spots for installation.

- Polished stainless.....2205-PS.....\$17.75 ea
- Chrome.....2205-CH.....\$12.75 ea
- Black2205-BL.....\$10.00 ea

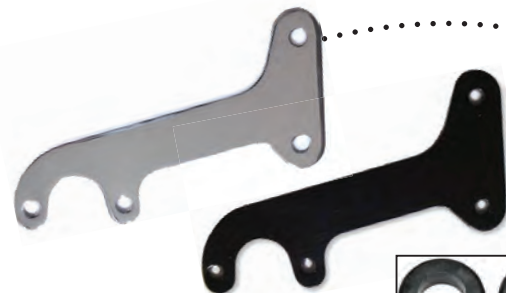

PIGTAIL TO BED GROMMET82214.....\$2.50 pr

FLEX WIRE COVERS

- Stainless2214.....\$8.85 pr
- Black.....2214-BLK.....\$5.50 pr





SENDING UNITS, ORIGINAL GAUGE ONLY

Will only work with stock, original gauge. If you have a reproduction stock looking gauge, you need aftermarket sender 2697 below. Senders for replacement tanks are adjustable in height
 53-55 Stock tank & gauge, 6 Volt,1607-3555 \$45.00 ea
 1956 stock tank, 14-94 ohm1607-56 \$59.95 ea
 Aftermarket sender, 78-10 ohms1605..... \$64.80 ea

SENDING UNITS, AFTERMARKET GAUGES

Use with reproduction stock gauges, or any aftermarket universal gauge 33-240 ohms. Height is adjustable to fit almost any tank
 12 Volt any tank, 33-240ohms.....2697..... \$38.00 ea

SENDER TO GAUGE WIRE3209-G..... \$4.00 ea

WIRE TO FRAME GROMMET2234..... \$1.95 ea

GAS SENDER ADAPTER KIT1605-ADPT\$19.50 kit
 Adapts small 5 hole aftermarket senders to stock large 6 hole tanks. Use with our 1605, or any aftermarket sender. Comes with gasket and hardware to fit most any tank made today.

SENDING UNIT GASKET

Cork & rubber1604-CRK..... \$2.80 ea
 Aftermarket1627 \$3.95 ea

SENDING UNIT HARDWARE KIT ...81601.....\$2.50 kit

Includes ground star washer and wire end.
AFTERMARKET TANK with 10-24 threads, just in case you bought tank elsewhere, Tisk-Tisk 81697 \$1.45 kit

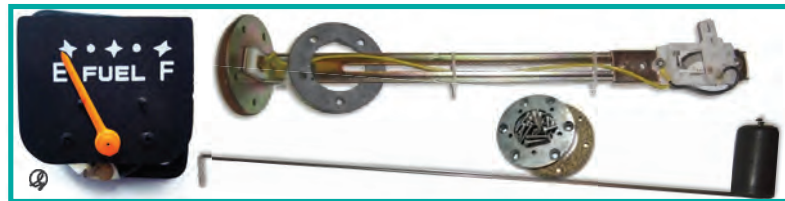

GAUGE & SENDER KIT

When installed, gauge looks like original but has all new technology inside, accurate & dependable. Gauge & sender match 33-240 ohm. Sender adapter kit to fit stock large or small hole tanks, depth is adjustable, everything included, Best buy.

•1953-55 kit, Stars ...2691-5355 \$95.00 kit

•1956 kit, Squares.... 2691-56 \$95.00 kit

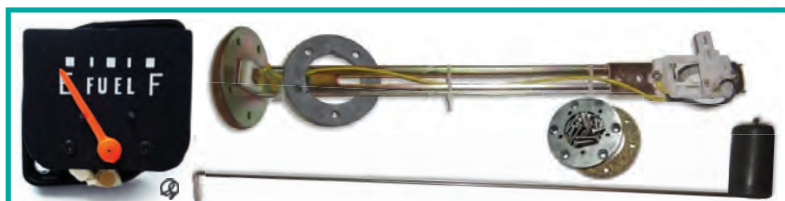

AFTERMARKET GAUGES (See page 48) should come with, and must use, sender with matching ohms. We can match most any gauge. Aftermarket gas senders have small 5 hole mounting plates, to use in a stock tank you will need our adapter kit above. Senders and gauges often do not work after storage and simply need cleaned, scrub the contacts gently with contact cleaner and one of those erasers on an ink pen. Check ground!!!!

SENDER BLOCK OFF PLATE, Small1626..... \$7.50 ea
 Large1626-LG..... \$8.00 ea

GAS FLOATS

•For original units, large diameter1602-LG..... \$14.95 ea
 •Small to fit units made after 561602-SM... **SALE** .. \$6.95

GAS TANK SENDER INSPECTION PLATE

Fits both original and reproduction floor panels. 1953-55 driver side Plate1633..... \$18.00 ea
 Plate screws81633..... \$1.00 set

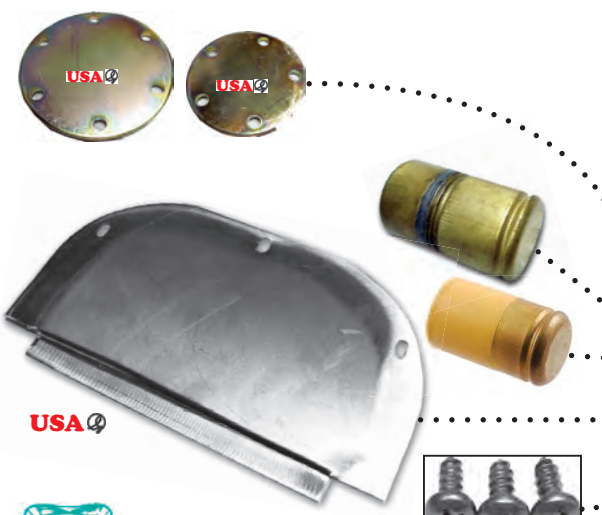



GAS CAPS

- Flip key locking.....1611-R..... \$42.50 ea
- Chrome locking cap.....1611-L..... \$13.50 ea
Very nice cap, smooth and rounded with no markings, no rings
- Chrome anti-surge stock cap.....1610..... \$9.80 ea
Nice stock rounded cap, no ugly stickers.

GAS TUBE TO BODY BOOT

- 1953-551606-5355 \$19.50 ea
- 1956.....1606-56 \$15.50 ea
This one is the correct shape, round ones are actually for the 57-60 and gap when used on 56, which had a slight teardrop shape.
- Panel truck.....P-1606..... \$22.50 ea

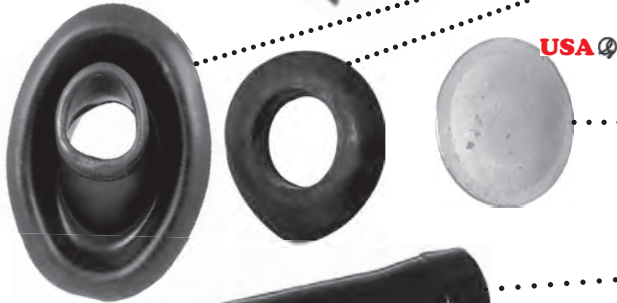

GAS FILLER HOLE PATCH

- 1956 upper passenger side.....1650-56 \$15.00 ea
- 53-55 lower driver side1650-5355 \$22.50 ea



GAS FILLER TUBE

- Plain steel.....1614-K..... \$28.75 ea
- Chrome.....1614-CH. **SALE**..... \$42.50
- Rubber, stock length, use this one1615-SHT \$7.85 ea
- Rubber, long.....1615-LNG..... \$12.50 ea
Use only with short incorrect replacement tubes you may have gotten elsewhere. Our tubes above are correct length.
Other ID sizes and lengths available
- Clamp, all stainless.....1616-SS..... \$1.65 ea
- Clamp, polished stainless1616-PS. **SALE**..... \$3.25



GAS PEDAL

- *Can sell you the cheaper one but linkage will poke through rubber*
- Gas pedal.....1612..... \$14.95 ea
- Gas pedal bolt set.....81612-SS..... \$1.90 set
- Gas pedal stop bolt & hardware81611..... \$2.25 set



PEDAL THROUGH FLOORBOARD LINKAGE

- *Ball swivel goes into back of pedal.....*1613..... \$39.95 ea
- Pedal linkage bolt set, bolt heads show on firewall.
Zinc.....81613-Z \$2.00 set
- Stainless bolt set81613-SX..... \$2.50 set
- Polished stainless button.....81613-PB..... \$6.50 set
- Hole plugs if not using linkage.....81614-PS..... \$5.00 set

CHOKE OR THROTTLE CABLE with KNOB

- Cut to fit, best buy, 60".....1014..... \$19.50 ea
- THREADED CABLE with NO Knob, order by length... \$14.85 ea
36"....1014-36. 48"....1014-48 60"....1014-60 66"....1014-66
- Cable backing nut & washer.....81014..... \$1.00 kit
- Choke & throttle cable grommet.....1618-G..... \$2.00 ea
- Choke bezel.....1035..... \$7.95 ea
- Throttle bezel.....1036..... \$7.50 ea

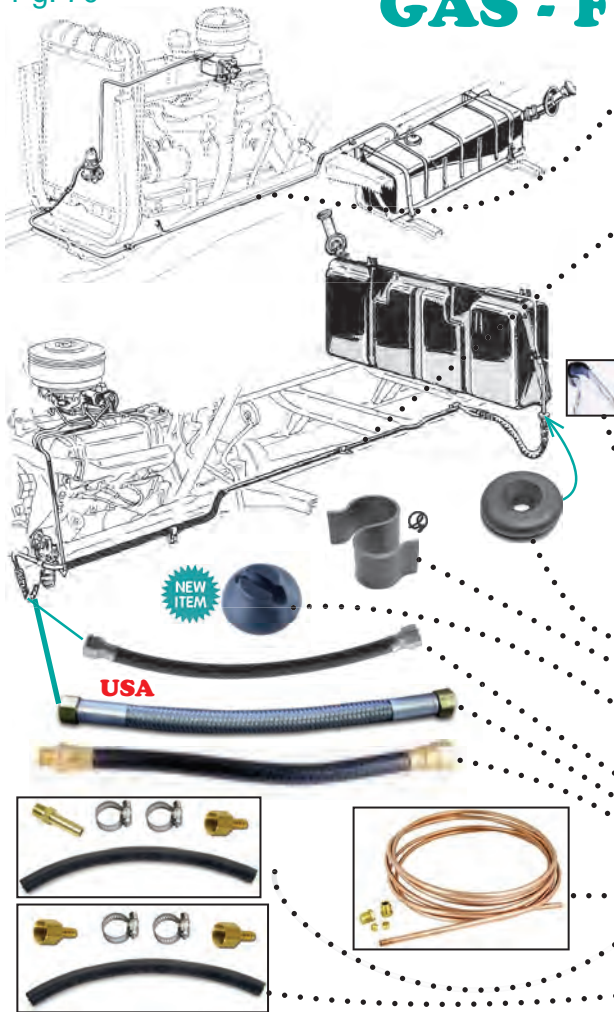
**1953-55 MAIN HARD GAS LINE**

Not for flat head, stainless, pre-formed with correct ends and protective covering at frame area.

6 cylinder or any passenger side pump.....1667-5355 \$88.50 ea
8 cyl Y block or any driver side pump.....1668-5355 \$60.00 ea

1956 HARD GAS LINES

Made for stock but can be used for most any engine, note pump side shown is 8 cyl with pump on driver, Hard line runs across in front and under radiator on the 6 cylinder for pump on pass. side.

Tank thru floor hard line, stainless.....1666-56SS..... \$42.50 ea
Tank thru floor hard line, zinc.....1666-56Z \$35.00 ea
6 cyl, or pump on pass side, stainless.....1667-56SS..... \$89.80 ea
6 cyl, or pump on pass side, stainless.....1666-56SS..... \$42.50 ea
8 cyl, or pump on driver side, zinc.....1668-56Z \$65.00 ea
8 cyl, or pump on driver side, stainless1668-56SS..... \$78.00 ea

GAS LINE CLAMP AND BOLT

Special thread cutting bolt and correct clamp. 6 cyl line uses 4, 8 cylinder line uses 2

Line to 56 tank.....81664..... \$0.95 ea
Line to frame.....81663..... \$0.85 set

GAS LINE FLOOR GROMMET1617-G..... \$2.95 ea**"S" LINE CLIP Joins fuel & brake line1636..... \$2.00 ea****GAS LINE BUMPER-CLIP, not stock, universal handy piece, self adhesive or screw on.....81665-B \$4.95 ea****FLEX HOSES**

1956 tank to line1665-56 \$33.88 ea
1956 tank to line, stainless1665-56BS..... \$33.88 ea
1953-56 6 & 8 cylinder, line to pump, 9".....1665-9 \$15.00 ea

COPPER HARD LINE KIT1665-CPR..... \$19.80 ea**DIY HOSE KIT, Male-Female1665-DIY \$11.00 ea**

Female-Female1665-FDIY \$13.00 ea

GAS DOOR CONVERSIONS**CURVED PANEL DOORS**

Use for cab or rear fender curved locations. Door is spring loaded with magnetic "touch latch" and pops open, filler spout has nifty trap door and does not have to be removed to refuel.

45° tube, round door, opens left1652-45RC\$124.00 kit
45° tube, square door, opens left1652-45SC.....\$129.50 kit
45° tube, round door, opens right.....1660-45RCR...\$124.00 ea
45° tube, square door, opens right1660-45SCR..\$124.00 ea

FORD OVAL DOOR 90° tube1654-C..... \$134.00 ea**FLAT PANEL DOORS**

Can be used in bed floor, rear fender or panel truck, or any flat area, can be slightly curved if needed so goes in rear fender by making the slight curve.

45° tube, round door, opens left1653-45RF.....\$124.00 kit
45° tube, square door, opens left1653-45SF.....\$124.00 kit
45° tube, round door, opens right1660-45RFR...\$124.00 ea
Straight tube, round door, opens left1653-90RF.....\$124.00 kit
Straight tube, square door, opens left.....1653-90SF.....\$124.00 kit
Straight tube, round door, opens right1660-90RFR..\$124.00 ea
Straight tube, square door, opens right1660-90SFR..\$124.00 ea

TEARDROP FILLER DOOR KIT1651-TD.....\$159.00 kit**BENDABLE GAS HOSE1661..... \$33.50 ea**

2" OD, 12" long but can be trimmed to almost any length and bends to almost any angle. Quite a breakthrough as gas hose is normally very stiff and difficult to work with. To reduce for 1 1/2" use a little piece of 1 1/2" as a spacer or this kit.....1663-2 \$7.90 pr

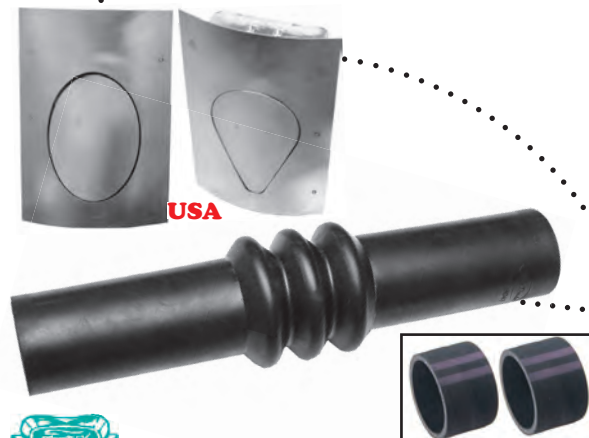
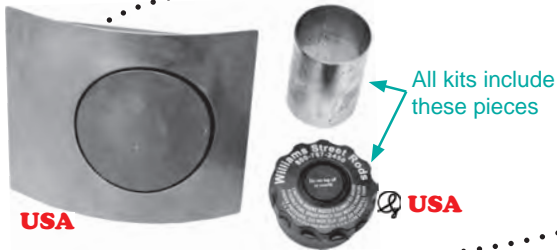

PANEL TRUCK TANKS, SEE PANEL SECTION

1953-55 TANK



USA



- GAS TANK, POLYETHYLENE 1699-M \$239.50 ea
Molded polyethylene, 15 gal. If using aftermarket senders, order adapter 1605-ADPT, use 4 inch hose & original or chrome fill tube on page 69. Most gas tanks are oversize shipping
- GAS TANK, STEEL..... 1690-5355 \$198.50 ea
17 gallon, very nice reproduction of original and baffled, has correct holes
- GAS TANK PICK-UP FITTING 1672..... \$7.95 ea
At 45 degree angle, connects hard line to internal pick up tube

GAS TANK STRAPS

- Straps 1619..... **SALE** \$29.50
- Tank strap pin & cotter..... 81616..... \$3.75 pr
- Tank strap bolts
- Stainless 81617..... \$3.50 pr
- Polished..... 81617-PS..... \$6.85 pr

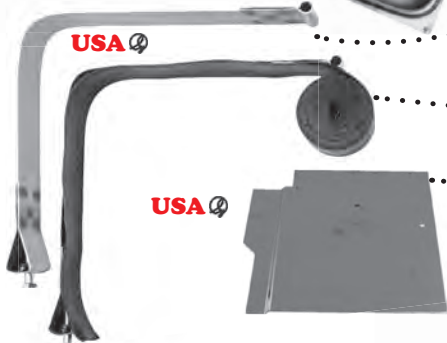

USA

USA

- GAS TANK INSULATORS 81621-G..... \$8.00 set
8ft of insulator, For steel or poly tanks, under straps and at braces
- GAS TANK SPLASH SHIELD 1621..... \$39.80 ea
Matches battery shield on other side, polished stainless
- GAS TANK SKID PLATE..... 1622..... \$48.00 ea
Goes on braces under tank, added protection, polished stainless



USA

1956 TANK

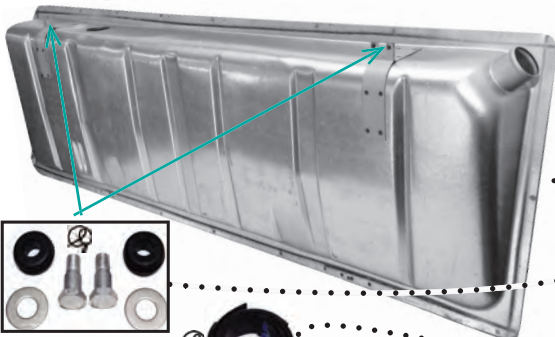

- GAS TANK, STEEL 1690-56 \$249.50 ea
18 gal. There are other tanks on the market with lower mounting flanges and drain in the wrong location, ours are correct. Good stock of Used 56 tanks also available. Oversized shipping
- UPPER MOUNTING GROMMET & BOLT KIT
Does both sides..... 81625..... \$10.50 kit

- UNDER TANK AND BACK TO WALL INSULATORS
Self adhesive anti rattle material 81622..... \$7.00 set
- LOWER FLANGE INSULATORS 1623..... \$2.90 pr



USA

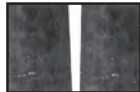

USA

- TANK DRAIN RUBBER GROMMET 1631..... \$19.50 ea
Goes under tank as insulator and seal around drain
- TANK FLOOR PLUGS, *Use when removing 56 tank*
- Floor hole under tank..... 1632..... \$1.25 ea
- Floor hole where line went..... 80211-75..... \$0.75 ea

OTHER TANK PARTS



USA



- DRAIN FITTING 1634-OR..... \$2.85 ea
- SLOSHING COMPOUND 1629..... \$45.00 ea
- ROLL OVER VENT, Remote 1641..... \$22.50 ea
This is the best choice for 1953-55 poly and underbed tanks
- ROLL OVER VENT, In Tank, 1/4NPT..... 1640..... \$15.00 ea
- ROLL OVER VENT, in Tank, 3/8NPT..... 1640-LG..... \$25.00 ea
- REMOTE VENT INSTALL KIT..... 1641-K..... \$17.25 kit
- IN-LINE FILTER KIT. With hose..... 1640-K..... \$8.00 kit
- FILTER only..... 1675..... \$4.00 ea
- TANK PICKUP TUBE..... 1643 \$21.00 ea



UNDERBED GAS TANK

2020 Mid Fifty
1953-56 Catalog

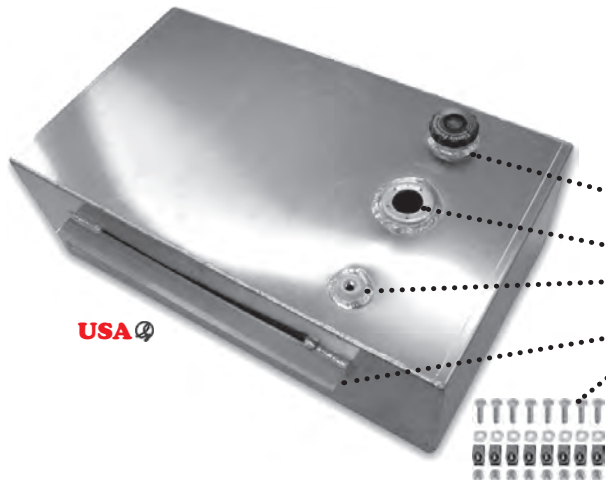

Our underbed Tanks are made specifically for 1953-56 F-100 frame and bed floor, 'cause that's what we do, however, most will fit 48-64. The fill port is positioned to come up in the center of the third board on the driver side. Intended for stock frames, may not clear modifications such as 4 bar set-ups, pro-street or coil-overs.

All our tanks have these features:

- Choice of fill port in bed wood or under a trap door.
- Fill is located in center of third board from driver side.
- Sender holes are pre-drilled and positioned for proper float location.
- Vent fitting accepts in-tank roll over vent or fitting for remote style, and is located under same board.
- Choice of crossmember mount or frame mount step down tank.
- Easy to install mounting nuts are included.

Gas filter and hose connectors are needed to protect tank from contaminants entering through open vent. The in-tank vent and filter kit is included in all the complete kits below



FILL PORT IN BED WOOD TANKS

Fill set up to be in center of third board on left.

- 19 gal. x-member mount tank, Tank only.. 1692-2B \$399.00 ea
- Complete with stainless port..... 91693-19.....\$479.00 kit
- 22 gallon frame mount tank, steps down under crossmember
- Tank only1691-2B \$399.00 ea
- Complete with stainless port.....91691-B\$479.95 kit



TRAP DOOR IN BED WOOD TANKS

Fill door in bed, with screw on trap door cap underneath

Fill set up to be in center of third board on left

- 19 gallon crossmember mount tank, (best choice we think)
- •Tank only1692-SC \$399.00 ea
- •Complete kit with oval door91692-V\$510.00 kit
- Complete kit with rectangle door91692-R.....\$515.00 kit
- 22 gallon frame mount tank, steps down under crossmember
- Tank only1691-SC \$399.00 ea
- • Complete kit with oval door91694-19V\$519.00 kit
- Complete kit with rectangle door91694-19R.....\$509.00 kit

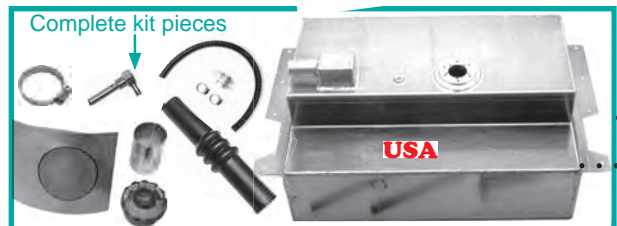

SIDE FILL DOOR OR PORT IN FENDER

No frame cutting is necessary, fills between frame and bed.

19 gallon crossmember mount tank.

- Tank only1692-SF \$429.00 ea
- Complete with door, hose & vent.....91696-XR\$569.95 kit
- 22 gallon frame mount tank, steps down under crossmember
- Tank only1696-19SF \$499.95 ea
- Complete with door, hose & vent.....91696-19\$679.00 kit



UNDERBED TANK, FRAME MOUNT

Fill fits in third board from left. fully baffled, pick tube, roll over vent valve, two ports for fuel injection fits 48-60, no moving x-members.

- 15 Gallon, Import..... 1691-15 \$325.00 ea
- 17 Gallon, USA.....1697-17..... **SALE** \$379.95

- **Tank Mounting system**, clip threads over frame, bring tank up, bolt thru frame into clip, Mounts any fanged tank, UNDER FRAME so can be serviced..... 81692 \$11.50 kit

IN-BED DIAMOND PLATE TANK AND TOOLBOX TANK COMBO

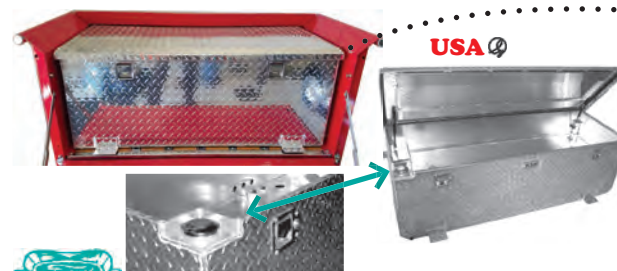

Made of .125 aluminum diamond plate. Two baffles to control fuel sloshing and to provide added stability. A key with double lock provides secure tool box section and fuel fill. Front of unit is one piece for a nice clean line, division between toolbox and fuel tank does not show. Fill located in corner of toolbox, easy to use secure when lid is closed and locked. Can be used as main or auxiliary tank. Ready for sending unit to match any gauge, includes pick-up tube, fill port cap, return line & vent fittings.

- 45 gallon1689-45 \$869.00 ea
- 25 gallon1689-25 \$839.00 ea



UNDERBED GAS TANK

1-800-252-1956
Direct 928-565-2763

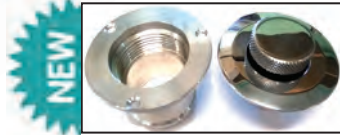

POLISHED CAST FILL PORT

With 2" bung polished cast aluminum. Has "gas" stamped on face
The key below does not come with it, but helps open it without scratching the surface

- Fill port, 1 1/2" bung1648-PS..... \$49.50 ea
- Fill port, 2" bung1647..... \$49.80 ea
- Mounting screws, polished stainless81648.....\$3.30 kit
- Fill port key, stainless1644-SS..... \$5.25 ea

POP UP FILL PORT1646-POP..... \$135.00 ea

BED FILL RUBBER HOSE KIT1645-K.....\$14.50 kit

Hose and hose adapter for use with most in bed tanks. Use with fill port and aluminum tanks

HOSE CLAMPS

- 2" hose, stainless.....1616-SS..... \$1.65 ea
- 2", polished stainless1616-PS..... \$3.85 ea
- 1 1/2", stainless1662-15 \$4.95 ea

GAS FILL HOSE REDUCER, 2" to 1 7/8" ..1664-R178 ...\$11.50 ea

GAS FILL HOSE

See individual tanks for correct size. Most tanks have 2" ID fills, but fill ports are 1 1/2" OD so we make the hose kit above 1645-K. Order 2" hose only if tank is 2" & fill tube is 2" Stock fill ports are 1 7/8"

- 2" ID, 6" long.....1664-2 \$12.50 ea
- 2" ID, 4" long.....1615-4252 \$7.95 ea
- 1 7/8" ID, 3" long.....1615-3 \$7.55 ea
- 1 7/8" ID, 4" long.....1615-SHT \$7.85 ea
- 1 7/8" ID, 6" long.....1615-LNG \$12.50 ea
- 1 7/8" ID, 8" long.....1615-8 \$15.50 ea
- 1 7/8" ID, 12" long.....1615-12 \$21.85 ea
- 1 1/2" ID, 4" long.....1663-15 \$9.50 ea
- 1 1/2" ID, 12", for side fill underbed tanks 1663-12 \$18.50 ea



ALUMINUM BED FILL DOORS

Beautiful, **best bed floor door ever!** Fits between bed rails. Push to open. Even made in Oval, we are building Fords, ya-know.

- OVAL, polished & ball milled 6.75x4.25.....1656-OG..... \$99.50 ea
- OVAL, polished smooth,1656-OS \$102.00 ea
- RECTANGULAR, 4 1/2" x 5"
 - Polished & ball milled,1656-RG \$98.50 ea
 - Polished smooth1656-RS \$98.50 ea

ECONOMY BED FILL DOORS Has visible mounting holes.

- OVAL, grooved.....1658-OG..... \$79.00 ea
- RECTANGULAR, grooved, not shown...1658-RG..... \$79.00 ea

EZ FILL CAP, We suggest using our handy trap door cap under

all bed fill doors, does not have to be removed cause not much room for fingers. Cap only1684..... \$14.50 ea

SCREW ON ALUMINUM BUNG AND EZ FILL CAP

Use to change any existing aluminum tank into a screw on type so it can be used with these new fancy fill doors. Must be welded to tank

- Bung only, aluminum1683..... \$25.00 ea
- Gas hose, 5/16" x 2 ft.1674-2 \$5.00 ea

BED BOARD LIFT FILLER CONCEALMENT KIT

Very nicely made set up that lifts complete bed board for access to under-bed tank. Show quality.

- Fits 1952-72.....1657.....\$695.00 kit

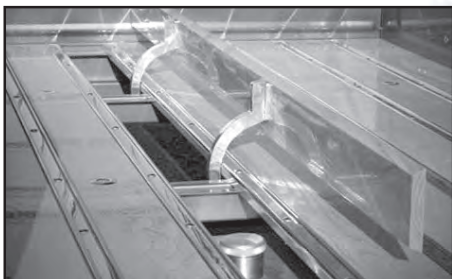

WINDSHIELD WASHER

2020 Mid Fifty
1953-56 Catalog

We call him
"Wishy-Washy"

WINDSHIELD SPRAY HEAD

Have wanted to make this for years, started on it in 1978, nozzle, pump, bracket, jar and fitting finished in 2010, slow but sure!

Nozzle.....3080..... \$50.00 ea

WINDSHIELD WASHER BAG, 1956

Original on 1956 but works on all years, bright red plastic, with white lettering, an exact duplicate of Fords original.

COMPLETE KIT, includes with *below...93084..... \$72.50 kit

Vacuum "F" fitting3087-F \$16.95 ea

Bag cap3085-C \$2.95 ea

Bag "See clear".....3084..... \$28.98 ea

Bag mounting bracket, black3086-B \$14.50 ea

Mounting bracket screws

Zinc.....83086..... \$0.50 pr

Polished stainless.....83086-PS..... \$1.25 pr

Bottom support3086-BTM..... \$7.95 ea

Inner bag hose and filter.....3088..... \$10.00 ea

Hose, from F-fitting to nozzle, small3089-5 \$4.50 ea

Hose, from F-fitting to pump, large3089-7 \$6.75 ea

WINDSHIELD WASHER JAR, 1948-55

Complete kit, includes everything below ..93085..... \$65.00 kit

Vacuum "F" fitting3087-F \$16.95 ea

Jar lid assembly.....3096..... \$26.50 ea

Stainless (originally steel) with fitting, sliding door, inner hose & screen

Jar lid, with trap door, no fitting or hose....3095..... \$15.00 ea

Jar, glass3098..... \$10.00 ea

Inner hose and filter.....3088..... \$10.00 ea

Bracket, chrome3097-CH \$22.50 ea

Not the greatest chrome, made in black but came in chrome.

Mounting bracket screws

Zinc.....83086..... \$0.50 pr

Polished stainless.....83086-PS..... \$1.25 pr

Bracket decal.....D-686..... \$4.95 ea

Hose, from bag or jar to nozzle, small3089-5 \$4.50 ea

Hose from bag or jar to pump, large3089-7 \$6.75 ea

HOSE GROMMET, 1953-55.....3027-G..... \$2.95

WINDSHIELD WASHER PUMP

Includes mounting hardware and Instructions. We love this pump, but for those of you that like all power stuff, electric alternative is on the next page, we do not make the round pump but it is available.

Foot pump3081..... \$55.00 ea

COMPLETE "SEE CLEAR" WASHER KIT

Includes spray nozzle, pump, hoses, hardware and instructions.

Biggest Savings in complete kit.

With complete bag kit93080-5660 \$150.00 kit

With complete jar kit93080-4855 \$150.00 kit



Wiper motors and switches are matched, do not interchange.

INTERMITTENT WIPERS

For most motors used on 1953-55 and 56-60 trucks since 80's. Dynamic park only. Switch comes with ugly knob shown, shaft is larger than stock, to use stock knob order adapter or knob kit below.

- Switch & knob kit, not shown.....92908.....\$135.00 kit
- Knob shaft adapter2908-SX.....\$27.00 ea
- Switch only2908-D.....\$99.95 ea
- Knob, Bezel, Nut, set screw & wrench91002.....\$22.00 kit
- Switch, motor & knob kit, 53-55.....93070-5355\$275.00 kit
- Switch, motor & knob kit, 56.....93070-56\$275.00 kit
- NEED IT ALL KIT

Intermittent wiper switch, knob, bezel, motor, linkage arms, brackets, pivots, chrome bezels & nuts, polished arms/blades.
1953-55 (shown).....93075-5355\$525.00 kit
1956.....93075-56\$469.00 kit



1953-55



1956 HIDDEN WIPER MOTOR CONVERSION

Fits 56-60 trucks. Converts 1956 motor to under dash. Uses your stock linkage arms, pivots, etc Use without cowl vent. To keep cowl vent use lift arm #3073.

- With 2 speed switch.....3072-56 \$249.80 ea
- With Intermittent switch3071-56\$325.00 kit
- With Intermittent with knob kit & bezel...93073.....\$299.95 kit
- COWL VENT LIFT ARM, OFFSET3073.....\$17.00 ea

NEED IT ALL KIT Intermittent wiper kit with knob & bezel kit, all linkage arms and brackets, pivots, all chrome bezels & nuts, polished stainless arms and blades.
1956 Hidden wiper need all kit93074-56\$499.95 kit



WINDSHIELD WASHER PUMP, ELECTRIC

Pump is controlled with intermittent switch, used with stock motors, can also be controlled with single switch. Pump comes with length of hose. You may need more depending on where you place a reservoir for the fluid. More washer parts on page 74

- Pump with hose3079.....\$25.00 ea
- Switch, 2 speed2909.....\$40.00 ea

For stock style **original coast to park only motors only**, use this switch to add electric pump to regular electric wiper motors



SPECIALTY WIPER KIT3039.....\$299.00 kit

Saves room under dash, clean install, intermittent wipers. Cable driven, best to install before other things are under dash. You will need your pivots as shafts must be modified with stock pivots, unless you get ones we have already modified, see below



MODIFIED SPECIALTY WIPER KIT

New pivot drums installed, send in your old pivots for a credit.
1953-553039-5355M\$379.00 kit
1956.....3039-56M\$379.00 kit
Knob & bezel add-on93039-A\$65.00 kit
Knob & adapter, insert, bezel, chrome pivot trim, nut & gasket

SIDE MOUNT KIT

Mounts off-side, eliminates under dash linkages. Needs knob and bezel add-on above if using stock switch

- 1953-55 standard switch3076-5355\$429.95 kit
- 1953-55 delay switch.....3077-5355\$479.95 kit
- 1956 standard switch.....3076-56\$519.50 kit
- 1956 delay switch.....3077-56\$549.95 kit

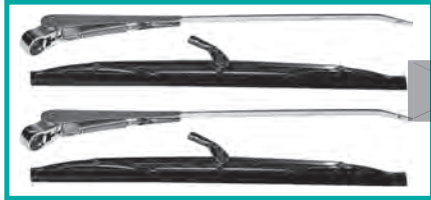

**WIPER ARMS & BLADES,**

Both arms are "lefts" on a '53-55 and point toward passenger side.

Arm, straight, polished stainless.....3041-L \$15.00 ea
Matching blade, polished stainless.....3044 \$15.00 ea

• WIPER KIT, 2 ARMS 2 BLADES.....93040-5355HD.. \$49.95 set

• Arm, curved, polished stainless.....3051-L \$15.00 ea
Matching blade, polished stainless.....3054-CV \$15.00 ea

Chop top kit, 2.5" chop93060-5355 \$59.95 set

We have shorter arms and blades available, just ask

Wiper blade refills3059 \$8.95 pr

ALUMINUM WIPERS, satin, can be polished, set with blades

Set of 2 blades and arms93047-4255 \$98.95 set

WIPER PIVOT

Wiper cowl pivot, 53-553004-5355 \$29.80 ea

Wiper pivot post covers

Polished aluminum, covers wiper post when not using wipers.

• Pointed3010-P \$21.80 pr

• Stubbed3010-S \$28.00 pr

Wiper pivot nut, chrome

• Hex, was original on 53-553008-CH \$5.95 ea

• Slotted, 1956, see tool below3007-CH \$5.95 ea

• Wiper pivot nut tool3006 \$8.95 ea

Getting slotted nut on & off was a paint chipping experience, so we made this handy tool

• Wiper pivot trim ring, chrome.....3009-CH \$7.50 ea

• Wiper pivot trim ring, polished alum3009-PA..... \$8.90 ea

• Wiper pivot gasket.....3011 \$2.95 pr

• Wiper pivot drum repair3005 \$12.50 ea

UNDER-DASH LINKAGE

• Assembly With CHROME Trim.....3037-CH \$159.95 ea

Complete, with chrome trim, both pivot assemblies, both linkage arms & clips. Everything ready to go. Best Buy

Assembly with NO Pivots or Trim3036 \$95.00 ea

Under-dash bracket only3036-BR \$61.00 ea

• Under-dash arm, passenger, 53-55.....3034-R..... \$28.50 ea

• Under-dash arm, driver, 53-55.....3033-L \$28.50 ea

Under-dash arm set, save \$\$3035-PR \$42.50 pr

• Linkage arm bushing, each arm uses 2 3031-SM..... \$6.50 ea

• Wiper linkage clip, use 3.....3012 \$1.95 ea

WIPER MOTOR

• Wiper motor kit3000-5355 \$149.95 kit

Includes electric motor, switch, bracket & clevis, converts 6 to 12 volt and vacuum to electric.

Mounting bracket.....3002-5355 \$18.00 ea

Bracket to brace bolts.....83002-5355 \$1.50 pr

WIPER SWITCH

For Dynamic park kit motors, since 90's....2909-RP..... \$40.00 ea

For Original coast to park & washer2909 \$40.00 ea

For Original coast to park2908 \$49.50 ea

Switch wiring ends, for replacement.....82909 \$1.50 kit

Switch wiring ends, for stock.....82908 \$1.50 kit

Switch backing nut, behind dash.....2912 \$0.50 ea

• Wiper switch bezel.....1032 \$7.95 ea

• Wiper switch nut, goes inside bezel2911 \$7.95 ea

• Wiper switch knob1002 \$6.50 ea

Knob kit, includes set screw & tool91002 \$22.00 kit

Switch removal tool80100 \$9.95 ea

Wiper knob set screws & tool81002 \$1.00 set

"NEED IT ALL" KIT *Everything.. knob to blades, chrome trim,*

Polished arms & blades, motor, switch, bracket & all hardware

With under-dash assembly93000-5355 \$389.00 kit

And intermittent wiper93075-5355 \$525.00 kit

Without under-dash bracket93001-5355 \$349.95 kit

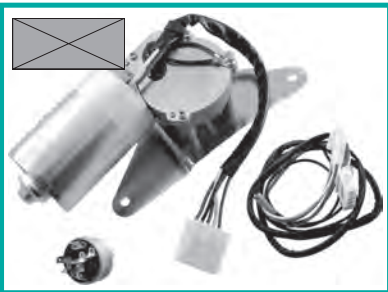

WIPERS, 1956



•WIPER ARMS & BLADES

Straight arm, polished stainless

- Driver side3041-L \$15.00 ea
- Passenger side.....3042-R..... \$16.80 ea
- Matching blade, polished stainless.....3044..... \$15.00 ea
- Wiper kit, 2 arms 2 blades93040-56HD ... \$49.95 set

•DIPPED arm, polished stainless

- Driver side3051-L \$15.00 ea
- Passenger side.....3052-R..... \$15.00 ea
- Matching blade, polished stainless.....3054-CV \$15.00 ea

•Wiper blade refills3059..... \$8.95 pr

Chop top kit, 2.5" chop93060-56 \$59.95 set

We have shorter arms and blades available, just ask

- ALUMINUM Arm & Blade set, Left.....3047-AL..... \$49.95 ea
- Right.....3047-AR \$49.95 ea



WIPER PIVOT

•Wiper cowl pivot, 19563004-56 \$29.50 ea

Wiper pivot post covers

Polished aluminum, covers wiper post when not using wipers.

Pointed3010-P \$21.80 pr

Stubbed3010-S \$28.00 pr

Wiper pivot nut, chrome

•Hex, was original on 53-553008-CH \$5.95 ea

•Slotted, 1956, see tool below3007-CH \$5.95 ea

•Wiper pivot nut tool3006..... \$8.95 ea

Getting slotted nut on & off was a paint chipping experience, so we made this handy tool

•Wiper pivot trim ring, chrome.....3009-CH \$7.50 ea

•Wiper pivot trim ring, polished alum3009-PA \$8.90 ea

•Wiper pivot gasket3011 \$2.95 pr

•Wiper pivot drum repair3005..... \$12.50 ea



UNDER-DASH LINKAGE ,1956

•Linkage arm3030..... \$22.00 ea

Arm fits both sides, has Deleon bushings installed.

•Center link3023..... \$20.00 ea

•Linkage arm bushing, small, one side3031-SM..... \$6.50 ea

•Linkage arm bushing, large, other side3031-56LG..... \$6.85 ea

•Wiper linkage clip, use 3.....3012..... \$1.95 ea



WIPER MOTOR

Is under hood on firewall, to move motor under dash see -age 65.

•Wiper motor kit3000-56 \$59.00 ea

Includes electric motor, switch, rubber insulator, bracket & clevis, converts 6 to 12 volt and vacuum to electric.

•Motor decal, 12v blueD-300..... \$6.50 ea

•Motor to bracket bolts83001..... \$1.00 set

•Wiring grommet3003-G..... \$1.95 ea

•Replacement insulator (comes with kit).....3001-56 \$3.75 ea

•Bracket to firewall bolts.....83002-56 \$1.50 set

•Wiper motor cover3075-WMC \$59.00 ea

Polished stainless, fits under cowl over wiper motor



WIPER SWITCH

For adding Delay feature to above kits since

early 90's with Dynamic park,2908-D..... \$99.95 ea

For Dynamic park motors, since 90's.....2909-RP \$40.00 ea

For Original coast to park & washer2909 \$40.00 ea

For Original coast to park2908 \$49.50 ea

•“NEED IT ALL” KIT

Everything from knob to the blades, chrome trim, polished stainless arms & blades, motor, switch, bracket & all hardware

With under-dash assembly93000-56 \$369.93 kit

And intermittent wiper93075-56 \$469.00 kit



HEATER

2020 Mid Fifty
1953-56 Catalog

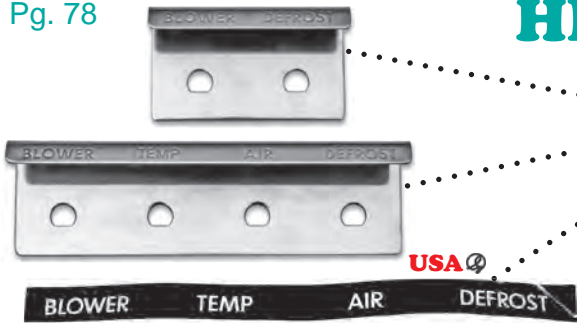

HEATER CONTROL BRACKET, POLISHED

- 2 Hole, stamped lettering.....1919-DR \$35.00 ea
- 4 Hole, stamped lettering.....1918-DR \$34.00 ea
- Mounting bolts, stainless81919..... \$3.00 set

HEATER BRACKET LETTERING DECALS

- Clear with white letters1920-W \$3.50 ea
 - Clear with black letters, (for stainless).....1921-B..... \$3.50 ea
 - Black with white letters1922.....\$6.00 ea
- Blower-Defrost, cut from your choice above.*

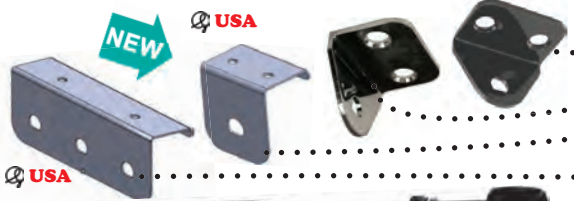

CABLE BRACKETS, We make a few of these, Handy! With No label area, in Black powder coated or Chrome

- Black powder coated 1918-1BK ...\$19.50
- Chrome..... 1918-1CH.....\$19.50
- Plain steel, with label area... 1 Hole 1917-1\$12.50 ea
- 2 Hole..... 1917-2\$18.00 ea
- 3 Hole..... 1917-3\$22.00 ea
- 4 Hole..... 1917-4\$25.00 ea

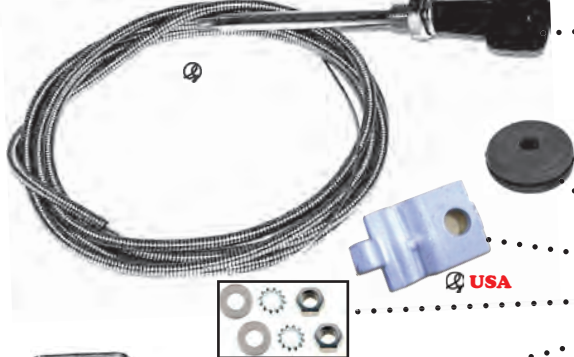

HEATER CABLE WITH CORRECT KNOB

- Cut to length, 60" long1014..... \$19.50 ea
- THREADED CABLE, NO KNOB, order by length,
- 36"1014-36 \$14.85 ea
- 48"1014-48 \$16.50 ea
- 60"1014-60 \$16.50 ea
- 66"1014-66 \$16.50 ea
- Heater cable backing nut & washers...81014.....\$1.00 kit
- Heater cable firewall grommet.....1618-G.....\$2.00 ea
- Heater cable clip, with screw1913.....\$3.45 ea
- Cable backing nuts81014.....\$1.00 kit

HEATER VALVE, IN ENGINE1927..... \$21.95 ea

HEATER WATER VALVE, In line1926 \$28.50 ea

Cable controlled, easy to use, original firewall mount style is no longer available. Best alternative we could find, also used in a/c

Recirculating heaters used a 2 hole bracket and the water circulated constantly unless you got out and turned it off under the hood, "yuck"! Side louvers were covered. Defrost was cable controlled. Fresh air heaters were "driver friendly" 4 hole bracket included cable to control water valve and fresh air was scooped in through louvers on passenger cowl. Both heaters used same core.



- Heater switch nut.....2911..... \$7.95 ea
- Heater switch backing nut2912..... \$0.50 ea
- Switch removal tool80100..... \$9.95 ea
- Heater bezel not available right now
- Heater switch knob1004.....\$5.95 ea
- Switch to motor wire harness3206-HTR..... \$7.50 ea

HEATER MOTOR

- Fits both recirculating and fresh air heaters if changing 53-55 to 12v
- 12 volt motor, exact of original1924..... \$169.50 ea
- 6 volt motor.....6V-1924 \$89.95 ea
- 12 volt motor, reproduction, best buy1925..... \$98.50 ea



HEATER MOUNTING NUTS & WASHERS, CHROME

- These mount the heater and cover threads showing on the firewall
- Recirculating heater.....81935-RC \$12.50 set
- Fresh air heater81935-FA..... \$15.25 set
- Mounting spacers81934-75 \$4.50 set

HEATER TUBE HOLE PLUGS81903-5356 \$1.95 pr

HEATER HOLES FIREWALL COVER

Used when no factory heater was installed. Can be cut to accept various hose locations or if firewall area is a mess, can be painted.

- Steel **SALE** 1900-5356 \$18.50
- Polished stainless.....1901-5356 \$29.00 ea

- FIREWALL COVER SCREWS81901-5356 \$1.50 ea

Working on bezels in Aluminum and chrome.





- DEFROST DEFLECTOR *Oversized shipping*
 - 1953-55 chrome, As available, requires core \$100.00 ea
 - 1956 chrome, As available, requires core
 - Screw set polished stainless, 1953-5581940-5355 \$4.00 set
 - Screw set polished stainless, 195681940-56 \$4.50 set

DEFROST TUBE

Plastic Reproductions

- 1956 driver or passenger.....1945-56 \$35.00 ea
- 1953-55 driver, deeper one1945-5355L \$29.95 ea
- 1953-55 passenger, shorter one.....1945-5355R..... \$29.95 ea
- 1956 driver or passenger, fiberglass.....1945-56F .. **SALE** .. \$32.50
- 1953-55 driver, fiberglass **SALE** ..1945-5355FL..... \$32.50
- 1953-55 passenger, Fiberglass **SALE** ..1945-5355FR..... \$32.50
- Defrost tube seal1943.....\$3.00 pr

Fiberglass SALE

Defrost tube attaching hardware

Threaded studs are pressed into 53-55 dash, use 56 for 53-55 dash with missing studs.

- 1953-5581947-5355 \$2.00 ea
- 1956.....81947-56 \$4.00 set

DEFROST HOSE

- Hose, pair (6 ft). Note size of heater outlets and defrost tubes
 - 1953-55, 2" diameter1928-5355 \$17.99 pr
 - 1956, 2 1/2" diameter1928-56 \$17.99 pr
- Defrost hose adapter, 2" to 2 1/2".....1952..... \$4.25 ea
Use to adapt 1953 heater to 56 truck and visa versa or a/c defrost hose to defrost tubes. Also aftermarket a/c units are 2"
- Defrost hose clamp
 - All stainless up to 3.25"81928-3 \$1.95 ea
 - Polished stainless, show quality1616-PS..... \$3.85 ea

FRESH AIR DUCT

See page 119 for cab repair panels with louvers

- LOUVER REMOVAL PATCH PANEL.....1903..... \$20.00 ea
Curved to match cowl, and flanged for easy installation
- Air intake cowl screws, polished81939..... \$4.00 set
Shows on outside of cab
- FRESH AIR DUCT, plastic reproduction .1939..... \$78.00 ea
New abs reproduction, scoops fresh air into heater.
- VINYL BOOT, BLACK1936..... \$9.50 ea
- FRESH AIR DUCT GASKET1937..... \$6.75 ea
- FRESH AIR DUCT COVER.....1938..... \$33.95 ea
New, made of black abs plastic, covers vent louvers from inside.
- HEATER TUBE FIREWALL SEAL.....1930..... \$4.90 pr
- HEATER SEAL KIT1904..... \$12.50 set
Includes 2 core seals & 1 Motor seal

- HEATER CORE *Rebuilt with new core. Heater cores have different tube designs. Note your style A, B, C or D. If in doubt send your core to us for rebuilding. Heaters are not the same in different years but can be interchanged with little problem, note defrost hose adapter and identification notes above.*

- Tubes, 1 straight and 1 angled1935-A..... \$235.00 ea
- Tubes, both angled1935-B..... \$235.00 ea
- Tubes, one angled more than other1935-C..... \$235.00 ea
- Tubes, both angled backwards.....1935-D..... \$235.00 ea
- Sold exchange, core charge for all above cores \$50.00 ea
- Copper tubes only, DIY, One tube1931..... \$25.00 ea

We make rebuild cores and tubes in copper, so very expensive, included in our cores, offered for radiator shops or DIY

Note compare your core, drawings are with the core toward you, and tubes away from you, pointing up,

- UNIVERSAL BOX HEATER.....1951..... \$203.50 ea
Not stock or original, but compact & similar to dealer add on heaters.

- HEATER HOSE FITTING, add to Radiator hose.....1932 \$19.95 ea

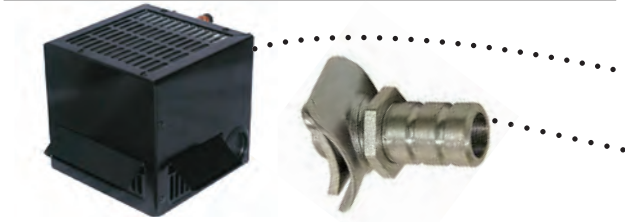
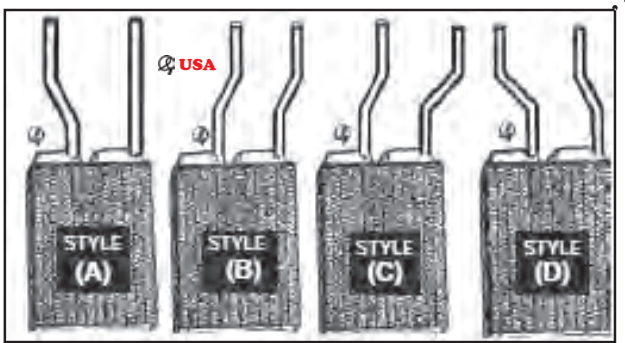



Complete inside and under hood kits shown above



VINTAGE AIR STYLE

Gen II technology, means the unit is smaller but more powerful with servo (electric not vacuum) motors to control all air-flow doors, and bi-level operation, (mixes heat and air for better dehumidified defrost and temperature control). Includes plastic under-dash piece for louvers and/or controls.

INSIDES KIT (EVAPORATOR KIT)

Includes unit & mounting brackets, control switches, wiring, duct hose, drain kit, water valve, reduced glove box and plastic under-dash panel.

- With rotary switches, for dash or under-dash panel
 - 1953-555203-5355\$645.00 kit
 - 1956.....5203-56\$645.00 kit
- With 4 lever horizontal electric control
 - 1953-555202-5355\$645.00 kit
 - 1956.....5202-56\$645.00 kit
- With oval control panel, *Must mount in dash or x-tend-a-dash.*
 - 1953-56, aluminum louvers5205-AL\$950.00 kit
 - 1953-56, plastic louvers.....5204-OV\$750.00 kit
 - 1953-55 round louvers, 1956 rectangular louvers



5016-2



ROUND LOUVERS, shown included in kits also see next page

RECTANGULAR LOUVERS included in some kits

- For 2" hose, sold each.....5016-2 \$14.50 ea
- Working on new kick panel for this rectangle louver.

See next page for more vent choices.



USA

X-TEND-A-DASH

Molded to fit contour of dash, adds 3 inches to bottom, allows glove box door to open. Will hold Vintage Air oval panel, gauges, Air Ride switches, etc

- Fiberglass, 1953-55, adds about 4".....7530-5355 ... \$150.00 ea
- Fiberglass, 19567530-56 \$150.00 ea
- ABS Black plastic, our design, 53-56....7531 \$139.50 ea

STEEL DASH EXTENSIONS see page 119

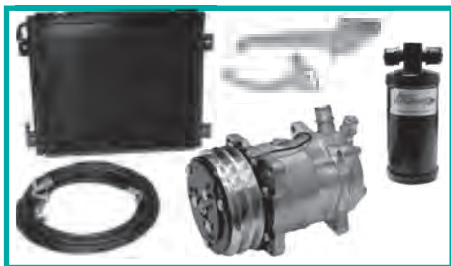

UNDER-HOOD KITS *Must be ordered with above insides kits*

Includes: compressor, hose kit, condenser & dryer assembly and engine compressor mount.

STANDARD KIT, PLAIN COMPRESSOR ON:

- Passenger side, Chevy.....5210-BK.....\$645.00 kit
- Driver side, Ford.....5211-BK.....\$645.00 kit
- Polished compressor, chrome dryer, compressor on:
- Passenger side, Chevy.....5212-CH\$675.00 kit
- Driver side, Ford.....5213-CH\$675.00 kit

COMPRESSOR BRACKET *Only a few listed here*

- Ford 2895054-289 \$95.00 ea
- Ford small block, Left5050-105L\$135.00 kit
- Flat head.....5052-FH.....\$275.00 kit
- Ford big block, 460.....5054-460 \$175.00 ea
- Y-Block5051-YB.....\$130.00 kit

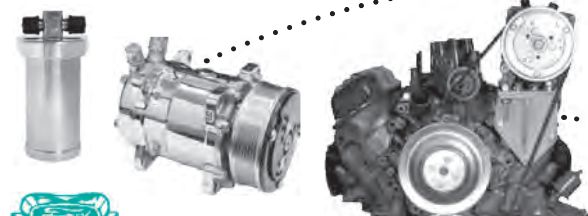

Q&A DIFFERENCES IN AIR CONDITIONING KITS:

- OLD AIR is somewhat easier to install in original location.
- OLD AIR leaves more glove box, VINTAGE AIR includes small, about 2 1/2" glove box.
- VINTAGE AIR comes with under-dash black plastic panel, some like it, some hate it, no discount without it.
- Oval switch panel and round louvers will not fit in it, they will fit in x-tend-a-dash though
- OLD AIR unit shows a little more but looks more like stock heater.
- DRYER is mounted on condenser in VINTAGE AIR KIT, Dryer can be mounted separately with OLD AIR KIT.
- BOTH KITS are set up for 134a refrigerant, R12 is available, just ask but you do not want it. Refrigerant is not included.
- VINTAGE AIR "servo" switches are not compatible with OLD AIR UNITS, use OLD AIR electric controls. ADD-ACE
- FOR A STOCK LOOK, use rotary switches with stock knobs in the dash, hide louvers under the dash.
- VENTS, prices listed are for each vent, same price by itself or with kit. Kits come with plastic non-directional vents. Keep in mind if you want directional and/or close-able vents, often you might or might not want cold air blowing on you.
- CUSTOM KICK PANELS WITH AC LOUVERS are available, see page 20.



OLD AIR KITS

This unit is easy to install, mounts in original heater holes, lines can exit through original motor hole, includes grommet, or go through kick panel for a clean firewall. Automatic dehumidified defrost.

INSIDES KIT

Cable controlled. Rotary switches includes center pod & side louver pods. Add your choice of switches and louvers below to use with in dash mounting or extended dash. Our favorite is our extended dash with 2 round louvers, billet oval controls and center louver hidden behind dash. Other accessories available, just no room to list here

1953-55, round side louvers.....	5232-5355.....	\$650.00 kit
1956, rectangle side louvers.....	5232-56.....	\$710.00 kit

ADDITIONS AND UPGRADES

Prices are for addition to above kits

Rectangle slide controls

- Horizontal, anodized black ADD-5010-H..... \$265.00 ea
 - Vertical, aluminum ADD-5010-V \$125.00 ea
 - Oval slide control, aluminum ADD-5009-OVA.....\$160.00 kit
 - Oval slide control, anodized black..... ADD-5009-OVB.....\$160.00 kit
 - Electric controls ADD-5010-E\$100.00 kit
 - Kick panel exit 5001-KX\$75.00 kit
- Hoses go to kick panel area and along or under inner fender*

LOUVERS Can be added to vintage air or old air kits. Priced for each ROUND

- Plastic, chrome triangle, stationary..... 5017-R2 \$15.00 ea
Nice piece, this one is included at no charge in above kits
- Plastic, black, closes & directs 5014 \$14.50 ea
- Billet aluminum, directs..... 5018-AL \$109.00 ea
- Pro Line, billet aluminum, directs..... 5019 \$119.00 ea

OVAL

- Billet aluminum, directs..... 5015-D \$99.95 ea
- Billet aluminum, stationary 5015 \$75.00 ea

RECTANGLE, Brushed Aluminum

- Aluminum, 4", closes & directs 5020-4..... \$118.00 ea
- Aluminum, 6", closes & directs 5020-6..... \$119.95 ea
- Plastic, 4", closes & directs..... 5016-2..... \$14.50 ea

• HOSE Y ADAPTER..... 1953-25..... \$7.95 ea

• Y Adapter, Cable Controlled 1954 . \$22.50 ea \$22.50 ea

• REDUCER 2.5" to 2" 1952 \$4.25 ea

UNDER-HOOD KIT

Pick your choice of above inside unit and ADD an under hood kit below. Kit includes, compressor, hose kit, condenser, dryer. Order correct bracket separately

Plain compressor & dryer 5240-BK\$650.00 kit

Polished compressor, chrome dryer 5241-CH.....\$690.00 kit

Must be ordered with above insides kits





CONDENSER5025-14 \$170.00 ea
The most efficient cross-flow available, more durable and handles increased head pressure of R134a systems, Works with both R134a and R12 refrigerant. New large tube more efficient design.



AIR CONDITIONING RECEIVER DRIER
Works with R134a or R12

- Black.....5023..... \$32.50 ea
- Bracket, black.....5023-BKT \$6.95 ea
- Chrome.....5023-CH \$78.00 ea
- Chrome bracket, only fits chrome dryer....5024-CH \$20.50 ea



SANDEN COMPRESSOR

8.4 CIR, maximum 6000 sustained RPM, double groove clutch, same compressor supplied with all complete kits

- Plain finish compressor5080..... \$220.00 ea
- Polished stainless compressor5080-PL \$265.00 ea
- Polished with serpentine clutch5081-PP..... \$280.00 ea
- Compressor mount, Y block5051-YB.....\$130.00 kit
More compressor mounts listed page 80

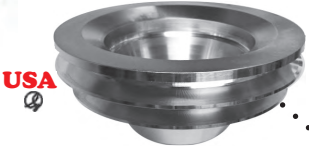

USA



PULLEYS

Fits 272, 292, 312 Y-block

- 2 groove v-belt crank pulley.....4510..... \$219.00 ea

ABS REDUCED GLOVE BOX

Sy's box, easy mounting about 3.5" deep. Use with A/C

- 1953-551024-M5355 \$25.50 ea
- 1956.....1024-M56 \$26.50 ea
- Installation clips & screws.....81025.....\$5.00 kit

"Y" HOSE CONNECTOR

- CABLE CONTROLLED1954..... \$22.50 ea
- ADAPTER, 2" to 2.5".....1952..... \$4.25 ea



USA



ELECTRIC FAN SWITCH & WIRING KIT

Turns fan on when the truck gets hot, Includes wire harness, sensor, fan relay, fuse & connectors.

- By water temp, adjustable5036.....\$52.50 kit
- By engine temp, range on 190°, off 170° ..5038.....\$69.95 kit
- By engine temp, 195°, for fuel injection....5038-195\$75.50 kit
- A/C compressor clutch sensor.....5037.....\$45.00 kit
Turns fan on when compressor clutch engaged, keeps A/C cooler even if the engine temperature is not hot enough to run the fan.



RADIATOR FAN

- 16" Superflo fan.....5031..... \$171.50 ea
- 16" 6 Volt Superflo fan.....6V-5031 \$99.00 ea
Ball bearing fan with aluminum motor housing to dissipate heat, reversible, push or pull. Mounts in shroud or on radiator, best one we have found. Width 16-3/4", thickness 3-7/8", blades 15-1/4"
- 16" Spal straight blade fan5030..... \$115.00 ea
- Fan mounting bolts, use without feet85033.....\$5.00 kit
- Wiring pigtail, attaches to Superflo fan5031-PT \$5.00 ea
- Attaching feet (6 pcs).....5031-FT \$6.50 set
- Fan bumpers, rubber85034..... \$5.75 set



FAN SHROUDS

See next page
If you need more cooling a shroud is often the answer. For proper cooling, air must be directed, moved and expelled. Do Not use a pusher fan, ineffective at moving air.



USA



- FAN ATTACHING BRACKETS.....5033..... \$69.95 pr
- Fan mounting pull strap kit5035.....\$8.50 kit
Goes through core, use if there is no other method to attach fan use good fan bumper kit , above85034..... \$5.75 set

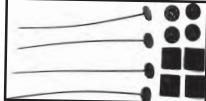

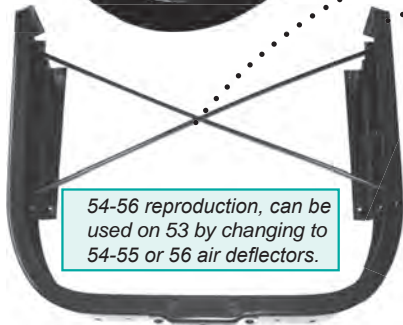
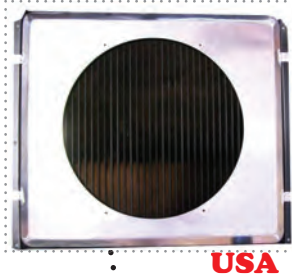

ABS RADIATOR SHROUDS

A must for proper cooling. Our custom shrouds need only 2 1/2" clearance and can decrease coolant temperature 30%. Leave black or paint, perfect fit, easy install, pre-drilled for fan

- 1 1/2" deep, 16" hole2313..... **SALE**\$115.00
- 1 1/2" deep, 16" hole with fan kit92313..... \$295.00 kit
- Fan, ABS shroud, hardware & engine temp wiring kit.
- 2 1/4" deep, 19" hole2318..... \$119.00 ea

Use with engine fan or mount electric fan to radiator

CUSTOM METAL SHROUDS 16" fan holes

ALUMINUM, fits Copper-Brass radiator only

- Shroud only2316-5356B...\$139.50 ea
- Shroud With Fan kit92316-53B...\$219.95 ea
- Aluminum fits aluminum radiator only.....2317-A.....\$120.00 ea
- Shroud With Fan kit.....92317-53A.....\$219.95 ea
- Aluminum, polished (alum radiator).....2317-AP.....\$156.50 ea
- Fan to metal shroud bolt kit.....82316.....\$9.50 set
- Plain steel2316.....\$158.50 ea
- Steel With flames.....GWG-SALE2312-FLM.....\$175.00**
- Polished SS Triangles..GWG-SALE2312-TR.....\$175.00**
- Polished SS Slots...GWG-SALE2312-SLT.....\$175.00**
- Polished SS Squared...GWG-SALE.....2315-16\$175.00**

ALUMINUM, WITH AIR BAFFLES ...2315-AR\$174.50 ea

STOCK STYLE ABS SHROUD

5" deep, 19.5" hole, stock style 8 cyl2314-A.....\$99.00 ea

RADIATOR FAN, SEE PREVIOUS PAGE

RADIATOR SHROUD MOUNTING BOLTS

- Polished stainless hex head82315-PX..... \$14.95 kit
- Polished stainless button head.....82315-PB..... \$15.50 kit
- Plain stainless hex, no acorns.....82315-SS..... \$6.50 kit
- Zinc, no acorns82315-Z \$3.00 kit

RADIATOR SADDLE CROSS-ROD BRACE

- 54-56 (53 use 54-55 air deflectors).....2333.....\$15.00 ea
- 54-56, to use with 53, use 54-55 air deflectors.

RADIATOR SUPPORT SADDLE *Oversized shipping*

- SADDLE2331-5456 **SALE**\$119.50
- To use with 53, use 54-56 air deflectors

- SADDLE ANGLE BRACE, left2332-L\$20.00 ea
- SADDLE ANGLE BRACE, right.....2332-R.....\$20.00 ea

- Radiator support metal insert2311\$6.00 ea
- Radiator support kit, 1953-552310-5355 \$19.95 kit
- Radiator support kit, 19562310-56 \$19.95 kit

UPPER RADIATOR VALANCE

Hood locking panel, goes over radiator from fender to fender

- Stock style2335.....\$139.95 ea

The following seals help direct air through radiator rather than around the sides, a big cooling factor when idling.

- "C" channel on underside of hood2309.....\$6.00 ea
- Hood to radiator seal, on hood2306.....\$7.95 ea
- Radiator to valance seal, on valance.....2307.....\$6.95 ea
- Radiator to gravel pan seal.....2308.....\$6.95 ea
- Valance bolts, polished hex81560-PX.....\$31.00 set
- Valance bolts, polished button.....81560-PB.....\$29.50 set

RADIATOR-BELT SPLASH SHIELD *Important piece, Protects radiator and engine belt area from flying road junk. Nothing will ruin your cooling system quicker than a rock in a belt.*

- Made in ABS plastic.....2329-A.....\$95.00 ea
- Mounting bolts, stock style82329.....\$5.50 ea
- Mounting bolts, polished.....82329-PS.....\$18.50 ea

All radiators are pressure tested and guaranteed for a full year. Radiator shipping is oversize. Use an electric fan unless going for as close to original as possible as when we are in traffic, or parades we are running close to idle and need the fan the most. Radiators on this page need around a 7-lb cap. You should never go over a 14-16 lb cap on any of these radiators. If you need more than that the problem is not with the radiator. Most engines should run 180-210 degrees. Shrouds, are needed most of the time to direct air "through" the radiator, otherwise you are only using half of it. Air also has to exit which is why our shrouds have exit holes.

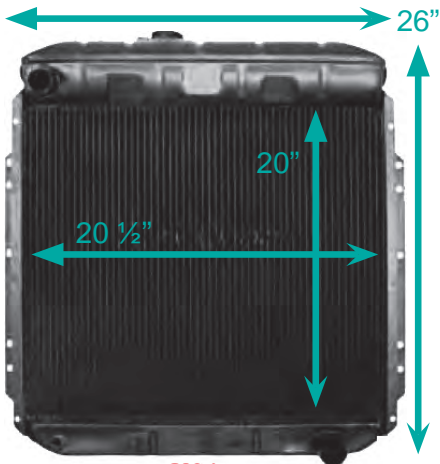

USA



USA



USA

IF YOU ARE OVERHEATING, GO THROUGH THIS CHECK LIST FIRST

1. Add an electric fan, make sure fan is getting enough power, fans need power, a scratch in the paint is not a ground, do NOT ground fan to radiator (serious electrolysis, radiator and system wide damage, WILL result.)
 2. Shroud the fan, make sure air is directed and can get through shroud.
 3. Check for slipping belts or collapsed hoses.
 4. Check radiator cap.
 5. Flush and refill with premium coolant, clean radiator, check for welding debris, etc aluminum, check for electrolysis residue.
 6. Use proper thermostat.
 7. Check water pump, truck uses lot of water, lot of air, racing style water pumps are too fast, water needs time to cool.
- Now you can decide if you need to replace the radiator.

COPPER / BRASS RADIATORS, STOCK STYLE

4 row, looks and fits like stock radiator but cools like an Indiana winter. This is not just an average 4 row radiator, it has a special heavy duty high efficiency core with full 1/2" tubes. We guarantee this radiator to cool almost any engine you can stick in an F-100. I had to back down on this claim now that you-all are stuffing 600HP and more under the hood! All copper-brass radiators use 7 lb caps. Note top is polished first then assembled so top straps do not show. Trans cooler included at no charge.

Top outlet	Bottom outlet	Black	Polished top
1 1/2"	1 3/4"	\$565.00 ea.	\$565.00 ea.
Center	Passenger	91050-4	91050-4PT
Center	Driver	91070-4	91070-4PT
Driver	Passenger	91055	91055-PT
Driver	Driver	91076	91076-PT
Passenger	Passenger	91056	91056-PT
Passenger	Driver	91075	91075-PT

FLAT HEAD		\$440.00 ea	\$645.95 ea
Both straight	Both straight	91040-90	91040-90PT
Both angled	Both angled	91040-45	91040-45PT



LS1 Engine, for this engine we suggest our cross flow, see next page
 Passenger

ALUMINUM RADIATORS STOCK STYLE

Looks like original but aluminum. Polished or unpolished, great radiator, great price, include a trans cooler built in. Cools engines up to 600 hp. For engines over 600 hp give us a call. Oversized shipping

Top outlet	Bottom outlet	Aluminum	Polished
		\$495.00 ea.	\$675.00 ea.
Top center.....	Bottom driver	91086-CD	91086-CDAP
Top center	Bottom passenger	91086-CP	91086-CPAP
Top driver.....	Bottom passenger	91086-DP	91086-DPAP
Top driver.....	Bottom driver	91086-DD	91086-DDAP
Top passenger	Bottom driver	91086-PD	91086-PDAP
Top passenger	Bottom passenger	91086-PP	91086-PPAP

Flat head		\$625.00 ea.	\$675.00 ea.
2 top & 2 bottom outlets, straight.....		91086-90A	91086-90AP



ALUMINUM CROSS-FLOW RADIATOR

ECONOMY

This is a nice radiator, fits in saddle with side brackets removed. 2 rows of 1" tubes, core is 17 5/8" X 22". Use for engines under 600 Hp. Have radiators for over 600 hp but no room for everything here.

- Top driver, bottom passenger91098-DP ...\$465.00 ea
- Top passenger, bottom driver91098-PD ...\$465.00 ea
- Top driver, bottom passenger, w/ shroud & fan .91099-DP ...\$599.00 ea
- Top passenger, bottom driver, w/ shroud & fan .91099-PD ...\$629.00 ea
- Shroud & fan only92340 \$235.00 kit

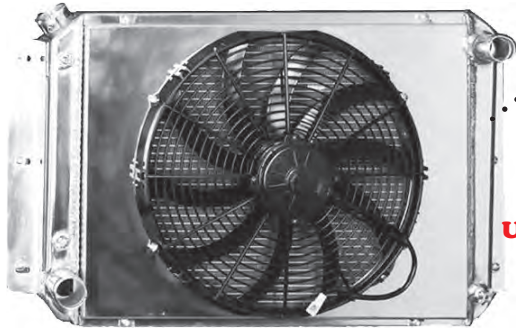

USA

SUPER NICE

A class piece, super nice, quality & satisfaction guaranteed. Designed and built exclusively for Mid Fifty. Standard size, bolts directly to original mounting brackets (small block). Large, remove original saddle angle brackets, Radiator mounts directly to saddle, special mounts are on radiator (big block or heavy cooling)

- Standard, top driver, bottom passenger91090-DP ...\$595.00 ea
- Standard, top passenger, bottom driver91090-PD ...\$535.00 ea
- Large, big block, top driver, bottom passenger..91091-DP ...\$535.00 ea
- Large, big block, top passenger, bottom driver..91091-PD ...\$535.00 ea
- LS1 engine, both outlets on pass, steam port ...91092\$625.00 ea
- LS1 engine, top driver, bottom passenger.....91093\$599.00 ea
- LT1 engine, reverse flow, special for LT191094\$599.00 ea
- Electric fan, see page 83.....5031\$171.50 ea



USA

- FAN MOUNTING BRACKET, for cross-flow....5034 \$69.95 kit
- Includes all mounting hardware. Brushed stainless.*



RADIATOR PIECES

- Radiator lower pet cock, angled2319-AG\$10.99 ea
- Radiator lower pet cock, straight2319-ST.....\$4.25 ea
- Radiator to saddle bolt kit
 - Polished stainless hex.....82301-PX \$12.50 kit
 - Polished stainless button.....82301-PB \$14.00 kit
 - Plain stainless.....82301-SS \$8.00 kit
- Cooler hole plugs.....82305\$2.50 pr



RADIATOR CAPS

- Thermo Cap, Temperature dial, 7 lb.....2303-TH \$42.50 ea
- Chrome, hexagon, 7 lbs2304-C7.....\$29.50 ea
- Chrome, round, 7 lbs.....2304-CR7\$18.00 ea
- Brass, hexagon, 7 lbs.....2304-B7\$18.00 ea
- Brass, round, 7 lbs.....2304-BR7\$20.00 ea
- Aluminum, 7lb, smooth top2303-A.....\$25.00 ea
- Aluminum, 7lb, ball milled top.....2303-AB\$25.00 ea
- Stock, 4 Lbs.....2305\$6.95 ea
- Stock, 7 Lbs.....2305-7\$6.95 ea



- OVERFLOW HOSE2327-H\$4.95 ea

- OVERFLOW TANK chrome, with cap. 15"2325\$54.50 ea
 - SACRIFICIAL ZINC ANODE2319-ZA.....\$13.95 ea
- Anti Electrolysis, 1/4 NPT



All header orders are double checked by the manufacturer to make sure they will fit in your truck the first time!

All headers made in the USA

All Headers listed on this page fit 1953-56 F-100 stock chassis unless specific chassis modifications are noted. Motor mounts, pads, oil pans and location of engine also determine the fit. See starter requirements. Black headers may be returned if not modified, Jet hot coated are not returnable as they should be fit before coating, we are happy to send them to you for fit first, then off for coating process. If you must return headers because of fit, please keep in mind we take the fit of our parts very seriously & research problems extensively.

***FOR BLACK JET HOT COATED Add "B" To part #**

- Y-BLOCK ENGINE 239, 272, 292, 312 stock chassis or IFS
 - Black Sanderson header 4300 \$395.00 pr
 - Jet hot coated, black 4300-JHB \$495.00 pr
 - Jet hot coated, silver 4300-JHS \$495.00 pr
 - Header gasket 4305-G8 **SALE** \$16.50
- FLAT HEAD ENGINE, FF-3
 - Plain..... 4306 \$330.00 pr
 - Jet hot coated, black..... 4306-JHB \$389.00 pr
 - Jet hot coated, silver..... 4306-JHS \$480.00 pr
 - Header gasket 4306-FH \$18.00 pr

FORD SMALL BLOCK, 289-351W

- FF4 and FF5 is more compact than FF2, see images
 - FF2 289-351W plain 4311 \$349.00 pr
 - FF2 289-351W jet hot coated, silver..... 4311-JH \$489.00 pr
 - FF2 289-351W jet hot coated, black..... 4311-2JHB \$525.00 pr
 - FF4 351W, plain 4313-4 \$345.00 set
 - FF4 351W, jet hot coated, silver 4313-4JHS \$459.00 pr
 - FF5 289-302, plain steel..... 4311-5 \$349.95 set
 - FF5 289-302, jet hot coated, silver 4311-5JH \$529.95 set
 - FF5 289-302, jet hot coated, black..... 4311-5JHB \$509.95 set
- Use Ford racing high torque mini starter #M-11000-A50

FORD CLEVELAND. 4 barrel only needs 3" clearance. FC3 passenger side exits higher and straight back, FC2 exits lower and down

- FC2 plain 4313-2 \$389.95 pr
- FC2 jet hot coated, silver 4313-2JH \$569.95 pr
- FC3 plain 4313-3 \$365.00 set
- FC3 jet hot coated, silver 4313-3JH \$425.00 set
- 2 barrel requires this adapter..... 4313-A \$79.00 pr

FORD BIG BLOCK, 429/460

- Black..... 4315 \$389.95 pr
- Jet hot coated. silver..... 4315-JH \$585.00 pr

FORD BIG BLOCK 390/427/428

- F427 exits lower than F390
- F427 plain 4314 \$389.95 pr
- F427 jet hot coated, silver 4314-JH \$585.00 pr
- F390 plain 4310 \$389.95 set
- F390 jet hot coated, silver 4310-JH \$585.00 pr

FORD BIG BLOCK, 429/460

- Plain..... 4316-461 \$389.95 pr
- Jet hot coated, silver..... 4316-461JH \$555.00 pr
- Jet hot coated, black..... 4316-461JHB \$585.00 pr

CHEVY

- Small block, plain..... 4317 \$289.95 pr
- Small block, jet hot coated, Silver..... 4317-JH \$450.00 pr
- Small block, jet hot coated, Black..... 4317-JHB \$469.95 pr
- Big block, plain 4319 \$389.95 pr
- Big block, jet hot coated 4319-JH \$579.95 pr
- Chevy LS1, plain steel..... 4318-LS1 \$345.00 pr
- Chevy LS1, Ceramic Black..... 4318-LS1B \$529.95 pr
- Chevy LS1, Ceramic Silver..... 4318-LS1S \$529.95 pr

EXHAUST DEFLECTOR TIPS

- Plain polished stainless 1451 **SALE** \$14.50
- Ford script..... 1450 \$16.90 ea
- V8 1452 \$16.90 ea
- Chevy bow-tie, for Chevy powered..... 1453 \$16.90 ea

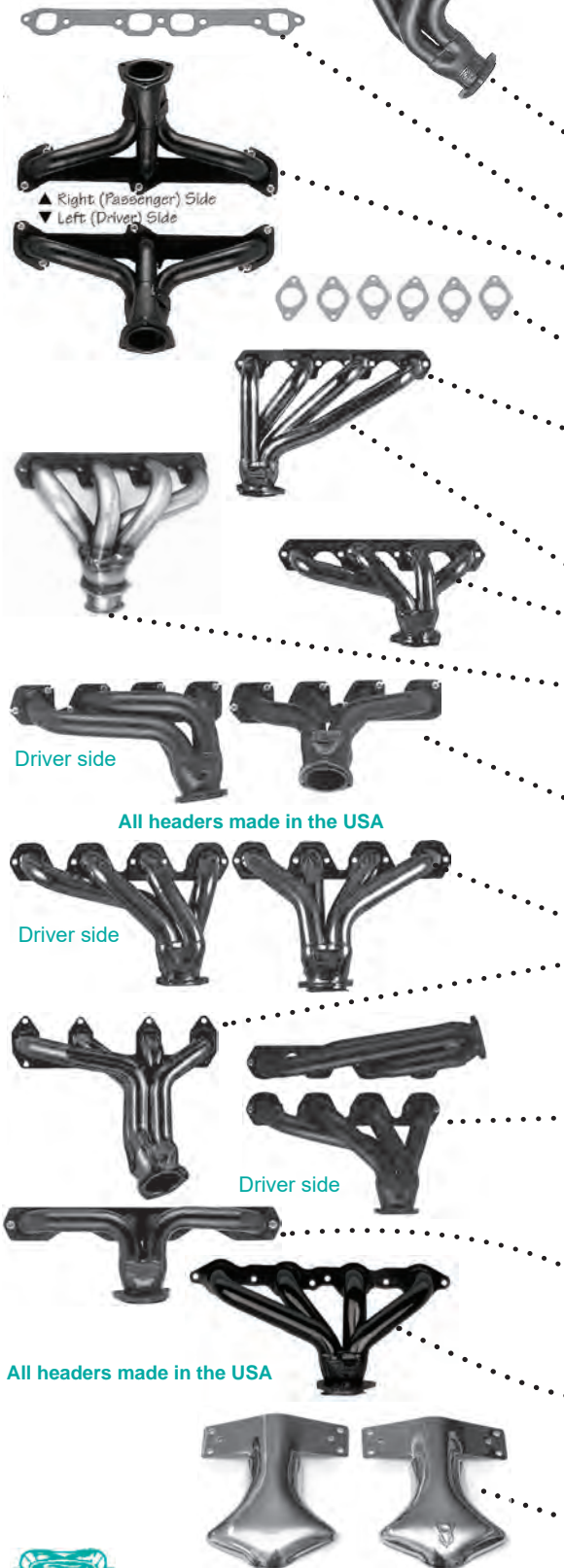

Driver side

All headers made in the USA

Driver side

Driver side

All headers made in the USA



53-56 FORD F-100 ENGINE INFO

QUICK HISTORY

The 1953 F-100 was the last year for the flathead engine in the US. Models in Canada, however, (Mercury M-Series), retained the flathead. 1954 saw the introduction of the new 239 CID overhead valve Y-block V8, dubbed "Power King." The six-cylinder engine's displacement was also increased from 215 to 223 CID and power steering was introduced as an option. In 1955 the 239 Y-block was replaced with the 272 and 292.

ENGINE LIST

Engine	Years	Power
215 CID Straight-6	1953	101 hp (75 kW)
239 CID Flathead V8	1953	100 hp (75 kW)
223 CID Mileage Maker I6	1954-55	115 hp (86 kW)
239 CID Y-block V8	1954-55	130 hp (97 kW)
223 CID Mileage Maker I6	1956	137 hp (102 kW)
272 CID Y-block V8	1956	173 hp (129 kW)
292 CID Y-block V8	1956	

THE FORD Y-BLOCK

The Y-block engine is a family of overhead valve V8 automobile piston engines from Ford Motor Company. It was introduced in 1954 (1953 trucks celebrated 50 years of Ford with a Flathead V8) on Ford trucks and cars to replace the side-valved Ford Flathead engine and was replaced by the Ford FE engine (on medium cars) and the Ford Windsor engine (on small cars) in 1962, and lasted until 1964 in Ford trucks.

239

The first Y-block on Ford automobiles was the 1954 239 in³ (3.9 L) Ford engine; known for its deep skirting, which causes the engine to resemble a Y. Rated at 130 hp (97 kW), it replaced the 239 in³ (3.9 L) flathead which was rated at 106 hp (79 kW). The Y-block was considered a major advancement over the flathead.

272

The 272 in³ (4.5 L) version was introduced in 1955. Most standard Fords used this engine. This engine, as well as the 292 version starting in 1956, was also produced by Ford of Brazil at its São Paulo plant facility (Ipiranga plant). The 272 version was used on Brazilian F-series trucks until 1977 and on the Brazilian Galaxie 500, launched in April 1967.

292

The 292 in³ (4.8 L) was also introduced in 1955. It was used in the Ford Thunderbird, Mercury, and some high-end Ford cars. In 1956, it was an optional engine for Ford cars, was commonly used in high-end models, and called the "Thunderbird V8" (the optional larger 312 in³ engine was called the "Thunderbird Special V8"). The 292 in³ was also used in Ford trucks, namely the F-100, through 1964.

223 MILEAGE MAKER I6

The 215 from the F1 trucks grew to 223 cu in (3.7 L) I-6 for the 1954 F-series. Output was at 115 hp (86 kW) (as the "Mileage Maker" in the trucks) and 120 hp (89 kW) in the 1955 Ford cars. Power was up to 137 hp (102 kW) in the 1956 trucks. The 223 cu in (3.7 L) I-6 was also used in 1963-1964 Ford Trucks which also used the Autolite 1100 Carburetor with stamping C4TF-E and produced 145 hp (108 kW) with 206 ft-lbs of torque.

239 FLATHEAD

Ford introduced the 239 cu in (3.9 L) engine in 1939. It produced 95 hp and 170 lb-ft. This was done to provide a more powerful engine for the Mercury cars, which Ford Motor Company started making in 1939. It was used in Mercury's in 1939 and in Fords in 1946. The latest iteration of this engine, used from 1948 to 1953, was initially designated the 8BA in automobiles and the 8RT in trucks. 8RT remained the truck engine designation throughout the entire run from 1948 through 1953. They were essentially identical. Earlier Ford V8s had the unique Ford designed distributor driven directly from the forward end of the camshaft, which was an inconvenient location for maintenance. This final flathead used a more conventional distributor driven at a right angle to the crankshaft and located at the right front of the engine where it was readily accessible. The water inlets and thermostat housings were moved to the front end of the heads, and the 24 studs and nuts that attached the heads on the old engine were replaced by 24 bolts.

ENGINE BLOCK COLOR	FIRING ORDER	223 6 CYLINDER	272 8 CYLINDER
1955-56 Pale yellow	223..... 1-5-3-6-2-4	Spark plug gap 0.035"	Spark plug gap0.035"
1954, thanks, Abe..... Red	239, 256 1-5-4-8-6-3-7-2	Timing, std Tns 4° BTDC	Timing.....8-10° BTDC
1953 thanks henryGreen	272, 279, 332.... 1-5-4-8-6-3-7-2	Bore and stroke ... 3.625" x 3.6"	Bore and stroke3.625" x 3.3"



6 CYLINDER
Push Rod Cover gasket....4337-6G..... \$13.99 ea

Y-BLOCK ENGINE PARTS



Y-block spark plug wire set.....1430.. **SALE**.. \$39.50
Valve cover, cork, 1954-594333-G.....\$14.75 set
Valve cover, neoprene, 1954-59.....4332-N..... \$36.95 pr



Oil pan gasket, 1954-644334-G..... \$14.95 ea
Valley cover4337-G..... \$6.50 ea



Timing cover set, 1954-644336-G.....\$17.95 set
Rear main seal4338-G..... \$23.95 ea



Head gaskets.....4335-G..... \$36.00 ea



Intake manifold, early 19544339-GE\$12.75 set



Intake manifold, 1955-634339-G.....\$13.95 set
1955-63 272-292-312



Cross-over pipe gasket.....4341..... \$2.95 ea



Power steering bracket, Saginaw pump4342-Y..... \$156.50 ea

Y-BLOCK ALTERNATOR BRACKET.....4350-B.....\$114.80 ea
Puts alternator in generator location



Billet aluminum 2 groove pulley.....4510..... \$219.00 ea
Fits 272-292-312, add ac, power steering, etc

DIP STICKS

- Flat head V81418..... \$25.00 ea
- Flat head V8, chrome1418-CH \$30.00 ea
- Y block V81419..... \$25.00 ea
- Y block V8 chrome1419-CH \$30.00 ea
- DIP STICK TUBE, Stainless.....1417..... \$49.95

OIL BREATHER CAP, Stock.....1410-5568 \$9.95 ea

OIL FILTER

- 6-8 cylinder canister type.....1415.. **SALE**.. \$9.95
 - Spin on type.....1413..... \$5.95 ea
 - Spin on type with check valve1416..... \$14.00 ea
 - Oil filter spin on adapter.....1411..... \$21.50
- *Fits 6 cyl flat-heads from 1952 & Y-blocks from **SALE***

Oil light sending unit2657..... \$10.50 ea





ORIGINAL MOTOR MOUNTS



- Rear side "u" pad, use 2 1405..... \$14.95 ea
- Bushing use 2 1421..... \$5.00 ea
- Rear side lower small pad use 2..... 1406..... \$7.25 ea
- Rear side bolt use 2 81407..... \$3.15 ea
- Front bar pad 1404..... \$19.95 ea
- Bar pad bolts..... 81404..... \$3.50 set
- Front bushing..... 1421..... \$5.00 ea
- Front round pad 1403..... \$5.95 ea
- Front center bolt81407..... \$3.15 ea

FLAT HEAD ENGINE PARTS

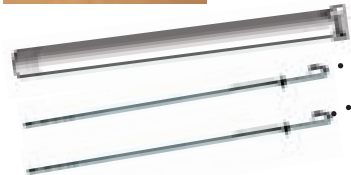
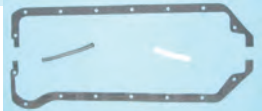
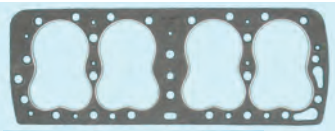

- Flat Head Cylinder gaskets, Driver.....4335-FGL ... \$33.00 ea
- Flat Head Cylinder gaskets, Passenger4335-FGR... \$33.00 ea
- Intake manifold gasket.....4339-FG \$10.75 ea
- Oil pan gasket.....4334-FG \$16.00 ea
- Rear main seal4338-FG \$19.00 pr
- Spark plugs, 239.....1431..... \$3.00 ea
- DIP STICK TUBE, 239.....1417-4853 .. \$12.00 ea
- Dip Stick, Flat Head V8, Painted1418..... \$25.00 ea
- Dip Stick, Flat Head V8, Chrome.....1418-CH \$30.00 ea
- OIL FILLER TUBE CAP.....1410-4853 .. \$25.80 ea

OTHER ENGINE AND TRANSMISSION PARTS

TRANSMISSION PAN GASKETS

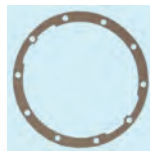

- Trans oil pan, Ford-O-Matic.....4451..... \$9.00 ea
- Trans oil pan, Ford-O-Matic.....4450..... \$7.25 ea
- Rear end carrier gasket.....1338..... \$6.50 ea
- Tail Pipe Hanger1460..... \$7.50 ea
- V8 single exhaust crossover pipe, 1953.....1461..... \$45.00 ea

We find most small blocks should sit about 34 3/4" from front of frame under bumper to center of motor mount. All IFS mounts can use most any stock pad as you are trimming to fit for height. Crossmember mounts are designed to use specific pads which are listed with each crossmember mount. Tubular mounts can be used in frames from 24" to 37" trim to fit.

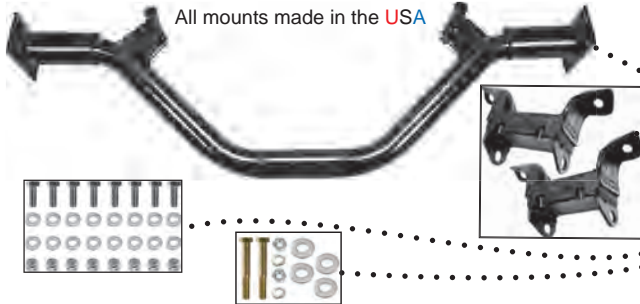

All mounts made in the USA

FORD SMALL BLOCK

- 221 • 260 • 289 • 302 • 351W & PRE 1973 CLEVELAND
- Mount, crossmember.....4419.....\$64.50 ea
- Mounting pads, For all engines, Except pre '73 Cleveland Pair4420.....\$52.50 pr
- Mounting pads, pre '73 Cleveland.....4478.....\$65.00 pr
- Mount to frame bolts (included above) 84438.....\$8.50 kit
- Pad to mount bolt set.....84419.....\$5.90 kit
- Pad to block bolts84422.....\$5.00 kit

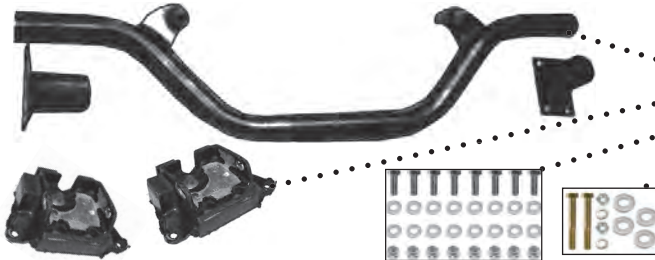

- 351M • 400M • 351C 1973-UP CLEVELAND
- Mount, crossmember, with bolts.....4477.....\$58.50 kit
- Mounting pads4478.....\$65.00 pr
- Mount to frame bolts (included above) 84438.....\$8.50 kit
- Pad to mount bolt set.....84419.....\$5.90 kit
- Pad to block bolts84422.....\$5.00 kit



- SIDE MOUNT 221 • 289 • 302 • 351W • 351C
- Includes pads & bolt kit (not for engines using 4478 pads)*
- Mount, side mount.....4445.....\$98.50 kit
- Replacement pads, does both sides4446..... \$36.50 set

All mounts made in the USA



FORD BIG BLOCK

- FE BLOCK • 332 • 352 • 390 • 406 • 427 • 428
- Mount, crossmember.....4437.....\$99.00 ea
- Needs "car" oil pan (rear sump) intended for 34" frame*
- Mounting pads4438.....\$50.00 pr
- You will most likely need these pads as they were seldom used in production cars.*
- Mount to frame bolt kit.....84437.....\$4.50 kit



- 429 • 460
- Mount.....4413.....\$104.95 kit
- Some Lincoln & Mercury oil pans may need changed as they are too deep, use 4 quart oil pan.*
- Mounting pads4498.....\$75.00 pr
- Mount to frame bolts (included above) 84438.....\$8.50 kit
- Pad to mount bolt set.....84413.....\$5.90 pr
- Pad to block bolts84422.....\$5.00 kit



- SIDE MOUNT 429 • 460
- Includes pads and bolt kit*
- Mount.....4485.....\$98.50 kit
- Replacement pads,.....4446..... \$36.50 set





All mounts made in the USA

CHEVY & GM ENGINES

- SMALL & BIG BLOCK 265 • 350 • 396 • 454
- Mount, crossmember.....4410..... \$59.80 ea
- Mounting pads4411 \$14.50 pr
- Mount to frame bolts (included above).... 84438.....\$8.50 kit
- Pad to crossmember bolts..... 84410.....\$5.90 kit

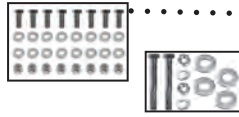

LS1 ENGINE

- Mounting Pads.....4412.....\$119.00 set
- *Conversion mounts use with crossmember mount above #4410 see also our new radiators for this engine.*
- Adjustable mounts4412-AM... \$95.00 set
- Use with 4411 pads above



GM SIDE MOUNT 283 • 350 • 396 • 454

Includes pads and bolt kit

- GM Mount4402.....\$106.50 kit
- Replacement pad kit, both sides4446..... \$36.50 set



These mounts do not work with 390 engine pads



IFS MOTOR MOUNTS

- IFS TRIM TO FIT MOTOR MOUNT, *Use with Camaro & Mustang II, etc independent front suspensions. IFS mounts can use most any stock pad as you are trimming to fit for height.*
- Mounts.....4462.....\$65.00 kit
- IFS SIDE MOUNTS, *Very strong, clears most IFS suspension and steering systems, easy to use & modify*
- Chevy engines.....4463-C..... \$79.00 pr
- Ford engines.....4463-F \$79.00 pr
- MOTOR TO MOUNT BOLT KIT
- Chevy84410.....\$5.90 kit
- Small block Ford.....84419.....\$5.90 kit
- Big block Ford.....84413..... \$5.90 pr

TRANSMISSION MOUNTS

- TUBULAR MOUNT
- Automatic, Ford or GM4436-AT \$46.50 ea
- Offset 1"4440..... \$78.50 ea
- *Offset mount to passenger side for most Volare Front IFS*
- Frame to mount bolt kit.....84437.....\$4.50 kit



All mounts made in the USA



- DROPPED TRANS MOUNT
- 6 inch drop, includes hardware.....4442..... \$78.50 ea
- Frame to mount bolt kit.....84438.....\$8.50 kit

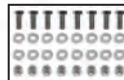

- C4-C6 FORD AUTOMATIC AND CHEVY AUTOMATIC
- Mount includes hardware4436..... \$49.00 ea
- Frame to mount bolt kit.....84437.....\$4.50 kit



MOUNT TO TRANSMISSION PAD

- Chevy, all applications4434..... \$25.00 ea
- Ford C4-C6 auto.....4435..... **SALE** \$12.50



WINDSHIELD COLORS

- Clear
- Tinted (greenish) 72%
- Shaded top (green tint to dark teal)
- Smoke (gray) 72%
- Smoke with shaded top

SIDE AND REAR WINDOW COLORS

- Clear
- Tinted (greenish) 44%
- Smoke (gray) 44%
- Double dark (limo) 22%

OUR GLASS is sanded and buffed to a fine smooth rounded edge, tempered for strength and safety. Unconditionally guaranteed to fit and arrive in one piece. Windshields and Big Back Windows are Laminated. Side windows and Standard Rear windows are Tempered. Tempered glass is safer and stronger.

COMPLETE GLASS KITS - see next page
SOLID SIDE WINDOWS - see page 106-107
WINDOW TRIM - see page 29 and 120



WINDSHIELDS, See top of page for color information

1953-55 Windshield	Clear	1711-5355C	\$250.00 ea
.....	Tint.....	1712-5355T	\$250.00 ea
.....	Smoke	1715-5355	\$250.00 ea
1956 Windshield	Clear.....	1711-56C	\$295.00 ea
.....	Tint.....	1712-56T	\$295.00 ea
.....	Smoke	1715-56	\$295.00 ea

SHADED WINDSHIELDS

Tinted with Teal top.....	1953-55	1714-5355ST.....	\$250.00 ea
Tinted with Teal top.....	1956.....	1714-56ST.....	\$295.00 ea
Smoke with Dark top ..	1953-55	1716-5355	\$295.00 ea
Smoke with Dark top .	1956.....	1716-56.....	\$295.00 ea

SUN-SHIELD, Roll up reflective heat shield for windshield, keeps damaging sun from interiors. Exclusive, made just for F-100's

.....	1953-55.....	0126-5355	\$32.95 ea
.....	1956	0126-5660	\$32.95 ea



WRAP AROUND REAR WINDOW

Installs from outside, trim in rubber first.

Clear.....	1724-56CLR.....	\$265.00 ea
Tint	1724-56TNT	\$275.00 ea
Smoke.....	1724-56SMK	\$275.00 ea

STANDARD REAR WINDOW See top of page for colors.

Rear window installation, glass goes in from inside of cab, pull rope from outside. Oversized shipping

Clear.....	1717-CLR	\$88.50 ea
Tint	1717-TNT	\$88.50 ea
Smoke	1717-SMK	\$88.50 ea

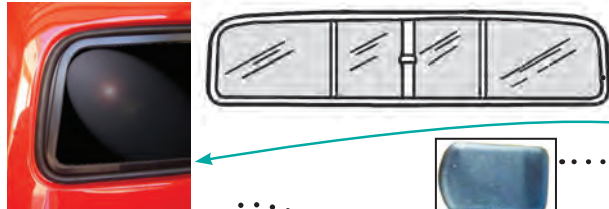

SLIDING REAR WINDOW

Smoke glass, black frame	1721.....	\$195.50 ea
Rear window gasket, USA.....	3103.....	\$25.00 ea
•Replacement lock and latch set.....	1722.....	\$15.00 ea

SIDE WINDOW GLASS

1953-55	Clear	1706-5355CLR.....	\$45.00 ea
.....	Tint.....	1706-5355TNT.....	\$45.00 ea
.....	Smoke.....	1706-5355SMK.....	\$45.00 ea
1956	Clear	1706-56CLR.....	\$45.00 ea
.....	Tint.....	1706-56SMK	\$45.00 ea
.....	Smoke.....	1706-56TNT.....	\$45.00 ea

VENT GLASS

1953-55	Clear.....	1700-5355CLR.....	\$24.00 ea
•1953-55	Tint	1700-5355TNT	\$24.00 ea
1953-55	Smoke.....	1700-5355SMK	\$24.00 ea
1956.....	Clear.....	1700-56CLR	\$24.00 ea
1956.....	Tint	1700-56TNT	\$24.00 ea
1956.....	Smoke.....	1700-56SMK	\$24.00 ea

Some 1953-55 glass passes too far up in outer corner, best solution is to split back corner of felt channel for, letting glass pass through slit when rolled up. Our glass is adjusted for better fit on 53-55 trucks



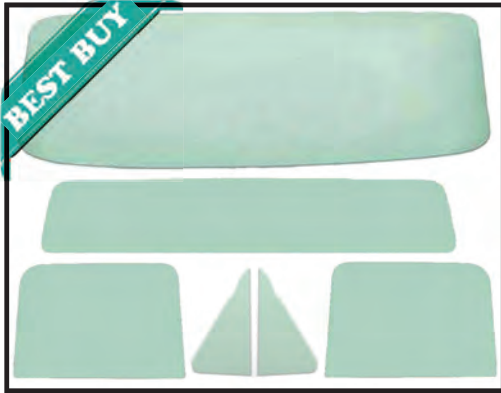

COMPLETE WINDOW GLASS KIT
WITH STOCK SIDE WINDOWS, Includes: Windshield, Standard Rear Window, 2 Sides and 2 Vents & install kit.

1953-55.....Clear.....	91715-5355CLR.....	\$450.00 kit
.....Tinted.....	91715-5355TNT.....	\$450.00 kit
.....Smoked.....	91715-5355SMK.....	\$450.00 kit
1956 Kit with Standard Small Window		
.....Clear.....	91715-56CLR.....	\$475.00 kit
.....Tinted.....	91715-56TNT.....	\$475.00 kit
.....Smoked.....	91715-56SMK.....	\$475.00 kit

SAVE WITH KITS!!!



WINDSHIELD AND REAR WINDOW INSTALL KIT
93126\$25.00



1953-55 COMPLETE GLASS KITS WITH SOLID SIDE WINDOWS

Windshield, Rear Window, install kit and Curved Solid Side Window kit.

STAINLESS BEAD
Clear.....91710-5355C.....\$650.00 kit
Tinted.....91710-5355T.....\$750.00 kit
Smoked.....91710-5355S.....\$650.00 kit

BLACK BEAD
Clear.....91710-5355BC.....\$650.00 kit
Tinted.....91710-5355BT.....\$750.00 kit
Smoked.....91710-5355BS.....\$650.00 kit

1956 COMPLETE GLASS KITS WITH SOLID SIDE WINDOWS

Windshield, Rear Window, install kit and Solid Side Window kit.

STAINLESS BEAD
Clear.....91711-56C.....\$650.00 ea
Tinted.....91711-56T.....\$650.00 kit
Smoked.....91711-56S.....\$650.00 kit

BLACK BEAD
Clear.....91711-56BC.....\$650.00 ea
Tinted.....91711-56BT.....\$650.00 ea
Smoked.....91711-56BS.....\$650.00 ea



GLASS HOLDER SUCTION CUPS, Handy for holding glass up while you work inside the door. We like to use 2 on each glass to hold straight..... 1742-GH..... \$17.50 set

SIDE GLASS SEAT TAPE... 81620..... \$5.00 pr

GLASS PATTERN KIT Side, vent, rear. Do-it-yourself
1953-55.....B-1710-5355.....\$15.00 kit
1956.....B-1710-56.....\$25.00 kit

DRY GRAPHITE, use in channels and felts for best results. Contains about half oz.....3128-23.....\$2.95 ea

WE STOCK ALL BRANDS OF RUBBER

If you have a question give us a call. Many are offering imported "econo" rubber these days. We must offer to Complete, however if you live in a hot or arid area, like we do, or plan on keeping the truck for a long time we do not advise it. Some of our custom builders like it for first fit, then put good stuff on after paint. We keep track of this stuff all the time, rubber sometimes changes and what we might advise might change over time.

NEED IT ALL RUBBER AND ANTI-RATTLE KIT, kits are always cheaper.

Windshield, rear window, vent rubber seals, outer door seals, polished stainless division bars with vent seats, lower felt wipes & upper & back channels, all with polished stainless bead, hardware, glue & instructions. See page 95

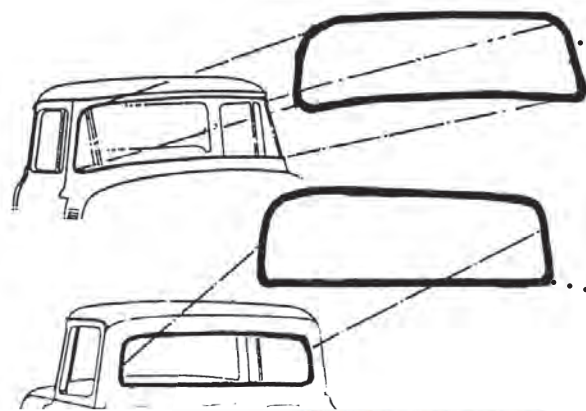
**• WINDSHIELD WEATHERSTRIP**

Windshields go in from outside. Glass, rubber, trim, then in truck.

1953-55, USA.....	3100-5355A.....	\$39.95 ea
1953-55, Imported.....	3100-5355E.....	\$28.50 ea
1956 with groove for trim, USA.....	3101-56GA.....	\$39.95 ea
1956 with groove for trim, Import.....	3101-56GE.....	\$34.50 ea
1956 without groove, USA.....	3102-56NA.....	\$39.95 ea
1956 without groove, Import.....	3102-56NE.....	\$28.50 ea

CUSTOM CAB WINDOW TRIM see page 120

1956 Windshield Custom cab had trim, 1956 Big Back had trim.

• REAR WINDOW WEATHERSTRIP

1953-56 standard window, USA.....	3103-A.....	\$25.00 ea
1953-56 standard window, Import.....	3103-E.....	\$20.00 ea
1956 big back window, USA.....	3104-BBA.....	\$39.80 ea
1956 big back window, Import.....	3104-BBE.....	\$39.00 ea
1956 big back with no trim.....	3104-NO.....	\$45.00 ea

Panel rear windows.....P-3132.....\$59.95 pr

• BUTYL WINDOW SEALER

3126.....\$9.95 ea
Seals rubber correctly, Windex or soap up a razor blade & rag, run Butyl around weatherstrip, between rubber and glass & wipe immediately for clean seal. We do not advise using new silicone or adhesive type windshield sealers.

• PLASTIC RAZOR BLADE

80106.....\$1.95 set
Set of 5. Handy for putting on window sealer, see above, instant "finger-nail". One of Sy's favorite things

• WINDOW INSTALL ROPE TOOL

3124.....\$15.95 kit
What a help, tool feeds correct size rope into rubber groove

• GLASS HOLDER SUCTION CUPS

Handy tool, holds glass up while you work inside door.....1742-GH.....\$17.50 set

• WINDOW INSTALL TOOL KIT

93126.....\$25.00 kit
Includes window rope tool, butyl sealer, plastic razor blade and rubber gloves

• WEATHERSTRIP LUBE

83127.....\$10.80 ea

• WEATHERSTRIP MULTI-USE TOOL

83124.....\$14.95 ea

**STANDARD REAR WINDOW**

Please read this! Rubber looks like this

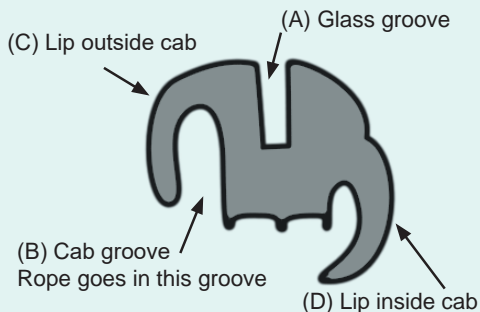

- The rubber is the same all around, there are no corners
- The standard rear glass is larger than the opening
- The standard rear glass is installed from **INSIDE** of truck
- You are pulling rope from **OUTSIDE** of truck (B)
- The larger part of the rubber (D) goes **INSIDE** truck
- The smaller part of rubber (C) goes **OUTSIDE** truck

If you install it backwards, then call and tell us there is something wrong with rubber or that glass is too big for hole, etc well then... We know you did not read the directions, and, you owe us lunch. If you are a professional glass installer, we will be expecting dinner

NOTE: Wrap around rear window installs like windshield, both are installed from outside of truck. In this order; rubber on glass, trim in rubber, entire assembly into truck, from the outside!



"I NEED ALL" CAB WINDOW WEATHER-SEAL & ANTI RATTLE KIT

Rear window seal
Standard or wraparound
USA Rubber

Windshield seal
With or without groove for stainless trim
USA Rubber

Stainless division bars

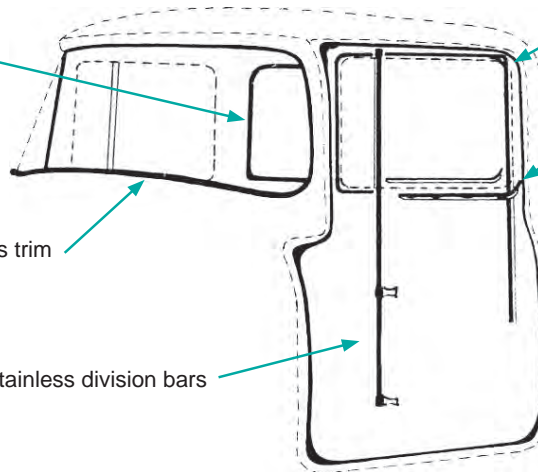

Upper & back channels
with stainless bead

Lower felt wipes with stainless bead

Door seals, hollow core

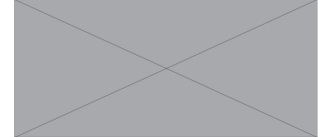

INCLUDES: windshield weatherstrip with or without groove for trim, rear window weatherstrip to fit standard or wrap around window, vent rubber seals, outer door seals, polished stainless division bars with vent seats, lower felt wipes & upper & back channels, all with polished stainless bead, hardware, glue & instructions.

1953-55	93101-5355 ...	\$339.95 kit
1956 standard rear window		
Windshield no groove for trim.....	93101-56N	\$339.95 kit
Windshield with groove for trim ...	93101-56W ..	\$339.95 kit
1956 wrap around rear window		
Windshield with groove for trim ...	93101-56B	\$359.95 kit
Panel truck.....		See page 191

I NEED IT ALL, AND I MEAN ALL RUBBER KIT

BEST BUY! SAVE \$



INCLUDES: the kit above plus cowl vent seal, hood to cowl seal, hood to radiator seal, hood bumper kit, radiator upper seal, gravel pan seal, running board to cab seal, cab plugs, front cab mounts upper & lower, rear arm bumpers, front & rear fender welt, running board grommets, firewall wire grommet, choke, throttle, heater, & overdrive grommets, bed insulators, gas tank insulators & gas tube grommet.

1953-55	93100-5355	\$499.95 kit
1956 standard rear window		
Windshield no groove for trim.....	93100-56N.....	\$499.95 kit
Windshield with groove for trim	93100-56W.....	\$499.95 kit
1956 wrap around rear window		
Windshield with groove for trim	93100-56B.....	\$499.95 kit
Panel truck.....		See page 191

Lots of choices out there, and we offer them all. Please read this and do not hesitate to call for help deciding which is best for you.

- Exact of original style is just that, exact of fords original. Should set with door closed for a at least a week or so after installation to "seat" or you may think it is too thick. It will eventually squash down a little.
- Best is our new hollow core seals, solves most normal fit problems, made more like late model rubber, allows door to close & seal properly.
- Domed style, kind of a universal rubber, Dan uses it on trucks he builds with good success. You may need to double up in corners or bring it out more toward edge.
- Econo rubber, others advertise and sell this cheaper seal, so we offer it as well. I do not list it here as it is, frankly, terrible, stinky, glue will not stick to it, yuck!!!!

DOOR WEATHERSTRIPPING

Each pair is correctly molded in right and left with bottom corners, unconditionally guaranteed. 1953-55 doors do well with our new hollow style or domed style. Note adjustment procedures and hinges.

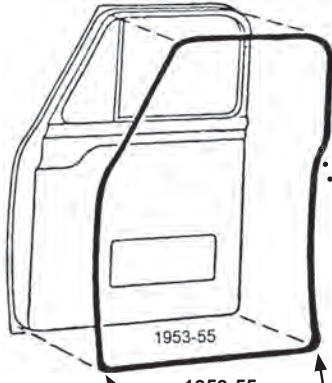

1953-55
Start in each bottom corner

HOLLOW STYLE, BEST

1953-55, pair	3109-5355	\$55.00 pr
1953-55, one door only, Left.....	3109-5355L.....	\$35.00 ea
Right	3109-5355R.....	\$35.00 ea
1956, pair.....	3109-56	\$55.00 pr
1956, one door only, Left.....	3109-56L.....	\$36.00 ea
Right	3109-56R.....	\$36.00 ea

DOME STYLE, GOOD

Universal, hollow core, no corners, self adhesive

Roll does 2 doors.....	3106-DM.....	\$45.00 pr
------------------------	--------------	------------

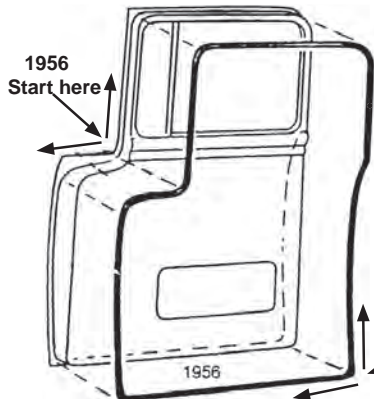

Do this corner next

EXACT OF ORIGINAL, made in USA

1953-55 . USA	3105-5355	\$59.95 pr
1956..... USA	3105-56	\$68.50 pr



DOOR SEAL LOWER RETAINER STRIP

A must for all years.

1953-56	7727	\$4.50 ea
---------------	------------	-----------

WEATHER-STRIP GLUE, BLACK One tube will do both doors.

We do not like the yellow stuff only because it is yellow, so use this

Large tube	3125	\$9.57 tb
------------------	------------	-----------



DOUBLE SIDED TAPE

Place on rubber then peel back as you apply. Comes in a very large roll, handy for many things though

60 yds.....	3129	\$16.50 rl
-------------	------------	------------



DOOR HINGE, ADJUSTABLE

This hinge allows for fine tune adjusting of in and out and angles. Easier than Fords solution of bending the entire door. Depending on where adjustments are needed you may need 1 or 2 per door. Includes adjustment set screws but not hinge bolts.

One hinge.....	1179.....	\$85.00 ea
----------------	-----------	------------

Also see door hinge bucket and pillars on page 119



Dome style

Hollow core

Original style



Seal goes in door like this



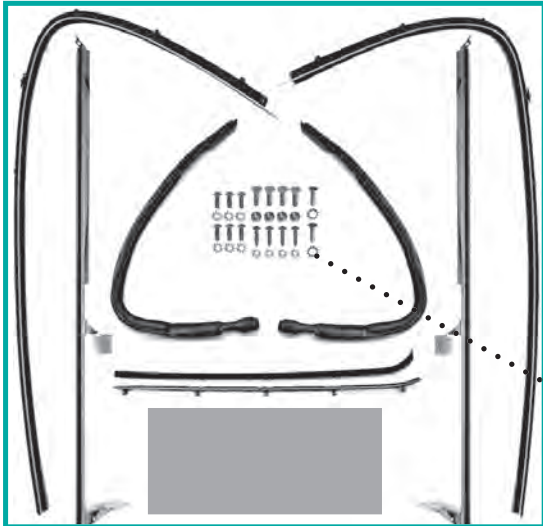

DELUXE SIDE WINDOW ANTI-RATTLE KIT

Does both doors. Includes: assembled division bars with stainless post and bead, lower felt wipers with clips and stainless bead, upper and back channels with stainless bead and installed clips

1953-55	3150-5355.....	\$199.95 kit
1953-55 Glue in Channels.....	3151-5355.....	\$179.95 kit
1956.....	3150-56.....	\$199.95 kit
1956 Glue in Channels.....	3151-56.....	\$179.95 kit
1953-55 with vent rubbers.....	93151-5355.....	\$239.00 kit
1956 with vent rubbers	93151-56.....	\$225.00 kit

Trouble with division bar fit? Check glass, it is only a fraction of an inch taller than it is wide, if it's in sideways it will cause all kinds of binding.

INDIVIDUAL ANTI-RATTLE PIECES

DIVISION BAR & CHANNEL HARDWARE KIT

Zinc.....	83151-Z.....	\$4.50 kit
Stainless.....	83151-SS.....	\$7.50 kit
Polished stainless.....	83151-PS.....	\$14.50 kit

WINDOW CHANNEL CLIPS83107-5 \$5.50 set
Correct clip but today's glues work even better.

UPPER & BACK WINDOW CHANNELS *Oversized shipping*

1953-55, stainless bead, with clips.....	3107-5355.....	\$35.95 ea
1956, with bead, with clips.....	3107-56.....	\$32.00 ea
Glue in, stainless bead.....	3107-GS.....	\$23.50 ea
Glue in, no bead.....	3107-GNB.....	\$29.50 ea
Glue in, extra long, 96", use for chop tops, solid sides, etc		
Stainless bead.....	3107-UN.....	\$42.50 ea
No bead.....	3108-B.....	\$42.50 ea

CLEAR SILICONE3127 \$4.25 ea
Use to install channels, lower felts and general sealing.

DRY GRAPHITE.....3128-23 \$2.95 ea
Use in felt channels makes them "slick"

LOCK SIDE UPPER & BACK CHANNEL BRACKET

Piece upper & back channels slide into, attached to latch (back) side of door above & below star.

Driver side	3114-L.....	\$40.00 ea
Passenger side.....	3114-R.....	\$40.00 ea
Mounting bolts, both sides, stainless.....	83153-SS.....	\$4.00 set
Mounting bolts, both sides, polished.....	83153-PS.....	\$6.90 set

LOWER FELT WIPES *Clips installed, stainless bead, does one door*

1953-55	3111-5355.....	\$29.80 pr
1956.....	3111-56.....	\$29.80 pr
Install clips, 10 pieces.....	83111-10.....	\$8.95 kit
Do-it-yourself felts, not curved at the end, glue or use clips		
Stainless bead.....	1727-ST.....	\$17.50 pr
Black bead.....	1727-BK.....	\$17.50 pr

DIVISION BAR ASSEMBLY *Complete, with stainless post & bead*

1953-55, right...3116-5355R or left...3116-5355L.....	\$44.80 ea
1956, right...3116-56R or left...3116-56L.....	\$44.80 ea
Install hardware, stainless.....	83152-SS..... \$3.00 kit
Install hardware, polished stainless.....	83152-PS..... \$8.25 kit
Captive nut & cage.....	81104..... \$2.35 ea

VENT SEATS, RUBBER *Don't order with division bars, are installed*

Glue on style	3120.....	\$6.50 pr
Steel reinforced 1953-55, one piece.....	3121-5355.....	\$9.00 ea
Steel reinforced 1956, one piece.....	3121-56.....	\$9.00 ea

RIVET INSTALLATION TOOL KIT81148..... \$17.25 kit
Includes tool and 36 rivets, for upper & lower vent frame pivots, upper cups, handle brackets and division bars

RIVET PACK 40 rivets, 3 sizes81147..... \$9.00 set

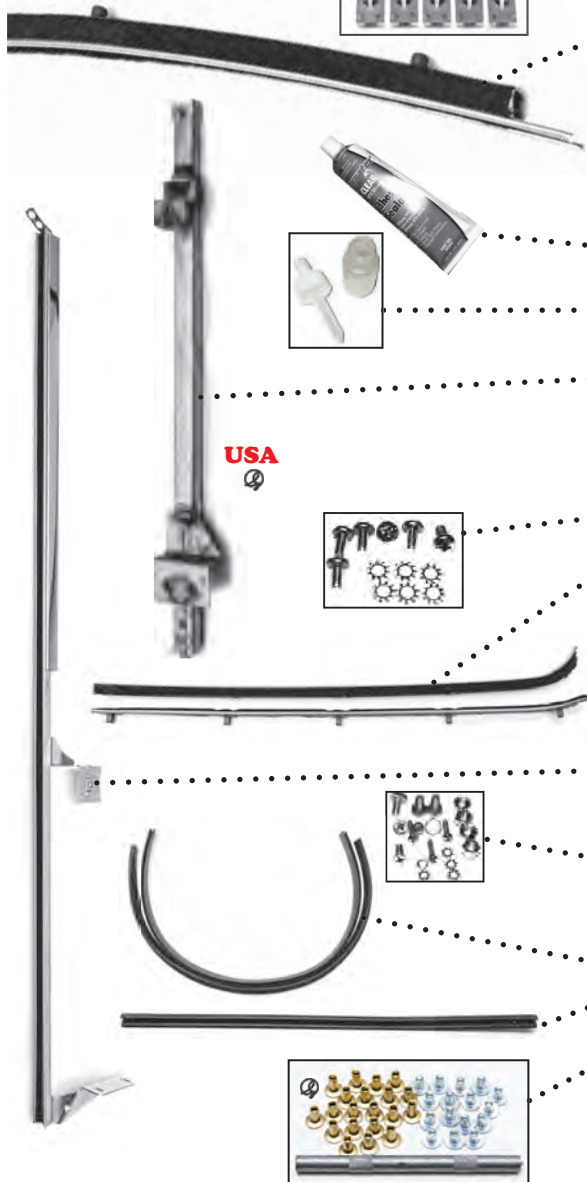



DOOR SHELL

Nice reproduction, complete inner & outer skin, no inner workings, inspection plates or handles. Ships freight, call for quote. 1956 FINISHED!!!! FITS!!

1953-55 driver.....	7795-5355L.....	\$495.00 ea
1953-55 passenger.....	7795-5355R.....	\$495.00 ea
1956 driver.....	7795-56L.....	\$789.95 ea
1956 passenger.....	7795-56R.....	\$789.95 ea

WINDOW SILL STRAIGHTENER STRIPS

Straighten lower window openings for repair or flat glass solid windows on a 53-55, set of inner and outer for each door, 4 pieces, with clip slots. Fits entire lower edge of window opening, if using with vents, cut at division bar.

Set of 4.....	3113-4.....	\$39.95 set
---------------	-------------	-------------

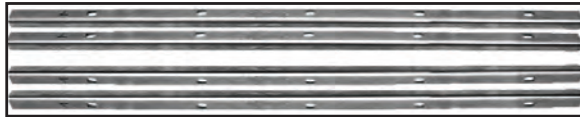

DOOR INSPECTION PLATE

Always use behind door panels to reduce noise & protect upholstered panels from indirect moisture. Inspection plate modifications, see page 13

• ABS, nice, easy to work with.....	2126-ABS.....	\$57.50 ea
• Steel.....	2126-STL.....	\$47.50 ea



GASKETS AND INSULATION

• Inspection plate gasket.....	SALE 2126-GSKT.....	\$19.85
• Self Adhesive gaskets.....	NEW 2126-GSA.....	\$18.85 pr
• Self Adhesive plate insulation.....	2126-CS.....	\$14.50 pr
• Inspection plate screw sets		
Zinc.....	81118-Z.....	\$3.50 kit
Stainless.....	81118-SS.....	\$6.90 kit
Polished stainless.....	81118-PS.....	\$10.50 kit

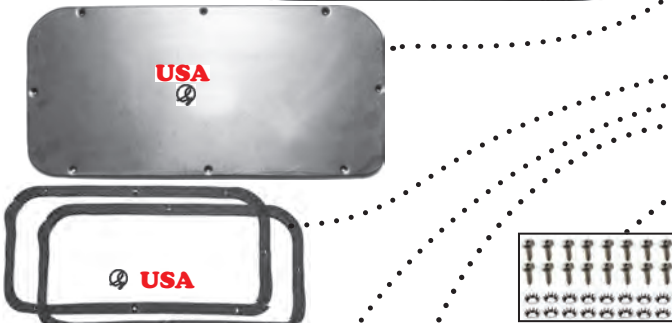

DOOR DAMPENER KITS, not shown

Strips of self adhesive material to reduce noise and vibration

Inner door does both.....	92180.....	\$25.00 kit
Outer, behind upholstery panel.....	92181.....	\$25.00 kit

LOWER OUTER DOOR PANEL

About 10 3/4" tall, black electro primer, oversize shipping

Driver.....	7724-L.....	\$42.00 ea
Passenger.....	7724-R.....	\$42.00 ea
USA driver, raw steel.....	7723-L.....	\$44.50 ea
USA passenger, raw steel.....	7723-R.....	\$44.50 ea
USA, Pair.....	7723-PR.....	\$88.50 pr



DOOR HINGE COVER PLATE

• Regular.....	1178.....	\$8.95 ea
• Oversize, for China panel.....	1177.....	\$11.50 ea

China repair panel has oversize hole so we made cover to fit.

LOWER INNER DOOR BOTTOM PANEL

18 gauge steel replacement panels, not a cover. TALL China made one goes up above hinge inspection hole. USA version goes to indent below inspection hole.

Short, driver 7" USA.....	7725-L.....	\$47.50 ea
Short, passenger 7" USA.....	7725-R.....	\$47.50 ea
• Tall, driver 9".....	7726-L.....	\$45.00 ea
• Tall, passenger 9".....	7726-R.....	\$45.00 ea

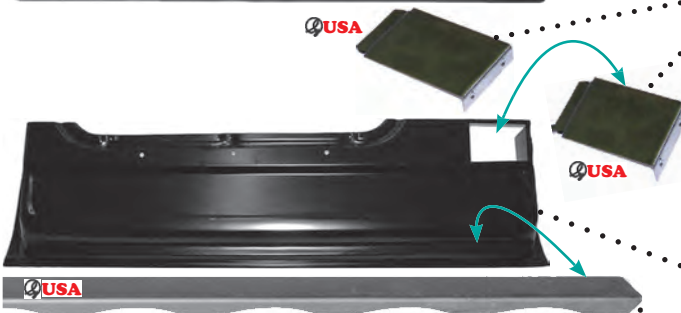

DOOR SEAL LOWER RETAINER STRIP

1953-56.....	7727.....	\$4.50 ea
--------------	-----------	-----------

Don't forget to drill drain holes in bottom of patch panels.

Retainer strip location
 A..11/16" to 7/8" from inside edge
 B..1 3/4" bottom edge of door
 C..2" from back hinge side of door
 D..3" from front side of door



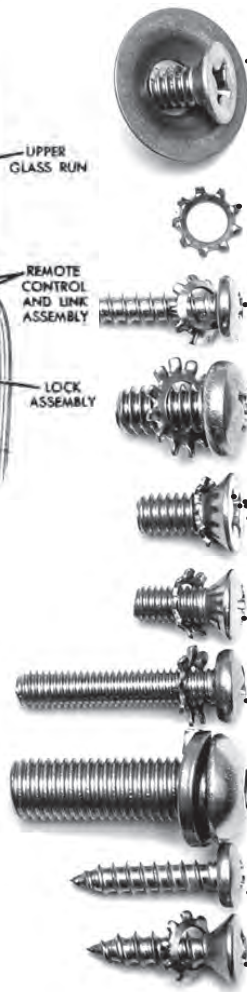
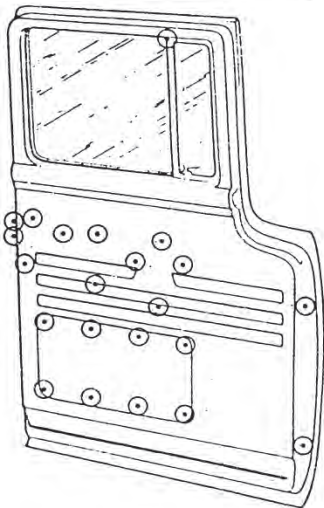
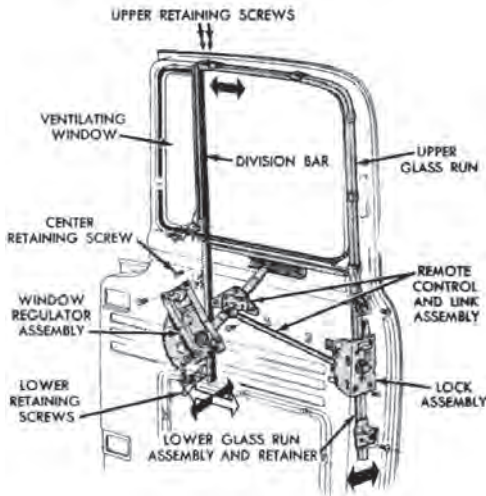

REPAIR WASHER & BOLT

For latch, door & window regulators. Special made washer to reinforce "walled" out holes in any of the countersunk locations on door, includes locking bolt
Each81107..... \$1.70 ea

1956 VENT FRAME SCREW WASHERS

Early production 1956 truck doors had oversize screw holes in this location. If yours is one, this is the fix.
Vent frame screw oversize washers
4 pieces81145-W\$0.65 set

DIVISION BAR INSTALL KIT

Stainless83152-SS\$3.00 kit
Polished stainless83152-PS\$8.25 kit

CHANNEL BRACKET INSTALL KIT

Stainless83153-SS\$4.00 set
Polished stainless83153-PS\$6.90 set

WINDOW REGULATOR SCREW KIT

Zinc81151-Z\$3.50 set
Stainless81151-SS\$5.50 set
Polished stainless81151-PS\$6.90 set

DOOR REGULATOR SCREW KIT

Zinc81090-Z\$2.50 set
Stainless81090-SS\$3.50 set
Polished stainless81090-PS\$5.00 set

DOOR LATCH SCREW KIT Originals

Zinc81108-OZ\$3.00 set
Stainless81108-OS\$5.00 set
Polished stainless81108-OPS\$7.50 set

DOOR LATCH SCREW KIT Replacements

Zinc81109-RZ\$3.00 set
Stainless81109-RSS\$5.00 set
Polished stainless81109-RPS\$7.50 set

OUTSIDE DOOR HANDLE SCREWS

Zinc81124-Z\$1.00 kit
Stainless81124-SS\$1.50 kit
Polished stainless81124-PS\$2.00 kit

DOOR HINGE BOLT SET Does one hinge

Black81129-B\$5.00 set
Stainless81129-SS\$6.75 set
Polished Button Head81129-PB\$8.50 set
Polished Hex Head81129-PX\$8.50 set

HINGE INSPECTION PLATE SCREWS

Zinc81178-Z\$3.00 set
Stainless81178-SS\$4.50 set
Polished stainless81178-PS\$5.90 set

DOOR INSPECTION PLATE SCREWS

Zinc81118-Z\$3.50 kit
Stainless81118-SS\$6.90 kit
Polished stainless81118-PS\$10.50 kit

COMPLETE DOOR SCREW SET

Zinc91120-Z\$20.00 set
Stainless91120-SS\$32.00 set
Polished stainless91120-PS\$46.00 set

FELT CHANNEL FORMING INSTRUCTIONS

Gently bend in a massaging manner toward end until both stainless beads slide forward.

If bead is caught on channel material, clip channel away from bead until it moves freely

Secure glass in upright position. Locate and match up center point of glass and channel

Smooth and massage channel into gentle curve.

Make sure bead ends are moving out and channel is sliding along entire length

Continue to shape against glass and straight down.

Clip off excess stainless bead. Install formed channels in channel holder brackets. Glue into place. Glue works better than clips in most cases.

Tip, if using clip in or clips, do not file down hole in bracket, file down clip for best results, again, glue works even better. To install cut a piece of 1/4" wood, put it in the channel and tap.

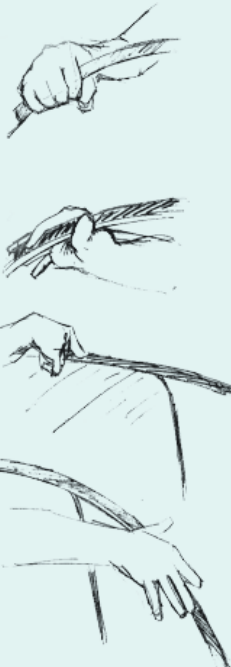

1953-55 VENT WINDOW COMPLETE ASSEMBLIES

Chrome & CLEAR Glass, Driver.....	91141-5355CL.....	\$295.00 ea
Passenger.....	91141-5355CR.....	\$295.00 ea
Chrome & TINTED Glass, Driver.....	91142-5355TL.....	\$295.00 ea
Passenger.....	91142-5355TR.....	\$295.00 ea

1953-55 VENT GLASS *Clear, tint, smoke, double dark*

Clear.....	1700-5355CLR.....	\$24.00 ea
Tinted.....	1700-5355TNT.....	\$24.00 ea
Smoke.....	1700-5355SMK.....	\$24.00 ea

• VENT GLASS SEAT TAPE, both sides81619-V..... \$5.00 pr

1953-55 VENT FRAME, new dies, better fit.

Polished stainless, very nice polished stainless reproductions, include upper pivot cup, lower pivot stem, handle bracket & shaft.

Left, Driver.....	1149-L.....	\$99.00 ea
Right, Passenger.....	1149-R.....	\$99.00 ea

• VENT FRAME SCREWS81145..... \$2.50 set

VENT WINDOW RUBBER SEALS

USA made, BEST BUY.....	3123-5355.....	\$69.95 pr
Imported.....	3123-5355B.....	\$49.95 pr

• VENT RUBBER PROTECTOR RIVET ...81143..... \$2.50 kit
Screw and special brass insert that protects 1953-55 rubber.

VENT WINDOW HANDLE

Driver.....	1140-5355L.....	\$24.50 ea
Passenger.....	1140-5355R.....	\$24.50 ea

• VENT HANDLE BUTTON KIT1148..... \$6.50 kit
Chrome button, spring, washer, pin, does one handle. (Correct Washer) Got your buttons elsewhere with the wrong washer?, That'll teach ya.

• CORRECT WASHERS81146..... \$2.50 pr

• HANDLE RETAINING PIN81141..... \$0.75 pr

• VENT HANDLE STRIKER PLATE.....1142-SP..... \$16.50 ea
Perfect detail.

• VENT HANDLE BRACKET & POST ASSEMBLY same both sides
1953-55 plain stainless.....1144-5355..... \$15.00 ea
1953-55 Polished stainless, Pair1143-5355PS..... \$42.50 pr
1953-55 Polished stainless, One.....1143-5355P1..... \$22.50 ea

• RIVET AND INSTALLATION TOOL KIT *Includes tool & 3 sizes rivets for upper & lower vent frame pivots, upper cups, handle brackets, & Division bars, 40 in all*.....81148..... \$17.25 kit

1953-55 UPPER PIVOT POST

Driver.....	1146-ML.....	\$15.00 ea
Passenger.....	1146-MR.....	\$15.00 ea

1953-55 VENT FRAME UPPER PIVOT CUP

Driver.....	1146-CL.....	\$20.00 ea
Passenger.....	1146-CR.....	\$20.00 ea

1953-55 VENT FRAME LOWER PIVOT

New reproduction, exact of original, includes stop washer. Locating knurls, tension washers & spring to keep vent from flopping in wind.

• Pivot assembly, Driver.....	1147-L.....	\$24.00 ea
Passenger.....	1147-R.....	\$24.00 ea
Post only.....Driver.....	1145-L.....	\$12.00 ea
Post only.....Passenger.....	1145-R.....	\$12.00 ea
• Pivot spring & washer set.....	1145-SPNG	SALE \$8.00
• Teardrop washer only.....	1145-WT.....	\$3.50 ea
• Spring only.....	1145-SP..	SALE \$5.00
• Lower serrated round washer.....	1145-WR.....	\$3.00 ea





1956 VENT WINDOW COMPLETE ASSEMBLIES

- Chrome with Clear Glass, Driver 91141-56CL \$295.00 ea
- Passenger 91141-56CR \$295.00 ea
- Chrome with Tinted Glass, Driver 91142-56TL \$295.00 ea
- Passenger 91142-56TR \$295.00 ea

VENT GLASS SEAT TAPE 81619-V \$5.00 pr

VENT GLASS Clear, tint, smoke, double dark

- Clear 1700-56CLR \$24.00 ea
- Tinted 1700-56TNT \$24.00 ea
- Smoked 1700-56SMK \$24.00 ea



VENT FRAME SCREWS 81145 \$2.50 set



VENT WINDOW RUBBER SEALS, Consider USA 56 Vent Seals
1956, USA made (best buy) 3123-56 \$69.50 pr
1956 Import 3123-56B **SALE** \$39.50

VENT WINDOW HANDLE, 56 Vent handles Lock against a stainless Striker area on Division Bar.

- Driver 1141-56L **SALE** \$23.50
- Passenger 1141-56R **SALE** \$23.50

VENT HANDLE BUTTON KIT 1148 \$6.50 kit
Chrome button, spring, washer, pin, does one handle.

- Got your buttons elsewhere with the wrong washer?, That'll teach ya.*
- Correct washers 81146 \$2.50 pr
- Handle retaining pin 81141 \$0.75 pr



VENT HANDLE BRACKET & POST ASSEMBLY

- 1956 plain stock, right, passenger 1144-56R \$15.00 ea
- 1956 plain stock, left, driver 1144-56L \$15.00 ea
- 1956 polished stainless, right 1143-56PSR \$25.00 ea
- 1956 polished stainless, left 1143-56PSL \$25.00 ea



RIVET AND INSTALLATION TOOL KIT *Includes tool & 3 sizes rivets for upper & lower vent frame pivots, upper cups, handle brackets, & division bars, 40 in all* 81148 \$17.25 kit



VENT FRAME LOWER PIVOT

1956 post only 1145-56 \$20.00 ea

LOWER NYLON BUSHING 1145-56PB \$4.00 ea

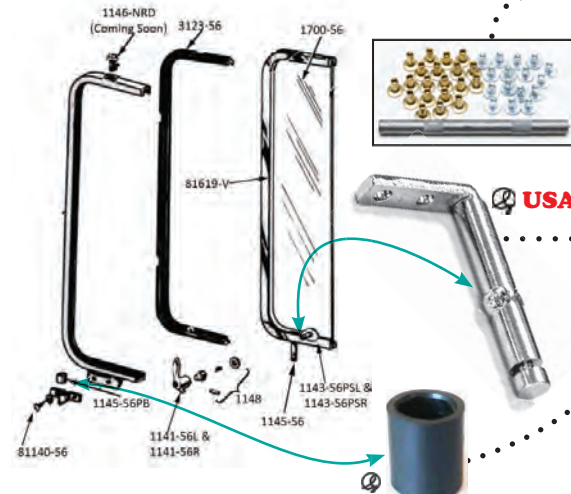

**DOOR HANDLE REMOTE REGULATOR****REGULATOR**

Stock length.....1090\$45.00 ea
 Rebuilt Original 1/4" longer shaft, \$25 core. 1090-L\$74.50 ea

REGULATOR WITH LONGER SHAFT, all new, not rebuilt

1953-56 1/4" longer, no core needed1090-L25\$59.00 ea

REGULATOR SCREWS *Does both sides*

Zinc.....81090-Z.....\$2.50 set
 Stainless.....81090-SS.....\$3.50 set
 Polished stainless.....81090-PS.....\$5.00 set

REPAIR SHAFT

•Stock length.....1100.....\$19.75 ea
 •1/4" longer shaft for thick upholstery1101-L.....\$19.75 ea
Requires tack welding to reassemble, 2 springs and tiny plunger may escape when disassembled, be careful, spring is not available.

HANDLE SHAFT EXTENSION or REPAIR,

Fits door & window shafts, Use as repair or to clear upholstery.

To secure well, drill original shaft a little for set screw to seat.

ONE EXTENSION, 4 set screws and wrench ...1100-EX.....\$16.50 ea

**USA****USA****WINDOW REGULATORS** *Some on market let window fall, we do not offer them.*

*Regulator with 1/4" extended shaft are rebuilt only, core charge applies
 Power regulators available, see page 108.*

REGULATOR

•1953-55 driver, stock shaft1105-5355L.....\$74.95 ea
 1953-55 passenger, stock shaft1105-5355R.....\$74.95 ea
 1953-55 driver, 1/4" longer shaft.....91103-5355L.....\$99.00 ea
 1953-55 passenger, 1/4" longer shaft.....91103-5355R.....\$99.00 ea
 •1956 driver, stock shaft.....1106-56L.....\$79.00 ea
 1956 passenger, stock shaft.....1106-56R.....\$79.00 ea
 1956 driver, 1/4" longer shaft.....991104-56L.....\$99.00 ea
 1956 passenger, 1/4" longer shaft.....91104-56R.....\$99.00 ea

•CAPTIVE NUT81104.....\$2.35 ea

WINDOW REGULATOR SCREWS *Does both sides*

Zinc.....81151-Z.....\$3.50 set
 Stainless.....81151-SS.....\$5.50 set
 Polished stainless.....81151-PS.....\$6.90 set

REPAIR SHAFT *With instructions*

1953-55 stock length1102-5355\$19.75 ea
 1953-55 1/4" longer shaft1103-5355L.....\$19.75 ea
 1956 stock length1102-56\$15.95 ea
 1956 1/4" longer shaft.....1103-56L.....\$19.75 ea

INNER REPAIR SPRING *This is the piece that most often breaks*

1953-551103-SP5355.....\$5.50 ea
 1956.....1103-SP56.....\$4.50 ea

LOWER GLASS LIFT CHANNEL

The smooth side goes toward outside of door. Install roller in channel from end, having trouble with steel rollers? Steel rollers may be too thick, use nylon rollers below

CHANNEL

•1953-551118-5355.....\$21.88 ea
 1956 driver.....1118-56L.....\$21.88 ea
 •1956 passenger.....1118-56R.....\$21.88 ea

GLASS SEAT TAPE KIT

Does both sides.....81620\$5.00 pr

WINDOW GLASS ROLLER *1956-1 per door, 1953-55-2 per door*

Nylon1116.....\$5.25 ea
You do not want steel, it was original, but anything on the market in last few years must be modified to work.

**USA****USA****USA****USA**



OUTSIDE HANDLES

If you are having trouble with handles bought elsewhere: if button retainer holes are wrong ask for button retainer screws 81128. If bad fit, if they "rock" & do not set properly they are defective. We issued a recall on bad ones that slipped us by a couple years ago, all we sell are correct, we will replace any bad ones, purchased from us of course.



- COMPLETE KIT Both handles, button kits, plungers, all pads, and polished screws. With buttons91124-WB..... \$75.00 kit
- OUTSIDE DOOR HANDLE Highest quality chrome
 - Driver 1124-L..... \$40.00 ea
 - Passenger 1124-R..... \$40.00 ea



MOUNTING HARDWARE

- Stainless81124-SS..... \$1.50 kit
- Polished stainless 81124-PS..... \$2.00 kit

- BUTTON KIT Does one handle.....81127..... \$14.55 kit

- BUTTON RETAINER SCREWS81128..... \$1.00 kit

- DOOR HANDLE PADS Does both doors.... 1126..... \$6.95 set



USA

- DOOR HANDLE SHIELDS New, made in self adhesive plastic film, lots easier to use protects paint, looks great, easy on and off.

- ChromeD-1128..... \$6.50 pr

- ClearD-1128-CLR..... \$6.50 pr

- Stainless Steel, not a decal 1128..... \$24.50 pr

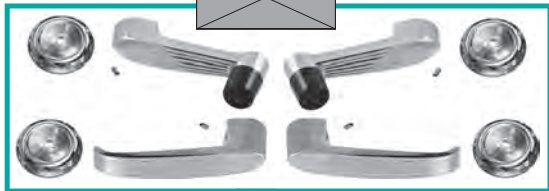

INSIDE HANDLES

COMPLETE KIT

- 1953-55 clip type91122-5355 \$80.00 kit
- 1956 set screw type.....91122-56 \$75.00 kit

INSIDE DOOR HANDLES Highest quality, chrome

- 1953-55 clip type 1121-5355 \$14.95 ea
- 1956 screw type 1121-56 \$14.80 ea

WINDOW CRANK HANDLE & KNOB Highest quality, chrome

- 1953-55 clip type 1120-5355 \$15.00 ea
- 1956 screw type 1120-56 \$15.00 ea
- 1956 for original regulator only 1120-56A \$15.00 ea
- Knob for window handle, included above.... 1120-K..... \$6.50 ea

- Handle clip set, 1953-55 (4)81122-5355 \$1.50 set

- Handle screw set, 1956 (4).....81123-56 \$2.00 kit

HANDLE TRIM RINGS (ESCUTCHEONS)

- 1953-55, polished stainless ring & rubber ... 1123-5355 \$7.95 ea

- 1953-55, rubber only 1123-RB \$4.00 ea

- 1953-55, stainless only 1123-S \$6.95 ea

- 1956, polished stainless 1123-56 \$8.45 ea

- 1956, LOWERED PROFILE so handle will clear upholstery,ABS, or other door trim 1123-56MD \$12.75 ea

Clearing Upholstery or ABS or other door panels. We have lowered profile Trim rings, Extended Handle Shafts, Regulators with Extended shafts installed & shaft extension.



NEW

HANDLE REMOVAL TOOL

- For clip type 1953-55 handles 1122..... \$9.95 ea

- HANDLE TRIM DEPRESSION TOOL80108 \$15.00 ea

Handy third hand tool, press belly against tool leaving 2 hands free to wrestle the little clip or set screw out, qualifies for rental program

- ARM RESTS, REPRODUCTIONS Plain...2125 \$50.00 pr

Complete assemblies ready to cover, if truck did not have arm rests originally, order install kit. If you have rectangular holes order clips.

Fat part goes toward front of truck. Arm Rests help stop us from pulling door shut with handle, saving handle and shaft. Base is black

- Covered arm rests, choice of materials2125-CVR..... \$98.50 pr

- Arm rest installation kit82125 \$5.00 kit

- Arm rest clip, original for rectangular holes. 2124-ELK..... \$2.50 ea



USA



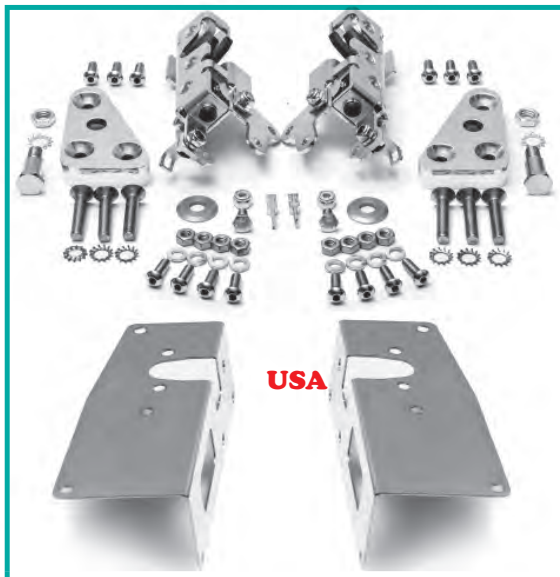
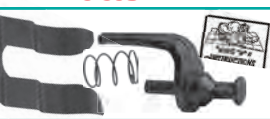

DOOR LOCKS & KEYS

Stainless cover lifts up, pointed part of lock to front. Unless custom cab or ordered with two locks, lock was only on passenger side. Know why? Safety, yes, safety Ford did not want you unlocking doors or exiting vehicle while parallel parked.

NEW USA!!! We also carry Imports like everyone else but not listed here. These can be re-keyed easily!! Imports cannot.

- MATCHING DOORS & KEYS 1130-2Da \$48.50 set
- DOOR LOCKS AND IGNITION SET *Includes keys*
2 Matching doors & ignition 1130-3PCa.. \$49.95 set
- PASSENGER LOCK & IGNITION .. 1130-Pla \$55.50 set
- DRIVER LOCK *Includes keys* 1131-D. **SALE** \$16.95
- DRIVER LOCK & Install kit. **SALE** 91131.....**\$42.50 kit**
KEY KNOB, *pop in ignition, looks like just another knob.*
- Stock knob with stock key 1009.....\$10.00 ea
- Billet aluminum knob with key 1009-AB.....\$18.00 ea
- Polished aluminum knob with key 1009-AP.....\$16.00 ea
- STOCK KEY Ignition or door..... 1138\$3.55 ea
- ROUND KEY *Door* 1138-RND\$2.95 ea
- LOCK RETAINER..... 1133\$4.95 ea
Install retainers from inside for cleaner application.
- LOCK LEVER 1136\$8.50 ea
This is piece that breaks most often, others are too long, ours is correct. To install, slip spring over end compress and insert into horse shoe shaped slot in back of lock, make sure lever fully inserts into hole in latch assembly locking arm.
- LOCK SPRING 1135\$1.79 ea
New exact reproduction, a must for proper lock operation.
- LOCK INSTALLATION KIT 81136 \$12.50 kit
Includes lock lever, spring, retainer, template & instructions.
- LOCK PAD
Not stock on truck, went on car, you may have to trim out inside to make work, looks nice but not supposed to be there.
- Molded edge..... 1139\$1.95 ea
- Gasket style, no outer edging..... 1139-G\$1.25 ea

ALTMANS EASY LATCH

Bear claw locking kit, neat, clean, easy to install, solves lots of problems. Uses new USA made "bear-claw" like latches, Will not fit any other makes or years, sorry. Uses stock door handles inside and out. Even locks with stock outside key lock! (Inside handle does not lock door) plates can be welded or bolted in, and cover the only hole made. Striker and pin are included and bolt on, covering original striker location. Perfect for an already painted truck, really neat kit !!!!

- Plain steel kit 1109 \$250.00 kit
- Polished stainless, plates & bolts 1109-PS \$325.00 kit
- Plain steel kit for shaved handles 1109-NH..... \$225.00 kit
- Shaved, polished..... 1109-NHPS.... \$329.00 kit
- Upgrade, emblem shaped washer...1109-WF\$15.00 pr

BEAR CLAW LATCH

Push lock lever down to lock, up to unlock. sold in pairs only. do not order with Easy Latch kit above, not the same, shown here for do-it-yourself..... 3233-LK\$39.95 pr

REMOTE KEYLESS ENTRY

Lights and sound, remote lock and unlock kit. Fun!, I love this, remote locks and unlocks the door, chirps the horn and flashes the lights, just like in a new truck. Neat!!! Complete with 2 remotes, power box, relays and instructions. All the figuring has been done for you, easy install..... 3239..... \$219.50 kit



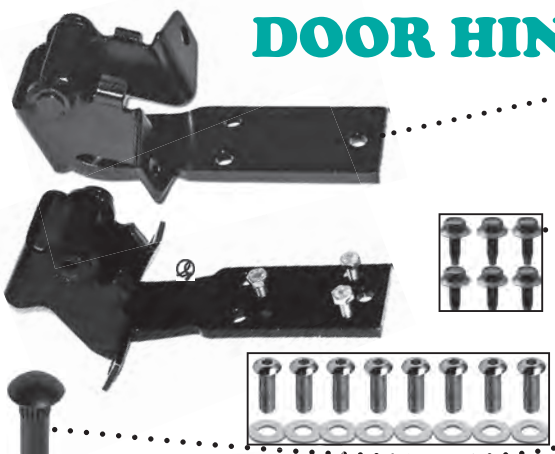

DOOR HINGE

- New reproduction 1174 \$65.00 ea
 - Adjustable 1179 \$85.00 ea
- Easier than bending the door, and allows for smaller adjustments*

DOOR HINGE BOLT SETS

- Each set only does one hinge*
- Stock black 81129-B \$5.00 set
 - Stainless hex 81129-SS \$6.75 set
 - Polished button 81129-PB \$8.50 set
 - Polished hex head 81129-PX \$8.50 set
 - Polished that show set 81129-AP \$18.50 set
- Just hinge to jam bolts that show with door open, or all 4 hinges*

DOOR HINGE PIN *oversize 11/32"* 1119-OS \$3.00 ea

DOOR HINGE COVER PLATE

- Steel 1178 \$8.95 ea
 - Oversize, for china made repair panels 1177 \$11.50 ea
- Needed with right side China made panel only, not shown*
- Cover plate screws, stainless 81178-SS \$4.50 set
 - Cover plate screws, polished stainless 81178-PS \$5.90 set

STAR LATCH REPRODUCTION *Include bumpers & hardware.*

- Note see kit at bottom of this page, use 56 with covers on 53-55 for safety*
- 1953-55 driver 1108-5355L \$75.00 ea
 - 1953-55 passenger 1108-5355R \$75.00 ea
 - 1956 driver 1108-56L \$85.00 ea
 - 1956 passenger 1108-56R \$85.00 ea

RUBBER LATCH BUMPERS 81085 \$2.00 pr

LATCH ASSEMBLY BOLT KIT *Does both sides. Original latches only. Caution: some competitors use metric bolts, identify first.*

- Polished stainless 81108-OPS \$7.50 set
- Stainless 81108-OSS \$5.00 set
- Zinc 81108-OZ \$3.00 set

WASHER & BOLT *Special made to reinforce "walled" out holes for latches and door or window regulators.* 81107 \$1.70 ea

STRIKER PLATE, CHROME

- 1953-55 driver 1110-5355L \$19.95 ea
- 1953-55 passenger 1110-5355R \$19.95 ea
- 1956 driver 1110-56L \$21.50 ea
- 1956 passenger 1110-56R \$21.50 ea

STRIKER SHIMS

Use as many as needed, do not use sand paper style anymore, costs as much as stainless to make and not as nice.

- Stainless, 1/16" thick 1113-SS \$5.00 ea
- Polished stainless edges 1113-PS \$6.50 ea

We know not much of this shows but what does peeks out every time door is open, so we made them in stainless & polished the edges.

LIFEGUARD STRIKER COVER *Polished stainless*

Introduced in '56 for better protection against doors flying open in an accident. Also fits 53-55, use 1956 star latches and strikers.

- Pair of right and left, polished stainless 1112 \$19.95 pr

STRIKER BOLT SETS, *With countersunk star washers.*

- Zinc, original Phillips head 81114-Z \$8.50 set
- Stainless 81114-SS \$15.75 set
- Polished stainless 81114-PS \$16.50 set

SAFETY FIRST KIT installs 1956 style latches, strikers and striker safety covers into any 1953-55 or 1956 Truck. Latch star then engages Striker behind the cover, "capturing" it. Helps prevent door star and striker from separating and letting door pop open, common occurrence in any small collision. Even normal driving with cab flexing, around curves, bumps, dips and such 91108-5356 \$239.95 kit

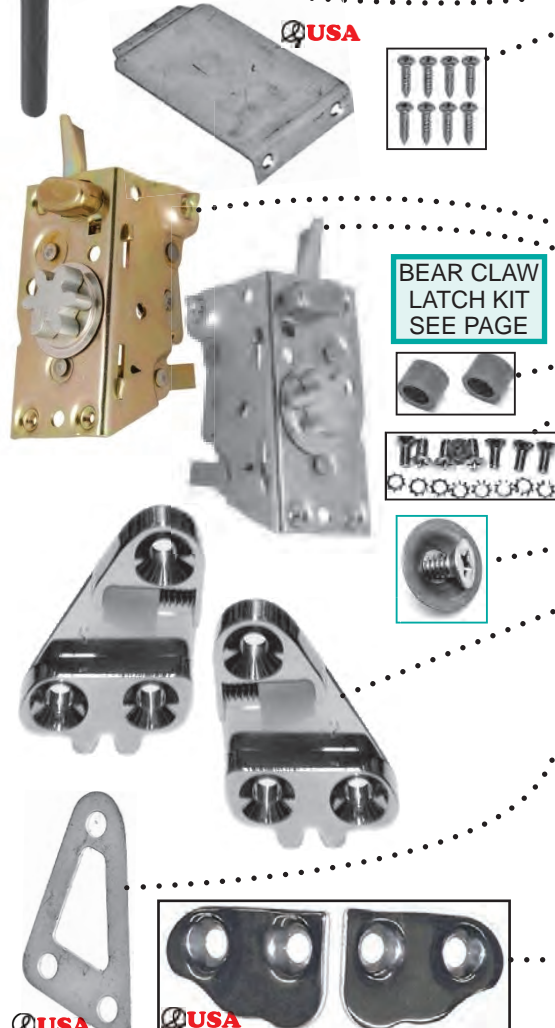

BEAR CLAW LATCH KIT
SEE PAGE

TRUCK IT

USA

USA

USA

NEW SAVE 91108-5356 \$239.95 kit

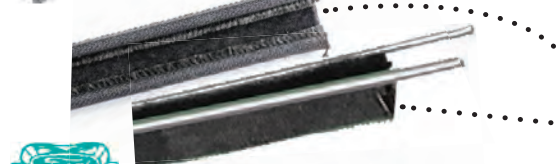
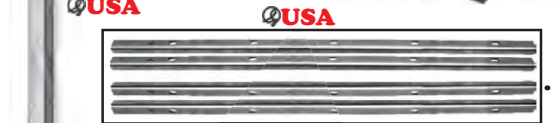
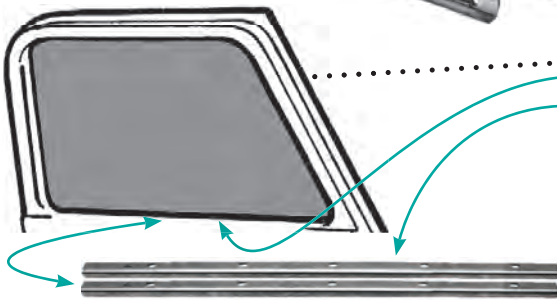
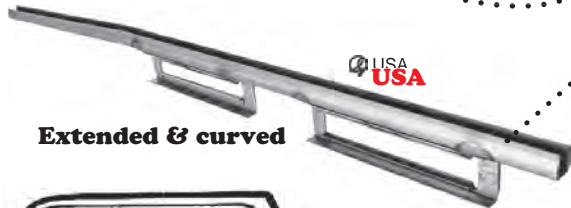
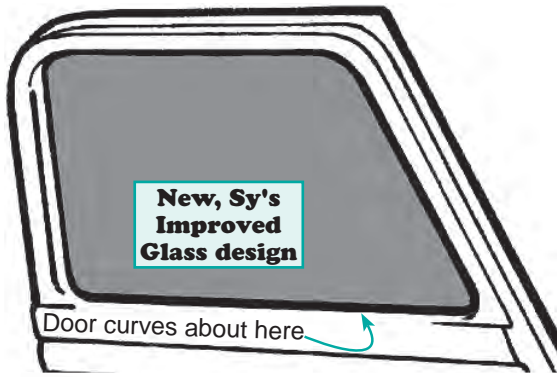

CAUTION, imported felts are NO GOOD, we do not sell.

1953-55 CURVED GLASS KIT

1953-55 doors have a slight curve, and upper hinge and adjoining sheet metal is in the way when eliminating vents. To install solid side windows you need kit with curved glass, OR you need to straighten glass opening. This can be done with our straighteners, but it's a lot of body work to cut out inner angles along door glass opening and replace with straight pieces. This CURVED GLASS kit can be installed in a finished truck without all that body work as the only cutting is hidden behind door panel. Comes with instructions, upper & back felt runs, lower felts, and everything you need to install. Oversized shipping Note we have improved our glass in 2019, it has extra length at lift channel so you can use clamp style power window kits, and we slightly adjusted glass angle/width for easier installation. Exclusively Mid Fifty

KIT WITH STAINLESS BEAD FELTS

Clear glass.....	91724-C.....	\$388.50 kit
Tinted glass	91724-T.....	\$388.50 kit
Smoke glass.....	91724-S.....	\$388.50 kit

KIT WITH NO BEAD, BLACK

Clear glass.....	91725-BC.....	\$388.50 kit
Tinted glass	91725-BT.....	\$388.50 kit
Smoke glass.....	91725-BS.....	\$388.50 kit

EXTENDED LIFTS FOR CURVED GLASS

Pair, ordered with kit, additional..... 1730-CX..... \$59.00 pr
Bottom of curved glass needs CURVED extended lift IF using stock window regulators, NOT needed with power window kits

For best results use power window kit and Power window install kit on page 108

1953-55 FLAT GLASS KIT

Flat glass, door curve must be straightened, Metal angle pieces to straighten door are included. Oversized shipping

KIT WITH STAINLESS BEAD FELTS (see felts bottom of page)

Clear glass.....	91721-C.....	\$366.50 kit
Tinted glass	91721-T.....	\$366.50 kit
Smoke glass.....	91721-S.....	\$366.50 kit

KIT WITH NO BEAD FELTS, BLACK (see felts bottom of page)

Clear glass.....	91720-NC.....	\$366.50 kit
Tinted glass	91720-NT.....	\$366.50 kit
Smoke glass.....	91720-NS.....	\$366.50 kit

INDIVIDUAL SOLID SIDE PIECES

1953-55 SOLID SIDE FLAT GLASS ONLY

Order by color 1725-(color)..... \$80.00 ea

1953-55 EXTENDED LOWER LIFT

Use with stock regulators, or if NOT using our TEMPERED glass, Laminated glass may break without support.

DRIVER.....	1731-5355XL.....	\$39.00 ea
PASSENGER.....	1731-5355XR.....	\$39.00 ea

DOOR WINDOW SILL STRAIGHTENER STRIPS

Set of inner and outer for each door

Set of 4 3113-4 \$39.95 set

LOCK SIDE UPPER & BACK CHANNEL BRACKET

Piece upper & back channels slide into, attached to latch (back) side

Driver side.....	3114-L.....	\$40.00 ea
Passenger side.....	3114-R.....	\$40.00 ea

LOWER FELT WIPES *Formed, with clips, does one door*

Stainless bead	1727-5355.....	\$49.95 pr
Black bead.....	1727-5355B.....	\$49.95 pr
Do-yourself, black bead, glue in	1727-BK.....	\$17.50 pr
Do-yourself, stainless bead, glue in ..	1727-ST.....	\$17.50 pr

WINDOW CHANNEL, FELTS, Solid sides are 96" long.

Black, No bead.....	3108-B.....	\$42.50 ea
Stainless bead.....	3107-UN96.....	\$42.50 ea



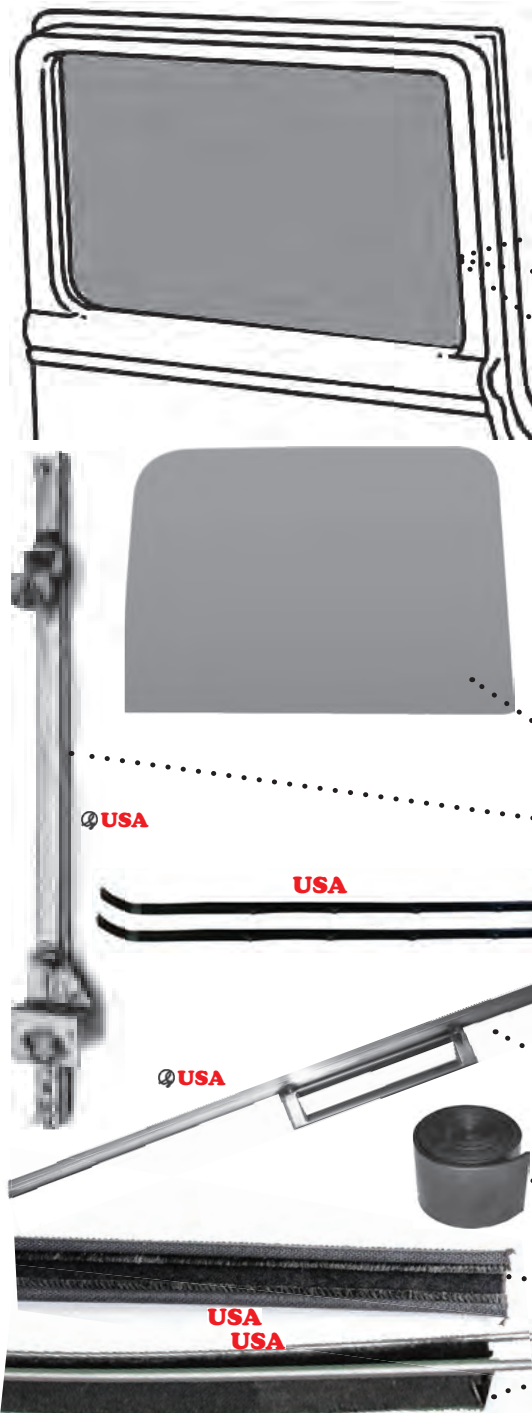

1956 SOLID SIDE GLASS KIT

Includes everything for both doors, tempered glass in choice of clear, tinted or smoke. One piece channels, front run channel brackets, bracket kit, lower felt wipers, hardware and instructions. Oversize shipping (A few Limo Dark Kits left, ASK)

KIT FOR STOCK WINDOW REGULATORS

Includes lower lift channels for stock regulators.

- POLISHED STAINLESS BEAD, Clear...91726-WCC\$366.50 kit
- Smoke ... 91726-WCS.....\$366.50 kit
- Tint.... 91726-WCT.....\$366.50 kit
- *BACK, NO BEAD.....Clear..... 91727-WCC\$366.50 kit
- Smoke 91727-WCS\$366.50 kit
- Tint 91727-WCT\$366.50 kit

*KIT FOR POWER WINDOW KITS

No lift channels, all power window kits come with lift channels.

- POLISHED STAINLESS BEAD\$306.50 kit
- Clear...91726-NOC Smoke...91726-NOS Tint...91726-NOT
- BLACK, NO BEAD\$306.50 kit
- Clear...91727-NOC Smoke...91727-NOS Tint...91727-NOT

NO GLASS KIT , Everything but the glass.

- Polished stainless bead..... 91728-56NG..... \$210.00 kit
 - Black, no bead..... 91729-56NG..... \$210.00 kit
- Order extended lower lift runners if using a stock regulators only.
Laminated glass may break without them, our glass is tempered so does not need them.

1956 INDIVIDUAL SOLID SIDE PIECES

- SOLID SIDE GLASS ONLY 1729-56\$70.00 ea
- Clear, tint, smoke
- LOCK SIDE UPPER & BACK CHANNEL BRACKET
- Holds window channel.
- Driver side, fits 1953-56..... 3114-L\$40.00 ea
- Passenger ,fits 1953-56..... 3114-R.....\$40.00 ea
- LOWER FELT WIPES, Formed, with clips, does one door
- Stainless bead 1727-56 \$49.95 pr
- Black Bead, 1727-56B..... \$49.95 pr
- Do-yourself, black bead, glue in 1727-BK \$17.50 pr
- Do-yourself, stainless bead, glue in .. 1727-ST..... \$17.50 pr
- 1956 EXTENDED LOWER LIFT RUNNER
- Use these if using stock window regulators, or if not using our tempered glass, laminated glass may break without this support.
- Driver..... 1731-5355XL\$39.00 ea
- Passenger..... 1731-5355XR\$39.00 ea
- GLASS SEAT TAPE KIT 81620 \$5.00 pr
- Does both sides, for setting glass into lower lift.
- GLASS FELT CHANNEL
- 96" Long. Goes around glass to bottom of door. Shape to fit any door, chop tops, etc Oversize shipping
- Black, no bead..... 3108-B.....\$42.50 ea
- Stainless bead..... 3107-UN.....\$42.50 ea

1956 solid side glass has a right & left, it looks like the same but curve is slightly different, determine correct side before setting in lift channels. Upper and back window channels take a little coaxing into shape. Solid side window channels make a complete upside down U shape going all the way up, over & down both sides of glass. If you rush this process the stainless bead will crimp and separate from felt material. Don't try messing with original style clips, glue channels in at original clip points with weatherstrip glue. Lubricate felts with dry graphite. See felt bending instructions on page 99



DRY GRAPHITE, use in channels and felts for best results.

We supply in handy eye dropper bottle so you can control application.

Bottle contains about half oz.....3128-23.....\$2.95 ea

POWER WINDOWS



Comes with extra "Horizontal" frame

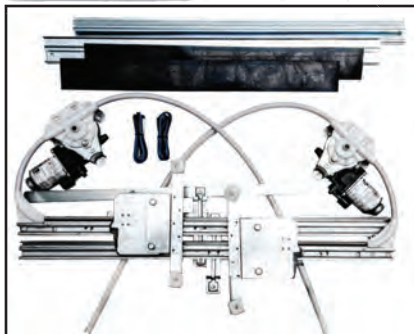
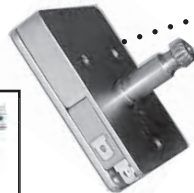
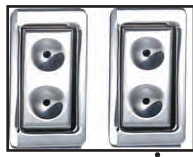

Most power window kits out there are universal, most use the same or comparable motors. We are only interested in the 1953-56 Ford truck however, so these are the ones we feel are best for that application. The things you need to consider are: which switches? If you want the window to go down without holding button, and if using solid sides windows

SWITCH CHOICES

I don't like the switches that normally come in power window kits, they have a little picture of a car window, and passenger side is backwards for heavens sake!! Therefore our power window kits are priced without switches, add switch kit of your choice below, includes & 3 switches

•BLACK SWITCHES, ILLUMINATED, BMW STYLE

- Illuminated, set 1744-AR \$159.00 set
- Illuminated, one only..... 1744-A1 \$20.00 ea

•BILLET OVAL SWITCHES

Billet switch sits in a billet frame, Oval no less! Building a Ford, right? No relay needed with remote controls

- Non-illuminated..... 1743-OV \$189.50 set

BILLET RECTANGULAR

- Illuminated, 2 individual 1743-RLT2 \$149.50 pr
- Illuminated 1743-RLT \$224.50 set
- Ball Milled and Illuminated..... 1743-R3 \$219.95 set

•CHROME, GM STYLE *High quality chrome toggle style*

- Non-illuminated..... 1744-CH \$159.00 set

•HANDLE SHAFT STYLE

Uses stock handle as switch, wiring diagram included. Both sides.

- China 1748 \$189.95 pr
- Made In USA 1748-USA \$299.80 pr
- Install bolts..... 81748 \$1.50 ea

Included, order only if you got switches elsewhere

POWER WINDOW CONVERSION KIT

Exceptionally smooth and quiet. Use with stock or solid side windows, 1956 or even curved 1953-55. Lots of power window kits out there, we carry a few different ones, however we like this one best so it is shown here. 3 Year warranty. Without switches, order choice of switches above

•POWER WINDOW KITS

- With clamp lift 1740-E \$349.50 kit
- With channel lift 1740-EX \$349.50 kit

AUTO EXPRESS MODULE 1745-EX \$38.75 kit

Use with any switch set, runs driver window all the way down with touch of button just like today's cars

•SUCTION CUPS Pair..... 1742-GH..... \$17.50 set

Holds window up while you work on the door.

•POWER WINDOW INSTALL KIT

Kit includes heavy duty cross bars to hang motor on, correct spacers, hardware & instructions. Makes installation a snap. No power window kits have long or strong enough motor mounting bars, and finding correct metric bolts is a pain. Sy's kit is made to install 1740 power windows but works with most we have tried.

- Install kit does both sides 1737 \$42.50 kit
- Just the Metric bolts and spacers..... 81737 \$7.50 kit

•POWER WINDOW REGULATORS

New power window regulators go right back in stock location. Mount up with stock bolts, and use stock window lifts. Too easy!! Order choice of switches above, handle shaft will not work. Can not be used with solid side windows as the regulator and motor are located under the vent window area.

- 1953-55, both sides 1742-5355 \$399.80 pr
- 1956, both sides 1742-56 \$399.80 pr

POWER WINDOW REGULATORS for SOLID SIDE ONLY

Fit in stock location and holes, will not fit with stock vent.

- 1953-55 1741-5355NV \$599.95 pr
- 1956..... 1741-56NV \$599.95 pr

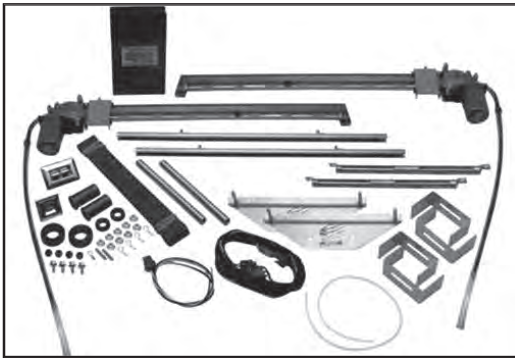

We stock 3 power window kits, the popular Specialty kit below and our favorite kit on the previous page. All power window kits on the market are "Universal-you-make-em-fit-your-vehicle"

SPECIALTY POWER WINDOW KIT

Cable driven. Includes black switches, double for driver and single for Passenger, stainless flexible door jam wire conduits and video instructions. Widely advertised, nice instructions, no install kit or switch choices. Nice kit, but same \$\$ would get kit on previous page with fancy billet switches plus the easy install kit, and all with same warranty. Kit\$459.95 kit



REMOTE WINDOW & DOOR CONTROLS

KEY-LESS ENTRY KIT

Remote lock and unlock kit. Fun!, I love this, remote locks and unlocks the door, chirps the horn and flashes the lights, just like in a new truck. Neat!!! Complete with 2 remotes, power box, relays and instructions. All the figuring has been done for you, easy install Kit\$219.50 kit



REMOTE CONTROLS

These include the 40 amp relays pre-wired and built into wire harness, so you can power the solenoids needed to open f-100 doors with power to spare. See solenoid below.

• 2 Function, for doors or windows..... 1746-2\$148.50 kit
 • 7 Function, for just about anything 1747-7\$174.50 kit



• WATERPROOF BUTTON ENTRY 1753-WR \$39.50 ea
 For activating solenoid, 5/8" x 1/4" 1/2" hole



DOOR POPPERS

• 25 lb, aluminum 3232-DP2\$59.50 pr
 • 25 lb, stainless version 3232-SS\$59.50 pr



DOOR OPENING SOLENOID

Extra heavy duty with brackets, 2 3/4" high, 2 1/16" thick, 4 1/4" long, cables, pulleys, connectors, wire, hardware and instructions.

For 2 doors 1750\$189.00 kit



MURPHY'S LAW EMERGENCY DOOR RELEASE KIT

Murphy says electrical system will go bad. Back-up for driver door when it does. 8 Ft. Stainless encased cable, & braided wire loom, billet ends, pull knob, cable clips and hardware.

Kit 1752\$39.95 kit

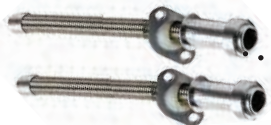

WIRE CONDUITS

• Braided with Swivel bases, best as turns corners better.
 Pair 1738-SW\$85.00 pr
 • Braided, alum inserts 1738 **SALE**\$41.50
 • Braided, with nylon inserts 1738-2\$34.50 pr
 Holds more wires than 1738
 • Nylon 1736\$16.95 pr
 Pair includes all 4 grommets



ALTMANS EASY LATCH

Neat, clean, easy to install, solves lots of problems. Will not fit any other makes or years, sorry. Uses stock door handles inside and out. Even locks with stock outside key lock. (Inside handle does not lock door) plates can be welded or bolted in, and cover the only hole made. Striker and pin are included and bolt on, covering original striker location. Perfect for an already painted truck, really neat kit !!!!

Plain steel kit 1109\$250.00 kit
 Polished stainless, plates & bolts are polished 1109-PS\$325.00 kit
 Plain steel kit for shaved outside handles 1109-NH\$225.00 kit
 Shaved, polished 1109-NHPS ...\$329.00 kit



HOOD STUFF

2020 Mid Fifty
1953-56 Catalog



- HOOD LACING *Rear hood rest that's attached to cowlwing, correct size!!*
 - Original, a woven material 2007 \$15.00 ea
 - Rubber, this one looks cleaner 2007-R \$10.00 ea
 - Self adhesive, domed 2006 \$12.00 ea
 - Hardware, original spiral tacks 82007 \$0.60 set
 - Hardware, polished stainless screws 82008 \$5.00 set



- HOOD TO COWL BUMPERS *Don't like hood lace, or need to raise or lower hood at cowl? Set of small rubber bumpers, order choice of heights 3/8", 7/16" for flip kits, 1/2" or 5/8" 82006-(size) \$6.90 set*

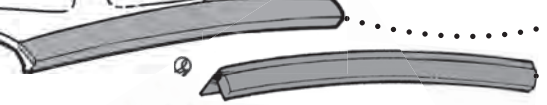

- LEADING EDGE OF HOOD 7756 \$79.00 ea
Front outer upper edge and angle with correct contour. Perfect rust repair



- FRONT HOOD UNDER SECTION 7755 \$89.00 ea
Complete piece goes all the way across with hood dowel location.



- HOOD TO RADIATOR SEAL, *slides in 'C' channel, hangs down*
 - Steel channel on hood underside 2309 \$6.00 ea
 - Rubber seal 2306 \$6.95 ea



- HOOD BUMPERS, *many upper bumpers are too small, these fit*
 - Complete set 2008 \$8.50 kit
 - Upper bumpers only, ones in hood 82006-56 \$4.50 pr
 - Hood to fender bumper, on fender 2009-B \$2.50 ea



- HOOD DOWEL
 - Hood dowel taps (nut) 2 pieces 2013-N \$2.00 pr
 - Hood dowel spring, stainless 2012-SS \$9.75 ea
 - Hood dowel spring, polished 2012-PS \$12.50 ea
 - Dowel spring retainer washer, stainless 2013-W \$8.50 ea
 - Dowel spring retainer washer chrome ... 2013-WCH \$10.90 ea
 - Hood dowel pin, plain steel 2013 \$25.00 ea
 - Hood dowel pin, plain stainless 2013-5356SS \$35.00 ea
 - Hood dowel pin, Polished Stainless 2013-BPS \$47.50 ea
 - Coarse thread dowel for some repo hoods ... 2013-13SS \$35.00 ea



- RADIATOR VALANCE 2335 \$139.95 ea
Hood locking panel, see page 83 for more valance parts



- HOOD CENTER LATCH *Goes on top, short handle so fits all 53-56*
 - Polished kit, includes everything below
 - With polished hex head bolts 92017-PX \$59.95 kit
 - With polished button head bolts 92017-PB \$59.95 kit
 - Hood center latch, stainless 2017-SS \$38.50 ea
 - Hood center latch, polished 2017-PS \$54.50 ea
 - Hood center latch spring 2018 \$1.00 ea
 - Center latch bolts, polished button 82017-PB \$9.50 set
 - Center latch bolts, stainless 82017-SS \$4.50 set
 - Center latch bolts, polished hex 82017-PX \$8.50 set



- HOOD SAFETY LATCH *Do not use with hood flip kits*
 - Safety latch, stainless 2016-SS \$29.50 ea
 - Safety latch, polished stainless 2016-PS \$38.50 ea
 - Install bolts, stainless 82014-SX \$3.90 set
 - Install bolts, polished hex 82014-PX \$4.75 set
 - Install bolts, polished button 82014-PB \$4.90 set
 - Safety latch repair spring 2015 \$3.75 ea
 - Safety latch repair rivet 2014 \$1.00 ea
 - Latch hole weld on patch 2339-FP \$2.75 ea
 - Latch hole bolt on cover, polished 2339-CV \$9.00 ea



- COMPLETE HOOD LATCH, DOWEL & SAFETY KIT
Includes Center & safety latch, dowel, spring & all hardware.
 - Stainless & plain steel 92015-SS \$116.95 kit
 - Polished stainless & chrome 92016-PS \$149.95 ea



- ALTMANS EASY HOOD LATCH KIT 2016-A \$189.95 ea
Shown painted black, comes silver zinc coated.



HOOD STUFF

1-800-252-1956
Direct 928-565-2763



STEEL HOOD.....7759 \$759.00 ea
Shipping can be crazy high, call for quote

HOOD HINGES , 1953-56 Hoods can be interchanged. 56 hinges can be used on 53-55 but 53-55 can NOT be used on 56, emblems can interchange by changing holes. If hood pops up in back while driving, adjust front hood dowel latch forward.

REPRODUCTION HOOD HINGES

Complete with spring. Not all springs are equal, many not so good on the market.

- 1956, passenger.....2003-56R \$69.00 ea
- 1956, driver.....2003-56L \$69.00 ea
- 1953-55, passenger.....2003-5355R \$69.00 ea
- 1953-55, driver2003-5355L..... \$69.00 ea

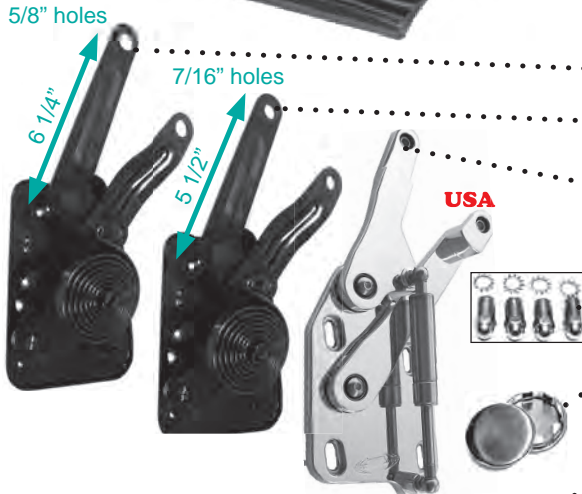

***BILLET ALUMINUM POLISHED HINGES**

Made for 56 but will fit 53-55 as well, hardware included. Very cool, very expensive. Still works the same as stock hinges.

- Pair2004 \$649.00 pr

• **HINGE BASE ACORN NUTS**.....82011 \$7.50 set
Only one side, bolts show when hood is open, these cover threads.

• **CHROME PLUGS** 82025 \$5.00 set
For holes if not using hinges

HOOD TO HINGE SHOULDER BOLTS

- Stock size
- 1953-552010-5355 \$3.50 ea
- 1956.....2010-56..... \$4.50 ea

• **Over size threads**
If original nuts are secure but stripped, tap nut to 3/8 SAE threads.

- 1953-552011-5355 \$10.00 ea
- 1956.....2011-56 \$10.00 ea

• **Bolts for fiberglass hoods**
Fiberglass hoods require longer bolts to reach threaded inserts

- 1953-552010-5355FB \$9.00 ea

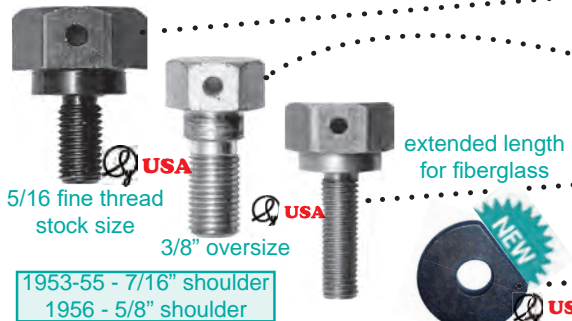

• **HOOD BOLT "D" WASHER**..... 82013-W..... \$2.25 ea

• **HOOD BASE BOLT**..... 82013-B..... \$1.50 ea

• **HOOD BOLT SAFETY WIRE**2005 \$2.50 rl
Bolts have holes for wire, pass through both bolts to keep stationary

• **HOOD BOLT SPRING WASHER**

- 1953-55 set of 4..... 82009-5355 \$4.50 set
- 1956 set of 4..... 82009-56 \$4.50 set

• **HOOD NUT REPAIR KIT** 82012 \$13.95 kit
Replaces missing tack welded nuts in hood braces, special taper sleeve nuts that collapse within, locking onto sheet metal. Simple installation tool and instructions included. Nut must be secure for hood to operate properly, set of 4 does both sides.

• **HOOD HINGE SPRING**2002 \$19.95 ea
Spring is intended to tighten only 1/3 to 1/2 a turn.

• **SPRING INSTALLATION TOOL & INSTRUCTIONS**
For removing & replacing springs..... 82002 \$13.50 ea
Also Included in repair kit below. Note we have new reproduction hinges so you might rethink rebuilding old ones.

• **HOOD HINGE REPAIR KIT**
Includes 2 new reproduction springs, installation tool, 4 shoulder bolts, nut repair kit & instructions.

- 1953-55 92002-5355 \$69.95 kit
- 1956..... 92002-56 \$69.95 kit

Note we have new reproduction hinges so you might rethink rebuilding old ones.



(CANTILEVERED: means hood is now secured at the other end)

Flipping the hood can solve many a "fit" problem, by sliding hood forward and up gives more access to engine area than before. Also with kit installed hood is adjustable in all four corners for a more uniform and smooth fit.

For both kits listed here, do not use safety latch (the one on pass side) or cowl lacing with any flip style hood kit as they pull forward first, then up, and will catch on cowl lace and latch. Use center latch, adjust striker plate accordingly. Hood alignment rods not needed but fender alignment rods are. Note how hood pulls forward first, this requires a different style hood lace so hood lip will not catch. Use hood bumpers or rubber lacing on hood instead, listed below

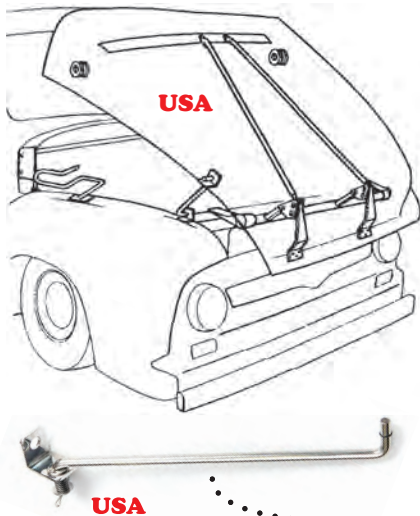

MMB HOOD TILT KIT

Complete kit, no BMW parts. Very simple to install using stock mounting locations and holes. Safety hood prop mounts down in front for security and complete engine access, plus a neat rubber hood bumper holder. Includes cover plates for original hinge mounting area. This kit is a little easier to install and a little heavier in construction than the other one below. DO NOT USE COWL LACING WITH FRONT TILT HOODS.

MMB HOOD TILT KITS

Plain.....	2030	\$350.00 kit
With polished stainless ramps & prop	2030-PBP	\$449.00 kit
Individual pieces For updates or, if you bought kit elsewhere tisk-tisk		
Roller ramp polished stainless, drive.....	2037-PSL	\$65.00 ea
Roller ramp polished stainless, pass	2037-PSR	\$65.00 ea
Roller, delron	2035-RL	\$7.50 ea
Roller shoulder bolt, polished/chrome	2039-PL	\$16.00 ea
Prop rod assembly, polished stainless	2036-PS	\$72.00 kit
Hinge hole covers.....	2038-PS	\$55.00 pr
Hinge hole chrome plugs (8)	82025	\$5.00 set
Prop rod rubber bumper holder	2035-BMP	\$6.00 ea
Prop Rod kit, Plain Zinc, bracket, spring, washer.....	2033	\$32.00 kit
Prop Rod kit, Polished SS, bracket, spring, washer.....	2033-PS	\$57.00 kit

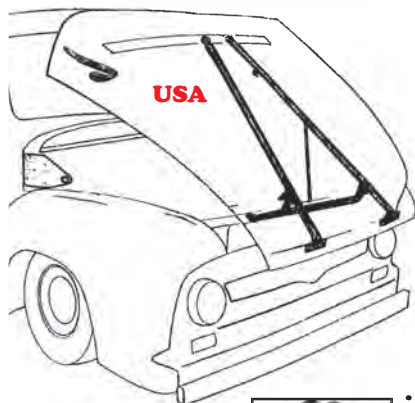

Y2K BILLET FLIP KIT

Roller is on a billet aluminum piece that mounts in existing hinge location. Track is up inside hood, and in billet aluminum. Hood braces double as adjusting rods with adjustable ends. Front hood assembly also adjusts for a perfect and easy fit, comes with threaded plates for easy installation. Prop rod rides on hood brace and props to core support out of the way

Y2K BILLET FLIP, COMPLETE	2040	\$369.00 kit
BILLET UPDATE KIT.....	2041-UP	\$159.95 kit

Converts older style BMW kit with roller ramps on fender to new style with billet aluminum roller mounts on cowl and billet aluminum ramps in hood

OTHER PARTS

- Hood to cowl bumpers..... 82006(size)..... \$6.90 set
Order by height, 3/8", 7/16" is about right, 1/2" or 5/8". There are usually 9 holes but have seen more, so we send you 11 pcs.
- Hood-cowl lace, protective bumper, GOES INSIDE HOOD with tilt kits.
- Domed style, self stick.....2006
- \$12.00 ea
- Cowl lace rubber, glue inside hood with tilt hood kit.....2007-R..... \$10.00 ea
- Holes still there? Polished screws.....82008
- \$5.00 set

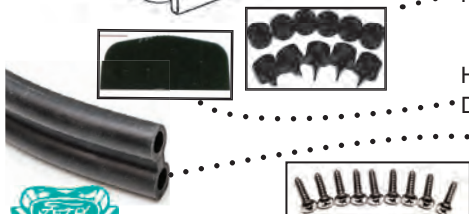



HOOD ALIGNMENT ROD

Has a small bend at back where it goes to hood reinforcement brace. DO NOT over-tighten, this rod can easily buckle a hood.

- Polished stainless.....2050-PS \$39.00 ea
- Plain stainless.....2050-SS \$29.00 ea

HOOD ROD BOLTS, rod to firewall bracket.

- Polished stainless hex 82053-PX \$6.00 pr
- Polished stainless button..... 82053-PB \$6.50 pr



FENDER ALIGNMENT ROD

This rod is important for proper alignment of fenders. Originals had large round end, the ones we make now-days have a smaller, cleaner end. Rods will not correct fender alignment if frame and/or cab mounts are to blame. See page 126 for cab alignment tips.

- Polished stainless.....2054-PS \$42.00 ea
- Plain stainless.....2054-SS \$33.00 ea

FENDER ALIGNMENT ROD KIT, 2 Fender Rods, Sy's Special

Acorn nut kit and firewall bolts. Polished92054.....\$99.95 kit



FENDER ALIGNMENT ROD FIREWALL BRACKET

Original was welded at firewall. Can be welded or bolted on.

- Polished stainless pair.....2059-PS \$68.50 pr
- Plain stainless pair.....2059-SS \$50.00 pr
- Alignment firewall bracket bolts..... 82059-PB \$15.00 kit

FENDER ALIGNMENT ROD BOLTS TO COWL

Both ends show it comes with acorn nuts to cover the threads.

- Polished button..... 82055-PB \$7.90 kit
- Polished stainless hex..... 82055-PX \$7.50 kit

HOOD INSULATION 7753-5356 \$37.50 ea

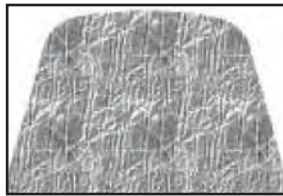

FENDER ALIGNMENT ROD VALANCE BRACKET

Die stamped copy of original.

- Plain stainless, Driver2055-SSL \$29.50 ea
- Passenger2055-SSR..... \$29.50 ea
- Polished stainless, pair.....2056 \$109.00 pr



FENDER ALIGNMENT ROD BRACKET BOLT KIT

Bolts that go to valance below, These are also included in front fender bolt kits on page 125

- Polished stainless button head..... 82056-PB \$12.00 set
- Polished stainless hex head..... 82056-PX \$10.00 set
- Black zinc 82056-BL..... \$5.00 kit

Use only if bolting brackets to cowl, needs new holes

FENDER OR HOOD ALIGNMENT ROD ADJUSTING END KIT

Kit with hex nuts, chrome 82050 \$10.00 kit
We made this fancy acorn nut to cover the thread end. Nice, huh!

Kit with Sy's adjusting acorns..... 82052 \$15.00 kit

ADJUSTING ACORNS, pair 82051 \$7.90 pr
Just replace adjusting acorns if existing hardware is already chrome.
All our hardware for stainless rods is chrome, as using stainless nuts against stainless rods in an adjustment area is just asking for trouble.
Always use anti seize, stainless will meld itself together, permanently



ANTI SEIZE 4 OZ BOTTLE 87000-4 \$6.95 ea



UPPER RADIATOR VALANCE

Hood locking panel, goes over radiator from fender to fender

- Stock style2335 \$139.95 ea
- Modified for cross flow radiator..... \$100 - \$120ea
- Used also available U-2335 \$100 - \$120ea



VALANCE BOLTS, polished hex..... 81560-PX \$31.00 set

Valance bolts, polished button..... 81560-PB \$29.50 set



See page for new front cowl & windshield section in process.

56 COWL VENT ASSEMBLY COMING SOON & Complete cowl & windshield section in works.



COWL VENT HINGES

Poorly fitting cowl vent? Is often just hinges, they are a little flimsy, held on by tack welds, and take a lot of abuse. Sometimes just easier to put new ones on.

- 1953-550908-5355\$28.50 pr
- 1956.....0908-56\$28.50 pr
- Install screws, stainless.....80902-SS\$1.50 set
- Install screws, polished stainless.....80902-PS\$2.65 set

USA

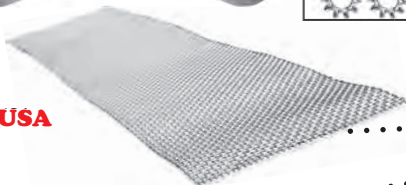

- COWL VENT REPAIR SCREEN.....0904\$20.00 ea
Repair your torn screen with new piece, comes with pattern

COMING SOON

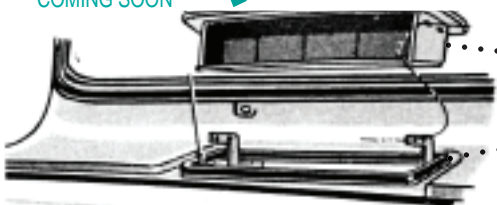

- COWL VENT UPPER REPAIR OR REPLACEMENT PANEL
1953-550901-5355\$46.50



- COWL VENT ASSEMBLY, 1956 0900-56
Reproduction. Coming soon, is in production as of 06/01/19



- COWL VENT RUBBER SEAL.....0902\$9.95 ea
Cowl vent seal installation, remove cowl vent, clean seal lip, Use even layer of good weatherstrip adhesive, (our #3125 or 3m cement, clamp down until set, clothespins are handy. Cowl vent can be adjusted both at the hinge screw point and most importantly at handle support bracket. To adjust, shift vent in elongated holes, if additional adjustment is necessary gently bend the cowl hinge arms. I said gently. Weather-seal is bear to install, it fits but you'll swear it doesn't.

USA



- COWL VENT SUPPORT DASH TO FIREWALL BRACE
1953-55, includes installed taps0909-5355\$28.50 ea
1956, includes installed taps0909-56\$28.50 ea
- Support brace mounting bolts.....80910\$2.00 set



USA



- COWL VENT HANDLE KNOB
Can be used with '53-55 handle by removing original rivets & knob
- Handle, 19561008\$6.00 ea
- Handle to brace bolts.....80907\$1.00 pr
- Handle bolt & washers, polished SS80908-PS\$3.95 kit
Goes through spring, includes acorn nut to cover threads
- Handle to lift arm bolts, "moon"80905-PS\$5.50 ea
- Handle tension spring.....0922\$6.00 ea



USA



- MODIFIED COWL VENT LIFT ARM3073\$17.00 ea
Sets arm over, is made to miss 1956 reversed under-dash wiper motor, or other obstacles



USA

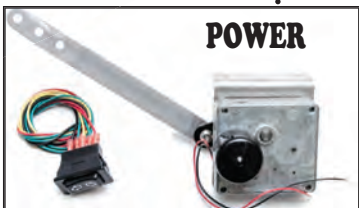

- POWER COWL VENT.....0905\$185.00 kit
Motor, switch, wiring, & bracket assembly. Mounts to existing stock cowl vent brace, if missing we have new ones, see above. Send your old cowl vent handle and arm in for credit. Special aluminum clevis and arm installed and ready, closes tight. Not just a universal fit, this is made specifically for the truck.



*Cowl Vent Handles and Lift Arms in the works
Call or see website to get on waiting list.*

Ask about scratch & dent firewalls & inner fenders, we often have good deals with minor handling damage.



• STOCK STYLE FIREWALL

Half sections, complete with toe board area. Not a cover, reproduction of 1956 original, split in half, extra material at center for installation. Goes from top of cowl to floor. Fits 53-55 but will have little wiper motor indent. Oversize shipping

Driver side **7770-L** **SALE** **\$118.50**
 Passenger side **7772-R** **SALE** **\$118.50**



• COMPLETE ONE PIECE FIREWALL

CAUTION: This piece has been reproduced in China. It is being advertised as 1956 and 1953-55. The 1953-55 is really just a 1956 with a gob of holes that match the 53-55. It will fit but requires some TLC. We talked them into a run without holes (pictured here) still has some heater mounting holes but at least we got a bunch eliminated. Freight shipping. We suggest the 56 No Holes as it will be easier to fit and use.

1956 NO HOLES **7773-56NH** **SALE** **\$250.00**

With Holes, not all correct, not suggested, just offered as FYI
 1956 With Holes 7773-56 rethink these
 1953-55 Holes in 1956 Panel ... 7773-5355.....rethink these



• CUSTOM FIREWALL COVER

Matches custom inner fenders, mounts under upper cowl ledge, and inner fender stock location, insulate & run wiring behind for clean firewall and extra sound & heat protection.

Plain steel 7509-STL **SALE** \$129.50
 Polished stainless 7509-PS **SALE** \$179.50



• CUSTOM FIREWALL REPLACEMENT

16 Gauge steel with 4" deep firewall setback. Welding required, not a cover, replaces firewall and gives 4" extra room for engine. Matches custom floor board & tunnel kit below.

4" setback 7519 \$475.00 ea
 For matching floorboards see next 2 pages.



• ABS INSIDE UNDER-DASH FIREWALL COVER

Made specifically for above custom set back firewall.

ABS 7517-ABS \$189.00 ea

TRANSMISSION HOLE COVER

• STEEL reproduction of original 7786 \$59.00 ea

• TALL for large transmissions 7786-TALL \$125.00 ea

• GASKET, 2 piece 7786-GSKT \$16.90 ea

TRANSMISSION COVER BOLTS

1953-55, stainless 80120-5355S \$8.50 set

1953-55, zinc 80120-5355Z \$5.50 set

1953-55 cage nuts 80123 \$6.95 set

1956 or all new floors, stainless 80121-56 \$7.50 set



• FLOOR PLATES

See page 174 for more info. And pictures.



• DIMMER SWITCH PLATE 2914-FP \$15.00 ea

Switch on column? use dimmer switch delete plate or plug hole with handy hole plug.

• DIMMER DELETE PLATE 2914-FPD \$10.00 ea

• DIMMER PLATE SCREWS 82912 \$0.95 set

• DIMMER SWITCH HOLE PLUG 82911 \$0.55 ea



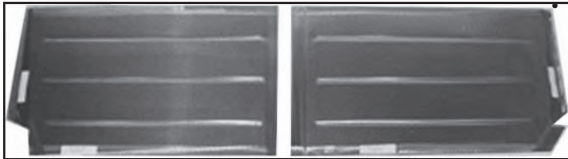

CUSTOM FLOOR BOARD & TUNNEL KIT

16 Gauge steel, replaces entire front floor, toe board and transmission area. High clearance for automatic transmissions. Oversize shipping.

- Use with Custom 4" setback firewall, see previous page 115
- Custom Floor board & Tunnel Kit 7518 \$305.00 set
- Kit to use with stock firewall..... 7518-SF \$299.95 set
- Matching rear floorboard 7516 \$160.00 ea

WELD SUPPORT BRACKET, Handy, use to assist when joining floor panels, adds support and supports floor panel while welding. 7722-B \$7.85 ea

FLOOR PANELS

Passenger sides are interchangeable if you are using a modern 10" long battery, use matching battery hole cover. Driver side 56 will fit 53-55 without gas tank, 53-55 will fit 56 just add a gas sender cover. Oversize shipping

IMPORT PANELS, are somewhat thinner than USA panels. Import panels only have 56 battery hole size. Make sure to use support & under floor center support found on next page.
1956 driver, import..... 7722-56L \$99.00 ea
1956 passenger, import..... 7722-56R \$99.00 ea

USA PANELS
1956 driver, made in USA..... 7721-56L \$99.00 ea
1956 passenger, made in USA..... 7720-56R \$95.59 ea
1953-55 driver side, USA..... 7721-5355L \$99.00 ea
1953-55 passenger side, USA..... 7720-5355R \$99.00 ea

NO HOLES cut out, 56 indents but not removed 16 gauge
1953-56, passenger..... 7720-JRN \$95.59 ea
1953-56, driver..... 7721-JL \$95.59 ea

REAR FLOOR SECTION Oversize shipping
Original style, complete..... 7789 \$179.00 ea
Custom rear floor section..... 7516 \$160.00 ea

BATTERY HOLE LID, see also page
With handle, 1953-1955..... 0117-5355 \$46.50 ea
With handle, 1956..... 0117-56 \$43.95 ea
Gasket, 1953-55 0115-5355 \$8.50 ea
Gasket, 1956 0115-56 \$8.50 ea

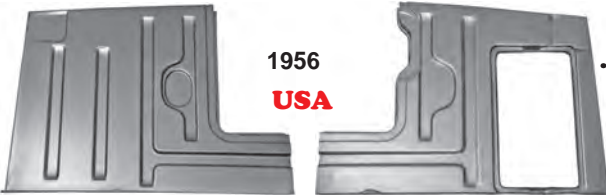
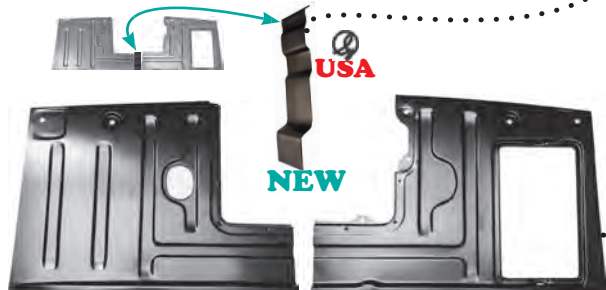

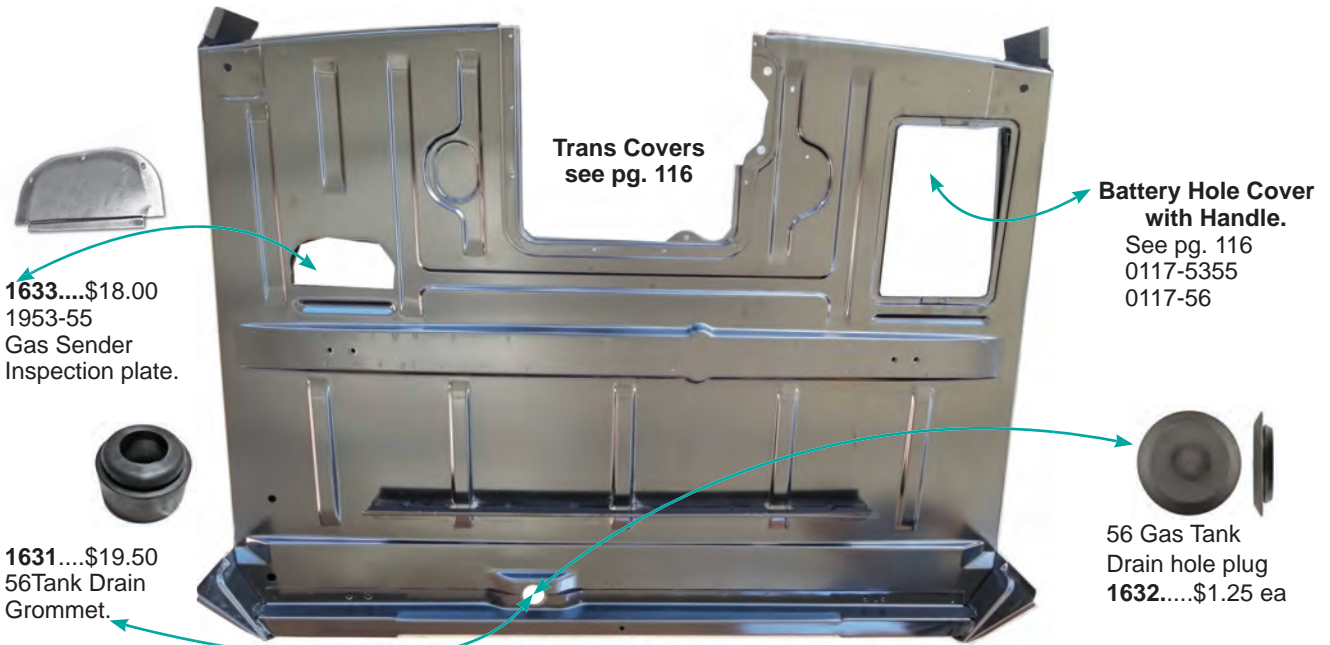

COMPLETE CAB FLOOR, Cab floors can be interchanged between 53-55 and 1956. Differences are Battery hole cover, 53-55 Gas Sender Inspection Hole Cover & 1956 Tank Drain hole. No provisions for 1953-55 gas filler tube. Complete Floor includes Rockers and under braces. Very large, ships via Truck. Imported

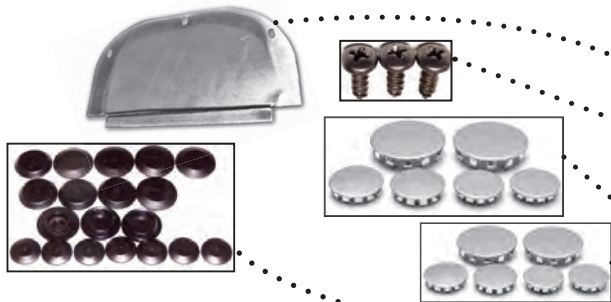

COMPLETE CAB FLOOR

- 1953-55.....7780-5355.....\$850.00 ea
- 1956.....7780-56.....\$850.00 ea

GAS TANK INSPECTION HOLE COVER

- 1953-55 1633\$18.00 ea
- Cover screws..... 81633.....\$1.00 set

HOLE PLUGS Handy for filling miscellaneous holes anywhere. Nickel plated plug buttons. See also specific applications for hole plugs such as gas drain, brake hole plug etc

- Large, 2 x 7/8" & 1"..... 80218-LG\$6.50 set
- Medium, 2 x 1/2", 5/8" & 3/4"..... 80218-MD\$5.00 set
- Black plastic assortment..... 80219\$4.50 set
- 6 each 3/8" 6 each 5/8" 6 each 3/4", 18 pieces total

Rocker panels see page 118

FLOOR BRACES

- CENTER BRACE..... 7788\$28.50 ea

- LEFT OR RIGHT BRACE..... 7787\$25.00 ea
- Includes seat track mounting taps.

REAR CAB MOUNT BRACKETS

- Base plate.....0738.....\$15.55 ea
- Base bracket, Left.....0739-L.....\$15.00 ea
- Right.....0739-R.....\$18.75 ea

FLOOR ACCESS COVER PLATE

- Includes screws..... 4666\$7.50 ea
- Neat low profile stainless cover for any new holes up to 5" for new floors or master cylinders, gas senders, etc with screws

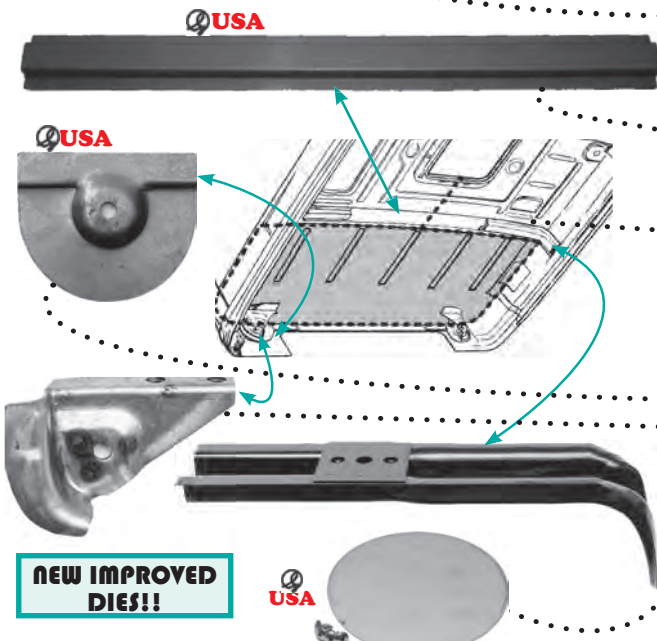

CAB REPAIR

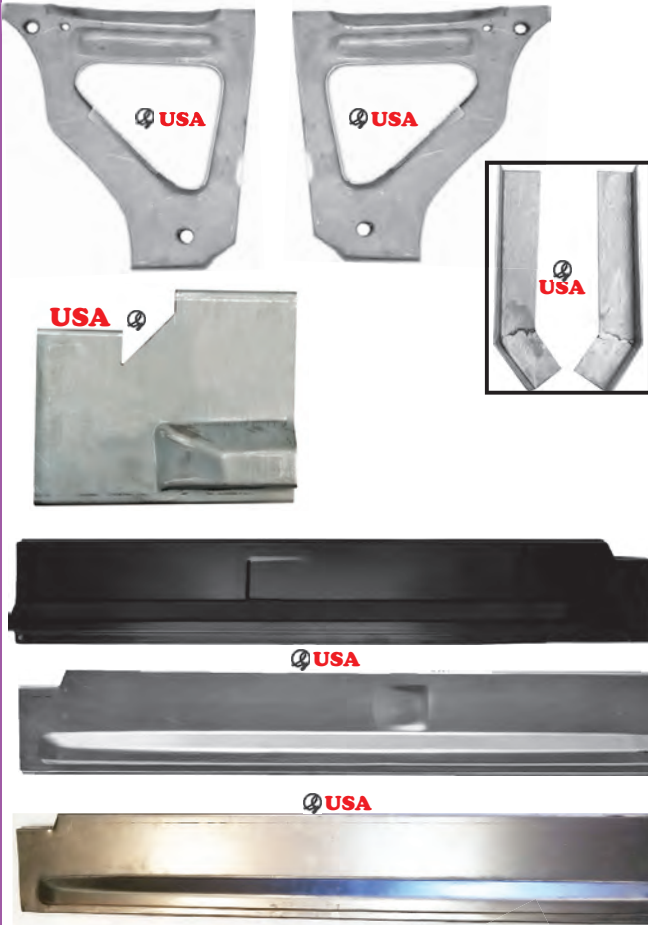

TRIANGLE GUSSET, Behind kick panel area,

Driver side 7716-L.....\$22.50 ea
Passenger side..... 7716-R.....\$22.50 ea

ROCKER "L" REINFORCEMENT,

1954-55 7719-55..... \$20.00 pr

ROCKER REINFORCEMENT

1956, Right passenger 7719-R.....\$20.00 ea
Left driver..... 7719-L.....\$20.00 ea
Fits over 56 rocker and Import replacements.

ROCKER PANELS

Imports have 56 indent for reinforcement piece, Black

Driver, Import..... 7729-56L.....\$48.50 ea
Passenger, Import 7729-56R.....\$48.50 ea

ROCKER PANELS, USA MADE

Heavy 16 gauge, nice upper lip to lay under floor for easy and strong welding installation

No reinforcement front indent

no reinforcement needed.

Driver, USA..... 7728-5356L.....\$49.50 ea
Passenger, USA 7728-5356R.....\$49.50 ea
Pair, USA..... 7728-5356..... \$98.50 pr

No Center Divot, Smooth

Driver, USA..... 7729-5356L.....\$49.50 ea
Passenger, USA 7729-5356R.....\$49.50 ea

FRONT CAB BODY MOUNT BRACKET

Little kick up part goes toward front at firewall

Driver 7718-L\$25.00 ea
Passenger 7718-R.....\$25.00 ea

INNER FENDER TO LOWER CAB MOUNTING ANGLE

Interchangeable. 56 Short, longer 53-55 style fits 56 as well

•Driver, 1956, will fit all..... 1564-L\$22.50 ea
Passenger, 1956, will fit all 1564-R.....\$22.50 ea
Driver, 1953-55, will fit all..... 1564-5355L\$22.50 ea
Passenger, 1953-55, will fit all..... 1564-5355R.....\$22.50 ea

FRONT LOWER DOOR PILLAR

..... With hinge bucket, Driver 7713-L\$49.50 ea
..... With hinge bucket, Pass 7713-R.....\$49.50 ea
..... No hinge bucket, Driver 7714-L\$39.75 ea
..... No hinge bucket, Pass..... 7714-R.....\$39.75 ea

• **REAR CAB PILLAR**, Driver 7715-L
Pass..... 7715-R.....\$39.00 ea



Patch Panels, most all are copy of a specific 1956 truck. Some require modification for 1953-55. Rear cab corners do not have 1953-55 gas filler area. Cab side cowl piece has small dip at top inner area, etc. Patch panels are not covers, they replace original sheet metal, however, they may not be exact duplicates of original. Original cabs are not all exactly alike as they were not all stamped from the exact same dies. Watch for notes in this book and our website for helpful hints on fit, etc



1956 DASH REPAIR7535\$59.00 ea
Rolled bottom edge and flanges for ease of installation, 18 gauge steel seam to seam , covers glove box area

X-TEND-A-DASH *Molded to fit contour of dash, adds 3 inches to bottom, allows glove box door to open. Will hold Vintage Air oval panel, gauges, Air Ride switches, etc*
 FIBERGLASS. 1953-55.....7530-5355\$136.50 ea
 1956.....7530-56\$136.50 ea
 ABS BLACK, paint-able.....7531\$128.50 ea



ROOF, SEE NEXT PAGE
DRIP RAIL, SEE NEXT PAGE
FRONT DOOR JAM, SEE PREVIOUS PAGE
COMPLETE REAR CAB PANELS SEE NEXT PAGES
FRONT COWL & WINDSHIELD SECTION
 Coming early 2020, Watch website for announcements

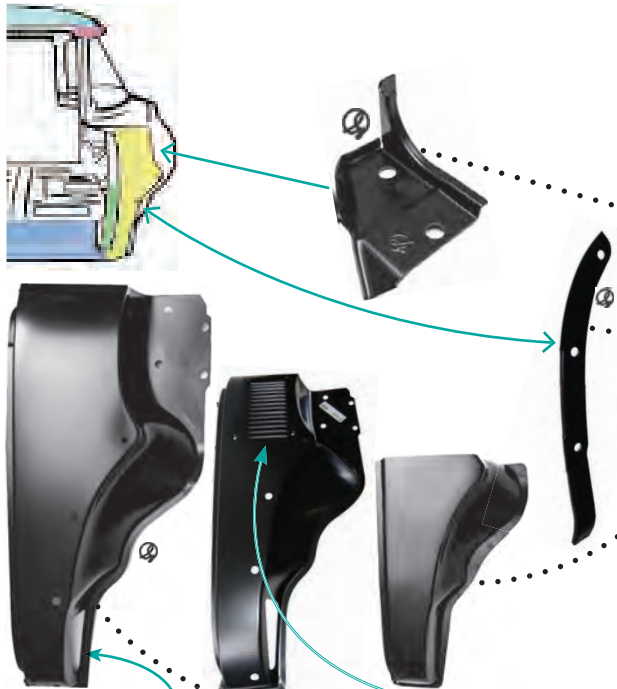

UPPER FENDER SUPPORT This little support often is cause of fender & hood misalignment, check for damage or fatigue.
 Driver side1562-L\$25.00 ea
 Passenger1562-R.....\$25.00 ea

FRONT COWL & FENDER REINFORCEMENT
Piece inside cab. Fender bolts through, includes locating nut.
 Driver1562-L
 Passenger1562-R.....\$20.00 ea

LOWER FRONT CORNER, 22"
 Driver7711-22L.....\$45.50 ea
 Passenger7711-22R.....\$45.50 ea

FRONT CAB CORNER & COWL
Goes all the way to upper seam, includes hood hinge area. Nice piece, best one for door edge area, oversize shipping.
 Driver7705-L\$55.00 ea
 Passenger, with louvers.....7705-FA\$65.00 ea
 •Passenger, No louvers7705-R.....\$58.50 ea

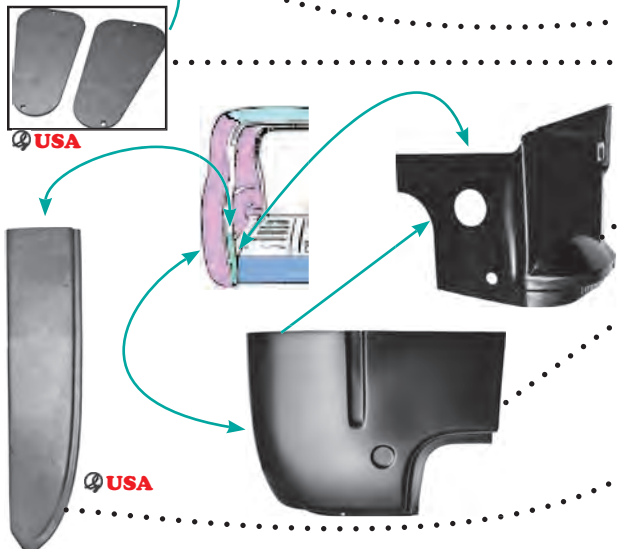

FRONT INSPECTION PLATE ...7712 \$16.50 pr
Use on some 55's, all 56's and all new panels with holes
 Inspection plate screws87712\$1.50 set

REAR INNER CAB CORNER
 Left.....7706-L.....\$65.00 ea
 Right7706-R\$65.00 ea

REAR CAB CORNER, 53-56, Nice sharp bends and correct curve, 15" tall, which is tall enough to cover 1953-55 gas tank filler indentation, (indent is not included)
 Left, driver side.....7709-L.....\$30.00 ea
 Right, passenger side.....7709-R\$30.00 ea

REAR LOWER CAB POST
 Driver.....7715-L.....\$39.00 ea
 Passenger7715-R\$39.00 ea
 FRONT POST SEE PREVIOUS PAGE

ROOF - REAR CAB PANELS

2020 Mid Fifty
1953-56 Catalog

ROOF PANEL

FIBERGLASS ROOF, *Can install with Plio-Grip panel Adhesive. (Chop tops also available see page 121)*

- 1953-55 Roof, fiberglass6528-5355 \$350.00 ea
- 1956 Roof, fiberglass.....6528-56 \$350.00 ea

STEEL ROOF 1956 only.....7766-56 \$349.95 ea

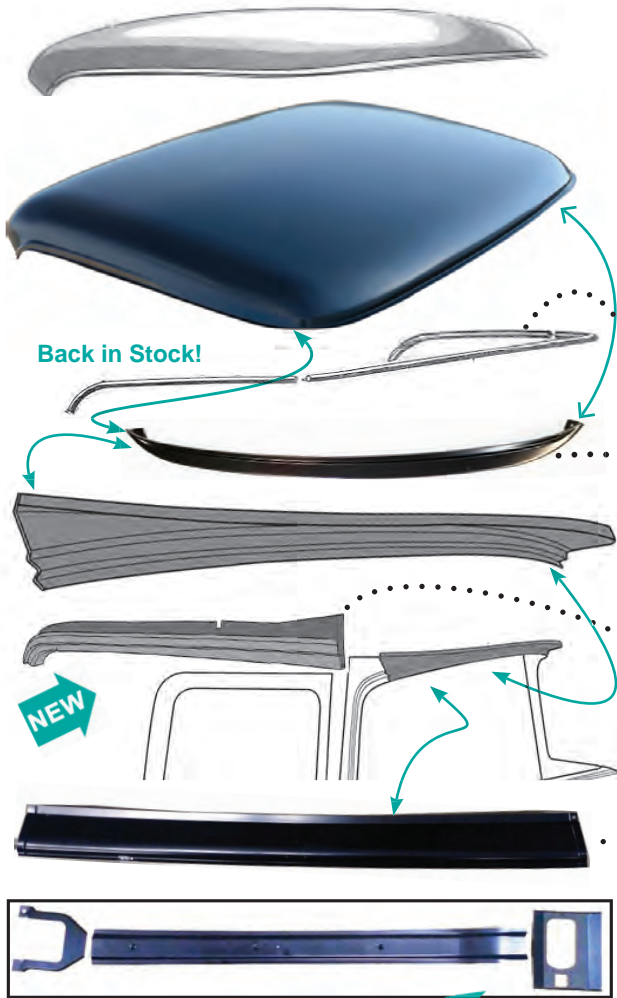

Back in Stock!

DRIP RAIL 1956 only97760..... \$148.50 set
3 piece, reproduction of original, 56' only available

NEW

SOFFIT-BEAK-OVERHANG, do not know what to call this piece but it is often rusted out. Right above and hanging over windshield on 1956 only7768-56 \$159.95 ea
Note is pre-assembled as would be almost impossible.

ROOF SUPPORT ABOVE DOOR HEADER, upper door jam & roof support, front part goes behind above header cover.
Driver side7763-56L \$142.50 ea
Passenger7763-56R \$142.50 ea
Pair7763-56 CALL

INNER HEADER COVER, goes inside above windshield, Mirror mounts on this.....7764-56 \$159.95 ea

CENTER SUPPORT & DOME LIGHT BRACKET MOUNT
3 piece set7765-56 \$89.95 set

BIG BACK WINDOW CONVERSION PANEL
Includes inside frame assembly, *complete from roof seam to 3" below window.*7792..... \$495.00 ea



REAR CAB PANELS

STANDARD WINDOW

- With Inner window & braces 7798-SWN..... \$695.00 ea
- Outer panel (no inner pieces)..... 7797-SW \$495.00 ea

BIG BACK WRAP AROUND WINDOW

- With Inner window & braces 7798-BWN..... \$750.00 ea
 - Outer panel (no inner pieces)..... 7797-BW \$495.00 ea
- Must be installed on original Big Back window Truck.
Difficult to install correctly without inner frame work.*



TRIM KIT, With TRIM, USA RUBBER & INSTALL KIT
Save with kit.....91226 \$299.95 kit
*See page #29 also Trim was original in all big back windows.
Installs like windshield, rubber on glass, trim in groove, entire assembly in truck trim OUTSIDE.*





COMPLETE FIBERGLASS DOG HOUSE

Fits 1953-1956. Requires crate and truck freight, call for quote. Nice quality and fit.

Front end6550\$1695.00 ea
 DIY, simple L bracket, mount to air deflector area, bolt sheet metal together, hinge to frame



FIBERGLASS 1956 CAB, COMPLETE

Complete 6556\$5650.00 ea
 Sounds like a lot of money until you check out what is included! One inch steel tube sub-structure assures no body flex. Convenient oak tack strips installed to simplify interior installation. All important details taken care of:

- Doors are hinged and installed and shaved
- Top and side cowl vents are removed
- Firewall holes are filled and smoothed
- The bottom of the floorboards are as smooth as the roof
- Door handles are shaved
- Upgraded bear claw door latches
- Stock windshield & rear glass will fit on stock rubbers
- Dash installed, glove box smoothed over
- Steering column mount installed
- Big back window option available ADD... \$495.00 ea
- Solid side glass and power windows installed ADD... \$595.00 ea

Chopped windshield is 3 1/2" shorter than stock. Chop top kit will chop cab 3 1/2" front & 2 3/4" in rear



1953-55 CHOP TOP

1953-55 EZ CHOP TOP KIT

Top is wider, longer and proportioned correctly. Rear window is proportioned perfect, not just tiny slit. Windshield is formed for this chop, not just a cut down stock one, die was produced so windshield fits correctly, no cutting and grinding just to have it break first time cab flexes. **Rear and side glass are limo dark smoke.**

Includes, roof, windshield, limo dark rear window & curved side glass with anti-rattle kit & DVD instructions
 (For other glass choices see below)

KIT, Limo sides & Back, Tint Windshield96520..... \$1455.00 kit

INDIVIDUAL CHOP TOP PIECES

- Chop top fiberglass roof, 1953-55 6529-5355.....\$395.00 ea
- Chop top fiberglass roof, 1956 6529-56.....\$395.00 ea
- Stock fiberglass roof, 1953-55..... 6528-5355.....\$350.00 ea
- 1956..... 6528-56.....\$350.00 ea
- Chop top Windshield, Tint only 1953-55..... 6522.....\$450.00 ea
- Chop top Rear glass, Tint..... 6523-T,\$75.00 ea
- Smoke 6523-S\$75.00 ea
- Limo dark.....6523-D\$100.00 ea

SOLID SIDE GLASS

- Curved, limo dark only, pair 6524.....\$350.00 pr
 - Solid side glass, to use flat glass in any color, straighten door openings with our 3113-4.....\$39.95 set
 - Anti-rattle kit for curved glass 6525..... \$179.95 kit
 - Anti-rattle kit for straight glass 6526.....\$225.00 kit
- Includes channel run steel inserts for front, channel felts & lower felts

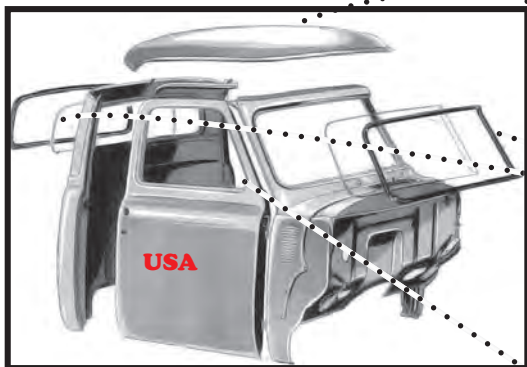

USA

•ABS HEADLINER MODIFICATION KIT, use for any chop top, kit has pre-curved molded pieces to help extend roof panels to fit, new clips, and Instructions, Kit.....2123-CTK..... \$89.00 kit

AIR DEFLECTOR

2020 Mid Fifty
1953-56 Catalog

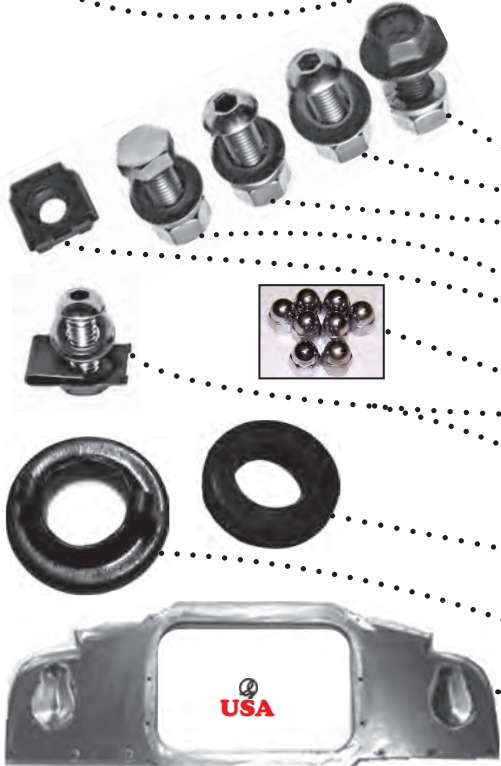
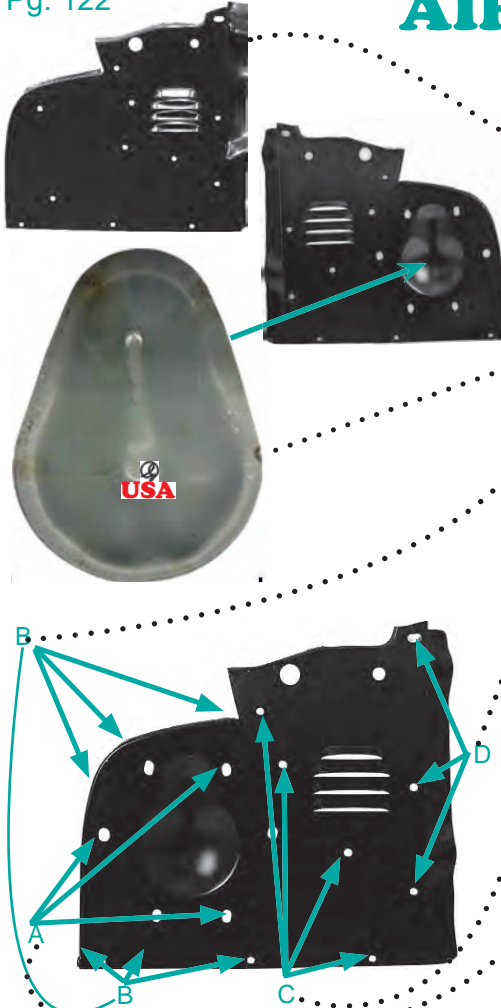

AIR DEFLECTOR PANELS *Steel, order by year of grille NOT year of truck. 1956 grille must have '56 air deflectors with bucket indent. 1953 steel deflectors are not produced at this time, working on them but 1954-55 works fine.*

- 1954-55, passenger 7741-5455R **SALE** ...\$68.50
- 1954-55, driver 7741-5455L **SALE** ...\$68.50
- 1956, passenger 7741-56R **SALE** ...\$68.50
- 1956, driver 7741-56L **SALE** ...\$68.50
- 1953-1956, fits all grilles... **SALE**7742-L.....7742-R..... **SALE** ...\$65.00 ea

AIR DEFLECTOR one side only, USA MADE..GWG-SALE...\$45.00 ea
1954-55 Left only.....7740-5455L **SALE** 1956 Right only.....7740-56R

- **BUCKET INDENT ONLY** 7749 \$24.50 ea
Easy conversion or repair if someone has cut a nasty hole in your air deflector

AIR DEFLECTOR BOLT KITS

B.) FENDER TO AIR DEFLECTOR BOLT KIT

These bolts do not show unless your head is in the wheel well. Of course we offer them in polished stainless for just that occasion.

- Zinc, with hardware 87005-Z..... \$7.50 kit
- Stainless hex, with hardware 87005-SX \$10.95 set
- Polished stainless button with acorn 87006-PB \$32.00 set

D.) RADIATOR SADDLE TO AIR DEFLECTOR BOLT KIT

4 show on grille side 2 show in the engine compartment

- Black original style 87007-B..... \$5.50 set
- Stainless hex 87007-SX \$5.50 set
- Polished stainless button 87007-PB \$15.00 set

C.) INNER FENDER TO AIR DEFLECTOR BOLT KIT

These peek through grille area and show in the engine compartment

- Black, original style 87008-B..... \$5.50 set
- Stainless hex head 87009-SX \$8.00 set
- Polished stainless hex 87009-PX \$20.00 set
- Polished stainless button 87009-PB \$22.00 set

A.) AIR DEFLECTOR TO GRILLE BOLT KITS *Shows under hood*

- Black, original style, use existing J nut 87003-Z..... \$5.50 set
- Polished stainless button, use existing J nut 87003-PB \$16.50 set
- Polished stainless hex, use existing nuts 87003-PX \$14.50 set

BOLTS

Kits save a buck or two but with modifications from stock you might need to order some separately. In some areas, where both ends of bolt show, we use a finish acorn nut to cover threaded end. We prefer lock washers & nuts as most of the truck should be test fitted before final assembly. If you prefer Nylox (nylon inserts-no lock washer) please let us know

- Black original style 8888 \$0.75 ea
- Stainless button head with flat, lock & nut 8853-SB \$2.00 ea
- Polished bolt & washer, plain flat, lock & nut 8853-PB \$3.00 ea
- Zinc plate hex head with 2 flats, lock & nut 8863-ZX \$0.55 ea
- Stainless hex head with 2 flats, lock & nut 8863-SX \$1.25 ea
- Polished bolt & washer, plain flat, lock & nut 8863-PX \$2.75 ea
- Cage nut 5/16" fine thread, each 87010 \$1.15 ea
- Cage nut 5/16" fine thread, set of 25 87010-25 \$24.50 set
- Acorn nuts, 5/16 -fine thread, set of 8 87016-8 \$15.50 set
- Bolts with J-nuts
 - Black original style, set of 6 81256-Z..... \$7.50 set
 - Polished hex, set of 6 81256-PX \$14.50 set
 - Polished button, set of 6 81256-PB \$15.50 set

AIR DEFLECTOR HOLE GROMMETS

- Large hole 2320-L \$2.50 pr
- Small hole 2321-M \$2.50 pr
- Reproduction of original, large 2233 \$3.95 ea
- Reproduction of original, small 2233-S \$3.95 ea

SOLID ONE PIECE AIR DEFLECTOR PANEL

Oversize shipping. Very custom, cleans up entire area, everything mounts just like it's supposed to. Great for front tilt or just to get rid of holes, louvers, etc

- 1953-55, no headlight bucket indents 7746-5355 \$375.00 ea
- 1956, with headlight bucket indents 7746-56 \$385.00 ea



FRONT LOWER VALANCE (GRAVEL PAN)

All gravel pans are oversize shipping. Match park lights to gravel pan, match park lights to grille. Grille will interchange but 1956 grille requires matching 1956 air deflectors.

FIBERGLASS With frame holes

- 1953 & 54 park light indents 1519-5354 \$179.95 ea
- 1955-1956 park light indents 1519-5556 \$179.95 ea

STEEL

WITH FRAME HOLES

- 1953 park light indents 1524-53 \$195.00 ea
1953 will fit 1954 if using grille other than stock 1954
- 1954 park light indents 1524-54 **SALE** \$177.00
- Grille to gravel pan bolts 81257-54 \$3.25 ea
- 1955-56 park light indents 1525-5556 \$195.00 ea

Park lights attach to gravel pan, 1953 & 54 have a smaller, more triangular indent for the park light base, 1955 & 56 indent is larger & more rectangular, see pictures. 1955 & 1956 bases can be interchanged by re-drilling mounting holes. Ground park light base somewhere else on fiberglass pans

NO FRAME HOLES

For use without bumpers

- 1953 park light indents 1526-53 \$195.00 ea
- 1954 park light indents 1526-54 \$195.00 ea
- 1955-56 park light indents 1526-5556 \$195.00 ea

- FRAME HOLE PATCH PANEL 1520 \$22.50 ea
Fills in frame hole on stock panel, good for custom or repair.

GRAVEL PAN BOLT KITS

- Zinc 81532-Z \$4.50 kit
- Stainless 81532-SS \$6.90 kit

GRAVEL PAN TO RADIATOR SEAL

- Seal 2308 \$6.60 ea
- Install screws, stainless 82308-SS \$1.50 set
Replaces original "staples" which are difficult to install, if you want staples, ask, they're free, but, "we did warn you!"

FRAME HORN COVERS

- Covers frame between bumper & pan.
Polished stainless 0606 \$31.00 pr

RADIATOR-BELT SPLASH SHIELD

Important piece, goes right behind front crossmember. Intended to protect radiator and engine belt area from flying road junk. Original was steel, too expensive, so went with ABS plastic.

- Made in ABS plastic 2329-A \$78.00 ea
- Mounting bolts, stock style 82329 \$5.50 ea
- Mounting bolts, polished 82329-PS \$18.50 ea

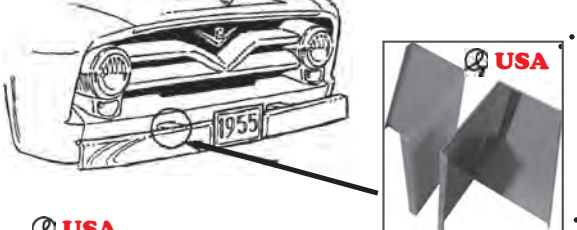
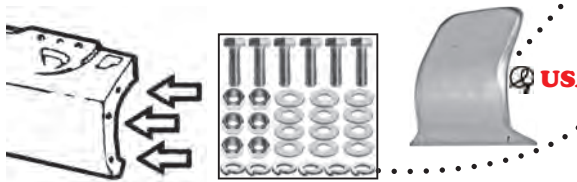

FRONT FENDERS

All Fenders are shipped by truck. Freight charges can be collect or prepaid. Call for quote, freight charges change often. Four can sometimes go as cheap as 2. See page 3 for more info.

STEEL FRONT FENDERS

Very good reproductions, best available fit like an original, 18 gauge steel, fender is complete all holes are punched.

Driver.....	7701-L.....	\$350.00 ea
Passenger	7702-R	\$350.00 ea

FRONT FIBERGLASS FENDER

Nice underside, smooth gel-coat, all components permanently bonded. Mounting holes not drilled but are marked. Very nice fender. 3 year guarantee

Driver.....	6600-L.....	\$250.00 ea
Passenger	6600-R	\$250.00 ea

FRONT FENDER UPPER MOUNTING BRACKET

Common rust and problem area, this piece holds the fender and is often the cause of fender or hood alignment problems if fatigued, bent, rusted or misaligned. If the truck has been hit this small piece will bend and forever cause hood and fender problems.

Driver.....	1563-L.....	\$22.50 ea
Passenger	1563-R	\$22.50 ea

FRONT COWL & FENDER REINFORCEMENT BRACE

Piece on inside of cab that fender bolts through, includes fender locating nut, this is where to start aligning fenders, rust or fatigue here can cause misalignment.

Left.....	1562-L.....	\$20.00 ea
Right	1562-R	\$20.00 ea

INNER FENDERS, SEE NEXT PAGE

INNER FENDER TO LOWER CAB ANGLE BRACKET

1953-55 were longer and caught the inner fender with both bolts. 1956 was shorter and only came to the first bolt. They each interchange so you can use long style on a 56 or short on a 53-55. Cage nuts are installed.

1956 driver, short	1564-L.....	\$22.50 ea
1956 passenger, short.....	1564-R	\$22.50 ea
1953-55 driver, long.....	1564-5355L.....	\$22.50 ea
1953-55 passenger, long	1564-5355R	\$22.50 ea
CAGE NUTS set (8) (included above).....	81564.....	\$8.50 set

We make brackets with nuts installed.

FRONT FENDER BRACE

Plain Steel, Left ..	1538-L	\$18.50 ea
Right	1538-R	\$18.50 ea
Polished stainless, driver.....	1539-LPS	\$26.00 ea
passenger.....	1539-RPS	\$26.00 ea
F-250 FRONT FENDER BRACE, Polished		
Left.....	F2-1539-LPS ..	\$26.00 ea
Right	F2-1539-RPS ...	\$26.00 ea

FRONT FENDER BRACE BOLT KIT

Stainless.....	81538-SX.....	\$6.00 set
Polished stainless, hex head	81538-PX.....	\$14.00 set
Polished stainless, button head.....	81538-PB.....	\$14.50 set

FENDER WELT

Rubber, die cut	1503-DC.....	\$12.50 pr
Rubber, uncut with pattern.....	1504	\$8.00 pr
Rubber, front & rear	1507	\$25.00 pr
Chrome, front & rear.....	1506	\$25.00 rl
Fabric, black	1501-FAB	\$18.00 rl
Fabric, colors, ask for samples.....	1501-(color).....	\$29.50 rl

ALIGNMENT BUMPERS On fender	2008.....	\$8.50 kit
-----------------------------------	-----------	------------



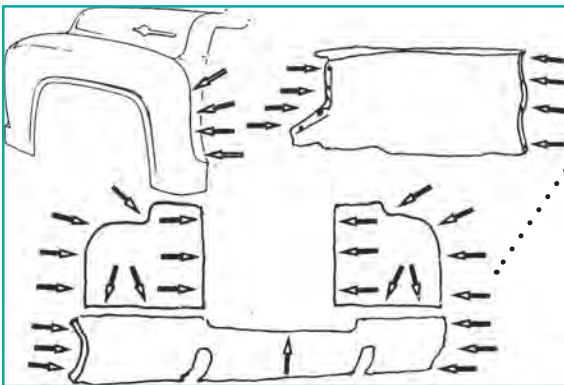
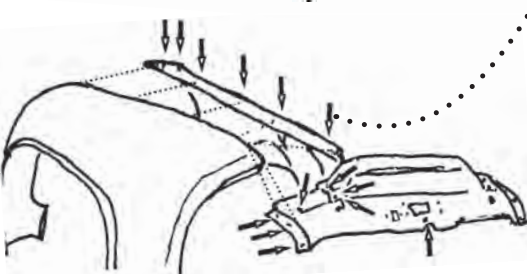
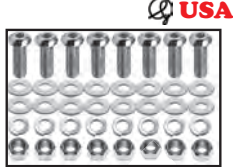

STEEL REPRODUCTION INNER FENDERS

18 gauge steel, just like the original. Oversize shipping

Driver side	7502-L	\$195.00 ea
Passenger side.....	7502-R	\$195.00 ea

CUSTOM INNER FENDERS

Front bolts to air deflector, (not in stock holes) & back to stock brace. Must be trimmed for IFS, new improved fit.

Oversized shipping

Plain steel.....	7503-D	\$259.95 pr
Polished stainless.....	7503-PS	\$299.00 pr

INNER FENDER BOLT KITS One bolt kit per inner fender

Black original style.....	87008-B.....	\$5.50 set
Stainless hex head	87009-SX	\$8.00 set
Polished stainless hex.....	87009-PX	\$20.00 set

Polished stainless button.....	87009-PB	\$22.00 set
Inner fender cage nut, fine thread	87010	\$1.15 ea
Cage nut set of 25	87010-25	\$24.50 set

When using fiberglass or nicer look on steel, replace cage nuts with chrome acorn nuts, set of 8..... 87016-8..... \$15.50 set

INNER FENDER WIRE CLIP Stock	3212	\$3.65 ea
------------------------------------	------------	-----------

CORNER REPAIR TAB	1560	CALL
-------------------------	------------	------

Rear steel inner fender corner replacement for stock inner fenders, a common rust area, see also the mounting brace on previous page

SPACER BAR	7501	\$34.00 pr
------------------	------------	------------

Professional builders use this in small gap between custom fender and inner fender, pre-punched holes, paint to match fender or black to disappear.

FRONT END BOLT KITS

UPPER FRONT FENDER TOPSIDE AND VALANCE

All body bolts that are visible with hood open, running down both fenders and across valance. Does not include latch bolts. We assume some of the existing cage nuts may be missing so we have included locks, nuts & washers with the following kits.

Black original style.....	87050-BL.....	\$22.50 kit
Plain stainless hex head.....	87050-SX	\$28.50 set
Polished stainless button head.....	87050-PB	\$78.50 set
Polished stainless hex head.....	87050-PX	\$68.50 set
Cage nuts	see above
J-nuts.....	see page 122

POLISHED COMBO KITS

Top is polished stainless and bottom kit is plain stainless, choose bolt style. Make sure you use anti-seize when putting it together the first time, because it probably won't be the last.

Button head bolts.....	87025-CMPB.....	\$139.00 kit
Hex head bolts.....	87025-CMPX.....	\$117.50 kit

LOWER FRONT END BOLT KIT

All the bolts that are somewhat hidden, does not include the ones along the top of the fenders. (See kits above). All bolts are fine thread and include both matching flat washers, nut & lock or Nylox.

Hex head zinc plated.....	87020-Z.....	\$29.00 kit
Hex head stainless	87020-SX	\$49.00 kit
Button head stainless	87020-SB	\$75.00 kit
Polished stainless hex	87020-PX	\$135.00 kit
Polished stainless button head.....	87020-PB	\$150.00 kit

If you want every bolt in the truck polished, great, but some threads show so you might want about 30 acorns & flats

Set	# IMNUTS	\$50.00 kit
-----------	----------------	-------------

ANTI SEIZE

4 OZ bottle.....	87000-4	\$6.95 ea
------------------	---------------	-----------

CAB MOUNTS, FRONT

2020 Mid Fifty
1953-56 Catalog



CAB ALIGNMENT TIP
Fenders and hood not lining up? With bolts finger tight, Place jack under FRAME at about location of front cab mount wing. Lift, often everything will line right up. This little guy and all his friends, especially the big cab mount wing are likely the culprits.

FRONT CAB MOUNT BOLT KITS

- Front, zinc..... 80702-Z..... \$4.50 pr
- Front, stainless..... 80702-SS..... \$9.50 pr
- Front & rear, zinc..... 80708-Z..... \$10.50 set
- Front & rear, stainless..... 80708-SS..... \$25.95 set

FRONT CAB BODY MOUNT BRACKET

- Is inside cab. Cab mount bolt goes through this, cab floor, then into mount plates*
- Driver..... 7718-L..... \$29.57 ea
 - Passenger..... 7718-R..... \$29.57 ea

FRONT CAB MOUNT UPPER CAP & PLATE

- This piece is often collapsed causing cab to lean. Note the plate shown goes beneath the floor with a little space between. If plate has rusted and collapsed cab will be a quarter inch off or more! If fenders and hood are not lining up this area is often the problem. Replace this, tack weld to floor and rocker, install new rubber and watch fenders and hood line up!*
- Driver side..... 0716-L..... \$14.00 ea
 - Passenger side..... 0716-R..... \$14.00 ea

FRONT CAB MOUNT CAP

- Goes over rubber mount, this is the cap attached to above plate.*
- Each..... 0719..... \$4.50 ea

FRONT MOUNT UPPER LARGE DONUT

- Pair..... 0700..... \$7.95 pr
- 1953-55 rubbers were more tapered and cap had a 45 degree flare, by 56 Ford made a small change and this is what we make today. This is NOT the same as front motor mount, though some sell as such, motor mount is too hard and does not have proper "spring".*

FRONT CAB MOUNT LOWER RETAINER

- Each..... 0717..... \$6.50 ea

CAB MOUNT RUBBER KIT

- Includes front large pads, front small pads, rear arm bumpers and 4 rubber bushings which in our experience are a waste of time without the steel bushings. Do not order this unless your steel bushing and/or rear cab arms are in good condition.*
- Kit..... 90703..... \$19.95 kit

CAB MOUNT FRAME WING

- Here is where a lot of front end misalignment starts. The cab is setting on this wing, if it is bent or fatigued, or if the frame is fatigued at this point the front fenders and hood will not align properly. Simple test, jack frame up below wing, if fenders fall into place, repair this wing and-or frame*

Now Black Powder Coated!!

- Left, Black..... 0736-5356PCL..... \$96.50 ea
- Right, Black..... 0736-5356PCR..... \$96.50 ea
- Mounting bolts..... 80736..... \$9.00 set

FRONT CAB MOUNT LOWER SMALL PAD

- Pair..... 0701..... \$7.95 pr

FRONT CAB MOUNT KIT

- Includes: 2 upper rubbers, 2 retainers, 2 lower pads, 2 bolts with hardware and 2 caps*
- Kit..... 90700-F..... \$42.50 kit
 - With floor plates..... 90700-WP..... \$58.50 kit
- SEE NEXT PAGE FOR FRONT AND REAR**

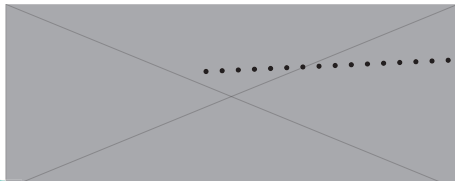
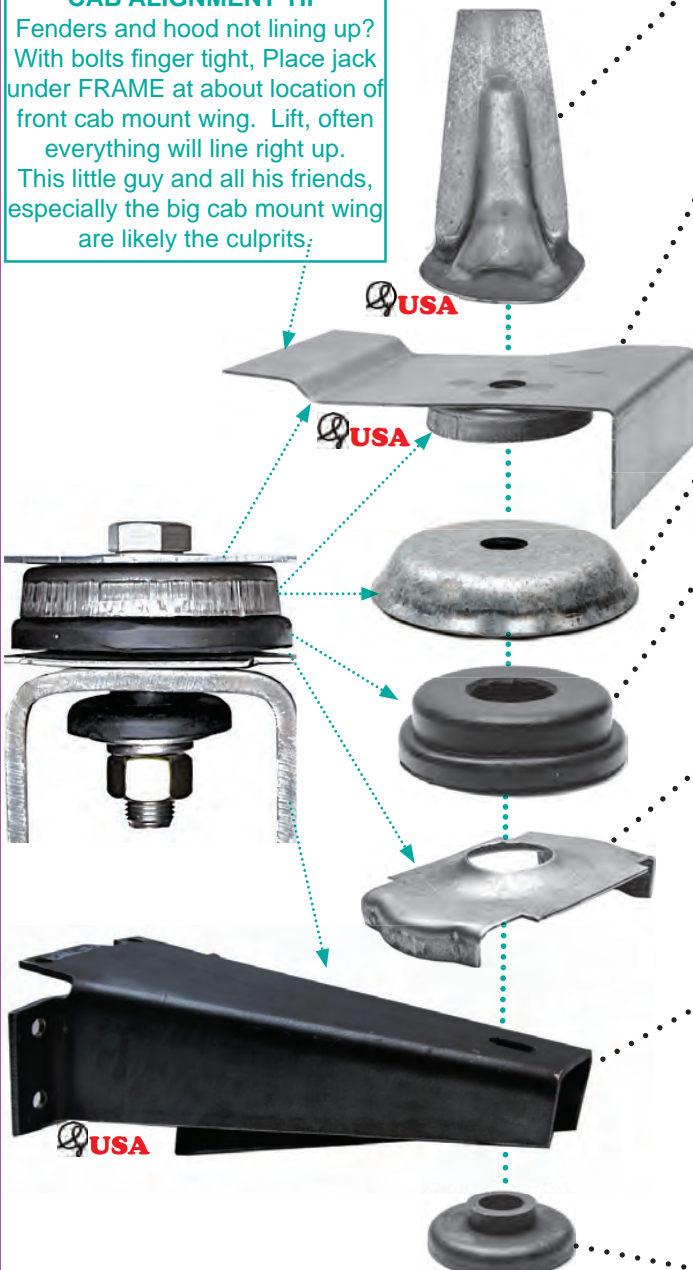



USA



USA

**NEW IMPROVED
DIES!!**



USA



REAR CAB MOUNT BASE BRACKET

Left..... 0739-L.....\$18.75 ea
Right..... 0739-R.....\$18.75 ea

REAR CAB MOUNT BASE PLATE...0738.....\$15.00 ea

REAR CAB MOUNT BOLT KITS

Rear set, zinc..... 80707-Z.....\$6.50 set
Rear set, stainless..... 80707-SS.....\$18.25 set
Both front & rear, zinc..... 80708-Z.....\$10.50 set
Both front & rear, stainless..... 80708-SS.....\$25.95 set

REAR CAB INSPECTION PLUGS....0703.....\$5.00 pr
Rear cab mount inspection hole cover.

REAR CAB MOUNT ARM REPAIR

Complete kit..... 0708.....\$13.50 set
Includes 4 rubber & 4 steel bushings, use only if the arm hole is not egg shaped. Only repairs the original style arm.

Steel bushing only 1 only..... 0707-S.....\$4.50 ea

Rubber bushing only, set of 4..... 0707-R..... **SALE**.....\$2.95

REAR CAB MOUNT ARM

ORIGINAL, CAST ARM..... 0704-CAST.....\$24.50 ea
Cast heavy duty arm, original F-100 arm was die bent steel with a small rubber bushing, it is not available. This fits the same, was used on larger trucks so has larger rubber bushing, bigger bushing, better ride.



USA

SY'S ADJUSTABLE ARM..... 0711.....\$59.00 ea

The answer for most cab arm problems. Easy installation and adjustment. If it looks like the bed is crooked, might be back of driver side cab. This arm will straighten it right up. (Stock distance hole center to center 6 1/4") after 50+ years of service most cab mounting areas have some fatigue even if you cannot see it. Fine tune cab at any time with just a simple turn even on an assembled truck.



USA

ADJUSTABLE ARM & BASE KIT..... 0712.....\$199.95 kit

Eliminates arms, brackets & bumpers, perfect if your brackets are gone or cab needs more side to side adjustment as well as up and down. Will fix even the worst misalignments. Nice hi tech look, about same money as all the stuff it replaces. Not as easily adjustable as sy's adjustable arms however. Powder coated black with red delron bushings replaces all stock rear mounting parts, except inspection hole plugs, order them separately above.



REAR CAB ARM BASE

Plain steel, each..... 0735.....\$23.50 ea

REAR CAB BASE TO FRAME BOLTS

Does both sides
Zinc..... 80735.....\$4.00 set
Polished stainless..... 80735-PS.....\$6.90 set



USA

REAR CAB MOUNT ARM BUMPERS

Pair..... 0706.....\$7.95 pr

FRONT & REAR CAB MOUNT KITS

2 front large pads, 2 upper caps, 2 lower retainers, 2 lower pads, 2 rear arm bumpers, 2 inspection plugs, all hardware and:

With rear cab arm repair kit..... 90702.....\$75.00 kit

With stock cab arms..... 90701.....\$105.00 kit

With adjustable cab arms (shown)..... 90704.....\$175.00 kit

Everything above, plus cap & plate assembly

With stock cab arms..... 90701-WP.....\$124.00 kit

With adjustable rear cab arms..... 90704-WP.....\$189.00 kit

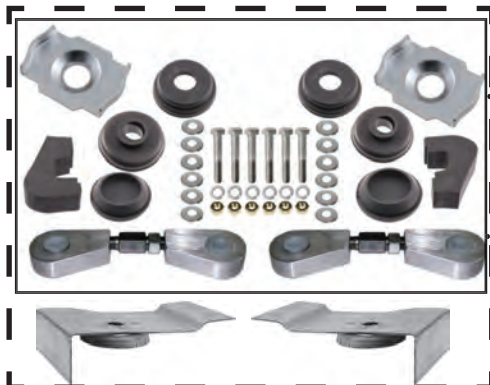

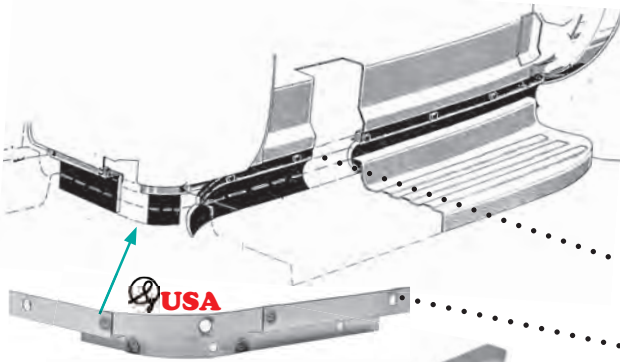

1956 CAB SKIRTING

1956 side and corner hangers secure to lower cab lip then go back under cab an inch before turning downward to hold skirt. Skirt ends up in same position as 1953-55. This is a good choice for cabs with imperfect edges. It straightens up the lower cab lip line and covers any damaged areas. Can be spot welded or secured with screws, clips or bolts, was originally attached with original style clips (difficult to use and expensive). 56 Hanger goes on outside of cab lip, 1953-55 goes inside.

• 1956 CAB SKIRT HANGERS

Can also be used on 53-55. These show, polished stainless is a nice touch. Large holes go up

• Corner hanger

Stock steel driver 7732-L \$16.50 ea
Stock steel passenger 7732-R \$16.50 ea

• Side hanger

Stock steel 7731 \$19.75 ea
Polished stainless 7731-PS \$29.75 ea

• Hanger mounting bolts

Stainless 80306-SS \$12.00 set
Polished stainless button head 80306-PB \$22.00 set

• ORIGINAL "X" CLIPS 80309 \$1.50 ea

Use if going exact of original, hard to work with & expensive

• 1956 CAB SKIRT RUBBER 0304-56 \$14.50 pr

If you want to fight with original staples, good luck FREE
If not, order attaching push clips or screws below

Small piece, for corner or? 0303-CNR \$8.90 pr
Attaching hardware, not original see above

Plastic push clips (20) 80305-56 \$3.50 set
Polished stainless screws 80307-PS \$14.50 set

• 1956 CAB SKIRT AND HANGER KIT

2 corners, 2 side channels, all rubber skirts & push clips
Stock steel 97732-56 \$89.95 kit
Polished Stainless 97732-PS \$159.95 kit
Sides & Skirts only, no corners, steel .. 97731 \$47.50 kit

1953-55 CAB SKIRTING

1953-55 hanger channels should be attached to a small lip on bottom of cab. If your's no longer has usable lip, see above, or neat fix is to use Up-Side Down style that attaches to running board and points UP toward cab. add weatherstrip glue for best results.

• UPSIDE DOWN CAB SKIRTING 0305 \$48.50 pr

• 1953-55 CAB SKIRT HANGER CHANNEL

This piece does not show below door, it goes on inside of lip, "C" points toward inside of cab
Plain steel 7730 **SALE** \$8.75
Polished stainless 7730-PS \$15.00 ea
I know it doesn't show, but, no painting, no rust, worth extra \$
Hardware kit 80303 \$6.50 set
Polished stainless, screws go all the way through the rubber into clips. We include 4 extras to go around corners

• 1953-55 CAB SKIRT RUBBER 0304-5355 \$19.95 pr

Hangs from 'C' channel, is attached around corners with screws.

• 1953-55 CAB SKIRT AND HANGER KIT

2 side hanger channels, 2 skirts and hardware kit.
Plain steel (polished screws) 97730-5355 \$47.95 kit
Polished stainless 97730-PS \$53.95 kit

• CUSTOM STAINLESS SKIRTS

With hardware 7304-FLX \$65.00 kit
Easy to install, polished stainless flexible steel, replaces rubber.

Note: 1953-55 Trucks may need corner hangers at top of page

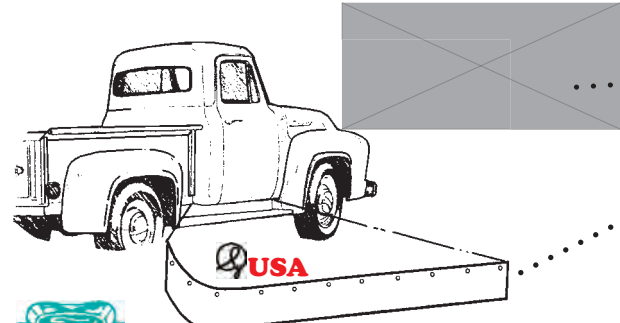
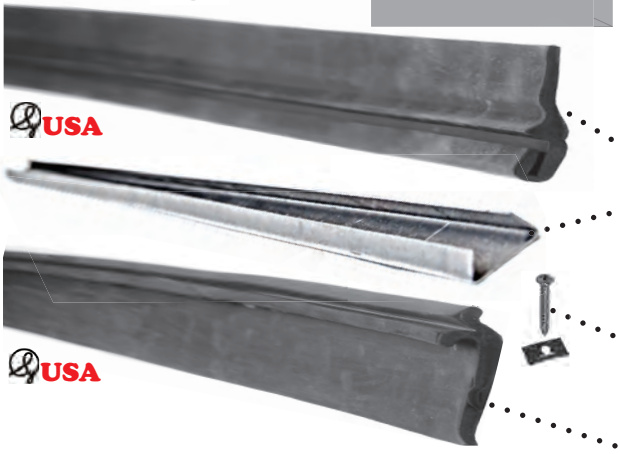
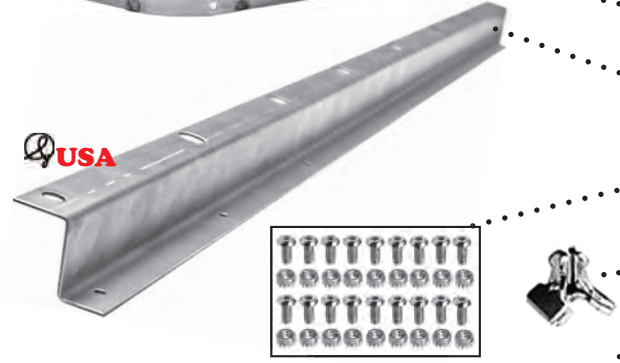

Running boards being stamped by original dies have die marks, wrinkles, and are galvanized. Boards made in china are pretty nice, punched for bolts and are a good reproduction, they also have wrinkles on edges like originals.

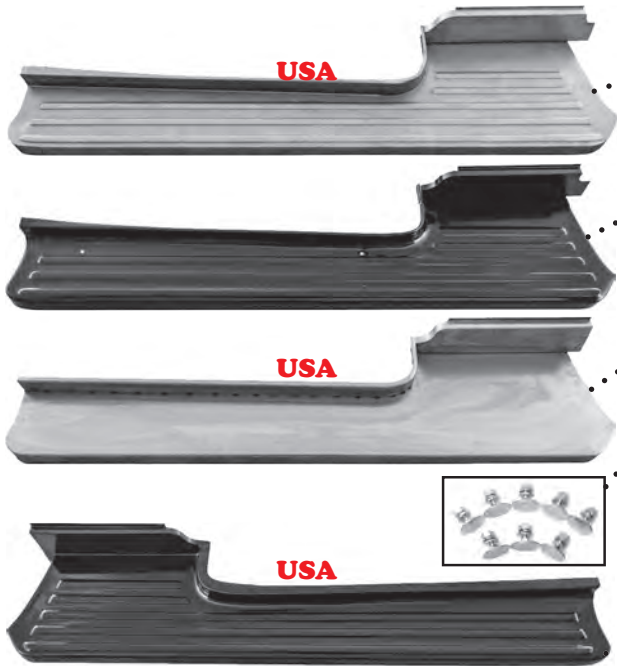

RUNNING BOARDS

- **ORIGINAL FORD DIE.**, made in USA, Galvanized, Some die marks and wrinkles. Pair0308-5356PR\$499.95 pr
 Driver0308-L\$299.95 ea
 Passenger...0308-R.....\$299.95 ea

- **CHINA MADE Black plated. Decent board, some die marks and wrinkles.** Driver0309-L\$215.00 ea
 Passenger0309-R.....\$215.00 ea
 Pair0309-5356\$419.95 pr

- **SMOOTHY, STEEL Smooth and hand formed, no bolt holes or ribs, Pair**0310-PR\$475.00 pr
- **Smoothy MOUNTING BOLTS**.....80314.....\$12.50 ea
Glue or tack weld on bottom of board.

- **FIBERGLASS, RIBBED**
 Driver6513-L\$195.00 ea
 Passenger6513-R.....\$195.00 ea
Has some advantages over steel in price and rust of course, but also is less likely to get small dents from road debris or stretch & bow when subjected to continuous weight loads such as being stepped on for 50 years.

Long bed running boards, see page 150

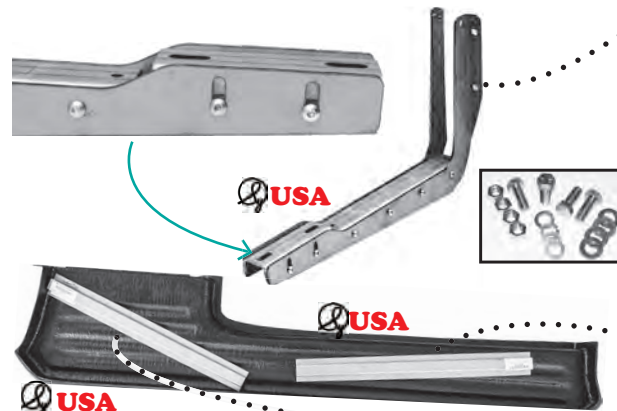

RUNNING BOARD BRACE, ADJUSTABLE

For fine tuning running board fit and angle, a perfectly straight line here straightens up the whole look of the truck. Accepts 53-55 gas tank and battery trays.

- Plain steel, each0342.....\$82.50 ea
 Plain steel, set of 40342-4\$319.95 set

- **BRACE MOUNTING BOLTS** To frame only, for running board top bolts see below. Kit does only one brace.
 Zinc.....80342-Z.....\$3.00 set
 Stainless button head.....80342-SB.....\$8.00 kit

REINFORCEMENT BRACES (Included in boards above)

- Front0333-26\$26.50 ea
- Rear0333.....\$28.50 ea

BOARD TO BRACES BOLT KIT Does both boards

- Polished stainless, hex80312-PS.....\$12.50 kit
- Polished stainless button.....80312-PB.....\$18.00 kit
- Plain stainless.....80312-SS.....\$8.00 kit
- Zinc.....80312-Z.....\$5.50 kit

BOARD TO REAR FENDER BOLT KIT Does both boards

- Plain stainless.....80313-SS.....\$6.50 kit
- Zinc.....80313-Z.....\$4.50 kit

BOARD TO FRONT FENDER BOLT & GROMMET KIT

Does both sides.....0311\$4.95 set

RUNNING BOARD SIDE PANEL Included with our boards

- Driver0332-L,\$39.80 ea
- Passenger0332-R.....\$28.50 ea

STEP PLATES Polished aluminum, (Mold being redone)

GET ON WAITING LIST FOR SPECIAL PRICES WHEN FINISHED.

- Ford script.....0324-PNTIn process
- **F-100 in Emblem, Fluted**.....0324-F100\$75.00 pr
- Bolt kit, polished, does both.....80324-PS.....\$6.15 set





REAR FENDERS

All fenders are shipped by truck, our discount of 65% is passed on to you. Can cost as much to send one as 2 or 4, see page 3. Call for a quote

3" WIDER REAR FIBERGLASS FENDERS

Notched for use with stock running board, rear of running board point goes inside notch. Guaranteed 3 years. Wheel clearance 13 1/2" note fiberglass fenders may need longer fender bolts, see next pg. See longer fender brace below also

Left, driver	6606-NL	\$240.00 ea
Right, passenger	6606-NR	\$240.00 ea

FIBERGLASS STOCK FENDERS

Left	6605-L	\$225.00 ea
Right	6605-R	\$225.00 ea

USA STOCK STEEL REAR FENDERS,

Very nice and the best buy. Galvanized satin coating on both sides of steel, Ford dies. Heavy gauge.

Left	1533-L	\$349.95 ea
Right	1533-R	\$349.95 ea

*REPRODUCTION STOCK STEEL FENDERS

Black electro-coated, made in China, in this case these China fenders are pretty good, nice reproduction China fender is thinner than USA one above

Left	1532-L	\$280.00 ea
Right	1532-R	\$280.00 ea



REAR FENDER PATCH

Front lower section where the bolts are that go to the running board. 6" tall, save your fender!

Driver side	1530-L	\$38.50 ea
Passenger side	1530-R	\$38.50 ea

REAR FENDER BRACE MOUNTING TABS

Right and left, can be welded or glued in

Pair	1535	\$23.50 pr
Driver	1535-L	\$14.50 ea
Passenger	1535-R	\$14.50 ea

REAR FENDER BRACE

Fits either side, goes from bed to rear of fender.

Stock fender, steel	1534	\$9.95 ea
---------------------------	------------	-----------

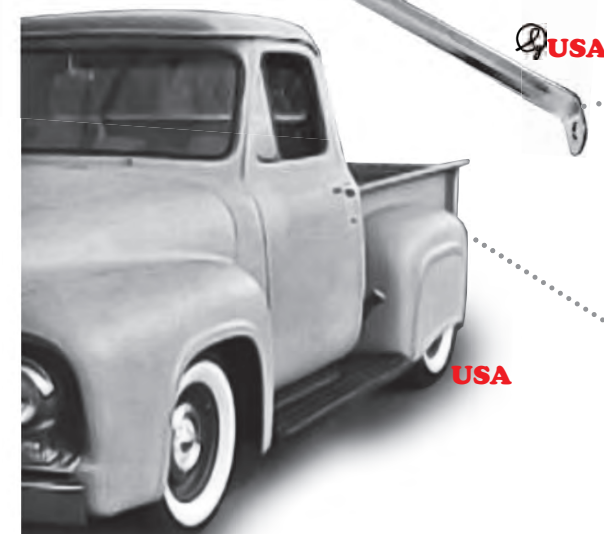

* 3' WIDER FIBERGLASS FENDER

Plain Stainless	1536	\$33.50 ea
Polished Stainless	1536-PS	\$34.50 ea

REAR FENDER BRACE BOLT KITS

Bolt is also part of bed bolt kits, it is the "extra" bolt in the bed side flange.

Stock brace, zinc	81536-Z	\$4.00 kit
Stock brace, polished hex head	81536-PX	\$8.50 kit
Stock brace, polished button head	81536-PB	\$9.50 kit
Wider brace bolt kit, polished	81537-PB	\$9.50 kit

FIBERGLASS FENDER SKIRTS

With hardware, copy of the original '50's skirts, can be taken on and off for show and go.

Pair includes inner brackets	6507	\$175.00 pr
------------------------------------	------------	-------------



FENDER WELTING

Correct bead, ours is 10' for each side, enough for both rear fenders, and between fender and running board and roll pan or dropped sides. All others are only 8' a side.

- Rubber, front & stock rear 20' 1507 \$25.00 pr
- Rubber, front, die cut 1503-DC \$12.50 pr
- Chrome, 20' roll 1506 \$25.00 rl
- Fabric, black 20' 1501-FAB \$18.00 rl
- Fabric, colors, 20' ask for samples 1501-(color) \$29.50 rl



STOCK STYLE BOLT KITS

Bed sides drilled or punched square? Fiberglass fenders? Want to match bed strip bolts? Existing fender bolts? We reproduced the original, only did it in stainless and made it longer. *Do not suggest gripper style, has tendency to dimple bed side, not shown here, if needed call.

- Each, stainless 81542-S \$3.50 ea
- Each, polished 81542-P \$3.75 ea
- Each, original 81541-OR \$1.50 ea
- Set of 24, steel, black 81541-OR24 ... \$36.00 ea
- Set of 24, stainless 81541-SS \$78.95 kit
- Set of 24, polished 81541-PS \$65.00 kit



USA

BUTTON HEAD BOLT KITS, not shown

With flat washer, use also on beds with round holes
Polished stainless 81543-PB \$59.00 kit
All sets include locks & nuts. Washers shown in picture are polished for under the button, washers for underside are shown below.



FENDER WASHER KIT Underside of wood

- Zinc plate 81546-Z \$3.00 kit
- Stainless 81546-SS \$6.75 kit
- Polished stainless 81546-PS \$29.95 kit



USA

RUBBER WASHERS, set of 24 ... 87077-24 \$9.50 set

Helps with fiberglass fender flanges sometimes, takes up any roughness, helps prevent cracks.



ACORN FINISH NUTS bling is bling!

Yes you can see these, if your head is in the fender well,
Polished 81547 \$33.50 kit



WHEEL TUBS, STEEL

Curved edge, inner flange and outer floor flange
Oversize shipping

STAMPED

- 2.75" width (long bed size) 6706-2 \$368.50 pr
- 4" width 6706-4 \$368.50 pr
- 7.5" width 6706-7 \$368.50 pr

Curved and formed 29.5" Wheel opening

- 2.75" width 6704-2 \$299.95 pr
- 4" width 6704-4 \$299.95 pr
- 6" width 6704-6 \$299.95 pr
- 8" width 6704-8 \$299.95 pr
- 9" width 6704-9 \$299.95 pr

Most any width available in this style.



CHOICES CHOICES CHOICES, SEE THE NEXT 3 PAGES FOR SHORT BED KITS

Choices when considering truck beds are endless, and confusing. We offer the bed in a variety of styles, types & combinations. See the following pages for kits. Please call for help if needed. Remember, kits are cheaper than individual pieces. We can almost always build a kit that has exactly what you want.

Bed sides fit 1953 through 1972, only difference is location of fender mounting, 57-72 are higher, if your running boards are not lining up this could be the problem, Ford sold a lot of replacement bedsides with 57-72 mounting pattern during the 70's. Beds are made of 16 gauge satin coated steel, unless otherwise noted. We have a display with no rust after 10 years of handling!!

Bed kits ship freight prepaid. A shipping quote will be needed based on your order and location. To get our sizable discount on bed freight costs please note these instructions. You should always try to ship to a business address or pick up at a dock, residential delivery adds at least \$98.00. Bed sides specially packaged additional \$50.00.

We price match most any competitors. You may not see the bed a competitor advertises on these pages. After 35 years we have a pretty good idea of what goes together best, and list kits so you end up with the best combination. Also there are beds that Sy will not sell for various reasons. Keep in mind what you want to end up with, polished stainless, tailgates with hidden supports or latches, no bolts showing, etc.

Please call, we can help and work up any combination you wish so you get what you want.

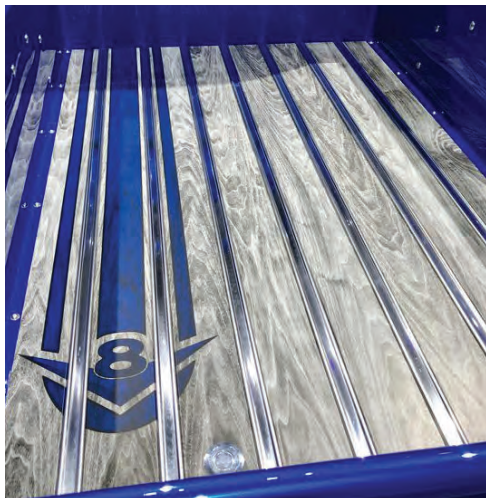
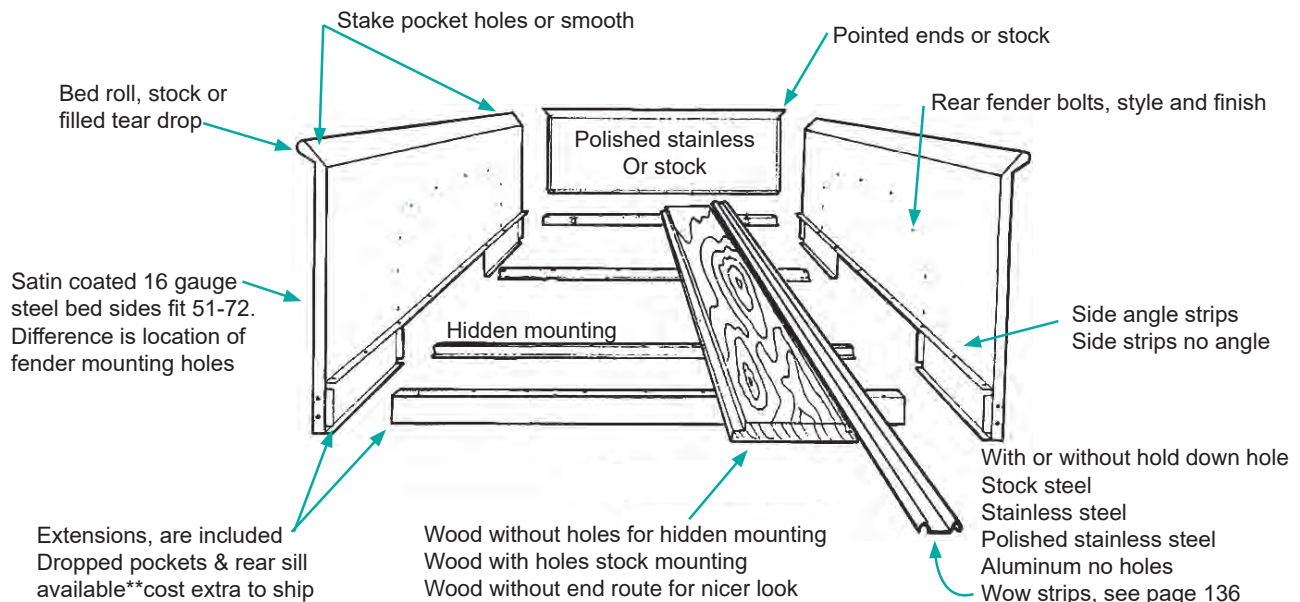

ALUMINUM BED FLOOR KITS ^{USA}

Positively beautiful!! The new Grey Barn wood series is gorgeous.

- Bolt-in lite weight, durable and weather resistant.
- 3X more scratch & scuff resistant than finished wood floor.
- Extruded from 6063-T6 "Aircraft quality" aluminum.
- Rugged polymer waterproof, stain proof & chemical resistant finish.
- Aluminum Bed Wood System installs similar to any wood floor

Using stock X-members

An accurate recreation of actual wood grains, digitally printed on a durable commercial grade floor laminate and applied to our extruded aluminum boards. Sold in kit form and shipped complete with Hidden Bolt Center Strips, Stainless Hardware, additional Under Floor Supports and your choice of Wood Grain Patterns and Colors. Only one listed here is our Favorite.

Barn-wood Grey kit, with polished strips90216-AB \$1399.95 set



Prices & part numbers not listed here.
Except for our Favorite, shown above.
Without the fancy V8 of course.



SHORT BED KITS

1-800-252-1956
Direct 928-565-2763

ADD A TAILGATE KIT BELOW TO ANY BED KIT ON NEXT 2 PAGES

Or see all tailgate choices on page 127.

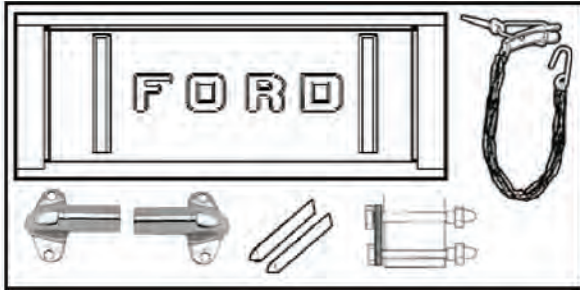

TAILGATE KIT, LETTERED, PLAIN STEEL

Includes CHAINS, Chain Covers, Hinges, bumpers & bolts.
Plain Steel chains and hinges 90252-Z\$415.95 kit

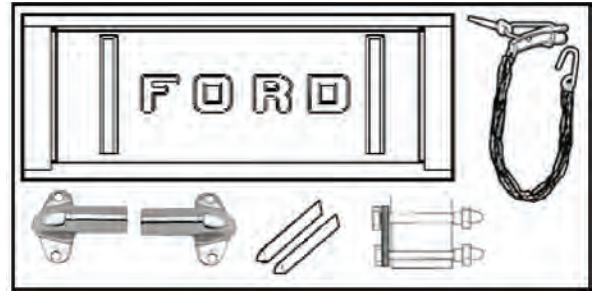

TAILGATE KIT, LETTERED, POLISHED

Includes CHAINS, Chain Covers, Hinges, bumpers & bolts.
Polished chains and hinges 90252-PS\$499.95 kit

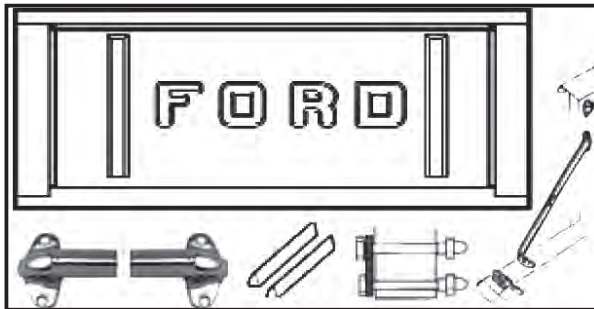

TAILGATE KIT, LETTERED, THUMB LATCHES

Chrome thumb latches & supports, Polished hinges & bolts
As shown 90254\$569.00 kit

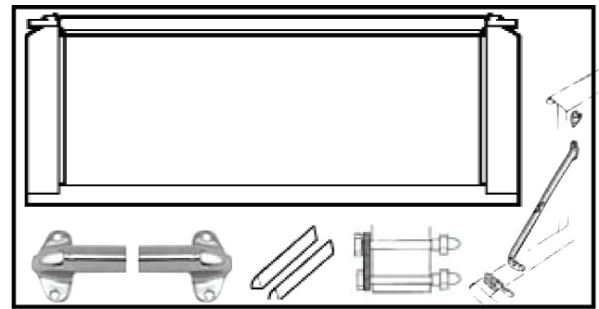

TAILGATE KIT, NO LETTERS, THUMB LATCHES

Chrome thumb latches & supports, Polished hinges & bolts
As shown 90255\$459.00 kit

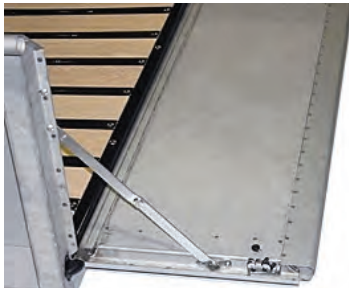

TAILGATES
Lots of styles
available. See
following pages

TAILGATE KIT, SMOOTH DOUBLE WALL WITH HIDDEN SUPPORTS AND LATCHES

Includes hinges, Zinc 90258\$415.00 kit
Polished Stainless 90259\$469.00 kit



RAISED BED FLOOR

NEW KITS see website for additional information.
Pieces and Kits available in heights from 2" to 4" floor lifts.
Kit includes special lifted flange bedsides (with NO stake
pocket holes) Crossmembers, Floor Lift crossmembers,
Front bed panel, Rear sill, Instructions and Hardware.

No Tailgate BED-5356X3\$1500.00 kit
Floor lifts available separately.



BULL NOSE BED STRIPS, Nice clean end on strip.

No sharp edge showing, no dirt catcher, Custom
Square holes punched, no hold down hole.

Steel set 90208-BN\$88.50 set
Polished set 90208-BNP\$188.50 set

Kits do not include TAILGATES, see page 133 for Tailgate kits, or Tailgates & latches pages

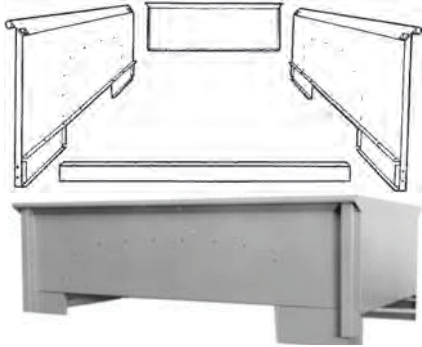

BASIC BED KIT

No substitutions on this bed kit, includes front bed panel, side bed panels, and rear crossmember.

Note: if adding strips & wood, complete kit is cheaper, see complete kits elsewhere on these two pages.

- With stake pocket holes.....BED-BA-WH.....\$795.00 ea
- No stake pocket holesBED-BA-NH.....\$865.00 kit
- With teardrops no stake holesBED-BA-TD\$1095.00 kit



BASIC BED KIT, IMPORTED

CAUTION: We sell Imported (China made) Bed pieces ONLY IN KITS, Because they do not fit well with USA Pieces or Stock Pieces.

No substitutions on this bed kit, includes imported front bed panel, Imported side panels, and imported rear crossmember.

Note: if adding strips & wood, complete USA kit is cheaper, see complete kits elsewhere on these two pages.

- IMPORT BED KIT.....BED-BA-BK.....\$779.95 ea

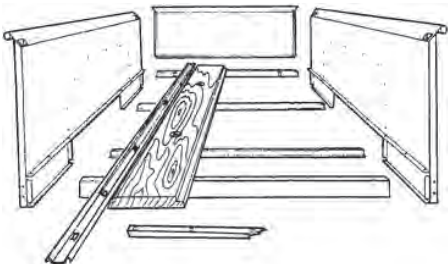

PLAIN STEEL BED KIT

Steel bed strips & hardware. Includes:

- | | |
|-----------------------------------|-----------------------------------|
| 2 Besides with stake pocket holes | 1 set bed strips, steel |
| 1 Front bed panel | 1 Steel end cap |
| 1 Front crossmember | 1 set hold down bolts, originals |
| 2 Center crossmembers | 1 set bed strip bolts, zinc plate |
| 1 Rear crossmember | 1 set under bed washers, zinc |
| 1 Set oak bed wood with holes | 1 set hold down insulators |

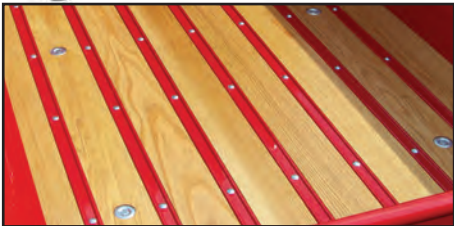

- Stone stock, with stake holes BED-STK\$1245.00 kit
- Stock, no wood BED-STKNW\$945.00 kit
- No stake holes, stock mounting..... BED-CR-SM\$1245.00 kit
- No stake holes, hidden mounting BED-CR-UM\$1245.00 kit
- No stake holes, teardrops, stock mounting BED-CR-TD\$1395.00 kit
- No stake holes, teardrops, hidden mounting.... BED-CR-TDUM\$1395.00 kit
- Any kit above with no wood..... DEDUCT\$-175.00
- Add bedside flange angles, steel..... 0209-NZ.....\$39.50 pr

Hidden mounting kits include Crossmembers with under bed mounting, bed wood with no holes & mounting bolts.

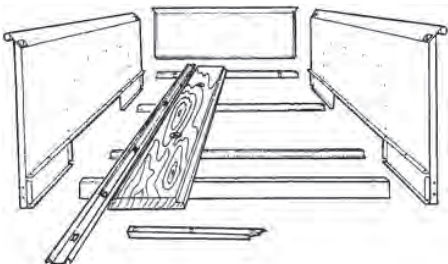

STAINLESS BED KIT

Stainless bed strips and hardware. Includes:

- | | |
|-----------------------------------|-------------------------------------|
| 2 Besides with stake pocket holes | 1 set bed strips, stainless |
| 1 Front bed panel | 1 end cap, stainless |
| 1 Front crossmember*** | 1 set hold down bolts, stainless*** |
| 2 Center crossmembers*** | 1 set bed strip bolts, stainless |
| 1 Rear crossmember | 1 set under bed washers, stainless |
| 1 Set oak bed wood*** | 1 set hold down insulators |
- ***Hidden mounting conversion pieces

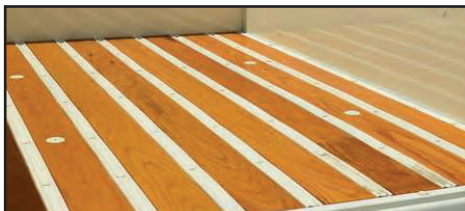

- With stake holes, stock mounting..... BED-SS-H.....\$1395.00 kit
- No stake holes, stock mounting..... BED-SS-NH\$1395.00 kit
- No stake holes, hidden mounting BED-SS-UM\$1395.00 kit
- No stake holes, teardrops, stock mounting BED-SS-TD\$1495.00 kit
- No stake holes, teardrops, hidden mounting.... BED-SS-TDUM.....\$1495.00 kit
- Any kit above with no wood..... DEDUCT\$-175.00
- Add bedside flange angles, stainless 0209-NS.....\$49.50 pr

Hidden mounting kits include Crossmembers with under bed mounting, bed wood with no holes & mounting bolts.



TEARDROPS Welding and finishing charge for teardrops is now \$200.00 or \$50.00 per teardrop.
You may be able to install them yourself for less, see teardrops on page 140

TAILGATES see page 133 for Tailgate kits, or Tailgates & latches pages

HIDDEN MOUNTING CONVERSION Crossmembers made for under bed mounting & bolts, wood has no holes.

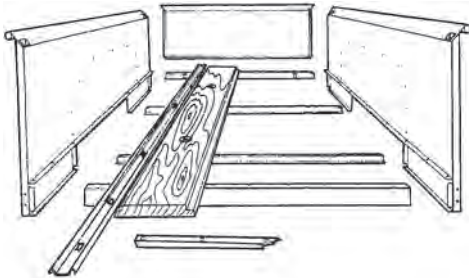

POLISHED STAINLESS BED KIT

One of our most popular kits, all high polished strips with polished bolts including ones for the end cap and bed side flange. Includes

- | | |
|------------------------------------|-------------------------------------|
| 2 bedsides with stake pocket holes | 1 set bed strips, stainless |
| 1 front bed panel | 1 end cap, polish stainless |
| 1 front crossmember*** | 1 set hold down bolts, stainless*** |
| 2 center crossmembers*** | 1 set bed strip bolts, stainless |
| 1 rear crossmember | 1 set under bed washers, stainless |
| 1 set oak bed wood*** | 1 set hold down insulators |
- ***Hidden mounting conversion pieces



- | | | |
|---|------------------|---------------|
| With stake holes, stock mounting | BED-PS-H..... | \$1445.00 kit |
| No stake holes, stock mounting..... | BED-PS-NH | \$1445.00 kit |
| No stake holes, hidden mounting | BED-PS-UM..... | \$1445.00 kit |
| No stake holes, teardrops, stock mounting | BED-PS-TD | \$1595.00 kit |
| No stake holes, teardrops, hidden mounting.... | BED-PS-TDUM..... | \$1595.00 kit |
| Any kit above with no wood..... | DEDUCT | -\$175.00 |
| Add bedside flange covers, polished..... | 90207-PS..... | \$79.50 pr |

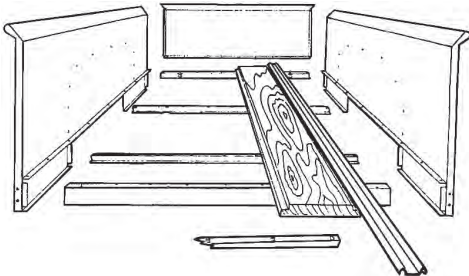

WOW BED KIT, hidden bolts

Polished & hidden fasteners. This is one of our most popular and beautiful bed kits, the strips include hidden "T" fasteners so no bolts show. Hidden mounting crossmembers are included to complete the "no bolts" look. Includes

- | | |
|--------------------------|--------------------------------------|
| 2 bedsides with no holes | 1 WOW bed strips, |
| 1 front bed panel | 1 end cap, polish stainless |
| 1 front crossmember *** | 1 set hold down bolts, stainless *** |
| 2 center crossmembers*** | 1 set bed strip bolts, stainless |
| 1 rear crossmember | 1 set under bed washers, stainless |
| 1 set oak bed wood *** | 1 set hold down insulators |
- ***Hidden mounting conversion pieces

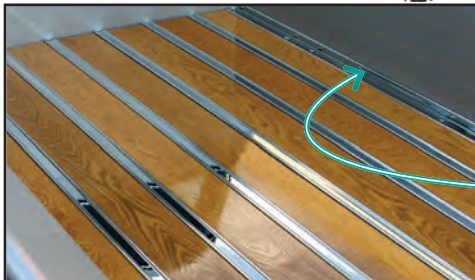

- | | | |
|--|------------------|---------------|
| No stake holes..... | BED-PS-W..... | \$1545.00 kit |
| With teardrops | BED-PS-WTD | \$1695.00 kit |
| Any kit above with no wood..... | DEDUCT | -\$175.00 |
| Add bedside flange covers, polished..... | 90207-PS..... | \$79.50 pr |

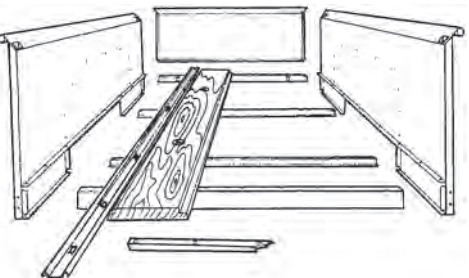

YOUR CHOICE BED KIT

Pick out any combination as long as it includes any style or finish of the following, then deduct \$100.00 from the total.

- 2 bed sides, any style, teardrop, smooth or dropped
- 1 front panel, stock or stainless top
- 3 under-bed crossmembers, stock stainless or hidden mounting
- 1 rear crossmember, stock, stainless or dropped
- 1 bed wood, with or without holes
- 1 set bed strips, steel, stainless, polished stainless
- 1 end cap, any finish
- 1 bed strip bolt kit, any finish
- 1 under-bed washer kit, any finish
- 1 set insulators

"Your choice" bed kit shipping may be higher than normal.

Additional shipping applied with common sense. Example, order a bed strip set and side angles only ONE shipping charge is added. All goes together in one special shipping box. SETS AND COMPLETE KITS ARE CHEAPER

All strips shown USA made.
For imports see website.

BED STRIPS

For bolt kits see next page

• **STOCK MOUNTING BED STRIPS** *Square holes & round holes.*

SET OF 7 STRIPS

Zinc plate	0208	\$75.00 set
Stainless	0208-SS	\$125.00 kit
Polished.....	0208-PS	\$175.00 kit

SINGLE STRIP, bed uses 2 with mounting round hole

Zinc	00208-ZW	\$12.00 ea
Stainless	00208-SWH.....	\$19.50 ea
Polished.....	00208-PWH.....	\$28.50 ea

• **NO ROUND MOUNTING HOLE STRIPS** Set of 7 strips.

All square holes, NO Round hole for mounting bolt.

Zinc plate	90208-Z.....	\$75.00 set
Stainless	90208-SS	\$125.00 set
Polished.....	90208-PS	\$175.00 kit

SINGLE STRIP, bed uses 5 or 7, All square holes

Zinc.....	00208-ZN	\$12.00 ea
Stainless	00208-SN	\$19.50 ea
Polished.....	00208-PN	\$28.50 ea

Best buy!

• **POLISHED STRIPS & END CAP KIT** 90210-P..... \$285.00 kit
Includes 7 strips, 49 strip bolts, washer kit, end cap & bolts. You supply the wood, kit does not include bolts for bed side. BEST BUY!

• **DRILL YOUR OWN HOLES STRIPS**, available in any length, call for help with these.

• **WOW BED STRIPS POLISHED**

Stainless with hidden fasteners	90205	\$299.00 kit
Individual strip.....	00205	\$58.00 ea

Strips have sliding bolts that go underneath, no bolt heads show. Sliding hidden bolts included. To complete no bolt look we even have end cap & flange covers without holes below. Also available in plain finish and various lengths, best to call as they are cut to order.

NEW STRIPS WITH BULL NOSE ENDS, Almost finished.

CUSTOM SMOOTHY STRIPS, ALUMINUM

Hidden bolts included no bolt heads show, (small sample available) We do not have a matching aluminum rear end cap.

• Domed aluminum style, set	0208-AD	\$429.95 set
• Flat style, not shown, see pg 183 set	0208-AF	\$399.95 set
• Regular aluminum style, set	0208-AL.....	\$250.00 set
Regular aluminum style, individual strip	00208-AL..	\$43.00/\$43.00 ea

Individual strips available, and custom lengths, call for help.

• **WOOD END CAP**, goes in groove at end of bed, but we suggest installing *on top of un-routed wood & side flange for a cleaner installation.*

Steel	0204	\$17.50 ea
Stainless.....	0204-SS	\$30.00 ea
Polished stainless.....	0204-PS	\$32.50 ea
No holes, polished stainless.....	0204-NH.....	\$38.00 ea

• **BED SIDE FLANGE STRIPS**, *Not stock but finishes off sides to match center strips also good repair for damaged or pitted lower bed side flange. Angle covers lower flange and up bed side an inch.*

• **FLANGE STRIPS, NO ANGLE**

Fits snug against bed side, finishes floor. One hole needs drilled in bed side angle near end, flange intended to meet end cap, not go under it.

Polished stainless, no holes	90206-NH.....	\$75.00 pr
Polished stainless.....	90207-PS	\$79.50 pr

• **FLANGE STRIPS, WITH ANGLE**, stock holes (no top roll)

Plain steel.....	0209-NZ	\$39.50 pr
Stainless	0209-NS	\$49.50 pr
Polished stainless.....	0209-NP	\$59.50 pr

FLANGE WITH ANGLE AND ROLL, we do not show here as we like one without roll much better. We have ones with roll, just ask.

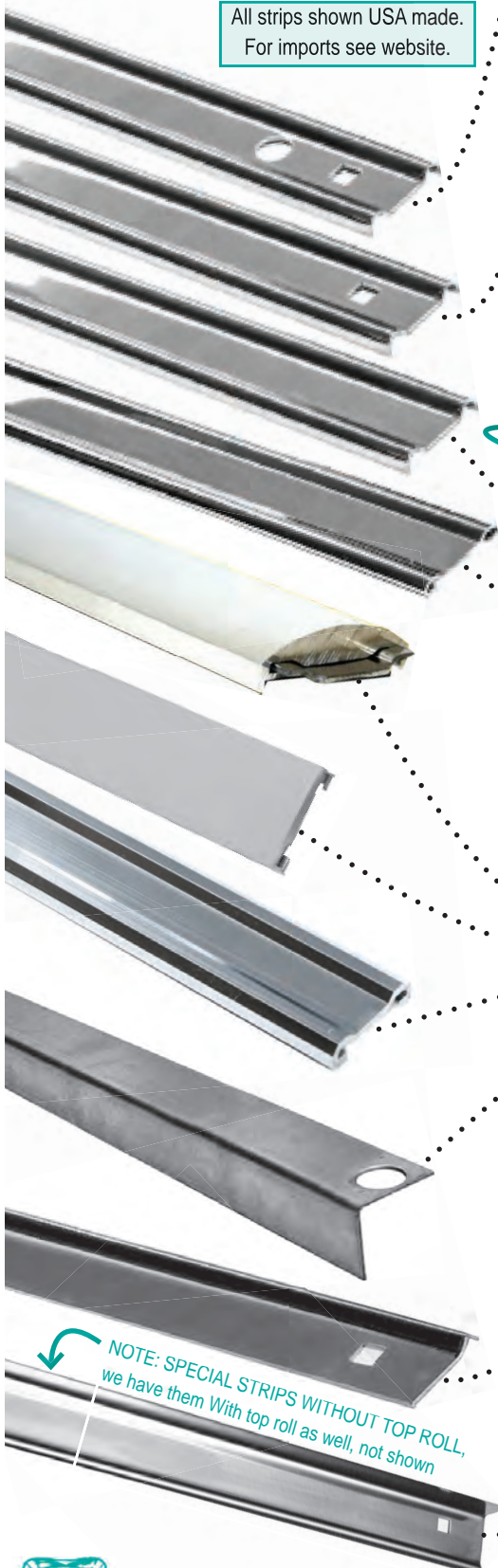

NOTE: SPECIAL STRIPS WITHOUT TOP ROLL, we have them With top roll as well, not shown



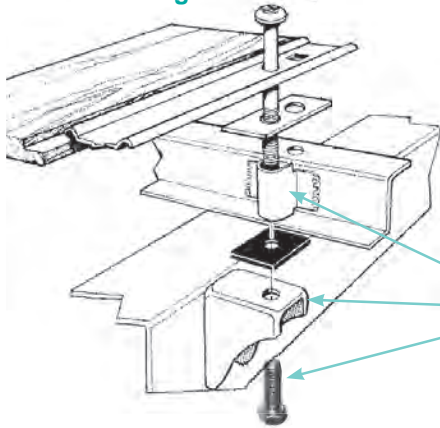

HIDDEN MOUNTING EXPLANATION: Shown is stock mounting bolt at front of bed. Note bed strip has an extra mounting hole for mounting bolt. This is eliminated when using "hidden mounting". Bed is secured to frame from underneath with bolt (C) coming up through bracket (B) into hidden mounting crossmember (0230-HD) which has a tap instead of the sleeve (A). Center x-members (0232-HD) also have threads welded inside, bolt goes through frame from underneath into threads. Wood sets on top of front bed panel flange, under side flanges.

- A.) Front crossmember sleeve
- B.) Frame brackets
- C.) Hidden mounting bolt

Bed wood goes over flange of front panel, under flange of bed sides.

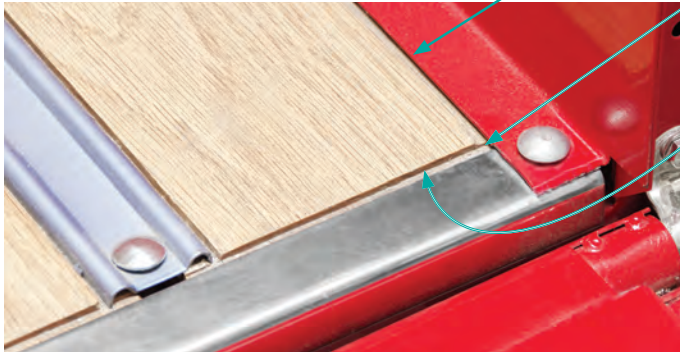

Note we do not indent ends of bed wood. We like the look better with end cap over bed flange instead of under, it is more level with strips and eliminates that dust catching crack. Grind down bed flange a tiny bit if you need to push the cap back to clear gate.

If you just must have original, ask for end rout, add \$20.00.



BED WOOD KIT

Clear red oak, with correct routed edges. Tail end of bed wood not routed, nicer installation, we like to set end cap above wood and bed side flange. See also end cap. With hold down bolt holes countersunk for stock mounting or without hold down bolt holes, for hidden underbed mounting. Oversize shipping

- Red oak with mounting holes 0215-WH \$365.00 set
- Red oak no mounting holes..... 0215-NH \$365.00 set
- Also available in white oak, call, about \$65 more.
- Exotics, walnut, cherry, etcBIG \$\$
- Do it yourself dimensions Just ask..... Free

NEW ALUMINUM BED FLOORS See Page 132
F-250 & F-350 long bed wood kits, see page 150



HEAT PROTECTOR

Guards your wood from harmful exhaust heat. Attaches under floor above exhaust, comes with hardware

- One, (for duals order 2) 0227-PS \$20.00 ea

COMPLETE BED FLOOR KITS

Includes: wood (8), strips (7), strip bolts (67), under wood washers, end cap & mounting bolts if needed.

WITH FRAME MOUNTING BOLTS (stock)

- Stock steel 90215-Z \$429.00 kit
- Stainless 90215-SS \$529.00 kit
- Polished stainless 90215-PS \$629.00 kit

HIDDEN MOUNTING (see cross-members on next page)

- Stock steel 90214-Z \$399.00 ea
- Stainless 90214-SS \$509.00 ea
- Polished stainless 90214-PS \$589.00 ea
- Polished WOW strips 90214-W \$639.00 ea

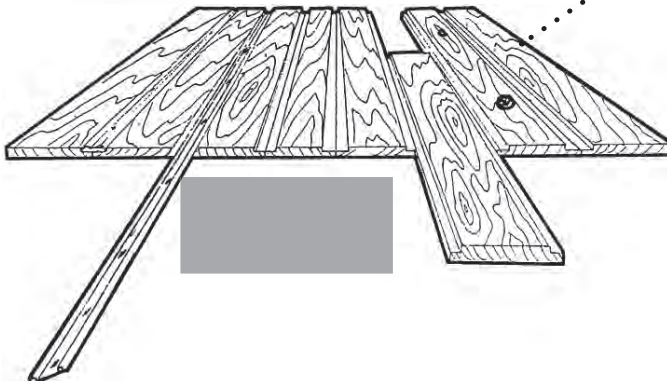

Single strips or boards are available, call for details. Add flange covers found on page 136 for a complete look

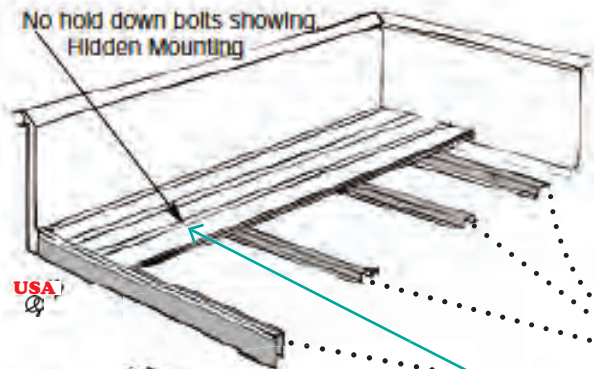

Beds mount to the frame in 8 locations. Two at the front through bed strip & sleeve on front crossmember then into a bracket on the frame (0234). 4 bolts go through bed wood with large concave washers countersunk into the wood, through x-member and into frame. The last 2 mount rear x-member bracket into frame. Bed can be mounted as a complete assembly or assembled on the truck. Hidden x-members have threads inside so can be attached to the frame from underneath meaning no mounting bolts show inside bed, this allows the bed to be installed or removed as one unit.



- STOCK STYLE CROSSMEMBERS**
- Front 0230 \$45.00 ea
 - Center (use 2, they face each other) 0232 \$45.00 ea
One side is shorter, it faces the axle on the upslope of frame
 - Rear..see below

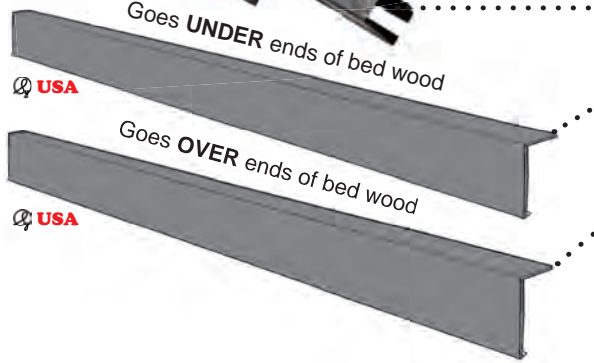

- HIDDEN MOUNT STYLE CROSSMEMBERS**
- Front 0230-HD \$55.00 ea
 - Center 0232-HD \$55.00 ea
 - Hidden mount bolt kit 80230 \$8.00 kit
 - Hidden bed mounting kit 90200-HD \$165.00 kit
Includes front and 2 center crossmembers, hardware & insulators.

- REAR CROSSMEMBER**
Complete with mounting brackets.
- Stock style, USA made 0233 \$75.00 ea
 - Black powder coated 0233-B \$95.00 ea
 - Crossmember to frame bolts 80233 \$3.50 set

- REAR X-MEMBER REPAIR OR COVER**
Quick and easy. Slips over rear sill.
- Plain steel (can spot weld for repair) 0221-RZ \$32.50 ea
 - Polished stainless 0221 \$42.50 ea

- REAR SILL & WOOD CAP COMBO**
Covers rear crossmember and bed wood ends. This has always been a spot I felt needed some "clean up". So, this piece replaces bed end cap, covers wood, then comes down and covers rear sill. Stock end cap bolt locations hold the top and I turned it under so a couple little screws would secure bottom out of sight. Neat, clean and covers any dings in rear sill.
- Plain steel 0221-CZ \$38.50 ea
 - Polished stainless 0221-CP \$55.00 ea
 - Bolt kit, same as rear end cap 80204-PS \$7.75 set

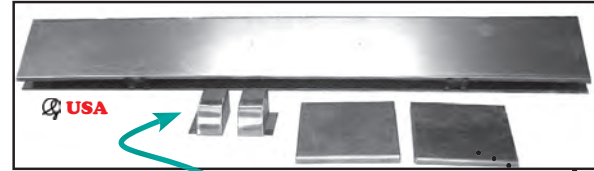

LONG BED CROSSMEMBERS See long bed on page 150

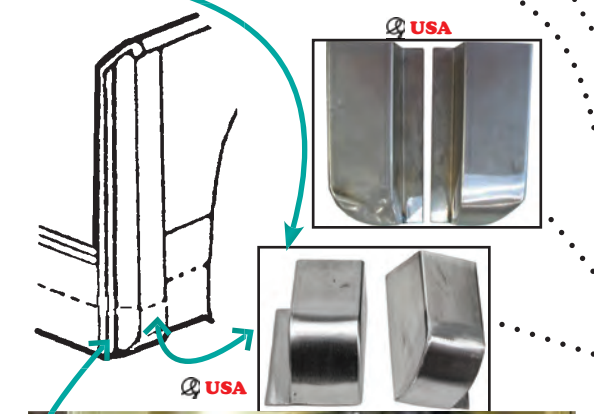

- HOLD DOWN BOLTS see bolt page
- **DROPPED REAR SILL**
Complete kit 90237 \$219.95 ea
Use in place of roll pan. Dropped sill with dropped extensions & curved end caps for stake pockets brings rear down to meet fender, makes truck look lower and brings bed more in line with bumper. Requires welding
- Dropped rear bed extensions 0238 \$50.00 pr
- Dropped rear sill (crossmember) 0237 \$135.00 ea

- **STAKE POCKET EXTENSION POINTED STYLE, DOUBLE ROUND**
Finished look from all sides 0229-RDR \$49.95 pr

- **STAKE POCKET EXTENSIONS**
Rear 0229 \$39.95 pr
- Front 0229-F \$39.95 pr

- **STAKE POCKET EXTENSION REVERSE ROUND**
Reversed, curves like roll pan, use in Rear, not intended for front.
Rear pair (not shown) 0229-RRR \$49.95 pr



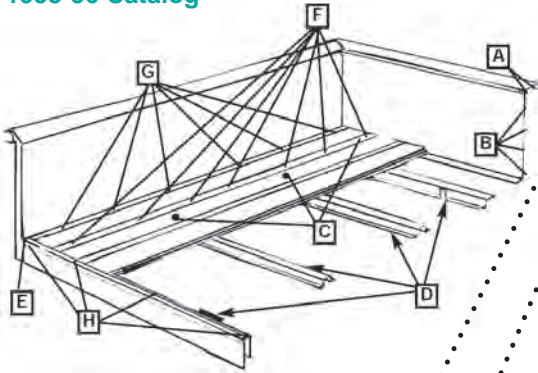

UNDER WOOD WASHER KIT

- Large washers that span gap and catch wood on both sides of strip bolts.
 Zinc.....80215-Z.....\$4.50 set
 Stainless.....80215-SS.....\$7.75 set

A.) FRONT BED PANEL TOP ANGLE BOLTS

- Zinc.....80202-Z.....\$2.00 set
 Polished stainless hex.....80202-PX.....\$7.90 set
 Polished stainless button.....80202-PB.....\$8.90 set

B.) BED SIDES TO FRONT BOLTS

- Use instead of welding, we include acorn nuts to cover the threads
 Polished hex & acorns.....80205-PX.....\$19.50 set
 Polished button & acorns.....80205-PB.....\$18.25 set

C.) HOLD DOWN BOLT KIT

- Replacements, 4 Phillips flat head, 4 countersunk washers & 2 carriage
 (see also individual bolts)
 Zinc.....80210-Z.....\$14.25 kit
 Stainless.....80210-SS.....\$27.00 kit
 Polished stainless.....80210-PS.....\$43.00 kit

D.) HIDDEN MOUNTING BOLT KIT

- Grade 8 and corrosion resistant, included with hidden cross-members

E.) BED SIDE END BOLT

- 80203-PS.....\$3.90 set

Where bed side, rear x-member and end cap come together (included in H)

F.) BED STRIP ONLY BOLT KIT

- 49 Bolts & hardware, this is kit most offer, it only does strips so leaves
 bedside flange without bolts. Bolts should match so see kit below.

- Polished stainless.....80208-PS.....\$85.00 kit

G.) BED SIDE FLANGE TO FLOOR BOLTS

- These are also included in our bed strip bolt kit (80209) below

- Polished.....80207-PS.....\$28.50 set

F-G.) SKID STRIP BOLT KIT

- All 67 bolts with locks & nuts. Not just half a set, does strips, rear sill &
 sides to wood. Use button head only with unpunched strips

- Zinc carriage head.....80209-Z.....\$30.50 kit

- Stainless carriage.....80209-SS.....\$72.50 kit

- Show polish carriage.....80209-SHW.....\$128.50 kit

- Polished stainless.....80209-PS.....\$115.00 kit

- Polished button.....80209-PB.....\$104.00 kit

- H.) END CAP BOLTS Polished (includes E).....80204-PS.....\$7.75 set

INDIVIDUAL HOLD DOWN BOLTS & WASHERS

- COUNTERSUNK WASHER, same as included in our hold down kits

- Zinc.....0213-Z.....\$1.50 ea

- Stainless.....0213-SS.....\$2.50 ea

- Polished stainless.....0213-PS.....\$4.50 ea

- FLAT HEAD BOLT, square drive, Zinc.....0212-Z.....\$3.50 ea

- Chrome.....0212-CH.....\$5.00 ea

- DOME HEAD BOLT, Chrome.....0211-CSM.....\$8.00 ea

-Zinc, fits.....0211-ZSM.....\$6.00 ea

-*Zinc, *not ours.....0211-Z.....\$3.00 ea

*Bolt does NOT fit inside reproduction strips, fits strips made pre 1965 only

- SQUARE DRIVE BOLT REMOVER.....80002.....\$4.25 ea

- FRONT X-MEMBER TO STRIP SPACER.....0214-SP.....\$5.00 pr

Goes between strip and crossmember to help keep strip from dimpling.

FRONT X MEMBER BED MOUNTING BRACKET

- Is attached to frame.....0234.....\$20.00 ea

- Bracket to frame bolts, does both.....80234.....\$3.50 set

- BED TO FRAME INSULATORS.....0214.....\$8.00 set

8 pieces, go between frame & cross-members, thin in front and back
 between bracket and frame, thick at each center crossmember to frame.

- BED SIDES TO WOOD INSULATORS...0216.....\$15.00 pr



Bed kits have big discounts. Check with us if considering individual pieces or call for help. Complete kits often ship for the same price as just one bed side

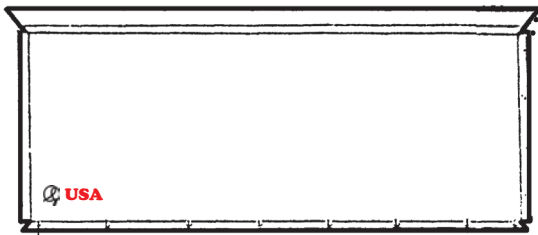

FRONT BED PANEL *Oversize shipping*

- Pointed ends, USA made 0200-14..... \$175.00 ea
 - Stock ends, USA, stock 0200..... \$175.00 ea
- Import does NOT fit together well with USA or Stock pieces, we have it, but not listed to avoid problems. see kits page*

FRONT BED PANEL TOP ANGLE BOLTS

- Zinc 80202-Z \$2.00 set
- Polished stainless hex head 80202-PX \$7.90 set
- Polished stainless buttons 80202-PB \$8.90 set

Stock front panel end is open and did not match the side, this lets water in and looks yucky, so we make it both ways. All our bed kits include the pointed one except Stone stock bed kit. If you want stock original please ask NOTE: Our panel does not fit China bedsides

NOTE: Imported from China Front Bed Panels and Side Bed Panels are available as well. They only fit together and do not interchange with USA made. (front Imported panel will not fit with USA sides, etc.) so are not listed here to avoid mistakes.

FRONT PANEL LOWER REPAIR FLANGE

- Use if your lower front bed panel is rusted, goes under bed wood*
- Repair flange 0210-RP \$29.50 ea

BED SIDES TO FRONT BOLTS

- Polished hex with acorns 80205-PX \$19.50 set
- Polished button with acorns 80205-PB \$18.25 set
- Zinc 80205-Z \$5.00 set

SIDE BED PANELS *Oversize shipping*

- With stake pockets, extensions & fender holes. 1953-56*
 - Note: China made bed panels are not listed as are not really compatible with USA or Stock bed components. (see import kit)*
 - Stock with stake pocket holes 0202-(R or L) ... \$300.00 ea
 - Smooth, no stake pocket holes 16 ga .. 0203-(R or L) ... \$310.00 ea
 - Teardrop bed panels, smooth 0201-(R or L) ... \$445.00 ea
- Front & rear roll ends in teardrop shape*

STAKE HOLE REPAIR PATCH

- Each, need 4 0225-1 \$6.00 ea

TEARDROP INSERTS

- Must be welded on, same as used on our bedsides*
- Plain steel set of 4 0218-4 \$25.00 set

STAKE POCKET

- Front 0205-F \$45.00 ea
- Rear, with or without holes for gate, light & chains
- Left 0205-RLN \$49.00 ea
- Right 0205-RRN \$49.00 ea

BED PANEL EXTENSIONS

- Rear, left 0207-L \$16.50 ea
- Rear, right 0207-R \$16.50 ea
- Front, left 0206-L \$25.00 ea
- Front, right 0206-R \$25.00 ea

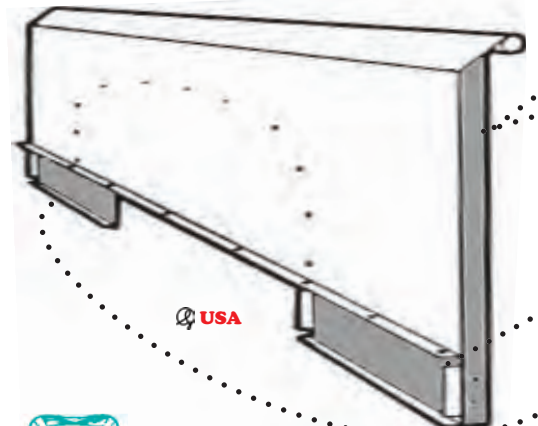
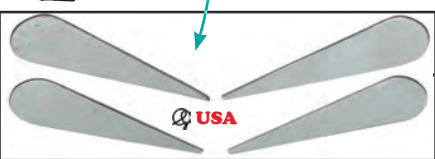
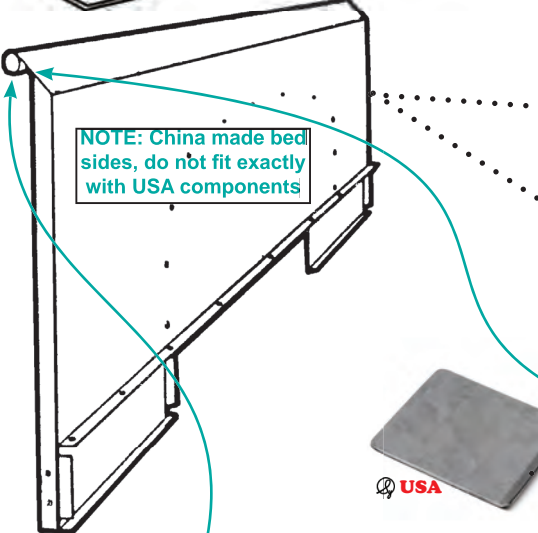
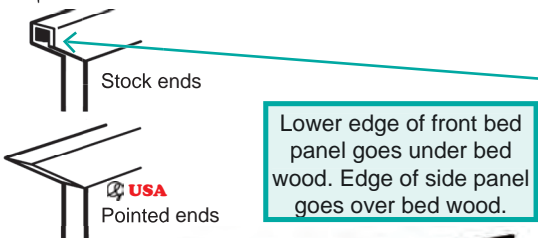

BED TRIM

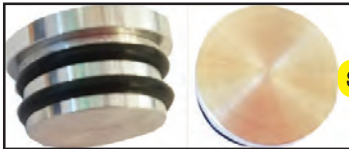

SALE

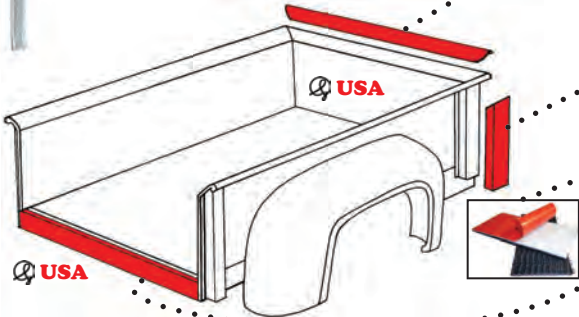
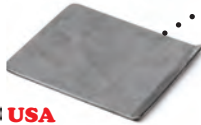

PLUG AND LIGHT SIZES;
 . 15/16" fits Chevy or beds made with pipe rolls.
 1 1/8" fits Pros-Pic & others,
 1 1/8-3/8) fits ours, most stock beds, Mar-K and most others

BED ROLL PLUGS

- Chrome 1.25" 80217 \$4.00 pr
- Chrome 1.5" 80216 \$5.00 pr
- Billet alum w/ 'O' rings 1 1/8" to 1 3/8" 0217-AL **SALE** \$27.50
- Polished alum w/ 'O' rings 1 1/8" to 1 3/8" 0217-PL \$29.50 pr
- Polished alum with 'O' ring 1 1/4" 0240-P \$29.50 pr
- With FORD SCRIPT, Satin 1 1/4" 0217-SAL \$67.00 pr
- With FORD SCRIPT, Polished 1 1/4" 0217-SPL \$67.00 pr

FUN LIGHTS, Fits bed roll, white lens, choice of bulb colors

- Clear bulb, White lens 2228 **SALE** \$9.50
- Amber bulb 2228-AMB \$12.00 pr

BED ROLL LIGHTS

Polished aluminum housing for brake and turn signals, doubles as "third light".

- LED, 1 1/8" hole, red 0244-18 \$125.00 pr
- LED, 1 1/4" hole, red 0244-25 \$135.00 pr
- LED, 1 1/4" hole, white 0244-25W \$140.00 pr
- LED, 1 1/4" hole, amber 0244-25A \$135.00 pr
- Standard bulb, red, 3rd brake light only.. 0228-RN \$78.50 pr
- Standard bulb, amber 0242-A \$77.50 pr
- Reflectors, no bulb
- Red 0241 \$46.50 pr
- For you out of country guys, amber.... 0241-A \$46.50 pr

- TIE-HOLD DOWN HOOK 3 7/8" Zinc 0217-TDH \$4.50 ea
- Chrome 0217-TDC \$12.50 ea

STAKE POCKET HOLE PATCH

- Do it yourself weld in patch for pocket hole, smooths out bedside
- One only 0225-1 \$6.00 ea
- Set of 4 0225-4 \$20.00 set

FRONT PANEL POLISHED STAINLESS TRIM

- Handy cover-up for slight damage.
- Stock panel ends 0219 \$49.95 ea
- Custom pointed ends, quick update 0219-PT \$49.95 ea

- POST COVERS, Polished SS, set of 4 0220 \$99.95 set
- DOUBLE SIDED TAPE KIT 80225 \$2.75 kit
- For installing stainless trim covers

- DUAL-LOCK ADHESIVE TAPE 6 pcs 82149-6 \$10.00 kit
- Like Velcro but much stronger, made for attaching trim and such

REAR SILL Crossmember REPAIR OR COVER

- Quick and easy repair or cover up of damaged rear sill.
- Plain steel 0221-RZ \$32.50 ea
- Polished stainless 0221 \$42.50 ea

SILL & WOOD CAP COVER COMBO

- Covers rear crossmember and bed wood ends. Replaces bed end cap, covers wood, then comes straight down and covers rear sill. Neat, clean and covers any dings in rear sill, good repair or cover, smooth custom look
- Plain steel 0221-CZ \$38.50 ea
- Polished stainless 0221-CP \$55.00 ea
- Bolt kit, same as rear end cap 80204-PS \$7.75 set

- BED TO CAB FRAME COVER, POLISHED STAINLESS
- Louvered . . . **GWG-SALE** 0222-LV \$29.95 pr.



SHORT BED TAILGATES

Long bed tailgates, see page 151



TAILGATE WITH STOCK F O R D LETTERS

Original dies, very nice exact of original gate. The one with no chain ears is not as nice as it should be and requires clean-up in that area to look right, or use a nice protector, see below. Oversize shipping.

With chain ears (use stock chains).....0250 \$375.00 ea
No chain ears0250-NE \$399.95 ea



TAILGATE WITH NO LETTERS

Made like original but without letters. Oversize shipping.

With chain ears, USA.....0250-NLM..... \$260.00 ea
No chain ears USA0250-NLNE... \$265.00 ea
NO letters, with chain ears, Import0250-NL..... \$250.00 ea
With louvers, 4 Rows USA.....0245-LV4 \$275.00 ea
With louvers, 7 Rows USA.....0245-LV7 \$285.00 ea



DOUBLE WALL SMOOTH TAILGATE0251-SM..... \$375.00 ea

Not a cover, complete double wall assembly, no chain latch ears. Smooth with bottom roll both sides.

TAILGATE KITS ARE CHEAPER SEE PAGE 133

EAR REMOVAL COVER, not ready in time for print, however the tailgate protector without notch below will cover that area nicely.



CHAIN LATCH EAR REPAIR

Stock steel0253-E \$35.00 pr



TAIL GATE ALIGNMENT BUMPERS.....0258 ... **SALE** \$3.50

Goes in upper edge (small triangular punches) aligns gate and bedsides. Wide side out, pushes bed side in when tailgate is closed



Tailgates with script style letters are 48-52, can use on 53-56 but not with stock chains and not original. Not listed here but available. We have decals for the letters, see page 130.

TAILGATE TOP ROLL PROTECTOR, COVER AND REPAIR

Quick and easy way to straighten top of a not quite perfect gate or protect paint on a perfect one. Attach with trim tape, screws or weld.

With notch for chain ear, polished ss.....0223-PS \$49.95 ea
With notch for chain ear, plain steel.....0223 \$39.95 ea
No notch for chain ear, polished ss0224-PS \$49.95 ea
No notch for chain ear, plain steel0224 \$39.95 ea
Long bed gate protector, polishedF2-0258-N \$59.95 ea
Tailgate protector screws, polished80220-PS\$3.00 kit
Double sided tape works just as well.

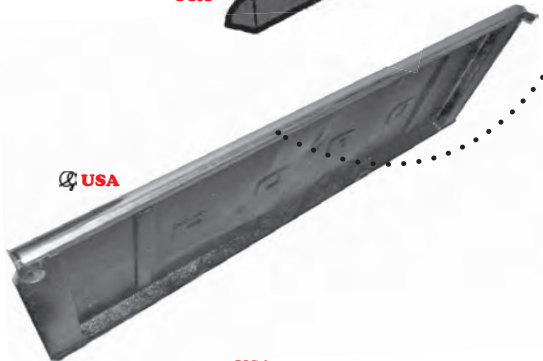

TAILGATE COVERS

18 gauge, wraps around, requires spot welding, covers entire gate, great fix for bad gates. Oversize shipping.

Smooth0247 \$85.00 ea
4 rows louvers0247-LV4 \$105.00 ea
7 rows louvers0247-LV7 \$125.00 ea
Louvers should match on tailgate and roll pan.



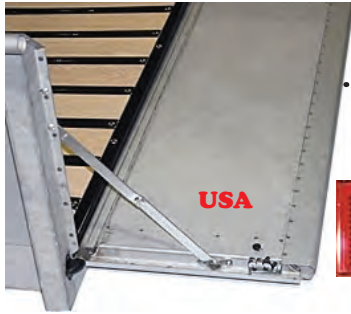

TAILGATE WITH HIDDEN LATCHES & SUPPORTS

NEAT, NEAT, NEAT! Tailgate includes hidden latches and supports. At last a gate with sturdy supports that mount to the side so you can actually "tailgate". Latches are "bear-claw" style to hold gate securely and open quick & easy with a small button.

*Gate is smooth style (Ford won't let us use FORD letters)
Also available with louvers, and for long bed.*

- Smooth gate, zinc supports 0246 \$370.00 ea
- Smooth gate, polished supports 0246-P \$435.00 ea
- Kit, with polished supports, hinges & bolts . 90259 \$469.00 kit
- Louvered, 4 rows 0246-V4 \$415.00 ea
- Louvered, 7 rows 0246-V7 \$425.00 ea
- Roll pan see page 127
- Long bed, page 151 F2-0246 \$395.00 ea



TAILGATE WITH CENTERED INSIDE HANDLE & LATCH, Handle is installed and includes latches, does not include supports, see next pg.

- Plain Coated Steel handle & support 0246-SHZ \$533.95 kit
- Polished Stainless handle & support 0246-SHS \$676.00 kit

CONVERSION KIT

Supports and latch kit for existing stock or re-manufactured gates. Convert your gate to similar neat latches & supports.

- Latch & zinc plate support 0276 \$145.00 ea
- Latch & polished stainless support 0276-PS \$210.00 ea
- Supports only, DIY, Zinc 0268-Z \$84.00 pr
- Supports only, DIY, Polished Stainless 0268-PS \$160.00 pr
- Hidden bear claw Latch, mini, DIY 0275 \$99.00 pr

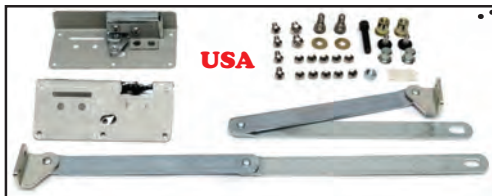

TAILGATE KITS (see also page 133)

We have many, many different gates and latching, Here are some of the more popular in handy kits. Kits Include: Gate, both hinges, alignment bumpers, attaching bolts and a latch & support style.

Kits with Chain supports, include chains

- With "FORD" letters, steel mounting 90252-Z \$415.95 kit
- With "FORD" letters, polished mounting. 90252-PS \$499.95 kit
- Inside latch and supports, polished hinges & latches, chrome supports
With "FORD" letters 90254 \$519.95 kit
- No letters 90255 \$449.95 kit

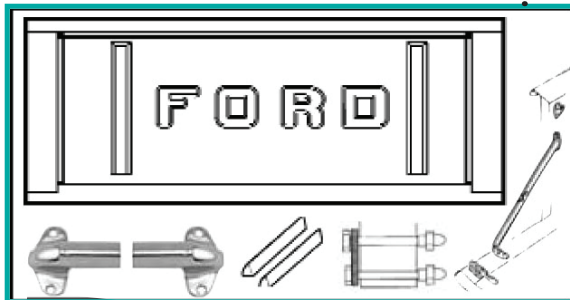

TAILGATE TOP PROTECTOR

With or without notch for chain ear. A handy repair for dented gate.

- Plain steel, with notch 0223 \$39.95 ea
- Plain steel, no notch 0224 \$39.95 ea
- Polished stainless, with notch 0223-PS \$49.95 ea
- Polished stainless, no notch 0224-PS \$49.95 ea
- Attaching screws, polished stainless 80220-PS \$3.00 kit
- F-250 and F-350 F2-0258-N \$59.95 ea

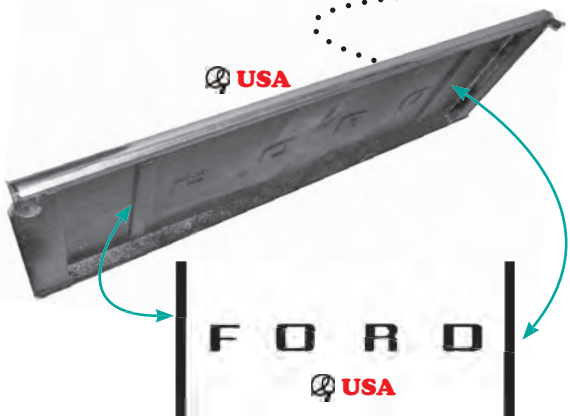

DIE CUT VINYL LETTERING & BARS

- Chrome D-0265 \$10.00 set
- Choose color D-0266-(Color) \$9.00 ea
- White, black, blue, red, silver, yellow, green, orange, purple*
- F-250-350 Chrome F2-0266-CH \$15.00 ea
- F-250-350 Colors F2-0266-(color) \$15.00 ea





CUSTOM INSIDE SUPPORTS

Show quality, triple chrome plated brass. Use with any latches. When the gate is closed these point toward the cab.

Supports0259 \$109.00 pr
Support screws, polished stainless ..80260-8\$4.25 kit



CUSTOM TAILGATE INSIDE LATCHES

Latch goes around corner, helps hold bed sides and tailgate together. Show quality, triple chrome plated over brass casting. Latch mounts on gate, hook on bed.

LATCHES0260 \$125.00 pr
Latch screws, polished stainless80260-16\$8.50 kit

SPACERS & MOUNTING BLOCKS, Have threaded holes for mounting latches. For proper alignment many beds need a spacer behind latch, plain steel, paint to match bed or polished aluminum. Seem to disappear when installed

NEW Sy added interior hole so no welds show (Hide-a-weld) Fits hook side or latch side, sold in pairs.

Spacer, plain steel0260-S \$19.95
Spacer, polished stainless0260-NPS\$39.95 set
Latch bolts for hide-a-weld spacers...80265-W\$4.75 kit



COMPLETE KIT, Latches, Hide-a-weld spacers, bolts & screws. Polished Stainless & Chrome90260



TAILGATE INSIDE LATCHES not locking, polished stainless, Latches0265-PS \$39.95 pr
Latch screws, polished stainless80260-8\$4.25 kit



SPACERS & MOUNTING BLOCKS
Latch spacers, hide-a-weld, Stainless ...0265-WS \$27.50 pr
Latch spacers, hide-a-weld, Polished....0265-WPS\$39.95 pr

COMPLETE KIT, Latches, Hide-a-weld spacers, Bolts & Screws Polished Stainless90265

LATCH RING PINS.....80263 \$6.50 pr
Locks both latches on this page, polished stainless pin and ring

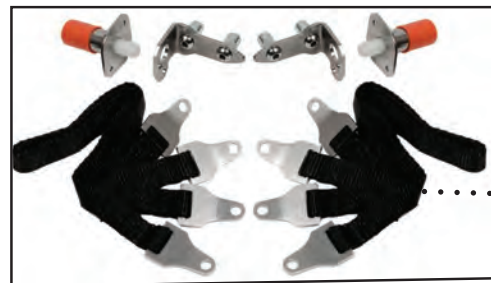

INSIDE LATCH & SUPPORT STRAPS

Easy install, easy open & close. Can be installed after paint! Small polished stainless steel brackets attach inside tailgate. Spring loaded catches trimmed in stainless install in stake pocket. Nylon woven support straps with stainless buckles hold gate no paint damage. Includes hardware & instructions.

Polished stainless kit0266\$182.50 kit
Straps only, 18".....0266-STP \$58.50 ea



TAILGATE ROLL THUMB LATCHES

We make 2 sizes as there are different tailgates out there. Thumb pull is spring loaded and removable for installation. Inside roll of gate may need cleaned up. We added a notch to miss the weld. Made from billet aluminum, requires small slot in gate and small hole in bed side, which is hidden in stake pocket.

Fits gates with 1 1/4" ID roll (most)0261-M \$89.95 pr
Fits gates with 1" to 1 1/16" ID roll.....0261-T \$89.95 pr
Grommets for bed side holes80261 \$1.00 pr

THUMB LATCHES

For installation below roll. Nice locking feature, made to install in gate side below roll. Great for gates with bad rolls, are not round, odd sized or have lots of welding debris. Even Chevys! Includes template & hardware.....0261-LK.....\$89.95 set





HINGES

- STEEL reproduction hinges, plain steel..... 0255-BL \$7.50 ea
- OUR HINGE, POLISHED STAINLESS ... 0257-PS \$29.95 pr
This is the best buy, nice stamping, nice polish.
- OLD STYLE Polished Stainless 0255-PS \$14.95 ea
- DISAPPEARING tailgate hinges 0269 \$79.95 pr
Simple and very slick, these virtually disappear when painted to match. Complete kit with hardware. Requires welding to bed post.



NUT-SERT FOR HINGES

- Install tool 80104 \$8.00 ea
- Nut-serts, 1/4-20 (4) 80249 \$3.75 set



TAILGATE HINGE BOLT KITS *polished stainless, acorn nuts where needed, does gate hinges only or tail lights only, for both see page 67*

- Polished hex, bed with taps 80246-PX \$10.00 kit
- Polished button, bed with taps 80246-PB \$12.00 kit
- Plain zinc, stock 80246-Z \$4.00 kit
- Polished hex, bed with no taps 80245-PX \$12.85 kit
- Polished button, bed with no taps 80245-PB \$14.50 kit



See page 67 for tailgate plus tail light bolt kits

TAILGATE CHAINS

- Stock with black rubber covers 0252 \$69.95 pr
- Polished stainless with black covers 0252-PL \$119.95 pr
- Polished stainless with clear covers 0252-PSC \$160.00 pr
- Chrome with black covers 0252-CH \$69.95 pr
China, chrome not up to par, but competitors sell so here they are.
- Long bed, polished, clear covers F2-0255-PS \$160.00 pr



TAILGATE LATCH BUMPERS

- 0253 \$4.35 pr
- CHAIN EYE BOLT FINISH ACORN
- For stainless chains, chrome 80252-PS \$5.75 pr
- For stock chains, chrome 80252-PLN \$5.75 pr



TAILGATE CHAIN COVERS

- Stock black rubber 0254-B \$9.95 pr
- Clear vinyl covers 0254-CL \$8.90 pr
- Vinyl covers, match upholstery colors 0254-(color) \$10.00 pr
- Fuzzy 0254-FZ \$12.00 pr
Yes fuzzy, protects paint, easy on and off, not water proof of course but just Velcro on and off, handy on seat belts too. No more covering chains with socks to protect paint!!



USA



USA

- INNER SUPPORT AND LATCH KIT, works on both double and single wall gates, as shown **SALE** 0264-A \$169.50
- With Polished hardware. **SALE** 0264-APS \$199.50



USA

← NEW

- FLOATING GATE SUPPORT HINGES, look original but hold gate with no visible means of support 0264 \$410.00 kit

TAILGATE SUPPORTS

- Supports similar to ones used on hidden support tailgate on previous page. Fits regular gate or any aftermarket gate with a double wall in this area. Complete with hardware and template. Very sturdy.*
- Zinc plated steel 0267 \$65.00 pr
- Polished stainless 0267-PS \$125.00 pr



USA

All roll pans are oversize shipping

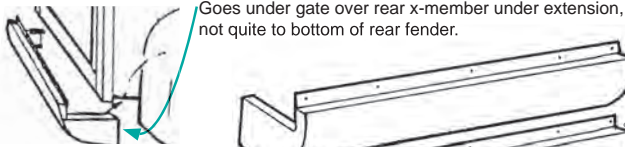

Side view, note how extended pan comes out under gate, while all rounded pans are flush with stock bed sill.

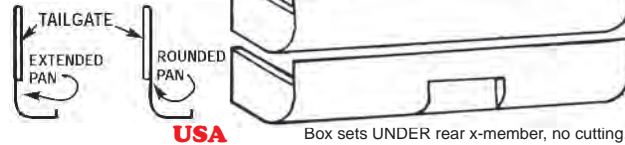

EXTENDED PAN STYLE

Called extended because it fits beneath tailgate extending out from rear sill. Flush with gate for a nice finished look from side of truck. Evens up tailgate for a nice profile. Extended pan does not come quite to bottom of rear fender, if using license box the original rear sill needs cut out, cut out area will be covered by pan. Easy to install can be bolted on or welded.

- Smooth7243.....\$115.00 ea
- With license box7243-B.....\$150.00 ea

ROUNDED PAN STYLE

Fits over rear bed sill, no cutting. Meets bottom of rear fender. Can be installed on finished beds, no cutting of rear sill, can be bolted or welded. Goes under bed extension.

- Rounded pan, smooth7241.....\$125.00 ea
- With license box7241-B.....\$160.00 ea
- Long bed smooth pan.....F2-7241\$195.00 ea
- Long bed with license boxF2-7241-B.....\$225.00 ea

LOUVERED PANS

Note if not ordering louvered gate and pan together, watch louver measurements, note how our gate and pan louvers line up in picture.

- Extended style, see description above
 - With 4 rows louvers & license box.....7243-BV4.....\$175.00 ea
 - With 4 rows louvers7243-V4\$145.00 ea
 - With 7 rows louvers7243-V7\$160.00 ea
 - Rounded style, meets bottom of fender
 - With 4 rows louvers & license box.....7241-BV4.....\$185.00 ea
 - With 4 rows louvers, no box7241-V4CALL
- Long bed pans are available with louvers as well, again, watch matching of louvers with gate, long bed can have 8 rows. Special order, call for help*

PAN CONSTRUCTION DETAIL *Extended style pans do not meet bottom of rear fender, Round pans DO. Pans are satin coated steel & spot welded. Excellent quality but seams are not hand finished. Working to bring our hand finished pans back, get on waiting list for notification.*

LOUVER MEASUREMENTS
4 rows of 4" louvers with license box.
Center line of row 1 ...6 5/8" from edge.
Center line of row 2 ...12 5/8" from edge



- LICENSE PLATE LIGHT2224.....\$10.00 kit
Very small and easy to install, one small hole to drill, I am not fond of those big round ones.



- ROLL PAN LIGHTS *just a few lights we have used in roll pans.*
 - Oval light, standard bulb.....2272.....\$16.99 ea
 - Oblong light, LED2274-LC.....\$29.95 ea
 - With sequential arrow.....2275-AC\$68.50 ea



- LED FLASHER, *LED Lights do not draw enough power to run a conventional flasher and some require special flashers. New 2 prong flasher includes polarity plug as well.*
 - 2 Prong2921-S2.....\$10.95 ea
 - 3 Prong, for 4 way hazards.....2921-3\$15.00 ea

- SEQUENTIAL LIGHT CONTROLLER .2225-SQ\$198.00 ea
Sealed housing, no relays to wear out, electronic flasher included. This flasher runs slow enough for three lights to turn on completely, works with LED lights, (may need ballast resistor) 2 year warranty. Made in USA!

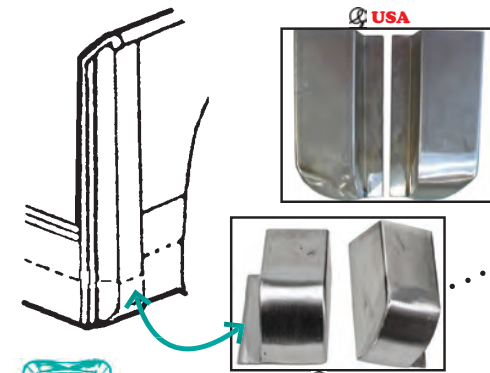

- STAKE POCKET EXTENSION POINTED STYLE, DOUBLE ROUND
Finished look from all sides 0229-RDR.....\$49.95 pr

- STAKE POCKET EXTENSIONS
 - Rear..... 0229\$39.95 pr
 - Front..... 0229-F\$39.95 pr

- STAKE POCKET EXTENSION REVERSE ROUND
Reversed, curves like roll pan, use in Rear, not intended for front.
Rear pair (not shown)..... 0229-RRR.....\$49.95 pr





NOW AVAILABLE IN COLORS!!!
Special highest quality fine grain bed cover topping material
Please ask for color samples, we are happy to send them. Please do not Try matching from color descriptions or printed colors on paper. Colors change so ask for samples

USA



••••• VELCRO BED COVER

No drilling, extra strong peel & stick Velcro adhesive. Cover designed to fit around and under rolled bed sides for a neater appearance both on and off. Velcro runs under the bed roll, plus we have added a small tab at the back corner to seal the bed side angle gap.

- Black Velcro bed cover 0146 \$175.00 ea
- Color Velcro bed cover 0145-ADCLR . \$120.00 ea
- Black, charcoal, navy, sand or white*
- Long bed black Velcro cover F2-0146 \$195.00 ea
- Long bed cover in colors 0145-ADCLR ... \$20.00 ea
- Replacement high temp Velcro..... 0153.....\$36.50 set

USA



••••• 50's STYLE SNAP ON BED COVER

Complete with anti-sail front rail, fits 51-72

- Black short bed only 0145 \$189.00 ea
- Colors, Additional charge..... 0145-ADCLR ... \$25.00 ea
- Black, charcoal, navy, sand, light gray or white*
- Bottom snap & screw (goes in truck)..... 80154..... \$0.90 ea
- Bottom snap & screw, set of 6 80154-6.....\$5.00 kit
- For repair only, do not order with cover, already comes with it.*

USA



••••• TONNEAU COVER SUPPORTS

Hardwood, rises only about 1/2" to shed water without looking like a covered wagon, sets gently on bed flare, includes foam pad to protect paint. Can be finished or painted. Oversize shipping.

- Short bed 0144 \$160.00 kit
- Long bed, see also long bed section F2-0144 \$160.00 ea

USA



••••• HATCH STYLE BED COVER WITH ALUMINUM FRAME

Easy removal from truck in about 20 seconds. Allows full access to truck bed raises completely up if needed. Double sided industrial tape and mechanical screws inside stake hole pockets. No marring of your paint or exterior bed. No Velcro or snaps

- Vinyl black 0148 \$399.00 ea
- Canvas black 0148-AB..... \$439.00 ea
- Sand 0148-SN..... \$439.00 ea
- Grey..... 0148-GR \$459.00 ea

••••• RIGID BED COVER KIT

6 1/2' bed only. Fiberglass with black smooth finish. We really like this cover, especially as has nice carpet installed, saves a bunch of work and is a nice professional job. Kit includes hinges, gas struts, weather-seal, handle & instructions. Tailgate stock ears for chains must be removed so tailgate will need inside latching.

- Oversize shipping, 4-6 week wait made to order.*
- Primer 0147-PR..... \$1200.00 ea
- Black..... 0147-B \$1300.00 ea
- Add center brake light..... 0147-ABLT \$190.00 ea

USA

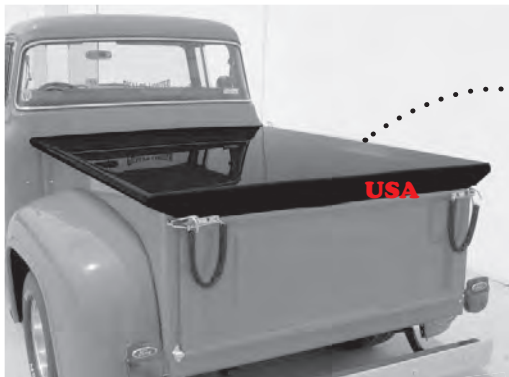

USA

••••• BED FLOOR MAT

- Charcoal carpet 0154-CH \$39.95 ea



••••• BED COVER, 6 1/2' BED TC-9102..... \$55.00 ea

Protect your bed while it is waiting to be installed or a quick cover up of coolers and such at outings.

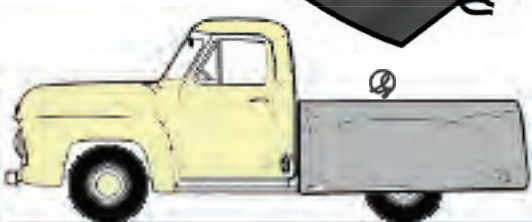

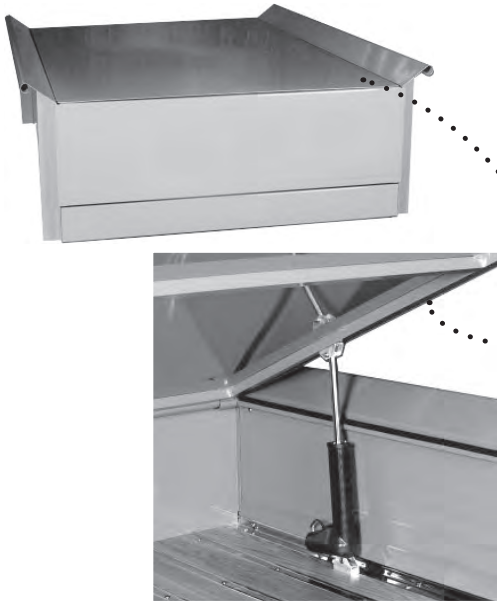

PRO'S PICK HARD TOP

Pro's Pick rigid tonneau covers are 100% aluminum with stainless steel brackets & hardware, no worry about rust.. Lid support structure has integrated rain gutters that direct rain water to a hidden drain and weatherstripping to keep out dust. Hard tops open and close electronically. Includes electric lift motors and up/down switch for cab interior.

Oversize freight shipping

- Pro's Pick Hard Top 0149-NO \$1750.00 kit
- Top with electric lift..... 0149 \$1750.00 kit

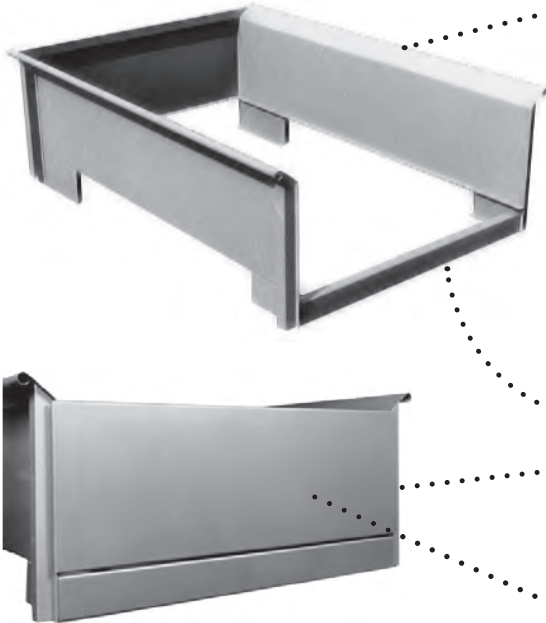

PRO'S PICK BEDS

- Fabricated from 16 gauge, satin coated steel (similar to galvanized). (same stuff we use on our beds)
- Plug welded construction (no spot welds to smooth out)
- Epoxy primed (so you can block sand and paint).

Bed sides, fronts and other pieces are available separately. But, remember, all Pros Pick pieces are designed to work on Pros Pick beds only, if mixing with other bed pieces modifications may be required. Teardrops are available to dress up the bed roll, add \$100.00 For 4. Bed kit includes sides, front panel, rear crossmember and center and front x-member included but not shown in picture. Rear x-member included is different than shown if ordering tailgate hidden hinge kit with bed. Oversize freight shipping

- Pro's Pick bedBED-PRO\$1599.00 ea
- Pro's Pick bed with tailgateBED-PRO-WG.... \$2399.00 kit

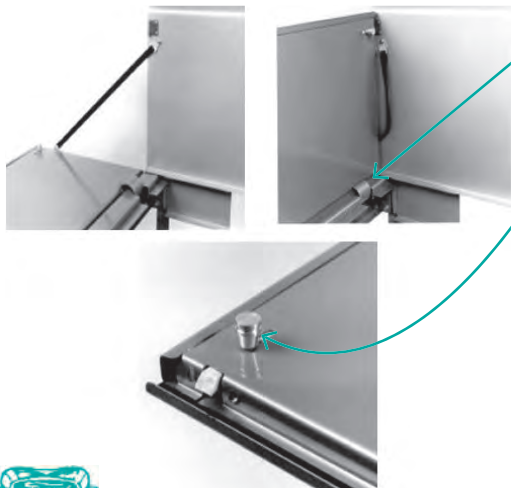

PRO'S PICK TAILGATE WITH HIDDEN HINGE KIT

- Pro's Pick tailgates ride on hinges that are hidden within rear cross member. When viewed from rear of truck the tailgate appears to float with no apparent means of attachment.
- Hidden latch assemblies are housed within the tailgate itself and actuated by two small knobs on the inside of the gate. Nylon latch bolts and stainless steel strikers assure smooth, quiet operation.
- Can be installed on stock beds, with some modifications may be required & Pros Pick rear crossmember must be used.

Kit includes:

- Smoothie gate, rear cross member with hidden hinges, hidden latch assemblies, nylon check straps AND stainless steel hardware
- GATE Kit 90251 \$899.00 kit
- If purchased with bed..... see above..... ADD \$800.00



8 FOOT LONG BED

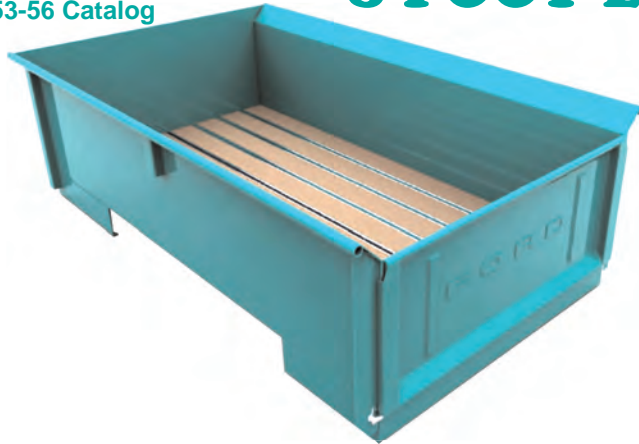

LONG BEDS fit 118" wheel base trucks.
 In 1956 an F-100 was produced with an 8' long bed on the 118" wheel base as well as the F-250. 1956 F-100 long bed has 5 lug wheels and same springs as short bed
 Up until 1956 long beds were installed only on 118" wheelbase F-250 Trucks. The following 9 pages cover our long bed and related parts. Long beds fit 1951-1979 F-250's as well with some crossmember and fender bolt changes. Note the dimensions below. We offer some custom updates to the bed and a basic kit for savings.
 If you have any questions please give us a call. For additional F-250 and F-350 pieces, springs, wheels, etc, see applications. Crate charges apply to long bed sides

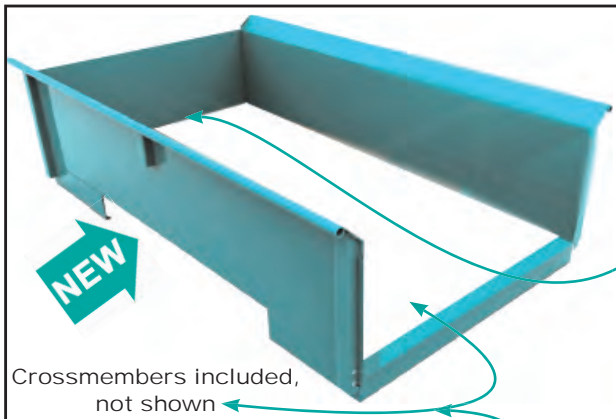
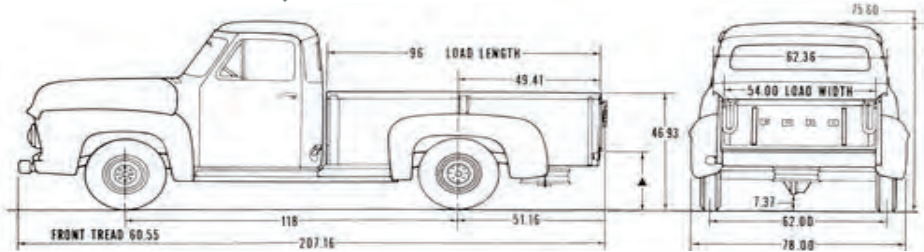

Crossmembers included, not shown

NOW AVAILABLE!!!!!!

LONG BED BASIC KIT, 8 Foot

Includes; both Bed Sides with stake pockets installed (no holes in flare) Front Bed panel, Front X-member, 4 Center X-members, and Custom Rear X-member.

With SMOOTH Front Panel . F2-90202 \$1860.00 kit
 With RIBBED Front Panel.... F2-90201 \$1995.00 kit

Now available Sy's LONG AND LOW BED, uses all the same pieces as a short bed except Long bed sides to fit. Does not need inner wheel tubs, use 3" wider fenders. Nice, custom looking bed on F-250!

Note can make any length, listed is 97" (8 foot bed)
LONG & LOW BASIC KIT F2-90284 \$1795.95 kit

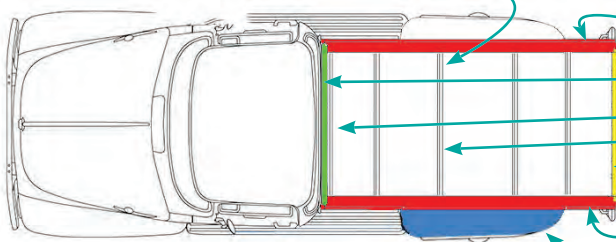

- Long & Low bedside
- Short bed front panel
- Front x-member, hidden mounting
- Center x-members (4) hidden mounting
- Rear x-member
- Long & Low bedside
- Use 3" wider fender



... BED COVER, TONNEAU

Protect your bed and contents. Velcro style, see standard section for more details & color choices.
 8 foot bed, black F2-0146 \$195.00 ea
 9 foot bed, black F3-0146 \$255.00 ea
 ask for free color samples before ordering colors, let your favorite lady check colors, shades are important!!!

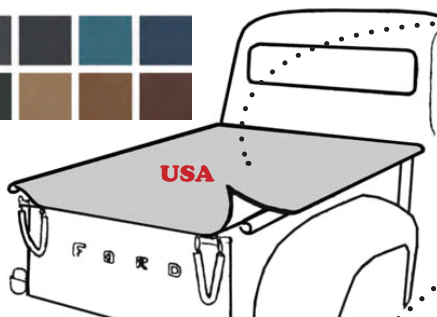

• TONNEAU SUPPORT

Perfect for that long expanse on your long bed. Has subtle curve to keep water from accumulating in center, padded ends protect paint. Hand crafted of the finest oak.
 Fits both 8 and 9 ft beds F2-0144 \$130.00 ea



LONG BED RUNNING BOARDS • REPAIR PARTS

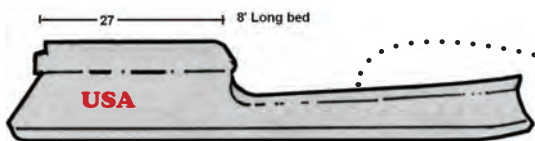

LONG BED STEEL RUNNING BOARDS

- Smooth steel boards, F2-0307-PR \$695.00 pr
Heavy gauge steel, hand made, include side panel.

THIS PAGE CONTAINS LONG BED PARTS ONLY



RUNNING BOARD MOUNTING BOLTS *Top F-250 & F-350*

- Stainless top shows..... F2-80310-SS\$9.50 kit
- Polished top shows..... F2-80310-PS\$15.00 kit

BOARD TO REAR FENDER BOLT KIT *Does both boards*

- Stainless..... 80313-SS.....\$6.50 kit
- Zinc..... 80313-Z\$4.50 kit

RUNNING BOARD TO BED SIDE PANEL

Steel goes between board and lower bed panel extension.

- Driver F2-0332-L \$36.50 ea
- Passenger F2-0332-R..... \$36.50 ea

RUNNING BOARD TO FRONT FENDER BOLT & GROMMET

- Does both sides..... 0311\$4.95 set



RUNNING BOARD BRACE, ADJUSTABLE

Great help aligning boards, adjusts in, out, up, down and fits in all locations. Perfect to adjust sagging or misaligned boards. Fits f-250 & f-350 use 3 on each side

- One brace 0342..... \$82.50 ea



BRACE TO FRAME MOUNTING BOLTS

- Zinc, does one brace 80342-Z \$3.00 set
- Stainless button head, does one brace 80342-SB.....\$8.00 kit

USA



STEP PLATES

Polished aluminum, straight back, red & black painted crest

- Ford F-100, Fits under door..... 0324-F100 \$75.00 pr
- Step plate bolts, polished 80324-PS.....\$6.15 set
- Step Plates for rear running board area at bed
- Deluxe with rubber insert..... 0324-DLX..... \$67.00 pr
- Ford Oval..... 0324-FRD \$55.00 pr
- No logo 0324-NL..... \$47.50 pr



0324-DLX



0324-FRD



0324-NL

LONG BED ROLL PANS

Custom made for 8 & 9 ft. Long beds, most styles we make for the standard bed are also available for the long bed, not all shown.

- Smooth pan F2-7241 \$195.00 ea
- Pan with license box..... F2-7241-B..... \$225.00 ea

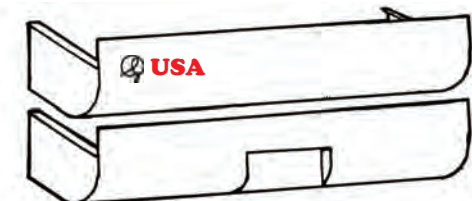

THIS PAGE CONTAINS LONG BED PARTS ONLY

LONG BED REPAIR PIECES

- Stake pocket, front..... F2-0221 \$60.00 ea
- Stake pocket, center (9ft bed only)..... F2-0223-C..... \$35.00 ea
- Front extension, driver..... F2-0206-L \$36.50 ea
- Front extension, passenger F2-0206-R..... \$36.50 ea
- Stake pocket, rear, driver..... F2-0225-L \$65.00 ea
- Stake pocket, rear, passenger..... F2-0225-R..... \$65.00 ea
- Rear extension, driver F2-0227-L \$28.50 ea
- Rear extension, passenger..... F2-0227-R..... \$28.50 ea

LONG BED FRONT BED PANELS

For 8 & 9 ft. beds, panels are shorter than bed sides, with a roll going across at top, meeting top of side. Call for help if needed.

- Stock ribbed style F2-0201 \$277.00 ea
- Smooth style..... F2-0202 \$195.00 ea

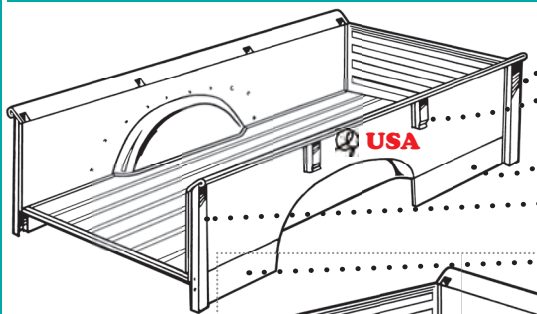

USA

THIS PAGE CONTAINS LONG BED PARTS ONLY





STOCK LONG BED TAILGATE

Long bed gates are longer and taller than short bed styles.

Stock with FORD letters F2-0250 \$400.00 ea



VINYL LETTERS F2-0266-BK \$15.00 ea

Add as trim to above gates, or make un-lettered gate look stock, see colors on page 130. Other Colors are \$16.50 each

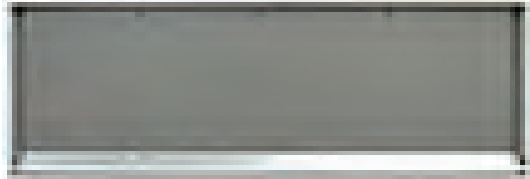

NO LETTERS, same as stock but center panel is smooth

With chain latch ears F2-0251 \$275.00 ea

Without chain latch ears F2-0252 \$275.00 ea



LOUVERED

4 Rows, with chain ears..... F2-0251-V4.... \$325.00 ea

4 Rows, without chain ears..... F2-0252-V4.... \$325.00 ea

8 Rows, with chain ears..... F2-0251-V8.... \$325.00 ea

8 Rows, without chain ears..... F2-0252-V8.... \$325.00 ea

Tailgates and covers fit 8 foot beds and F-350 9 foot beds.

THIS PAGE CONTAINS LONG BED PARTS ONLY

LONG BED TAILGATE COVERS, not shown

For cover or repair, rolls over top edge, cleans up years of abuse.

Cover, smooth F2-0254 \$95.00 ea

Cover, 4 rows louvers F2-0254-V4.... \$110.00 ea

Cover, 8 rows louvers F2-0254-V8.... \$135.00 ea



LONG BED TAILGATE TOP PROTECTOR Quick and easy dress-up or cover-up for tailgate top roll, plus protects paint from chipping and wear. Made for gates with or without chain latch ears

With notch for chain latch F2-0258 \$59.95 ea

Without notch..... F2-0258-N..... \$59.95 ea



DOUBLE WALL GATE WITH CENTER INSIDE HANDLE And STAINLESS SUPPORTS

Flush, smooth style tailgate, no chains. Tailgate with handle and supports, includes special hinges. Stock and our bed sides require simple modification for tailgate to fit.

Kit with Stainless links F2-0246-

Kit with Zinc plate links

DOUBLE WALL SMOOTH TAILGATE F2-0253 \$395.00 ea

Very custom, very smooth, double wall so accepts hidden latch and Support systems of all types.



LONG BED GATE WITH HIDDEN LATCH & SUPPORT

The latest in hidden latches and supports, installed already! This is best thing to come along for gates in years! Fits 53-87

Plain steel supports F2-0246 \$395.00 ea

Polished stainless supports F2-0247 \$450.00 ea

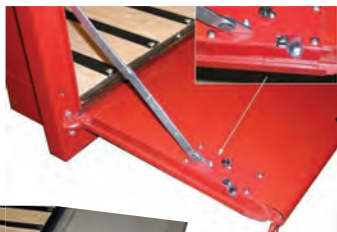

LATCH & SUPPORT KIT

Complete with claw style latches, supports, all hardware, template and instructions to install in your stock, or most any reproduction or double wall style gate.

Plain zinc F2-0276..... \$159.95 ea

Polished stainless..... F2-0276-PS..... \$250.00 ea

Supports only, polished F2-0277-PS..... \$135.00 ea

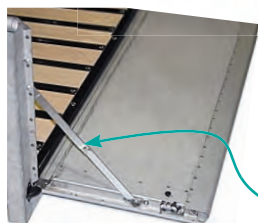

8 FOOT LONG BED FLOOR

2020 Mid Fifty
1953-56 Catalog



LONG BED PARTS ONLY



THIS PAGE CONTAINS
LONG BED PARTS ONLY

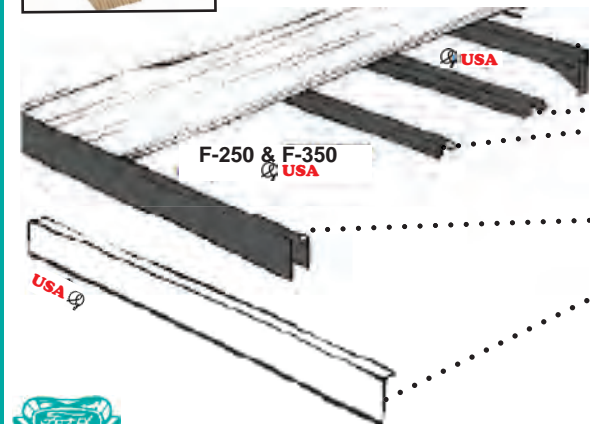

F-250 & F-350
USA

BED STRIPS

- Stock square punched holes, sets
 - Zinc plate, with holes F2-90208-Z \$95.00 set
 - Stainless, with holes F2-90208-S \$150.00 set
 - Polished, with holes F2-90208-P \$195.00 set
- No holes punched, sold each
 - Zinc plate F2-0207-Z \$18.00 ea
 - Stainless F2-0207-SS \$21.00 ea
 - Polished F2-0207-PS \$26.00 ea
- Polished wow strips, set F2-90209-W \$349.95 set
With hidden fasteners set includes special "T" bolts

STRIP BOLTS....see next page

BED SIDE ANGLE FLANGE COVER

Great cover up for area along lower bed flange, nice edging for polished strips. For straight sides only won't work with wheel tubs.

Polished, no holes F2-0210-NP \$65.00 pr

LONG BED WOOD *Red oak, 7 pieces, fits 1956 1/2 ton long bed and 1953-80 3/4 ton long beds. No hold down holes or wheel tub cutouts. Does NOT come with hold down holes, wheel tub cutouts.*

- No hold down holes F2-90211 \$450.00 set
- With hold down holes F2-90212-WH \$589.85 set

FLOOR KIT, *Add with above for a complete bed kit. Includes oak boards (no hold down holes) strip and side bolts, mounting blocks and choice of strip styles & finish. No hold down bolts, see also next page hold down kits*

- With stock zinc strips & bolts F2-90215-Z \$595.00 kit
- With stainless strips & bolts F2-90215-S \$645.00 kit
- With polished strips & bolts F2-90215-P \$695.00 kit
- With polished Wow strips & fastener .. F2-90215-W \$795.00 kit
Wow strips have hidden fasteners, see strip page 131 for info.

HOLD DOWN BOLTS

See next page for more styles and information.

- Replacements, zinc F2-80212-Z \$30.00 kit
- Replacements, stainless F2-80212-SS \$71.00 kit
- Replacements, polished F2-80212-PS \$108.00 kit

INSULATORS *Crossmember to frame*..... F2-0214 \$10.00 ea

FRONT BED MOUNTING BRACE

Front crossmember sets on this, it sets the bed above frame

- Brace 0234 \$20.00 ea
- Brace mounting bolts 80234 \$3.50 set

WOODEN MOUNTING BLOCKS *Go inside crossmembers, lifts x-members above frame*..... F2-0215....**SALE**\$49.00 set

LONG BED CROSSMEMBERS

Center crossmembers at the wheel well are shorter, because many wheel wells have been changed we punch mounting holes in the long crossmember to fit both (all 4 spots).

- Front F2-0230 \$65.00 ea
- Centers, long F2-0232 \$65.00 ea
Punched for with or without wheel tubs, takes 2 or 4
- Centers, short F2-0233 \$65.00 ea
Use with stock wheel tubs only (2)
- Rear, like original F2-0234 \$225.00 ea
- Rear Custom, easier made & installed, does not go inside stake pockets, has bracket F2-0235 \$129.50 ea

REAR SILL REPAIR OR COVER, x-members see next page.

Handy for straightening up, covering up or repairing damaged rear sills. Quick & easy makes bed look new.

- Plain steel F2-0238-Z \$48.50 ea
- Polished stainless F2-0238-PS \$55.00 ea



THIS PAGE CONTAINS
LONG BED PARTS ONLY

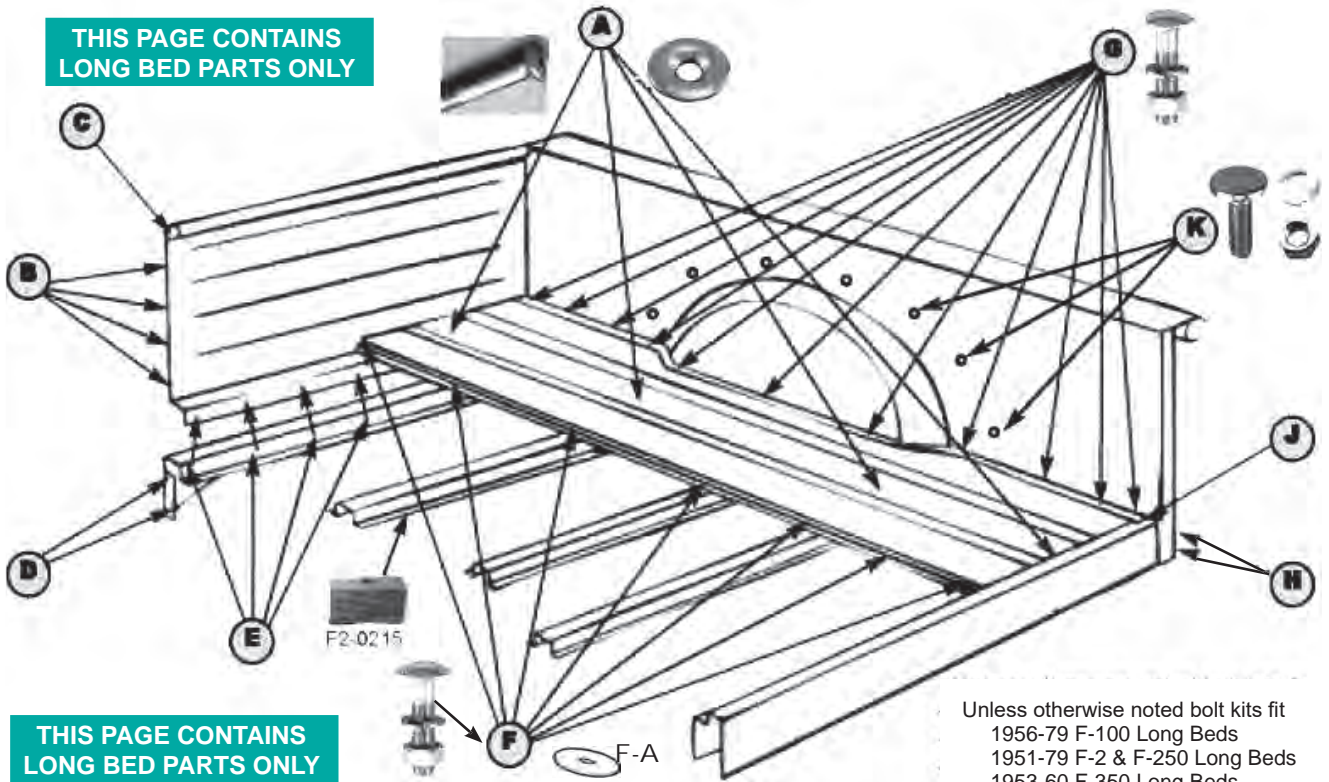

THIS PAGE CONTAINS
LONG BED PARTS ONLY

Unless otherwise noted bolt kits fit
1956-79 F-100 Long Beds
1951-79 F-2 & F-250 Long Beds
1953-60 F-350 Long Beds

A.) HOLD DOWN BOLTS

Includes countersunk washers. Long beds 1953-80 F250, 56-80 F-100, 53-60 F-350

Replacements, zinc	F2-80212-Z	\$30.00 kit
Replacements, stainless.....	F2-80212-SS.....	\$71.00 kit
Replacements, polished	F2-80212-PS.....	\$108.00 kit

B.) FRONT PANEL TO SIDE PANEL BOLTS

Polished kits include polished acorn nuts.

Hex, zinc.....	F2-80202-Z	\$7.50 kit
Hex, polished stainless.....	F2-80202-PX.....	\$26.00 kit
Button, polished stainless.....	F2-80202-PB.....	\$28.50 kit

C.) FRONT PANEL TOP ROLL TO SIDE BOLTS

Hex, zinc (ea)	F2-80201-Z	\$1.65 ea
Hex, polished stainless (ea)	F2-80201-PX.....	\$4.75 ea
Button, polished stainless(ea) ...	F2-80201-PB.....	\$5.00 ea

D.) FRONT Crossmember TO LOWER SIDE PANEL

Polished kits include polished acorn nuts.

Hex, zinc.....	F2-80203-Z	\$4.00 kit
Hex, polished stainless(ea)	F2-80203-PX.....	\$14.00 kit
Button, polished stainless(ea)	F2-80203-PB.....	\$15.00 kit

E.) FRONT PANEL TO FRONT Crossmember

These peek out a little if you are looking.

Hex, zinc(ea)	F2-80204-Z	\$6.00 ea
Hex, stainless(ea).....	F2-80204-SX.....	\$7.00 ea
Hex, polished stainless(ea)	F2-80204-PX.....	\$12.00 ea
Button, polished stainless(ea) ...	F2-80204-PB.....	\$14.00 ea

F.) BED FLOOR STRIP BOLTS (Includes F & F-1)

1953-80 F-250 long bed, 56-80 F-100 long bed

Carriage, zinc	F2-80208-Z	\$28.00 kit
Carriage, stainless.....	F2-80208-SS.....	\$51.00 kit
Carriage, polished stainless	F2-80208-PS.....	\$68.00 kit

F-A.) UNDER WASHERS Strip bolt to wood, 1.50 wide

Stainless.....	F2-80208-WS.....	\$8.00 kit
----------------	------------------	------------

G.) BED SIDE PANEL FLANGE TO FLOOR BOLTS

Carriage, zinc	F2-80207-Z	\$12.50 kit
Carriage, stainless.....	F2-80207-SS.....	\$18.95 kit
Carriage, polished stainless	F2-80207-PS.....	\$28.50 kit

H.) REAR CROSS MEMBER TO SIDE PANEL

Hex, Zinc (ea)	F2-80205-Z	\$4.50 ea
Hex, polished stainless(ea)	F2-80205-PX.....	\$7.50 ea
Hex, stainless(ea).....	F2-80205-SX.....	\$6.50 ea
Button, polished stainless(ea)	F2-80205-PB.....	\$8.50 ea

J.) REAR Crossmember TOP TO SIDE PANEL

Button, stainless(ea).....	F2-80206-SB.....	\$2.50 kit
Button, polished stainless(ea)	F2-80206-PB.....	\$5.00 kit

K.) REAR FENDER BOLTS Made stainless to polish

With square shoulder, stainless.....	81541-SS	\$78.95 kit
With square shoulder, polished	81541-PS	\$65.00 kit
Button head with washer, for round holes, does both sides		
Stainless, set of 24	81543-SB	\$22.50 kit
Polished, set of 24	81543-PB	\$59.00 kit
Underside washer kit.....	81546-SS	\$6.75 kit

ASSEMBLY BOLT KIT Includes B,C,D,E,H

Zinc.....	F2-80219-Z	\$22.50 ea
Polished stainless.....	F2-80219-PX.....	\$58.50 kit
Button, polished stainless.....	F2-80219-PB.....	\$68.50 kit

FLOOR BOLT KIT Includes A,F,F-1,G,J

Zinc.....	F2-80215-Z	\$65.00 kit
Polished stainless.....	F2-80215-PS.....	\$190.00 kit

See also individual bolt applications in standard section.

9 FOOT LONG BED

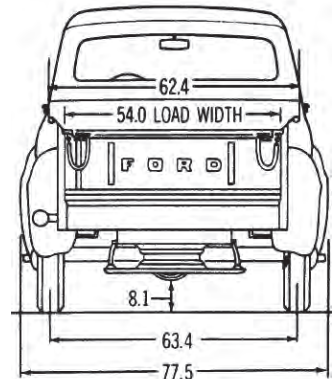
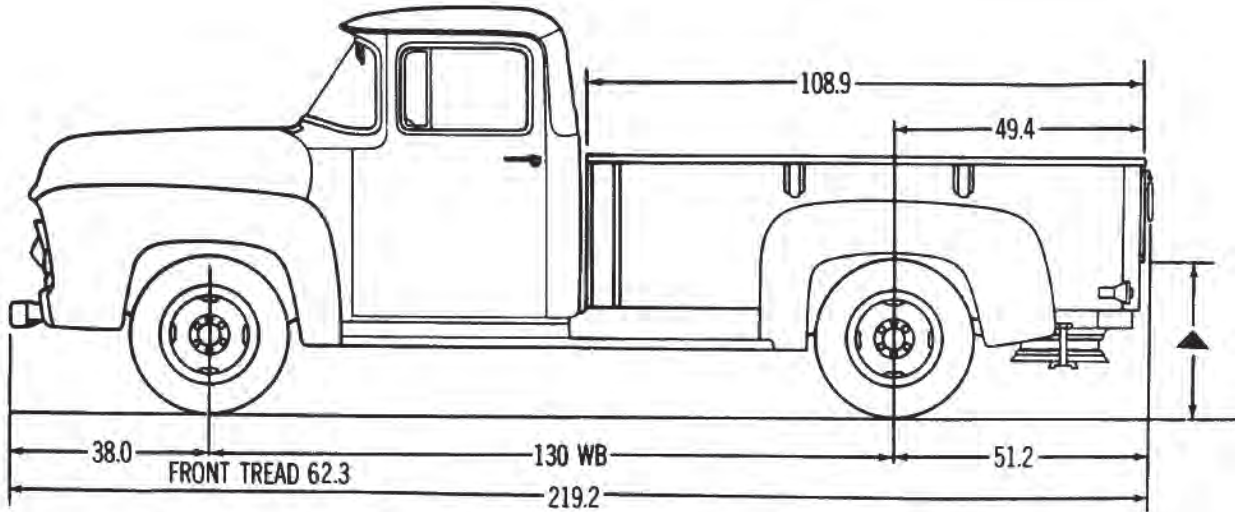

9 Foot bed will fit on 1948 through 1983 with some changes in crossmembers and fender holes. This bed is heavy, huge and requires crating, special handling and truck freight. We will quote with the best possible truck line and pass our discounts on to you. The front panel, tailgate, crossmembers, hinges, latches, bolt kits, covers, running board braces, etc are the same as 8 foot beds, see previous long bed pages for all the choices. 9 foot beds are made to order so not listed here. Bed sides come with no fender holes, sides fit many years with various fender hole patterns (6.5' bed sides have holes) and come with stake pockets but no holes in side angle for stake pockets. Smooth, beautiful beds!!!

Due to all the variations and decades of wear individual pieces may need some love to fit with old pieces. Kits are pre-fitted so we know they match. INDIVIDUAL PIECES SEE PREVIOUS 8 foot bed pages. these items are same for 9" and 8' beds; CROSS-MEMBERS BOLT KITS, FRONT BED PANELS & TAIL GATES

9 foot bed sides are made to order, can be from 100-112'

9' BED KIT, Basic.....F2-90202-9.....\$1995.00 kit •
Smooth front panel, sides, Front x-member,
Center x-members and Rear x-member.

BED SIDES, 9' smooth sides, no tubs installed.

Driver..... F2-0205-9L.....\$750.00 ea • • •
Passenger.....F2-0205-9R\$750.00 ea • • •

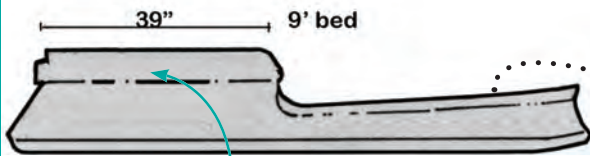
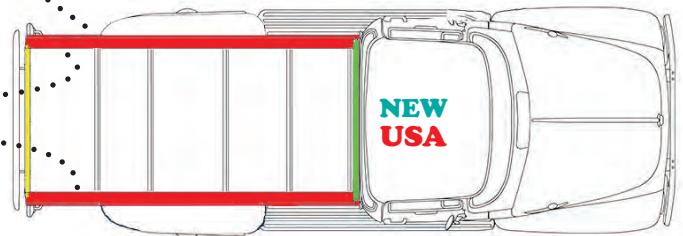

ONE TON LONG BED STEEL RUNNING BOARDS

Heavy gauge steel, hand made, include side panel.
Smooth steel, driver.....F3-0307-L.....\$335.00 ea
Smooth steel, passenger.....F3-0307-R.....\$335.00 ea



F-350 RUNNING BOARD TO BED SIDE PANEL, STEEL
DriverF3-0332-L.....\$48.50 ea
PassengerF3-0332-R.....\$48.50 ea

**THIS PAGE CONTAINS
LONG BED PARTS ONLY**

RUNNING BOARD BRACE, ADJUSTABLE

For fine tuning running board fit and angle, a perfectly straight line here straightens up the whole look of the truck. Accepts 53-55 gas tank and battery trays.

Plain steel, each0342\$82.50 ea
Plain steel, set of 40342-4\$319.95 set

BRACE MOUNTING BOLTS To frame only, Top bolts see bolt pg.

Kit does only one brace.
Zinc.....80342-Z.....\$3.00 set



**THIS PAGE CONTAINS
LONG BED PARTS ONLY**

**THIS PAGE CONTAINS
LONG BED PARTS ONLY**

One ton 9 foot long bed uses same tail gate, front panel, and x-members as 8 foot bed. See choices on the F-250 pages.

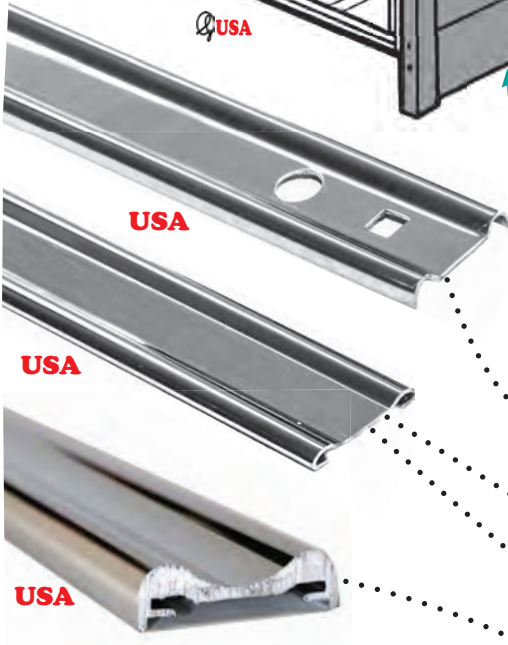
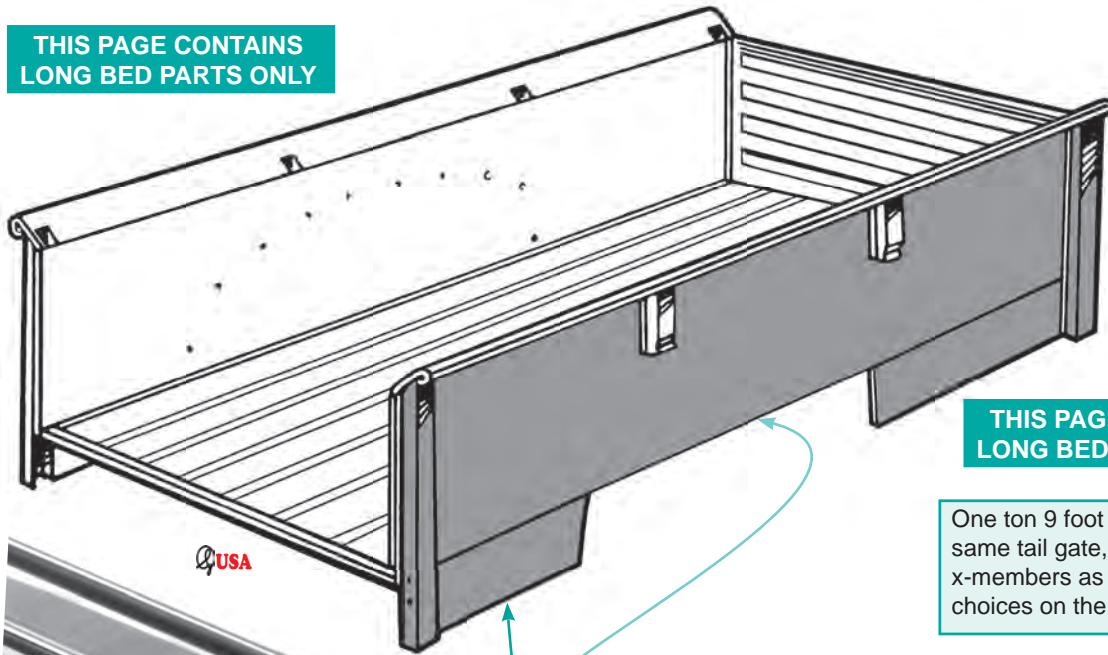

- **BED SIDES, 9' smooth sides, no tubs installed.**
 - Driver..... F2-0205-9L \$750.00 ea
 - Passenger..... F2-0205-9R..... \$750.00 ea
- **BED PANEL EXTENSION (included with bedside above)**
 - FRONT, Left.....F3-0206-L.....\$42.50 ea
 - Right.....F3-0206-R\$42.50 ea
 - REAR, Left.....F3-0207-L.....\$30.00 ea
 - Right.....F3-0207-R\$30.00 ea

BED STRIPS

- Stock square punched holes. Sold in sets of 6 pcs.
 - Steel, satin finish with holesF3-90208-Z..... \$140.00 set
 - Stainless steelF3-90208-S..... \$195.00 set
 - Polished, with holes.....F3-90208-P..... \$195.00 set
- No holes. Drill your own, sold each
 - SteelF3-0212-Z.....\$22.00 ea
 - Polished stainless.....F3-0212-P.....\$32.00 ea
- Polished wow strips with hidden fastness
 - Set includes special "T" bolts.....F3-90209-P..... \$299.00 set

• **NEW ALUMINUM STRIPS AVAILABLE, ORDER BY LENGTH**
NEW Flat style and Domed styles.

• **9 FT BED WOOD**

Red oak, 7 pcs, 1 center, 2 middles, 2 left sides & 2 right sides.
No holes or wheel tub cutoutsF3-90213\$395.00 ea



• **INSULATORS** Crossmember to frameF2-0214\$10.00 ea



• **WOODEN MOUNTING BLOCKS**F2-0215 \$49.00 set
Go inside crossmembers holding them above frame.



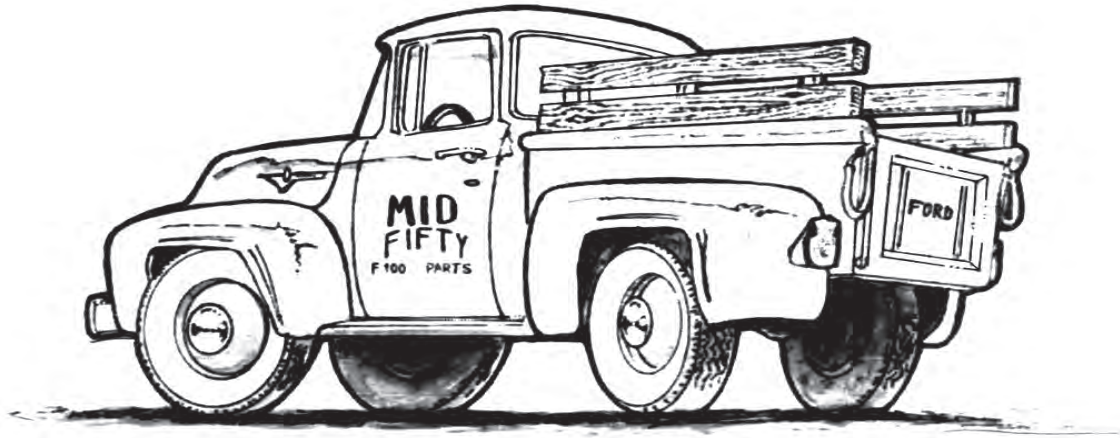

TRUCK LOWERING TIPS

ALL MEASUREMENTS ARE FROM STOCK HEIGHT, ALL MEASUREMENTS ARE APPROXIMATE

FRONT LOWERING OPTIONS

Reversed eye spring main leaf only	1 3/4" drop	page 144
Short & smooth spring stack	3" drop	page 143
Mono leaf spring, stock eye	3" drop	page 143
3" Drop axle	3" drop	page 165
Mono leaf spring, reversed eye	4-5" drop	page 143
Mustang II, IFS.....	Stock is 4" drop.....Dropped spindles is 6" drop.....	page

REAR LOWERING OPTIONS

Extended "Y" hanger	1" drop	page 142
Moving rear spring hanger up	2" drop	FREE
Reversing rear spring hanger	2" drop	FREE
Reversed eye spring main leaf only	2 1/4" drop	page 144
Reversed eye spring complete stack.....	2 1/4" drop	page 146
Mono leaf spring, stock eye	3" drop	page 143
NEW adjustable spring hanger.....	0 to 3.5" drop.....	page 142
Short & smooth spring stack	3 3/4" drop.....	page 143
Rear axle flip, springs below axle	4+" drop	page 184
Mono leaf spring, reversed eye	5" drop	page 143

You can get darn close (about 75%) of the ride of an IFS with a pair of SHORT & SMOOTH STACKS or MONOS in the front, a pair of SHORT & SMOOTH STACKS in the rear and SWAY BARS both front & rear.

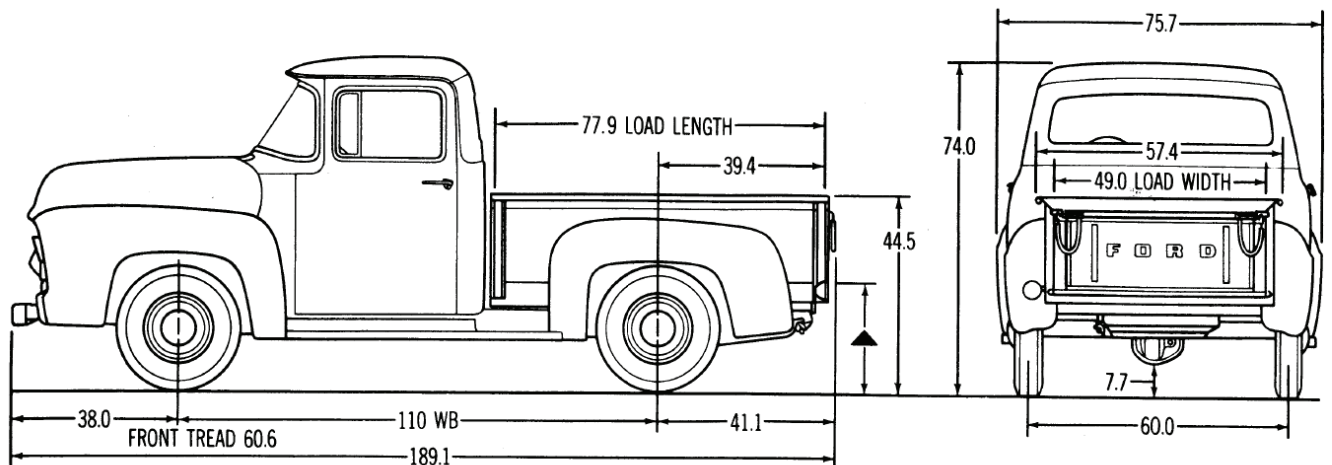

ALL DIMENSIONS WITH 6.70 x 15-4 P.R. TIRES (LOADED)





With sway bars



Without sway bars



USA



USA



USA

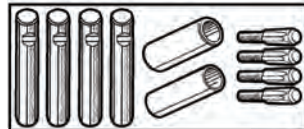

USA



ANTI-ROLL-SWAY BARS

What a difference in handling!! Sway bars help eliminate body roll and control over & under steer. Kits come with mounts and hardware. Includes mounts for both stock and tube axle.

- FRONT SWAY BAR KIT 2899 \$149.00 kit
Heavy duty, highest quality, not universal. Front sway bar and down and forward springs gives you the best handling improvement for the least outlay of dollars.
- Tube Axle Mounting bracket ONLY 2845 \$24.00 pr
Use with tubular drop axle, included in above sway bar kit, listed only in case you have sway bar from elsewhere and tube dropped axle.

- REAR ANTI-ROLL SWAY BAR KIT 2898 \$189.00 kit
7/8" Chromoly, works great with any leaf spring set up, mono, short stack or stock. Mounts with springs above (shown) or below axle. Works with stock axle or later model 3" housing. Frame bracket goes to outside.
- Pan hard bars and traction control see website

LOWERING REAR WITH HANGERS

- REAR EXTENDED "Y" HANGER SHACKLE KIT
Hanger is extended 2 inches, gives better travel, includes bushings, gives one inch actual lowering at center of spring.
Both hangers with bushings & bolts 2802 \$90.00 pr
F-250 hangers F2-2802-25. \$110.00 pr
- PIN & BUSHING KIT FOR EXTENDED "Y" HANGERS
4 pins, 2 eye bushings & 4 lock pins 2840 \$48.00 kit
You need eye bushings for other end of spring, only need 4 pins as upper bolt and delron bushings are included above.
- FRONT OF REAR HANGERS, ADJUSTABLE
Original cast spring hangers are no longer available, we are making replacements. Adjustable makes it easier to lower (or raise) the truck. More styles are in progress, if you have a specific need, let us know. New poly bushings improve movement, ride and sound. Replaces eye bushings in spring main leaf. Beautiful black powder coated hanger comes with bushings and hardware.
Pair 2810-A \$95.00 pr
Hanger to frame bolt kit 84438 \$8.50 kit
F-250 pair F2-2810-A...\$110.00 pr
- EXTENDED Y HANGERS, NO BUSHING,
FOR USE WITH ADJUSTABLE HANGERS 2802-NB
No Bushing, bushings are included with adjustable hangers
- POLLY BUSHING GREASE, Best we have found, and YES you should use it..... 82802 \$1.95 ea

"I NEED ALL" & "I MEAN ALL" LOWERING KITS

See next few pages for individual lowering springs and parts

FRONT

- I NEED ALL Big block 2 front short & smooth stacks, 4 U-bolts & pin kit 92852-BB \$489.00 kit
- I NEED ALL Small block 2 front short & smooth stacks, 4 U-bolts & pin kit 92852-SB \$489.00 kit
- & I MEAN ALL! Big block above kit plus hanger bars, & spring shims 92853-BB \$559.00 kit
- & I MEAN ALL! Small block above kit plus hanger bars, & spring shims 92853-SB \$559.00 kit
- & I MEAN ALL!, DOWN AND FORWARD Big block, above plus extended drag link 92855-BB \$699.00 kit
- & I MEAN ALL!, DOWN AND FORWARD Small block, above plus extended drag link 92855-SB \$699.00 kit

REAR

- I NEED ALL Short & smooth stacks, 4 U-bolts & pin kit, choose year 92860-(year) \$629.00 kit
- & I MEAN ALL! Above kit plus extended Y-hangers & pin kit for a 5" drop, choose year 92861-(year) \$669.00 kit
- Flip the spring hanger & move up on frame for a 1" to 1 1/2" drop (don't forget the hole for pin removal) FREE
- Unless we sell you the grade 8 bolts to do it with 84438 \$8.50 kit

LOWERING SPRINGS

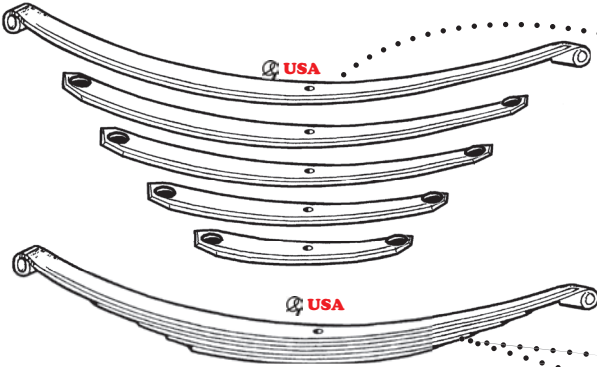

Remember the measurements are from original stock height. Most springs are oversize shipping.

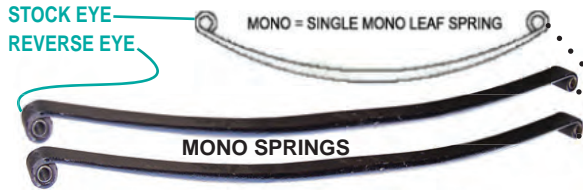

Note: Front monos, remove front round spring bumper. Rear, reverse eye, flip hanger or see Sy's adjustable hangers. Under axle use stock eye for clearance.



SEE NEW POLY BUSHINGS ALSO



All our springs have eye bushings installed. Use these Mid Fifty kits without eye bushings.



SHORT & SMOOTH LEAF SPRING STACKS

Our springs are specifically designed for an F-100 with small block or big block engines. If you have modifications let us know for proper spring configuration. Comes with installed poly buttons, eye bushings and center bolt. We stand behind them 100%. These & a pair of sway bars will give you most the ride and handling of an IFS at a fraction of the cost. Springs below are reverse eye. Stock eye lowered springs will lower you 1.25"-2" less, but do not require flipping hanger

- Front, for Small Block 2866-SB \$279.50 ea
- Front, for Big Block 2866-BB \$279.00 ea
- Rear 1953-54 (48") 2867-5354 \$269.00 ea
- Rear 1955-56 (52") 2867-5556 \$289.00 ea

- **Front, down & forward**, small block 2869-FSB \$239.00 ea
 - **Front, down & forward**, big block 2869-FBB \$239.00 ea
- It has always bothered me that front wheel is not centered in opening. Sy's spring solves it, helps weight distribution, bump steer & improves handling. Moves center point forward 1 1/4".
Drag link tube must be lengthened or see our 2707-EXT.

MONO LEAF SPRINGS

- Reversed eye mono leafs can be shimmed for less than a 5" drop.
- Front, stock eye, 3" drop 2891-3 \$545.50 pr
- Front, reverse eye, 5" drop 2891-5 \$545.50 pr
- Front, down & forward, see above why Sy had these cast, centers wheel in fender, reverse eye only 2894-5 \$499.00 pr
- Rear, 1953-54 stock eye 2892-3 \$545.00 pr
- Rear, 1953-54 reverse eye 2892-5 \$545.00 pr
- Rear, 1955-56 stock eye 2893-3 \$485.00 pr
- Rear, 1955-56 reverse eye 2893-5 \$535.00 pr

Note: when using reversed eyes in rear, flip forward spring hanger to avoid binding of spring eye, raise it on frame for additional drop.

Or, better yet see Sy's adjustable spring hangers on previous page. Don't forget to drill a hole for spring pin removal,

- EXTENDED DRAG LINK TUBE 2707-EXT \$115.00 ea
Core charge, we need your old tubes to make \$30.00 ea
- PIN REMOVAL TOOL For rear spring to hanger pin
12" long 2801-P \$4.00 ea
- BUSHING REMOVAL TOOL saves more expensive socket and-or thumb, easy bushing removal Front... 2801-F \$11.50 ea
Rear... 2801-R \$11.50 ea

- SPRING PIN & SHACKLE BUSHING KITS Use with all our springs
- Front 2895 \$44.50 kit
- Rear 2896 \$55.95 kit
- F-250 rear F2-2896 \$139.95 kit

- ALIGNMENT SHIM, FRONT Needs trimmed for fronts. use longer head front bolts, and rear head spacers below.
- 2 Degree 2839-2 \$10.50 ea
- 4 degree 2839-4 \$10.50 ea

- UPPER U-BOLT TIE PLATE, protects spring & aligns U-bolts.
Does front or rear 2808 \$10.00 ea



POSIES BRAND SPRINGS, sold in pairs only, Fronts not available with wheel centering, rethink Sy's centering springs above.

- FRONT DUAL FLEX, 3" DROP 2860-5356 \$399.95 pr
- FRONT SUPER SLIDE, 2" DROP 2861-5356 \$539.80 pr
- REAR SUPER SLIDE, 1953-54 2862-5354 \$399.95 pr
- REAR SUPER SLIDE, 1955-56 2862-5556 \$539.80 pr





- **MAIN LEAF ONLY LOW & SMOOTH LEAF SPRING KIT**
Order by year of frame. Includes 2 reversed eye main leaves with eye bushings installed, poly spring liner, center bolts and clamps.
Front, for Small Block 92835-SB \$299.00 kit
Front, for Big Block 92835-BB \$329.55 kit
Rear, 1953-54 92836-5354 \$319.00 kit
Rear, 1955-56 92836-5556 \$319.00 kit



- **MAIN LEAF ONLY (MLO) LEAF SPRING** Lowered & reversed eye.
Rear reversed eye, flip forward spring hanger to avoid binding.
Front, 1953-56, small block 2853-SB \$135.00 ea
Front, 1953-56, big block 2853-BB \$135.00 ea
Rear, 1953-54 2864-5354 \$145.00 ea
Rear, 1955-56 2864-5556 \$145.00 ea



- **POLY RIDE SPRING LINER**
30' does both sides. Spring leaves ride against each other and eventually make a groove which acts like a stopper causing jolts & choppy ride. Liner goes between leaves, gives a quieter, smoother slide. Point edges down. Stock may need more than 30', grind down any ridges and smooth out spring tips.
Front 30 ft 2831-F \$22.50 rl
Rear 30 ft 2832-R \$25.00 rl
10' in case you need extra, front 2831-10F \$12.50 rl
10' in case you need extra, rear 2832-10 \$12.50 rl



- **POLY BUTTONS** Our springs are indented for special buttons, adding buttons to existing spring requires drilling spring steel, rethink poly ride above. Button, one only 2833 \$2.50 ea
Set of 16, for 2 spring stacks 2833-16 \$25.00 set

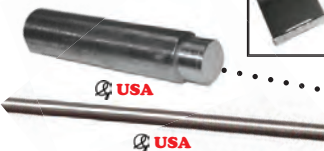

- **SPRING CLAMPS** Use 2 toward the front, 1 toward the rear.
Front set of 3 2837-F \$8.50 set
Rear set of 3 2838-R \$8.50 set
- **BUSHING REMOVAL TOOL** Front 2801-F \$11.50 ea
Rear 2801-R \$11.50 ea



- **PIN REMOVAL TOOL** For rear pin 2801-P \$4.00 ea
- **SPRING PIN & SHACKLE BUSHING KITS**
• Front 2895 \$44.50 kit
• Rear 2896 \$55.95 kit

All our springs have eye bushings installed, Use these Mid Fifty kits without eye bushings.

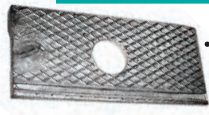

- **ALIGNMENT SHIM, FRONT** Needs trimmed for fronts. use longer head front bolts, and rear head spacers below.
2 Degree 2839-2 \$10.50 ea
4 degree 2839-4 \$10.50 ea



- **UPPER U-BOLT TIE PLATE**, protects spring & aligns U-bolts.
Does front or rear 2808 \$10.00 ea



- **CENTER BOLTS**
• Front with longer head, use with shims ... 2835-F58 \$4.25 ea
• Front for Mono springs 2836-MF \$2.50 ea
• Rear for Stock or Lowered springs 2836-R \$3.95 ea
• Rear for Mono springs 2836-MR \$2.50 ea
• Rear bolt head spacers, use with shims.. 2836-SPC \$2.50 pr



- **U BOLTS**
Short & smooth, front 2875 \$8.50 ea
Short & smooth, rear, stock axle 2870 \$9.95 ea
Short & smooth, rear, 3" axle 2873 \$8.50 ea
Mono springs, front 2875-M \$15.00 ea
Mono springs, rear, stock axle 2870-M \$15.00 ea
Mono springs, rear, 3" axle 2873 \$8.50 ea

Note: if you are removing your own spring leaves, we suggest: starting at bottom: keep #1 (shortest one) remove #2 (next one), keep #3, remove #4, and so on, depending on how many you have. Never go under 5 springs. Some secondary (below main) may have a "wrap" cut it back away from eye 1.5". Add new main leaf with reversed eyes, poly ride, and new clamps. Makes about a 3 to 3 1/2" drop. All used spring leaves should be checked for cracks, fatigue or uneven arch, and any grooves where ends touch spring above. Use longer head center bolt to accommodate alignment shims. To distribute weight nice and evenly, it should look like drawing



STOCK FRONT SPRING

2020 Mid Fifty
1953-56 Catalog



FRONT SPRING HANGER PERCH

Front of the front spring, includes installed shackle bushing.

- Original cast style2805..... \$47.50 ea
 - **Replacement style** 2805-RP..... \$32.50 ea
- Bolts included not shown.

FINALLY FINISHED, Replace the old cast hangers!!!



FRONT HANGER BARS

Watch for wear here, often overlooked

- INNER.....2806-IN\$7.95 ea
- OUTER, WITH STOP NOTCH..... 2806-OUT ...\$7.95 ea

SPRING HANGER & PIN REPLACEMENT SET

Aftermarket hangers and stationary pins, one side only, truck needs two kits, see original style on next page.

- Kit for one side..... 2806 \$41.95 ea

FRONT SPRING SHACKLE FRAME BRACKET

Back of front spring..... 2804 Working on a replacement for this item, check website, not quite finished in time for print.



FRONT SPRING U BOLT, STOCK..... 2875.....\$8.50 ea

U-BOLT UPPER PLATE, FRONT

- Stock axle..... 2808 \$10.00 ea

THIS PAGE IS STOCK EYE, STOCK ARCH SPRINGS

STOCK SPRING MAIN LEAF ONLY, (MLO) STOCK EYE

- Front, 1953-56..... 2857-K \$135.00 ea
- Separate leaves order by length..... \$15.00 to ..\$80.00 ea.

Stock Arch Springs will likely RAISE your truck from where it sets after all these years.

STOCK FRONT SPRING ASSEMBLY

Stock eyes, stock arch, these are stock high-flying springs, check measurements on page 142, be sure this is what you want, if you want any lower see previous pages. We have improved the ends for quieter ride even on this Stock style. *Stock springs are *special order, and not returnable.

- Assembly 2858-K \$250.00 ea

STOCK FRONT SPRING, FORWARD CENTER

Centers wheel in wheel well, maintains STOCK height.

- Moves axle forward 1.25" 2859-K \$260.00 ea

All our springs have tapered, not cut, ends. Tapered ends offer the smoothest ride, moving friction away from end of spring. And they include POLY buttons at tips.

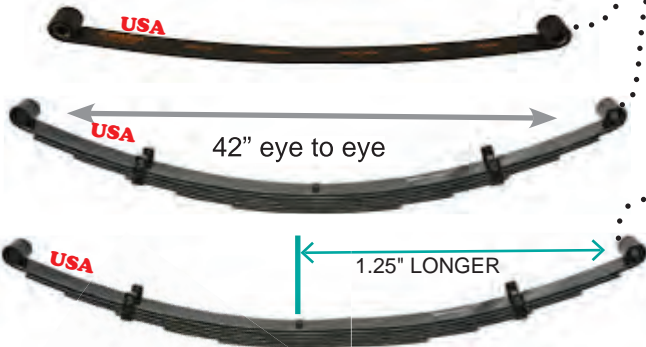

FRONT SPRING SHIM

Fat part to rear, see also center bolt above.

- 2 degree, stock on most trucks..... 2839-2 \$10.50 ea
- 4 degree, needed most trucks 2839-4 \$10.50 ea

CENTER BOLT W/ LONGER HEAD 2835-F58.....\$4.25 ea

All our front springs come with these longer headed bolts, most trucks need shims so also need longer headed center bolt.

CENTER BOLTS, Standard head

- Front for stock spring..... 2836-F..... \$3.50 ea
- Front for Mono spring 2836-MF \$2.50 ea



STOCK FRONT SPRING

1-800-252-1956
Direct 928-565-2763

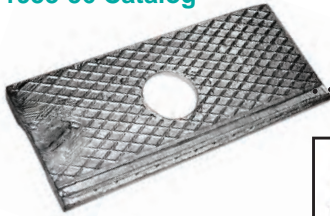

••• FRONT SPRING SHIM

Fat part to rear, see also center bolt above.

- 2 degree, stock on most trucks.....2839-2.....\$10.50 ea
- 4 degree, needed most trucks.....2839-4.....\$10.50 ea



••• FRONT SPRING CLAMPS

- Set of 3, does one spring.....2837-F.....\$8.50 set



••• SPRING BUMPERS

Get rid of the stock bumper unless you are going exact of original, causes problems with any lowered spring. If using, see new one below.

- FRONT ACORN BUMPER2813\$8.25 ea
- POLY BUMPER, nice replacement ...2817\$8.00 ea



••• BUSHING REMOVAL TOOL

Makes removal much easier

- Front2801-F.....\$11.00 ea
- Rear.....2801-R\$11.00 ea

- PIN REMOVAL TOOL *For rear pin*2801-P.....\$4.00 ea

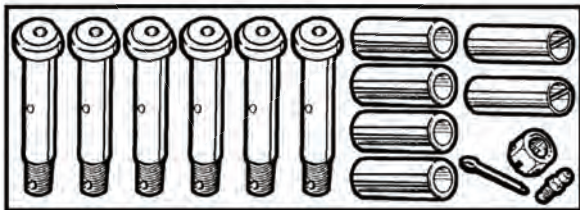

••• SPRING PIN & BUSHING KIT

Do not order this kit with our springs as all our complete springs and spring main leaves have eye bushings installed. Kit includes, 6 pins, 4 eye & 2 shackle bushings & hardware. If using any of our springs order kit below

- Kit2826\$47.50 kit



••• FRONT SPRING PIN & SHACKLE BUSHING KIT

Use this kit with all our springs2895\$44.50 kit Includes 6 pins, 2 shackle bushings & hardware, both sides.



••• INDIVIDUAL PIECES

- FRONT PIN COTTERS & ZERKS ...82824\$2.50 kit



- FRONT SPRING PIN.....2821\$6.75 ea



- FRONT SPRING EYE BUSHING2822\$6.00 ea

*is installed in all our springs and main leaves
DO NOT ORDER if using OUR springs, is included*



- FRONT SPRING PERCH BUSHING, Thinner, goes in the Perch or Hanger on frame.....2823\$6.75 ea

Items on this page deal with STOCK ORIGINAL springs, for lowered springs, improved ride, front end centering springs or any other modifications, check previous pages.
F-250 pins & bushings call or see website

REAR SPRING MOUNTING & LOWERING

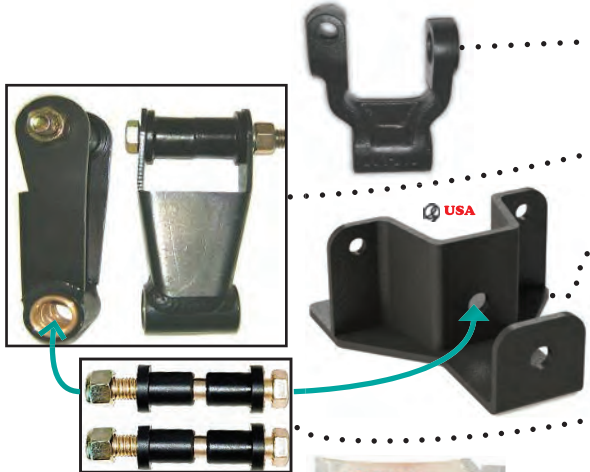

• REAR "Y" HANGER..... 2812 \$39.99 ea
Includes shackle bushing. We suggest extended Y-hangers
Today's castings are not as nice as originals.

• EXTENDED "Y" HANGERS 2802 \$95.00 pr
Extended 2 inches, remove Eye bushing from springs,
Bushings included replace spring eye bushing.

• REAR LEAF SPRING HANGER
Original cast hanger no longer available so Sy designed this
one, comes with bushings and hardware. Powder coated black
REAR OF REAR, not adjustable..... 2811-A..... \$45.00 ea

• BUSHING & BOLTS that fit INSIDE existing eye bushing
4 bushings & 2 bolts, to use extended Y hanger and Rear
spring Hanger. 82803-B75K \$17.50 kit
Use 1 pr. in Y hanger, 1 pr. in each spring eye, 3 pr. total needed.

• POLY BUSHING GREASE, 1 tube goes long way.
Always use with poly busings 82802 \$1.95 ea



• ADJUSTABLE HANGER FRONT OF REAR,
Sy's adjustable hangers, stock to lower, Can raise truck 1" or
Lower it 3 1/4" and anywhere in-between. Poly Bushing
• PAIR OF HANGERS with bushings.. 2810-A..... \$95.00 pr
F-250 Front of rear, adjustable F2-2810-A \$110.00 pr



ALL PARTS MADE IN USA, ADJUSTABLE LOWERING

• COMPLETE REAR HANGERS KIT, Adjustable front
hangers, extended Y hangers, Rear hangers, 6 Bolts,
12 Bushings that fit *Inside* stock eye bushings
& Lube. Easy install, Adjustable lowering.
SAVE, KIT DISCOUNTED OVER 50.00.
Adjustable lowering kit..... 92802..... \$249.95 kit

U-BOLTS are included in many Kits on various pages.

See Stock and Conversion Spring or Axle pages as kits contain correct sizes and styles *plus kits are cheaper.*

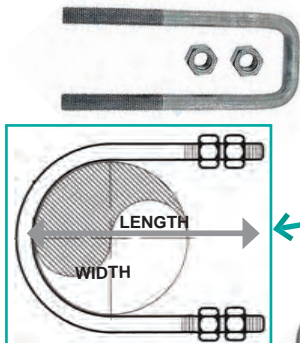

U-BOLTS, SQUARE, OVER SPRING STYLE

U-Bolt, 2" Mono spring x 3.5" leg..... 2870-M..... \$15.00 ea
U-Bolt, 2" spring x 7" leg..... 2870..... \$9.95 ea
Use for 1942-56 Rear Stock Springs or Short & Smooth

U BOLT MEASURING, ROUND, Inside Width is Axle Diameter, Stock 1948-56
Axle is 2.5" diameter. Most Ford 9" and other later models are 3" (many Ford outer
 housings vary from 2.87 to 3.15 in diameter, for U-bolts, spring perches, etc. (most
 common 3" axle tubes.) Length is inside height, see drawing, Thread is 1/2-20

U BOLTS, ROUND, REAR CONVERSIONS, INSTALL OVER AXLE

2.5" STOCK AXLE HOUSING, 8" length..... 2872..... \$9.82 ea
3" WIDE AXLE HOUSING, 6" length 2873..... \$8.50 ea
8" length 2873-08..... \$8.85 ea
10" length 2873-10..... \$8.95 ea

NUTS, rear U-bolts are 1/2" and we prefer using a double nut on each leg.
Correct nuts are included on our U-bolts but here are the sets if needed.

• DOUBLE NUT Set, 16 82870-50..... \$6.25 set
• HIGH NUT Half inch set of 8 82875-50..... \$5.85 set

U-BOLT TO SPRING PLATES

• U-BOLT TIE PLATE, for rear 3" axle..... 2885..... \$10.00 ea
• U-BOLT TIE PLATE, for rear 2.5" axle 2885-25..... \$12.00 ea
• U-bolt tie plate, upper, does front or rear..... 2808..... \$10.00 ea





LEAF SPRING BUMPERS

- POLY BUMPER, nice replacement2817 \$8.00 ea
- REAR ROUND BUMPER2818 \$9.75 ea
Original 53-54, use with 55-56 by drilling hole in frame.
- Bolts for bumper.....82818\$1.65 pr
- Bolts for bumper if using C section.....82818-CS\$2.85 pr



REAR SPRING CLAMPS

- Replacements, does one spring2838-R..... \$8.50 set
You will need 2 sets for 2 springs, some like to add extra clamps but originally only 3 were used.

SPRING PIN & BUSHING KITS

- **WITH EYE BUSHINGS**2834\$59.95 kit
6 Pins, 4 eye & 2 shackle bushings, 6 locking pins and hardware. Do not order this kit with our springs or main leaves as they all have the eye bushings installed.
- **WITHOUT EYE BUSHINGS**2896\$55.95 kit
Use this kit with all our springs as eye bushings are installed in all our springs and main leaves.



INDIVIDUAL PIECES

Kits are much cheaper, Eye busings are installed in all our springs and main leaves.

- REAR SPRING PIN2827 \$6.00 ea
- REAR SPRING LOCKING PIN2830 \$1.95 ea
- REAR SPRING EYE BUSHING.....2828\$8.50 ea
Thicker one, installed in all our springs and main leaves.
- REAR SPRING SHACKLE BUSHING, *Thinner one, Goes in "Y" hanger*2829 \$6.00 ea
- REAR SPRING ZERKS.....82826 \$2.50 set
- BUSHING REMOVAL TOOL *Makes removal much easier*
Bushing removal tool, front.....2801-F \$11.00 ea
Bushing removal tool, rear.....2801-R..... \$11.00 ea
- PIN REMOVAL TOOL, *what was Ford thinking, a tiny hole in the frame to drive out spring pin. After couple destroyed screwdrivers, we came up with this handy piece. For rear spring to hanger pin, 12" long*2801-P \$4.00 ea

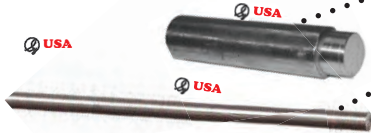
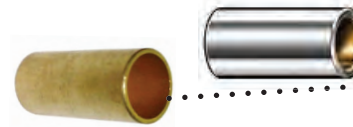

Stock Arch Springs will likely RAISE your truck from where it sets after all these years.

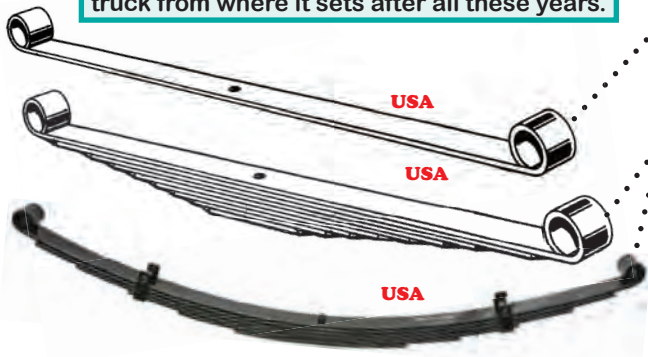

REAR SPRING MAIN LEAF ONLY

- (MLO) stock eyes, stock arch
53-54 frame, 24" x 24" 2855-K5354 \$145.00 ea
- 55-56 frame, 24" x 28" 2855-K5556 \$145.00 ea

REAR STOCK SPRING ASSEMBLY

- *Stock eyes, stock arch, these are stock-high flying springs, check measurements on page 142, to be sure this is what you want, if you want any lower see lowering section. Stock springs are special order and not returnable. Our springs have tapered ends for better ride and smoother quiet action. Otherwise they are STOCK.*
- 53-54 frame, 24" x 24" 2856-K5354 \$330.00 ea
- 55-56 frame, 24" x 28" 2856-K5556 \$350.00 ea

SEPARATE LEAVES

- Order by length..... \$15.00 to..... \$95.00 ea.



U-BOLT UPPER TIE PLATE

- 2808.....\$10.00 ea
Use with any spring set up, this plate protects spring & aligns u-bolts. Rear plate fits 2 1/2"(stock) and 3" (later model) axles



REAR SPRING CENTER BOLT

- Each 2836-R..... \$2.75 ea
- Spacers for center bolt 2836-SPC\$2.50 pr
If using shims of any kind, spacers lengthen bolt head for proper centering

FRONT SHOCK MOUNTS

2020 Mid Fifty
1953-56 Catalog

1956-66 Original shock mounts are not available, we make replacements & extended mounts, shown on these few pages.

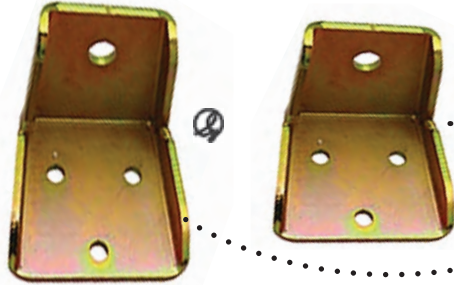

1956 UPPER SHOCK MOUNT.....2402.....\$29.95 ea

Replaces original, uses stock frame holes, can be front or rear

1956 UPPER EXTENDED SHOCK MOUNT, POST SHOCK
Taller by 1 1/2" for better travel, use 2 of the original holes or reposition for best shock length and angle

Fits right or left front.....2402-T\$32.50 ea

USA

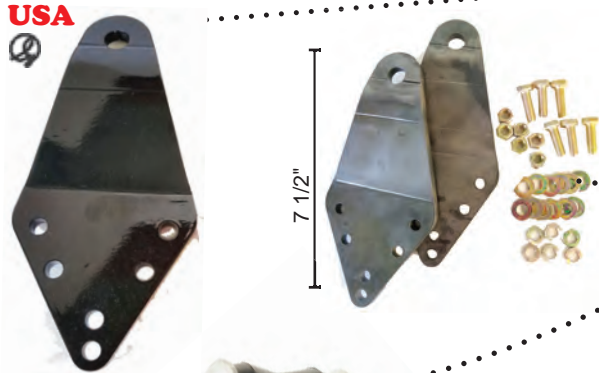

UPPER EXTENDED SHOCK MOUNT, FOR EYE SHOCKS

See note at bottom of page, also check out complete kit below. On some 53-55 trucks this will hit inner fender, if so use 2402-T.

New style fits all years.

Plain steel2408..... \$39.95 pr

Powder Coated.....2408-PC \$56.50 pr

SHOCK MOUNT TO FRAME MOUNTING BOLTS

Does 2 mounts82402.....\$6.50 set

SHOCK STUDS

Goes in new or original upper mounts.

With bushings, replacement2403.....\$9.50 ea

Without bushings2403-NO\$7.50 ea

SHOCK BUSHINGS

Eye bushings, does 1 end of 1 shock..2405-E \$2.75 pr

Post bushings, 1 post.....2405-P \$5.65 pr



USA

USA



1956 FRONT LOWER SHOCK MOUNT

Stock style, uses post shock

Passenger side.....2407-R.....\$19.50 ea

Driver side2407-L\$19.50 ea

Pair Powder Coated Black.....2407-PC \$59.95 pr

FRONT LOWER EXTENDED SHOCK MOUNT

Goes beneath front axle just like original, but, lowers mounting point. Works for 53-55 and 56, changes 56 style to eye type shock. Eliminates stock cast piece on 53-55

Pair2409..... \$49.95 pr

Pair Powder Coated Black.....2409-PC \$59.95 pr



USA

LONGER SHOCK MOUNTING KIT

Includes 2 upper and 2 lower extended shock mounts, shock studs, and hardware. See notes below. Kit does both sides.

Plain Steel Kit92408-5356 .. \$112.50 kit

Powder Coated Black it92408-PC\$134.50 kit



USA

SHOCKS 180 Psi nitrogen gas cylinder. Order by shock travel length, the shock should be somewhere in-between being full compressed and fully extended when on truck, that way it has room to move up and down when on the road. Post ends are available if needed, see web or call.

Min 9" - Max 13.5"2440-EE.....\$41.50 ea

Min 10" - Max 15.5"2441-EE.....\$41.50 ea

Min 11.75" - Max 18.5".....2442-EE.....\$41.50 ea

Min 12.75" - Max 20.5"2443-EE.....\$41.50 ea



Problem is, when an F-100 is lowered, especially the front of a 1956, there is not enough room for any shock travel and even fewer decent shocks to choose from. The solution for lowered trucks is to convert post-post shock to an eye-eye shock and lengthen mounting locations. We have a couple ways to help. Upper mount (2408) is taller and uses a shock stud. Lower mount (2409) is dropped, this means you will have more travel distance with a longer shock, longer shock equals better ride. Sy.





Stock 1953-55 rear shocks used stud, shock had eye, stock 1956 used mount #2402, shock had post.

UPPER SHOCK MOUNT

- Stock height, can be front or rear2402.....\$29.95 ea
- Attaching bolts, does both82402.....\$6.50 set

SHOCK STUDS

- Replacement2403.....\$9.50 ea
 - Reproduction of original '53-55.....2404.....\$18.50 ea
- Presses into casting, rethink this, hard to install.*

SHOCK EYE BUSHINGS

- Eye bushings, does 1 end of 1 shock...2405-E \$2.75 pr

REAR SHOCK Crossmember ASSEMBLY

- Crossmember fits 1953-55 and 1956
- With shock brackets2401.....\$85.00 kit
- Crossmember only2400.....\$32.50 ea
- Crossmember to frame bolts82400.....\$6.00 set

SHOCKSSee previous page

REAR AXLE CONVERSION SHOCK MOUNTS

Use shock studs above with these mounts kits see page 184

Shock mount for axle below springs

- Stock location, shocks mounted at the slightest angle and as far apart as possible give the best performance.
- Welds to 3" axle housing2888.....\$24.50 ea
- For 2.5" axle housing.....2888-2\$26.00 ea
- Shock mount for axle above springs
- 3 " axle, Driver...2889-L Passenger...2889-R\$26.50 ea
- 2.5 " axle, Driver...2889-2L Passenger...2889-2R ...\$26.50 ea

Axle info, call or see web for more info, two qualities, plus stretched stock axle available.

DROPPED AXLES & KING PINS



• **3" DROPPED FRONT AXLE** *Lowers front end 3" from stock. Use with Sy's down & forward springs to center front wheel in wheel well & improve handling. Use stock spindles and king-pins. Tie rod must be dropped. Oversize shipping. See web or call for more info*

- TUBULAR DROP AXLE 3" USA.....2890.....\$495.00 ea
- LIGHT DUTY DROP AXLE, 3" Import2890-53LD\$389.95 ea
- STRETCHED STOCK DROPPED AXLE, 3" drop, need your old axle or core.....2890-5356K3 ..\$550.00 ea

FRONT LEAF SPRING U-BOLT PLATES

- Tubular axles are wider (thicker) than stock I-beam axles so tie plates need to be longer to make U-bolts straight.
- For drop axle2808.....\$10.00 ea

SWAY BAR MOUNTING BRACKET2845.....\$24.00 pr

Use with our sway bars on page 143, for dropped axles

KING PIN SET *King pin pieces not available separately so do not force! Bearing on bottom, Bushings go in spindle, no bushings in axle.*

- Stock (.859)2841.....\$69.95 set
- KING PIN REPLACEMENT BUSHING2842-B\$7.50 ea
- Lubrication hole does not line up but bushing is correct size.

AXLE LOCKING PIN *Included above*2843.....\$3.50 ea

AXLE REAMING TOOL.....82841-T\$145.00 ea

- SPINDLE GREASE FITTINGS82841.....\$7.90 set
- 4 Angled fittings, note with disc brakes the top one may need moved. These do not come with the king pin kit.

STEERING BUMP STOPS for Dropped Axles

- Bolt style for stock location.....2844-5356A.....\$20.00 pr
- Bump stop Pitman arm style.....2844-4864A.....\$48.00 kit

DROP KIT For TIE ROD ENDS Drop kit for stock tie rod ends, Billet machined steel.....2718.....\$48.50 pr

DROPPED TIE ROD ENDS2719-DP.....\$70.00 pr

- Matching tie rod2714-DRP.....\$55.00 ea
- Complete kit.....92719\$126.50 kit



STOCK STEERING

2020 Mid Fifty
1953-56 Catalog

arm has stock bend

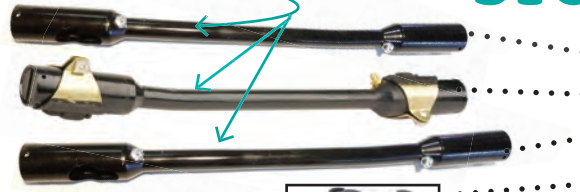

Longest end goes to spindle arm ball, grease fittings point down, arm has slight bend

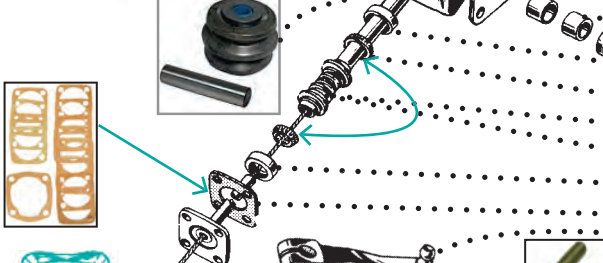
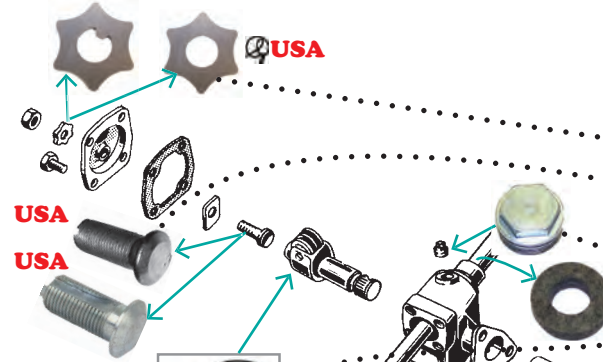
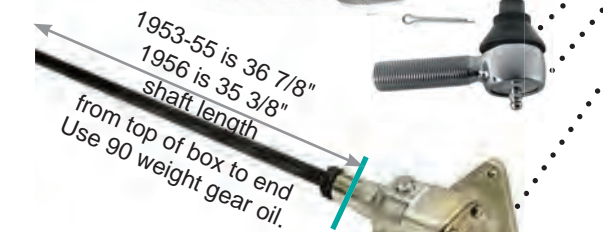
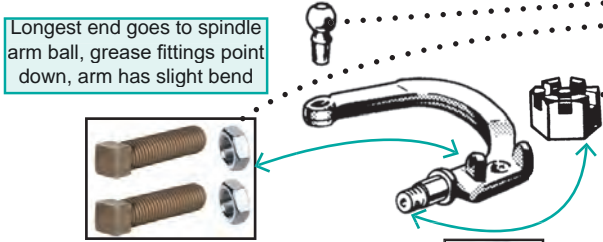

DRAG LINK TUBE

- STOCK length tube only 2707\$70.00 ea
- STOCK With Installed end kits 2707-ASSEM\$75.50 ea
- Extended drag link tube 2707-EXT\$115.00 ea
Use with down and forward springs see page #
- Drag link internal end kit 2708\$15.00 kit
Each kit does one end. Cotters and grease fittings not included
- Drag link zerks and cotters 82708\$3.50 kit
- Drag link dust seal, use 2 2708-A\$7.50 ea

STEERING SPINDLE & ARM

- Ball stud 2709\$28.00 ea
- Stop bolt and taps, set of 2 2844\$4.00 pr
- Spindle arm nut 2710\$10.95 ea
- Steering arm Used only available.

TIE ROD

- We only sell heavy duty due to wider tires, etc*
- Custom heavy duty tie rod, 47.25" 2714\$49.00 ea
 - Jam nut, left 2713-L\$2.50 ea
 - Jam nut, right 2713-R\$2.50 ea
 - Tie rod end, left 2711-L\$14.95 ea
 - Tie rod end, right 2711-R\$14.95 ea
 - Tie rod dust seal, included above 2715 **SALE**\$1.25
 - Tie rod ends, chrome.....Left 2712-CL
Right 2712-CR\$21.95 ea
 - Dropped tie rod ends 2714-DRP\$69.80 ea

REBUILT STOCK STEERING BOX

- Our boxes have all new parts and are guaranteed*
- Core charge, need sector gear asm. . CORE\$100.00 ea
 - 1953-55 2736-5355\$450.00 ea
 - 1956 2736-56\$450.00 ea

STEERING BOX REBUILD KIT COMPLETE

- Includes worm gear and shaft, bearings, races, sector roller gear, sector bushing, sector seal, adjusting screw, lock nut, complete gasket set & instructions.*
- 1953-55 92734-5355\$289.95 kit
 - 1956 92734-56\$319.95 kit

BOX MOUNTING BOLTS, Polished.. 82736\$6.00 set

STEERING BOX BUSHING & BEARINGS

- With sector roller rebuild gear and instructions*
- (No worm gear & shaft) 2741-SE\$195.00 kit
 - Bushing & bearing kit only 2741\$64.50 kit

STOCK STEERING BOX REBUILD PIECES

- Instructions No charge
- Plate bolt kit 82746-PS\$5.00 set
- Adjustment bolt washer, with keyway .. 2751-SWK\$4.75 ea
• No keyway 2751-SWN\$4.25 ea
- Adjustment thrust bolt, no keyway 2753\$8.00 ea
No keyway is best as it does not tend to leak like with keyway.
- Adjustment bolt With keyway 2753-N\$9.50 ea
- Filler plug, new repo 2754\$14.00 ea
- Felt dust seal 2744\$1.90 ea
- Sector rebuild roller gear 2743\$129.00 set
Includes instructions, new repo
- Sector inner bushing, use 2 2748\$5.95 ea
- Sector oil seal 2749\$5.00 ea
- Upper race 2752\$10.00 ea
- Roller cage bearing, use 2 2747 **SALE**\$6.95
- Worm gear & shaft, 1953-55 2740-5355\$195.00 ea
- Worm gear & shaft, 1956 2740-56\$225.00 ea
- Lower race 2750\$29.99 ea
- Gasket & shim kit 2745\$8.94 kit
- Pitman arm 2706\$97.00 ea
- Pitman arm bolt & nut 82706\$3.85 ea





STEERING WHEEL

Cancel clip is installed on these wheels, beautiful reproduction.
*Note some wheels out there have defective large horn openings, careful when looking at "cheap" wheel.

1953-55	2700-5355	\$195.00 ea
1956 (shown)	2700-56	\$195.00 ea

New horn buttons & related parts see page 34

STEERING WHEEL PARTS

Steering wheel nut	2757	\$0.75 ea
Upper shaft spring	2758	\$3.50 ea
Top bearing retainer sleeve	2756	\$13.50 ea
Top centering bearing	2755	\$10.50 ea

COLUMN SUPPORT

Support plate, chrome, \$25 core	2722-CH	\$55.00 ea
Support plate insulator	2725	\$2.95 ea
Support brackets, chrome, \$25 core	2723-CH	\$45.00 set
Support bracket bolts, polished	82723-PS	\$6.50 pr
Column support to dash bolts	82722	\$2.75 pr

STEERING COLUMN FLOOR SEALS

Column shift, brake & clutch	2728-CS	\$7.50 set
Floor shift, brake & clutch	2728-FL	\$7.50 set
Automatic, brake seal	2729	\$5.00 set
Brake arm seal only	2729-BRK	\$3.60 ea

custom floor plates for steering conversions, see page 174

FLOOR PLATES

Complete kit, 4 plates, full insulator and polished bolts. See page 160 for complete list		
• Stock Kit	94668-5356	\$72.50 set
Floor plate screw set	84667	\$2.00 ea
Plate bolt kit, with polished acorns	84668	\$8.95 kit
• Full plate insulator	2727	\$7.50 ea

AUTOMATIC INDICATOR Not available, get on waiting list.

NEUTRAL LOCK OUT SWITCH WIRING

For use with starter button 1953-55	3275-5355	\$28.50 ea
---	-----------------	------------

GEAR SHIFT KNOB

• Spear style for column shift	1006-S	\$6.60 ea
• Ball style for floor shift	1006-B	\$6.00 ea

• SHIFT TUBE SPRING	2765-4055	\$2.75 ea
---------------------------	-----------------	-----------

SHIFT HANDLE RUBBER INSULATOR

3 Speed trans	2761	\$6.25 ea
Automatic	2761-A	\$7.95 ea

SHIFT HANDLE REPAIR KIT

1948-55	2764-4855	\$24.50 kit
1956	2764-56	\$1.00 ea
• Shift Handle Pin	2764-56	\$1.00 ea
• Shift Handle Spring	2767-4055	\$1.25 ea
• Shift Handle Spring cap	2766-4055	\$5.95 ea

SHIFT ARM LEVER, AT COLUMN

• Low & Reverse, long-straight	2776-1R	\$25.95 ea
• Second & Third, short-curved	2776-23	\$25.95 ea

SHIFT LINKAGE REPAIR

• 1 Grommet with rivet	2773-G	\$4.95 ea
• Set of 4 grommets with tool	2772	\$27.00 set
• Tool only	2773-TL	\$8.50 ea

• Shift Arm at Trans First & Reverse	2778-1R	\$16.50 ea
• Shift Arm at Trans, Second & Third	2778-23	\$16.50 ea
• Shift Arm Clip, set of 4	2767	\$3.85 set

Shift arm, cup, etc. not available, but have stock of good used pieces. Call for prices and availability

STEERING JOINTS

SAFETY: Steering should be designed so that the column should collapse or be deflected away from the driver upon impact. Mustang II front ends are easy to design with a collapsible shaft, most other truck setups are a little tight. Never, use any shaft less than 3/4"

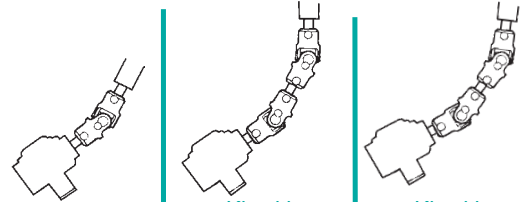
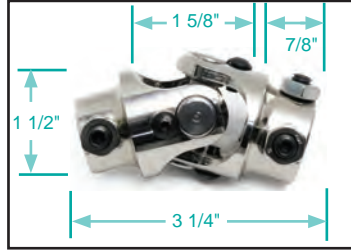

STEERING BOX

Steering Column

	Stock column (welds to shaft)	One u-joint. \$79.00 ea	Kit with 2 u-joints & spacer shaft \$165.00 kit	Kit with vibration reducer \$250.00 kit
Toyota box, 1979-89 11/16" with 36 Splines	Stock column (welds to shaft)..... J1116-75R	J1116-75R	J1116-V-75R	J1116-V-75R
	Coupler, use with stock automatic..... JC1116-75R \$24.95 ea		
	GM or IDIDIT aluminum with 48 splines..... J1116-148		J1116-V-148	J1116-V-148
	GM or IDIDIT steel 1"DD 2 flat sides..... J1116-1DD		J1116-V-1DD	J1116-V-1DD
	FORD column small "3/4" 36 spline..... J1116-736		J1116-V-736	J1116-V-736
Volare box, Corvair, Vega 5/8" With 36 Splines GM rack 79 & later	Stock column (welds to shaft)..... J636-75R	J636-75R	J636-V-75R	J636-V-75R
	GM or IDIDIT aluminum with 48 splines..... J636-148	J636-148	J636-V-148	J636-V-148
	GM or IDIDIT with 1"DD 2 flat sides..... J636-1DD	J636-1DD	J636-V-1DD	J636-V-1DD
	FORD column small "3/4" 36 spline..... J636-736	J636-736	J636-V-736	J636-V-736
GM 800 box, Pre-1977 13/16" with 36 Splines	Stock column (welds to shaft)..... J836-75R	J836-75R	J836-V-75R	J836-V-75R
	GM or IDIDIT aluminum with 48 splines..... J836-148	J836-148	J836-V-148	J836-V-148
	GM or IDIDIT with 1"DD 2 flat sides..... J836-1DD	J836-1DD	J836-V-1DD	J836-V-1DD
	FORD column small "3/4" 36 spline..... J836-736	J836-736	J836-V-736	J836-V-736
GM 800 box, 1978 & later 605 box 1978-1984 Corvette 63-67	Stock column (welds to shaft)..... J730-75R	J730-75R	J730-V-148	J730-V-148
	GM or IDIDIT aluminum with 48 splines..... J730-148	J730-148	J730-V-1DD	J730-V-1DD
	GM or IDIDIT with 1"DD 2 flat sides..... J730-1DD	J730-1DD	J730-V-736	J730-V-736
	FORD column small "3/4" 36 spline..... J730-736	J730-736		
Mustang rack 9/16" with 26 splines	Stock column (welds to shaft)..... J75R-962	J75R-962	Use collapsible shaft when possible	
	GM or IDIDIT aluminum with 48 splines..... J148-9626	J148-9626	Use collapsible shaft when possible	
	GM or IDIDIT with 1"DD 2 flat sides..... J1DD-9626	J1DD-9626	Use collapsible shaft when possible	
	FORD column small "3/4" 36 spline..... J736-9626	J736-9626	Use collapsible shaft when possible	

With collapsible shaft

With plain shaft

Mustang Power, Ford, all 3/4" with 36 splines

Stock column.....	J736-CP-75R	J736-P-75R
GM or IDIDIT aluminum with splines.....	J736-CP-148	J736-P-148
GM or IDIDIT with 1"DD 2 flat sides.....	J736-CP-1DD	J736-P-1DD
FORD column small spline.....	J736-CP-736	J736-P-73

Mustang IFS steering uses long shaft, great opportunity for safety, use collapsible shaft

COLLAPSIBLE SHAFT, 39.5-42.75 3/4"DD x 1"DD.....	4645	\$179.50 ea
STEERING SHAFT SUPPORT BEARING, HEIM JOINT.....	4649	SALE \$14.50
DOUBLE SWIVEL JOINTS, all sizes available, order by ends.....		\$169.00 ea

RAG JOINTS

use when angle U-Joint not needed, and 400 steering box on next page

Rag joint, 3/4" 30 spline X 1" DD.....	JR730-1DD	\$79.00 ea
Rag joint, 3/4" 30 spline X 3/4" 36 splines.....	JR730-736	\$79.00 ea
Rag joint, 3/4" 30 spline X 3/4" DD.....	JR736-7DD	\$79.00 ea
Rag joint, 3/4" 30 spline X 3/4" Round.....	JR730-75R	\$88.50 ea

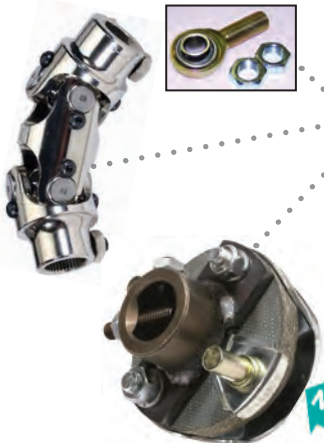

NEW

U-JOINTS below are stocked but not listed above \$79.00 ea

3/4" round & 3/4" round.....	J75R-75R	3/4" 36 splines & 3/4" round.....	J736-75R
3/4" round & 3/4" double D.....	J75R-7DD	5/8" 36 spline & 3/4" double D.....	J636-7DD
3/4" round & 1" double D.....	J75R-1DD	13/16"-36 splines & 3/4" double D...	J836-7DD
3/4" round & 1" 48 splines.....	J75R-148	1" double D & 1" double D.....	J1DD-1DD
3/4" double D & 3/4" double D.....	J7DD-7DD	1" double D & 3/4" double D.....	J1DD-7DD
3/4" double D & 1" 48 splines.....	J7DD-148	1" double D & 1" 48 splines.....	J1DD-148
3/4" double D & 9/16" 26 splines..	J7DD-9626	Mustang manual box.....	J1DD-9626
3/4" double D & Mustang V.....	J7DD-V7	Set screw goes in joint.....	J100.....\$1.00 ea
3/4" double D & 3/4" 30 splines.....	J730-7DD	Allen holding screw.....	J101.....\$1.00 ea
3/4" 36 splines & 1" double D.....	J736-1DD	Vibration reducer, needs 2 1/2".....	\$169.00
3/4" 36 splines & 1" 148 splines.....	J736-148	COUPLERS.....	\$25.00 to \$40.00
3/4" 36 splines & 3/4 double D.....	J736-7DD	11/16-36 spline x 3/4" round.....	JC1116-75R
3/4" 36 splines & 3/4" 36 splines.....	J736-736		

SHAFTS, double nickel plated

3/4" DD x 3" steel ..	4641-7DD3.....	\$6.85
\$6.85 ea	3/4" DD x 6" steel.....	4641-7DD6
\$15.00	Nickel.....	4640-6.....\$13.50
	3/4" DD x 18" steel..	4641-7DD18.....\$39.00
	Nickel.....	4640-18.....\$39.00
	3/4" x 36" Nickel....	4640.....\$59.00
	3/4" round x 6".....	4642-7R6.....\$10.00
	3/4" round x 16".....	4642-7R16.....\$20.00
	1DD x 7" hollow.....	4642-1DD6.....\$55.00



Bleeding power steering, yes, it does need done. Power steering systems are "self-bleeding" but we are installing new components. With truck off, fill reservoir and let sit for a bit, raise the front end and turn wheels back and forth slowly (engine is still OFF) allow the box to draw fluid, keep adding fluid to reservoir, keeping it full, when level stops dropping, start truck and continue to turn wheels until fluid stays full. Put cardboard, upside down rug, etc under front tires, will let tires slide on concrete floor, saves tires, floor and your back. New steering having trouble? If the problem is on one side or one direction, check box or rack or pitman arm areas. If problem is on both sides or directions, it is probably the pump, the fluid or hoses, do the bleeding procedure above.

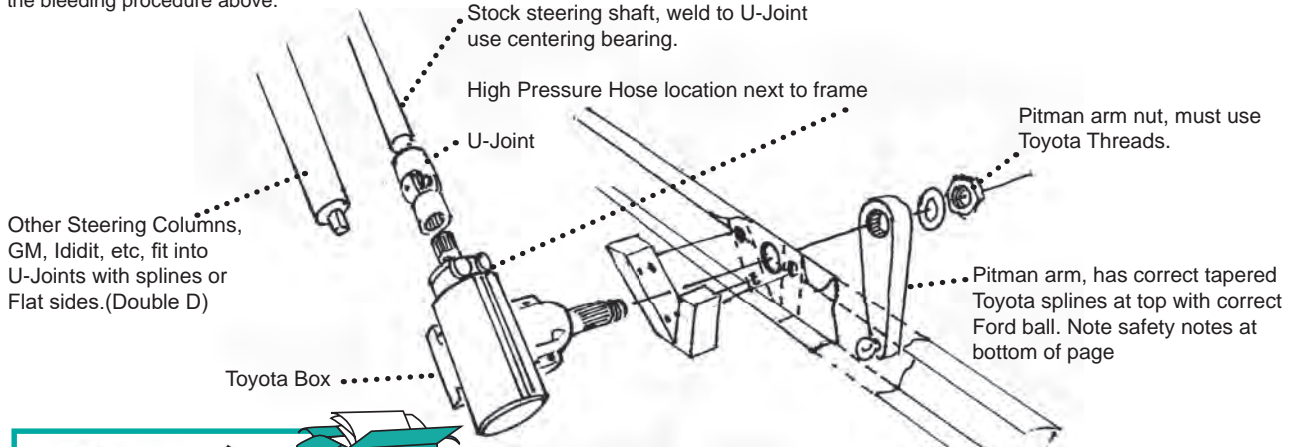

TOYOTA CONVERSION

TOYOTA STEERING CONVERSION KITS

Bracket, pitman arm, sector nut, centering bearing & hardware.

- Stock column, with u-joint 94620 \$265.00 kit
- Stock column, with coupler 94620-JC \$220.00 kit
- Another steering column, call first 94621 \$255.00 kit

TOYOTA TO FORD PITMAN ARM 4623 \$79.00 ea

Hardened & installed drag link ball and Toyota splines.

BOX MOUNTING BRACKET 4620-CJ \$95.00 ea

Bolt in, lines the box up perfectly for stock or custom column, Open hole in frame 1/4" toward front

BOLT KIT Box to bracket, bracket to frame..... 84620 \$10.00 kit

HOSE KIT 4628 \$100.00 kit

USED TOYOTA BOX as available..... 4621-U \$325.00 ea

REBUILT TOYOTA BOX 4621-RB..... \$585.00 ea

Used box is not tested but if something is wrong we will replace it. Use a box from a 1980-84 and some 1985-87 Toyota 4X4 Pick-up.

TOYOTA SECTOR SHAFT NUT 4624 \$8.00 ea

SHAFT WASHER 4624-W \$2.75 ea

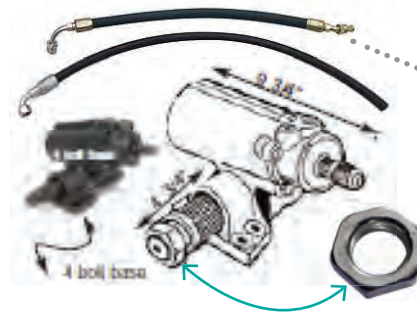

400 SERIES POWER STEERING

Best buy, easy install, all new parts

Compact design closely modeled after original manual steering box. A 13.6:1 ratio (2.75 turns lock to lock) gives performance & handling of rack and pinion conversion without need for extensive modifications. Cheaper than our old Toyota conversion with used box, and is all NEW

• COMPLETE KIT 4614-5356..... \$535.00 ea

• BOX ONLY..... 4613-5356..... \$379.00 ea

• HOSE KIT 4628 \$100.00 kit

• RAG JOINT FOR COLUMN TO BOX

CPP, IDIDIT, FLAMING RIVER, most GM....JR730-1DD ... \$79.00 ea

Stock column shaft..... JR730-75R..... \$88.50 ea

other Rag Joints or U-joints see previous page



COLUMN CENTERING DELRON BUSHING & SLEEVE
Use at bottom of column..... 4625.....\$22.50 kit

HORN ADAPTING KIT, to use original horn button & column with Toyota or 400 Series conversions

..... 4629.....\$150.00 kit



POWER RAM ASSIST STEERING

This system is great for the purist. It bolts to the existing steering system and clears all of the factory components. This will allow the use of the factory steering columns and allow for a stock look without having to suffer with manual steering. Kit includes power cylinder, drag link, heavy duty tie rod, new style tie rod ends, control valve assembly, hoses and all necessary mounting hardware, everything but pump. Includes modified pitman arm but we need the old ones to modify for the next guy so must charge core to get them back.

Power ram assist steering kit.....4630 \$899.00 kit

POWER STEERING PARTS



POWER STEERING PUMPS

*You need the pump and reservoir to make a complete pump
Uses Saginaw brackets to mount to engine*

- Saginaw pump & reservoir, black.....4615-B.....\$159.00 ea
- Saginaw pump replacement.....**4532 SALE.....\$89.50**
- Saginaw pump & reservoir, billet, keyway.....4534\$355.00 ea



Pulley not included

Brackets need to match the engine, pumps need to match brackets and pulleys need to match pump AND match belt type

POWER STEERING BRACKETS & PULLEYS

- 289/302/351W Saginaw bracket, black4562-E.....\$89.00 ea
- 289/302/351W Saginaw bracket, billet4562-P.....\$170.00 ea
- Matches the billet pump above*
- Y-Block Saginaw bracket, black.....4342-Y.....\$155.00 ea



- Pulley, 1 groove, keyway, polished alum4513-KA\$57.50 ea
- Pulley, 1 groove, keyway, satin alum4513-KSA.....\$52.50 ea
- Pulley, 1 groove, keyway, black4513-KB\$37.00 ea
- Pulley, 2 groove, keyway, black4513-KB2\$37.00 ea
- Pulley, 2 groove, keyway, chrome4513-KC2\$42.00 ea



OTHER POWER STEERING PARTS

- Power steering flow valve, adjustable4617\$129.00 ea
Loose or tight - Now, with the turn of a knob, you can adjust the "feel" of your power steering. Pressure port: 1/4 npt; Return port: 3/8 npt.
- Power steering hose in-line filter4618\$27.00 ea
- Hose kit4628\$16.00 ea



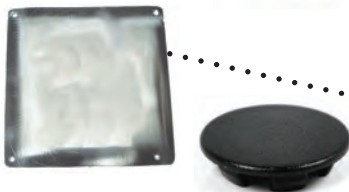

Beautiful column with 5 position tilt, self-canceling turn signals, 4 way flashes, horn, standard GM wiring harness & dress up kit with aluminum knobs and chrome levers. Includes horn and turn signal plugs. Columns accept 1969-up GM steering wheels or most any adapter available. Straight columns (no tilt) are available at 50 bucks less, not shown here. Columns listed do not accept stock steering wheel. To use stock Ford wheel order 4710-(finish)

We suggest a 30" column length with a 4 1/2" drop. However, all lengths are available, just add length to part number. NOTE: Retro columns are same as these, just more expensive. we only stock 30" columns as that is what fits best.

Tilt column style & finish	30" tilt, no shift	30" tilt, with shift
Steel, ready to paint	IN-ST-30 \$385.00	IS-ST-30 ... \$565.00
Chrome, show quality	IN-CH-30 ... \$519.00	IS-CH-30... \$775.00
Satin brushed aluminum	IN-AL-30 \$665.00	IS-AL-30 ... \$950.00
Polished aluminum, show	IN-PA-30 \$665.00	IS-PA-30 ... \$950.00
Powder coated black	IN-BK-30..... \$495.00	IS-BK-30 ... \$650.00

ADD ON'S AND UPGRADES

Best to add when column being built, prices include labor charge.

Cruise & switches, use turn signal handle and/or tilt handle so only 2 on tilt column or 1 on straight column

- Cruise control
 - Non computerized engines..... 4703-N \$389.00 kit
 - Computerized engines adjustable 4704-C \$279.00 kit
 - Cruise control polished aluminum cover... 4705-PC \$29.00 ea
- Dimmer switch or wiper, push button, single speed wipers only, on turn signal or tilt handle, call for details
- Neutral safety switch, installed 4702-NS CALL
- Key in column 4706 \$295.00 ea
- Keyless ignition
 - Add to column, touch n' go 4708 \$868.95 ea
 - Dash mount button 4707 \$550.00 ea

HORN RELAY 4633 \$34.50
Needed to go from all GM style column wiring to Ford system wiring. Included with above columns, shown here for DIY or repair.

•SHIFT INDICATOR

Sticks on column, with pointer. Indicators with housings, see website, or call, no room here

- P R N D L2 L1 4631-DLL \$26.50 set
- P R N D 3 2 1 4631-321 \$26.50 set
- P R N D 2 1 (AOD-E 92-up) 4631-D21 \$29.50 ea
- P R N D D 1 (AOD '80-93) 4631-DD1 \$26.50 set
- RIGHT HAND DRIVE, 3 2 1 D N R P 4631-R321 ... \$30.00 set
- RIGHT HAND DRIVE, L L D N R P 4631-RDLL... \$30.00 set

•GM PLUG IN ADAPTER 4632-DK5 \$16.90 kit
*Female end that matches plug in on all IDIDIT & most stock GM columns, makes it a lot easier, comes with connection kit, use with GM 3 7/8" plug, just cut off end** see drawing. Only 8 connections are used with most columns. Included with columns.*

Switch on column?

- use dimmer switch delete plate or plug hole with handy hole plug.
- DIMMER SWITCH DELETE PLATE 2914-FPD \$10.00 ea
 - Dimmer Switch Mounting Screws 82915 \$1.00 set
- DIMMER SWITCH HOLE PLUG 82914 \$2.00 kit

COLUMN OUTSIDE DIAMETERS
No Shift, Steel or Chrome 2"
With Shift, this pg columns are 2 1/4"
All Aluminum & Polished are 2 1/4"

COLUMN SHAFT **END STYLE**
Steel and Chrome Columns 1" Double D
Aluminum & Polished Columns 1" 48 Spline



CPP STEERING COLUMNS

Column drops see next page (both these columns are 2')

Column floor mounts see page 160

U-joints see page 154,

(shaft is 1" DD these columns only)

These columns will accept most any aftermarket GM style wheel and or adapter kit, does not come with neutral safety switch, and one is not available



- Plug connector and hazard warning adapter..... 4739 \$16.00 ea
- Chrome, automatic shift, 30" 4731 \$299.00 ea
- Black, automatic shift, 30" 4735 \$299.00 ea
- Chrome, no shift 30" 4730 \$299.00 ea
- Black, no shift 30" 4734 \$299.00 ea
- Black, no shift 32" 4734-32 \$299.00 ea
- Chrome, no shift 32" 4730-32 \$299.00 ea
- Paintable, automatic shift 30" 4732 \$299.00 ea
- Paintable, no shift 30" 4733 \$299.00 ea
- Lower support.....2" ..4657-A20..... \$121.00 ea



Very nice polished stainless and chrome, well built, similar to IDIDIT and Flaming River columns, some import parts

*Accepts most any 67-94 GM style wheel or adapters.

*Use any 1" Double D joint at bottom.

*Column is 2" in diameter

*We suggest 30", but 32" and 33" are available (ask)

FLAMING RIVER COLUMNS

Very nice column, fits the truck great, short bell gives more cab room. Available with or without chrome lighted shift indicator

We offer this column as the shifter and tilt area is only 8 inches which allows the use of a 30 inch column, with less column sticking out in the cab. Includes Polished stainless shift arm, dress up kit, GM wiring with 4 1/4" connector. Shift indicator is attached, illuminated and has chrome housing. Real nice column. Nice shift indicator.

Flaming river columns are also available with key in column and keyless start and in paintable stainless



- 30" COLUMNS, WITH SHIFT 2" DIAMETER, 1"DD SHAFT
- Polished & Chrome with indicator.....4651-WS \$755.00 ea
- Milled is paint-able.....4651-WSM \$625.00 ea
- 30" COLUMN, NO SHIFT 2" DIAMETER, 1"DD SHAFT
- Polished & Chrome4652-NO \$485.00 ea
- Milled is paint-able.....4652 \$335.00 ea
- ADD DIMMER SWITCH4701-D..... \$108.00 ea

- 30" COLUMN FOR STOCK FORD WHEEL
- Polished.....4650-FWP \$689.95 ea
- Mill Finish, paint-able.....4650-FWM..... \$673.95 ea
- Black Powder coated.....4650-FWB \$673.95 ea

SHIFT LINKAGE KITS

- LOKAR Ford AOD 4695-AOD \$75.00 ea
- Ford C4-C6..... 4690-C4C6..... \$85.00 ea
- Stainless steel. Fully adjustable to match any shifting mechanism and indicator perfectly. Linkage kits are available in short (10" to 17"), long (17" to 23"), fits most transmissions, GM TH-350, 400, 700R, 200R, 4L80E and more. Linkage kit works on all columns shown here and most others.*
- Short 10"-17"4690.....\$59.00 kit
- Long 17"-23"4691..... \$59.00 ea

- SHIFT LINKAGE, CABLE CONTROL
- 2" Column to Ford Trans, C4..... 4692-20..... \$139.50
- 2" Column to Ford Trans, C6..... 4693-20..... \$136.50
- 2" Column to Ford Trans, AOD 4694-20..... \$221.50
- 2" Column to GM Trans, GM 4696-GM20. \$136.50 ea
- 2.25" Column to Ford Trans, C4..... 4692-225..... \$136.50
- 2.25" Column to Ford Trans, C6..... 4693-225..... \$136.50
- 2.25" Column to Ford Trans, AOD.... 4694-225..... \$195.00
- 2.25" Column to GM Trans, GM 4696-GM225..... \$136.95



ALUMINUM COLUMN DROPS

DROPS most trucks need 4.5"
but we carry 3.5" & 5.5" Lengths.
Measure from dash
to center of column.

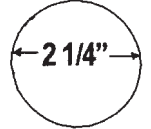
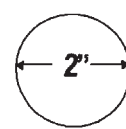

2" columns

2 1/4" columns



Drop comes apart
here for column

Measure from Dash,
to center of column.
4.5 is best for truck

	PRICE	2" columns No Shift	2 1/4" columns With Shift
4.5" DROP, BRUSHED.....	\$83.00	4672-4B	4674-4B
4.5" DROP, POLISHED.....	\$83.00	4672-4P	4674-4P
3.5" DROP, BRUSHED.....	\$83.00	4672-B	4674-B
3.5" DROP, POLISHED.....	\$83.00	4672-P	4674-P
5.5" Available, add 5 to part number.....			

*Van and GM car styles are special order, not many made.

SMOOTH COLUMN DROPS

A more sleek and smooth design, rounded edges, very high polish. Available in 1 3/4" and 2" hole size only. Flaming River. Drop lengths, 2 1/2" & 5 1/2", our trucks usually need 4.5".

- 4.50" Drop, 1.75 hole, polished ss.....4655-4\$102.95 ea
- 4.50" Drop, 2" hole, polished ss.....4656-4\$103.00 ea

STOCK COLUMN, NOSTALGIC LOOK

Fits Stock columns, very nice curved nostalgic design.

Column hole 1.5"

- With shift tube area.....4671-3S.....\$49.95 ea
- With no shift.....4671-3.....\$54.95 ea

GM VAN COLUMN

Welds to column, bolts to dash.....4679-VAN\$36.50 ea

ADJUSTABLE COLUMN DROP

Isn't this the neatest thing! Great for those of us that start with one column and end up with another.

Simply change the inner rings to fit your column. Chrome finish.

- 4.5" drop, most common for truck.....4670-4\$59.95 ea
- 3.5" drop, used in some trucks.....4670-3\$59.95 ea
- 4.5" with 1 accessory hole.....4670-4A1\$99.95 ea
- 4.5" with 3 accessory holes.....4670-4A3\$99.00 ea

CHROME ADJUSTABLE COLUMN FLOOR MOUNT

Can be used both inside on floor and outside in engine compartment. Easy, great for those of us that change out columns during a build

Fits most columns.....4660.....\$49.95 ea

.See also next page for matching floor mount

DASH EXTENSION WITH STEERING COLUMN MOUNTS

Extension includes custom built in column mount, very nice clean look, cheaper too! Extension is steel, note the nice rounded bottom edge that matches rounded bottom of original dash. Angles out from bottom of dash, perfect for all add on controls, AC, etc

For 1.75" column or stock column.....7540-25\$165.00 ea

For 2" column.....7540-2\$165.00 ea

For 2.25 column.....7540-25\$165.00 ea

- With no inner lip & no support ring.....7534.....\$99.00 ea

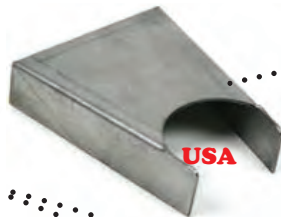

FLOOR MOUNTS

2020 Mid Fifty
1953-56 Catalog



SWIVEL FLOOR MOUNTS *Billet aluminum ball and collar swivel design, beautiful polished finish, no clamps or boots needed*
 INSIDE CAB PIECE
 1 3/4"4658-75 \$119.95 ea
 2"4658-20 \$122.50 ea

USA
USA



***FIREWALL SIDE COLUMN COVER.** Covers screws.
 Fits all Column widths.....4659 \$59.00 ea

***COMPLETE FLOOR MOUNT.** Polished aluminum,
 Order by column size, complete set, inside and outside.
 For steel & Alum., 51mm.....2"4657-A20..... \$121.00 ea
 2.25"4657-A25..... \$123.50 ea
 For chrome or painted, 52 mm...2"4657-20..... \$121.50 ea
 2.25.....4657-25 \$119.00 ea
 Stock original columns use.....4657-A75..... \$119.00 ea

**NEW floor mount
colum supports**

***COMPLETE CHROME 2" nice piece!**4657-CH \$78.50 ea

***FLOOR MOUNT, WITH ALUMINUM TRIM RING**
 1 3/4"4662-17 \$52.95 kit
 2"4662-2 \$51.50 kit
 2.25"4662-24 \$52.50 kit

USA



***BRACKET FLOOR MOUNTS** *out or inside of firewall, tilt & adjustable*
 2" column.....4661-2 \$29.50 ea
 2 1/4" column.....4661-24 \$28.50 ea

***FLOOR MOUNT BOOT,** *Fits this or split & pinned trim below,*
 Black.....4665-BL..... \$19.95 ea
 Charcoal4665-CHR \$18.50 ea
 Grey.....4665-GRY \$22.95 ea

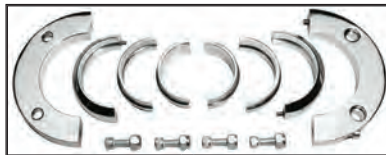

***ALUMINUM SPLIT & PINNED TRIM RINGS**
 Column trim & rubber boot4663 \$39.95 kit
 Brake or clutch trims.....4664 \$19.95 ea

***CHROME ADJUSTABLE COLUMN FLOOR MOUNT**
*Can be used both inside on floor and outside in engine compartment.
 Easy, great for those of us that change out columns during a build
 Fits most columns.....4660 \$49.95 ea*

USA



TWO PIECE COLUMN FLOOR PLATES, new plates have punch out brake and clutch holes. choice of clounn holes. Plates are installed like a sandwich, plates-rubber-plates, then entire assembly installed inside cab. Kits include 2 pr plates, rubber insulator, bolts.

STOCK STYLE, 2 PC4668-5356 \$29.95 pr
 PLATE KIT, 2 Plate sets, Insulator & Bolts.94668-5356 \$72.50 set

USA



***FULL PLATE INSULATOR, RUBBER**2727 \$7.50 ea
Use with all floor plates for good seal, protection from dust & heat.

***TOP COLUMN HOLE**4669-5356T \$29.95 ea
 PLATE KIT, 2 Plate sets, Insulator & Bolts.94669-5356T ... \$72.50 set

USA



***MID COLUMN HOLE**4669-5356M \$29.95 ea
 PLATE KIT, 2 Plate sets, Insulator & Bolts.94669-5356M .. \$72.50 set

USA

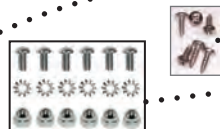

***FLOOR PLATE, NO Column Hole**4668-5356B \$29.95 ea
 PLATE KIT, 2 Plate sets, Insulator & Bolts.94668-5356B... \$72.50 set

***Floor Plate Screw set**.....84667 \$2.00 ea
***Floor Plate bolt kit, with Polished acorns**84668 \$8.95 kit

NEW



***FLOOR PLATE WITH BUILT IN BILLET SWIVEL MOUNT, 2"**
 Knock out Brake and Clutch holes.....4667-2MNT ... \$137.95 ea
FLOOR PLATE BOLTS *Polished & acorns* ...84668 \$8.95 kit



USA
FLOOR MOUNTS

1-800-252-1956
 Direct 928-565-2763



NOTE: Drilled and slotted rotors and black powder coated calipers pictured are extra, see upgrades

Look at all it comes with!

- Cross member
- Coil springs, heavy duty
- Spindles, stock mustang or dropped
- Disc Brakes
- Shocks
- Upper and lower control arms
- Rack & pinion
- Boxing plates
- Sway bar
- Plus mounting hardware

MUSTANG II SUSPENSION KIT

THERE IS A HIGH SHIPPING COST DUE TO BEING PACKAGED IN 9 LARGE, HEAVY BOXES

SEE OPTIONS BELOW4200.....\$1489.00 kit

YOUR CHOICE OF

HEIGHT (How low to go?)

- ___ STOCK HEIGHT, drops truck or 4"
- Is "Mustang stock" lowers truck 4 inches
- ___ DROPPED SPINDLES, lowers truck 6"

WHEEL BOLT PATTERN

- ___ 5 X 4.5"
- ___ 5 x 4.75"
- ___ 5 x 5.5" (stock F-100)

STEERING CHOICE, Rack & Pinion

- ___ Manual
- ___ Power

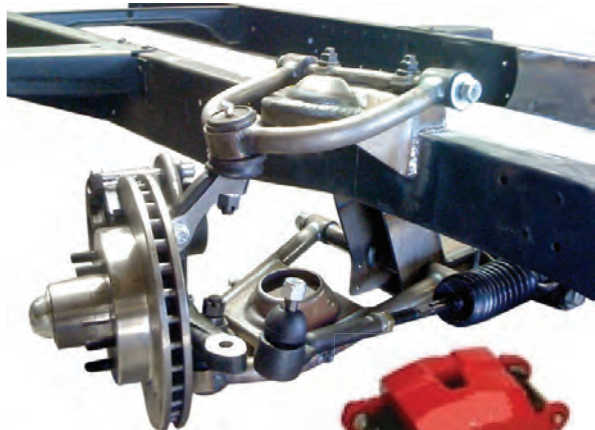

Installation in progress,
courtesy of David Scott Farrell



BRAKE UPGRADES

- Add powder coated calipers ...5989-APC... \$60.00 ea
Black, Red, Blue or Silver
- Add slotted & drilled rotors.....5989-ADR... \$75.00 ea

MOTOR MOUNTS

- Trim to fit.....4462.....\$55.00 kit
- Open Style, GM engines4463-C.....\$79.00 pr
- Ford engines.....4463-F\$79.00 pr



A word about brakes, there are disc kits, power booster kits, kits for IFS, front kits, rear kits, bolt on, weld on and, who knows what on, kits. The kit for your truck depends on what you want, how fancy, how pricey, how easy to install, what wheels, what front end, what rear end, what modifications, who's driving, how often, how far, etc. We are happy to help find just the right combination or an expert in the brake & suspension field for any information or help. Please keep in mind, truck weighs over a ton and half, is top heavy & front heavy. Get as much weight behind front axle as possible. Reconsider sway bars, seat belts & forward springs.



DIY BASIC DISC BRAKE BRACKET KITS

Order by wheel pattern, bolts on to stock or new dropped axle and stock spindle (original hub not needed) includes: caliper brackets, spacers, hardware, instructions all information on usable calipers and rotors.

- 5 On 4 1/2" bolt pattern kit 5986-450 \$149.00 kit
76 to 81 Volare rotors and 70 to 77 Camaro calipers
- 5 on 4 3/4" bolt pattern kit..... 5986-475..... \$149.00 kit
70 to 77 Camaro rotors and 70 to 77 Camaro calipers
- Stock: 5 on 5 1/2" bolt pattern 5986-550..... \$149.00 kit
73-93 Ford F-150 rotors & 71-87 GM calipers



FRONT DISC BRAKE CONVERSION KIT

Bolts choice of wheel pattern disc brakes to truck properly with no modifications. Designed to support calipers with perfect alignment for even pad wear and safe dependable service. Includes: loaded calipers, rotors, inner bearings, outer bearings, grease seals, brake hoses, banjo bolts, spindle nuts, dust caps and a basic bracket kit with caliper brackets, spacers, hardware & instructions. Note: kits include all pieces shown but differ in bracket style. Order by hub & wheel bolt pattern

- 5 on 4 1/2" 5987-450 \$395.00 kit
- 5 on 4 3/4" 5987-475 \$395.00 kit
- 5 on 5 1/2" 5987-550 \$395.00 kit

WHEEL BOLT PATTERNS

- 1953-56 Truck wheel 5 x 5 1/2
- Ford car, later trucks 5 x 4 1/2
- Chevy wheels 5 x 4 3/4
- Some Other GM 5 x 5
- Aspen, Volare, etc 5 x 4 1/2

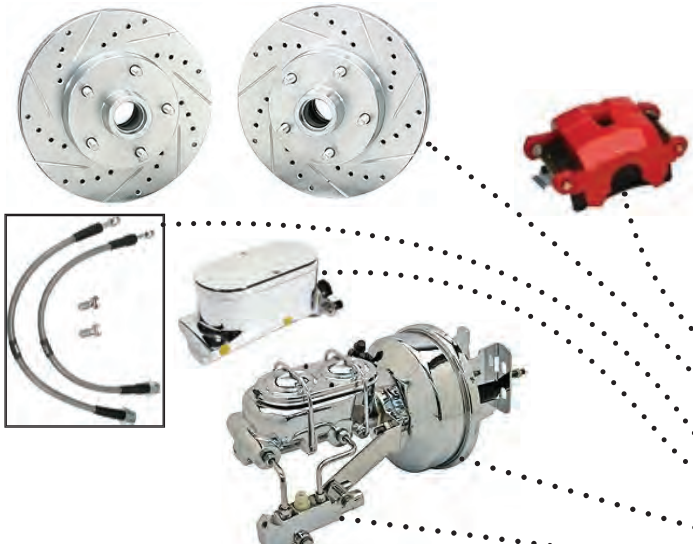

UPGRADES *Must be purchased with kits, Price is ADDED to kit.*

- For disc brakes, booster kits & whole shebangs, below
- Powder coated calipers 5989-APC \$60.00 ea
Red, black, blue or silver
 - Cross-drilled & slotted rotors 5989-ADR \$75.00 ea
 - Stainless braided hoses 5989-ASH \$59.00 pr
 - Chrome master cylinder and cap 5954-AMC \$100.00 ea
Chrome master cylinder does not need prop valve
 - Chrome booster & bracket 5954-ACB \$120.00 ea
 - Chrome prop valve & bracket 5954-APV \$75.00 ea
 - Aluminum master cylinder 5954-AA \$60.00 ea
 - Aluminum remote reservoir 5954-ARR \$150.00 ea



WHOLE SHEBANG DISC BRAKE & BOOSTER KIT

Complete disc brake kit shown above with pre-valved power brake booster & master cylinder & bracket assembly (shown on next page (5955-cm) ready to bolt in. Remote fill comes with plastic reservoir.

- See above for fancy upgrades.
- 5 on 4 1/2" kit..... 5990-450 \$649.00 kit
 - 5 on 4 1/2" kit with remote fill..... 5991-R450 \$699.00 ea
 - 5 on 4 3/4" kit..... 5990-475 \$649.00 kit
 - 5 on 4 3/4" kit with remote fill..... 5991-R475 \$699.00 ea
 - 5 on 5 1/2" kit..... 5990-550 \$649.00 kit
 - 5 on 5 1/2" kit with remote fill..... 5991-R550 \$699.00 kit



POWER BRAKE BOOSTER CONVERSIONS Pg. 177

BRAKE KITS ON THIS PAGE ARE PRE-VALVED, DO NOT USE IN LINE VALVES!!

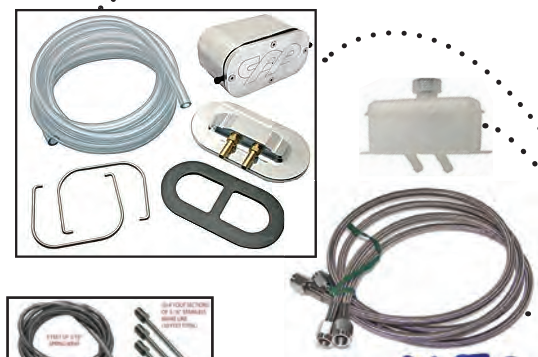
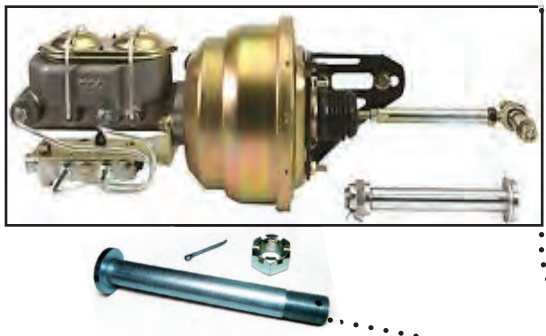
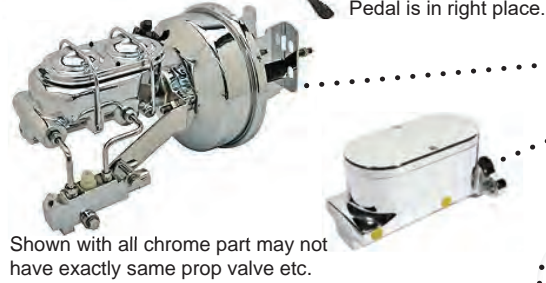

PRE-VALVED FIREWALL MOUNT BRAKE BOOSTER KIT
Bracket incorporates firewall, dash and steering column making the assembly rigid and strong. Includes pedal arm but not pedal.
 Drum front, drum rear 5953-MM \$299.00 kit
 Disc front drum rear 5953-CM \$299.00 kit
 Disc front and disc rear 5953-CC \$299.00 kit
 Bracket assembly only 5951 \$159.00 kit

UPGRADES Add upgrades of chrome to kits, additional costs are:
 Add chrome master cylinder 5954-AMC \$100.00 ea
Chrome master cylinder does not need prop valve & bracket
 Add all chrome, m/c & booster 5954-SM \$300.00 kit
 Add chrome prop valve & bracket 5954-APV \$75.00 ea
 Add chrome booster 5954-ACB \$120.00 ea
 Add aluminum master cylinder 5954-AA \$60.00 ea
 Add chrome & aluminum custom m/c 5954-ALM \$330.00 ea
 Add aluminum remote reservoir 5954-ARR \$150.00 ea

PRE-VALVED FRAME MOUNT POWER BRAKE BOOSTER KIT
Complete kit ready to bolt in. No in line valves needed. Includes proper booster and master cylinder for each application, assembled with booster mounting bracket, strut rod stabilizer, drive rod assembly and hardware kit. Use your stock brake pedal arm. Relocates master cylinder behind original hole in floor, use the included fill bottle or if you want to use floor access move it back, use 0517-4852 or 4666. Can be converted to remote anytime with kit below. Use clutch bracket & shaft conversion kit #5950 with clutch.
 Drum front-drum rear 5955-MM \$299.00 kit
 Disc front-drum rear 5955-CM \$299.00 kit
 Disc front-disc rear 5955-CC \$299.00 kit
 Remote fill reservoir, drum front-drum rear .. 5957-RMM \$389.00 kit
 Remote fill reservoir, disc front-drum rear ... 5957-RCM \$389.00 kit
 Remote fill reservoir, disc front-disc rear 5957-RCC \$389.00 kit

BRAKE SHAFT, AUTOMATIC TRANS 0520-A \$30.00 ea
 Use with all under floor brake kits to eliminate clutch pedal & linkage.

CLUTCH BRACKET & SHAFT KIT 5950 \$59.00 ea
 Use this kit when using a clutch pedal for all power brake conversions.

LOW PRESSURE BRAKE SWITCH 0518-LP \$22.50 ea
 Comes on at 20-50 lb pressure instead of approx. 90-100 lb, compatible with silicone fluid, new, even faster

BRAKE LIGHT PULSATER 2922 \$15.00 ea

VACUUM PORT KIT Polished aluminum 0578 \$29.95 kit

VACUUM HOSE
 For firewall booster, 3' 0579-3 \$8.50 ea
 For under floor booster kit, 5' 0579-5 \$15.00 ea

REMOTE MASTER CYLINDER CONVERSION KIT
Easy change to remote fill. Polished aluminum cap, chrome clamps, gasket & line. Fits disc-drum and disc-disc kits sold here over the years. Does not fit drum-drum
 With plastic reservoir 5923 \$92.95 kit
 With billet reservoir 5923-BR \$209.95 kit
 Billet reservoir 5927 \$139.00 ea
 Plastic reservoir 5926 \$29.00 kit

BRAIDED STAINLESS HOSES
 Behind seat 5928-3FT \$119.95 pr
 Firewall mount 5928-5FT \$139.95 pr

DO IT YOURSELF BRAKE LINE KIT 5901-S \$139.95 kit
 Includes 30 feet of tube, fittings, unions, spring wrap and clips

SPEED BLEEDERS, two bleeders
 3/8" 0573-38 \$20.00 pr
 5/16" 0573 \$20.00 pr

NEW, one person can bleed brakes, check valve keeps air from entering back into brake lines, simple, easy saves a ton of work and money.



ALL BRAKE KITS ON THIS PAGE REQUIRE IN-LINE VALVES Install check valve as close to master cylinder as possible but rear check valve must be AFTER proportioning valve. See diagram

NOTE by the time you add up non-valved kits and valves plus plumbing them you could have gotten a pre-valved kit.



- **MANUAL MASTER CYLINDER**
Adds dual master cylinder without booster.
Manual dual master cylinder.....5914\$69.00 ea
Manual disc drum master cylinder, includes proportioning valve installed5913\$189.00 kit



- **MASTER CYLINDER MOUNTING BRACKET KIT, NEW design**
Mounts Master cylinders, both Manual AND with Power Booster. Comes with plungers and hardware for both applications, Very clever design, easy install, lines everything up perfectly5911\$84.00 kit

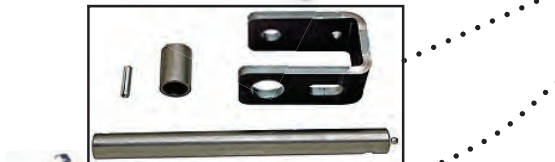

- **BRAKE SHAFT, AUTOMATIC TRANS** 0520-A.....\$30.00 ea
Use with all under floor brake kits to eliminate clutch pedal & linkage.
- **CLUTCH BRACKET & SHAFT KIT** 5950 \$59.00 ea
Use this kit when using a clutch pedal for all power brake conversions.

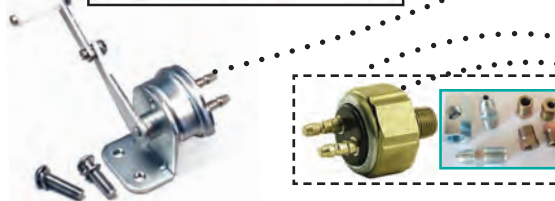

- **ADJUSTABLE BRAKE LIGHT SWITCH** ... 0576\$22.00 ea
Mounts between floor and pedal arm. Stainless steel, heavy duty & reliable, best switch available for the money
- PRESSURE ACTIVATED BRAKE LIGHT SWITCH**
With fittings, for all power conversions or new dual master cylinders of any kind. Includes special low pressure as it works faster and safer,
• switch and kit90518\$29.50 ea
• switch only0518-LP\$22.50 ea
• Fitting kit0571-F\$9.95 kit



- **VACUUM PORT KIT** Polished aluminum.....0578\$29.95 kit
- **PLASTIC FILL BOTTLE KIT**5924\$10.50 ea
These are included with pre-valved kits in this book so order only if using brakes from this page or if you (gasp!!) Got a kit elsewhere.



- **WELD ON BRACKET KIT**
Use this kit **only** if you need to relocate pedal arm or if truck is missing frame or arm pieces. Locate pedal to left or right for better clearance. Requires valves, see below. not best choice for 53-56
BRACKET KIT ONLY5970\$199.00 kit
With BOOSTER & MASTER CYLINDER5975\$369.00 kit



- **FIREWALL MOUNT "SWING PEDAL" Bolt on application**
Bracket kit5951\$159.00 kit
With booster & master cylinder5925-SP\$379.00 kit
[Better is the pre-valved firewall kit see previous page](#)



- **BRAKE PEDAL MOUNT ADAPTER**..... 0500-ADP\$20.00 ea
- **FLOOR ACCESS PLATE**4666\$7.50 ea
Flat round plate for relocating access to master cylinders, gas senders, etc



- **BRAKE VALVES**
Adjustable proportioning valve0583\$59.95 ea
10 lb check valve, red.....0581\$25.95 ea
2 lb check valve, blue0582 **SALE**\$24.95

KITS BELOW ON SALE, \$99.95

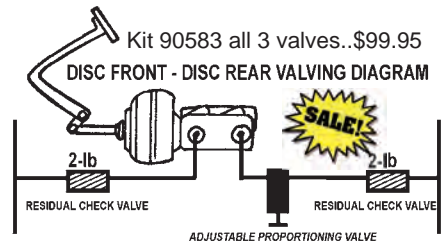



Brackets are not sold separately. Kit is set up for stock emergency brake cable. You must use a disc brake front and rear master cylinder & proportioning valve booster kit or similar set up.

REAR DISC BRAKE CONVERSIONS

Kit is shown with upgraded drilled rotors, see upgrades below. Includes rotors, calipers, mounting brackets, hose kit, gasket, e-brake adapters & hardware. (Not made for stock Dana 44 rear end) order by rear end type, bolt pattern & bolt size. Bolt on.

GM 10 or 12 bolt rear end	5963-GM.....	\$599.00 kit
Ford car 9" 4.5 bolt pattern, 3/8" bolts	5964-38.....	\$599.00 kit
Ford car 9" 4.5 bolt pattern, 1/2" bolts	5964-5.....	\$599.00 kit
Ford truck 9" 5.5 bolt pattern, 3/8" bolts	5965-3.....	\$599.00 kit
Ford truck 9" 5.5 bolt pattern, 1/2" bolts	5965-5.....	\$599.00 ea

UPGRADES Must be purchased with kits

Cross-drilled & slotted rotors	5989-ADR...	\$75.00 ea
*Powder coated calipers	5989-APC...	\$60.00 ea
<i>Red, black, blue or silver</i>		
*Stainless braided hoses	5989-ASH....	\$59.00 pr

THINGS YOU MIGHT NEED WHEN INSTALLING REAR BRAKES

*REAR FRAME BOXING PLATES

Rear boxing plate above axle, solid.....	4495	\$40.00 pr
Rear with C-section & brake provision ...	4493-B.....	\$45.00 pr
KIT, both sides and inserts	4493-B5356....	\$57.50 pr

Left side has hole and notch to for brake hose & bracket and inserts have axle bumper mounting provision.

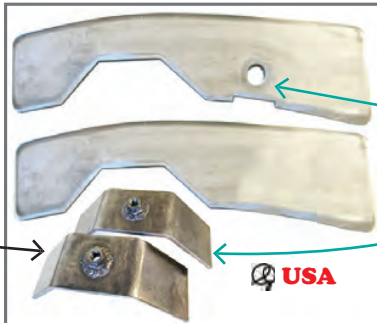

NEW

*Rear brake hose frame bracket.....	0530.....	\$9.50 ea
Brake bracket bolts.....	80563.....	\$1.85 pr
*Rear end vent, polished, long neck	1336.....	\$12.75 ea

Very nice piece, fits through and holds on the brake junction block as well.

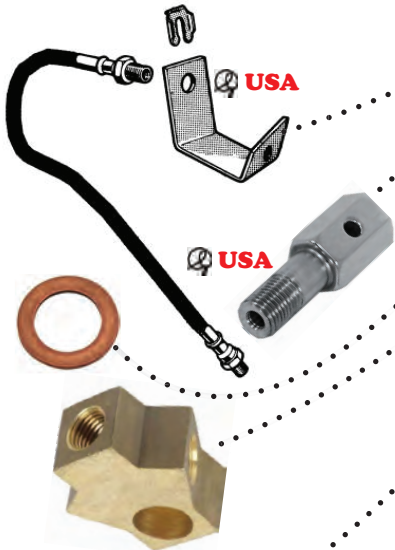

*Center fitting to hose washer.....	0523.....	\$1.20 ea
Rear brake center block fitting.....	0522.....	\$18.00 ea
*Do it yourself brake line kit		
<i>Includes 30 feet of tube, fittings, unions, spring wrap and clips</i>		
Steel	5901-K	\$75.00 kit
Stainless kit	5901-S	\$139.95 kit
*Speed bleeders, 2 bleeders, 5/16.....	0573.....	\$20.00 pr
3/8.....	0573-38.....	\$15.00 pr
10 MM.....	0573-M10....	\$14.50 set

New, one person can bleed brakes, check valve keeps air from entering back into brake lines, simple, easy saves a ton of work and money.

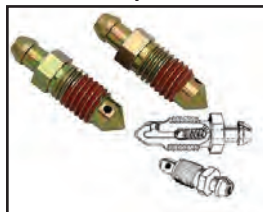
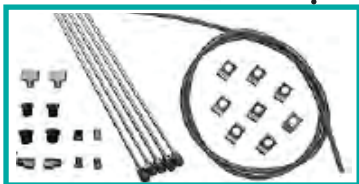

Mike installs calipers on front in brake class.

PEDAL PAD, CLUTCH OR BRAKE

- Stock style 0500 \$8.50 ea
Has correct threads, watch for China ones with metric threads
- Big truck, F-350-up F3-0500 \$15.00 ea
- Billet aluminum, back in stock 0500-BA \$25.00 ea
Chrome and rubber street rod style
- Adjustable 0500-PA \$50.00 ea
- Non-adjustable 0500-PT \$37.95 ea



USA

BRAKE & CLUTCH PARTS

- Brake & clutch shaft 0520 \$30.00 ea
- Brake or clutch floor seal 2729-BRK \$3.60 ea
- Brake & clutch arm bumpers 0519 \$3.95 pr
Both go under toe board and bumper part to the outside.
- Brake or clutch arm trims 4664 \$19.95 ea
See also page # for steering column trim pieces

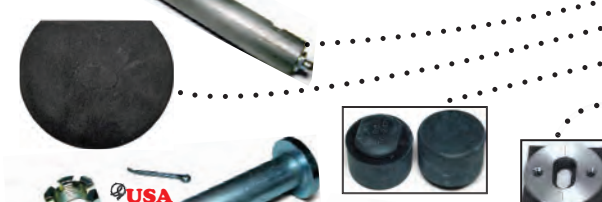

BRAKE ARM & SHAFT PARTS

- Brake arm return spring 0527 \$3.85 ea
Replace this spring, if weak it allows continuous pressure on master cylinder, causing overheating of brake fluid and brake troubles.
- Brake shaft, automatic trans 0520-A \$30.00 ea
Use when removing clutch pedal assembly under floor.
- Brake shaft frame mounting bolts 80590 \$6.90 set
- Bottom special cutter thread bolt 80591 \$0.75 ea
- Brake arm bushing 0528 \$12.50 ea
- Brake arm bushing tool 0529 \$9.50 ea
Makes removal and install easier, cheaper than ruining bushing
- Brake arm to eye pin 0521-A \$8.75 ea
- Brake arm to master cylinder eye bolt 0521 \$15.75 ea



CLUTCH PARTS

- Clutch roll pin, secures pawl to shaft 0815 \$2.50 ea
- Brake & clutch shaft 0520 \$30.00 ea
New old stock clutch parts are becoming extinct. If you have some good used clutch pieces please let us know so we can pass the information on to those trying to keep the original clutch assembly. WORKING ON THE PAWL AND BRACKETS, SEE WEBSITE
- Clutch arm locking pin 0801 \$2.50 ea
- Clutch arm return spring 0802 \$5.00 ea
- Clutch arm return spring anchor bracket 0803 **SALE** \$12.50 ea
*Goes under acorn bumper on driver side, **ON SALE... \$10.00***
- Clutch shaft bushing, truck takes 2 0540 \$2.95 ea
- Clutch adjusting rod 0807 \$7.95 ea
- Adjusting rod tapered nut 0808 \$13.00 ea
- Clutch pivot bracket 0810 \$28.50 ea
- Clutch shoulder bolt 0804 \$16.50 ea
- Clutch shaft bushing spacer 0809 \$10.00 ea
- Clutch shaft Felt Bushing 0804-FW \$2.85 ea



- Clutch bracket and shaft conversion 5950 \$59.00 ea
Use only when adding power brakes but keeping clutch. Clutch pivot bracket is more narrow for clearance



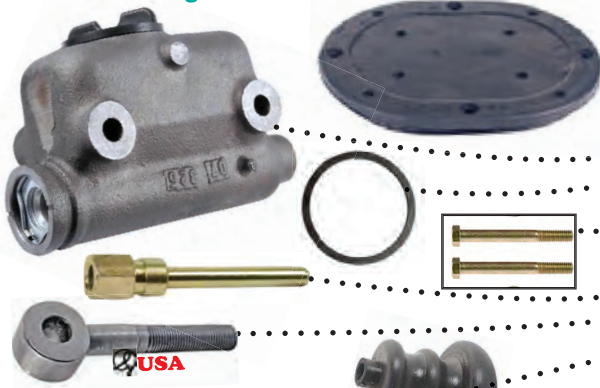

MASTER CYLINDER PIECES

- Master cylinder floor hole cover..... 0517.....\$12.95 ea
pops into floor hole without screws.
- **Master cylinder**, new not rebuilt..... 0512.....\$92.00 ea
- Master cylinder cap gasket..... 0512-G.....\$2.50 ea
Master cylinder cap is no longer available
- Master cylinder mounting bolts..... 80512..... \$3.90 pr
- Master cylinder push rod 0512-P\$11.50 ea
- Master cylinder to arm eye bolt 0521.....\$15.75 ea
- Master cylinder boot, bellows style..... 0512-A\$4.95 ea



- **MASTER CYLINDER KIT** 90512.....\$92.00 kit
Includes: master cylinder, cap, gasket, push rod & boot
- Master cylinder rebuilt kit..... 0513.....\$18.00 kit
- Master cylinder repair spring 0513-A\$5.00 ea



- Master cylinder & brake hose copper washers
Thicker one, goes at master cylinder.. 0515-2.....\$1.25 ea
Thinner one, goes at bolt fitting 0515-1.....\$1.25 ea
- Set of 2, (thick and thin)..... **SALE** 0515.....\$1.69



- 3 HOLE FITTING (at master cylinder) .. 0516.....\$26.95 ea
- 3 hole fitting is bigger on a 3/4 ton, order F2-0516\$27.50 ea



- **LOW PRESSURE BRAKE SWITCH**..... 0518-LP\$22.50 ea
Mounts & looks like stock, standard 1/8" pipe thread. Best!!
- Stop light switch connectors..... 80518..... \$1.25 pr
- BRAKE LIGHT SWITCH, Stock 0518.....\$6.00 ea
Requires 60-100 lbs of pressure to activate, often the cause of delayed brake lights. Low pressure switch below MUCH better



- STOP LIGHT SWITCH BOLT 0514.....\$8.00 ea

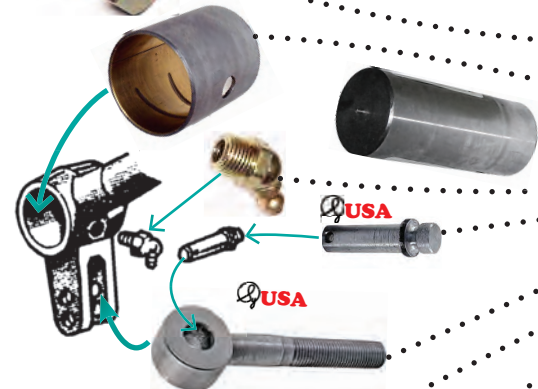

MASTER CYLINDER TO BRAKE ARM PIECES

- Brake arm bushing 0528.....\$12.50 ea
- Brake arm bushing remove-install tool ... 0529.....\$9.50 ea
- Brake arm Zerk (grease) fitting..... 80510.....\$1.25 ea
- Brake arm to eye pin 0521-A\$8.75 ea
- Brake arm to master cylinder eye bolt... 0521.....\$15.75 ea



- BLEEDER SCREW, standard..... 0508.....\$1.95 ea
- Speed Bleeder with check ball, 5/16" 0573\$14.50 pr
- 3/8" 0573-38..... \$15.00 pr
- Brake Bleeding syringe tool, curved tip ... 80500.....\$4.50 ea

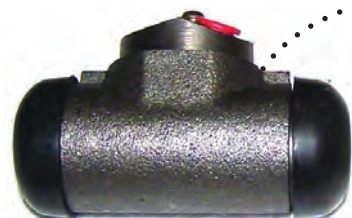

WHEEL CYLINDER

- Front 1953-56 passenger **SALE** 0504-RF\$23.50
- Front 1953-56 driver **SALE** 0504-LF\$23.50
- Rear 1953-54 passenger... **SALE** 0506-RR\$19.50
- Rear 1953-54 driver..... **SALE** 0506-LR.....\$19.50
- Rear 1955-56 passenger... **SALE** 0507-RR\$19.50
- Rear 1955-56 driver..... **SALE** 0507-LR\$19.50

- WHEEL CYLINDER REBUILD KITS *Springs are included*
- Front (1 1/16" cups)..... 0509-F\$9.00 ea
- Rear 1953-54 (1" cups) 0510-5354.....\$9.00 ea
- Rear 1955-56 (7/8" cups)..... 0510-5556.....\$9.00 ea

- WHEEL CYLINDER TO SHOE LINK
0503-SP..... \$4.95 ea

FRONT WHEEL HUB

- Hub dust cap1312.....\$6.00 ea
- Spindle nut1310.....\$4.75 ea
- Spindle washer1311.....\$2.95 ea
- Outer bearing1304. **SALE**\$13.50
- Outer race1306.....\$7.95 ea
- Lug nut concave washer1309-CW\$4.95 set
Made to help center and align worn wheel holes, set of 5
- Lug nut1309.....\$0.75 ea
- Lug nut set of 51309-SET\$3.50 set
- Lug bolt1308.....\$2.45 ea
- Inner race1305.....\$7.95 ea
- Inner bearing1303. **SALE**\$20.50
- Drum seal1307.....\$5.00 ea

STOCK BRAKE WHEEL COMPONENTS

- Brake Pin nuts & locks80546.....\$2.85 set
 - Brake anchor pin DD washer0546-APD\$5.00 ea
 - Brake pin wing washer0546-APW\$6.00 ea
 - Brake Anchor Pin, SS, with nut & lock0546-AP. **SALE**\$24.50
 - Park brake pull lever0538-PR.....\$29.95 pr
 - Adjusting hole cover, steel0543-STL.....\$4.00 ea
 - Adjusting hole cover, rubber0543-RB. **SALE**\$1.45
 - Retracting spring, pr does 1 wheel0547 **SALE**\$3.95
 - Shoe anchor spring0548 **SALE**\$5.95
 - Shoe hold down kit0549\$9.85 kit
 - Adjuster star wheel assembly0541 **SALE**\$10.88
 - Brake shoes, 2 brakes, 4 pcs. Front0545-F\$25.95 set
 - Rear0545-R. **SALE**\$39.50
- Shoes no longer need cores, Original 2 short, 4 long. Long to back. Replacements are same but causes no fitting issues.*
- Brake Drum, Front **SALE** 0501-F\$69.50
 - Brake Drum, Rear0502-R.....\$59.50 ea

BRAKE LINES AND HOSES

- Rear brake hose retaining clip0554\$1.95 ea
- Rear brake hose frame bracket0530.....\$9.50 ea
- Brake bracket bolt80530..... CALL
- Rear brake hose0525.....\$24.00 ea
Only one needed in center, goes to the center block fitting
- Center fitting to hose washer0523.....\$1.20 ea
- Rear brake center block fitting0522.....\$18.00 ea
- Rear axle brake clamp & bolt0526-RA.....\$3.50 pr
bolts into rear end, full clamp, original was half clamp.
- Rear end vent, polished, long neck1336.....\$13.77 ea
- "S"line clip, joins fuel & brake line1636.....\$2.00 ea
- Front brake hose, use 2 **SALE** ..0524.....\$15.50
- Brake line clip & bolt0526.....\$1.50 ea
- Steel brake lines
For stock brakes, pre-bent 3/16" hard lines complete with proper ends and wrap installed, made from Ford specs.
- Stainless5905-SS.....\$175.00 kit
- Stock steel5904-SK.....\$150.00 set
- D-Y-I brake line kit
Includes 30 feet of tube, fittings, unions, spring wrap and clips
- Stainless5901-S.....\$139.95 kit
- Plain steel5901-K.....\$75.00 kit

We use this long snout end,
so much easier to install!!





E-BRAKE PARTS

HANDLE REPAIR, we do not make handles yet but do make a few repair & rebuild pieces.

- Sector gear.....0559..... \$11.75 ea
- Park handle inner repair spring.....0558..... \$5.50 ea
WAS-\$8.25 Expensive but most often problem with broken handle. Finally made enough to cut price by almost 1/2!!
- Handle to dash mounting bolts.....80551-PX.....\$8.50 kit
- FRONT CABLE ADJUSTING CLEVIS 0555..... \$12.50 ea
Not casting like original, made in steel, fits correctly
- PIN & COTTER80555..... \$2.50 set
- CABLE TO FRAME BRACKETS0560..... \$24.50 pr
- BRACKET MOUNTING BOLTS80560..... \$2.00 pr
- BRACKET CABLE CLAMP & BOLT0561-5367 \$2.77 pr

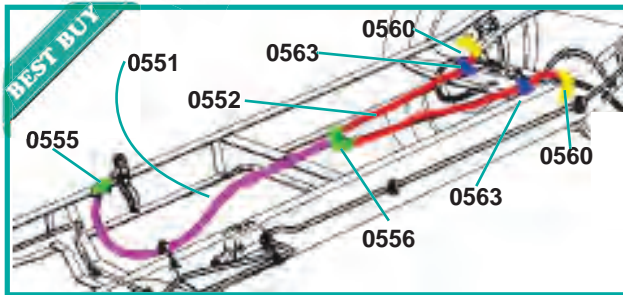

- REAR CABLE MOUNTING TAB0563..... \$10.00 ea
At crossmember secures brake cable, truck needs 2
- TAB MOUNTING BOLTS.....80563..... \$1.85 pr
- HORSE-SHOE CLIP AT HOSE AND CABLE ENDS
Smaller of the clips (pair).....0553..... \$4.75 pr

NEED ALL E-BRAKE CABLE KIT, includes Front Cable, Rear Cable, Yoke, Cable Clamps, Cable Clips, X-Member Mounting Tabs, Rear Frame Cable Brackets & Adjusting nuts Complete Need all Kit.....90552.....\$167.75 kit



- **REAR PARKING/EMERGENCY BRAKE CABLE** *To both rear wheels, fits stock rear end and most Ford 9 inch rear ends.*
- With Yoke, Black Plastic sleeve.. **SALE** 0552..... **SALE..\$46.50**
- With Yoke, Metal outer sleeve, USA.....0552-5360A... \$49.95 ea
- CENTER YOKE.....0556..... \$6.50 ea
- BRAKE CABLE ADJUSTING NUTS.....80553..... \$0.50 set
2 go on cable at Yoke to adjust tension, 1 for clevis at handle



- **FRONT PARKING BRAKE CABLE**
- CABLE0551..... \$47.50 ea
- Front cable adjusting nuts80553..... \$0.50 set
One for clevis below, and 2 for cable at yoke, adjusts tension
- Front cable adjusting clevis0555..... \$12.50 ea
- Pin & cotter.....80555..... \$2.50 set



- BRAKE SPREADER BAR for E-brake...0542..... \$14.50 ea
- SPREADER BAR SPRING.....0537..... \$4.00 pr



- PULL LEVER, Pair, 1 for each wheel..0538-PR \$29.95 pr
Passenger0538-R..... \$18.50 ea
Driver0538-L \$18.50 ea
- PULL LEVER LINK PIN.....0539..... \$2.75 ea
- SPRING TO LINK PIN CLIP0553-3979 \$1.25 ea

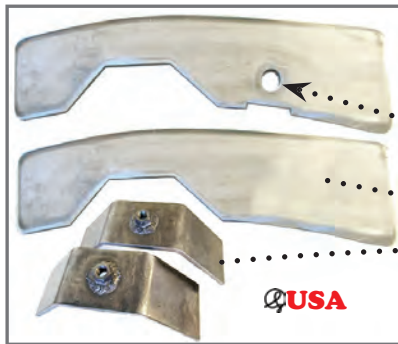

FRAME BOXING PLATES, Rear

- KIT, both sides and inserts 4493-B5356\$57.50 pr
Left side has hole and notch to for brake hose & bracket and inserts have axle bumper mounting provision.
- Rear boxing plate above axle, solid..... 4495.....\$40.00 pr
- Rear pr. with C-cutout, hole & notch 4493-B5356\$57.50 pr
Left side has hole and notch to for brake hose & bracket
- Rear pr. with C-cutout, No hole or notch .. 4493.....\$42.00 pr
- C-section insert, with bumper mount..... 4494.....\$25.00 pr



- **Bumper kit for Boxed frames** 92818.....\$21.50 kit



- **LONG BOLTS** for bumpers for C-sections not bought from us, Ours have provision for axle bumper.... 82818-CS.....\$2.85 pr



U-BOLTS

- Rear spring, stock axle 2870\$9.95 ea
- Rear spring, 3" axle housing..... 2873.....\$8.50 ea



SPRING U-BOLT TIE PLATE

- 3" Axle housing (9") 2885.....\$10.00 ea
- Original axle has 2 1/2" axle housing 2885-25.....\$12.00 ea



SPRING SEAT PADS *Weld to axle. Springs set on these*

- Stock rear axle, 2 1/2" 2883.....\$10.00 ea
- Axle with 3" housing 2884-3.....\$10.00 ea



AXLE CONVERSION SHOCK MOUNTS

For 3" axle housings, also see complete kits below.

- Axle below springs, stock, welds to axle 2888.....\$24.50 ea
- Axle above springs, passenger 2889-R.....\$26.50 ea
- Axle above springs, driver 2889-L.....\$26.50 ea
- SHOCK STUDS for either 2403.....\$9.50 ea



BRAKE HOSE TAB & CLAMP KIT

- For 9" axle conversion..... 0532.....\$19.85 ea

REAR AXLE CONVERSION KITS



"AXLE BELOW SPRINGS (stock location)

Converting to popular Ford 9" or any axle with a 3" housing.

Includes: seat pads, tie plates, shock mounts and U bolts

- Requires welding shock mount to axle ... 2881..... \$119.00 kit
- Same kit with shock studs 2881-WSS \$128.50 kit

"FLIP" KIT, AXLE ABOVE SPRINGS

Installs axles with 3" housings, No welding required for shock mount but frame will need C-sectioned. Includes, seat pads, tie plates with shock brackets and U Bolts.

- Lowers truck 4 1/2 to 6 inches..... 2882..... \$99.00 kit
- Kit for 2.5" axle 2882-25..... \$99.00 kit
- With shock studs 2882-WSS \$109.00 kit
- Need it all kit92882..... \$168.50 kit





Chrome..1332 Finned Alum..1333 Poly-Clear..1331
Polished Fins..1333-PL

REAR END COVER *Stock rear end, Dana 44*

- Chrome cover 1332 \$39.95 ea
- Cast finned aluminum cover 1333 \$183.00 ea
- Polished finned cover (Shown)..... 1333-PL..... \$138.00 ea
- Clear cover 1331 \$225.00 ea



- Rear end cover gasket 1334 \$6.90 ea
- Rear end cover plug, magnetic..... 1335-M..... \$6.50 ea
- Bolts, polished, hex head 81335-PX \$18.50 set
- Bolts, polished, button head 81335-PB \$19.50 set
- Bolts for finned cover, polished button..... 81333-PB \$22.50 set
- REAR END VENT polished, long neck 1336 \$12.75 ea



REAR AXLE PARTS, STOCK

- Forward bearing and race set..... 1321-4621 \$38.00 set
- Rearward bearing and race set 1322-SET \$49.95 ea

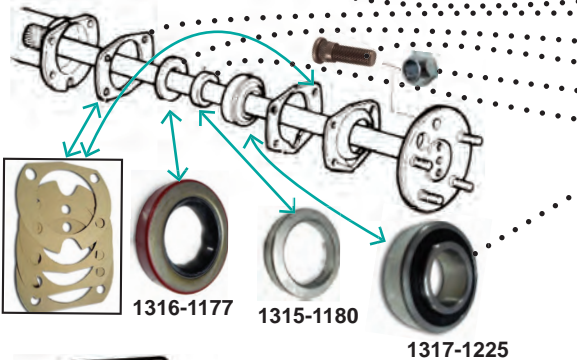

- Pinion seal 1319-4676 \$9.95 ea
- Axle housing gasket set (4) 1318-1001 \$10.90 set
- Drum seal 1316-1177 \$4.95 ea
- Lug bolt..... 1308 \$2.50 ea
- Lug nut..... 1309 \$0.75 ea
- Bearing retainer ring **SALE** 1315-1180 \$3.90
- Bearing **SALE** 1317-1225 \$14.50

SPARE TIRE CARRIER MOUNTS

Side mount is being worked on, we are very close at time of printing, get on waiting list.

SIDE BED MOUNT, Not exact of original, but made in components so will fit some of the various mounting patterns we have found. Bolts together to allow for better adjustments.

- SIDE BED MOUNT ASSEMBLY 1370 \$169.95 ea
- UPPER MOUNTING PLATE, angled ... 1374 \$20.00 ea
- LOWER MOUNTING PLATE,

- Flat, 2 hole..... 1375 \$11.50 ea
- Angled with angle on end 1375-L \$16.50 ea

- Spare carrier mount bolts with acorns inside bed. Polished carriage, square holes 81370-PS \$25.75 set
- Polished button head 81370-PB \$26.75 set

SPARE TIRE UNDER-BED HANGER ASSEMBLY

Spare tire under-bed hanging bolts

the lower tire bar is not available at this time, we are working on a replacement so watch for announcements.

- Knob bolt 1378 \$24.50 ea
- Knob bolt upper frame nut & washer ..81378..... \$0.98 ea

- "J" BOLT, 6" long..... 1379 \$16.00 ea
- "J" Bolt Cotter Pin, (included above) ..81379..... \$0.45 ea

- WING NUT, replacement 1376-R \$7.95 ea
- WING NUT, Cast Reproduction 1376 \$109.50 ea
- Very expensive, Kevin Hand makes one at a time. **SALE** \$99.50

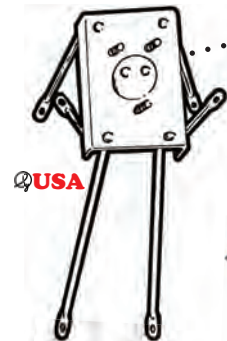

WHEEL • HUB CAP

2020 Mid Fifty
1953-56 Catalog

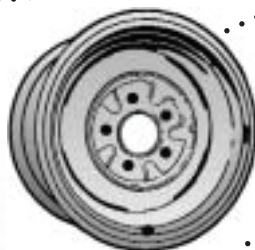
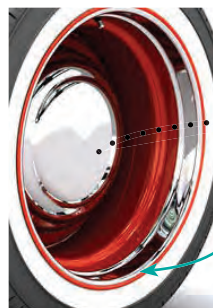

HUB CAPS, POLISHED STAINLESS STEEL

- 1946 STYLE 1300-46..... \$30.00 EA
- SCRIPT FORD LETTERING..... 1300-SCPT \$28.50 ea
- BLOCK FORD Letters unpainted 1300..... \$28.50 ea
- PAINTED LETTERS, BLUE..... 1300-PNT \$42.00 ea

BABY MOON

- WITH RING no letters..... 1300-NO \$28.50 ea
- NO RING, no letters..... 1300-BM \$28.50 ea

BEAUTY RINGS

- SMOOTH STYLE 15"..... 1301-SM15 \$28.50 ea
- SMOOTH STYLE 16"..... 1301-SM16 \$30.00 ea
- RIBBED STYLE 15"..... 1301-RB15..... \$28.50 ea
- RIBBED STYLE 16"..... 1301-RB16..... \$30.00 ea
- CONVEX STYLE 15" 1301-VX15..... \$28.50 ea
not shown

- F2 HUBCAP F2-1300 \$49.50 ea

WHEELS \$80 to \$180 depending on size and options
15" - 17" diameter 4.5" - 10" widths
Many bolt patterns Many back spacing options
Plain steel Chrome or coated finish

WHEEL ADAPTERS BILLET, for street use, some cast in stock but cast are for "off road" use only. \$129.95 pr

1384-08.....HUB 4 1/2", WHEEL 4 3/4"	1384-09.....HUB 4 1/2", WHEEL 5"
1384-12.....HUB 4 3/4", WHEEL 5"	1385-16.....HUB 5 1/2", WHEEL 4 1/2"
1385-17.....HUB 5 1/2", WHEEL 4 3/4"	

WHEEL SPACERS, BILLET,
for street use, 1.25" thick 1387-23.....5.5".....\$129.95 pr

LUG NUT CONCAVE WASHER
..... 1309-CW.....\$4.95 set
Made to help center and align worn wheel holes, set of 5

WHEEL BOLT PATTERNS
1953-56 Truck wheel . . .5 x 5 1/2
Ford car, later trucks . . .5 x 4 1/2
Chevy wheels5 x 4 3/4
Some Other GM5 x 5
Aspen, Volare, etc5 x 4 1/2

We sell almost 100 different combinations in stock style wheels depending on diameter, width, bolt pattern etc So please call us so we can help you pick out the right one, no room here to list them all.

1953-54 wheels were painted to match truck, in 1955 they were snow shoe white and 1956 they were colonial white (both colors were somewhat off white toward cream) (all F-250 wheels in all years were black) Stock wheels are 15", 5" wide with a bolt pattern of 5 1/2" and backspace of 3". We suggest for most trucks that are not "exact of original" but want the original look, a 6" or 7" wheel might be a better choice. Extra shipping costs. Wheels over 8" wide SPECIAL ORDER non returnable





PANEL TAIL LIGHTS Complete assembly with glass lens, lights made in recent years are interchangeable, simply turn the lens over, bulb is in center. We suggest quartz or halogen bulbs for visibility because glass lens is thick. Better use LED lens.

- Driver, left P-2222-L \$74.95 ea
- Passenger, right..... P-2222-R..... \$74.95 ea
- With blue dot, driver or passenger..... P-2222-B..... \$79.50 ea
- LIGHT ASSEMBLY WITH LED LENS . P-92223 \$88.50 ea

TAIL LIGHT LENS

- LED lens P-2223-LED ... \$29.80 ea
Latest and greatest, at last a tail light we can actually see for the panel. Long lasting, cool and bright! Simple install, just replace stock bulb, no other changes, can't get simpler or better. Fits either side.
- Glass lens..... P-2223 \$8.00 ea
- Glass with blue dot installed..... P-2223-D..... \$15.00 ea



- GASKET P-2224 \$1.95 ea

BRIGHT BULBS Panel truck light is small & dim so we suggest high power bulbs, halogens or best, LED above.

- High power 55 watt bulbs 2262-HPC \$3.50 ea
- Halogen, 12 volt..... 2267 \$7.99 ea



- BODY TO LIGHT PAD** P-2221 \$7.50 pr
Not included above, nice molded piece, not just a gasket.



- TAIL LIGHT HARNESS** P-3208 \$45.00 ea
Turn Signals & License Light wire included



TAIL LIGHT WIRE THROUGH FLOOR GROMMET

- Original style..... P-2212 \$2.50 ea
- Replacement, not exact of original 82214..... \$2.50 pr



PANEL TRUCK REAR LICENSE LIGHT

- Complete assembly P-2228 \$30.00 ea
With lens, housing, socket, bulb, gasket & retainer
- Lens retainer, exact of original..... P-2227 \$15.00 ea
- Retainer mounting screws, stainless..... P-82226 \$2.00 set
- Lens, clear glass, perfect reproduction.. P-2226 \$10.00 ea
- License light lens gasket P-2225 \$1.95 ea
- License light bulb..... 2618-12V \$1.50 ea
- License bulb socket & pigtail 2253..... \$9.95 ea
- Spring & contact for repair only 2254 \$2.50 kit



- DOOR ACCESS PLATE** P-1138..... \$23.50 ea
- Door Plate Screws..... P-81138..... \$2.00 ea



GROMMETS FOR LICENSE LIGHT WIRE

- On door, jam edge, exact if original... 2233..... \$3.95 ea
- On door, jam edge, replacement 82214 \$2.50 pr
- On door, center behind plate light..... 2320-L..... \$2.50 pr
- On body, door jam area, both sides .. 2233-S \$3.95 ea



PANEL TRUCK PARTS

2020 Mid Fifty
1953-56 Catalog



USA

PANEL TRUCK GAS TANK KIT P-1690\$459.50 kit
New aluminum tank includes straps. Fits in stock location, use stock fill tube (I am working on reproducing the tube please call). Tank is 3" shorter in front so you can use new underfloor brake boosters like sold in this catalog or any other



USA

TANK MOUNTING BRACKET P-1613 \$44.97 ea
Copy of original, mounts to frame at back of tank. (Takes one)
Mounting bracket bolts P-81613 \$2.50 ea



USA

PANEL TANK STRAPS P-1618 \$19.95 ea
Stock tank uses 2 straps and on mounting bracket. Strap at front of tank mounts to crossmember. Replacement tank uses different straps.

Tank strap mounting bolts..... P-81618 \$4.75 ea



USA

GAS NECK GROMMET P-1606 \$22.50 ea



GAS TUBE replacement kit, in process, ask



GAS DOOR

Flat panel with 45 degree angle filler tube, use for panel truck or any flat area, can be slightly curved.

Flat with round door 45% tube 1653-45RF\$124.00 kit

Flat with square door 45% tube..... 1653-45SF\$124.00 kit



USA

RUNNING BOARD SKIRT P-0304 \$24.50 pr
These are 58 1/2" long, if you get them elsewhere they will be too short.

PANEL TRUCK RUNNING BOARDS *Oversize shipping*

SMOOTHY, NO RIBS STEEL P-0308 \$555.00 pr

Stock style ribbed fiberglass, left P-6551-L \$225.00 ea

Stock style ribbed fiberglass, right..... P-6551-R..... \$225.00 ea



USA

PANEL TRUCK INSULATION KITS, PRE-CUT

Includes all needed pieces, glue and aluminum tape.

Panel truck roof 1953-55 P-92177-5355 ...\$179.00 kit

Panel truck roof 1956 P-92177-56\$250.00 kit

Floor, front only 1953-55 92170-5355.....\$149.00 kit

1956..... 92170-56.....\$149.00 kit

Panel truck body..... P-92179\$289.00 kit

Panel truck rear door dampeners..... P-92176\$65.00 kit

Complete panel kit, 1953-55..... P-92170-5355 ...\$699.00 kit

1956..... P-92170-56\$699.00 kit

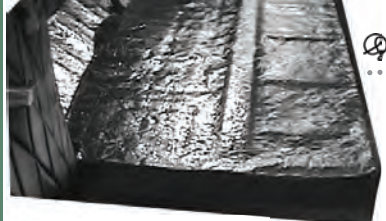

USA

PANEL TRUCK FRONT HEADLINER *Oversize shipping*

Panel board, does only the front back to door post area

1953-1955 P-2109-5355 \$120.00 ea

1956..... P-2109-56 \$120.00 ea

ABS FRONT HEADLINERS may be ready by printing

PANEL REAR BOW PATTERN..... P-2130 \$6.00 ea

Full size drawing of bow curves

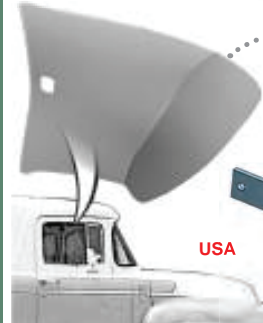

USA



NEW ITEM

USA

PANEL TRUCK REAR BUMPER BRACKETS

Plain Steel, set of 4.....P-0604-A.....\$199.00 set

REAR PANEL BUMPER

Polished stainless, no holesP-0600 \$335.00 ea

Not exact of original, not as large, tucks in closer to body, original bumper is 69" end to end, with an 8 1/2 " radius, this bumper is 64 3/4" with a 5 1/2 " radius. Both are 5" wide.

Oversize shipping. No mounting holes for brackets, must be drilled, or glued to brackets. Worth it, makes nice neat bright polished bumper.



Many of our Panel Truck pieces have been out of stock last couple years. Unfortunately we lost one of the best fabricators we have ever known. Kim Stewart, May he rest in peace. He was much loved and is missed by family and friends. His work will live on in many trucks. Please understand Panel truck items are made one at a time, small quantities at best, bear with us as we work the items back into stock.

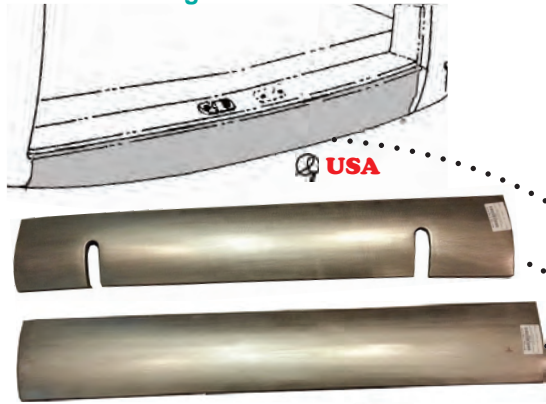

PANEL REAR LOWER PAN

- FIBERGLASS for with bumper P-6553 \$205.00 ea
Has two little openings for bumper brackets not shown here.
- STEEL, WITH bumper holes P-7553 CALL
- STEEL, NO bumper holes P-7554 \$300.00 ea

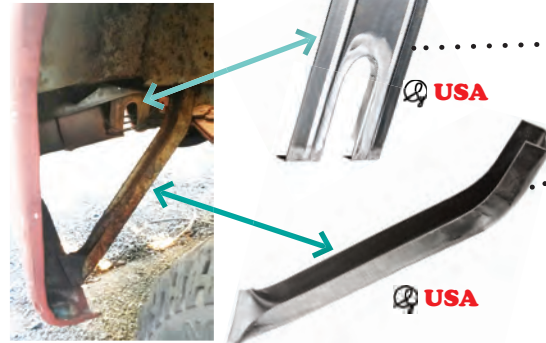

REAR LOWER PAN REINFORCEMENT BRACE

- inside on both sides, one P-7552 \$30.00 ea

PANEL TRUCK REAR FENDER BRACE

- Each P-1534 \$25.00 ea

PANEL WOOD FLOOR METAL PARTS

- FRONT END CAP P-0206 \$38.50 ea
- FRONT END CAP SCREWS P-80208 \$2.85 pr
- SIDE RUNNERS, pair P-0209 \$110.00 pr
 - Side runner, Driver P-0209-L \$58.50 ea
 - Side runner, Passenger P-0209-R \$58.50 ea

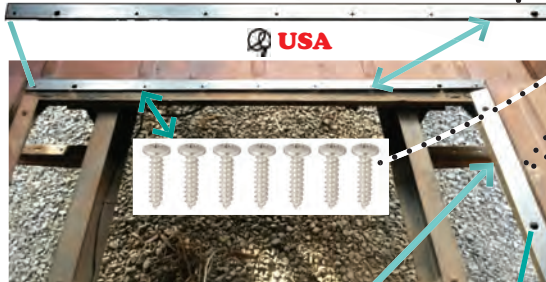

- SIDE RUNNER BOLTS, Bolts go into captive nuts in under-bed frame channel P-80209 \$15.00 set

PANEL TRUCK FLOORS: are **not** individual pieces, it is a sheet of plywood. Do not use individual pieces, exhaust could come inside truck. We love to sell fenders but not because you nodded off while driving. We are working on a nice setup to solve this if you are interested ask so we can notify you when finished.



UNDER-WOOD FLAT REAR CROSS SILL

- CROSS SILL P-0235 \$110.00 ea
- CROSS SILL WITH CORNERS... P-0236 \$150.00 ea
 - CORNER ONLY, left P-0237-L \$18.50 ea
 - CORNER ONLY, right P-0237-R \$18.50 ea



FLOOR FRAME CROSS MEMBERS

- FRONT CROSSMEMBER P-0230 \$85.00 ea
- MIDDLE, use 2 P-0231 \$75.00 ea
- REAR P-0233 \$148.50 ea.



BODY TO FRAME BOLTS

- Stainless P-81113-SS \$32.50 set
- Polished stainless P-81113-PS \$46.50 set



- INSULATORS, floor to Crossmember at bolts
Set of 6 pieces P-0214 \$9.50 set

PANEL FLOOR EDGE TO BODY WITH RUBBER

- Pair P-0220 \$52.50 pr
- Passenger P-0220-R \$28.50 ea
- Driver P-0220-L \$28.50 ea

PANEL TRUCK PARTS

2020 Mid Fifty
1953-56 Catalog

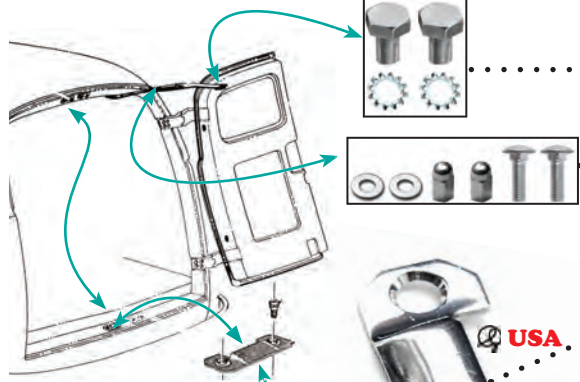

- TOP SLIDE GUIDE, am working on it, ask
- TOP SLIDE GUIDE MOUNTING BOLTS *Does both sides*
 - Stainless..... P-81182-SS.....\$6.00 set
 - Polished..... P-81182-PS.....\$8.50 set
- TOP SLIDE GUIDE STOP BOLT
 - Stainless..... P-81185-SS..... \$4.00 pr
 - Polished stainless with acorn nuts.. P-81185-PS..... \$8.50 pr

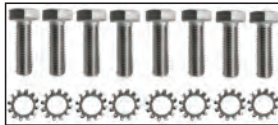
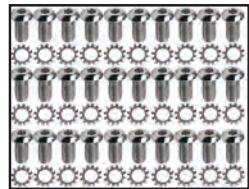
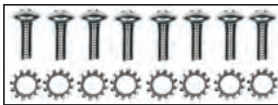

- PANEL TRUCK STRIKER PLATES
 - These go both at the top and bottom of both doors on the body. Sy made in stainless as latch "strikes" them and paint chips, polished of course because it just looks good.*
 - Panel striker, stainless..... P-1175.....\$12.50 ea
 - Panel striker, polished..... P-1175-PS.....\$15.00 ea
- REAR DOOR STRIKER BOLTS, does both upper & both lower
 - Stainless..... P-81181-SS.....\$15.00 set
 - Polished..... P-81181-PS.....\$20.00 set

- INSPECTION PLATES, working on, just ask
- DOOR ACCESS PLATE..... P-1138.....\$23.50 ea
 - Door Plate Screws..... P-81138..... \$2.00 ea
- INSPECTION PLATE & LATCH SCREWS *Does both doors*
 - Stainless..... P-81183-SS.....\$16.50 set
 - Polished..... P-81183-PS.....\$22.00 set



- DOOR HINGE, *coming soon, ask for information*
- DOOR HINGE BOLTS (HINGE TO BODY) *Does one door*
 - Stainless..... P-81180-SS.....\$10.50 set
 - Polished..... P-81180-PS.....\$15.00 set

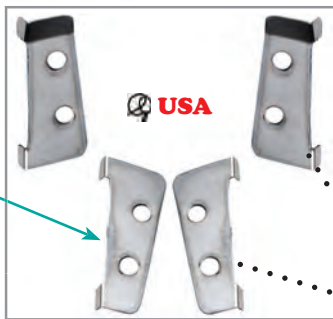

- REAR DOOR HINGE PIN..... P-1177.....\$2.85 ea
- Rear Door Hinge Pin, Oversize..... P-1177-OS.....\$3.50 ea
- Polished Stainless.....
- REAR DOOR HINGE DUST COVERS
 - Set of 4..... P-1169-SET.....\$69.95 ea
 - Individual Hinge Dust Covers
 - Driver UP..... P-1168-LT.....\$18.50 ea
 - Driver DOWN..... P-1168-LB.....\$18.50 ea
 - Passenger UP..... P-1168-RT.....\$18.50 ea
 - Passenger DOWN..... P-1168-RB.....\$18.50 ea



- REAR LEFT DOOR DOVETAIL..... P-1173.....\$24.95 ea
- LEFT DOVETAIL BOLTS
 - Stainless..... P-81184-SS.....\$2.00 pr
 - Polished..... P-81184-PS.....\$3.50 pr



- REAR RIGHT DOOR DOVETAIL RECEIVER OR STRIKER
 - Aluminum..... P-1174-AL.....\$19.50 ea
 - Polished aluminum..... P-1174-PA.....\$22.50 ea
 - Plain steel..... P-1174.....\$16.50 ea
- STRIKER-RECEIVER BOLTS
 - Bolt kit, stainless..... P-81174.....\$2.25 ea
 - Bolt kit, polished..... P-81174-PS.....\$3.25 ea



PANEL TRUCK PARTS

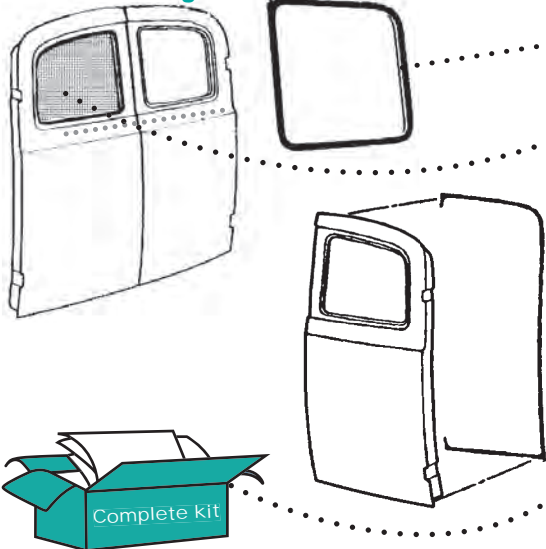

• REAR WINDOW SEALS..... P-3132.....\$59.95 pr
Small square side goes out, long round side in.

• REAR WINDOW GLASS, *takes 2 per truck, oversize shipping*
Clear..... P-1708-CLR\$50.00 ea
Tinted..... P-1709-TNT\$50.00 ea
Smoke..... P-1708-SMK.....\$50.00 ea

REAR WINDOW PATTERN..... B-1708.....\$10.00 ea

• REAR DOOR SEALS P-3130..... \$74.95 pr
Pair includes both doors and center piece

• "I NEED IT ALL" WEATHER-SEAL & ANTI-RATTLE KIT
Includes rear door and window seals.
1953-55 panel..... P-93102-5355 \$559.00 kit
1956 with windshield trim groove P-93102-56WG ... \$549.00 kit
1956 no trim groove..... P-93102-56NO \$549.00 kit



• PANEL TRUCK DOOR LOCKS
Matching ignition, all doors P-1130-4..... \$129.50 set
Rear door lock only..... 1131-P..... \$34.50 ea



• PANEL TRUCK LOCK LEVER P-1176.....\$15.00 ea
Slips into the end of rear door lock, activates locking mechanism

USA



• REAR DOOR LOCK RETAINER ..P-1133.....\$8.50 ea



• PANEL DOOR LATCH ROD SHOULDER BOLT
Each door has 2 rods & 2 plates, one rod has 2 rivets, (P-81140) where plate attaches to rod. Other door has 1 rivet and this bolt that attaches the whole thing together. High \$\$ because could not make many..... P-1190.....\$5.25 ea



• ACTIVATOR ROD RIVETS Set P-1196.....\$3.50 set
Each door has 2 rods & 2 plates, one rod has 2 rivets where plate attaches to rod. Other rod has 1 rivet and 1 shoulder bolt P-1140 that attaches the whole thing together.



• PANEL TRUCK OUTSIDE HANDLE
Beautiful finish, long shaft P-1170-L.....\$49.95 ea
Long shaft for inside handle, if not using inside handle, cut shaft, with inside handle, drill and tap shaft to 10/32.
Outside handle screws, polished.... P-81171\$1.45 pr
Outside handle pad P-1171\$4.00 ea



• PANEL INSIDE HANDLE P-1172.....\$12.55 ea
Uses 10/32 screw, polished SS..... P-81172.....\$0.80 ea

**HANDLE AND LATCH rods & regulators are in process,
get on waiting list.
You will be notified as pieces are finished.**

Many of our Panel Truck pieces have been out of stock. Unfortunately we lost one of the best fabricators and metal artist we have ever known. *Kim Stewart*, May he rest in peace. He was much loved and is missed by family and friends. His fine work lives on in many trucks! Please understand Panel truck items are made often one at a time, small quantities at best, Please bear with us as we work the items back into stock.



ABS INTERIOR	12-13
AIR CONDITIONING	80-81-82
AIR DEFLECTOR	122
ALTMANS EASY LATCH	105
ANTENNA	30
ANTI-RATTLE KIT	97
ARM RESTS	14
ASH TRAY	38
AWESOME ASSEMBLY KITS	65
AXLE, FRONT	165
AXLE, REAR STOCK	184-185
BATTERY BOX	56-57
BATTERY FLOOR HOLE LID	57, 117
BED BOLTS	139
BED COVERS	147
BED, CUSTOM, PROS PICK	148
BED FLOOR	137
BED KITS	132-135
BED MAT	26
BED PARTS	138-141 148-149
BED ROLL PLUGS	141
BED STRIPS	136
BEZELS	39
BIG BACK WINDOW CONVERSION	120
BODY REPAIR PANELS	117-130
BOOKS	10
BOXING PLATES	179
BRAKES	176-183
BULBS, HEADLIGHT	59
BUMPERS	28
CAB, COMPLETE	120
CAB MOUNTS	126-127
CAB REPAIR PANELS, CORNERS	116-121
CAB SKIRTING	128
CARPET	18-19
CENTER CONSOLES	14
CHOKE OR THROTTLE CABLE	39
CHOP TOP	121
CHRISTMAS CARDS	7
CIGAR LIGHTER	38
CLUTCH PARTS	180
COLUMN DROPS	171
COURTESY LIGHT	35
COVERS, TRUCK	27
COWL VENT	114
CUP HOLDERS	37-38
CUSTOM CAB EMBLEMS	33
DASH COVER	26
DASH FRAME	41
DASH PANELS	44-47
DASH REPAIR	119
DASH TRIM, DEFLECTOR	78-79
DECALS	9
DEFROST	78-79
DIMMER SWITCH	61
DIP STICK	88
DISC BRAKE KITS	176
DOG HOUSE	121
DOME LIGHT	35
DOOR HANDLE REGULATOR	103
DOOR HARDWARE	99
DOOR HINGE	105
DOOR LATCH	105
DOOR LOCKS	104
DOOR PANELS	12-15
DOOR REPAIR	98
DOOR WEATHERSTRIPPING	96
DOOR & WINDOW HANDLES	103
DRAG LINK	166
DRIP RAIL	120
DROPPED AXLE	165
EMBLEMS	32-33
EMERGENCY BRAKE	183
ENGINE	87-89
ENGINE MOUNTS	90-91
EXHAUST	88-89
FAN	83
FENDER ALIGNMENT	113
FENDER & FRONT END COVER	26
FENDERS, FRONT	124
FENDERS, REAR	130-131
FENDER WELT	131
FIREWALL	115
FIREWALL COVERS	115
FLOOR	116-117
FLOOR MAT	21
FRAME BOXING PLATES	179
FRAME HORN COVERS	28
FUN FORD STUFF	6-7-8
GAS CAPS	73
GAS/FUEL LINES	70
GASKETS	88-89
GAS SENDERS	68
GAS STUFF	68-72
GAS TANK	71-72
GAUGES, AFTERMARKET	48-49
GAUGES, STOCK	42-43, 57
GIFT CERTIFICATES	6
GIFTS	6-8
GLASS	92-93
GLASS KITS	93
GLOVE BOX	37
GRAVEL PAN	123
GRILLE	32
HEADERS	86
HEADLIGHT	59-61
HEADLINER	22
HEATER	78-79
HEAT SHIELD, HOOD.....	26
FLOOR	24
HINGE, DOOR.....	105
HINGE, HOOD	111
HOOD EMBLEM	33
HOOD & HOOD PARTS	110-113
HOOD TILT KITS	112
HORN	34
HUB CAPS	186



ID PLATE.....	36	SHORT & SMOOTH LEAF SPRING.....	158
IFS SUSPENSION.....	175	SHROUDS.....	83
IGNITION.....	58	SIDE WINDOW ANTI-RATTLE.....	97
INNER FENDER.....	125	SIGNS.....	7
INSULATION.....	19, 24, 25	SLIDING REAR WINDOW.....	192
KEYS.....	104	SOLID SIDE WINDOW.....	106-107
KICK PANELS.....	20	SPARE TIRE CARRIER.....	185
KING PINS.....	165	SPEEDOMETER CABLE.....	40
KNOBS.....	39	SPRINGS, LOWERING.....	158-159, 162
LATCH, DOOR.....	105	SPRINGS, STOCK.....	160-161-163
LATCH, HOOD.....	110	STAKE POCKET.....	138
LOCKS & KEYS.....	104	STARTER SOLENOID.....	53, 58
LONG BED.....	150-155	STEERING, STOCK.....	167
LOWERING KITS.....	157-159, 162	STEERING COLUMN, CUSTOM.....	166-169, 172-174
LOWERING TIPS.....	156	STEERING CONVERSIONS.....	169-170, 174
MANUALS.....	10	STEP PLATES.....	129, 150
MASKS.....	26	SUN VISORS, OUTSIDE.....	29
MASTER CYLINDER.....	179	SWAY BARS.....	157
MIRRORS.....	31	TAILGATES & PARTS.....	133, 142-145, 148, 153
MMB HOOD TILT KIT.....	112	TAIL LIGHT.....	64-67
MOLDING.....	120	TANK, GAS.....	71-72
MONO LEAF SPRINGS.....	158	TEMPERATURE SENDERS.....	50
MOTOR MOUNTS.....	91	TIE ROD.....	165
MUSTANG II IFS.....	175	TONNEAU COVER.....	147
OIL FILTER, SENDER ORIGINAL.....	87	TOYOTA STYLE STEERING.....	169
OVERDRIVE PARTS.....	50	TRANSMISSION COVERS.....	117
PANEL TRUCK PARTS.....	187-191	TRANSMISSION MOUNTS.....	91
PARKING BRAKE.....	183	TRIM, WINDOW.....	29
PARKING LIGHT.....	63	TRUCK COVERS.....	27
PATCHES.....	8	TURN SIGNALS.....	62
PATCH PANELS.....	116-119	U-JOINTS.....	168
PIN & BUSHING KIT.....	159	UNDER-BED GAS TANK.....	77-72
POWER STEERING.....	169-170	UNDER DASH COVERS.....	21
POWER WINDOWS.....	108-109	UPHOLSTERY.....	14-15
RADIATOR & PARTS.....	83-85	VALANCE, GRAVEL PAN.....	123
RADIO.....	30	VALANCE, RADIATOR.....	83
RAG JOINT.....	168	VALVE COVER DECALS.....	9
RATING PLATE.....	36	VENT WINDOW.....	100-101
REAR AXLE.....	184-485	VISORS, INSIDE.....	23
REAR VIEW MIRROR.....	31	VISORS, OUTSIDE.....	29
REAR WALL.....	12	VOLTAGE REDUCERS.....	53
REMOTE KEYLESS ENTRY.....	109	VOLTAGE REGULATORS.....	58
ROCKER PANELS.....	118	WEATHERSTRIPPING.....	94-96
ROLL PANS.....	146	WHEELS.....	186
ROOF, steel and fiberglass.....	120	WHEEL TUBS.....	131
RUBBER SEALS.....	94-95	WINDOW REGULATORS.....	102
RUNNING BOARD.....	129, 150	WINDOW RUBBERS.....	94-95
SAMPLES.....	11	WINDOW TRIM.....	120
SEAT BELTS.....	17	WINDOW VISORS, INSIDE.....	23
SEAT COVERS.....	15-16	WINDSHIELDS.....	92
SEAT FOAM.....	16	WINDSHIELD WASHER.....	74
SEAT PARTS.....	16	WIPERS.....	75-77
SENDING UNITS.....	50	WIRING, 6 VOLT.....	53
SHIRTS.....	6	WIRING ACCESSORIES.....	54-55
SHOCKS.....	164-165	WIRING HARNESSSES.....	51-52
SHOP MANUALS.....	10	WRAP AROUND WINDOW.....	120



MAIL ORDERS TO:
MID FIFTY F-100 PARTS
5221 HIGHWAY 68
GOLDEN VALLEY, AZ 86413
FAX ORDERS TO:
1-928-565-2822
PHONE ORDERS:
1-800-252-1956
or 928-565-2727

NAME _____
 STREET _____
 CITY _____
 STATE _____ ZIP _____
 PHONE _____
 email: _____

TRUCK YEAR _____ GRILLE _____ ENGINE _____ TRANS _____
 REAR AXLE _____ FRONT SUSPENSION _____

Note: We Assume 1/2 Ton Short bed, Pick Up, 12 Volt. If Other Please Note:

PART NUMBER	DESCRIPTION NOTE: CHROME, POLISHED STAINLESS, ETC.	QUANTITY PR. EA. KIT	PRICE EACH	TOTAL PRICE

Please list any items we do not have you may need, we are adding all the time and will notify you if it becomes available.

<p>SHIPPING: Normal shipping charges are 10% of total order MINIMUM SHIPPING\$13.00</p> <p>UPS 3 DAY AIR, MINIMUM additional charge (1 lb starts at\$14.00 UPS 2 DAY AIR, MINIMUM additional charge (1 lb starts at\$18.00 UPS NEXT DAY, MINIMUM additional charge (1 lb starts at\$24.00 Ups charges by dimensions and weight for AIR and Ground packages</p> <p>COD, UPS charge for collecting on delivery...per box\$10.50 PAYMENT: We accept Master Card, VISA, Discover & American Express, Debit, or Enclose a Check or Money Order. We also ship UPS COD, add \$10.50 cod fee. NOTE: Call for help with oversize pieces or any special shipping requirements.</p> <p>Charge or Debit card Number, American Express, MasterCard, Visa or Discover Expiration date v-code _____</p>	TOTAL PARTS	
	NORMAL SHIPPING 10% of total	
	UPS AIR FEE	
	UPS COD FEE \$10.50, per box	
	8.85% Sales Tax AZ Residents ONLY	
OTHER		
TOTAL		



SALE

watch for this **SALE** throughout book, prices shown are Sale prices and some are limited quantities and limited time.

1948-52 F-1 Catalog

Now Available

Just call or email for a Free copy
Working on a 57-60, 61-66 catalog
Check website for parts until finished



See page 115



NEW

COMPLETE ONE PIECE FIREWALL

CAUTION: This piece has been reproduced in China. It is being advertised as 1956 and 1953-55. The 1953-55 is really just a 1956 with a gob of holes that match the 53-55. It will fit but requires some TLC. We talked them into a run without holes (pictured here) still has some heater mounting holes but at least we got a bunch eliminated. Freight shipping.

We suggest the 56 No Holes as it will be easier to fit and use.

1956 NO HOLES.....7773-56NH ... **SALE**... \$250.00

NEW

See page 129



F-100 STEP PLATES

Pair.....0324-F100..... \$75.00 pr

Expected Dec 2019,

get on waiting list for special price.



56 DOOR SHELL

\$495.00

DRIVER.....7795-56L

PASSENGER7795-56R

See page 98

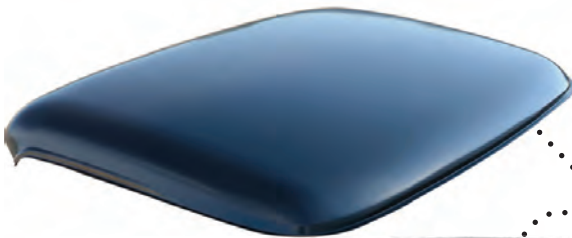

Back in Stock!

• **STEEL ROOF** 1956 only.....7766-56 \$349.95 ea



• **DRIP RAIL** 1956 only97760..... \$148.50 set
3 piece, reproduction of original, 56' only available



• **SOFFIT-BEAK-OVERHANG**, often rusted out above and hanging over windshield 1956.....7768-56 \$159.95 ea
Note is pre-assembled, too hard to install otherwise.

See page 120

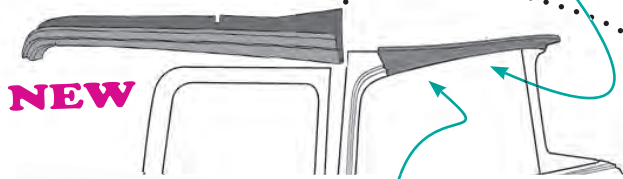

• **ROOF SUPPORT ABOVE DOOR HEADER**, upper door jam & roof support, front part goes behind above header cover.
Driver side7763-56L \$142.50 ea
Passenger7763-56R..... \$142.50 ea

See page 120



• **INNER HEADER COVER**, goes inside above windshield, Mirror mounts on this.....7764-56 \$159.95 ea



• **CENTER SUPPORT & DOME LIGHT BRACKET MOUNT**
3 piece set.....7765-56 \$89.95 set

NEW STUFF Too many new parts to list here, watch for NEW signs throughout book.

QUICK FIND MAP

THE PAGE NUMBER LISTED IS THE BEGINNING OF THAT SECTION, SEE THE PAGES FOLLOWING IT FOR MORE RELATED ITEMS

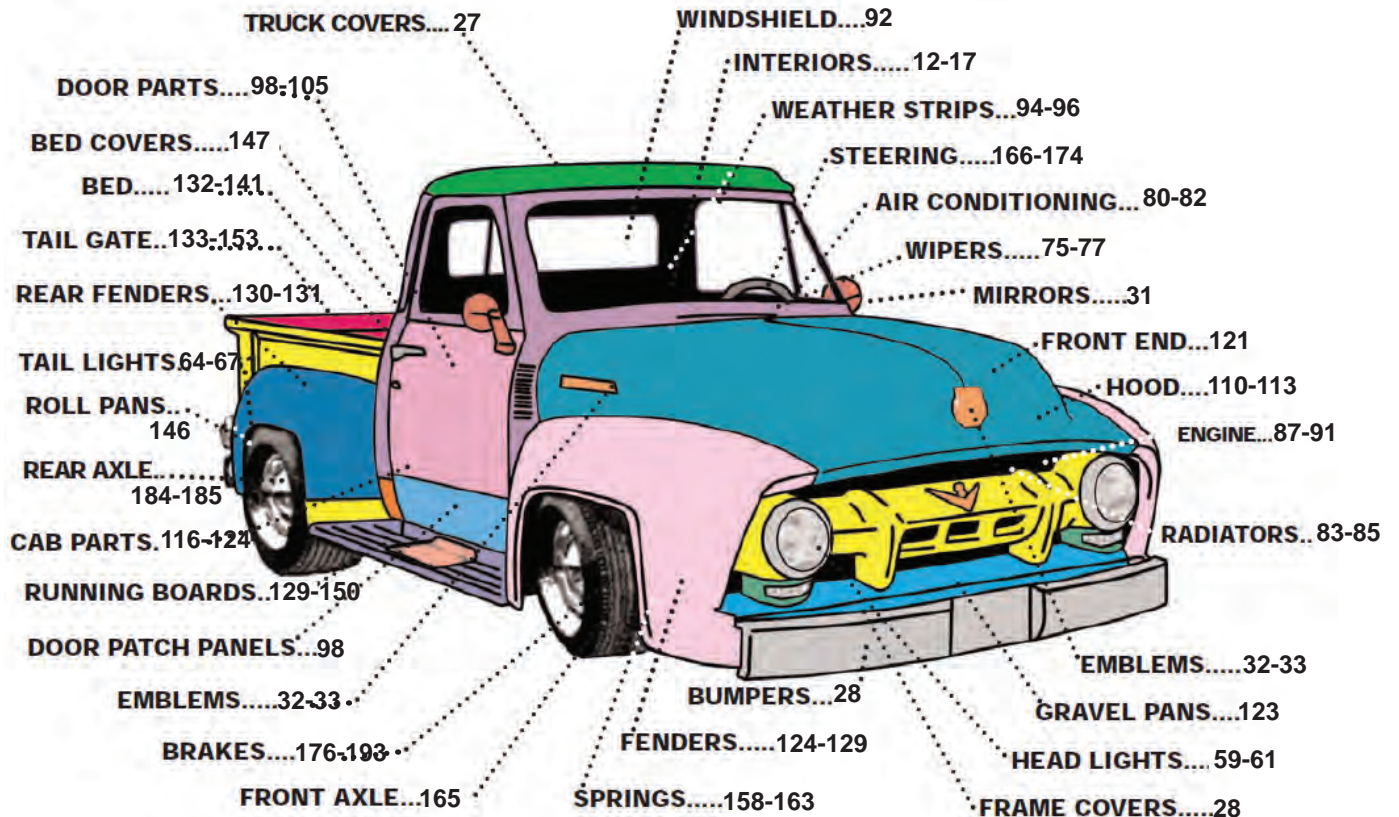

MID FIFTY F-100 PARTS INC.

The web is wonderful, but we find speaking to each other personally is often the best way to help.
Give us a call.

1-800-252-1956

1-928-565-2763

If you are visiting Las Vegas or Laughlin NV, don't forget to visit our showroom near Kingman AZ,

5221 Hwy. 68, GOLDEN VALLEY, AZ 86413

Visit our Website: MIDFIFTY.COM

Fax 1-928-565-2822 e-mail: mail@midfifty.com web: www.midfifty.com

