

Wisconsin Society of Architects
July/August 1991



W I S C O N S I N

Architect

1991 WSA Design Awards

DIALOGUE

WSA Convention Report

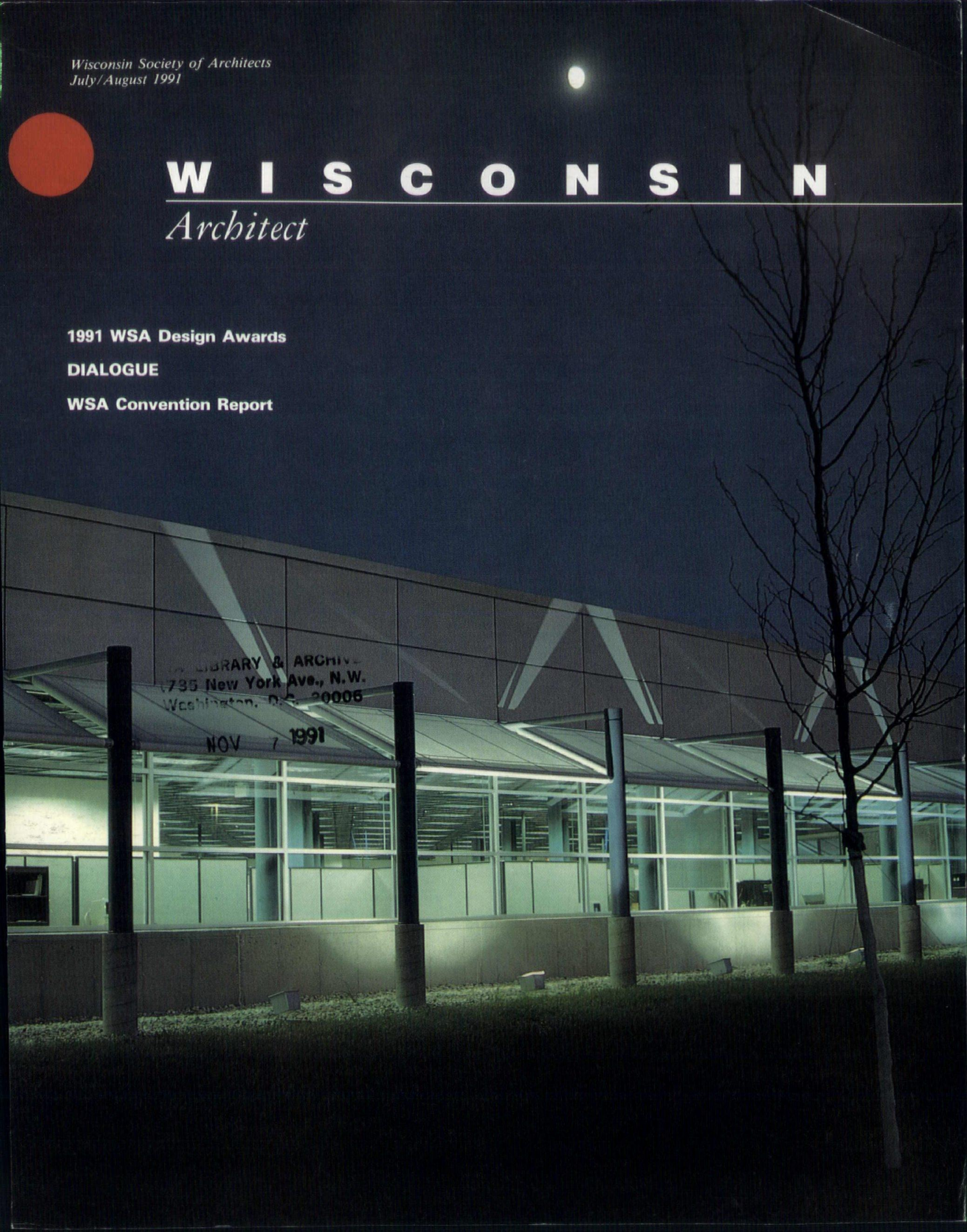

LIBRARY & ARCHIVE
1735 New York Ave., N.W.
Washington, D.C. 20006

NOV 7 1991

Training

(tran•ing) 1: the act or process of one who trains.
2: the state of being trained.



Webster defines it as a skill or discipline...
...we say it's skill in the work we do!



Wisconsin Pipe Trades Produce.
Union Plumbers, Steamfitters and Sprinklerfitters

P.O. BOX 296 NEKOOSA, WI 54457 • PHONE (715) 325-2323

W I S C O N S I N

Architect

Wisconsin Society of Architects Board of

Directors: Richard W. Eschner, AIA, *President*;
Roger D. Roslansky, AIA, *Vice President/President-Elect*; Emma Macari, AIA, *Secretary/Treasurer*, Jay A. McLean, AIA, *Past President*; Ross T. Potter, AIA; Brian F. Larson, AIA; James E. Larson, AIA; Douglas H. Smith, AIA; Kevin J. Connolly, AIA; Lisa L. Kennedy, AIA; Walter L. Wilson, AIA; Horst W. Lobe, AIA; Robert E. Shipley, AIA; Erik D. Hansen, AIA; Stan M. Ramaker, AIA; E. Mitchell Spencer, AIA; Tim Larson, AIA; Kent A. Calloway (Associate Representative); Jeff Polachowski (UWM SARUP Student Representative); Jamison White (MSOE Student Representative); William M. Babcock, *Executive Director*.

Wisconsin Society of Architects/AIA: 321 South Hamilton Street, Madison, Wisconsin 53703—Phone (608) 257-8477.

Wisconsin Architects Foundation Board of

Directors: 321 S. Hamilton Street, Madison, Wisconsin 53703—Phone (608) 257-8477; Gary V. Zimmerman, AIA, *President*; Orville E. Arnold, *Vice President*; Jack L. Fischer, AIA, *Secretary/Treasurer*; Robert D. Cooper, AIA; Dean Robert C. Greenstreet, Clarence Huettentrauch, AIA, FCSI; James T. Potter, AIA; Richard J. Griese, AIA; Valentine J. Schute, Jr., AIA; William M. Babcock, *Executive Director*.

North Central Region AIA: Robert C. Mutchler, AIA, *Director*.

Southwest Wisconsin Chapter: Horst W. Lobe, AIA, *President*; Robert E. Shipley, AIA, *Vice President/President-Elect*; John W. Sutton, AIA, *Secretary/Treasurer*.

Southeast Wisconsin Chapter: Lisa L. Kennedy, AIA, *President*; Walter L. Wilson, AIA, *Vice President/President-Elect*; Jeri McClenaghan-Ihde, AIA, *Secretary/Treasurer*.

Northwest Wisconsin Chapter: Tim P. Larson, AIA, *President*; E. Mitchell Spencer, AIA, *Vice President/President-Elect*.

Northeast Wisconsin Chapter: Erik D. Hansen, AIA, *President*; Stan M. Ramaker, AIA, *Vice President/President-Elect*; Mark Keating, AIA, *Secretary/Treasurer*.

Wisconsin Architect, Inc.; *Board of Directors*; Richard W. Eschner, AIA; Jay A. McLean, AIA; Roger D. Roslansky, AIA, Emma Macari, AIA.

Wisconsin Architect Editorial Board: Peter J. Schuyler, AIA, *Chair*; Dean Robert C. Greenstreet, Douglas C. Ryhn, Nancy J. Hubbard; William M. Babcock. *Chapter Coordinators:* Robert E. Shipley, AIA; Daniel J. Becker, AIA; David G. Peterson, AIA; Dennis L. Olson, AIA.

Magazine Staff

Editor

William Babcock

Coordinating Editor

Grace Stith

Advertising & Production Manager

Cheryl Seurinck

Honor Awards

- 26 Gilbert M. Simmons Library
Herbst Eppstein Keller & Chadek, Inc.
- 28 Kilbourn Knoll Historic Apartments
Sunarc Studio
- 30 Onalaska Public Library
HSR Associates, Inc.
- 32 Heurikon Corporation
Potter Lawson Architects

Merit Awards

- 34 The Avenue
Design Coalition, Inc.
- 35 Riveredge Nature Center
Plunkett Keymar Reginato Architects
- 36 Kohler Design Center
Heike/Design Associates, Inc.
- 37 Goldi
Kubala Washatko Architects, Inc.
- 38 Wisconsin Education Association Council
Potter Lawson Architects

Features

- 11 DIALOGUE
- 19 Convention Exhibitors
- 44 DIALOGUE...More Than Just Talk
Victoria Carlson
- 48 The Great Debate: A Mystery
Victoria Carlson
- 50 A Greenprint of the 21st Century: Seeking Architectural Options
Mary Guzowski

Departments

- 7 Guidelines
- 41 FYI
- 55 Forum
- 57 Society News
- 61 Marketplace
- 61 Advertiser Index

Cover: Heurikon Corporation, Madison, Wisconsin
Potter Lawson Architects
Photographer: Jim Potter, AIA

WISCONSIN ARCHITECT serves the design and construction industry in Wisconsin with circulation to Architects, Engineers, General Contractors, Business and Interior Designers, Landscape Architects, Certified Planners, Developers, Specifiers, Construction Managers, Builders, Manufacturers, and Suppliers. *Wisconsin Architect* is the official publication of the Wisconsin Society of Architects/A.I.A., published by Wisconsin Architect, Inc. Address all editorial and advertising inquiries to: Editor, Wisconsin Architect, 321 S. Hamilton St., Madison, WI 53703; phone 608/257-8477. Wisconsin Architect and the WSA disclaim liability for statements by the editors, contributors, and advertisers.

SMART MONEY. THE PIVOTAL PART OF ANY NEW CONSTRUCTION PROJECT.

If you're in the design or contracting business, Wisconsin Electric's Smart Money For Business program can provide added value to your service.

Contact us with your new construction projects early on. We'll help you design and build more efficient, comfortable, higher-value facilities. And, we offer cash incentives to make it worth your while.

Your clients benefit immediately, and later,

when energy-efficiency measures translate into lower energy costs and higher productivity and profits.

To include Smart Money in your next new construction project, or to apply for your Professional Design Incentive, contact Wisconsin Electric at 1-800-544-7989. In the Milwaukee area, call 221-4900.

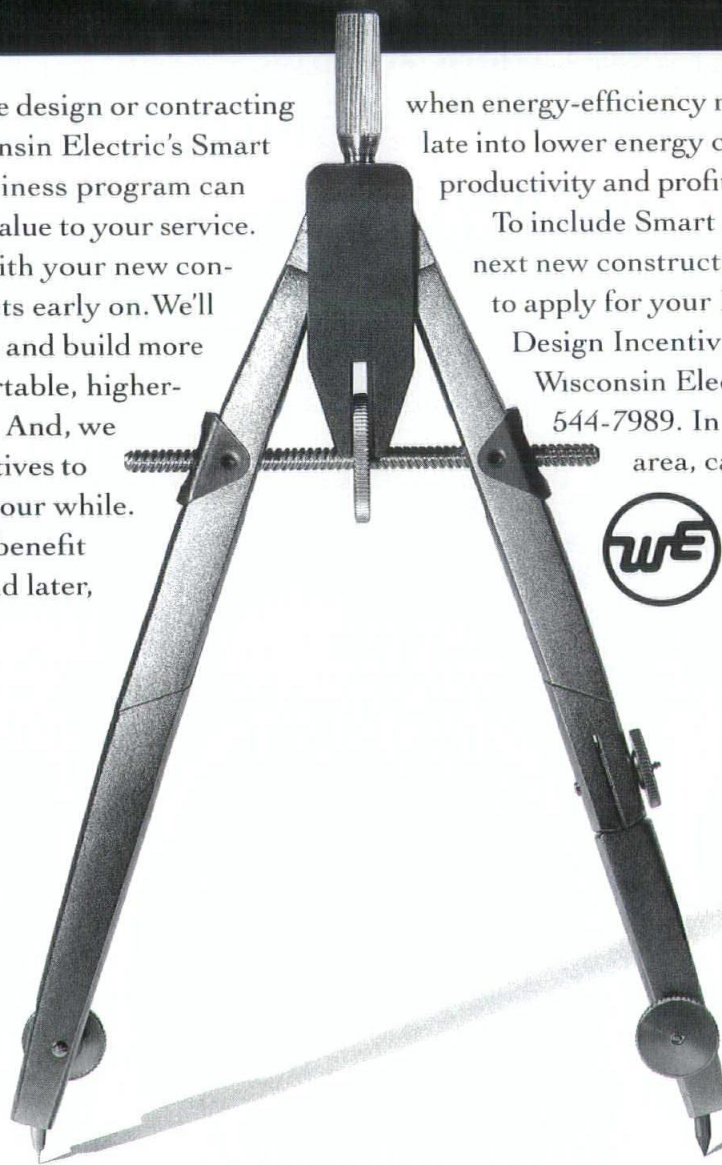

SMART MONEY FOR BUSINESS PROGRAM

CALL 221-4900. OUTSIDE MILWAUKEE, 1-800-544-7989.

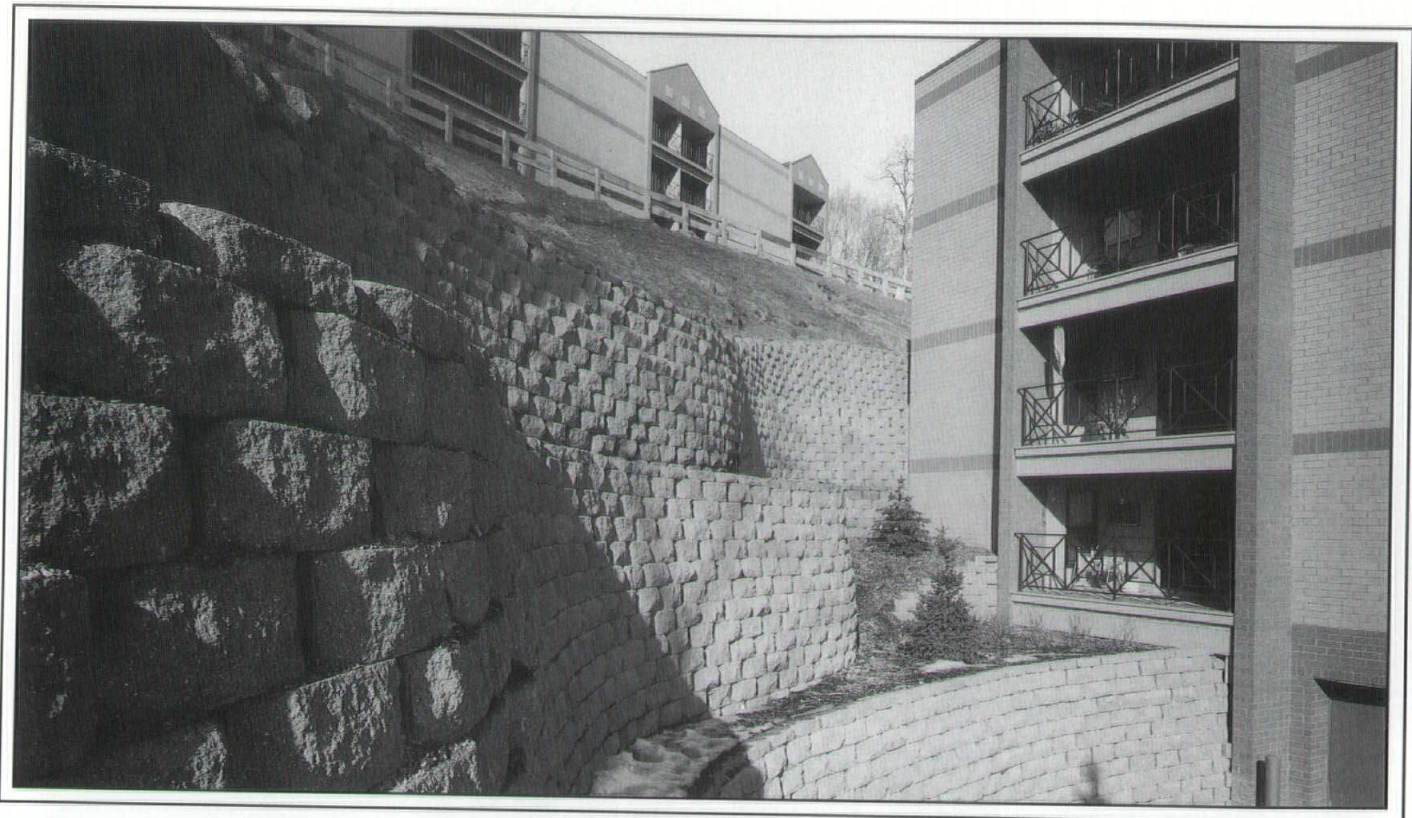

Sculptured Rock is your natural choice for a permanent and beautiful landscape.

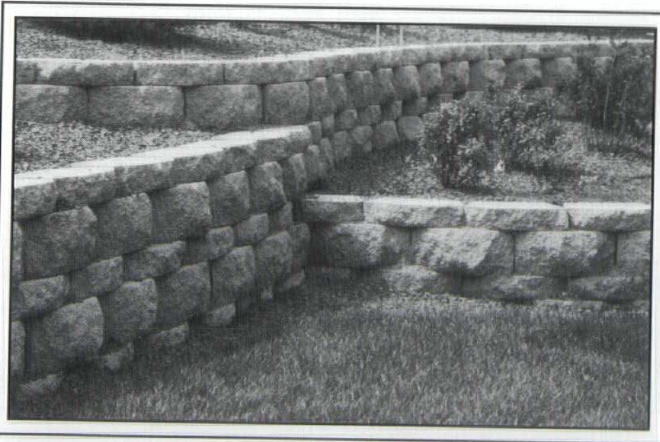

KeyStone® retaining walls are designed to function beautifully for a lifetime, providing long term savings compared to timbers which will deteriorate.

There are no metal members in **KeyStone** to rust away, such as found in timbers.

No cumbersome tools, mortars, cutting or preservative treatments are required with **KeyStone**, and the wall goes up in half the time of old methods.

Build it to last!

- Individual concrete units locked together with fiberglass dowels.
- Available in 8" or 4" high mini-units.
- Choice of face, color and texture.
- Strong, permanent and maintenance free.
- Quick and easy installation reduces labor.

KEYSTONE
RETAINING WALL SYSTEMS

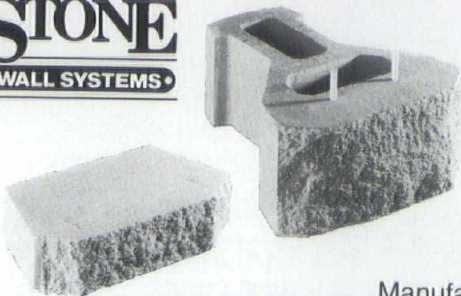

Manufactured in this area by

BEST BLOCK  **COMPANY**

WEATHER-TEK IS OPENING A NEW WINDOW OF OPPORTUNITY FOR YOU.

**MARVIN
WINDOWS
ARE MADE
TO ORDER.**



At Weather-Tek, we believe building with the best is the only way to build. That's why we now offer the better alternative to aluminum windows: Marvin Wood Windows, for both commercial and residential applications.

For over a decade, Weather-Tek has been known for bringing quality and service to the architectural community with products such as Carlisle Single Ply, Naturalite Skylights and Metal-Era Roof Edge systems. Now we've added Marvin Wood Windows to our impressive list.

Marvin windows give you the beauty that only wood can provide, with quality fine-grained Ponderosa pine that's made Marvin the window



of choice in residential applications for more than 40 years.

And across the entire line, Marvin wood and clad wood windows are built to perform — and in many cases, even out-perform — commercial grade aluminum windows.

Now, you can have it all: The beauty of wood, commercial-code compliance and prices comparable to aluminum.

From names you can trust, Marvin Windows and Weather-Tek. Call us at 414-521-2555.

N4 W22450 Bluemound Road,
Waukesha, Wisconsin 53186.

**WEATHER-TEK
BUILDING
PRODUCTS, INC.**



Good design had a really good year. *The July/August issue continues the tradition of showcasing the design achievements of Wisconsin's architectural community. The nine award-*

winning projects were selected by a jury of three distinguished architects, including Cathy Simon, FAIA, San Francisco; Ines Elskop, New York; and Francis Halsband, FAIA, New York. The jury was unanimous in lauding the diversity of the projects submitted.

For the first time since my involvement with the WSA Design Awards program, a jury has specifically found in the three new building projects an affinity to the landscape, to the siting of the building, to the prairie design...a very appropriate design feature for Wisconsin. The other winners, in interiors, housing and restoration, also had a community of good planning and execution of detail.

There were 79 entries considered for award; the four Honor Awards and five Merit Awards represent over 10% of the submittals. This is a record for our program, so the WSA can proudly say "Good design had a really good year."

Congratulations to all the architects, consultants, owners and contractors involved in the award-winning projects.

Emma Macari, AIA, Co-Chair

1991 WSA Design Awards Committee

"How do I end up with so much functional space in my buildings? By using natural gas furnaces in all my designs. The new high-efficiency furnaces are so small they can fit in a closet, leaving plenty of room for

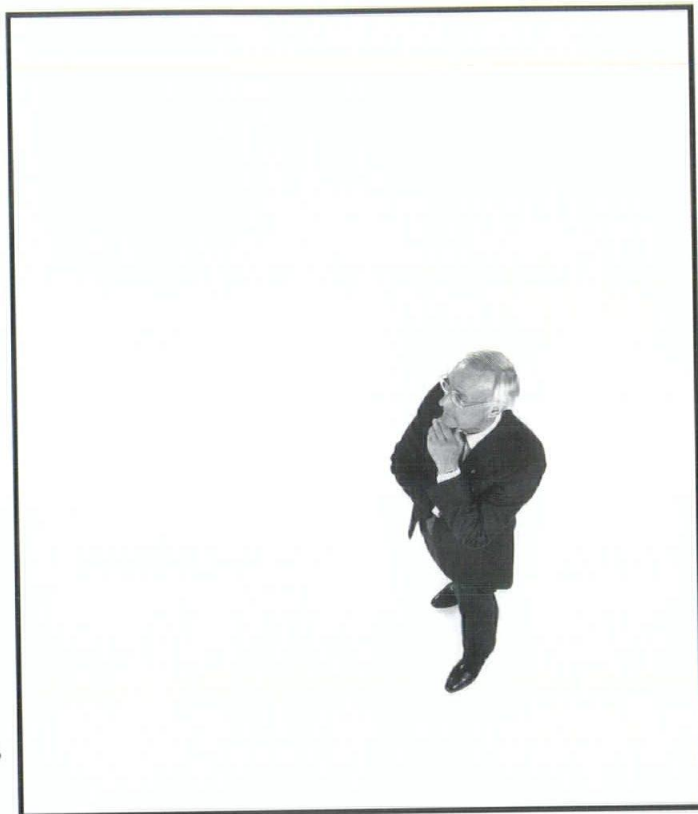

the dry heat reduces expansion and contraction of building materials.

"Thanks to high-tech gas furnaces, I can actually walk in space."

Bruno Franceschi - Architect/Developer

All in all, I can't think of a better way to launch a new building than using natural

other office essentials. And today's natural gas furnaces don't require a fire-rated room, which means even more space for me to explore.

The
WISE[™]
Choice
WISE Choices For Business

Tenants actually prefer natural gas furnaces. They save energy, money and

gas furnaces."

If you'd like to discover how high-efficiency natural gas furnaces can help you get into space, call Wisconsin Gas at (414) 291-6985 (in Milwaukee) or (608) 837-8551 (outside Milwaukee) today. Your future tenants will be so happy, they'll be in orbit.

WISCONSIN GAS

Response.

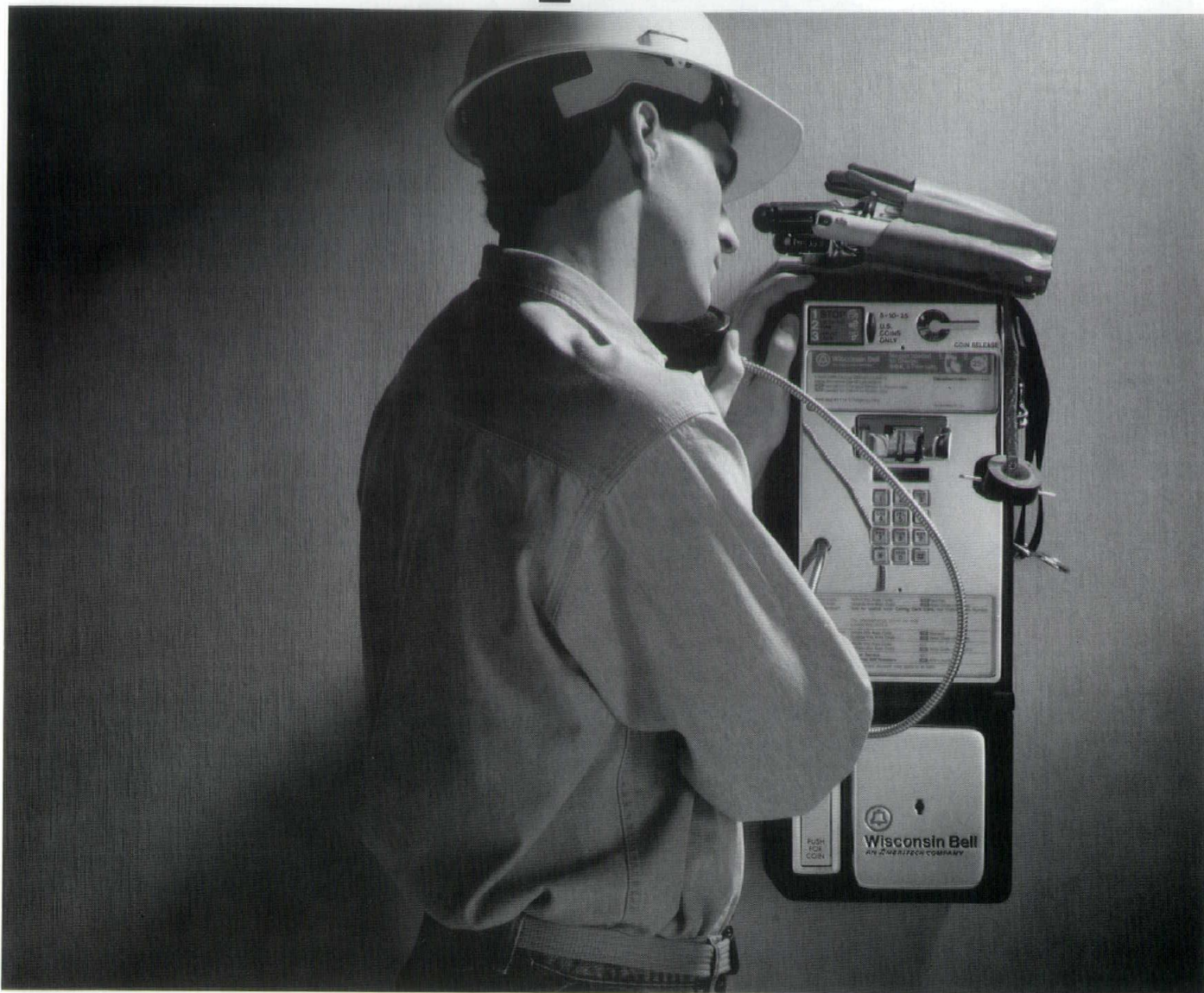

You're responsive to your customers. And at Wisconsin Bell, we're responsive to them, also.

Which means if a problem should arise, you'll get a quick response from us - we'll repair or replace your Wisconsin Bell public phone at no cost to you. Response like that has helped us provide dependable, reliable service to public telephone agents for over 100 years.

Wisconsin Bell. We're everything you want in a public telephone. For more information about Wisconsin Bell public telephones, call **1-800-924-2772**.



Wisconsin Bell
AN AMERITECH COMPANY

The Concrete Advantage

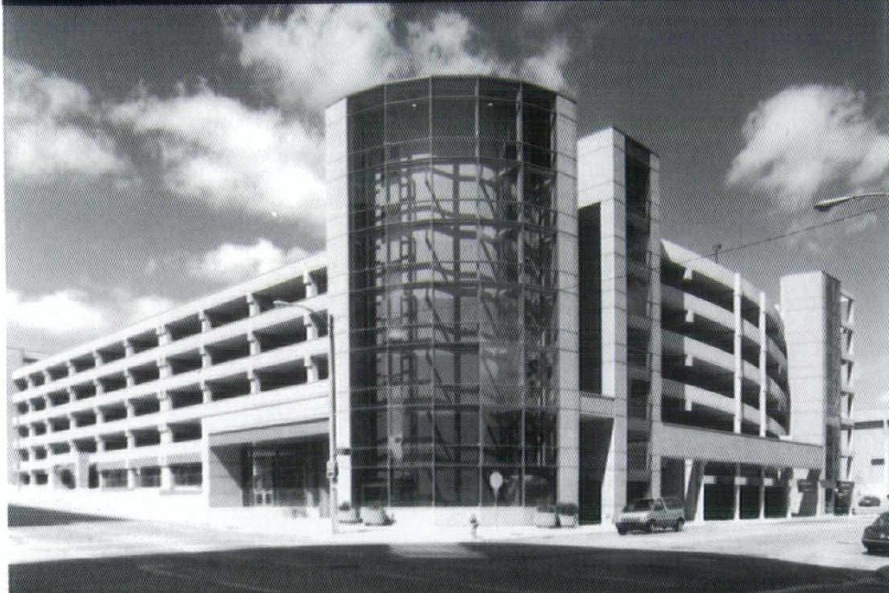

Bradley Center Parking Structure, 8th and West State Street, Milwaukee

Cast in place concrete parking structures.

Cast in place concrete is economical, durable and flexible. And its monolithic structure eliminates most of the maintenance associated with other construction methods.

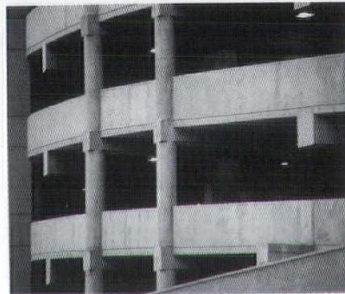

STRUCTURAL CONCRETE PROMOTION TEAM
Wisconsin Ready Mixed Concrete Association
9415 W. Forest Home Avenue
Hales Corners, WI 53130



800-242-6298

Pominent Wisconsin landscape architect selling his Door County "Dream Retreat" property. High, spacious, wooded, bluff lot on private road near Ellison Bay. Amenities include dramatic views of Green Bay waters, The Clearing and exhilarating sunsets; abundant wildflowers; and peaceful solitude. Yet convenient to sand beach, tennis courts, boat launching area and outstanding fishing. Currently assessed at \$32,000. Will sell for \$29,900. (608) 233-0180.

Classic curves — strength and beauty are combined in the new fiberglass Tulip Collection from LFI. Rich colors are molded into litter receptacles, ash urns, and planters. Only from LFI/Landscape Forms.



Bill Quinlan
835 West Webster
Chicago, IL 60614
312/871-8810
312/871-4617 FAX

DIALOGUE



John G. Horky, AIA, 1991 WSA Convention Chairman.

The 1991 WSA Convention, held May 7 & 8 in Oconomowoc, initiated what is hoped to become an ongoing DIALOGUE on architecture. From the Honor Awards Banquet and opening general session with Grabow and Rotondi through the marketing presentation by Stu Rose, the annual two-day conference featured exceptional speakers, on-target professional development seminars, outstanding displays of design and construction industry products and services, plus plenty of interaction, fun and mystery!

Special thanks are in order for members of the 1991 WSA Convention Committee: Chairman John Horky, AIA; David Ewanowski, AIA; J.T. Heater, AIA; Nancy Hubbard; Lisa Kennedy, AIA; David Petrusis; Jim Sullivan; Allen Washatko, AIA;

and Chuck Western. Their hard work and dedication to duty resulted in another informative, entertaining and successful Convention.

In addition to all of the outstanding exhibitors, the generous support received by the following Convention sponsors enabled the WSA to feature exceptional keynote speakers and offer several special programs and events that otherwise would not have been possible: Oscar J. Boldt Construction Company, Klipstein Insurance Services, Inc., Wisconsin Concrete Masonry Association, Building Service Inc., and Best Block Company. Thank you!

Ace photographer Joe Paskus captured the following memorable moments from the 1991 WSA Convention...DIALOGUE.



Gordon Orr, FAIA, receives Citation from WSA President Richard Eschner, AIA.



Kerry VanDross presents Best Block Company contribution to WAF.



WAF President Gary Zimmerman, AIA, accepts Milwaukee Chapter CSI contribution from Clarence Huettnerauch, AIA, FCSI.

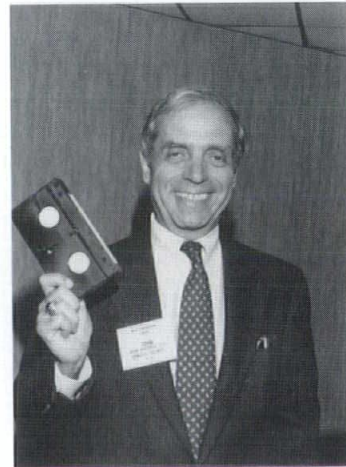

Why is this man smiling? John DiNardo, AIA General Counsel.

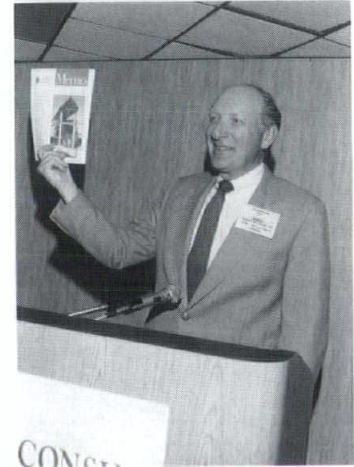

Robert Mutchler, AIA, AIA Regional Director.



Leonard H. Reinke, FAIA, 1991 WSA Golden Award recipient.



Emma Macari, AIA, Co-Chair WSA Design Awards.

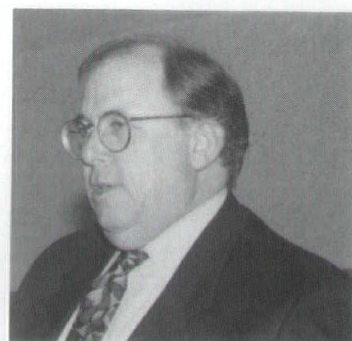

Alan Chimacoff, AIA.



WSA President Richard Eschner, AIA, and Jim Rossmeissl, Oscar J. Boldt Construction Co.

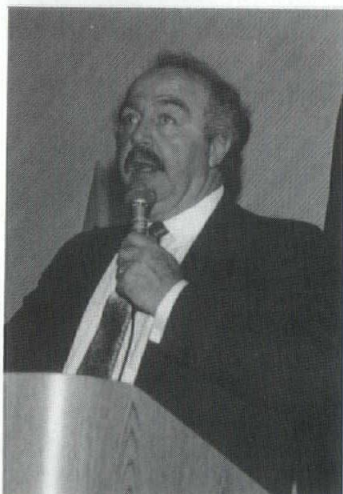

Ron Dentinger, Wisconsin's Funniest Person.





"Building a DIALOGUE" with Curt Hastings, Jim Rossmeissl and Tom Kraemer.



"How to Win & Keep Clients" with Patricia Keating, James Plowman, Ken Domurath and Jim Whiteside.

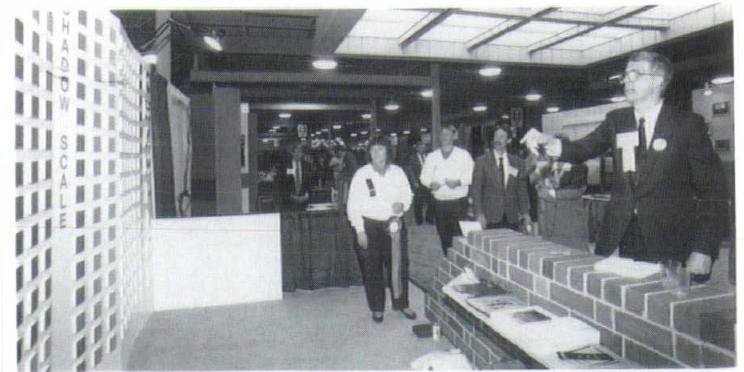

WSA President Dick Eschner, AIA, sharpens up his dart game.

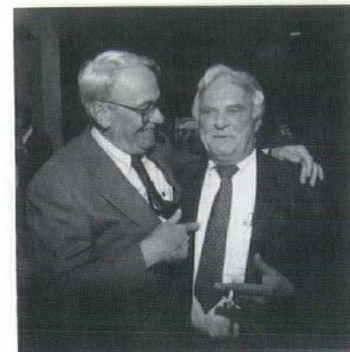

A chance to bump into old friends.



Some DIALOGUE on the exhibit floor.



Popcorn & Beer?

Record-breaking attendance kept
WSA staff busy.

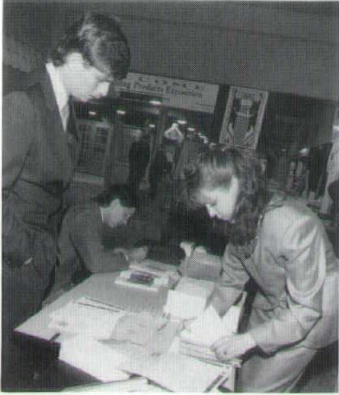

Photo courtesy of Mary Ann Tate.

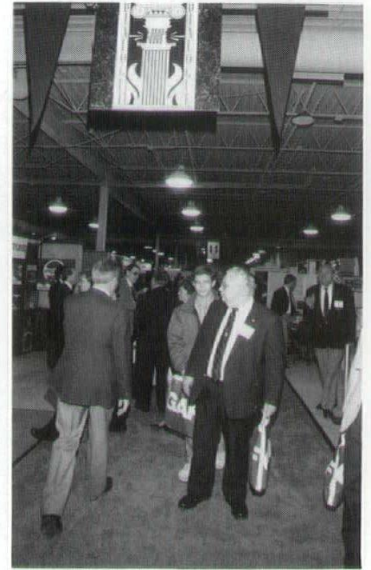

Photo courtesy of Mary Ann Tate.

A Tough Choice Made Beautiful

With Monarch Tile's selection of over 275 varieties of tile, it's a tough choice. But that's the beauty of it, because it's that choice that provides you freedom. To select the colors, sizes, textures and finishes that best fit your next project,

Visit Our
Showroom!

3635 N. 124th St.
Brookfield, WI 53005

or call!

414/781-3110
800/843-1550



Tizio Plus®

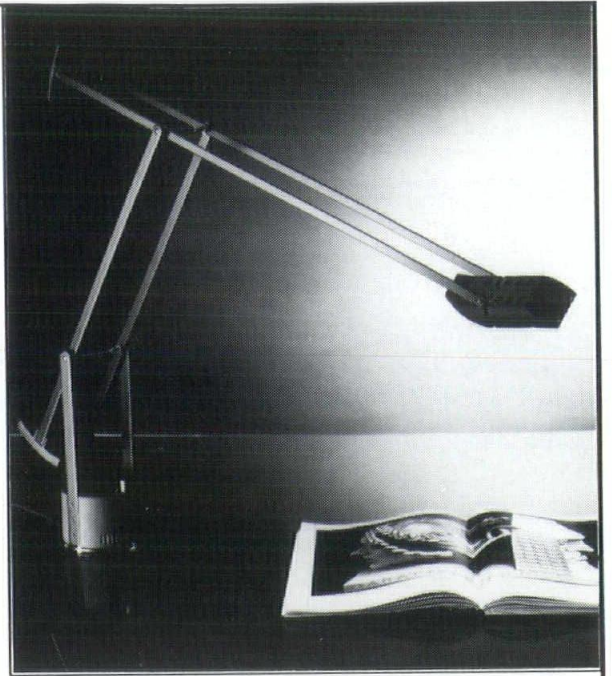

208 West Kinzie Street
Chicago, IL 60610
312.644.0510

Artemide®

IMPORTANT NOTICE FREE COMPUTER DESIGN SERVICE FOR MASONRY WALLS

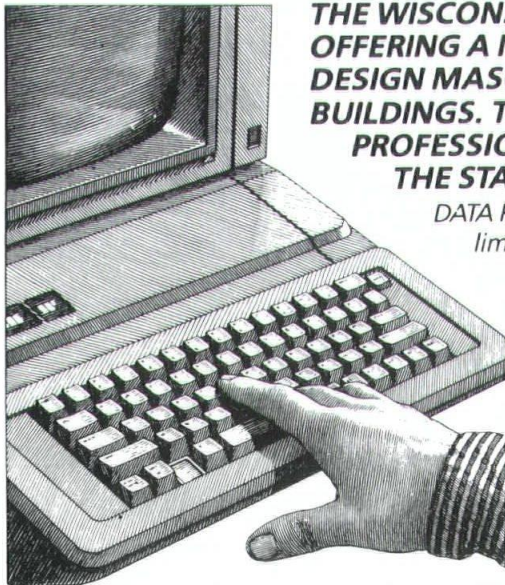

THE WISCONSIN CONCRETE & PRODUCTS ASSOCIATION IS OFFERING A NEW SERVICE WHICH WILL ANALYZE OR DESIGN MASONRY WALLS FOR LOW, MID OR HIGH RISE BUILDINGS. THIS SERVICE IS OFFERED FREE TO DESIGN PROFESSIONALS—ARCHITECTS AND ENGINEERS—IN THE STATE OF WISCONSIN.

DATA PROVIDED: The program will check resisting moments limited by steel stress, masonry stress and deflection of the wall. It also checks shearing resistance limited by shear stress and bond strength and checks flexural compressive stresses, both allowable and actual. Once the stresses have been determined, the programs will check various masonry configurations to arrive at the configuration which would be the most economical construction.

CALL OR WRITE TODAY FOR COMPLETE INFORMATION

414 773-2888
1-800-722-4248
RICHARD H. WALTER, P.E.
EXECUTIVE DIRECTOR, WCMA

WCMA
Wisconsin
Concrete
Masonry Association

P.O. Box 339 • Valders, WI 54245 • 414-773-2888 • 1-800-722-4248 • FAX: 414-773-2823

Cure For The Common Window Pain.

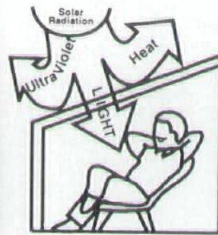

HEAT MIRROR™ stops 99.5% of fabric-fading ultraviolet radiation. *It's absolutely transparent to let in maximum light, yet reflects heat back to its source. Your homeowners stay warmer in winter, cooler in summer.*

Specially coated film between twin sealed air spaces doesn't restrict light, but holds back heat. It actually insulates up to R-4.5. **better than any other type of window.** All of our sun rooms, patio rooms and windows are available with HEAT MIRROR glass. Call us now. Don't settle for the common pane; switch to the wonder window.

**Four Seasons Remodeling
& Design Group**
Menasha, Wisconsin 54952
(414) 722-8786



CLASSIQUE™ elevator. Ideal for homes or condos.



- Affordable and elegant addition.
- Ideal when stairs are a problem.
- Can be installed where space is limited.
- Installed in new or existing dwellings.
- Oak paneling with choice of Natural Oak, Pennsylvania Cherry, or Antique Walnut finishes.
- Exclusive 2-year warranty.

Ask about other Cheney products.

FOR FREE BROCHURE, WRITE OR CALL:

1-800-782-1222
IN WI 1-800-552-7711

Freedom of Movement®

CHENEY 

Dept. WA791 P.O. Box 51188
2445 South Calhoun Rd., New Berlin, WI 53151

Why do

business

with

Klipstein

Insurance

Services?

- Because we specialize in designing insurance programs for architects and engineers.
- Because we provide the individual attention you need and deserve.
- Because we are knowledgeable about the many risks the design industry may encounter.
- Because we are independent insurance agents who can choose the best policies available for you.

Wisconsin's exclusive carrier of Design Professional Insurance Company (DPIC). **PLAN**

KLIPSTEIN
INSURANCE SERVICES, INC.



216 N. Midvale Blvd. • Madison, WI 53705
1-800-279-7181 • Paul Berta, Tom Dowling

**For Brick
as well as
Concrete
everyday is
TEWSday**

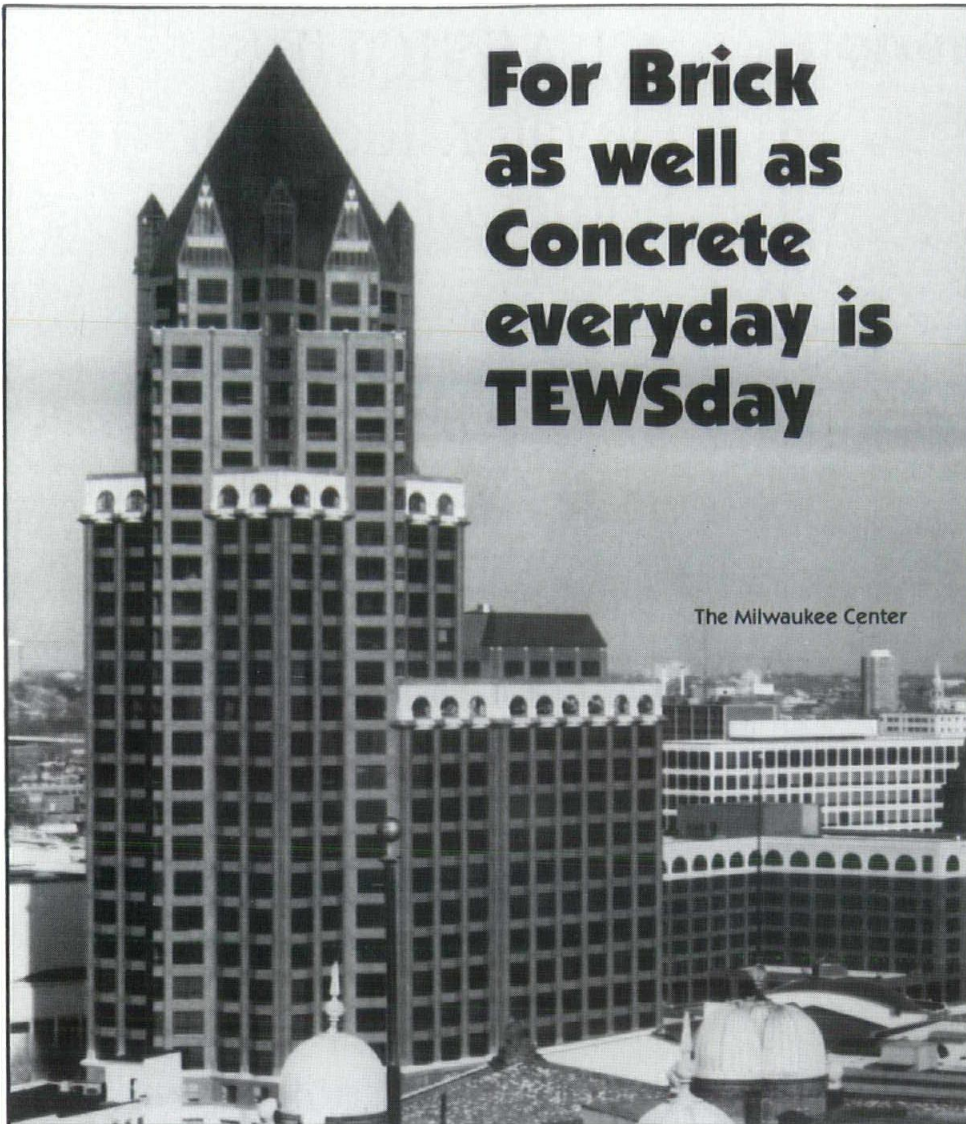

The Milwaukee Center

TEWS
Company

Contractor Supply Center

7200 South 10th Street, Oak Creek, Wisconsin
414/764-8700 Toll-free 1-800/686-8401

*Black & White Murals *8x10 Glossy Repros
*We Reproduce Blueprints or Masters For
Making Blueprints

PHOTOCOPY

104 East Mason St. Milwaukee, Wisconsin 53202

For Service . . .

CALL: 1-(414)-272-1255

S
U
P
P
O
R
T
I
S
E
O
U
R
S

An artistic
expression of
our expertise—
to fashion
metal & glass
to perfection

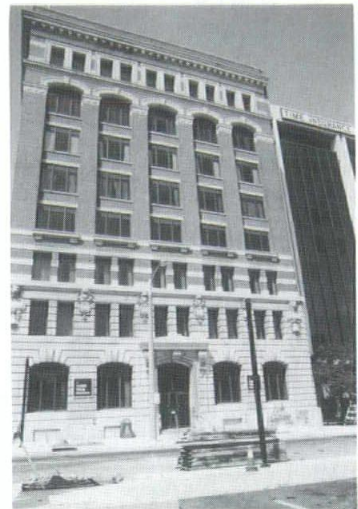

Time Insurance Building, Milwaukee, WI
Blake-Wirth-Horn & Associates

**Architectural Windows
Window Replacement
Translucent Panels**

arwin

Arwin Builders' Specialties, Inc.
2145 South 162nd Street
New Berlin, WI 53151

**(414) 782-1090
1-800-876-1090**

WSA Convention Exhibitors

The 1991 WSA Convention included one of the largest expositions of design and construction industry products and services ever, featuring the latest in new technology and materials. The support of the following 1991 WSA exhibitors made DIALOGUE possible. Thank you!

A/E Graphics, Inc.
4075 N. 124th St.
Brookfield, WI 53005
Contact: Fred Gennerman
414-781-7744

Acoustical Floors of Wisconsin
75 Industrial Ct., Ste. C
Hartland, WI 53029
Contact: Robert Gatchel
414-367-3306

Pete Alexander Company, Inc.
4513 Hwy. 92
Brooklyn, WI 53521
Contact: Pete Alexander
414-455-7011

American Olean
1000 Cannon Ave.
Lansdale, PA 19446
Contact: Curtis Yocum
215-855-1111

Ampersand Sign & Display Studio
1019 Jonathan Dr.
Madison, WI 53715
Contact: Larry Jorgenson
(608) 273-2733

Andersen Windows Inc.
507 Butler Dr.
Waukesha, WI 53186
Contact: Jim Sullivan
414-544-5085

Fred G. Anderson, Inc.
5825 Excelsior Blvd.
Minneapolis, MN 55416
Contact: Greg Block
612-927-1821

Architectural Sales Corp.
187 E. Becher St.
Milwaukee, WI 53207
Contact: Jennifer Hansen
414-482-4860

Areways, Inc.
1076 Ehlers Rd., Box 763
Neenah, WI 54956
Contact: John Kentile
414-725-2667

Arwin Builders' Specialties, Inc.
2145 S. 162nd St.
New Berlin, WI 53151
Contact: Morton Armour
414-782-1090

Baraboo Tent & Awning
123 Second St.
Baraboo, WI 53913
Contact: Bob Roltgen
608-356-0140

Bend Industries Inc.
11412 W. Brown Deer Rd.
Milwaukee, WI 53224
Contact: Robert Whitson
414-362-700

Best Block Company
P.O. Box 91
Butler, WI 53007
Contact: Kerry VonDross
414-781-7200

Block Iron & Supply
P.O. Box 557
Oshkosh, WI 54901
Contact: Tom Reigh
1-800-236-2040

Blueprints, Inc.
10930 W. Rogers St.
West Allis, WI 53227
Contact: Steve Miller
414-327-5010

Brick Distributors of Wisconsin
P.O. Box 910
Eau Claire, WI 54702
Contact: Gary Bergh
715-834-7701

The Brickyard, Inc.
3352 S. Clement Ave.
Milwaukee, WI 53207
Contact: John Heinzelman
414-481-9600

John E. Buhler Co., Inc.
1331 N. 29th St.
Milwaukee, WI 53208
Contact: John E. Buhler
414-344-9157

CMI-Constroms, Inc.
1045 Gemini Rd.
Eagan, MN 55121
Contact: Randall Provart
612-688-6867

Centec Security Systems
15360-A W. Beloit
New Berlin, WI 53151
Contact: Mark Strunsee
414-425-7000

Century Fence Co.
P.O. Box 466
Waukesha, WI 53187
Contact: Don Lucas
414-547-3331

CertainTeed Corp.
N9694 County O
Wisconsin Dells, WI 53965
Contact: Fritz Winnes
608-254-2202

Champion Companies of Wisconsin
1850 S. Calhoun Rd.
New Berlin, WI 53151
Contact: Sherrie Halford
414-786-8260

The Cheney Company, Inc.
2445 S. Calhoun Rd.
New Berlin, WI 53151
Contact: Art Holzinger
414-782-1100



Bend Industries, Inc., First Place

Childcrest Distributing
W135 N5511 Campbell Dr.
Menomonee Falls, WI 53051
Contact: Julia Otten
414-781-2551

Chimney Specialists Inc.
869 N. Main St.
Highland, WI 53543
Contact: George Breiwa II
608-929-4887

Co-Ex Corporation
P.O. Box 326
Rocky Hill, CT 06067
Contact: John Voss
David Fogelstrom
203-257-7555

Cold Spring Granite Company
202 South Third Ave.
Cold Spring, MN 56320
Contact: Pam Miller
1-800-551-7502

Composite
525 E. 2nd St.
P.O. Box 1888
Ames, IA
Contact: Kim Ulvestad
515-232-1748

J.F. Cook Co., Inc.
P.O. Box 88
Oak Creek, WI 53154
Contact: James Moon
414-762-4000

Cornell Corporation
P.O. Box 338
Cornell, WI 54732
Contact: David Tonnancour
715-239-6411

Cornell Iron Works, Inc.
Crestwood Industrial Park
Mountaintop, PA 18707
Contact: Shirley Barry
1-800-233-8366

D.L. Couch Contract Wallcovering
3250 N. Post Rd., #140
Indianapolis, IN 46226
Contact: Dennis Couch
317-895-9500

Edward Sales Co.
6530 Cambridge St.
Minneapolis, MN 55426
Contact: David Plummer
612-929-6794

Elastizell of Wisconsin, Inc.
20070 W. Lincoln Ave.
New Berlin, WI 53146
Contact: Raymond Munch, Jr.
414-547-5565

Fabcon, Inc.
6111 W. Hwy. 13
Savage, MN 55378
Contact: Mary Kay Mohowald
612-890-4444

Gagnon Clay Products Co.
P.O. Box 2425
Green Bay, WI 54306
Contact: Jim Gagnon, Jr.
414-435-5318

Georgia-Pacific Corp.
133 Peachtree St., NE
Atlanta, GA 30303
Contact: Ron Blanchard
404-521-4246

International Conference of Building Officials
6738 NW Tower Dr.
Kansas City, MO 64151
Contact: Ken Christensen
816-741-2241

Interpane Coatings, Inc.
201 Interpane Lane
Deerfield, WI 53531
Contact: Holly Walheim
608-764-5461

JWC Building Specialties Inc.
3540 N. 126th St.
Brookfield, WI 53005
Contact: Jim Cogan
414-780-7060

Jaekle Wholesale Inc.
2310 Daniels St.
Madison, WI 53704
Contact: Fred Mooers
608-221-8400

Kawneer Company
W310 S8672 Caspar Dr.
Mukwonago, WI 53149
Contact: Mike Bettice
414-363-3445

Kinetics, Inc.
P.O. Box 7426
Madison, WI 53707
Contact: Janet Warren
608-241-4118

MDC Wallcoverings
150 S. Sunnyslope Rd., -126
Brookfield, WI 53005
Contact: Dennis Raasch
414-784-2213

Marvin Windows
8043 24th Ave., South
Minneapolis, MN 55425
Contact: Dawn Pfeiffer
612-854-1464

Master Blue Print Inc.
810 W. Badger Rd.
Madison, WI 53713
Contact: Mark Osterhaus
608-256-4884

S.A. Maxwell
225 E. St. Paul Ave., Ste. 404
Milwaukee, WI 53202
Contact: Kyle Frey

Mid-Western Reps
P.O. Box 51794
New Berlin, WI 53151
Contact: Christine Ahl
414-789-8687

Milwaukee Telephone/Cellular
3545 N. 124th St.
Brookfield, WI 53005
Contact: Sandy Barootian
414-783-5500



Res-Com Window Solution, Second Place

Florstar Sales Inc.
8301 W. Parkland Ct.
Milwaukee, WI 53223
Contact: Thomas Peters
414-355-9555

David Fogelstrom & Assoc.
675 N. Brookfield Rd.
Brookfield, WI 53045
Contact: David Fogelstrom
414-782-7713

Formica Corporation
10300 W. Fountain Ave., #415
Milwaukee, WI 53224
Contact: Lisa Berry
414-355-5911

GAF Building Materials Corp.
50 Lowry Ave., North
Minneapolis, MN 55411
Contact: Diane Anderson
612-529-9121

GMB Engineering Equipment
12845 W. Burleigh
Brookfield, WI 53005
Contact: Jerry Bobb
414-782-5240

Gypsum Floors Inc.
3135 Meier Rd.
Madison, WI 53704
Contact: William Brown
Ted Belanus
608-221-1636

The H Window Company
1324 E. Oakwood Dr.
Monticello, WI 53562
Contact: Brian Pantzke
612-295-5305

Hallmark Building Supplies, Inc.
6050 N. 77th St.
Milwaukee, WI 53218
Contact: Debra Prickett
414-464-9990

Halquist Stone Company
Box B
Sussex, WI 53089
Contact: Dave Johnson
414-246-3561

Hurd Millwork Co.
575 S. Whelen Ave.
Hedford, WI 54451
Contact: Jerry Toftum
1-800-477-4873



Formica Corporation, Third Place

LaForce Hardware & Manufacturing
P.O. Box 10068
Green Bay, WI 54307
Contact: Tom Hansen
414-497-7100

The Lurie Companies
120 N. Milwaukee St.
Milwaukee, WI 53201
Contact: Larry Koepf
414-271-4724

Modulex Inc.
2920 Wolff St.
Racine, WI 53404
Contact: Pierre Husson
414-632-5330

Modu-Line Windows, Inc.
930 Single Ave.
Wausau, WI 54401
Contact: Vaughn Paxson
715-845-9666

Otis Elevator Company
3720 N. 124th St.
Milwaukee, WI 53222
Contact: R.E. Graeff
414-461-8400

Parkwood Chicago, Inc.
2100 S. Foster Ave.
Wheeling, IL 60090
Contact: Deb Moore
1-800-551-0086



Andersen Windows, Inc., Honorable Mention

J.W. Peters & Sons, Inc.
P.O. Box 160
Burlington, WI 53105
Contact: John Garipey
414-763-2401

Poblocki Sign System
11607 W. Dearbourn Ave.
Wauwatosa, WI 53226
Contact: Sue Schlegel
414-256-7400

Prostar, Inc.
Box 09448
Milwaukee, WI 53209
Contact: Greg Koller
414-444-4400

Rawplug Milwaukee Co.
P.O. Box 26706
Milwaukee, WI 53226
Contact: Jim Knuth
414-466-2400

Raynor Garage Doors
East River Road/P.O. Box 448
Dixon, IL 61021
Contact: Darla Mumford
815-288-1431 ext. 2328

Real Brick Products, Inc.
106 N. Washington St.
Owosso, MI 48867
Contact: Becky Pearce
517-723-8380

Reprographic Technologies
2845 S. Moorland Rd.
New Berlin, WI 53151
Contact: Brian Garrity
414-796-8162

Res-Com Window Solutions
P.O. Box 864
Oconomowoc, WI 53066
Contact: Lyn Reed
414-567-3666

RM Contract Wallcovering
725 Nicholas Blvd.
Elk Grove, IL 60007
Contact: Gregg Johnson
708-640-8060

Troy Wesnid Furniture, Inc.
Represented by Judith Richter
Interiors
5157 N. Lake Dr.
Milwaukee, WI 53217
Contact: Judith Richter
414-964-6400

Roddiscraft, Inc.
5112 N. 37th St.
Milwaukee, WI 53209
Contact: William H. Roddis
414-466-1468

S&S Sales Corporation
12030 W. Silver Spring Rd.
Milwaukee, WI 53225
Contact: Dan Naumann
414-464-8550

STS Consultants, Ltd.
11425 W. Lake Park Dr.
Milwaukee, WI 53224
Contact: Lavetta Torke
414-359-3030

Sage Upholstery Workroom
7460 N. Teutonia Ave.
Milwaukee, WI 53209
Contact: Alan Sage
414-228-7001

Parkwood Chicago, Inc., Honorable Mention



Marvin Windows, Honorable Mention

Schlage Lock Co.
1114 McKinley St.
West Bend, WI 53095
Contact: Dan Sauer
414-334-9011

Spancrete Industries, Inc.
10919 W. Bluemound Rd.
Milwaukee, WI 53226
Contact: Al Creekmur
414-258-4110

Stickler & Associates, Inc.
333 N. 121 St.
Milwaukee, WI 53226
Contact: Stephen Stickler
414-771-0400

Sullivan Brothers, Inc.
2515 S. Stoughton Rd.
Madison, WI 53716
Contact: Jerry Sullivan
608-222-1277

Sullivan Brothers Supply, Inc.
2515 S. Stoughton Rd.
Madison, WI 53716
Contact: Dan Benzine
608-222-9088

Lee Tate Sales, Inc.
432 N. Merrill
Park Ridge, IL 60068
Contact: Lee Tate
708-823-5832

Champion Companies of Wisconsin, Honorable Mention



Best Block Company, Honorable Mention

Thoro System Products
673 Aspen
Buffalo Grove, IL 60089
Contact: Steve Downs
708-459-6079

Trenwyth Industries, Inc.
One Connelly Rd./P.O. Box 438
Emigsville, PA 17318
Contact: Lee Fischl
717-767-6868

Twin City Testing Corporation
662 Cromwell Ave.
St. Paul, MN 55114
Contact: Beatrice Beenen
612-641-9340

United Brick & Tile, Inc.
5402 Lien Rd.
Madison, WI 53704
Contact: Joe Goodwin
608-241-3844

USG Interiors Inc.
1914 N. Prospect, Apt. 25
Milwaukee, WI 53202
Contact: Jeff Johnson
414-271-3161

**Vande Hey-Raleigh Architectural
Roof Tile**
1565 Bohm Dr.
Little Chute, WI 54140
Contact: Erv Vosters
414-766-0156

Ver Halen, Inc.
4700 N. 124th St.
Butler, WI 53007
Contact: John Calawerts
414-463-7700

Windows, Inc.
P.O. Box R
DeSmet, SD 57231
Contact: Debra Combs
605-854-9126

Wisconsin Bell, Inc.
6812 Aetna Ct.
Wauwatosa, WI 53213
Contact: Thomas Lesniak
414-778-3135

Wisconsin Natural Gas Co.
233 Lake Ave.
Racine, WI 53403
Contact: Peter Schumacher
414-637-7681



Ver Halen, Inc., Honorable Mention

Vistawall Architectural Products
1143 Ellis St.
Bensenville, IL 60106
Contact: Terry Robinholt
708-350-2580

**Weather-Tek Building Products,
Inc.**
N4 W22450 Bluemound Rd.
Waukesha, WI 53186
Contact: James Miller
414-521-2555

**Weyerhaeuser Architectural
Doors**
1698 Edgerton St.
Maplewood, MN 55117
Contact: Greg Schuyler
612-772-2846

Wilsonart
1100 Chase Ave.
Elk Grove Village, IL 60007
Contact: Kathryn Kimball
708-437-1500

**Wisconsin Concrete Masonry
Association**
9501 South Shore Dr.
Valders, WI 54245
Contact: Richard Walter, P.E.
414-773-2888

Wisconsin Blue Flame Council
333 W. Everett St., A413
Milwaukee, WI 53203
Contact: Joyce Davis
414-221-3356

Wisconsin Natural Gas Company
233 Lake Ave.
Racine, WI 53401
Contact: Karen Fossum
414-637-7681 ext. 2238

Wood-Lam Inc.
230 Sussex St.
Pewaukee, WI 53072
Contact: Thom Osenga
414-691-2000



ATOMIC
interiors

608•251•5255

632 W. WASHINGTON AVE
MADISON, WI 53703

Does it pay to save energy?

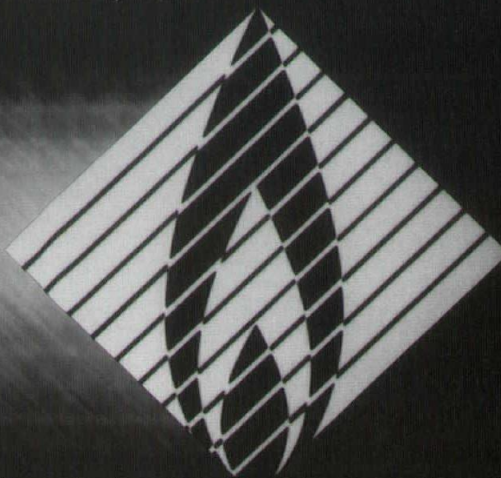

Yes...both today and tomorrow. Wisconsin Natural Gas Company will pay you to reduce your energy consumption...and your energy bills. We have rebate programs for everything from new construction to boiler tune-ups to gas air conditioning. And, lower monthly energy bills mean more dollar bills in your pocket. We'll help you create a customized Blueprint for Savings. Call us at (414) 637-7681.



**BLUEPRINT
FOR SAVINGS**

*Blueprint for Savings is available to WN
Commercial/Industrial customers only.*

**Plan On Savings,
Plan On Natural Gas.**

THE PROBLEM:

Warping, cracking, paint peeling—the same old trim problems.

THE SOLUTION:

G-P PrimeTrim™

The same old trim problems are no problem for PrimeTrim™. PrimeTrim is a premium engineered trim product that offers you the superior performance of premium trim at an installed cost competitive with commodity trim.

- Proven in over four years of lab and field tests.
- Factory-applied, oven-baked prime coat saves on-site priming.
- 16' lengths allow fewer joints, easier handling and installation.
- No knotholes or irregularities—waste is reduced.
- Paint can't crack at finger joints, because there aren't any.

The end result: superior performance and versatile beauty for your homes, and savings for your bottom line. To learn more about G-P PrimeTrim,

call Madison 608-241-3874, Milwaukee 414-464-7900.

Solve it with G-P™



"PrimeTrim" and "Solve it with G-P" are trademarks of Georgia-Pacific Corporation. ©1991, Georgia-Pacific Corporation. All rights reserved.

We're warm, quiet, and on the level.



Commercial Infloor[®] radiant heat provides comfort and affordability.



Acousti-Mat[™] increases sound control 50% over wood frame and 100% in concrete construction.*



Dura-Cap[™] or Level-Right[™] can level to a smooth, hard (up to 4650 psi) underlayment.

We're GYP-CRETE[®]

New or existing buildings benefit from the full range of Gyp-Crete products. Infloor is a dust-free, economical heating alternative that's energy efficient too. Acousti-Mat controls impact and

sound infiltration by installing between subfloor and tile, wood or any floor covering. Level-Right and Dura-Cap are our flowable underlayments that cure to a smooth, hard surface.

*Ask for sound test data.

Milwaukee:
Acoustical Floors of Wisconsin, Inc.
(414) 367-3306

Madison: D & M Construction (608) 222-0944
Green Bay: Superior Gypsum Floors (414) 336-7225

VAT PROBLEMS?

Gyp-Crete underlayment systems encapsulate old vinyl asbestos tile cheaper, faster, and safer than removal.

LLANGER ROOFING & SHEET METAL INC.

ESTABLISHED 1920

(414) 476-5800

345 S. CURTIS RD., MILWAUKEE, WI 53214

NEW — REROOFING — REPAIR

BUILT-UP ROOFING

ASPHALT
COAL TAR
ELASTOMERIC

MEMBRANE WATERPROOFING

BUILT-UP SYSTEMS
ELASTOMERICS

ARCHITECTURAL SHEET METAL

METAL FLASHINGS
MANSARD PANELING

A WISCONSIN TRADITION OF
QUALITY FOR OVER 80 YEARS

Brick
Block
Pavers
Tile
Stone

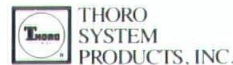

WISCONSIN
BRICK & BLOCK
CORPORATION

6399 NESBITT RD MADISON, WI 53719
(608) 845-8636 • (800) 362-6633
FAX: (608) 845-8630

**WORKERS' COMPENSATION INSURANCE
CAN
COMPENSATE THE EMPLOYER, TOO!**

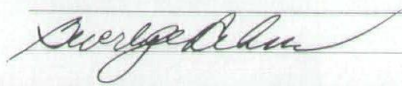
DESIGN PROFESSIONALS SAFETY ASSOCIATION, INC.		8722
19000 MAC ARTHUR BLVD., STE. 500 714-833-0673 IRVINE, CA 92715		90-2881/1222
PAY TO THE ORDER OF	1989	19
DPSA Policyholders	\$ 539,021.00	
Five Hundred Thirty Nine Thousand Twenty One and no/100 ----- DOLLARS		
VOID IF NOT PRESENTED FOR PAYMENT WITHIN 6 MONTHS		
 WESTMINSTER OFFICE 535 WESTMINSTER MALL WESTMINSTER, CA 92683		
FOR	1988 Dividend Distribution	
⑈008722⑈		

Last year, the WSA Endorsed Group Workers' Compensation Plan returned 39.1% of premiums to the policyholders in the form of dividends. Over the last seven years, the average dividend declared has been 32.0% of premium!

If your firm is not enrolled in a dividend paying program, then now is the time to contact AA&C, the Design Professionals Service Organization. Please call Kelley Cunningham at 1-800-854-0491 Toll Free.



Association Administrators & Consultants, Inc.
19000 MacArthur Boulevard, Suite 500
Irvine, California 92715

Purcell Imaging

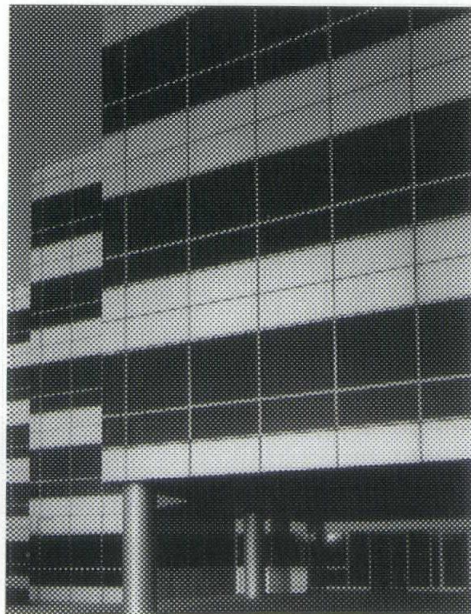

photography
architectural • interior • computer generated

Represented by Halvorsen & Associates 414.821.1585

414.278.8290 FAX 414.278.7278

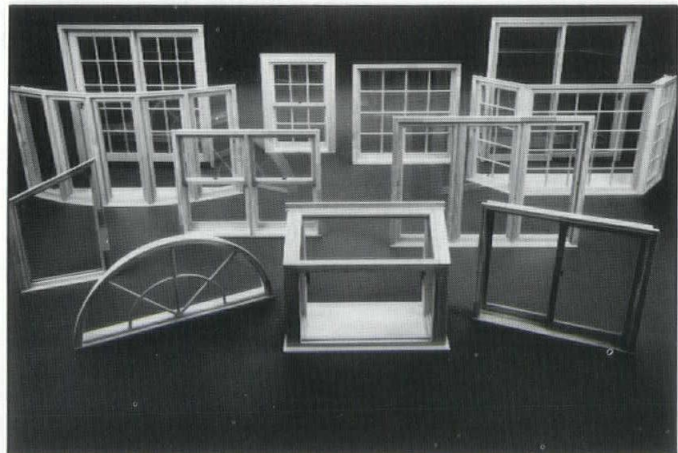

HERE IN ITS SIMPLEST FORM IS A MARVIN WINDOWS CATALOG.

Most window manufacturers make just a few standard shapes and sizes. Marvin offers you thousands to choose from. With everything from authentic divided lites to Round Tops.

All Marvin windows are constructed of fine-grained Ponderosa pine. This wood was chosen for its excellent insulating properties and the way it accepts a stain-and-varnish or paint finish.

A variety of glazing options are available, including insulating glass and special energy-saving Low E glass. So

heating and cooling costs are significantly reduced. What's more, Marvin windows are carefully weatherstripped to eliminate drafts and further reduce energy loss.

And you don't have to wait a long time to have your windows made to order. Delivery is usually within three weeks from the time they receive the order.

Call or stop in today for complete details on Marvin Windows.



builders world, inc.

p.o. box 881 • waukesha, wisconsin 53187 • (414) 542-8883



Project

Gilbert M. Simmons Library

Architect

Herbst Eppstein Keller & Chadek, Inc.

Contractor

Rasch Construction & Engineering

City

Kenosha, Wisconsin

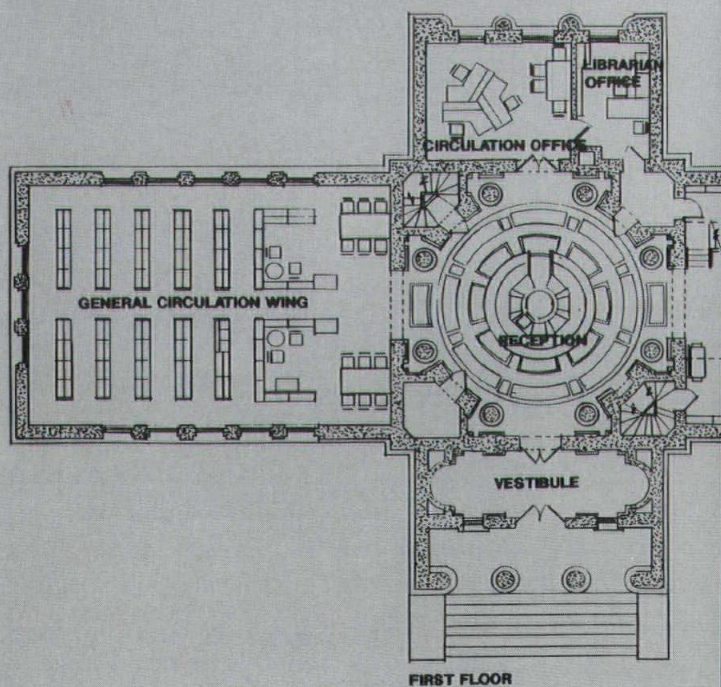
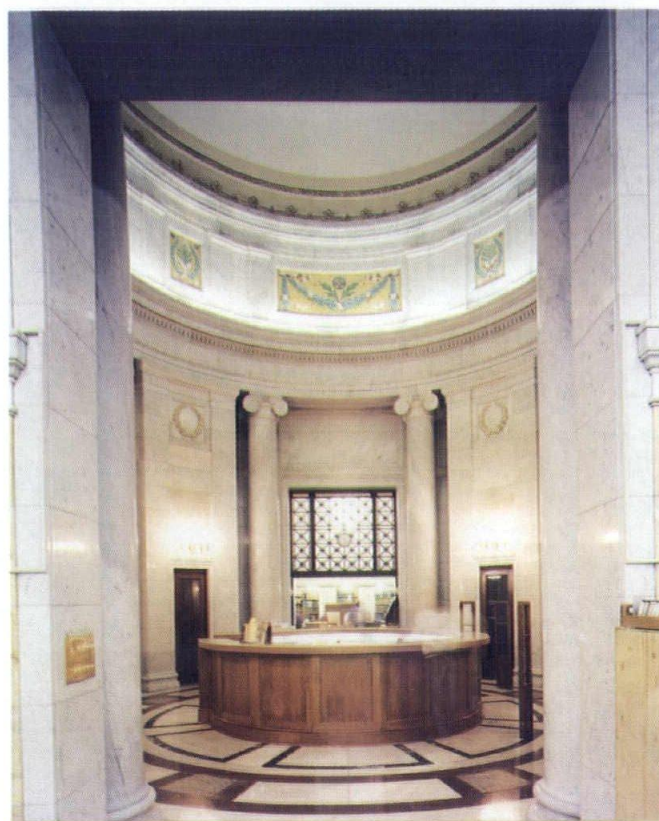

Jury Comment

Design interventions are very modest, and necessary additions such as lighting are particularly sensitive and appropriate in scale. The beautiful spaces are restored in a very restrained, straightforward fashion.

Honor

This library renovation involved returning the interior to a traditional state in keeping with the building's neoclassical essence while still maintaining a contemporary functionality. The building is set on a raised platform and is a neoclassical cruciform plan with a central rotunda. Designed in 1900, it was used as the central public library. Originally, one wing was a dedicated reading room and the other was a closed circulation area with mezzanine.

The exterior renovation work involved the replacement of terrace platform stone, resurfacing of the terrace surface and the installation of hand and guard rails. The entire roof was retiled with an Italian tile that replicates the original tiles.

The plaster and ornamentation in the building was completely repaired and restored. The entire interior was repainted, and all marble in the building was cleaned. Appropriate remodeling was completed as necessary to make the air conditioning grills as inconspicuous as possible.

The interior design solution returned the mezzanine to the west wing, increasing reading/study space. The mezzanine utilizes an existing stairway that had been walled up during prior remodeling. The metal railing was replicated, and contemporary indirect lighting was replaced with replications of the original light fixtures.

Photography: Edward J. Purcell

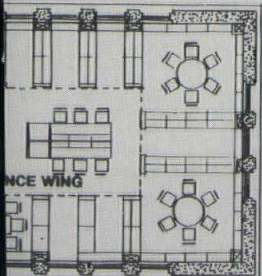



Project

Kilbourn Knoll Historic Apartments

Architect

Sunarc Studio

Contractor

Master Builders, Inc.

City

Milwaukee, Wisconsin

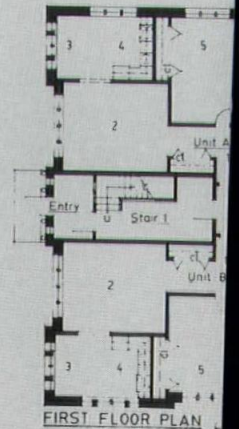



Honor

Jury Comment

This is a wonderful new use for this building with its interior designed much more in keeping with a modern lifestyle. The built product looks good, and the interior planning is excellent.

The program was to provide affordable, energy efficient family and handicap apartments in a historic building. The building, located in a central city neighborhood, had been abandoned and vandalized over the past ten years.

In addition to the financial requirements of the project, the inefficient and obsolete physical layouts of the existing apartments, the structural decay of the floors, roof and portions of the brick veneer, and the absence of any functioning mechanical systems required that the entire building be "gut rehabbed." At the same time, the significant architectural features of the original structure had to be maintained so that the building could be placed on the National Register of Historic Places. The project also had to meet all current life-safety and handicap-access requirements and include features generally associated with "market rate" housing.

Due to the extremely limited budget, the load-bearing balloon frame interior walls were retained and entirely new apartment layouts devised. Energy-related work included a new staged hydronic boiler system, insulation of all exterior walls and attic, combination storm windows, repair of the historic wood windows with zinc muntin bars, water conserving plumbing fixtures and efficient lighting fixtures.

Photography: Helmut Toldt

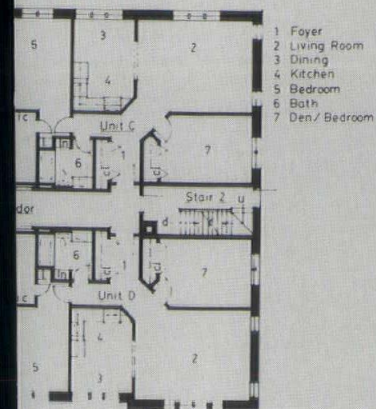



Project

Onalaska Public Library

Architect

HSR Associates, Inc.

Contractor

Olympic Builders

City

Onalaska, Wisconsin

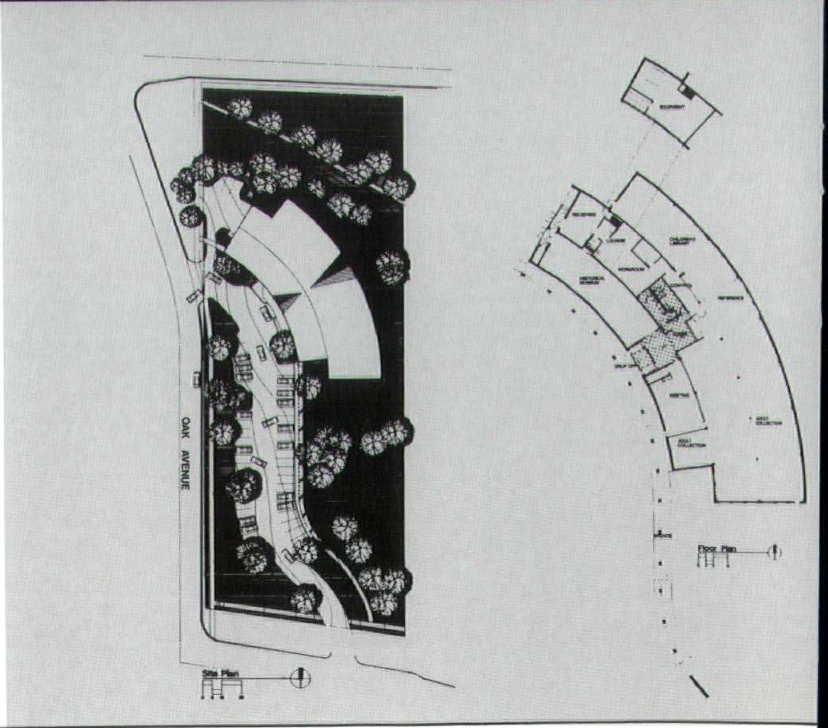



Honor

Jury Comment

This is a most pleasant and well designed building which reaches out and uses its site to bring people to it. The interiors, though very simply organized, are well done, making this library a very calm and peaceful place to read.

A serpentine-shaped path serves as an organizing spine for both the building and parking area extending through a heavily wooded park. Designed to move between and around existing trees, the shape also was used to complement the soft, romantic environment.

The building and parking area were placed along the path, saving all major trees. An entry portico extends beyond the building, reaching out onto the site as an open colonnade and terminating with a large sign visible from the busy intersection. The colonnade connects the remote parts of the parking lot with the building entrance and serves as a built landscape form for the transition.

The interior spaces include a historical museum and public meeting room area, both designed for after-hour use. The centrally located control desk is visible from the front door and provides visual surveillance of all parts of the easily accessible library space. Spatial volume accentuates and connects the entry, control desk and park beyond. The high clerestory windows in the lobby and over the book-shelving bring in desired natural light and allow glimpses of the tree tops.

Photography: Mick Hales



Project

Heurikon Corporation

Architect

Potter Lawson Architects

Construction Manager

Planning Associates, Inc.

City

Madison, Wisconsin



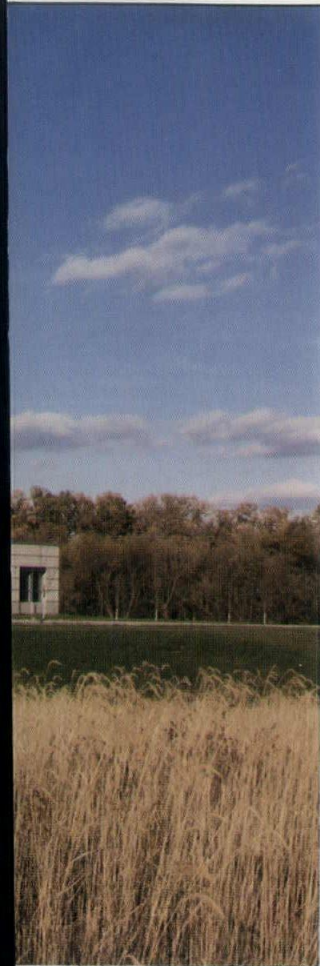

Honor

Jury Comment
 Its manipulation of perspective is a conceptual idea translated into real architecture and made from real materials. A beautiful, very carefully scaled combination of building and landscape.

This building is situated on an open rolling prairie landscape. The placement defines an outdoor space between the building and the small wooded area to the east, while the curved glass wall front provides sweeping views of the open prairie.

The exterior expresses the two main activities of the corporation, the engineering and manufacturing of computer products. Engineering functions are represented by a lightweight curved wall consisting of glass, aluminum panels and a steel and canvas sunsreen. Manufacturing activities are represented by a volume enclosed in a masonry block wall. The smooth and lightweight materials reflect the company's high-tech image, while the masonry block walls are more expressive of the act of making.

The central core of the building houses a shared conference center where the two departments meet. The central corridor simultaneously reflects the separation and the interdependence of the two departments while anchoring the corporation to the landscape. A view corridor, from the entry of the building towards the wooded space to the rear, expands as it reaches the landscape and forms a triangular wedge in the center of the building. Skylights are cut into the structure and create an interior sun-lit courtyard during the day. The expanding view corridor, extended into the landscape and defined by fruit trees, creates an employee garden shared by both departments.

Photography: James T. Potter, AIA

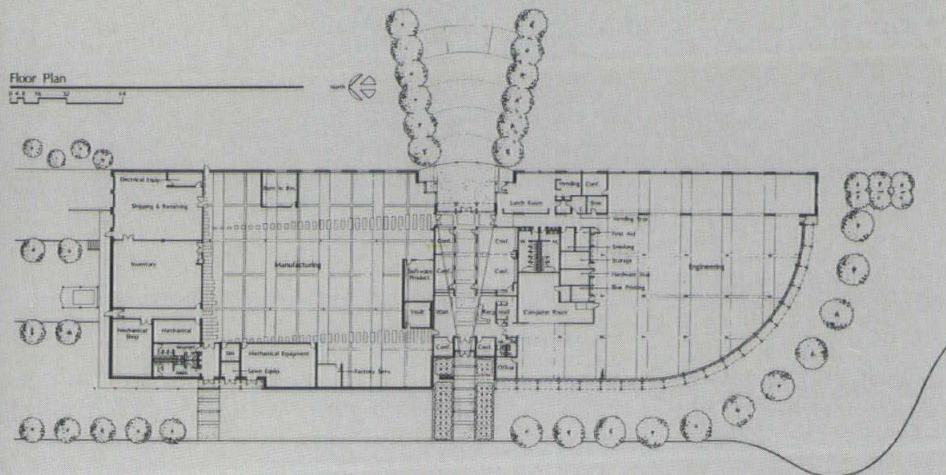



Merit

Jury Comment

The new buildings in this complex are an unpretentious but joyous and cheerful advocacy of a neighborhood context. The massing of units and roofing is wonderfully sensitive.



Project

The Avenue

Architect

Design Coalition, Inc.

Contractor

Krupp Construction Company

City

Madison, Wisconsin

This project successfully reconciles a demanding and enlightened program with a modest budget. It recycles a key neighborhood feature in an act of community-building where no one is left out.

The original hospital and boiler buildings were gutted to make way for 32 units with large glassed-in laundry rooms located at circulation nodes, a community room with kitchen and bicycle storage areas. New construction included eight superinsulated wood frame units scaled and articulated to recall the surrounding two-unit dwellings.

Meetings with a review committee of service providers and individuals with various disabilities helped to fine tune unit design and detailing. The "universally-usable" playground and site are wheelchair accessible to foster play between children of all ages and physical abilities. Textural and olfactory cues also were incorporated into the site design and planting schedule to ease wayfinding for the visually-impaired.

Photography: Ruth Fankhauser



Merit

Jury Comment

The building gives dignity to the subject by not destroying the natural setting in which it is placed. The wood and masonry detailing is wonderful and well proportioned.



Project

Riveredge Nature Center

Architect

Plunkett Keymar Reginato
Architects

Construction Manager

C.M. Associates of Milwaukee

City

Newburg, Wisconsin

The educational classrooms became the major component of the program. The focus of this nature building is the center module, an eight-sided barn-like element similar to structures built by immigrants in Ozaukee County. All visitors enter the 30-foot high center module for orientation. The visitors' attention is directed upward for a view of the sky and outward to the prairie and ponds. Adjacent to the core are two wings, a classroom/lab wing and an administrative wing that accommodates offices on the first floor and a large reference library tucked under the eaves.

The building design includes the retention and restoration of a 1,500 square foot barn and silo. The field stone was specified to be local small rounded stone with a heavy mortar appearance similar to the hand work seen on the turn-of-the-century area barns.

The site is a natural sanctuary of prairies, forests, ponds and marshes adjacent to the head waters of the Milwaukee River. The building was placed to disturb as little of the natural environment as possible.

Low level incandescent lighting leads visitors from small parking clusters to the main entrance through an area of brush and fallen trees. Hiking paths are strategically located to converge on grassy outdoor classroom meeting areas that are molded into the site.

Photography: Steve Poast



Merit

Jury Comment

This project is a successful integration of a new and old building. It's festive and fun, employing careful planning of the new inside space while designing a generous and compatible addition to the outside.



Project

Kohler Design Center

Architect

Heike/Design Associates, Inc.

Contractor

Ty-Mar Industries, Inc.

City

Kohler, Wisconsin

The project is an example of preserving the best historical architectural elements of an existing 1920s English Tudor building, expanding the building with historical replication and providing a functional interior suitable for the 1990s.

The first phase of the project included a 20,000 square foot expansion of a former three-story recreation hall, providing a grand entry, showroom space and design staff offices. Great care was taken in both the interior and the exterior to match the existing architecture, structure, materials and detail.

The second phase included the renovation of the recreation hall to include the new product showroom and Kohler Museum. As visitors enter the showroom, they are greeted by a bold, curved glass block reception desk. White walls and ceiling reflect natural light from windows and skylights. A multi-level spa platform rises to an exposed space-frame mezzanine surrounded by walls of glass block and stainless steel with water washing its vertical surfaces.

The lower level museum and theater space feature curved alcove displays on the history of Kohler and a small orientation theater.

Photography: Eric Oxendorf



Merit

Jury Comment

A little bit of everything is here, and it is fun and done well. All the material changes are carefully designed. It makes you want to buy shoes!



Project

Goldi

Architect

Kubala Washatko Architects, Inc.

Construction Manager

Kubala Washatko Architects, Inc.

City

Chicago, Illinois

The client requested a store on the cutting edge of fashion and design—a retail sensation “to bombard the senses.” In this spirit, the architect was asked to juxtapose a classical motif with a Memphis-style theme.

A challenge was to draw shoppers to the back of a very small space. While the front of the store is relatively spacious, the back funnels down to only nine feet. A fault line seams together the classic and Memphis sides and draws customers to the back. Although both styles were generated in Italy, the contrast between the two could hardly be greater.

Arching over the store, a classic barrel vault incorporates a Sistine Chapel-like ceiling. Rather than copy Michelangelo directly, Venus, attended by cherubs, is the “fresco’s” theme. The Roman goddess of love and beauty ascends into the clouds and selects from shoes presented by winged sprites. On the Memphis side, a road warrior Mars plays counterpoint. A mischievous punk pigeon, in a tiny leather coat, chains and mohawk, casts a knowing eye. The illusion of space, created through the skillful use of mirrors, light and color, is heightened by the outrageous Memphis style.

Photography: Mark Heffron



Merit

Jury Comment

It's unusual to see an office building that fits so well into the landscape and to see an interior and an exterior designed as one. It is beautiful, very sensitive and looks like a wonderful space to be in.



Project

*Wisconsin Education
Association Council*

Architect

Potter Lawson Architects

Contractor

J.H. Findorff & Son, Inc.

City

Madison, Wisconsin

This prominent hill site overlooks a confluence of roadways which serve the central city, offering dramatic views toward the State Capitol and the surrounding countryside.

The Romanesque masonry forms impart a citadel-like sense of strength and permanence appropriate to the owner and to the gateway location of the site. Use of cascading roofs and stepped massing recalls the graceful integration of agricultural buildings with the land. These forms, with the horizontal banding of colored masonry, ease the building onto the site, allowing it to crown the hill without diminishing it. Warm, buff-colored brick was selected to enliven the prominent northern facade which receives little sunlight during winter months.

The linear, three-story configuration derives from the many private offices organized for optimal views. Specialized functions, including conference rooms, the employee lunchroom and a staircase, are in prominent locations within articulated shapes.

Photography: Douglas N. Kozel, AIA

SPANCRETE — A BETTER WAY TO BUILD.



"I have built in Wisconsin for over 30 years. I know what I like and what works. On the Silvernail Woods Office Park, for example, I demanded the best building products available. I made it my showcase and I put my offices there. I used precast concrete for the structure and again on the exterior because I believe it to be the building system of the future. And, of course, I chose Spancrete."

Bryce Styza

Spancrete offers one of the more practical, versatile and economical building systems used today: **PRECAST, PRESTRESSED CONCRETE.**

Precast concrete buildings by Spancrete are structurally sound, aesthetically pleasing, require little maintenance, and retain high resale value. Plus, Spancrete is erected fast — in all weather conditions.

To learn how Spancrete's precast concrete building products can be designed into your next project, call your nearest Spancrete producer. You will agree, Spancrete *is* **A BETTER WAY TO BUILD.**



Spancrete Industries, Inc.
10919 W. Blue Mound Rd.
Milwaukee, WI 53226
(414) 258-4110

Spancrete Inc.
2448 Century Rd.
Green Bay, WI 54307
(414) 494-0274

Spancrete of Illinois, Inc.
4012 Route 14
Crystal Lake, IL 60014
(312) 775-6402 • (815) 459-5580

Enhance with Tile From Butler Tile Sales



While IAC ceramic tile is priced comparably to most higher grades of vinyl, carpet and wood, it's far more durable, and a lot less trouble. There's no stripping, waxing, sealing, or buffing — ever. And because it's made by IAC, it resists stains, acids and other corrosive substances. In fact, IAC has more than three times the abrasion resistance of current industry standards — as well as nearly twice the breaking strength and almost five times the bonding strength of standard tile.

Tile of Distinction Ceramic Tile Showroom

- Serving Wisconsin builders, architects, and interior designers for 35 years
- Hundreds of samples on display
- Experienced design consultants available to assist you
- Fast delivery of hundreds of different tiles from our warehouse

746 N. 109th St., Milwaukee, WI 53226 • 414-476-0970
toll free 1-800-242-0847

When it comes to great fabrication our reputation

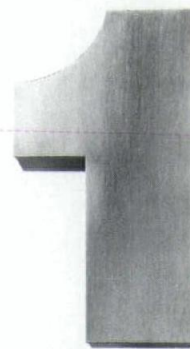

is stainless.

Our reputation is stainless by design. We're the Sheet Metal Contractors of Milwaukee, whose shining products are seen all over the city, from fancy duct work to monumental architecture. Sheet Metal is better by design!

Sheet Metal Contractors of Milwaukee
2515 North 124th Street
Suite 200
Brookfield, Wisconsin 53005
(414) 784-6889

SMC
Sheet Metal Contractors
of Milwaukee



Be Confident Your Walls Are Going Up Plumb and True.

With Igloo™ stay-in-place concrete forms you needn't worry. Igloo forms interlock, like giant Lego building blocks, to form walls that are plumb, straight and level. Adjustable in two inch increments, dimensional errors are easy to locate and correct. You can rest easy knowing your foundation is being built to plan.

Use Igloo forms above grade as well as below. The high density EPS provides a stable substrate for stucco-type finishes, or any wall covering. Nearly four inches of insulation provide a factor close to R-18. And you can choose the original ten inch form or pour solid concrete walls with the new variable width form.

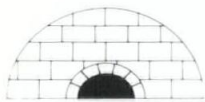

IGLOO™ Concrete Forms (414) 632-6898

Racine Form Works Inc. P.O. Box 4179 Racine, WI 53404



Exceptional
Value

486 COMPUTER Portable or Desktop

- 33 MHZ
- 8 MEG RAM
- 1.2 & 1.4 FLOPPY
- 140 MEG 15MS HARD DRIVE
- 101 KEYBOARD
- 15" 1024 X 768 NON-INTERLACED MONITOR
- 16 BIT VGA CARD WITH 1 MEG RAM
- 2 SERIAL, 1 PARALLEL PORT

Room for Expansion • 1 year parts and labor

Portable
\$5,980

Call
(414) 774-3882

Desktop
\$4,280

Networking: Reading the "Lay of the LAN"

Remember when people used to talk about having "my computer talk to your computer"? Although that phrase has been replaced with the term "networking," the idea remains the same—networking is after all by definition a system that interconnects.

Those who are responsible for marketing their firm's abilities are certainly well aware of their need to network. This form of interconnecting is often called "press the flesh" networking, the characteristics and benefits of which are fairly well known and understood.

But how familiar are you when it comes to a Local Area Network (LAN)? Utilizing a LAN will allow you to link your firm's information system resources with your firm's human resources, creating an Information Systems Network (ISN) that can link up with other networks inside or outside of your firm.

A LAN will provide the capabilities to compute in a multi-tasking and/or multi-user production environment—if you are interested in reading files and writing files from or to each other's storage devices, sending messages or E-mail to one another, sharing printing or plotting devices and operating the multi-user network versions of your critical software applications within the confines of your workstation, then a LAN is for you. With such benefits, a brief introduction to LAN technology may certainly be in order.

A LAN is comprised of three essential components that allow groups of computer users to interact with one another: a software component which is an operating system which supersedes all other operating systems; adapter cards, which preprocess the transmission of data between nodes; and con-

ductors, which provide the umbilical link between each node on the network.

There are two "architectures" through which information flows, client/server and peer-to-peer. A client/server architecture requires a "dedicated server"—a powerful computer dedicated to the sole task of managing and processing requests for services from the "clients" (nodes) on the network. A peer-to-peer architecture performs similarly—albeit more slowly—but does not require a dedicated server.

Server methodology is analogous to a school hall monitor—checking hall passes and routing the student to the appropriate destination. Each architecture must rely on a server methodology that monitors and manages service requests throughout the network.

In peer-to-peer networks, each node is a hall monitor and any node on the network may be designated as a server, each taking a turn to process network services. This time sharing arrangement confers more flexibility than a network based on a dedicated server and is considerably less expensive to obtain and maintain (O&M).

Thus, peer-to-peer networks are well suited for small to medium sized work groups that need to keep costs down and want to take advantage of networking productivity benefits. According to firm profiles listed in the 1991 WSA Construction Industry Handbook, many Wisconsin A/E/C firms certainly seem to fit into this category.

Dedicated servers really shine in large workgroup environments where access to mainframes, telecommunication gateways and multiuser databases or accounting applications are required. These

performance features are worth the increased O&M costs.

Take for example, down-time due to system crashes or glitches. When the server is down, everybody on the network is down. If a peer server goes down, each peer may reboot and run an alternate operating system. If you have doubts about the credibility of this statement, ask for the current balance of your checking account next time you're at your bank.

With the possible exception of backing up an entire network from a dedicated server, there are no beneficial reasons for the majority of A/E/C firms to utilize a client/server architecture.

In closing, two developments have recently cropped up in the marketplace. The first is not very surprising; mail order companies are price-busting the strangle hold long enjoyed by local dealers by configuring machines as dedicated servers with the industry leading LAN equipment and software.

The second is a real V-8! An industry pundit has recently reported that a client/server architecture on a chipset is right around the proverbial corner—providing dedicated servers as original equipment. If true, this development will lower the costs of implementing a client/server LAN by many thousands of dollars.

Isn't the computer industry's product release rumor mill intriguing? What excitement and risk it offers. This, dear colleague, is called reading the "Lay of the LAN."

EDITOR: The author is an Associate member and information technology consultant specializing in architectural/engineering/construction technology.



**YOUR BUILDING PARTNER
SINCE 1952**

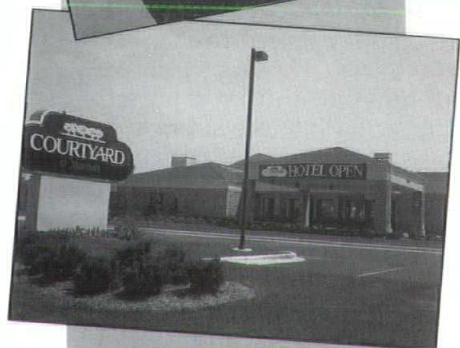
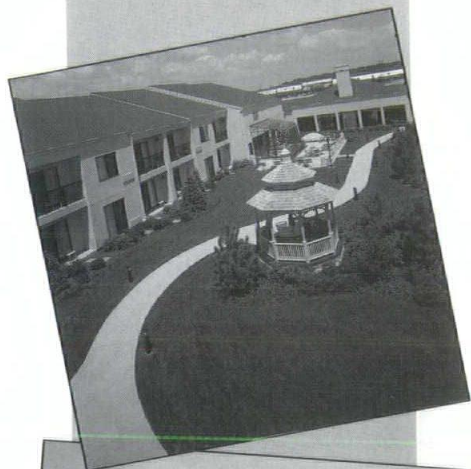

**COURTYARD BY MARIOTT
BROOKFIELD, WI**

**IN MILWAUKEE CALL
FRED BERSCH
(414) 358-3505**

**IN MADISON CALL
JERRY HENRICH
(608) 222-5100**



The Acceptable Greenhouse Effect



WISCONSIN SOLAR DESIGN

414-444-1639 608-831-2112

**Greenhouses
Solariums
Skylights**

Specializing in Glass Design & Structural Engineering

Concrete Wall and Floor Sawing and Removal, 24" from each side. Poured Concrete with Rebar. New, Diamond Wire Saw, unlimited depth of cut. Any size machine base, or block of concrete can be sawed flush off floor and/or into sections.

Hydraulic and Electric Equipment
No Dust or Gas Fumes

If you have a concrete sawing or removal application, which seems difficult or impossible, call us - we have latest world wide technology. We saw for hospitals - commercial - industry - walls for contractors and home owners.

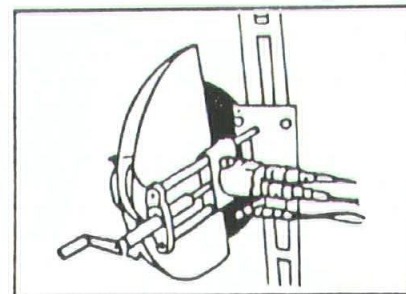

CONCRETE REMOVAL INC.

(414) 766-1721 • 1020 Prospect, Kaukauna

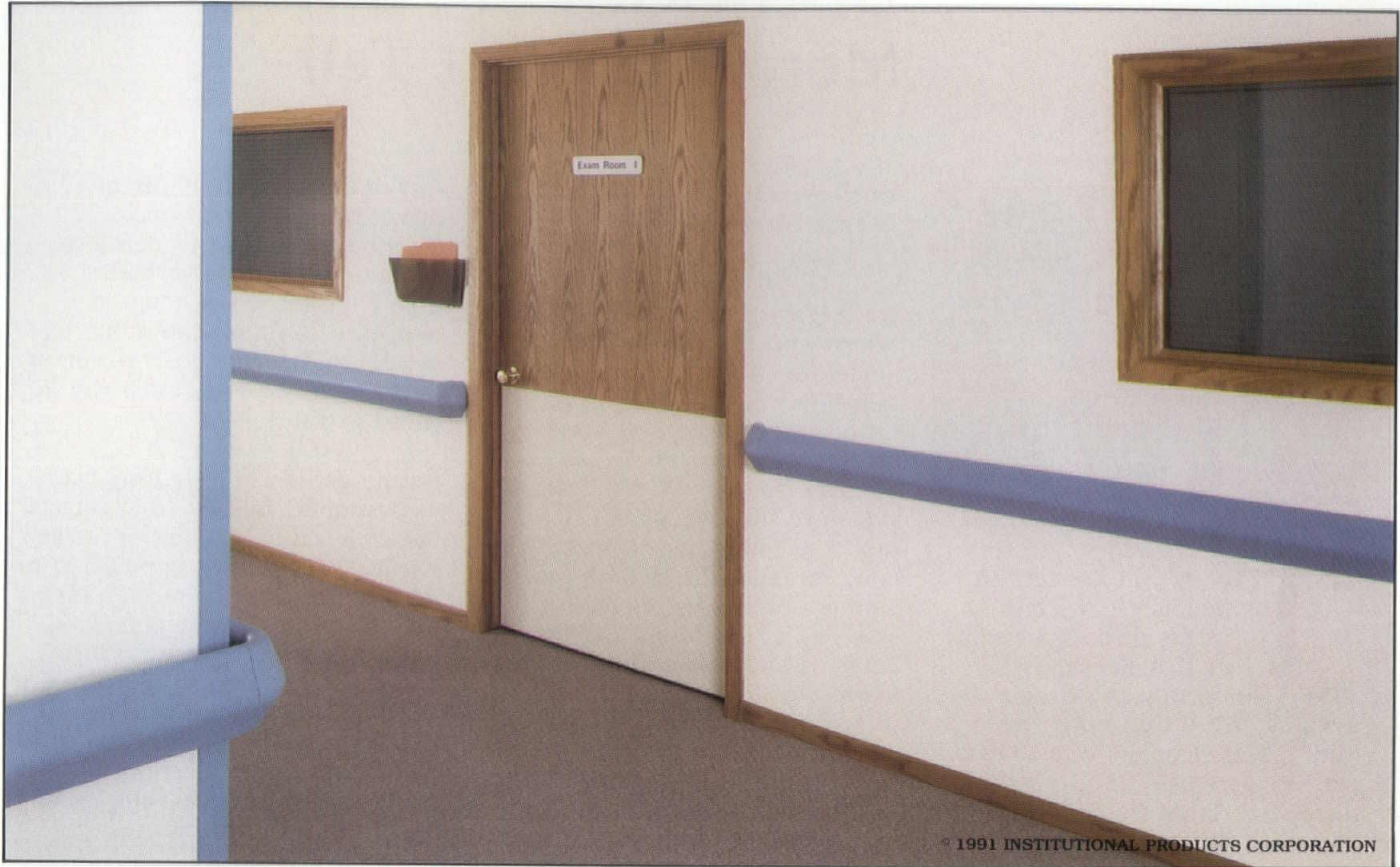

© 1991 INSTITUTIONAL PRODUCTS CORPORATION

1100 HANDRAIL

The attractive angular shape of the rigid vinyl cover, works with the aluminum retainer to provide impact protection. This attractive design protects a 5 1/4" vertical wall space and provides an 1 1/2" diameter gripping area. Matching returns and outside corners are constructed of injection molded thermoplastics.

All mounting hardware is included. Please specify the type of wall you have. Recommended bracket spacing is 30 inches. The 1100 Handrail is available in thirteen colors (see below). Custom Colors are available.

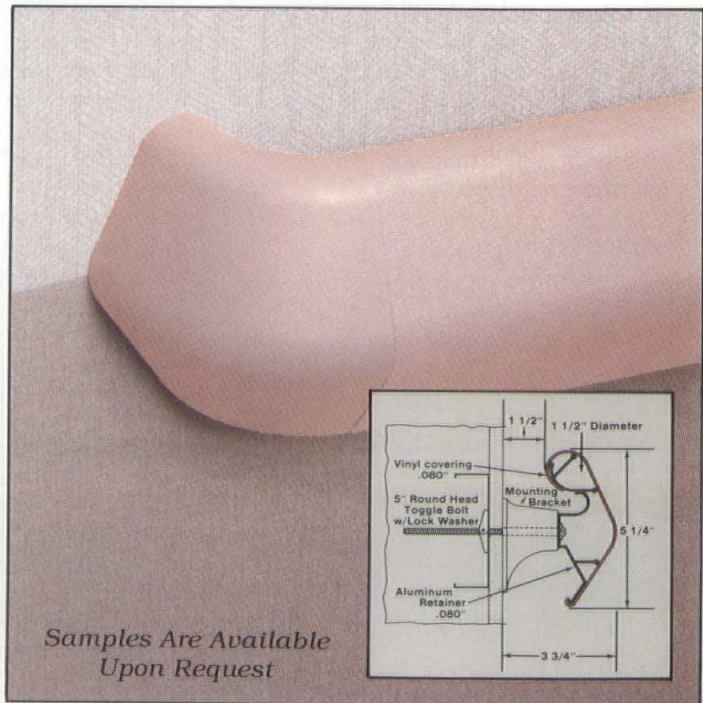
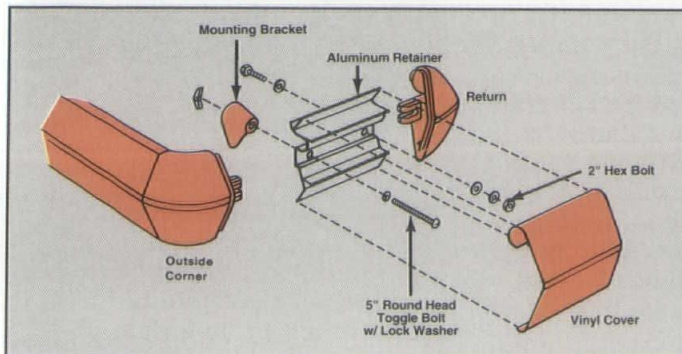

Samples Are Available
Upon Request

HANDRAILS ARE AVAILABLE IN THE FOLLOWING COLORS:



DIALOGUE... More Than Just Talk



Stephen Grabow & Michael Rotondi, AIA.

Today you are here to dialogue." With these words of both welcome and challenge, 1991 chair John Horky, AIA, opened a dynamic WSA Convention held May 7-8 in Oconomowoc's Olympia Village Resort. This year's theme of "DIALOGUE" spoke to everyone; along with heady, theoretical disclosure on the nature of beauty and architecture, there was also straight-forward, practical advice on marketing strategies for the 90s. And, as always, there was a lively, collegial exchange of greetings and shop-talk as members gathered from across the state in the best professional spirit of the WSA.

Grabow and Rotondi: Some Truths about Beauty

"Is beauty in the eye of the beholder? Is beauty subjective, or are there objective ways to create beauty and to evaluate it?" moderator Allen Washatko, AIA, asked Tuesday morning in his introduction of keynote speakers Stephen Grabow, Ph.D., and Michael Rotondi, AIA. Washatko explained that the WSA Convention's keynote topic stemmed from concern about the lack of dialogue amongst architects, both in Wisconsin and throughout the country, and also derived from the absence of a clear theoretical base in architecture.

Grabow was first to grapple with the complex issue of beauty. A professor and former director of the School of Architecture and Urban Design at The University of Kansas, he is the author of the critically acclaimed biography, *Christopher Alexander: The Search for a New Paradigm in Architecture*. Grabow's current work-in-progress is *Affinities of Form*, a study relating architectural principles to art, science and philosophy.

Beauty is neither totally subjective nor objective, Grabow said. He based his points on the premises that since the Renaissance most thinkers have viewed the universe as homogeneous, and that great art is part of everyday life on all levels. Drawing an analogy between form and sports, Grabow explained that in the "pure swing" of baseball or golf there is a natural movement that becomes an

ideal configuration of performance. Grabow went on to describe the human tendency to admire certain gestures and events—in his terms, "special moments"—yet he noted that free will also influences our perception of the beauty we are otherwise inclined to value.

Beauty and form have long been of passionate interest to architects, but architecture's union of art and science gives greater significance to this consideration of form, Grabow said. Recalling historical connections between architectural form and nature, and referring to James Gleick's 1987 bestseller, *Chaos: Making a New Science*, Grabow considered the implications of human-made forms existing within the larger world of nature.

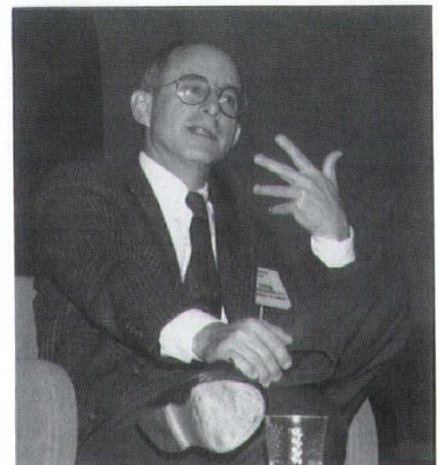

Stephen Grabow.

"If you want to make really meaningful forms, the 'pure swing' of form, the 'dead-solid perfect' form, then it's going to be in another category, in a class of forms that is part of the universe," he explained.

“There is a general realm of natural forms which exists continuously, at all levels, and to the extent that we can create forms that resonate with what is going on naturally, we will create these ‘special moments,’ ” Grabow concluded.

Michael Rotondi then took the microphone—and took the audience on a trek across desert sands dunes, through time and into the nature of the cosmos, over to the fifteen-foot-wide Tokyo site of a recent Morphosis high-rise project, and finally into his passionate, fiercely individualistic sense of design and the creative process.

A principal of the Santa Monica firm of Morphosis, Rotondi is also director of the Southern California Institute of Architecture.

Rotondi began by re-thinking the problem before him. In reconsidering some of the underlying ideas of the “DIALOGUE” theme, he questioned whether the lack of theoretical consensus in the profession is really a negative factor. He rejected the notion that theory is (or ought to be) generative. Using as an example the creative activity of children (who have limited prior knowledge), he took issue with the idea that theory must precede making.

His approach to the issue emphasized not simply the beauty of things, but the beauty of things that embody the process of their making. According to Rotondi, making and thinking are “a simultaneous act.” Explaining his frustration with the labeling of Morphosis’ work as “deconstructionist,” Rotondi emphasized his commitment to wholeness, completeness, and coherence in architecture.

Rotondi explored the connections between beauty, truth and order throughout history. No universal definitions of these words exist, and in fact, these concepts change as cultures change, he observed.

He sought to explain our current condition by noting that a “radical shift” in our sense of order occurred two hundred years ago. In contrast to a pre-ordained, immutable sense of truth, beauty and order, the idea has emerged that truth is not revealed but is made.



Michael Rotondi, AIA.

“In the 20th century, creative activity has been defined by the confrontational relationship between personal freedom and collective will,” Rotondi said. He explained that in a rapidly changing world of blurring boundaries and communication across disciplines, artistic and scientific achievements move beyond the dictates of tradition, and so intuition replaces a collective value system. Rotondi noted that such periods offer great potential for architecture, but unfortunately, instead, architecture too often becomes reactionary.

In response to this dilemma, Rotondi stressed the need to understand the cosmos and our place in it. Also reflecting the contemporary interest in “chaos theory,” Rotondi emphasized that traditional, mechanical or linear views of order have become outmoded and must be replaced by what he called “radically new systems of thought and concepts of order that embrace time and chance and the power of the contingent.”

Rotondi concluded with this advice to architects seeking beauty in an uncertain age:

“You must come to the natural world with no intentions of discovery. It does not give easily. You develop methods of inquiry, although seemingly unintentionally, and you proceed almost by accident. Yet [you are] prepared with open mind, keen senses and skill. You will not be afraid of its secrets or the new direction you are destined to go in. You must become an intellectual *nomad*.

“Everything you experience, real and imagined, will be mediated through you. Your mind and body will work as one, constructing an order that is uniquely yours, yet familiar to everyone else.

“It will be your beauty and your truth—and most importantly, it will be your gift to the world.”

Although there was a rather surprising degree of consensus in their presentations, Grabow and Rotondi differed in their responses to a question raised about the direction architectural schools should take.

Grabow advocated an emphasis on the tradition of descriptive geometry. He also urged schools

to stop indulging in what he termed "a wacky, rampant individualism and excessive idiosyncratic creativity" that favors flamboyance over substance and objective truth.

Maintaining that "people learn in spite of the institutions they're in," Rotondi attacked the authoritarian confines of many schools.

"On the one hand, they tell students to be creative, to take risks, to do all the things that will make the world a better place to live. But then the institution is a goddamned dinosaur! The institution doesn't take any risks! It develops systems that perpetuate itself, in ways that have to rely on habits and routine, that are about repetition and not about creative activity itself," Rotondi charged.

Grabow and Rotondi may have disagreed on education, but together they created a dialogue that was a compelling and profound learning experience.

Rose: Dialogue of the Deal

The WSA's "DIALOGUE" wasn't limited to whether or not beauty was in the eye of the beholder. Wednesday's sessions offered many opportunities to learn the communication skills and marketing strategies that clearly show prospective clients the beauty of architectural services.

Dr. Stuart Rose, AIA, a nationally known marketing consultant to A/E firms, led a panel discussion Wednesday morning that tapped the insights and expertise of four marketing professionals. Panelists included Diane Chamness, owner of Chamness Marketing Network; James Rossmessl, vice president of sales and corporate develop-



Is Anybody Listening? Diane Chamness and Tom Carter.

ment with the Oscar J. Boldt Construction Company; and Helena Van Winkle, marketing manager with Graef, Anhalt, Schloemer and Associates, Inc.

Responding to questions from the audience, the panel addressed a wide range of marketing strategies and principles. Their combined views provided a wealth of suggestions for adapting and fine-tuning standard approaches, including these tips:

- A brochure is an expensive tool that needs interesting pictures and information to keep it out of the wastebasket. A letter with an informational tidbit directed at a client's interest might work better.
- Initial encounters depend on good listening, open-ended questions, prior contact at professional meetings, less "hard sell" and more rapport building.
- Firms need meetings suited to their particular style of workplace. A spirit of marketing involves everyone.

- Perks should be tasteful and appropriate. Try to combine the social and professional, such as sponsoring a technical seminar and brunch before a football game. Provide information that is helpful and causes a client to depend on you.

- Particularly in tough times, try to keep clients. By the end of the century, architectural practice will primarily consist of update, renewal and renovation. Follow up!

"How to Win Clients in a Slowing Economy" was the timely topic of Rose's luncheon program Wednesday afternoon. It was also a fitting send-off for WSA Convention participants, as Rose emphasized that the key to survival in the 90s is dialogue in a variety of forms.

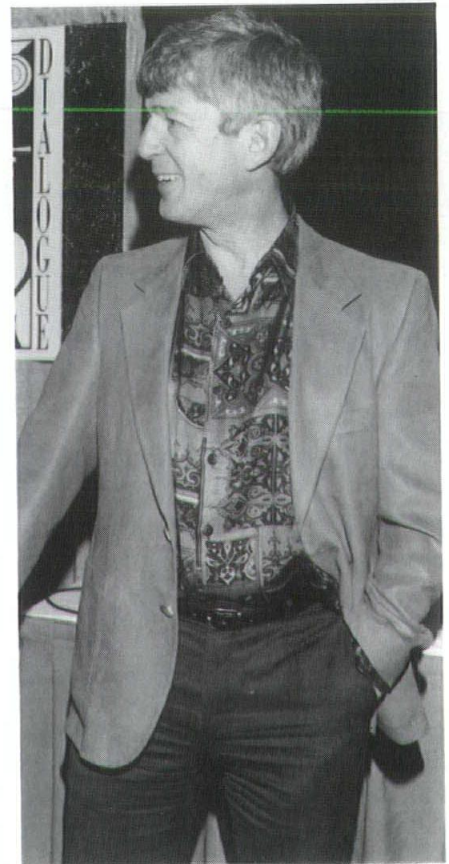

Stuart Rose, AIA.

Warning that tough times are coming, Rose whipped out his magic marker, enlisted the audience's participation and aggressively set about the task of analyzing what the trends are and what kind of jobs they will create. He observed that the impact of the trend in elderly population would be more elderly housing, health care, civic centers, marinas, golf facilities and growth in small towns near water. Rose also noted that "boomers" in their 40s are outgrowing the singles' bars and are heading for family restaurants. Moreover, the "boomette" of their delayed childbearing is creating the need for more schools and daycare facilities.

This process of following trends to active markets can be a vital part of office dialogue, Rose explained. He suggested that each person in the firm be responsible for reading

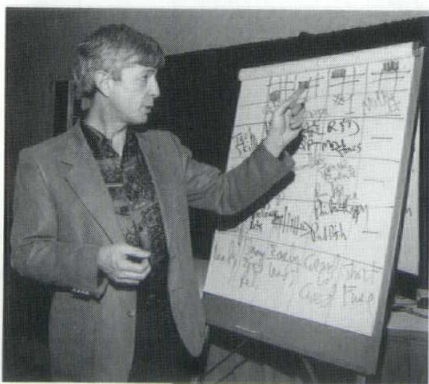

Dr. Rose.

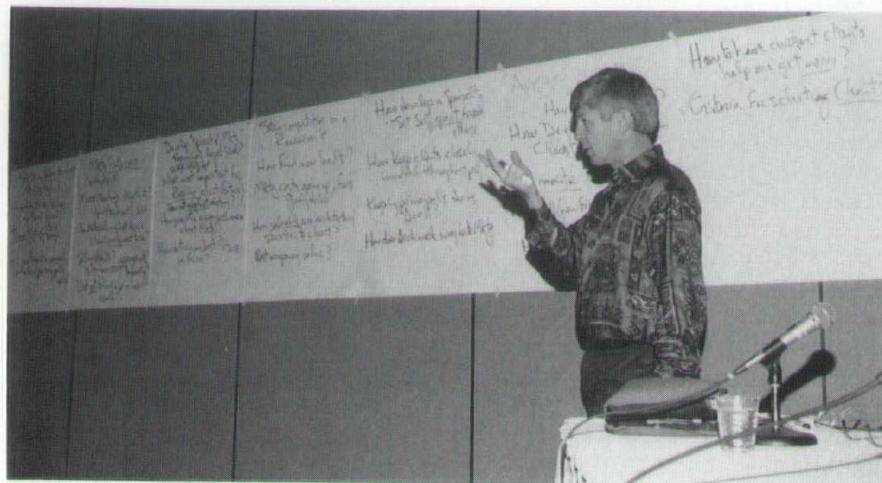

a different non-architectural magazine and reporting on trends it covers. Brainstorming sessions, perhaps involving allied professionals and vendors, could also reveal upcoming trends, he said.

Rose summarized his marketing advice for the 90s in two points: first and foremost, pay attention to where markets are coming from, and also, "listen to your clients about markets, problems, concerns, goals—and ways you can do better on projects."

Rose's emphasis on communication showed that in business, talk can be profitable. He closed with an idea for more dialogue: take a few of your clients to lunch, remind them that you value working with them, and ask them what

they like about your firm and what you could do better.

"It is amazing how clients will help you to design, to modify, to adjust your firm," Rose noted. "And when it comes from them, and you then implement [the ideas], you'll find it leads to much greater success."

In this positive way, "DIALOGUE" ended—and new dialogues, no doubt, began throughout the architectural profession across Wisconsin. **WA**

EDITOR: The author is a freelance writer and a lecturer at UW-Oshkosh. She has written extensively on architecture and popular culture.

Photography: Joe Paskus

The Great Debate: A Mystery

To ask a question as weighty as “What is beauty?” is to entertain the great mystery of our existence. The 1991 WSA Convention had its lighter moments, however—and the mystery that entertained those attending the WSA Construction Industry Reception in the exhibition hall Tuesday night was truly great. Great fun, that is!

After a day packed with informative sessions, Convention participants found more to ponder than just the displays of building products and services. Wandering by the model windows and tile samples were a real cast of characters: secret agents with dark glasses and walkie-talkies, cheerleaders, a European countess loaded with rhinestones and insults aimed at her ex-husband, and a couple of fur-hatted self-proclaimed “visiting architects from—uh, uh—North Dakota” with Russian accents and designs beyond architecture.

“Who—or what—are these people?” was the question of the evening. Convention-goers had the opportunity to find out by picking up clues at each exhibit booth and conversing with the characters themselves.

The high point of the evening was to have been a debate between Eastern-block critic Igor Voostenmooster and Milwaukee’s own defender W. C. Booth. However, before Voostenmooster had the chance to publicly slam midwestern architecture, the debate bombed. And so with a loud “bang,” Booth was reduced to a bag of—well, you had to be there.

Before the conflict blew up, Voostenmooster granted an exclusive interview to *Wisconsin Archi-*

tect. When asked what he disliked about Milwaukee, he replied “It starts on the north and goes to the south.”

Midwestern architecture, Voostenmooster said, did have its redeeming qualities. “You done good on sprawl,” he conceded.

And what of Wisconsin’s own Frank Lloyd Wright? “He was wrong,” Voostenmooster declared.

Proudly wearing the key to the city of Toledo, Ohio (where he was invited—and then invited never to return), Voostenmooster described his own architectural innovation: “Is new concept—double hinge, swing-loop anchor concept, based on Rubik’s cube, track lighting and bird cage.”

Contrary to what circumstantial evidence would suggest, Voostenmooster did not eliminate his rival Booth. In fact, in the end, Voostenmooster helped the audience solve the puzzle that prevented a bomb from leveling Milwaukee. The moral of the story? Wisconsin architecture stands up to even the toughest criticism.

As for the larger “whodunnit,” this mystery was a production of the Oshkosh-based theatrical company *Mysteries Made to Order*. **WA**

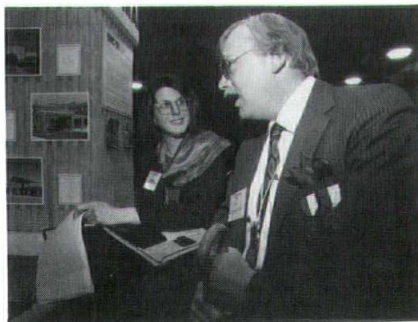

Exclusive interview.

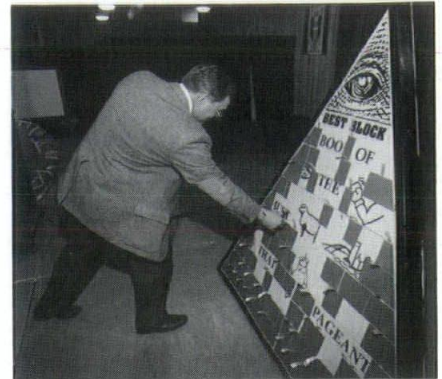

The mystery revealed.

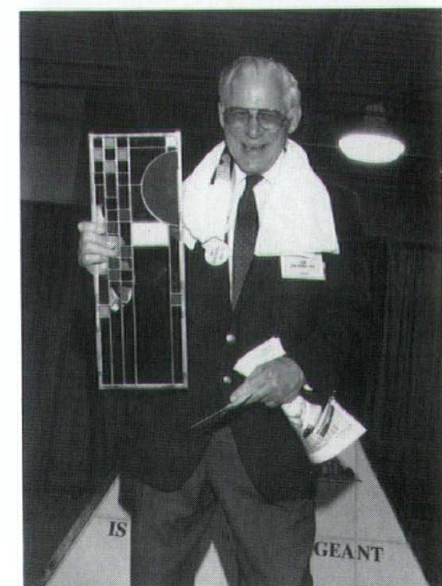
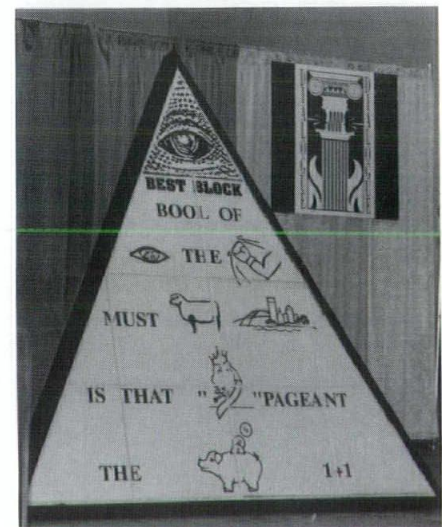

And the winner is...Len Reinke, FAIA.

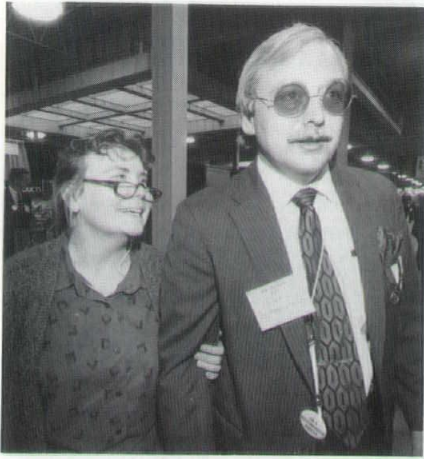

Olga & Igor Voostenmooster.



Voostenmooster Boosters.

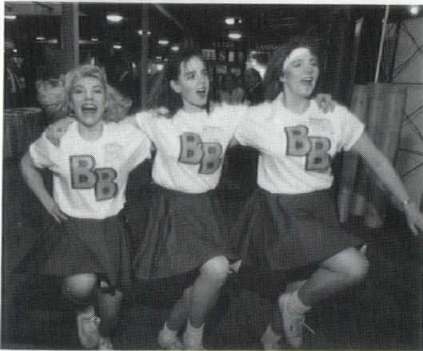

Booth Brigade.

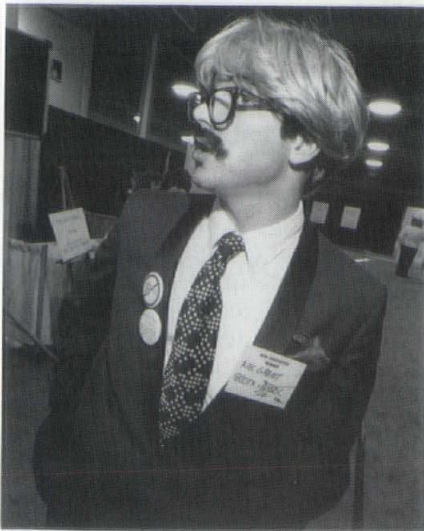

The cast of characters...



W.C. Booth and Madame Bobinska.

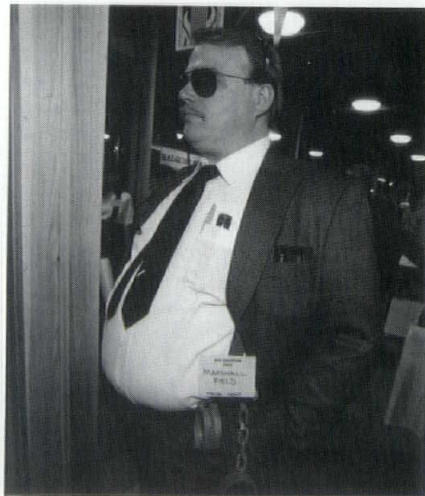

Agent Marshall Field.

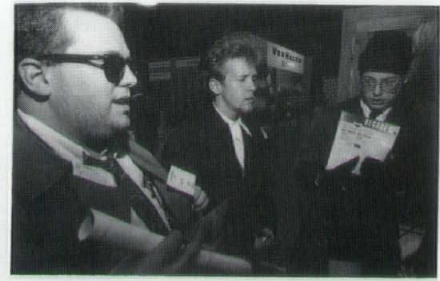

North Dakota architects?

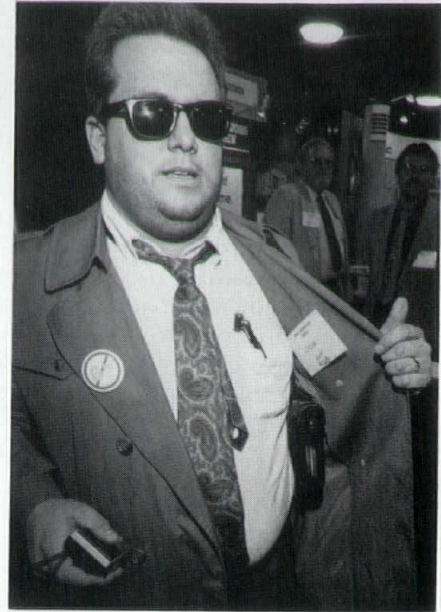

Not KGB.

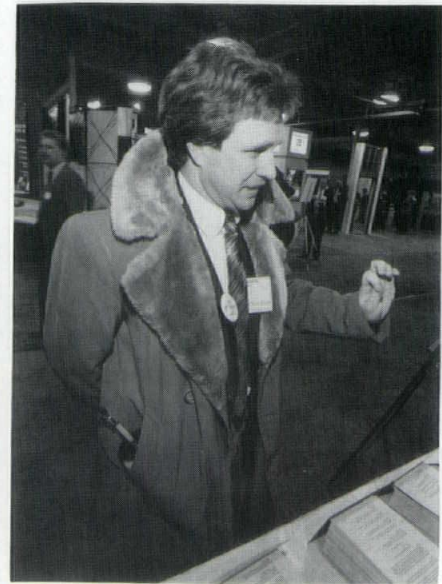

A Greenprint of the 21st Century: Seeking Architectural Options

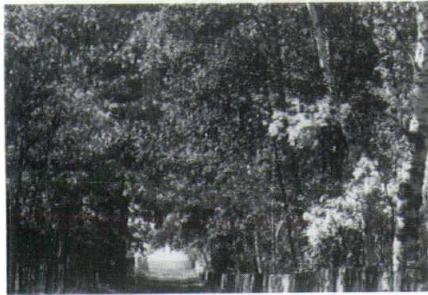

In light of the many environmental concerns facing us today, it has become increasingly important for the architectural profession to define and implement ecological principles and criteria. Well known environmental issues such as ozone depletion, the greenhouse effect and deforestation are directly linked to the construction industry through the use of energy, chloroflourocarbons (CFCs) and wood products. For example, the U.S. consumes 35% of the world's energy, with one-third utilized in buildings, primarily for heating, cooling and lighting.¹ This article will review ways in which the profession and individual architects may begin to address the many ecological issues related to architectural design.

Environmental issues impact the design, material selection, construction, operation and maintenance of buildings. New developments in architectural practice and technology suggest that we can redefine our relationship to the environment in a responsive and sustainable manner. Today, state-of-the-art energy efficient buildings may consume less than one-quarter of the energy of an average structure the same size.² In addition to reducing energy consumption, an ecological approach to building design strives to minimize impact on the environment through response to environmental forces, sensitivity to site and integration of renewable and environmentally sound resources and technology. During

the 1970s, technological advances were developed in response to the energy crisis of that decade. Though some momentum was lost during the 1980s, a new definition of ecological architecture is emerging which goes beyond energy to encompass larger concerns such as building toxicity, pollution, impact on natural resources and the environmental costs of material selection.³ The issues for the 1990s are larger and more holistic, while still acknowledging the critical role of energy consumption. The profession must begin to define and address the multitude of issues regarding architecture and its environmental impacts.

Environmental Criteria

A serious problem for architects is the unavailability of comprehensive ecological data by which he or she may make informed decisions. In April 1990, the American Institute of Architects (AIA) announced plans to develop *The Environmental Resource Guide* for architects. The guide will begin with building materials such as flooring, carpeting and finishes. The AIA will be using information

to comprehend the ecological issues one must address the effects of extracting, processing, manufacturing and transporting the materials, as well as material toxicity and recyclability. To date, very little research and information is available which encompasses the full spectrum of ecological issues. In addition, material specification is only one aspect of the broader concerns previously mentioned. The question then becomes, how does the architect begin to address the complex set of ecological issues facing us today while awaiting guidelines from the government or the AIA? There are two levels on which ecology may be approached, the first through the professional community, and second by the individual architect.

Professional Options

On the professional scale, a number of significant steps have been made, such as the formation of the AIA Committee on the Environment, and the upcoming *Environmental Resource Guide*. While these are significant beginnings, broad support from professionals is required to initiate the development of comprehensive

The profession must begin to define and address the multitude of issues regarding architecture and its environmental impacts.

provided by the EPA, manufacturers and conservation organizations.⁴ The multitude of building materials, components and systems makes it intensely time consuming and difficult for the individual architect to assemble such information. The AIA resource guide will be a valuable tool, providing a desk-top resource on finishes, with guides to follow for other levels of material selection.

Determining the complete ecological impact for material selection is complex. To fully com-

prehend the ecological issues one must address the effects of extracting, processing, manufacturing and transporting the materials, as well as material toxicity and recyclability. To date, very little research and information is available which encompasses the full spectrum of ecological issues. In addition, material specification is only one aspect of the broader concerns previously mentioned. The question then becomes, how does the architect begin to address the complex set of ecological issues facing us today while awaiting guidelines from the government or the AIA? There are two levels on which ecology may be approached, the first through the professional community, and second by the individual architect.

A method of labeling building products (green labeling) has been proposed in the UK which would define building products in terms of health, safety, environmental impact and energy consumption.⁵

Green labeling has received mixed governmental reactions due to issues of funding, logistics and product assessment. The implementation of this system would provide much needed criteria to architects and designers. A system of green labeling has been in effect in West Germany since 1978.

(CO₂) emission, internal air quality, use of tropical hardwoods, hazardous building materials, standards for lighting and energy consumption.⁶ Credit would be given for areas which have been addressed, and if the building meets specified ecological standards, green certification would be

granted. The label would include a plaque visible to the public, with details of relevant environmental issues. This certification would bring ecological issues into the public arena, helping inform the public and increasing support for ecologically sound building design.

The profession should become part of the global solution by taking a vocal and visible role in developing ecological guidelines and standards for architectural design.

The "Blue-Angel" environmental label provides information on the environmental aspects of building products, with testing conducted by private laboratories to ensure credibility. Today, we take for granted the listing of ingredients and nutritional values for food products; a labeling requirement provided by manufacturers for the health and safety of consumers. The environmental health of our planet should be of no less concern, despite logistical, economic and political impediments. Tax advantages provided for environmentally sound building materials could help reduce complacent attitudes by providing economic as well as ecological incentives.

Another alternative proposed in the UK is the voluntary green labeling of entire buildings. The concept is to promote ecologically conscious designs and bring them to the attention of the public. While green labeling of buildings is in the developmental stage, the idea of identifying encouraging and rewarding ecological design is significant. The building design would be submitted to an independent panel of certifiers who would access the design and specifications based on specific ecological criteria. For example: use of chloroflourocarbons (CFCs) in construction, carbon dioxide

granted. The label would include a plaque visible to the public, with details of relevant environmental issues. This certification would bring ecological issues into the public arena, helping inform the public and increasing support for ecologically sound building design.

The most important effort by the Royal Institute of British Architects (RIBA) may be its effort to encourage professional involvement in disseminating information to the public. In May 1990, the RIBA added a new policy to their Code of Conduct which asks its



members to persuade their clients to permit the use of environmentally benign materials and to employ energy efficient specifications and construction techniques.⁷ The first and most significant step is for the architectural profession to redefine the relationship of the architect to the environment in ecological terms and to acknowledge the critical role that archi-

Individual Options

The role of individual architects in adopting an ecological perspective is critical for motivating the development of professional criteria and principles. Despite the complexity of the issues and the lack of comprehensive resources, there are a number of ways in which the individual architect may address ecology today. Many very important solutions can be resolved at the drawing board by addressing design principles such as spatial organization, zoning, form, massing, and configuration. By considering orientation, sensitivity to site, topography, sun, wind, light and climate, a good portion of the ecological battle may be won during the design phase. If we integrate architectonic solutions up front, technological solutions can be used to reinforce an already ecologically based design. There are many excellent resources available today, such as David Pearson's *The Natural House Book*, which give detailed climatically and environmentally responsive design strategies. Addressing architectonic solutions is the first and perhaps most influential step an architect can take to begin to address ecological design.

By now there are also many well documented and easily implemented technological approaches to major issues such as ozone depletion and the greenhouse effect. During the past several years, alternatives to building refrigerants, insulating foams and energy intensive materials have been widely published and

researched. For example, it should be standard practice to use climate and site responsive architectural solutions which minimize the need for air conditioning by maximizing natural ventilation through orientation, zoning and shading devices. Alternatives to CFCs have received extensive attention due to professional and public pressure.

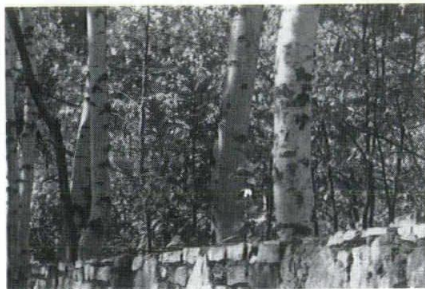

Manufacturers have responded to this pressure with research and development to minimize CFCs in the building industry. The power of the individual should not be underestimated. For example, the debate on tropical hardwoods has prompted the International Tropical Timber Council (ITTC) to agree to the principle of developing an international labeling scheme which would ensure and certify that lumber is from a sustainable source.⁸ To date, no system exists, and there is no method of verifying whether specifying tropical hardwoods is contributing to global deforestation or whether the species is threatened or endangered. The ITTC has developed a study to determine the feasibility of monitoring timber from its source to the consumer, which may serve as a basis for future labeling and monitoring systems. Meanwhile, the specification of sustainable timber sources could help motivate the development of comprehensive information from the ITTC and from suppliers of the endangered wood products.

However, architects should not believe that ecologically sensitive

designs are achieved simply by eliminating CFC refrigerants, foam insulation and topical hardwoods. Unfortunately the solutions are far more elusive. Virtually all building materials contain some toxic elements, and utilize manufacturing processes which consume energy and contribute to the harmful build-up of CO₂ gases (subsequently contributing to the greenhouse effect). Material toxicity is one example of the difficulty of identifying environmental consequences. Even the most common materials contain compounds

turers of building materials and components have embraced ecological principles and can provide resources to aid the design process. Much research, documentation and dissemination of information is needed, and architects should begin to ask questions of the building industry. As more questions are asked, an increasing awareness of ecological priorities will promote the development of comprehensive evaluative criteria and accessible information. Architects can have an impact in initiating further research; expressing

An approach which addresses the well-being of the environment, the builders, and the building users in the broadest ecological sense is required.

dangerous to the environment and to building occupants. For example, it takes a good deal of research to determine which carpets contain harmful volatile organic compounds (VOCs) or contribute to toxic outgassing. Many exterior paints still contain mercury and high VOC emissions, despite extensive research on the health hazards. In addition, some plywoods and particle boards still produce formaldehyde emissions. Finding ecological alternatives for commonly specified materials can be laborious and time consuming, but such alternatives do exist. A commitment in time, and therefore money, must be made in order to ensure ecologically responsible building specifications and practices. Much of the responsibility will fall on the shoulders of individual architects until further research and resources are available.

Architects should require manufacturers to provide ecological criteria on materials. Interest from the profession can ultimately instigate change of current manufacturing practices. Many manufac-



and voicing concerns can begin to develop ecological criteria which is so seriously needed.

From deforestation to the greenhouse effect and ozone depletion, individual actions have global impacts. By bringing together architectonic and technological responses, the architect can help shape an environment which is ecologically sustainable. It is only through individual actions that we can find global solutions.

The most important task facing the profession and the individual architect is the redefinition of our relationship to the environment in ecological terms. Rather than taking a reactive position, as in the energy debate of the 1970s, we should take a pro-active stance to

initiate the implementation of ecological building standards. An approach which addresses the well-being of the environment, the builders, and the building users in the broadest ecological sense is required. Evaluative criteria and principles will help make ecological design a standard practice rather than an exception. We cannot define environmental issues

sibility for the ecological impacts of all aspects of architectural design. **WA**

EDITOR: The author is an assistant professor in the Department of Architecture at the University of Wisconsin-Milwaukee. She is currently researching ecological design practices in Wisconsin. If you have any information to share

REFERENCES

- ¹ Alex Wilson, "Light Duty," *Architecture*, (December 1990), p.81.
- ² Ibid.
- ³ Stewart Mosberg, "Technic Topics," *Progressive Architecture*, (March 1991), p. 62.
- ⁴ Amy Gray Light, "Design Community Takes Environmental Action," *Architecture*, (June 1990), p. 31.
- ⁵ Catherine Slessor, "Building Biology: Green Labelling," *Architects Journal*, (February 7, 1990), pp. 62-63.
- ⁶ Ibid.
- ⁷ Environment and Energy Policy Committee, "Energy Policy," *Royal Institute of British Architects Journal (RIBA Journal)*, (July 1990), p. 18.
- ⁸ Catherine Slessor, "Tropical Hardwoods: Fruits of the Forest," *Architects Journal*, (August 8, 1990), p. 50.

Addressing architectonic solutions is the first and perhaps most influential step an architect can take to begin to address ecological design.

in terms of energy and economic costs only, for the cost to the environment may be the greatest of all. It is the task of the profession as a whole and for individual architects to accept the respon-

on the subject, she can be contacted through the Department of Architecture, Engelmann Hall, University of Wisconsin-Milwaukee, Milwaukee, Wisconsin 53211.



Photography: Mike Mau

Pride of the Fleet!



Vessels which ply the Great Lakes from ports around the world do not run on water alone. Complicated electrical systems are required for engine controls, refrigeration and ventilation, for lighting, for communication (both on-board and ship-to-shore), for guidance, housekeeping, human amenities, kitchens and, yes, for the ever present computers.

It takes specially acquired knowledge to install, maintain and improve marine electrical applications. The electrical contractor called in the Port of Milwaukee is Uihlein Electric.

And all this expertise is also available to the landlocked. Call us, won't you?

(414) 781-1260

Uihlein Electric Company Inc. 12630 W. Townsend, Brookfield, WI 53005



**Uihlein
Electric**

Electrical Contractors
and
Engineers



MID-CITY BLUE, INC.
810 NORTH PLANKINTON AVE.
MILWAUKEE, WI 53203
(414) 276-0950

Diazo Printing
Pin Bar Overlays
Specification Printing
Xerox 2080
Xerox 2510
Xerox 3080
Cad Plotting

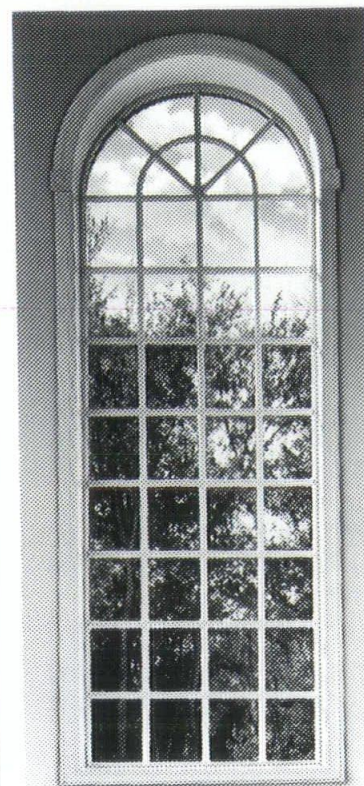

**WHEN IT COMES TO
WINDOWS, WE FILL SOME
PRETTY TALL ORDERS.**

This window is just one example of how unique ideas take shape at The Pella Window Store.[®] Which is why if you're in the market for windows, you should set your designs on Pella. Visit The Pella Window Store[®] soon. And see how our windows can turn out even better than you imagined.



VERHALEN
**The Pella
Window Store[®]**

Green Bay	Madison	Marquette, MI
Mequon	Milwaukee	Neenah
Racine	Waukesha	Wausau

The Golden Rule



1991 WSA Golden Award Recipient
Leonard H. Reinke, FAIA.

I was recalling the many developments and changes that have occurred during my membership in The American Institute of Architects...and have paraphrased a president's message I wrote for *Wisconsin Architect* in 1964: "The question is often posed...what is the AIA doing for me? I pay my dues, what do I get?"

No organization, the WSA included, can create individual professional competence or solve individual problems. This each architect must do alone. However, the WSA can unite the efforts of all its members to create a climate of high professional standards, ethics and public esteem "to make the profession of ever increasing service to society."

To this purpose, many members in the past and present have dedicated their time and talents. From these efforts, each member benefits...be they an energetic participant or a by-stander.

The WSA has a variety of activities for everyone—the Board of Directors, Chapter officers, *Wisconsin Architect* magazine, Wisconsin Architects Foundation, Honor Awards, annual Convention and numerous committees of many interests. The decision to be a participant or just a by-stander is up to you. The question really is: "What are you doing for the Wisconsin Society, other than paying your dues?"

To this list of activities, I recommend attending a national AIA Convention, learning first hand about national programs, hearing outstanding speakers, participating

in a variety of seminars and enjoying special tours, exhibits and entertaining evenings, including the unique Dodge Party. I also urge you to participate in a national committee that interests you. Starting as a corresponding member and then attending meetings where you will meet a sharp group of architects from all over, with whom you can share your interests.

I witnessed the beginning of the Wisconsin Chapter/AIA in the late '40s, and I am glad to be in the company of the many members that had a part in its development on through the years into the Wisconsin Society of Architects with its own building, the Stoner House, and the viable organization it is today.

The more you become involved, the more interesting this profession becomes.

The thought I want to leave with you is that we have had dedicated leadership in the past...and we have very effective leadership in the present. The future leadership is up to you, the younger members. Become informed and get involved. The WSA and the AIA are great institutions...and they need you.

EDITOR: The author is the 1991 recipient of the WSA Golden Award, the highest honor the WSA can bestow on one of its members. The article contains excerpts from his comments at the Awards Luncheon held in conjunction with the 1991 WSA Convention.

INNOVATIVE DESIGNS for 1991

FULL OVAL LITE DOOR IN PINE, FIR & OAK

Beveled glass set in brass caming is 5/8" triple insulated. Raised moulding is applied around glass and panel. Door is available 3'-0" x 6'-8", sidelights are 1'-0" & 1'-2" x 6'-8-1/2".

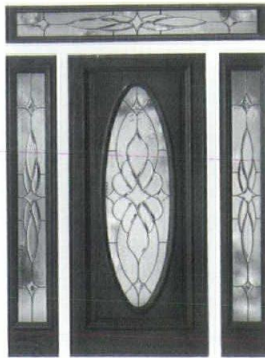

BARRINGTON

MORGAN'S NEW 7' DOOR AND SIDELIGHT IN PINE AND FIR

Stately seven foot door and sidelight can be trimmed to fit standard 6'-8" openings. Door is available 3'-0" x 7'-0", sidelights are 1'-0" & 1'-2" x 7'-0-1/2".

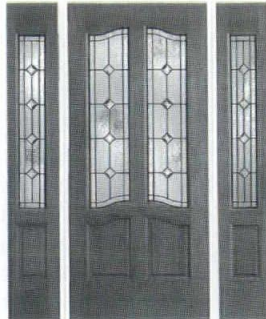

DIAMOND WEDDINGTON

ASYMMETRICAL GLASS DESIGN COMPLEMENTS OAK

Beveled edge glass set in gold caming. Raised mouldings surround panels and 5/8" triple insulated glass. Door is available 3'-0" x 6'-8", sidelights are 1'-0" & 1'-2" x 6'-8-1/2".

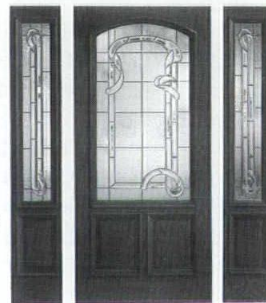

RIBBON OAKS

MORGAN'S MATCHING TRANSOM COMPLETES THE TOTAL ENTRANCE

Brass camed decorative glass accents the rich wood tones of this pine door. Matching transom adds drama to a high ceilinged foyer. Use transom with 3'-0" door and two 1'-0" or 1'-2" sidelights.



BELLAIRE



Morgan doors are distributed thru dealers by The Radford Company.

- Oshkosh
- Madison
- LaCrosse
- Duluth

Morgan
WE BRING NEW IDEAS
TO YOUR DOOR

PBBS EQUIPMENT CORP

5401 N. Park Dr., Butler, WI 53007

SINCE 1955

BOILER ROOM

Service - Parts - Sales - Chemical - Engineering

24 Hour Service
Radio Dispatched

INDUSTRIAL Large Parts
COMMERCIAL Inventory

Cleaver Brooks *FACTORY AUTHORIZED PARTS & SERVICE*

ALL MAKES

Webster Burners
And-Car Systems

SERVICE

Troubleshooting - Repairs - Cleaning - Refractory Work
Efficiency Tune-Ups - Service Contracts - Inspections
Mobile Boiler Room Rentals - Descaling - Conversions

SALES

Boiler Room Equipment & Accessories - Chemical
Systems Burners - Chemical Treatment & Analysis
Propane Systems And-Car Boiler Blowdown Systems
And-Car Monitor Systems

THROUGHOUT WISCONSIN AND UPPER MICHIGAN
Milwaukee (414) 781-9620 • Madison (608) 249-6604
Green Bay (414) 494-3675 • Stevens Point (715) 344-7310
FAX (414) 781-8526

THROUGHOUT MINNESOTA AND NW WISCONSIN
THE HEINEN CO.
MINNEAPOLIS (612) 936-9800
DIVISION OF PBBS EQUIPMENT CORP.

UNITED brick & tile, inc.

Now Open

New

Retail-Design-Center
6634 Watts Rd.
Madison's West Side

Ceramic Tile

- American Made
- Tile & Grouts
- Large Inventory
- Midland
- KPT
- Huntington Pacific

Face Brick

- Midland
- Ochs
- Gleason
- Kansas
- Glen Gery

Fireplaces

- Superior Zero Clearance

West (New Location)
Retail Design Center
6634 Watts Rd.
Madison, WI
608-274-4155

East
Showroom-yard-warehouse
5402 Lien Rd.
Madison, WI
608-241-3844

1991 Fall Workshop

The annual WSA Fall Workshop is scheduled for Friday, October 18, 1991, at Devil's Head in Merrimac. Mark your calendar, reserve the date and plan to participate.

Joe Powelka, AIA, chairperson of the 1991 Fall Workshop, has put together a great program for this annual one-day practice-orientated seminar. This year's Workshop will build upon recent WSA seminars that focused on successful firm practice and management techniques. Workshop speakers will help prepare you to go after diversified markets, to expand the scope of architectural services and to successfully meet the varied needs of existing and prospective clients.

Regional Director

In accordance with established protocol for the North Central Region, which includes Wisconsin, Minnesota, North Dakota and South Dakota, it is the WSA's turn to nominate the next Director to represent the Region on the national AIA Board of Directors. At its recent meeting, the WSA Board of Directors voted unanimously to support the nomination of James W. Miller, AIA, for the three-year term that begins in December 1991.

Jim Miller is president of Flad & Associates in Madison. He has taken on many leadership positions with the WSA over the years, including a term as WSA President in 1986 during which he initiated the WSA's annual long-range planning process. Jim will be an effective and articulate spokesperson for architects in

Wisconsin and throughout the North Central Region. His vision for the profession includes architects taking back responsibility and assuming the leadership role in the design and construction industry.

"My door is open or I am just a phone call away," Miller said in accepting the nomination and encouraging members to contact him with any comments, questions or suggestions. "Your ideas and counsel will help me better serve both the North Central Region and the profession."

Jim can be contacted at: Flad & Associates, 6200 Mineral Point Road, P.O. Box 5098, Madison, WI 53705; (608) 238-2661.

WAF Directors

Richard J. Griese, AIA, DePere, Clarence Huettenrauch, AIA, Mequon, and Dean Robert C. Greenstreet, Milwaukee, were unanimously elected to three-year terms on the Board of Directors of the Wisconsin Architects Foundation at the WAF Annual Meeting in Oconomowoc. The meeting was held in conjunction with the 1991 WSA Convention.

WAF President Gary V. Zimmerman, AIA, thanked retiring WAF Board member Robert L. Yarbrow, AIA, Wild Rose, for his dedicated years of service on behalf of the WAF in promoting architectural education and scholarship.

Zimmerman also had the privilege and pleasure of formally accepting generous contributions to the WAF from the Milwaukee Chapter CSI and Best Block Company. Clarence Huettenrauch presented the CSI gift and Kerry VonDross represented Best Block.

Memorial Scholarships

In his report at the WAF Annual Meeting, President Gary Zimmerman, AIA, announced that the Wisconsin Architects Foundation had initiated two model Memorial Scholarship Fund programs. The two WAF scholarships will memorialize Elmer Johnson, one of the leading architects in Wisconsin for over a quarter of a century, and Richard Hunzinger, a premier general contractor in the greater Milwaukee area.

The goal of the WAF is to raise a \$15,000 endowment for each of the Memorial Scholarship Funds. Annual WAF scholarships will be provided to UWM SARUP students from each of the funds. The Elmer Johnson Scholarship will recognize students who exhibit design excellence and the highest order of graphic talent along with all-around academic achievement. The Richard Hunzinger Scholarship will be awarded to architecture students in recognition of their academic achievement and demonstrated construction technology skills.

Individual and firm contributions to these two WAF Memorial Scholarship Funds are welcomed. Generous contributions already have been received by the WAF from the following people and companies: *Elmer Johnson Memorial Scholarship*—Jim Bruner, Vern Cottam, Tom Eschweiler, AIA, Gary Grunau, Paul Grunau, Burleigh Jacobs, Glen Langer, Lyman Precourt, Mac Slater, AIA, Tews Company and Reggie Thomas; *Richard Hunzinger Memorial Scholarship*—Fritz Forrer, Mark Gleischman, Frank Lorenz and Waste Management, Inc.

Sales Tax

Despite the efforts of many WSA Legislative Minutepersons who contacted their state legislators, the Joint Finance Committee on June 8th voted 10-6 to increase the state sales tax to 6% and expand the tax to a number of professional services, including architectural, engineering and interior design services. The sales tax increase/property tax relief package is part of the Committee's 1991-93 state budget proposal.

The proposed sales tax on architectural services still must be approved by both the State Assembly and State Senate before being sent to Gov. Thompson. The Governor has consistently pledged to veto any proposed general sales or income tax increase.

Wisconsin Architect's ace investigative reporter recently tracked down WSA Executive Director Bill Babcock in the halls of the State Capitol to get the scoop on this crazy sales tax proposal. Babcock apologized for not having time to talk and handed the reporter a news release issued by the WSA on May 24th from which the following is excerpted.

Legislative budget proposals to expand the state sales tax to a broad list of professional services are fraught with "serious tax equity, enforcement, compliance and administrative problems," according to an analysis by the Wisconsin Society of Architects.

These administrative and enforcement problems have caused other states, such as Florida and Massachusetts, to give up on their brief attempts to expand the sales tax to professional services, according to William Babcock, ex-

ecutive director of the statewide architects group. "Unfortunately, sales tax expansion proponents in Wisconsin appear inclined to ignore these legitimate problems and tax equity questions," Babcock said.

The WSA analysis identified a number of problems with trying to expand the sales tax to architectural and other professional services. These were outlined in its response to a letter from State Senator Joseph Leean, a Waupaca Republican who introduced legislation earlier this session that would, among other things, increase the state sales tax to 6% and expand its scope and reach to include various professional services.

The analysis identified the following enforcement and administrative problems with proposals that would attempt to expand the sales tax to professional services:

- Expanding the sales tax would result in much higher enforcement and compliance costs. According to the Department of Revenue, the state would incur "substantial administrative costs" for the initial registration of 65,000 new sales and use taxpayers, processing additional returns and development of new forms and computer systems. An estimated 85 new full-time state employees would be needed at an annual cost of over \$3.3 million. In addition, initial state administrative development costs would total over \$4.6 million for the first two years. The cost to professional firms of trying to comply with the new tax would total many times the enforcement costs estimated for state government.

- Larger businesses would be able to avoid the sales tax by providing these professional services with in-house staff or by purchasing these services through offices located outside of Wisconsin. As a result, the burden of an expanded sales tax would fall disproportionately on smaller Wisconsin-based businesses, their employees and their clients because they would not be able to easily avoid the tax.

- Out-of-state businesses and individuals would not be subject to the state sales tax on services provided by Wisconsin professionals. While this is important for the many Wisconsin professional firms that provide services outside of Wisconsin, these out-of-state clients would now be paying 6% less for these services than their Wisconsin-based counterparts and competitors.

- One sales tax expansion proposal, Senate Bill 48, contains a list of services over seven pages long. No precise definitions are provided and the listing often includes the catch-all language "...and other related services, including but not limited to..." This proposed statutory language will result in a great deal of confusion and misunderstanding and lead to protracted tax disputes and expensive litigation in an effort to determine what services actually would and would not be subject to the new expanded tax.

- No guidelines are provided as to how local county sales taxes, in place in 40 counties, would be administered and enforced. This has serious tax equity and competitive implications that would depend on whether the local sales tax will be based on where the professional services are provided or the location of the client or project.

- It is not possible for Wisconsin to enforce the sales/use tax on professional services provided by out-of-state firms except in a very limited and random fashion. Tax officials in other states have found a use tax on professional services is unenforceable for all practical purposes. This would put Wisconsin-based professionals at a competitive disadvantage because state sales taxes cannot be consistently and effectively collected from out-of-state professional firms providing services in Wisconsin.

- The design and construction process is very complex, often spanning several years for an individual building project and involving a large number of different firms and consultants. Proposals to expand the sales tax to architectural, engineering and other professional consulting services create a host of unresolvable administrative and enforcement questions, including: How will existing contracts be treated? Will the taxation of subconsultant services result in a pyramiding of sales taxes on top of sales taxes and an effective sales tax rate on these professional services of more than 6%? When is the tax liability created and payment due? How will the tax be administered fairly when professional services are delivered in a non-traditional manner (e.g. design-build, construction managers, etc.)?

“Because of the inherent inequities and administrative problems associated with proposals to expand the sales tax to professional services, the WSA remains strongly opposed to such state tax increase packages,” Babcock said. The state architects group is one

of over 50 professional and business organizations that have joined forces in the Coalition Against New Taxes (CANT) to fight the proposed sales tax base expansion.

Fair Housing

The federal Fair Housing Amendments Act of 1988 created several new protected classes including persons with disabilities. In May, the Wisconsin Legislative Council voted without objection to introduce legislation which would amend the state fair housing law and make it “substantially equivalent” to federal law. Consideration of the proposed legislation by the Legislature could begin in the fall session.

The Legislative Council is composed of leadership from both parties in the Assembly and the Senate. The proposal was put together by a 19-member committee chaired by Rep. Rebecca Young and made up of six legislators and 13 public members representing local government, realtors, builders, persons with disabilities and fair housing advocates.

There are four areas in which provisions would be changed: 1) expansion of classes of protected persons and types of discrimination covered, 2) accessibility of new construction and remodeled existing housing, 3) zoning of “community living arrangements,” and 4) enforcement procedures. In summary, the proposal would:

- Add as protected classes “family status” and “persons with disabilities” and redefine “discrimination.”

- Include the seven federal site and building design criteria for new multi-family housing and add these criteria to current requirements for rehabilitation of existing multi-family housing, and direct the Dwelling Code Council to study accessibility in one and two family dwellings.

- Modify state zoning laws relating to community and other living arrangements, creating a new category “adult care homes” serving four or fewer adults as permitted use in any residential area, reducing the required spacing from 2500 feet to 500 and replacing community advisory committees with neighborhood relations plans as part of CBRF licensing.

- Extend the time in which a complaint can be made, provide for an election of forum, prosecution of cases by the Department of Justice and authorize awards of damages and penalties for violations.

Details of the proposed legislation are in the “Committee Report #10 to the Legislative Council,” dated May 2, 1991. The report is available free (for single copies) from the Legislative Council, One East Main Street, Suite 401, Madison 53701-2536. For further information, you may want to contact Thomas Hirsch, AIA, Department of Health & Social Services, (608) 266-7797.

Potty Parity

The WSA office periodically receives letters from irate women who have been forced to wait in long lines to use public restrooms. “Why don’t architects do something about this inequitable situation?” they ask. Well, state representative Rosemary Potter, Milwaukee, plans to introduce

legislation that would give women "equal access" to public restrooms.

Potter's "potty parity plan" would direct DILHR to ensure that in new public buildings women would no longer have to wait longer in line to answer nature's call than men. As one newspaper editorial noted, "...Green Bay has a city ordinance guaranteeing potty parity. It's time to extend the favor to women throughout Wisconsin. Potter's potty parity plan deserves to go to the head of the line."

Drafting Competition

The WSA conducted its 10th Annual VTAE Student Drafting Competition this spring. This year a "computer aided drafting" competition was added to the traditional "hand drafting" contest.

The nine winning entries...seven hand drafted and two CAD... were displayed on the exhibit floor at the 1991 WSA Convention. Winners of the hand drafting competition included: Michael Alan Zager, MATC, *First Place*; Andy Curran, WITC, *Second Place*; Nancy Fier, MATC, *Third Place*; and the following *Honorable Mentions*: Mike Walters, WITC, Luanne Patrick, NWTC; David Guzlecki, MATC; and John Deprey, NWTC. The winners of the new CAD competition were Dan Matson, WITC, *First Place*, and Patricia Shandorf, WITC, *Second Place*. A total of 58 entries were submitted by students attending four different technical colleges.

Thanks are in order for Jim Schlueter, AIA, and Kevin Connolly, AIA, who coordinated this year's competition. The WSA established the drafting competition to open the lines of communication between WSA members and VTAE students and instructors and to encourage excellence in technical training.

Continuing Education

As part of a new outreach program, the UWM School of Architecture and Urban Planning is developing a series of Continuing Education courses geared toward the architecture profession. During the next academic year, courses will be offered on the following topics:

- Architectural Registration Exam (ARE) Preparation
- Specifications
- Writing Skills for Architects
- Introduction to Geographic Information Systems
- Designing for the Disabled
- Facilities Design
- Multi-Objective Decision Methods in Planning
- Introduction to Office Practice
- AutoCAD

The courses, which vary from one day to ten weeks, will all be offered in the evenings or on weekends. A brochure listing details of the courses will be mailed in August. For further details, call Janet Tibbetts, Continuing Education Coordinator, at (414) 229-4016.

People & Places

John Somerville, AIA, Green Bay, represents the architectural profession on the eleven-member Wisconsin Main Street Council. The Council is appointed by the governor to monitor and make recommendations on the Main Street Program. This past year the Council explored ways to encourage smaller towns to participate and to expand design services provided to communities.

Gene Eggert, AIA, Milwaukee, has relocated the offices of Architectural Designs to 1219 North Cass Street, Milwaukee, WI 53202; phone: (414) 276-7255, FAX: (414) 276-7258.

The 9th annual antiques show and sale to benefit the Milwaukee County Historical Society will be held October 4-6, 1991 at the historically refurbished Grain Exchange Room of the Mackie Building, 225 E. Michigan St., Milwaukee. As an added attraction, the critically acclaimed Chuck Engberg Quartet, featuring Chuck Engberg, AIA, on saxophone, will provide the entertainment for the preview party the evening of October 3, 1991. For more information, contact Kathleen O'Hara at (414) 273-8288.

Membership Action

Please welcome the following new WSA members:

AIA

George Owen, Southeast
Thomas Van Hoof, Southeast
Thomas Hirsch, Southwest
Douglas R. Hirsch, Southwest
Mark Mattes, Southeast
Sheldon Segel, Southeast

Associate

Robert J. Sworski, Northwest
Bradley Egan, Southeast

Beautiful design, comfort and superior durability are the major components of **LFI/Landscape Forms'** new Kenworthy Wooden Bench Collection.

The Kenworthy Collection consists of five 72-inch garden-style benches with 24-inch companion chairs. All of the benches are made from temperate-forest hardwoods and are available for both interior and exterior applications. Rain forest products are not used.

For more information on the Kenworthy Collection and other LFI products, call 1-800-521-2546 or write to LFI/Landscape Forms, Dept. EPB, 431 Lawndale Avenue, Kalamazoo, Mich. 49001. Fax 616-381-3455.

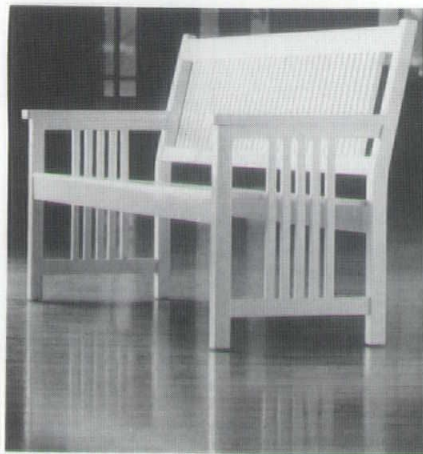

Gyro Tech, Inc. introduces the GT 1100 System thermo-guard whisper slide, designed for high-volume pedestrian traffic. The system is concealed in the overhead frame and slides open by means of a solid state control and quiet reinforced drive belt. The door "slides" open to allow passage and provides smooth, economical and convenient automatic operation for any new structure.

The GT 1100 carries a 20-year proven record and will meet or exceed all building code requirements. It is completely self-contained and sealed off from the environment. Components are easily replaceable in the event of any damage, thus reducing down time, servicing and cost of replacement.

The system requires no air or oil. All

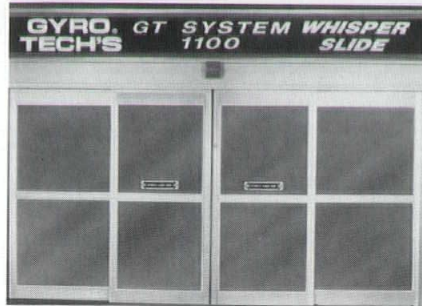

systems are available in standard clear or dark bronze finishes. Black and special finishes are available on request.

For more information on this revolutionary system, contact Gyro Tech, Inc., P.O. Box 906, Muskego, Wisconsin 53150, (414) 679-0045.

Best Block Company announced the recent formation of a landscape products division, Great Scapes. Great Scapes is located on Best Block Company's campus at W140 N5870 Lilly Road, Menomonee Falls, WI.

Great Scapes will provide one of the most extensive landscape product selections in the area. Landscape contractors will be provided a private, restricted area for convenient and easy access. An expanded loading area and truck fleet will make product loading and delivery simple and fast.

For more information on Best Block Company's newest division, Great Scapes, contact Dave Grueshow, Manager, (414) 781-4880 or write, Great Scapes, a Division of Best Block Company, PO Box 915, Butler, WI 53007.



A brand new full-color booklet by **Andersen Windows, Inc.**, features their complete low-maintenance product line. This handy booklet also provides information on creating custom combinations of Andersen standard-size windows and patio doors, energy facts, planning a project, choosing a contractor, and basic size charts. It's a complete resource on windows and patio doors. For a free copy call **The Radford Company** in Oshkosh at 1-800-444-0345.



- 24 Acoustical Floors of WI, Inc.
- 62 Arnold & O'Sheridan, Inc.
- 16 Artemide, Inc.
- 18 Arwin Builders Specialties, Inc.
- 25 Association Administrators & Consultants
- 23 Atomic Interiors
- 5 Best Block
- 25 Builders World
- 40 Butler Tile Sales
- 17 The Cheney Co.
- 62 F.J.A. Christiansen Roofing Co.
- 42 Concrete Removal, Inc.
- 62 Dolan & Dustin
- 62 Elemente Design Elements
- 17 Four Seasons Design Group
- 62 Bert Fredericksen, Inc.
- 23 Georgia Pacific
- 62 Gorski & Associates
- 43 Institutional Products Co.
- 17 Klipstein Insurance Service
- 62 La Force Hardware & Manufacturing Co.
- 62 Lang Associates, Inc.
- 24 Langer Roofing & Sheet Metal, Inc.
- 10 LFI-Landscape Forms, Inc.
- 6 Weather-Tek
- 54 Mid-City Blue, Inc.
- 62 Midwest Visual Equipment Co.
- 62 Milwaukee Blueprint Service
- 16 Monarch Tile Mfg. Co.
- 56 PBBS Equipment Corp.
- 64 J.W. Peters & Sons, Inc.
- 18 Photocopy, Inc.
- 25 Purcell Imaging, Ltd.
- 40 Racine Form Works
- 56 The Radford Co.
- 40 Sheet Metal Contractors of Milwaukee
- 39 Spancrete Industries
- 42 Stevens Construction
- 62 Strass-Maguire & Associates, Inc.
- 18 Tews Co.
- 62 J. Turner & Co.
- 54 Uihlein Electric
- 56 United Brick & Tile
- insert Vande Hey's Roofing Tile, Inc.
- 54 Ver Halen, Inc.
- 40 Voison
- 9 Wisconsin Bell
- 23 Wisconsin Blue Flame Council
- 24 Wisconsin Brick & Block Corp.
- 6, insert Wisconsin Concrete Masonry Assn.
- 4 Wisconsin Electric Power Co.
- 8 Wisconsin Gas Co.
- 2 Wisconsin Pipe Trades
- 63 Wisconsin Public Service
- 10 Wisconsin Ready Mixed Concrete Assn.
- 42 Wisconsin Solar Design
- 62 Wisconsin Testing Laboratories

This index is published at no cost to advertisers, as a service to readers of Wisconsin Architect. Publisher assumes no responsibility for errors or omissions. When writing to advertisers, tell them you saw their message in Wisconsin Architect. They want to know.



DOLAN & DUSTIN, INC. CONSULTING ELECTRICAL ENGINEERS

1011 N. MAYFAIR RD WAUWATOSA, WI 53226-3448
(414) 774-4543 FAX (414) 774-4579

Electrical Power - Primary & Secondary Distribution
Lighting Design • Security & Communications Systems
Grounding • Emergency Generation • Uninterruptible Power

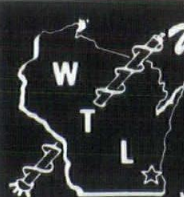

Wisconsin TESTING LABORATORIES

Geotechnical Engineers

Soil Borings

Materials Testing & Inspection

Menomonee Falls, WI 53051 • (414) 252-3300



FJA CHRISTIANSEN ROOFING CO., INC.

Milwaukee, Wisconsin

LET US SHARE OUR ROOFING EXPERIENCE WITH YOU
Project Review • Job Site Investigations • Budget Pricing
Scott K. Christianson 414-445-4141 FAX 414-449-4748

Strass-Maguire & Associates, Inc

CONSULTING * STRUCTURAL * INDUSTRIAL * ENGINEERS



9000 N. DEERBROOK TRAIL, SUITE #110

MILWAUKEE, WI 53223

#414/354-4046 FAX 414/354-5008

BERT FREDERICKSEN, INC.

CONSULTING ENGINEERS

3245 North 124th Street Brookfield, Wisconsin 53005-3112
TELEPHONE 781-9070 (414)

HEATING • VENTILATING • AIR CONDITIONING

Bert Fredericksen-Chairman John Fredericksen-President Bert T. Fredericksen-V. President



ARNOLD AND O'SHERIDAN, INC.
CONSULTING ENGINEERS

Structural Electrical
Mechanical Civil

608•271•9651

815 FORWARD DRIVE MADISON, WI 53711

414•783•6130

4125 N. 124TH BROOKFIELD, WI 53005



Wausau, WI (715) 845-1333
Green Bay, WI (414) 435-2488

Associates, Inc. • Consulting Engineers • Electrical and Automation Specialists
• Lighting Design • Instrumentation and Controls
• High, Med, Low Voltage Design • Automation
• Systems Design • Testing



MILWAUKEE BLUEPRINT SERVICE

7526 W. Appleton Ave., Milwaukee, WI 53216

Fast Diao Printing • Specs • Supplies

Free Pick-Up and Delivery with Minimum Order

(414) 464-2350

1-800-686-2350

Meeting Room AV Systems Design

Need more help when you design meeting rooms using AV, video or computers? Call Mr. Flint Bridge at Midwest Visual. (414) 784-5880.



J. Turner & Co., Ltd.

Distinctive contract furniture

4910 Frontage Rd., Sheboygan, WI 414-452-4555

Specializing in Hospitality, Healthcare, and Dormitory Casegoods.

Gorski and Associates

Professional CAD Services
Point Line and AutoCAD

2671 Bruce Parkway/McFarland, WI 53558
(608) 838-6033

ELEMENTE
design elements



Audubon Court
333 West
Brown Deer
Road
Milwaukee
Wisconsin
53217
414-352-3444
Fax 414-352-6847

LA FORCE

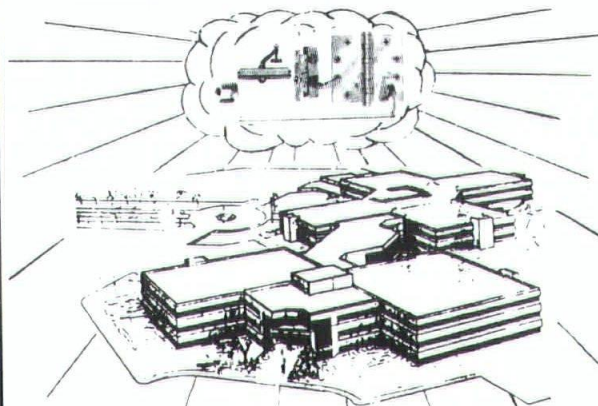

Whatever applications your project requires,
we can supply all the door hardware you need.

- Complete Selection
- Competitive Prices
- Reliable Service

Let us be your headquarters for door hardware.

LA FORCE



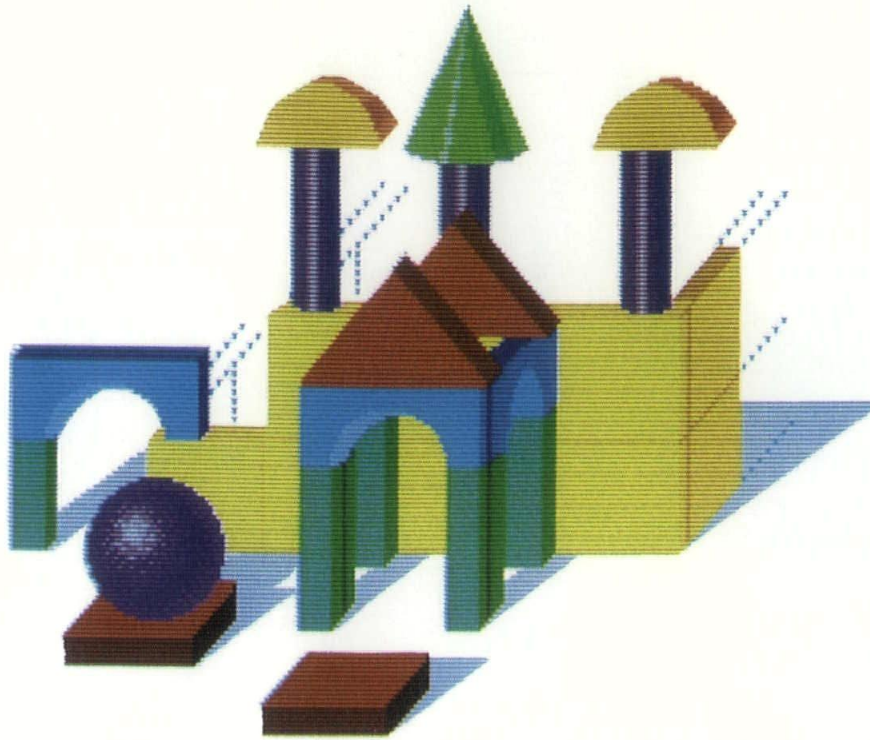

Hardware & Manufacturing Co.
1060 W. Mason St., Green Bay, WI 54303
(414) 497-7100

THE REPUTATION YOU CAN BUILD ON



DESIGN INCENTIVES

a financing, funding and rebate program to encourage energy-efficient commercial & industrial facilities design.

-  **Financing** at prime rate to implement the most energy-efficient options during construction.
-  **Funding** for 50% (up to \$5,000) of engineering costs for the study of alternate, more energy-efficient options.
-  **Rebates** for the implementation of the most energy-efficient options.
-  **PLUS** the long term savings accrued due to lower energy costs generated by state-of-the-art technologies.
-  **Eligibility**...All new retail gas or electric commercial and industrial customers of WPS who are planning or are involved in new construction may qualify for the program.

For a full explanation of the **DESIGN INCENTIVES** program, call Wisconsin Public Service Corporation (414) 433-1719 and ask for **DESIGN INCENTIVES**. Or, write **DESIGN INCENTIVES-MARKETING**, Dept. 31N, P.O. Box 19001, Green Bay, WI 54307-9001.



WISCONSIN PUBLIC SERVICE CORPORATION

Architect: Loeb, Schlossman & Hackl
Engineer: Stefanos Associates, Inc.
General Contractor: Harbour Contractors, Inc.



Beauty... Without Limits

No matter what your aesthetic vision, J.W. Peters can bring it to life. . .with versatile, economical precast architectural concrete.

At our newly enhanced 53,000 sq. ft. architectural facility in nearby Algonquin, Ill., we're doing exciting things with precast concrete. Incorporating the latest colors and aggregates. Making efficient use of stone and masonry veneers. Casting the vivid patterns and geometries today's architects and developers demand.

Midrise or highrise, J.W. Peters can deliver, on time, and on budget. If you can visualize it, we can cast it.



JW PETERS
AND SONS, INC.

34212 West Market Street • Burlington, WI 53105 • (414) 763-2401
(312) 782-4691 (Chicago) • (414) 272-7222 (Milwaukee)