

Accuride® Wheels Product Catalog 2019

The only company delivering industry-leading
steel and aluminum wheels.



Your only single source for industry-leading wheel end solutions.
STEEL & ALUMINUM WHEELS | DRUMS | HUBS | ROTORS | SLACK ADJUSTERS

THE ALUMINUM WHEEL JUST GOT

STRONGER

The New Industry Standard 42644
A True 40 Pound Wheel

Brighter
>100 Gloss Units



QUANTUM 99

Accu-Lite[®] Steel Wheels

5 Year Warranty Against Corrosion

65 lbs
51487
51637



67 lbs
51408



PRO FINISH™
WHEELS REFINISHED BY  ACCURIDE

**Best-in-class steel wheel refinishing
with powerful corrosion protection**



OEM Quality Now Available to the Aftermarket

Enhance Safety and Improve Appearance

**Warranty Against Rust Damage
with Steel Armor**

Steel Armor™
Superior Coating Technology



2X CORROSION
RESISTANCE

2YR LONGER
SERVICE

200,000
MILES FURTHER

**5 Year Warranty Against
Corrosion Now Standard**

Steel wheels available in:

Steel Armor™ PKWHT21 - White | PKBLK21 - Black | PKGRY21 - Gray

ALUMINUM WHEEL FINISH OPTIONS

Maximize your profit and savings by switching to the lightest aluminum wheel offering in the market. Accuride aluminum wheels allow you to increase payload, improve fuel economy, reduce tire wear, and achieve better heat dissipation, increasing your resale value. Accuride offers one of the widest selections of wheel finishes in the industry.

SP and XP aluminum wheel finishes offer superior shine and value, while Accu-Shield®, Accu-Armor™ and Accu-Flange™ offers a wide range of aluminum wheel finish options for every application.

ALUMINUM FINISHES

Aluminum Finish Code	Aluminum Finish Name
SP	Standard Polish (Both Sides)
XP	Extra Polish (Both Sides)
C	Accu-Shield® Wheels with Protective Coating
F	Accu-Flange™ Protective Flange Coating
R	Accu-Armor™ Wheel Surface Treatment
FC	Accu-Flange™ with Accu-Shield®
RF	Accu-Armor™ with Accu-Flange™

For example, 42644SPFC = Standard Polish with Accu-Flange™ and Accu-Shield®. Contact your sales representative for more information on Accuride's aluminum finishes.

Accu-Shield® Wheels with Protective Coating (C)

Don't mess with unnecessary refinishing costs, keep your wheels shining as if they were new with Accu-Shield®. This low maintenance, easy cleaning clear coating will keep your truck looking good.

Accu-Flange™ Protective Flange Coating (F)

Ideal for severe-duty applications where loads are prone to shifting, circumstances requiring frequent stops and starts, as well as gritty operating environments that accelerate flange wear.

Accu-Armor™ Wheel Surface Treatment (R)

Texturized and anodized sparkle silver finish will outperform in any environment, and maintain its sharp appearance with low maintenance. Ideal for vocational applications.

STEEL WHEEL FINISH OPTIONS

Steel Armor™

Revolutionary coating technology, combating corrosion for extended wheel life. Steel Armor™ solves your wheel-corrosion headache. Think premium rust protection. More miles of service over the life of your wheels. A superior finish that looks great and lasts longer, reducing maintenance costs. Our proprietary powder coat process and technology makes all this possible. And it comes with a standard five year warranty!

ProFinish™

Best-in-class steel wheel refinishing with powerful corrosion protection. For those who want an OEM coating on their refinished steel wheels, Accuride has the answer. Our advanced Steel Armor® coating combats corrosion with its revolutionary technology and superior finish. Accuride warrants ProFinish™ steel wheels to be free of rust damage for twelve (12) months from the date of refinishing indicated on the wheel. Review the complete warranty to understand the coverage and ensure you qualify for ProFinish warranty eligibility.

TABLE OF CONTENTS

Page 4 Pages 6-7 Pages 8-9	General Information Wheel Finish Options Active Part Number Index Wheel and Rim Limited Warranty
SECTION I Pages 11-12 Pages 13-14 Page 14 Pages 14-15 Page 15	Hub-Piloted Tubeless Wheels Hub-Piloted — 10-Hole, 285.75mm Bolt Circle Hub-Piloted — 8-Hole, 275mm Bolt Circle Hub-Piloted — Styled Steel Wheels Hub-Piloted — 10-Hole, 11¼" Bolt Circle, Special Bus Application Hub-Piloted — 10-Hole, 335mm Bolt Circle
SECTION II Page 17 Page 18 Page 18	Stud-Piloted Tubeless and Tube-Type Wheels Stud-Piloted — 10-Hole, 11¼" Bolt Circle Stud-Piloted — 10-Hole, 8¾" Bolt Circle Stud-Piloted — 6-Hole, 8¾" Bolt Circle
SECTION III Page 20 Page 21 Page 22	Demountable Rims, Spacer Bands and Components Tubeless Demountable Rims Heavy Duty Tube-Type Demountable Rims Demountable Rims Dimensions
SECTION IV Pages 24-25 Page 26	Duplex® Disc Wheels and Duplex® Demountable Rims Duplex® Disc Wheels Duplex® Demountable Rims
SECTION V Pages 28-31	Light Truck Wheels Light Truck Wheels
SECTION VII Page 33 Page 34 Page 35 Page 36 Page 37 Page 38 Pages 39-40 Pages 41-42 Page 43 Page 44 Page 45 Page 46 Page 47 Page 48 Pages 49-55 Page 56 Page 57	General Information Wheel Guard® Separator Plate Recommended Nut Torque Chart Aluminum Wheel Hand Hole Size by Part Number Accuride/Arconic Cross Reference Types of Accuride Rims, Rings, and Typical Disc-To-Rim Attachment Locations Accuride Typical Product Stamping How to Identify Damaged Rims/Wheels Changeover from Conventional to Wide Base Tubeless Tires Selected Duplex® Changeover Applications 385/65R22.5 and 425/65R22.5 Tire Size Selected Duplex® Changeover Applications to Aluminum and Drive/Trailer Dual Spacing of Wheels Dual Spacing of Demountable Rims Changeover from Tube-Type Tires to Tubeless Tires Chart for Properly Matching Truck Tires to Rims/Wheels Obsolete Part Number Index Rim/Wheel Glossary Accuride Facilities and Production Locations

WARNING: Air pressure in an inflated truck tire mounted on a rim/wheel creates explosive energy; this pressure can cause the tire/rim assembly and/or components to burst apart with great force. If struck by an exploding tire or rim component, you can be seriously injured or killed. FEDERAL OSHA REGULATIONS REQUIRE ALL EMPLOYERS TO PROVIDE TRAINING FOR ALL EMPLOYEES WHO SERVICE SINGLE-PIECE AND MULTI-PIECE RIMS/WHEELS. THIS TRAINING SHOULD ENSURE THAT EACH EMPLOYEE DEMONSTRATES AND MAINTAINS HIS ABILITY TO SERVICE SINGLE AND MULTI-PIECE RIMS/WHEELS. THIS KIND OF SAFETY, SERVICE, AND MAINTENANCE INFORMATION IS CONTAINED IN THE ACCURIDE RIM/WHEEL SAFETY & SERVICE MANUAL, WHICH SHOULD BE RETAINED BY YOU. The Accuride Rim/Wheel Safety & Service Manual and other educational, informational, and training items are available free of charge at www.AccurideCorp.com. Please reference page 33. You may also write to Literature Distribution, Accuride Corporation, 7140 Office Circle, Evansville, IN 47715 or call (800) 626-7096 to receive free copies. Outside the US call (812) 962-5000. You should not, nor should you let your employees, service rims/wheels unless they are thoroughly trained and completely understand this safety information.



ACTIVE PART NUMBER INDEX

Part Number	Size and Type	Page Number	Item Number	Part Number	Size and Type	Page Number	Item Number
590-1	Wheel-Guard	33	6	29667	19.5 x 6.00	28	1
590-3	Wheel-Guard	33	3	29668 ⁽⁶⁾	16 x 4T	-	-
790-2 ⁽¹⁾	Wheel-Guard	33	1	29683 ⁽²⁾	22.5 x 12.25	24	2
27403	22.5 x 7.50	17	4	29685 ⁽²⁾	19.5 x 7.50RW	11	1
27404	22.5 x 8.25	17	5	29695 ⁽²⁾	19.5 x 6.75RW	13	2
27406	24.5 x 8.25	17	7	29699 ⁽²⁾⁽³⁾	24.5 x 8.25	-	-
27599 ⁽²⁾	24.5 x 8.25	17	3	29705 ⁽²⁾⁽³⁾	24.5 x 8.25	-	-
27833C	22.5 x 8.25	17	6	29707 ⁽²⁾⁽³⁾	24.5 x 8.25	-	-
27834C	22.5 x 8.25	14	4	29729 ⁽¹⁾	20 x 10.00-5°	-	-
28112	17.5 x 6.75HC	18	1	29737 ⁽¹⁾	20 x 10.00-5°	-	-
28145	17.5 x 6.75HC	18	2	29741 ⁽¹⁾	20 x 10.00-5°	-	-
28410	24.5 x 8.25	17	11	29747 ⁽⁵⁾	16 x 6.5J	-	-
28440	22.5 x 8.25	15	5	29748 ⁽¹⁾	20 x 10.00-5°	-	-
28465	22.5 x 13.00	25	10	29805	22.5 x 12.25	24	8
28476C	22.5 x 8.25	17	9	29806	22.5 x 12.25	24	9
28510	22.5 x 9.00	17	10	29807	22.5 x 12.25	24	10
28549	22.5 x 8.25	17	8	29816	22.5 x 12.25	25	7
28608 ⁽²⁾	22.5 x 9.00	17	2	29818	22.5 x 13.00	25	8
28615 ⁽²⁾	22.5 x 8.25	17	1	29838PK	18 x 8J	-	-
28632 ⁽²⁾	22.5 x 8.25	15	7	29850 ⁽¹⁾	20 x 10.0-5°	-	-
28656	17.5 x 6.75HC	14	1	29857	20 x 10.0-5°	-	-
28684	22.5 x 13.00	25	9	29883	19.5 x 6.00 RW	Use 29884	-
28827	24.5 x 8.25	12	13	29884	19.5 x 6.00RW	30	2
28828	22.5 x 8.25	12	9	29911	20 x 10.0-5°	-	-
28844 ⁽²⁾	22.5 x 7.50	11	3	29914	20 x 10.0-5°	-	-
29001	22.5 x 7.50	12	2	29922	20 x 10.0-5°	-	-
29015	19.5 x 6.00	28	3	29923	21 x 18.0-5°	-	-
29039	22.5 x 9.00	12	11	31450	24 x 8.5-5°	21	1
29057	22.5 x 13.00	24	14	31674	22.5 x 12.25	26	1
29058	22.5 x 13.00	24	15	31677	22.5 x 12.25	26	2
29146	22.5 x 13.00	24	11	31679	22.5 x 12.25	26	3
29169	22.5 x 8.25	12	10	40004 ⁽²⁾⁽⁷⁾	22.5 x 8.25	-	-
29174	22.5 x 13.00	24	12	40006 ⁽²⁾⁽⁷⁾	22.5 x 8.25	-	-
29195	19.5 x 7.50RW	12	1	40008 ⁽²⁾	22.5 x 8.25	11	7
29300	22.5 x 9.00	12	12	40014 ⁽²⁾	22.5 x 8.25	15	2
29303	22.5 x 13.00	24	13	40018 ⁽²⁾	19.5 x 6.00RW	30	1
29340 ⁽⁵⁾	17 x 7.5J	-	-	40160 ⁽²⁾	19.5 x 7.50RW	13	3
29348 ⁽²⁾	22.5 x 8.25	13	5	40162 ⁽²⁾	19.5 x 7.50RW	13	4
29374 ⁽²⁾	22.5 x 12.25	24	3	40164 ⁽²⁾	22.5 x 11.75	25	1
29376 ⁽²⁾	22.5 x 13.00	24	5	40166 ⁽²⁾	22.5 x 11.75	25	2
29378 ⁽²⁾	22.5 x 12.25	24	1	40171 ⁽²⁾	17.5 x 6.75	13	1
29380 ⁽²⁾	22.5 x 13.00	24	4	40176 ⁽²⁾	22.5 x 11.75	25	3
29388	19.5 x 6.00RW	18	3	40178 ⁽²⁾	22.5 x 11.75	25	4
29395 ⁽⁵⁾	17 x 7.5J	-	-	40180 ⁽²⁾	22.5 x 9.00	15	4
29506	19.5 x 6.00RW	18	4	40386 ⁽²⁾	22.5 x 11.75	25	5
29545	24.5 x 8.25	12	8	40394 ⁽²⁾	22.5 x 11.75	25	6
29551 ⁽⁵⁾	17 x 7.5J	-	-	40620 ⁽²⁾⁽³⁾	22.5 x 8.25	-	-
29560 ⁽²⁾	22.5 x 8.25	15	1	40639 ⁽²⁾⁽³⁾	22.5 x 9.00	-	-
29562 ⁽²⁾	22.5 x 9.00	15	3	41012 ⁽²⁾	22.5 x 9.00	11	8
29579	16 x 6K	29	2	41362 ⁽²⁾	24.5 x 8.25	11	6
29583	16 x 6K	31	2	41644 ⁽²⁾	22.5 x 8.25	11	5
29584	19.5 x 6.00RW	31	1	41730 ⁽²⁾	22.5 x 9.00	11	9
29587	16 x 6K	28	2	42140 ⁽²⁾	22.5 x 14.00	24	6
29588	16 x 6.5J	28	4	42142 ⁽²⁾	22.5 x 14.00	24	7
29602 ⁽²⁾	19.5 x 8.25RW	11	2	42644 ⁽²⁾	22.5 x 8.25	11	4
29627	22.5 x 14.00	24	16	50052 ⁽¹⁾	22.5 x 12.25	-	-

⁽¹⁾ Call (800) 626-7096 for availability and minimum quantities.

⁽²⁾ Aluminum Wheels.

⁽³⁾ Available only through Freightliner Dealers.

⁽⁴⁾ Available only through Navistar Dealers.

⁽⁵⁾ Available only through Ford Dealers.

⁽⁶⁾ Available only through GM Dealers.

⁽⁷⁾ Available only through Western Star Dealers.

⁽⁸⁾ Available only through PACCAR Dealers.

ACTIVE PART NUMBER INDEX

Part Number	Size and Type	Page Number	Item Number
50082	20 x 10.00	-	-
50095 ⁽⁶⁾	17 x 6.5	-	-
50172	22.5 x 14.00	24	17
50180	19.5 x 6.75RW	14	2
50198 ⁽⁶⁾	17 x 6.5J	Use 50642	-
50201	20 x 10.00	-	-
50232	19.5 x 6.75RW	14	3
50240 ⁽⁶⁾	17 x 7.5J	-	-
50257	20 x 10.00	-	-
50264 ⁽³⁾	17 x 7.5	-	-
50291 ⁽⁶⁾	22.5 x 8.25	-	-
50344 ⁽⁶⁾	22.5 x 8.25	-	-
50409	24.5 x 8.25	12	6
50434	22.5 x 7.50	-	-
50593	22.5 x 9.00	15	6
50641	24.5 x 8.25	12	7
50642	17 x 6.5J	29	1
51408	22.5 x 8.25	12	3
51487	22.5 x 8.25	12	4
51637	22.5 x 8.25	12	5
100065	Wheel-Guard	33	2
30371225	22.5 x 7.50	20	2
30391225	22.5 x 8.25	20	3
30391245	24.5 x 8.25	20	4
31868175	17.5 x 6.75HC	20	1
32051225	22.5 x 8.25	20	5
32051245	24.5 x 8.25	20	7
32052225	22.5 x 9.00	20	6

⁽¹⁾ Call (800) 626-7096 for availability and minimum quantities.

⁽²⁾ Aluminum Wheels.

⁽³⁾ Available only through Freightliner Dealers.

⁽⁴⁾ Available only through Navistar Dealers.

⁽⁵⁾ Available only through Ford Dealers.

⁽⁶⁾ Available only through GM Dealers.

⁽⁷⁾ Available only through Western Star Dealers.

⁽⁸⁾ Available only through PACCAR Dealers.



ACCURIDE WHEELS AND WHEEL END SOLUTIONS (AWES) LIMITED WARRANTY TO FILE A WARRANTY CLAIM, CALL (800) 869-2275 ext 1

Accuride Wheels and Wheel End Solutions (AWES) warrants to the original purchaser or the original end user that its products are free from defects in material and workmanship. The limited warranty time-frame (reference table below) is based on the date of product manufacture and shall be void if the product is altered, modified, misapplied, misused, neglected, repaired or not maintained in accordance with the instructions printed in the product-specific Accuride's Safety & Service Manuals⁽²⁾.

GENERAL PRODUCT OVERVIEW

Product Type	8 years/ 96 months	5 years/ 60 months	2 years/ 200,000 miles ⁽¹⁾	1 year/ 12 months
Accuride Aluminum Wheels ⁽²⁾		Industry Standard Aluminum Wheels Duplex [®] Aluminum Wheels ACCU-SHIELD [®] Wheels ACCU-ARMOR [™] Wheels	Flange Wear on ACCU-FLANGE [™] Wheels	
Accuride Steel Wheels ⁽²⁾	EverSteel ^{®(7)} Corrosion Only ⁽⁶⁾	Extra Service Wheels [™] (ESW) StyLED Steel Wheels Tubeless Wheels and Demountable Rims Steel Armor ^{™(6)}		ProFinish [™] Corrosion Only ⁽⁶⁾ Duplex [®] Steel Disc Wheels Duplex [®] Demountable Rims Tube-Type Wheels & Demountable Rims Light Truck Wheels Steel Bolt-Together Specialty Wheels

Product Type	6 years/ 1,000,000 miles ⁽¹⁾	5 years/ 500,000 miles ⁽¹⁾	4 years/ 400,000 miles ⁽¹⁾	3 years/ 350,000 miles ⁽¹⁾	3 years/ 300,000 miles ⁽¹⁾	2 years/ 200,000 miles ⁽¹⁾	Limited Warranty ⁽²⁾
Gunite Slack Adjusters ⁽²⁾	Over-The-Road/Line Operated Trucks and Trailers ⁽⁴⁾	Over-The Road/Line Operated Trucks and Trailers ⁽³⁾	School Bus/City Delivery Vehicles ⁽⁴⁾		School Bus/City Delivery Vehicles ⁽³⁾ Severe Service: Garbage/Refuse Trucks, Fire Trucks, Logging, etc. ⁽⁴⁾	Severe Service: Garbage/Refuse Trucks, Fire Trucks, Logging, etc. ⁽³⁾	
Gunite Hubs ⁽²⁾		TRU-SET [®] Trailer		TRU-SET [®] Front/Steer TRU-SET [®] Rear/Drive			Industry Standard Hubs
Gunite Brake Drums ⁽²⁾							Industry Standard Brake Drums
Gunite Disc Brake Rotors ⁽²⁾⁽⁵⁾							Industry Standard Disc Brake Rotors
Gunite Spoke Wheels ⁽²⁾							Industry Standard Spoke Wheels

(1) Time or miles, whichever occurs first. Time is measured from date of manufacture.

(2) See Remedies and Limitations of Remedies and refer to appropriate Accuride guide for additional limited warranty condition details: Accuride Rim/Wheel Safety & Service Manual, Gunite Heavy-Duty Brake Drums, Gunite Automatic Slack Adjuster Service Manual, Gunite Disc Brake Rotors Maintenance Manual, and Gunite Disc Wheel Hubs, High-Performance Hubs, Spoke Wheels Maintenance & Installation Manual, and Steel Wheel Refinishing Criteria.

(3) Manufactured prior to April 6, 2015.

(4) Manufactured on or after April 6, 2015.

(5) Limited warranty for life of product.*

* "Life of product" means such period until the product has reached its maximum/minimum brake surface limitation. Product remains subject to the terms and conditions in this limited warranty, including the provisions on additional product warranty criteria and remedies and limitation of remedies.

(6) Designated steel wheels are covered by a limited warranty to be free of "rust damage" from the date of manufacture indicated on the wheel: ProFinish[™] for twelve (12) months, Steel Armor[™] for sixty (60) months and EverSteel[®] for ninety-six (96) months. Rust damage is defined as rust sufficient to require refinishing as determined by Accuride in accordance with the most current version of Accuride's technical bulletin W2.043 Steel Wheel Refinishing Criteria. The Steel Armor[™] and EverSteel[®] Warranties do not cover, and expressly exclude, rust in the crevice between the disc and the rim. The Steel Armor[™] and EverSteel[®] coating limited warranties herein apply to wheels manufactured by Accuride on or after January 1, 2017. EverSteel[®] wheels manufactured before January 1, 2017 may be covered by a prior sixty (60) month warranty which is not changed by this update.

(7) Limited Availability.



ACCURIDE WHEELS AND WHEEL END SOLUTIONS (AWES) LIMITED WARRANTY TO FILE A WARRANTY CLAIM, CALL (800) 869-2275 ext 1

ADDITIONAL PRODUCT SPECIFIC LIMITED WARRANTY CRITERIA

Wheels and Rims: The warranty shall be void if the product is used with improper tire sizes, inflation pressures, or exceeded load ratings. The warranty shall be void if the product is not properly maintained in accordance with the Accuride Rim/Wheel Safety & Service Manual. The warranty does not cover defects resulting from corrosion except as stated elsewhere in this document, other non-Accuride components, accident, excessive speed or other abnormal or severe operating conditions.

ACCU-ARMOR™, ACCU-SHIELD®, ACCU-FLANGE™, STEEL ARMOR™, PROFINISH™ and EVERSTEEL®: Accuride does not cover the following conditions: (i) Any damage in the areas of the mounting surfaces, such as the area under the mounting nuts, the area in contact with hubs or drums and the area in contact with other wheels in dual position, (ii) Any damage due to cleaning, including damage from the use of abrasives, abrasive brushes, steel wool, scouring pads, strong chemicals or corrosion except as stated elsewhere in this document, and/or (iii) Any damage to the wheel finish due to wheel/tire assembly, removal, balancing weight, misuse, or chipping, whether by contact with road obstacles such as stones, gravel, curbs, barriers, signs, tire changing equipment or otherwise. ACCU-SHIELD® products are not covered for corrosion. ACCU-FLANGE® products, after washing, can have wheel polish or carnauba wax applied with a 100% cotton cloth. The STEEL ARMOR™ and EVERSTEEL® limited warranties are void with respect to, and expressly exclude, all wheels that have been refinished or refurbished and, for wheels used without an Accuride Wheel-Guard®, the disc face and any other areas impacted by this failure. The EVERSTEEL® limited warranty is void with respect to, and expressly excludes wheels that have had the serial number sticker removed or defaced. The STEEL ARMOR™, PROFINISH™, and EVERSTEEL® warranties expressly exclude and do not cover (a) paint appearance, paint integrity, or paint adhesion to the wheels due to chipping effect and (b) corrosion in the crevice between the wheel disc and rim. Accuride recommends cleaning wheels with mild soap and water.

Standard Brake Drums, Spoke Wheels, Disc Wheel Hubs, Automatic Slack Adjusters, and Hardware: The above warranty shall be void if (i) any goods have exceeded Accuride's acceptable wear limits or have been subjected to accidents or abnormal conditions of use, temperature, moisture, dirt or corrosive matter, or (ii) the product fails as the result of another manufacturer's product. The TRU-SET® disc wheel hub requires the use of a seller-approved hubcap and lubricant

REMEDIES AND LIMITATIONS OF REMEDIES

In the event of any material breach of the above limited warranties, Accuride agrees to repair or replace,* at its sole option, without charge any and all of its warrantable product that fail during normal use and service due to defects in material and/or workmanship, all subject to the original purchaser providing written notice of the alleged breach within 30 days of failure. Time is of the essence herein, and original purchaser's failure to provide written notice to Accuride within the required time of any alleged breach of the foregoing warranty will release and discharge Accuride from any obligation or liability for that breach of warranty. In no event will Accuride be liable for any other costs associated with the replacement or repair of product covered under this warranty, including labor, installation or other costs incurred by customer.

* - NOTWITHSTANDING THE ABOVE, THE SOLE REMEDY UNDER THE STEEL ARMOR™ AND EVERSTEEL® WARRANTIES SHALL BE THE PAYMENT OF US \$35 FOR STEEL ARMOR™ AND US \$45 FOR EVERSTEEL® OR THE REPAIR OR REPLACEMENT OF THE WHEEL (AT ACCURIDE'S SOLE OPTION) IF A WARRANTABLE PRODUCT FAILS DURING NORMAL USE AND SERVICE DUE TO DEFECTS IN MATERIAL AND/OR WORKMANSHIP. Only one claim per wheel may be paid under the Steel Armor™ and EverSteel® warranties. The remedy described in this paragraph is Accuride's sole and exclusive obligation under these warranties and in no event will Accuride be liable for special, incidental or consequential damages.

Customer must timely report the breach of warranty and demonstrate warrantability under the then applicable procedures during the warranty period. The remedies set forth herein shall be the sole and exclusive remedies available to the original purchaser so that Accuride repair, replacement, or payment as described above is a fulfillment of all Accuride obligations. Accuride SHALL NOT BE LIABLE FOR ANY CONSEQUENTIAL OR INCIDENTAL DAMAGES OF ANY KIND. FURTHER, UNDER NO CIRCUMSTANCE SHALL ACCURIDE BE LIABLE FOR DAMAGES BEYOND THE PRICE OF THE GOODS PURCHASED BY THE ORIGINAL PURCHASER, WHETHER IN CONTRACT, IN TORT OR UNDER ANY WARRANTY OR OTHER USE.

Accuride reserves the right to require product return and/or washing (as previously noted) prior to warranty assessment as a condition of eligibility for warranty remedies. Product return expense must be paid by the product owner and if the product is found warrantable, reasonable freight expenses may be reimbursed by Accuride. No goods are to be returned to Accuride without a Returned Goods Authorization (RGA). If Accuride determines that any of the returned goods are non-warrantable, Accuride reserves the right to charge the original purchaser for the recovery of all transportation costs and expenses incurred in examining, processing and handling such goods. Any controversy or claim that customer may wish to bring that is arising out of or related to this limited warranty or breach hereof must be commenced in writing within 30 days of notification of warrantable status or shall be deemed to be waived.

Any product deemed non-warrantable is the property of the original purchaser and can be returned to the original purchaser upon its request and at its sole cost and expense. Should the non-warrantable item(s) not be reclaimed, Accuride will disposition the product no sooner than 30 days after original purchaser notification has been made.

For all warranty related questions, please contact your Accuride warranty administrator at (800) 869-2275 Option 1 or submit questions or claims to warrantyadmin@accuridecorp.com.

THE ABOVE WARRANTY IS THE SOLE AND EXCLUSIVE WARRANTY GIVEN BY ACCURIDE AND IS IN LIEU OF ALL OTHER WARRANTIES EXPRESSED, STATUTORY OR IMPLIED, INCLUDING WARRANTIES OF MERCHANTABILITY AND FITNESS FOR A PARTICULAR PURPOSE, ALL OF WHICH ARE EXPRESSLY DISCLAIMED BY ACCURIDE. IN NO EVENT SHALL THIS WARRANTY BE DEEMED TO COVER INCIDENTAL, SPECIAL, INDIRECT OR CONSEQUENTIAL DAMAGES OF ANY KIND.

HUB-PILOTED TUBELESS WHEELS



Hub-Piloted
Tubeless Wheels

Stud-Piloted
Tubeless Wheels

Demountable
Rims & Components

Duplex Disc® Wheels
Duplex® Demountable
Rims

Light Truck Wheels

General Information

ACCURIDE 15° TUBELESS ALUMINUM WHEELS



**Hub-Piloted Dual-Mounting
Two-Piece Flange Nut**

10-Hole, 285.75mm Bolt Circle, 220mm Bore

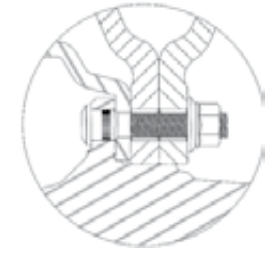

Item	Wheel Size	Part Number ⁽⁴⁾	Wheel Offset	Disc	Installed Valve	Approx. Wt. (lbs)	Maximum Load & Infl. (lbs) - (psi)
1	19.5 x 7.50RW ⁽¹⁾⁽²⁾	29685SP/XP	6.25"	.875"	TR545D	38	6700 - 125
2	19.5 x 8.25RW ⁽¹⁾⁽²⁾	29602SP/XP	6.63"	.875"	TR545D	39	7250 - 120
3	22.5 x 7.50	28844SP/XP	6.45"	.935"	TR545D	55	7300 - 120
4	22.5 x 8.25	42644SP/XP	6.59"	.800"	TR544C	40	7400 - 131
5	22.5 x 8.25	41644SP/XP ⁽⁵⁾	6.59"	.875"	TR545D	45	7400 - 131
6	24.5 x 8.25	41362SP/XP	6.59"	.875"	TR545D	54	7400 - 131
Heavy Load Applications							
7	22.5 x 8.25 2.0" Hand Hole	40008SP/XP	6.59"	.935"	TR545D	54	8100 - 131
8	22.5 x 9.00	41012SP/XP	3.12" ⁽³⁾	.980"	TR543E	51	10200 - 131
9	22.5 x 9.00	41730SP/XP	7.00"	.980"	TR545D	58	10000 - 130

⁽¹⁾ "RW" denotes revised well for increased brake clearance.
⁽²⁾ Requires special 15 x 8⁵/₈" brake package.
⁽³⁾ Not approved for dual application. (inset listed)
⁽⁴⁾ Available in Standard Polish and Extra Polish.
⁽⁵⁾ Limited availability, replaced by 42644SP/XP.

Hub-Piloted
Tubeless Wheels

Stud-Piloted
Tubeless Wheels

Demountable
Rims & Components

Duplex Disc® Wheels
Duplex® Demountable
Rims

Light Truck Wheels

General Information

ACCURIDE 15° TUBELESS STEEL WHEELS



**Hub-Piloted Dual-Mounting
Two-Piece Flange Nut**

10-Hole, 285.75mm Bolt Circle, 220mm Bore

ACCUMOUNT EXTRA SERVICE WHEELS

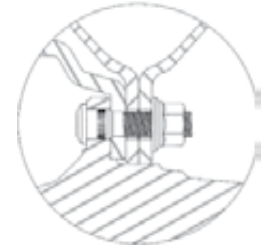

Item	Wheel Size	Part Number	Hand Holes	Wheel Offset	Disc	Recommended Valve	Approx. Wt. (lbs)	Maximum Load & Infl. (lbs) - (psi)
1	19.5 x 7.50RW ⁽¹⁾⁽²⁾	29195	5	6.40"	.437"	TR546-36	65	6700 - 120
2	22.5 x 7.50	29001	5	6.44"	.437"	TR500	72	6610 - 120
3	22.5 x 8.25	51408 ⁽⁵⁾	2	6.60"	.437"	TR572-F19	67	7400 - 120
4	22.5 x 8.25	51487 ⁽⁵⁾	5	6.60"	.437"	TR572-F19	65	7400 - 120
5	22.5 x 8.25	51637 ⁽⁵⁾	10	6.60"	.437"	TR572-F19 ⁽⁴⁾	65	7400 - 120
6	24.5 x 8.25	50409	2	6.59"	.437"	TR572-D19	78	7400 - 120
7	24.5 x 8.25	50641	5	6.59"	.437"	TR572-D19	76	7400 - 120
8	24.5 x 8.25	29545	10	6.62"	.437"	TR573	85	7400 - 120
Heavy Load Applications								
9	22.5 x 8.25	28828	2	6.62"	.472"	TR573	79	8000 - 130
10	22.5 x 8.25	29169	5	6.62"	.472"	TR573	78	8000 - 130
11	22.5 x 9.00	29039	5	5.25" ⁽³⁾	.500"	TR573	103	10000 - 130
12	22.5 x 9.00	29300	5	7.00"	.625"	TR573	108	10000 - 130
13	24.5 x 8.25	28827	2	6.62"	.472"	TR573	86	8000 - 120

⁽¹⁾ "RW" denotes revised well for increased brake clearance.
⁽²⁾ Requires special 15 x 8⁵/₁₆" brake package.
⁽³⁾ Not approved for dual application. (inset listed)
⁽⁴⁾ Valve TR572-12E may provide improved valve access to inner dual.
⁽⁵⁾ Refer to bulletins W2.020, W2.021 and W2.027 for heavy duty application.

Hub-Piloted
Tubeless Wheels

Stud-Piloted
Tubeless Wheels

Demountable
Rims & Components

Duplex Disc® Wheels
Duplex® Demountable
Rims

Light Truck Wheels

General Information

ACCURIDE 15° TUBELESS ALUMINUM WHEELS



Hub-Piloted Dual-Mounting Two-Piece Flange Nut

8-Hole, 275mm Bolt Circle, 221mm Bore

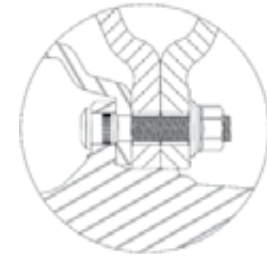

Item	Wheel Size	Part Number ⁽⁴⁾	Wheel Offset	Disc	Installed Valve	Approx. Wt. (lbs)	Maximum Load & Infl. (lbs) - (psi)
1	17.5 x 6.75	40171SP/XP	5.55"	.827"	TR544C	30	5515 - 142
2	19.5 x 6.75RW ⁽¹⁾⁽²⁾	29695SP/XP	5.60"	.830"	TR545D	36	5000 - 125
3	19.5 x 7.50RW ⁽¹⁾⁽²⁾	40160SP/XP	6.25"	.875"	TR545D	39	6700 - 131
4	19.5 x 7.50RW ⁽¹⁾⁽²⁾⁽³⁾	40162SP/XP	6.25"	.875"	TR545D	39	6700 - 131
5	22.5 x 8.25	29348SP/XP	6.59"	.935"	TR545D	55	7300 - 120

⁽¹⁾"RW" denotes revised well for increased brake clearance.

⁽²⁾ Fits only ISO Hub back-up for 8-holes, 275mm system.

⁽³⁾ Bolt holes are 32.87mm. ISO Standards are 26mm.

⁽⁴⁾ Available in Standard Polish and Extra Polish.

Hub-Piloted
Tubeless Wheels

Stud-Piloted
Tubeless Wheels

Demountable
Rims & Components

Duplex Disc® Wheels
Duplex® Demountable
Rims

Light Truck Wheels

General Information

ACCURIDE 15° TUBELESS STEEL WHEELS



**Hub-Piloted Dual-Mounting
Two-Piece Flange Nut**

8-Hole, 275mm Bolt Circle, 221mm Bore

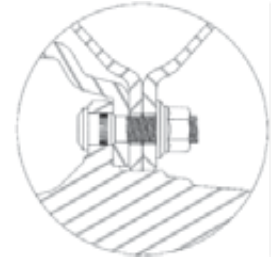

Item	Wheel Size	Part Number	Hand Holes	Wheel Offset	Disc	Recommended Valve	Approx. Wt. (lbs)	Maximum Load & Infl. (lbs) - (psi)
1	17.5 x 6.75HC ⁽¹⁾	28656 ⁽²⁾⁽⁵⁾	4	5.60"	.437"	TR500 ⁽⁴⁾	54	5355 - 125
2	19.5 x 6.75RW ⁽³⁾⁽⁷⁾	50180 ⁽²⁾⁽⁶⁾	4	5.50"	.375"	TR575	59	5000 - 120
3	19.5 x 6.75RW ⁽³⁾⁽⁷⁾	50232 ⁽²⁾⁽⁶⁾	6	5.00"	.375"	TR575	58	5000 - 120

⁽¹⁾ "HC" denotes heavy construction to differentiate from light truck rims.

⁽²⁾ Fits only ISO hub back-up diameter for 8-hole, 275mm system.

⁽³⁾ "RW" denotes revised well for increased brake clearance.

⁽⁴⁾ For inner duals use TR574 with F29 bend and a 2" extension.

⁽⁵⁾ Bolt holes are 26mm. ISO Standards are 24mm.

⁽⁶⁾ Bolt holes are 25mm. ISO Standards are 24mm.

⁽⁷⁾ Requires special 15 x 8^{5/8}" brake package.

ACCURIDE 15° TUBELESS STEEL WHEEL



**Hub-Piloted Dual-Mounting
Two-Piece Flange Nut**

**10-Hole, 11¼" Bolt Circle, 8.67" Bore
Special Bus Application with 1.22" Bolt Holes**

EXTRA SERVICE WHEELS

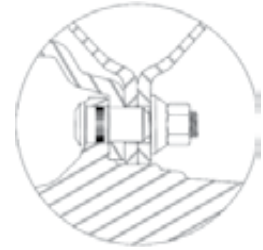

Item	Wheel Size	Part Number	Hand Holes	Wheel Offset	Disc	Recommended Valve	Approx. Wt. (lbs)	Maximum Load & Infl. (lbs) - (psi)
4	22.5 x 8.25	27834C ⁽⁸⁾⁽⁹⁾	5	6.62"	.437"	TR572	76	7400 - 120

⁽⁸⁾ Check clearance. May not fit some older bus applications.

⁽⁹⁾ "C" suffix denotes balanced wheel.

Hub-Piloted
Tubeless Wheels

Stud-Piloted
Tubeless Wheels

Demountable
Rims & Components

Duplex Disc® Wheels
Duplex® Demountable
Rims

Light Truck Wheels

General Information

ACCURIDE 15° TUBELESS ALUMINUM WHEELS



**Hub-Piloted Dual-Mounting
Two-Piece Flange Nut**

10-Hole, 335mm Bolt Circle, 281mm Bore

ULTRAMOUNT 335

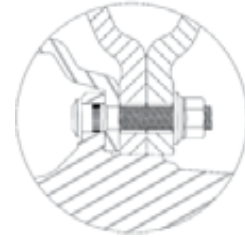

Item	Wheel Size	Part Number ⁽²⁾	Wheel Offset	Disc	Installed Valve	Approx. Wt. (lbs)	Maximum Load & Infl. (lbs) - (psi)
1	22.5 x 8.25	29560SP/XP	6.69"	.866"	V3-20-7	53	8046 - 138
2	22.5 x 8.25 ⁽¹⁾	40014SP/XP	6.69"	.866"	V3-20-7	53	8046 - 138
3	22.5 x 9.00	29562SP/XP	6.89"	.866"	V3-20-7	55	9094 - 141
4	22.5 x 9.00 ⁽¹⁾	40180SP/XP	6.89"	.866"	V3-20-7	55	9094 - 141

⁽¹⁾ Bolt holes are 32mm. ISO standards are 26mm.

ACCURIDE 15° TUBELESS STEEL WHEELS



**Hub-Piloted Dual-Mounting
Two-Piece Flange Nut**

10-Hole, 335mm Bolt Circle, 281mm Bore

ULTRAMOUNT 335

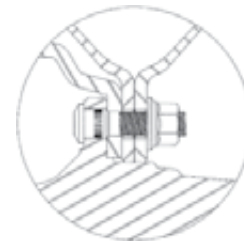

Item	Wheel Size	Part Number	Hand Holes	Wheel Offset	Disc	Recommended Valve	Approx. Wt. (lbs)	Maximum Load & Infl. (lbs) - (psi)
5	22.5 x 8.25	28440	10	6.62"	.433"	TR570-14E	87	7500 - 130
6	22.5 x 9.00	50593	10	7.00"	.625"	TR573-D23	111	10500 - 130

ACCURIDE 15° TUBELESS ALUMINUM WHEEL



**Hub-Piloted Dual-Mounting
Two-Piece Flange Nut**

**10-Hole, 11¼" Bolt Circle, 8.67" Bore
Special Bus Application with 1.22" Bolt Holes**

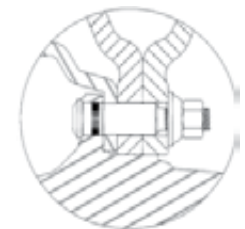

Item	Wheel Size	Part Number ⁽²⁾	Wheel Offset	Disc	Installed Valve	Approx. Wt. (lbs)	Maximum Load & Infl. (lbs) - (psi)
7	22.5 x 8.25	28632SP/XP	6.59"	.860"	TR545D	54	7300 - 120

⁽²⁾ Available in Standard Polish and Extra Polish.

Hub-Piloted
Tubeless Wheels

Stud-Piloted
Tubeless Wheels

Demountable
Rims & Components

Duplex Disc® Wheels
Duplex® Demountable
Rims

Light Truck Wheels

General Information

STUD-PILOTED TUBELESS WHEELS

Hub-Piloted
Tubeless Wheels

Stud-Piloted
Tubeless Wheels

Demountable
Rims & Components

Duplex Disc® Wheels
Duplex® Demountable
Rims

Light Truck Wheels

General Information



ACCURIDE 15° TUBELESS ALUMINUM WHEELS



**Stud-Piloted Dual-Mounting
Double Cap Nut**

10-Hole, 11¼" Bolt Circle, 8.72" Bore

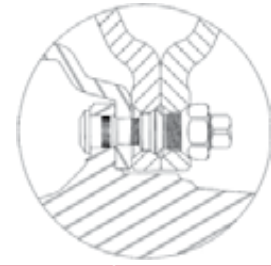

Item	Wheel Size	Part Number ⁽⁴⁾	Wheel Offset	Disc	Installed Valve	Approx. Wt. (lbs)	Maximum Load & Infl. (lbs) - (psi)
1	22.5 x 8.25	28615SP/XP	6.59"	.935"	TR545D	54	7250 - 120
2	22.5 x 9.00	28608SP/XP	7.00"	.980"	TR545D	60	9000 - 130
3	24.5 x 8.25	27599SP/XP	6.59"	.935"	TR545D	62	7200 - 120

Hub-Piloted
Tubeless Wheels

Stud-Piloted
Tubeless Wheels

ACCURIDE 15° TUBELESS STEEL WHEELS



**Stud-Piloted Dual-Mounting
Double Cap Nut**

10-Hole, 11¼" Bolt Circle, 8.72" Bore

EXTRA SERVICE WHEELS

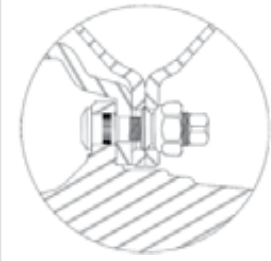

Item	Wheel Size	Part Number	Hand Holes	Wheel Offset	Disc	Recommended Valve	Approx. Wt. (lbs)	Maximum Load & Infl. (lbs) - (psi)
4	22.5 x 7.50	27403	2	6.44"	.437"	TR500	73	6610 - 120
5	22.5 x 8.25	27404	2	6.62"	.437"	TR572	78	7400 - 120
6	22.5 x 8.25	27833C ⁽¹⁾⁽²⁾	5	6.62"	.437"	TR572	75	7400 - 120
7	24.5 x 8.25	27406	2	6.62"	.437"	TR573	86	7400 - 120

Heavy Load Applications

8	22.5 x 8.25	28549	2	6.62"	.472"	TR573	79	8000 - 130
9	22.5 x 8.25	28476C ⁽¹⁾⁽²⁾	5	6.62"	.472"	TR573	77	8000 - 130
10	22.5 x 9.00	28510 ⁽³⁾	2	7.00"	.625"	TR573	110	9000 - 130
11	24.5 x 8.25	28410	2	6.62"	.472"	TR573	86	8000 - 120

⁽¹⁾ Check clearance. May not fit some older bus applications.

⁽²⁾ "C" suffix denotes balanced wheel.

⁽³⁾ Because of the thicker disc, longer studs must be used. When longer studs are used, wheels with thinner discs cannot be used in a dual assembly because the inner cap nut can bottom out before the wheel is securely clamped.

⁽⁴⁾ Available in Standard Polish and Extra Polish.

Demountable
Rims & Components

Duplex Disc® Wheels
Duplex® Demountable
Rims

Light Truck Wheels

General Information

ACCURIDE 15° TUBELESS STEEL WHEELS

Hub-Piloted
Tubeless Wheels



Stud-Piloted Dual-Mounting Double Cap Nut

10-Hole, 8 $\frac{3}{4}$ " Bolt Circle, 6.50" Bore

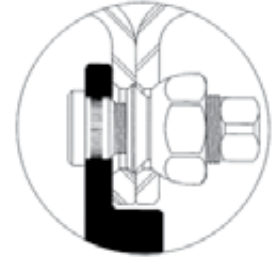

Item	Wheel Size	Part Number	Hand Holes	Wheel Offset	Disc	Recommended Valve	Approx. Wt. (lbs)	Maximum Load & Infl. (lbs) - (psi)
1	17.5 x 6.75HC ⁽¹⁾	28112	2	6.19"	.420"	TR570-14C	58	5070 - 125

Stud-Piloted
Tubeless Wheels

Demountable
Rims & Components



Stud-Piloted Dual-Mounting Double Cap Nut

6-Hole, 8 $\frac{3}{4}$ " Bolt Circle, 6.50" Bore

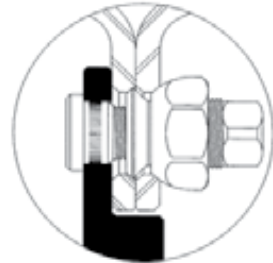

Item	Wheel Size	Part Number	Hand Holes	Wheel Offset	Disc	Recommended Valve	Approx. Wt. (lbs)	Maximum Load & Infl. (lbs) - (psi)
2	17.5 x 6.75HC ⁽¹⁾	28145	2	6.07"	.420"	TR500	58	5070 - 125
3	19.5 x 6.00RW ⁽²⁾	29388	2	5.00"	.375"	TR435	52	3640 - 110

Duplex Disc® Wheels
Duplex® Demountable
Rims

Steel Stud-Piloted Mounting Double Cap Nut

6-Hole, 222.25 mm, Japanese

Item	Wheel Size	Part Number	Hand Holes	Wheel Offset	Disc	Recommended Valve ⁽²⁾	Approx. Wt. (lbs)	Maximum Load & Infl. (lbs) - (psi)
4	19.5 x 6.00RW ⁽²⁾	29506	6	127mm	9.53mm	V3-20-1	50.5	3640 - 110

⁽¹⁾ "HC" denotes heavy construction to differentiate from light truck rims.

⁽²⁾ "RW" denotes revised well for increased brake clearance.

Light Truck Wheels

General Information

DEMOUNTABLE RIMS AND COMPONENTS



Hub-Piloted
Tubeless Wheels

Stud-Piloted
Tubeless Wheels

Demountable
Rims & Components

Duplex Disc® Wheels
Duplex® Demountable
Rims

Light Truck Wheels

General Information

ACCURIDE 15° TUBELESS DEMOUNTABLE RIMS

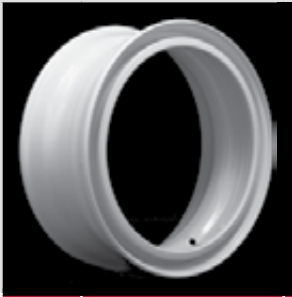

EXTRA SERVICE RIMS



Item	Rim Size	Part Number	Rim Offset	Recommended Valve	Approx. Wt. (lbs)	Maximum Load & Infl. (lbs) - (psi)
1	17.5 x 6.75HC ⁽¹⁾	31868175	3.90"	TR572	46	4805 – 125
2	22.5 x 7.50	30371225	4.26"	TR572	64	6610 – 120
3	22.5 x 8.25	30391225	4.75"	TR573	68	7300 – 120
4	24.5 x 8.25	30391245	4.75"	TR573	74	7300 – 120
Heavy Load Applications						
5	22.5 x 8.25	32051225 ⁽²⁾	4.75"	TR573	69	8000 – 120
6	22.5 x 9.00	32052225 ⁽²⁾	5.00"	TR574	87	10000 – 130
7	24.5 x 8.25	32051245 ⁽²⁾	4.75"	TR573	76	8000 – 120

⁽¹⁾ "HC" denotes heavy construction to differentiate from light truck rims.

⁽²⁾ Requires a six spoke cast spoke wheel to carry indicated load rating.

DUAL SPACINGS

All dimensions in inches.

(See pages 46 and 48 for additional information)

Rim Width Size	Rim Type	Rim Offset	Dual Spacing With Spacer Band Width			
			3 ³ / ₈ "	3 ⁵ / ₈ "	4"	4 ¹ / ₄ "
7.5	FL, 5°	4.75"	12.9	13.1	13.5	13.8
8.0	5°	5.00"	13.4	13.6	14.0	14.2
8.5 ⁽³⁾	5°	5.30"	---	---	14.6	14.8

⁽³⁾ 8.5 tube-type rims require M type spacer bands to fit smaller diameter cast spoke wheels (see "E" dimension on page 22).

SPACER BANDS FOR TUBELESS DEMOUNTABLE RIMS

Rim Diameter	Use Spacer Band Size
17.5"	15"
22.5"	20"
24.5"	22"

See page 26 for Duplex Demountable Rims

HEAVY DUTY TUBE-TYPE DEMOUNTABLE RIMS

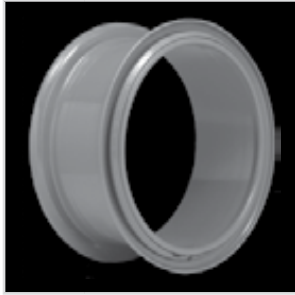

5° Radial Commander® 3-Piece Rim

- 5° bead seats on both sides provide maximum support under entire width of tire beads.
- Continuous base and side ring minimize tire bead chafing.



RIM ASSEMBLY

Item	Rim Size & Type	Part No. ⁽¹⁾	Approx. Wt. (lbs)	Maximum Load & Infl. (lbs) - (psi)
1	24 x 8.5 - 5° ⁽³⁾	31450 ⁽⁴⁾	110	8900 - 120

COMPONENTS

Item	Rim Size & Type	Rim Base	Side Ring		Lock Ring	
		Part No. ⁽¹⁾⁽²⁾	Markings/Size & Type	Part No. ⁽¹⁾	Markings/Size & Type	Part No. ⁽¹⁾
2	24 x 8.5 - 5° ⁽³⁾	31450X	24 x 8.5 - 5°	31450SR	24 x 8.5 - 5°	31450LR

⁽¹⁾ Product has liquid topcoat over epoxy black E-coat.

⁽²⁾ "X" suffix on part number indicates rim only (side ring and lock ring are excluded).

⁽³⁾ 8.5 tube-type rims require M type spacer bands to fit smaller diameter cast spoke wheels (see "E" dimension on page 22).

⁽⁴⁾ Sold only as separate components - 31450X, 31450SR, and 31450LR.

Available Educational, Informational, and Training Items for Heavy Duty Tube-Type Demountable Rims

SAFETY AND SERVICE MANUALS

- Safety/Service Manuals - English
- Safety/Service Manuals - Spanish
- Safety/Service Manuals - French

CHART

Accuride Rim & Ring Matching Wall Chart

VIDEO

"Servicing Single and Multi-Piece Wheels"

DO NOT MIX OBSOLETE PART NUMBERS WITH NEW REPLACEMENT COMPONENTS. For example, 31450LR cannot be used to replace the 313D5LR. A new 31450 assembly needs to be purchased to replace any of the obsolete components or assembly.

WARNING: Improperly assembled or serviced wheel and/or rim parts could result in personal injury or death. Use only side and lock rings that are stamped with the same size and type as the rim base. Do not interchange components from different manufacturers or obsolete components. All components are stamped with size and type information.

Do not use parts you can't identify.

Air pressure in an inflated truck tire mounted on a rim/wheel creates explosive energy; this pressure can cause the tire/rim assembly and/or components to burst apart with great force. If struck by an exploding tire or rim component, you can be seriously injured or killed.

FEDERAL OSHA REGULATIONS REQUIRE ALL EMPLOYERS TO PROVIDE TRAINING FOR ALL EMPLOYEES WHO SERVICE SINGLE-PIECE AND MULTI-PIECE RIMS/WHEELS. THIS TRAINING SHOULD ENSURE THAT EACH EMPLOYEE DEMONSTRATES AND MAINTAINS HIS OR HER ABILITY TO SERVICE SINGLE AND MULTI-PIECE RIMS/WHEELS. THIS KIND OF SAFETY, SERVICE, AND MAINTENANCE INFORMATION IS CONTAINED IN THE ACCURIDE RIM/WHEEL SAFETY & SERVICE MANUAL, WHICH SHOULD BE RETAINED BY YOU.

The Accuride Rim/Wheel Safety & Service Manual and other educational, informational, and training items are available free of charge at www.AccurideCorp.com. You may also write to Literature Distribution, Accuride, 7140 Office Circle, Evansville, IN 47715 or call (800) 626-7096 to receive free copies. Outside the US call (812) 962-5000. You should not, nor should you let your employees, service rims/wheels unless they are thoroughly trained and completely understand this safety information.

Hub-Piloted
Tubeless Wheels

Stud-Piloted
Tubeless Wheels

Demountable
Rims & Components

Duplex Disc® Wheels
Duplex® Demountable
Rims

Light Truck Wheels

General Information

DIMENSIONS FOR TUBE-TYPE RIMS BY PART NUMBER (All dimensions in inches)

Part Number	Size		Rim Offset	A	B	C	D	E	F	G
	Dia.	Width								
31450 ⁽¹⁾	24	8.5	5.30	23.372	.314	.750	1.75	22.422 ⁽¹⁾	2.000	5.25

⁽¹⁾ 8.5 tube-type rims require M type spacer bands to fit smaller diameter cast spoke wheels.

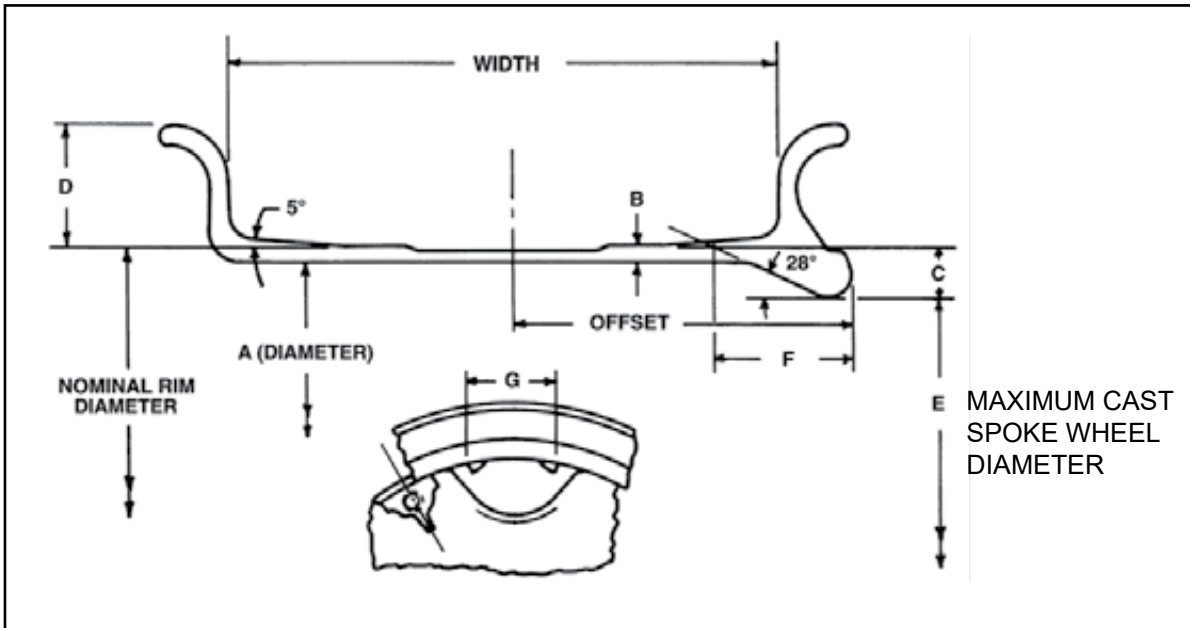

Hub-Piloted
Tubeless Wheels

Stud-Piloted
Tubeless Wheels

Demountable
Rims & Components

Duplex Disc® Wheels
Duplex® Demountable
Rims

Light Truck Wheels

General Information

DUPLEX[®] DISC WHEELS AND DUPLEX[®] DEMOUNTABLE RIMS



Hub-Piloted
Tubeless Wheels

Stud-Piloted
Tubeless Wheels

Demountable
Rims & Components

Duplex Disc[®] Wheels
Duplex[®] Demountable
Rims

Light Truck Wheels

General Information

ACCURIDE 15° TUBELESS DUPLEX® DISC WHEELS



Aluminum Hub-Piloted Mounting⁽¹⁾ Two-Piece Flange Nut

10-Hole, 285.75mm Bolt Circle, 220mm Bore

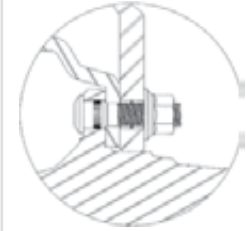

Item	Wheel Size	Part Number ⁽⁸⁾	Inset ⁽²⁾	Outset ⁽²⁾	Disc Thickness	Installed Valve ⁽³⁾	Approx. Wt. (lbs)	Maximum Load & Infl. (lbs) - (psi)
1	22.5 x 12.25	29378SP/XP	---	0.56"	1.120"	TR543E	62	11400 - 120
2	22.5 x 12.25	29683SP/XP	2.88"	4.00"	1.125"	TR545E	62	11400 - 125
3	22.5 x 12.25	29374SP/XP	4.75"	---	1.125"	TR545E	66	11000 - 131
4	22.5 x 13.00	29380SP/XP	---	0.56"	1.120"	TR543E	64	12300 - 120
5	22.5 x 13.00	29376SP/XP	5.25"	---	1.125"	TR545E	68	11000 - 120
6	22.5 x 14.00	42140SP/XP	---	0.50"	1.0"	TR543E	54	12800 - 131
7	22.5 x 14.00	42142SP/XP	---	2.00" ⁽⁴⁾	1.0"	TR543E	55	12800 - 131



Steel Hub-Piloted Mounting⁽¹⁾ Two-Piece Flange Nut

10-Hole, 285.75mm Bolt Circle,
220mm Bore, .625" Disc

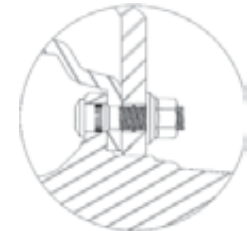

Item	Wheel Size	Part Number	Inset ⁽²⁾	Outset ⁽²⁾	Hand Holes	Disc Position	Recommended Valve ⁽⁵⁾	Approx. Wt. (lbs)	Maximum Load & Infl. (lbs) - (psi)
8	22.5 x 12.25	29805	---	0.63"	5	2	TR574-24E	119	11500 - 125
9	22.5 x 12.25	29806	4.00"	---	5	1	TR500	119	11500 - 125
10	22.5 x 12.25	29807	4.75"	---	5	1	TR574-24E	119	11500 - 125
11	22.5 x 13.00	29146	---	0.63"	5	2	TR574-26E	132	11000 - 110
12	22.5 x 13.00	29174	2.62"	---	5	2	TR500	129	11000 - 110
13	22.5 x 13.00	29303	4.32"	---	5	1	TR574-26E	132	11000 - 110
14	22.5 x 13.00	29057	5.25"	---	5	1	TR574-26E	132	11000 - 110
15	22.5 x 13.00	29058 ⁽⁶⁾	5.25"	---	0 ⁽⁷⁾	1	TR574-26E	153	13000 - 130
16	22.5 x 14.00	29627	1.38"	2.00" ⁽⁴⁾	5	2	TR573	127	12800 - 125
17	22.5 x 14.00	50172	---	0.00"	5	2	TR543E	127	12800 - 125

⁽¹⁾ These wheels require two-piece metric flange nuts and grade 8 or higher 22mm wheel studs and 450-500 ft. - lbs. nut torque are recommended.

⁽²⁾ Inset is the lateral distance from the rim centerline to the mounting surface of the disc. Inset places the rim centerline inboard of the mounting surface; outset places the rim centerline outboard of the hub surface.

⁽³⁾ Aluminum Duplex® wheels come with valve installed.

⁽⁴⁾ The outset of Duplex® wheels can affect the loading on the axle end. When retrofitting trailers with wheels having an outset greater than 0.63 inches, consult the axle manufacturer.

⁽⁵⁾ The valve shown is for the inset position.

⁽⁶⁾ Rim flanges are reinforced.

⁽⁷⁾ Wheel disc has small valve access hole.

⁽⁸⁾ Available in Standard Polish and Extra Polish.

ACCURIDE 15° TUBELESS DUPLEX® DISC WHEELS



Aluminum Hub-Piloted Mounting Two-Piece Flange Nut

10-Hole, 335mm Bolt Circle, 281mm Bore

ULTRAMOUNT 335

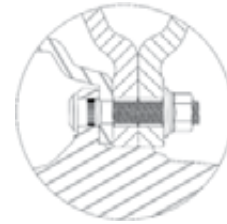

Item	Wheel Size	Part Number ⁽⁹⁾	Inset (mm)	Outset (mm)	Bolt Hole (mm)	Approx. Wt. (kg/lbs)	Maximum Load (kg/lbs)	Maximum Infl (bar/psi/kPa)
1	22.5 x 11.75	40164SP/XP	120	148	26	24.8 / 54.7	5000/11023	9.5 / 138 / 952
2	22.5 x 11.75	40166SP/XP	0	25	26	23 / 50	5000/11023	9.5 / 138 / 952
3	22.5 x 11.75	40176SP/XP	120	148	32	24.6 / 54	5000/11023	9.5 / 138 / 952
4	22.5 x 11.75	40178SP/XP	0	25	32	23 / 50	5000/11023	9.5 / 138 / 952
5	22.5 x 11.75	40386SP/XP	135	161	32	25.7 / 57	5000/11023	9.5 / 138 / 952
6	22.5 x 11.75	40394SP/XP	135	161	26	25.9 / 57	5000/11023	9.5 / 138 / 952

Steel Stud-Piloted Mounting⁽¹⁾ Outer Cap Nut

10-Hole, 11¼" Bolt Circle, 8.72" Bore, .625" Disc

Item	Wheel Size	Part Number	Inset ⁽³⁾	Outset ⁽³⁾	Hand Holes	Disc Position (see pg. 26)	Recommended Valve ⁽²⁾	Approx. Wt. (lbs)	Maximum Load & Infl. (lbs) – (psi)
7	22.5 x 12.25	29816	4.75"	---	2	1	TR574-26E	129	10000 – 105 ⁽⁶⁾
8	22.5 x 13.00	29818	---	0.63"	2	2	TR574-26E	132	10000 – 105
9	22.5 x 13.00	28684	5.25"	---	0 ⁽⁴⁾	3	TR501 ⁽⁵⁾	135	10250 – 110

Heavy Duty (HD) Steel Stud-Piloted Mounting⁽⁸⁾ Heavy Duty Outer Cap Nut

10-Hole, 13 3/16" Heavy Duty Bolt Circle, 10.69" Bore, .625" Disc

Item	Wheel Size	Part Number	Inset ⁽³⁾	Outset ⁽³⁾⁽⁷⁾	Hand Holes	Disc Position (see pg. 26)	Recommended Valve ⁽²⁾	Approx. Wt. (lbs)	Maximum Load & Infl. (lbs) – (psi)
10	22.5 x 13.00	28465	6.12"	---	0 ⁽⁴⁾	3	TR570	133	10210 – 110

⁽¹⁾ These wheels use standard cap nuts with 7/8" (.875") spherical radius.

⁽²⁾ The valve shown is for the inset position.

⁽³⁾ Inset is defined as the lateral distance from the rim centerline to the mounting surface of the disc. Inset places the rim centerline inboard of the mounting surface; outset places the rim centerline outboard of the hub surface.

⁽⁴⁾ Wheel disc has small valve access hole.

⁽⁵⁾ Wheel has two valve holes. Plug unused valve hole with Dill VS#902 or Schrader#345 plug.

⁽⁶⁾ Wheel may be used at 9370 lbs - 120 psi with 385/65R 22.5 LR J tires.

⁽⁷⁾ The wheel must only be installed in the inset position because bolt chamfers are only on one side of the disc.

⁽⁸⁾ These wheels require Heavy Duty (HD) outer cap nuts with a 1 3/16" spherical radius. Standard cap nuts have a 7/8" (.875") spherical radius.

⁽⁹⁾ Available in Standard Polish and Extra Polish.

Hub-Piloted
Tubeless Wheels

Stud-Piloted
Tubeless Wheels

Demountable
Rims & Components

Duplex Disc® Wheels
Duplex® Demountable
Rims

Light Truck Wheels

General Information

ACCURIDE 15° TUBELESS DUPLEX® DEMOUNTABLE RIMS

For Installation on Cast Spoke Wheels Designed for 20 x 8.0 or Narrower Tube-Type or 22.5" Diameter Tubeless Demountable Rims



Duplex® Demountable Rims for Front Applications

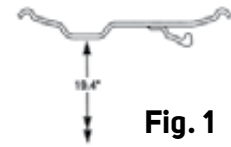

Item	Rim Size	Part Number ⁽¹⁾	Rim Offset ⁽²⁾	Mounting Ring	Recommended Valve ⁽³⁾	Approx. Wt. (kg)	Maximum Load & Infl. (lbs) – (psi)	Valve Hole Location ⁽⁴⁾
1	22.5 x 12.25	31674	3.00"	Fig.1	TR574E13	100	9270 – 115	LS
2	22.5 x 12.25	31677	4.00"	Fig.1	TR574E13	100	9270 – 115	LS
3	22.5 x 12.25	31679	4.75"	Fig.1	TR574E13	100	9270 – 115	LS

⁽¹⁾ Requires a six spoke cast spoke wheel.
⁽²⁾ Rim offset is defined as the lateral distance from the rim centerline to the face of the mounting ring.
⁽³⁾ The valve listed places the end of the valve near the mounting ring clamping face. Shorter valves TR501 or TR500 may be used.
⁽⁴⁾ "BDC" denotes bottom drop center, "LS" denotes long side.

Disc Positions

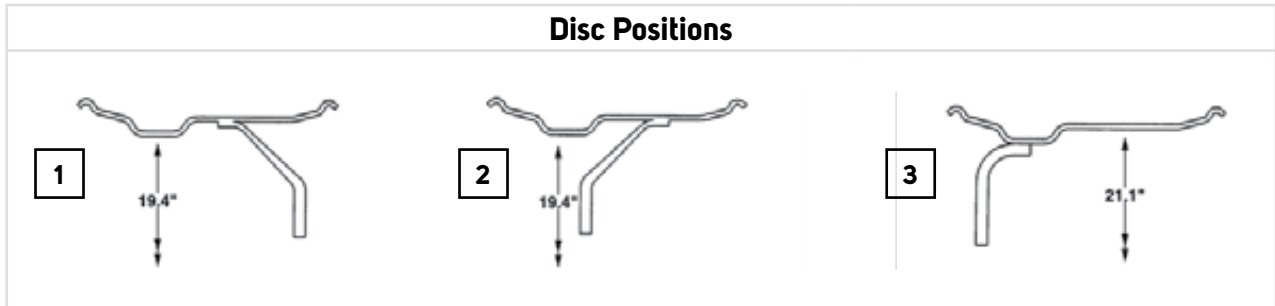

Hub-Piloted Tubeless Wheels

Stud-Piloted Tubeless Wheels

Demountable Rims & Components

Duplex Disc® Wheels
Duplex® Demountable Rims

Light Truck Wheels

General Information

LIGHT TRUCK WHEELS



Hub-Piloted
Tubeless Wheels

Stud-Piloted
Tubeless Wheels

Demountable
Rims & Components

Duplex Disc® Wheels
Duplex® Demountable
Rims

Light Truck Wheels

General Information

LIGHT TRUCK WHEELS

Hub-Piloted
Tubeless Wheels



**Hub-Piloted Dual-Mounting
Use Clamping Plate w/90° Cone Nuts**

**10-Hole, 7¼" Bolt Circle, 5.25" Bore
(P-300 Chevrolet or GMC Typical)**

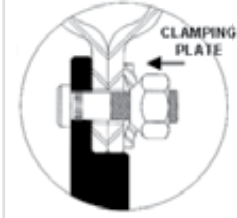

Item	Wheel Size	Rim Type	Part Number	Hand Holes	Wheel Offset	Disc	Valve Hole Dia.	Recommended Valve	Approx. Wt. (lbs)	Maximum Load & Infl. (lbs) - (psi)
1	19.5 x 6.00	15° Tbls	29667	5	5.08"	.375"	.625"	TR500	48	3000 - 95

Stud-Piloted
Tubeless Wheels



**Hub-Piloted Dual-Mounting
Use Clamping Plate w/90° Cone Nuts**

**8-Hole, 6½" Bolt Circle, 4.56" Bore
(¾, 1 Ton, Chevrolet or GMC Typical)**

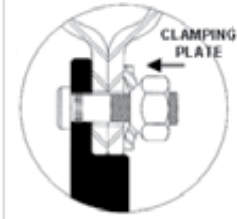

Item	Wheel Size	Rim Type	Part Number	Hand Holes	Wheel Offset	Disc	Valve Hole Dia.	Recommended Valve	Approx. Wt. (lbs)	Maximum Load & Infl. (lbs) - (psi)
2	16 x 6K	5° DC	29587	4	5.00"	.308"	.453"	TR600HP	35	2440 - 80
3	19.5 x 6.00	15° Tbls	29015	4	5.00"	.296"	.625"	TR573	46	2540 - 80

Demountable
Rims & Components



**Hub-Piloted Dual-Mounting
Use Only GM Swiveling Lug Nut⁽¹⁾**

**8-Hole, 6½" Bolt Circle, 4.60" Bore
(¾, 1 Ton, Chevrolet or GMC Typical)**



Item	Wheel Size	Rim Type	Part Number	Hand Holes	Wheel Offset	Disc	Valve Hole Dia.	Recommended Valve	Approx. Wt. (lbs)	Maximum Load & Infl. (lbs) - (psi)
4	16 x 6.5J	5° DC	29588	4	5.04"	.308"	.453"	TR600HP	34	2440 - 80

Duplex Disc® Wheels
Duplex® Demountable
Rims

Light Truck Wheels

CLAMPING PLATE TABLE

Wheel Size	Wheel P/N	Replaces P/N	Clamping Plate General Motors P/N
19.5 x 6.00	29015	27774	472536
19.5 x 6.00	29667	29207	349071

⁽¹⁾ The GM P/N for the M14-1.5 swiveling lug nut is 9591924. This type of nut is also called a two-piece flange nut or cone locking nut.

General Information

LIGHT TRUCK WHEELS



Hub-Piloted Dual-Mounting Use Only GM Swiveling Lug Nut⁽¹⁾

8-Hole, 210mm Bolt Circle, 154.3mm Bore
(3/4, 1 Ton, Chevrolet or GMC Typical)

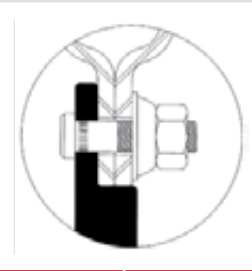

Item	Wheel Size	Rim Type	Part Number	Hand Holes	Wheel Offset	Disc	Valve Hole Dia.	Recommended Valve	Approx. Wt. (lbs)	Maximum Load & Infl. (lbs) - (psi)
1	17 x 6.5J	5° DC	50642	5	137mm	.330"	.453"	TR600	41	3000 - 80

⁽¹⁾ The GM P/N for the M14-1.5 swiveling lug nut is 9591924. This type of nut is also called a two-piece flange nut or cone locking nut.



Hub-Piloted Dual-Mounting Use Only Ford Swiveling Lug Nut⁽²⁾

8-Hole, 6½" Bolt Circle, 4.88" Bore
(Ford 3/4 and 1 Ton Typical)

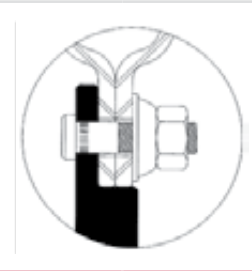

Item	Wheel Size	Rim Type	Part Number	Hand Holes	Wheel Offset	Disc	Valve Hole Dia.	Recommended Valve	Approx. Wt. (lbs)	Maximum Load & Infl. (lbs) - (psi)
2	16 x 6K	5° DC	29579	8	5.15"	.308"	.453"	TR600HP	35	2500 - 80

⁽²⁾ The Ford P/N for the 9/16-18 swiveling lug nut is 391223. This type of nut is also called a two-piece flange nut or a cone locking nut.

Hub-Piloted
Tubeless Wheels

Stud-Piloted
Tubeless Wheels

Demountable
Rims & Components

Duplex Disc® Wheels
Duplex® Demountable
Rims

Light Truck Wheels

General Information

LIGHT TRUCK WHEELS

Hub-Piloted
Tubeless Wheels



Aluminum Light Truck Wheel Hub-Piloted Dual Mounting Two-Piece Flange Nut

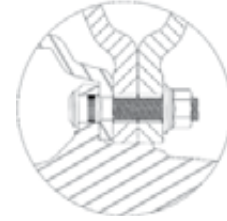

10-Hole, 225mm Bolt Circle, 170.10mm Bore

Item	Wheel Size	Part Number ⁽¹⁾	Wheel Offset	Disc	Installed Valve	Approx. Wt. (lbs)	Maximum Load & Infl. (lbs) - (psi)
1	19.5 x 6.00RW ⁽³⁾	40018SP/XP	5.35"	.598"	TR545D	32	4000 - 115

⁽¹⁾ Available in Standard Polish and Extra Polish.

Stud-Piloted
Tubeless Wheels

Demountable
Rims & Components



Hub-Piloted Dual-Mounting Use Only Ford Swiveling Lug Nut⁽²⁾

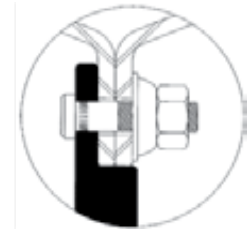

10-Hole, 225mm Bolt Circle, 170.10mm Bore

Item	Wheel Size	Rim Type	Part Number	Hand Holes	Wheel Offset	Disc	Valve Hole Dia.	Recommended Valve	Approx. Wt. (lbs)	Maximum Load & Infl. (lbs) - (psi)
2	19.5 x 6.00RW ⁽³⁾	15° Tbls	29884	5	5.35"	.375"	.453"	TR416S	52	4000 - 115

⁽²⁾ The Ford P/N for the M14 x 2.0 swiveling lug nut is N811599. This type of nut is also called a two-piece flange nut or a cone locking nut.

⁽³⁾ "RW" denotes revised well for increased brake clearance.

Duplex Disc® Wheels
Duplex® Demountable
Rims

Light Truck Wheels

General Information

LIGHT TRUCK WHEELS



Hub-Piloted Dual-Mounting Use Only Ford Swiveling Lug Nut⁽¹⁾

8-Hole, 225mm Bolt Circle, 170.10mm Bore
(Ford F-Super Duty Typical)

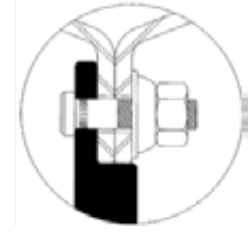

Item	Wheel Size	Rim Type	Part Number	Hand Holes	Wheel Offset	Disc	Valve Hole Dia.	Recommended Valve	Approx. Wt. (lbs)	Maximum Load & Infl. (lbs) - (psi)
1	19.5 x 6.00RW ⁽²⁾	15° Tbls	29584	5	5.35"	.375"	.453"	VS 902 K	51	3750 - 115



Hub-Piloted Dual-Mounting Use Only Ford Swiveling Lug Nut⁽¹⁾

8-Hole, 170mm Bolt Circle, 125.10mm Bore
(Ford F-Super Duty Typical)

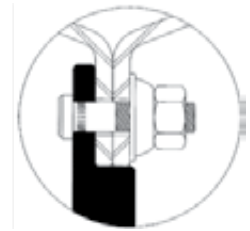

Item	Wheel Size	Rim Type	Part Number	Hand Holes	Wheel Offset	Disc	Valve Hole Dia.	Recommended Valve	Approx. Wt. (lbs)	Maximum Load & Infl. (lbs) - (psi)
2	16 x 6K	5° DC	29583	4	5.35"	.330"	.453"	TR600HP	37	2600 - 80

⁽¹⁾ The Ford P/N for the M14 x 2.0 swiveling lug nut is N811599. This type of nut is also called a two-piece flange nut or a cone locking nut.

⁽²⁾ "RW" denotes revised well for increased brake clearance.

Hub-Piloted
Tubeless Wheels

Stud-Piloted
Tubeless Wheels

Demountable
Rims & Components

Duplex Disc® Wheels
Duplex® Demountable
Rims

Light Truck Wheels

General Information

GENERAL INFORMATION

Hub-Piloted
Tubeless Wheels

Stud-Piloted
Tubeless Wheels

Demountable
Rims & Components

Duplex Disc® Wheels
Duplex® Demountable
Rims

Light Truck Wheels

General Information

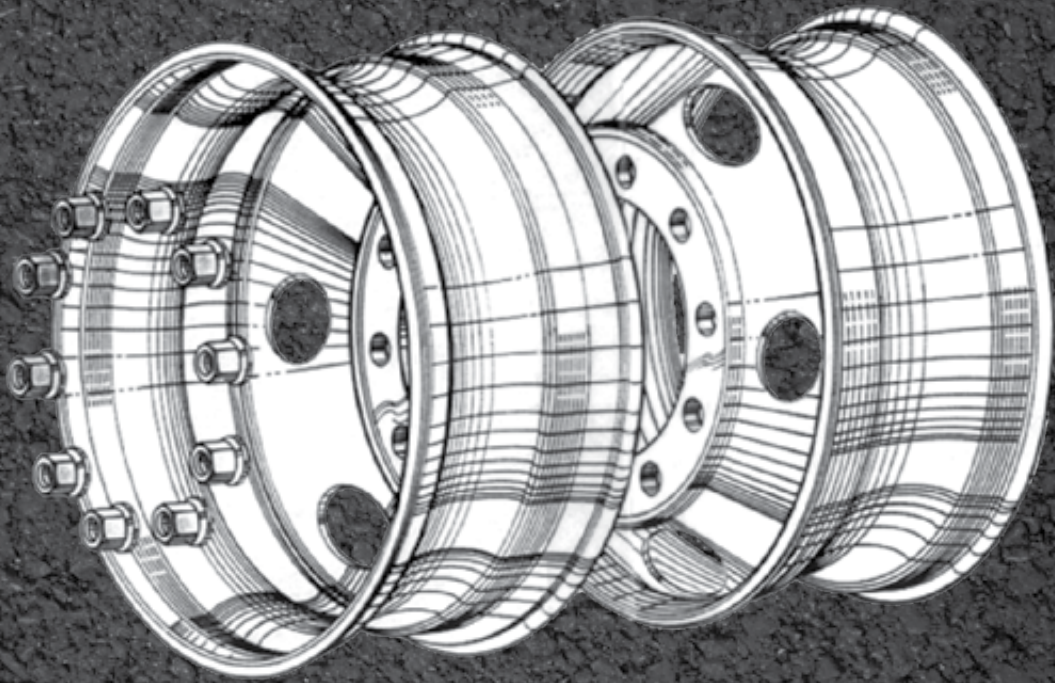

WHEEL-GUARD® SEPARATOR PLATE

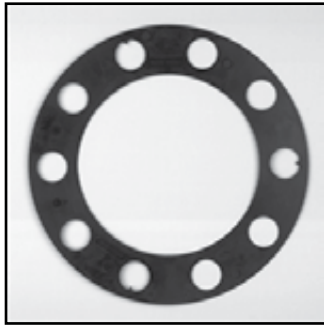

590-1

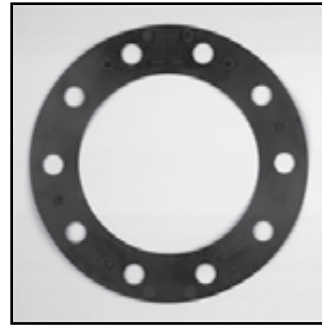

590-3

The Wheel-Guard® Separator Plate is approximately .035" thick. It is placed between the hub or drum and the wheel, and/or between two wheels in dual applications. Not to be installed between hub and brake drum. The Wheel-Guard® is recommended in severe applications where corrosion and/or wear have been identified. Both aluminum and steel wheels can benefit from use of the Wheel-Guard®. Care must be exercised in centering the separator plate prior to torquing, and stud length must be checked as each plate is approximately .035" thick.

Item	Part Number	Bolt Circle	Application
1	790-2	8 hole - 275mm	hub-piloted; 22mm diameter studs
2	100065	10 hole - 225mm	hub-piloted; 14mm diameter studs
3	590-3	10 hole - 285.75mm	hub-piloted; 22mm diameter studs
4	738-1	10 hole - 335mm	hub-piloted; ISO European Mount, 22mm diameter studs
5	590-2	10 hole - 11¼"	stud-piloted; ¾" diameter studs
6	590-1	10 hole - 11¼"	stud-piloted; 7/8" and 1½" diameter studs

Available Accuride Educational, Informational, and Training Items

ITEM DESCRIPTION	ITEM DESCRIPTION
CATALOGS Wheel and Rim Catalog - English SAFETY AND SERVICE MANUALS Safety/Service Manuals - English Safety/Service Manuals - Spanish Safety/Service Manuals - French	VIDEO Accuride Wheels Service Video
CHARTS Accuride Rim & Ring Matching Wall Chart Hub-Piloted/Stud-Piloted Wheel Mounting System Identification Chart Wheel Out of Service Wall Chart WRIS Nut Torque Chart	OTHER Hub-Piloted, 8-Hole, 275mm Bolt Circle chassis label Hub-Piloted, 10-Hole, 285.75mm Bolt Circle chassis label Nut and Chamfer Gage Kit (P/N 5400) Accuride touch up spray paint can (Gray #5411, White #5412, Black #5413) Aluminum Wheel Flange Wear Gage #5401K Accuride Touch Up Pens (Gray 5416, White 5417, Black 5415)

The Accuride Rim/Wheel Safety & Service Manual and other educational, informational, and training items are available free of charge at www.AccurideCorp.com. You may also write to Literature Distribution, Accuride, 7140 Office Circle, Evansville, IN 47715 or call (800) 626-7096 to receive free copies. Outside the US call (812) 962-5000. You should not, nor should you let your employees, service rims/wheels unless they are thoroughly trained and completely understand this safety information.

Hub-Piloted
Tubeless Wheels

Stud-Piloted
Tubeless Wheels

Demountable
Rims & Components

Duplex Disc® Wheels
Duplex® Demountable
Rims

Light Truck Wheels

General Information

RECOMMENDED NUT TORQUE

Mounting	Thread Size	Torque ft-lbs	Nut Type
LIGHT TRUCK			
10-Hole, 7.25" Hub-Piloted (Ford) (5.47" Bore)	9/16 - 18	125 - 165	Two piece flange
10-Hole, 7.25" Hub-Piloted (GM) (5.25" Bore) - With Clamping Plate	5/8 - 18	171 - 179	90° cone ⁽¹⁾ With Clamping Plate
8-Hole, 6.50" I.O.C. (Ford)	9/16 - 18	175 - 200	90° cone
	5/8 - 18	175 - 200	90° cone
8-Hole, 210mm, Hub-Piloted (GM)	M14 x 1.5	136 - 144	Two piece flange
8-Hole, 6.50" Hub-Piloted (Ford) (4.88" Bore)	9/16 - 18	125 - 165	Two piece flange
	5/8 - 18	130 - 170	Two piece flange
8-Hole, 6.50" Stud-Piloted (Ford) (4.88" Bore) - Single Wheel	9/16 - 18	130 - 150	60° cone
8-Hole, 6.50" Hub-Piloted (GM)	M14 x 1.5	110 - 120	Two piece flange
8-Hole, 6.50" Hub-Piloted (GM) (4.56" Bore) - With Clamping Plate	9/16 - 18	136 - 144	90° cone ⁽¹⁾
	M14 x 1.5	136 - 144	With Clamping Plate
8-Hole, 6.50" Hub-Piloted (GM) (4.60" Bore)	M14 x 1.5	136 - 144	Two piece flange
8-Hole, 170mm, Hub-Piloted (Ford) (125.10mm Bore)	M14 x 2.0	150 - 160	Two piece flange
8-Hole, 225mm Hub-Piloted (Ford) (170.10mm Bore)	M14 x 2.0	150 - 160	Two piece flange
6-Hole, 8.75" Stud-Piloted	3/4 - 16	450 - 500	.875" spherical radius
	1 - 1/8 - 16	450 - 500	.875" spherical radius
6-Hole, 222.25mm Stud-Piloted Japanese .866" Nut Type	M20 x 1.5	325 - 400	.866" spherical radius
MEDIUM/HEAVY TRUCK, TRAILER AND BUS			
10-Hole, 13 3/16" HD Stud-Piloted	15/16 - 12	750 - 900	1.187" spherical radius
	1 - 5/16 - 12	750 - 900	1.187" spherical radius
10-Hole, 335mm Hub-Piloted	M22 x 1.5	450 - 500	Two piece flange
10-Hole, 11 1/4" Stud-Piloted	3/4 - 16	450 - 500	.875" spherical radius
	1 - 1/8 - 16	450 - 500	.875" spherical radius
10-Hole, 11 1/4" Hub-Piloted (Bus Mount)	3/4 - 16	300 - 350	Two piece flange
	7/8 - 14	350 - 400	Two piece flange
10-Hole, 285.75mm Hub-Piloted	M22 x 1.5	450 - 500	Two piece flange
10-Hole, 8.75" Hub-Piloted	11/16 - 16	300 - 400	One piece flange
10-Hole, 8.75" Stud-Piloted	3/4 - 16	450 - 500	.875" spherical radius
	1 - 1/8 - 16	450 - 500	.875" spherical radius
10-Hole, 200mm Hub-Piloted (Ford)	M14 x 2.0	150 - 160	Two piece flange
10-Hole, 225mm Hub-Piloted (Ford)	M14 x 2.0	150 - 160	Two piece flange
8-Hole, 285mm Stud-Piloted Japanese	Check truck manufacturer for torque details		
8-Hole, 275mm Hub-Piloted	M20 x 1.5	280 - 330	Two piece flange
	M22 x 1.5	450 - 500	Two piece flange
Demountable Rims	3/4 - 10	200 - 260	Flat nut

⁽¹⁾ These nuts can only be used with a clamping plate. Do not use 90° cone nuts against the disc face.

Note: Hub, stud and spoke wheel manufacturers may have different torque requirements. Consult Accuride Field Engineering at (800) 869-2275 if torque recommendations conflict. Refer to Accuride's Rim/Wheel Safety and Service Manual for information on torque and nut tightening sequence.

Hub-Piloted
Tubeless Wheels

Stud-Piloted
Tubeless Wheels

Demountable
Rims & Components

Duplex Disc® Wheels
Duplex® Demountable
Rims

Light Truck Wheels

General Information

ALUMINUM WHEEL HAND HOLE SIZE BY PART NUMBER

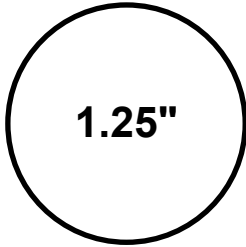

1.25"

40164 40176
40386 40394

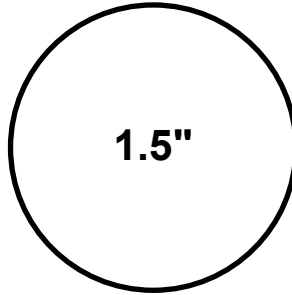

1.5"

29374 29376
29378 29380
29683 41012

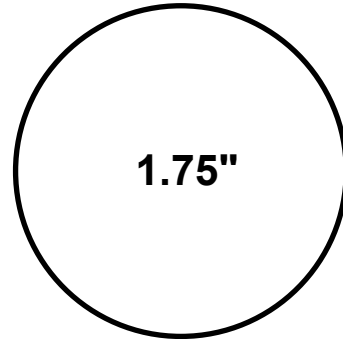

1.75"

40166 40178

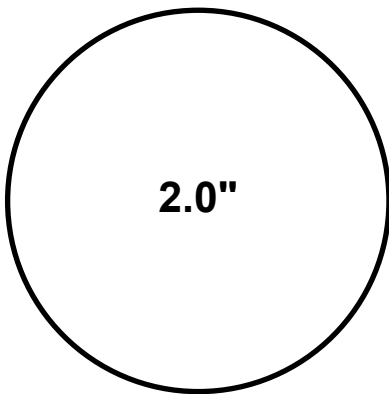

2.0"

27599 28608 28615
28632 28844 29348
29602 29685 29695
40008 40018 40160
40162 42140 42142

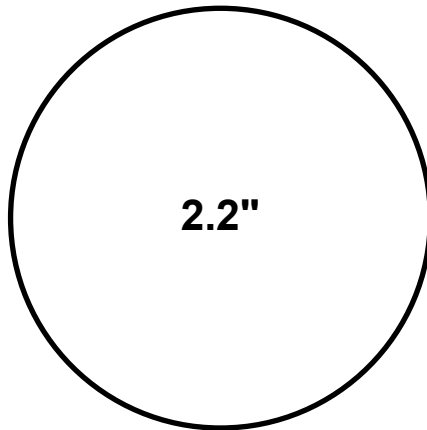

2.2"

29560 29562
40014 40180

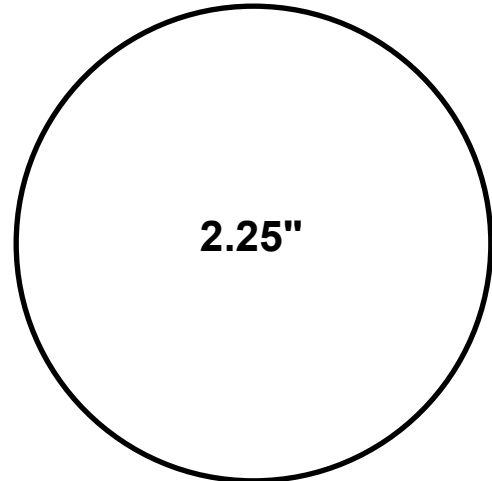

2.25"

41730 42644

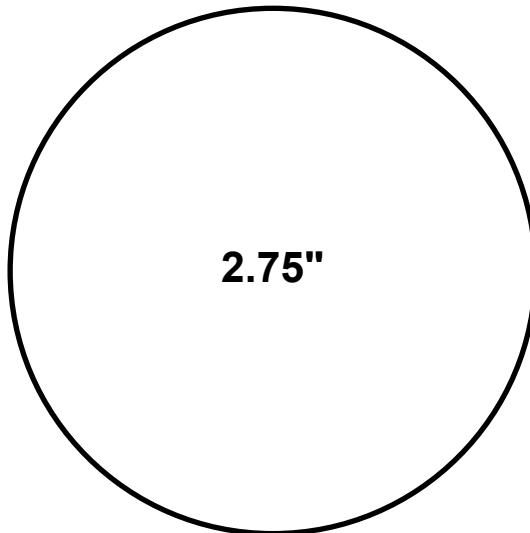

2.75"

41362 41644

Hub-Piloted
Tubeless Wheels

Stud-Piloted
Tubeless Wheels

Demountable
Rims & Components

Duplex Disc® Wheels
Duplex® Demountable
Rims

Light Truck Wheels

General Information

ACCURIDE/ARCONIC CROSS REFERENCE

CROSS REFERENCE

Arconic P/N	Accuride P/N	Size	Mount	Bolt Hole	Bolt Circle	Bore
66347x	40171	17.5 x 6.75	Hub-Piloted; Dual Mounting	8	275mm	221mm
76320x	40018	19.5 x 6.00	Hub-Piloted; Dual Mounting	10	225mm	170mm
76542x	29695	19.5 x 6.75	Hub-Piloted; Dual Mounting	8	275mm	221mm
77349x	40160	19.5 x 7.50	Hub-Piloted; Dual Mounting	8	275mm	221mm
77362x	29685	19.5 x 7.50	Hub-Piloted; Dual Mounting	10	285.75mm	220mm
87360x	28844	22.5 x 7.50	Hub-Piloted; Dual Mounting	10	285.75mm	220mm
88311x	28615	22.5 x 8.25	Stud-Piloted; Dual Mounting	10	11 1/4"	8.72"
88344x	29348	22.5 x 8.25	Hub-Piloted; Dual Mounting	8	275mm	221mm
88361x	28632 ⁽³⁾	22.5 x 8.25	Hub-Piloted; Bus Mounting	10	11 1/4"	8.67"
Ultrax	42644 - 40 lb	22.5 x 8.25	Hub-Piloted; Dual Mounting	10	285.75mm	220mm
88367x	41644 - 45 lb	22.5 x 8.25	Hub-Piloted; Dual Mounting	10	285.75mm	220mm
88565x	40008 ⁽¹⁾	22.5 x 8.25	Hub-Piloted; Dual Mounting	10	285.75mm	220mm
88651x	40014	22.5 x 8.25	Hub-Piloted; Dual Mounting	10	335mm	281mm
88652x	29560	22.5 x 8.25	Hub-Piloted; Dual Mounting	10	335mm	281mm
89300x	28608 ⁽¹⁾	22.5 x 9.00	Stud-Piloted; Dual Mounting	10	11 1/4"	8.72"
89U63x	41012 ⁽¹⁾⁽⁴⁾	22.5 x 9.00	Hub-Piloted; Dual Mounting	10	285.75mm	220mm
89U64x	41730 ⁽¹⁾	22.5 x 9.00	Hub-Piloted; Dual Mounting	10	285.75mm	220mm
89652x	29562 ⁽¹⁾	22.5 x 9.00	Hub-Piloted; Dual Mounting	10	335mm	281mm
89651x	40180	22.5 x 9.00	Hub-Piloted; Dual Mounting	10	335mm	281mm
82262x	29378	22.5 x 12.25	Hub-Piloted; Single Mounting	10	285.75mm	220mm
82362x	29683	22.5 x 12.25	Hub-Piloted; Single Mounting	10	285.75mm	220mm
82462x	29374	22.5 x 12.25	Hub-Piloted; Single Mounting	10	285.75mm	220mm
83462x	29376	22.5 x 13.00	Hub-Piloted; Single Mounting	10	285.75mm	220mm
84U62x	42142	22.5 x 14.00	Hub Piloted; Single Mounting	10	285.75mm	220mm
84U60x	42140 ⁽²⁾	22.5 x 14.00	Hub-Piloted; Single Mounting	10	285.75mm	220mm
98312x	27599	24.5 x 8.25	Stud-Piloted; Dual Mounting	10	11 1/4"	8.72"
98U63x	41362	24.5 x 8.25	Hub-Piloted; Dual Mounting	10	285.75mm	220mm

The last number of the Arconic part number represents the Arconic finish.

0-SP; 1-XP; 2-XP; 3-XP; 7-SP; 8-SP Duplex inset position; 9-SP Duplex inset position; DB-C; DF-F; DD-FC

(1) Must confirm ADB clearance

(2) 0.50" difference in outset

(3) Bus application

(4) Not approved for dual applications – inset is 3.12"

Available Accuride Finishes

SP	Standard Polish	SPC	Standard Polish with Accu-Shield®
XP	Extra Polish	XPC	Extra Polish with Accu-Shield®
F	Accu-Flange™	FC	Accu-Flange™ with Accu-Shield®
R	Accu-Armor™ Finish	RF	Accu-Armor™ with Accu-Flange™

TYPES OF ACCURIDE RIMS, RINGS, AND TYPICAL DISC-TO-RIM ATTACHMENT LOCATIONS

**5° RADIAL COMMANDER®
3-PIECE TUBE-TYPE RIMS**



Rim Size	Type
24 x 8.5	5°

**15° TUBELESS
ALUMINUM WHEELS**

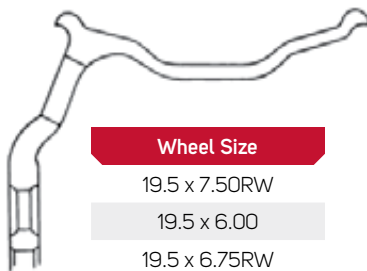

Wheel Size
19.5 x 7.50RW
19.5 x 6.00
19.5 x 6.75RW
19.5 x 8.25RW
22.5 x 7.50
22.5 x 8.25
22.5 x 9.00
24.5 x 8.25

**15° TUBELESS STEEL WHEELS
(Welded on Well)**

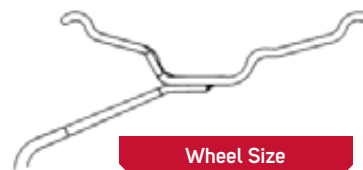

Wheel Size
19.5 x 6.00
19.5 x 6.00RW
19.5 x 6.75RW

**15° TUBELESS STEEL WHEELS
(Welded on Ledge)**

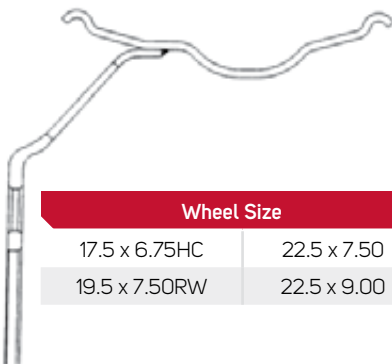

Wheel Size	
17.5 x 6.75HC	22.5 x 7.50
19.5 x 7.50RW	22.5 x 9.00

**5° DROP CENTER
DUAL STEEL WHEEL**



Wheel Size
16 x 6K
16 x 6.5J
16 x 7K
17 x 6K
17 x 7.5J

**5° DROP CENTER
SINGLE STEEL WHEEL**

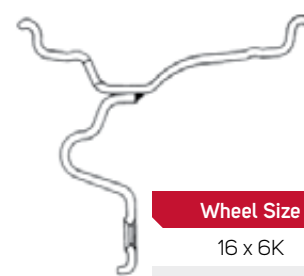

Wheel Size
16 x 6K
16 x 7K

Hub-Piloted
Tubeless Wheels

Stud-Piloted
Tubeless Wheels

Demountable
Rims & Components

Duplex Disc® Wheels
Duplex® Demountable
Rims

Light Truck Wheels

General Information

ACCURIDE TYPICAL PRODUCT STAMPING

Hub-Piloted
Tubeless Wheels

Stud-Piloted
Tubeless Wheels

Demountable
Rims & Components

Duplex Disc® Wheels
Duplex® Demountable
Rims

Light Truck Wheels

General Information

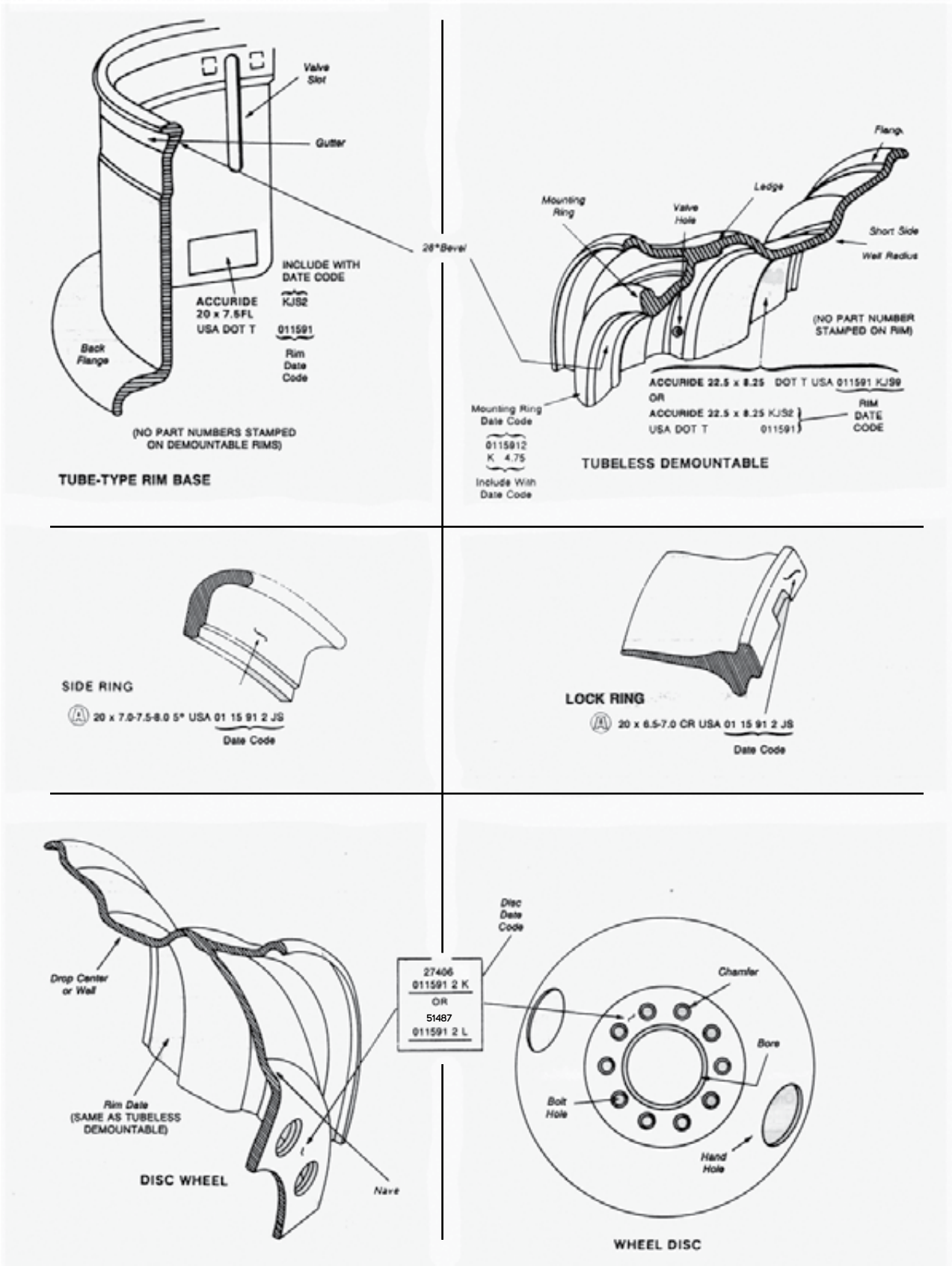

HOW TO IDENTIFY DAMAGED RIMS/WHEELS

Rim/wheel components can become damaged. Check all metal surfaces for rust or corrosion buildup, cracks in metal, bent flanges and side rings, deep rim tool marks on rings or in gutter areas. Watch for the problems illustrated in the following two pages and take the corrective actions to prevent further problems. Remember, it is dangerous to assemble cracked, bent, severely corroded, or sprung rim/wheel components. Such items should be destroyed and discarded.

RIM BASE CRACKS

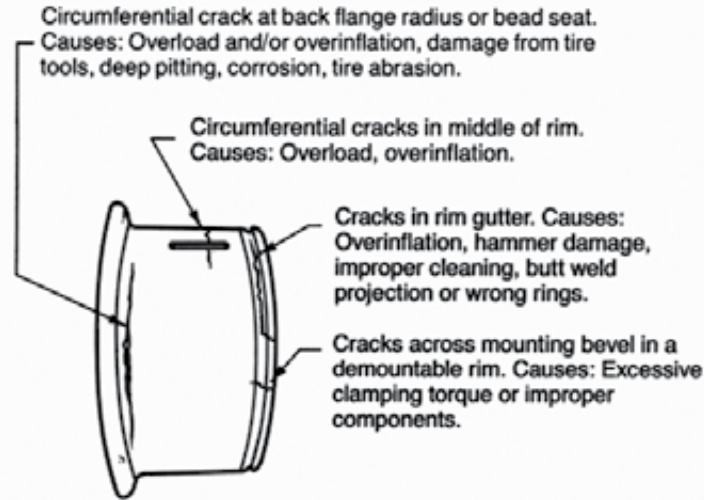

Flange or rim gutter chorded or bent. Causes: Excessive or improper torque, wrong hub or clamp, severe impact, run flat or hammering on rim gutter.

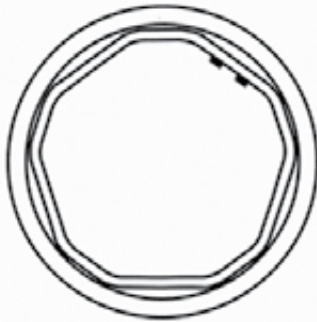

Mounting ring chorded or bent. Causes: Excessive or improper torque, wrong hub or clamp, severe impact.

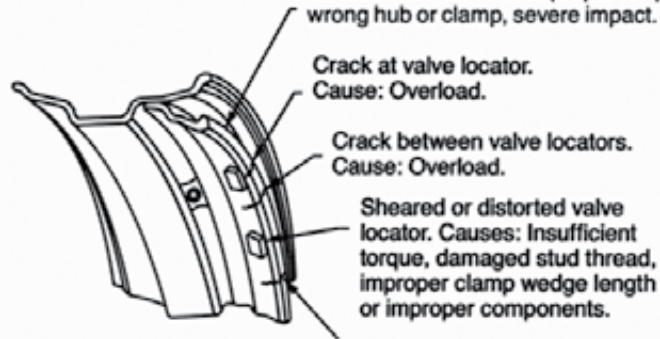

Lateral crack at spoke or clamp fit. Causes: Excessive or improper torque, wrong hub or clamp.

Hub-Piloted
Tubeless Wheels

Stud-Piloted
Tubeless Wheels

Demountable
Rims & Components

Duplex Disc® Wheels
Duplex® Demountable
Rims

Light Truck Wheels

General Information

HOW TO IDENTIFY DAMAGED RIMS/WHEELS

Hub-Piloted
Tubeless Wheels

Stud-Piloted
Tubeless Wheels

Demountable
Rims & Components

Duplex Disc® Wheels
Duplex® Demountable
Rims

Light Truck Wheels

General Information

DISC WHEEL CRACKS/BOLT HOLE DISTORTION

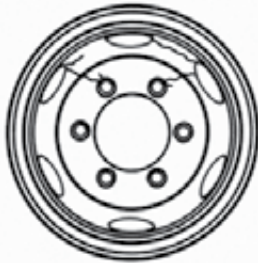

Handhole to handhole.
Handhole to bolt hole.
Handhole to rim.
Cause: Overloading.



Bolt hole to bolt hole.
Causes: Loose cap nuts,
small hub backup (also
see bolt hole cracks/distortions).

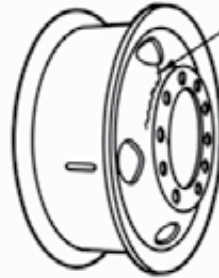

Cracks at disc nave
and/or handhole.
Causes: Bad fit-up,
damaged hub,
overload or sharp
edge at handhole.

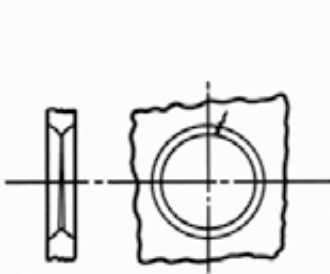

Crack originating from thin
edge of stud hole. Cause:
Damaged or worn-out at
chamfers.

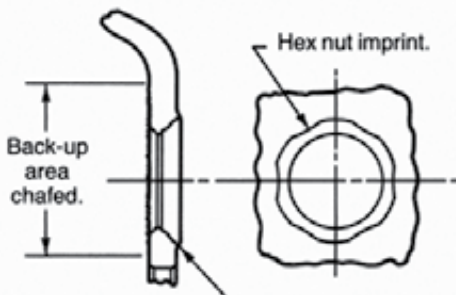

Chamfer enlarged or worn out
by nut. Causes: Loose cap nuts or
insufficient nut torque due to damaged
threads, improper torquing or by worn-
out nut.



Chamfer extruded on
side opposite nut.
Causes: Too much
torque or improper nut.

TUBELESS RIM LEAKS

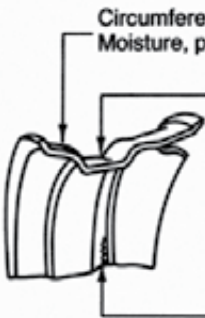

Circumferential cracks at bead seat. Causes:
Moisture, pitting and erosion by the tire bead.

Circumferential cracks in well radius.
Causes: Overload or overinflation.
Corrosion due to water from the air
lines, improper mounting lubricant,
balance or sealer.

Circumferential cracks at attachment
weld. Causes: Overload, overinflation
or loose mounting on vehicle.

Note: Wheel with well welded discs
may not be approved for use with
radial tires.

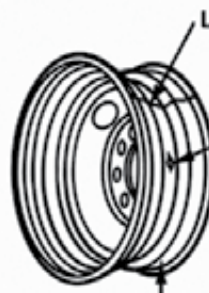

Leak at butt weld. Cause: Overload.

Leak at valve hole. Causes:
Damage or severe
corrosion.

Leak under tire bead, groove
or ridge across bead seat.
Causes: Corrosion, tire tool
marks, bent flange or other
damage.

CHANGEOVER FROM CONVENTIONAL TO WIDE BASE TUBELESS TIRES

FRONT APPLICATIONS

Required Information for Duplex® Changeover Calculations			
Determine the following information and insert into the calculation below			
<i>OBTAIN THIS INFORMATION FROM THE TRUCK and THE CHOICE FOR THE NEW WIDE BASE TIRE</i>		<i>OBTAIN THIS INFORMATION FROM THE ACCURIDE CATALOG AND/OR TIRE DATA BOOK</i>	
Existing Wheel/Rim Part Number	<input type="text"/>	Existing Wheel Inset or Rim Offset ⁽¹⁾	<input type="text"/>
Existing Tire Size	<input type="text"/>	Existing Tire Section Width ⁽²⁾	<input type="text"/>
Proposed Wide Base Tire Size	<input type="text"/>	Proposed Wide Base Tire Section Width ⁽³⁾	<input type="text"/>
Existing Overall Width (See Figure 1 - page 45)	<input type="text"/>		

⁽¹⁾ Determine the existing wheel inset or rim offset from the part number and the catalog information. Inset is offset minus disc thickness

⁽²⁾ Determine the existing tire section width from the chart on page 48.

⁽³⁾ Determine the proposed wheel/rim width and wide base tire section width from the chart on page 46.

The new Duplex® wheel inset or rim offset is determined by inserting the above information into the following calculation.

Wide Base Changeover Calculation

$$\begin{array}{ccccccc}
 \text{Existing} & & \text{Existing} & & \text{Proposed} & & \text{NEW DUPLEX®} \\
 \text{Wheel Inset} & + & \text{Tire Section} & = & \text{Wide Base Tire} & = & \text{WHEEL INSET OR} \\
 \text{or Rim Offset} & & \div 2 & & \div 2 & & \text{RIM OFFSET} \\
 & & \text{Width} & & \text{Section Width} & & \\
 \hline
 \boxed{} & + & \boxed{} & = & \boxed{} & = & \boxed{}
 \end{array}$$

Refer to the Duplex® part number listings on pages 24-26 and choose the next smaller available wheel inset or rim offset for this application. This choice will maintain the existing inside clearance between the tire or wheel/rim and the frame/suspension. If adequate inside clearance exists, the next larger wheel inset or rim offset may be chosen.

The change in the overall width of the vehicle should be determined to verify that the new width is not over the maximum allowed by law. Use the following calculation to determine the new overall width. This new width should be checked against federal, state, and local regulations to assure compliance with maximum width restrictions.

$$\begin{array}{ccccccc}
 \text{Existing} & & \text{Existing} & & \text{Existing} & & \text{New Duplex®} & & \text{Wide Base} & & \text{NEW} \\
 \text{Overall Width} & +2x & \text{Wheel Inset} & - & \text{Tire Section} & -2x & \text{Wheel Inset} & + & \text{Tire Section} & = & \text{OVERALL} \\
 & & \text{or Rim Offset} & & \text{Width} & & \text{or Rim Offset} & & \text{Width} & & \text{WIDTH} \\
 \hline
 \boxed{} & +2x & \boxed{} & - & \boxed{} & -2x & \boxed{} & + & \boxed{} & = & \boxed{}
 \end{array}$$

It is recommended that the wheel/rim be mounted on the truck without the tire to verify clearances prior to tire mounting. Products which have had a tire mounted may not be returned.

Hub-Piloted
Tubeless Wheels

Stud-Piloted
Tubeless Wheels

Demountable
Rims & Components

Duplex Disc® Wheels
Duplex® Demountable
Rims

Light Truck Wheels

General Information

CHANGEOVER FROM CONVENTIONAL TO WIDE BASE TUBELESS TIRES

FRONT APPLICATIONS CONTINUED

Wide Base Tire Section Width and Dimension Chart

Information from The 2018 Tire & Rim Association Yearbook

Tire Size ⁽²⁾	Rim Width	Tire Section Width
15 ★ 22.5	11.75	15.30
	12.25	15.50 ⁽¹⁾
445/50 ★ 22.5	14.00	17.52
445/55R ★ 22.5	14.00	17.80
385/65 ★ 22.5	11.75	15.31
	12.25	15.51 ⁽¹⁾
16.5 ★ 22.5	13.00	16.75
	12.25	16.45 ⁽¹⁾
425/65 ★ 22.5	12.25	16.61
	13.00	16.91 ⁽¹⁾
	14.00	17.31 ⁽¹⁾
445/65 ★ 22.5	13.00	17.48
	14.00	17.88 ⁽¹⁾
18 ★ 22.5	13.00	17.60 ⁽¹⁾
	14.00	18.00

⁽¹⁾ This value was calculated by the following formula: Tire section width will change 0.1" each 1/4" change in rim width from the design rim width.

⁽²⁾ A ★ denotes both radial and bias tires.

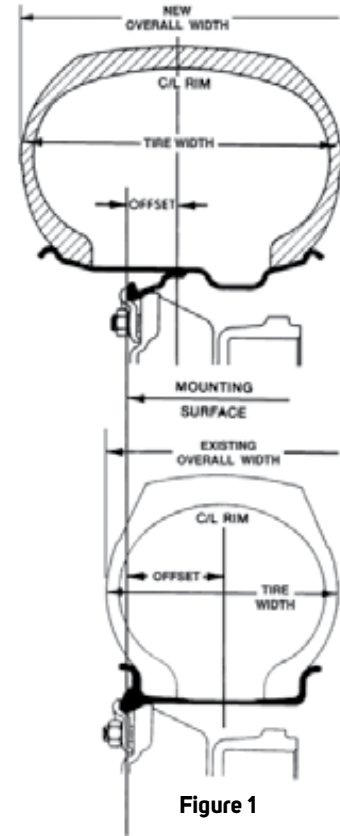

Figure 1

Hub-Piloted
Tubeless Wheels

Stud-Piloted
Tubeless Wheels

Demountable
Rims & Components

Duplex Disc® Wheels
Duplex® Demountable
Rims

Light Truck Wheels

General Information

SELECTED DUPLEX® CHANGEOVER APPLICATIONS 385/65R22.5 TIRE SIZE

Factors which may effect fitment:

- Drum clearance on older applications
- Inside clearance
- Maximum outside track (overall width) (max is usually 102")

Use the following recommendations:

- Inside clearance will be preserved and the outside track will increase by 9"
- **For Hub-Piloted steel wheel applications:**
 - 12.25 width - 29806

Alternative Recommendation

- The new overall width will be increased 7½" and the inside clearance will be reduced by ¾"
- **For Hub-Piloted steel wheel applications:**
 - 12.25 width - 29807
- **For Stud-Piloted steel wheel applications:**
 - 12.25 width - 29816

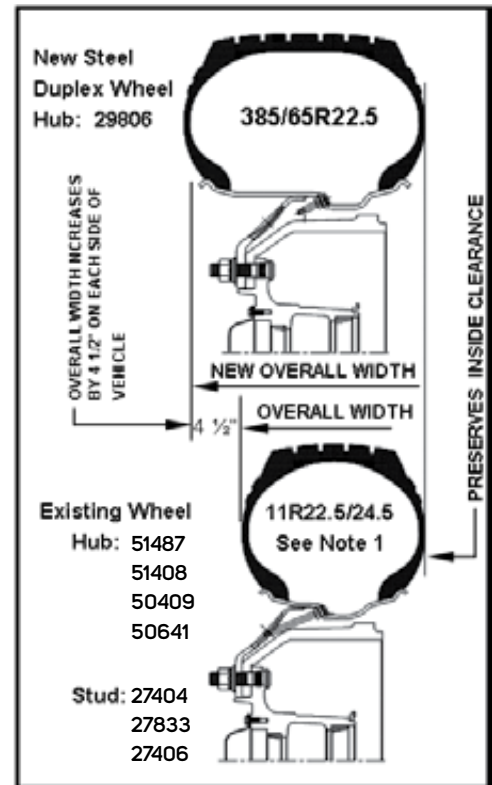

SELECTED DUPLEX® CHANGEOVER APPLICATIONS 425/65R22.5 TIRE SIZE

Factors which may effect fitment:

- Drum clearance on older applications
- Inside clearance
- Maximum outside track (overall width) (max is usually 102")

Use the following recommendations:

- Note that the inside clearance will be reduced by ¾" and the outside track will increase by 10"
- **For Hub-Piloted steel wheel applications:**
 - 12.25 width - 29806

Alternative Recommendation

- The new overall width will be increased 8½" and the inside clearance will now be reduced by 1½".
- **For Hub-Piloted steel wheel applications:**
 - 12.25 width - 29807
- **For Stud-Piloted steel wheel applications:**
 - 12.25 width - 29816

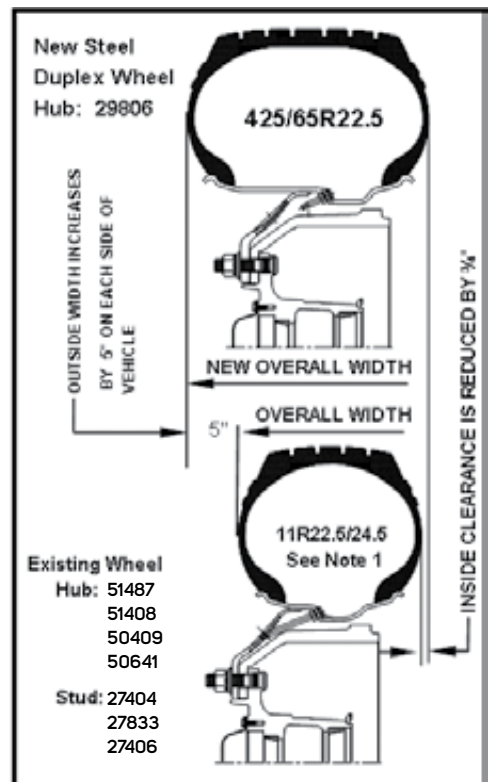

Note 1: Changeover also applies to 275/80 and 295/75 low profile tires.

Hub-Piloted
Tubeless Wheels

Stud-Piloted
Tubeless Wheels

Demountable
Rims & Components

Duplex Disc® Wheels
Duplex® Demountable
Rims

Light Truck Wheels

General Information

SELECTED DUPLEX® CHANGEOVER APPLICATIONS TO ALUMINUM

Factors which may effect fitment:

- Drum clearance
- Inside clearance
- Maximum outside track (width) (max is usually 102")

Use the following recommendations:

- Hub-Piloted applications only
 - 29374
- New overall width is increased as follows:
 - 385/65R22.5 tire - 3¾" each side of the vehicle
 - 425/65R22.5 tire - 4¼" each side of the vehicle
- Reduces the inside clearance as follows:
 - 385/65R22.5 tire - approx 1"
 - 425/65R22.5 tire - approx 1½"

Alternative recommendation:

- Hub-Piloted applications only
 - 29683
- Overall width increases an additional 2" each side from the dimensions shown above and in the sketch.
- Inside clearance is not changed from original.

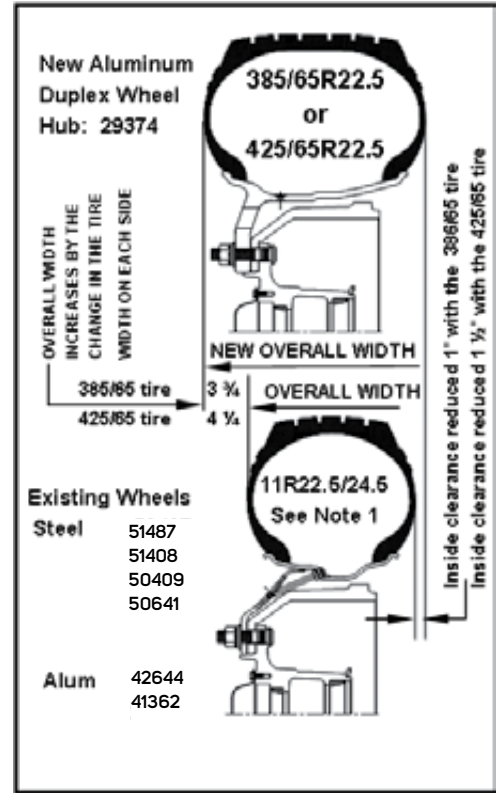

SELECTED DUPLEX® CHANGEOVER APPLICATIONS – DRIVE/TRAILER

Factors which may effect fitment:

- Drum clearance on older applications
- Centerline alignment is recommended for best distribution of bearing loads. If outside alignment changeovers are preferred, bearing loading should be verified with axle manufacturer.

385/65R22.5 and 425/65R22.5 Recommendations:

- **Hub-Piloted applications:**
 - 12.25 width - Steel 29805; Aluminum 29378 (385 and 425 Tires)
 - 13.00 width - Steel 29146; Aluminum 29380 (425 Tire Only)
- **For Stud-Piloted applications:**
 - 13.00 width - Steel 29818 (425 Tire Only)

445/50R22.5

- **Tractor Applications**
 - Hub-Piloted applications:
 - 14.00 width - Steel 29627; Aluminum 42142
- **Trailer Applications**
 - Hub-Piloted applications:
 - 14.00 width - Steel 50172; Aluminum 42140

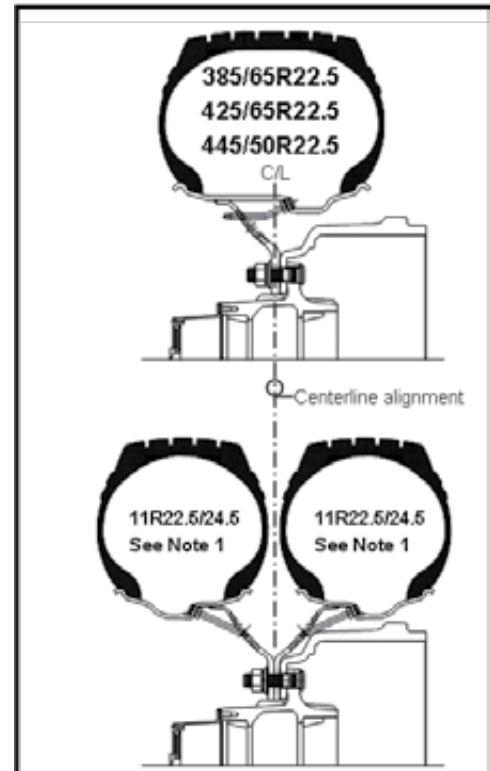

Note 1: Changeover also applies to 275/80 and 295/75 low profile tires.

DUAL SPACING OF WHEELS

As shown in the diagram below, the sum of the wheel offsets of the two wheels used equals the dual spacing. The recommended minimum dual spacing for tire clearance is shown in the chart to the right.

Tire clearance can be calculated by subtracting one tire section width from the sum of the two wheel offsets. This information is found in tire data books (also see chart). For more accuracy, the grown tire width at the rated load can be used instead of the new tire section width. This dimension can be obtained either by actual measurement of the tire width (including protective side ribs) or by referring to the tire manufacturer's data book.

In addition to determining tire clearance, the wheel offset directly affects two other important dimensions: (1) the vehicle clearance and (2) the overall vehicle width of tires (see diagram below).

Vehicle body clearance, which is the distance from the inside tire to the spring or other body structures, will change proportionally to any change in offset of the inside wheel.

The overall vehicle width of tires is the distance from the outside tire wall of one tire to the outside tire wall of the tire on the opposite end of the axle. This dimension will be altered correspondingly by an increase or decrease in wheel offset. Overall vehicle width will change proportionally to any offset changes of the wheel, if the tire projects beyond the body structure. The maximum vehicle width is regulated by law.

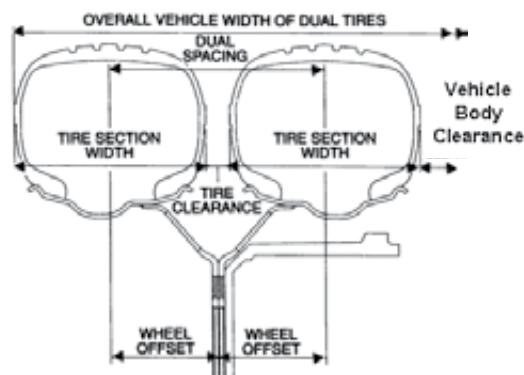

2018 Wheel Selection And Tire Spacing

Information from The Tire & Rim Association Yearbook

Tire Sizes ⁽¹⁾	Design Rim Width ⁽²⁾	Tire Section Width ⁽³⁾	Minimum Dual Spacing ⁽³⁾
Light Truck			
6.50R16LT	4.50	7.15	8.30
7.50 ★ 16LT	6.00	8.65	10.00
LT215/85 ★ 16	6.00	8.50	9.88
LT225/75 ★ 16	6.00	8.78	10.20
LT245/75 ★ 16	7.00	9.76	11.34
LT265/75 ★ 16	7.50	10.51	12.20
LT285/75 ★ 16	8.00	11.26	13.07
LT235/70R16	7.00	9.45	10.94
LT235/85 ★ 16	6.50	9.25	10.75
LT255/70R16	7.50	10.24	11.89
LT255/85 ★ 16	7.00	10.04	11.65
LT275/70R16	8.00	10.98	12.76
8.00 ★ 16.5	6.00	8.00	9.00
8.75 ★ 16.5	6.75	8.75	9.90
9.50 ★ 16.5	6.75	9.50	10.70
LT235/80 ★ 17	6.50	9.25	10.75
LT265/70 ★ 17	8.00	10.71	12.44
Medium And Heavy Truck			
11.00 ★ 24	8.00	11.55	13.20
12.00 ★ 24	8.50	12.40	14.10
9 ★ 17.5HC	6.75	9.00	10.30
10 ★ 17.5HC	7.50	10.00	11.40
8 ★ 19.5	6.00	8.00	9.10
225/70 ★ 19.5	6.75	8.90	10.00
245/70 ★ 19.5	7.50	9.76	10.98
265/70 ★ 19.5	7.50	10.31	11.61
305/70 ★ 19.5	9.00	12.01	13.50
9 ★ 22.5	6.75	9.00	10.30
10 ★ 22.5	7.50	10.00	11.40
11 ★ 22.5	8.25	11.00	12.50
12 ★ 22.5	9.00	11.80	13.50
235/80 ★ 22.5	6.75	9.17	10.31
245/75 ★ 22.5	7.50	9.76	10.98
255/70 ★ 22.5	7.50	10.04	11.30
265/75 ★ 22.5	7.50	10.31	11.61
275/80 ★ 22.5	8.25	10.87	12.24
295/75 ★ 22.5	9.00	11.73	13.19
305/75 ★ 22.5	9.00	12.01	13.50
315/80R22.5	9.00	12.28	13.82
11 ★ 24.5	8.25	11.00	12.50
12 ★ 24.5	9.00	11.80	13.50
275/80 ★ 24.5	8.25	10.87	12.24
285/75 ★ 24.5	8.25	11.14	12.52

⁽¹⁾ A ★ denotes both radial and bias tires.

⁽²⁾ For additional approved rim contours and widths see page 47.

⁽³⁾ Tire section width and minimum dual spacings will change 0.1" for each 1/4" change in rim width from the design rim width.

Hub-Piloted
Tubeless Wheels

Stud-Piloted
Tubeless Wheels

Demountable
Rims & Components

Duplex Disc® Wheels
Duplex® Demountable
Rims

Light Truck Wheels

General Information

DUAL SPACING OF DEMOUNTABLE RIMS

As shown in the diagram, the sum of the offsets of the two rims used, plus the width of the spacer band, equals the dual spacing of the demountable rim assembly. The recommended minimum dual spacing for each tire and rim combination is shown in the chart to the right. More spacing is required when tire chains are to be used.

The tire clearance can be calculated by subtracting one tire section width from the dual spacing (this information is found in tire data books and the chart on this page). For more accuracy, the grown tire width at the rated load can be used instead of the new tire section width. This dimension can be obtained either by actual measurement of the tire width (including protective side ribs) or by referring to the tire manufacturer's data book.

If there is sufficient spoke length on the rear spoke wheel, spacing and tire clearance can be increased (by changing the spacer band width) (see pages 20 and 44). The clamp length must also be changed.

In addition to determining tire clearance, rim offset directly affects two other important dimensions: (1) vehicle clearance and (2) the overall vehicle width of the tires.

Vehicle body clearance, which is the distance from the inside tire to the spring or other body structures, will change proportionally to any change in offset of the inside rim.

The overall vehicle width of tires is the distance from the outside tire wall of one tire to the outside tire wall of the tire on the opposite end of the axle. This dimension will be altered correspondingly by an increase or decrease in rim offset. Overall vehicle width will change proportionally to any offset changes of the rim, if the tire projects beyond the body structure. The maximum vehicle width is restricted by law.

2018 Wheel Selection And Tire Spacing

Information from The Tire & Rim Association Yearbook

Tire Sizes ⁽¹⁾	Design Rim Width ⁽²⁾	Tire Section Width ⁽³⁾	Minimum Dual Spacing ⁽³⁾
Medium And Heavy Truck			
11.00 ★ 24	8.00	11.55	13.20
12.00 ★ 24	8.50	12.40	14.10
9 ★ 17.5HC	6.75	9.00	10.30
10 ★ 17.5HC	7.50	10.00	11.40
8 ★ 19.5	6.00	8.00	9.10
225/70 ★ 19.5	6.75	8.90	10.00
245/70 ★ 19.5	7.50	9.76	10.98
265/70 ★ 19.5	7.50	10.31	11.61
305/70 ★ 19.5	9.00	12.01	13.50
9 ★ 22.5	6.75	9.00	10.30
10 ★ 22.5	7.50	10.00	11.40
11 ★ 22.5	8.25	11.00	12.50
12 ★ 22.5	9.00	11.80	13.50
235/80 ★ 22.5	6.75	9.17	10.31
245/75 ★ 22.5	7.50	9.76	10.98
255/70 ★ 22.5	7.50	10.04	11.30
265/75 ★ 22.5	7.50	10.31	11.61
275/80 ★ 22.5	8.25	10.87	12.24
295/75 ★ 22.5	9.00	11.73	13.19
305/75 ★ 22.5	9.00	12.01	13.50
315/80R22.5	9.00	12.28	13.82
11 ★ 24.5	8.25	11.00	12.50
12 ★ 24.5	9.00	11.80	13.50
275/80 ★ 24.5	8.25	10.87	12.24
285/75 ★ 24.5	8.25	11.14	12.52

⁽¹⁾ A ★ denotes both radial and bias tires.

⁽²⁾ For additional approved rim contours and widths see page 48.

⁽³⁾ Tire section width and minimum dual spacings will change 0.1" for each 1/4" change in rim width from the design rim width.

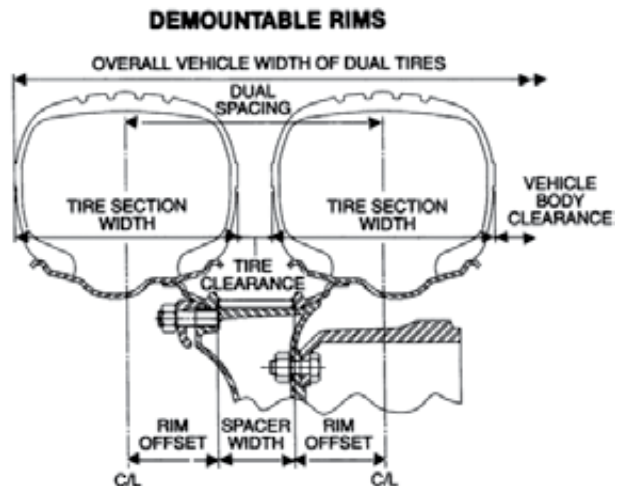

CHANGEOVER FROM TUBE-TYPE TO TUBELESS TIRES

Tubeless tires mounted on one-piece 15° drop center rims are completely interchangeable with tube-type tires and rims on the same cast spoke wheels except for cast spoke wheels designed to carry 8.5 and wider tube-type rims. When making a tubeless conversion, the first step is to select the proper replacement tubeless tire and drop-center rim.

The next step is to determine the dual spacing of the original rim and spacer band combination as shown on page 20 for 5° and FL rims. Then find in the dual spacing chart, below, the dual spacing for the new tubeless

assembly using the original size spacer band. If this spacing varies considerably from that of the original tube-type assembly, the clearance between tires, vehicle body clearance, and/or overall width of dual tires may be incorrect. These conditions will require a change in width of the spacer bands and possibly the clamps.

2018 Tubeless Tire and Rim Changeover Table

Information from The Tire & Rim Association Yearbook

Tube-Type Tire (Width x Dia.) ⁽¹⁾	Replaced by Tubeless (Width x Dia.) ⁽¹⁾	Preferred Tire Rim (Dia. x Width)	Alternate Tubeless Rim (Dia. x Width)
8.25 ★ 15TR	9 ★ 17.5HC	17.5 x 6.75HC	---
9.00 ★ 15TR	10 ★ 17.5HC	17.5 x 7.50HC	17.5 x 6.75HC
8.25 ★ 20	9 ★ 22.5	22.5 x 6.75	22.5 x 7.50/6.00
9.00 ★ 20	10 ★ 22.5	22.5 x 7.50	22.5 x 6.75
10.00 ★ 20	11 ★ 22.5	22.5 x 8.25	22.5 x 7.50
10.00 ★ 22	11 ★ 24.5	24.5 x 8.25	24.5 x 7.50
11.00 ★ 20	12 ★ 22.5	22.5 x 9.00	22.5 x 8.25
11.00 ★ 22	12 ★ 24.5	24.5 x 9.00	24.5 x 8.25

⁽¹⁾ A ★ denotes both radial and bias tires.

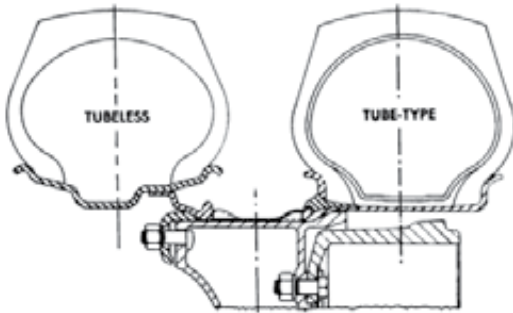

Rim Dimensions and Dual Spacing For 15° Tubeless Rims Sizes 6.75 Through 9.00

Part Number	Size		Rim Offset	A	B	C	D	E	Dual Spacing with Spacer Band Width			
	Dia.	Width							3 3/8	3 5/8	4	4 1/4
31868175	17.5	6.75	3.90	14.5	8.67	13.550	15	3.75	11.2	11.4	11.8	12.0
30371225	22.5	7.50	4.26	19.5	9.50	18.550	20	3.75	11.9	12.1	12.5	12.8
30391225	22.5	8.25	4.75	19.5	10.25	18.550	20	3.75	12.9	13.1	13.5	13.7
32051225	22.5	8.25	4.75	19.5	10.25	18.550	20	3.75	12.9	13.1	13.5	13.7
32052225	22.5	9.00	5.00	19.5	11.20	18.550	20	3.75	--	13.6	14.0	14.2
30391245	24.5	8.25	4.75	21.5	10.25	20.550	22	4.50	12.9	13.1	13.5	13.7
32051245	24.5	8.25	4.75	21.5	10.25	20.550	22	4.50	12.9	13.1	13.5	13.7

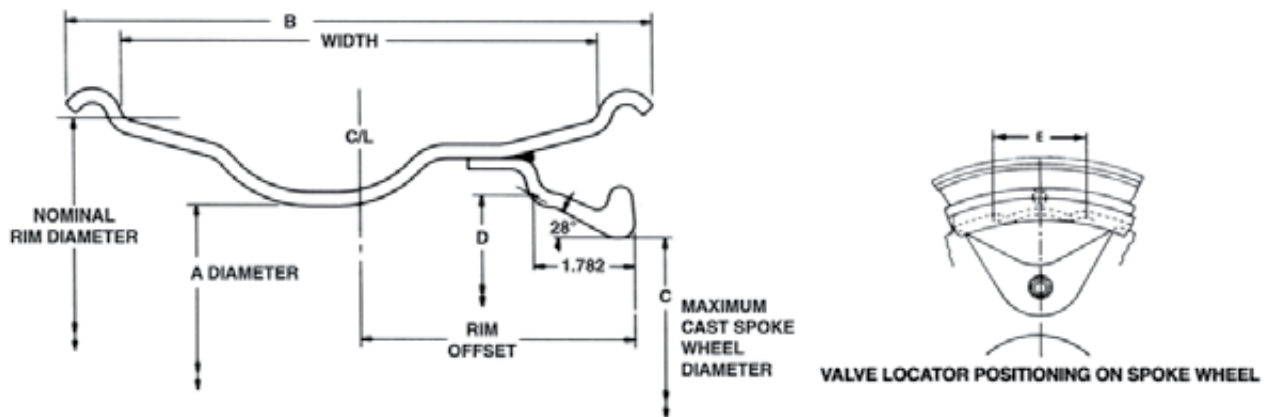

Hub-Piloted
Tubeless Wheels

Stud-Piloted
Tubeless Wheels

Demountable
Rims & Components

Duplex Disc® Wheels
Duplex® Demountable
Rims

Light Truck Wheels

General Information

CHART FOR PROPERLY MATCHING TRUCK TIRES TO RIMS/WHEELS

Information obtained from the 2018 Tire & Rim Association Yearbook

Tire Size ⁽¹⁾	Approved Rim Contours ⁽²⁾	Tire Size ⁽¹⁾	Approved Rim Contours ⁽²⁾
LIGHT TRUCKS		MEDIUM AND HEAVY DUTY TRUCKS	
6.50 ★ 16LT	4½K, 4.50E, 5K, 6K, 6L	11.00 ★ 24	7.5, 8.0, 8.5, 8.50VM
7.50 ★ 16LT	5.50F (SDC), 6K, 6L, 6½L, 7L	12.00 ★ 24	8.0, 8.5, 8.50VM, 9.0
LT225/75 ★ 16	6J, 6½J, 7K	8 ★ 19.5	5.25, 6.00, 6.00RW, 6.75, 6.75RW
LT245/75 ★ 16	6½J, 7J, 7½J, 8J	225/70R 19.5	6.00, 6.00RW, 6.75, 6.75RW
LT265/75 ★ 16	7J, 7½J, 8J	245/70R 19.5	6.75, 6.75RW, 7.50, 7.50RW
LT285/75 ★ 16	7½J, 8J, 8½J, 9J	265/70R 19.5	7.50, 7.50RW, 8.25, 8.25RW
LT215/85 ★ 16	5½J, 6J, 6½J, 7J	305/70R 19.5	8.25, 8.25RW, 9.00
LT235/80 ★ 17	6J, 6½J, 7J, 7½J	9 ★ 22.5	6.00, 6.75, 7.50
LT235/85 ★ 16	6J, 6½J, 7J, 7½J	10 ★ 22.5	6.75, 7.50, 8.25
LT255/85 ★ 16	6½J, 7J, 7½J, 8J	235/80R 22.5	6.75, 7.50
LT235/70 ★ 16	6J, 6½J, 7J, 7½J	245/75R 22.5	6.75, 7.50
LT255/70 ★ 16	6½J, 7J, 7½J, 8J	255/70R 22.5	6.75, 7.50, 8.25
LT265/70 ★ 17	7J, 7½J, 8J, 8½J	265/75R 22.5	7.50, 8.25
LT275/70 ★ 16	7J, 7½J, 8J, 8½J	11 ★ 22.5	7.50, 8.25
8.75 ★ 16.5	6.00, 6.75	275/80R 22.5	7.50, 8.25, 9.00
9.50 ★ 16.5	6.75, 8.25	295/75R 22.5	8.25, 9.00
LOW PLATFORM TRAILERS		305/75R 22.5	8.25, 9.00
9R17.5HC	6.75HC, 6.75	12 ★ 22.5	8.25, 9.00
215/75R 17.5HC	6.00HC, 6.75HC	315/80R 22.5	8.25, 9.00, 9.75
10R17.5HC	6.75HC, 7.50HC, 6.75, 7.50	11 ★ 24.5	7.50, 8.25
		275/80R 24.5	7.50, 8.25, 9.00
		12 ★ 24.5	8.25, 9.00
		285/75R 24.5	7.50, 8.25, 9.00
		WIDE BASE (DUPLEX®)	
		15 ★ 22.5	11.75, 12.25
		385/65R 22.5	11.75, 12.25
		16.5 ★ 22.5	12.25, 13.00
		425/65R 22.5	12.25, 13.00, 14.00
		445/50R 22.5	14.00, 15.00
		445/65R 22.5	13.00, 14.00
		455/55R 22.5	14.00, 15.00
		18 ★ 22.5	13.00, 14.00

⁽¹⁾ A ★ denotes both radial and bias tires. An R indicates radial tires only.
⁽²⁾ SDC denotes semi-drop center rims.
 Note: For tire sizes not shown, consult the Tire Manufacturer for approved rim contours.

Hub-Piloted
Tubeless Wheels

Stud-Piloted
Tubeless Wheels

Demountable
Rims & Components

Duplex Disc® Wheels
Duplex® Demountable
Rims

Light Truck Wheels

General Information

OBSOLETE PART NUMBER INDEX

Part Number	Size	Mounting Type	Outset ⁽¹⁾	Inset ⁽¹⁾	Potential Replace ⁽²⁾	Part Number	Size	Mounting Type	Outset ⁽¹⁾	Inset ⁽¹⁾	Potential Replace ⁽²⁾
240 - 5° - 1	20 x 7.0 - 5° ⁽³⁾	Dem				25622	22 x 8.0 - 5° ⁽³⁾	10H - 11.25"	6.88		
262FL2 - 1	20 x 7.5 FL ⁽³⁾	Dem				25662	20 x 7.5 - 5° ⁽³⁾	10H - 11.25"	6.38		
276-5-1	22 x 8.0 - 5° ⁽³⁾	Dem	5.00			25666	20 x 8.0 - 5° ⁽³⁾	10H - 11.25"	6.38		
277-5-1	24 x 8.0 - 5° ⁽³⁾	Dem	5.00			25668	20 x 8.0 - 5° ⁽³⁾	10H - 11.25"	6.88		
241D5LR	22 x 7.0 - 7.5 - 8.0 - 5°	Lock Ring				25672	22.5 x 8.25	10H - 11.25"	6.38		27833C
242D5LR	24 x 7.0 - 7.5 - 8.0 - 5°	Lock Ring				26039	20 x 7.5 - MS	10H - 11.25"	6.75		
263D5SR	22 x 8.0 - 5°	Side Ring				26205	19.5 x 14.00 WHL	10H - 11.25"	3.06		
264D5SR	24 x 8.0 - 5°	Side Ring				26357	20 x 7.5 - MS	6H - 8.75"	6.25		
276D51X	22 x 8.0 - 5° ⁽³⁾	Rim Only				26385	22.5 x 14.00 WHL	10H - 11.25"	3.06		29818 ⁽⁵⁾
277D51X	24 x 8.0 - 5° ⁽³⁾	Rim Only				26386	22.5 x 14.00 WHL	10H - 11.25"	0.44		29818 ⁽⁵⁾
312 - 5 - 1	20 x 8.5 - 5° ⁽³⁾	Dem				26414	22.5 x 14.00	Rear Dem		2.75	
313 - 5 - 1	24 x 8.0 - 5° ⁽³⁾	Dem	5.30			26415	22.5 x 14.00	Rear Dem		0.56	
313D51X	24 x 8.0 - 5° ⁽³⁾	Rim Only				26464	20 x 8.0 - 5° ⁽³⁾	10H - 11.25"	6.62		
313D5LR	24 x 8.0 - 5° ⁽³⁾	Lock Ring				26538	20 x 6.5 FL ⁽³⁾	6H - 8.75"	6.50		
313D5SR	24 x 8.0 - 5° ⁽³⁾	Side Ring				26580	22.5 x 14.00	Front Dem ⁽⁴⁾		5.82	13244 ⁽⁶⁾⁽⁵⁾
13180	22.5 x 14.00 WHL	10H - 11.25"	4.75	4.12		26642	22.5 x 14.00 WHL	10H - 11.25"	4.25	3.62	29818 ⁽⁶⁾⁽⁵⁾
13189	22.5 x 14.00	Front Dem ⁽⁴⁾				26654	22.5 x 14.00 WHL	10H - 11.25"	3.69	3.06	29818 ⁽⁶⁾⁽⁵⁾
13224	22.5 x 13.00	Front Dem		5.00		26660	22.5 x 14.00 WHL	10H - 11.25"		1.63	
13228	22.5 x 13.00	Front Dem	3.94			26738	19.5 x 13.00	Front Dem		2.44	
13229	22.5 x 12.25	Front Dem	5.44		31679 ⁽⁵⁾	26785	22.5 x 13.00 WHL	10H - 11.25"	3.06		
13244	22.5 x 13.00	Front Dem	5.62			26786	22.5 x 13.00 WHL	10H - 11.25"	0.41		
13257	19.5 x 12.25 WHL	10H - 11.25"	1.70			26787	22.5 x 13.00	Rear Dem			
13279	22.5 x 12.25	Front Dem		4.44		26788	22.5 x 13.00	Rear Dem			
13290	22.5 x 12.25	Front Dem			31674 ⁽⁵⁾	26793	19.5 x 13.00 WHL	10H - 11.25"	3.06		
13293	22.5 x 14.00 WHL	10H - 11.25"	3.69	3.06	29818 ⁽⁶⁾⁽⁵⁾	26794	19.5 x 13.00 WHL	10H - 11.25"	0.44	0.19	
13298	22.5 x 13.00	Front Dem		1.20		26811	22 x 8.0 - 5° ⁽³⁾	10H - 11.25"	6.65		
13308	22.5 x 13.00	Front Dem		2.50		26831	22.5 x 14.00 WHL	10H - 13.188"		7.12	
13333	22.5 x 14.00 WHL	10H - 11.25"	5.75	5.25		26870	19.5 x 14.00 WHL	10H - 11.25" ⁽⁴⁾	4.88	4.25	
13348	19.5 x 12.25 WHL	10H - 11.25" ⁽⁷⁾	3.12	2.50		26874	22.5 x 14.00 WHL	10H - 11.25"	5.25	4.62	
13349	22.5 x 13.00	Front Dem ⁽⁷⁾		5.62		26875	19.5 x 14.00 WHL	10H - 11.25" ⁽⁴⁾	5.25	4.62	
13350	22.5 x 12.25	Front Dem		4.75	31679	26886	22.5 x 14.00	Rear Dem		2.93	
13351	22.5 x 12.25	Front Dem		3.63	31674 ⁽⁵⁾	26887	22.5 x 14.00 WHL	10H - 11.25"	5.75	5.25	
13354	22.5 x 13.00	Rear Dem				26891	19.5 x 14.00 WHL	10H - 11.25"	3.69	3.06	
13491	22.5 x 12.25	Front Dem		6.44		26894	19.5 x 14.00 WHL	10H - 11.25" ⁽⁴⁾	4.72	4.09	
13580	22.5 x 14.00	Front Dem		4.17		26915	22.5 x 14.00 WHL	10H - 13.188"	6.25	5.75	
25415	22.5 x 8.25	10H - 11.25"	6.62		27834C	26917	20 x 7.5 - FL ⁽³⁾	10H - 11.25"	6.38		
25430	22.5 x 8.25	10H - 11.25"	6.62		27833C	26919	22.5 x 13.00	Front Dem		3.25	
25438	20 x 7.0 - 5° ⁽³⁾	10H - 11.25"	6.50			26920	19.5 x 13.00 WHL	10H - 11.25"		2.75	
25441	20 x 7.5 - FL ⁽³⁾	10H - 11.25"	6.50			26934	22.5 x 14.00 WHL	10H - 11.25"	6.25	5.75	
25451	22.5 x 7.50	10H - 11.25"	6.12		27403	26935	22.5 x 14.00 WHL	10H - 11.25" ⁽⁴⁾	4.38	3.75	
25495	22.5 x 8.25	10H - 11.25"	6.62		27833C	26940	22.5 x 14.00	Rear Dem			
25524	20 x 8.0 - 5° ⁽³⁾	10H - 11.25"	6.62			26942	22.5 x 13.00	Front Dem		5.83	13244
25617	22 x 7.5 - 5° ⁽³⁾	10H - 11.25"	6.56			26965	22.5 x 14.00	Rear Dem			

⁽¹⁾ Outset/Inset—(Inches) See Pg. 25 footnote (3) or Pg. 56 for definition.

⁽²⁾ Check vehicle clearances prior to mounting tire.

⁽³⁾ Tubeless wheel/rim available. See catalog.

⁽⁴⁾ Well Welded—check clearance I.D. upon replacement.

⁽⁵⁾ Offset Difference.

⁽⁶⁾ 13.00" Rim.

⁽⁷⁾ Reinforced Flanges.

⁽⁸⁾ Replacement wheel has a different disc contour which allows less clearance for brakes. Check clearance before ordering.

⁽⁹⁾ Potential replacement has an alternate rim contour which requires different side and/or lock ring.

⁽¹⁰⁾ Check clearance.

⁽¹¹⁾ This wheel has a .453" valve hole. Wheels supplied on original vehicle have a .625" valve hole.

⁽¹²⁾ 7.50" Rim.

OBSOLETE PART NUMBER INDEX

Part Number	Size	Mounting Type	Outset ⁽¹⁾	Inset ⁽¹⁾	Potential Replace ⁽²⁾	Part Number	Size	Mounting Type	Outset ⁽¹⁾	Inset ⁽¹⁾	Potential Replace ⁽²⁾
27048	22.5 x 14.00 WHL	10H - 11.25"	3.06			27760	22.5 x 14.00 WHL	10H - 13.188"HD		7.12	28465 ⁽⁶⁾
27079	20 x 7.5 - FL ⁽³⁾	10H - 11.25"	6.12			27765	22.5 x 8.25	10H - 11.25"B	6.62		27834C ⁽¹⁰⁾
27089	22.5 x 13.00 WHL	10H - 11.25"		5.81		27766	22.5 x 8.25	10H - 11.25"B	6.62		27834C ⁽¹⁰⁾
27093	22.5 x 13.00	Front Dem		4.50	13228	27772	16 x 5.50 - F	8H - 6.50"	5.00		29587
27121	20 x 6.5 - CR ⁽³⁾	6H - 8.75"	5.62			27773	22.5 x 12.25 WHL	10H - 13.188"HD		6.25	28465 ⁽⁶⁾
27122	20 x 6.5 - CR ⁽³⁾	6H - 8.75"	6.00			27774	19.5 x 6.00	8H - 6.50"	5.00		29015
27123	20 x 6.5 - CR ⁽³⁾	10H - 11.25"	6.00			27775	19.5 x 6.00	10H - 7.25"	5.00		
27124	20 x 7.0 - CR ⁽³⁾	6H - 8.75"	6.12			27784	22.5 x 6.75	6H - 8.75"	5.93		
27126	20 x 7.0 - CR ⁽³⁾	10H - 11.25"	6.44			27785	22.5 x 6.75	10H - 8.75"	6.00		
27211	19.5 x 12.25 WHL	10H - 8.75" ⁽⁴⁾	3.12	2.50		27791	22.5 x 14.00 WHL	10H - 13.188"HD		7.12	28465 ⁽⁶⁾
27212	19.5 x 12.25 WHL	10H - 8.75"	0.44			27796	16 x 6K	8H - 6.50" I °C	5.00		
27215	19.5 x 12.25 WHL	10H - 11.25" ⁽⁴⁾	3.12	2.50		27833	22.5 x 8.25	10H - 11.25"	6.62		27833C
27216	19.5 x 12.25 WHL	10H - 11.25"	0.44			27834	22.5 x 8.25	10H - 11.25"B	6.62		27834C
27221	22.5 x 12.25 WHL	10H - 11.25"	3.12	2.50	29816 ⁽⁶⁾	27836	22.5 x 8.25	10H - 11.25"	6.62		27404 ⁽¹⁰⁾
27222	22.5 x 12.25 WHL	10H - 11.25"	0.44			27910	17.5 x 6.75	6H - 8.75"	5.62		28145
27225	22.5 x 12.25	Rear Dem	0.38	0.38		27913	22.5 x 13.00 WHL	10H - 11.25"	0.44		29818 ⁽⁵⁾
27226	22.5 x 12.25	Rear Dem	1.87	1.87		27917	22.5 x 13.00 WHL	10H - 11.25"	3.06		
27233	22.5 x 12.25 WHL	10H - 11.25"		4.88		27922	16 x 5.5-F	8H - 6.50"	5.00		29587
27234	22.5 x 12.25 WHL	10H - 11.25"	5.06	4.56	29816 ⁽⁶⁾	27924	22.5 x 12.25 WHL	10H - 11.25"	0.44		29818 ⁽⁶⁾⁽⁶⁾
27235	22.5 x 12.25 WHL	10H - 11.25"	5.62	5.12	29816 ⁽⁶⁾	27944	22.5 x 6.75	10H - 11.25"	5.91		
27236	22.5 x 12.25 WHL	10H - 11.25"	6.80	6.30	29816 ⁽⁶⁾	27945	20 x 7.5 -5 ⁽³⁾	10H - 11.25"	6.50		
27238	19.5 x 12.25	Front Dem		2.44		27952	22.5 x 12.25 WHL	10H - 11.25"	5.18	4.56	29816
27239	22.5 x 12.25 WHL	10H - 13.188"		5.87		27953	22.5 x 12.25 WHL	10H - 11.25"	2.25	1.62	
27256	22.5 x 12.25 WHL	10H - 11.25"	6.25	5.75	29234	27954	22.5 x 12.25 WHL	10H - 11.25"	3.12	2.50	29816 ⁽⁶⁾
27257	22.5 x 12.25 WHL	10H - 11.25"	2.25	1.62		27955	22.5 x 12.25 WHL	10H - 11.25"	4.25	3.62	
27258	22.5 x 12.25 WHL	10H - 11.25"	6.39	5.89	29816	27956	22.5 x 12.25 WHL	10H - 11.25"	4.75	4.12	
27271	22.5 x 12.25 WHL	10H - 11.25"	4.62	4.12		27957	22.5 x 12.25 WHL	10H - 11.25"	5.75	5.12	29816
27292	22.5 x 12.25 WHL	10H - 11.25"	7.06	6.56	29816 ⁽⁶⁾	27958	22.5 x 13.00 WHL	10H - 11.25"	5.88	5.25	
27344	20 x 7.0 - LB ⁽³⁾	10H - 11.25"	6.12			27959	22.5 x 13.00 WHL	10H - 11.25"	3.69	3.06	29818 ⁽⁵⁾
27355	22.5 x 14.00 WHL	10H - 13.188"HD		6.62	28465 ⁽⁶⁾	27960	22.5 x 13.00 WHL	10H - 11.25"	5.25	4.62	
27461	22.5 x 8.25	10H - 11.25"	6.62		27833C ⁽¹⁰⁾	27964	22.5 x 13.00 WHL	10H - 11.25"	4.25	3.62	
27471	22.5 x 8.25 AL	10H - 11.25"	6.59		28615	27967	19.5 x 12.25 WHL	10H - 8.75"	3.12	2.50	
27503	22.5 x 8.25	10H - 11.25"	6.62		27404 ⁽¹⁰⁾	27968	19.5 x 12.25 WHL	10H - 8.75"	0.44		
27611	22.5 x 8.25	10H - 11.25"	6.62		27834C ⁽¹⁰⁾	27969	19.5 x 12.25 WHL	10H - 11.25"	3.12	2.50	
27685	22.5 x 7.50	10H - 11.25"	6.44		27403	27970	19.5 x 12.25 WHL	10H - 11.25"	0.44		
27686	22.5 x 8.25	10H - 11.25"	6.62		27833C ⁽¹⁰⁾	27980	19.5 x 13.00 WHL	10H - 11.25"	4.88	4.25	
27688	24.5 x 8.25	10H - 11.25"	6.62		27406	27981	19.5 x 13.00 WHL	10H - 11.25"	5.25	4.62	
27709	22.5 x 8.25	10H - 11.25"	6.62		27834C ⁽¹⁰⁾	27982	19.5 x 13.00 WHL	10H - 11.25"	4.72	4.09	
27721	22.5 x 14.00	Front Dem		4.75	13228 ⁽⁶⁾	27983	19.5 x 13.00 WHL	10H - 11.25"	4.38	3.75	
27727	20 x 6.5 - LB ⁽³⁾	10H - 8.75"	5.84			27984	19.5 x 13.00 WHL	10H - 11.25"	0.31		
27728	20 x 7.0 - LB ⁽³⁾	10H - 8.75"	6.02			27985	19.5 x 13.00 WHL	10H - 11.25"	3.06	2.43	
27742	22.5 x 12.25 WHL	10H - 13.188"		6.30		27994	16 x 6KS	8H - 6.50"	5.00		29587 ⁽¹¹⁾
27756	16 x 6KS	8H - 6.50"	5.00		29587 ⁽¹¹⁾	27995	16.5 x 6.00	8H - 6.50"	5.00		

⁽¹⁾ Outset/Inset—(Inches) See Pg. 25 footnote (3) or Pg. 56 for definition.

⁽²⁾ Check vehicle clearances prior to mounting tire.

⁽³⁾ Tubeless wheel/rim available. See catalog.

⁽⁴⁾ Well Welded—check clearance I.D. upon replacement.

⁽⁵⁾ Offset Difference.

⁽⁶⁾ 13.00" Rim.

⁽⁷⁾ Reinforced Flanges.

⁽⁸⁾ Replacement wheel has a different disc contour which allows less clearance for brakes. Check clearance before ordering.

⁽⁹⁾ Potential replacement has an alternate rim contour which requires different side and/or lock ring.

⁽¹⁰⁾ Check clearance.

⁽¹¹⁾ This wheel has a .453" valve hole. Wheels supplied on original vehicle have a .625" valve hole.

⁽¹²⁾ 7.50" Rim.

Hub-Piloted
Tubeless Wheels

Stud-Piloted
Tubeless Wheels

Demountable
Rims & Components

Duplex Disc® Wheels
Duplex® Demountable
Rims

Light Truck Wheels

General Information

OBSOLETE PART NUMBER INDEX

Hub-Piloted
Tubeless Wheels

Stud-Piloted
Tubeless Wheels

Demountable
Rims & Components

Duplex Disc® Wheels
Duplex® Demountable
Rims

Light Truck Wheels

General Information

Part Number	Size	Mounting Type	Outset ⁽¹⁾	Inset ⁽¹⁾	Potential Replace ⁽²⁾	Part Number	Size	Mounting Type	Outset ⁽¹⁾	Inset ⁽¹⁾	Potential Replace ⁽²⁾
27997	22.5 x 13.00	Rear Dem		2.75		28379	22.5 x 13.00 WHL	10H - 13.188"HD ⁽⁷⁾		7.12	28465 ⁽⁵⁾
27998	22.5 x 13.00	Rear Dem		2.00		28396	22.5 x 13.00 WHL	10H - 13.188"HD ⁽⁷⁾		6.81	28465 ⁽⁵⁾
27999	22.5 x 12.25	Rear Dem		1.88		28408	22.5 x 8.25	10H - 285.75mm	6.62		51408
28000	16.5 x 6.75	8H - 6.50" I °C	5.38			28409	24.5 x 8.25	10H - 285.75mm	6.62		50409
28001	22.5 x 12.25	Rear Dem		1.88		28414	22.5 x 6.75	8H - 275mm	5.93		
28004	19.5 x 6.00	10H - 8.75"	4.75			28415	22.5 x 7.50	8H - 275mm	6.44		29028
28118	22.5 x 12.25 WHL	10H - 11.25"	0.44			28433	19.5 x 14.00 WHL	10H - 11.25"	4.63	4.00	29307
28119	22.5 x 12.25 WHL	10H - 11.25"	2.25	1.62		28445	22.5 x 13.00 WHL	10H - 11.25"	5.88	5.25	28684
28120	22.5 x 12.25 WHL	10H - 11.25"	3.12	2.50	29816 ⁽⁵⁾	28452	24.5 x 8.25AL	10H - 285.75mm	6.59		41362
28122	22.5 x 14.00 WHL	10H - 11.25"	4.25	3.62		28460	20 x 6.5 - CR ⁽³⁾	8H - 275mm	6.00		
28124	22.5 x 12.25 WHL	10H - 11.25"	4.90	4.28		28466	19.5 x 6.75	8H - 275mm	5.50		50180
28125	22.5 x 12.25 WHL	10H - 11.25"	4.25	3.62		28473	24.5 x 8.25	10H - 11.25"	6.59		27599
28126	22.5 x 12.25 WHL	10H - 11.25"	5.75	5.12	29816 ⁽⁵⁾	28474	22.5 x 8.25	10H - 11.25"	6.59		28615
28127	22.5 x 13.00 WHL	10H - 11.25"	3.06			28476	22.5 x 8.25	10H - 11.25"	6.62		28476C
28128	22.5 x 13.00 WHL	10H - 11.25"	0.44		29818 ⁽⁵⁾	28484	22.5 x 8.25	8H - 275mm	6.62		
28132	22.5 x 12.25 WHL	10H - 11.25"	6.38	5.75	29816 ⁽⁵⁾	28487	22.5 x 8.25	10H - 285.75mm	6.62		51487
28157	22.5 x 6.75	6H - 8.75"	5.94			28492	22.5 x 7.50	10H - 335mm	6.50		
28158	22.5 x 6.75	10H - 11.25"	5.93			28511	16 x 6K	8H - 6.50"	5.00		29579
28160	22.5 x 6.75	10H - 8.75"	5.93			28512	16 x 6K	8H - 6.50"	5.35		29579
28165	22.5 x 12.25 WHL	10H - 11.25"	5.31	4.68	29816	28513	16 x 6K	10H - 7.25"	5.35		
28167	22.5 x 13.00 WHL	10H - 13.188"HD		7.12	28465	28520	19.5 x 6.00	6H - 8.75"	2.50		
28169	22.5 x 13.00 WHL	10H - 11.25"	3.44	2.51	29816 ⁽⁵⁾	28532	19.5 x 6.75	8H - 275mm	5.66		50180
28174	22.5 x 13.00 WHL	10H - 13.188"HD	6.12			28537	20 x 7.5 LW ⁽³⁾	10H - 11.25"	6.50		
28175	22.5 x 12.25 WHL	10H - 13.188"HD	6.25			28538	20 x 8.0 LW ⁽³⁾	10H - 11.25"	6.88		
28177	16 x 6K	8H - 6.50"	5.00		29587 ⁽¹¹⁾	28542	22.5 x 9.00	10H - 285.75mm	7.00		29300
28179	19.5 x 6.00RW	6H - 8.75"	4.75			28546	16 x 7K	8H - 6.50"		0.25	29508
28184	19.5 x 13.00 WHL	10H - 11.25"	4.72	4.09		28547	24.5 x 8.25	10H - 285.75mm	6.59		29699
28192	22.5 x 9.00	10H - 11.25"	3.12			28548	22.5 x 8.25	10H - 285.75mm	6.59		40620
28308	16 x 6K	8H - 6.50"	0.50			28550	22.5 x 12.25	Rear Dem	1.88		
28322	16 x 6K	8H - 6.50" I °C	5.00			28551	22.5 x 13.00	Rear Dem	2.75		
28324	17.5 x 8.25HC	10H - 8.75"	6.62		28112	28560	22.5 x 8.25AL	10H - 11.25"	6.59		28632
28326	22.5 x 13.00 WHL	10H - 11.25"	5.38	4.75	28684 ⁽⁵⁾	28572	22.5 x 13.00	10H - 13 3/16"		6.12	28465
28327	22.5 x 13.00 WHL	10H - 11.25"	4.24	3.62		28603	16 x 6K	8H - 6.50"	5.00		29587
28333	16 x 6K	8H - 6.50"	5.00			28609	22.5 x 6.75	6H - 8.75"	5.93		
28338	22.5 x 13.00 WHL	10H - 13.188"HD		6.12	28465	28612	19.5 x 6.75RW	8H - 275mm	5.60		50180
28348	16.5 x 6.00	8H - 6.50"	5.00			28613	22.5 x 8.25AL	10H - 285.75mm	6.59		40008
28353	16 x 6K	8H - 6.50" I °C	5.00			28618	16 x 6K	8H - 6.50"	5.15		29579
28356	16.5 x 6.00	8H - 6.50" I °C	5.00			28623	16 x 6K	8H - 6.50"	5.00		29587
28368	22.5 x 7.50	10H - 335mm	6.50			28624	22.5 x 7.50	10H - 285.75mm	2.62		
28374	16 x 6K	8H - 6.50"	5.00		29587 ⁽¹¹⁾	28626	22.5 x 8.25-15°	10H - 11.25"	6.59		28584
28375	16 x 6K	10H - 7.25	5.35			28628	22.5 x 8.25-15°	10H - 11.25"	6.59		28615
28377	20 x 7.5 - FL ⁽³⁾	10H - 11.25"	6.25			28630	22.5 x 13.00	Rear Dem	2.75		
28378	16 x 6K	8H - 6.50"	0.50								

⁽¹⁾ Outset/Inset—(Inches) See Pg. 25 footnote (3) or Pg. 56 for definition.

⁽²⁾ Check vehicle clearances prior to mounting tire.

⁽³⁾ Tubeless wheel/rim available. See catalog.

⁽⁴⁾ Well Welded—check clearance I.D. upon replacement.

⁽⁵⁾ Offset Difference.

⁽⁶⁾ 13.00" Rim.

⁽⁷⁾ Reinforced Flanges.

⁽⁸⁾ Replacement wheel has a different disc contour which allows less clearance for brakes. Check clearance before ordering.

⁽⁹⁾ Potential replacement has an alternate rim contour which requires different side and/or lock ring.

⁽¹⁰⁾ Check clearance.

⁽¹¹⁾ This wheel has a .453" valve hole. Wheels supplied on original vehicle have a .625" valve hole.

⁽¹²⁾ 7.50" Rim.

OBSOLETE PART NUMBER INDEX

Part Number	Size	Mounting Type	Outset ⁽¹⁾	Inset ⁽¹⁾	Potential Replace ⁽²⁾	Part Number	Size	Mounting Type	Outset ⁽¹⁾	Inset ⁽¹⁾	Potential Replace ⁽²⁾
28633	19.5 x 14.00 WHL	10H - 11.25"	4.63	4.00		29066	22.5 x 8.25-15°	10H - 11.25"	6.59		
28640	22.5 x 9.00-15°	10H - 285.75mm	7.00		29730	29068	22.5 x 8.25AL-15°	10H - 285.75mm	6.59		42644
28641	24.5 x 8.25	10H - 285.75mm	6.62		50641	29070	24.5 x 8.25-15°	10H - 285.75mm			
28642	22.5 x 7.50	10H - 285.75mm	6.44		29001	29094	22.5 x 8.25AL-15°	10H - 285.75mm			42644
28658	19.5 x 8.25RW	10H - 285.75mm	6.62			29105	22.5 x 8.25AL-15°	10H - 285.75mm	6.59		42644
28670	22.5 x 6.75	6H - 8.75"	5.93			29110	22.5 x 8.25-15°	10H - 11.25"	6.59		28615
28671	16 x 6.00	10H - 7.25"	5.35			29112	22.5 x 8.25-15°	10H - 11.25"	6.59		28615
28680	19.5 x 6.75RW	8H - 275mm	5.60		50180	29114	22.5 x 8.25-15°	10H - 285.75mm	6.59		29703
28682	16 x 6K	8H - 6.50"	5.15			29116	22.5 x 8.25-15°	10H - 285.75mm	6.59		29701
28687	24.5 x 8.25-15°	10H - 11.25"	6.59			29118	24.5 x 8.25-15°	10H - 11.25"	6.59		27599
28689	24.5 x 8.25-15°	10H - 11.25"	6.59			29120	24.5 x 8.25-15°	10H - 11.25"	6.59		27599
28803	22.5 x 12.25-15°	10H - 285.75mm	4.63	4.00	29806	29122	24.5 x 8.25-15°	10H - 285.75mm	6.59		29705
28810	22.5 x 7.50	10H - 11.25"	6.45		28841	29124	24.5 x 8.25-15°	10H - 285.75mm	6.59		29707
28820	24.5 x 8.25-15°	10H - 285.75mm	6.59			29126	22.5 x 8.25AL-15°	10H - 285.75mm	6.59		42644
28824	22.5 x 8.25-15°	10H - 11.25"	6.59			29133	22.5 x 7.50-15°	10H - 11.25"	6.59		
28831	22.5 x 8.25-15°	10H - 285.75mm	6.59			29137	24.5 x 8.25AL-15°	10H - 285.75mm	6.59		41362/10HH's
28832	22.5 x 8.25-15°	10H - 285.75mm	6.59			29138	16 x 6K	8H - 6.50"	5.00		29587
28837	24.5 x 8.25-15°	10H - 285.75mm	6.59			29147	22.5 x 12.25-15°	10H - 285.75mm	--	0.63	29805
28839	24.5 x 8.25-15°	10H - 285.75mm	6.59			29152	22.5 x 13.00-15°	10H-13.188"HD ⁽⁷⁾		7.12	28465
28841	22.5 x 7.50	10H - 11.25"	6.45			29153	22.5 x 13.00-15°	10H-13.188"HD ⁽⁷⁾		6.12	28465
28842	22.5 x 9.00	10H - 11.25"	7.00			29154	16 x 7K	8H - 6.50"	0.25		
28849	20 x 8.5 -5°	10H - 285.75mm	7.00			29157	22.5 x 12.25-15°	10H-13.188"HD ⁽⁷⁾		6.00	28465 ⁽⁶⁾
28852	22.5 x 8.25-15°	10H - 11.25"	6.59			29161	16 x 6K	8H - 6.50"	0.50		
28853	19.5 x 6.00	6H - 8.75"	5.00		29388	29164	22.5 x 7.50-15°	10H - 335mm	6.31		
28855	20 x 8.5 -5°	10H - 11.25"	7.00			29165	24.5 x 8.25AL-15°	10H - 285.75mm	6.59		41362
28860	16 x 6K	6H - 222.25mm	5.00			29168	24.5 x 8.25-15°	10H - 285.75mm	6.62		28827
28865	24.5 x 8.25-15°	10H - 11.25"	6.59			29170	24.5 x 8.25AL-15°	10H - 285.75mm	6.59		41362
28867	24.5 x 8.25AL-15°	10H - 285.75mm	6.59		42644	29171	24.5 x 8.25AL-15°	10H - 285.75mm	6.59		41362
28869	22.5 x 6.75	8H - 275mm	5.70			29172	22.5 x 8.25AL-15°	10H - 285.75mm	6.59		42644
28889	22.5 x 12.25-15°	10H - 11.25"	4.63	4.00	29816 ⁽⁵⁾	29173	22.5 x 8.25AL-15°	10H - 285.75mm	6.59		42644
28899	20 x 10.0 -VE 5°	10H - 11.25"	6.62	6.00		29175	22.5 x 13.00-15°	10H-13.188"HD ⁽⁷⁾		7.12	28465 ⁽⁵⁾
29020	20 x 8.0 -5°	10H - 335mm	6.77			29176	22.5 x 13.00-15°	10H-13.188"HD ⁽⁷⁾		6.81	28465 ⁽⁵⁾
29021	24 x 8.5 -5°	10H - 335mm	7.62			29177	22.5 x 13.00-15°	10H-13.188"HD ⁽⁷⁾		6.12	28465
29025	24 x 8.5 -5°	10H - 285.75mm	6.59			29178	24.5 x 8.25AL-15°	10H - 285.75mm	6.59		41362
29027	22.5 x 8.25-15°	10H - 285.75mm	6.59			29179	24.5 x 8.25AL-15°	10H - 285.75mm	6.59		41362
29028	22.5 x 7.50	8H - 275mm	6.20			29181	20 x 8.0 -5° ⁽³⁾	10H - 285.75mm	6.88		
29030	22.5 x 8.25-15°	10H - 11.25"	6.59			29182	22.5 x 13.00-15°	10H - 11.25"	3.43	2.81	
29035	22.5 x 8.25-15°	10H - 285.75mm	6.59			29183	22.5 x 12.25-15°	10H - 11.25"	4.62	4.00	
29037	24.5 x 8.25-15°	10H - 285.75mm	6.59			29184	24.5 x 8.25AL-15°	10H - 285.75mm	6.59		41362
29052	22.5 x 7.50-15°	8H - 285mm	162mm			29185	24.5 x 8.25AL-15°	10H - 285.75mm	6.59		41362
29054	22.5 x 12.25-15°	10H - 285.75mm	5.38	4.75	29807	29186	19.5 x 6.00RW	8H - 225mm	5.35		29584
29056	22.5 x 12.25-15°	10H - 285.75mm	6.38	5.75	29807	29189	24.5 x 8.25AL-15°	10H - 285.75mm	6.59		41362
29064	24.5 x 8.25-15°	10H - 11.25"	6.59			29207 ⁽⁸⁾	19.5 x 6.00	10H - 7.25"	5.08"		

⁽¹⁾ Outset/Inset—(Inches) See Pg. 25 footnote (3) or Pg. 56 for definition.

⁽²⁾ Check vehicle clearances prior to mounting tire.

⁽³⁾ Tubetless wheel/rim available. See catalog.

⁽⁴⁾ Well Welded—check clearance I.D. upon replacement.

⁽⁵⁾ Offset Difference.

⁽⁶⁾ 13.00" Rim.

⁽⁷⁾ Reinforced Flanges.

⁽⁸⁾ Replacement wheel has a different disc contour which allows less clearance for brakes. Check clearance before ordering.

⁽⁹⁾ Potential replacement has an alternate rim contour which requires different side and/or lock ring.

⁽¹⁰⁾ Check clearance.

⁽¹¹⁾ This wheel has a .453" valve hole. Wheels supplied on original vehicle have a .625" valve hole.

⁽¹²⁾ 7.50" Rim.

OBSOLETE PART NUMBER INDEX

Part Number	Size	Mounting Type	Outset ⁽¹⁾	Inset ⁽¹⁾	Potential Replace ⁽²⁾	Part Number	Size	Mounting Type	Outset ⁽¹⁾	Inset ⁽¹⁾	Potential Replace ⁽²⁾
29211	22.5 x 12.25-15°	10H - 11.25"		0.63	29818 ⁽⁶⁾	29372	22.5 x 8.25-15°	10H - 285.75mm	6.59		
29215	22.5 x 13.00-15°	10H - 11.25"	3.25	2.62	29818 ⁽⁶⁾	29390	22.5 x 8.25-15°	10H - 11.25"	6.59		
29216	22.5 x 13.00-15°	10H - 11.25"		0.63	29818 ⁽⁶⁾	29393	20 x 10.0-VE 5°	10H - 285.75mm	4.63		
29218	22.5 x 12.25-15°	10H - 11.25"	5.38	4.75	29816	29394	22.5 x 12.25-15°	10H - 11.25"	6.38	5.75	29816 ⁽⁶⁾
29220	22.5 x 12.25-15°	10H - 11.25"	4.63	4.00	29816	29396	22.5 x 8.25	10H - 285.75mm			51637
29221	22.5 x 12.25-15°	10H - 11.25"	2.88	2.25	29816 ⁽⁴⁾	29398	16 x 6K	8H - 6.50"	0.25		29579
29222	22.5 x 6.75-15°	10H - 11.25"	5.93			29399	16 x 6K	8H - 6.50"	5.15		29579
29223	16 x 6K	8H - 170mm	5.35		29583	29508	16 x 7K	8H - 6.50"	0.25		
29232	16 x 7K	8H - 170mm	0.25			29521	19.5 x 6.00RW	8H - 225mm	135.8 mm		29584
29236	19.5 x 6.75RW	8H - 225mm	5.50		29585	29540	22.5 x 8.25	10H - 285.75mm	6.59		42644
29237	19.5 x 7.50RW CAST	8H - 275mm	6.25		40160	29543	22.5 x 8.25	10H - 285.75mm	6.59		
29301	22.5 x 13.00-15°	10H - 11.25"	4.95	4.32	28684 ⁽⁵⁾	29544	24.5 x 8.25	10H - 285.75mm	6.59		
29304	19.5 x 7.50RW CAST	10H - 285.75mm	6.25		29685 Forged	29546	22.5 x 9.00-15°	10H - 285.75mm	3.12		29039 ⁽⁴⁾
29305	17 x 6K	8H - 6.50"	5.00			29549	22.5 x 8.25	10H - 285.75mm	6.59		
29307	19.5 x 14.00-15°	10H - 11.25"	4.63	4.00		29550	24.5 x 8.25	10H - 285.75mm	6.59		
29309	24.5 x 8.25 CAST	10H - 285.75mm	6.59		41362	29555	22.5 x 8.25AL-15°	10H - 285.75mm	6.59		42644
29311	20 x 10.0 -VE 5°	10H - 11.25"	1.56			29571PK	22.5 x 8.25-15°	10H - 11.25"	6.62		27833C/5HH's
29314	22.5 x 12.25-15°	10H - 11.25"	5.31	4.68		29575	16 x 6K	8H - 6.50"	0.50		
29315	16 x 6K	8H - 6.50"			29579	29576	16 x 7K	8H - 6.50"	0.25		
29316	16 x 6K	8H - 6.50"	5.35		29579	29577	16 x 6K	8H - 6.50"	5.00		29579
29317	16 x 6K	8H - 6.50"			29579	29578	16 x 6K	8H - 6.50"	5.35		29579
29318	16 x 6K	8H - 6.50"	5.15		29579	29580	16 x 6K	8H - 6.50"	5.15		29579
29319	16 x 7K	8H - 6.50"	0.25		29508	29581	16 x 6K	10H - 7.25"	5.35		
29329	22.5 x 7.50	8H - 275mm	6.45			29582	16 x 7K	8H - 170mm	6.35mm	0.25	
29330	24.5 x 8.25-15°	10H - 11.25"	6.62			29585	19.5 x 6.75RW	8H - 225mm	5.50		
29330C	24.5 x 8.25-15°	10H - 11.25"	6.62			29586	17 x 6K	8H - 170mm	5.00		
29331	22.5 x 6.75-15°	8H - 275mm	5.70		28869	29610	20 x 10.0 -VE 5°	10H - 335mm		6.00	
29333	22.5 x 7.50	10H - 285.75mm	6.45			29611	20 x 10.0 -VE 5°	10H - 335mm		5.00	29911
29334	16 x 6K	8H - 6.50"	5.00		29587	29624	17 x 7.5J	5H - 135mm	14.00mm		
29339	17 x 7.5K	5H - 135mm	0.55		29551	29625	17 x 7.5J	5H - 135mm	14.00mm		
29342	19.5 x 7.50RW-15°	10H - 285.75mm	6.25		29685	29626	17 x 7.5J	5H - 135mm	14.00mm		
29344	22.5 x 8.25-15°	8H - 285mm	164mm			29637	22.5 x 8.25	10H - 285.75mm	6.59		51637
29346	24.5 x 8.25-15°	10H - 285.75mm	6.59			29644	22.5 x 8.25	10H - 285.75mm			42644
29350	16 x 6K	8H - 6.50"	5.00		29587	29646	22.5 x 8.25	10H - 285.75mm	6.59		
29352	22.5 x 8.25-15°	10H - 285.75mm	6.59		42644	29648	24.5 x 8.25	10H - 285.75mm	6.59		
29356	17 x 6K	8H - 6.50"	5.00			29660	22.5 x 14.00	10H - 285.75mm	2.00		42142
29360	22.5 x 8.25-15°	10H - 285.75mm	6.59			29670	22.5 x 8.25	10H - 285.75mm	6.59		
29361	16 x 6.5J	8H - 6.50"	128mm		29588	29677	22.5 x 12.25 - 15	10H - 285.75mm	5.38	4.25	
29362	24.5 x 8.25	10H - 285.75mm	6.59		41362	29679	22.5 x 13.00 - 15	10H - 285.75mm	5.63	4.50	
29364	22.5 x 9.00-15°	10H - 335mm	6.93		50593	29681	22.5 x 9.00	10H - 285.75mm	7.00		
29368	17 x 6K	8H - 6.50"	5.35			29697	22.5 x 8.25	10H - 285.75mm	6.59		40620
29369	19.5 x 7.50RW-15°	8H - 275mm	6.25		40160	29701	22.5 x 8.25	10H - 285.75mm	6.59		
29371	19.5 x 6.00-15°	8H - 170mm	136mm			29703	22.5 x 8.25	10H - 285.75mm	6.59		

⁽¹⁾ Outset/Inset—(Inches) See Pg. 25 footnote (3) or Pg. 56 for definition.

⁽²⁾ Check vehicle clearances prior to mounting tire.

⁽³⁾ Tubetless wheel/rim available. See catalog.

⁽⁴⁾ Well Welded—check clearance I.D. upon replacement.

⁽⁵⁾ Offset Difference.

⁽⁶⁾ 13.00" Rim.

⁽⁷⁾ Reinforced Flanges.

⁽⁸⁾ Replacement wheel has a different disc contour which allows less clearance for brakes. Check clearance before ordering.

⁽⁹⁾ Potential replacement has an alternate rim contour which requires different side and/or lock ring.

⁽¹⁰⁾ Check clearance.

⁽¹¹⁾ This wheel has a .453" valve hole. Wheels supplied on original vehicle have a .625" valve hole.

⁽¹²⁾ 7.50" Rim.

OBSOLETE PART NUMBER INDEX

Part Number	Size	Mounting Type	Outset ⁽¹⁾	Inset ⁽¹⁾	Potential Replace ⁽²⁾	Part Number	Size	Mounting Type	Outset ⁽¹⁾	Inset ⁽¹⁾	Potential Replace ⁽²⁾
29717	19.5 x 6.00RW	8H - 275mm	5.00			31292	22.5 x 12.25-15°	Front Dem		2.00	
29720	22.5 x 8.25	10H - 285.75mm	6.59			31293	22.5 x 12.25-15°	Front Dem		2.62	
29730	22.5 x 9.00	10H - 285.75mm	7.00		41730	31294	22.5 x 12.25-15°	Front Dem		3.00	31674
29736	19.5 x 6.75RW	8H - 225mm	5.50		29585	31295	22.5 x 12.25-15°	Front Dem		3.44	31674 ⁽⁴⁾
29740	21 x 18	10H - 335mm		2.75		31296	22.5 x 12.25-15°	Front Dem		3.75	31677 ⁽⁴⁾
29745	19.5 x 6.00RW	8H - 225mm	5.35		29584	31297	22.5 x 12.25-15°	Front Dem		4.00	31677
29746	16 x 6K	8H - 170mm	5.35			31298	22.5 x 12.25-15°	Front Dem		4.44	31677 ⁽⁴⁾
29784	19.6 x 6.00-15°	10H - 7.25"	4.60		27775	31299	22.5 x 12.25-15°	Front Dem		4.75	31679
29787	16 x 4T	5H - 4.50"	0.94			31300	22.5 x 12.25-15°	Front Dem		5.44	
29801	16 x 7J	5H - 5.50"	12mm			313-5-1	24x 8.5-5°				31450 ⁽¹³⁾
29808	22.5 x 12.25	10H - 285.75mm		5.75	29807	31614	22.5 x 12.25-15°	Front Dem		4.75	
29809TK	22.5 x 13.00 - 15°	10H - 285.75mm		0.63	29146	31656	22.5 x 13.00-15°	Front Dem		3.94	13228
29810TK	22.5 x 13.00 - 15°	10H - 285.75mm		2.62	29174	31658	22.5 x 12.25	Rear Dem	0.38		
29811TK	22.5 x 13.00 - 15°	10H - 285.75mm		4.32	29303	31659	22.5 x 13.00	Rear Dem	0.00		
29812TK	22.5 x 13.00 - 15°	10H - 285.75mm		5.25	29057	31671	22.5 x 12.25-15°	Front Dem		1.10	31674 ⁽⁵⁾⁽⁴⁾
29813	22.5 x 13.00 - 15°	10H - 285.75mm		5.25	29057	31673	22.5 x 12.25-15°	Front Dem		2.62	
29814TK	22.5 x 12.25	10H - 11.25"	0.63			31675	22.5 x 12.25-15°	Front Dem		3.44	31674 ⁽⁴⁾
29815TK	22.5 x 12.25	10H - 11.25"		4.00	29816	31676	22.5 x 12.25-15°	Front Dem		3.75	31677 ⁽⁴⁾
29817TK	22.5 x 12.25	10H - 11.25"		5.75	29816	31678	22.5 x 12.25-15°	Front Dem		4.44	31677
29819TK	22.5 x 13.00	10H - 11.25"		2.62	29816 ⁽⁵⁾	31680	22.5 x 12.25-15°	Front Dem		5.44	31679 ⁽⁴⁾
29820TK	22.5 x 12.25	10H - 11.25"		4.32	28684 ⁽⁵⁾	31681	22.5 x 13.00-15°	Front Dem		3.50	13228 ⁽⁴⁾
29829TK	20 x 8.0 - 5° ⁽³⁾	10H - 11.25"	6.88			31682	22.5 x 13.00-15°	Front Dem		4.75	13228
29831TK	20 x 7.5 - 5° ⁽³⁾	10H - 285.75mm	6.65			31686225	22.5 x 9.00-15°	Dem	5.00		32052225
29832TK	20 x 7.5 - 5° ⁽³⁾	10H - 11.25"	6.50			31689	22.5 x 13.00-15°	Front Dem		4.50	13228
29837	17 x 6.5J	8H - 200mm	5.56			31703	22.5 x 12.25-15°	Front Dem		4.00	31677
29839	19.5 x 6.00RW	10H - 225mm	5.35		29884	31716175	17.5 x 6.75HC	Dem	4.00		31868175
29841	17 x 7.5J	8H - 170mm	40mm			31814175	17.5 x 8.25HC	Dem	4.75		
29842TK	20 x 8.0 - 5° ⁽³⁾	10H - 285.75mm	6.88			31871225	22.5 x 6.75-15°	Dem	3.90		30371225 ⁽²⁾⁽⁴⁾⁽²⁾
29846TK	22.5 x 9	10H - 335mm	6.93		50593	31986	22.5 x 12.25-15°	Front Dem		4.44	31677
29855	18 x 8J	8H - 170mm	40mm			32201TK	22.5 x 13.00-15°	Front Dem	3.94		13228
29856	17 x 7.5J	8H - 170mm	40mm			32202TK	22.5 x 13.00-15°	Front Dem	5.62		13244
29875	19.5 x 6.75RW	10H - 225mm	5.50			40000	22.5 x 8.25	10H - 285.75mm	6.59		
29879	19.5 x 6.75RW	10H - 225mm	5.50			40002	22.5 x 8.25	10H - 285.75mm	6.59		
29889	16 x 6K				29583	40010	24.5 x 8.25	10H - 335mm	6.79		
29890TK	22.5 x 14.00	10H - 287.75mm	2.00	1.375	29627	40012	22.5 x 9.00	10H - 285.75mm	3.12		41012
29891TK	22.5 x 14.00	10H - 287.75mm	0.00	0.625	50172	40016	22.5 x 14.00	10H - 285.75mm	0.5		
29943	16 x 6K	8H - 6.5"	5.15		29579	40020	22.5 x 8.25	10H - 285.75mm	6.59		42644
30872	19.5 x 13.00-15°	10H - 11.25"	0.31			40036	22.5 x 13.00	10H - 285.75mm		2.38	
30645225	22.5 x 7.50-15°	Dem	4.50		30371225 ⁽⁴⁾	40048	20 x 10.00	10H - 335mm			
30375225	22.5 x 7.50-15°	Dem	4.40		30391225 ⁽⁴⁾	40082	20 x 10.00	10H - 335mm			
30375245	24.5 x 8.25-15°	Dem	4.40		30391245 ⁽⁴⁾	40124	22.5 x 8.25	10H - 285.75	6.59		42644
31061	22.5 x 14.00-15°	Rear Dem				40168	16 x 7.00	8H - 6.50"	0.25		
31291	22.5 x 12.25-15°	Front Dem		1.11	31674	40169	17.5 x 6.75	8H - 6.50"	0.83		

⁽¹⁾ Outset/Inset (Inches) See Pg. 25 footnote (3) or Pg. 56 for definition.

⁽²⁾ Check vehicle clearances prior to mounting tire.

⁽³⁾ Tubeless wheel/rim available. See catalog.

⁽⁴⁾ Well Welded—check clearance I.D. upon replacement.

⁽⁵⁾ Offset Difference.

⁽⁶⁾ 13.00" Rim.

⁽⁷⁾ Reinforced Flanges.

⁽⁸⁾ Replacement wheel has a different disc contour which allows less clearance for brakes. Check clearance before ordering.

⁽⁹⁾ Potential replacement has an alternate rim contour which requires different side and/or lock ring.

⁽¹⁰⁾ Check clearance.

⁽¹¹⁾ This wheel has a .453" valve hole. Wheels supplied on original vehicle have a .625" valve hole.

⁽¹²⁾ 7.50" Rim.

⁽¹³⁾ A new 31450 assembly needs to be purchased to replace any of the obsolete components or assembly.

Hub-Piloted
Tubeless Wheels

Stud-Piloted
Tubeless Wheels

Demountable
Rims & Components

Duplex Disc® Wheels
Duplex® Demountable
Rims

Light Truck Wheels

General Information

OBSOLETE PART NUMBER INDEX

Part Number	Size	Mounting Type	Outset ⁽¹⁾	Inset ⁽¹⁾	Potential Replace ⁽²⁾
40170	17.5 x 6.75	10H - 8.75"	5.55		
40470	22.5 x 8.25	10H - 225mm		2.40	
40550	24.5 x 8.25	10H - 285.75mm	6.59		
41016	22.5 x 14.00	10H - 285.75mm	0.50		42140
41140	22.5 x 14.00	10H - 285.75mm	0.50		42140
41142	22.5 x 14.00	10H - 285.75mm	2.00		42142
41644	22.5 x 8.5	10H - 285.75mm	6.59		42644
41660	22.5 x 14.00	10H - 285.75mm	2.00		42142
50165	22.5 x 12.25	10H - 285.75mm		5.25	29807
50194	20 x 10.00				
50271	17 x 6.5J	8H - 6.50"	5.00		
50274	16 x 7J	5H - 5.50"	12mm		
50275	17 x 6.5J	8H - 200mm	5.56		
50276	18 x 8J	8H - 170mm		40mm	
50277	17 x 7.5J	8H - 170mm		40mm	
50307	22.5 x 8.25	10H - 285.75mm	6.60		51487
50308	22.5 x 8.25	10H - 285.75mm	6.60		51408
50352	24 x 8.5	10H - 335mm	6.89		
50379	24.5 x 8.25	10H - 285.75mm	6.59		50409
50381	24.5 x 8.25	10H - 285.75mm	6.59		50641
50408	22.5 x 8.25	10H - 285.75mm	6.60		51408
50475	22.5 x 8.25	10H - 285.75mm		2.19	
50487	22.5 x 8.25	10H - 285.75mm	6.60		51487

Hub-Piloted
Tubeless Wheels

Stud-Piloted
Tubeless Wheels

Demountable
Rims & Components

Duplex Disc® Wheels
Duplex® Demountable
Rims

Light Truck Wheels

General Information

RIM/WHEEL GLOSSARY

APPROVED RIM WIDTH - Rim width sizes approved by The Tire & Rim Association for use with the tire.

BALANCED WHEEL - A wheel that is within 30 inch-ounces of balance.

BEAD SEAT - Surface of a rim that contacts the tire bead. The bead seat angle is usually 5° for tube-type tires and 15° for tubeless tires.

BOLT CIRCLE - The diameter of the circle which traces through the centerline of the bolt holes. It defines the bolt hole spacing around the disc in a wheel.

BOLT HOLES - The holes in the disc of a wheel through which the bolts or the studs pass. For stud-piloted wheels, the bolt holes are chamfered and used to center the wheels.

BORE - The center hole (pilot) of the wheel. With hub mount wheels, it is used to center the wheel.

BUTT WELD - Transverse weld in a rim.

CAPACITY - Demountable rim or disc wheel maximum carrying load. Expressed in load (lbs) and inflation pressure (psi) cold.

DESIGN RIM WIDTH - Nominal rim width. Rim width on which a tire performs best. Approximately 75 percent as wide as the tire width designation.

DEMOUNTABLE RIM - A rim with valve locaters which is used with a cast spoke wheel to provide the method of attaching tires to the vehicle.

DISC WHEEL - A permanent assembly of a disc and a rim.

DOUBLE CAP NUT - The inner and outer nuts used to secure stud-piloted wheels to a vehicle. The inner dual wheel is attached by an inner cap nut with a spherical radius and the outer dual wheel is attached by an outer cap nut with a spherical radius.

DUAL SPACING - Lateral distance from wheel centerline to wheel centerline in a dual wheel arrangement. It is determined by adding two offsets (disc wheels) or two offsets plus one spacer band width (demountable rims).

HALF DUAL SPACING - See "Wheel Offset."

HAND HOLE - Opening in the disc area of a wheel for the purpose of valve stem access to inside dual tire and chain application.

HUB-PILOTED WHEEL - Wheels that are designed to center on the hub at the bore of the wheel. These wheels generally have straight through bolt holes, since the bolt holes only supply clearance for the stud. Hub-piloted wheels are used with two piece flange nuts.

INSET - The lateral distance from the rim centerline to the mounting surface of the disc. Inset places the rim center line inboard of the mounting surface.

LOCK RING - Third piece of a 3-piece rim assembly which locks the side ring to the rim base.

LONG SIDE - The side of the rim which has a ledge.

MINIMUM DUAL SPACING - The minimum allowable distance between the wheel centerlines in a dual arrangement.

MULTI-PIECE RIM - A rim consisting of more than one part. Usually two pieces (rim base and side ring), or three pieces (rim base, side ring, and lock ring).

OFFSET - See "Rim Offset" or "Wheel Offset."

OUTSET - The lateral distance from the rim centerline to the mounting surface of the disc. Outset places the rim centerline outboard of the hub surface.

RIM (also see demountable rim) - The item that supports the tire. It may consist of one piece (tubeless drop center type) or two or three piece (tube-type).

RIM BASE - The major piece of a multi-piece rim assembly. It supports the tire bead on one side, provides a locking mechanism for the side ring or lock ring, and provides a bevel surface for attaching to a spoke wheel.

RIM OFFSET - The lateral distance from the rim surface that contacts the spacer band to the rim centerline (Demountable Rim see page 46).

SHORT SIDE - The side of the rim which does not have a ledge.

SIDE RING - A removable piece of a multi-piece rim assembly which provides lateral support for one tire bead.

SPACER BAND - Band of steel which separates two demountable rims on spoke wheels (also called "spacers").

SPOKE WHEEL - A casting with 3, 5, or 6 spokes that attaches to the axle and provides a means of attaching a demountable rim to a vehicle. Also called "Cast Spoke Wheel."

STUD-PILOTED WHEELS - Wheels that are designed to center on the studs of a hub. These wheels have chamfers at the bolt holes into which a ball seat or conical nut is installed to center the wheel. The center bore of the wheel is only for clearance of the axle end.

SUPER SINGLE - Duplex® or wide base.

TWO-PIECE FLANGE NUT - A nut attached to a washer that is used to secure hub-piloted wheels to a vehicle.

VALVE HOLE - The hole in the rim into which a valve is installed to inflate or deflate the tire/rim assembly.

VALVE LOCATERS - The guides located on either side of the demountable rim valve slot or valve hole to properly locate the tire valve between spokes. Sometimes called "drivers," "rim drivers," "locating lugs," etc.; they are either indented or welded on.

VALVE SLOT - Opening in a tube-type rim to receive the tire tube valve stem.

VENT HOLE - Opening in the disc area of a wheel for the purpose of air ventilation.

WHEEL - See "Spoke Wheel" or "Disc Wheel."

WHEEL OFFSET - The lateral distance from the disc mating surface (surface between the wheels as a dual assembly) to the rim centerline (disc wheel - see page 48).

Accuride Corporate Headquarters

7140 Office Circle
Evansville, IN 47715
(812) 962-5000, (800) 626-7096
FAX: (812) 962-5400

Customer Service Department

Place an order, check existing orders,
inquire about price, availability,
and delivery.
(800) 626-7096
FAX: (812) 962-5436
customerservice@accuridecorp.com

Sales

(800) 626-7096
FAX: (812) 962-5430
sales@accuridecorp.com

International Sales

(812) 962-5000
FAX: (812) 962-5400
internationalsales@accuridecorp.com

Field Engineering

For technical and warranty information
(800) 869-2275
FAX: (270) 827-7697
Warranty Claims FAX: (815) 964-0775
fieldengineering@accuridecorp.com

Accuride Michigan Sales Office

39209 Six Mile Road
Suite #100
Livonia, MI 48152
(866) 515-4977, (734) 666-5678
FAX: (734) 666-5637

AOT (Assemblies On Time)

4800 Gateway Boulevard
Springfield, OH 45502
(937) 323-9669
FAX: (937) 322-1000

Accuride Erie

1015 East 12th Street
Erie, PA 16503
(814) 480-6400
FAX: (814) 452-0809

Accuride Henderson

2315 Adams Lane
Henderson, KY 42420
(270) 826-5000, (800) 626-7096
FAX: (270) 827-7656

Accuride de Mexico

Ave. Norte America No 301
Parque Industrial Las Americas
Autopista Monterrey-Laredo Km 31.5
Cienega de Flores, N.L. 65550
(011) 5281-8158-8800
FAX: (011) 5281-8158-8805

Accuride Assemblies de Mexico

Avenida Internacional #130
Parque Industrial Vynmsa Escobedo
Escobedo, NL 66062
(52)-(81)-8158-8800 ext 8609

Accuride Canada Inc. and Distribution Center

31 Firestone Boulevard
London, Ontario N5W 6E6 Canada
(519) 453-0880, (800) 399-0880
FAX: (519) 453-7084

Accuride Distribution Center

950 North Raddant Road
Batavia, IL 60510
(630) 454-4535
FAX: (630) 454-4498

Accuride Distribution Center

8901 Forney Road
Dallas, TX 75227

Accuride Distribution Center

820 Frontenac Road
Naperville, IL 60563

Accuride Distribution Center

3800 Fruit Valley Road
Vancouver, WA 98660

Accuride Distribution Center

30 Hengst Drive
Camden, SC 29020



Your only single source for industry-leading wheel end solutions.

STEEL & ALUMINUM WHEELS | DRUMS | HUBS | ROTORS | SLACK ADJUSTERS

(800) 823-8332 | (812) 962-5000 | accuridecorp.com

7140 Office Circle | Evansville, IN 47715 USA