

# YOUR WINDOW PRODUCT GUIDE



EVERYTHING YOU NEED TO KNOW ABOUT BUYING WINDOWS

Also featuring  
**PATIO, GARDEN &  
ENTRY DOORS.**



CONTENTS



**ABOUT**

- 2-3 **WHY CHOOSE ALL WEATHER WINDOWS:** Our passion for windows and doors  
 4 **ENERGY EFFICIENCY:** Being green saves you money  
 5 **V-WELD:** An introduction to V-weld innovation

**PRODUCTS****6-13 HOW TO CHOOSE YOUR WINDOWS**

- 7 **Choose your frame material:** PVC / Metal Clad PVC  
 8-9 **Choose your window:** Operating style, Customization, Acrylic Blocks  
 10-11 **Choose your glass:** Glass options and ratings  
 12-13 **Choose your options:** Colour, Brickmould, Grilles, Hardware, Textured Glass.

**WINDOWS****14-31 PVC Windows**

- 16-23 **Apex 9000/9500/9600/9800 SERIES**  
 24-25 **EnergySaver 2000/2500 SERIES**  
 26-27 **Titan 6500 SERIES**  
 28-29 **Magnum 7000 SERIES**  
 30-31 **Carriage 6800 SERIES**

**32-35 Metal Clad PVC Windows**

- 33-35 **Apex Alloy 9900/9950 SERIES**

**DOORS****36-39 HOW TO CHOOSE YOUR DOORS**

- 37 **How to choose your doors:** Patio, Garden, Entry Doors  
 38 **Choose your options:** Brickmould, SDLs, Grilles, Hardware  
 39 **Entry Door Features**

**40-43 Patio & Garden Doors**

- 41 **Viscount Sliding Doors**  
 42-43 **Strong Arm II**

**44-49 Entry Doors**

- 44-45 **Steel & Fiberglass**  
 46-47 **Style Index**  
 48-49 **Decorative Glass Lites**

**50 GLOSSARY****LOCATIONS**

- 51 **FIND US:** Branch locations and contact information  
 51 **ENERGY STAR® CLIMATE ZONES**

**52-53 SHOPPING LIST**

# WHY CHOOSE ALL WEATHER WINDOWS?



## 9 EMPLOYEES IN AN EMPTY WAREHOUSE

It all started in a 10,000 sq ft manufacturing facility in 1978. Three guys with a handful of employees rolled up their sleeves and started building quality windows.

Today, All Weather Windows has grown to become Canada's largest privately owned window and door manufacturer. With two leading-edge manufacturing plants, numerous branches and over 1000 dealers across Canada, it shows what a few people with a lot of ambition, a lot of great product, and a tonne of elbow grease can accomplish.

## WE'RE NOT FOND OF CANADIAN WEATHER EITHER

Canadian weather is no walk in the park – unless that park is filled with knee-deep high snow.

Harsh weather is what separates the good windows from the bad. And as a proudly Canadian company, we truly understand the bad. Heavy rain on the West Coast. Heat and humidity in the East. Unforgiving blizzards on the Prairies. And the bitter cold of the North. These distinct Canadian climate zones are exactly what our products have been rigorously tested for by the Canadian Standards Association (CSA) – Canada's leading authority for compliance testing to international standards. After all, just because you have to live with Canadian weather, doesn't mean it has to live with you.

## AVERAGE ANNUAL SNOWFALL

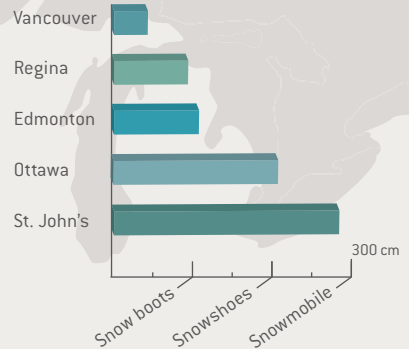

Building homes with Habitat for Humanity



Mississauga manufacturing plant



All Weather Windows RONA MS Bike Tour Team



Meeting ENERGY STAR®'s highest standards



Leading edge airtight, watertight V-weld technology

## CARING FOR OUR COMMUNITIES

All Weather Windows is dedicated to supporting a wide variety of charitable organizations in the communities where we do business.

Our company has been very fortunate to have enjoyed years of success, and there's no better way to share that success than by giving back to organizations that enrich the lives of Canadians. Organizations include The Salvation Army, Heart & Stroke Foundation, Habitat for Humanity, Terry Fox Foundation and Special Olympics, as well as causes like the fight against cancer, ALS, cystic fibrosis, autism, and multiple sclerosis.

## MOTHER NATURE ISN'T AN IN-LAW

Canadian weather may be harsh at times, but we still believe the environment is something that should be respected.

We promote sustainable initiatives by partnering with key environmental organizations and building councils like the Canada Green Building Council, Canadian Home Builders' Associations, Canadian Standards Association, and Built Green Canada. We also follow the strictest ENERGY STAR® standards for quality framing, weatherstripping, and glass coating – leaving larger energy savings and a smaller environmental footprint. It's all part of why we're consistently an ENERGY STAR® award winner.

## WINDOW TECHNOLOGY ISN'T BORING...TO US

Our enthusiasm for window technology may be hard to understand for those who don't live, breathe and eat windows – and we're willing to bet you don't eat windows.

We're driven to continually develop innovative solutions that help lower environmental impact, improve energy efficiency, and increase home comfort. We invest heavily in research and development to create new leading-edge products that outperform conventional windows – like our advanced water management techniques and machine welded V-weld technology. Solutions like these are what keep us excited about our work, so you get the latest innovations in windows.

# HOW CAN ENERGY EFFICIENCY SAVE YOU MONEY?



## COMMITTED TO GREEN

Research from Natural Resources Canada indicates that because of the Canadian climate, we spend far more money each year on heating than we do on cooling our homes — adding up to a lot of wasted cash.

Luckily, installing ENERGY STAR® qualified windows can put a stop to this by cutting your energy consumption by up to 16%. It can also save <sup>3</sup>/<sub>4</sub> of a tonne of greenhouse gas emissions annually. That's equivalent to the carbon offset of planting 80 trees. And it's our windows are built to the highest energy efficient standards, consistently earning ENERGY STAR® awards year after year.



## CALCULATE YOUR SAVINGS

To find out how much you can save on your energy bills with our windows, use the Energy Saver Calculator at [allweatherwindows.com](http://allweatherwindows.com).

Experiment with different windows and various energy efficient glass options, and see how it will affect your energy savings. The calculator will also show your approximate reduction in greenhouse gas emissions and what that equates to in terms of litres of gas, acres of forest, and tonnes of recycled waste.

## GREEN REBATES

Homeowners who replace their windows and doors with new ENERGY STAR® rated products may be eligible for rebates. To find out what rebates are currently being offered, visit us at [allweatherwindows.com](http://allweatherwindows.com)

# AN INTRODUCTION TO V-WELD INNOVATION

All Weather Windows is proud to be one of the first manufacturers in North America to launch the groundbreaking technology of V-weld as part of our Apex window series. No other window offers such exceptional performance in keeping the outside elements from seeping into a home – virtually eliminating air and water leaks.

## V-WELD IS MORE THAN JUST A FANCY SOUNDING NAME

Conventional windows use mechanical mullions joined with gaskets and silicone, which contract and expand with temperature differences. This can lead to separation between joints, causing air and water leaks. To eliminate this, V-weld Apex windows are fusion-welded together leaving no gaps, cracks, spaces, slits or any other synonyms that water can seep through. This manufacturing process provides superior frame integrity and ensures better performance than conventional combination windows in water and air tests.

### V-WELD PRODUCTS

#### APEX (PVC WINDOW)

- 9000 SERIES
- 9500 SERIES
- 9600 SERIES
- 9800 SERIES

#### APEX ALLOY (METAL CLAD PVC WINDOW)

- 9900 SERIES
- 9950 SERIES

### V-WELD WINDOW TECHNOLOGY



Fusion-welded combination window



### TRADITIONAL WINDOW TECHNOLOGY

Combination window joined together with screws

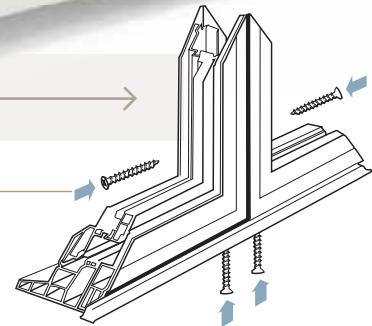



WINDOWS





# CHOOSE YOUR FRAME MATERIAL

New windows increase comfort and add a touch of beauty and elegance to your home, while helping you save on energy bills. They

can also add tremendous curb appeal to your home, increasing the resale value.



## PVC

Our Polyvinyl Chloride (PVC) windows are energy efficient, durable, and resistant to moisture and corrosion.

Frames also reduce heat loss, while insulating sound, ensuring an energy efficient, quietly comfortable home. Plus they're virtually maintenance free, with no need to paint, stain or refinish.

## METAL CLAD PVC

Create a statement by upgrading from PVC to our award winning Metal Clad PVC windows.

With bold styling and a variety of exterior colour choices, these windows combine the strength and elegance of aluminum cladding with all the benefits of a fusion-welded PVC frame. The result is superior durability and energy efficiency. And just like our PVC windows, they're virtually maintenance free.

**PRICE RANGE: \$ — \$\$\$\***

**PRICE RANGE: \$\$ — \$\$\$\$\***

\*Price range may vary, depending on options.

# CHOOSE YOUR OPERATING STYLE

When choosing windows, consider the energy efficiency of each window operating style, as well as the weather conditions in your city. The more severe the weather, the better performance you'll need for your windows.

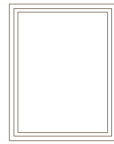

## FIXED

A fixed window is basically a casement or awning window that doesn't open, but offers energy efficiency.



## PICTURE

Picture windows do not open. They offer a low-profile frame to maximize glass surface, allowing a beautifully clear, unobstructed view.



## CASEMENT

Hinged on the side, casement windows swing outward like a door, providing excellent air circulation into your home. They are also one of the most energy efficient operating windows because of their tight seal when closed.



## AWNING

An awning window is a casement window that is hung horizontally. Hinged on top, it swings outward, shielding from the rain while providing good ventilation and constant airflow. Like the casement window, it is also one of the most energy efficient operating windows.



## BAY & BOW

Bay and bow windows allow you to expand an area in your home. Made up of a combination of windows attached at an angle, these windows extend beyond the wall, opening up any room.

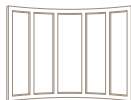

## SINGLE HUNG

With a bottom sash that slides up, the single hung window allows controlled airflow into your home.



## DOUBLE HUNG

This window opens from the top and bottom – with an upper sash that slides down and a lower sash that slides up for total airflow control.

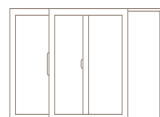

## GLIDER

The Glider window has one or more sashes that slides open horizontally.

Sash: The framework that holds the panes of a window in the window frame. Most commonly refers to the moving part of a window that opens but is also available in a non-opening fixed and picture sash window style.

# CUSTOMIZE



If you're considering something more distinctive, we can help you create a unique combination of windows to suit your home.

Note: More custom options available. Talk with a sales representative to achieve the look that suits your home.

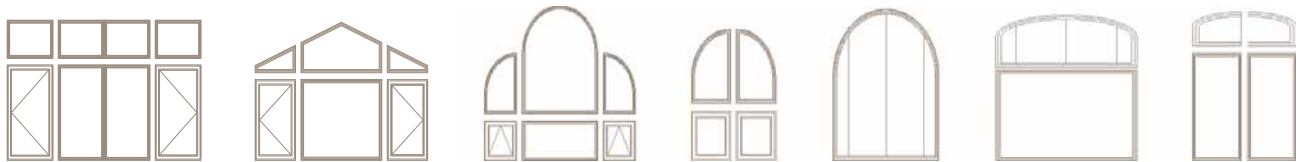

## ACRYLIC BLOCK

To ensure privacy, while still letting in natural light, consider acrylic block windows.

Ideal for bathrooms and front entrances, acrylic block windows can be constructed in various sizes using 6-inch or 8-inch blocks to form squares or rectangles.

### Block Combinations

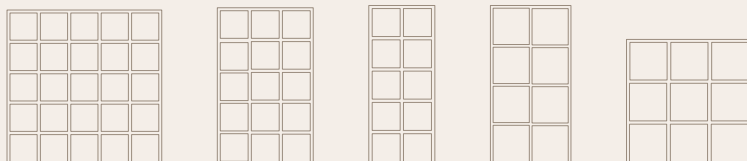

# CHOOSE YOUR GLASS



Good design and correct installation are important factors in ensuring energy efficient windows, but glass performance plays the biggest role.

Different glass options have different benefits, so before choosing your glass, be sure to consider the weather conditions of where you live. Colder climates will require more insulation power and specific glass coatings to improve energy efficiency.



## GLASS OPTION RATINGS

GLASS NAME	HEAT SYSTEM	DESCRIPTION	U-VALUE*	R-VALUE*	SHGC*	VISIBLE LIGHT	UV BLOCK
CLEAR	DUAL	Dual pane, clear glass, no coatings	2.725	2.083	0.760	81%	42%
	TRI	Triple pane, clear glass, no coatings	1.760	3.226	0.685	74%	52%
LOW-E	HS1A-C180	Dual pane, one Low-E coating, Argon	1.476	3.846	0.685	79%	71%
	HS2A-C180	Triple pane, one Low-E coating, Argon	1.045	5.434	0.615	73%	76%
	HS3A-C180	Triple pane, two Low-E coatings, Argon	0.755	7.518	0.560	70%	87%
SUNSTOP	HS4A-C270	Dual pane, one SunStop coating, Argon	1.408	4.032	0.367	70%	86%
	HS5A-C270	Triple pane, one SunStop coating, Argon	1.056	5.376	0.338	63%	88%
	HS6A-C270	Triple pane, two SunStop coatings, Argon	0.704	8.064	0.310	54%	96%

\*Metric values are from centre of glass.

\*Rating may vary by product line. See your sales representative for more details. All performance is C.O.G. (centre of glass) ratings based on Vision v4.0 simulations. All C.O.G R-values are based on ASHREA Winter Conditions.

R-Value: A measurement of the resistance of heat transfer through glass. The higher the R-Value, the better the window insulates against heat.

Solar Heat Gain: The amount of the sun's heat that transfers through glass from the exterior to the interior side. The higher the solar heat gain, the more a window allows heat to pass through into a home.

U-Value: A measure of the rate of nonsolar heat flow through a material or assembly. The lower the U-Value, the greater a window's resistance to heat flow and the better its insulating value.

**PRODUCT HIGHLIGHT:** Low-E only adds about 10% to the cost of an average window package and can offer between 35%-105% better insulating value.

## ENERGY EFFICIENT GLASS OPTIONS:

### DUAL PANE

These windows have two panes of glass with no special coating applied. The dual panes of glass are spaced a 1/2 inch apart, and the air between the panes acts as an insulation barrier, making your windows more energy efficient.

### TRIPLE PANE

A step up from dual pane is triple pane glass. Also spaced a 1/2 inch apart, these three panes provide more insulation than dual pane when it comes to energy efficiency. This helps lower heating costs, virtually eliminates condensation and also acts as an excellent sound barrier, giving your home added privacy.

### ARGON GAS

Argon gas is an inert gas—non-toxic, clear and odourless. Used to fill the space between panes of glass, argon gas minimizes convective currents that occur between glass panes. This reduces the tendency for glass to collect frost on cold winter days and improves the insulation quality of your windows.

### LOW-E

Applied to the glass surface, Low-E (low emissivity) is a clear coating that reduces heat loss by reflecting furnace heat back into a room. It also allows a large percentage of outside solar energy to pass through the glass into your home. This coating is most beneficial in the winter, since the heat provided by the sun can reduce the demands on your furnace. When combined with dual or triple pane glass, Low-E can offer between 35%-105% better insulating values than non Low-E glass. No other coating has a greater impact on reducing heating bills and improving the overall comfort of a home.

### SUNSTOP

SunStop uses two layers of Low-E coating over top one another to block out the sun's heat, light and UV rays. Perfect for south and west facing windows, this coating keeps your home cool and comfortable in the summer to help reduce air conditioning costs. SunStop also improves the insulation properties of glass to help keep your home warmer in the winter when compared to clear glass.

### LOW-E

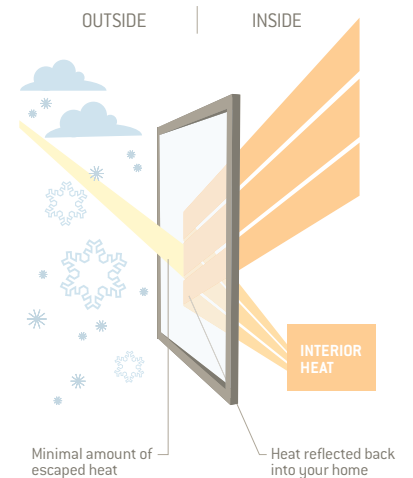

### SUNSTOP

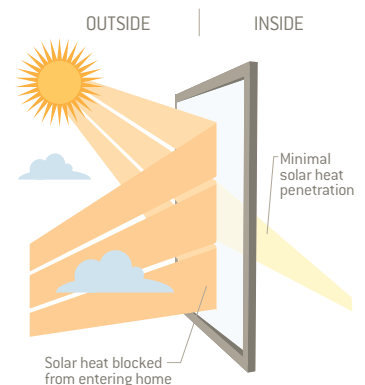

**DID YOU KNOW?** ENERGY STAR® qualified windows can reduce your energy costs by up to 16%.

# CHOOSE YOUR OPTIONS

There are a variety of options for wood and PVC windows. Choose from different colours, brickmoulds, grilles and hardware. Be bold or subtle; the choice is yours.

## COLOUR

Add a personal touch to your windows with an array of colour choices to match the style of your home.



## BRICKMOULD

Enhance your home's curb appeal by installing exterior brickmould. Choose from different colours and styles to add more prominence and beauty to your windows.

Brickmould options may vary depending on product



No Brickmould



2" Metal Clad PVC Colour Brickmould



Apex 9000 1" PVC Brickmould with J channel



Apex 9500 2" PVC Brickmould



Apex 9600 1 1/2" PVC Brickmould

## HARDWARE

Our Encore series of hardware features a sleek contemporary design, and a folding handle option that reduces interference with curtains and blinds.



White



Wicker



Brushed Nickel

Hardware options may vary depending on product

Brickmould: Attached to the window and covering the gap between your home's exterior and the window frame, it allows you to change out your current windows without disturbing the exterior of your home.

## TEXTURED GLASS OPTIONS



Reeded Cross



Rain



Gluechip



Reeded Narrow



Opaque



Pin Obscure

## SIMULATED DIVIDED LITES (SDL's) & GRILLES



7/8"



1 1/4"

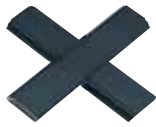

2"

### SDL's

Simulated Divided Lite (SDL) Grilles are installed on the exterior and interior of the glass surface to simulate the look of divided panes of glass. Traditionally, individually divided panes of glass reduce energy efficiency by creating multiple seams and joints for every pane. With the simulated design, you get the beautiful look of divided glass, without sacrificing energy efficiency.



5/16"



5/8"



1"



5/8" Georgian Grille

### INTERNAL GRILLES

Internal Grilles are installed between panes of glass, leaving the exposed interior and exterior glass surfaces smooth and easy to clean. These grilles provide that beautiful look of divided light, while being maintenance free.

Georgian Grilles have a more detailed bevel.



PVC





# PVC WINDOWS



All Weather Windows offers an extended lineup of PVC windows that present an attractive combination of energy efficiency, low maintenance, comfort and value.

Choose a window series constructed with either a heavy framed individual box window system or one using an ingenious common mullion system that eliminates fasteners in the window frame's drainage path.

Innovative designs and unique features set our PVC windows apart. Set back glazing on many product series provides better structural strength and also improves thermal efficiency and water management by reducing window exposure. An internal, sloped bridging design ensures water drains to the outside and our PVC drip lip forces water to drip straight down, away from your wall.

## KEY FEATURES

- Maintenance-free frame
- Excellent insulating qualities
- Long life span
- Affordable

## AVAILABLE PRODUCTS

### APEX

- 9000 SERIES
- 9500 SERIES
- 9600 SERIES
- 9800 SERIES

### TITAN

- 6500 SERIES

### ENERGY SAVER

- 2000 SERIES
- 2500 SERIES

### MAGNUM

- 7000 SERIES

### CARRIAGE

- 6800 SERIES



## APEX 9000 SERIES



The 9000 series Full Frame Integral Brickmould Casement/Awning provides superior energy performance with warm edge spacer and fusion welded multiple chamber frame.

The casement/awning operating style is hinged on the side providing excellent air circulation.

The 4 9/16" frame is equipped with accessory grooves to accept a wide range of brickmould options, ranging from 1 1/2 to 3 1/2", giving you the choice to design the look that suits your style. Our 9000 series frame features an integral nailing fin for ease of installation and additional protection from air infiltration.

The large selection of grille patterns and colours gives you the opportunity to create a unique look which fits the character of your home.

### KEY FEATURES

- Triple weatherstripping system keeps out rain and cold air, thus reducing heat loss and drafts
- Warm edge spacer for improved energy performance
- Heavy duty spring loaded screen for better performance
- Fusion welded multiple chamber frame for superior energy performance
- Interior integral 1/2" or 3/4" extension channel
- Integral nailing flange provides a barrier against the elements
- Limited lifetime PVC and sealed unit warranties
- Optional "coastal" hardware to protect from saltwater.

**FUSION WELDED INSTEAD OF SCREWS VIRTUALLY ELIMINATES WATER LEAKS.**

*Read more on Page 5*



#### EXTERIOR VIEW

- 4 9/16 inch Frame
- Apex series 9000 casement/picture
- 1" integral brickmould with J Channel



#### INTERIOR VIEW

- 4 9/16 inch Frame
- Apex series 9000 casement/picture
- 1" integral brickmould with J Channel



**PRODUCT HIGHLIGHT:** Leak proof V-weld technology

**PRICE RANGE:** \$ — \$\$\$  
*based on customized additions*

**STYLES:**

**9000 SERIES**

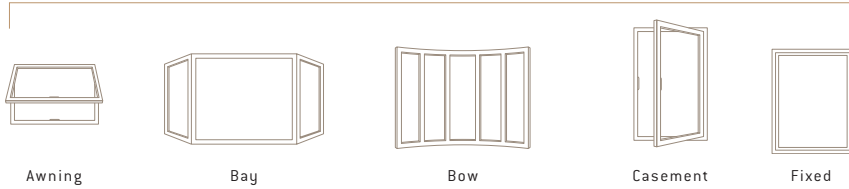

Awning

Bay

Bow

Casement

Fixed

**FRAME COLOURS:**



White Wicker

**OPTIONAL EXTERIOR COLOURS:**



Wicker Sable Pebble Canyon Clay

**CSA RATINGS\***

Window Style	Air Infiltration	Water Penetration	Wind Load	Forced Entry
9000 Awning	A3	B7	C3	F20
9000 Casement	A3	B7	C5	F20
9000 Picture	Fixed	B7	C4	N/A

\* Testing is done to A440-00 standards. Testing results are for single windows with no grilles. Ratings higher than A3, B3, C3 must be specified at time of order. Go to [www.csa.ca](http://www.csa.ca) for more information on these ratings.

**HARDWARE COLOURS:**



White Wicker

**OPTIONAL ENHANCEMENTS**

**GRILLE PATTERNS:**

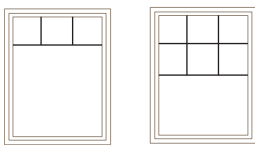

Single Top Ladder

Double Top Ladder

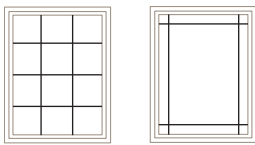

Rectangular

Perimeter

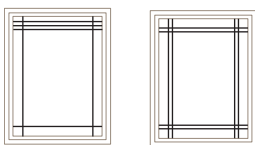

Empress

Double Perimeter

**INTERNAL GRILLE WIDTHS:**

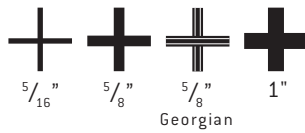

5/16"

5/8"

5/8" Georgian

1"

**SDL (SIMULATED DIVIDED LITES) WIDTHS:**

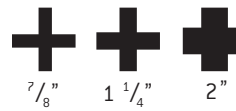

7/8"

1 1/4"

2"

**INTERNAL GRILLE COLOURS:**



White Wicker Gold Lead Patina

**SDL COLOURS:**



White Wicker

Actual colours may vary.

## APEX 9500 SERIES



Classic Profiled Sash detail

9500 Classic Profiled Sash Casement

The 9500 Series Full Frame Integral Brickmould Casement/ Awning features a classic profiled sash adding a wonderful architectural detail to your home.

This window can be upgraded to high performance Tri-pane glass to ensure you achieve maximum energy efficiency. The casement/awning operating style is hinged on the side providing excellent air circulation.

The 4 9/16" frame is equipped with accessory grooves to accept a wide range of brickmould options, ranging from 1 1/2" to 3 1/2", giving you the choice to design a look that suits your style. Our 9500 series frame features an integral nailing fin for ease of installation and additional protection from air infiltration.

The large selection of grille patterns and colours gives you the opportunity to create a unique look which fits the character of your home.

### KEY FEATURES

- Available with Dual or Triple pane
- Triple weatherstripping system on casements and awnings keeps out rain and cold air
- Profiled sash adds classic architectural detail to the window
- Fusion welded multiple chamber frame for superior energy performance
- Heavy duty spring loaded screen for better performance
- Interior integral 1/2" or 3/4" extension channel
- Integral nailing fin provides a barrier against the elements
- Limited lifetime PVC and sealed unit warranties
- Optional "coastal" hardware to protect from saltwater.

**FUSION WELDED INSTEAD OF SCREWS VIRTUALLY ELIMINATES WATER LEAKS.**

*Read more on Page 5*



#### INTERIOR VIEW 4 9/16 inch Frame

- Apex series 9500 casement/ fixed
- 1" integral brickmould with J Channel



#### EXTERIOR VIEW 4 9/16 inch Frame

- Apex series 9500 casement/ fixed
- 1" integral brickmould with J Channel



**PRODUCT HIGHLIGHT:** V-weld plus available Triple Pane

**PRICE RANGE:** \$ — \$\$\$

*based on customized additions*

**STYLES:**

**9000 SERIES**

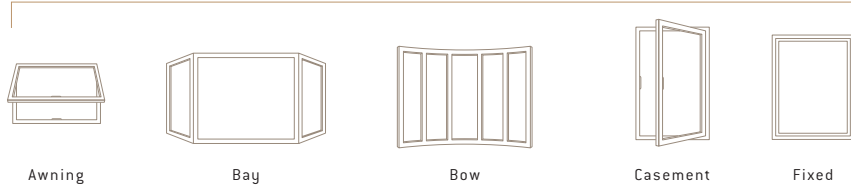

**FRAME COLOURS:**



**OPTIONAL EXTERIOR COLOURS:**

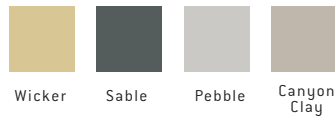

**CSA RATINGS\***

Window Style	Air Infiltration	Water Penetration	Wind Load	Forced Entry
9500 Awning	A3	B7	C3	F20
9500 Casement	A3	B7	C5	F20
9500 Fixed	Fixed	B7	C4	N/A

\* Testing is done to A440-00 standards. Testing results are for single windows with no grilles. Ratings higher than A3, B3, C3 must be specified at time of order. Go to [www.csa.ca](http://www.csa.ca) for more information on these ratings.

**HARDWARE COLOURS:**



**OPTIONAL ENHANCEMENTS**

**GRILLE PATTERNS:**

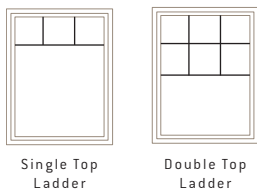

**INTERNAL GRILLE WIDTHS:**

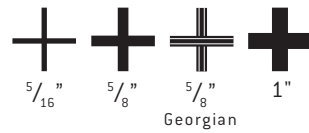

**SDL (SIMULATED DIVIDED LITES) WIDTHS:**

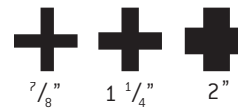

**INTERNAL GRILLE COLOURS:**

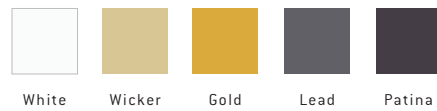

**SDL COLOURS:**



Actual colours may vary.

## APEX 9600 SERIES



The 9600 Series Full Frame Integral Brickmould Picture provides superior energy performance with a warm edge spacer and fusion welded multiple chamber frame.

The picture style window allows a clear, unobstructed view through the glass.

The 9600 Series Full Frame Integral Brickmould Glider features a triple weatherstripping system, warm edge spacer and fusion welded multiple chamber frame to ensure energy efficiency and comfort for your home. Our Single Glider operating style features a tilt-in sash making it easy to clean the outside of the window. The Single Hung operating style allows the bottom sash to slide up for controlled air movement.

The 3 1/4" frame is equipped with accessory grooves to accept a wide range of brickmould options, ranging from 1 1/2" to 3 1/2", giving you the choice to design a look that suits your style. Our 9600 series frame features an integral nailing fin for ease of installation and additional protection from air infiltration.

The large selection of grille patterns and colours gives you the opportunity to create a unique look which fits the character of your home

### KEY FEATURES

- Triple weatherstripping system keeps out rain and cold air, thus reducing heat loss and drafts
- Warm edge spacer for improved energy performance
- Heavy duty spring loaded screen for better performance
- Tilt-in sash makes cleaning easy
- Fusion welded multiple chamber frame for superior energy performance
- Interior integral 1/2" or 3/4" extension channel
- Integral nailing fin provides a barrier against the elements
- Limited lifetime PVC and sealed unit warranties

#### EXTERIOR VIEW

3 1/4 inch Frame

- Apex series 9600 Single Hung Exterior
- 1" integral brickmould with J Channel



#### EXTERIOR VIEW

3 1/4 inch Frame

- Apex series 9600 Single Glider



#### INTERIOR VIEW

3 1/4 inch Frame

- Apex series 9600 Picture
- 1" integral brickmould with J Channel



**PRODUCT HIGHLIGHT:** Leak proof V-weld technology

**PRICE RANGE:** \$ — \$\$\$  
*based on customized additions*

**STYLES:**

**9600 SERIES**

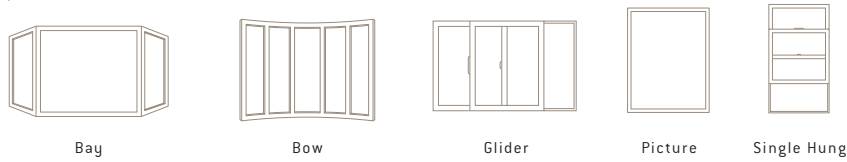

**FRAME COLOURS:**



**OPTIONAL EXTERIOR COLOURS:**

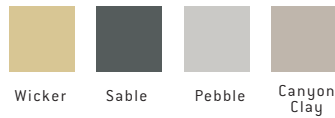

**CSA RATINGS\***

Window Style	Air Infiltration	Water Penetration	Wind Load	Forced Entry
9600 Picture	Fixed	B7	C4	N/A
9600 Single Glider	Fixed/A3	B7	C4	F20
9600 Single Hung	Fixed/A3	B7	C3	F20

\* Testing is done to A440-00 standards. Testing results are for single windows with no grilles. Ratings higher than A3, B3, C3 must be specified at time of order. Go to [www.csa.ca](http://www.csa.ca) for more information on these ratings.

**HARDWARE COLOURS:**



**OPTIONAL ENHANCEMENTS**

**GRILLE PATTERNS:**

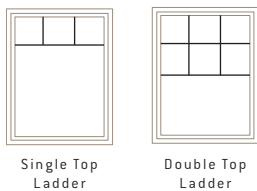

**INTERNAL GRILLE WIDTHS:**

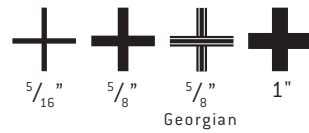

**SDL (SIMULATED DIVIDED LITES) WIDTHS:**

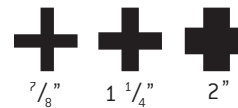

**INTERNAL GRILLE COLOURS:**

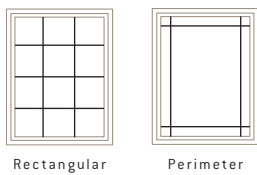
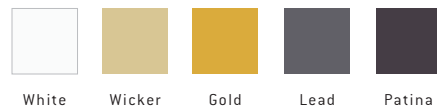

**SDL COLOURS:**

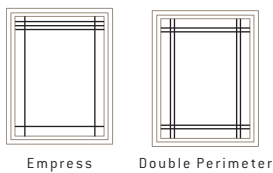

**FUSION WELDED INSTEAD OF SCREWS VIRTUALLY ELIMINATES WATER LEAKS.**  
*Read more on Page 5*

Actual colours may vary.

## APEX 9800 SERIES



The 9800 Double Hung window features a tilt-in sash making it easy to clean the outside of the window.

It also offers our triple weatherstripping system that keeps the rain and cold air from penetrating, thereby reducing heat loss and uncomfortable drafts.

Our 9800 Double Hung window comes with a 3 1/4" fusion welded multiple chamber frame for superior energy performance. The frame will accommodate a variety of integral brickmould options ranging from 1 1/2" to 3 1/2" for both siding and brick homes. Choose one that suits your home's unique style.

The 9800 Series Full Frame Integral Brickmould Fixed Sash window offers a warm edge spacer and fusion welded multiple chamber frame to ensure energy efficiency and comfort for your home. The fixed sash style looks like a casement or awning, but cannot open.

The 3 1/4" frame is equipped with accessory grooves to accept a wide range of brickmould options, ranging from 1 1/2" to 3 1/2", giving you the choice to design a look that suits your style. Our 9800 series frame features an integral nailing fin for ease of installation and additional protection from air infiltration.

The large selection of grille patterns and colours gives you the opportunity to create a unique look which fits the character of your home.



### KEY FEATURES

- Triple weatherstripping system keeps out rain and cold air, thus reducing heat loss and drafts
- Warm edge spacer for improved energy performance
- Heavy duty spring loaded screen for better performance
- Tilt-in sash makes cleaning easy
- Fusion welded multiple chamber frame for superior energy performance
- Interior integral 1/2" or 3/4" extension channel
- Integral nailing fin provides a barrier against the elements
- Limited lifetime PVC and sealed unit warranties

#### EXTERIOR VIEW

3 1/4 inch Frame

- Apex series 9800 Double Hung



#### EXTERIOR VIEW

3 1/4 inch Frame

- Apex series 9800 Picture
- 1" integral brickmould with J Channel





**PRODUCT HIGHLIGHT:** Leak proof V-weld technology

**PRICE RANGE:** \$ — \$\$\$  
*based on customized additions*

**STYLES:**

**9800 SERIES**

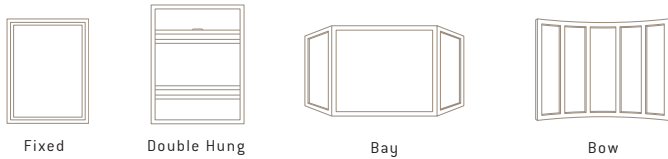

**FRAME COLOURS:**



**OPTIONAL EXTERIOR COLOURS:**

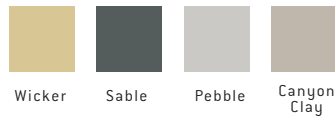

**CSA RATINGS\***

Window Style	Air Infiltration	Water Penetration	Wind Load	Forced Entry
9800 Fixed	A3	B7	C2	F20
9800 Double Hung	A3	B7	C3	F20

\* Testing is done to A440-00 standards. Testing results are for single windows with no grilles. Ratings higher than A3, B3, C3 must be specified at time of order. Go to [www.csa.ca](http://www.csa.ca) for more information on these ratings.

**HARDWARE COLOURS:**



**OPTIONAL ENHANCEMENTS**

**GRILLE PATTERNS:**

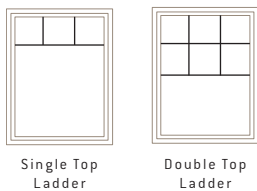

**INTERNAL GRILLE WIDTHS:**

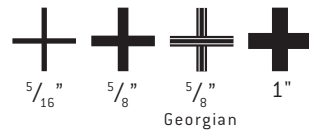

**SDL (SIMULATED DIVIDED LITES) WIDTHS:**

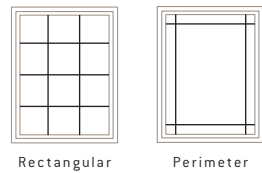
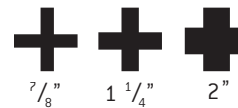

**INTERNAL GRILLE COLOURS:**

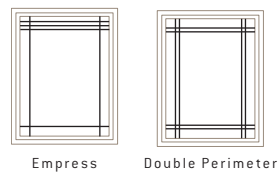
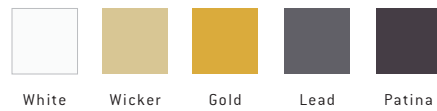

**ALUMINUM SDL COLOURS:**



**FUSION WELDED INSTEAD OF SCREWS VIRTUALLY ELIMINATES WATER LEAKS.**  
*Read more on Page 5*

Actual colours may vary.

## ENERGYSAVER 2000 & 2500 SERIES



Like the name suggests, EnergySaver windows offer superior energy savings.

A rubberized gasket seal and warm edge spacer keep the outside temperature from invading your home. Energy efficiency is further enhanced with a multi-chambered PVC extrusion that improves the insulation quality of the window. And to top it all off, this versatile window will accommodate a triple glazed sealed unit and our full selection of brickmould options.

EXTERIOR DETAIL  
FIXED  
CASEMENT



- 1 Multi-chamber PVC extrusion
- 2 Warm edge spacer for improved energy performance
- 3 PVC interior heavy extruded glazing stop
- 4 Triple weatherstripping to seal sash
- 5 Integral nailing fin

**PRODUCT HIGHLIGHT:** Optimal energy performance

**PRICE RANGE:** \$ — \$\$\$

*based on customized additions*

**STYLES:**

**2000 SERIES**

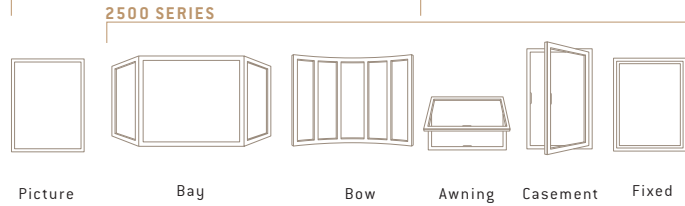

**CSA RATINGS\***

Window Style	Air Infiltration	Water Penetration	Wind Load	Forced Entry
2000 Picture	Fixed	B7	C4	N/A
2500 Awning	A3	B7	C3	F20
2500 Casement	A3	B7	C5	F20
2500 Fixed	Fixed	B7	C3	N/A

\* Testing is done to A440-00 standards. Testing results are for single windows with no grilles. Ratings higher than A3, B3, C3 must be specified at time of order. Go to [www.csa.ca](http://www.csa.ca) for more information on these ratings.

**FRAME COLOURS:**



**OPTIONAL EXTERIOR COLOURS:**

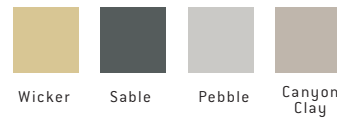

**STANDARD HARDWARE**



**OPTIONAL HARDWARE**

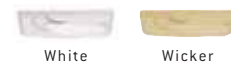

**OPTIONAL ENHANCEMENTS**

**GRILLE PATTERNS:**

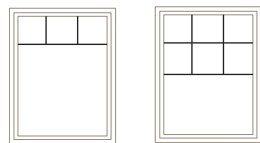

Single Top Ladder Double Top Ladder

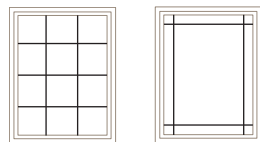

Rectangular Perimeter

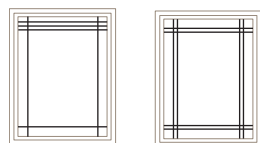

Empress Double Perimeter

**INTERNAL GRILLE WIDTHS:**

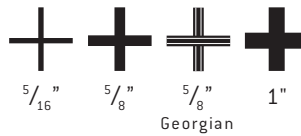

**SDL (SIMULATED DIVIDED LITES) WIDTHS:**

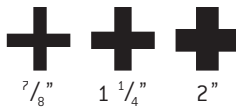

**INTERNAL GRILLE COLOURS:**



**SDL COLOURS:**



Actual colours may vary.

# TITAN 6500 SERIES



Titan PVC windows take the performance of dual pane windows to a new level. Their unique one piece frame gives the windows better strength and durability, and improves resistance to water and air infiltration. Placement of the sealed unit at the centre of the frame offers enhanced energy performance and long-term structural integrity.



INTERIOR DETAIL  
GLIDER

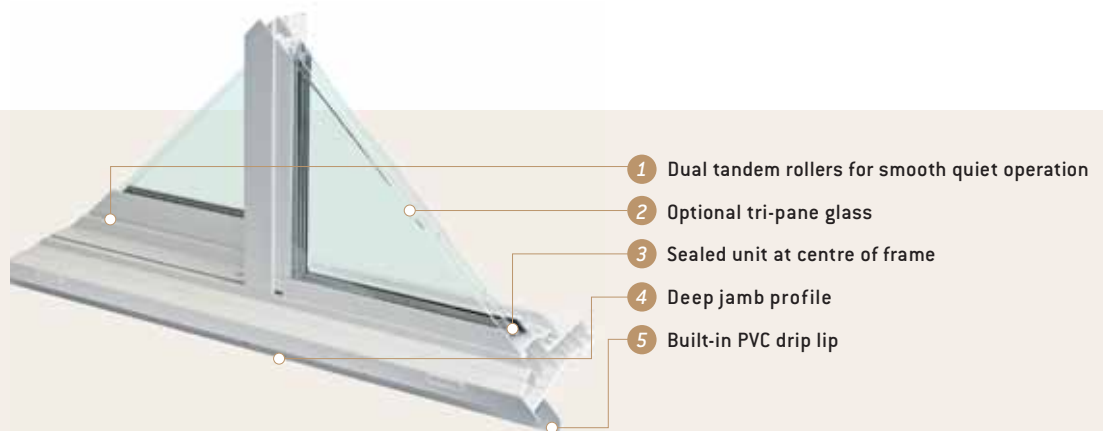

**PRODUCT HIGHLIGHT:** Long-term structural integrity

**PRICE RANGE:** \$ — \$\$\$  
*based on customized additions*

**STYLES:**

**6500 SERIES**

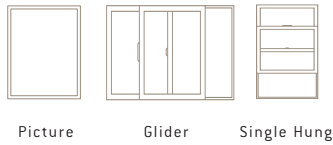

**FRAME COLOURS:**



**CENTRE WALL PLACEMENT**

Positioning the glass in the centre of the wall improves the circulation of the room air against the window. This helps to reduce condensation, provides better ventilation, and creates a warmer, more comfortable interior.

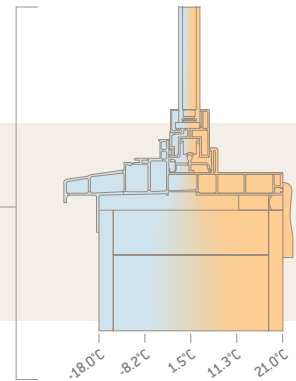

**CSA RATINGS\***

Window Style	Air Infiltration	Water Penetration	Wind Load	Forced Entry
6500 Picture	Fixed	B7	C4	N/A
6500 Glider	Fixed/A3	B3	C4	F10
6500 Single Hung	Fixed/A3	B3	C4	F20

\* Testing is done to A440-00 standards. Testing results are for single windows with no grilles. Ratings higher than A3, B3, C3 must be specified at time of order. Go to [www.csa.ca](http://www.csa.ca) for more information on these ratings.

**OPTIONAL ENHANCEMENTS**

**GRILLE PATTERNS:**

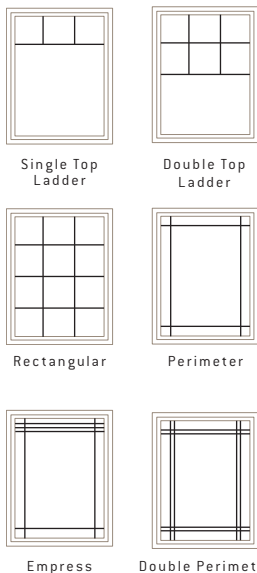

**INTERNAL GRILLE WIDTHS:**

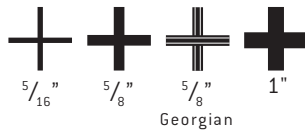

**INTERNAL GRILLE COLOURS:**

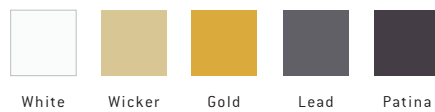

Actual colours may vary.

## MAGNUM 7000 SERIES



With a sturdy casement-style PVC exterior frame, our Magnum windows offer the bold and robust appearance of a wide profile.

Combine this with our multiple brickmould options, and you've got the perfect window to add some extra character to your curb appeal.



### EXTERIOR DETAIL WIDE PROFILE GLIDER



- 1 Adhesive glazing tape
- 2 Wide look for casement style appearance
- 3 Extruded PVC glazing stop
- 4 Integral nailing fin

**PRODUCT HIGHLIGHT:** Bold styling

**PRICE RANGE:** \$ — \$\$\$  
*based on customized additions*

**STYLES:**

**7000 SERIES**

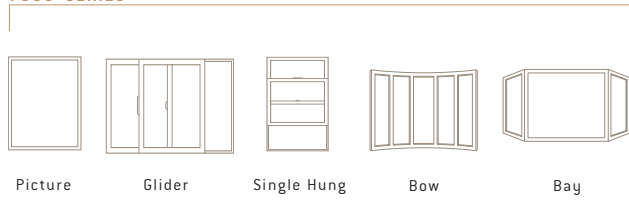

**CSA RATINGS\***

Window Style	Air Infiltration	Water Penetration	Wind Load	Forced Entry
7000 Picture	Fixed	B7	C3	N/A
7000 Glider	Fixed/A3	B3	C5	F20
7000 Single Hung	Fixed/A3	B3	C5	F10

\* Testing is done to A440-00 standards. Testing results are for single windows with no grilles. Ratings higher than A3, B3, C3 must be specified at time of order. Go to [www.csa.ca](http://www.csa.ca) for more information on these ratings.

**FRAME COLOURS:**



**OPTIONAL EXTERIOR COLOURS:**

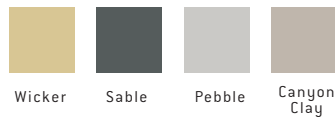

**OPTIONAL ENHANCEMENTS**

**GRILLE PATTERNS:**

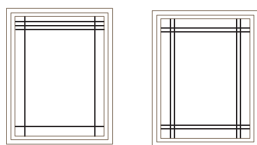
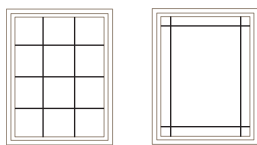
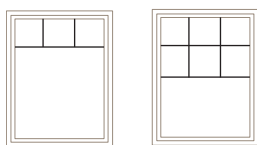

**INTERNAL GRILLE WIDTHS:**

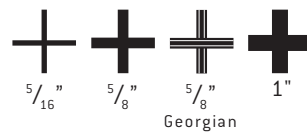

**INTERNAL GRILLE COLOURS:**

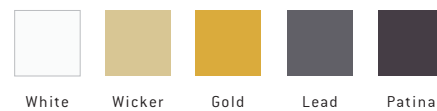

Actual colours may vary.

## CARRIAGE 6800 SERIES



Carriage windows feature a slim profile and provide a larger viewing area than other windows. The 6800 series of windows offer an excellent choice for those wanting great performance and value.

With a clip-in common mullion design, the need for fasteners, caulking and sealants are eliminated – creating good thermal performance and excellent water management.

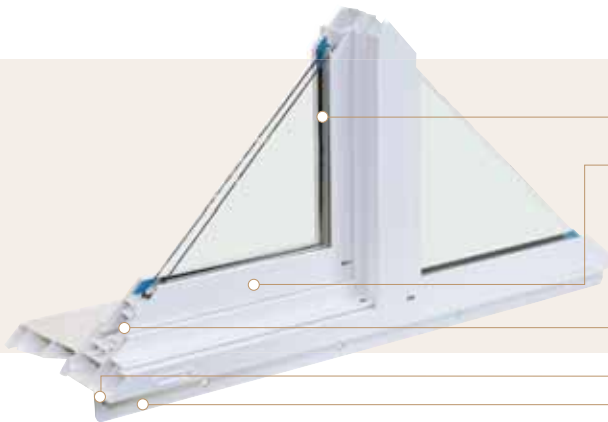

- 1 Adhesive glazing tape
- 2 Extruded PVC glazing stop
- 3 Dual tandem rollers for smooth quiet operation
- 4 Built-in PVC drip lip
- 5 Integral nailing fin



**PRODUCT HIGHLIGHT:** Great value

**PRICE RANGE:** \$ — \$\$\$

*based on customized additions*

**STYLES:**

**6800 SERIES**

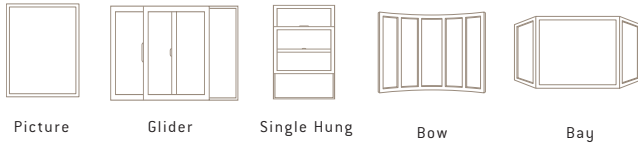

**CSA RATINGS\***

Window Style	Air Infiltration	Water Penetration	Wind Load	Forced Entry
6800 Picture	Fixed	B7	C4	N/A
6800 Glider	Fixed/A3	B3	C4	F10
6800 Single Hung	Fixed/A3	B3	C3	F10

\* Testing is done to A440-00 standards. Testing results are for single windows with no grilles. Ratings higher than A3, B3, C3 must be specified at time of order. Go to [www.csa.ca](http://www.csa.ca) for more information on these ratings.

**FRAME COLOURS:**



**OPTIONAL ENHANCEMENTS**

**GRILLE PATTERNS:**

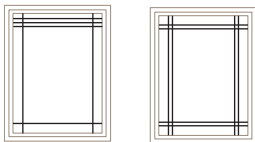
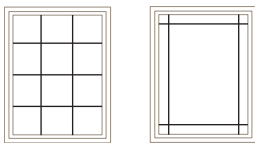
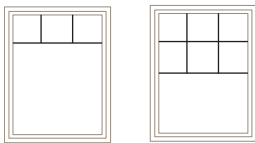

**INTERNAL GRILLE WIDTHS:**

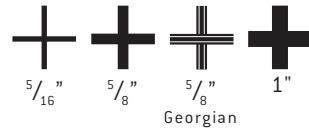

**INTERNAL GRILLE COLOURS:**

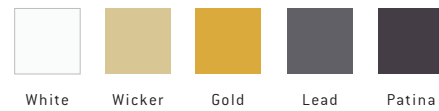

Actual colours may vary.



METAL CLAD PVC



## METAL CLAD PVC



Our innovative Metal Clad PVC windows combine the strength and elegance of aluminum cladding with all the benefits of a PVC frame.

Throw in the revolutionary leak resistant technology of V-weld, and the result is an award winning window with superior durability and energy efficiency. And just like our PVC windows, they're virtually maintenance free.



### KEY FEATURES

- Superior strength and durability
- Leak resistant technology
- Maintenance-free interior
- Numerous colour options
- Sleek and elegant exterior



### AVAILABLE PRODUCTS

#### APEX ALLOY

- 9900 SERIES
- 9950 SERIES



**MACHINE WELDING VIRTUALLY ELIMINATES WATER LEAKS.**

Read more on Page 5

# APEX ALLOY 9900 & 9950 SERIES

**BEST  
SELLER**



The Apex Alloy window series, with revolutionary V-weld technology, virtually eliminates air and water leaks.

A high performance fusion-welded PVC frame delivers improved energy efficiency and advanced structural integrity. Combined with the strength and bold colour styles of the exterior aluminum cladding, the Apex Alloy series creates a uniquely durable window design that can be customized to suit anyone's personal tastes. Available with dual or triple pane glass options.



**FUSION-WELDING VIRTUALLY  
ELIMINATES WATER LEAKS.**

Read more on Page 5

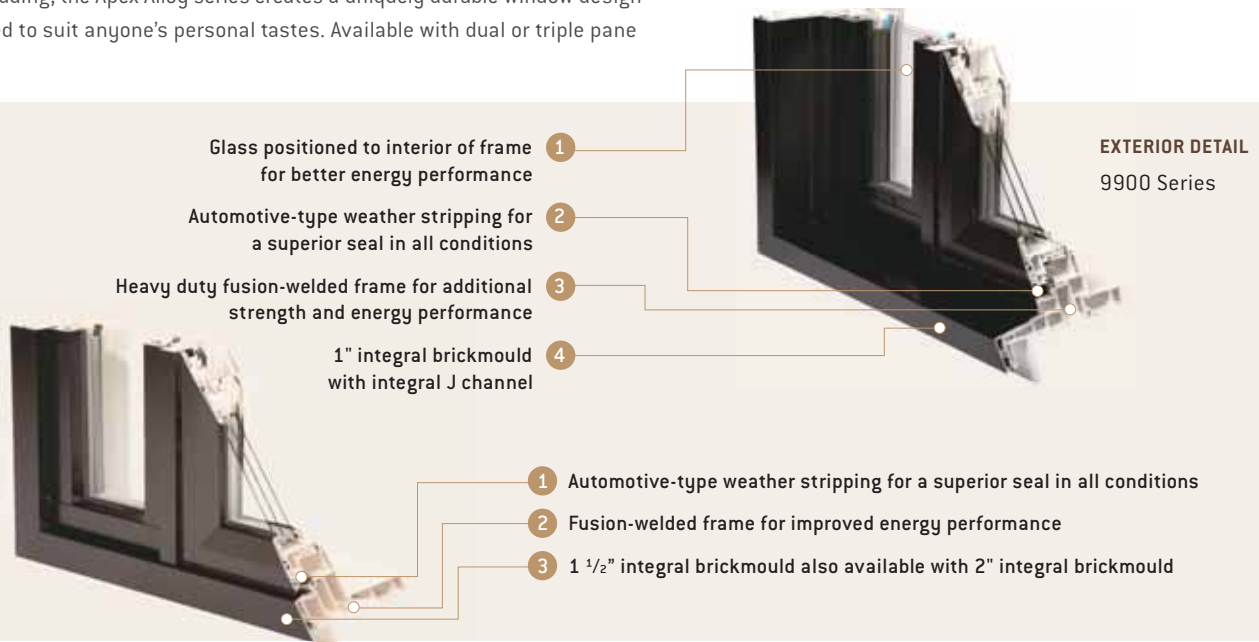

**PRODUCT HIGHLIGHT:** Leakproof V-weld technology

**PRICE RANGE: \$\$ — \$\$\$\$**

Based on customized additions

**STYLES:**

**9900 SERIES**

**9950 SERIES**

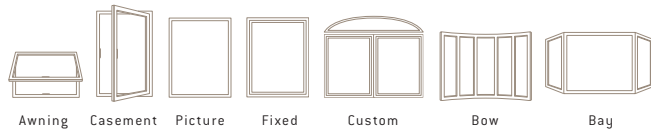

**EXTERIOR CLADDING COLOURS:**

STANDARD AVAILABILITY:

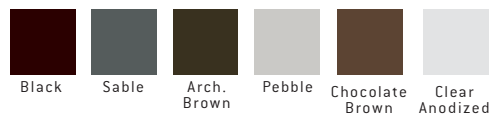

PREMIUM WOOD:

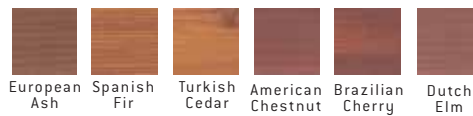

FRAME COLOURS:

STANDARD:



HARDWARE COLOURS:

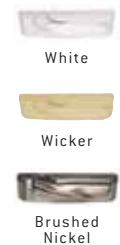

PREMIUM METALLIC:

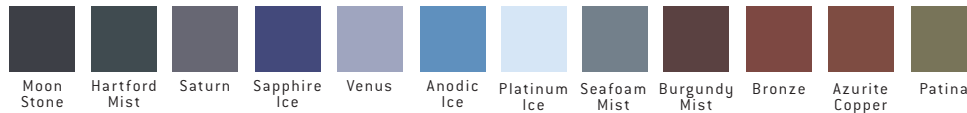

PREMIUM SOLID GLOSS OR MATTE\*:

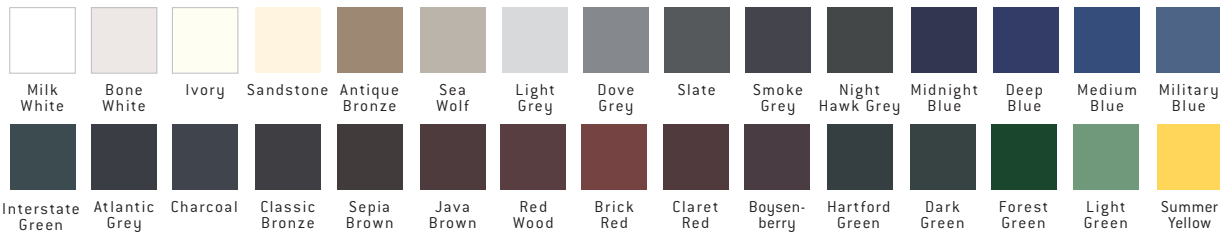

**CSA RATINGS\***

Window Style	Air Infiltration	Water Penetration	Wind Load	Forced Entry
9900/9950 Awning	A3	B7	C3	F20
9900/9950 Casement	A3	B7	C3	F20
9900/9950 Picture	Fixed	B7	C3	N/A
9900/9950 Fixed/Casement	A3	B7	C3	N/A
9900/9950 Radius/Polygon	Fixed	B7	C3	N/A

\* Testing is done to A440-00 standards. Testing results are for single windows with no grilles. Ratings higher than A3, B3, C3 must be specified at time of order. Go to [www.csa.ca](http://www.csa.ca) for more information on these ratings.

**OPTIONAL ENHANCEMENTS**

GRILLE PATTERNS:

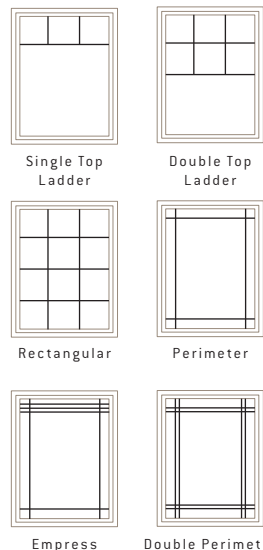

INTERNAL GRILLE WIDTHS:

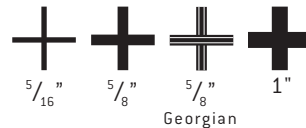

SDL (SIMULATED DIVIDED LITES) WIDTHS:

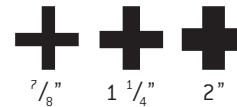

INTERNAL GRILLE COLOURS:



INTERIOR SDL COLOURS:



EXTERIOR SDL COLOURS:



BRICKMOULD OPTIONS:

**9950 series is available with a 2" brickmould**

Available in all exterior cladding colours noted above

See page 14 for illustrations

SPLIT FINISH COLOURS

Customize your interior and exterior georgian grilles or SDLs to match your windows.

Ask your sales representative for more details.

Actual colours may vary.

\*Premium colours may have extended lead times.



DOORS



# HOW TO CHOOSE YOUR DOORS

Beyond functionality, the type of door you choose can say a lot about who you are.

It can add a personal aesthetic style to your home, as well as expand a room by bringing in the outdoors. And like our windows, all our doors offer superior energy efficiency.



## PATIO DOORS

With a large glass surface, the transparency of sliding doors provides a large view of the outdoors, while brightening up the interior of a home.

The transparency also creates a more natural appeal and opens up a room to give it an expansive feeling. And since sliding doors don't need additional room to swing open, they take up less space than hinged doors.

## GARDEN DOORS

Garden doors have always been admired for their elegant beauty, but their versatile functionality has major benefits as well.

Like patio sliding doors, french and garden doors are mostly glass – allowing natural light to brightening up a room. But since they're hinged, when open, they can literally create a continuous space that extends from the interior of a home into the outdoor space.

## ENTRY DOORS

All Weather Windows manufactures a variety of front entry doors – textured fiberglass, smooth fiberglass, and high-definition steel – all with decorative glass options.

For details on our complete line of entry doors, pick up our All Weather Windows Door catalogue at your nearest dealer, or visit [allweatherwindows.com](http://allweatherwindows.com).

### AVAILABLE PRODUCTS

**VISCOUNT** (PVC)

### AVAILABLE PRODUCTS

**STRONG ARM II**  
(PRE-FINISHED STEEL  
AND FIBERGLASS)

### AVAILABLE PRODUCTS

**BARRINGTON**  
(TEXTURED FIBERGLASS)

**RUSTIC**  
(TEXTURED FIBERGLASS)

**TRUE WHITE OAK**  
(TEXTURED PREFINISHED FIBERGLASS)

**BELLEVILLE**  
(SMOOTH FIBERGLASS)

**CRAFTSMAN SMOOTH SKIN**  
(SMOOTH FIBERGLASS)

**STA-TRU** (PREFINISHED STEEL)



ALL OF OUR DOORS ARE ENERGY STAR® QUALIFIED.

# CHOOSE YOUR OPTIONS

There are a variety of options for our doors. Choose from different colours, brickmoulds, grilles and hardware. Be bold or subtle; the choice is yours.

## BRICKMOULD

Enhance your home's curb appeal by installing exterior brickmould. Our 2" wide brickmould gives your front entrance a wider, more classic appearance. Available in a variety of colours.

Brickmould options may vary depending on product.



## INTERNAL GRILLES

Internal Grilles are installed between panes of glass, leaving the exposed interior and exterior glass surfaces smooth and easy to clean. These grilles provide that beautiful look of divided light, while being maintenance free.

For more information on grilles, see page 13.



Single Top Ladder



Double Top Ladder

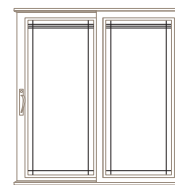

Empress

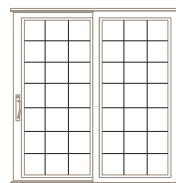

Rectangular

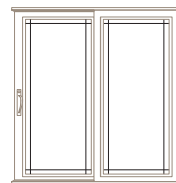

Perimeter

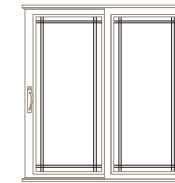

Double Perimeter

## PATIO DOOR HARDWARE

Our different door styles have a selection of door handles and added security features to choose from. Select the one that suits you and your home best.

Hardware options may vary depending on product.



Multi-Point Locking System



Key Lock (Optional)



# ENTRY DOOR FEATURES

## ONE-PIECE DOOR SILL

Constructed as one piece, our door sill offers exceptional durability. Warp-resistant laminated wood posts offer improved strength, while features like a built-in drip lip keep air and water from seeping into your home.

DETAIL  
SILL FEATURES

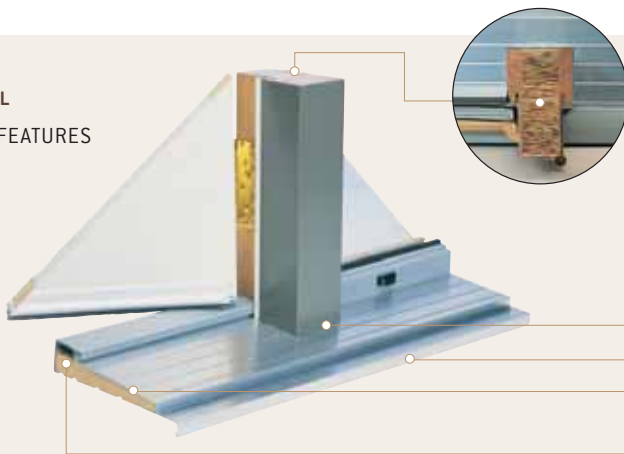

- 1 Engineered laminated woodposts give improved strength and are warp resistant
- 2 Non-wicking neoprene gaskets used at all joinery; no caulking is used
- 3 Drip lip
- 4 One piece sill design
- 5 Full sill blocking

## DOOR SWEEP

Our industry-best door sweep lasts longer, operates smoother, and seals out moisture better than any other. Each fin seal is made with a clear centre pile, prolonging the lifespan of the seal, while providing better protection against the elements.

DETAIL  
DOOR SWEEP  
FEATURES



- 1 Gasket sealed on both sides
- 2 Water dam
- 3 Triple fin seals
- 4 Built-in drain hole
- 5 Drip lip

\* Colour options are available



# VISCOUNT (PVC)

**PRODUCT HIGHLIGHT:** Great value

**PRICE RANGE:** \$ — \$\$  
*Based on customized additions*



Our Viscount patio doors feature a PVC welded sash and frame for optimal energy performance.

Nylon rollers with stainless steel ball bearings provide effortless sliding functionality.

Available in wicker or white, Viscount doors are a practical solution at a great value for cottages and new home construction. For added security, optional keyed-lock door handles and spring-loaded foot locks are available. These sturdy devices provide more security at a minimal cost.



## OPTIONAL ENHANCEMENTS

### GRILLE PATTERNS:



Single Top Ladder

Double Top Ladder

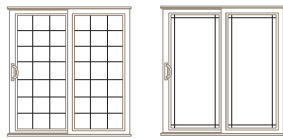

Rectangular

Perimeter



Empress

Double Perimeter

### INTERNAL GRILLE WIDTHS:

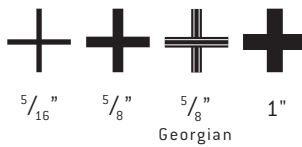

5/16"

5/8"

5/8"  
Georgian

1"

### INTERNAL GRILLE COLOURS:



White

Wicker

Gold

Lead

Patina

Actual colours may vary.

## STRONG ARM II GARDEN DOORS (PRE-FINISHED STEEL & FIBERGLASS)



The Strong Arm II garden door combines style, unique functionality, and low maintenance.

Engineered laminated wood posts offer superior strength and virtually eliminate warping. And to protect against the outside elements, all joinery is gasket sealed, with no caulking needed.

Our garden doors are available in single to four-wide configurations, with one panel opening as a door and the second panel opening window style (swing out only) or fixed. Metal cladding on the doorpost and jambs is available in our 7 standard colours.



### STRONG ARM II FEATURES

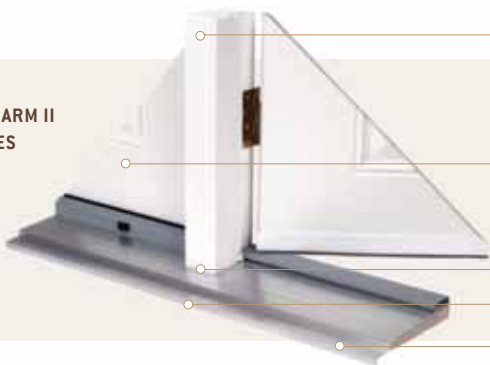

- 1 Engineered wood post for exceptional strength
- 2 Fixed or venting panel
- 3 Gasket sealed joinery
- 4 Built-in drip lip
- 5 One piece door sill

**PRODUCT HIGHLIGHT:** Versatile functionality

**PRICE RANGE: \$\$ — \$\$\$**  
Based on customized additions

**EXTERIOR (CLADDING) COLOURS:**

STANDARD BRICKMOULD & JAMB WRAP



**RENOVATION OPTION**

If you're renovating your patio doors, we can provide a specially sized garden door (not shown) to fit perfectly in place of your existing sliding patio door.



**OPTIONAL ENHANCEMENTS**

**GRILLE PATTERNS:**

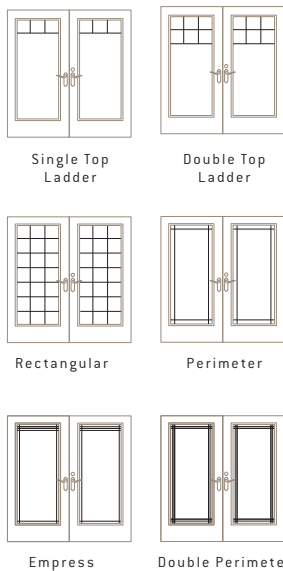

**INTERNAL GRILLE WIDTHS:**

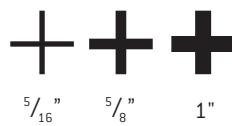

**INTERNAL GRILLE COLOURS:**



**BRICKMOULD OPTIONS:**

Available with a 2" brickmould  
Available in all exterior cladding colours noted above

Actual colours may vary.

## ENTRY DOORS (STEEL & FIBERGLASS)



Like our Strong Arm II garden doors, our entry doors are built to withstand whatever Mother Nature throws at them.

Manufactured wood posts provide extra strength that is warp resistant. Seams and joinery are sealed with gaskets, instead of messy caulking that can break down over time. And to prevent water infiltration, a one-piece door sill is used, featuring a drip lip that forces water away from the base of the door.

Strong Arm II door frames also incorporate a common frame construction with multi-combination post, resulting in a stronger, more versatile frame.

For added variety, metal cladding on doorposts and jambs are available in our eight standard colours.

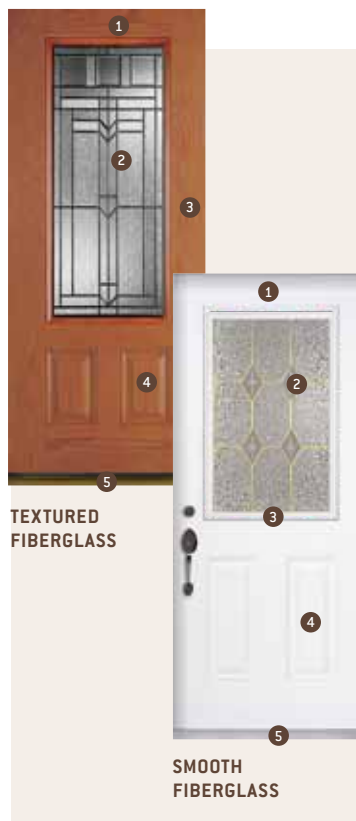

### FIBERGLASS DOORS

- 1 HIGH PERFORMANCE FIBERGLASS FACING**  
Specially engineered fiberglass facings provide maximum protection and durability. Fiberglass is dent resistant and resists splitting, cracking and warping.
- 2 GLASS INSERTS**  
All decorative glass inserts feature a triple pane 1" insulated assembly. Dual pane insulated inserts and flush-glazed frame designs are also available.
- 3 ENGINEERED STILES**  
Hinge and lock stiles feature laminated lumber providing excellent dimensional stability.
- 4 POLYURETHANE CORE**  
Rigid polyurethane foam, meeting strict environmental guidelines, provides maximum thermal protection and dimensional stability.
- 5 ROT-RESISTANT BOTTOM RAIL**  
A high-performance composite material is used on all bottom rails, giving excellent rot resistance.

**PRODUCT HIGHLIGHT:** Excellent durability

**PRICE RANGE:** \$\$ — \$\$\$  
*Based on customized additions*

**COLOURS:**

STANDARD BRICKMOULD & JAMB WRAP

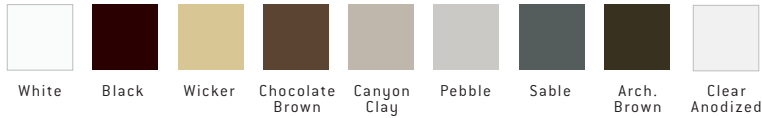

**DOOR MATERIAL:**

TEXTURED FIBERGLASS



SMOOTH FIBERGLASS



PRE-FINISHED STEEL



**STEEL & FIBERGLASS DOOR FEATURES**



**INTERNAL BLOCKING**

The lock area is reinforced with a block, serving as a solid mounting surface.



**DEEP WOOD GRAIN TEXTURE**

The unique deep wood grain texture provides a surface for easy finishing.



**TRUE SQUARE-EDGE DESIGN**

A square-edge design provides an attractive wood appearance and easy field matching.

*\*Feature not available with steel doors*



**ENHANCED STAINABILITY**

While wood requires a multi-coat staining or painting process, a fiberglass door is much easier and faster to stain.

# FRONT ENTRY DOORS (STYLE INDEX)



## BARRINGTON® FIBERGLASS ENTRY DOOR

The Barrington® fiberglass door collection defines a superior level of luxury. Distinct raised moulding and detailed wood grain texture brings warmth and elegance to your home. Combine this with our factory-glazed, proprietary collection of decorative glass, and the result is a new dimension of elegance in fiberglass entry doors.



**BARRINGTON®**



AvantGuard™ Black Walnut/AvantGuard™ Spanish Cedar finishes

AvantGuard™ Black Walnut finish 6 Panel

Flagstaff™ Plank AvantGuard™ Black Walnut/AvantGuard™ Spanish Cedar finishes

Flagstaff™ Plank (Stainable)

Sierra™ Camber Top Plank/Sierra™ Camber Top (Stainable)

Craftsman Oak/Craftsman Mahogany (Stainable)

Barrington™ Oak (Stainable)

		SURFACE	DESIGN SIZE	PANEL MOULDING	GLAZING	
TEXTURED FIBERGLASS	Barrington®	AvantGuard™ (Prefinish)	<ul style="list-style-type: none"> <li>• Prefinished authentic hardwood texture</li> <li>• Available in the AvantGuard™ Black Walnut &amp; Spanish Cedar texture</li> </ul>	<ul style="list-style-type: none"> <li>• Available in 6'8" &amp; 8'0" heights, plus 3'6" widths in 8'0" heights</li> </ul>	<ul style="list-style-type: none"> <li>• Classic wide profile creating a distinctive heirloom quality design</li> </ul>	<ul style="list-style-type: none"> <li>• Factory-glazed sidelite with one proprietary decorative glass or clear insulated glass</li> </ul>
		Sierra™ Mahogany	<ul style="list-style-type: none"> <li>• Stainable authentic Mahogany texture in a planked or non-planked profile</li> </ul>	<ul style="list-style-type: none"> <li>• Extensive collection of unique designs, 6'8" &amp; 8'0" heights, plus 3'6" widths available in 8'0" heights</li> </ul>	<ul style="list-style-type: none"> <li>• Beautiful raised moulding integrated into the facing, no plant-on applique</li> </ul>	<ul style="list-style-type: none"> <li>• Factory-glazed sidelites with proprietary, decorative glass</li> <li>• Architecturally correct alignment between glazing frame &amp; panel moulding in three styles</li> </ul>
		Flagstaff™	<ul style="list-style-type: none"> <li>• Stainable authentic Mahogany texture in a classic plank door design with contemporary styling</li> </ul>	<ul style="list-style-type: none"> <li>• Available in 6'8" &amp; 8'0" heights, plus 3'6" widths in 8'0" heights</li> </ul>	<ul style="list-style-type: none"> <li>• Vertical plank design featuring clean lines</li> </ul>	<ul style="list-style-type: none"> <li>• Factory-glazed sidelites with proprietary, decorative glass</li> <li>• Architecturally correct alignment between glazing frame &amp; panel moulding in three styles</li> </ul>
		Craftsman	<ul style="list-style-type: none"> <li>• Stainable straight-grain hardwood, Oak texture and authentic hardwood Mahogany texture</li> </ul>	<ul style="list-style-type: none"> <li>• Available in 3'0" x 6'8"</li> </ul>	<ul style="list-style-type: none"> <li>• Mission or Craftsman style with three recessed panels</li> </ul>	<ul style="list-style-type: none"> <li>• Factory-glazed with custom glazing system with three options including clear</li> </ul>

\*Doorlites for wood grain textured fiberglass are available with stainable frames.

\*\*Doors come unstained/unpainted except for AvantGuard™ finishes, True White Oak & Sta-Tru Steel.



**RUSTIC**



Mahogany True 4 Panel

Mahogany Rustic 2 Panel, Camber Top

**BELLEVILLE**  
Fiberglass Entry Doors



Smooth (Primed)

Cheyenne Smooth (Primed)

Smooth (Primed)

**TRUE WHITE OAK**



True White Oak (Pre-finished)

**HIGH DEFINITION STEEL**



Sta-Tru<sup>®</sup> High Definition Smooth (Pre-finished)

Sta-Tru<sup>®</sup> High Definition Smooth Square Top (Pre-finished)

Sta-Tru<sup>®</sup> High Definition Smooth (Pre-finished)

**CRAFTSMAN SMOOTH SKIN**



Craftsman Smooth (Primed)



			SURFACE	DESIGN SIZE	PANEL MOULDING	GLAZING
TEXTURED FIBERGLASS	Rustic	N/A	• Deep graining and distinct plank detail of true distressed wood	• Available in 3'6" x 6'8"	• Panel profiles with a distinctly European architectural style	• Compatible with our full line of Glass glazing inserts, architecturally correct stile and rail proportions
	Pre-finished White Oak	True White Oak	• Pre-finished in UV protected White Oak wood-grain finish	• Available in 6'8" designs	• Traditional recessed panels	• Compatible with our full line of Glass inserts
SMOOTH FIBERGLASS	Belleville <sup>®</sup>	Cheyenne Smooth	• Paintable smooth skin finish	• Available in 6'8" & 8'0" designs	• Unique sticking and beaded panel design	• Compatible with our full line of Glass inserts
		Smooth	• Paintable smooth skin finish	• Exclusive collection of both Smooth & Textured designs; both traditional & unique; 6'8" & 8'0" heights available	• High Definition panel profile	• Compatible with our full line of Glass inserts
	Craftsman Smooth Skin	N/A	• Paintable smooth skin surface	• Available in 6'8" & 8'0" designs	• Premium high definition recessed panels	• Available in 3 factory flush-glazed glass inserts: Metropolis, Spring & Clear • Clear glass comes with a selection of internal grille or external SDLs
STEEL	Sta-Tru <sup>®</sup> HD	N/A	• Prefinished white smooth surface	• Available in 6'8" designs	• High Definition panel profile	• Compatible with our full line of Glass inserts

\*Doorlites for wood grain textured fiberglass are available with stainable frames.

\*\*Doors come unstained/unpainted except for AvantGuard<sup>™</sup> finishes, True White Oak & Sta-Tru Steel.

## DECORATIVE GLASS LITES



Adelaide



Alston



Alys



Aria

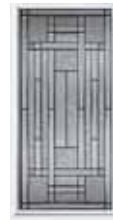

Attraction



Aurora



Brise



Cachet



Classic Elegance



Chord



Cuzco



Element



Evangeline II



Everton



Franklin



Georgian



Glace



Gloria



Harlow



Iron Springs



Kallima



Kordella



Madrid



Marquise



Mondrian

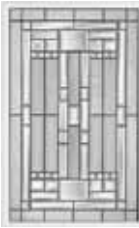

Naples



Navarro



Panama



Pear

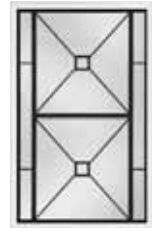

Quattro



Riverton



Riviera



Rockland

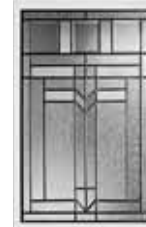

Royston



Sienna



Waterton



Woodbridge



Zavalla

Thermacrystral Decorative Door Lites

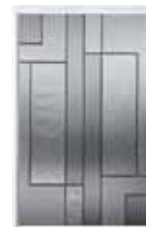

Métropolitain



Newcastle



Sorrento

Silk Screen Decorative Door Lites



Louisbourg

For more lite options,  
see our door catalogue.

# GLOSSARY

## BRICKMOULD

Attached to the window and covering the gap between your home's exterior and the window frame, it allows you to change out your current windows without disturbing the exterior of your home.

## BUILT GREEN CANADA

Built Green Canada is a third party certification program established in 2003 that promotes environmentally responsible building practices and products. The Built Green name means All Weather Windows practices resource-efficient and environmentally friendly construction – providing healthier indoor air, preserving natural resources and improving a home's durability.

## CSA CERTIFICATION

CSA (Canadian Standards Association) provides product testing and certification services for a variety of products. Recognized internationally, a CSA certification mark indicates that All Weather Windows' products have been tested by experts, and meet recognized standards for safety and performance.

## DOOR JAMB

For doors, the jamb is the vertical portion of the frame onto which a door is secured. The jamb holds the weight of the door through its hinges, making it a significant component to the overall durability and security of the door.

## ER(ENERGY RATING)-RATING

An ER-rating is derived from solar heat gain, heat loss through frames, centre and edge of glass, and air leakage heat loss. The combined effect is measured in number of watts per square metre and is

either positive or negative. A positive number represents a net heat gain and helps in reducing the home's heating costs. A negative number indicates that the product loses more energy through heat loss and air infiltration than it gains in solar energy absorbed from the sun (i.e. the home's heating system has to work harder in colder weather).

## MULLION

A mullion is the vertical piece that connects side-by-side units of a window.

## PASSIVE SOLAR HEAT GAIN

Solar heat that passes through a material and is captured naturally, not by mechanical means.

## RELATIVE HEAT GAIN

A calculated relationship of heat gain (through a window system) that accounts for centre-of-glass U-Value and centre-of-glass shading coefficient based on a standard inside and outside temperature.

## SASH

The framework that holds the panes of a window in the window frame. Most commonly refers to the moving part of a window that opens but is also available in a non-opening fixed and picture sash window style.

## SHADING COEFFICIENT

A glass measurement comparing solar heat transmission, related to 1/8 inch clear glass.

## U-VALUE

A measure of the rate of nonsolar heat flow through a material or assembly. The lower the U-Value, the greater a window's resistance to heat flow and the better its insulating value.

## VISIBLE LIGHT TRANSMITTANCE

The percentage or fraction of the visible light spectrum that is transmitted through the glass of a window or skylight as reduced by the sash material and reluctance of the glass.

## WARM EDGE SPACER

Spacers appear around the perimeter of the sealed glazing unit to provide uniform separation between the panes of glass in multiple-paned windows. They absorb moisture from the trapped air in the space between the glass, preventing fogging and condensation. A high-performance warm edge spacer can increase the energy efficiency of a window.

## WEATHERSTRIPPING

Weatherstripping is a component of a window that provides a seal between the frame and the sash. It is used to prevent air leakage. The better the weatherstripping, the better the window performance.

## WINDOW JAMBS

Window jambs are located inside the framing of a window, along the top and sides for structural support. Inferior jambs can be a weak point in a window, allowing for leaks or security concerns.

## WINDOW WISE

We are part of Window Wise's Replacement Window Quality Assurance program, which means our customers can rest assured that they're protected by an industry-backed guarantee.



## ENERGY STAR® CLIMATE ZONES

ENERGY STAR® was introduced to Canada in 2001 to help consumers easily identify products that save energy and money, while helping to protect the environment. Today, ENERGY STAR® is the international symbol for premium energy efficiency across North America.

ENERGY STAR® qualified windows are required in order to achieve New Homes status qualification. This status can affect the resale value of your home and qualify you for rebates. All Weather Windows will work with you to ensure your windows and doors meet or exceed ENERGY STAR® qualifications in your specific climate zone.



# FIND US

We're always interested in starting a conversation about your needs and how we can meet them. Contact one of our locations or visit [allweatherwindows.com](http://allweatherwindows.com) to find a dealer near you.

## LOCATIONS

### ALBERTA

#### EDMONTON (HEAD OFFICE)

18550 – 118A Avenue  
Edmonton, AB, T5S 2K7  
P: 780-451-0670 F: 780-454-7474  
TF: 800-232-9407

#### CALGARY

#5, 5342 – 72 Ave SE  
Calgary, AB, T2C 4X5  
P: 403-720-0022 F: 403-720-0050  
TF: 888-932-3387

#### RED DEER

Bay 190 6040 - 47 Avenue  
Red Deer, AB T4N 1C2  
P: 403-348-0701 F: 403-348-0585  
TF: 855-348-0701

#### LETHBRIDGE

3753 5th Avenue N  
Lethbridge, AB, T1H 5L4  
P: 403-327-0701 F: 403-327-0075  
TF: 877-327-0701

### SASKATCHEWAN

#### SASKATOON

822 – 45 Street East  
Saskatoon, SK, S7K 0W5  
P: 306-242-9600 F: 306-934-5264  
TF: 800-589-9899

### REGINA

645 Henderson Drive  
Regina, SK, S4N 6A8  
P: 306-761-2600 F: 306-546-4491  
TF: 888-672-2202

### BRITISH COLUMBIA

#### VANCOUVER

A101, 9355 – 198 Street  
Langley, BC, V1M 3J9  
P: 604-513-5744 F: 604-513-5746  
TF: 800-518-8338

### MANITOBA

#### WINNIPEG

124 Terracon Place  
Winnipeg, MB, R2J 4G7  
P: 204-947-2433 F: 204-956-4504  
TF: 800-892-5340

### ONTARIO AND ATLANTIC

#### MISSISSAUGA

3100 Caravelle Drive  
Mississauga, ON, L4V 1K9  
P: 905-696-0005 F: 905-696-9994  
TF: 800-291-6501

**CANADA TOLL FREE:** 800-638-5709

#### GENERAL INQUIRIES:

[info@allweatherwindows.com](mailto:info@allweatherwindows.com)

# CHECKLIST

**1** Consider these details when shopping for windows:

**a** Is this for a  **Renovation** or  **New Construction**?

**b** How many windows do you need? \_\_\_\_\_

**c** What are the rough measurements of your windows?

Sketch out your windows and note the dimensions on the opposite page.

**d** What direction do the windows face? How many?



QTY: \_\_\_\_\_ QTY: \_\_\_\_\_ QTY: \_\_\_\_\_ QTY: \_\_\_\_\_



QTY: \_\_\_\_\_ QTY: \_\_\_\_\_ QTY: \_\_\_\_\_ QTY: \_\_\_\_\_

**2** Choose your frame material (see page 9):



PVC  Metal Clad PVC

**3** Choose your operating style (see page 10):

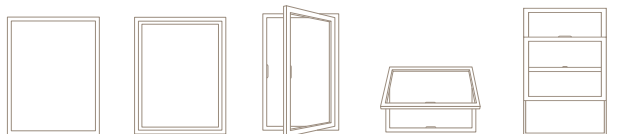

PICTURE  FIXED  CASEMENT  AWNING  SINGLE HUNG

QTY: \_\_\_\_\_ QTY: \_\_\_\_\_ QTY: \_\_\_\_\_ QTY: \_\_\_\_\_ QTY: \_\_\_\_\_



DOUBLE HUNG  GLIDER  BOW  BAY

QTY: \_\_\_\_\_ QTY: \_\_\_\_\_ QTY: \_\_\_\_\_ QTY: \_\_\_\_\_

**4** Choose your glass type (see page 12):

Dual Pane  Tri-pane

**5** Choose your glass coating (see page 13):

Low-E  SunStop

**6** Choose your exterior window colour (see page 18):

**PVC FRAME**



White  Wicker

**PVC BRICKMOULD EXTERIOR**



White  Wicker  Pebble  Slate  Canyon Clay

\*Actual colours may vary.

To get the perfect windows for your home, meet with an All Weather Windows authorized dealer for all your options.





## DID YOU KNOW?:

Replacing your windows and doors reduces your energy consumption by up to 16%.

## RECOGNIZING GOOD VALUE IN WINDOWS AND DOORS

With thousands of different windows and doors to choose from, how do you recognize good value? Look for products that have the CSA and ENERGY STAR® mark.

Products certified under CSA International's Windows and Doors Certification Program have been tested by experts and meet recognized standards for safety and performance. ENERGY STAR®, on the other hand, recognizes premium energy efficiency. Products that are ENERGY STAR® qualified save energy and money, while helping to protect the environment.

You can rest assured that our windows and doors are all CSA tested and ENERGY STAR® qualified, which means our products meet and exceed recognized standards for safety, performance and energy efficiency.



For more information visit  
[allweatherwindows.com](http://allweatherwindows.com)



Join the conversation: professional advice, share experiences, renovation tips, contest updates and more.