

# Mercedes-Maybach S-Class

Effective from 1 December 2018 Production.



MAYBACH





Impressive spaciousness, elegant design and high-quality materials create an unparalleled ambience, particularly in the rear. Characterised by exquisite materials using excellent handcrafting skills, the Mercedes-Maybach S-Class epitomises exclusivity and luxury.

For more information visit [www.mercedes-benz.co.uk](http://www.mercedes-benz.co.uk) or call 0333 222 0500.

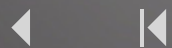

# Contents

Model prices	4
Mercedes-Maybach S 650 – Exterior	5
Wheel choices	8
Mercedes-Maybach S 650 – Interior	9
Upholstery and trim choices	12
Standard equipment	18
Driving Assistance package	23
First Class Cabin package	24
Business Telephony package	26
designo Leather package	27
Mercedes-Maybach Genuine Accessories	28
Mercedes-Maybach Collection	29
Colour choices	31
Trim and upholstery combinations	44
Technical data and dimensions	45
Road Fund Licence	48
Services and insurance	49

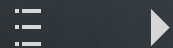
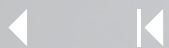

# Model prices



## Mercedes-Maybach S650

Petrol – 5,980 cc, 12-cylinder, 630 hp/463 kW,  
Transmission 7G-TRONIC PLUS, CO<sub>2</sub> 320 g/km<sup>1,\*</sup>

**Basic RRP  
excl. VAT**

£146,562.50

**Total RRP  
incl. VAT**

£175,875.00

**Vehicle Excise Duty (RFL)  
Band M first year rate<sup>2</sup>**

£2,070.00

**Rec. OTR  
price<sup>3</sup>**

£178,660.00

**P11D  
value**

£176,535.00

**BiK tax rate  
2018/19**

37%

**Vehicle Excise Duty (RFL)  
Band M premium rate**

£450.00

<sup>1</sup>The indicated values were determined according to the prescribed measurement method – Worldwide Harmonised Light Vehicle Test Procedure (WLTP). Figures shown may include options which are not available in the UK.

<sup>\*</sup>CO<sub>2</sub> figures have been converted into NEDC-equivalent values for use with the current VED and BIK tax legislation.

Figures shown are for comparability purposes; only compare with other cars tested to the same technical procedures. Figures may not reflect real life driving results, which will depend upon a number of factors including factory-fitted options, accessories fitted (post registration), variations in weather, driving styles and vehicle load. Further information about the test used to establish fuel consumption and CO<sub>2</sub> figures can be found at <http://www.mercedes-benz.co.uk/WLTP>

<sup>2</sup>A different first year rate of Vehicle Excise Duty (Road Fund Licence) applies for new cars. Please refer to page 48 for the relevant rate for the second and subsequent years

<sup>3</sup>The recommended on-the-road price includes the Road Fund Licence applicable to the standard model plus delivery charge (£635.00 incl. VAT), new vehicle registration fee (£55.00) and number plates (£25.00 incl. VAT). VAT is calculated at the standard rate of 20%

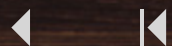

# Mercedes-Maybach S 650 – Exterior

The exterior design of the Mercedes-Maybach S-Class combines stylish poise and assurance with trailblazing exclusivity. The dramatic exterior lines convey an impression of power and dynamism. The prominent front end immediately asserts the ambition

to lead. The striking bonnet and sharply-defined headlight contours accentuate the high-tech character of the car. Its elegant looks are emphasised by the three twin louvres of the radiator trim in chrome complete with 'MAYBACH' lettering.

---

## Closing aid for doors and boot lid

When initially engaged, doors and boot lid are automatically closed by servo motors, ensuring smooth and virtually silent closing

## Doorhold system

Door mirrors – electrically operated, folding and heated

Exhaust system – with twin visible chrome-plated tailpipes

Heat-insulating, noise-insulating and infrared-reflecting laminated glass

**KEYLESS-GO Comfort package – KEYLESS-GO, remote boot closing and hands-free access**

Vehicle can be conveniently unlocked, started and locked, simply by carrying an electronic key. In addition, the convenient hands-free access function allows hands-off, fully automatic opening and closing of the boot lid by performing a kicking motion under the rear bumper – particularly useful when laden with luggage

LED rear lights

---



---

## MAGIC BODY CONTROL with Curve Tilting Function

Features a highly-sensitive sensor system that scans the road ahead for bumps or potholes and then adjusts the car's suspension accordingly. Curve tilting allows higher cornering speeds with reduced body lean, thereby improving cornering stability, thus creating high levels of comfort.

## MAGIC VISION CONTROL

Allows the driver the best possible visibility even during the wiping process. Washer fluid is sprayed directly in front of the wiper blades and wiped away without delay. A heating system effectively lowers the risk of icing up

## MULTIBEAM LED with ULTRA RANGE Highbeam

Enables quick, precise adjustment of the driving lights to the current road and traffic conditions. The light can always be switched on precisely where it is required via 84 individually controllable LEDs. Adaptive Highbeam Assist Plus as part of MULTIBEAM LED allows the continuous use of high-beam headlights, as illuminated vehicles which are detected and which might be dazzled are excluded from the cone of light. The range of the ULTRA RANGE Highbeam reaches up to 642 m.

## Panoramic sliding roof with MAGIC SKY CONTROL

Large panoramic roof changes from dark to transparent or vice versa within a few seconds. In its tinted state, it substantially reduces heating-up of the vehicle interior

---



---

**Parking package – Active Parking Assist with PARKTRONIC and 360° camera**

PARKTRONIC monitors front and rear while vehicle is being manoeuvred and warns the driver if risk of collision is detected. Active Parking Assist helps find appropriate parking slots and can also automatically manoeuvre the car in and out of perpendicular and parallel parking spaces

Privacy glass – from side windows of rear B-pillar round to rear window

Radiator grille – new Maybach-specific design with chrome vertical struts and 'MAYBACH' lettering

Rear fog light in LED technology, in the centre of the rear apron

Remote boot lid release

Run-flat tyres

Speed-sensitive steering with variable steering ratio

'V12' lettering on front wings

Windscreen wipers including rain sensor with two sensitivity stages

---







Mercedes-Maybach S 650 exterior. Optional feature shown: designo ruby black (lower colour)/aragonite silver (upper colour) (code C17)



# Wheel choices

Choose between multi-spoke alloy wheels painted in thulium silver; or, instead of delicate spokes, exclusive 10- or 20-hole forged alloy wheels (available at no additional cost), which underline the flagship model's high-quality look.



20" multi-spoke alloy wheels painted in thulium silver (code 13R)



20" multi-spoke alloy forged wheels high-gloss ceramic-polished (code R28)



20" forged alloy wheels (code R91)

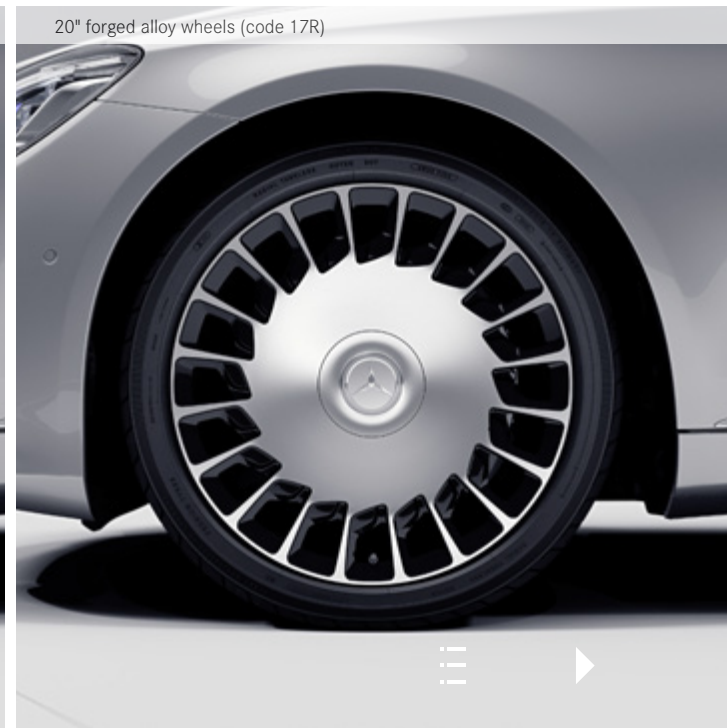

20" forged alloy wheels (code 17R)

---

**20" alloy wheels (4) (code 13R) – standard**  
Multi-spoke design painted in thulium silver  
front: 245/40 R20 tyres, rear: 275/35 R20 tyres

**20" alloy wheels (4) (code R28) – no-cost option**  
Multi-spoke forged in high-gloss ceramic-polished  
front: 245/40 R20 tyres, rear: 275/35 R20 tyres

**20" alloy wheels (4) (code R91) – no-cost option**  
Maybach 10-hole forged wheels  
front: 245/50 R20 tyres, rear: 275/35 R20 tyres

**20" alloy wheels (4) (code 17R) – no-cost option**  
Maybach 20-hole forged wheels  
front: 245/50 R20 tyres, rear: 275/35 R20 tyres

---

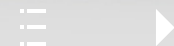
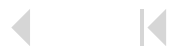



# Mercedes-Maybach S 650 – Interior

The interior of the Mercedes-Maybach S-Class indulges its passengers with a luxurious atmosphere of well-being. The cockpit impresses with its sophisticated, uncluttered design, an innovative control and display concept, and craftsmanship showing unerring attention to detail. Occupants of the Mercedes-Maybach S-Class travel in unsurpassed

comfort, relaxation and safety. Apart from ensuring excellent support, the luxurious seats offer six different massage settings. Memory functions for seats and headrests, as well as steering column and exterior mirrors can be stored and recalled at the touch of a button for up to three passengers.

---

12V sockets (4) – one in front and two in rear of centre console, and one in boot

#### AIR-BALANCE package

Premium scents are available to provide an individual atmosphere to suit your mood and taste. At the same time, a unique ionising and filtering process helps to enhance the air quality inside the cabin.

AGARWOOD MOOD is standard with the S-Class Maybach. A choice of high quality interior fragrances to suit personal preferences is available from Mercedes-Benz Accessories.

Ambient lighting – choice of 64 colour settings

Climatised front and rear seats including seat heating and ventilation

Cup holders – front (2) and rear (2)

Dual-bonded widescreen (12.3-inch) cockpit display with COMAND Online system

Electric roller sun blinds – rear window and rear side windows

---



---

Electric windows (4) with PRE-SAFE® closing function

#### ENERGIZING Comfort

Intelligent cross-linking of all comfort systems. Drivers can choose from six different expert-configured programs for activation and relaxation, depending on their personal needs.

Floor mats (4) – velour floor mats with ‘V12’ emblem

Replaced with designo floor mats when ordering the designo Exclusive semi-aniline leather

#### Front and Rear Seat Comfort package

Provides optimum lateral support by means of individually-controlled air chambers which inflate depending on steering angle, lateral acceleration and vehicle speed. Massage function has six different programs, with a choice of low- or high-intensity settings

#### Front and Rear Seat Memory package

Front seats, two outer rear seats, front head restraints, steering column and exterior door mirrors – electrically adjustable with memory and four-way lumbar support

Front centre armrest with embossed Maybach emblem

Diamond quilting replaces the embossed Maybach emblem when ordering the designo Exclusive semi-aniline leather

---



---

Garage door opener – integrated in rear-view mirror

For questions regarding compatibility please visit [www.homelink.com](http://www.homelink.com)

Glasses stowage compartment

Illuminated door sill panels with ‘MAYBACH’ lettering

Illuminated vanity mirrors in rear

IWC-design analogue clock

Map pockets on front and rear backrests

Parcel nets in boot and front passenger footwell

Reading lights – front and rear

Rear armrest including stowage compartment with cover  
Replaced by Business Console which extends from the front centre console through to the parcel shelf when ordering the optional First Class Cabin package

---







Brown burr walnut wood trim with IWC-design analogue clock



Illuminated door sill panels with 'MAYBACH' lettering

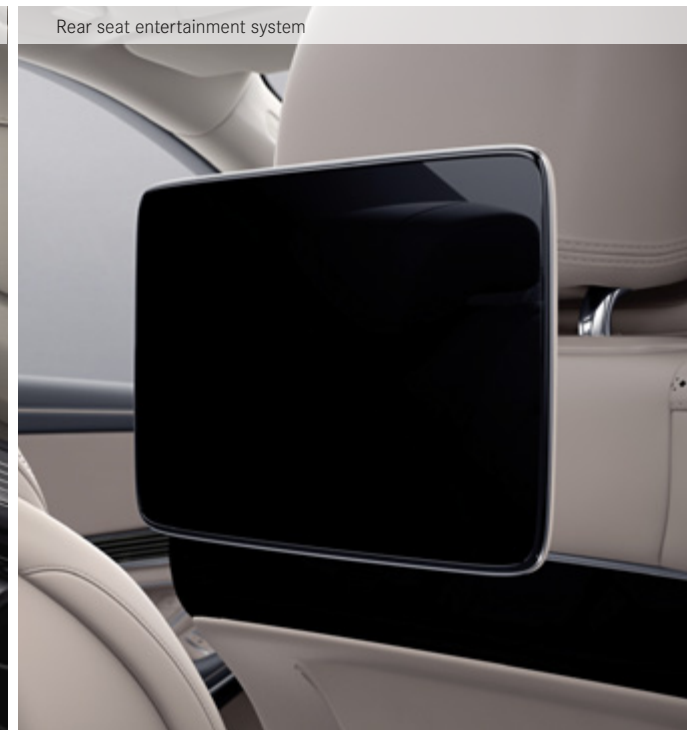

Rear seat entertainment system

---

#### Rear Seat Reclining package

EASY ADJUST luxury front head restraints; front seats with extended adjustment; reclining outer rear seats (up to 43.5°) and additional leg rest and footrest

Rear sill protector in stainless steel

Service indicator ASSYST

Smartphone integration with Android Auto and Apple CarPlay™

Steering column – electrically adjustable with EASY-ENTRY function

Steering wheel – 3-spoke multifunction sports steering wheel in wood/black nappa leather, with Touch Control buttons and with 'MAYBACH' lettering

Sun visors with illuminated vanity mirrors

THERMOTRONIC four-zone automatic climate control in the front and rear

#### Warmth Comfort package

Heatable armrests in front and rear; heated multi-function steering wheel

---



# Upholstery and trim choices

*designo*

The high-quality standard of the Mercedes-Maybach S-Class is impressively demonstrated in the material selection of the interior. There is the option to choose between designo Exclusive semi-aniline leather or Exclusive nappa leather.

## designo Exclusive semi-aniline leather features

Centre part of dashboard partially finished in quilted diamond pattern in silk beige nappa leather

designo velour floor mats with designo badge

Front and rear centre armrests in nappa leather with diamond quilting (rear only with First Class Cabin package)

Seat upholstery layout featuring an exclusive diamond design on the entire seat centre section upholstery buttons and Budapest piping

Upper part of the dashboard and beltlines in nappa leather with piping and contrasting topstitching

'V12' badge in the backrests of front and rear seats

## Exclusive nappa leather features

Front and rear centre armrests in nappa leather with contrasting topstitching

Seat upholstery layout with diamond design and contrasting topstitching

Upper section of instrument and door centre panels in nappa leather with contrasting topstitching

'V12' badge in the backrests of front and rear seats

Velour floor mats

designo Exclusive semi-aniline leather in silk beige/satin red pearl



Exclusive nappa leather in silk beige/espresso brown



# Upholstery choices – designo Exclusive semi-aniline leather

*designo*

It takes just a few carefully chosen ingredients to turn your Mercedes-Maybach S-Class into an individual work of art. designo Exclusive semi-aniline leather upholstery in silk beige combined with satin red pearl, titanium grey pearl or deep sea blue adds to a truly luxurious look. All colour options are available at no additional cost. All choices

feature a quilted diamond pattern repeated in the centre section of the dashboard, seats in designo Exclusive semi-aniline leather with diamond design detail to the entire seat centre section, upholstery buttons, Budapest piping and ‘V12’ badges.

designo Exclusive semi-aniline leather in silk beige/deep sea blue (code 962A)



designo Exclusive semi-aniline leather in silk beige/titanium grey pearl (code 965A)



designo Exclusive semi-aniline leather in silk beige/satin red pearl (code 975A)





## Upholstery choices – Exclusive nappa leather

Exclusive nappa leather makes an especially soft impression due to its smooth and natural surfaces, giving the interior that ‘feel-good’ factor. Exclusive nappa leather is available in six attractive colour options at no additional cost.





Exclusive nappa leather in black/black (code 501A)



Exclusive nappa leather in nut brown/black (code 514A)

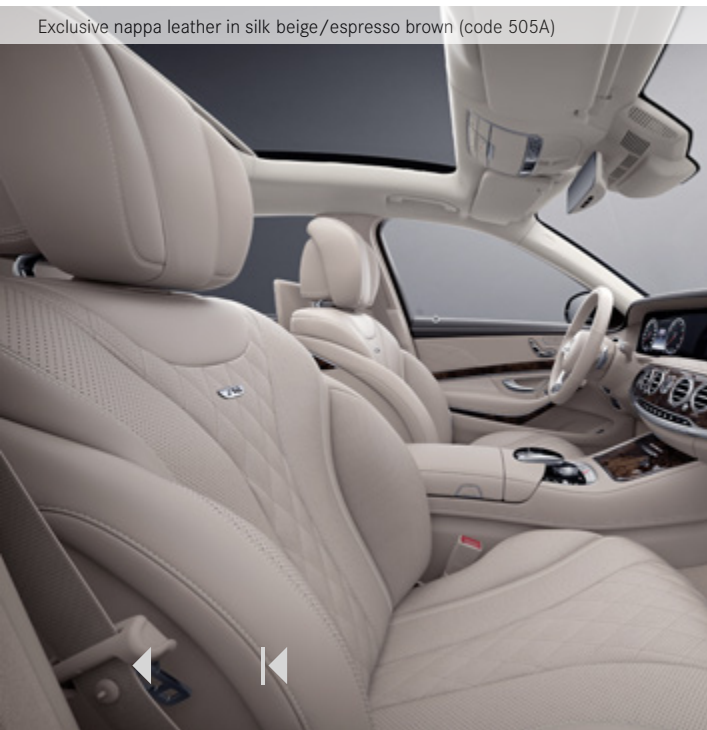

Exclusive nappa leather in silk beige/espresso brown (code 505A)

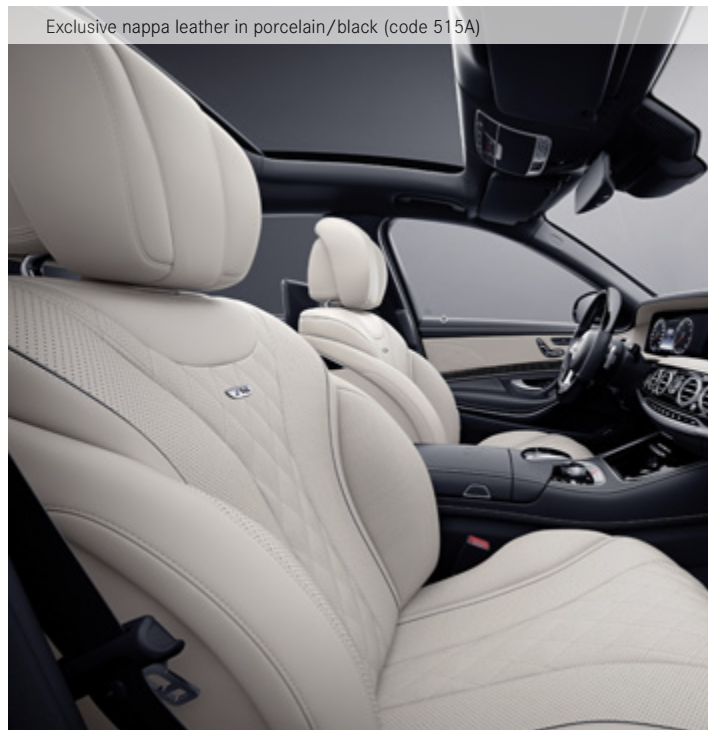

Exclusive nappa leather in porcelain/black (code 515A)

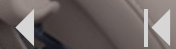



# Trim choices

Add eye-catching highlights to your Mercedes-Maybach S-Class, thanks to a carefully-selected range of high-quality light and dark wood trims as well as designo black piano lacquer. All trim choices are available as a no-cost option.



designo black piano lacquer flowing lines (code H16)



Brown burr walnut wood (code H29)

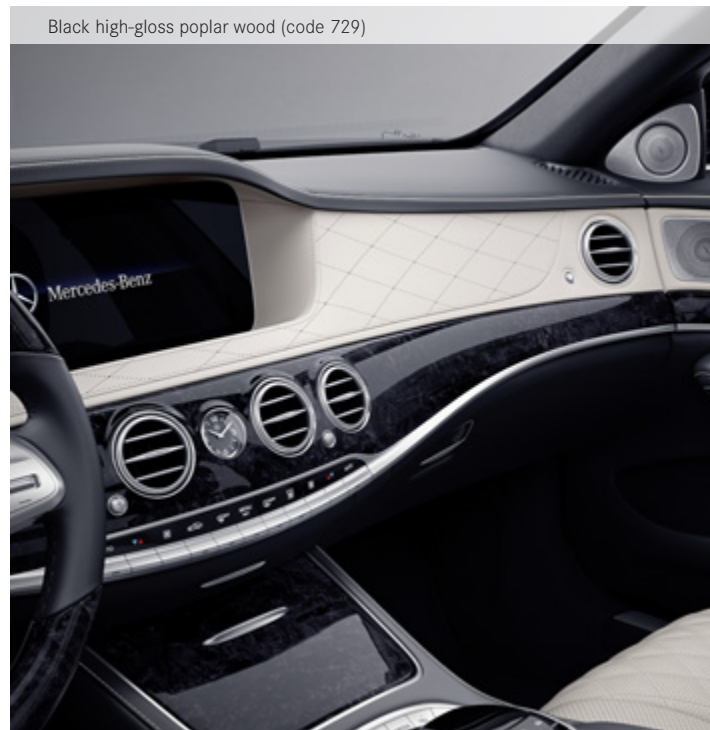

Black high-gloss poplar wood (code 729)

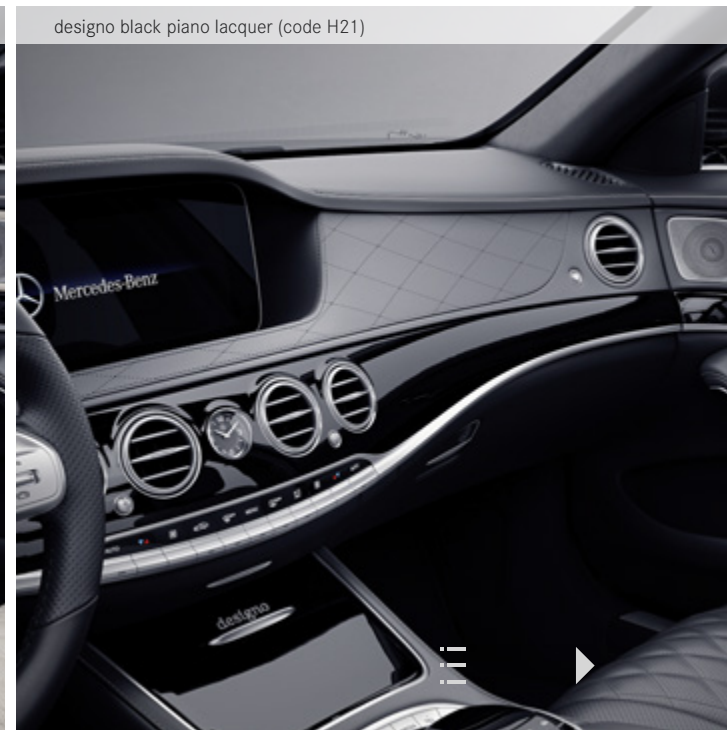

designo black piano lacquer (code H21)

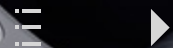

# Standard equipment

The term 'standard' hardly befits Mercedes-Maybach's level of equipment. It's hard to find a limousine with such a high degree of comfort and safety. The seats incorporate a wealth of features for your wellbeing. They are designed to offer the best support and maximum relaxation thanks to climatisation, as well as a Front and Rear Seat Comfort package. The two outer rear seats can be reclined up to 43.5°.

For an even brighter atmosphere inside the cabin, there is a panoramic sliding roof with MAGIC SKY CONTROL. All the while, the Burmester® high-end 3D surround sound system, TV tuner and TV rear entertainment system with two 10-inch screens, DVD player and wireless headphones answer all your audiovisual needs.

---

## Transmission and Suspension

7G-TRONIC PLUS 7-speed automatic transmission with steering column gear selector, DIRECT SELECT steering wheel gearshift paddles and SPEEDTRONIC cruise control

Direct Steering

ECO start/stop function

### MAGIC BODY CONTROL with Curve Tilting Function

This suspension system offers another milestone in driving comfort, detecting bad road surfaces in advance and reacting accordingly. The active damping system of the suspension works with a road surface scan to achieve this. A stereo camera captures a detailed picture of the conditions ahead which is then analysed to allow the system to decide how best to dampen each individual wheel to compensate for any uneven surfaces ahead – all in a split second. Curve tilting allows higher cornering speeds with reduced body lean, thereby improving cornering stability and thus creating high levels of comfort

---

## Paint, Trim and Upholstery

Metallic paint

Trim – designo black piano lacquer

### Upholstery – Exclusive Nappa Leather package

Armrests and lining of centre console in nappa leather with contrast stitching

Colour-contrast fluting on beltline

DINAMICA microfibre roof lining

Door panels with hand-stitched facings in nappa leather

Exclusive nappa leather upholstery

Extended trim parts: additional wood trim in door centre panels and rear air vent covers

Nappa leather upper dashboard with diamond-pattern perforations and contrast stitching

Perforated diamond pattern in continuation of front door armrests and in rear door seat function control panels

Seats in diamond pattern nappa leather with contrast stitching

---

## Security and Safety

Active bonnet – pedestrian safety measure

Adaptive brake lights

### ADAPTIVE BRAKE system

Including HOLD function, Hill-Start Assist, brake priming and dry braking in wet conditions

Airbags – driver and front passenger

Airbags – front and rear sidebags

Airbags – windowbags

Alarm system with immobiliser and interior protection (MBSS3)

Anti-lock braking system (ABS) with Brake Assist (BAS)

ATTENTION ASSIST – monitors steering and can help alert to long journey fatigue

Continuously analyses driver behaviour and steering movements. If patterns are recognised which characterise drowsiness, the driver is prompted to take a break, and an audible warning is sounded. At the same time COMAND Online offers to locate a rest stop





Embossed Maybach emblem on centre armrest

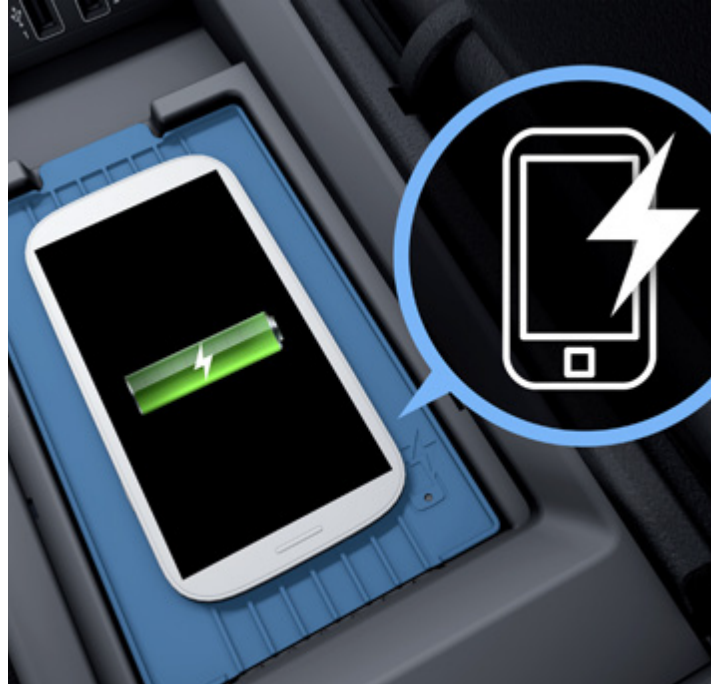

Wireless charging for mobile phones in the front



Front Seat Memory package



Panoramic sliding roof with MAGIC SKY CONTROL



Night View Assist Plus

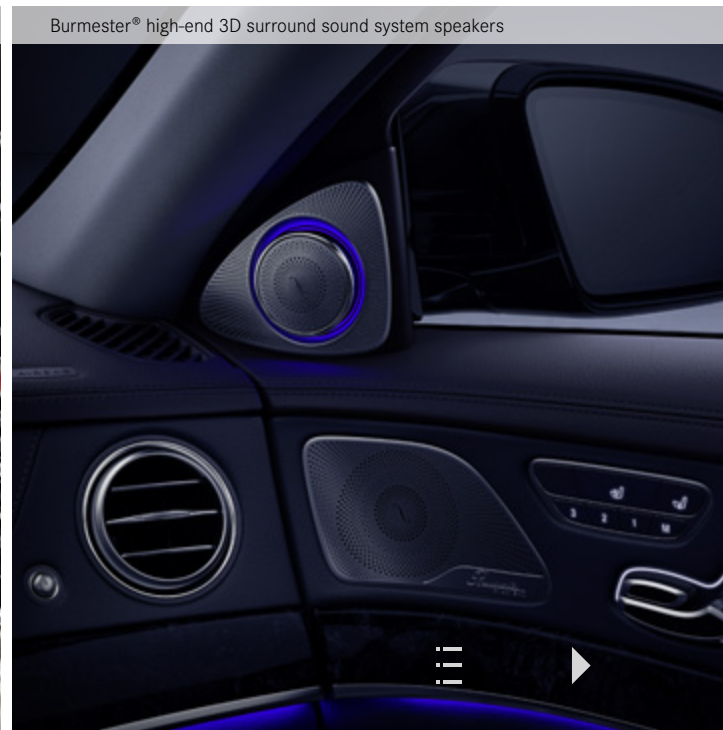

Burmester® high-end 3D surround sound system speakers

---

### Security and Safety (continued)

Automatic child seat recognition (ACSR) on front passenger seat for child seats with transponder specially approved by Mercedes-Benz

Automatically dimming rear-view mirror and driver's exterior mirror

Brake Assist (BAS) with brake servo assistance when emergency braking is detected

Brake pad wear indicator

Crosswind Assist

Detects sudden, strong gusts of wind and helps the driver stay in lane by means of targeted braking

Electric parking brake

Electronic Stability Programme (ESP®) with Acceleration Skid Control (ASR)

ESP® Curve Dynamic Assist

Especially when accelerating on bends, ESP® can ensure improved handling by detecting understeer and effecting a remedy through braking intervention

Exterior mirrors – electrically adjustable, folding and heated with projection of logo

First-aid kit

---

Front passenger seat with PRE-SAFE® positioning function

Headlight Assist – automatic headlight activation

Head restraints, rear (3) – outer two, electrically adjustable

Intelligent Rear Seat Belts package

Illuminated seat belt buckle extenders facilitate seat belt fastening on outer rear seats

Inflatable three-point seat belts with integrated belt bags on outer seats

i-Size and ISOFIX child restraint system (two outer seats)

Locking wheel bolts

Night View Assist Plus

Enables drivers to recognise pedestrians or larger animals earlier in the dark. They are clearly shown on the multifunction display of the instrument cluster. To do this the system illuminates the road ahead with two dazzle-free infrared lights. With the help of an infrared camera located behind the windscreen, the entire area within high beam headlight range is shown as a crystal-clear greyscale image. A thermal imaging camera in the radiator grille is able to give a precise warning by distinguishing between irrelevant objects such as traffic sign combinations or bushes and relevant objects such as pedestrians or large animals. The latter are highlighted in colour by small 'photo mounts'. The Spotlight function enables endangered pedestrians to be flashed at several times, so that the driver registers them even more quickly and the former recognise the danger

---

PRE-SAFE® anticipatory safety system

PRE-SAFE® Impulse

In the early phase of a crash, the front occupants are pulled away from the direction of impact and deeper into their seats by their seat belts

Rain-sensing wipers – two-stage

Rear seat belt status indicator

Remote central locking

Seat belts, rear (3) – three point

Seat belt pre-tensioners, belt force limiters and automatic belt height adjustment – front and outer rear seats

Traffic Sign Assist

The front-mounted camera detects speed limit warnings, no-overtaking signs and their cancellation, and shows them in the COMAND display. If a no-entry sign is detected and the driver disregards this, the systems emits a visual and acoustic warning as part of the no-entry warning function

Tyre pressure monitoring system

Warning triangle

---





Dual-bonded widescreen (12.3-inch) cockpit display with COMAND Online system



Head-up display



MAGIC VISION CONTROL – adaptive windscreen wiper system

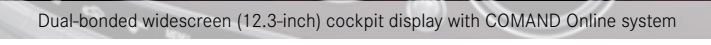

Touchpad and COMAND Online controller



Mercedes me connect

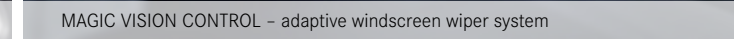

Privacy glass

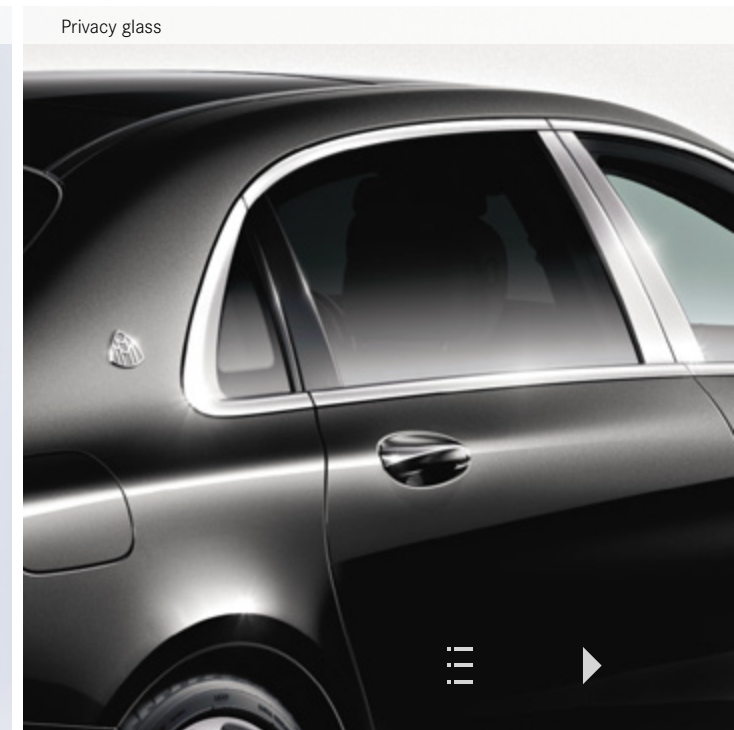
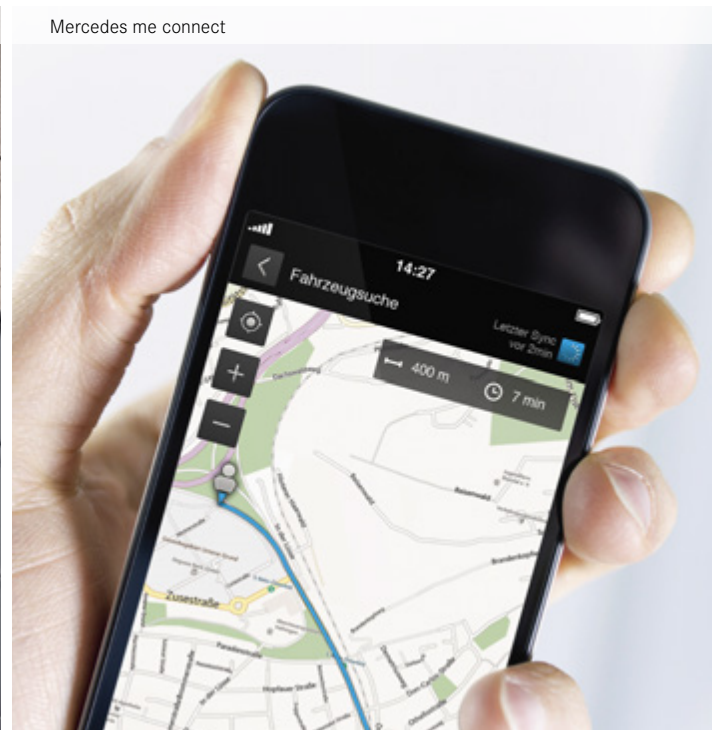

---

## Communications and In-Car Entertainment

Bluetooth® interface with high-definition call quality for hands-free telephony

### Burmester® high-end 3D surround sound system

26 speakers and 28-channel amplifier with total output of 1,590 W

Central controller dial to operate audio functions and telephone (when connected)

### COMAND Online system with Media Interface

Includes radio, 12.3-inch colour display, hard disk drive (HDD) navigation with 3D map display, Live Traffic Information and European map data updates free of charge for the first three years, Speed Limit Assist and LINGUATRONIC voice control. Integrated WLAN hotspot for onboard access of WLAN-enabled devices. Also includes SD memory card slot, 10 GB music register and MP3 compatibility. Media Interface allows connection and control of portable media devices (e.g. MP3 player, USB storage media)

COMAND Online remote control

DAB digital radio tuner

Digital operating instructions for COMAND Online

Dual-bonded widescreen (12.3-inch) cockpit display with COMAND Online system

---

## Head-up display – key driver information at a glance

A virtual image (approx. 21×7 cm) is projected into the driver's field of view, appearing to float above the bonnet approx. 2 m ahead. Both display height and content can be adjusted individually, while the information shown can be activated and deactivated according to your preference

### Mercedes-Benz emergency call system (eCall)

### Mercedes me connect (standard services)

Including emergency call system (eCall), accident recovery, breakdown management and maintenance management; Mercedes-Benz apps and in-car internet access for Facebook, internet radio, sending routes from Google Maps™ to the vehicle, news and weather reports; internet-enabled mobile phone required

### Rear seat entertainment system

Two 10-inch screens on rear seat backrests, DVD player, two sets of wireless headphones and remote control for COMAND Online system

---

## Smartphone integration – comprising Apple CarPlay™

Compatible iPhones (iPhone 5 and newer) can be integrated into the vehicle via Apple CarPlay™. Please check on [www.apple.com/uk/ios/carplay/](http://www.apple.com/uk/ios/carplay/) for compatibility and approved apps. Certain features and apps require a 3G or 4G data connection. Control of features available through voice control and controller on centre console

### Touchpad

### Voice amplification system

This innovative function makes it easier to communicate with the rear passengers from the front. The two microphones in the interior mirror are also used to pick up speech for the hands-free telephone system. These signals are then discreetly amplified depending on the amount of driving noise, and continuously adjusted for the speaker's volume and the ambient noise level

### Wireless charging system (front) for mobile devices

Charges mobile phones which support the Qi standard wirelessly on a charging surface, Near Field Communication (NFC) for quickly connecting to mobile phone

---



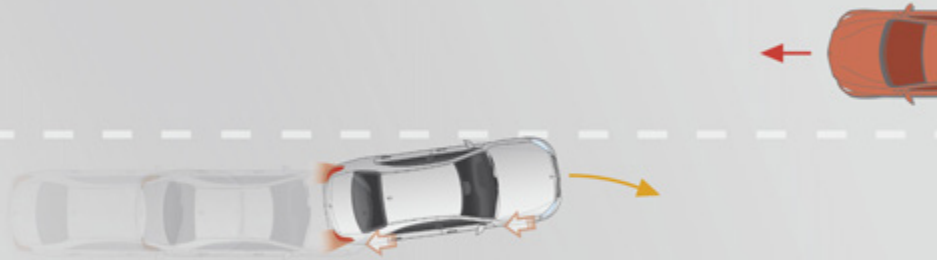

Active Lane Keeping Assist

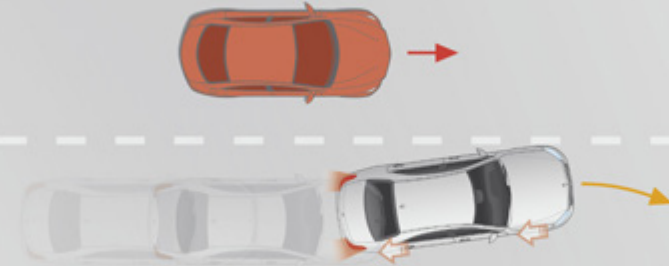

Active Blind Spot Assist

## Driving Assistance package (standard)

More comfort and less stress for the driver, and therefore more safety for all road users, for example by virtue of semi-automated driving, autonomous braking in certain

**Active Distance Assist DISTRONIC** controls the distance to vehicles in front up to a speed of 131 mph and if necessary brakes the vehicle with up to 50% of the maximum braking power

**Active Steering Assist** helps the driver keep the vehicle in the centre of its lane on straight stretches of road or slight bends. Reduces the risk of accidents and improves protection for both the occupants and other road users

**Active Speed Limit Assist** adopts speed limits detected automatically as the new set speed for Active Distance Assist DISTRONIC

**Active Braking Assist** with Cross-Traffic Function and Congestion emergency braking function can help to avoid or lessen the consequences of accidents with vehicles in front as well as crossing vehicles and pedestrians

**Evasive Steering Assist** is able to support the driver with making an evasive manoeuvre when, in a situation of danger, he/she decides to avoid a pedestrian who has been detected by the system

dangerous situations and active assistance during evasive and braking manoeuvres initiated by the driver.

**Active Blind Spot Assist** can warn the driver of vehicles in the blind spot during a lane change and can help to avoid a collision by means of one-sided brake application

**Active Lane Keeping Assist** can warn the driver when they unintentionally leave their lane and can use one-sided brake applications to help manoeuvre the vehicle back into its lane (including in the case of broken lane markings if there is a risk of collision)

**PRE-SAFE® PLUS** is able to initiate preventive measures to protect occupants against an impending rear impact, including warning traffic following behind, activating the seat belt tensioners or applying the brakes when the vehicle is stationary

**Route-based speed adaptation.** Adaption of speed before curves, roundabouts, junctions, toll roads. Allows for smoother and more accurate functionality of several driving assistant systems





Champagne flutes



Folding tables in the rear



Refrigerated compartment in rear

## First Class Cabin package

Business or pleasure, the First Class Cabin is at your service. Here, rear seat passengers can work or relax in complete luxury. Boot space is reduced by 40 litres.

### Champagne flutes

A drive in a quite exceptional vehicle can be celebrated in style with two high quality silver-plated champagne flutes

### Individual rear seats

The continuous Business Console transforms the rear into a mobile office. Two 12V sockets and temperature-controlled cup holders make for a comfortable travelling and working environment. The Business Console extends from the front centre console through to the parcel shelf

**First Class Cabin package (code DA9)** – designed and priced as a package, including items as listed.

Total incl. VAT £7,300.00

### Folding tables in the rear

With the two high-quality folding tables, the Business Console of the First Class rear suite can be converted into an office desk in seconds. The stowage trays provide space for a notebook or working documents

### Refrigerated compartment in rear

Elegantly integrated into the rear armrest and with a capacity of approx. 8.5 litres. Temperature can be set between approx. 4–15° C using two control switches







Individual rear seats

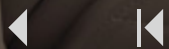



Rear wireless charging



Car telephony with sim card module

## Business Telephony package

Charging your smartphone has never been easier. With the Business Telephone package, mobile phones can be charged wirelessly.

**Business Telephony package (code DP6)** – designed and priced as a package, including items as listed.  
Total incl. VAT £900.00

### Business telephony in the rear

The Bluetooth® handset is integrated in the rear armrest, where it is clearly visible and ideally accessible. It is also charged automatically here. The system has its own hands-free zone in the rear and allows call transfer from the rear to the front and vice versa. A second telephone can also be connected

### Rear wireless charging

Wireless charging for numerous mobile phones that support or can be upgraded to support the Qi standard

### Car telephony with sim card module

Telephone module and SIM card reader in the glove compartment (permanently installed).  
Direct cable connection to the exterior aerial via a mobile communications transmission and reception unit integrated into the vehicle.  
LTE mobile telecommunications standard.  
Operation by coupling the mobile device via the Bluetooth® protocol SAP or by using the customer's vehicle SIM card.  
Hotspot availability as a result of using the customer's contract





Two MAYBACH cushions in the upholstery colour



designo nappa leather roof liner with topstitching and window frame trim in nappa leather in the upholstery colour

## designo Leather package

With high-grade touches of leather in the interior, the designo Leather package sets a luxurious and stylishly coordinated tone – from the instrument panel to the window frame trim and seat cushions to the designo nappa leather roof liner.

**designo Leather package (code U6 1)** – designed and priced as a package, including items as listed.

Total incl. VAT £13,150.00

---

### designo nappa leather roof liner with topstitching

Including leather-covered sunblinds, grab handles and A-, B- and C-pillars

Rear vanity mirrors leather-covered with diamond quilting

Finished in porcelain (75U) in vehicles with interior in silk beige/deep sea blue (962A), silk beige/satin red pearl (965A) or silk beige/titanium grey pearl (975A)

Front seat consoles on driver and front passenger sides in nappa leather in the upholstery colour

---

---

Side instrument panel covers on driver and front passenger sides in nappa leather in the upholstery colour

Two seat cushions in the upholstery colour, two-tone with border in diamond quilting and MAYBACH logo:

Finished in nappa leather with Exclusive nappa leather interior; or in designo Exclusive semi-aniline leather/nappa leather with designo Exclusive semi-aniline leather interior

Window frame trim at front (including triangular tweeters) and rear in nappa leather in the upholstery colour

---



# Mercedes-Maybach Genuine Accessories

We've developed a range of Accessories you can add to help personalise and enhance your Mercedes-Maybach S-Class. Your local Mercedes-Benz Retailer can advise on fitting costs of Accessories, where applicable. Further information on our full range of Genuine Accessories can be found on the Mercedes-Benz UK website.

## Style & Travel

The 'Style & Travel Equipment' components are simple to attach and remove. The modular system centres around a base support which can be combined with the product of your choice – coat hanger, universal hook or folding table

Base support £23.40 (incl. VAT)

Coat hanger £67.60 (incl. VAT)

Folding table £107.40 (incl. VAT)

Universal Hook £28.00 (incl. VAT)

## Champagne flute

Exclusive, solid silver-plated Robbe & Berking champagne flute for insert in the rear centre console

Total RRP £656.50 (incl. VAT)

## Flacon perfume atomiser, transparent/black

The interior of the vehicle can be fragranced individually to suit your tastes. Flacons for perfume atomiser, 15 ml. Available in a variety of fragrances.

Total RRP from £56.00 (incl. VAT)

Coat hanger



Champagne flute



Flacon perfume atomiser



# Mercedes-Maybach Collection

The Mercedes-Maybach Collection is a range of products bearing the famous Mercedes-Maybach insignia and is designed to the same high standards as our cars. You can expect to find the uncompromising quality and innovation for which Mercedes-Benz is best known in our Collection items. Further information can be found on [www.mercedes-benz.co.uk/collection](http://www.mercedes-benz.co.uk/collection)

## Business card wallet, black

With its three slip pockets, the black nappa lambskin lends the wallet a refined look with metal stud on the front, featuring the double M logo outlined in black. The back is embossed with MAYBACH lettering. Size approx. 10.5×7.0 cm

Total RRP £235.00 (incl. VAT)

## Key ring, black

This high-quality key ring in nappa leather and zamak alloy with MAYBACH lettering offers a strong visual appeal. The harmonious design is rounded off by a three-dimensional metal double M logo on the front

Total RRP £200.00 (incl. VAT)

## Cufflinks, black

The Maybach cufflinks are certain to round off your look to perfection. These black accessories in glass on silver rhodium complement any outfit. The design is completed by a sand-blasted double M logo on the front and engraved MAYBACH lettering on the back

Total RRP £327.00 (incl. VAT)

Business card wallet



Key ring



Cufflinks



**Business bag, black**

The practical bag in black calfskin offers space for numerous documents and has an attractive look, rounded off with beige topstitching, an embossed double M logo on the front, MAYBACH lettering on the back and four metal studs. It features a two-way zip fastening, and various compartments inside and a pocket for documents outside of the bag. The detachable, adjustable and padded leather shoulder strap ensures optimum carrying comfort. Size approx. 38 × 41 × 10 cm

Total RRP £4,213.50 (incl. VAT)

**Holdall, black**

The travel bag in calfskin offers space for everything that's important with two main and several internal compartments. Among the design features of the bag is a padded inner compartment that makes it easy to securely carry a notebook or important documents. The adjustable carrying strap made from the original material of the Mercedes-Maybach seat belts makes it possible to adjust the bag to fit for comfortable carrying. You can also fasten the bag to a trolley case. Size approx. 56 × 28 × 32 cm

Total RRP £1,999.00 (incl. VAT)

Business bag



Holdall



# Colour choices – metallic paints

The highly durable nature of the Mercedes-Benz paint system makes it one of the best clear coats available in the automotive industry. Metallic paint finishes are all available at no additional cost.

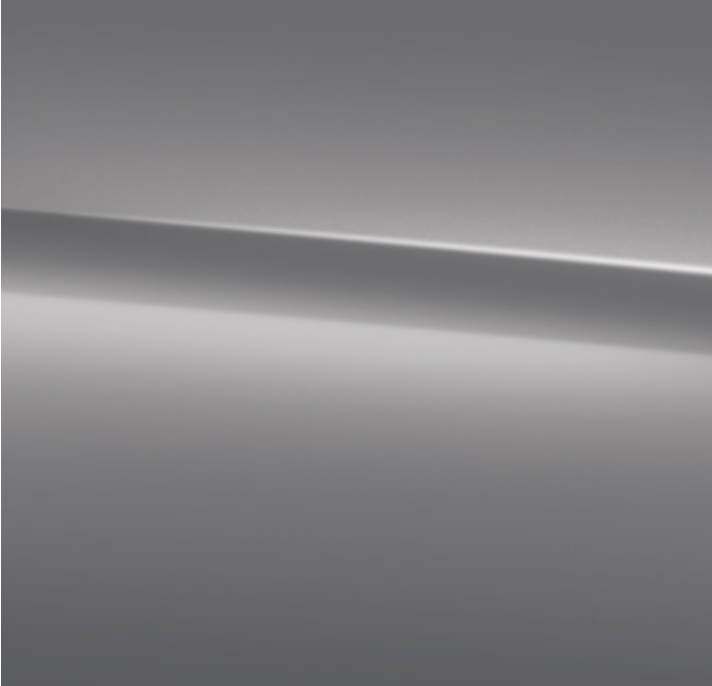

selenite grey (code 992U)

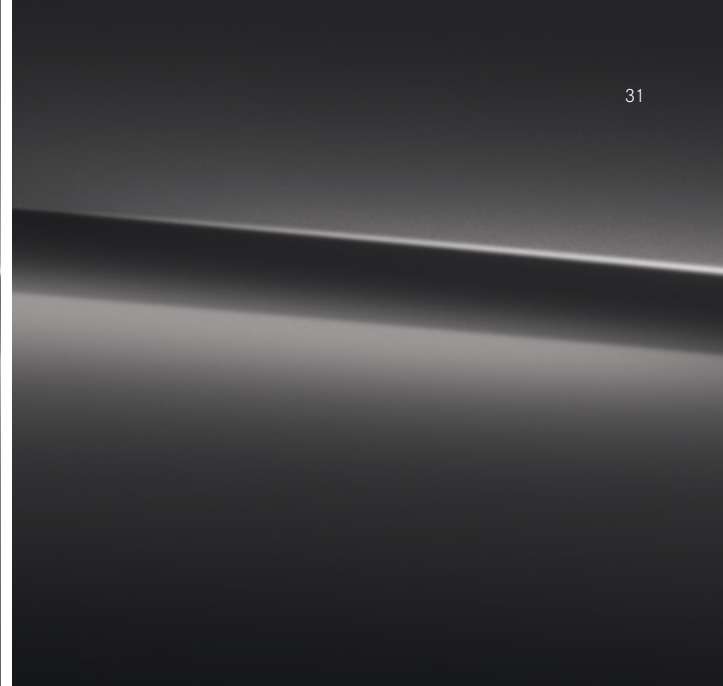

obsidian black (code 197U)



magnetite black (code 183U)

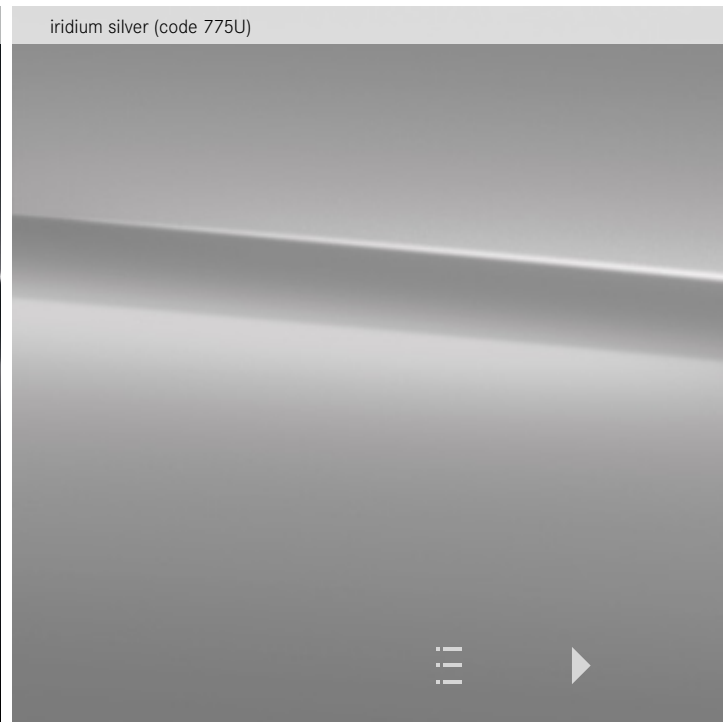

iridium silver (code 775U)

Please note that, owing to limitations of on-screen representation, paint colours may differ from those shown



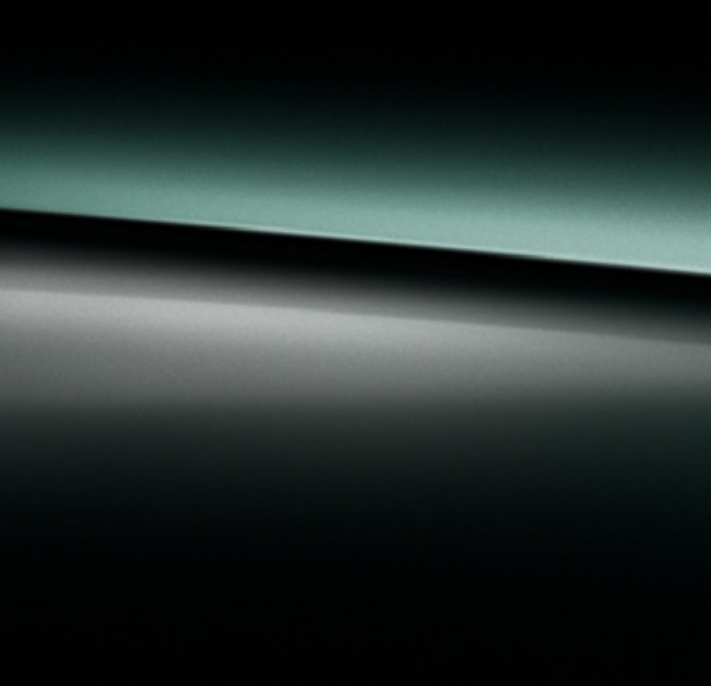

emerald green (code 989U)

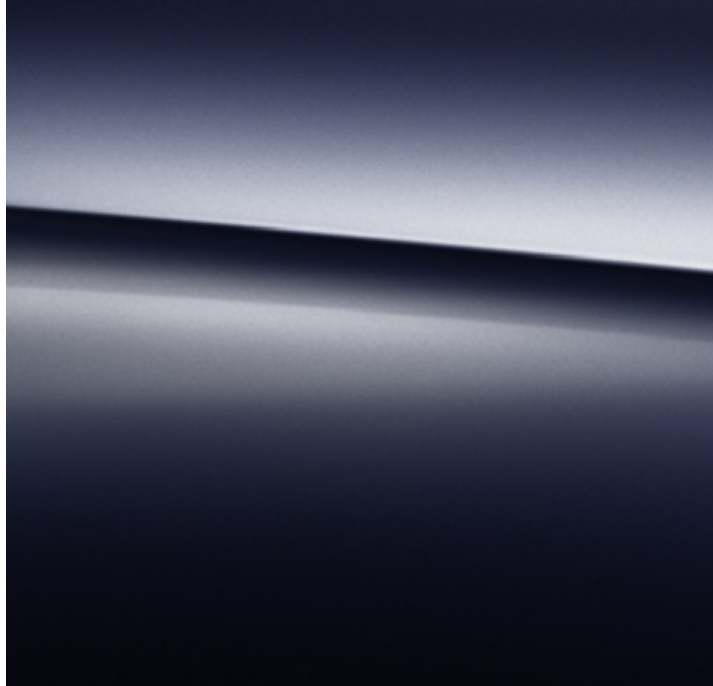

cavansite blue (code 890U)

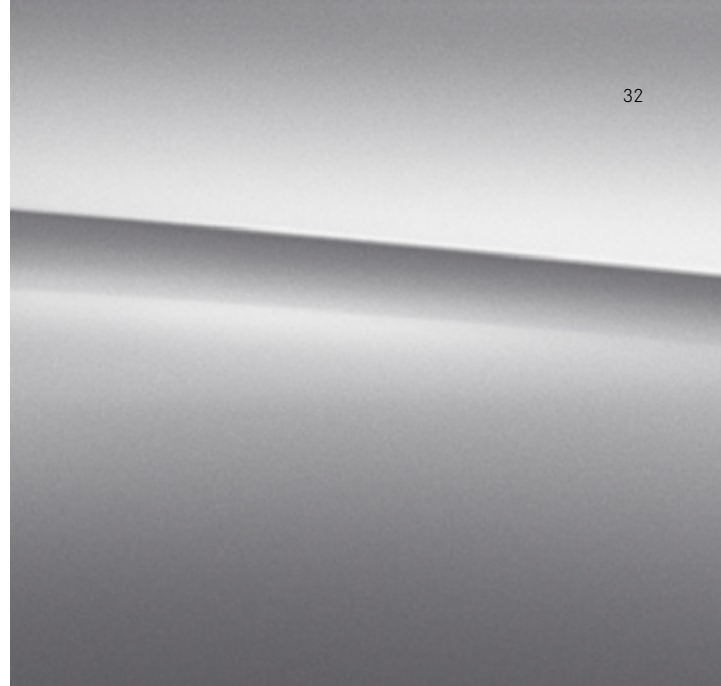

diamond silver (code 988U)



diamond white (code 799U)

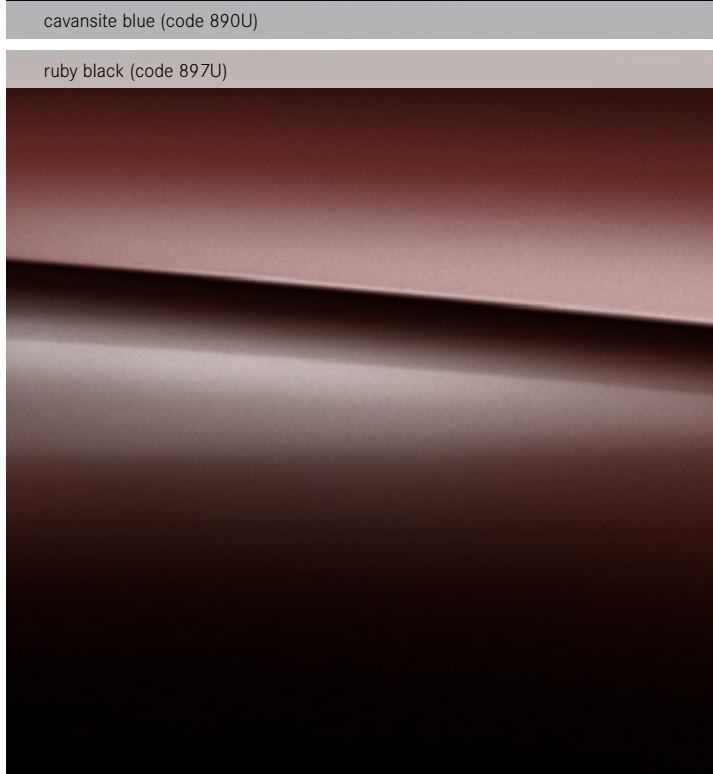

ruby black (code 897U)

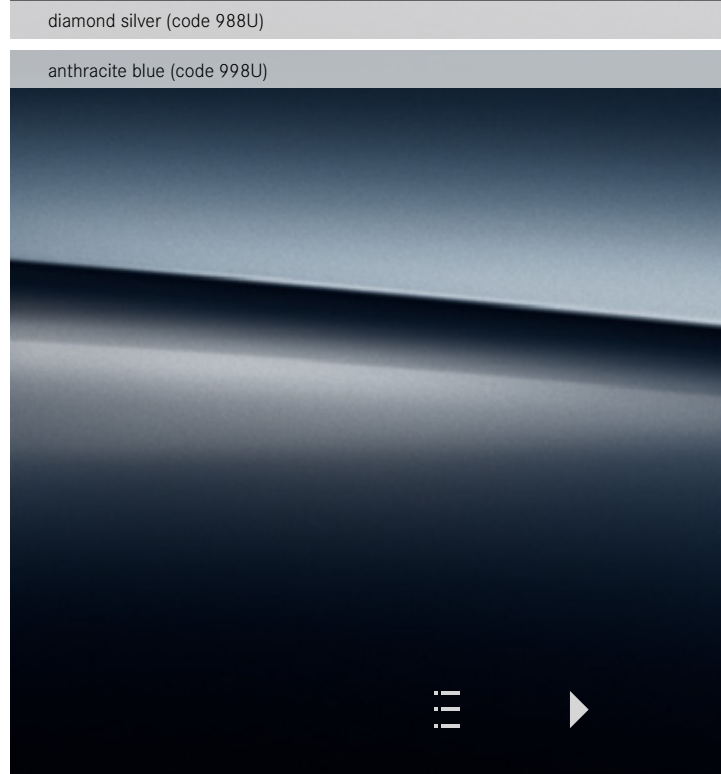

anthracite blue (code 998U)



## Colour choices – designo paint

An extra degree of exclusivity is guaranteed with designo's paint finish, which is available at additional cost.

designo magno cashmere white<sup>1</sup> (code 049U)

Basic RRP £2,250.00 (excl. VAT)

**Total RRP £2,700.00 (incl. VAT)**



<sup>1</sup>designo magno matt paint finish requires extra care. Please refer to the Owner's Manual for instructions. Please note that, owing to limitations of on-screen representation, paint colours may differ from those shown.



## Colour choices – designo two-tone paints

The designo two-tone exterior paint features two coats for a mesmerising piano lacquer effect with a striking impression of depth. Available in nine dark colour combinations, at additional cost, the second bodywork coat is applied by hand by highly skilled varnishers at the Mercedes-Maybach Manufaktur.

Basic RRP £10,666.67 (excl. VAT)

**Total RRP £12,800.00 (incl. VAT)**





designo selenite grey (lower colour)/iridium silver (upper colour) (code C10)





designo magnetite black (lower colour)/selenite grey (upper colour) (code C11)





designo obsidian black (lower colour)/selenite grey (upper colour) (code C12)





designo obsidian black (lower colour)/iridium silver (upper colour) (code C13)





designo obsidian black (lower colour)/aragonite silver (upper colour) (code C14)





designo anthracite blue (lower colour)/aragonite silver (upper colour) (code C15)







designo emerald green (lower colour)/aragonite silver (upper colour) (code C16)

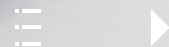
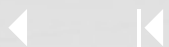



designo ruby black (lower colour)/aragonite silver (upper colour) (code C17)





designo ruby black (lower colour)/obsidian black (upper colour) (code C18)



# Trim and upholstery combinations

	Exclusive nappa leather				designo Exclusive semi-aniline leather		
	black (501A)	silk beige/ espresso brown (505A)	nut brown/black (514A)	porcelain/black (515A)	silk beige/ satin red pearl (975A)	silk beige/ titanium grey pearl (965A)	silk beige/ deep sea blue (962A)
<b>Dashboard</b>							
Steering wheel	black	silk beige	black	black	silk beige	silk beige	silk beige
Upper dashboard trim	black	espresso brown	black	black	satin red pearl	titanium grey pearl	deep sea blue
Centre dashboard trim	black	silk beige	nut brown	porcelain	silk beige	silk beige	silk beige
Lower dashboard trim	black	silk beige	black	black	silk beige	silk beige	silk beige
<b>Seats</b>							
Seat cushion centre section	black	silk beige	nut brown	porcelain	silk beige	silk beige	silk beige
Side bolster trim	black	silk beige	nut brown	porcelain	silk beige	silk beige	silk beige
Head restraint	black	silk beige	nut brown	porcelain	silk beige	silk beige	silk beige
Contrast stitching	black	silk beige/ espresso brown	nut brown/black	porcelain/black	silk beige/ satin red pearl	silk beige/ titanium grey pearl	silk beige
Seat belt	black	silk beige	nut brown	black	silk beige	silk beige	silk beige
<b>Doors</b>							
Door trim at beltline	black	espresso brown	black	black	satin red pearl	titanium grey pearl	deep sea blue
Door centre panel	black	silk beige	nut brown	porcelain	silk beige/ satin red pearl	silk beige/ titanium grey pearl	silk beige
Lower door trim	black	silk beige	black	black	silk beige	silk beige	silk beige
<b>Roof lining</b>	black	porcelain	black	black	porcelain	porcelain	porcelain
<b>Parcel shelf</b>	black	espresso brown	black	black	satin red pearl	titanium grey pearl	deep sea blue
<b>Floor covering</b>							
Front and rear	black	silk beige	black	black	silk beige	silk beige	silk beige
Boot	black	black	black	black	black	black	black

# Technical data

Petrol engine		
<b>Model</b>	S 650	
<b>Engine</b>		
Capacity	cc	5,980
Arrangement/cylinders/valves	V/12/36	
Power <sup>1</sup>	hp (kW) at rpm	630 (463)/5,000
Torque <sup>1</sup>	Nm at rpm	1,000/2,300-4,200
<b>Transmission</b>		
7G-TRONIC PLUS	●	
<b>Performance</b>		
	auto.	
Acceleration 0-62 mph	sec	4.7
Top speed	mph	155 <sup>2</sup>
<b>Weights and capacities</b>		
	auto.	
Kerb weight <sup>3</sup>	kg	2,360
Perm. Gross Vehicle Weight	kg	2,820
Boot capacity	l	500
Fuel tank capacity/of which reserve	l	80/8
Turning circle	m	12.9

● Standard

<sup>1</sup>Figures according to Directive 80/1269/EEC in the currently applicable version <sup>2</sup>Electronically limited <sup>3</sup>Figures according to Directive 92/21/EC (kerb weight with fuel tank 90% full, driver, 68 kg, and luggage, 7 kg) for standard-specification vehicles. Optional extras and accessories will generally increase this figure and reduce the payload capacity accordingly <sup>4</sup>All figures are based on a standard specification with the smallest tyre size <sup>5</sup>The choice of wheels and transmission may affect CO<sub>2</sub> emissions and corresponding Road Fund Licence

<sup>6</sup>The indicated values were determined according to the prescribed measurement method - Worldwide Harmonised Light Vehicle Test Procedure (WLTP). Figures shown may include options which are not available in the UK

\*CO<sub>2</sub> figures have been converted into NEDC-equivalent values for use with the current VED and BIK tax legislation.

Figures shown are for comparability purposes; only compare with other cars tested to the same technical procedures. Figures may not reflect real life driving results, which will depend upon a number of factors including factory-fitted options, accessories fitted (post registration), variations in weather, driving styles and vehicle load. Further information about the test used to establish fuel consumption and CO<sub>2</sub> figures can be found at <http://www.mercedes-benz.co.uk/WLTP>

Petrol engine		
<b>Model</b>	S 650	
<b>Fuel consumption</b> <sup>4,5,6</sup>		
	mpg	auto.
Combined (consumption dependent on chosen optional equipment)	l/100 km mpg	14.1-14.5 20.0-19.5
<b>CO<sub>2</sub> emissions</b> <sup>5,6,*</sup>		
	g/km	auto.
Emissions standard	EU6	
20" alloy wheels - code 13R	320	
20" alloy wheels - code R28	320	
20" alloy wheels - code R91	320	
20" alloy wheels - code 17R	320	
<b>Insurance</b>		
Group rating	tba	
Insurance ratings may vary depending on model line and specification. Please refer to <a href="http://www.thatcham.org/abigrouprating/">http://www.thatcham.org/abigrouprating/</a> for further details		



# Dimensions

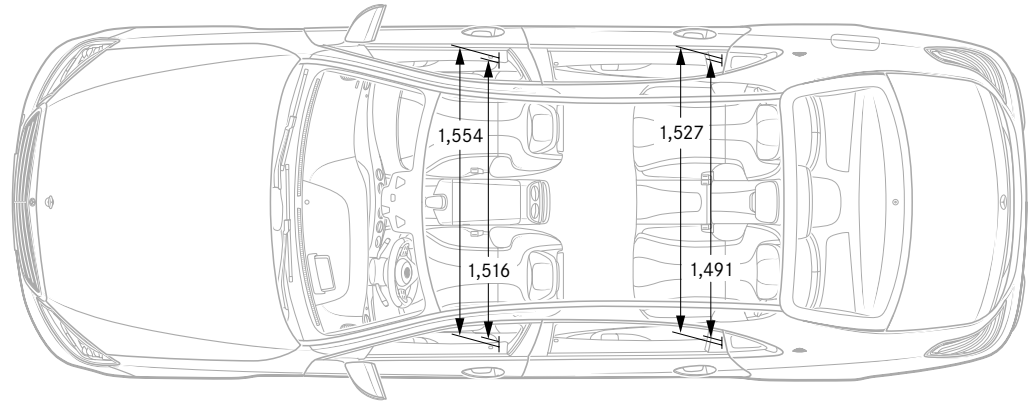
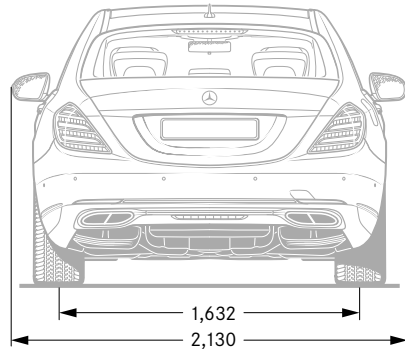
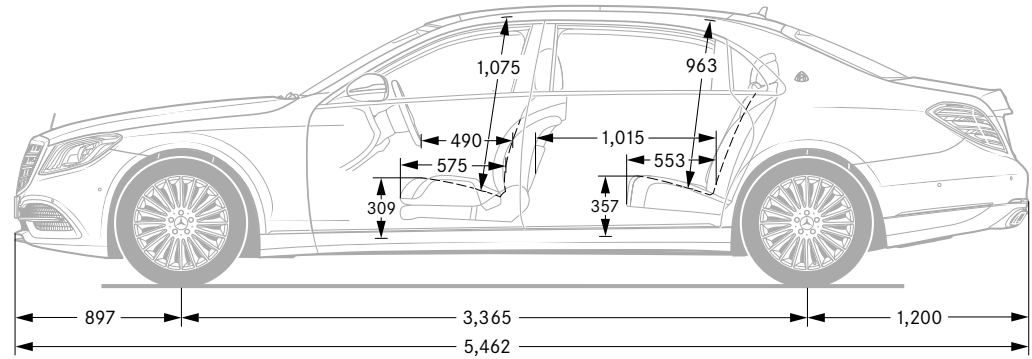
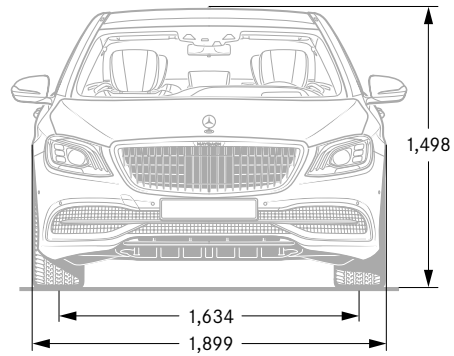

All measurements in millimetres. The dimensions shown are mean values and apply to standard-specification, unladen vehicles. Dimensions may vary slightly depending on the engine. Please consult your Retailer for further information. The figures on pages 45–46 are correct at time of publication. Please refer to the government website for latest data – <http://www.dft.gov.uk/vca>



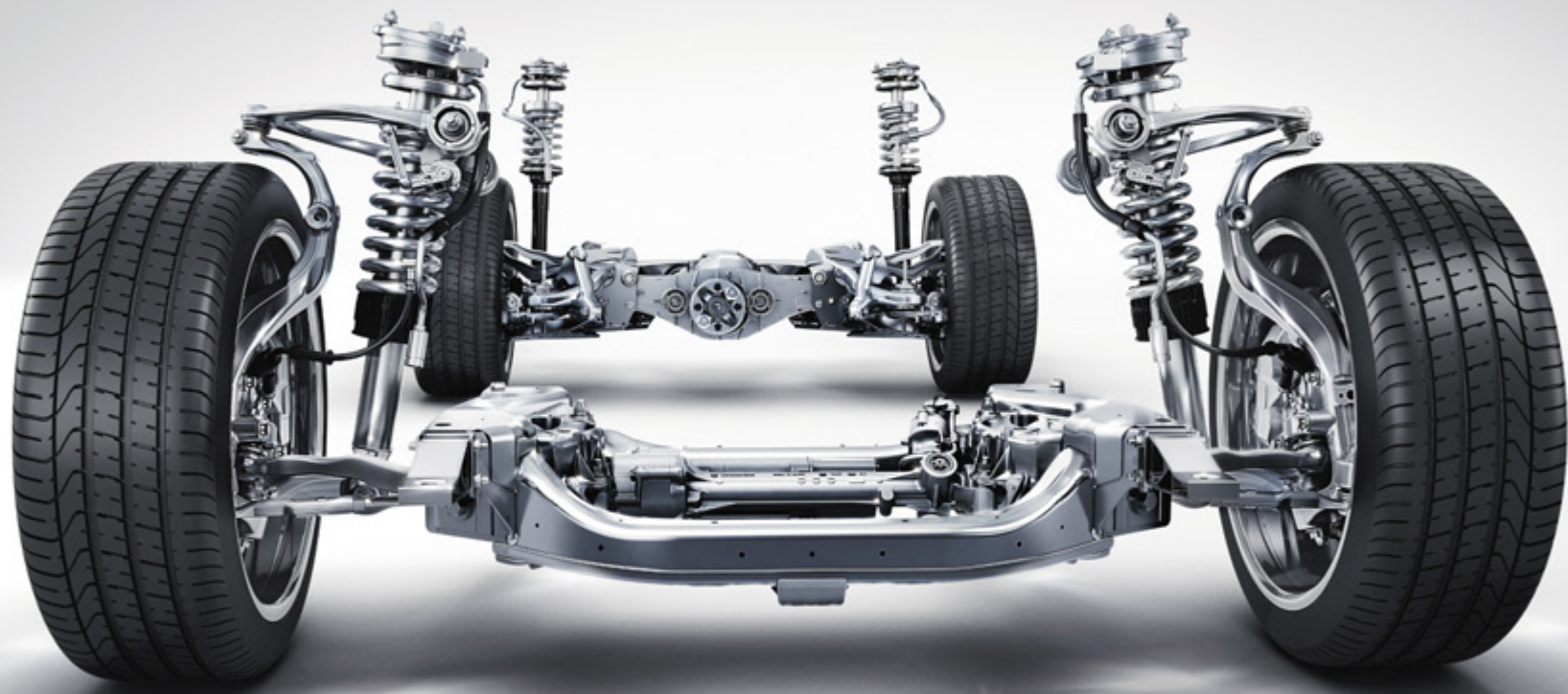

MAGIC BODY CONTROL detects bad road surfaces in advance and reacts accordingly. The active damping system of the suspension works with a road surface scan to achieve this

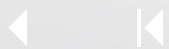

## Road Fund Licence

All road vehicle registrations are subject to Vehicle Excise Duty (Road Fund Licence), which varies in accordance with the vehicle's CO<sub>2</sub> emissions.

A first year rate for each taxation band will apply. The table below shows the bands (A–M) created by the DVLA and the corresponding Road Fund Licence CO<sub>2</sub> emissions are listed in the technical data on page 45, and the relevant Excise Duty is reflected in the on-the-road prices on page 4.

Band	CO <sub>2</sub> emissions	First year rate (£)	First year rate diesel (£) <sup>1</sup>	Standard rate (£)	Premium rate (£) <sup>2</sup>
A	0 g/km	0.00	0.00	0.00	310.00
B	1 to 50 g/km	10.00	25.00	140.00	450.00
C	51 to 75 g/km	25.00	105.00	140.00	450.00
D	76 to 90 g/km	105.00	125.00	140.00	450.00
E	91 to 100 g/km	125.00	145.00	140.00	450.00
F	101 to 110 g/km	145.00	165.00	140.00	450.00
G	111 to 130 g/km	165.00	205.00	140.00	450.00
H	131 to 150 g/km	205.00	515.00	140.00	450.00
I	151 to 170 g/km	515.00	830.00	140.00	450.00
J	171 to 190 g/km	830.00	1,240.00	140.00	450.00
K	191 to 225 g/km	1,240.00	1,760.00	140.00	450.00
L	226 to 255 g/km	1,760.00	2,070.00	140.00	450.00
M	over 255 g/km	2,070.00	2,070.00	140.00	450.00

<sup>1</sup>Premium rate only applicable to vehicles where the list price is over £40,000 including any factory-fitted options, standard UK delivery charge, number plates, fuel and VAT

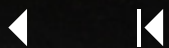



# Services and benefits

## Mercedes-Benz ServiceCare

We believe that servicing costs should be as flexible and affordable as possible for your Mercedes-Maybach S-Class, which is why we offer ServiceCare.

With ServiceCare we guarantee the price of parts and labour for up to four services and safeguard against further inflation. It also covers the cost of all recommended service items including brake fluid, spark plugs, air filters, fuel filters and screen wash.

You can choose either to add your servicing costs into your monthly spend or pay the full amount in a one-off payment, giving you peace of mind that they are taken care of for the period of the plan.

## Warranty and breakdown cover

Every Mercedes-Benz comes with a three-year unlimited mileage warranty against manufacturing or material defects<sup>1</sup> and up to 30 years warranty against perforation due to corrosion from the inside out.<sup>2</sup> What's more, it's also covered by Mercedes-Benz Roadside Assistance – a unique package comprising up to 30 years pan-European breakdown assistance.<sup>2</sup>

## Insurance

Since our name is synonymous with reliability, who better to trust with your motor insurance? Mercedes-Benz Insurance provides a motor insurance policy specifically designed to give you the cover you would expect from Mercedes-Benz. For a motor insurance quotation, call **0345 600 2180**.\*

<sup>1</sup>Applies to vehicles sold by Mercedes-Benz in the UK to its franchised Retailers <sup>2</sup>Subject to full Terms and Conditions, dependent on date of registration, available upon request Mercedes-Benz Motor Insurance is underwritten by Aviva Insurance UK Limited. Credit provided, subject to status, by Mercedes-Benz Financial Services UK Ltd, MK15 8BA \*For joint protection, calls may be recorded and/or monitored. All calls charged at local rate. We may decline to quote in some circumstances





Effective from 1 December 2018 Production. Information correct at time of publication.

Prices and specifications are subject to change without prior notice.

MBX222PL/0119

Mercedes-Benz Cars UK Limited, Tongwell, Milton Keynes, MK15 8BA. Company number 2448457 [www.mercedes-benz.co.uk](http://www.mercedes-benz.co.uk)

