

---

# *Leavenworth Papers*

---

Number 24

## **Forging the Ninth Army-XXIX TAC Team The Development, Training, and Application of American Air-Ground Doctrine in World War II**

by Christopher M. Rein, Ph.D.



**Combat Studies Institute Press  
US Army Combined Arms Center  
Fort Leavenworth, KS**

Cover Image: *Thunder in the Ardennes*, by Anthony Saunders, Oil on Canvas, 2015. Artwork licensed from the Military Gallery Wendover, Bucks, United Kingdom.

# *Forging the Ninth Army-XXIX TAC Team*

*The Development, Training, and  
Application of American Air-Ground  
Doctrine in World War II*



Christopher M. Rein, Ph.D.



Combat Studies Institute Press  
An Imprint of Army University Press



## Library of Congress Cataloging-in-Publication Data

Names: Rein, Christopher M., author. | Army University Press (U.S.), issuing body.

Title: Forging the Ninth Army-XXIX TAC Team : the development, training, and application of American air-ground doctrine in World War II / by Christopher M. Rein.

Other titles: Development, training, and application of American air-ground doctrine in World War II

Description: Fort Leavenworth, Kansas : Army University Press, 2019. |

Includes bibliographical references.

Identifiers: LCCN 2019015107 | ISBN 9781940804606

Subjects: LCSH: United States. Army Air Forces. Tactical Air Command, 29th--History. | United States. Army. Army, 9th--History. | United States.

Army--Aviation--Ground support--History--20th century. | United States.

Army Air Forces--Ground support--History. | Close air support--History--20th century. | World War, 1939-1945--Aerial operations, American. | World War, 1939-1945--Campaigns--Western Front.

Classification: LCC D790.244 .R45 2019 | DDC 940.544973--dc23 | SUDOC D

110.2:T 11 LC record available at Caution-<https://lcn.loc.gov/2019015107>

2019



Army University Press publications cover a variety of military history topics. The views expressed in this Army University Press publication are those of the author(s) and not necessarily those of the Department of the Army or the Department of Defense. A full list of Army University Press publications is available at: <http://www.armyupress.army.mil/Books/>.

The seal of the Army University Press authenticates this document as an official publication of the Army University Press. It is prohibited to use the Army University Press' official seal on any republication without the express written permission of the Director of the Army University Press.

Editor  
Michael L. Hogg

## Foreword

40 years ago, the Combat Studies Institute published the first Leavenworth Paper, Robert A. Doughty's *The Evolution of US Army Tactical Doctrine, 1946-1976*. That publication inaugurated a series of studies designed to address the issues most pressing to the Army. The Leavenworth Papers were distinguished by their acute analysis rooted in rigorous research and a well-developed understanding of how military organizations operate. The series remains vital to today's professional dialogue, demonstrating how rigorous historical inquiry can facilitate the understanding of military operations, in all their complexity and variety.

Christopher M. Rein's *Leavenworth Paper 24: Forging the Ninth Army-XXIX TAC Team* is an excellent addition to the series. This new study looks deeply into how the US Army implemented air-ground operations in northwest Europe after Operation Overlord. Based heavily on the personal papers of key leaders, unit reports, and other primary sources, *Forging the Ninth Army-XXIX TAC Team* shows how the Army trained, organized, and employed its air-ground teams in 1944 and 1945. Relying heavily on experimentation, testing, and objective assessment, the Army and its air forces successfully created organizations and practices that by 1945 often proved decisive on the battlefield.

As Dr. Rein's study points out, this success was not inevitable. Army leaders entered World War II convinced their air-ground teams were prepared for modern mechanized warfare. After costly failures early in the war, these men revised doctrine and introduced new training techniques. This account of clear-eyed adaptation and innovation then serves as a contemporary call for continued improvement in the training and application of air-ground doctrine, in ways that might mirror the US Army's experiences in World War II. *Leavenworth Paper 24*, like the other studies in the series, offers critical insights from the Army's past that can illuminate the challenges of today.

Donald P. Wright  
Deputy Director  
Army University Press



*For Dr. Adrian Lewis, for providing yet another example of successful ground-air coordination, and for the Soldiers and Airmen of Ninth Army and XXIX TAC.*





## Table of Contents

Foreword.....	iii
Introduction.....	1
Chapter 1—The Development of Air-Ground Doctrine, 1914-1944.....	7
Chapter 2—Stateside Doctrinal Development, 1940-1943 .....	25
Chapter 3—Training to New Doctrine, 1942-1944 .....	45
Chapter 4—Getting Together: Ninth Army and XXIX TAC in Brittany, July-October 1944.....	69
Chapter 5—Queen and the Ardennes, November-December 1944 .....	97
Chapter 6—Operation Grenade: Closing up to the Rhine, January-February 1945 .....	127
Chapter 7—Operation Flashpoint and the Ruhr, March-April 1945 .....	155
Conclusion .....	179
Bibliography .....	185



## Illustrations

Figure 1.1. Cartoon illustrating the AAF’s prioritization of close air support.....	9
Figure 1.2. British Communications for an Air Support Control .....	19
Figure 2.1. Aerial photograph of detraining area in Jasper, TX during Louisiana Maneuvers .....	26
Figure 2.2. Simulated attack by A-20 during maneuvers.....	33
Figure 2.3. Induction of the National Guard into Federal Service, September 1940-June 1941 .....	34
Figure 2.4. Ground forces receive instruction during maneuvers.....	38
Figure 3.1. Primary Army Maneuver Areas During World War II .....	46
Figure 3.2. Form for requesting air support used during 1943 Louisiana Maneuvers....	49
Figure 3.3. Liason aircraft during maneuvers .....	50
Figure 3.4. Lt. Gen. William H. Simpson and XII Corps Staff during Tennessee Maneuvers, October 1942.....	53
Figure 3.5. Chief of Staff Gen. George Marshall, Maj. Gen. William H.H. Morris, of XVIII Corps, and Lt. Gen. William Simpson during 1944 maneuvers in Louisiana .....	56
Figure 3.6. Divisions Assigned to Ninth Army and Stateside Maneuvers.....	60-61
Figure 4.1. US Ninth Army Operations in Brittany, 1-12 August 1944.....	70
Figure 4.2. Lt. Gen. Lewis H. Brereton awards the Air Medal to XXIX TAC Chief of Staff Col. Dyke Meyer.....	73
Figure 4.3. Lt. Gen. William H. Simpson and Brig. Gen. Richard E. Nugent.....	76
Figure 4.4. Ninth Army Operations in the Reduction of Brest .....	79
Figure 4.5. Bomb damage in Brest .....	84
Figure 4.6. German commanders at the surrender of Brest .....	86
Figure 4.7. Squadrons Assigned to XXIX TAC .....	90

Figure 5.1. Ninth Army Operations in Operation Queen.....	101
Figure 5.2. Panels marking the front lines of the Ninth US Army on 16 November 1944.....	103
Figure 5.3. Bomb damage in Julich in Operation Queen.....	104
Figure 5.4. Combined Ninth Army and XXIX TAC Headquarters, Maastricht, Netherlands .....	109
Figure 5.5. Comparison of air effort and ground losses during Operation Queen .....	112-113
Figure 5.6. Lt. Gen. William H. Simpson, Gen. Sir Bernard Montgomery, and Lt. Gen. Omar Bradley .....	119
Figure 6.1. Ninth US Army in Operation Grenade .....	128
Figure 6.2. Gen. Montgomery was a frequent visitor at Ninth Army Headquarters during Operation Grenade .....	138
Figure 6.3. Ninth Army vehicles negotiating flooded streets along the Roer River .....	141
Figure 6.4. Simpson earned well-deserved recognition for Ninth Army’s efforts to close up to the Rhine River .....	149
Figure 7.1. Ninth Army Operations Across the Rhine, March-May 1945 .....	156
Figure 7.2. P-47s provide close air support in Marienau, Germany .....	168
Figure 7.3. (Front) Ground commanders Simpson, Patton, Bradley, Hodges, Gerow; (Back) air commanders Nugent, Weyland, Vandenberg, Stearley, May 1945 .....	170
Figure 7.4. Lt. Gen. William H. Simpson thanks Brig. Gen. Richard E. Nugent for air support provided by XXIX TAC to Ninth Army .....	173

## Introduction

The combination of American ground and air power in the European Theater of World War II remains one of the most successful examples of air-ground cooperation in recorded history. By the spring of 1945, the US Army had four numbered field armies (First, Third, Seventh, and Ninth) with three allied armies (First Canadian, Second British, and First French) in an unbroken line from Switzerland to the North Sea. Each field army had an assigned tactical air command (IX, XIX, XII, and XXIX, respectively) with fighter-bombers and tactical reconnaissance aircraft assigned to provide direct support on the battlefield. 9th Air Force also had a strong force of twin-engined medium bombers, while the Strategic Air Forces (US 8th and RAF Bomber Command), which had already significantly degraded both the *Luftwaffe* and German industrial capacity, also stood ready to support the ground forces. Under the combined weight of this offensive, and along with a massive Soviet effort to the east which mirrored the western allies in its emphasis on tactical support aircraft, the Allies crushed the German military in the field and ended the terror of Hitler's Third Reich.

Since the war's end, historians have debated the relative merits of various aspects of Allied strategy and force allocation. Was the Mediterranean theater a diversion or essential preparation? Should the western Allies have advanced on Eisenhower's "broad front," or adopted Montgomery's "single thrust" across the North German Plain? And what did strategic bombing actually accomplish? Sustained analysis and critique of airpower on the battlefield is often lost in these debates. After being almost forgotten in the wake of the war, when nuclear weapons appeared to make large-scale ground combat impossible, the topic received a resurgence in attention beginning in the mid-1980s with Dan Mortensen's path-breaking work.<sup>1</sup> During that decade, ground and air commanders sought studies of successful cooperation to buttress their ideas about AirLand Battle, the US Army doctrine that helped resuscitate the service in the wake of the Vietnam War and provided an organizing construct for the eventual victory in Iraq in 1991.<sup>2</sup> That conflict appeared to vindicate airpower's decisive role on the battlefield, leading to additional studies through the 1990s, including the two seminal works on American tactical airpower in World War II.

Thomas Hughes' dissertation on Maj. Gen. Elwood R. "Pete" Quesada, completed at the University of Houston in 1994 and published the following year by The Free Press as *Overlord: General Pete Quesada and the Triumph of Tactical Air Power in World War II*, highlights the role of tactical airpower and General Quesada's contributions as the commander of IX Tactical Air Command (TAC). Soon afterward, David Spires authored a study of Brig. Gen. Otto P. Weyland of XIX TAC and that organization's support for Lt. Gen. George Patton's Third Army, published as *Air Power for Patton's Army: The XIX Tactical Air Command in the Second World War* by the Air Force History and Museum Program in 2002. Since that time, studies of Allied tactical air power in World War II have continued to proliferate on both sides of the Atlantic, with Ian Gooderson's *Air Power at the Battlefront*, and, most recently David Ian Halls' *Strategy for Victory* chronicling the RAF experience, with Thomas Griffith's *MacArthur's Airman* providing much needed perspective from the Pacific theater.<sup>3</sup> With other scholars filling in around the edges, it appears that the story of tactical airpower in World War II is becoming well-chronicled.

But several aspects have escaped historians' attention thus far. While Hughes' work expertly traces tactical developments in theater, by following Quesada's career, it misses much

of the innovation that occurred stateside. In the headquarters of the Army Ground Forces and Army Air Forces, planners coordinated and wrote doctrine, while the Army Air Force's School of Applied Tactics in Orlando, Florida, tested and refined it. While ground forces built the massive organization and trained infantrymen, armor crews and artillerymen, aircrews perfected their craft at various training bases, such as the reconnaissance school house at Key Field, near Meridian, Mississippi. Finally, in the maneuver areas across the country, ground and air forces finally came together to validate the doctrine and train to the new concepts. Hughes' book also ends shortly after the Ardennes offensive, omitting the final campaign when airpower was most effective. Spires' work covers the final offensive in a single chapter but likewise begins in 1944, with the Allied armies poised for a breakout from Normandy.

This study seeks to explore the roots of the successful innovation by examining the development of air ground doctrine, the early failures and efforts to revise it in the Mediterranean theater, and the stateside maneuvers that trained the bulk of the Army's higher-number infantry divisions originally from the National Guard and Reserves that carried much of the load in 1944 and 1945. The book is organized chronologically, beginning in Chapter One with air-ground developments in the Great War and interwar period, including a trans-national approach that builds on important work by Rich Muller, now a colleague of Hughes' at the School of Advanced Air and Space Studies.<sup>4</sup> Chapter Two explores in detail the effort to revise the doctrine found wanting in North Africa, while Chapter Three covers efforts to implement this new air-ground doctrine in the large-scale maneuvers that each division completed prior to deploying, building on Chris Gabel's important work on AGF training.<sup>5</sup>

But the true test of doctrine, as well as of equipment, training and organization comes in the crucible of combat. Rather than re-examine the experiences of First and Third Army, both of which are expertly covered in Hughes' and Spires' works, respectively, and require no revision, I have chosen to analyze Lt. Gen. William Hood Simpson's Ninth Army, and Brig. Gen. Richard Nugent's associated XXIX TAC as a case study of how well the later-mobilized divisions performed in their first tests in combat. Many of the units that composed Ninth Army had the benefit of training under doctrine revised after the North African campaign and fully implemented in the Tennessee, Louisiana, and California-Arizona Maneuver areas. The ground units participating in these exercises had robust air support, compared to early maneuvers, and these divisions and squadrons had the opportunity to practice integration before being committed to combat. Ninth Army's successes in combat, first in the siege of Brest, covered in Chapter Four, then in Operation Queen, the drive to the Roer River, detailed in Chapter Five, demonstrate that Ninth Army was able to quickly and effectively integrate new units into the existing system. The reduction of the Atlantic coast fortress of Brest featured static, urban warfare, unlike what Patton's armored units were experiencing in their breakout across France, but far more relevant to the upcoming battles around Aachen and the Ruhr Valley. American planners again attempted to use heavy bombers, as they had in Operation Cobra, to blast an opening through the German defenders and into the Rhine Valley. But Operation Queen failed miserably in this regard, though it did secure a jumping-off position for the push to the Rhine, as high casualties and attritional combat that wore down successive formations in both Ninth and First Army marred the campaign. Here weather and logistics difficulties hampered air operations, depriving ground forces of essential cover and support.

After the interruption of the “Battle of the Bulge” in the Ardennes, which both Ninth Army divisions and XXIX TAC squadrons played an instrumental role in blunting, the combined headquarters took the lead when the Allies resumed the offensive. In Operation Grenade, covered in Chapter Six, they crossed the Roer River and closed up to the Rhine and then, in Operation Flashpoint, the subject of Chapter Seven, they crossed the Rhine, encircled the Ruhr, and reached the Elbe River, the agreed-upon demarcation line between the western Allies and the Soviets. In the breakout into the Ruhr Valley and encirclement of Germany’s primary industrial area the Ninth Army-XXIX TAC team demonstrated exemplary coordination in tactical reconnaissance, interdiction, and close air support, having largely won the contest for air superiority over the battlespace. As such, this campaign provides a clear example of the desired end-state of air-ground coordination, and offers suggestions for how airpower and ground forces might again be employed on an urban battlefield in central Europe. In each of these four campaigns, the Ninth Army-XXIX TAC team continued to modify the employment of airpower to meet the army’s needs and built upon the solid foundation laid during maneuvers in the hills of Tennessee, swamps of Louisiana, and the deserts of Arizona and California.

This study hopes to help answer several questions of vital importance to ground force commanders, including how to best integrate the efforts of air and ground forces, and how military organizations learn, and implement those lessons during wartime. It should be of particular use to an organization such as the US Army’s Combined Arms Center, charged with developing and implementing combined-arms doctrine across the Army and understanding how theater-derived lessons are best collected, tested and implemented in stateside training establishments. Thus it offers direct benefits to both warfighters and trainers in helping them succeed in their vital tasks and offers to inform both practitioners as well as doctrine writers and trainers in preparing the United States for any future armed conflict.

The book builds on the work of earlier historians who have focused on the training process for American divisions in World War II and the employment of tactical airpower in Northwest Europe in 1944-1945. Chris Gabel’s excellent work on the Army Ground Force’s (AGF) Louisiana and Carolina maneuvers of 1941 demonstrates how critical these early, nascent maneuvers were for preparing the Army for war.<sup>6</sup> Unfortunately, he provides only brief coverage of the intensive training period that followed, the development of additional training areas, and the continued improvement in the quality of the exercises conducted there through 1944, when most divisions finally deployed overseas. David Spires’ work *Air Power for Patton’s Army* still serves as the model study of the air-ground team during the Allied drive through France and into Germany. Pete Mansoor’s work, *The GI Offensive in Europe: The Triumph of American Infantry Divisions, 1941-1945*, details the process by which the AGF successfully mobilized, trained and equipped American infantry divisions during World War II, though often with an emphasis on the manpower policies that saw multiple divisions built, stripped for cadres for other units—in some cases several times—and then rebuilt for employment.<sup>7</sup> Training, and re-training, was a vital part of this process, as all but a handful of divisions completed the required maneuver period prior to overseas deployment, testing its ability to effectively combine with other branches, including armor, artillery, and aviation before decisively engaging in western Europe. Mansoor found that, “Huge maneuver areas located across the United States allowed the Army to conduct sustained large-scale, multidivision maneuvers for the first time in its history. Facilities and training improved as mobility progressed and reached a peak in early 1944 as the Army prepared for the invasion of

France.”<sup>8</sup> I extend this argument to trace the development of air-ground training from its initially inadequate state, for a variety of reasons, including untested doctrine, insufficient forces available for training, and technological limitations that inhibited close coordination, to argue for the later effectiveness of these exercises in building robust air-ground teams.

In his work *Closing With the Enemy: How GIs Fought the War in Europe, 1944-1945*, Michael Doubler chronicled the remarkable rehabilitation of close air support, from the failures on D-Day to the successes of the breakout in late July. Like Thomas Hughes, he credits one man, Maj. Gen. Elwood “Pete” Quesada, with almost single-handedly bringing about this remarkable transformation.<sup>9</sup> By virtue of his young age, Quesada outlived many of his contemporaries and thus enjoyed the last word on the rehabilitation of tactical airpower, but this influence has led to an overemphasis on his theater-derived solutions at the expense of the longer, more thorough and, I argue, more important work that took place in the stateside training establishment from 1942-1944. Doubler concluded, “the hard-earned improvements and lessons learned in Normandy put the air-ground component of the combined arms team on solid ground for the remainder of the war,” which is certainly true, but his focus on the two short months in Normandy conceals the important work that occurred elsewhere.<sup>10</sup>

Research on this project began while I served as an Associate Professor at the Air Command and Staff College, during which time I was able to access many of the records of XXIX TAC and its assigned squadrons, as well as General Nugent’s Diary, at the Air Force Historical Research Agency. Through a generous Minerva Research Grant, provided to faculty of Professional Military Education schools, I was able to spend several weeks at the National Archives in College Park, Maryland, working in the Ninth Army’s records, including a number that had been “lost in the stacks,” and only catalogued in 2013. I also worked briefly at the Library of Congress in the Hoyt Vandenberg Papers and at the Army Heritage and Education Center in Carlisle, Pennsylvania, in the Alvan Gillem, Jr. Papers. After moving to CSI, another generous research grant enabled me to return to Carlisle and examine General Simpson’s Papers in detail, as well as those of his Chief of Staff, James E. Moore. At Fort Leavenworth, the Combined Arms Research Library has been a treasure trove of World War II records, and I appreciate Elizabeth Dubuisson’s patient response to many requests to examine documents housed there.

I remain grateful for the support of the Combat Studies Institute, Army University Press, especially the Deputy Director, Dr. Donald Wright, for his support of this project, and to Col. Katherine Guttormsen for her exemplary leadership during the time when it was completed. Brig. Gen. Scott Efflandt, as Provost, Army University and Lt. Gen. Michael Lundy, as Commanding General, Combined Arms Center, ensured the press had the robust support it requires to produce this and other projects and studies. Finally, I must thank Dr. Adrian Lewis, who provided a very successful example of coordination between the ground and air forces, when he agreed to serve as my dissertation advisor at the University of Kansas. I remain grateful for his guidance and mentorship throughout the process of learning the historian’s craft and in serving as a civilian historian for the Army. But without the sacrifices of the soldiers and airmen of the Ninth Army and XXIX TAC almost 75 years ago, we would not have a successful example of air-ground coordination to study and provide both guidance and inspiration as we work to prepare for our nation’s next test, which we earnestly hope will never come, but will find us prepared to meet it if it does. It is to the soldiers of Ninth Army and the airmen of the XXIX Tactical Air Command, that this volume is dedicated.



## Notes

1. Daniel R. Mortensen, ed., *Airpower and Ground Armies: Essays on the Evolution of Anglo-American Air Doctrine, 1940-1943* (Maxwell AFB, AL: Air University Press, 1998).
2. See James Kittfield, *Prodigal Soldiers: How the Generation of Officers Born of Vietnam Revolutionized the American Style of War* (New York: Potomac Books, 1997), among others.
3. Ian Gooderson, *Air Power at the Battlefield* (London: Frank Cass, 1997); David Ian Hall, *Strategy for Victory: The Development of British tactical Air Power, 1919-1943* (Westport, CT: Praeger, 2008); and Thomas E. Griffith, *MacArthur's Airman: General George C. Kenney and the War in the Southwest Pacific* (Lawrence, KS: University Press of Kansas, 2017).
4. Richard Muller, "Close Air Support: The German, British, and American Experiences, 1918-1941," in Williamson Murray and Allan Millet, *Military Innovation in the Interwar Period* (Cambridge, UK: Cambridge University Press, 1996).
5. Christopher Gabel, *The US Army GHQ Maneuvers of 1941* (Washington, DC: Center of Military History, 1991).
6. Gabel.
7. Peter R. Mansoor, *The GI Offensive in Europe: The Triumph of American Infantry Divisions, 1941-1945*. (Lawrence, KS: University Press of Kansas, 1999).
8. Mansoor, 12.
9. Thomas Hughes, *Overlord: General Pete Quesada and the Triumph of Tactical Air Power in World War II* (New York: The Free Press, 1995).
10. Michael Doubler, *Closing with the Enemy: How GIs Fought the War in Europe, 1944-1945* (Lawrence, KS: University Press of Kansas, 1994), 71.



## Chapter 1

### The Development of Air-Ground Doctrine, 1914-1944

From the inception of the aerial weapon, interested parties, from statesmen charged with protecting their country's strategic interests down to the soldiers and airmen responsible for fighting the battles have, debated the proper use of the airplane in warfare. For most of the first thirty years, prior to the development of the intercontinental bomber and the atomic weapon, the most pressing issues revolved around incorporating the airplane into existing combat units, both on land and at sea. World armies and navies recognized the airplane's potential as a reconnaissance asset and for correcting artillery fire, either on enemy ground formations or warships. But the airplane's ability to supplement or supplant heavy artillery, either through its rapid response or near ubiquitous presence, especially during mobile operations, and increasing accuracy helped planners appreciate the airplane's value as a vital asset on the battlefield.

Thus, integrating the airplane within existing formations dominated doctrinal discussions, as airmen emphasized the importance of first winning control of the skies, in allowing freedom to operate, as well as the importance of keeping the air arm massed for decisive effect, rather than dispersing it to subordinate units. After World War I, the British and Germans took the lead in this discussion, with the best treatise of the interwar period coming from the pen of a British airman, Sir John Slessor, whose *Air Power and Armies* provided an excellent distillation of contemporary thought based on the author's experiences in the Great War and in the various empire-policing missions the RAF performed in the 1920s and 1930s. But German doctrine, emphasizing mobility on the battlefield, most effectively integrated the airplane, particularly its new fighters and dive bombers, into tactical formations. Based on experience gained in wargames with the Soviet Union, designed to circumvent Versailles Treaty restrictions, and in actual combat in the Spanish Civil War, the German *Luftwaffe* entered the war with the most complete understanding of combined arms doctrine. For the Americans, first catching up to and then pushing ahead of their adversaries proved a formidable task. Fortunately, they had the early assistance of their Allies, especially the RAF, which developed a modern system of air support in the Western Desert against the vaunted *Afrika Korps*. But American planners, and especially doctrine writers and trainers stateside had to distill this new information into workable procedures, and then train and exercise the massive formations destined for Europe in these new concepts. Their inability to successfully do so prior to the Normandy invasion in 1944 represents a significant shortcoming, but the seeds of success had already been planted across the Atlantic allowing the air-ground team to quickly remedy the deficiencies and failures of 6 June 1944.<sup>1</sup>

#### D-Day Close Air Support

Close Air Support for the Allied landings in Normandy was one of the significant failures of that otherwise successful operation. In his analysis of Omaha Beach, historian Adrian Lewis found that institutional barriers and deficient training meant that "The air force, however, was unwilling to support these efforts and even at Normandy was incapable of providing close air support to the ground forces."<sup>2</sup> As a result of the extensive use of fighters assigned to the tactical air force as escorts for the strategic bombing offensive, "the tactical air force was too poorly trained in close air support to assist."<sup>3</sup> Peter Mansoor agrees, noting in *The GI Offensive*

in Europe that, in a 1st Infantry Division amphibious exercise at Cape Henry, Virginia in early 1942, the “biggest problems” were “inadequate air and naval gunfire support—deficiencies that the army and navy still had not corrected when the division landed on the beaches of Normandy over two years later,” calling into question the value of stateside training exercises in correcting deficiencies.<sup>4</sup> These tests took place even before the landings in North Africa, offering little opportunity to benefit from the lessons of that campaign. But later exercises, including Exercises Duck and Fox, conducted in January and March 1944 at Slapton Sands, should have provided a final dress rehearsal in air-ground coordination for Operation Overlord. But, as Mansoor notes, “Alarming, the Ninth Tactical Air Force participated in neither Duck nor Duck 2, so the [29th] division was not able to test its air-ground coordination system.”<sup>5</sup> Even the 9th Air Force representative had to admit that his service was “conspicuous by our absence,” and Mansoor concludes, “the result of the lack of air-ground training in Exercise Fox was the inability of combat forces to receive on-call close air support when they needed it badly on the beach. D-Day would be no different.”<sup>6</sup>

On 10 March 1944, Gen. Dwight D. Eisenhower’s air commander, Air Marshal Sir Trafford Leigh-Mallory requested that all fighter aircraft assigned to 9th Air Force be relieved from their assignment as escorts for the Eighth Air Force and placed under Allied Force Headquarters control in order to begin training with the ground troops designated for the assault. But Lt. Gen. Carl A. “Tooe” Spaatz objected, arguing that the strategic bombing raids were providing essential support for the invasion, by destroying the *Luftwaffe*, gaining air superiority over the invasion convoys and beaches, and by seriously interrupting the German and French transportation networks behind the beaches, interdicting the potential flow of reinforcing or counterattacking forces into the beachhead. Indeed, this “Transportation Plan,” was largely successful, delaying the arrival of German panzer formations and seriously degrading those units that did arrive. In addition, most of the groups destined for 9th Air Force did not even arrive in the UK until March or April of 1944, after the final rehearsals for the landing. Fortunately, most of these groups had supported stateside training maneuvers and therefore had a strong foundation for rectifying the failures in Normandy.

In making the argument, Spaatz was adhering to the most recent doctrinal guidance issued by the War Department. Field Manual 100-20, published in July 1943, after the campaign in North Africa, which specified a three-tiered priority of missions for tactical air forces. It argued, “First priority—To gain the necessary degree of air superiority,” followed by “Second priority—To prevent the movement of hostile troops and supplies into the theater of operations or within the theater.”<sup>7</sup> Once these objectives had been met, forces were free to focus on the “Third priority—To participate in a combined effort of the air and ground forces, in the battle area, to gain objectives on the immediate front of the ground forces.”<sup>8</sup> Thus, using fighters assigned to the tactical air forces to escort strategic bombing raids, focused on German aircraft factories and synthetic fuel plants seemed to fit within published doctrine, but the same manual also specified a division of tactical and strategic air forces, and, to Leigh-Mallory, it was unclear why the fighter groups attached to the strategic forces could not perform the escort duties, freeing the tactical forces up for training to perform their highly specialized mission.

Unfortunately, the airmen were unable to resolve their differences, requiring the theater commander to weigh in. As Lewis reports, Eisenhower sided with Spaatz. “The close air sup-

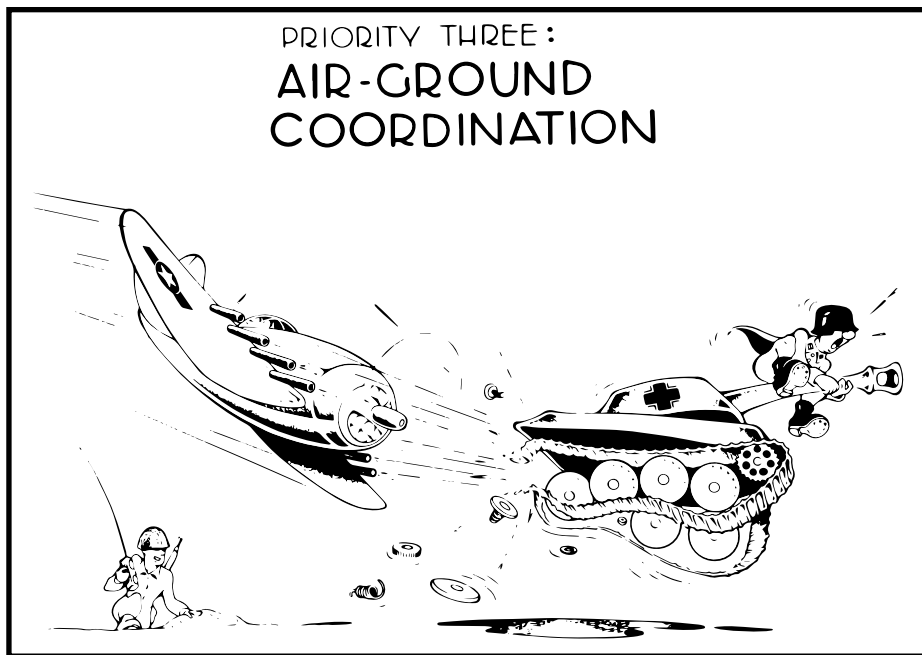

Figure 1.1. Cartoon Illustrating the AAF's Prioritization of Close Air Support.

port mission was last in priority in the minds of American airmen, and as a consequence, the air force was poorly trained in this mission on 6 June 1944.”<sup>9</sup> By the time the 9th Air Force fighters had been relieved of their escort responsibilities and were ready to being training with the ground forces they were intended to support, the training window had already closed and the ground forces were in their secure camps near their embarkation points. As the frustrated commander of the First US Army, Lt. Gen. Omar Bradley, reported, “as a result of our inability to get together with air in England, we went into France almost totally untrained in air-ground cooperation.”<sup>10</sup>

As a result, when American infantrymen found themselves pinned down under the still-intact guns overlooking Omaha Beach, they were unable to call upon the thousands of Allied aircraft sitting just across the Channel in their English bases. Although each assaulting Regimental Combat Team (brigade) had an attached Air Support Party (ASP) equipped with VHF radios for contacting supporting fighters, they could not control the aircraft directly. The ASPs had to first relay their request to a ship just offshore, which then relayed the request to the Allied Combined Air Control Center at Uxbridge for approval. Unfortunately, the communications network broke down. V Corps made only six requests for air support on the morning of D-Day, preferring to use the more responsive and effective naval gunfire support provided by destroyers just off the beachhead, especially after the ASPs suffered heavy casualties on the beaches. The 9th Air Force headquarters at Uxbridge received only thirteen requests all day. A few aircraft managed to attack the German defenders, but did so without direct communications with the ground forces. As Lewis laments, “the air forces were incapable of improvising success from failed plans. They were too poorly trained in direct support of ground forces.”<sup>11</sup> As a result, “the air force would not acquire the training, develop the procedures, or achieve the necessary level of integration with army units to conduct on-call close air support missions in

close proximity to ground forces until well after the Normandy invasion.” British scholar Ian Gooderson agrees, noting,

Many of these problems resulted from inadequate air-support training of both ground and air forces. For example, the US air and ground forces that fought in Normandy had had little opportunity to train together in England before D-Day. The Ninth Air Force was committed to supporting operations of the Eighth (strategic) Air Force until a very late stage and when, in May 1944, it became available for such training it was too late – the ground forces had been sealed into their pre-embarkation marshalling areas and were no longer available for exercises. Few large-scale regimental or divisional exercises involving aircraft had taken place, thus troops were unused to working with aircraft while the fighter-bomber pilots remained unfamiliar with working with troops and were largely untrained in dive-bombing and strafing battlefield targets.<sup>12</sup>

This led to an intensive period of improvisation during the Normandy campaign, during which the system perfected in stateside training exercises made its way into the theater air-ground support architecture.

In defense of the airmen, they were not expected to be needed on D-Day. Despite the lack of a days-long preparatory bombing effort that would have tipped off the invasion plan and landing sites, Allied planners compensated with a massive bombardment of the beach defenses and extensive on-call naval gunfire support for the amphibious assault. Again, in accordance with published doctrine, commanders pulled the strategic air force from its assigned mission on D-Day and employed it in a heavy strike on the beach defenses. But, Lewis records, these aircraft were likewise untrained for this specialized mission and were unprepared to overcome the poor weather that restricted visibility over the landing area, and most of their bombs fell harmlessly half a mile or more behind the beach defenses.<sup>13</sup> Though medium bombers assigned to 9th Air Force attacking at low level inflicted significant damage on German forces defending Utah Beach, the 8th Air Force’s over 1,000 high-altitude heavy bombers and their six million pounds of bombs were completely ineffective at Omaha.<sup>14</sup> Thus, “the Eighth and Ninth Air Forces did not develop the proficiency they needed to perform the breakout bombing mission and the close support mission until well after D-Day.”<sup>15</sup>

In his analysis of Maj. Gen. Elwood R. “Pete” Quesada’s career as a commander of tactical airpower, Thomas Hughes reached a similar conclusion about the efficacy of tactical airpower on D-Day. Hughes found,

The elaborate signals plan to direct air support had, by then, collapsed under what the German war philosopher Karl von Clausewitz once called “the fog of war.” Well over half the American air liaison parties on Omaha Beach were now knocked out. There was precious little radio contact between the support parties ashore and their comrades afloat. The communications net, which had called for a series of relay points stretching from the beach to fighter-direction centers offshore, to headquarters ships, and finally to the Combined Control Center at Uxbridge, was too cumbersome for the fast-paced battle. The vaunted efficiency of Uxbridge broke down under the weight of confusion... For any company commander on the beach

who needed fighters overhead quickly, the multistage signals net meant only frustration—and sometimes death.<sup>16</sup>

Ironically, this unwieldy and failing support system was also in perfect alignment with published doctrine, after a lengthy and intense struggle to centralize control of air support under a single air commander rather than apportioning it to subordinate ground commanders who might misuse it. FM 100-20 had insisted, in all-caps, for emphasis that “AVAILABLE AIR POWER MUST BE CENTRALIZED AND COMMAND MUST BE EXERCISED THROUGH THE AIR FORCE COMMANDER,” and, “THE SUPERIOR COMMANDER WILL NOT ATTACH ARMY AIR FORCES TO UNITS OF THE GROUND FORCES UNDER HIS COMMAND.”<sup>17</sup> But later in the war, in the highly successful “Tactical Air Commands” (TACs) assigned to support each numbered army, this is essentially what happened. The AAF delegated control of several groups of tactical fighters to the TAC commander, who then worked closely with the army commander to ensure effective and timely air power employment, most notably in Lt. Gen. George Patton’s Third Army, supported by Brig. Gen. Otto P. Weyland’s XIX TAC, but also in the new formations still deploying to the theater.<sup>18</sup> The highly-centralized structure in place on 6 June, the result of years of doctrinal development and refinement, prevented any form of distributed control where corps and division commanders could quickly and effectively arrange for desperately needed close air support.

Fortunately, Quesada eventually recognized what was happening and by mid-afternoon had switched his unit, IX Fighter Command and its 1,500 assigned fighters to a backup net controlled from his headquarters at Middle Wallop. He put units on ground alert and authorized them to contact the forward-most controllers directly. In the absence of established communications, he authorized them to attack enemy positions on the beach directly, without positive control. Paratroopers of the 82nd Airborne Division scattered behind the beaches submitted urgent requests for air support against counterattacking German formations, and Quesada threw his fighters into the fray, eventually launching seven missions into the beachhead. While the results were a marked improvement from the situation in the early morning hours, much of the damage had already been done. ASPs in the Omaha beachhead did manage to establish communications the following day, but they directly controlled only two missions.<sup>19</sup> Tactical fighters attacked “targets of opportunity” at random making some contribution to the interdiction effort, but did not provide on-call CAS where and when they were most needed.

How could an air support system, refined in years of warfare, through countless stateside training exercises, fail so miserably in its first major test in northwest Europe? Was it a result of inadequate doctrine, or were training and technical issues responsible? Perhaps most importantly for current and future developers of combined arms doctrine, how did the Allies manage to “fix” this flawed system, and do so quickly, in time to contribute to the successful breakout from Normandy, the pursuit across France, and in cracking the vaunted “West Wall” into Germany? The answers to those questions require a detailed examination of doctrinal development during and after the Great War, and in the early stages of the Second World War. The ground and air forces, both stateside and overseas, had already refined, published and trained to a new doctrine that facilitated a remarkable rehabilitation. While units deployed overseas quickly in the early stages of the war did not benefit from this concerted effort, those divisions and groups raised and trained in the massive stateside enterprise during 1942 and 1943 were already en

route to the theater, and these units bore the brunt of the coming campaign, modeling what became by far the most successful air-ground system the world had ever seen.

## Interwar Developments

The first use of the airplane in combat came in Libya in 1911, during the Italo-Turkish War when an innovative Italian lieutenant flung a few hand grenades from his pocket onto the Ottoman troops below.<sup>20</sup> For the next 30 years, attempts to coordinate these efforts proceeded apace rapid technological developments that saw larger, faster, and more capable aircraft delivering ever-increasing payloads of bombs against troops armed with sophisticated weapons for self-defense. This development of the airplane coincided with the first efforts to exploit the electromagnetic spectrum, resulting in the development of radar for detection of and attacks against airplanes, and radio communications that provided the potential for far-more effective communications than hand-scrawled messages delivered in empty wine bottles or half-filled sandbags. In the test of the Great War, efforts to coordinate ground and air forces jumped forward, and by 1918, German *schlachtfliegern* were capable of strafing trenches and disrupting the fire of artillery batteries behind the lines in order to support infiltration attacks by “storm-troopers” filtering through the Allied defensive lines. All-metal monoplanes equipped with crew-protecting armor and rudimentary communications foreshadowed the opening stages of the next war twenty years later, but the result in 1918 was a general revulsion towards war, underwritten with pacifist commitments to never again repeat the mistakes of the Great War.

Cash-strapped governments found the 1928 Kellogg-Briand Pact’s outlawing of war a convenient excuse for slashing defense budgets and stifling innovation. But an unwary Europe continued to experiment, with German forces taking advantage of a “flying school” in the Soviet Union for clandestine trials, while France and Great Britain’s colonial conflicts, mostly in Africa and Asia, offered additional opportunities to test new methods. The United States’ wars in Central America served a similar function, but primarily for the US Marine Corps, as the Army Air Force remained more interested in continental defense, which envisioned engaging any hostile force at sea, long before it could effect a landing and contact American ground forces.<sup>21</sup> Soviet doctrine vacillated between ideas about “Deep Battle,” most frequently associated with Marshal Mikhail Tukhachevsky, that envisioned strategic bombing raids deep in the enemy rear area, and more practical concerns that recognized that the country lacked the industrial base to build a strategic bomber force. Further, Soviet planners recognized that, despite the non-aggression pact, German rhetoric about *lebensraum* and *untermenschen* was fundamentally incompatible with a lengthy peaceful coexistence with Hitler’s Germany. On the Asian continent, the rising Japanese empire found its war with Chinese forces in Manchuria and China an opportunity to test its own aircraft and their ability to support incursions by the ground forces. French or British terror bombing of Arab or African villagers proved a poor test of newly-developed doctrine, and it was not until the Spanish Civil War that the belligerents had the opportunity to try their new ideas and equipment against a first-rate power.

The Spanish Civil War proved to be a crucial laboratory for the refinement of several aspects of tactical air doctrine. As James Corum notes, “The Luftwaffe’s doctrine of close air support and joint air/army operations did not become part of Luftwaffe doctrine because of the Spanish War. As has been noted, close air support operations had long been a part of Luftwaffe doctrine.”<sup>22</sup> But the conflict still proved to be of great value to the reconstituted *Luftwaffe*, as



it was able to “work out and perfect many of the tactics and techniques necessary for coordinating close air support operations.”<sup>23</sup> By 1939, it was the best-trained air force in the world in CAS, but that was still a subordinate mission to air superiority and interdiction. Still, the lead over the Allies was significant. “It would not be until late 1942 that the RAF could effectively fly the kind of close support missions the Luftwaffe had been doing since 1939. The US Army Air Forces did not work out an effective close support system until 1943-1944.”<sup>24</sup> As a result, for the western Allies, “an effective operational theory and doctrine of air power had to be created after the start of the war and lessons learned at great cost of lives and equipment.”<sup>25</sup>

The Spanish Civil War would not even have been possible without developments in tactical airlift, as German Ju-52 transport aircraft airlifted Gen. Francisco Franco’s nationalist forces from Spanish Morocco across the Mediterranean into Spain, enabling them to confront the existing Republican government, which turned to the Soviet Union for assistance. German and Italian aircraft, carrying Nationalist markings as part of the “volunteer” Condor Legion, engaged Soviet-built biplanes in dogfights above Spanish cities and field armies. The Germans quickly recognized that their existing inventory was outclassed, and rushed new aircraft types, including the Me-109 and Ju-87 *Stuka* into the fight, enabling the Nationalists to gain the upper hand. The Fascist air forces followed a similar “trinity” of air superiority, interdiction and close air support, established in Germany’s 1935 *Dienstvorschrift* (Service Regulations) 16, *Luftkriegführung* (Conduct of Aerial Warfare) focused on gaining control of the skies, restricting the movement of opposing ground forces and then attacking those troops directly engaged with the front-line forces.<sup>26</sup> The Condor Legion also experimented with terror bombing, most notably at Guernica on 26 April 1937 in which hundreds of civilians died, but the German air commanders generally found it counterproductive.

As a result of their experience in Spain and subsequent reforms, revised instructions issued in 1939 stipulated: “In order to ensure the necessary close cooperation, the air commander should establish his command post near that of the army formation he is supporting. He must maintain communication with his units through his own signals network. He must be aware that the successful operation of his units depends on the existence of good, quick, and reliable signals communication.”<sup>27</sup> In addition, the air forces required precise maps of the ground battle, kept continually up to date by attached liaisons from the ground forces, presaging the later use of ground liaison officers (GLOs) by the British and American air forces.<sup>28</sup> Indeed, Corum and Muller found “methods of liaison, the collocation of army and air force command posts, and appropriate roles for different types of aircraft predated the analogous British and American reforms in North Africa by several years.”<sup>29</sup> The authors agreed that “by the summer of 1939 the Luftwaffe was the best-equipped and most operationally capable air force in the world,” consisting of modern equipment and well-thought-out and combat-tested doctrine.<sup>30</sup>

But the successful attempts at coordination between air and ground forces proved to be the most fruitful legacy of German involvement in the Spanish Civil War. As Williamson Murray found in his examination of the *Luftwaffe*, the service’s CAS doctrine came directly from the Spanish Civil War: “Against considerable opposition and without official sanction, [Wolfram von] Richthofen developed the techniques and tactics of close air support for ground forces in offensive operations.”<sup>31</sup> He also worked to establish reliable communications between ground and air forces and, after observing accuracy issues that threatened friendly ground forces, worked to develop “blind bombing” aids and pushed wider adoption of highly-accurate dive

bombers. The Condor Legion's dive bombers, once assured of air superiority, could operate effectively against Republican ground forces and had significant physical and psychological effects on those troops. Timing these effects to occur alongside an assault by friendly forces, resulting in significant victories for the Nationalists, factored in Franco's eventual triumph in the war. Most significantly, the Germans learned the importance of mobility for both their ground and air forces, and equipped flying squadrons and ground establishments with sufficient transport to keep up with fast-moving troops, enabling continual support through the advance and only infrequent interruptions for a change of base.<sup>32</sup> The *Luftwaffe* immediately sought to incorporate these "lessons learned" into existing doctrine, tactics and training, but, sadly, many western observers chose to ignore the potential lessons. Speaking at the Army War College in 1938, the future commander of the Army Air Forces, Gen. Henry H. "Hap" Arnold, condemned both sides in the Spanish Civil War for focusing on close support at the expense of other missions.<sup>33</sup> In general, the AAF dismissed the campaign, as both sides largely received their weapons and equipment from abroad, and neither side practiced true "strategic bombing" against an industrial infrastructure, as currently envisioned. As Thomas Greer notes, "Most observers agreed that the struggles in China, Ethiopia, and Spain were in no sense major wars or real tests of modern airpower. They were regarded as limited proving grounds for the weapons and techniques of support aviation."<sup>34</sup> But Arnold did not speak for the entire AAF. Other officers, including Col. George Kenney, who went on to serve as one of the AAF's outstanding tactical leaders during WWII as "MacArthur's Airman" in the Southwest Pacific, was suitably impressed by German successes in Spain and sought to learn as much as he could from it.<sup>35</sup>

The clearest expression of ideas on the employment of tactical airpower during the interwar period came from the pen of Air Marshal Sir John Slessor, a British airman whose *Air Power and Armies* benefitted significantly from both his experience as the commander of a RAF Army cooperation squadron during the Great War and his time spent performing the duties of empire policing during the 1920s and 1930s. Written during his time as an instructor at the Army's Staff College at Camberley, Slessor's work served as a blueprint for the employment of army support aviation at the outset of World War II. The RAF's miserable failures in Norway, France, and Greece can be attributed more to the failure to adopt Slessor's ideas as service doctrine than to any inherent flaws in the work itself. And the rapid resuscitation of British tactical airpower in Egypt's western desert under first Raymond Collishaw and then Sir Arthur Coningham can be attributed to the deep thinking on the subject and the staff college instruction that Slessor and his acolytes provided.<sup>36</sup>

Alongside concerted efforts to build a long-range strategic bombing force, the Army Air Forces continued to develop and refine their "attack" aviation, although this branch was not free from doctrinal squabbles about employment. While advocates of the ground forces requested a dive bomber capable of operating accurately in close proximity to ground forces, air advocates preferred to focus on light, twin-engined bombers with the necessary range and payload to raid enemy airfields, making them far more useful in the air superiority campaign than for close support.<sup>37</sup> The AAF also adopted the distinction between "tactical" and "strategic" air forces expressed in German doctrinal manuals, but it was clear that it did not value the two equally. Despite wartime protestations that all aviation had to be concentrated under a single air commander, the AAF was more than happy to assign obsolete reconnaissance and artillery-spotting aircraft to the tactical air forces while retaining the most capable front-line fighters and bomb-

ers in the “strategic” force, where they would be less likely to be drawn into the ground battle. Prewar exercises demonstrated the inadequacy of this separation, as the army-cooperation-type aircraft, such as the O-47, proved inadequate for either reconnaissance or artillery spotting, leading the army to eventually develop its own light aviation, using liaison aircraft assigned to individual artillery battalions for correction, coupled with demands for more capable interdiction and close support aircraft to intervene in the ground battle. All of these changes were still in work as the Army mobilized National Guard divisions and scheduled army-level maneuvers to test existing doctrine, tactics, and equipment. In a process described in detail in the following chapter, staff officers revised the Army’s tactical support doctrine based on lessons culled from the 1941 Louisiana and Carolina maneuvers and published it in April 1942 as FM 31-35, *Aviation in Support of Ground Forces*, which served essentially unchanged throughout the war, though the ideas and methods described underwent continual modification and refinement in theater. The manual had the benefit of the German campaigns in Poland, France, and Russia, but predated the significant British developments worked out in the western desert in 1942.

### Early Wartime Developments

While American professionals and doctrine writers attempted to sift lessons from state-side training maneuvers, the opening acts of the war provided much more grist for the mill. The German thrust into Poland in September, 1939, using techniques refined in the Spanish Civil War, enabled Germany to overrun the country in a matter of weeks, prompting western journalists to coin a new word, *blitzkrieg*, to describe the “new,” lightning war. But German analysts knew that the image of armored spearheads covered by aircraft was largely a myth—most German troops entered Poland on foot and most equipment was still pulled by horses. And, while there were successful instances of close air support later in the campaign, German success came largely from focused attacks on the Polish Air Force in the campaign’s opening days, giving the ground forces protection and winning freedom of movement for the *Luftwaffe*. Once German fighters and bombers could range freely behind the lines, they had little difficulty interdicting Polish communications and breaking up troop assembly points. Only when the air campaign had largely been won did the German *Stukas* appear in large numbers directly over the front-line troops. The most glaring deficiency was in the collection and dissemination of tactical reconnaissance, which the *Luftwaffe* worked to correct in the months that followed. But the image of well-coordinated German combined-arms had a powerful effect on western observers, spurring ground commanders in Great Britain and the United States to demand the same type of close support the Germans were allegedly enjoying, sparking new doctrinal discussions and debates, as well as a great deal of public interest.<sup>38</sup>

The most pressing issue revolved around how to command air support. Some ground commanders, viewing the aircraft as an adjunct to the combined-arms team, insisted on full control by the ground commander in each sector. Just as each division commander would have full control over attached armor and artillery assets, so too should he be able to assign and apportion his air support where and when he saw fit. But airmen, even those of a tactical bent who had refused to imbibe the prevalent strategic bombing theory, still saw value in concentrating air assets, to ensure mass at the decisive point, rather than wasting assets on ground alert in quiet sectors and then lacking sufficient strength to achieve the desired effects when called upon. But ground commanders feared that concentration would lead air commanders to use fighters and bombers deep in the enemy rear, where the effects would be temporal, or, at least,

not felt for some time, while the need for attacking or defending troops was immediate. This led to further debates about the timing and sequencing of missions. Airmen insisted that the air superiority mission had to come first, arguing that attempting to conduct interdiction or close support missions in the face of strong aerial opposition would lead to heavy losses or require a debilitating number of escorts in order to protect the force. By deliberately targeting enemy air assets, both in the air and on the ground, the air commander could win freedom of action to successfully and decisively intervene in the ground battle. For airmen who paid attention, this was the true lesson of Poland.

The debate simmered through the “*Sitzkrieg*” of the winter of 1939-1940, with the western Allies deploying their assets behind the Maginot Line and, largely in accordance with pre-war doctrine, allocating aircraft to certain sectors of the front, but failing to provide any mechanism for effective and responsive communications between the ground and air forces. While French and British fighters and light bombers remained scattered from the Alps to the English Channel, the Germans concentrated their attack aviation over the armored spearheads that attempted to breach the Allied lines at Sedan and race to the channel. While individual Allied aircraft, such as the RAF’s Supermarine Spitfire and the French *Armée de l’Air* Dewoitine De-520 were more than an individual match for the German Me-109, *Luftwaffe* concentration enabled the Germans to gain local control the skies wherever they desired. The British wisely withheld their most capable air defense aircraft in the home islands, sparing a crippling loss of ground support technicians and equipment in the evacuation. The French threw all their aircraft into the battle, but had too few of the modern fighters to achieve anything other than a temporary and local air superiority. Tardy attacks by obsolete tactical bombers typified the British and French air effort, and most of these aircraft did nothing more than contribute to the victory tallies for the new German aces.

In short, France was a disaster for the RAF. The shortest response time achieved from requests for air support to aircraft overhead was four hours, and this required officers phoning London on ground lines to arrange support.<sup>39</sup> As a result, aircraft often arrived too late to effectively intervene, and advancing German ground forces eventually overran their airfields. Again, to the careful observer, the lesson of concentrating tactical aircraft under an air commander who could first win local air superiority and then intervene at the decisive point became apparent. Spaatz and Kenney, two of the best AAF commanders of WWII, observed the collapse in France and believed that the German doctrine was largely in accordance with ACTS teachings.<sup>40</sup> Indeed, the *Luftwaffe*’s effective doctrine and training had allowed the Germans to compensate for technological and numerical deficiencies. In examining German close air support, James Corum found, “The German success in this field was not due to superior technology or a massive commitment of resources, but rather due solely to superior doctrine and training.”<sup>41</sup>

After the fall of France, the British vindicated their decision not to forward-deploy their air force, and demonstrated the potential for integrating new technologies, such as radar and radio communications, with their victory in the Battle of Britain. A *Luftwaffe* designed primarily as a ground-support force was less capable in conducting an independent air campaign while Fighter Command’s centralized control allowed a numerically-inferior force to meet each successive German attack, providing additional support for centralization, but ignoring that this method worked best in an air-only campaign with comparatively limited requirements.<sup>42</sup>

While each of Fighter Command's four sector commanders retained the freedom to employ his force using their preferred tactics, Dowding's headquarters maintained centralized control and rotated squadrons through active and quiet sectors, ensuring attrition did not render units combat-ineffective and maintaining a fresh flow of replacement units into the battle. For the Germans, they were never able to achieve air superiority, preventing them from delivering devastating attacks on the RAF's airfields and industrial infrastructure, further vindicating doctrine that placed achieving control of the air at the top of the list. As both sides withdrew to lick their wounds in the winter of 1940-41, the Germans felt their actions the previous year had bought enough time in the west to launch their campaign for *lebensraum* against the *untermenschen* in the east. The RAF, while remaining focused on defeating the German "blitz" in the skies over England, gained some breathing room to help beleaguered defenders elsewhere in the empire, most notably in front of the Suez Canal in Egypt. American observers felt that the German failure vindicated their decision to build a strategic air force at the expense of tactical airpower, as they felt the Germans' inadequate tactically-oriented air force had been the key to the RAF's success.

The German campaign in Russia proved to be a repeat of Poland and France on a much larger scale, at least until the Russian weather and geography intervened at the end of 1941. German attacks on Soviet airfields won the essential air superiority and the Soviet Air Force (*Voyenno vozdushnye sily*, or VVS) lacked the ability to capably direct or control their forces, resulting in heroic but suicidal attacks on superior German formations. But the Soviets were largely unprepared, as the principal chroniclers of the VVS found, as "there was no settled sense of air theory in place in 1941 to provide a baseline for organization, operations and training. In fact, the emphasis had shifted from bombers to fighters and ground attack aircraft designs, but this critical redefinition of priorities had not been properly translated into a functioning air doctrine."<sup>43</sup> And Stalin's purges did not encourage innovative thinking. The poor state of Soviet training, logistics, and technology would have undercut even the best doctrine, providing a cautionary tale for making sweeping doctrinal revisions based on flawed experiments.

With control of the skies, German dive bombers again had the freedom of action to closely support ground formations, providing an effective air-ground team in the massive encirclement battles of the summer and early fall of 1941. In yet another German innovation, later falsely claimed to have been created *sui generis* by Allied airmen, "von Richthofen in 1941 placed experienced Stuka pilots in Mark III Panzers equipped with air-ground radios, to serve as mobile forward air controllers. For the first time, Luftwaffe CAS units could coordinate ground attacks right from the front lines."<sup>44</sup> These efforts again vindicated German tactical doctrine, but the Soviet withdrawal of their industrial infrastructure out of the occupation zone, coupled with new types of fighters and ground-attack aircraft, drawn up as a result of the technological inferiority recognized in Spain, finally began rolling out of the factories. The IL-2 *Sturmovik* became one of the premier ground-attack aircraft of the war, while new fighters built by the design firms headed by Yakovlev, Lavotchkin, and Mikoyan and Gurevich were able to hold their own against the German fighters. Once the Russian winter paralyzed the German logistics network and froze lubricants in German aircraft engines, the VVS was able to contest control of the air, contributing to the halt at the gates of Moscow and Leningrad. By December of 1941, the VVS was already covering counterattacks with new aircraft, first with fighter sweeps alone, but eventually providing close air support, tactical reconnaissance, and interdiction of

the retreating Germans.<sup>45</sup> Faced with the dire threat, and without air bases in range of the German industrial network, the VVS abandoned any pretenses at strategic airpower and reoriented into a tactical support force. Proving that imitation is the sincerest form of the flattery, Soviet airmen gradually adopted German tactics and techniques, creating a tactical support air force that eventually bested the Germans at their own game. As the leading chroniclers of the Red Air Force, Von Hardesty and Ilya Grinberg observed, “The VVS actively emulated the superior tactics of the Germans.” As a result “The VVS emerged as the largest operational-tactical air force in the world by the end of the war.”<sup>46</sup>

## **RAF and USAAF Reforms**

In North Africa, British forces attempting to protect Egypt from Italian incursions finally had the opportunity to experiment with solutions designed to prevent a repeat of the dismal performance in France. Ground commanders and airmen used to a long and close association during the 1920s and 1930s, when aircraft proved to be a valuable supplement to reduced ground forces performing the “empire policing” mission in nearby colonies, such as Somaliland and Palestine, quickly developed and implemented reforms that improved coordination between the services.<sup>47</sup> In this effort, they received substantial assistance from forces at home, including an administration intent upon finding a solution, and exercises in Northern Ireland designed to experiment with new techniques and methods. But it was not to be a simple process. Army commanders, convinced the RAF’s independence had been the root of the failure, insisted on the formation of an “Army Cooperation Force,” that would develop new aircraft types specifically for ground support missions and place them under the exclusive control of the ground commander. Airmen pushed back, arguing for centralized control under an air commander and modifying existing aircraft types, most notably the Hawker Hurricane, into a capable ground support aircraft.<sup>48</sup>

The early battles in North Africa, against an inept Italian Air Force, did little to solve the doctrinal debate, as the RAF quickly won air superiority and helped the ground forces drive the Italians out of Egypt and deep into Libya. But redeployments in a failed attempt to help defend Greece in the summer of 1941, coupled with German reinforcements in Field Marshal Erwin Rommel’s *Afrika Korps*, as well as a sustained air campaign against the British base at Malta that helped secure Axis supply lines, tilted the scales. As a result, Axis forces quickly pushed the army in the Western Desert back into Egypt, cutting off an entire Australian division in the port city of Tobruk. The data from these see-saw campaigns appeared incomplete and were twisted by advocates of both centralization and dispersal to justify dissenting viewpoints. But reforms slowly took hold, including an emphasis on developing tactical intelligence in a joint network that cut response times for requests for support, and increased mobility for air squadrons in order to help them keep up with the advances and withdrawals across the empty desert. One confirmed lesson was the importance of the ground and air commanders sharing a headquarters, to ensure close coordination and keep both commanders informed of the others’ intentions, capabilities, and dispositions. After a failed attempt to relieve Tobruk, during which the RAF employed its aircraft in strict accordance with the army’s ideas, allocating aircraft to specific commanders and sectors, Prime Minister Winston Churchill finally weighed in on the debate and decreed that the RAF’s system of centralized control would prevail, but ordered close cooperation and the use of the entire air force, not just obsolete aircraft relegated to the army cooperation mission, to support future campaigns.<sup>49</sup>

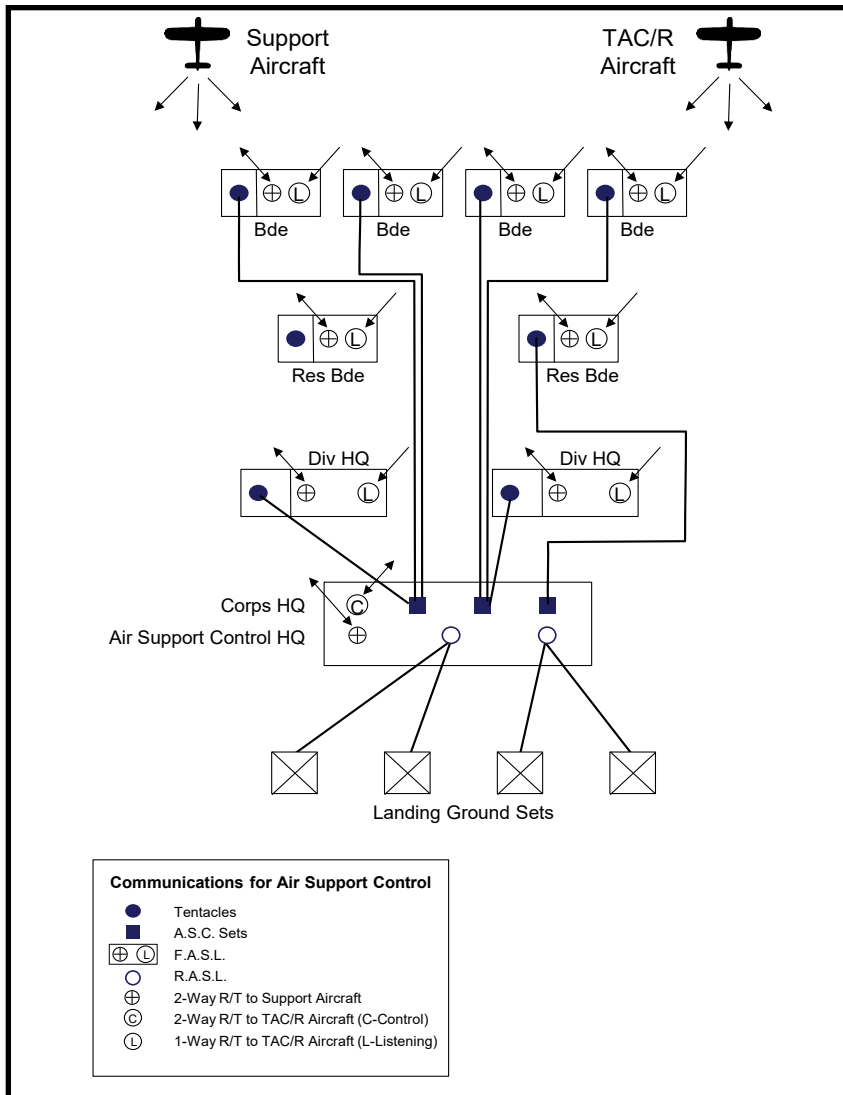

Figure 1.2. British Communications for Air Support Control. Graphic created by Army University Press staff.

According to Ian Gooderson, a new system for air support cut response times down to less than 30 minutes, as forward air support liaisons (FASLs) assigned to each brigade submitted requests adjudicated at air support controls (ASCs). By 1942, the systems developed in the UK and Western Desert had been fused together, incorporating the best ideas of both, as UK-trained “tentacles,” or forward control teams, deployed to North Africa. “Thus as a result of a combination of theory, experimentation and training in the UK and practical experience in North Africa, a British air support system had been created by the end of 1942, which was to remain essentially the same throughout the war.”<sup>50</sup> By 1944, the “tentacles” had been renamed air support signals units, assignable to corps, division, or brigade headquarters, as well as RAF headquarters and individual wings and groups. Most often, the “tentacle” consisted of a team mounted in a half-track equipped with a bulky VHF radio, enabling them to keep up with armored formations.

Forces operating under this system eventually relieved Tobruk and pushed Rommel back into Libya, only to be fatally weakened by additional withdrawals to shore up the crumbling Asian branch of the empire after the Japanese attacks in December of 1941. This gave Rommel the breathing room he needed to again push into Egypt, where the RAF's mobility and flexibility enabled devastating air attacks on his advancing columns, buying time for British and Commonwealth ground forces to successfully hold a defensive line at El Alamein. From here, new leadership, in the form of Field Marshal Sir Bernard Montgomery and Air Marshal Sir Arthur Coningham forged the first truly great air-ground team, resulting in victory at El Alamein, a successful drive across Libya and eventual victory in North Africa. Along the way, they took the Anglo-American forces that had landed in Morocco and Algeria in November of 1942 in the Torch landings under their wing and imparted their collected knowledge to a new generation of American commanders, including generals Eisenhower, Bradley, Patton, Spaatz, Quesada, and Cannon. But success in North Africa did not mean the end of doctrinal debates, though it did provide a validation of existing doctrine and create a nucleus of trained and experienced personnel to transmit the reforms through the training establishment to the units that would carry the fight into Northwest Europe in 1944-45.

One of the central figures for the transmission of British ideas into American air-ground tactics was John Cannon. The airman had commanded the XII Air Support Command during the Torch landings, earning high praise from George Patton, the task force commander. After the landings, Cannon moved on to a posting in charge of XII Training Command, responsible for indoctrinating newly arrived airmen into the rapidly evolving tactics and procedures used in theater. He also had several opportunities to train with the ground forces in theater, as most of the American ground units remained in Morocco to guard against any potential incursion from Spanish Morocco. Ground and air units practiced mutual recognition and prepared detailed operational plans for air support in the invasion of Sicily, where Patton commanded the US Seventh Army while Cannon assumed command of 12th Air Force. One of these innovations, borrowed from the British, was the "Rover Joe" system of air controllers attached to forward units of the ground forces. From a jeep equipped with a VHF radio, fighter pilots attached as liaison officers to the ground forces could contact available aircraft and then direct attacks on units in the immediate front, speeding the response time and ensuring more effective attacks with lower risks to the ground forces. This system spread throughout 12th Air Force and the Fifth Army during the Italian campaign.<sup>51</sup>

Another innovation included the "horsefly" forward air controllers. In an airborne version of the "Rover Joe" program, pilots who had completed their initial tour volunteered to fly light, liaison-type aircraft over the front lines, conducting reconnaissance and directing air strikes onto enemy positions and formations. The light craft could never have survived in a contested air environment, but growing numbers of Allied aircraft coupled with heavy German losses due to both overextension in multiple theaters and the increasingly heavy strategic bombing attacks on the homeland stretched the *Luftwaffe* to, and beyond, the breaking point. With local air superiority, airmen could focus on tactical interdiction and provide increasingly effective and timely close air support. Unfortunately, this innovation did not appear until the spring of 1944, preventing rapid dissemination in time for the Normandy landings. But, as Kent Greenfield notes, airmen and ground commanders were making progress. "It was growing out of the efforts of airmen and ground troops and their commanders working together in the field, at home and abroad. This was notably true in Italy, where effective air-ground cooperation developed



through a practical approach to common problems. This was the approach on which General McNair had consistently insisted and it was beginning to pay dividends.”<sup>52</sup>

A plan to cut the German logistics network in Italy, code-named Operation Strangle, intended to deny essential supplies to German forces holding the Gustav Line centered on Monte Cassino and containing the Allied beachhead at Anzio. Unfortunately, the low initial consumption rates, the redundant road and rail network, and the remarkable ability to quickly rehabilitate the transportation network frustrated the Allied effort.<sup>53</sup> As Richard Hallion notes, interdiction is much more effective during heavy fighting, when defenders are forced to consume resources at a high rate.<sup>54</sup> While the operations contributed to the breakout from Anzio and liberation of Rome, it did not have the decisive effect planners hoped.<sup>55</sup> But the focus on interdiction, after winning air superiority, aligned closely with published doctrine and was being used simultaneously against the French road and rail network in preparation for the D-Day invasion. But ground commanders who believed that the Air Force over-allocated assets to maintaining air superiority and then interdiction were concerned that close air support was getting short shrift. Air commanders were reluctant to risk assets in the highly-contested environment over the front lines, with well dug-in targets and heavy anti-aircraft defenses, when there were more lucrative and lightly-defended targets well behind the front lines. Instead of the sequential accomplishment of each mission, as stipulated in doctrine, proponents of tactical air power began to argue for accomplishing these missions in parallel, preventing CAS from languishing at the bottom of the priority system. Coningham, among others, was more flexible on the strict order of the trinity. For example, interdiction could contribute to air superiority if it could cut the flow of fuel and supplies to forward air bases.<sup>56</sup> According to Hallion, “Sicily and Italy were a necessary transition step between the development of air support in the Western Desert and Tunisia and its ultimately successful application during the Normandy operations and the breakout across France. Methods of command and control, the doctrine of FM 100-20, and the air leaders who would run the tactical air war until the collapse of the Nazi machine were all tested and evaluated in the proving ground of Mediterranean warfare.”<sup>57</sup> New aircraft, especially the P-47 Thunderbolt, merged with improved ideas and refined procedures. According to Ira Eaker, commander of the Mediterranean Allied Air Forces, “The Mediterranean has been the primary crucible of the development of tactical air-power.”<sup>58</sup>

## **Conclusion**

Thus, by the time of the Normandy landings, the US Army Air Forces had over a year of combat experience in providing close support to ground forces, and had largely won control of the skies over France and Italy. Given the experience levels and permissive environment, it would not be unreasonable to expect a much more responsive system to be in place on D-Day. With the attention focused on refining ground support techniques in stateside training exercises, new units entering the battlespace had a much better appreciation of the capabilities of tactical airpower than units that had been garrisoning Great Britain since 1942. Unfortunately, tactical airpower was found wanting in its first test in France. But thanks to developments theorized and tested by German airmen during the interwar period, refined in the UK and the Western Desert, further honed in the Italian campaign, and finally refined and disseminated in the stateside training establishment, the experience of the first few days in Normandy did not typify the rest of the campaign in France and Germany. The renaissance was remarkable but, given the level of effort and attention directed towards training and doctrine in the continental US, it should not have been unexpected.

## Notes

1. For an excellent summary of developments in all three nations during this period, see Richard Muller, "Close Air Support: The German, British, and American experiences, 1918-1941," in Williamson Murray and Allan Millett, eds. *Military Innovation in the Interwar Period* (Cambridge, UK: Cambridge University Press, 1996), 144-190.
2. Adrian Lewis, *Omaha Beach: A Flawed Victory* (Chapel Hill, NC: University of North Carolina Press, 2001), 78.
3. Lewis, 25.
4. Peter Mansoor, *The GI Offensive in Europe: The Triumph of American Infantry Divisions, 1941-1945* (Lawrence, KS: University Press of Kansas, 1999), 52.
5. Mansoor, 66.
6. Mansoor, 67.
7. Field Manual (FM) 100-20, *Command and Employment of Air Power* (Washington, DC: GPO, 1943), 10.
8. FM 100-20, 11.
9. Lewis, *Omaha Beach*, 217.
10. Omar Bradley, *A Soldier's Story* (New York: Henry Holt, 1951), 249.
11. Lewis, *Omaha Beach*, 239.
12. Ian Gooderson, *Air Power at the Battlefield* (London: Frank Cass, 1997), 49-50.
13. Lewis, *Omaha Beach*, 147.
14. Thomas A. Hughes, *Overlord: General Pete Quesada and the Triumph of Tactical Air Power in World War II* (New York: The Free Press, 1995), 5.
15. Lewis, *Omaha Beach*, 239.
16. Hughes, *Overlord*, 8.
17. FM 100-20, 2.
18. See David N. Spires, *Air Power for Patton's Army* (Washington, DC: Air Force History and Museums Program, 2002)
19. Hughes, *Overlord*, 9-11.
20. Alan Johnston, "Lybia 1911: How an Italian Pilot began the Air War Era," *BBC News*, 10 May 2001, <http://www.bbc.com/news/world-europe-13294524>.
21. Richard Hallion, *D-Day, 1944: Air Power over the Normandy Beaches and Beyond* (Washington, DC: Air Force History and Museums Program, 1994), 163.
22. James S. Corum, *The Luftwaffe: Creating the Operational Air War, 1919-1940* (Lawrence, KS: University Press of Kansas, 1997), 223.
23. Corum, 223.
24. Corum, 286.
25. Corum, 286.
26. For a full translation, see Richard S. Corum and Richard Muller, *The Luftwaffe's Way of War: German Air Force Doctrine, 1911-1945* (Baltimore, MD: Nautical & Aviation Pub., 1998).
27. Corum and Muller, 196.
28. Corum and Muller, 198.
29. Corum and Muller, 194.
30. Corum and Muller, 11.
31. Williamson Murray, *Strategy for Defeat: The Luftwaffe, 1933-1945* (Maxwell Air Force Base, AL: Air University Press, 1983), 15.
32. Corum, *Luftwaffe*, 249.
33. David R. Mets, "A Glider in the Propwash?," in Daniel R. Mortensen, ed, *Airpower and Ground Armies: Essays on the Evolution of Anglo-American Air Doctrine, 1940-1943* (Maxwell AFB, AL: Air University Press, 1998), 56.

34. Thomas Greer, *The Development of Air Doctrine in the Army Air Arm, 1917-1941* (Maxwell AFB, AL: Air University Press, 1955), 101.
35. Corum, *Luftwaffe*, 260.
36. See Michael Bechthold, *Flying to Victory: Raymond Collishaw and the Western Desert Campaign, 1940-1941* (Norman, OK: University of Oklahoma Press, 2017).
37. Greer, *The Development of Air Doctrine in the Army Air Arm, 1917-1941*, 88.
38. Ian Michael Hall, *Strategy for Victory: The Development of British Tactical Air Power, 1919-1943*, (Westport, CT: Praeger, 2007), 40; Michael Bechthold, "A Question of Success: Tactical Air Doctrine and Practice in North Africa, 1942-43," *The Journal of Military History*, 68 (July 2004): 821-51, 826.
39. Gooderson, *Air Power at the Battlefront*, 24.
40. Greer, *The Development of Air Doctrine in the Army Air Arm, 1917-1941*, 109.
41. Corum, "The Luftwaffe's Army Support Doctrine, 1919-1941," *The Journal of Military History*, 59 (January 1995): 53.
42. Robert F. Futrell, *Ideas, Concepts, Doctrine: Basic Thinking in the United States Air Force, 1907-1960* (Maxwell AFB, AL: Air University, 1971), 99.
43. Von Hardesty and Ilya Grinberg, *Red Phoenix Rising: The Soviet Air Force in World War II* (Lawrence, KS: University Press of Kansas, 2012), 50.
44. Corum, "The Luftwaffe's Army Support Doctrine, 1918-1941," 73.
45. Hardesty and Grinberg, *Red Phoenix Rising*, 90.
46. Hardesty and Grinberg, *Red Phoenix Rising*, 2
47. See James S. Corum and Wray Johnson, *Air Power in Small Wars* (Lawrence: KS: University Press of Kansas, 2003).
48. David Ian Hall, *Strategy for Victory: The Development of British Tactical Air Power, 1919-1943* (Westport, CT: Praeger, 2008), 63-64, 80.
49. Hall, 83, 108.
50. Gooderson, *Air Power at the Battlefront*, 26.
51. Kenneth Steadman, *A Comparative Look at Air-Ground Support Doctrine and Practice in World War II* (Fort Leavenworth, KS: Combat Studies Institute, 1982), 9.
52. Kent R. Greenfield, *Army Ground Forces and the Air-Ground Battle Team*, (Fort Monroe, VA: Army Ground Forces Historical Section, 1948), 68
53. See Eduard Mark, *Aerial Interdiction in Three Wars* (Washington, DC: Center for Air Force History, 1994).
54. Hallion, *D-Day, 1944*, 186.
55. Hallion, 185.
56. Daniel R. Mortensen, "The Legend of Laurence Kuter," in Daniel R. Mortensen, ed., *Airpower and Ground Armies: Essays on the Evolution of Anglo-American Air Doctrine, 1940-1943* (Maxwell AFB, AL: Air University Press, 1998), 104.
57. Hallion, *D-Day, 1944*, 186.
58. Hallion, 186.



## Chapter 2

### Stateside Doctrinal Development, 1940-1943

While global developments proceeded at a furious pace, a slumbering stateside training establishment struggled to keep up with developments. The massive pre-war maneuvers of late 1941 provided a critical experiment for the refinement of air-ground doctrine and resulted in the publication in April of 1942 of Field Manual (FM) 31-35, *Aviation in Support of Ground Forces*, which remained current, if flawed, throughout the war. Chief of Staff Gen. George Marshall made the difficult decision to lock a system in place for training instead of constantly revising doctrine based on developments in the field. This decision provided at least a baseline of continuity for deploying ground units, even if it had to be updated with the latest techniques in the field upon arrival in theater. Once the ground and air forces had agreed on a common system, deploying divisions trained to the new manual, as air-ground cooperation gained increased emphasis in the maneuvers each division completed prior to deploying. Although the Army Air Forces lacked fully-trained units to support these exercises early in the war, by mid-1943, increasingly realistic exercises provided a shared understanding for ground and air commanders that benefitted from increased experience, especially in the Mediterranean theater.

At the conclusion of the North African campaign, the AAF published FM 100-20, *Command and Employment of Air Power*. While technically not superseding FM 31-35, the new manual, approved without the AGF's concurrence, further clarified command relationships and the priority of missions for air forces. Aligning closely with the Luftwaffe's "trinity" of air superiority, interdiction, and close air support, FM 100-20 also firmly established the ground and air commanders as coequal, though for the remainder of the war the air commander functioned as a de facto subordinate member of the ground commander's staff, both at the theater and army levels. But the air commanders did enjoy a significant degree of autonomy, and coordination and cooperation increasingly came to characterize the air-ground relationship at all levels. This freedom and flexibility maximized the effectiveness of the aerial weapon and eventually led to the most capable air-ground system the world had ever seen. With highly effective and responsive air cover, British and American ground columns liberated France, broke through the West Wall into Germany, and overran that country's primary industrial region, the Ruhr Valley. None of these achievements would have been possible without the doctrinal development and refinement that took place long before and far away from those decisive campaigns, in the musty halls of the War Department and the dusty roads and muddy fields of the Louisiana and Tennessee maneuver areas.

#### Pre-war Doctrine and TR 440-15

As the world edged closer to war in the late 1930s, the Army sought to refine its air support doctrine, incorporating the most recent doctrinal and technological developments in order to ensure its forces were as well-prepared for modern combat as they possibly could be. This involved a series of doctrinal updates, flowing out of the War Department in a dizzying array of field manuals, regulations and training circulars, each attempting to revise and update its predecessor with the most current information possible. On 15 October 1935, the War Department issued an update to TR 440-15, *Fundamental Principles of the Employment of the Air Service*, which had been issued in January 1926. This slim pamphlet did little more than reaffirm that



Figure 2.1. Aerial Photograph of Detrainment Area in Jasper, TX during Louisiana Maneuvers.

air power would be used to support the ground forces in the attainment of their objectives. Paragraph 3 stated,

The mission of the Air Service is to assist the ground forces to gain strategical and tactical success by destroying enemy aviation, attacking enemy ground forces and other enemy objectives on land or sea, and in conjunction with other agencies to protect ground forces from hostile aerial observation and attack. In addition it furnishes aerial observation for information and for artillery fire and also provides messenger service and transportation for special personnel.”<sup>1</sup>

The broad outline of missions, based largely on experience gained in the Great War, could be categorized as 1) air superiority, 2) ground attack, 3) air defense, 4) observation and reconnaissance, and 5) courier service, or what would become known as Airlift. The injunction for “attacking enemy ground forces and other enemy objectives on land or sea,” was particularly ill-defined, leaving open the question of whether that would involve close air support, as the ground forces desired, or focus more on interdiction, as the Air Service preferred, though the inclusion of the words “or sea” suggested the latter interpretation.<sup>2</sup>

The issue of command was similarly muddled. Para 3b. stated, “Some units always operate as organic elements of ground commands, while others may be temporarily attached by ground units or may cooperate by indirect support in the area of the ground battlefield or at a distance therefrom,” leaving open both the direct assignment of air units to ground commanders, along the lines or armor or artillery units, as well as the possibility of an independent command for aviation,

free from interference by ground commanders, as Air Service proponents of strategic bombing certainly preferred. Thus, the deliberately vague early doctrine struck a compromise, leaving open a number of possibilities without necessarily closing down any potentially fruitful avenues.

But the command relationships outlined in paragraph 11 proved more enduring. In directing that, "Observation aviation is an integral part of Infantry divisions, corps, and armies," the regulations separated reconnaissance and artillery spotting aircraft from the air commander's purview, making it far easier for the airmen to neglect this vital branch. In the early campaigns of 1942, the AAF's observation squadrons, poorly trained and equipped with outdated equipment, failed their first test in combat in North Africa.<sup>3</sup> Indeed, the rehabilitation of both tactical and strategic reconnaissance, most notably in the photographic squadrons assigned to both types of air forces, was one of the greatest success stories of the war.

Paragraph 11b further envisioned that, "An army air force of attack and pursuit aviation is an integral part of each field army." This force structure endured well into 1945, with 9th Air Force in Europe composed of fighters and medium bombers, and, indeed, to 1991 in Tactical Air Command, which included all aircraft except Strategic Air Command's nuclear-capable bombers and associated air refuelers, and the Military Airlift Command's airlift assets. 9th Air Force's subordinate commands, IX, XIX, and XXIX TAC, as well as 12th Air Force's XII and XXII TACs each operated with a specific field army, the 1st, 3rd, 9th, 7th, and 5th, respectively. While not officially assigned to the army commander, they were undoubtedly an "integral part" of each command, functioning alongside the army staff in delivering air power where it was most urgently needed.

Paragraph 11c provided the justification for the strategic air forces, including 8th Air Force in the UK and 15th Air Force in Italy, as well as 20th Air Force in the Pacific Theater. It stipulated, "GHQ air force of bombardment and pursuit aviation and airships is an integral part of GHQ," suggesting that this force would not be under the control of ground commanders, but could be retained at the highest level, even outside the theater commander's control, as Arnold did with the B-29s in the Pacific. Thus, despite historical case studies of the benefits of unified commands, the doctrine clearly established an "Army air force," charged with cooperating directly with the ground forces, and a "GHQ Air Force," which was "organized into large units, highly mobile and capable of effective action within the theater of operations or against distant objectives. It serves the double purpose of assisting directly the ground forces by joining in the ground battle and indirectly by operating against hostile lines of communication."<sup>4</sup> Para. 14d continued, "The GHQ air force may assist the army in the execution of tactical missions by being employed on the battle front against objectives within the enemy combat zone or, indirectly, when conditions are favorable, by carrying out special missions at great distances from the ground forces." Thus, while observation, pursuit, and attack would work directly with, and even under, the ground commander, the GHQ air force, under airmen, would be free to range behind the battle lines, conducting interdiction and even strategic attack missions. While bombers could, and would intervene in the ground battle, as during Operation Cobra in July 1944, the clear preference was for independent, strategic missions that ultimately contributed to the ground forces' success. The formal separation of these two branches, and the relative emphasis and support provided to each, lay at the root of the service's doctrinal squabbles throughout the 1930s.

But the revised Regulation did little to specify just how aircraft would contribute to the ground battle, other than by relaying information obtained by aerial reconnaissance and cor-

recting artillery fire. As Philip Wielhouwer found in his study of the development of tactical support doctrine, “TR 440-15 correctly identified that air-ground operations required close coordination, but failed to address methodology for attack in a fluid battle, or a mechanism for requesting and controlling air support. The publication listed sound organization, effective training, and quality equipment as requirements for effective air action, yet it made no mention of air-ground communications or interservice training. Vague and watered down, TR 440-15 did not provide enough clear direction to aid in actual combat operations.”<sup>5</sup> To fill this void came a flurry of new field manuals in the “1-“ series, most notably FM 1-5, *Employment of the Aviation of the Army*, issued in April 1940, which officially superseded TR 440-15, and FM 1-10, *Tactics and Technique of Air Attack*, issued in November 1940.<sup>6</sup> Both manuals benefitted from exercises conducted that year under the auspices of the Army’s General Headquarters (GHQ), specifically in the Third Army Maneuver Area on the border between Louisiana and Texas.

### **The 1940 Third Army Maneuvers**

As the European war erupted in September of 1939, the United States began to cast off its blanket of isolationism and prepare for the increasingly likely possibility that the services of its armed forces would again be required to intervene in the conflict then raging on the European continent. Accordingly, in early September, President Franklin D. Roosevelt authorized an increase of the active-force to 227,000 troops and the National Guard to 235,000, with increased training for both. This act provided the troop basis for a series of maneuvers in the summer of 1940 that tested both the newly activated and mobilized formations as well as the concepts they would employ in combat. By May, the service was ready for the first corps-vs-corps maneuvers in the Army’s history.<sup>7</sup> Conducted under Third Army, headquartered at Fort Sam Houston in San Antonio, Texas, the 5-25 May maneuvers pitted IV Corps’ 1st, 5th, and 6th Divisions against the provisional IX Corps’ 1st Cavalry and 2nd Infantry Divisions. Faced with the daunting prospect of breaking onto the European continent, and hoping to replicate German successes, the exercise’s main goals were to test “the use of combat aviation in the preliminary stages of an advance against enemy concentrations,” and to refine “the combined action of combat aviation and mechanized forces.” For both pre-planned and “on call” support, IV Corps controlled the services of a provisional observation group of four squadrons (the 3rd, 15th, 16th and 97th) and, in a vestige from the last war, the 2nd Balloon Squadron, all designed primarily to support reconnaissance and intelligence collection. Combat aviation came from the 3rd Light Bomb Group and 1st Pursuit Group, which at least would be capable of attacks on opposing forces. IX Corps enjoyed similar support from two observation squadrons (the 1st and 22nd) and the 1st Balloon Squadron, with the same combat aviation units available. To maximize availability, the bomb and pursuit squadrons supported both sides.<sup>8</sup>

Perhaps not surprisingly for an exercise that still involved balloon units, the steps taken towards more effective air-ground coordination were halting at best. IV Corps observed that “there must be close liaison between the infantry division and the supporting aviation,” but reported that “no new tactics were developed during those maneuvers.”<sup>9</sup> The corps tested an “autogyro” (early helicopter) and reported favorably on its ability to keep track of friendly movements. The contraption “rendered excellent service in keeping regimental headquarters informed as to the location of the several detached elements of the regiment,” fulfilling the “observation” function admirably. Ground units recommended assigning an observation squadron



to each division, in order to “have observation planes habitually at its disposal to assist in reconnaissance missions.”<sup>10</sup> But, even here, the observation squadrons were too poorly trained and insufficiently equipped to effectively perform their assigned mission. The Corps reported, “none of the squadrons had a full complement of pilots and so their ability was restricted... observation squadrons must have a considerable number of planes capable of landing on improvised or simple landing fields. The planes we had [O-47s], required such elaborate landing fields, that we could not find appropriate ones in proper tactical locations for them. They must be able to land close to headquarters so as to be in the communication net.”<sup>11</sup> The air corps had a preference for a heavier and faster aircraft theoretically capable of surviving on a modern battlefield, while the ground forces demonstrated a clear preference for the liaison-type of aircraft that eventually both fulfilled that role and performed the artillery spotting mission. This was yet another case where the lower-tech solution was better suited to the mission.<sup>12</sup>

Despite conducting an opposed crossing of the Red River near Alexandria and successfully repelling a IX Corps armored counterattack, IV Corps’ efforts did not materially advance air-ground cooperation. The post exercise report included such revelations as “there is serious doubt as to relative value of balloons versus heavier-than-air craft such as autogyros,” recommending that, “extensive tests should be made without delay to arrive at a solution.”<sup>13</sup> Communications suffered as well. The corps’ staff reported, “A special radio set, belonging to the Air Corps, was used at the corps’ CP for the exclusive use of aviation,” and recommended “that this necessary additional radio set should be included in the equipment of the corps signal battalion,” as “the satisfactory functioning of the corps aviation is absolutely dependent upon rapid and positive communications.”<sup>14</sup>

But the primary reason for the failure to develop air-ground coordination came from the absence of combat aviation in the exercise. Despite assigning a fighter and bombardment group, the air corps was unable to support the training. IV Corps lamented, “because of the non-availability of combat aviation, no opportunity was afforded to test any team tactics between it and the infantry or cavalry. In this connection it is believed that great harm can be done to ground troops by not having worthwhile amounts of combat aviation operating with them and against them; without it they cannot have a proper conception of its use and the steps they must take to make its use most effective or to minimize the effect of hostile combat aviation.” Thus, the net effect of the exercise seemed to confirm existing air corps doctrine: observation units of whatever capability (and, given the later adoption of rotary-wing assets in the post-war Army, the “autogyro” test was prescient!) could safely be assigned to ground units, but fighter and bomber aircraft had much more important things to do than train for the close air support mission with ground forces. In their defense, these higher-priority tasks involved training and preparing to conduct the air superiority and interdiction missions, but the inability to provide a single combat aviation unit for the exercise did not bode well for future operations. And the provision of well-equipped and well-trained air units would not necessarily have ensured success, given the miserable state of equipment and training in the ground forces in 1940, especially the National Guard divisions that had suffered from years of neglect.<sup>15</sup>

## **1940 Doctrinal Publications**

At the same time the ground and air forces were failing to capitalize on opportunities to improve coordination, new publications sought to resolve important doctrinal disputes and pro-

vide a framework for future tests. Field Manual 1-5, *Employment of the Aviation of the Army*, issued less than a month before the 1940 Third Army maneuvers, sought to update TR 440-15, taking advantage of overseas developments in the Spanish Civil War and the opening campaign of World War II in Poland. It was an incremental step, reiterating command relationships and airpower capabilities and describing the function of different types of aircraft. Its worst feature was directing the parceling out of aviation units to corps and division commanders, rather than maintaining control at a higher headquarters that could mass an effective force and then shift it to the decisive point. The desire to avoid this subordination to ground units led directly to the establishment of tactical and strategic aviation, to preserve the latter's independence.

Much more significant was the 20 November 1940 publication of FM 1-10, *Tactics and Technique of Air Attack*, which sought to codify for the first time the basic tactics and techniques of close air support. While most of the manual focused on generic air attacks against fixed targets the very last section (perhaps symbolically!) provided seven paragraphs on "Support of Ground Forces."<sup>16</sup> Within this context, one key paragraph provided five types of support available:

- (1) Destruction or neutralization of enemy aviation forces opposing the supported ground forces by antiaircraft defense and counter air force operations.
- (2) Reconnaissance, liaison, and observation.
- (3) Delivery of fire on the immediate front of ground forces.
- (4) Air attack against targets in the hostile rear areas.
- (5) Support, both in the air and on the ground, of parachute troops and air infantry.<sup>17</sup>

Here, the traditional air superiority mission still earned top billing, but the reconnaissance mission had moved up to second, and the close support mission occupied the third position. Interdiction had slipped to fourth and a new role, support for airborne troops, emerged in fifth place. The higher placement of close support suggested that the ground forces viewed the interdiction mission as subsumed in other forms of air attack and was beginning to insist that air support assets and capabilities be focused on close support in the battle space, rather than on more distant targets. Further, a following paragraph did not envision a strictly sequential accomplishment of these missions. It directed, "While the most effective results from supporting aviation are obtained through the neutralization of effective hostile air resistance in the area of operations, the lack of assured local control of the air does not prevent the use of aviation in direct support of ground forces where the operation is critical and the end to be accomplished warrants the acceptance of the risk of heavy losses in the friendly aviation forces."<sup>18</sup> Thus, in critical situations, close support could still be provided, even in the face of strong enemy resistance, but with the understanding that it would lead to higher losses and decreased effects.

"Direct support" missions fell into six subcategories, again with some overlap with the broader "ground support missions. Para. 205 listed the following types of "direct support" for ground forces:

- a. Observation and Reconnaissance
- b. Attack on Defensive Organization
- c. Isolating the battle area
- d. Blocking movement of enemy reserves

e. Attacks on hostile mechanized forces

f. After breakthrough<sup>19</sup>

Of the missions characterized as “direct support,” three (c., d., and e.) could easily be listed as “interdiction,” and, with observation units attached to the ground forces performing the reconnaissance mission, the only remaining missions for combat aviation would be supporting attacks on and through prepared positions.

In accomplishing this role, the manual envisioned a special relationship between aviation and armored forces, again reflecting the perception that the combination of these two weapons had been the key to German success, and suggesting some lingering connection between the two branches that had both grown out of the traditional horse cavalry. Para. 206, “Support of Armored Forces,” argued that aviation assets,

must be able to concentrate rapidly the mass of its fire power on successive attack objectives with a precision timed to the high mobility of the supported armored unit...Rapidity in execution of support missions is vital to success, limiting the time for counteraction by enemy forces. To insure both the prompt execution of aviation support missions and the exploitation thereof by mobile ground troops positive advance arrangements must be made for simple, prompt communication between the ground forces and supporting aviation.<sup>20</sup>

Indeed, this paragraph accurately forecast the “armored column cover” mission that typified tactical air activities in the fall of 1944 in France and the spring of 1945 in Germany.

Unfortunately, the manual had less to offer on what exactly the “positive advance arrangements” should entail. It did suggest that “temporary decentralization of control of combat aviation in direct support of armored forces may be necessary in order to insure the timely employment of aviation in close coordination with the supported forces for the accomplishment of a specific task,” which is essentially what the Tactical Air Commands eventually achieved. Assigning aircraft to Air Support Controls at the corps or even division levels ensured even closer coordination and more rapid response times, even though it ran counter to air force mandates for centralization. This dilemma remains after 75 years, as contemporary air planners weigh the value of centralization at a Combined Air Operations Center with the benefits of permitting control at much lower levels in order to provide rapid response times to time-sensitive targets. The manual also foresaw the possibility of “Direct radio telephone communication between armored and supporting air units,” and the value of “the extensive interchange of liaison officers by the participating forces,” which would later be enshrined in the use of Tactical Air Liaison Officers (TALOs) with the ground units and Ground Liaison Officers (GLOs) with the air units.

The section’s final paragraph could have come directly from the pen of the Chief of Staff or, at the very least, the commander of the Army Ground Forces, Lt. Gen. Lesley McNair:

Effective teamwork is essential to success in combined air-ground operations. This can only be achieved through intensive training and indoctrination of both forces. Aviation used in direct support of ground forces must be thoroughly familiar with ground warfare through intensive peacetime training and should be fully trained to participate promptly and effectively anywhere on the battlefield to destroy resistance

that impedes the advance of our ground forces. Thorough joint training and tactical exercises will further tend to develop sound tactical doctrines of employment.

Fortunately, the following year brought ample opportunity to train together and test new methods, in the largest training exercises ever held in the United States.

As the only functional corps-level headquarters in the United States at the time, IV Corps, based at Fort Benning, Georgia, continued to play a central role in developing air ground doctrine. After the abortive attempts in 1940, new tests and exercises provided additional opportunities for experimentation, refinement and, most importantly, codification in the new manuals that trained the Army for World War II. A central figure in the training program, Maj. Gen. Lloyd R. Fredendall, commanded the 4th Motorized Division at Benning in 1941, before leading II Corps in both the Louisiana and Carolina maneuvers. He also served as II Corps' commander in North Africa, including the Battle of Kasserine Pass and then, largely as a result of that debacle, returned stateside to command Second Army in Memphis, where he had the opportunity to direct further divisional-level maneuvers including air-ground cooperation in the giant Tennessee maneuver area east of Nashville.

In June 1941, IV Corps hosted a series of tests and demonstrations at Fort Benning with the 17th Bomb Wing at Savannah and the new 2nd Armored Division and soon-to-be motorized 4th Infantry Division, as well as the mobilized 31st "Dixie" Division of the Florida, Alabama and Mississippi National Guards. These tests resulted in the publication of an interim "Training Circular," TC 52, on 29 August 1941, which served as a blueprint for the Louisiana and Carolina Maneuvers.<sup>21</sup> The Benning tests emphasized control of air forces and responsiveness to ground requests, resulting in the "air support control" system for routing, processing, and servicing requests for ground forces in contact with the enemy.<sup>22</sup> As Philip Wielhouwer described it, "TC 52 contributed significantly to CAS doctrine by establishing an air force command post to be closely linked to the ground force command post, expanding the air support request system, and detailing extensive radio and landline links between air and ground command elements. These fundamental procedures contributed to the planning and execution of follow on tests."<sup>23</sup> Refinement and practice with light bomber squadrons of the 17th Bomb Wing cut average response time to just over an hour from ground alert, but this was in a permissive environment with little strain on the communications net.<sup>24</sup> Unfortunately, the demands of a major exercise, not to mention a massive amphibious landing, could easily overwhelm fragile communications networks leading to delays, breakdowns, and the failure of the entire air support system. As the Army was then struggling with development of anti-tank weapons, airmen interested in attacks on armored vehicles could have stepped into this void and offered the "tank-killing airplane" as a stop-gap solution, as the RAF was then doing in the Western Desert. But the focus on a ground-based system and an ideological preference for interdiction over CAS left this potential unfulfilled until 1944.

As a warm-up for the Louisiana Maneuvers, Second Army held an exercise in June east of Nashville, in what later became the Tennessee maneuver area, the training area that most closely approximated the terrain and climate in Northwest Europe.<sup>25</sup> In the exercise, three infantry divisions, the 5th, 27th, and 30th squared off against Maj. Gen. George Patton's 2nd Armored Division. Each side had the services of one observation squadron, used mostly to evaluate camouflage and concealment, but the troops did experiment in protection from air attack. On 12 June, troops in Shelbyville, Tennessee blacked-out all lights in the town and anti-aircraft units blazed away with blanks at the sounds of A-20s from the 15th Bomb Squadron flying from Fort



Figure 2.2. Simulated Attack by A-20 during maneuvers.

Benning's Lawson Field, near Columbus, Georgia. The attackers were short one aircraft, which crash-landed en route near Chattanooga, highlighting the Army Air Force's reluctance to risk scarce assets supporting maneuvers when it saw more pressing training problems.<sup>26</sup> Aircraft of the 8th Bomb Squadron, flying from Chattanooga, attacked vehicle concentrations and truck columns throughout the exercise, but, overall, interaction was limited and of dubious value. For his part, Patton brought a personally-owned aircraft with him and employed the Stinson Voyager throughout the maneuvers for reconnaissance.<sup>27</sup>

### **The 1941 GHQ Maneuvers—Louisiana**

The 1941 Louisiana Maneuvers were the largest training exercises ever held in the continental United States. Conducted from 15-28 September, the tests pitted Lt. Gen. Ben Lear's Second Army against Lt. Gen. Walter Krueger's Third Army in a sprawling maneuver area that covered most of Louisiana west of the Red River and parts of eastern Texas across the Sabine River. Second Army based at Camp Polk, near Leesville, while Third Army centered on the National Guard training posts of Camp Livingston and Camp Beauregard north of Alexandria. The exercise also benefitted from the close proximity of air bases in Lake Charles, Alexandria and especially Barksdale Field near Shreveport, long the home of the Army Air Force's attack aviation squadrons. The maneuver area, and the AAF units stationed near it, including the III Air Support Command, headquartered at Esler Field near Alexandria, continued to support air-ground training through 1944, but never again on the scale of the 1941 maneuvers.

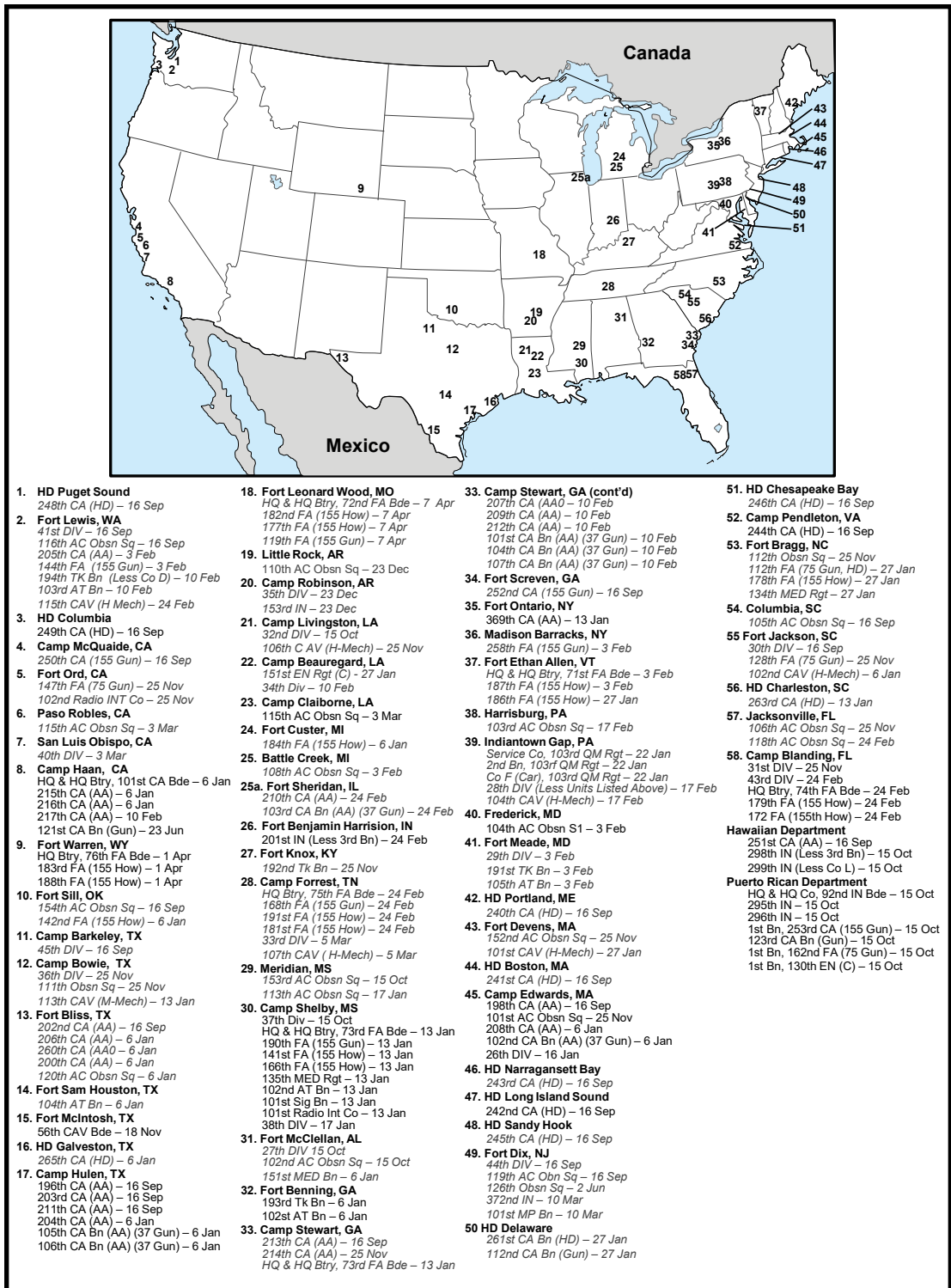

Figure 2.3. Induction of the National Guard into Federal Service, September 1940-June 1941. Graphic created by Army University Press staff.

The exercises also benefitted from the mobilization of all 18 National Guard Divisions over the previous year, as a result of the Selective Service and Training Act of 1940, and filled their understrength ranks with volunteers and draftees. The 1941 maneuvers served as a “capstone” exercise for the previous year of training before a scheduled demobilization later that fall. In total, ten of the activated National Guard divisions participated in the Louisiana Maneuvers, with three more taking part in the First Army’s Carolina maneuvers in November, while two Guard divisions trained with First Army at Fort Lewis in August. Instead of returning to civilian life after the exercises, the divisions had their mobilization extended for several more months during the exercises, which some historians have suggested, adversely affected morale in these units.<sup>28</sup>

As historian Christopher Gabel related in his excellent study of the 1941 GHQ Maneuvers, “to encourage experiments with light liaison airplanes, the firms of Piper, Aeronca, and Taylor offered the free use of eleven Cub-type sport planes for the maneuver season,” which was a complete success and resulted in the adoption of these types within each artillery battalion.<sup>29</sup> The Air Force also offered four full pursuit (fighter) groups and another four bomber groups, over 600 aircraft in total, to support the exercise.<sup>30</sup> Each group operated the most modern types available, including the A-20 light bomber that equipped most support squadrons in North Africa, the new B-25 and B-26 medium bombers, which the AAF was eager to test in its envisioned airfield attack role, and P-38, P-39, and P-40 fighters, which likewise became the AAF’s front-line fighters in the Tunisian desert.<sup>31</sup> Due to a shortage of dive bombers, the AAF requested two Navy dive bomber squadrons equipped with the SBD *Dauntless*, identical to the AAF’s A-24. Eager to perfect their support of forces ashore in amphibious operations, the Navy increased their allotment and sent three fighter, four dive bomber, and one torpedo squadron, which could also perform the observation mission.<sup>32</sup> Lear’s 2nd Air Support Command (ASC) included the maneuver-tested 17th Bomb Wing and the 6th Pursuit Wing, augmented by another group’s worth of Navy aircraft, while Krueger’s similarly-composed 3rd ASC controlled the 2nd Bomb Wing, 10th Pursuit Wing, and another four Navy squadrons, which Krueger ordered to find and fight Lear’s two armored divisions.<sup>33</sup>

In accordance with procedures developed at Fort Benning in June, and in something of a doctrinal compromise, exercise planners organized these units into an ASC assigned to each Army. While ostensibly satisfying the ground forces demand that aviation assets be subordinate to ground commanders, in reality it concentrated each army’s assets into a single striking force that could be allocated and controlled in accordance with the army commander’s intent. Thus, the exact model that would be used with great success in the skies over Europe in 1944-1945 was already in use before the United States entered the war. Although the rudimentary ASCs had a long way to go to become highly effective Tactical Air Commands of the European Theater of Operations, their establishment and codification solved one of the thornier doctrinal debates.<sup>34</sup>

Despite poor weather from a tropical storm, a direct consequence of holding the exercise at the height of the hurricane season on the Gulf Coast, Third Army’s aircraft relentlessly attacked the advancing Second Army’s armored forces and the vital bridges over the Red River in their rear, precipitating mock dogfights with defending aircraft from 2nd ASC.<sup>35</sup> The operations focused largely on air superiority and interdiction, as the two armies were not yet in contact, which ideally suited the airmen and their conception of the employment air power in the ground battle. One mixed lesson was the futility of defending fixed objectives with “standing patrols,” rather than offensive attacks on enemy airfields, as 2nd ASC failed miserably in its

attempts to protect the river crossings against the 3rd ASC's bombers. Aerial reconnaissance easily uncovered road-bound and poorly camouflaged formations, presenting a wealth of interdiction targets and allowing Krueger to redeploy his anti-tank forces into the path of the armored divisions.<sup>36</sup> Only the 1st Armored Brigade proved capable of coordinating an attack with supporting aircraft, achieving a limited breakthrough on 18 September, but it could not prevent Third Army forces from overrunning some of the Second Army's forward airfields.<sup>37</sup> In the second phase of the maneuvers, troops of Maj. Gen. George Patton's 2nd Armored Division duplicated this feat when they swung around the Second Army's western flank and captured the army's main air base at Barksdale Field. While focusing on interdiction proved to be an excellent use of tactical aviation, it also limited responses for specific requests for air support from the corps and division commanders.

In terms of doctrinal development, this was unfortunate, but for educating ground commanders on what tactical air forces could and would do, and what that effort would cost, it was a valuable lesson. To drive the point home, and reinforce the vulnerability of convoys to air attack, the AAF conducted a live-fire demonstration at Barksdale for an assembled crowd of 4,000 officers and effectively demonstrated what modern weapons were capable of against motorized and armored vehicles.<sup>38</sup> Immediately after the exercises, the Army removed senior officers who had performed poorly, and replaced them with those who were on an upward trajectory. One of the many beneficiaries was Brig. Gen. William H. Simpson, who ascended from an assignment running an infantry training center at Camp Wolters, Texas to command of the Kansas, Missouri, and Nebraska National Guard's 35th Infantry Division shortly thereafter.

In actual application, the tests left much to be desired. While command arrangements had been resolved, the priority of missions still drove a wedge between air and ground commanders. The two ASC commanders preferred to employ their units, especially the fast medium bombers, in air superiority and interdiction missions, destroying the opposing airfields to win command of the air and then using that command to target vulnerable fixed targets, such as bridges and road junctions. At least this was the impression Chief of Staff George Marshall left the maneuvers with, although the Army commanders praised the support they received, as even the commander of the Army Ground Forces, Maj. Gen. Lesley McNair found the air forces "surprisingly effective."<sup>39</sup> Opportunities to test the new "air support control" system refined at Fort Benning lagged behind the other two, "higher priority" missions. Thus, the air-ground team squandered a golden opportunity to push the development of air-ground doctrine farther along. As Chris Gabel found, "Unfortunately, the maneuvers produced few suggestions on how such problems could be solved. The absence of communication between air and ground at the front, in conjunction with limited fuel capacities in aircraft, fear of hostile aviation, and Army Air Forces reticence, precluded the possibility of keeping planes airborne over the battlefield where they could have responded immediately to ground requests."<sup>40</sup> The ability to conduct "armored column cover" would have to wait until 1944, with serious repercussions on the North African battlefield. And air-ground doctrine was not alone, as both armor and anti-tank doctrine suffered similar deficiencies, with similarly fatal results.

### **The 1941 GHQ Maneuvers—The Carolinas**

The Louisiana Maneuvers were but the first of what was intended to be an army-level wargame for each of the four numbered armies in the continental United States. While Sec-



ond and Third Army, in the southeastern and south-central regions of the country had fulfilled their objectives in a joint exercise, First Army, in the northeast, and Fourth Army, on the west coast, would have to spar with a detached corps on their own. Fourth Army completed their maneuvers at Fort Lewis, Washington in August, with only the four divisions available on the west coast, but the First Army maneuvers promised to be a much larger affair. After securing use of a training area stretching from roughly Fort Bragg, near Fayetteville, North Carolina, to Fort Jackson, outside of Columbia, South Carolina, the Army planned to test Lt. Gen. Hugh Drum's massive First Army, headquartered at Fort Drum, New York and augmented by mobilized National Guard divisions of this densely populated part of the country, against Third Army's IV Corps, reinforced with the Armored Force's two armored divisions, all commanded by Maj. Gen. Oscar Griswold. While the Louisiana Maneuvers had tested two similar armies, with the armored divisions swapping sides halfway through, the Carolina maneuvers sought to emulate the German campaigns of 1940 in France and 1941 in the Soviet Union, both to divine ways to halt armored thrusts, and to duplicate them against static positions when the opportunity arose. While the Louisiana Maneuvers had seen the air assets split evenly among the attackers and defenders, the Carolina maneuvers sought to replicate the imbalance the Germans had achieved in their "blitzkrieg" campaigns, which would help move past the air superiority phase of operations and move more quickly into interdiction and, ideally, close air support. Vindicated in the Louisiana trials, both First Army and the reinforced IV Corps, itself almost the size of a field army, each had an Air Support Command attached, manned, and partially equipped to relay requests from commanders in the field to the waiting pilots at the airfields. While communications difficulties still hampered the system, the fluid maneuvers helped to further refine air-ground techniques and doctrine.

As Christopher Gabel notes, "In the first Carolinas Maneuver, First Army's air arm, the 1st Air Support Command, would consist of the 6th Pursuit Wing (six Army squadrons reinforced by one Marine squadron) and the 3rd Bombardment Group (three squadrons of light bombers plus one Navy dive-bomber squadron). The 1st Air Support Command, however, lacked the medium bombers necessary to conduct the full range of air operations."<sup>41</sup> In contrast, IV Corps held the preponderance of assets. "Aside from its greater mobility, IV Corps' only advantage over the First Army would be in the air. Griswold's air arm, the 3rd Air Support Command, consisted of the 2nd Pursuit Wing (one Marine and six Army pursuit squadrons) and the 10th Bombardment Wing (one Navy and seven Army bomb squadrons), which together with non-combat planes totaled 366 aircraft to 1st Air Support Command's 320."<sup>42</sup> In addition to 3rd ASC's larger size and more powerful striking force, it also contained a specially-designated "combat air support unit," a bomb group tasked with immediately responding to ground requests, in an effort to speed up the average 1.5 hour response time experienced in Louisiana. Gabel noted, "This group assumed all of the direct frontline support functions and handled requests without referring to command headquarters, thus eliminating one link in the communications chain and freeing the rest of the command for other operations."<sup>43</sup>

In many respects, the command relationships mirrored the situation in Louisiana. On one side was a larger, less mobile field army commanded by an older general who did not see field service in the coming war, as neither Lieutenant Generals Lear nor Drum, distinguished veterans of the Great War, made it onto a Second World War battlefield. Opposing them were



Figure 2.4. Ground Forces receive Instruction during maneuvers.

commanders of smaller, more mobile forces who went on to distinguish themselves as corps and army commanders in the Pacific Theater of World War II, Walter Krueger in command of Sixth Army in Gen. Douglas MacArthur's Southwest Pacific theater, and Oscar Griswold as commander of the amphibious XIV Corps in Adm. Chester Nimitz's Central Pacific Theater. Thus the exercises marked in many ways a transition from an older to a newer form of warfare emphasizing mobility and combined arms techniques rather than plodding, single-arms affairs.

The broad and unfordable Pee Dee River separated the two armies, funneling each side into vulnerable river crossings that promised ample opportunity for interdicting aircraft to disrupt carefully-laid timetables.<sup>44</sup> The "fighting" was concentrated along the river where it flowed from North into South Carolina, and continued raids on the First Army bridgeheads stymied the attackers, preventing a crossing in force, though aerial attrition was very high, with 66 aircraft "lost" on 23 separate missions.<sup>45</sup> Ferries and pontoon bridges enabled First Army's reconnaissance elements to cross the river, but IV Corps' speedy armored units easily constrained the attacking troops in their bridgeheads, a valuable lesson for Allied planners of the Normandy invasion three years later. Relieved by its two following infantry divisions, which fought desperately to contain the growing bridgehead, IV Corps' three mobile divi-

sions, the 1st and 2nd Armored and 4th Motorized, reassembled into a powerful striking force that hoped to catch its larger but more ponderous opponent off guard. 3rd Air Support Command spent itself attempting to interdict the river crossings and contain the buildup, but the Fabian resistance bought Griswold the time he needed to launch an armored column into the enemy rear.

But this was not the only envelopment he had planned to throw his opponent off balance. An airborne raid on Pope Field captured the airdrome for several hours and would have cost the 1st Air Support Command most of its aircraft and trained personnel by the time nearby ground forces liberated the field. The operation fit neatly with the AAF's preference for gaining air superiority, and found new allies in the airborne forces that depended on airlift, but escorting the attack deprived IV Corps' mobile forces of close support for much of the day, and inflicted equally heavy losses on 3rd ASC, rendering it combat-ineffective as well. In what must have been a comfort to commanders still in awe of the German "blitzkrieg," the slower, heavier First Army appeared to be winning the battle. By burning up his stronger and more mobile units in a number of spoiling counterattacks, Griswold had failed to achieve mass anywhere along the front and was unable to achieve the kind of breakthrough that might have won him the day. While the US Army understood the idea of massing aircraft and armored formations, it was still incapable of putting it into action. And it had missed yet another golden opportunity to weld a more effective combined-arms team.

The second phase of the maneuvers was little more than a reduction of IV Corps positions defending the city of Camden, given the 2-1 disparity between the attacking and defending forces. First Army even gained the 17th Bomb Wing from 3rd Air Support Command, giving it at least parity in the air.<sup>46</sup> Not content with these advantages, Lieutenant General Drum sought to prove the old adages, "If you're not cheating, you're not trying," and "all is fair in love and war," by illegally moving his troops into their jump-off positions ahead of time, in violation of his orders. As a result, his hammer blows fell on Griswold's hapless armored divisions, who were unsuited for the defensive mission. In the air, the situation approximated that in France and Germany in 1944-1945, as support aircraft sought to reduce fixed positions and interdict the flow of supplies and reinforcement into the defending forces. In an eerie preview of the Battle of Kasserine Pass in February 1943, Maj. Gen. Lloyd R. Fredendall twice allowed spoiling attacks by armored columns to penetrate his II Corps' front, (the same unit he would command in Tunisia), before they outran their logistics and had to be withdrawn or eliminated. But, with the counter-thrusts contained and eliminated, First Army pressed on for Camden, aided immeasurably by the capture of a copy of IV Corps' defensive plans. Airborne forces seized vital bridges into the city but aircraft otherwise did not play an important role in the assault, and the maneuvers terminated on 30 November, well after six Japanese aircraft carriers left their ports in the home islands for the strike on Pearl Harbor.

While the exercises had brought air and ground units together to work on new methods and techniques of cooperation, they left much still to be desired. According to Gabel,

of the 167 raids flown by the 1st and 3rd Air Support Commands, 99 went against airdromes, railroads, and bridges; 37 against armored and mechanized units (by preference, those detected in their assembly areas behind the lines); and 31 against miscellaneous targets, including enemy frontline troops. The air support commands actively resisted the dissipation of force that small-scale direct-support operations

would necessitate and generally made no attempt to attack what they considered to be unremunerative targets.<sup>47</sup>

For the AAF, this represented a confirmation of published doctrine, but the ground forces found the inability to provide effective direct support, if and when required, to be disconcerting. Gabel continues, “On the other hand, ground commanders did not fully appreciate the capabilities and limitations of air power. They could not be trusted to discern the feasible from the impractical, nor did they understand the importance of air missions executed beyond their line of sight. The air support command was a compromise that satisfied neither the airman’s desire for centralized autonomy nor the ground soldier’s demand for maximum support at the cutting edge of battle.”<sup>48</sup>

Yet, this was the very nature of compromise: while neither side got what it *wanted*, both got what they *needed*. The Air Support Command, and its successor, the Tactical Air Command, provided an almost-perfect balance of subservience and autonomy, once vast training and technical issues had been resolved. Airmen delivered airpower when and where needed, and ground commanders had a capable and responsive system to request and coordinate it. As Chris Gabel acknowledges, “the solution, which owed much to British experience, did not involve choosing between centralization and decentralization; rather, it involved centralization and decentralization simultaneously.”<sup>49</sup> But the root of the failures in North Africa lay in Gabel’s observation that “by 1944 the Army Air Forces possessed such an abundance of aircraft and pilots that it could perform every conceivable air mission to satisfaction, ranging from strategic bombing to the direct support of frontline troops.”<sup>50</sup> In 1941, this was decidedly not the case. And, given that it could support only one or two missions effectively, the Army Air Forces in North Africa concentrated on effectively wresting control of the skies from the Axis powers and then interdicting their vulnerable supply lines across the Mediterranean. These higher-priority missions meant that close support suffered but, in the end, the doctrine was correct. Devoting the entire effort to close support would have prolonged the campaign. Winning control of the skies and shutting down the Axis ports saved lives in the long run.<sup>51</sup>

The most visible result of the exercises was the publication of a new doctrinal manual, one that formed the theoretical basis for air-ground support throughout the war, despite extensive modifications in the field. The War Department issued FM 31-35 *Aviation in Support of Ground Forces*, on 9 April 1942, after a winter of drafts, debate, and discussion. The manual’s principal author, Col. William E. Lynd, served as an artilleryman with the Idaho National Guard in the Great War, where he received training as an aerial observer in 1918. After the war, he completed pilot training and commanded a pursuit (fighter) group in Hawaii before reporting to the Air Staff. As a student at the Command and General Staff College at Fort Leavenworth in 1933, he wrote about his experiences directing air support during the St. Mihiel offensive, which consisted primarily of taking aerial photographs and correcting artillery fire.<sup>52</sup> Thus, he was uniquely qualified to write the new doctrine, having also served with the 2nd Air Support Command during the maneuvers. In March, 1942, the new head of the AAF’s Ground Support Division, Col. David M. Schlatter “inherited a virtually complete draft manual” created by Lynd and his counterparts at the GHQ, reorganized as the Army Ground Forces (AGF) and shepherded it through the approval process.<sup>53</sup>

The new manual’s stated purpose was to “prescribe organization for combat, general functions, and employment of aviation used in tactical support of ground forces.” In that limited range, it must be judged a success, as it provided an organization, the ASC, which largely en-

duced throughout the war, described all of the various roles and missions, including airborne operations, and began to explore the communications requirements essential for effective control.<sup>54</sup> It was intended to be what is now known as “joint doctrine,” covering “only matters of common interest to the air and ground forces.”<sup>55</sup> It allowed for designating units to support specific ground units but emphasized that this did not remove them from the air commander’s control.<sup>56</sup> The control mechanism flowed from Air Support Parties (ASPs) at the corps or division level, linked to the Air Support Control at the army headquarters as well as the supporting airfields. Unfortunately, there was still no provision for direct contact between the supporting aircraft and the ASPs. It did mandate that “the command post of the air support command is immediately adjacent to the command post of the supported unit—in this case an army,” a truism just then being proven in the western desert of Egypt.<sup>57</sup> Thus, the effective organization of a network was largely complete, and lacked only the fielding of a mobile, reliable radio to permit direct communications from ASPs to supporting aircraft. The manual also emphasized the close coordination and cooperation required of ground and air elements, not least in the intelligence function, where both forces rapidly shared information on targets and the evolving situation, preventing the stove-piping of information in air or ground networks.

The missions listed ranged from “reconnaissance,” reflecting the importance of intelligence and the future assignment of one tactical reconnaissance group to each tactical air command in 1944-1945, to attacks on defended positions, enemy reserves, and mechanized forces, all of which fell under the traditional umbrella of close air support. The air superiority mission slipped on the ASC’s priority list, under the assumption that the “independent,” or strategic air force would concentrate on this mission, but the manual recognized that “when other air forces are inadequate or not available, the destruction or neutralization of hostile aircraft or anti-aircraft by support aviation may be necessary.”<sup>58</sup> Airmen preferred not to hit targets “within the effective range of the weapons of ground forces,” and argued that small, dispersed or concealed forces were “not suitable targets for support aviation,” due to the difficulty of successful attack.<sup>59</sup> While the manual suggested a clear preference for interdiction, it did not mandate a priority, and left considerable flexibility in the supported commander’s hands.

The manual benefitted from the inclusion of pre-formatted forms for requesting air support, the predecessor of the modern “nine-line” format that standardizes requests in terms of description, location, and presence and proximity of friendly forces. While air commanders could evaluate the feasibility of a requested attack, the manual still left the decision to order the mission with the commander of the supported unit.<sup>60</sup> Aircraft could be held on ground or air alert, but the air alert was acknowledged to be “uneconomical.” While airmen complained extensively about “air umbrellas,” this mission often fell to the fighter or “interceptor” command and was not usually performed by the air support command. The only squadrons specifically assigned to ground commanders were the “observation” squadrons, a type of aviation found obsolete during the North African campaign. Instead, the tactical reconnaissance group replaced it, largely on a scale commensurate with that envisioned in the manual. In a construct that continued throughout the war, each army was to have “An observation group consisting of two medium observation squadrons and a photo squadron.” Throughout its campaigns, XXIX TAC enjoyed the services of the 363rd Tactical Reconnaissance Group, with the 60th and 61st Tactical Reconnaissance Squadrons and the 33rd Photographic Reconnaissance Squadron, almost exactly in accordance with the manual, with only minor changes in terminology and equip-

ment. The envisioned assignment of observation squadrons to corps and division-level headquarters was eventually dispensed with, replaced with light, liaison-type aircraft with the field artillery battalions. Detailed sections on observation and photography further outlined those responsibilities. The employment of airborne forces in both maneuvers necessitated a section on "Air Transport," and the addition of "support of parachute and other airborne troops" at the bottom of the list of missions. Recognizing that these units would lack the organic firepower of an infantry or armored division, the manual directed a greater allocation of air support for airborne operations, especially aerial resupply and medical evacuation, as Ninth Army learned in its support for Operation Varsity, the airborne drop across the Rhine in 1945.

Perhaps the most welcome addition was the inclusion of a detailed section on communications requirements, including procedures for setting up networks to be used by ground and air forces and the types and numbers of required equipment. Most interestingly, a diagram on page 48 included two notes, the first of which directed, "After bombardment aviation takes off from an airdrome on an air support mission, it can be brought for control purposes into either an air support control or air support party radio net," allowing for the possibility, if not the requirement, for direct communications between the supported and supporting forces.<sup>61</sup> The second note sought to "shorten the kill chain" between the sensor and shooter, establishing that "observation aviation may initiate requests for air support direct to an air support control or air support party, or may guide bombardment aviation to targets, in which event it would be brought into an air support control or air support party net as required," predicting the "horsefly" mission developed in Italy in 1943, and the later role of the "Airborne Forward Air Controller," or AFAC. While unfortunately not establishing requirements and procedures, the manual at least envisioned the use of a much more responsive air-ground system.

Thus, the manual codified many of the lessons of the 1941 maneuvers, but failed to fully resolve the thorny issue of command relationships. Although the manual was intended as a stop-gap, it endured throughout the war, though FM 100-20, issued after the North African campaign in 1943 clarified some of the command relationships, most notably by asserting that the ground and air commanders were co-equal and independent, but should cooperate closely together, as the British commanders Bernard Montgomery and Arthur Coningham had done in the western desert. Most importantly, FM 31-35 provided an established, tested (in maneuvers if not in actual combat) baseline to begin training the rapidly mobilizing active, National Guard, and reserve divisions then reporting to training camps across the country. While Chief of Staff Gen. George Marshall struggled with the temptation to revise the manual after the initial combat in the Mediterranean, he ultimately decided to forego the delay and disruption to the training cycle that this would create. But lessons, techniques and procedures still filtered back into the training command, in the form of combat-experienced trainers and leaders, who could then impart the most current methods of gaining air support for ground troops to those who would carry the fight into France in 1944. These included battle-experienced RAF officers at the AAF's School of Applied Tactics (AAFSAT), the replacement for the shuttered ACTS, who arrived at the new school in Orlando in March 1943.<sup>62</sup> In doctrinal schoolhouses and training bases across the country, but most notably in the large maneuver areas established in 1941, soldiers and airmen practiced the new techniques and methods together, hammered out agreements, and built the working relationships successfully exploited in Northwest Europe in 1944 and 1945.

## Notes

1. Tactics and Techniques Developed by the United States Tactical Air Commands in the European Theater of Operations, AAF Evaluation Board in European Theater of Operations Training Regulation 440-15, *Fundamental Principles of the Employment of the Air Service* (Washington, DC: GPO, 1926.)

2. TR 440-15.

3. See Christopher M. Rein, "From 'Observation' to 'Tactical Reconnaissance:' The Development of American Battlefield ISR in World War II," *Air Power History*, Vol. 63 (Spring 2016): 32-45.

4. TR 440-15, Para. 14a.

5. Philip Wielhouwer, "Trial by Fire: Forging American Close Air Support Doctrine, World War I through September 1944," Thesis, Command and General Staff College, Fort Leavenworth, KS, 2004, 7.

6. Greer, *The Development of Air Doctrine in the Army Air Arm, 1917- 1941*, 113.

7. Gabel, *The US Army GHQ Maneuvers of 1941*, 14.

8. "Third Army Maneuvers, May 5-25, 1940, Sabine Area," CARL Doc. N2836.1

9. HQ, IV Corps, "Final Report Third Army Maneuvers, May 1940," CARL Doc. N2836.3, 33.

10. "Final Report," 34.

11. "Final Report," 42. The report summarized, "The present observation plane (O-47) is unsatisfactory for Corps and Divisions. Observation planes must be capable of landing and taking off on small improvised landing fields near the Corps CP." 45.

12. Some current proposals advocate bringing light, fixed-wing aircraft, such as the AT-6 or Super Tucano into Security Force Assistance Brigades or light formations. See John Bolton, "Precedent and Rationale for an Army Fixed-Wing Ground Attack Aircraft," *Military Review* (May-June 2016): 78-87.

13. "Final Report," 17.

14. "Final Report," 19.

15. Gabel, *The US Army GHQ Maneuvers of 1941*, 13-14. One study found that 20 percent of the National Guard's division and staff officers were incapable of performing their assigned jobs; Gabel, 16.

16. FM 1-10, *Tactics and Technique of Air Attack*, (Washington, DC: GPO, 1940), iii.

17. FM 1-10, para. 203 (12) c., 115.

18. FM 1-10, para. 204c., 116.

19. FM 1-10, 116-117.

20. FM 1-10, 116-117.

21. Wielhouwer, "Trial by Fire," 21.

22. Wielhouwer, 20-21.

23. Wielhouwer, 22.

24. Wielhouwer, 21.

25. In his study, Pete Mansoor found that the 100th Division's maneuver period in November and December of 1943 "was valuable for the men of the Century Division, for the terrain and weather conditions they experienced in the mountains east of Nashville were very similar to what they would find in the Vosges a year later." Mansoor, *The GI Offensive in Europe*, 209.

26. Woody McMillin, *In the Presence of Soldiers: The 2nd Army Maneuvers & Other World War II Activity in Tennessee*, (Nashville: Horton Heights Press, 2010), 48.

27. McMillin, 52, 55-56, 62.

28. Flint Whitlock, *The Rock Of Anzio: From Sicily To Dachau, A History Of The U.S. 45th Infantry Division* (New York: Basic Books, 2005), 42.

29. Gabel, *The US Army GHQ Maneuvers of 1941*, 49, 118.

30. Gabel, 55.

31. Gabel, 56; Christopher M. Rein, *The North African Air Campaign: The US Army Air Forces from El Alamein to Salerno*, (Lawrence, KS: University Press of Kansas, 2012).

32. Gabel, *The US Army GHQ Maneuvers of 1941*, 56.

33. Gabel, 68.

34. Gabel, 57, 119.
35. Gabel, 70.
36. Gabel, 88, 102.
37. Gabel, 82-84.
38. Gabel, 119-120.
39. Gabel, 118.
40. Gabel, 120.
41. Gabel, 126.
42. Gabel, 128.
43. Gabel, 128.
44. Gabel, 136.
45. Gabel, 137.
46. Gabel, 156.
47. Gabel, 179.
48. Gabel, 180.
49. Gabel, 189.
50. Gabel, 190.
51. See Rein, *The North African Air Campaign*.
52. Maj. William E. Lynd, "Air Operations in Support of the 89th Division in the St. Mihiel Offensive, 12-16 September, 1918," MA Thesis, Command and General Staff School, Fort Leavenworth, KS, 1933.
53. Futtrell, *Ideas, Concepts, Doctrine*, 132-133.
54. It established that, "An air support command is habitually attached to or supports an army in the theater," with "observation type aviation" organic, and "other types assigned or attached as the situation requires." (1)
55. FM 31-35, 1.
56. FM 31-35, 2.
57. FM 31-35, 5.
58. FM 31-35, xx.
59. FM 31-35, xx.
60. FM 31-35, 13.
61. FM 31-35, 48.
62. Mortensen, "The Legend of Laurence Kuter," in *Airpower and Ground Armies*, 119.



## Chapter 3

### Training to New Doctrine, 1942-1944

Following the massive wargames in the fall of 1941 and smaller maneuvers in the summer of 1942, the Army did not have an opportunity to fully develop and implement a comprehensive training program for its divisions headed overseas until mid-1943. From then until the bulk of the units had moved overseas in the late summer of 1944, the Army ran almost continuous exercises on its three primary maneuver areas in the forests of Louisiana, the hills and valleys of Tennessee, and the California and Arizona deserts. While pre-war units, and those mobilized before the war shipped out hastily in 1942 to meet emergencies across the globe, most divisions remained stateside where they underwent an unending program of individual, small-unit, and larger unit training, culminating in division- and corps-level maneuvers before moving to ports of embarkation for overseas shipment. Constant levies on newly-organizing divisions for trained soldiers and leaders meant later-deploying units struggled to maintain readiness, and they were periodically stripped for cadres for the units deploying ahead of them. In spite of this personnel turnover, most divisions completed at least one intensive period of maneuvers before shipping overseas.

Most importantly, the quality of that training, especially in air-ground coordination, steadily improved as lessons learned from the combat theaters gradually filtered into training syllabi and experienced soldiers and airmen returned to lead the units through their training exercises. By the summer of 1943, air-ground support doctrine had been sufficiently refined to provide a workable baseline for common training, and more aviation units were available to support the training exercises, with each of the major areas enjoying the support of a designated Air Support Command, which could also send detachments to support training exercises and demonstrations for ground units at their home stations. By the fall of 1943, each maneuver area had at least one reconnaissance group available, manned by trained pilots who had completed the rigorous course at Key Field, near Meridian, Mississippi. There, experienced airmen from both the USAAF and RAF who had fought in the North African campaign provided a realistic syllabus and helped develop procedures for providing information and photographs for ground commanders. When infantry and armored divisions reported to a maneuver area, they typically had the support of one of these newly-renamed reconnaissance groups, and an exchange of liaison officers between the two units codified both the specific procedures and importance of requesting and receiving timely tactical reconnaissance. As a result, the months-long maneuvers completed between the summer of 1943 and the spring of 1944 provided realistic training for the bulk of the Army Ground Force units destined for the European Theater of Operations.

While the army had organized its four stateside armies geographically, with the First Army in the Northeast, Second Army in the Midwest, Third Army in the Southeast and Fourth Army on the West Coast, the AAF preferred a functional organization for each of the corresponding numbered air forces. As the service's official history explains it, "Throughout the war, however, the Second Air Force remained the principal center for developing heavy and very heavy bombardment groups. The responsibility of the First and Fourth Air Forces was chiefly the training of fighter units, while the Third Air Force directed light and medium bombardment, reconnaissance, and air support activities. The I Troop Carrier Command performed the special task of

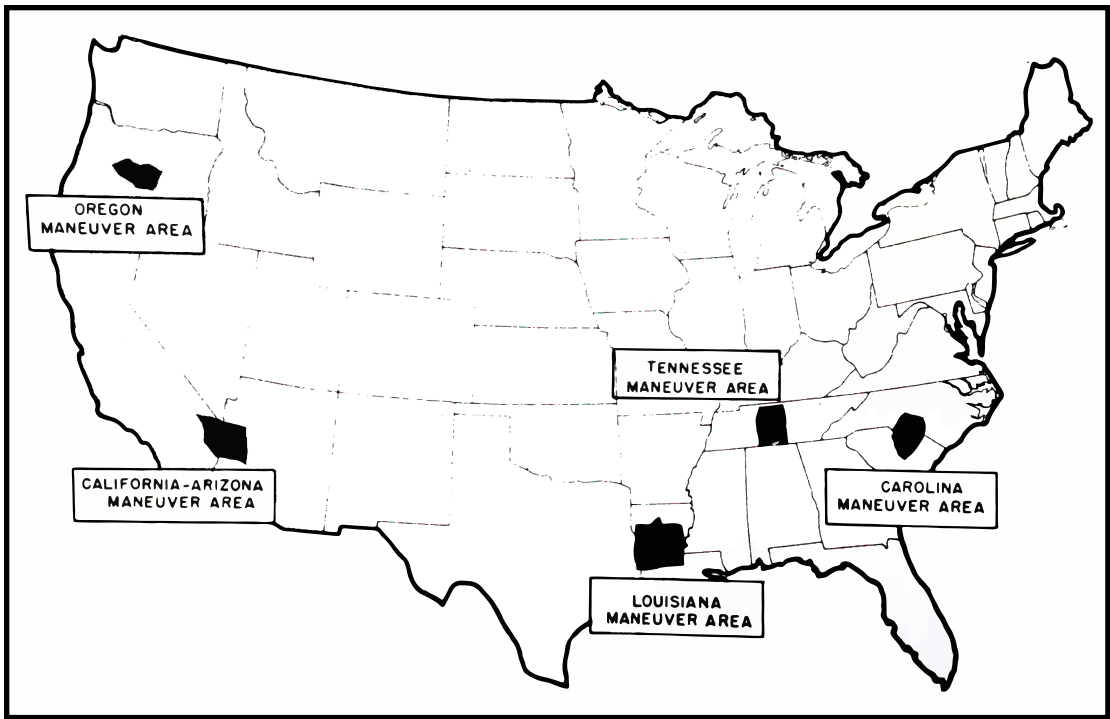

Figure 3.1. Primary Army Maneuver Areas during World War II. Graphic created by Army University Press staff.

training units for air movement of troops and equipment.”<sup>1</sup> Thus, while each numbered army, and its designated maneuver area, initially had the services of the corresponding numbered air force’s Air Support Command (I-Carolina, II-Tennessee, III-Louisiana, and IV-California-Arizona, respectively), on 7 February 1943, these four organizations consolidated under 3rd Air Force and were later renamed “Tactical Air Divisions,” accordingly.<sup>2</sup> With the exception of the IASC, each remained at the same maneuver area performing essentially the same mission until the suspension of corps-level maneuvers in early 1944. The numbered armies saw a similar consolidation, with First and Third Armies shipping overseas to become the first numbered armies established in northwest Europe, while Second and Fourth Armies took over the state-side training mission for the eastern and western halves of the continental US, respectively.

In redesignating the pre-war “Observation Groups,” most of which had languished in the National Guard, as “Reconnaissance Groups,” the Army Air Force had a major task on its hands. As the service’s official history explains it:

The tactical reconnaissance program, initiated after the abandonment of the observation groups in 1943, came under criticism as soon as the new units went into action. Deficiencies were reported in the same subjects as with the early photo reconnaissance groups: gunnery and instrument flying, photography, and knowledge of aircraft and maintenance. The tactical reconnaissance units were also criticized for their poor adjustment of artillery fire. In an effort to correct the principal weaknesses, the training organizations greatly extended the hours given to gunnery instruction and instrument flying. Increased time was likewise given to ground and air training in the direction of artillery fire. General readiness for combat was

substantially improved during 1944 by the practice of sending RTU [Replacement Training Unit] graduates to the 1st or 2nd Tactical Air Division for additional training in combined maneuvers with ground force units in the United States. The three or four weeks of field experience was possible because the tactical reconnaissance program was producing pilots in excess of commitments; the proportion engaging in combined exercises grew steadily in the closing months of the war.<sup>3</sup>

Similar efforts created a functional photographic reconnaissance schoolhouse at Will Rogers Field, near Oklahoma City. There, pilots of photographic reconnaissance aircraft, typically modified versions of the most advanced fighters, the P-38 and P-51, adapted high-altitude techniques designed primarily to support the heavy bomber force with post-strike reconnaissance to lower altitude photo mapping intended to provide ground commanders detailed reconnaissance of the terrain and enemy to their immediate front. The AAF's Photographic Reconnaissance Groups (PRG) had in-house developing labs that could churn out copies of prints in great quantities. Testing these procedures in stateside exercises refined the process and helped ground commanders understand what level and speed of photographic reconnaissance they could expect in theater.

### **Third Army and the Louisiana Maneuver Area**

In the Third Army's Louisiana Maneuvers of 1942, Lt. Gen. Krueger continued to place an emphasis on developing the air-ground team, stating on 6 August 1942, before VIII Corps went through its paces, "One of the primary purposes of these maneuvers is to train the air ground team more effectively."<sup>4</sup> But the corps' training still suffered from outmoded methods, as the maneuver period had the support of only a Provisional Air Support Command, equipped with an observation group and a light bombardment group. It took until the IV Corps maneuvers in October to add an aviation signal battalion capable of providing even a rudimentary network for control. The corps critique disparaged the level of support provided, claiming "Ground commanders are not getting anywhere near the air support of which the air units are capable," and "Maximum efficiency in performance of observation aviation is not yet realized."<sup>5</sup> But practice identified problems and offered opportunities to perfect interdiction, if not direct support. By the IV Corps maneuver, a critique on 14 September reported, "Considerable improvement was noted in bombing. The operation of the air-ground CP [Command Post] was very good...air-ground coordination generally has distinctly improved."<sup>6</sup> The missions focused primarily on interdiction of bridges and attacks on command posts. Despite being hampered by poor weather, Krueger observed,

Throughout September 16th the weather permitted air operations about 50% of the time. During this period, the Red bombing force dropped 144,000 pounds of bombs on bridging equipment, on rail and road bridges, and on command posts and other objectives. From about nightfall on the 16th to noon of the 17th, air operations were possible about 60% of the time. During this period about 96,000 pounds of bombs were dropped on bridging equipment and on bridges under construction. During the remainder of the exercise the weather permitted flying about 70% of the time, some 300,000 pounds of bombs dropped on ponton bridges and boats and foot bridges. These figures are extremely impressive, and while no doubt the Red bombing force would have suffered considerable losses, the effectiveness of

its operations would have been very great. At any rate, the work done by the Red bombing force and other aviation units on both sides was very creditable indeed.<sup>7</sup>

The AAF in the maneuver areas rapidly developed the ability to “isolate the battlefield,” in the parlance of the day, knocking out bridges, requiring engineers to quickly repair or improvise crossings of the many streams and rivers in western Louisiana. Reconnaissance assets could generally identify and relay the location of crossing sites quickly, enabling pre-planned strikes on these vital areas. But successful attacks on dug-in positions or mobile formations continued to elude the air-ground team.

While the other maneuver areas entered a winter lull, Third Army continued an almost-unbroken string of exercises that eventually trained twenty-nine divisions, seven more than Second Army’s total in Tennessee and nine more than Fourth Army in the California-Arizona Maneuver Area. Over the winter of 1942-43, the quality of air ground training steadily improved, as lessons from North Africa entered the curriculum and the reorganized and better trained reconnaissance groups replaced the incapable observation groups. When units were not in the field, staffs could still train and practice procedures for coordination, as did officers from X Corps, including the 86th, 87th, and 103rd Infantry Divisions and II Air Support Command, including the 321st Medium Bomb Group and 77th Observation Squadron, from 1-15 December 1942. Despite continued challenges with unsuitable flying weather and difficulty in clearly marking the forward lines, the post-exercise report found, “the exercise proved an excellent medium for training air-ground teams. The need for training air and ground units together so that each had an understanding of the tactics, techniques, capabilities and limitations of the other, became even more apparent as the exercise progressed.”<sup>8</sup> Upon the conclusion of the exercise, Lt. Gen. Krueger and most of the well-trained Third Army staff departed for the Southwest Pacific, where they became the nucleus of Gen. Douglas MacArthur’s Sixth Army, which worked very closely with Lt. Gen. George Kenney’s 5th Air Force in the New Guinea campaign. The X Corps’ commander, Lt. Gen. Courtney Hodges, took over Third Army and worked to rebuild a new cadre capable of leading six major maneuvers between February 1943 and March 1944.

Hodges was a decorated infantryman from the Great War who went on to command First Army through most of its time in combat.<sup>9</sup> But from 1926-1929, he had served as an instructor at The Air Corps Tactical School (ACTS), when it was still at Langley Field, Virginia, before its removal to Maxwell Field, Alabama, where the decreased proximity and oversight by the War Department allowed independent strategic bombardment theory to flourish. In Louisiana, Hodges directed a continuation of the work begun in building a close partnership between the air and ground forces in the training area. The first maneuver period, featuring a rebuilt VIII Corps, with the 77th and 90th Infantry Divisions, had the support of a full Air Support Command, relocated to Barksdale Field and equipped with two medium bomb groups, the 344th and 386th, the 312th Dive Bomber Group, and the 71st Observation Group, augmented by a photo-mapping flight that could provide near-real time aerial photographs. In addition, each maneuver period began with an air support “school” and demonstration for the assembled officers of the tested units. But the combination of green units on the ground and in the air meant that, in the maneuver’s first phase, “Air support was uncoordinated and poorly executed; air field signals were not sufficiently employed.”<sup>10</sup> Clearly, much work remained to reach the level of the departed commanders and staffs.

<b>BOMB REQUEST</b>		
How Sent: _____ / _____ /1943		
↑ BOMB REQUEST ↓	Intro	To _____
	ASC	From _____
	Out of	To _____
	ASC	From _____
	Request Unit & No.	A _____
	No. of APS	B _____
	Target	C _____
	Time of Atck	D _____
	Allowable Error	F _____
	Instructions & Miscel.	G _____
Authorized By: _____		
Time: _____	Time Sent _____	Time Rec'd _____
↑ AIRM ACTION ↓	To _____	
	From _____	
	Request Unit & No.	H _____
	No. of APS	I _____
	Est T O T	J _____
	Inst. & Miscel.	K _____
	_____	_____
	Time Sent _____	Time Rec'd _____

Figure 3.2. Form for Requesting Air Support used during 1943 Louisiana Maneuvers. Form recreated by Army University Press staff.

Fortunately, there was ample opportunity for improvement. An exercise practicing aerial resupply, based on a demonstrated need in the fighting on Guadalcanal and in New Guinea, proved successful and provided practical experience in marking and identifying ground positions from the air, and delivering air-dropped parcels accurately. Transport aircraft demonstrated their expertise in this task when they delivered paratroopers of the 507th PIR to their assigned landing zone later in the exercise. Close support training received a boost when air support parties equipped with an SCR-299 radio and attached to the 77th Division's two forward infantry regiments were able to direct air attacks on positions in advance of the attacking units. Though effective only "50 percent of the time," this was a significant improvement from 0 percent previously.<sup>11</sup> In the subsequent phase, the Air Support Command flew "42 observation missions, 13 medium bombardment missions, five dive-bombardment missions and nine



Figure 3.3. Liason Aircraft during Maneuvers.

fighter missions,” achieving effectiveness rates above 80 percent and providing reports within an hour and a half of receiving requests for information.<sup>12</sup> The bomb missions remained pre-planned, rather than on-call, and troops often failed to lay out identification panels and, when they did, aircraft struggled to see them through the pine trees and dense underbrush from 4,000 feet, preventing closer coordination.

The commander of the 77th Observation Group and the II Air Support Command detachment at Esler Field, Col. John C. Kennedy, reported that the time from request to bombs-on-target was typically less than one hour, using the following procedure: The division’s G-3 initiated a request through the divisional air support party, which evaluated the request and sent it to the Air Support Control at corps headquarters for approval. If approved, the ASC sent the mission to the airfield for execution, where a bombed-up aircraft waited on standby. Once the assigned squadron had an aircraft en route, it notified the ASC of the mission’s composition and expected time of arrival, which the ASC then forwarded to the ASP with the requesting unit. While armed aircraft overhead could have cut this response time significantly, units lacked communications equipment far enough forward to permit direct contact between front-line units and attacking aircraft. But each successful mission refined the procedure further and, most importantly, trained another division and squadron in the technique of air support.<sup>13</sup> Kennedy also recommend that the light “liaison” aircraft organic to each observation squadron be turned over directly to the ground commanders, as they had been to artillery units, to increase their utility and coordination. There was little reason for the observation squadrons, equipped with three different types of aircraft, to continue to support equipment and communication that could easily be handled directly at corps or division headquarters, other than that they were

fixed-wing aircraft and typically required some sort of improved surface to take off and land. The L-4s and L-5s were eventually assigned directly to ground formations, increasing their utility for reconnaissance, courier, and transportation, and absolving the AAF of responsibility for their care and feeding.<sup>14</sup> The lower speed also promised improved reconnaissance, as the higher speed P-39 and P-40 fighters and A-20 light bombers assigned to the observation squadrons often missed well-camouflaged positions and introduced location errors in their reports, placing one tank battalion over three miles from its actual location near Flatwoods.<sup>15</sup>

In his instructions to his command prior to the maneuvers, under the heading “Air-Ground Team Development,” Colonel Kennedy observed:

While frequently the Ground Commander’s mission can be more efficiently facilitated by attack of distant non-battle-field-targets, training in this type of operation does not require the presence of the two forces in the same maneuver. The two forces are now together; they may not be together again without the presence of a third force, the real enemy. Therefore, full advantage of this opportunity will be taken to approach combat efficiency in immediate close support, the kind requiring the closest team work, intimate liaison, the most mutual understanding, the greatest simultaneous combined efforts, the greatest speed, and the most precise timing and coordination.<sup>16</sup>

Kennedy ranked his mission priorities as follows: (1) Immediate Close Support, (2) Close Support, (3) Distant Support, (4) Counter Air Force Missions. While this reversed the usual priorities, exercise planners considered it essential, in order to maximize the value of joint training.<sup>17</sup> This was the spirit of cooperation essential for air and ground forces to finally “get together” in training before engaging in combat.

In one of the first exercises in the Louisiana Maneuver Area to benefit from practical experience in North Africa, the two divisions sparring reported improvements in both the quality of aerial reconnaissance and the timeliness of its submission. In a report on the 10th Phase of the 2nd Maneuvers, airmen with the II Air Support Command reported that officers of the 85th Division, soon to depart for the Italian Theater, were pleased with reports received from the 71st Reconnaissance Group as the division attacked a bridgehead defended by one RCT of the 93rd Division at Burr Ferry, across the Sabine River. Despite weather that varied from “Rain. Low Ceilings. [and] Thunderstorms” to “Intermittent Rain. [and] Low Ceilings,” throughout the four days of the problem, officers reported that “Air Task Forces continued to unearth enemy positions with seeming facility,” which could also have been a comment on the Army’s inattention to camouflage and concealment. Most importantly, “a speed up was evident in the transmission of intelligence information between the airdrome [in this case, Esler Field, near Alexandria] and the Air Support Party Officer.”<sup>18</sup> Aircraft responded to requests in an average of just over one hour from initiation to aircraft overhead, and information from reconnaissance flights took an average of thirty-nine minutes after landing to reach the air support parties in the field, with delivery of photographs taking over three hours. Best of all, on the majority (15 out of 24) of missions, the 85th Division Command Post had direct contact with aircraft overhead, improving communications links and helping to cut response times.<sup>19</sup> The final report found, “Communications functioned very well this phase and considerable improvement was made in air to ground contact.”<sup>20</sup> In addition, umpires judged that combat aircraft, including P-40 fighters, B-25 medium bombers and DB-7 dive bombers, were so effective in dropping permanent

and pontoon bridges within the bridgehead that the attacking aircraft had to be withdrawn in order to allow the exercise to proceed, a situation not unlike modern cyber participation in war-games and exercises today.<sup>21</sup> These same aircraft also conducted a preparatory bombardment in support of an 85th Division attack, demonstrating that air and ground assets were moving closer to real-time coordination on the battlefield.<sup>22</sup> But challenges remained, including poor communications and low availability rates due to both weather and inadequately-trained maintenance personnel. As a result, “Ground commanders did not realize either the power or the limitations of ground support.”<sup>23</sup>

Improvement came in the following maneuver period, when interdiction again proved effective and “Reconnaissance kept Blue informed of every major move in time to take action against it; vectographs and obliques of critical positions of the Blue MLR [main line of resistance] aided in planning defenses.”<sup>24</sup> But, while reconnaissance continued its improvement, attack or combat aviation lagged. Low serviceability rates and continued difficulty with identification—obscured marker panels and rapidly dispersing colored smoke frustrated attempts at recognition from the air—meant that much work remained to create a viable air-ground team.<sup>25</sup>

In January of 1944, the Third Army headquarters deployed to Europe, bringing the cadre of the Fourth Army headquarters on the West Coast, including its commander Lt. Gen. William H. Simpson and his staff, to San Antonio to oversee the final maneuvers in Louisiana. Simpson’s headquarters had been operating the California-Arizona Maneuver Area (CAMA) or Desert Training Center (DTC) in the absence of a corps headquarters at that facility and had extensive experience with the established training cycle. In May of 1944, the Fourth Army headquarters received sufficient augmentees to form a second army headquarters, which retained the name of Fourth Army, while Simpson’s organization became Eighth Army and shipped out for England. Upon arrival, it had its designation changed to Ninth Army to prevent confusion with the British Eighth Army.<sup>26</sup>

Overall, the Louisiana Maneuver Area’s continuous and sustained exercises (see table for a complete listing) set the stage for the successful coordination in Europe in 1944. Ten of the divisions eventually assigned to Ninth Army completed a cycle in Louisiana, seven of them using revised doctrine and procedures established in the summer of 1943. Newly-deploying units had a basic understanding of the air-ground support process and quickly adapted to existing procedures in theater, making a seamless transition into the combat zone. And leaders trained in these exercises, many of whom deployed in advance of their assigned units, helped build and refine the theater-wide system of close air support.

## **Second Army and the Tennessee Maneuver Area**

The Tennessee Maneuver Area, chosen primarily for its similar terrain and climate to central Europe, and the availability of the broad Cumberland River to practice contested crossings, turned into a vital air-ground cooperation school for many of the divisions deployed to the European theater. Centered on the broad uplands east of Nashville, the area offered a mix of hills, valleys, and dense forests that provided the closest approximation to what units would see in Northwest Europe. In a prescient speech to the Lebanon Lions Club on 14 July 1943, Lt. Gen. Lloyd Fredendall, recently returned from command of II Corps in North Africa, told the assembled civic leaders, “The Cumberland River, whose crossing we have made a vital part of almost every problem, is ideally suited to the type of forced river crossings that will be made





Figure 3.4. Lt. Gen. William H. Simpson and XII Corps Staff during Tennessee Maneuvers, October 1942.

on the Marne, the Meuse, the Aisne, the Po, the Somme, across which our engineers must lead the way... Your rolling hills, your ravines, your open fields and this wood—yes, even your dust and your mud—are strikingly similar to the ever-lasting problems of terrain which we shall soon find ourselves in the battles we are training for here.”<sup>27</sup>

In addition to the terrain, the maneuver area also enjoyed ample air support from a number of nearby airfields. Nashville’s Gillespie airport and Berry Field, now the city’s international airport, sat just west of the area. Murfreesboro’s Sky Harbor and municipal airports at Gallatin, Lebanon, and Manchester increased opportunities for the use of lighter, liaison-type aircraft. Farther northwest sat Camp Campbell, near Clarksville, while Fort Knox in Kentucky hosted Goodman Field, an all-weather airport built to support the armored schoolhouse that was just a short flight from the training area. To the south, Camp Forrest enjoyed the support of newly-built Northern Field in Tullahoma, while Chattanooga’s municipal airport also saw extensive use. Additional Third Air Force assets from Forts Benning and Stewart in Georgia also frequently participated in the maneuvers. Despite difficult weather and challenging terrain, the Tennessee Maneuver Area was ideally suited to serve as an air-ground schoolhouse and proving ground.

While Second Army’s headquarters had been established in Chicago, the principal city of the Midwest, heavy use of the Tennessee Maneuver area resulted in a move to Memphis, which enjoyed excellent rail connections across the region. Second Army essentially took over the campus of Cumberland College in Lebanon, Tennessee, which served as the command’s for-

ward headquarters.<sup>28</sup> The local high school's gymnasium hosted many air-ground conferences, and a requisitioned farm in nearby Taylorsville provided the setting for the school's practical demonstrations.<sup>29</sup> With the decline of First Army's Carolina Maneuver Area, which became primarily an airborne exercise area at Fort Bragg, the I Air Support Command, headquartered at Charlotte's Morris Field, spent most of its time in the Tennessee Area, especially after being redesignated the I Tactical Air Division in September 1943, under the leadership of Col. Ralph Stearley. Operating most often from Tullahoma's Northern Field, the I TAD formed the primary air support unit for the maneuver area, sending detachments to support the opposing forces north of the Cumberland River and coordinating with external support for each exercise period.

In October 1942, one of the first exercises on the new maneuver area, Lieutenant General Simpson, then commanding the XII Corps at Fort Jackson, South Carolina, raved about the thoroughness and realism of the exercises. Upon his return he told several colleagues that the exercises were "the best I've ever seen." He wrote, "I commanded the Blue Forces, consisting of a Corps that included an Armored Division and combat aviation," and appreciated the experience his new corps staff gained in the maneuver area.<sup>30</sup> A month later he elaborated, "We had some realistic and very interesting maneuvers. The splendid 4th Armored Division under General Wood was there and served in my corps in all the problems. We also had Motorized Divisions, a Corps Artillery Brigade, all kinds of engineers, an Air Corps Ground Support Command with dive bombers and a lot of other odd units. We had a variety of problems, including river crossings, with Air support, that were most instructive," foreshadowing Simpson's experiences two years later.<sup>31</sup> Earlier, before leaving the 30th Division at Fort Jackson to assume corps command, Simpson emphasized to his new regimental commanders that "Preliminary air-ground training and training in special operations will be stressed during this period. The maneuvers will include air-ground maneuvers, special operations, and operations with mechanized units."<sup>32</sup> But the units did not have the chance to participate, as the division was largely broken up for cadres shortly after Simpson turned over command. But he wrote, "I know that the 30th Division would have held its own had it gone to the maneuvers before being broken up. Our training in the 30th last summer was along [the] right lines."<sup>33</sup> He wrote Lt. Gen. Ben Lear, then in command of Second Army, "I am convinced that every division should wind up its training with at least one or two months of realistic maneuvers."<sup>34</sup>

The local newspapers covered the war games with all the fervor of a sports contest. An undated clipping in Simpson's files reported,

It's Maj. Gen. William H. Simpson vs. Maj. Gen. Paul Peabody in the maneuver problem scheduled to end today in the Second Army's mid-Tennessee mock-battle area; and tanks against dive bombers. General Simpson commands the Blues, which with "plenty" of tanks and engineer forces, are attacking a theoretical Cumberland River defense line commanded by General Peabody with plenty of demolition squads heavy artillery and dive bombers. General Simpson has only observation planes and General Peabody has all the combat planes.

The piece reminded readers, "The Germans used dive bombers effectively as artillery in their rapid conquest of France," and, therefore, "The use of dive bombers against an armored force, a tactic employed by the Germans in Libya without notable success, is being thoroughly tested in the battle problem begun in the Cumberland river valley Tuesday." It continued, "Dive bombers take the air to blast the Blue armored columns advancing northward to attack the river

line and are also expected to be extremely effective in knocking out whatever ponton bridges the Blue army attempts to throw across the Cumberland.”<sup>35</sup>

But Simpson’s XII Corps, comprised of the 6th and 8th Infantry Divisions and 4th Armored Division, crossed the Cumberland River, after umpires ruled that dive bombers had destroyed the Hunter’s Point Bridge, forcing XII Corps engineers to build and defend several pontoon bridges to sustain the offensive. Once across the Cumberland, Simpson’s troops overran the Lebanon airport, providing a reprieve from the dive-bomber attacks and presaging events 30 years later when Israeli ground forces overran Egyptian SAM (surface-to-air missile) sites across the Suez Canal, proving that ground forces could effectively support the Air Force’s quest for air superiority.<sup>36</sup> The AAF suffered a number of fatal accidents during this maneuver period, losing a B-25 at Nashville on 20 October, and two P-40s in separate incidents at Tullahoma on 21 October and 14 November. Response times for requests for air support averaged over one hour and twenty minutes, judged too slow by the ground forces, but Lieutenant General Lear, observing on behalf of the AGF, called the exercises the “finest maneuvers I have ever witnessed.”<sup>37</sup>

A later study of the Tennessee maneuvers found, “The air units had as their mission the securing of enemy information expeditiously to ground combat unit commanders; mutual recognition systems, marking of front lines, bombing missions in direct support, strafing missions to make ground troops more air conscious, emergency supply by air to ground units, and transport of airborne troops, both paratroop and glider.”<sup>38</sup> These were widely-varying missions, requiring a number of different types of aircraft to accomplish, necessitating complicated command structures that did not always work as designed. But that was the point of the exercises. The same study found, “In the 1943-44 Tennessee maneuvers, airpower took on a greater role, participating in more problems with more men and more advanced aircraft.”<sup>39</sup> Eventually, the latest aircraft in the AAF’s arsenal supported the exercises, including P-38 fighters, B-25 bombers, and F-4 and F-5 photo reconnaissance aircraft. The reconnaissance missions far outpaced combat missions, 539-95 in the August period, 451-178 in October, and 347-53 in December, when “weather conditions and other factors prevented the use of bombers and fighters.”<sup>40</sup> Medium bombers flew for only two days during the November-January maneuver period.<sup>41</sup> Even the normal demonstration at Taylorsville on 20 November was obscured by fog and mist.<sup>42</sup>

Col. Ralph Stearley, commander of the I Air Support Command, opened the July maneuvers with an Air Support Conference on 2 July 1943 at the Second Army’s maneuver headquarters in Lebanon. III Corps was the lead headquarters for the exercise, containing the 30th and 80th Infantry and 10th Armored Divisions, all supported by the 73rd Observation Group. Stearley opened by telling the assembled officers that, “The guiding principal in North Africa was that air force operations and ground force operations in the Theater will be coordinated by means of timely planning, conferences of pertinent commanders and staffs, and through the exchange of liaison officers.” He then quoted from Montgomery’s paper, likely written by Air Marshal Arthur Coningham, on the importance of close cooperation and securing the air before attempting anything on the ground.<sup>43</sup>

In explaining the composition of the tactical air force, he pointed out that it would contain reconnaissance, medium bomber, and fighter-bomber units, as well as an aircraft warning unit and a control unit, a vast improvement over the ill-equipped and poorly supported observation squadrons that had first landed in North Africa. Stearley admitted that the 68th Observation



Figure 3.5. Chief of Staff Gen. George Marshall, Maj. Gen. William H.H. Morris, of XVIII Corps, and Lt. Gen. William Simpson during 1944 maneuvers in Louisiana.

Group had failed miserably in North Africa, and that British assets had provided the bulk of the tactical reconnaissance for American units in the theater. But reconnaissance training had improved significantly and the squadrons were beginning to be equipped with the new P-51 aircraft. While the strategic air force generally operated separately, Stearley issued the AAF's promise that "in a critical situation where our force is in trouble, part or all of the strategic air force could be and was diverted to a tactical air force mission."<sup>44</sup>

He pointed out that most combat aviation assets had deployed immediately, to fill requisitions in the Mediterranean and Pacific theaters, and acknowledged, "this has hampered our training some, and the ground force training some, but we have been doing the best we could, and must continue to do the same thing. To the theater, where the fight is going on, there must be sent the best equipment and the best trained units."<sup>45</sup> He then emphasized the priority of the three missions enshrined in the soon-to-be-issued FM 100-20, specifically, "1st Priority—The gaining of Air Superiority, 2nd Priority—The prevention of the movement of hostile troops and supplies, 3rd Priority—The participation in the combined effort in the battlefield area."<sup>46</sup> After dismissing the wasteful "air umbrellas" that had failed in North Africa, Stearley explained that

air superiority would be won by sustained action against enemy airfields, but did not mention that the strategic air forces had largely performed this role in North Africa. To defend against enemy attacks, radar detection permitted earlier warning for air defense artillery and a far more economical use of fighter aircraft.

Once this was complete, the air forces could proceed with an uninterrupted “isolation of the battlefield,” surmising that “If a hostile force is denied food, ammunition and reinforcements, aggressive action on the part of our ground forces will cause him to retire and the immediate objective will be gained.”<sup>47</sup> In that action, close cooperation by air and ground forces would build synergy. Stearley reported, “The advance of the ground troops often makes available new airdromes needed by the air force. Massed air action on the front will pave the way for an immediate advance.” Despite this reassurance, the airman reminded the ground commanders that close support missions were “expensive in aircraft and personnel,” and “less effective than actions listed under Priorities 1 and 2,” and carried the risk of “friendly fire” incidents. But, at least, instead of ignoring these missions, Stearley opined, “these missions are the most difficult to perform, therefore we practice them in maneuvers in order that we may perform them when required.”<sup>48</sup>

Stearley closed with an example from the Battle of France in which he argued that the Germans had performed these three missions, in the order described, in order to achieve their devastating success. In arguing for the centralization of control at the theater level, Stearley stated, in a foreshadowing of the Goldwater-Nichols legislation establishing combatant commanders over 40 years later, “This theater commander will exercise command of the air forces through the air force commander and command of the ground forces through the ground force commander,” again quoting extensively from Montgomery (Coningham) to reinforce his point.<sup>49</sup> Driving it home, he argued, “General Montgomery is an army commander, a ground force commander, but he understands the use of air, and his victory in North Africa is proof.”<sup>50</sup> Stearley closed with the statement that, “We want to help the ground forces and we will cooperate with them in the fullest. However, we feel that we know the capabilities and limitations of the air forces better than the ground commander. If we know what he wants done and what he wants to know, we will serve him in the best way we know how.”<sup>51</sup>

Stearley updated his comments for the next period of maneuvers, on 10 September, to include the actual text from FM 100-20, which had been published in the interim. But most of the new guidance had already been in place, and the gist of Stearley’s remarks varied little from the conference held in early July, except to describe the expanded control group, consisting of a control squadron, aircraft warning squadron, communications squadron, and intelligence squadron. These organizations formed the heart of the tactical air commands in theater and enabled control of the fighter and reconnaissance groups attached to it. To the successful example of the Germans in France, Stearley added a description of the campaign for Lae in the Southwest Pacific, “an excellent example of the proper use of air power.” Lt. Gen. George Kenney’s fliers had first destroyed over 300 Japanese aircraft on their airfields, then targeted resupply barges supplying the Japanese garrison, and finally delivered both paratroopers and direct attacks on the defenders themselves. The result was a complete victory with light losses.<sup>52</sup> Thus, airmen and ground commanders appeared to have resolved many of the thorniest issues, about priorities, command relationships, organizations and types of equipment, and command and control procedures. All that was left was to train the massive forces headed for the theater in the techniques so that all would become proficient.<sup>53</sup>

Stearley closed with the observation that “I can imagine no more delightful future than to take a well-trained I Tactical Air Division to a theater and operate with the same Corps and Divisions that I trained with in the United States. Our tactical units under the new system will have more flying hours, be more familiar with their equipment, and be, in general, better trained than the tactical units we have sent to the theater previously. The pilots of these units will not only be good pilots, they will be good soldiers, men who know air tactics, know the mission of the air force, and know something of the organization and the task of the ground forces.”<sup>54</sup>

The 35th Infantry Division’s time in the Second Army Maneuver Area in Tennessee marked the unit’s second large-scale maneuvers, but the first since its limited participation in the 1941 Louisiana maneuvers. Much had changed in the interim, and the wargames in Middle Tennessee over the holiday season of 1943 were some of the most realistic possible for divisions that would spend the next Christmas on the line in Germany and Luxembourg. As one wag from the division remembered it:

The devil was given permission one day,  
to select a good place for the soldiers to play.  
He looked around for a month or more  
wanting a place that would make them sore.  
And, at last was delighted a country view  
where the black walnut and the hickory grew,  
and vowed that Tennessee could not be beat  
as a place for maneuvers in rain, snow, and sleet.  
He scattered the rocks so the men could not sleep  
and brought weather so cold it froze the sheep.  
He then sent some rain, the bed rolls to soak  
and a few cards and dice, so the men could stay broke.  
Now we’re on the last problem we’ve all done our part,  
and at the end of this week the furloughs will start.  
Then the men will go home with tall tales to tell  
of the things that they did through this six weeks of hell.<sup>55</sup>

While the infantrymen in their foxholes struggled to cope with the conditions, their commanders and staff officers continued to develop and refine procedures for close support. They were aided immeasurably by the AAF’s assignment of a full Fighter Control Squadron, allowing robust communications support, and enough aircraft for each side to have its own provisional Air Support Command.<sup>56</sup>

In the AGF’s after-action report for the 22 November 1943-17 January 1944 maneuvers, observers found the one reconnaissance group, “sufficient to provide ample visual reconnaissance,” but noted that “the types of aerial photos normally to be expected from a reconnaissance group were available to a limited extent,” mostly because “there were no F-5’s [photo-equipped P-38’s] available.”<sup>57</sup> But the photo shortage did not materially impact training as, mosaics and long strips were, “available from the film library and use was made of them by participants.”<sup>58</sup> Most nota-

ble was the presence of an entire group of fighter-bombers, the 48th, which later saw extensive service in XXIX TAC during the winter of 1944-45, for the duration of the maneuvers.<sup>59</sup> Thus, the division had an opportunity to work with the same types of units, and on roughly the same scale (one group per corps) as would be available in theater. The fighters were doubly important because weather frequently grounded the few medium bombers available. Anti-aircraft training benefitted from the provision of radar warning sets, which provided detection to a central control room, where operators relayed information to anti-aircraft units with a SCR-299 radio, providing a fully integrated air defense system, something woefully lacking only two years before.

The 48th Fighter Group's journey to the Tennessee Maneuvers is instructive in understanding the levels of chaos present within the AAF at the time. Though the group eventually settled in for a lengthy stay in the Tennessee maneuver area, arriving on 20 Aug 1943 and remaining until 27 January 1944, it transitioned through several aircraft types during its first two years of service. Activated as a light bombardment group on 20 January 1941, flying twin-engined A-20s, an "attack" aircraft that saw extensive, but not always successful use in North Africa, it became a dive bomber group in September, 1942, equipped initially with A-24 (Navy SBD *Dauntless*), A-35 (obsolete Vultee *Vengeance*) and A-36 (P-51) dive bombers, before becoming a more traditional fighter group with P-39 and P-40 fighters. It did not receive its first P-47s, the type of aircraft it employed on the continent, until after it arrived in England in March, 1944. During most of its time in the Tennessee maneuver area, the group benefitted from the leadership of Lt. Col. Charles C. Kegelman, who had earned a Distinguished Service Cross leading the very first 8th Air Force raid from England on 4 July 1942. Flying *Bostons* (A-20s) borrowed from the RAF, Kegelman's group hit a German airfield in Holland at low level, where his plane predictably suffered several flak hits, knocking out one engine and causing the aircraft to actually "bounce" off the ground. In his recovery, Kegelman found a flak tower in his sights and squeezed off a long burst, destroying the emplacement. Having a combat experienced commander helped impress upon the young pilots the difficult conditions they would soon face on the continent.<sup>60</sup>

While at Key Field, Mississippi, the Reconnaissance schoolhouse, in July 1943, the 48th received its first P-40s and transferred out the enlisted aircrew who had manned the twin .50-caliber guns in the back seat of the A-24. On 27 June, the group transferred 27 pilots to the 404th Fighter Group, another future XXIX TAC unit, and reported it was down to only seven A-24s, having received 21 A-35s three days earlier. It continued to receive new pilots graduated from the fighter training schools at Dothan and Selma, Alabama, and quickly transitioned from the obsolete dive bombers to more modern A-36s and P-40s. Once in the maneuver area, the group rotated its squadrons through "field conditions" at outlying fields to acclimate the pilots and ground crews to what they could expect on the continent, as well as supporting the ongoing maneuver period by forming the "Blue Air Force" when the exercise opened on 16 September. On 21 September, the pilots had their request to drop "flour bombs" on the Red Army refused, for fear of hitting and injuring the umpires, who would then no longer be able to rule that blue air power had degraded or destroyed the red ground units. The group sustained its support throughout the exercise, finally giving up its A-35s in late October and transitioning to a P-40 group for the next maneuver period.<sup>61</sup>

The maneuvers also tested out the exchange programs put in place in mid-1943. Ground liaison officers at the opposing airfields "were very useful in keeping air units abreast of the ground situation, in assisting in the briefing of the pilots and observers, and in following up

Division	Activated	Maneuvers? Old Doctrine Revised Doctrine Improved Doctrine	Moved to Emb. Port	Assigned to 9th Army
2	Sep '17	TX-Jun '41, LA-Aug-Sep '41; LA, Jul-Sep '42	Sep '43	5 Sep-22 Oct
8	Jul '40	Car-Oct-Nov '41, TN, Sep-Nov '42, CAMA, Apr-Jul '43,	Nov '43	5 Sep-22 Oct, 20 Dec-3 Feb
17 Airborne	Apr '43	Car, Dec '43-Jan '44; TN, Jan-Mar '44	Aug '44	7 Apr-8 May
26	Jan '41	Car, Oct-Nov '41; TN, Jan-Mar '44	Aug '44	24 Aug-28 Sep
29	Feb '41	Car-Oct-Nov '41; Car, Jul-Aug '42	Sep '42	5-21 Sep, 22 Oct-8 May
30	Sep '40	Car-'41; TN, Sep-Nov '43	Jan '44	22 Oct-22 Dec, 3 Feb-8 May
35	Dec '40	Ark, Aug '41, LA-Sep '41; TN, Nov '43-Jan '44; WV, Feb-Mar '44;	May '44	30 Jan-8 May
44	Sep '40	LA, Feb-Apr '44	Aug '44	26 Aug-14 Oct
75	Apr '43	LA, Feb-Apr '44	Oct '44	9 Dec-22 Dec, 17 Feb-8 May
78	Aug '42	TN, Jan-Mar '44	Oct '44	9 Nov-5 Dec, 22 Dec-2 Feb
79	Jun '42	TN, Apr-Jun '43; CAMA, Aug-Nov '43	Mar '44	7 Apr-8 May
83	Aug '42	TN, Jul-Aug '43	Mar '44	5-21 Sep, 15 Feb-8 May
84	Oct '42	LA, Sep-Nov '43	Sep '44	10 Sep-22 Dec, 3 Feb-8 May
94	Sep '42	TN, Sep-Nov '43	Jul '44	11 Jul-6 Jan
95	Jul '42	LA, Jun-Aug '43; CAMA, Nov '43-Jan '44; WV, May-Jul '44;	Jul '44	7 Jul-8 May
102	Sep '42	LA, Sep-Nov '43	Sep '44	28 Aug-8 May
104	Sep '42	OR, Sep-Nov '43; CAMA, Dec '43--Mar '44;	Aug '44	24 Aug-5 Nov, 22 Dec-3 Feb
2 Armor	Jul '40	LA-'41, Car-'41	Sep '42	22 Oct-22 Dec, 16 Feb-8 May
5 Armor	Oct '41	CAMA, Sep-Oct '42, TN-Apr-Jun '43	Feb '44	27 Jan-8 May

Figure 3.6. Divisions Assigned to Ninth Army and Stateside Maneuvers.



Division	Activated	Maneuvers? Old Doctrine Revised Doctrine Improved Doctrine	Moved to Emb. Port	Assigned to 9th Army
<b>7</b> Armor	Mar '42	LA-Oct '42, CAMA, Apr-Jul '43	Jun '44	8 Oct - 16 Dec
<b>8</b> Armor	Apr '42	LA, Feb-Apr '44	Oct '44	8 Oct-16 Dec
<b>9</b> Armor	Jul '42	CAMA, Jul-Oct '43; LA, Nov '43-Jan '44	Aug '44	29 Jul-22 Oct
<b>10</b> Armor	Jul '42	TN, Jul-Aug '43	Sep '44	26 Aug-10 Oct
<b>11</b> Armor	Aug '42	LA, Jun-Aug '43; CAMA, Nov '43-Jan '44	Sep '44	26 Sep-20 Dec
<b>12</b> Armor	Sep '42	TN, Sep-Nov '43	Sep '44	13 Nov-5 Dec
6/25 in earlier maneuvers, 4/25 deployed before revised training				

and expediting information obtained from bomber, photo and visual reconnaissance missions.” Most importantly, “the ground liaison officers used in maneuvers were drawn from the participating units,” providing a reservoir of experienced GLOs for the overseas theater and building teamwork among deploying air and ground units.<sup>62</sup> Efforts to mark front lines for close support were less successful, as the smoke intended for the purpose dissipated before the aircraft arrived, but two years earlier ground and air units had merely discussed the theoretical means available for doing so. Even unsuccessful attempts were a sign of progress. While unable to duplicate the procedures during the exercise itself, the pre-maneuvers demonstration “illustrated accepted means of air-ground visual communication and close support.”<sup>63</sup> Artillery shells marked the forward edge of the bomb area and aircraft bombed just beyond it, to the satisfaction of the assembled spectators.

Much like the Third Army exercises in Louisiana, the Second Army maneuvers in Tennessee provided a valuable laboratory for testing new methods and techniques of air support and for training deploying units in the doctrine, procedures and challenges of effective air support. Fully half (12 of 24) of the divisions eventually assigned to Ninth Army completed a training cycle in the Tennessee maneuver area, most of them (nine) after the summer of 1943 when the new doctrine was available and air-ground schools preceded each maneuver period. The realistic training for air and ground forces in similar terrain to that in northwestern Europe was an important part of the process of training the air-ground team.

#### **Fourth Army and the California-Arizona Maneuver Area (CAMA)**

Unlike the rain and snow of the Tennessee Maneuver Area, Army planners selected the deserts north of Yuma in the California-Arizona Maneuver Area (CAMA) to prepare troops for the potential of fighting in the North African deserts. While that campaign concluded before many of the desert-trained units could be shipped to the theater, the wide-open expanses proved ideal for mobile forces, especially the new armored divisions, to practice maneuvers unimpeded in

the open, largely uninhabited terrain. Unfortunately, it also proved misleadingly easy for support aircraft to find and follow the ground forces they were supporting, especially when telltale dust clouds revealed their position, giving some false lessons on the ease of close air support. But the open terrain facilitated cooperation between assigned ground units and the IV Air Support Command, later the III Tactical Air Division based at nearby Thermal Army Airfield. Desert exercises emphasized “Rapid, close-in air support of units, on call,” and many commanders argued that the desert training was the most thorough and realistic of all the maneuver areas.<sup>64</sup>

The War Department ordered the creation of what was initially called the Desert Training Center in early 1942 to prepare units for the fighting in North Africa. Its first commander Maj. Gen. George Patton, did eventually command both the Western Task Force, landing in Morocco, and II Corps, the primary American ground headquarters, in the advance on Tunis. He went on to forge one of the most effective air-ground teams of the war with Brig. Gen. Otto P. Weyland’s XIX TAC while in command of Third Army in the breakout across France.<sup>65</sup> But most of Patton’s expertise came in theater, in Tunisia and Sicily, as the DTC was a poor laboratory and doctrine and techniques were still insufficiently developed during his tenure there. This was not the case for his successor, Maj. Gen. Alvan C. Gillem, Jr., who later commanded XIII Corps, one of Ninth Army’s three assigned corps.<sup>66</sup>

Initial plans envisioned the assignment of a composite group consisting of a “combat” squadron, an observation squadron and an “air ambulance” to the training area, but trainers found the single “combat” squadron inadequate and later secured the services of an entire medium bombardment group, and other units rotated through when they were sufficiently trained to add value to the exercises, in order to enhance their own abilities.<sup>67</sup> Training plans for ground units emphasized both hostile and friendly air, to condition units to the possibility of attack and refine methods for coordinating support, to include the use of “live bombs.”<sup>68</sup> Throughout, the War Department emphasized the requirement for “combined training with the Army Air Forces,” and observers believed that “supplemented by enough aviation of the right kind, many valuable lessons concerning aviation in support of ground forces could be gained.”<sup>69</sup> Early attempts at coordination involved pre-planned, “softening up” attacks on positions that had been located by light, liaison aircraft, followed by marking of the front lines with colored smoke and a “carpet bombing” attack forward of that line. Patton’s notes emphasized the requirements for close coordination with air assets, both in reconnaissance and in preparatory attacks on located formations.<sup>70</sup>

The first full exercise at the DTC took place in September 1942, under the II Armored (later XVIII) Corps with the 7th Infantry and 3rd and 5th Armored Divisions. A longer cycle from December until February again hosted an armor-heavy corps, the IV Armored (later XX) with the 6th Infantry and 4th and 6th Armored Divisions under Maj. Gen. Walton Walker. After leading XX Corps in Patton’s Third Army in Europe, Walker recalled that,

higher commanders and their staffs and all officers and troops had benefited from their training in the Center, but that the top command had benefited most, gaining confidence and perspective from the direction of large operations in the desert. He had found no doubt in the minds of those who had been through the Center, (generals or privates) that their training there was the best they had received, and that the desert was the best place ever found for the training of the Army.<sup>71</sup>

After another brief lull until mid-April, the CAMA saw continuous use until March of 1944, training a total of 12 infantry and seven armored divisions, including seven of the 25 divisions later assigned to Ninth Army, five of them after the middle of 1943 after the revised air-ground doctrine was in wide use. The massive size of the maneuver area allowed corps-level exercises to take place simultaneously. The 95th Infantry Division's training period along with the 11th Armored Division from November 1943 to January 1944 overlapped with both the previous and subsequent training cycles.<sup>72</sup> During this period, observers reported that the air commander, Col. Aubrey W. Scholfield "was cooperative and commanded participating air units in an excellent manner," but that "the CAMA offered great possibilities for air training which were not being realized," due to a shortage of units.<sup>73</sup> The historical record, most of which comes from the Army Ground Forces perspective, is highly critical of the AAF for the shortages in the training exercises, perhaps because most were written in the immediate post-war period, when the Army had serious concerns about the newly-independent Air Force's willingness and ability to perform the fixed-wing CAS mission. But the AAF did assign units to the maneuver areas, including the 76th Reconnaissance Group, reorganized under the new model adopted after North Africa, and these units were effective in training division and corps staff in the procedures for coordinating air support. That they certainly could have done more does not detract from the significant improvements they were able to achieve. Despite all its criticism, the G-3 of the AGF admitted in November of 1943 that "the air-ground training being given in CAMA was by far the most satisfactory training being received by AGF units in the United States."<sup>74</sup>

Initially, the AAF made available only a few only a few observation-type aircraft, but on 9 January 1943, the War Department requested a full air support command for the Desert Training Center.<sup>75</sup> At the same time, the Army Ground Forces directed the air support command to conduct a two-day "school" for the officers of the units rotating through the area, emphasizing "direct air support of front line units," beginning with the next series of maneuvers. While air support parties worked with subordinate ground units, down to the regimental or combat command level, the ASC still had only two understrength groups, one of dive bombers and another of the old observation-type.<sup>76</sup> Requests for air support frequently resulted in "friendly fire" incidents and air units continued to demonstrate a preference for interdiction over close support. One report found "employment against such targets and attempts to knock out enemy airdromes prevented at times the acceptance of air party requests from divisions for combat support," but coordination improved gradually over each exercise.<sup>77</sup> Ground commanders repeatedly asked for additional units to approximate the strength of an overseas Air Support Command, but the AAF was still struggling to meet commitments in active theaters in the Southwest Pacific and the Mediterranean, and to build up its heavy bomber force. Adequate units were not available in sufficient numbers until later in the year.

Perhaps the greatest contribution of the CAMA to air-ground cooperation was a series of tests in November of 1943 designed to push control of air units as far forward as possible. Instead of having an Air Support Party at division headquarters, ground and air commanders sent Air Liaison Officers equipped with VHF radios right up to the front lines, to communicate directly with aircraft providing direct support. This communications link was the key to an effective system. As a result of the tests in the CAMA and experiments in the Italian Theater, ground units in Northwest Europe enjoyed direct contact with supporting aircraft, through their assigned ALO, and were able to coordinate support in minutes rather than hours.<sup>78</sup>

## **The Closing of the Maneuver Areas and Suspension of Stateside Training**

By January 1944, most of the Army divisions scheduled for mobilization had either already completed their training and shipped overseas or were scheduled to do so in the coming months. To alleviate shortages of service units, the AGF began to consider consolidation into a single maneuver area, given the reduced demand for training, to free up more units for overseas service. The AAF concurred, deactivating the reconnaissance groups attached to each of the closed training areas and reassigning the pilots to units slated for overseas movement. Accordingly, on 22 January 1944, the AGF announced its decision to close the Tennessee and California-Arizona Maneuver Areas and consolidate all training in the Louisiana Maneuver Area.<sup>79</sup> The AAF kept two reconnaissance groups at Esler and Barksdale Fields to support training, and rotated combat units through as they prepared to ship overseas. This new organization, designated the III Tactical Air Command on 10 April 1944, had the mission of controlling air units assigned to maneuvers, testing new techniques, training replacement aircrew for overseas squadrons, and controlling the demonstration squadrons at the schoolhouses at Forts Benning, Riley, and Leavenworth, all under the leadership of Brig. Gen. Hume Peabody.<sup>80</sup>

Of the 25 divisions that eventually spent substantial time assigned to Ninth Army, 20 of them completed their division maneuvers during the most productive period, after new procedures developed in theater had been disseminated across the training establishment in mid-late 1943 but before the suspension of large-scale exercises due to overseas movements in 1944. The five units that did not complete maneuvers during this period, the 2nd, 8th, and 29th Infantry Divisions, and the 2nd and 5th Armored Divisions all moved overseas in 1942 and 1943 and, except for the 2nd Armored, which had been engaged in the Mediterranean campaign, had little opportunity to for extensive air-ground training. But, by the time they came under Ninth Army control, each had several months of combat experience. (See Figure 3.6)

In July of 1944, shortly before he was killed by American heavy bombers while observing the Normandy breakout, Gen. Lesley McNair summarized the stateside maneuvers and their effect on air-ground training. In predicting the suspension of future exercises due to shortages of ground and air units caused by pressing overseas commitments, McNair reflected, "Beginning with the 1941 large maneuvers, every effort has been made by this headquarters to introduce air operations in the most realistic possible fashion. It is believed that the air forces also have endeavored to utilize maneuvers both as a means of training their own forces and in order to assist the ground forces. The limiting factor through the years has been invariably the lack of air units with sufficient preliminary training to make air support feasible, realistic and of substantial training value."<sup>81</sup> While true, the shortages do not indicate a lack of interest by the AAF and obscure the valuable training, primarily in reconnaissance and intelligence work, that proved to be incredibly beneficial in the campaign against the Axis in 1944-1945. Commanders and staff officers trained in the increasingly realistic maneuvers adapted easily to the slightly-advanced procedures in place in theater, and both ground and air units shared a common understanding of how their counterparts functioned, and how they could best coordinate support in order to accomplish their missions. While in-theater developments were certainly important, the doctrine, tactics, and training refined and conducted in the stateside training establishment was a significant factor in the eventual success of the combined air-ground team in northwest Europe.

## Notes

1. Wesley Craven and James Cate, eds., *The Army Air Forces in World War II*, Vol. VI (Chicago: University of Chicago Press, 1947), 604.
2. Kent R. Greenfield, *Army Ground Forces and the Air-Ground Battle Team* (Fort Monroe, VA: Army Ground Forces Historical Section, 1948), 36.
3. Craven and Cate, *The Army Air Forces in World War II*, Vol. VI, 621.
4. Francis Smith, "History of The Third Army," *Army Ground Forces Study No. 17* (Washington, DC: Historical Section, Army Ground Forces, 1946), 33.
5. Smith, 34.
6. Smith, 34.
7. Smith, 34.
8. Smith, 36.
9. See Sylvan and Smith, *Normandy to Victory: The War Diary of General Courtney H. Hodges and the First U.S. Army* (Lexington, KY: University of Kentucky Press, 2009).
10. Smith, "History of the Third Army," 44.
11. Smith, 57.
12. Smith, 62.
13. "Third Army Maneuvers, Feb. 1943, Section IV, Air Support," C&GS School, Fort Leavenworth, Kansas. Special Collections, Combined Arms Research Library, Fort Leavenworth, KS, 2.
14. "Third Army Maneuvers, Feb. 1943, Section IV, Air Support," 2.
15. "Third Army Maneuvers, Feb. 1943, Section IV, Air Support," 2.
16. HQ, II Air Support Subcommand, Esler Field, Alexandria, LA, 16 February 1943, Operational Memo No. 2, in "Third Army Maneuvers, Feb. 1943, Section IV, Air Support," C&GS School, Fort Leavenworth, Kansas. Special Collections, Combined Arms Research Library, Fort Leavenworth, KS.
17. HQ, II Air Support Subcommand, Esler Field, Alexandria, LA, 16 February 1943, Operational Memo No. 5, 2, in "Third Army Maneuvers, February 1943, Section IV, Air Support," C&GS School, Fort Leavenworth, Kansas. Special Collections, Combined Arms Research Library, Fort Leavenworth, KS.
18. Headquarters, II Air Support Subcommand, "Report of Air Operations, Tenth Phase, Second Maneuver Period, 201800 thru 231530 May 1943," 23 May, 1943, Folder 373.2, Box 983, Central Decimal Files, October 1942-May 1944, Record Group 18, Records of the Army Air Forces, NARA2, College Park, MD.
19. "Report of Air Operations, Tenth Phase, Second Maneuver Period," RG 18, NARA, 2.
20. "Report of Air Operations, Tenth Phase, Second Maneuver Period," 7.
21. "Report of Air Operations, Tenth Phase, Second Maneuver Period," 2; Author's experience at Red Flag exercises at Nellis AFB.
22. Smith, "History of the Third Army," 71.
23. Smith, 72.
24. Smith, 80.
25. Smith, 88.
26. Theodore Parker, *Conquer: The Story of Ninth Army 1944-1945* (Washington, DC: Infantry Journal Press, 1947), 16-17.
27. McMillin, *In the Presence of Soldiers*, 273.
28. For a full discussion of the maneuvers' impact on the state, see McMillin, *In the Presence of Soldiers*.
29. McMillin, *In the Presence of Soldiers*, 303.
30. Simpson to Mrs. Arthur Harper, 15 November 1942, Simpson Papers, Folder 2, Box 3, Simpson Papers, AHEC.
31. Simpson to Capt. George West, 15 December 1942, Folder 2, Box 3, Simpson Papers, AHEC.

32. Memorandum for Infantry Regimental Commanders for Office of the Commanding General, Thirtieth Division, Fort Jackson, SC, 26 June 1942, in Folder 28, Box 2, Simpson Papers, AHEC.
33. Simpson to Mrs. Arthur Harper, 15 November 1942, Simpson Papers, Folder 2, Box 3, Simpson Papers, AHEC.
34. Simpson to Lear, 16 November, 1942, Folder 2, Box 3, Simpson Papers, AHEC.
35. "Simpson Pits Wits Against Paul Peabody," Undated newspaper clipping in Folder 18, Box 18, Simpson Papers, AHEC.
36. McMillin, *In the Presence of Soldiers*, 119.
37. McMillin, 123, 125, 129.
38. McMillin, 271.
39. McMillin, 271.
40. McMillin, 319-320, 324, 339, 343.
41. Kent R. Greenfield, *Army Ground Forces and the Air-Ground Battle Team*, (Fort Monroe, VA: Army Ground Forces Historical Section, 1948), 121.
42. McMillin, *In the Presence of Soldiers*, 337.
43. "Conference on Air Support to the Assembled Officers of Second Army at Air Support School," 2 July 1943, 2, Folder 373.21, "Support of Ground Forces," Box 984, Central Decimal Files, October 1942-May 1944, Record Group 18, Records of the Army Air Forces, NARA, 2, College Park, MD.
44. "Conference on Air Support," 3, NARA2.
45. "Conference on Air Support," 9, NARA2.
46. "Conference on Air Support," 4, NARA2.
47. "Conference on Air Support," 5, NARA2.
48. "Conference on Air Support," 8, NARA2.
49. "Conference on Air Support," 8, NARA2.
50. "Conference on Air Support," 8, NARA2.
51. "Conference on Air Support," 12, NARA2.
52. "Conference on Tactical Air Force to Assembled Officers of Second Army," 10 September, 1943, Lebanon, Tennessee. Folder 373.21, "Support of Ground Forces," Box 984, Central Decimal Files, October 1942-May 1944, Record Group 18, Records of the Army Air Forces, NARA2, College Park, MD, 5.
53. "Conference on Tactical Air Force to Assembled Officers of Second Army," 10 September, 1943, Lebanon, Tennessee. Folder 373.21, "Support of Ground Forces," Box 984, Central Decimal Files, October 1942-May 1944, Record Group 18, Records of the Army Air Forces, NARA2, College Park, MD, 1-3.
54. "Conference on Tactical Air Force to Assembled Officers of Second Army," 9.
55. Bob Wells, 35th Division Association Newsletter, March, 2006.
56. McMillin, *In the Presence of Soldiers*, 351, 323.
57. Maneuver Director Headquarters, Second Army, "Report of Air Support for Maneuvers," 25 February 1944, Folder 373.21, "Support of Ground Forces," Box 984, Central Decimal Files, October 1942-May 1944, Record Group 18, Records of the Army Air Forces, NARA2, College Park, MD.
58. "Report of Air Support for Maneuvers," NARA2.
59. Air Force Historical Research Agency (AFHRA) Record Group 446.01, History of III Tactical Air Division, 1944.
60. Maurer, *Air Force Combat Units of World War II* (Washington, DC: GPO, 1982), 106; Craven and Cate, *The Army Air Forces in World War II*, Vol III, 634.
61. "48th Fighter Group, April-August 1943," Box 3260, NM-6, Entry 7, World War II Combat Operations Reports, Record Group 18, Records of the Army Air Forces, NARA2, College Park, MD.
62. Greenfield, *Army Ground Forces and the Air-Ground Battle Team*, 83.
63. Greenfield, 83.

64. HQ, AGF, 6 April 1943, "Organization and Training, Desert Training Center," Folder "Field Maneuver Confidential File," Box 16, Entry 16, RG 337, Records of the Headquarters of the Army Ground Forces, NARA2, College Park, MD.
65. See David N. Spires, *Airpower for Patton's Army* (Washington, DC: Air Force History and Museums Program, 2002).
66. Sidney Meller, "The Desert Training Center and C-AMA," Study No. 15, (Washington, DC: Historical Section, Army Ground Forces, 1946).
67. Meller, 5.
68. Meller, 13.
69. Meller, 7, 14.
70. Meller, 15.
71. Meller, 44.
72. Jean Moenk, *A History of Large-Scale Army Maneuvers in the United States, 1935-1964* (Fort Monroe, VA: US Continental Army Command, 1969), 72.
73. Meller, "The Desert Training Center and C-AMA," 59.
74. Meller, 59.
75. I.H. Edwards to CG, AAF, 9 January 43, Folder "Field Maneuver Confidential File," Box 16, Entry 16, RG 337, Records of the Headquarters of the Army Ground Forces, NARA2, College Park, MD.
76. Meller, "The Desert Training Center and C-AMA," 57-58.
77. Meller, 58.
78. Greenfield, *Army Ground Forces and the Air-Ground Battle Team*, 74-75.
79. "Reduction of Number of Maneuver Areas," 22 January 1944, Folder "Field Maneuver Confidential File," Box 16, Entry 16, RG 337, Records of the Headquarters of the Army Ground Forces, NARA2, College Park, MD.
80. "History of III Tactical Air Command, 1944," Record Group 448.01, AFHRA.
81. Greenfield, *Army Ground Forces and the Air-Ground Battle Team*, 123.





## Chapter 4

### Getting Together

#### Ninth Army and XXIX TAC in Brittany, July-October, 1944

Both Ninth Army and XXIX TAC were very much “battle born” organizations, carved out of existing formations already employed in the fight against Germany and built up with units that had gained extensive combat experience during the first three months of fighting in France. This critical period, when untested, early-deploying divisions and fighter groups adapted what they had learned during training exercises to the realities of combat in the *bocage*, is amply covered in other narratives, especially Thomas Hughes’ *Overlord* and David Spires’ *Airpower for Patton’s Army*. But, by focusing on leaders and units that spent significant time prior to D-Day in the theater, these accounts, as well as those of the ground combat units, minimize the process by which commanders integrated new units into the fight in order to build combat power. When First and Third Armies broke out to the east, 12th Army Group needed another numbered army headquarters to oversee the battle still raging in Brittany and to administer the flow of new divisions and corps headquarters into the campaign. And this new army, Simpson’s Ninth, required its own Tactical Air Command, as both Quesada’s IX TAC and Weyland’s XIX TAC were now following the First and Third armies east, across the Seine towards the German border. Accordingly, 9th Air Force established a third TAC, the XXIX, under the former 9th Air Force A-3, Brig. Gen. Richard Nugent, to support Ninth Army in Brittany and continuing after it took its position in the line advancing on Germany.

Relegated to a minor area, scrambling for resources in a time when the breakout had combined with logistical strain to produce local scarcity, and under pressure to quickly wrap up a minor operation in order to support the main thrust, Simpson and Nugent quickly established the Ninth Army-XXIX TAC team in Brittany and successfully reduced the isolated fortress of Brest, with its excellent, though now thoroughly wrecked harbor and its massive submarine pens. Though the battle for the city did not yield the hoped-for results, as the effort to rehabilitate the harbor was not worth the benefits due to the extreme distance from the front lines and the wrecked condition of the French rail network, the battle did provide an opportunity for Ninth Army and XXIX TAC to build upon both their training and their by-now extensive experience to forge yet another weapon in the form of an effective combined air-ground team for the theater commander’s arsenal.

#### Breakout into Brittany

Following the D-Day landings, the Allied forces embarked on a two-month campaign that simultaneously saw a gradual buildup of strength within the beachhead and an attritional grinding down of the German defenders blocking access into the interior of France. While the air forces had played a substantial role in both efforts, winning air superiority that allowed the buildup to proceed essentially unhindered by German interference, and interdicting the flow of German reinforcements and logistics into the battle, they were unable to provide sufficient close support to help the ground forces break through their cordon. But the transfer of air units from their bases in England into the beachhead, aided substantially by the conquest of the Cotentin Peninsula, and the continued and sustained combat made the air support both more responsive and more effective, leading to a massive plan for the final breakout.

Figure 4.1.1. US Ninth Army Operations in Brittany, 1-12 August 1944. Graphic created by Army University Press staff.

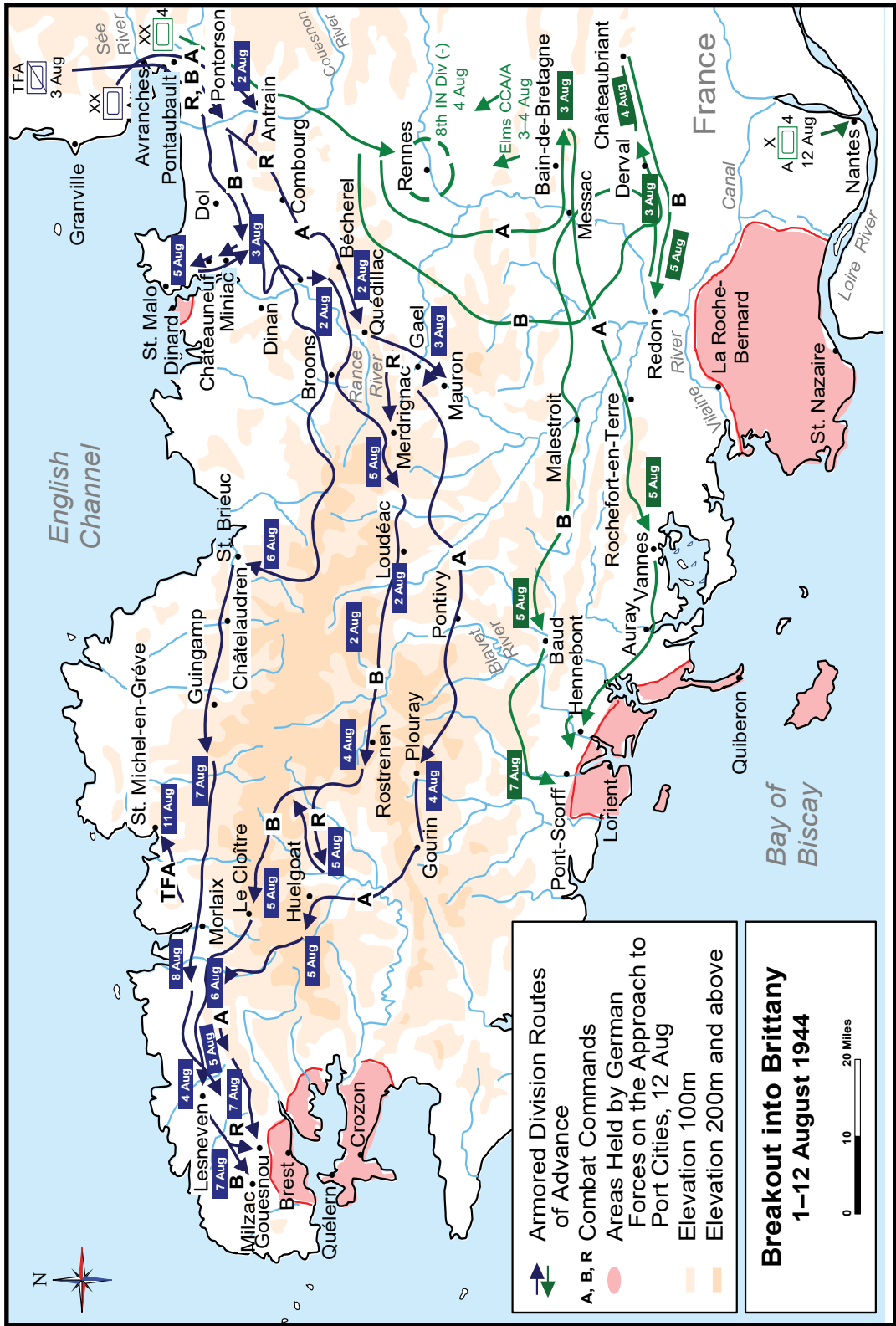

In late July, the Allies launched Operation Cobra, in which thousands of heavy bombers from the 8th Air Force, supported by medium and fighter-bombers from 9th Air Force, blasted open a hole in the German lines, enabling two corps of armored and mechanized divisions to punch through and break out into the rolling country beyond. Though this effort was not without difficulties, as poor weather resulted in an aborted attack on 24 July and numerous “shorts” caused substantial casualties among the lead elements of the assaulting divisions on 25 July, including Lt. Gen. Lesley McNair, commander of the Army Ground Forces, it eventually succeeded. VII and VIII Corps, each with two armored divisions in the lead and a division of motorized infantry following, broke into the German rear, flowed through Avranches and spilled into the countryside beyond. On 1 August, the Allied command activated Third Army under Lt. Gen. George Patton who, until then, had been in England as commander of a fictional army poised for a landing at Calais, a part of the elaborate Allied deception plan that kept large numbers of German troops and equipment out of Normandy.

Patton’s Third Army, and the new XIX TAC under Brig. Gen. Otto P. Weyland, turned the corner at Avranches and wheeled east, behind the German lines. At the same time, Hitler ordered a massive armored counterattack to seal off this penetration which Hodge’s First Army, and most notably the 30th Infantry Division, aided by massive applications of Allied tactical airpower, blunted at Mortain. Patton’s advance trapped the attackers in what became known as the Falaise pocket, which occupied most of the Allied attention in the middle of August, as British forces advancing south from the beachhead closed with Third Army units attacking north in an attempt to close off the exit at the base of the pocket. VIII Corps’ continued advance west into Brittany became a supporting effort, as it was hoped that the important ports along the Bay of Biscay could be captured largely intact in order to support the logistical effort. By the time VIII Corps commander Troy Middleton’s two armored divisions, the 4th and 6th, reached the Atlantic coast, they were now hundreds of miles behind the front lines.

Rather than methodical advances, Patton wanted slashing armor attacks, with the 4th Armored Division, followed by the 8th Infantry Division rushing to Quiberon Bay, which the Allies hoped to develop into an improvised port, and the 6th Armored, followed by the 79th Infantry Division advancing to Brest. Saint-Malo, a smaller port on the Channel coast, was bypassed for now.<sup>1</sup> But the armored spearheads reached their objectives easily, aided by perfect flying weather for the fighter-bombers flying armored column cover overhead. Two groups flew armored column cover missions, with the 365th Fighter Group supporting 6th Armored and the 371st working with 4th Armored, while the 358th Fighter Group conducted a general armed reconnaissance over Brittany, breaking up troop concentrations and attacking road-bound columns.<sup>2</sup> According to one prisoner-of-war captured at Brest, “the Allied Air Force at that time made troop movements impossible during the day.”<sup>3</sup> The fighters remained constantly over each column, and were relieved at one-hour intervals. “Planes and tanks worked closely together, talking to each other by VHF radio.”<sup>4</sup> XIX TAC’s official history described the procedures employed:

Units supporting armored column cover were directed in the day’s operations order to contact the appropriate ground station when approaching the head of the column. If no targets were given, and if the area was free of enemy aircraft, they were instructed to sweep ahead of the column for up to 30 miles, attacking any military objectives that might obstruct its progress.”<sup>5</sup>

During the breakout, the fighter-bombers overhead remained the best source of information about the location of the armored spearheads.<sup>6</sup> XIX TAC's official history recorded, "In this highly mobile form of warfare the leading armor often outran its communications, and the army's latest information on the location of its spearheads frequently came from reconnaissance or fighter-bomber pilots."<sup>7</sup> Ground liaison officers assigned to the fighter groups facilitated this process, as the XIX TAC historian reported: "To make the most of this source of information, our pilots on armored column cover were instructed to include in their reports, whenever possible, the point at which the head of the column was last observed."<sup>8</sup> 4th Armored reached Lorient on 7 August, pinning the garrison within the defenses, and 6th Armored reached Brest the same day.

While these momentous events unfolded, Ninth Army waited patiently in the UK. While Simpson and his immediate staff had arrived in time for the D-Day landings, the main body did not disembark until 28 June, and almost immediately assumed the responsibility of receiving newly-arriving units.<sup>9</sup> The headquarters had an opportunity to acclimate to the theater in July, making frequent visits to the continent and adding additional staff officers, including a G-2 (Air) and G-3 (Air), as well as the 125th Liaison Squadron, equipped with the same light aircraft initially tested in the Louisiana maneuvers that greatly facilitated command and control.<sup>10</sup> In August, Ninth Army undertook final preparations for commitment, moving to the continent in late August, with XIII Corps under Maj. Gen. Alvan Gillem, Jr., remaining behind to continue the reception duties, and opened officially on 5 September with headquarter at Mi-Foret, near Rennes. Ninth Army assumed responsibility for Middleton's VIII Corps which, since early August had been in contact with the defenders of Brest and was then in the middle of the month-long battle to reduce the garrison. The mobile units, including 4th and 6th Armored, had been detached and the corps headquarters had three infantry divisions on line, the 8th, which had followed the 4th Armored into Brittany, and the 2nd and 29th, which had been "pinched out" of the Falaise battle and became available farther west.<sup>11</sup> They were all experienced units, with the 29th having assaulted Omaha Beach on D-Day. The Army directly controlled another infantry division, the 83rd, which had captured the channel port of St. Malo, where aircraft of the 9th Air Force used napalm, or jellied gasoline, in combat for the first time on 17 August.<sup>12</sup> The 83rd kept watch on the garrisons of Lorient and St. Nazaire as well as the lower reaches of the Loire valley below Nantes.<sup>13</sup> Thus, the Army had two missions: the capture of Brest and guarding the line of the Loire valley, protecting Third Army's flank and rear.

While VIII Corps assumed responsibility for the first mission, much of the second fell to 9th Air Force, including Weyland's XIX TAC, from which the AAF carved Nugent's XXIX TAC in mid-September. Thus, the airmen, in addition to supporting operations on several fronts, actually "held" a frontage of their own, conducting daily reconnaissance sweeps to locate the German forces moving up from southern France and attacking these formations, in conjunction with the French resistance, whenever they were found. On 16 September, *Generalmajor* Botho Elster, harassed unceasingly by the air, cut off from escape by the linkage between Third Army and Seventh Army, then coming up from the south of France, and worried about what would happen if his troops fell into the hands of the bitter French resistance, offered to surrender the remnants of his command.<sup>14</sup> Simpson, aware of the airmen's contribution to Elster's decision, insisted that Weyland be there to receive the surrender at the Beaugency Bridge over the Loire, which largely relieved the remaining threat to both Third and Ninth Army's southern flank. In



Figure 4.2. Lt. Gen. Lewis H. Brereton Awards the Air Medal to XXIX TAC Chief of Staff Col. Dyke Meyer.

asking Maj. Gen. Macon, commanding the 83rd Infantry Division, to accept Elster's surrender on his behalf, Simpson wrote, "It would appear proper to have General Whelan [Weyland] of the XIX Tactical Air Command present at the ceremony and to give him and his command, due credit on being instrumental in accomplishing the surrender."<sup>15</sup>

At the time XXIX TAC has just become operational, in the closing stages of the battle for Brest. Nugent's organization officially activated on 14 September at Vermand, France, with the 84th and 303rd Fighter Wings, 309th and 334th Signal Companies, 9th and 66th Airdrome Squadrons, the 66th Tactical Command Squadron, the 306th Fighter Control Squadron, and the 573rd Signal Battalion.<sup>16</sup> The Ninth Army's history records, "This was the start of an extremely successful Army-Tactical Air Command relationship which lasted to the conclusion of hostilities in Europe."<sup>17</sup> Unlike XIX TAC, which had been organized in February as the deception component of Patton's fictional army, but in anticipation of its commitment alongside Third Army, XXIX TAC had to be created out of whole cloth. According to a preeminent history of the Army's role in World War II, the command was "created by taking a rib from the other two tactical commands in the theater."<sup>18</sup> Headquarters personnel came from the experienced staffs of the two fighter wings, especially Col. Dyke Meyer, who served as chief of staff of IX TAC and was the former commander of the 366th Fighter Group.<sup>19</sup> Based on his experiences, and conforming to procedures that originated in the RAF in the Western Desert, "Col. Meyer insisted on duplication of every item of equipment to endow the TAC with greater mobility and allow it to be split in two for advanced echelon movements."<sup>20</sup> Nugent and his nascent

organization operated as a provisional part of Weyland's command throughout the operations in Brittany, becoming an independent command only after their movement east. But the 9th Air Force assigned the first fighter groups to XXIX TAC control in late September, to help the organization get up to speed. The 373rd Fighter Group came under XXIX TAC control on 29 September, with the 36th Fighter Group arriving two days later.<sup>21</sup> While the groups remained officially assigned to IX TAC, to facilitate coordination across the dispersed frontage, XXIX TAC operated the control center in Brittany, directing operations against the city until its fall, with the 358th and 362nd groups providing the bulk of the support there.<sup>22</sup>

### **The Commanders: Simpson and Nugent**

The two men who led the Ninth Army-XXIX TAC team came from disparate backgrounds, and almost from different generations. Born in 1888 in Weatherford Texas, Lt. Gen. William Hood Simpson was one of the unsung heroes of the US Army in World War II. He served brilliantly as an army commander but always avoided the limelight, both by his nature as a soft-spoken Texan and because he commanded the third American army to enter combat in Northwest Europe, after Courtney Hodges' First and the far-more flamboyant George Patton's Third. Simpson graduated from West Point in 1909, alongside fellow army commanders Jacob Devers and George Patton, but near the bottom of his class, according to a classmate, "not by any means due to lack of intelligence, but to insufficient schooling before entrance," as quality schools remained scarce on the Texas frontier and Simpson took long breaks to assist with ranching duties in his youth.<sup>23</sup> After graduation, he served as an infantry officer with the 6th Infantry Regiment, including service in North Dakota and the Philippines, and along the Mexican border during the Punitive Expedition against Pancho Villa in 1916. Active service earned him a position as the Chief of Staff of the 33rd Infantry Division in World War I, which was heavily engaged in the Meuse-Argonne offensive of 1918. After the war, he graduated with distinction from both the Command and General Staff School at Fort Leavenworth in 1925 and the Army War College at Fort McNair in 1928. During the interwar period, he became a recognized training specialist, at both at the Infantry Replacement training Center at Camp Wolters, Texas and as the commander of the ROTC detachment at Pomona College. When the war began, then Colonel Simpson took command of the 9th Infantry Regiment at Fort Sam Houston, Texas, but quickly moved up to division command, after the housecleaning following the Louisiana maneuvers. Successful stints as the commanding general of both the 30th and 35th Infantry Divisions earned rapid promotion to lieutenant general and command of both XII Corps and Fourth Army. He took the cadre of that organization, first to Fort Sam Houston, where it became Eighth Army and then to England where it was finally designated the Ninth. In addition to his command experience and participation in and responsibility for the maneuver exercises in 1943 and 1944, from 13-18 September 1943, he attended the Army Air Forces School of Applied Tactics' Senior Officer Course, which gave higher-level commanders an overview of air-ground organization and operations based on Montgomery and Coningham's effective partnership in North Africa, and explained how the tactical air forces would be established in a theater, and what their specific roles and missions were.<sup>24</sup>

Simpson was an avid student of military history and devoured biographies, especially of Allenby and the Confederacy (his family was a distant relation of Confederate Gen. John Bell Hood, and his father had served in Confederate Gen. Nathan Bedford Forrest's command).

In early 1942, while commanding the 35th Infantry Division at San Luis Obispo, he ordered several books from the Infantry Journal Press, including Hermann Foertsch's *The Art of Modern Warfare*, which detailed the doctrinal underpinnings of the early German victories in the war, a volume prepared by the Infantry School under Marshall's leadership titled *Infantry in Battle*, and a copy of Ardant du Picq's classic *Battle Studies*, as well as Charles Willoughby's *Maneuver in War* and the volume on Allenby.<sup>25</sup> Later that year he supplemented his library with Douglas Southall Freeman's *Lee's Lieutenants*, a study in command in Lee's Army of Northern Virginia, a topic of special interest to Simpson, as well as works on guerrilla warfare and Maj. Gen. E. B. Swinton's *The Defence of Duffer's Drift*, based on his experiences in the Boer War.<sup>26</sup> Mrs. Simpson later recalled, "I doubt if there's a military history or biography he hasn't read," surely an exaggeration, but a clear indication of how the general spent much of his off-duty time.<sup>27</sup> Simpson's preparation and knowledge evidently paid off, as after the war, Gen. Eisenhower said of him, "If Simpson ever made a mistake as an army commander, it never came to my attention...Alert, intelligent, and professionally capable, he was the type of leader that American soldiers deserve."<sup>28</sup>

Nugent, in contrast, was 14 years younger, having been born in Altoona, Pennsylvania in 1902. He was yet another native of the Keystone state who went on to distinguished service with the AAF in World War II, a group that included Gen. Carl Spaatz and Chief of Staff Gen. Henry H. "Hap" Arnold. Nugent came to XXIX TAC after serving as the A-3 of the Allied Expeditionary Air Force (AEAF), dual-hatted as the A-3 for 9th Air Force, from May to August 1944, during which time he became intimately familiar with the organization's operations and key personnel. He had a fairly typical career for an AAF officer during the interwar period, but, like O. P. Weyland at XIX TAC, came from a ground forces background. After graduating from West Point in 1924, he served as an armor officer with the 17th Tank Battalion at Camp Meade but also worked to develop new types of tanks at the Aberdeen Proving Grounds in Maryland. 1st Lieutenant Nugent transferred to the Air Corps in 1929 and completed his flight training at San Antonio's Brooks and Kelly Fields, serving with the 25th Bomb Squadron and the 7th and 44th Observation Squadrons in Panama, allowing him to reconnect with the ground forces. Then-Captain Nugent served with bomber and observation squadrons again at Langley Field, in Virginia, before attending the Air Corps Tactical School and Command and General Staff College in consecutive years from 1937-1939.

Upon graduation, he served in a variety of staff roles at the AAF Headquarters in Washington, where his administrative talents in the Planning Section earned him an assignment on the War Department General Staff in General Marshall's office. In only three years' time he went from the rank of captain to brigadier general, both a sign of the rapid expansion of the AAF, as well as the rank stagnation during the interwar years. His own efforts may have aided his advancement, as one of his key tasks was to complete an "Age-in-Grade" study in 1942 establishing maximum ages for officers on active service.<sup>29</sup> After a brief stint in command of a fighter wing in Philadelphia, he deployed overseas to join the growing cast assembling from the cross-channel invasion. Like his peers, Quesada and Weyland, Nugent was deficient in command experience but very well-connected to the senior leadership of the AAF, especially the new 9th Air Force commander and future Chief of Staff, Hoyt Vandenberg, one of Arnold's personal favorites.<sup>30</sup> Detached duty as an air observer during the Battle of Britain and as Sir Trafford Leigh-Mallory's operations officer at AEAF Headquarters gave him experience with



Figure 4.3. Lt. Gen. William H. Simpson and Brig. Gen. Richard E. Nugent.

his RAF counterparts, which benefitted Ninth Army during the three months it was under the control of the British 21st Army Group, from the Bulge battle until after crossing the Rhine.

Despite their generational differences, the men got along well together. The older Simpson understood the importance of airpower and appreciated Nugent's talents for organizing and employing it. And Nugent's time as an armor officer and close association with the ground forces while in observation squadrons in the 1920s and 1930s helped him understand and appreciate the challenges the ground forces faced, and motivated him to provide the best possible support for them. Though they could not always keep their headquarters collocated during rapid advances, both men always ensured they kept at least a detachment at the other's headquarters in order to facilitate close cooperation. Simpson did not undertake major operations until he had been assured of sufficient air support, and Nugent religiously placed the army's needs ahead of his own or those of his branch.

It is worth considering, however, if the idea of a close partnership, as has been suggested by other authors, in the case of Hodges and Quesada, as well as Patton and Weyland, was a reflection of reality or a concerted effort by the Army Air Forces to elevate the TAC commanders to a level co-equal with that of the Army commanders, as suggested in FM 100-20. The AAF arranged for a photographer to take photos of Simpson and Nugent together in February of 1945, and there is little official documentation to support a close working, or even personal



relationship between the two men, especially given the age differences.<sup>31</sup> On 10 December, in response to a request from Hodges to meet at his headquarters, Simpson asked, "Should I bring my boy who corresponds to Pete? [Quesada]," meaning Nugent, at best an unflattering description of his youthful air commander.<sup>32</sup> Simpson may not have been able to bridge the generational gap between the two men or, given Ninth Army's later reliance on artillery rather than close air support, in could also be a more significant indicator of how the seasoned Army commander viewed yet another provider of support forces, such as a Chief Engineer or Chief of Artillery. But well after the war, in an oral history provided in the early 1970s, Simpson recalled of Nugent that he had been a classmate of the Ninth Army Chief of Staff, James Moore, and that Nugent was "a very able commander. I was very fond of him," that, "he merged his XXIX Tactical Air Command very closely to the Ninth Army headquarters. He was almost the same as a member of the family. Personally, we got along fine. His ideas and mine just clicked," and that he was "awfully pleasant to deal with," suggesting a deeper appreciation between the two men.<sup>33</sup>

## The Siege of Brest

From the time 6th Armored arrived on the outskirts of Brest, American forces had maintained a leaky cordon around the city. The rapid advance had outflanked many of those troops assigned to defend the fortress, and some historians have suggested that a rapid assault on the city might have resulted in the citadel's capitulation. Middleton later recorded that Patton had told him: "there aren't more than 10,000 Krauts in the entire peninsula.' Whether he was just guessing or whether his G-2 had estimated for him, I don't know. In the final capture of Brest we took something like 38,000 prisoners."<sup>34</sup> But 6th Armored was not the right tool for the job. Heavily defended with well-placed anti-tank guns, the city required assault by infantrymen, a deficiency in the division. The tank-heavy unit was at a disadvantage, in both mobility and firepower, when up against strongly-emplaced, large-caliber guns in urban terrain. Artillery ammunition was woefully deficient, with many units having less than one unit of fire available, due to the rapid advance from the bridgehead and transportation difficulties on roads where disorganized units of Germans still disrupted supply lines. The VIII Corps Artillery AAR reported, "a severe rationing policy was necessary."<sup>35</sup> And tactical airpower could not have made good this deficiency, at least not right away. Most airfields were still well back within the Normandy beachhead, and the battle to first contain and then destroy the German thrust at Falaise consumed most of the available tactical support aircraft for the middle two weeks of August. Thus, Middleton had little choice but to bring up his infantry and artillery ammunition, and plan a set-piece assault that could reduce the strongpoints and force the defenders to surrender.

While 6th Armored sat outside Brest, German forces assigned to its defense attempted to filter back in, and some were more successful than others. The 2nd *Fallschirmjaeger* (Parachute) Division, the region's only mobile forces, had deployed outside the city in an attempt to stop the Allied drive but had been largely bypassed. Unfortunately, most of the paratroopers, and their commander *Generalmajor* Hermann-Bernhard Ramcke, a committed Nazi but the hero of the capture of Crete in 1942, managed to elude the blockade. Forces of the 266th Division, a static organizations responsible for other coastal positions in Brittany, were less successful, stumbling into the rear of 6th Armored, which put the majority of the division into captivity. Thus Ramcke, upon assuming command of the fortress, had roughly three divisions-worth of troops available to him, with naval troops and laborers partially compensating for the deficien-

cies in the 266th. But the quality was uneven. While the paratroopers still enjoyed high morale, the static divisions, especially the city's primary garrison, the 343rd Division, contained large numbers of older men and forced laborers and soldiers from Germany's eastern conquests. These *Ostbattalions* provided several instances of unexpected surrenders for the attacking infantrymen of VIII Corps, and were especially susceptible to morale-crushing air attacks. The paratroopers, in contrast, required much more effort to dig out of their fixed positions.

By 25 August, Middleton had brought up the remainder of his corps and placed them in line around the city. Brest sat on the southern side of the Brittany peninsula, along an irregular coastline studded with outcroppings. Thus, before the city itself could be assaulted, these flanking promontories had to be reduced first. Middleton arranged his three divisions around the city's perimeter. On his right, to the west of the city, Charlie Gerhardt's now-veteran 29th Infantry Division covered the sector from the coast to the Penfeld River, which flowed roughly through the center of the city to the excellent harbor. The 29th's sector included strong forts on the western end of town, including the famed submarine pens, as well as several excellent positions along the coast that could enfilade any attackers inland. Directly across the harbor from the 29th's sector, the tip of the Crozon peninsula offered additional forts that could deliver large-caliber fire over the heads of the defenders directly opposing the lead elements of the 29th. The division's soldiers would have to dig the defenders out of all of these forts before they could enter the city itself. Elements of the 5th Ranger Battalion secured some of the more troublesome positions. On 3 September, the Rangers took Fort Toulbroch immediately after a fighter-bomber strike by a flight of four P-47s from the 358th Fighter Group. The aircraft recorded three direct hits, then strafed the defenders, allowing the Rangers to secure the position. The 29th was approaching 100 days of continuous combat, from the landings on June 6 through the attack on St. Lo and the vicious fighting in the hedgerows, but the rapid advance had given it time to catch its breath and receive much needed replacements.<sup>36</sup>

In the center of the VIII Corps line, the "Pathfinders" of the 8th Infantry Division occupied a narrow sector between the Penfeld River and a fairly straight highway running south from Gouesnou into the city. But a protrusion of the urban area north to Lambezellec meant that the 8th encountered fixed defenses sooner than its neighbors, and had more of them to fight through before reaching the city's center. During the assault, the 8th Infantry Division was pinched out by the 29th Infantry Division on its right and 2nd Infantry Division on its left, and redeployed around to the Crozon peninsula south of the city to block any escape across the harbor. On Middleton's left, to the east of the city, the men of the "Indianhead," or 2nd Infantry Division covered the line from the divisional boundary to the wide Etern River, really an extension of the harbor itself. Across the river to the south lay the Daoulas peninsula, which featured a number of forts that could offer flanking fire to the 2nd's advance. Thus, the peninsula had to be cleared first before the division could enter the city, but the 38th Infantry Regiment had largely completed that task by 30 August. Aerial observation materially aided this advance, as a German POWs later reported, "movements were handicapped by the lively enemy aerial Surveillance."<sup>37</sup>

By 25 August, VIII Corps was on line and Middleton ready to jump off. But the long distances between Brest and the supply dumps on the Normandy beaches meant that essential supplies, especially artillery ammunition, were slow in arriving. Pre-war Air Corps doctrine had repeatedly emphasized that aircraft were not to be used within range of friendly artillery, judging that the

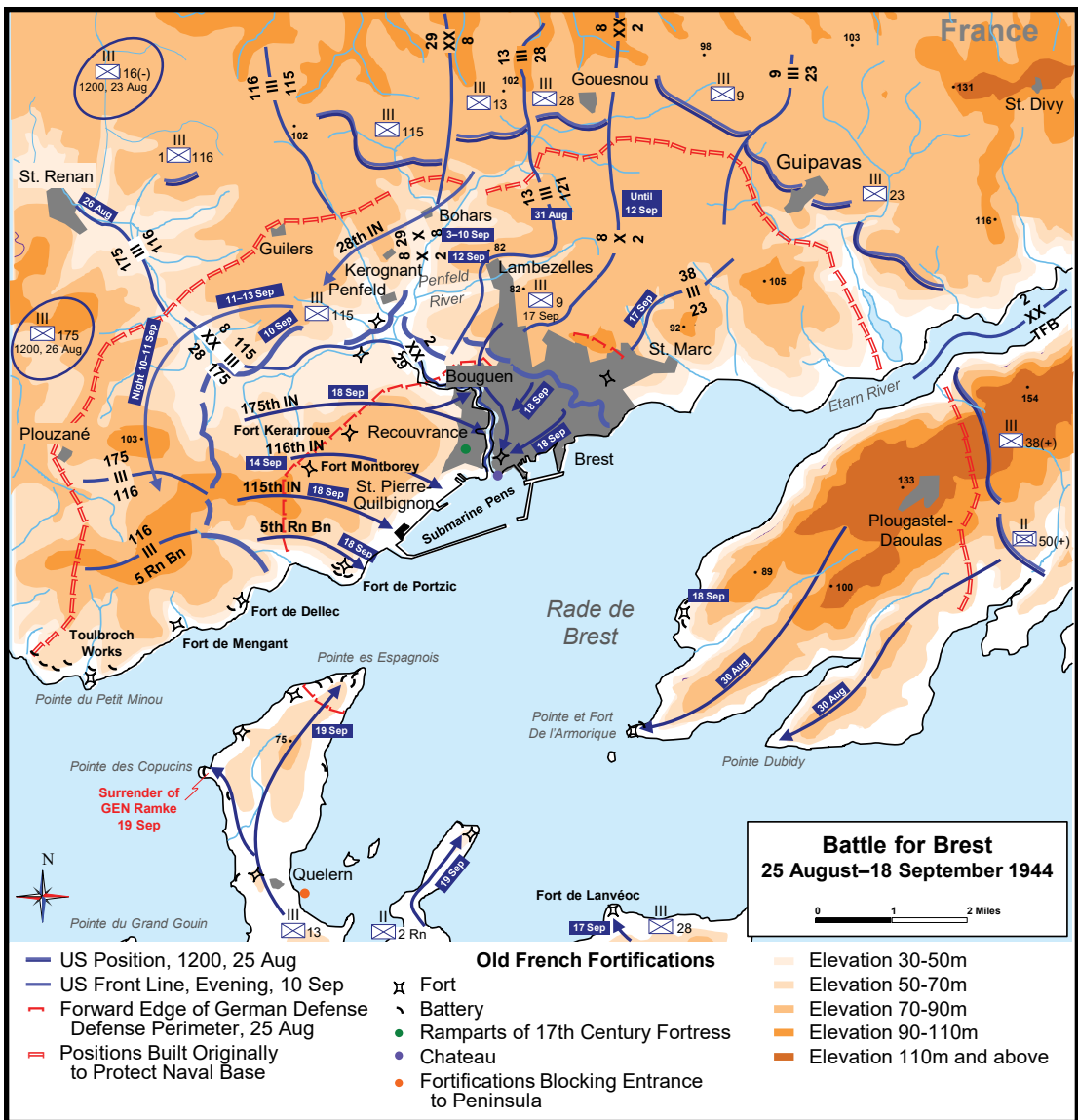

Figure 4.4. Ninth Army Operations in the Reduction of Brest. Graphic created by Army University Press staff. weight of fire and accuracy would exceed that of aircraft, and that it could be delivered with much less risk than by aircraft attacking fixed positions presumably well defended by anti-aircraft artillery. But this assumed a well-supplied attacking force along a static frontage. In the absence of adequate artillery support, aircraft could indeed serve as “flying artillery,” using their inherent speed and mobility to both transport high explosives from rear areas and then deliver cross-domain fires when and where they were most needed. After dire artillery ammunition shortages caused a suspension of the assault just two days after it began, aircraft began to take on a much larger role in delivering both massed and precision fires into Brest.

The city had sustained massive air attacks since the fall of France, especially on the hardened submarine pens protected by up to twelve feet of concrete. During the Battle of the Atlantic, when

German U-boats took a heavy toll on Allied shipping, and when the North Africa-bound convoys had to cross the Bay of Biscay from England in order to effect the Operation Torch landings, Allied heavy bombers paid frequent visits to Brest, but could do little to impact the U-boat war, other than wreck unprotected machine shops and imperil the lives of French civilians and forced laborers, and possibly a few submariners on shore leave, outside the boundaries of the naval yard. These attacks focused on facilities along the harbor's edge and somewhat removed from the most built-up areas. In order to target the city's landward defenses, VIII Corps requested new attacks by medium and heavy bombers to suppress the defenders and wreck fixed positions within the city itself.

To augment his firepower, Middleton requested as much air support as he could get from whatever the source. Despite increasing clouds and rain that limited their effectiveness, seven groups of medium bombers augmented by 150 heavy B-17s hit the city on 25 August, with the RAF's heavy bombers following at night. The next day, 8th Air Force's heavies and 9th Air Force's mediums hit the city again but the ground troops made little progress. The siege required a gradual reduction rather than a rapid advance; pillboxes had to be reduced by flame-throwers and hardened defenders dug out of almost every position.<sup>38</sup> To aid in the advance, the fighter-bombers began keeping four-plane flights on aerial alert for each division, which proved timely and effective. The 2nd Infantry Division later reported, "Fighter bombers afforded the finest air support experienced by this Division in the entire war by striking designated targets from 'air alert.' The Division Commander was able, by virtue of almost continuous daily support, to strike all known or suspected personnel and material. The advance of infantry elements in numerous instances was materially aided."<sup>39</sup> As a final example of cross-domain fires, and an additional incentive to surrender, a British battleship, the HMS *Warspite*, added the weight of its 15-inch guns in a sustained shore bombardment.<sup>40</sup> But neither effort could overcome the strength of the defenses or the artillery shortage, exacerbated by additional allocations of motor transport to Patton's rapid advance to the east. Middleton postponed the main attack until 7 September, when he hoped he could build sufficient reserves, but continued to claw at the perimeter to improve his position. In the meantime, aircraft had to fill the void with massive aerial raids.<sup>41</sup> Middleton requested more heavy and medium bombers, and fighter-bombers equipped with rockets and napalm that had proven effective at Saint-Malo.<sup>42</sup> But on 1 September the corps commander complained that his air support "left much to be desired," and made it clear that he wanted "more and better air support."<sup>43</sup>

A major part of the perceived ineffectiveness of the heavy and medium bombers stemmed from the lack of communication between these units and the ground forces. In a questionnaire circulated after the war, respondents from the Ninth Army reported difficulty in having medium bombers check in with ground controllers, not to request any change of target, but to simply determine when the air attack had concluded so that the ground forces could begin their assault. The respondents noted, "at that time the bombardment aviation was based in the United Kingdom and the communications were extremely sluggish between the ground units at Brest and the bombardment aviation. This problem was later alleviated."<sup>44</sup> Had better communication been available, the ground forces might have made additional target requests. Officers of the 2nd Infantry Division reported,

Medium and heavy bombers were valuable in general destruction of large targets, such as communication centers, heavy caliber gun positions and other enemy installations...Heavy bombers should have been used earlier in the Brest Campaign, to breach the ancient wall surrounding the inner city. When the ground forces fi-

nally reached this defended wall, there was no means available to the ground force commander to breach this obstacle. Capture of Fortress Brest resulted from saturation artillery and mortar fires, combined with a fortuitous sneak attack through a weakly defended entrance in the wall. Heavy bombers could have been employed against this wall during the early days of the campaign, materially reducing the time and effort for certain capture of the inner city.<sup>45</sup>

It is hard to imagine, given the tremendous destruction inflicted on the city, that there were targets missed by the saturation bombing, but this example serves to highlight that sheer tonnage dropped does not matter as much as placing weapons at the precise point that is of greatest interest and use to the assaulting ground forces.

On 5 September, the Army Air Force and the RAF's Bomber Command delivered a massive bombardment against the city and its fixed defenses. Just as Brigadier General Stearley had promised at the demonstrations in the Tennessee maneuvers, the heavy bombers would intervene in the ground battle when required. Eleven groups of medium bombers added their weight to the struggle, flattening large sections of the city and knocking out some positions, but the net effect, much as it had been at Monte Cassino a year before, was to create even better defensive positions in the rubble, as well as block mobility through the city. The counterproductive bombing, despite providing a tremendous morale boost to the attackers, was not as effective as it appeared to be. Indeed, the Air Force's postwar official history argued, "the missions of the heavies and of mediums alike involved a considerable waste of effort."<sup>46</sup> Contributing to this effort, fighter bombers from XIX TAC struck pin-point targets, especially just in front of the leading echelons. This had a more desirable effect, as the precision attacks targeted gun positions and emplacements that held up the advance, keeping gunners underground in their bombproof shelters and away from their weapons. On 5 September, twelve of 9th Air Force's 18 fighter-bomber groups were over Brest, and tactical reconnaissance aircraft assigned to the 10th Photographic Reconnaissance Group were on hand to adjust artillery fire, largely because the heavy flak and dense smoke prevented the field artillery's indigenous light aircraft from getting high or close enough to the front to perform their mission. But, in a payoff from the weeks of training in the tac recce schoolhouse at Key Field in Meridian that had been devoted to adjusting fire in exercises down at Camp Shelby, "veteran artilleryman rated their work as the best they had ever experienced."<sup>47</sup>

As the Ninth Army history reports, this massive and sustained level of air support was only possible because German air power was virtually nonexistent—there were only two minor bombings, with "no casualties or damage." Thus:

The Brest operation was really unique in the respect that it was the first operation of the Allied armies in northern Europe to be almost completely free of enemy air attack. Fighters of the American Ninth Air Force were able to carry out missions in cooperation with the ground forces with practically no interference from enemy interception; the attacking troops were free from enemy air attack.<sup>48</sup>

The results vindicated pre-war and wartime doctrine prioritizing air superiority, and tactical aircraft continued to devote sorties to suppressing German aircraft, both in the air and on their airfields, throughout the remainder of the war. Failed *Luftwaffe* efforts at aerial resupply showered the attackers with their first supply of Iron Crosses, small-arms ammunition, and

even codebooks. But Allied airdrops could be off-target as well, as evidenced by the blizzard of leaflets demanding the Germans surrender that dropped on the 2nd Infantry Division command post.<sup>49</sup>

By 8 September, the sustained attacks had collapsed the perimeter to the point that heavy bombers could no longer be used in the constrained space, and they were withdrawn from the battle, much to the relief of strategic airpower advocates in 8th Air Force.<sup>50</sup> Each division continued the attack with six fighter-bombers on constant call and began to break into the inner line of defenses. In addition to air superiority, which prevented the Luftwaffe from providing any support or relief, the attackers were also beginning to benefit from the effects of the sustained interdiction campaign, which had prevented the buildup of sufficient reserves inside the fortress. Indeed, even construction had been limited by shortages of concrete, as deliveries fell to less than half of what the defenders had requested in the months before the battle.<sup>51</sup> With on-call flying artillery, effective spotting, and ammunition shortages among the defenders, the Allied superiority in multiple domains was beginning to take its toll on the garrison's beleaguered defenders. In the absence of the heavy and medium bombers, XIX TAC's fighter-bombers picked up the slack, and, according to ground commanders, close air support was "paying big dividends."<sup>52</sup> On 6 September, the command sent six of its eight fighter groups to Brest, and flew 33 of 37 missions over the city. It maintained this level of effort on 7 and 8 September, but dropped to only three groups on 9 and 10 September. From then until the conclusion of the siege on 18 September, only two groups, the 358th and 362nd, devoted the bulk of their daily effort to Brest.<sup>53</sup>

Joining the fighter groups over the city was the new 363rd Tactical Reconnaissance Group, under the command of Lt. Col. James M. Smelley.<sup>54</sup> The 363rd had been a P-51 *Mustang* group, but this aircraft's unsuitability for ground support coupled with the pressing need for a new tac recee group for XXIX TAC led to its conversion to tactical reconnaissance. The fighter pilots and armorers transferred out to other groups while a new batch of reconnaissance pilots and technicians responsible for maintaining the cameras and processing film transferred in, along with the new F-6 aircraft. Since the rest of the airframe was identical to the P-51, the group kept the well-trained and experienced maintenance personnel, enabling it to activate on 5 September, just one month after it ceased operations as a fighter group. On 10 September, it flew its first missions over Brest, when four missions adjusted artillery fire. On 11 September, eight missions went south of the Loire to monitor the 20,000 Germans coming up to surrender, but twelve more covered Brest. The following day the reconnaissance pilots were back over the fortress, completing 28 missions, including four artillery adjustments, and another 24 over the Loire. The following day, the new Ground Liaison Officers from Ninth Army arrived at the group, cementing the bond between ground and air and allowing the ground officers to quickly transmit the pilot's post-mission reports to ground commanders, as had been practiced in the final Tennessee maneuvers. As the siege reached its climax, weather began to interfere, resulting in the cancellation of two missions of the fifteen scheduled on 13 September, all fifteen missions on 14 September and fourteen of the fifteen scheduled on 15 September, but good weather returned the following day and the group flew daily missions until the surrender.<sup>55</sup>

Blocking the advance in the 29th's sector was the massive Fort Keranroux, sited atop a 100-meter prominence that guarded the western approaches to the city.<sup>56</sup> Sustained attacks by

tactical aircraft virtually obliterated the defensive position, allowing the 29th to enter the western fringes of Brest. The commander of the 175th Infantry Regiment reported,

From personal observation, FORT KERANROUX is nothing but a mass of rubble, destroyed buildings, equipment, motor vehicles, etc., strewn over the entire area. Along one side of the Fort there is one large concrete pillbox and gun position intact. Prisoner interrogated by PWI team made statement that when the Fort was bombed, approximately 30 men ran to the lower floor of the fort and were buried when bombs struck.<sup>57</sup>

From that point, the fighting became true urban combat, as attackers fought street by street and house by house. The rubble reduced the vertical element of the battle but complicated the task of ferreting defenders out of improvised positions. Poor weather on 14 September grounded the air support, but aircraft were back in the sky the following day with now eight fighter-bombers on constant call for each division.<sup>58</sup> As the American infantrymen reached the waterfront on 18 September, the last, hardened paratroopers retreated across the harbor to the tip of the Crozon Peninsula, but found their escape blocked by the redeployed 8th Infantry Division, and a single fighter-bomber circling overhead to help induce the last holdouts to surrender.<sup>59</sup> When American infantrymen reached Ramcke's final position, the assistant division commander, Charles Canham demanded that the German general cease all resistance. Stalling for time to destroy cryptographic equipment, and loathe to surrender to an officer inferior to him in rank, the defeated paratrooper demanded to see Canham's credentials. Pointing to the tired, dirty and disheveled infantry surrounding him, Canham responded simply, "These are my credentials," ending the battle and giving the 8th Infantry Division its motto, which it carried proudly throughout the Cold War until casing its colors in 1992.<sup>60</sup>

### **Airpower's Effectiveness**

In their after-action reports, and in memoirs written years later, commanders fondly recalled the effectiveness of air support throughout the siege. In his AAR submitted on 26 September, Maj. Gen. Walter Robinson, commanding general of the 2nd Infantry Division, reported that his division had received support from 97 missions, including 705 aircraft, since 23 July, two-thirds of which came in response to requests from front-line battalions or artillery forward observers or ALOs. Most of the attacks were not in close proximity to the front lines, and "the value of the air support was evident to our small units only after they reached the target area and saw the extent to which the enemy strong points had been reduced. Other effects not always immediately apparent to the ground troops were restriction of hostile movement, neutralizing weapons by keeping their crew under cover and limiting hostile observation."<sup>61</sup> Unlike commanders in North Africa who were highly critical of air support in that theater, Robinson recognized that support delivered beyond the front lines, while not always apparent, could have a significant effect on the battle. One such example occurred on 8 September, when, according to the CO of the 23rd Infantry, "air bombed and strafed all during the afternoon a hill which had been holding us up previously. That night the remnants of the enemy withdrew and we occupied the hill without resistance the next morning."<sup>62</sup> There were instances of close cooperation, such as on 27 August, when 12 P-47s hit a battery only 200 yards in front of friendly lines, and on 3 September when eight P-47s "bombed and strafed enemy positions 150 to 200 yards in front" of the 3rd Battalion of the 23rd Infantry.<sup>63</sup> In these cases, the fluorescent



Figure 4.5. Bomb Damage in Brest.

marker panels, tested in the Tennessee maneuvers of 1943, effectively marked the front lines and “reduced the possibility of error and the distrust in the minds of the troops.”<sup>64</sup> In fact, that afternoon, Middleton issued the following order: “Effective 4 September 1944 and for the duration of the Brest campaign, front lines of ground troops will be marked during daylight by cerise-colored fluorescent panels.”<sup>65</sup> But marker panels were not foolproof. Troops behind the front lines began displaying them routinely, endangering friendly troops forward of their position. And the Germans began “spoofing” the markers with red cloth, although closer inspection often revealed the incorrect shade.

Despite the occasional misidentification, ground forces were becoming more anxious to have close-in air support, and trusted that it would be delivered accurately. The CO of the 38th Infantry reported that his command took a well-defended hill on 9 September east of Brest with light losses after an extensive air attack. As a result, “Men in the line and commanders of all grades appreciate air support and are generally willing to accept a few misplaced bombs. Company B of this regiment was strafed on one occasion by our planes. The planes went on, however, and reduced an enemy emplacement that would have caused more losses that did the accidental strafing. After capturing the position, most of the company declared they were glad they had the air support, despite the strafing,” though they preferred that they be made parallel to, rather than perpendicular to the front lines.<sup>66</sup>

The company commander, William McArtor, elaborated:

At this time, four P-47 Fighter bombers were seen circling the area at a low altitude, and as a precautionary measure, the air identification panels were displayed.



The planes circled twice more, then came in low across the company's front from right to left with all guns firing. This pass was a little too close, and two men in the 1st Platoon were wounded by the planes' fire. However, the enemy stopped firing and the company moved forward about 50 yards with the air identification panels prominently displayed. Then the planes returned for a second run. This time the fire was well ahead of the leading platoons and the advance continued. A third run was made by the planes before they departed. Under cover of this fire, B Company had advanced to the enemy position. The enemy defenders were found to be disorganized by the strafing. The 3rd Platoon began to clear the enemy from his trenches and dugouts. A few small groups offered resistance and the platoon advanced slowly across the nose of the hill and started down the far side. The 1st Platoon, in the low ground on the right of the company's zone of action, advanced abreast of the 3rd Platoon without opposition. The enemy position on the west side of Hill 100 had consisted of extensive trenches, dugouts, concrete troop shelters, and two batteries of AA guns, one 40mm, one 88mm. However the air corps and artillery had seriously damaged the position prior to B Company's attack. The final strafing had driven the defenders underground and for the most part they remained there until dug out by men of the 3rd Platoon. Over 100 prisoners were taken in this area. While it was generally regretted that the planes' initial fire had resulted in two casualties in the 1st Platoon, the members of the company were in agreement that casualties would have been more numerous had the planes not made such a timely appearance.<sup>67</sup>

McArtor believed that, "The assistance rendered by the fighter bombers on the morning of 9 September 1944 was of great value and enabled the company to overcome with little effort what might have been the most troublesome enemy position encountered," and, "when properly utilized, air support is a tremendous asset to the ground forces."<sup>68</sup>

Robinson's division avidly collected information on potential targets suitable for attack by the air from front-line units, artillery observers, especially those frustrated by their own lack of ammunition, and civilian evacuees and prisoners of war.<sup>69</sup> While this supported pre-planned missions, the 2nd Infantry Division preferred to have "on call" support, both to reduce the response time and to prevent the possibility of "friendly fire" incidents due to changes in the situation during the time between mission request and execution.

The 29th Division reported a similar positive experience with the close tactical support at Brest. On 7 September, attacks by two groups of four fighter-bombers each enabled the 2nd Battalion, 115th Infantry Regiment to take Beuzig, which led to flank attack on Kergonant, the key terrain in sector.<sup>70</sup> Four days later, aircraft bombed Ilioc and Recouvrance, helping the 175th Infantry Regiment enter both of those towns. Most targets were prearranged with formal requests and averaged a 45-minute response time, but this was cut to as little as ten minutes when using "Air alert" fighters. One regimental commander indicated a strong preference for air alert because it prevented wasted missions due to changing conditions, insulated against weather cancels, and was much faster than calling aircraft from ground alert, especially when bases were far behind the front lines. It is no surprise that airmen supporting ground forces in Iraq sixty years later adopted similar tactics, with CAS stacks on call at individual "killboxes" to provide immediate, highly responsive support. The division AAR summarized, "In general,



Figure 4.6. German Commanders at Surrender of Brest.

the combat soldiers are enthusiastic about air support and want the greatest possible air support employed to assist their fight on the ground. It bolsters their confidence and decreases the enemy's effectiveness...the closer the air strikes, the better he likes it."<sup>71</sup> The mere presence of aircraft was often sufficient to reduce the volume of artillery fire.

Maj. Gen. Charlie Gerhardt of the 29th Division described the process his command used to request air support:

In this Division when a frontline unit makes a request for a bombing mission through the S-3 of its regiment to the G-3 for Air, it is decided at the War Room which of the number of requests (if simultaneous) are to be given priority. If a frontline unit's target is accepted, the troops adjacent to the target area are notified to display panels, and the request for air goes via direct wire to the Air Support Officer. The Air Support Officer calls upon Division Artillery for colored smoke to mark the target if he considers this necessary. At the same time he contacts the air to describe the location of the troops and target.<sup>72</sup>

Close coordination kept the attacking aircraft updated of changes to the ground situation, and cancelled the attack if ground troops moved too close to the intended target. If loitering aircraft did not have a target at the end of their designated air alert time, the G-3 (Air) solicited targets from the regimental S-3s, or chose from a list of pre-planned targets, to prevent aircraft from returning with full bomb racks. Gerhardt also endorsed the use of liaison aircraft from the artillery batteries who "make a valuable contribution to the bombing procedure by locating and describing targets in such a way as to render them identifiable to pilots, and by checking [the] effect of missions."

The 29th Division's report did not believe the diversion of heavy bombers had been useful. It reported, "heavy bombardment was of little value since it had to be kept at a safe distance from friendly ground troops," and "military objectives were proof against this type of attack," which German prisoners who had survived them corroborated.<sup>73</sup> But, while the heavy bomber attacks had limited effects, due to their lack of precision, the division "found from inspection after capture of installations attacked from fighter-bombers that great damage had been done, and in numerous instances these installations had been destroyed," observations again confirmed by German prisoners who felt that "cooperation between our air and ground forces was remarkably good."<sup>74</sup> But American ground forces still singled out the P-47 for its "greater accuracy."<sup>75</sup>

Finally, the 29th noted that assigning specific units to certain units sectors (which early air power advocates had railed against as dispersing the combined effect) had distinct advantages. The 29th's report found "The same pilots should be used repeatedly over the same area since they quickly become familiar with terrain features, location of our troops and enemy installations. It was noted that those flights operating with the Division most frequently were the most effective."<sup>76</sup> From the 29th's "Recapitulation" of air support received during the siege, squadrons of the 358th Fighter Group, based at Pontorson, were most frequently engaged in the division's sector, and the division's report singled out the group's 366th and 367th Fighter Squadrons as the most effective. The 362nd Group also supported the division extensively, with the 377th and 379th Fighter Squadrons also receiving special mention.<sup>77</sup> Unlike the 2nd Division, the 29th reported that "During the entire operation against the City of Brest no casualties in our ground personnel were caused by our friendly planes."<sup>78</sup>

## **Airpower and Combined Arms**

While most accounts of the integration of aviation into the ground battle focus on how aircraft cleared the way for armor or helped the infantry advance, AAF aircraft, and artillery effectively worked together in a number of ways that enhanced the effectiveness of each branch. As the perimeter around Brest contracted, the defenders were able to pull more of their anti-aircraft artillery into ever-denser concentrations, increasing the effectiveness of that weapon, and AAF losses began to rise as a result. In one particular case, Capt. Edward Whitman of the 354th Fighter Group took a fatal hit to his P-51 Mustang's cooling system (one of the things that made the P-47 a superior ground attack aircraft was its air-cooled radial engine) forcing him to bail out. Whitman landed in the 29th Division's sector, near a battery of the 110th Field Artillery Battalion. Ironically, Whitman began his career as a private in that same unit when it was part of the Maryland National Guard, and his father was currently serving in the unit.<sup>79</sup> On 19 September, XXIX TAC's 363rd Tactical Reconnaissance Group suffered its first loss of the war when German gunners shot down 2nd Lt. James Silva's photo-reconnaissance F-6 (P-51) while it took photos of the next possible target, St. Nazaire.<sup>80</sup> Suppression of anti-aircraft defenses became increasingly important, and artillery units helped to fill the gap. As Joseph Balkoski describes it:

The moment American warplanes appeared overhead, alert artillery observers grabbed their binoculars and scanned the German lines, striving to detect nearby sources of anti-aircraft artillery fire. If a German flak gun could indeed be observed, the artillerymen promptly called down upon it a furious barrage of howitzer shells, usually with uncanny accuracy. Such an impressive performance typically caused

the enemy to think twice before opening fire with abandon on American aircraft, a development deeply appreciated by the pilots.<sup>81</sup>

Thus, both airmen and artillerymen engaged in suppressive fires that kept German gunners away from their weapons, allowing other members of the combined-arms team to operate successfully.

The VIII Corps artillery benefitted materially from the efforts of aerial reconnaissance throughout the battle. Initially, support came from the 10th Reconnaissance Group at Rennes, but, by the end of the siege, the 363rd Tactical Reconnaissance Group had completed its transition from a fighter to a recce outfit and was performing the mission with a new cadre of reconnaissance pilots trained at Key Field and tested in stateside maneuvers. These pilots took advantage of the long summer daylight hours to fly four missions daily, at 1100, 1300, 1500, and 1800, concentrating on counter-battery fire. According to the VIII Corps Artillery AAR, “observation would have been impossible by other means.”<sup>82</sup> The light, liaison-type aircraft intended to support individual artillery battalions struggled to perform this mission, due to intense anti-aircraft artillery at lower altitudes and a thick haze that obscured the battle area. As a result, the tactical reconnaissance missions “filled a definite need in all stages of the observation.”<sup>83</sup> Rather than pre-briefing pilots on planned missions, tac recce pilots arriving overhead conducted real-time coordination on the most pressing targets, in a further example of successful decentralization.<sup>84</sup> The report appreciated the effort expended, including the loss of a single aircraft in late August, recording, “The pilots who operated for the VIII Corps Arty in the BREST area have been uniformly well trained and were good shots...It is believed that the results obtained justified the flying of the missions.”<sup>85</sup> That the 363rd, a new group built up of pilots largely directly from the training establishment, could perform so well in its first real test, provides proof of the efficiency of the stateside training establishment and exercises conducted there.

While aerial correction proved satisfactory, distribution of aerial photographs, both for planning fire missions and for the assaulting ground forces, lagged initially, largely due to the distances between Brest and Rennes and the difficulty in delivering developed prints back to the front. But more and better photographs gradually became available as the siege progressed, although the final VIII Corps Artillery report claimed, “air photographs were not furnished in sufficient quantities and as often as was necessary.”<sup>86</sup> In some cases, the light aircraft indigenous to field artillery battalions also helped direct airstrikes, in a modification of the “Horsefly” technique developed in Italy. Again, close coordination between the branches magnified the capabilities of each.<sup>87</sup>

## **Redeployment to the East**

As operations wrapped up in Brest, Allied Headquarters began to question the wisdom of reducing the remaining strongpoints on the Atlantic coast. It had taken a full division a week to root 12,000 defenders out of St. Malo, and a full corps a month to dig another 30,000 out of Brest. Whatever its faults, the Allied high command could at least recognize diminishing returns when they saw it. Middleton recommended that newly-arriving divisions maintain the blockade of Lorient and St. Nazaire as part of their training, and allow the defenders to maintain their own prisoner-of-war camp, without any requirement for Allied logistical support. Higher authorities accepted Middleton’s recommendation, preferring to devote resources to the liberation of Antwerp, much closer to the front lines, instead of Lorient, now over 500 miles from the fighting, with a largely destroyed rail network connecting it to the German frontier.

To add impetus to that push, Ninth Army and XXIX TAC quickly untangled themselves from operations in Brittany, turning security over to the Communications Zone of the Interior, and scraping together sufficient transportation to reach the front. Initial plans called for Ninth Army to fill the gap between First Army, then engaged at Aachen, and Third Army, then focused on Metz, and keep those two formations linked as they drove on Cologne and Frankfurt, respectively. In between was the Ardennes, a quieter sector that the German had successfully used in their drive to Channel in 1940. But, as Simpson and Nugent's units closed up on their new sector, higher commanders intervened, denying them the fate of facing the German onslaught in the Battle of the Bulge. Omar Bradley feared that, with four American armies now on the continent (from north to south, the First, Ninth, and Third in 12th Army Group, and the Seventh, coming up from southern France in 6th Army Group), his army group might have to give up one army to British Gen. Sir Bernard Montgomery's 21st Army Group, comprised of only the Canadian First and British Second armies and running short of replacements after the failed Operation Market Garden. Such a transfer would allow each army group to control three numbered armies.

If that happened, Bradley did not want to lose his former command, the large and experienced First Army. For this reason, on 9 October, he made the decision to shift Ninth Army around to First Army's left flank.<sup>88</sup> This would ostensibly provide First Army flank protection as it drove into the Hurtgen Forest, but it also meant that if any American formation fell under British control, it would be the much smaller and less-experienced Ninth Army.<sup>89</sup> Bradley was nothing if not prescient—after the Bulge penetration cut communication between 12th Army Group to the south and Ninth Army to the north, Simpson's command did indeed fall under operational control of Montgomery's 21st Army Group from mid-December until the first week of April, lessening its visibility somewhat in American eyes. While the reassignment did not materially impact the organization's effectiveness, as both Simpson and Nugent worked well with their British and Canadian counterparts, it did snarl logistics and lines of communications, which Ninth Army and XXIX TAC spent most of October trying to sort out.

Fortunately, both commands took advantage of a simple swap of units in order to achieve the desired reorganization. Simpson exchanged the III and VIII Corps for the XIII and XIX, the latter an experienced command, but the former a new headquarters composed of previously uncommitted divisions.<sup>90</sup> Nugent's shuffling was more complicated, as XXIX TAC traded the four fighter groups it controlled on 20 September for four new ones just arriving on new bases in Belgium.<sup>91</sup> It also took advantage of the lull after the surrender of Brest to conduct a brief training period. As the organization's official history reports, "The XXIX TAC was born and baptized under fire, packed its practice training into a hectic four-day capsule period in Northern France, and took its place in combat beside the other TACs—a babe, and yet an expert, in arms."<sup>92</sup> Four days of simulations and war games followed, to train new units and weld the team together. The exercises reinforced the doctrinal priorities of air superiority, interdiction, and close air support.

Nugent had not arrived at his new command post at St. Quentin until 22 September but immediately arranged for a meeting with Simpson at Rennes on the 25th. The men emphasized the importance of marker panels and discussed the redeployment plans to the east.<sup>93</sup> Nugent had more trouble with his own branch, and he struggled constantly to build his "bastard" organization out of IX TAC. He found Quesada unhelpful in securing the release of the 6th Tactical Air Communications Squadron's equipment, without which the command

		1944			1945			
Group	Equipment	OCT	NOV	DEC	JAN	FEB	MAR	APR
36 FG	P-47					det. 29 Jan		
48 FG	P-47					det. 16 Jan		
366 FG	P-47				att. 29 Jan			
370 FG	P-38, P-51				att. 29 Jan		Con- verted P-38s to P-51s	
373 FG	P-47				det. 29 Jan	att. 8 Feb		
404 FG	P-47					det. 16 Jan		
405 FG	P-47				att. 8 Feb			
406 FG	P-47				att. 8 Feb			
363 TRG	F-5, F-6							

Figure 4.7. Squadrons Assigned to XXIX TAC. Red-shaded blocks represent time that the unit was attached to the command.

could not function. It took a conference of the TAC commanders, which now included Brig. Gen. Gordon Saville's XII TAC coming up from Italy, on 27 September to sort many of these issues out.<sup>94</sup>

On 2 October, Nugent met with Middleton at VIII Corps and Maj. Gen. Stroh at the 8th Infantry Division, both of whom requested photographic reconnaissance of their front but understood that the command would be unable to provide much support during its move, unless the front line units were attacked. The following week, Nugent briefed Simpson on their status and recorded, "General Simpson expressed himself as well pleased with the plan and our organization."<sup>95</sup> The following week, the men met again when Nugent learned of the redeployment north and that, effective 20 October, Ninth Army would trade VIII Corps for XIX Corps, and that Nugent would assume control of the 48th and 404th Fighter Groups at St. Trond, Belgium, to cover that sector.<sup>96</sup> Thus the hard work XXIX TAC had done during the first half of the month in building relationships with its assigned fighter groups and the divisions they would support was somewhat undone, but at least the critical relationships between the groups and the divisions themselves were preserved. Indeed, on 12 October, Nugent reported that henceforth, air support officers should remain with the divisions and corps to which they were assigned instead of moving when assigned to new

numbered armies. The same would hold true for ground liaison officers with the groups. The decentralized command and control network allowed for these vital relationship to be built and maintained.<sup>97</sup>

XXIX TAC spent the next two weeks getting to know its new commands and its new mission. On 20 October Nugent learned of Ninth Army's flank protection mission and the projected drive to the Rhine River. The following day, he called on Maj. Gen. Raymond McLain at XIX Corps, who would lead this drive, and the following day opened his Fighter Control Center near Maastricht. Though the groups were still 130 miles away, near Rheims, stable communications enabled effective control. On 24 October, Nugent met with Gerhardt at the 29th Division, Maj. Gen. Leland Hobbs at 30th Division, and Ernie Harmon at 2nd Armored and got acquainted with the ASPOs for each division. "All commanders expressed themselves as delighted with the quality of our air support rendered to date by XXIX TAC and had no suggestions to make for improvement. General Hobbs stated that he specifically did *not* want any heavy or medium efforts on his front," a legacy of Operation Cobra, when 30th had suffered high casualties from the heavy bombers' shorts. Reflecting the experiences of Brest, Nugent observed, "All are very keen on the maximum use of air alert. Air alert has been essential in the past due to the lack of artillery ammunition and may be required in the future for the same reason."<sup>98</sup> A final meeting on 27 October with his assigned ASPOs, G-3 (Air), and GLOs firmed up the organizations principles and plans, and another on the 29th revealed the first intimations of what would become Operation Queen, and that heavy bombers would be involved in push-off.

Despite the multiple unit transfers and changes of station during October, the command still managed to fly over 2,000 sorties for the month, many of them air superiority against the newly-resurgent *Luftwaffe*, in which it traded thirteen of its own aircraft for twenty-nine of the enemy, but also dropped over 600 tons of bombs, primarily on airfields and transportation targets in Germany.<sup>99</sup> During this time, the 363rd TRG lost one of its three squadrons of F-6s, the 162nd, to XII TAC, supporting Seventh Army, meaning it flew the whole month at two-thirds strength, before finally receiving a replacement, the 33rd Photographic Reconnaissance Squadron, equipped with F-5s (photo-reconnaissance P-38s) in November. The group moved to its new base in Luxembourg by C-47 on 1 October, where the 25 officers and 91 enlisted men managed to perform 68 missions during the rest of the month, mapping the Ninth Army's new frontage and conducting detailed reconnaissance of German road, rail, and barge traffic behind the lines.<sup>100</sup> On 29 October, the group attempted to conduct spotting for registration fires for the Ninth Army artillery, but the group history reported, "None of the three Artillery adjustment were successful. Either we could not contact the ground battery or else when we did we ran out of gas."<sup>101</sup> But this was the beginning of a long and successful association between the group and the ground forces, as the unit's history reported, "members of the Ninth Army agreed that the group supplied some of the best reconnaissance of any group in the ETO."<sup>102</sup>

## Conclusion

In light of later criticism levied against the Army Air Forces for the lack of air support, and in stark contrast to that received on Omaha Beach during D-Day, higher-level commanders were more than satisfied by the effort at Brest. Middleton's staff later reported, "there was very little additional assistance that the Air Force might have given."<sup>103</sup> Ninth Army agreed, noting, "The results achieved by the air elements in the Brest campaign were all that could have been

expected of them.”<sup>104</sup> The 2nd Infantry Division caustically added, “The attack on Fortress Brest was the only occasion in which sufficient fighter bombers were provided.”<sup>105</sup> One account of the battle argued, “The level of air-ground cooperation at Brest represented a pioneering moment in the history of the American Army,” contrasting the poor support the 29th Division had received on D-Day with that available to it just three months later.<sup>106</sup> A 12th Army Group report later surmised, “Fighter-bombers probably never before had worked so closely with attacking ground forces.”<sup>107</sup> While much of the rehabilitation took place within the beachhead, it was aided immeasurably by the commitment of new ground and air units that benefitted from extensive pre-deployment training.

The air campaign for Brest approximated the conditions in many of the pre-war maneuvers stateside. While exercise planners had dispensed with the counter-air missions out of expediency, to maximize air-ground training, in Brittany they were unnecessary. Pushing German airfields east of the Seine largely removed the threat of German aircraft from the battle—indeed, they launched only two minor attacks that caused little damage. The AAF’s doctrinal preference in stateside maneuvers, isolating the battlefield, or interdiction, was also redundant. Allied control of the Atlantic Ocean prevented naval resupply and the 4th Armored Division’s capture of Nantes and blockade along the Loire prevented communication with German forces elsewhere in France. All that was left was the AAF’s third priority—close air support. Fortunately, the units assigned to Ninth Air Force were prepared for and capable of executing this type of mission. While no amount of bombardment could have forced the defenders of Brest to surrender by itself, the combined action of air and ground forces gradually reduced the perimeter and forced the expenditure of finite resources, compelling the German surrender.<sup>108</sup>



## Notes

1. Martin Blumenson, *Breakout and Pursuit* (Washington, DC: Office of the Chief of Military History, 1961), 349.
2. Elwood Quesada Oral History Interview, "Twelve Thousand Fighter-Bomber Sorties: XIX Tactical Air Command's First Month of Operations in Support of Third US Army in France," K239.0512-1813, Reel 3, Air Force Historical Research Agency, Maxwell AFB, AL.
3. Rudolf Kogard, "Brest, 343rd Infantry Division, (May-18 Sep 44)," 26, MS # B-427, Historical Branch, Headquarters, US Army Europe, Combined Army Research Library, Fort Leavenworth, KS.
4. "XIX TAC First Month," 1 August.
5. "XIX TAC First Month," 2 August.
6. Craven and Cate, *The Army Air Forces in World War II*, Vol. IV, 245.
7. "XIX TAC First Month," 4 August.
8. "XIX TAC First Month," 4 August.
9. Parker, *Conquer*, 19.
10. Parker, 18.
11. Blumenson, *Breakout and Pursuit*, 634.
12. Craven and Cate, *The Army Air Forces in World War II*, Vol. IV, 262.
13. Parker, *Conquer*, 20.
14. Parker, 50.
15. Simpson to Macon, 16 September 1944, Folder 5, Box 3, Simpson Papers, AHEC.
16. "XXIX TAC Periodic History, October 1944- April 1945," AFHRA 538.02, Air Force Historical Research Agency, Maxwell AFB, AL.
17. Parker, *Conquer*, 30.
18. Charles McDonald, *The Last Offensive* (Washington, DC: Center for Military History, 1973), 380.
19. *Mission Accomplished: The Story of XXIX TAC* (Paris: Stars & Stripes, 1945).
20. *Mission Accomplished*.
21. Spires, *Airpower for Patton's Army*, 114, 331.
22. Spires, 331.
23. "World Battlefronts," *Time*, 19 February 45; Thomas R. Stone, "General William H. Simpson: Unsung Command of US Ninth Army," *Parameters*, 9 (1981): 44-52; Thomas R. Stone, "He Had the Guts to Say No: A Military Biography of General William Hood Simpson," Thesis, Rice University, Houston, TX, 1974.
24. Memo, HQ, AAFSAT Registrar, 22 Sep 43, Folder 4, Box 3, Simpson Papers, AHEC; "AAF-SAT ANSCOL Course, Class 1943C," v. 5, AFHRA 248.411, Maxwell AFB, AL.
25. William H. Simpson Papers, Folder 27, Box 2, Army Heritage and Education Center, Carlisle, PA.
26. Simpson to *The Infantry Journal*, 20 November, 1942, Folder 2, Box 3, Simpson Papers, AHEC.
27. Ruth Simpson in Simpson Biography, Folder 14, Box 15, Simpson Papers, AHEC.
28. Dwight D. Eisenhower, *Crusade in Europe* (New York: Doubleday, 1948), 376. Biography compiled from Stone, "General William H. Simpson, 44-52; Stone, "He Had the Guts to Say No;" Maclyn Burg, "Oral History Interview with General William H. Simpson, 15 March 1972," Eisenhower Presidential Library, Abilene, KS.
29. "Age-in-Grade Study," Headquarters, US Army, September 1942, Combined Army Research Library, Fort Leavenworth, KS.
30. "Brigadier General Richard E. Nugent, Deputy Chief of Staff, Operations, Ninth Air Force," AFHRA 533.101-4.
31. Simpson Diary, 15 Feb 1945, Simpson War Diary, Box 7, Simpson Papers, AHEC.
32. Simpson to Hodges, 10 Dec 1944, Folder 2, Box 7, Simpson Papers, AHEC.
33. Simpson Oral History, 453, Folder 7, Box 16, Simpson Papers, AHEC.

34. Frank Price, *Troy H. Middleton: A Biography* (Baton Rouge, LA: Louisiana State University Press, 1974), 189.
35. "Report on the Artillery with the VIII Corps in the Reduction of Brest, 22 August – 19 September, 1944," N-10350, Combined Arms Research Library, Fort Leavenworth, KS, 51-52.
36. For a detailed account of the 29th ID at Brest, see Joseph Balkoski, *From the Beachhead to Brittany: The 29th Infantry Division at Brest, August-September 1944* (Mechanicsburg, PA: Stackpole Books, 2008), the third volume in his excellent series on the history of the 29th Division in World War II.
37. Rudolf Kogard, "Brest, 343rd Infantry Division, (May-18 Sep 44)," MS # B-427, Historical Branch, Headquarters, US Army Europe, Combined Army Research Library, Fort Leavenworth, KS.
38. Blumenson, *Breakout and Pursuit*, 643.
39. "Answers to Questionnaire for Key Commanders on 'The Effects of Strategic and Tactical Air Power on Military Operations, ETO,'" N-12236, Combined Army Research Library, Fort Leavenworth, KS, 36.
40. Blumenson, *Breakout and Pursuit*, 643
41. Blumenson, 636.
42. Blumenson, 642.
43. Blumenson, 644.
44. "Answers to Questionnaire," 8.
45. "Answers to Questionnaire," 36.
46. Craven and Cate, *The Army Air Forces in World War II*, Vol. IV, 264.
47. Craven and Cate, 264.
48. Parker, *Conquer*, 31
49. Parker, 31.
50. Blumenson, *Breakout and Pursuit*, 645.
51. Kogard, "Brest, 343rd Infantry Division."
52. Spires, *Airpower for Patton's Army*, 112.
53. Spires, 112.
54. Smelley changed his name to Shelley after the war according to "363rd Tactical Reconnaissance Group History," GP-RCN-363-HI, AFHRA, Maxwell AFB, AL.
55. "363rd Tactical Reconnaissance Group Post-Mission Reports," GP-RCN-363-SU-RE-D, AFHRA, Maxwell AFB, AL.
56. Blumenson, *Breakout and Pursuit*, 648.
57. "Air Support in Operations Against Brest," Box 860, 29th Infantry Division Collection, US Army Records, European and Pacific Theaters, Dwight D. Eisenhower Presidential Library, Abilene, KS, 2.
58. Blumenson, *Breakout and Pursuit*, 650.
59. Blumenson, 652.
60. Price, *Troy H. Middleton*, 199.
61. 8ID AAR, Record Group 338, Records of the European Theater of Operations, Records Relating to Military Operations, 1944-1945, NARA2.
62. 8ID AAR.
63. Headquarters, 12th Army Group, *Immediate Report No. 65*, "Close Air Support of Ground Forces Around Brest," N-3768, Combined Arms Research Library, Fort Leavenworth, KS.
64. According to "Air Support in Operations Against Brest," each squad carried two 18" by 18" panels, while each company carried two large (30" by 12") panels. The British had first experimented with cloth panels to mark friendly positions in the Great War. Richard Muller, "Close Air Support: The German, British, and American experiences, 1918-1941," in Williamson Murray and Allan Millett, eds. *Military Innovation in the Interwar Period* (Cambridge, UK: Cambridge University Press, 1996), 149.

65. Joseph Balkoski, *From the Beachhead to Brittany: The 29th Infantry Division at Brest, August-September 1944* (Mechanicsburg, PA: Stackpole, 2008), 135.
66. *Immediate Report No. 65.*
67. William S. McArtor, "Operations of Company B, 38th Infantry (2nd Infantry Division) During the Battle for Brest, France, 8 September–10 September, 1944," 15-16, Donovan Research Library, Fort Benning, GA. <https://www.benning.army.mil/library/content/Virtual/Donovanpapers/wwii/STUP2/McArtorWilliamS%20CPT.pdf>, accessed on 11 December, 2017.
68. McArtor, 25, 27.
69. *Immediate Report No. 65.*
70. "Air Support in Operations Against Brest," 1.
71. "Air Support in Operations Against Brest," 4.
72. "Air Support in Operations Against Brest," 4.
73. "Air Support in Operations Against Brest," 5.
74. "Air Support in Operations Against Brest," 5.
75. "Air Support in Operations Against Brest," 6.
76. "Air Support in Operations Against Brest," 6.
77. "Air Support in Operations Against Brest," Annex 3..
78. "Air Support in Operations Against Brest," 6.
79. Balkoski, *From Beachhead to Brittany*, 136.
80. "363rd Tactical Reconnaissance Group History."
81. Balkoski, *From Beachhead to Brittany*, 135-136.
82. "Report on the Artillery with the VIII Corps in the Reduction of Brest, 22 August – 19 September, 1944," N-10350, Combined Arms Research Library, Fort Leavenworth, KS, 33.
83. "Report on the Artillery with the VIII Corps in the Reduction of Brest," 33.
84. "Report on the Artillery with the VIII Corps in the Reduction of Brest," 34.
85. "Report on the Artillery with the VIII Corps in the Reduction of Brest," 34.
86. "Report on the Artillery with the VIII Corps in the Reduction of Brest," 54.
87. "Report on the Artillery with the VIII Corps in the Reduction of Brest," 38.
88. Charles McDonald, *The Siegfried Line Campaign* (Washington, DC: Center for Military History, 1963), 378.
89. Omar Bradley, *A Soldier's Story* (New York: Henry Holt, 1951), 435-437.
90. McDonald, *The Siegfried Line Campaign*, 379.
91. On 20 September, XXIX TAC received the 48th FG at A-74 (Cambrai); the 367th FG at A-71 (Clastres), the 370th FG at A-73 (Royel Amy), and the 474th FG at A-72 (Peronne). On 1 October, it swapped these units for the 36th FG at A-68 (Juvincourt); the 366th FG at A-70 (Laon, Couvren); the 373rd FG at A-62 (Reims-Champagne), and the 363rd TRG at Sandweiler in Luxembourg. On 17 October it lost the 366th FG but reassumed control of the 48th and 404th FGs at A-92, (St. Trond Belgium), while retaining the 36th FG at A-68 (Juvincourt); the 373rd FG at A-62 (Reims), and the 363rd TRG at Sandweiler. These four FGs (36, 48, 373, and 404) and the 363rd TRG remained with the command until the Bulge battle, with the 36th and 373rd FGs and 363rd TRG moving to A-89 (Le Culot, Belgium) and Y-10 (Louvain) Meldert, simplifying the commands logistics by placing it on only two airfield complexes (St. Trond and Le Culot), which were just behind the Army's front. But the organizational swaps and relocations created some chaos within the command. XXIX TAC History, AFHRA 538.02, Maxwell AFB, AL.
92. *Mission Accomplished: The Story of XXIX TAC.*
93. Excerpts from Brig. Gen. Richard E. Nugent's War Diary, 22, 25 September 1944, AFHRA 533.13-2, Maxwell AFB, AL.
94. Nugent's War Diary, 27 September 1944.
95. Nugent's War Diary, 8 October 1944.

96. Nugent's War Diary, 16 October 1944.
97. Nugent's War Diary, 12 October 1944.
98. Nugent's War Diary, 27 October 1944.
99. "XXIX TAC Periodic History, October 1944-April 1945."
100. "363rd Tactical Reconnaissance Group History."
101. "363rd Tactical Reconnaissance Group History."
102. "363rd Tactical Reconnaissance Group History."
103. "Answers to Questionnaire," 53.
104. "Answers to Questionnaire," 83.
105. "Answers to Questionnaire," 113.
106. Balkoski, *From Brittany to Beachhead*, 137.
107. *Immediate Report No. 65*, 130, quoted in Balkoski, *From Brittany to Beachhead*, 137.
108. Craven and Cate, *The Army Air Forces in World War II*, Vol. III, 263.

## Chapter 5

### Queen and the Ardennes, November-December 1944

Ninth Army and XXIX TAC's move to extreme southern Holland came with just enough time to prepare for and execute the next phase of the Allied advance, the exploitation of the gap First Army had carved in the Siegfried Line around Aachen. With the bulk of the assigned units, First Army continued the drive through the Hurtgen Forest, hoping to debouch onto the open plains beyond and close up to the Rhine before winter weather could stall the campaign. Ninth Army's task was to cover the left flank of this drive, supporting the advance on the right and keeping the continuous front tied in with the British 21st Army Group on the left. Initially, Simpson had only one corps, the XIX, available for this task, but the experienced 29th and 30th Infantry and 2nd Armored Divisions gave him a powerful striking force for the drive to the Roer River. To fill any gap opened on his left, units of the XIII Corps, operational on 8 November and including the green 84th and 102nd Infantry and 7th Armored Divisions, stood prepared to receive their baptism of fire. Supporting them, Nugent had four complete fighter groups (the 36th, 48th, 373rd, and 404th), all of whom had arrived in theater just prior to the Normandy landings, and a full tactical reconnaissance group, the 363rd, with the addition of a specialized photographic squadron alongside the two tactical reconnaissance squadrons.<sup>1</sup> From its humble beginnings in Brittany, the Ninth Army-XXIX TAC team was becoming a highly capable and effective organization that, Simpson hoped, could push through to the Rhine and threaten the vital Ruhr industrial region in a matter of weeks.<sup>2</sup>

But events conspired against this rapid exploitation. Despite a massive aerial preparation that dwarfed even Operation Cobra only four months earlier, the rapid breakout never came and the campaign turned into a month-long slog through muddy plains dotted with fortified villages, all shielded from supporting aircraft by persistent mist, fog, and low-hanging clouds that spit first rain and then sleet and finally snow on the advancing columns. German units formed by new levies from the population, labeled *Volksgrenadier* divisions and buttressed by the few armored units not designated for the counteroffensive through the Ardennes, conspired to give ground slowly enough and inflict sufficient casualties to prevent any threat to the secret counterattack. The German supply situation had improved dramatically with a shortening of the lines between factories and forces, and the defenders were now well-stocked in artillery and ammunition. "For once the Germans were capable of laying down really massive fires," while Allied artillery ammunition remained strictly rationed.<sup>3</sup> They had burrowed deep into the stout stone-and-timber buildings of the farming villages dotting the plain, and then expertly camouflaged their positions, making them difficult for aircraft to neutralize. As a result, Ninth Army suffered growing casualties, especially trench foot and exposure caused by insufficient supplies of winter equipment, and combat fatigue from the repeated thrusts forward into ever-present minefields and machine-gun fire.

Though Ninth Army overcame these obstacles and achieved their objectives within the first two weeks, they could not advance across the Roer River until First Army had secured massive dams on the river's upper reaches. With these still in German hands, any attack could be cut off by a flood of water released from the dams, isolating the assault force on the far side of a widening inland sea. While Ninth Army waited, and First Army ground down division after di-

vision in the brutal combat of the Hurtgen, German panzers massed behind the quiet Ardennes sector, hoping to duplicate their success in breaching Allied lines in 1940. The assault, dubbed Operation *Wacht Am Rhein* (Watch on the Rhine) thoroughly disrupted the Allied timetable for the next two months. With a rapid redeployment from Third Army and the shifting of First and Ninth Army air and ground units south to first contain and then eliminate the penetration, Allied forces destroyed many of the German reserves in the West, easing the eventual task of reaching the Rhine. But the slow progress in November, and the anxious watching and waiting in December while the team shrank to impotence proved the most trying period in the Ninth Army-XXIX TAC team's existence.

### **Air and Ground Planning for Queen**

Shortly after opening for business in Maastricht, Ninth Army and XXIX TAC received directions to begin preparing for a joint offensive alongside First Army and its supporting air command IX TAC. As Gen. Omar Bradley wanted to again leverage the Allied strategic bomber force to help open a path through the German defenses, planners from all four staffs met to coordinate an integrated plan that would maximize the use and effectiveness of all available assets. Courtney Hodges, then commanding First Army and its deputy during the Cobra breakout, remained convinced of the efficacy of carpet bombing along the front lines to stun the defenders and open a breach in the lines. But Ninth Army's 30th Infantry Division experienced the worst of the "short" bombs in Cobra, with hundreds of casualties among the lead formations, and its commander doubted the heavy bomber's ability to deliver ordnance accurately with even worse weather in November. The commander of the 30th Division, Maj. Gen. Leland Hobbs, worked to push the heavy bombers as far back from the front lines as possible, preferring to see them used against towns and roads well behind the lines to prevent reinforcements and resupply from reaching the troops at the front. Hobbs' ideas meshed neatly with those of the airmen in XXIX TAC, who saw them as both doctrinally sound and a confirmation of what they had spent the previous month doing: attacking road and rail networks beyond the Roer and the Rhine.<sup>4</sup> Instead of the massive bombardment, tactical aircraft could provide more surgical strikes, as they had in Ninth Army's reduction of Brest, delivering fires when and where needed, rather than the "all and then nothing" approach of the heavy bombers. As a later report found, "It was decided to find which type of bombing in the final analysis most assisted the ground force effort."<sup>5</sup> On 2 November, Ninth Army held a planning conference with Simpson and Nugent and their staffs, but Nugent lacked key details on the ground scheme of maneuver he needed to complete his air plan. The next day, air and ground commanders of both armies and tactical air commands, including Simpson and Hodges, the army commanders, Quesada and Nugent, the TAC commanders, and Joe Collins and Raymond McLain, the VII and XIX Corps commanders, respectively, met at the First Army headquarters to firm up the planning effort.<sup>6</sup>

To resolve remaining issues, the principal air commanders met again on 7 November at the 9th Air Force headquarters.<sup>7</sup> Attendees included Maj. Gen. Hoyt Vandenberg, commanding 9th Air Force, Quesada, Nugent, Anderson, of IX Bomber Command, Thurman Thorsen, the First Army G-3, Brig. Gen. Charles Hart, the First Army's artillery commander, Col. Dyke Meyer, the Ninth Army A-3 and Nugent's Chief of Staff, and Col. William Fagg, the Ninth Army's G-3-Air. The assembled cast covered the many factors influencing their planning, including, "weather, the weight of effort to be used, air-ground coordination, safety precautions, and the

marking of friendly front lines and communications.”<sup>8</sup> Allocation of an incredible number of assets emerged as the pivotal issue. In addition to 9th Air Force’s fighter and medium bomber groups, commanders wanted the full weight of the AAF and RAF’s heavy bombers thrown into the fray, providing a total of “more than 4,500 planes, approximately half of them heavy bombers,” in what was “World War II’s largest air attack in direct support of ground troops.”<sup>9</sup> The air plan was actually three separate plans, based on weather and availability. Plan A envisioned heavies, mediums, and fighters, but required good weather both at the bomber bases in the UK and over the target. Plan B excluded the heavies, limiting the weather requirements to the fighter and medium bomber bases on the continent. Plan C assumed the weather would be below the minimums for the medium bombers, and therefore employed only fighter-bomber support. To maximize the possibility of executing the preferred option, Plan A, Bradley authorized a full week of execution dates, from 10-16 November, with Queen set to launch on the first day when weather forecasts suggested that Plan A could be executed. If the entire week was a washout, the Army Group would launch the offensive on 16 November with whatever assets could fly, even if none of them could. As the weather deteriorated throughout the week, the fallback plan became increasingly likely, but on 15 November, forecasters predicted that Plan A could go ahead as scheduled the next day. The weather was far from ideal, but did allow all three groups of aircraft to participate.<sup>10</sup>

Having established the timing, planners then worked to resolve the different preferences of the two numbered armies in the attack. As a compromise, First Army received the desired carpet bombing in its sector, with 8th Air Force’s heavies targeting designated areas just across the lines around Eschweiler, while the RAF Bomber Command attacked the cities of Julich and Duren, astride the road network leading to the forces opposite Ninth Army’s front. Eleven groups of the more accurate medium bombers attempted to fill the gap between the deeper heavy bomber targets on Ninth Army’s front with raids on Linnich and Aldenhoven, but the latter town was spared at the last minute after 2nd Armored expressed concerns about cratering in the town that might slow their vehicles and limit their ability to maneuver. Fighter bombers of both IX and XXIX TAC assumed the burden of flying close-in fire support for their respective armies. Ninth Army commanders placed a higher reliance on the fighter-bombers, realizing they were both more responsive to emerging needs and more accurate, minimizing the threat of inaccurate bomb runs and “short rounds.” To support the attack, both armies used their artillery in a “counterflak” barrage on “64 heavy and medium enemy flak batteries with artillery fire in VII and XIX corps zones for ten minutes prior to strike,” to suppress ground-to-air fires and reduce casualties among the heavy and medium bombers and the fighters that would follow them.<sup>11</sup> Artillery liaison aircraft remained airborne to adjust this fire. Overall, the plan was “designed to execute the mission of neutralizing prepared positions, destroying enemy personnel, and disrupting communications and supply.”<sup>12</sup>

Ninth Army’s operations order for Operation Queen was ambitious, to say the least. While acknowledging that it was the supporting effort, it stated the object as “to attack in zone to the RHINE in close conjunction with the First Army, protecting its left flank. After the First Army has reached the RHINE, Ninth Army to attack northward between the RHINE and MEUSE Rivers in conjunction with the Second British Army.”<sup>13</sup> Once Simpson’s command had completed this task, it would be in position to cross the Rhine and envelop the Ruhr from the north, as was actually done in March and April of 1945. But the intermediate task was simply closing up on the

Roer River. To reach this objective, the Army planned to exploit the gap carved in the German defensive barrier known as the “Westwall” or Siegfried Line, by First Army in October. Although the Germans had constructed belts of defensive positions behind the gap, these were not as strong as the still-intact concrete bunkers and pillboxes still facing the British Second Army to the north and the First Army in the Hurtgen Forest to the south. The eight mile-wide gap stretched from Geilenkirchen on the north to Wurselen in the south, and the Ninth Army’s frontage included another mile and a half of Westwall defense in each of those two cities. Plans called for thrusts on each wing to take the cities from behind while pushing directly east from the center.

Thus, the army had the unenviable task of attacking on a diverging front, which would disperse combat power as it advanced. Even worse, it had placed the three elements of its main effort, 2nd Armored, and 29th and 30th ID on line from north to south, abreast of each other, so there was no reserve or exploitation force. An ideal attack would have led off with the two infantry divisions and held the armored division in reserve for reinforcement or exploitation. But 2nd Armored had its own sector of the front, and the task of driving towards Linnich, astride the Roer, along with the attached 406th Infantry Regiment of the 102nd Division. Once it had taken the high ground around Gereonsweiler, the rest of the 102nd could take over the 2nd Armored’s sector, pass through the armor and press into Linnich, making 2nd Armored available elsewhere. To the south, Charlie Gerhardt’s 29th Infantry Division made the main effort, striking through Aldenhoven for the city of Julich, just across the Roer and only six miles from the jump-off point. Once there, the 2nd Armored would pass through the 29th for exploitation to the Rhine. To assist them, Leland Hobb’s 30th Infantry Division attacked southeast, taking Mariadorf and Hongen, and then cooperated with the 104th Infantry Division to “pinch out and mop its area to the army boundary, and prepare for future operations,” protecting 29 ID’s right flank.<sup>14</sup> Simpson did have XIII Corps in reserve, as Maj. Gen. Alvan C. Gillem’s command became operational on 8 November, but he fed these units into the fight piecemeal, using the 84th Division in a joint operation with the British 43rd (Wessex) Division to pinch out Geilenkirchen, taking the city from behind, and attaching Regimental Combat Teams (brigades) of the 84th and 102nd Infantry Divisions to each of the three attacking divisions to get the new units some experience. The 7th Armored remained behind the army front in reserve, recuperating from an October battle in the British sector in the Peel Marshes, but available as an emergency reserve or exploitation force. Thus, the army’s task, while simple on paper, involving a short advance across relatively open terrain with secure flanks and an adequate force, was actually quite a bit more difficult than it appeared, due to an inexperienced corps, poor weather that limited off-road mobility and air support, and a dispersing effort.<sup>15</sup>

The German Fifth Panzer Army units opposing Ninth Army had their own problems, but enjoyed the advantage of defending prepared positions. To the north, the 183rd *Volksgrenadier* Division was well dug-in at Geilenkirchen and the smaller towns behind it stretching northeast down the Wurm River Valley, and initially faced 2nd Armored as well. The 246th *Volksgrenadier* Division held the frontage opposite 29th and 30th ID, but the latter division’s attack to the southeast brought it into contact with the 3rd *Panzer* *grenadier* Division, holding Wurselen, and the Old Hickory Division’s efforts became concentrated there, leaving the Blue and Gray Division to face the *volksgrenadiers* unsupported to the north. The German LXXXI Corps, which controlled the southern half of the Ninth Army objective area, had two fresh infantry divisions in reserve, the 340th and 363rd *Volksgrenadier*, while the XLVII Corps in the north could call on the rebuilt 9th Panzer Division, fresh from opposing the “Market Garden” offen-



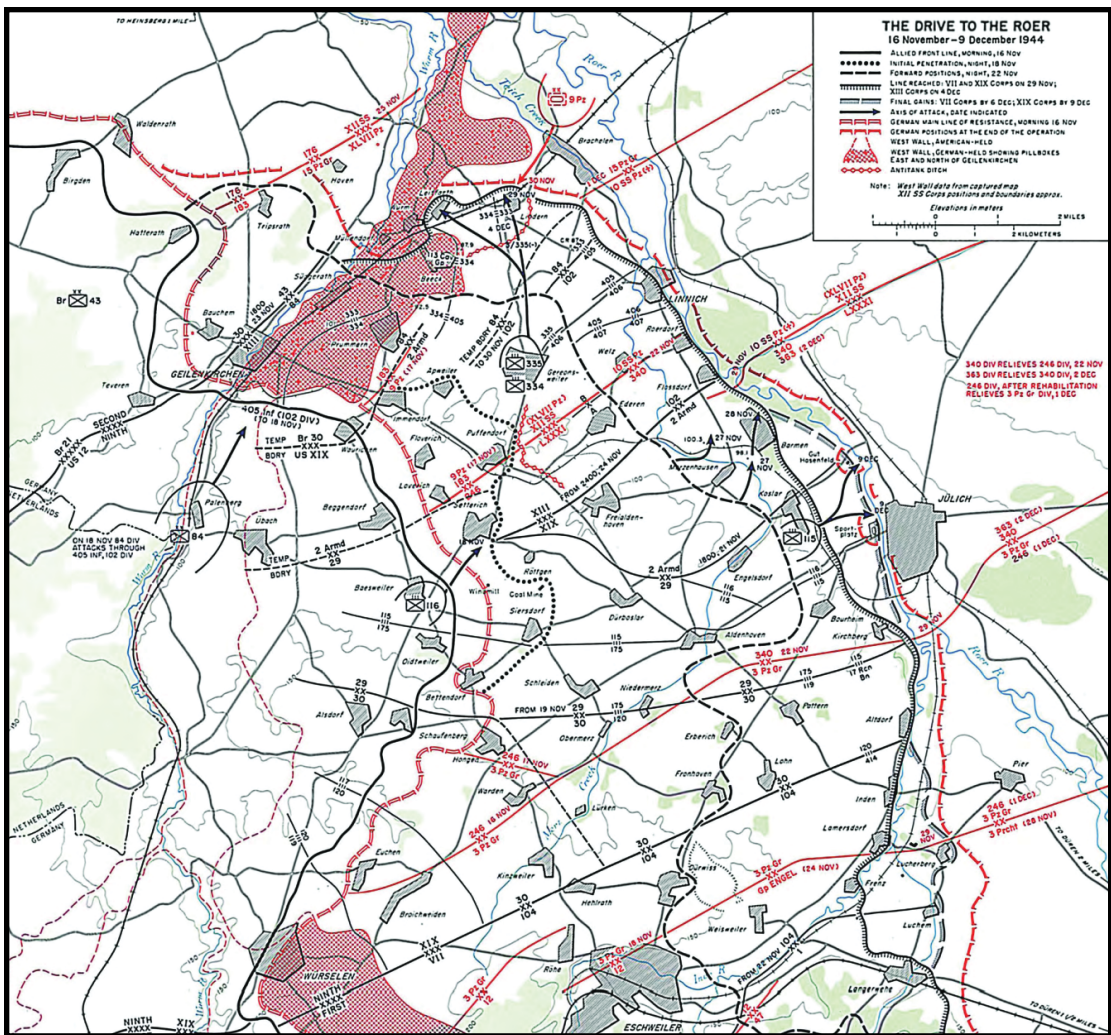

Figure 5.1. Ninth Army Operations in Operation Queen. Graphic created by Army University Press staff.

sive in September and stiffened by 36 Royal Tiger tanks of *Schwere Panzer Abteilung* (Heavy Tank Detachment) 506, to oppose 2nd Armored. Indeed, this force counterattacked on the first full day of the offensive, temporarily halting 2nd Armored’s progress but providing the opportunity for a comparatively rare tank-vs.-tank armored action in the West, precipitating what the commander of the 67th Armored Regiment called, “the biggest tank battle in 2nd Armored’s history.”<sup>16</sup> After defeating 9th Panzer, 2nd Armored next faced XII SS Panzer Corps and the 10th SS Panzer Division, also a veteran of the Market Garden operations, as well as elements of the 15th *Panzergranadier* Division, both plugged in to relieve 9th Panzer. Fortunately these units blunted themselves against 2nd Armored instead of the more vulnerable infantry divisions on either flank. But these rebuilt, rested, well-equipped, and well dug-in divisions provided a formidable foe for the soldiers of Ninth Army, and the airmen supporting them.<sup>17</sup>

With the major issues resolved and the operational plan approved, Nugent and his Chief of Staff, Col. Dyke Meyer traveled to Quesada’s headquarters on 8 November, where they “worked

up a written air plan to put into effect the general decisions reached at the conferences yesterday.”<sup>18</sup> One they completed that plan, Nugent then briefed each of his fighter groups on their roles, and then met with Colonel Meade, the Ninth Army G-3, to finalize details on fighter-bomber support. The final plan for the fighter-bombers involved all three Tactical Air Commands then in operation on the continent. While IX and XXIX TACS supported their respective ground armies, Brig. Gen. O.P. Weyland’s XIX TAC allocated sorties to identified German command posts on D-Day for Queen, demonstrating again that distributing control did not prevent concentration in an emergency. Building on experience gained at Brest, the plan for each of the two TACs supporting the assault again designated fighter groups to work with specific divisions. Within IX TAC, the plan assigned three groups to support one of the three attacking divisions: the 365th FG with the new 104th ID; the 368th FG with the seasoned “Big Red One,” or 1st ID, and the 366th FG with the 4th ID. Three more groups, the 367th, 370th, and 474th received fixed targets, most of which were crossroads, followed by fighter sweeps and armed reconnaissance.<sup>19</sup>

Nugent planned for his groups in XXIX TAC to flex throughout the day, beginning with fixed targets before the bombardment, but then picking up ground formations after the jump off. The 36th FG was to send a squadron to Geilenkirchen and two more to Gereonsweiler on its first mission, hit Heinsberg on its second mission and Jackerath on its third, all interdiction missions well-beyond the army’s left flank. The 48th FG opened with squadron attacks on Loverich, Floverich, and Immendorf, forming a line directly across from 2nd Armored, before switching to armored column cover for the division in its drive on Gereonsweiler. The 373rd FG began with squadron missions on Schleiden, Siersdorf, and Setterich in the 29th ID zone, before launching more squadron missions against Bourheim, Pattern, Niedermerz, and Erberich, deeper along the 29th and 30th ID boundary. The 404th FG opened with squadron attacks on Mariadorf, Hongen, and Bettendorf, 30th ID’s D-Day objectives, before flying deeper interdiction group missions against Erkelenz and Elsdorf. Each group was to fly three group missions, launching at 0800, 1100, and 1430, respectively, and all four groups received instructions to be familiar with the callsigns and codewords of all of the divisions of Ninth Army, to permit rapid retasking, if necessary. Throughout the day, the 363rd Tactical Reconnaissance Group performed visual reconnaissance missions, artillery correction missions, and collected post-strike aerial photographs. In the UK, the strategic air forces finalized plans for their support of the offensive. The 8th Air Force’s fighters received an assignment for armed reconnaissance east of the Rhine, deconflicting from 9th Air Force operations. RAF Bomber Command allocated 450 Halifaxes to Julich, 385 Lancasters to Duren, and another 198 Lancasters to Heinsberg, all escorted by seven Mustang and sixteen Spitfire squadrons. Thirty-six Mosquito and 66 Lancaster Pathfinders would mark Julich and Duren with incendiaries to aid the follow-on groups.<sup>20</sup>

At that point, the waiting began. While the ground forces appreciated the delay, as it gave units returning to XIII Corps from duty in the British sector additional time to recover, Nugent was impatient and anxious, writing on 14 November, “We are still waiting for weather on the big jump-off for Operation ‘Q.’ Everything that can be done had to the best of my knowledge been done. It is the first major operation in which the Ninth Army and the XXIX TAC are involved. Our reputations as good fighting units will depend on the outcome.”<sup>21</sup> In the meantime, shaping operations continued, as Nugent’s P-47s continued their attacks on German positions on the Ninth Army front when weather allowed.



Figure 5.2. Panels Marking the Front Lines of the Ninth US Army on 16 November 1944.

Targets often came as a result of reconnaissance missions by the 363rd TRG, which reported on 3 November, “Considerable traffic was noted in the Julich Koln area. The traffic was largely to the north and south, with the majority of trains moving toward the south. Twenty-one trains with an approximate total of 600 cars were observed in the target area. The railroad cars, possibly loaded with armor, were seen on siding at F-1672.” On the 7th the group again reported railroad tank cars headed south and east, but the weather cancelled all missions between 12 and 14 November. This movement was likely the redeployment of German armored division from the now-quiet British sector to the First and Ninth Army fronts, though some of the units could also have been destined for the buildup opposite the Ardennes.<sup>22</sup> Thus, while the ground forces waited and finalized their preparations, the air forces were already active in the battlespace, attempting to wear down the defenders and deny them both air cover and resupply and reinforcement. A force designated and trained exclusively for close air support might have sat idle during this period, but multi-role aircraft could provide a meaningful contribution to the operation’s success.

An ominous note sounded on 15 November, when XXIX TAC lost two pilots to “friendly” ground fire, prompting Simpson to send a letter to his corps commanders directing them not to fire on friendly aircraft, even though, “at times aircraft may inadvertently attack friendly troops” suggesting that neither side was blameless in the ongoing fratricide.<sup>23</sup> The letter read, in part,

within the last two weeks three aircraft of the XXIX Tactical Air Command have been lost through the fire of our own troops, with one pilot seriously wounded and two pilots killed...If many errors occur on either side, it will cause loss of confidence by the unit which sustains the losses and will lessen or destroy the fine spirit and mutual esteem which now exist between the supported and supporting units.<sup>24</sup>

Preventing “friendly fire” incidents, especially by the heavy bombers, had been a major part of the Queen planning effort, and again reflected the preferences of the two field armies. In the Ninth Army sector, where all the heavy bombers struck targets well to the rear of the army frontage, the simple expedient of white marker panels sufficed to delineate the front lines.(see Figure 5.2). The post-operation report recorded,

In the zone of the Ninth US Army, the front lines were marked with cerise and yellow panels. This special display consisted of markers along a line parallel to, and approximately 500 yards in rear of, the front lines. The panels were placed in markers of approximately four markers per mile. Each marker consisted of nine panels. The markers were to be displayed not later than 1000 hours on “D” day and were allowed to remain in place until H plus two hours.”<sup>25</sup>

But First Army required more extensive preparations, which included, in addition to panels, silver barrage balloons hung at 2,000 feet along the front, a marker beacon transmitting on a preset frequency, and red flak bursts fired 500 yards apart at an altitude 2,000 feet below the heavy bombers. Most of these measure proved ineffective, as the bomber aircrew reported seeing few of the visual markers, though the SCS 51 electronic beacon behind First Army was more effective.



Figure 5.3. Bomb Damage in Julich during Operation Queen.

## Operation Queen, 16-23 November, 1944

All of the planning at 9th Air Force Headquarters and among the subordinate commanders at the two Tactical Air Commands paid dividends when the heavy bombers droned overhead just after noon. The attacks went in as scheduled, with light resistance and fair accuracy, with the spillage from the designated 8th Air Force targets in the First Army zone falling away from, rather than towards the attacking troops. Two hours later, the RAF heavies did an even better job at Julich and Duren, dropping 5,640 tons on Julich, Duren, and Heinsburg, virtually leveling those towns but killing an estimated 3,000 soldiers and civilians in Duren alone.<sup>26</sup> RAF post-strike reconnaissance photos showed the center of Duren destroyed, with the remainder badly damaged and roads impassable. Julich was “almost completely destroyed,” including its rail yards, and the attack successfully dropped the bridge over the Roer.<sup>27</sup> But the impact was not quite what the ground forces desired. Expecting a heavy artillery barrage before any offensive, German commanders had pulled their troops back from the front lines to secondary positions farther in the rear. This tactic spared many, but put others directly in the path of the falling bombs. The German 47th Division reported that a “large percentage of very young and inexperienced personnel had a high percentage of shell-shock cases,” and an NCO, and later POW from the 12th Division reported his men were “still numb 45 minutes after the bombardment,” and that “It was our luck that your ground troops did not attack us until the next day. I could not have done anything with these boys of mine today...they didn’t listen to orders.”<sup>28</sup>

In the Ninth Army sector, XXIX TAC flew 136 sorties, dropping 46.5 tons of bombs on ten different towns and suffered the loss of only one aircraft.<sup>29</sup> But, despite the lack of an artillery preparation, in order to gain surprise, the ground advance left something to be desired. In the north, Combat Command B (CCB—a brigade-sized element) of 2nd Armored advanced between 1300 and 2500 yards, clearing the fortified towns of Immendorf, Loverich, and Floverich, all of which had been successfully attacked by the 48th Fighter Group, as well as heavy doses of artillery, and advanced beyond to Puffendorf, forcing the commitment of the German armored reserves. A later survey found, “damage in the towns, though extensive, did not hinder the passage of the assault waves.”<sup>30</sup> Unfortunately, anti-tank guns at Apweiler, which had escaped preliminary bombardment, ambushed Company G, 67th Armored Regiment, knocking out seven M4 tanks. By the end of the day, the company was down to two of its 16 tanks.<sup>31</sup> In the 29th ID sector, the advance covered 3,000 yards but fell short of the villages of Siersdorf, Bettendorf, and Setterich, in what was regarded as the toughest sector of the corps front. 30th ID fared even worse, gaining only 600-1000 southeast, being slowed by the stout defenders of Wurselen. But the 120th Infantry did take the town of Mariadorf after a heavy raid by the 404th Fighter Group.<sup>32</sup> Overall, XIX Corps suffered 30 men killed, 241 wounded, and 30 missing, but took 800 prisoners.<sup>33</sup> XIX Corps was apparently pleased with the results, noting XXIX TAC “did the best job they have ever done for the XIX Corps.”<sup>34</sup> 2nd Armored reported “excellent results,” and the 29th Division’s 115th Infantry believed the airstrikes on Setterich had been very effective.<sup>35</sup> The air attack had not achieved a breakthrough, but neither had the Cobra attacks on the first day. The pressing question for 17 November was whether or not the German defenders had been sufficiently weakened to permit another breakthrough.<sup>36</sup>

The morning of the 17th brought a return of the cloudy, misty weather that limited air support late on the 16th, forcing a cancellation of many of XXIX TAC’s second and third missions. The 404th Fighter Group managed only two missions that could be conducted from

higher altitude, a leaflet mission and a raid on a suspected POL dump.<sup>37</sup> The lack of support was unfortunate, as 17 November brought the largest German armored counterattack of the offensive. CCB of 2nd Armored planned to continue their attack through Apweiler to Gereonsweiler and hoped to be in the latter village by nightfall, but a mobile formation from the 9th Panzer Division that was already west of the Roer River upset their timetable. As day broke, a force of an estimated 45 Mark V (Panther) and Mark VI (Tiger) tanks supported by infantry, hit two battalions of the 67th Armor Regiment at Puffendorf just as they were forming up for their own assault. The German superiority in both main gun range and armor protection quickly told, as the frustrated gunners watched their 75mm rounds ricochet off the German tanks. Throughout the day, the unsupported Shermans lost tank after tank, even after pulling back into the village, until by late in the day some companies had only a few remaining. Fortunately, reinforcements from CCA, built around the 66th Armored Regiment, helped stabilize the situation, but prevented them from supporting a drive on Setternich. But the stubborn resistance held Puffendorf while inflicting losses on the attackers. A separate attack by ten Panthers pierced Immendorf but failed to regain the town. 2nd Armored had held but it was completely defensive and lacked critical air support. McDonald noted, "Fighter-bombers of the XXIX TAC braved unfavorable elements to maintain a semblance of air cover over the battlefield through most of the day, but mists and rain denied any real contribution against pinpoint targets like tanks."<sup>38</sup> Nugent recorded in his diary, "Three groups got off this morning, 1 for XIX Corps cover, 1 for armored column cover, and 1 for armed recce," but even these sorties had to be recalled at 1030 when the weather began closing in on the fighter bases.<sup>39</sup> But slight improvement in the afternoon permitted a response. Nugent recorded, "Approximately 40 tanks were reported on the front of the 2nd Armored Division and a picked flight of eight experienced pilots were sent after them in the afternoon. They were supposed to be marked by red smoke but in the fog the red smoke could not be seen."<sup>40</sup> Airmen were frustrated by their inability to decisively intervene when they were most needed, but Nugent was comforted by reports that "we did everything humanly possible to assist the ground forces. XIX Corps was most appreciative of the work we had done under difficult conditions."<sup>41</sup> XXIX TAC flew only 78 sorties and dropped 22 tons of bombs, less than half of the effort the day before. But the front that brought the wet weather was already on its way out.

To the south, the 30th Infantry Division's advance gained momentum on 17 November, as the gains of the previous afternoon enabled the 119th Infantry to clear Wurselen, making a battalion of that regiment available to support the 2nd Armored Division, which, as a "heavy" armored division, had two armored regiments and only one of armored infantry, making it deficient in infantry support. The rest of the 30th ID gained momentum as well, as it broke through the crust northwest of Wurselen and pushed the defenders back toward the 104th Division attacking from their rear. The fear of being cut off undermined resistance in the sector and, according to the Army's official history, "the 30th Division's advance was one of the better gains made anywhere during the early days of the November offensive."<sup>42</sup>

Fortunately, 18 November brought clear weather and XXIX TAC's largest contribution to the battle.<sup>43</sup> The tankers of 2nd Armored noticed that, compared to the desperate fight the day before, the starch seemed to have gone out of the German counterattack.<sup>44</sup> McDonald helped explain why: "A rare day of good flying weather may have kept the Germans under cover; for the XXIX TAC's fighter-bombers roamed far and wide. The planes knocked out at least two German tanks,

while tank destroyers accounted for three more, and the 2nd Armored Division's 92nd Armored Field Artillery Battalion took credit for another.<sup>45</sup> Nugent reported, "The weather is finally and unexpectedly clear, visibility is good and ceilings on the whole unlimited. All groups have flown at least two missions and some of them three."<sup>46</sup> With overhead cover, 29th ID cleared Siersdorf and Bettendorf, pushing into Setterich, while 30th ID captured Warden, leaving only one town, Kinzweiler, between them and their objective, the army boundary. 2nd Armored took Apweiler and sent a platoon of 66th AR to support 29th ID at Setterich.<sup>47</sup> The German defenders could not move without control of the skies, and the army rated its air support as "extremely effective," with a total of 352 sorties in direct support. 18 November marked XXIX TAC's busiest and most productive day of the campaign launching 480 sorties, and delivering 152 tons of bombs, at a cost of only one aircraft missing in action. The 363rd Tactical Reconnaissance Group also took advantage of the clear skies to fly 28 successful missions, out of 36 scheduled, and took the first good photos of the airstrikes on the 16th. It reported excellent support from the Ground Liaison Officers, Majors Kring and Neel and Private Lerman, attached to the group, reporting, "through their conscientious efforts a situation map of the most complete detail has been maintained by daily sitreps."<sup>48</sup> The large air effort and the ability to steal a march on the German defenders set the stage for further gains in the days that followed.<sup>49</sup>

After the unexpected and extremely beneficial clear skies on 18 November, the weather began deteriorating again, worsening to the point where XXIX TAC airmen flew few sorties between 21 and 25 November, and none at all from 22 to 24 November. But the ground advance continued the momentum provided by the heavy attacks on the 16th and the close support rendered on the 18th. The 30th ID gained over 2,000 yards on 19 November, with the 117th Infantry clearing St. Joris, Kinzweiler, and Warden, closing up on the army boundary and pressuring the defenders of Eschweiler from behind. But that city held out until 25 November, when the 104th ID's capture of Weisweiler cut the city off, leading to its evacuation. Pinching out Eschweiler cleared the largest city in the zone of the Queen advance and allowed the 30th to redeploy facing northeast, where it pushed on to the Roer.<sup>50</sup>

The real progress during this period came in the 29th ID zone, perhaps an indication of the effectiveness of leveling Julich on operations there, and the continued efforts of the fighter bombers. Once the attacking infantrymen, supported by tanks from 2nd Armored, had attrited the German forces west of the Roer, the difficulty in transferring reinforcements across the river became evident. From jumping-off positions around Siersdorf, the 29th focused its efforts on a direct line toward Julich, pushing through Durboslar on the 19th, prompting a counterattack by twelve assault guns. "Although bazooka teams either disabled or frightened away four guns which penetrated the village, it remained for fighter-bombers of the XXIX TAC to force the bulk of the guns to retire from a nearby hill from which they were making a misery of the 115th Infantry's occupation of the village."<sup>51</sup> By 22 November, they were within a mile of Julich and the easternmost point of Ninth Army's advance. The more compact attack came from the introduction of XIII Corps on the army's left flank, allowing 2nd Armored to sidestep to the right and take over some of 29th ID's frontage. The armored division's advance continued to prove the old adage that "armor attracts armor," as a counterattack by the 9th Panzer Division stalled the division's advance on Merzenhausen, a small town that attracted outsized attention in the week that followed.<sup>52</sup> 2nd Armored used the capture of Setterich by 29th ID to shift part of CCA through the town and advance on Ederen and Freialdenhoven on 19 November. The

assault reached the outskirts of Freialdenhoven on the 19th and, after being delayed by a heavy mist on the morning of the 20th, finally entered the town later that day.

But farther north, CCB operations against Gereonsweiler and Prummern again sparked a large commitment of German armor, this time an estimated 60-80 tanks. The attack began ominously in a heavy rain that liquefied the fields around the town and precluded any air support. Artillery barrages filled the gap with a preparatory barrage and the operation kicked off near noon and soon entered the town.<sup>53</sup> The Army's official history recorded, "The 30 Corps counted instead upon a steady softening process by fighter-bombers which began as early as 8 November with a napalm strike against Geilenkirchen. Assistance was to be provided by both the Second British Tactical Air Force and the Ninth Army's usual ally, the XXIX TAC. At least two groups of XXIX TAC fighter-bombers were to operate on 18 November, D-Day for Operation Clipper."<sup>54</sup> The 84th ID, attached to XXX (Br) Corps, with the 43rd (Wessex) Division eventually pinched out the Geilenkirchen section of the Westwall, which had formed a dangerous salient along the corps, army, and army group boundary. The Corps commander, Lt. Gen. Brian Horrocks was impressed by the division's preparation, later remarking, "The more I saw of the 84th, the more impressed I became with the system of training that had been evolved during the war in the USA."<sup>55</sup> This was but the first episode in a long history of cooperation between Ninth Army and Montgomery's 21st Army Group.<sup>56</sup>

Fortunately the weather was better at the airfields to the rear, and the 404th Fighter Group flew eight missions of armored column cover on the 19th, covering Gereonsweiler, Aldenhoven, and Ederen, and worked directly with the 2nd Armored's forward Air Support Party, call sign "Cutbreak," a Sherman tank equipped with a SCR-610 radio.<sup>57</sup> The 404th's sorties were a significant part of XXIX TAC's 374 sorties, and 141 tons of bombs delivered on 19 November, the second busiest day of the campaign. In addition to the air effort, British flamethrowing "Crocodile" tanks provided critical support in clearing bunkers before they succumbed to the ever-present mines. The attack on Ederen also proceeded against light opposition, falling to the armored infantrymen on 20 November. The next day, 2nd Armored seized high ground east of Gereonsweiler and cleared Merzenhausen, enabling them to look across the Roer at the flattened ruins of Linnich.<sup>58</sup> The air effort fell off precipitously on 20 and 21 November, after the record-setting days on 18 and 19 November. On the 20th, XXIX TAC flew only 83 sorties, delivering a measly four tons of bombs, and followed that up on the 21st with 105 sorties and a paltry 19 tons. Losses also climbed in the marginal weather, with one aircraft missing on the 20th and three on the 21st. The weather then turned so bad that the command could not launch a single sortie in the three days that followed.

By 23 November, a week into the attack and Thanksgiving Day, the soldiers and airmen of Ninth Army and XXIX TAC had plenty to be thankful for, including the turkey dinners at the air bases and, if not hot meals, at least turkey sandwiches for the frontline troops.<sup>59</sup> Their attack was more than three-quarters of the way to its initial objective of the Roer River, and casualties had not been excessive. But, beneath the optimism, the realization that this would not be a clean breakout to the Rhine began to settle in. Poor weather on 22 and 23 November grounded all flights, and the defenders used this lull to halt all momentum on the 22nd and counterattack at Merzenhausen on the 23rd, clearing part of the town. The army remained stalled the following day, as it used the lull to clear Bourheim, at the point of the 29th ID advance. Nugent took advantage of the poor weather and lull in operations to visit his airdromes. At airfield Y-29 at Asch, eight miles northwest of Maastricht, he reported, "Conditions at this airdrome are indeed



rugged. It is a sea of mud. There is no housing and the only place to pitch a tent is in the deep mud or adjoining woods which will probably never dry out until summer. The runways, however, are surfaced with PSP [an innovation from the Carolina Maneuvers] and it will probably be a better location for the 363rd than their present station at Y-10.” Nugent wanted to move the 363rd closer to the front, and to the combined Army and TAC headquarters in Maastricht, to speed the receipt of its valuable intelligence. With the group commander’s approval, Nugent hoped to displace his TRG forward, and move the field’s current tenant, the 366th FG, then assigned to IX TAC, closer to the First Army front. On 26 November, the XXIX TAC hosted a football game between its team and one from the 404th Fighter Group at the Maastricht stadium, “for the pleasure of our hosts and friends, the wonderful Dutch,” in which the TAC’s “Maroon Wave” defeated the 404th Fighter Group’s “Thunderbirds” 3-0.<sup>60</sup> It took most of the next week to close up to the Roer, and the recognition that, with control of the dams upstream, the Germans could flood the valley and cut off any advance across the river to much of the urgency out of the advance. Queen had been a tactical success, but it was increasingly clear that the Allies would not be able to “Win the War in ’44.”<sup>61</sup>



Figure 5.4. Combined Ninth Army and XXIX TAC Headquarters, Maastricht, Netherlands.

### **Closing up to the Roer, 23-30 November**

Operations the final week of November focused on closing up on the Roer River across the Ninth Army frontage in order to facilitate a forced crossing and a continuation of the of-

fensive to the Rhine. In the XIX Corps zone, the villages of Pattern, Lohn, and Altdorf, stood between the 30th ID and Inde River, a tributary of the Roer that joined it just south of Julich. But Altdorf proved a tough nut to crack, and occupied the division's attention until it finally fell on 28 November. As a result of good flying weather on 26 and 27 November, the 363rd TRG was able to photograph the village, and, before the attack, each squad had aerial photos of its objective in Altdorf.<sup>62</sup> 29th ID had the shortest route, but also two of the most obstinate objectives on its route to Julich. The villages of Bourheim, southwest of Julich, and Koslar, just northwest, blocked access to the city itself and it took most of a week to cover the half mile belt containing these two villages, leaving the 29th still a mile short of the rubble city itself. To the north, 2nd Armored focused its efforts on Barmen, which fell on 28 November. XIII Corps, with the 84th Division returned from British control on 23 November, continued the drive east.<sup>63</sup> The 102nd division, occupying the southern half of the corps frontage, took Flossdorf and Roerdorf as well as most of Linnich, which lay astride the Roer. North of them, the 84th had a tougher task attacking into both the army group boundary and the intact Westwall defenses in the triangle between the Roer and Wurm rivers. When the offensive finally halted, Brachelen, in the 84th's sector, was the only town still in German hands on the west bank of the Roer along Ninth Army's front. Clearing skies on 25 November allowed XXIX TAC to again take to the air and render important support in clearing the strongpoints blocking the Army's advance. The command flew 305 sorties and dropped 97 tons of bombs on the 25th, with one aircraft missing, and approximated that effort the next day, flying 304 sorties and dropping 105 tons of bombs against no losses. This was the second heaviest period of support during Queen, after the missions a week earlier on 18 and 19 November.

German dispositions had remained largely unchanged, but fresh divisions rotated into the line. In LXXXXI Corps, 30th ID still faced the remnants of the 3rd *Panzergranadier* in the south, while the 340th *Volksgranadier* division relieved 246 *Volksgranadier* on 22 November opposite 29 ID and 2nd Armored. The strength of the German position remained in the north, where XII SS Panzer Corps had the 10th SS Panzer Division, which had relieved 9th Panzer so that it could prepare for its role in the Bulge offensive, blocking the advance on Linnich.<sup>64</sup> Ninth Army's advance had already diverted some divisions destined for the Bulge offensive, but not enough to seriously threaten German plans.<sup>65</sup>

In the 30th ID sector, Altdorf fell on 28 November, closing out the division's contribution and providing it two critical weeks of rest before being thrown into containing the Bulge breakthrough.<sup>66</sup> The division was able to meticulously plan its attack on the village thanks to extensive photographs taken on 25 and 26 November by the 363rd TRG during a brief period of clear weather. It also helped that the bulk of the German defenders were farther north, launching a counterattack on the 29th ID and 2nd Armored front to prevent the divisions from reaching Julich. Despite the rubble and dropped bridge, Julich offered a fan of roads stretching to the east that the Germans clearly wanted to deny to Ninth Army. On 27 November, Nugent reported his command was still waiting for their microwave early warning (MEW) radar, which would provide advance notice of German raids and justify basing aircraft closer to the front, as well as his SCR-584, a targeting radar which would have allowed aircraft to bomb accurately through the clouds and mist. Two days later Nugent learned that his MEW was "on the dock," but would not arrive until 16 December.<sup>67</sup> The MEW could speed response times, moving aircraft closer to the front, and the SCR-584 promised to increase the command's ability to provide support during periods of poor

weather. IX and XIX TAC had enjoyed the benefit of these technological marvels since the late summer, but Ninth Army and XXIX TAC remained lower on the priority list.<sup>68</sup>

The Blue and Gray Division jumped off on 25 November headed for Koslar and initially the attack benefitted from the clear skies. While the clearing skies encouraged the troops, according to the division's chronicler, "If a P-47 or two could fly over Koslar, the men's morale would be boosted still further."<sup>69</sup> A pre-dawn attack carried Companies F and G of the 116th Infantry into Koslar, but then the difficult work of consolidating this gain into the division's line began, as the Germans launched their "inevitable counterattack."<sup>70</sup> German attackers eventually infiltrated around the town, cutting off the depleted company, which held on with artillery strikes and air support. 1st Sgt. Marvin West recorded in his diary, "All day our planes have given out some red-hot hell. They sure are good for morale for these old beat-up, weary doughboys."<sup>71</sup> But the real heroes in Koslar were the artillery forward observers who called in countless requests for fire that broke up attack after attack, and the pilots of the division's liaison section, who flew their L-4 aircraft over the village and dropped essential supplies, including plasma for the wounded and batteries for the forward observer's radios.<sup>72</sup> On November 27, soldiers of the 1st Battalion, 116th Infantry finally broke into Koslar and linked up with the lost company, as the German attackers withdrew across the Roer to reconstitute. A 340th VgD report claimed, "In addition to the heavy losses in officers and men, the efficiency of the units was severely reduced by ... the trenches [which] were all deeply-flooded, the constant strain to which the troops were exposed under the continuous barrage fire and fighter-bomber attacks, the failure of small arms due to dampness, and by general fatigue."<sup>73</sup>

Even without the benefit of the new technology, the fighter-bomber groups committed to this area continued to attrite German defenders and punished counterattacks. On 26 November aircraft dropped incendiaries that helped to break up an armored counterattack near Bourheim. The flames helped mark the target for follow-on flights who struggled to find it through bad weather. Two days later the 404th Fighter Group broke up another armored counterattack on the 2nd Armored front near Barmen, earning praise from the division's commander, Major General Ernest Harmon.<sup>74</sup> The 29th ID's 175th Infantry had jumped off for its attack on Bourheim on 22 November, provoking a strong German response, and the battle for the town raged for four days. XXIX TAC aircraft could do nothing to help on 23 and 24 November, but took advantage of the clearing weather to make their contribution to the battle. A battalion commander reported that air broke up two counterattacks on the 26th, raising spirits and morale. Again, "Enemy artillery [was] kept at a minimum while air cover was up."<sup>75</sup>

AAF aircraft continued to work well with the light aircraft assigned to the artillery battalions. An air observer for the 224th Field Artillery Battalion spotted tanks near Bourheim and had his battery mark them with white phosphorus and red smoke, enabling aircraft to attack and destroy them. As the ground advance approached the dense city of Julich, intense anti-aircraft fire from positions concealed inside the city pushed the supporting aircraft to altitudes where identification of targets became difficult.<sup>76</sup> The artillery's smoke rounds and incendiaries increased the likelihood of spotting a target during the brief run through the worst of the German flak.<sup>77</sup> Another observer from the 283rd FA Battalion later did the same later with three tanks near Koslar. As they had at Gereonsweiler a week earlier, aircraft struggled to dig German defenders out of prepared positions, but proved particularly adept at breaking up counterattacks when they left their protective cover. An infantry battalion commander at Koslar credited air

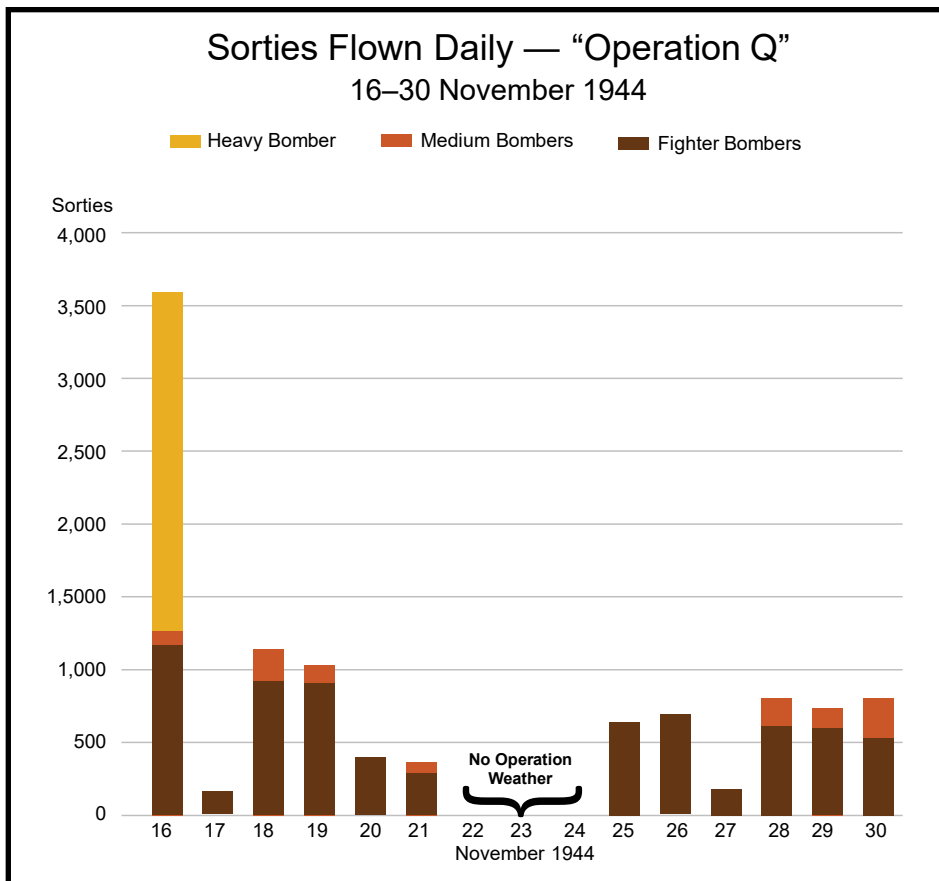
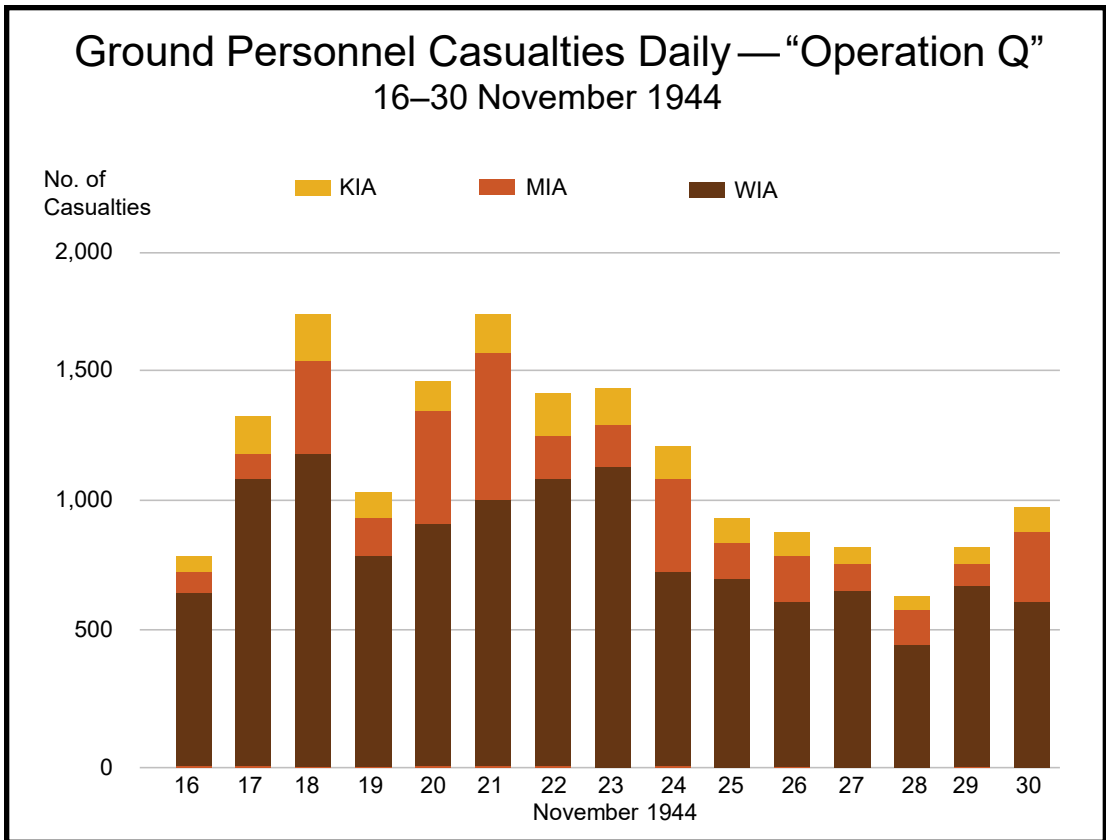

Figure 5.5. Comparison of air effort and ground losses during Operation Queen. **(Above)** Sorties Flown During Operation Queen. **(Right)** Ground Personnel Casualties Daily During Operation Queen. Graphic created by Army University Press staff.

strikes and artillery with “eliminating the fire from the east flank that had given us plenty of trouble at the beginning of the operation.”<sup>78</sup> A platoon leader in Company I, 175th Infantry, noted that defenders tended to stay in their holes when aircraft were overhead, but opened up when they left. He also appreciated the support in the advance. “We can just walk right in on them after those P-47s strafe them,” he said. “There’s lots of times when we can’t move an inch and then the 47s come over and we just walk in almost without a shot.”<sup>79</sup>

On 28 November, the 29th ID and 2nd Armored cleared Koslar, Merzenhausen and Barmen, leaving only the Sportplatz and other defensive positions on the west bank of the Roer in German hands in the XIX Corps Zone. November 28 and 29 marked another peak in air support. From only thirty-nine sorties delivering fourteen tons of bombs on 27 November, XXIX TAC increased its effort to 293 sorties and 106 tons on the 28th, with one pilot killed and another missing, and boosted that to 301 sorties and 116 tons, including 5,000 gallons of napalm, on the 29th, but suffered another pilot wounded.<sup>80</sup> Part of the effort on the 28th came when the 404th flew armored column support for 2nd Armored at Flossdorf, dropping eight 500-lb bombs that destroyed four tanks, two more tanks at Barmen, and a locomotive and eight railroad cars at Esch. The panzers at Flossdorf had again been marked with red artillery smoke



by Cutbreak.<sup>81</sup> But two consecutive days of satisfactory weather seemed to be the limit at this time of the year, as the output on 30 November dropped to 197 sorties delivering 34 tons, with yet another pilot missing in action, this time in a dive-bombing attack by 16 P-47s of the 404th Fighter Group armed with three 500-lb bombs each.<sup>82</sup>

With only a sliver of territory remaining west of the Roer on the XIX Corps front, the Army’s attention shifted to the north, where the XIII Corps headquarters became operational on 29 November, controlling the now-seasoned 84th and 102nd Divisions. The day before, Nugent met the corps and division commanders at corps headquarters, where he fielded a request from Major General Gillem to place the bulk of the XXIX TAC’s effort on his corps’ front. Nugent noted that the 102nd was “commanded by Gen. Frank Keating, a classmate of mine at Leavenworth. The weather is not good for tomorrow but in accordance with General Simpson’s desire, they were complimented on their plans of attack and told that weather permitting they would get good air support.”<sup>83</sup> Unfortunately the weather was poor early on the 29th and the first mission of the day could not locate its targets, but “later in the morning it improved slightly and the air support for the attack of the XIII Corps was adequate.”<sup>84</sup> The reunions from his days as a ground officer continued, as Nugent met with Col. Dwight Rosebaum, commanding Combat Command “A” in XIII Corps’ 7th Armored Division. Nugent recalled, “Colonel Rosebaum served with me in the tanks at Camp Meade in 1924 and 1925.”<sup>85</sup> Units of the 102nd Division pushed into Lindern and Beeck, a 700 yard advance, on 29 November, before bumping into the rear of the Westwall pillboxes, which the Germans now defended from the west. On 30 No-

vember the division took Welz and Flossdorf on the right flank and cleared Lindern, meaning that both corps had now reached the Roer.<sup>86</sup> In the 335th Infantry's attack on Lindern, "Colonel Parker hoped that systematic artillery and fighter-bomber attacks for several days preceding 29 November would suffice as preparation fires."<sup>87</sup>

The apparent success of Operation Queen led to another planning effort for crossing the Roer, as Nugent's Chief of Staff, Colonel Dyke Meyer and the Army's G-3-Air Colonel Fagg worked with the Army's G-3 on preliminary plans for a crossing between Linnich and Julich. Apparently, concerns about the Roer dams had not yet intruded on the planning process and optimism still prevailed in the Army and TAC headquarters. The next day, the staff officers briefed their plan to General Simpson and planned to use four groups from IX TAC, half of the 8th Air Force and one-third of the RAF's Bomber Command to again attempt to blast open a path to the Rhine and beyond.<sup>88</sup> But on 1 December, the planner received a bucket of cold water. At a meeting of the First and Ninth army commanders, their associate TAC commanders and the Allied Supreme Commander, General Eisenhower, to discuss the plans for the Roer crossing, Nugent recorded, "General Eisenhower believes that the dams on the Roer should be blown or captured prior to attempted crossings."<sup>89</sup> As a result, on 4, 8, and 11 December, the RAF flew three missions against the Roer dams, attempting to destroy them and allow Ninth Army to continue its drive, but the thick, reinforced concrete dams withstood the attack, necessitating a lengthy and costly ground campaign to seize the objectives.<sup>90</sup>

In the two weeks since the last heavy bomber effort, the combined Ninth Army and XXIX TAC team had achieved their intermediate objective of the west bank of the Roer River, and were actively planning for a crossing and continued effort beyond. During this period, the command flew 4,501 sorties, delivering 1,145.45 tons of general-purpose bombs, 3.47 tons of fragmentation bombs, 22,200 gallons of napalm, and, in a statistic that clearly indicated which type of missions occupied the bulk of the command's effort, claimed only two German aircraft shot down, but lost 18 of their own to ground fire.<sup>91</sup> A later study found, "In the zone of the Ninth US Army, the medium and heavy strikes were back from the front lines so far that no immediate assistance was felt by the ground troops. Since 'D' day, many points hit by bombers and fighter bombers have been taken. Damage in the towns is extensive but it is difficult to ascertain the source of damage as the towns were subjected to very heavy artillery, assault gun, and mortar barrages in conjunction with the air strikes." Even if post-strike assessment made it difficult to assess physical damage, the ground forces knew the value of close support. A staff officer in the 29th Division wrote,

Without the assistance of our close supporting air arm, the advance of the 29th Infantry Division in Operation 'Q' from the position on 16 November 1944 in the vicinity of Baesweiler to the west bank of the Roer River on 1 December 1944 would have been decidedly more difficult. Our previous conclusions on the benefits of dive bombers have been substantiated; enemy artillery is definitely lessened while our air is up; movement of enemy troops is brought to a standstill, both because of their terror of attacking aircraft and the destruction of their bridges and other communications; dive bombing and strafing keeps the enemy in his shelters and trenches, and neutralizes his effectiveness as opposition to friendly advances.<sup>92</sup>

Air had not gotten the army to the Roer. But it had helped it get there, and speeded the advance while reducing the cost in the process.

## **The Fight before Julich and Redeployment for the Bulge, 1-31 December**

The first week of December saw only minor gains along the Ninth Army frontage. While 29th ID closed up to the west bank of the Roer opposite Julich, and XIII Corps fought to expand its salient behind the Westwall, the remainder of the units began to consolidate their gains against any German counterattack, rumors of which kept popping up persistently in intelligence reports. Post-mortems for Queen and discussion for conducting an opposed crossing of the Roer, an exercise repeated ad nauseam in the various stateside training maneuvers, dominated staff activity, but gaining the necessary jump-off points still required effort, assistance and sacrifice. When the German counteroffensive commenced on 16 December in the Ardennes, it did not so much disrupt the Ninth Army advance as it weakened the command, by siphoning off units to hold the shoulders of the “bulge” and contain the penetration. Ninth Army and XXIX TAC made substantial contributions to this task, usually by transferring divisions and fighter groups to First Army and IX TAC to the south, and extending its frontage while reverting to a defensive role. While some units received a well-earned respite, others leapt out of the frying pan and into the proverbial fire.

Closing up on Julich proved to be the principal task for the soldiers and airmen. In addition to the fortified village of Gut Hasenfeld, the Germans had turned a stadium on the west bank of the Roer opposite Julich into a strongly fortified position. According to the Army’s official history, “Artillery and air support bombarded both objectives and the town of Julich across the river but with no telling effect on the enemy’s will to resist,” demonstrating the limitations of attacking strongpoints in heavily built-up areas.<sup>93</sup> But that did not stop them from trying. “On at least two occasions, fighter-bombers of XXIX TAC pounded the objectives for 15 minutes before attacks; yet as the infantry tried to close, German fire remained thick.”<sup>94</sup> Finding it difficult to root the defenders out of the reinforced concrete, Gerhardt’s division again turned to their air support for assistance. On 5 December, Gerhardt asked specifically for support against the Sportplatz itself. The next day, despite 600-foot ceilings and less than one mile visibility, 36 P-47s of the 48th Fighter Group took to the air at 1340 and were dropping 500-lb general purpose bombs on the complex less than 20 minutes later. The following morning, soldiers of the 29th Division walked in in what Gerhardt claimed was “one of the most brilliant examples of air-ground cooperation it is possible to imagine”<sup>95</sup> For their efforts, the 48th Fighter Group, veterans of the Tennessee Maneuver Area, received a Distinguished Unit Citation. McDonald reported, “By dawn of 9 December the entire west bank of the Roer in the zone of the Ninth Army had been cleared.”<sup>96</sup> But the 29th continued patrolling in their sector and attempted to suppress the volume of fire coming from the destroyed city across the river. On 12 December, the division again issued a call for assistance in reducing fire coming from the NCO school in Julich, and received support in less than three minutes from on-call aircraft overhead.

To the north, XIII Corps reached its final objectives on 4 December, despite being committed piecemeal during the offensive. It had proven to be a successful initiation for Gillem’s Corps, which went on to play important roles in the campaigns of the following year, and the army’s official history noted, “A distinctly encouraging aspect of the campaign was the performance of new divisions.”<sup>97</sup> At the conclusion of the campaign Simpson issued the following message:

I wish to commend the officers and men of the XXIX TAC for excellent close support afforded the Ninth Army on Nov. 16, the initial day of the current offensive.

The support afforded by your command, executed as it was under difficult conditions, contributed materially to the initial success of the ground troops. I desire also to make record of my appreciation of the splendid cooperation existent between ground and air troops which has been especially exemplified during the progress of the present campaign.<sup>98</sup>

Indeed, General Simpson was so impressed with the ground fighting that he sought to transmit the expertise to his newly arrived units, in a fashion similar to the demonstrations held at the Maneuver areas. According to Major General McLain, "These demonstrations are based on actual operations which, in the opinion of this headquarters, were outstanding."<sup>99</sup>

A history of the 30th Division reported, "Two engagements were such classic examples of technique in village fighting that they were re-enacted as demonstrations, at the express desire of General Simpson of Ninth Army, for the benefit of newly arrived commanders of divisional units."<sup>100</sup> This event took place on 13 and 14 December at Alsdorf, beginning with a lecture by Lieutenant General Harmon in the Princess Theater on "team-play and coordination of tanks, infantry, artillery, and air," followed by a demonstration.<sup>101</sup> Harmon's outline included the note, "For efficient air-support, air observer should ride in tank far enough forward to see the formation to the front," as "Cutbank" had done on multiple occasions.<sup>102</sup> The following day, Major General Hobbs provided an infantry division's perspective in a recreation of their attack on St. Joris, emphasizing the value of the aerial photographs. "Each house of section of the village is assigned to a squad or platoon as its immediate objective. By using vertical photos, or tracings or sketches therefrom, for briefing the men, and by advancing rapidly on a broad front designated houses can be assaulted before the Germans are prepared to resist effectively."<sup>103</sup> As the original assault took place during poor flying weather, artillery provided most of the fire support, but the general repeatedly emphasized the importance of accurate tactical intelligence that could only be obtained by aerial photographs, the only form of overhead imagery then in existence.

While the ground forces rested and trained, the air forces continued their shaping campaign to set the conditions for a successful crossing. The 404th FG alone had a very busy two weeks preceding the German offensive. On 1 December the group conducted an armed reconnaissance mission at Julich and completed a dive-bombing mission against Hattdorf, Boslar, and Baal. On 2 December the armed recon extended as far as Frankfurt, and the following day 12 P-47s dive-bombed Pattern. On 4 December they struck Boslar again, after artillery marked positions with white smoke, improving coordination. 5 December saw a return to the interdiction campaign, with attacks against marshalling yards and a roundhouse at Rheydt and Hambock, and a leaflet mission. The air-to-air mission returned, with an intercept mission on the 6th, top cover and area cover for the RAF heavy bomber attack on the Roer dams on the 8th, and an escort mission for medium bombers over Duren on the 10th, with follow-up bombing of a factory at Gevenich. Foul weather closed down operations until another leaflet mission on the 14th and shaping attacks on Schevich, Esch, and Elsdorf. On the 15th, the 404th escorted medium bombers working over the marshalling yards at Dusseldorf, with 12 P-47s armed with napalm, white phosphorus, and general-purpose bombs contributing their weight to the attack.<sup>104</sup>

While Nugent's fighter groups continued their efforts, the XXIX TAC commander spent his time addressing coordination issues and attempting to glean lessons learned from the recent operation. On 2 December, he attended an anti-aircraft conference, which addressed issues



surrounding the V-1s that continued to overfly the army's rear area. British gunners wanted authorization to fire on the flying bombs through the overcast based on sound alone, but Nugent worried about the impact this might have on his aircraft as they returned to their bases behind the lines. Sadly, this issue defied coalition and technological remedies and even re-emerged in future conflicts, such as when an American Patriot battery downed a RAF Tornado in the First Gulf War.

On 5 December, Nugent attended another conference with Eisenhower, Air Marshal Sir Arthur Tedder, Ike's principal deputy for air, Maj. Gen. Carl "Tooney" Spaatz, commander of the US Strategic Air Forces, and all of the TAC commanders focused on "how the heavy bombers could best support the advance of the ground troops and whether the effort could be better expended in close support of the ground troops in contra-distinction to the oil and communications centers on which both the RAF and US heavies are now engaged." The conference obviously reflected the continued and ongoing rift on targeting and priorities that dominated the ground-air relationship throughout the war. Senior airmen wanted the strategic bombers "fenced off" from ground commanders to allow them to proceed with their work uninterrupted but the theater commander insisted that all assets remain available for use in whatever task he deemed most pressing. The recent request for another heavy bomber mission to support the Roer crossing, as well as the ongoing attacks on the dams that had diverted some of the RAF's heavy bomber effort, likely precipitated the conference. For his part, Quesada pushed for more carpet bombing, as in Cobra and the First Army sector in Queen, noting that ground forces would have to be pulled back to provide a margin of safety. Nugent, after conferring with the XIX Corps commander, Raymond McLain, disagreed, arguing that enemy would occupy the buffer, creating additional obstacles and shielding the carpeted area. Instead, he advocated for more reliance on the tactical fighter bombers, a position that likely put him in the service's good graces, as it aligned with their priorities. On 10 December, he was at the 84th ID headquarters to coordinate air support for an advance in the XIII Corps sector and prepare the plan for the Roer River crossing.<sup>105</sup>

As the planning effort for continuing the advance intensified, Simpson and Nugent traveled to Army Group headquarters at Spa on 11 December to brief and gain approval for the current plan. Significantly, Bradley told Simpson that his army would likely come under control of the British 21st Army Group later in the campaign, making the actual assignment just a few weeks later during the Bulge offensive less of a shock. The next day, the airmen briefed the Ninth Army G-3, G-3 (Air) and all air support party officers at the corps and division levels on the plan. On 13 December, XXIX TAC met with the corps and division commanders at Heerlen to again brief the air plan for the crossing. Nugent's summary revealed that First Army's preferences still held sway with Bradley, as the plan was, "based mainly on the carpet bombing principle to ensure the crossing of the Roer, combined with additional missions to seal off the area from German reserves by interdiction of communication centers, marshalling yards, etc." On 14 December, Nugent and Simpson again met to discuss modification to the plan based on input from the subordinate commanders.<sup>106</sup>

On 16 December, the day the German counteroffensive broke on the First Army front, Nugent was at a conference with Quesada and representatives of his IX TAC, as well as planners from 8th Air Force and RAF Bomber Command to coordinate support for the Roer crossing. The RAF refused to bomb blind within five miles of the ground troops, (even though 8th Air Force would) but would bomb visually below 5,000 to 7,000-foot ceilings, which 8th Air

Force would not, due to concerns about losses from ground fire. Ninth Army refused to attack without fighter-bomber support, while First Army would not go without heavies, revealing by now hardened preferences based on past experiences. A compromise plan suggested splitting the effort at the army boundary and fanning out from there. Again, the RAF would work on the Ninth Army front, while 8th Air Force supported First Army. Cryptically, Nugent's diary noted, "Heavy German night air action in this vicinity." The next day, en route to Spa to report the compromise to Bradley, Nugent found the plan overtaken by events, writing, "today the first appearances of a large scale German counter attack appear on the First Army front." As Ninth Army was still inactive, Nugent immediately sent two of his fighter groups to oppose the thrust and cancelled all army support missions. XXIX TAC also sent groups armed with fragmentation bombs after German airfields but "large formations of FW 190's and ME 109's" intercepted the attack, "as they were approaching. They were forced to jettison their bombs and a general dogfight followed." After returning and re-arming, a second attack penetrated the defensive screen and claimed 23 aircraft destroyed, at a loss of eight of their own.<sup>107</sup>

Simpson seemed to recognize fairly early on that the German offensive represented an opportunity rather than a setback. On 17 December, his aide, Capt. Robert Fay, recorded in the general's war diary,

The CG seemed pleased to fight it out this way, for the Boche is denied his well-established fortifications, well dug-in and reinforced as they were, for open field warfare, but is committing his slim reserves. Once the advance is stopped, we stand a fair chance of smashing his forces pretty badly and thus eliminating some possible future battles between the Roer and the Rhine Rivers. Undoubtedly this will be one of the deciding battles of the war, and may even preface its end.<sup>108</sup>

Simpson was indeed prescient, and this view helps explain why he was so willing to have his divisions transferred to First Army and employed in crushing the attack from the northern shoulder. Every German soldier they killed in the Ardennes was one less he would have to dig out of strong positions east of the Roer, as he had just spent a month doing west of that river.

On 17 December, lead elements of the First SS Panzer Division captured over 100 American soldiers near Malmedy, Belgium. As the prisoners stood in an open field, the SS troops opened fire, killing 86 while survivors scattered into the woods. Throughout the offensive, elements of the division committed other atrocities against both American POWs and Belgian civilians. In response, American units in the area, including the 30th Division, began issuing retaliatory orders against the SS. Simpson's war diarist recorded, "American troops are now refusing to take any more SS prisoners... While we cannot order such a thing, the CG himself personally hopes that every GI will hear these stories and make that a battle rule; as the 30th Division did. The CG feels very strongly about this. The Jerry has come to call the 30th 'Roosevelt's Butchers,'" a nickname later modified to "Roosevelt's SS," on the surface suggestive of elite status or effectiveness, but in reality reflecting Old Hickory's ruthlessness towards its foe in the wake of Malmedy.<sup>109</sup>

On 20 December, the planned transfer of Ninth Army to the British 21st Army Group went into effect and Air Vice Marshal Sir Arthur Coningham, commander of the 2nd Tactical Air Force (TAF), XXIX TAC's new headquarters called to say that Nugent's command was now under his operational control, and requested a conference. Nugent noted, "the weather is still



Figure 5.6. Lt. Gen. William H. Simpson, Gen. Sir Bernard Montgomery, and Lt. Gen. Omar Bradley.

poor.” At the requested conference the next day in Brussels, Nugent received orders to perform armed recce, while IX TAC concentrated on the German armor and 8th Air Force fighters hit the Luftwaffe airfields east of the Rhine. On 22 December, Simpson and Nugent discussed the arrangement, with Simpson agreeing that his forces would not receive any air support unless attacked. Nugent reported, “the weather is still bad with dense fog. Troops are pouring into positions for the counter offensive as soon as the German spearheads have been slowed. This is our big chance. Several days of good weather for air action followed by a heavy, well-placed counter offensive should end the war.”<sup>110</sup> While the massive air attacks of the following days did not “end the war,” they did take much of the starch out of the German counterattack. This was small consolation to the ground soldiers who had been overrun and captured in the first few days, or who had managed to channel and blunt the armored drives into their lines, but it did provide reassurance that the crisis had passed. On 23 December, XXIX TAC was in on the kill, sending two groups to southern area and two more against the German airfields at Bonn. British Y-intercepts confirmed the attack’s success, as many German aircraft radioed their plans to recover at disabled fields, scattering the German force. That same day, XXIX TAC sent its two tactical reconnaissance squadrons, the 160th and 161st to Conflans airfield where, as part

of Weyland's XIX TAC, they supported Third Army's attack against the southern shoulder of the penetration, with RAF reconnaissance units taking over the effort on Ninth Army's front.<sup>111</sup>

The ability to quickly reassign aircraft paid immediate dividends, as Nugent reported on 24 December that an 8th Air Force raid pulled German fighters up from the battlefield, which "uncovered the German columns on the road as completely as though they had had their clothes stripped from them. As a result, my fighter bomber squadrons have been having a field day."<sup>112</sup> The effort continued the following day, as Nugent observed, "Today is Christmas. The XXIX Tactical Air Command Santa Clauses are delivering presents to the German army in the penetration area."<sup>113</sup> On 26 December, the XXIX TAC staff examined new tactics sent from AAF-SAT, demonstrating that the stateside support effort had not ended with the reduction in training exercises for deploying divisions. The sustained operations of the past week had also resulted in severe shortages of P-47s, including 30 aircraft in two of the groups, and the headquarters requested more replacements and temporarily reduced squadron allotments from sixteen aircraft to twelve to alleviate the effects. Nugent closed the year with a conference at St. Trond with Coningham, Quesada and Air Vice Marshals Sir Victor Groom, 2nd TAF's Senior Staff Officer, and Sir Harry Broadhurst, commanding the RAF's No. 83 Group, to discuss 2nd TAF's plans for supporting the counteroffensive. From 16-30 December, XXIX TAC flew 2,676 sorties rendering important aid to the aerial attacks on the Bulge. The rapid reassignment of aircraft in response to the German counteroffensive vindicated the system of distributed control employed by the TACs. Contrary to some airmen's pre-war claims, the aircraft did not sit idly in quiet sectors, but quickly shifted to the most vital point. Ground commanders, including Simpson, readily assented to this redistribution, knowing that "his" aircraft, and more, would return when and where he needed them.<sup>114</sup>

## Conclusion

The Army's official history correctly noted that the "German defense never had cracked, despite Allied air and artillery superiority," and "Even the gigantic air support program for the November offensive was not a new solution but for all its size, a conservative copy of similar programs in Normandy."<sup>115</sup> While the campaign did not achieve its objective of a breakout and pursuit to the Rhine, it substantially improved the Army's position by closing up to the Roer River, an obstacle that could not be crossed until the dams upstream had been captured or destroyed. In addition, it adversely affected German plans for the Bulge counteroffensive, absorbing combat power and diverting resources from that attack.<sup>116</sup> McDonald found, "German prisoners totaled 8,321; the Ninth Army actually buried 1,264 enemy dead and estimated that the Germans lost another 5,000 killed."<sup>117</sup> In addition, the 10th SS Panzer Division had been scheduled for the Ardennes offensive, but never made it.<sup>118</sup> But this success was not without cost. The Germans "had inflicted upon the Ninth Army more than ten thousand battle casualties: 1,133 killed, 6,864 wounded, and 2,059 missing," and destroyed over 100 tanks while the elements claimed another 20,000 non-battle casualties.<sup>119</sup> The cold, wet weather had taken its toll on the infantrymen, with trench foot the most serious casualty. In the first 15 days of the Roer River offensive, trench foot cases "constituted 8.2 percent of all medical admissions in the Ninth Army," and it was "directly attributable to the wet and the cold."<sup>120</sup> Hindsight made it clear that Ninth Army, with a much more favorable jumping off position on a flat, treeless plain and already inside the Siegfried Line, should have been the Army Group's main effort. McDonald, again, observed, "Even a superficial glance at the terrain in front of the Ninth Army as opposed to that facing the First Army would raise the question of why the First instead of the Ninth

drew the role of 'main effort' in the November offensive."<sup>121</sup> But Ninth Army, at the beginning of November, was an untried and untested organization. After Queen, that was no longer true.

The Queen offensive highlighted the increasingly effective cooperation between groups and squadrons of XXIX TAC and the corps and divisions of Ninth Army. Again, deferring to Charles McDonald, "the ground troops gradually developed confidence in their air support and a genuine appreciation of it. Troops who early in the campaign seldom asked for air strikes against targets closer than a thousand yards from the front lines later were naming targets as close as 300 yards. For their part, airmen came to appreciate the effective protection which artillery could provide against enemy flak. To help promote mutual understanding, teams of pilots and ground officers were exchanged for several days at a time to share their opposites' living conditions and combat hazards."<sup>122</sup> All of these things, from increasing ground troops' confidence in air's capabilities, to coordinating with artillery and anti-aircraft units, to exchanging personnel, had been tested and proven in the training grounds in the years preceding.

Post-mortems on Queen and the efficacy of heavy bombers in the tactical support role remained. A Ninth Army study found,

Initially progress was limited since the attack ran into very strong enemy defensive positions covered by wire and mine fields. Very bitter fighting ensued when the enemy launched counterattacks and losses were considerable on both sides... Later substantial progress was made through the enemy defensive belt and leading elements engaged the main enemy strong point at Eschweiler, where enemy resistance soon weakened... The advance of the Allied Armies has been supported to the fullest possible extent daily by the IX and XXIX Tactical Air Commands.<sup>123</sup>

The study recommended continued and constant efforts to mark the front lines, especially with the decreasing effectiveness of German air, the employment of 260-lb fragmentation bombs with instantaneous fuses to inflict maximum damage with minimal cratering, and a rapid advance, in which, "every effort should be made to reach the enemy before he can recover from the initial shock of bombardment."<sup>124</sup> In addition, the "bombing should be continuous. Only by hitting the enemy again and again as the troops are advancing can the maximum in air support be achieved."<sup>125</sup> Additional recommendation included, "Whenever practical fighter bomber planes should remain over the bombed area for the longest possible period after the attack by heavier planes. The mere presence of the planes causes material reduction in the amount of artillery fire received while our troops are attacking" and, "Coordination between air and ground forces is best achieved by a mutual understanding of problems and capabilities. Key personnel should visit either air or ground force headquarters whenever possible."<sup>126</sup>

The doctrine established early in the war proved viable. Winning air superiority provided aircraft the freedom to wage an interdiction campaign and enabled direct participation in the ground battle. Assigning groups to individual TACs did not limit their utility or prevent concentration, as demonstrated in the rapid response to the Bulge breakthrough. Major General Gillem, commanding XIII Corps, wrote his son, a pilot who had completed a tour with the 31st Fighter Group in Italy and was then a staff officer in the plans division of the Headquarters, Army Air Forces, "The air is doing a fine job over here, and particularly so in connection with tanks. I visualized this possibility some time back and I know it must be very comforting to the people on the ground to have that close support, something which a great many people didn't want. It is facilitating the

advance on all fronts and will continue to do so as long as they wipe out the German air. The latter is absolutely missing in the back areas; there is no such thing, I know.”<sup>127</sup>

A Ninth Army study completed in 1945 found that the first few hours of “Operation ‘Q’ was the largest scale close support effort ever flown by the American Air Forces. No allied lives were lost as a result of the effort. The operation was successful.”<sup>128</sup> While success can be relative, the statement is undoubtedly true. Ninth Army and XXIX TAC, along with First Army and IX TAC, and the heavy bomber forces still in England, successfully planned and executed a major operation that substantially improved the Allied position, continued the steady attrition of German combat power, and blunted the effectiveness of the German counterattack, truly Germany’s last desperate gamble of the war. Perhaps most importantly, it had introduced yet another highly capable, well-trained, and now experienced air-ground team to the Allied order of battle. Operating under British control in the months that followed, Ninth Army and XXIX TAC continued their successful cooperation, finally forcing the long-deferred opposed crossing of the Roer, an exercise itself extensively practiced in all of the stateside maneuver areas. While apparently unsuccessful in winning the war before the end of the year, Ninth Army and XXIX TAC’s efforts ensured that the German effort to defend their borders and continue hostilities could not extend very far into the new year.

## Notes

1. Craven and Cate, *The Army Air Forces in World War II*, Vol. III, 124. The four groups operational dates were 20 Apr. (48th FG), 1 May (404th FG) and 8 May (36th and 373rd FGs). The 363rd TRG transitioned from a P-51 group to a tactical reconnaissance group in August of 1944, with an entirely new cadre of pilots, though it did not receive its photographic reconnaissance squadron, the 33rd, until the first week of November. But all five XXIX TAC groups had the maximum amount of time stateside before deploying to the theater. Many of their commanders had longer experience, but the formation had been built and trained in air-ground cooperation during late 1943 and early 1944. On 31 October, the groups of Nugent's force occupied the following airfields: The 36th and 373rd FGs were at Le Culot, (now Beauvechain) Belgium, 40 miles west of XXIX TAC HQ at Maastricht while the 363rd TRG operated from Le Culot East (now Goetsenhoven) eight miles away. The 48th and 404th FGs were at St. Trond, Belgium, 20 miles west of Maastricht, which was itself only 20 miles west of the front. Thus, flight times to the front lines were less than ten minutes at full throttle.

2. Parker, *Conquer*, 78.

3. McDonald, *Siegfried Line*, 386, 396; Parker, *Conquer*, 75.

4. Parker, *Conquer*, 80.

5. Headquarters, Ninth United States Army, "Study of Air Support Given First and Ninth Armies During Operation 'Q'" 23 January 1945, Folder 109-0.4, Box 2408, Entry 427, World War II Operations Reports, 1940-1948, Ninth Army, Record Group 407, Records of the Adjutant General's Office, National Archives and Records Administration, College Park, MD.

6. Nugent's War Diary, 2 and 3 November 1944.

7. McDonald, *Siegfried Line*, 403.

8. Parker, *Conquer*, 80.

9. McDonald, *Siegfried Line*, 404.

10. "Study of Air Support Given First and Ninth Armies During Operation 'Q.'"

11. "Study of Air Support Given First and Ninth Armies During Operation 'Q.;" Parker, *Conquer*, 81; McDonald, *Siegfried Line*, 404.

12. Parker, *Conquer*, 80.

13. IX TAC Headquarters, "Operation 'Q,'" Box 54, Hoyt Vandenberg Papers, Library of Congress, Washington, DC.

14. "Study of Air Support Given First and Ninth Armies During Operation 'Q.'"

15. Summarized from McDonald, *The Siegfried Line Campaign*, 391-406, Parker, *Conquer*; and "Hell on Wheels in the Drive to the Roer: The Employment of the 2nd Armored Division in a Limited Objective Attack," unpub. research report, Officers Advanced Course, The Armored School, Fort Knox, KY, 1949, copy in Combined Arms Research Library, Fort Leavenworth, KS.

16. "Hell on Wheels," 5.

17. See Harry Yeide, *The Longest Battle: September 1944 to February 1945 from Aachen to the Roer and Across* (St. Paul, MN: Zenith Press, 2005), 106-110; "Hell on Wheels," 6.

18. Nugent's War Diary, 8 November 1944.

19. IX Tactical Air Command, "Operation 'Q.'"

20. IX Tactical Air Command, "Operation 'Q.'"

21. Nugent's War Diary, 14 November, 1944.

22. "363rd Tactical Reconnaissance Group Post-Mission Reports," GP-RCN-363-SU-RE-D, AFHRA, Maxwell AFB, AL.

23. Nugent's War Diary, 14 November 1944; Simpson to Alvan C. Gillem, 15 November 1944 in Alvan C. Gillem Papers, Army Heritage and Education Center, Carlisle Barracks, PA.

24. Simpson to Alvan C. Gillem.

25. "Study of Air Support Given First and Ninth Armies During Operation 'Q.'"

26. Yeide, *The Longest Battle*, 112.

27. "Study of Air Support Given First and Ninth Armies During Operation 'Q.'"
28. "Enemy Reaction to the Air Bombardment, 16 Nov. 1944," in First US Army G-2 Periodic Report 165, 22 November 1944, reprinted in HQ, IX TAC, "Operation 'Q' and Offensive by First and Ninth U.S. Armies," 23 February 1945, in Folder "1944, Operation 'Q'", Box 7, Courtney Hodges Papers, Dwight D. Eisenhower Presidential Library, Abilene, KS.
29. McDonald, *Siegfried Line*, 525; XXIX TAC Periodic History, October 1944-April 1945, 538.02, Air Force Historical Research Agency, Maxwell AFB, AL.
30. "Hell on Wheels," 13.
31. "Hell on Wheels," 36-37.
32. McDonald, *Siegfried Line*, 500.
33. Yeide, *The Longest Battle*, 122.
34. McDonald, *Siegfried Line*, 525.
35. McDonald, 525.
36. IX Tactical Air Command, "Operation 'Q,'" 13.
37. 404th Fighter Group, Mission Reports, November 1944, Folder "404th Fighter Group," Box 3462, Entry 7, Record Group 18, Records of the Army Air Forces, NARA2, College Park, MD.
38. McDonald, *Siegfried Line*, 532.
39. Nugent's War Diary, 17 November 1944.
40. Nugent's War Diary, 17 November 1944.
41. Nugent's War Diary, 17 November 1944.
42. McDonald, *Siegfried Line*, 503.
43. McDonald, 536.
44. "Hell on Wheels," 36-37.
45. McDonald, *Siegfried Line*, 540.
46. Nugent's War Diary, 18 November 1944.
47. Hell on Wheels," 36-37.
48. "363rd Tactical Reconnaissance Group History," GP-RCN-363-HI, AFHRA, Maxwell AFB, AL.
49. IX TAC Headquarters, "Operation 'Q'," Box 54, Hoyt Vandenberg Papers, Library of Congress, Washington, DC.
50. Nugent's War Diary, 19 November 1944; McDonald, *Siegfried Line*, 505.
51. McDonald, 539.
52. McDonald, 530.
53. "Hell on Wheels," 63; Nugent's War Diary, 20 November 1944.
54. McDonald, *Siegfried Line*, 548.
55. Brian Horrocks, *A Full Life* (London: Collins, 1960), 235, quoted in Yeide, *The Longest Battle*, 159.
56. McDonald, *Siegfried Line*, 545.
57. 404th Fighter Group, Mission Reports; Steven Ossad, *Omar Nelson Bradley: America's GI General* (Columbia: University of Missouri Press, 2017), 211. The 404th missions launched at 0730, 1030, 1035, 1110, 1315, 1345, 1345, and 1530.
58. Nugent's War Diary, 21 November 1944.
59. Nugent's War Diary, 23 November 1944.
60. Nugent's War Diary, 26 November 1944; XXIX TAC Periodic History.
61. Nugent's War Diary, 22 and 23 November 1944. See Hughes, *Overlord* for a discussion of Quesada's and Hodge's frustration with First Army's inability to punch through to the Roer.
62. Robert L. Hewitt, *Work Horse of the Western Front: The Story of the 30th Infantry Division* (Washington, DC: Infantry Journal Press, 1946), 160; Robert Baumer, *Old Hickory, The 30th Division: The Top-Rated American Infantry Division in Europe in World War II* (Guilford, CT: Stackpole, 2017), 351-352.
63. McDonald, *Siegfried Line*, 556.
64. McDonald, 567.



65. McDonald, 559.
66. "Study of Air Support Given First and Ninth Armies During Operation 'Q.'"
  67. Nugent's War Diary, 27 and 29 November 1944.
  68. See Thomas Hughes, *Overlord: General Pete Quesada and the Triumph of Tactical Air Power in World War II* (New York: The Free Press, 1995).
  69. Balkoski, *Our Tortured Souls*, 198.
  70. Balkoski, 199.
  71. Balkoski, 200.
  72. Balkoski, 206-7.
  73. Balkoski, 210.
  74. *Mission Accomplished: The Story of XXIX TAC*.
  75. "Study of Air Support Given First and Ninth Armies During Operation 'Q'"
    76. Balkoski *Our Tortured Souls*, 185.
    77. Yeide, *The Longest Battle*, 190.
    78. "Study of Air Support Given First and Ninth Armies During Operation 'Q'"
      79. "Study of Air Support Given First and Ninth Armies During Operation 'Q'"
        80. Yeide, *The Longest Battle*, 195; XXIX TAC Periodic History.
        81. 404th Fighter Group, Mission Reports.
        82. 404th Fighter Group, Mission Reports.
        83. Nugent's War Diary, 28 November 1944.
        84. Nugent's War Diary, 29 November 1944.
        85. Nugent's War Diary, 29 November 1944.
        86. "Study of Air Support Given First and Ninth Armies During Operation 'Q.'"
          87. McDonald, *Siegfried Line*, 568.
          88. Nugent's War Diary, 29-30 November 1944.
          89. Nugent's War Diary, 1 December 1944.
          90. McDonald, *Siegfried Line*, 598.
          91. XXIX TAC Periodic History.
          92. "Study of Air Support Given First and Ninth Armies During Operation 'Q,'" 11.
          93. McDonald, *Siegfried Line*, 577.
          94. McDonald, 577.
          95. *Mission Accomplished: The Story of the XXIX TAC*.
          96. McDonald, *Siegfried Line*, 577.
          97. McDonald, 574, 621.
          98. *Mission Accomplished: The Story of the XXIX TAC*.
          99. "XIX Corps Demonstration, 2nd Armored Division Tank-infantry Assault of Tactical Locality, 30th Infantry Division Infantry Assault of Fortified Village," N4770, Combined Arms Research Library, Fort Leavenworth, KS.
            100. "XIX Corps Demonstration," 162.
            101. "XIX Corps Demonstration."
            102. "XIX Corps Demonstration," 2.
            103. "XIX Corps Demonstration," 1.
            104. 404th Fighter Group, Mission Reports.
            105. Nugent's War Diary, 25 November, 2, 5, and 10 December 1944.
            106. Nugent's War Diary, 11, 12, 13 and 14 December 1944.
            107. Nugent's War Diary, 16-19 December 1944.
            108. Simpson War Diary, 17 December 1944.
            109. Hugh Cole, *The Ardennes and the Battle of the Bulge* (Washington, DC: Center of Military History, 1965), 261-264; Simpson War Diary, 23 December 1944.

110. Nugent's War Diary, 22 December 1944.
111. Nugent's War Diary, 20-23 December 1944; AFHRA GP-RCN-363-HI.
112. Nugent's War Diary, 20-23 December 1944.
113. Nugent's War Diary, 20-23 December 1944.
114. Nugent's War Diary, 25-31 December 1944.
115. McDonald, *Siegfried Line*, 577, 619.
116. McDonald, 622.
117. McDonald, 577.
118. McDonald, 616.
119. McDonald, 577, 617.
120. McDonald, 617.
121. McDonald, 401.
122. McDonald, 382.
123. "Study of Air Support Given First and Ninth Armies During Operation 'Q,'" 11.
124. "Study of Air Support Given First and Ninth Armies During Operation 'Q,'" 11.
125. "Study of Air Support Given First and Ninth Armies During Operation 'Q,'" 11.
126. "Study of Air Support Given First and Ninth Armies During Operation 'Q,'" 11.
127. Letter, 16 September 1944, Alvan C. Gillem to Alvan Cullom Gillem, Jr., Box 6, Gillem Papers, Army Heritage and Education Center, Carlisle Barracks, PA.
128. "Study of Air Support Given First and Ninth Armies During Operation 'Q,'" 2.

## Chapter 6

### Operation Grenade

#### Closing up to the Rhine, January-February 1945

As 1945 opened in the Ninth Army-XXIX TAC sector of the Allied front lines, the situation was, in many respects, the same as it had been for weeks. Ninth Army still held an elongated frontage along the Roer River, staring across the valley into the tempting, open country of the North German Plain and the Rhine, just 20 miles away. Beyond that lay the great German industrial corridor of the Ruhr, without which the Reich could surely not continue the war, and beyond that, Berlin, still an imposing distance away, but much less than what the Army had already covered from Brest to the banks of the Roer. In other respects, though, the situation had changed dramatically as a result of the German counteroffensive in the Ardennes. The “last gasp” had failed miserably and Hitler had tossed away much of Germany’s shrinking supply of available military power, including men, armor, and aircraft, in one roll of the dice. American defenders inflicted heavy losses on German mobile forces, the key to halting any penetration, especially when the blanket of clouds lifted around Christmas, allowing Allied aircraft to savage the exposed columns strung out on the narrow and constricted roads in the rugged and heavily forested region. While counterattacks from First and especially Third Army did manage to repel the assault, winning the “Battle of the Bulge,” they were unable to seal off the penetration and trap the German forces inside it. Instead, they slowly squeezed the “bulge” like a tube of toothpaste, allowing many of the German divisions to escape. Fortunately, the benefits of waging war as part of a grand alliance now came into play. On 12 January, the Soviets opened their long-awaited grand winter offensive along the Vistula, crushing Germany’s eastern flank, necessitating the withdrawal and redeployment of the Bulge survivors. Thus, German combat power in the west took a second heavy blow, leaving a much-weakened crust facing Ninth Army.

While its adversary had suffered a significant decline, Ninth Army had not emerged unscathed from the month-long battle. From the strong force positioned on the Roer on 16 December, it now had only five divisions covering almost double the frontage it had before the attack. In the north, Maj. Gen. Alvan Gillem’s XIII corps, which had won its spurs in Operation Queen, had only the 29th and 102nd divisions to hold what before the counteroffensive had been the Ninth Army’s entire 15-mile frontage. To free up First Army resources for the northern shoulder of the Bulge, Maj. Gen. Raymond McLain’s XIX Corps took over VII Corps’ frontage in the Hurtgen, and held the thirty miles from Julich to Simmerath with the 104th, 8th, and 78th Infantry Divisions, from north to south. In the event of a German attack in Ninth Army’s sector, an unlikely but still possible course of action, as demonstrated by the *Nordwind* attack against Seventh Army on 1 January, Simpson had no mobile reserve to counter the threat. The five overstretched infantry divisions were a far cry from the powerful, 12-division, three-corps army he led in Operation Grenade a little over a month later.

While Nugent’s XXIX TAC did not suffer the same level of force reductions through reassignment as Ninth Army, it still found its efforts focused to the south. Despite losing the two tactical reconnaissance squadrons to IX TAC in late December, the four fighter-bomber groups continued to work in the area over and behind the Bulge through mid-January, while British

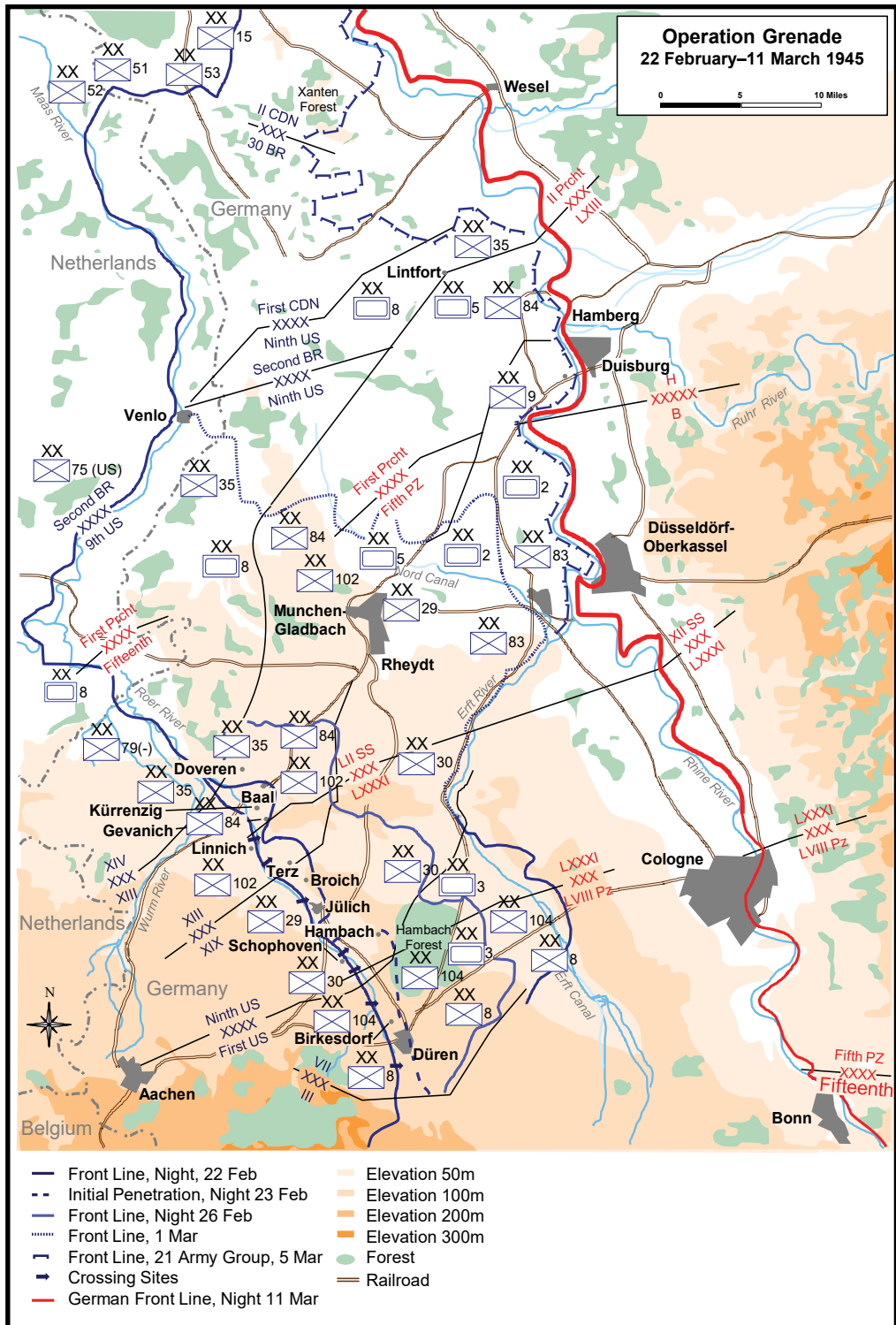

Figure 6.1. Ninth US Army in Operation Grenade. Graphic created by Army University Press staff.

Photographic Reconnaissance Units (PRUs) took over the mission of surveilling Ninth Army's front for signs of activity. But an attempted German airstrike on Allied air bases up and down the front, intending to catch weary revelers still in their bunks early on the morning of 1 January, inflicted heavy losses on RAF forces in 2nd TAF, leading to the loss of regular surveillance across the Roer. Fortunately, XXIX TAC's 363rd TRG regained one of its tactical squadrons, the 161st TRS, on 5 January, allowing it to resume the mission, but the 160th did not return until 7 February.<sup>1</sup> XXIX TAC's airbases also suffered heavy losses in Operation *Boden-Platte*, as German Me-109s of *Jagdgeschwader 2* and Fw-190s of *Schlachtgeschwader 4* attacked A-92 (St. Trond), home to the 48th and 404th Fighter Groups, destroying five aircraft, including three heavy bombers that had made emergency landings at the field, and damaging another 27 P-47s and two more B-17s, while the defending anti-aircraft gunners knocked down five of the attackers.<sup>2</sup> But the force assigned to A-89 (Le Culot) hit B-56 (Evere and Haren, near Brussels, now the NATO Headquarters) instead, sparing the 36th and 373rd Fighter Groups any losses but inflicting heavy casualties on the RAF. Nugent recalled, "the British to the north of us suffered heavily according to Americans who were at their fields."<sup>3</sup> German aircraft even strafed the combined Ninth Army and XXIX TAC headquarters in Maastricht but did not inflict any significant damage. Across the Ninth Army sector, anti-aircraft gunners brought down an estimated 70 of the 200 attackers, inflicting heavy losses.<sup>4</sup> Unfortunately, the attacks led to jumpy anti-aircraft gunners targeting returning Allied aircraft, an additional benefit of injecting any entropy into a system and contesting control of the air. But before Nugent could count his blessings that the groups remained near full strength, on 15 January he lost both the 48th and 404th groups to IX TAC, part of a larger reshuffling intended to switch the bulk of the tactical support aircraft to the Ninth Army front for the resumption of the offensive.

Nugent expected to receive seven fighter-bomber groups but, in the end, got only five. He suspected that 9th Air Force Headquarters had withheld the additional groups from his command because Ninth Army was still under British 21st Army Group's control, and Bradley was loathe to allow any more resources to come under Montgomery's command if he could prevent it. Bradley's shallowness undermined the coalition, especially considering that the main Allied effort in February came in the 21st Army Group sector. Fortunately, the RAF's 2nd TAF and Nugent's five groups in XXIX TAC, augmented when required with sorties from Quesada's adjoining IX TAC, provided adequate air support for the ground commanders in the upcoming offensive.

The Allied plan for resuming the offensive involved a classic "pincers" attack by the First Canadian Army in the north and Ninth Army in the south. From positions gained in the failed Market Garden offensive in September the British and Canadian forces planned to drive south-east between the Maas and Rhine Rivers to what they hoped would be a jump-off point for crossing the Rhine just north of the Ruhr near Wesel. Montgomery intended for an offensive in this area to take advantage of the Allies' four great advantages, armor, fighter-bombers, transportation, and gasoline, and "Simpson proposed that an attack be launched in the terrain best suited to exploit these items of Allied superiority."<sup>5</sup> With Ninth Army driving northeast from a crossing of the Roer, the two armies had the potential to produce a classic *kesselschlacht*, or "cauldron battle," encircling the German forces west of the Rhine and opening a path for an unopposed advance by the British Second Army, holding the sector between the two attacking forces.<sup>6</sup> Although intended to be a simultaneous offensive, the German destruction of the Roer

dams on the eve of Ninth Army's scheduled offensive delayed its jump off by two weeks, leaving the combined Canadian and British army to face the Germans alone. But this eventually led to a repetition of what had happened in Normandy in July. When German armor concentrated against the First Canadian Army's thrust, as it had against the British at Caen, it left a weakened flank for exploitation. Just as Bradley's First Army broke through the German lines at St. Lo, Simpson's Ninth faced a fatally weakened enemy across the Roer. One significant difference was the employment of airpower in the attack. While Bradley insisted, both in Cobra and in repeated instances afterwards, including Operation Queen, on a robust employment of strategic bombers to blast a path through German defenses. Simpson, and particularly his principal air advisor, Nugent, had determined that this was not the best course of action. Waiting until after noon while the heavy bombers performed their work during Queen cost the attackers half a day, and gave the Germans a long night to repair damage and reestablish positions. It would also require a withdrawal from the front lines of as much as 3,000 yards, to provide an effective safety cushion, which the ground forces vehemently opposed.<sup>7</sup>

Nugent felt that the preparatory bombardment was an ideal mission for field artillery, especially now that they enjoyed adequate stocks of ammunition through the recently reopened port of Antwerp. This also freed up Nugent's command to work on the AAF's preferred mission of interdiction, now that supremacy had been assured over the battle area. Airmen such as Nugent argued that the costs were lower and effects greater when aircraft went after roads and rail lines in the rear, rather than the better defended static positions on the front lines. But they remained willing, and able to perform the CAS mission, especially once the attackers shook free. Nugent betrayed his background as an armor officer when he revealed in an interview just before the jump-off,

I would not send any of my planes out just to help the morale of the ground troops, but if the strafing would make the Jerries keep their heads down and stirred up, well, that's a legitimate employment of air power, if our infantry takes advantage of the situation. There's one thing I believe should not be done, and that is taking away the planes when an armored column is on the move. Major General White, who commands the 2nd Armored, told me how the Germans could counter-attack if the fighter-bombers left the advancing column, but as long as our planes were there the Germans didn't dare bring out their tanks, armored vehicles and tank destroyers. No such air cover will ever be diverted by our control center.<sup>8</sup>

In the same interview, in which Maj. Harry Franck described him as a "pocket-sized Eisenhower with the same kind of baldness, easy smile, and obvious competency," Nugent elaborated on his thoughts on the employment of airpower:

I don't believe in carpet bombing and I've talked the Ninth Army out of using it. That is the artillery's job and it was done at St. Lo only because we didn't have enough artillery ammunition on the continent at the time. But using airpower for such a job is like sending clerks out to battle.<sup>9</sup>

Events in the Army sector helped reinforce this belief, especially after an attack on the 104th Infantry Division's command post on 10 January by an errant heavy bomber that killed twenty men and wounded another fifty.<sup>10</sup> Nugent clearly preferred the important work his forces had done in the interdiction campaign, an effort echoed in the AAF's Operation Clarion, a

theater-wide attack on all elements of Germany's transportation system launched the day prior to Ninth Army's attack. Nugent said,

I believe an excellent example of our work recently is what we did to the marshalling yards at Neuss as an aid in isolating this part of the battlefield. The main bridges are permanently cut and now we're piling up the rail cuts as a prelude to the jump-off. We damaged the Neuss bridges and then when the rail traffic jammed up in the Neuss marshalling yard we smacked it. Traffic has been forced east of the Rhine, so we switched over to catch it there, especially the north and south movements. That we couldn't hit the Rhine bridges affected our interdiction plan a great deal, of course, because we build such operations around natural obstacles, above all, big rivers like the Rhine. The flak around those bridges is terrible, however, and it'd cost the heavies a lot to attack them.

Nugent's views about the suitability of the bridges for heavy bomber attack are questionable, but reflect service prerogatives dating at least to the evacuation of Messina at Sicily, when the AAF leadership preferred to use the heavies in that theater against targets far afield rather than attempting to prevent the evacuation.<sup>11</sup> Had the heavy bombers dropped the bridges over the Rhine, they certainly would have relieved Nugent's force of a heavy burden, but they also would have precluded the coup at Remagen.<sup>12</sup> As it was, the priority of the interdiction effort is clearly reflected in the missions his force flew prior to and during Operation Grenade. While "armed recon," including on-call CAS, or "armored column cover," still featured prominently in his groups' post-mission reports, by far most of the scheduled missions targeted the German rail system, both east and west of the Rhine.

For his part, Lieutenant General Simpson wasn't as sure about the bridges, but certainly appreciated the support his forces received. On the same day that Harry Franck interviewed Nugent, he also gained an audience with Simpson. The lanky Texan, who had appeared on the cover of *Time* magazine the day before, told his questioner, "It's out of my field, though I must say it would have been helpful." Perhaps "some of the higher-ups figured we could win west of the Rhine and wanted those bridges open so the German could send stuff over and commit themselves. The policy might slow me down locally, but in the whole picture mean more for the war." Here Simpson demonstrated his appreciation of the broader contexts of waging modern war. Rather than focus on the yard-by-yard advances of his own army, in comparison to his peers, he was happy to do whatever it took to win, even if it meant sitting on his hands for two months while photos of Bradley, Hodges, and Patton filled the news magazines back home. The Army's official history found, "The headquarters already had established a reputation for steady, workmanlike performance. As General Bradley was to put it later, the Ninth Army, 'unlike the noisy and bumptious Third and the temperamental First,' was 'uncommonly normal.'"<sup>13</sup>

Overall Simpson was very pleased with the support he received from XXIX TAC, especially during his previous operation.

I consider the XXIX TAC's support in our November 16th drive as an excellent example of air power. When we advanced to the Roer opposite Julich, covering ten or twelve miles and gaining all our objectives, the Germans made a last-ditch stand at the Sportpalast [Sportplatz] a sergeant in the 29th Division led a platoon

into it right after the dive bombers plastered it and got a battlefield commission for his work. These soldiers approve of close, really close, support. The XIXth Corps, our oldest corps from the point of view of action on the line, repeatedly says that XXIXth TAC gives them the best support possible.<sup>14</sup>

And the interview also revealed his willingness to have the spotlight shine on others:

The Third and First Armies, with the break-through to cope with, really have a better example there on the importance of airpower than I can give you. But there is no question about it, tactical airpower is a tremendous factor in all advances, and not only by close support but by isolation of the battlefield and by strategic bombing. Harrying them as they retreat by destroying their vehicles is very important and makes a big difference.<sup>15</sup>

Thus, while Simpson appreciated XXIX TAC's ability and willingness to intervene directly on the battlefield when required, he obviously understood the tremendous advantages conferred by keeping the German air off his supply depots and logistics lines, and the fighter-bombers' ability to limit the forces his troops had to face across the lines. The resumption of mobile warfare and breakout to the Rhine highlighted these advantages, as air and armor resumed their highly successful partnership brokered in the breakout across France, and German forces fleeing the front or moving to counterattack found themselves much more vulnerable than they had been dug into bunkers hidden in the basements of villages in the Roer valley.

The first step in throwing three full corps across the Roer came in rebuilding Ninth Army and XXIX TAC back to full strength. As the Bulge battle wound down, Simpson received many of his old divisions back, and placed them in line almost exactly where they had been in November, highlighting the temporary nature of the German disruption to Allied plans. As Charles McDonald detailed in *The Last Offensive*, the Army's official history of the campaign, Ninth Army had only five divisions in Gillem's XIII Corps and McLain's XIX Corps, but needed to build to ten divisions, allowing three in each corps and one in army reserve. The first move was to reduce the army's extended frontage to allow Simpson to focus on the narrow attack zone. On 5 February, he handed XIX Corps' three divisions back to the First Army's VII Corps, still on Ninth Army's right flank, but across what was now the Army Group boundary. This reduced the attack frontage to a more manageable twenty miles but cut the army down to only two divisions, meaning he now needed eight more. XIX Corps, now without any assigned divisions, shifted left to take over XIII Corps's 29th Infantry Division, then received back the two divisions detached to deal with the emergency, the 30th Infantry Division and 2nd Armored Division, rebuilding the corps to its former strength during Queen. In addition, as XIX Corps had the most difficult mission of moving along the outside of Ninth Army's wheeling attack to the left, McLain also received the 83rd Infantry Division, temporarily in corps reserve but available to plug any gaps that might open in the widening front. Gillem's XIII Corps kept the 102nd Infantry Division, welcomed the return of the 84th Infantry Division, and received the 5th Armored Division to replace the 7th Armored Division it lost in December. These two veteran corps provided the powerful strike across the Roer.<sup>16</sup>

From 15-26 January, the British XII Corps, consisting of the 43rd (Wessex), 52nd (Lowland), and 7th Armored (Desert Rats) Divisions, supported by the American 102nd Division and aircraft from XXIX TAC, launched Operation Blackcock to clear a dangerous salient into



the 21st Army Group lines around Heinsberg.<sup>17</sup> But the imminent plans for Operation Veritable, the First Canadian Army's portion of the double envelopment, meant Montgomery wanted to reduce the British Second Army's frontage in order to concentrate his strength on his left. Accordingly, Maj. Gen. John B. Anderson's untested XVI Corps moved into the sector but with three veteran divisions, the 35th and 79th Infantry Divisions and the 8th Armored Division to bolster the new headquarters, All three had been involved in the fighting on the southern side of the salient or in the expanded Seventh Army zone in Alsace. XVI Corps was not scheduled to participate in the initial assault, but would follow the other two corps across the Roer. As XIII corps wheeled north, it would uncover the crossing sites in the XVI Corps zone, eliminating the requirement for a contested crossing.<sup>18</sup> The new assignments gave the Ninth Army a total of ten divisions in three full-strength corps. Two additional infantry divisions, the 75th and 95th, received temporary assignments elsewhere in 21st Army Group, but later came under Ninth Army control as army reserves. Of the twelve total divisions that participated in Operation Grenade with Ninth Army, all except the 29th Infantry Division and 2nd Armored Division were later-deployers who had completed a full maneuver period after the summer of 1943.<sup>19</sup>

XXIX TAC enjoyed a similar period of strengthening in the weeks prior to the offensive. At the beginning of January, most of the fighter-bomber groups were still engaged against the German forces retreating from the "Bulge," primarily over the area between St. Vith and Coblenz, but by mid-month they shifted back to the Ninth Army sector, flying mostly interdiction missions.<sup>20</sup> With the departure of the 48th and 404th groups on 16 January, Nugent had only the 36th and 373rd Fighter Groups remaining in his command, as well as the understrength 363rd Tactical Reconnaissance Group, leading a frustrated Nugent to comment, "there are either too many TACs or insufficient groups. This is evidenced by the cannibalization of the forces available to one TAC to permit another to operate effectively."<sup>21</sup> Nugent also seethed at the declining effectiveness of his force, writing,

the accuracy of dive bombing of this Command has reached an all-time low. Over four group missions have been sent out in the past few weeks to knock out one wooden bridge; the bridge still stands. I have directed Col. Meyer to put one squadron per day on the Dive-Bombing range until reasonable accuracy is obtained. We have all neglected training in the hurly burly of combat. This lack is now forcibly impressed on our consciousness by failure of combat effort to produce results.<sup>22</sup>

On 21 January, Nugent finally received some good news when he learned that XXIX TAC would be rebuilt to six total groups (five FG, one TRG), but he remained concerned about continuing enemy air attacks on his vital SCR-584 radars at his forward director posts (FDPs), which resulted in damage and injuries for the crews, and for the safety of his microwave early warning (MEW) radar, which still had not arrived, as the large radar would be an obvious target and require much better protection than was currently being afforded.<sup>23</sup> On 17 February, Nugent learned that the MEW was to be sited at Valkenburg, and would with work closely with the existing FCC, but Nugent elected not to shift his headquarters to the MEW site.<sup>24</sup>

On 22 January, Nugent learned the details of the plus-up to his command. The two groups at Le Culot (the 36th and 373rd) moved to IX TAC on 28 January, while XXIX TAC gained the airfields at Y-29 (Asch, now Zutendaal) with the 366th Fighter Group, and Y-32 (Ophoven) with the 370th Fighter Group, the first and only P-38 *Lightning*-equipped group to serve with XXIX TAC, thought the unit transitioned to P-51 *Mustangs* in March. On 8 February, XXIX

TAC gained the 406th Fighter Group, alongside the 366th at Asch, and the 405th at Ophoven, along with the 370th, and the 373rd Fighter Group returned to XXIX TAC Control after a brief, two-week absence (See Figure 4.7. Squadrons Assigned to XXIX TAC on page 100).<sup>25</sup> Nugent welcomed the build-up but the final transfers had come in just days before the scheduled jump-off on 10 February, leading to a chaotic period of planning for the offensive. At full strength, he had over 300 fighter-bombers in his command, and could call on similar numbers from IX and XIX TAC in an emergency, as well as over 600 medium bombers and almost 3,000 heavies. Against this aerial armada, Nugent's A-2 estimated German air strength at less than 400 day fighters, including 75 jets, and an equal number of night fighters and bombers. It was unlikely that a heavily damaged Luftwaffe would be able to intervene significantly in the coming battle.<sup>26</sup> Throughout the month of January, XXIX TAC flew 2,453 sorties, dropping 1,009 tons of bombs, and lost 17 aircraft, most to ground fire.<sup>27</sup> The XXIX TAC football team provided a small bright spot and welcome diversion on 28 January at Chantilly with a 12-0 victory over the 2nd AADA, according to Nugent, "composed of many college football stars including at least one All American," winning the 9th Air Force championship, and on 6 February the TAC commander treated the team to dinner at his own "personal expense."<sup>27</sup> By the time of the attack, Ninth Army and XXIX TAC controlled over 300,000 men, five groups of fighter-bombers and another TRG, and over 1,400 tanks, while building up ample stocks of ammunition to support the attack. Opposing them, the Germans had only four understrength infantry and Volksgrenadier divisions, giving Ninth Army a 6:1 advantage in manpower.<sup>28</sup>

At the beginning of February, Nugent's two remaining groups focused on honing their dive bombing skills with attacks on bridges designed to interdict German transportation. The 366th hit bridges near Einruhr and Stomeln on multiple days, while the 370th focused their efforts southwest of Neuss and at Horrem.<sup>29</sup> The interdiction effort continued after the 8th, when the other three groups came under XXIX TAC control, but this left little time to prepare for the offensive scheduled to jump off on 10 February. Fortunately, German destruction of the flood-gates on the dams upstream provided a two-week delay for the offensive. This bought Nugent's reinforced command ample time to work on the German road and rail network behind Ninth Army's front, and the entire AAF executed Operation Clarion, a theater-wide attack on all nodes of the German transportation system, which, planners hoped, would overwhelm repair forces and lead to increased petroleum use, heightening the effects on the strategic bombers' "oil plan."<sup>30</sup> Unfortunately, the delay occasioned by the flooding meant that First Canadian Army had to face the entire German strength for two weeks without any active support from Ninth Army. Though the Commonwealth forces eventually reached their objectives on the Rhine, the two weeks of slogging through the flooded valley against well-prepared German defensive positions resulted in high casualties among the Canadian and British forces. Canada's official history reported, "The total casualties of First Canadian Army for the period beginning on 8 February and extending through 10 March were computed at 1,049 officers and 14,585 other ranks; the majority of these were British soldiers, Canadian casualties numbering 379 officers and 4,925 other ranks."<sup>31</sup>

Although the Allies had long hoped that Ninth Army and 21st Army Group would form the northern arm of the encirclement of the Ruhr, the direct planning effort for Operation Grenade did not begin until mid-January. Before that time, Ninth Army had been most concerned with the possibility of a German offensive in its own zone. On 4 January, Simpson and Nugent met

to discuss plans for pulling back air support to the Ninth Army sector if it was required. Nugent briefed Simpson that he had arranged for the return of the two fighter groups then working with IX TAC as well as both of the tac recce squadrons.<sup>32</sup> The following day the army received assurances from 21st Army Group that the British 5th Armored and 43rd Infantry Divisions stood ready to support Ninth Army if required. But Nugent found the ground commanders less helpful in developing an air plan. He wrote,

All through my associations with the ground forces I found that very little comment is made on any air plan. This is due to the fact that the higher ranking officers and the senior members of their staffs are practically ignorant of Air Forces and their employment. They have little, if any, knowledge of their capabilities or their limitations. This should be corrected in the education system of the Army in peace time. Intelligent comment and constructive criticism are essential in any Air Plan which supports ground forces. The only thing the ground forces are really interested in is weight of effort. They want everything they can get in the way of air effort but as to applying it intelligently they are no help.<sup>33</sup>

Nugent's comments represent a remarkable shift in air force attitudes toward ground commanders and their control over air operations. From complaints that ground commanders were "meddling" in North Africa and concerns that ground commanders would not know how to employ their assigned airpower effectively, Nugent, found that officers in Ninth Army were either so happy with the support they received, or so trusted his judgement that they offered little constructive input. Clearly there was a fine line between too much and too little input, but it is surprising how far the pendulum had swung in such a short time.

Nugent clearly envisioned a command relationship where air and ground commanders were free, and even invited, to submit their informed views on the employment forces in other domains. At a conference with the Ninth Army commander on 9 January, Nugent expressed his concern for a German counterattack along a Simmerath-Aachen axis, through the Hurtgen Forest, and informed the Army commander that he had arranged to have the entire force of the medium bombers of the IX Bomber Command on call in the event of such an attack in order to disrupt it. He repeated these concerns in another meeting on 17 January, but, by then, the Soviet offensive had pulled most of the remaining German mobile forces out of the area. Nugent also remained concerned about the German Air Force's strength in the area, not realizing how badly they had suffered in the heavy strikes of 1 January, and planned a heavy preemptive raid on German airfields to reduce their capability.<sup>34</sup>

After receiving Montgomery's approval to move forward with planning for the offensive on 20 January, Nugent met with Simpson three days later to brief him on the status of his forces, and told him he had received assurances the command would be reinforced in time for the attack. At the meeting, the XIII Corps' Chief of Artillery, Brig. Gen Roland P. Shugg imprudently reported that he lacked night Tac-R for artillery adjustment and "would listen to no more Air Corps excuses for failure to do their job." Before Nugent could respond, Simpson rebuked Shugg and asked Nugent to explain the difficulty. Nugent reported that he had tried to brief the new organization on his pilots' capabilities and limitations but had thus far been unsuccessful. He later recalled, "I have asked these artillery men to visit me here in order that I could improve relations with them. I do not like any of them. They are ignorant, biased, and heartily dislike the air corps. However, it is essential that we work together as smoothly as possible."<sup>35</sup> But

Nugent immediately scheduled a visit by the artillery chiefs and a demonstration with his Tac Recce Group at their airfield, Le Culot East (Y-10), to facilitate direct communication with the reconnaissance squadrons on artillery adjustment.

Several senior artillery officers, with the notable exception of General Shugg, arrived for the discussion and demonstration, including attending a mission brief and debrief and an opportunity to ask the pilots questions. Nugent recorded, "These discussions were most beneficial in that where certain recommendations could not be accepted the recommending officer could understand why it could not be." In the orientation rides that followed, the tac recce aircrew made a few converts, including Brig. Gen. John Uncles, commander of the 34th Field Artillery Brigade, whom Nugent reported as, "friendly toward and sympathetic with the Air Forces. He evidently has greater knowledge than any of the others on their powers and limitations." Brig. Gen. George Shea, the XIX Corps Artillery Commander, and Brig Gen. Charles C. Brown of XVI Corps both benefitted, and Nugent recalled, "their attitude has much improved," but lamented, that "General Shugg, the most vicious and the one who needed the indoctrination most refused to go."<sup>36</sup> Air and armored forces also required improved coordination, and on 5 February Nugent met with Brig. Gen. I.D. White and Col. Gus West of the 2nd Armored Division to discuss "means of identifying friendly tanks from the air especially under present conditions where the Germans have captured quantities of our fluorescent panels and quite a number of American armored vehicles," increasing the possibility of friendly fire incidents during the mobile phase of the breakout.<sup>37</sup> On 31 January, Simpson and Nugent received confirmation that the 12th Army Group's counteroffensive had indeed slowed as it approached the Siegfried Line, and that they could expect an imminent change in effort to Ninth Army and reinforcements for XXIX TAC.<sup>38</sup>

This notification shifted the final planning for Grenade into high gear. As he and his staff developed the air plan for the crossing, Nugent recorded, "My estimate of the air situation indicates very clearly that carpet bombing is unnecessary and undesirable."<sup>39</sup> He believed that his command's fighters and the medium bombers of IX Bomber Command could handle the support requirements. He wanted a total of seven groups, including "one fighter bomber group to perform cover for each assault corps during the river crossing and to be utilized later as armored column cover when the armor breaks into the open."<sup>40</sup> The next day he and his staff briefed Simpson, who concurred with the plan, then went to 12th Army Group headquarters at Spa to coordinate the plan with Bradley's First Army, which would provide flank support. Bradley voiced his concern about the large reinforcement slated for XXIX TAC and, according to Nugent, "stated that serious consideration should be given before assigning so much force in view of the fact that it would go under British control, meaning Air Marshal Coningham, and that difficulty might be found in returning it to Tactical Air Commands operating with Twelfth Army Group."<sup>41</sup> Despite his success during the war, Bradley had a penchant at times for protecting his parochial interests and remained distrustful and suspicious of the British.<sup>42</sup>

On 3 February Nugent completed his coordination at Namur with the 9th Air Force commander, Hoyt Vandenberg, as well as XIX TAC's Otto P. Weyland and IX TAC's Elwood "Pete" Quesada. Upon learning of the final assignment of groups for the attack, Nugent was dismayed to find that he would get four groups on "lousy airdromes," Y-29 (Asch) and Y-32 (Ophoven). He wrote, "Both airdromes are built on swamps and are subject to serious danger of becoming

non-operational in the event of continuous rains which have started.”<sup>43</sup> Ophoven was the “most discouraging” as it lacked sufficient hardstands for the over 60 P-47s scheduled to arrive on 7 February and most of the aprons were under water, and the perimeter road for bomb and gas truck had become impassible for wheeled vehicles.<sup>44</sup> Nugent wanted to keep the 48th and 404th Groups at St. Trond if Ophoven became unusable, but these two groups had already departed for, and would remain with, Quesada’s IX TAC. Only the return of the 373rd Fighter Group on A-89 (Le Culot) gave him an adequate base. But Nugent felt the sting of being the lowest priority, in both numbers and capability, and “informed General Vandenberg that the number of groups which could be effectively employed on my front was limited only by the number of Groups in the Ninth Air Force, that on the breakthrough at St. Lo General Quesada used 18 fighter groups effectively.”<sup>45</sup> He expressed his desire that all groups in excess of minimum for requirements for IX and XIX TACs be sent to XXIX TAC but, perhaps due to Bradley’s influence, was refused and February opened with three equally balanced TACs for the drive to the Rhine.<sup>46</sup> Adding salt to the wound, Nugent recorded a visit to his Combat Ops Fighter Control Center on 13 February by XIX TAC’s Weyland, “sporting his brand new double stars,” as a result of his promotion to major general, reminding Brigadier General Nugent that without the numbers of fighter-bomber groups XIX had controlled during the breakout across France, there would be little opportunity for him to win similar laurels.<sup>47</sup>

Having completed the coordination with his fellow Americans, Nugent traveled the next day to No. 83 Group Headquarters at Eindhoven for a conference with the 2nd TAF commander, Air Marshal Sir Arthur Coningham, and the commanders of No. 83 Group, Air Vice Marshal Harry Broadhurst and No. 84 Group, Air Vice Marshal Edmund “Teddy” Huddleston. The commanders agreed to operate fronts separated by nationality, as P-47s had recently made high-speed passes on unidentified *Typhoons* and *Spitfires*. Coningham did not want any 8th Air Force support for his coming offensive as, “it was the opinion of higher authority, in which he concurred, that the heavies could be much more usefully employed inside Germany at this time.”<sup>48</sup> Nugent was disappointed as, “this cancels my plans for the neutralization of the German airdromes which could affect Grenade and for the destruction of the Rhine Bridges which would isolate the battle area along the Rhine,” but the likelihood of switching the 8th Air Force heavies away from oil and transportation targets was not very high.

On 7 February, the day before the scheduled jump-off for Veritable, Field Marshal Montgomery met with Simpson and his corps commanders at XIII Corps headquarters. Nugent learned that he would control seven total groups for the assault, but the additional two were IX TAC groups in the Nancy area, far from the battlefield with no landline communications, and Nugent would only have operational control of these two groups for a brief period. The next day, he learned that even this arrangement was unworkable, as interference from higher headquarters prevented his effective control. He wrote, “targets which were passed last night to the two fighter groups supposedly under my operational control were scanned over closely by the Ninth Air Force headquarters who accepted one and refused the other.” Nugent was livid, as the cancellation forced retasking of other groups to cover the scheduled mission. 9th Air Force Headquarters agreed to refrain from further interference, but the episode highlighted the dangers of over-centralization and excessive or extraneous layers in an operational chain-of-command and the negative effect on both response time and mission accomplishment.<sup>49</sup> On 9 February, Nugent met with the pilots of



Figure 6.2. General Montgomery was a frequent visitor at Ninth Army Headquarters during Operation Grenade.

the four groups fighting the mud and water at Asch and Ophoven and, “asked them for their special efforts as it would save the lives of many doughboys and would be a direct step toward our ending the war.”<sup>50</sup> But, later that day Simpson phoned to notify Nugent of the postponement due to the release of water from the dams upstream. Nugent recalled, “he, more than anyone else, was reluctant and disappointed in the necessity for postponement. The First Army was supposed to capture these dams in time to permit this operation to proceed on schedule.”<sup>51</sup> Simpson and Nugent met with Montgomery on 11 February to discuss the effects of the delay and noted that the current in the crossing zone was still eight miles per hour, and that engineers had estimated that it would take until 25 February for the flood

to completely subside. A river that was normally no more than thirty yards wide had now expanded to 300 yards, and, in some places, to over a mile.<sup>52</sup>

The Canadian attack known as Operation Veritable jumped off on schedule on 8 February with an air support program similar to that seen in the Ninth Army's sector during Operation Queen the previous November. Rather than carpet bomb directly along the front, which required either risking casualties from errant bombs or withdrawing from hard-won ground at the front in order to provide a buffer zone, RAF heavy bombers instead focused their efforts on the transportation centers of Cleve and Goch behind the lines, while 8th Air Force heavies hit the road and rail bridges at Wesel. As it would in Operation Grenade when it finally jumped off, and as the AAF had argued in pre-war doctrine, field artillery provided most of the direct fire support as well as the massive pre-attack bombardment in Veritable. RAF fighter-bombers of No. 84 Group, especially the new *Typhoons* and venerable *Spitfires* provided close air support with a "cab rank" (taxi stand) system of on-call CAS while No. 83 Group focused on protecting both the air and ground forces from interference by German aircraft. In one attack on 18 February on Moyland Wood by the Royal Winnipeg Rifles and the Fort Garry Horse, No. 84 Group flew over 100 sorties and provided key support to the attacking infantry and armor.<sup>53</sup> Unfortunately, air's ability to effectively intervene in the ground battle suffered from two important defects which the RAF could not address. The increased flow of water rushing down the Roer and, below its junction at Roermond with the Maas (Meuse), in that river as well, along with German breaches in the levee holding back the Rhine meant that much of the attack zone lay under water, canalizing the approach onto a long ridge through the Reichswald bristling with German prepared defensive positions. At the same time, the weather closed in on the battle area 9 February, effectively halting close support, leaving the RAF fighters to focus on rail interdiction and armed reconnaissance over the roads well behind the front.<sup>54</sup>

In the time between 8 February and the beginning of Operation Grenade on 23 February, the First Canadian Army gains measured between 15 and 20 miles and provided room for Operation Blockbuster, the exploitation phase of the initial infantry attack by the British 11th and Canadian 4th Armored Divisions. This attack, launched on 26 February, about the same time Ninth Army shook free from the defenses along the Roer, benefitted greatly from the combined efforts of both armies. Aircraft provided much better support during the more fluid phase of the operations, with fighter bombers hitting point targets while medium bombers focused on chokepoints and transportation centers farther afield.<sup>55</sup> Clear skies on 28 February aided the effort immeasurably, as the Canadian official history reported,

For the first time since "Blockbuster" started, there had been appreciable help from the air. Bad weather on 26 and 27 February had deprived the troops on the ground of close air support, but on the 28th conditions improved sufficiently for No. 84 Group to fly 602 sorties, of which 258 were in prearranged and 31 in immediate support. Sonsbeck was bombed and the village of Winnekendonk almost obliterated. Nearer the battle line attacks were made on gun and mortar positions, troop concentration areas and factory buildings.<sup>56</sup>

But the good weather never lasted long, and on 1 March, "Changeable weather made air support spasmodic; No. 84 Group flew 246 sorties, including 100 against pre-planned targets and 20 in 'immediate' support."<sup>57</sup>

RAF fighters battled both the elements and stubborn German defenders, leading a banner day by No. 84 Group on 2 March, when,

in spite of far from favourable weather, No. 84 Group flew more than 300 sorties over the battle area, chasing off enemy aircraft and striking at known gun and mortar positions and at barges and ferry jetties along the Rhine. At night Mosquitoes attacked the river crossings and harassed movement in the German rear. As the German bridgehead continued to shrink our pilots found their difficulties increasing. Choice of targets west of the Rhine became very limited, and the converging Allied advance made it necessary to exercise extreme care in attacks. The enemy's anti-aircraft guns in the bridgehead, were now in an unpleasantly high concentration. Moreover, No. 84 Group had been suffering such heavy casualties that on 1 March it was decided to reduce the number of aircraft operating in close support of the ground forces. This situation, combined with persistent bad weather, resulted in no close air support being available to our troops during the final week of "Blockbuster."<sup>58</sup>

Nevertheless, "the long-awaited junction between the First Canadian and Ninth US Armies came on the afternoon of 3 March, when the 4th/7th Royal Dragoon Guards, working ahead of the 53rd Division, encountered cavalry of the 16th US Corps in the village of Berendonk, three miles north-west of Geldern."<sup>59</sup> But the poor weather limited air's ability to interdict the German evacuation. Again, in the Canadian official history, C. P. Stacey reported, "German officers later expressed surprise at our air forces' failure to harass this movement more effectively; one spoke particularly of the tempting target offered by the bridges on the afternoon of 6 March, when, the damage done by the bombing having been repaired, vehicles were steadily streaming across them in daylight. But he forgot the weather: on that day it stopped flying by the tactical air forces almost entirely."<sup>60</sup> The AAF's history agreed, noting that the poor weather from 6-10 March prevented air attacks on the concentration at Wesel, but did point out that the 2nd TAF flew 21,976 sorties during the period between 1 February and 11 March, including 1,211 on 8 February alone, when "fighter-bombers of XXIX TAC and medium bombers of the IX Bombardment Division joined the attack for several days."<sup>61</sup>

As First Army closed in on the Roer dams in early February, reconnaissance sorties from the 363rd TRG confirmed that the Germans had skillfully blown open the floodgates, ensuring a steady discharge that would keep the Roer valley flooded for days, if not weeks. Lieut. William Grusy flew the mission to Schwammenauel Dam through low clouds and rain, reporting, "I had to fly in valleys and gorges, clearing hills and trees by a mere 50 feet to reach the target."<sup>62</sup> The river immediately rose by as much as five feet, widened by 1,000 yards, and increased its flow to nine feet per second, effectively preventing any crossing.<sup>63</sup> Almost a year earlier, on the morning of 21 March 1944, 21 soldiers of the 26th Infantry Division drowned when their assault boat overturned in the rain swollen Cumberland River near Averitt's Ferry in the worst training accident in the Tennessee Maneuver Area, making commanders aware of the hazards and limits of crossing flood-swollen streams.<sup>64</sup> An early thaw combined with heavy rains exacerbated the effects of the blown dams and made it seem that even Mother Nature had conspired against the soldiers and airmen anxious to end the war. But the brief respite, though it greatly increased the difficulties in the First Canadian Army's sector, actually proved beneficial for the Ninth Army-XXIX TAC team. It gave the





Figure 6.3. Ninth Army Vehicles Negotiating Flooded Streets Along the Roer River.

soldiers scheduled to participate in the assault crossing an additional two weeks to practice techniques along the flooded Inde River behind the lines, and allowed for an impressive buildup of artillery ammunition now flowing into the army's supply depots from Antwerp, along with the arrival of new equipment, including the M36 Tank Destroyer, with its 90mm gun, and the new M24 light tanks. But storage space was at a premium, and shells had to be piled on the shoulders of roads to keep them out of the mud.<sup>65</sup>

Nugent's airmen put the two weeks to good use, magnifying their attacks on the transportation corridors along the Ninth Army front. With five full groups now available, the command had adequate resources for a robust program designed to limit the flow of supplies and mobility of reinforcements. In the two week period from 8-22 February, the 366th and 373rd Fighter Groups continued to work on bridges near Neuss while cutting rail lines between Cologne and Grevenbroich, and extended armed reconnaissance patrols to the east bank of the Rhine. The 370th and 406th groups targeted bridges near Zieverich and rail lines between Neuss and Cologne, while the 405th Group targeted bridges around Noithausen and flew a single support mission against the Citadel in Julich. These attacks were in full consonance with the air plan for the operation, which envisioned two distinct phases: a preparation phase focused on interdiction and an execution phase during which the airmen would switch their efforts to CAS. The first phase outlined the

following priorities: 1) preventing rail traffic between Cologne and Wesel, including attacks on bridges, rail lines, marshalling yards, and moving trains; 2) Cutting roads to prevent trucks from shuttling around the rail cuts; 3) Destroying road transportation; and 4) Targeting petroleum and other, supplies, including ammunition dumps and other military installations.<sup>66</sup>

But the big effort came on 22 February, the day prior to Ninth Army's attack, when four of the five groups flew escort missions for Operation Clarion, a theater-wide assault on the German transportation network intended to paralyze the system by overwhelming the repair capacity and, hopefully, causing a collapse of the German state. The plan harkened back to airmen's desires for a "knockout" war-winning blow, but they again found their hopes unfulfilled.<sup>67</sup> But Clarion's timing did work to Ninth Army's benefit, as it significantly degraded the German ability to respond to the attack and likely facilitated the breakthrough and breakout to the Rhine. In addition, the AAF's concentration on interdiction during the two week-period prior to Grenade was entirely in accordance with published doctrine for air-ground support. With air superiority, if not air supremacy, largely won, interdiction was the next priority mission, and the Allies turned the full weight of their air arm to achieving this objective. Though they could never completely destroy the German transportation system, they could cause significant disruption that significantly impacted the German army's ability to fight.<sup>68</sup>

As early as 6 January, Nugent had attended meetings discussing Clarion's efforts to target the German rail network, but the attack had to be postponed until the Bulge had been completely erased. By early February, the operation was back on the books, and only awaiting a period of clear weather in order to execute the attacks. At the earlier meeting, Nugent reported, "Intelligence sources have indicated for some time that the German railway workers were becoming disaffected and a strong discouraging blow might topple the system."<sup>69</sup> On 22 February, the day of the attack, he reiterated in his diary that Clarion was, "designed to strike German railway and water transportation systems throughout the whole German nation," though his groups' primary contribution was to escort the medium bombers who made the attacks and then conduct armed reconnaissance east of the Rhine. The plan included some fighter-bomber attacks on German synthetic oil plants, demonstrating that the tactical air force was being drawn into the strategic air campaign, further blurring the lines between weapon and effects.<sup>70</sup> Unfortunately, the attack failed to achieve its intended goal of a general collapse, and the Air Force's official history reported, "no sign of a general breakdown," as the bombing had "only local and temporary effects."<sup>71</sup> But Ninth Army's AAR found that "Although [Operation] 'Clarion' was not designed specifically to assist 'Grenade,' it undoubtedly contributed to its success," and Ninth Army's postwar history agreed, noting, "Whereas the accurate accomplishments of such an effort are difficult to assess, it can be reasonably concluded that this extremely heavy attack contributed materially to the weakening of the enemy and consequently to the success of the ground forces' progress."<sup>72</sup>

While the interdiction campaign proceeded, commanders and staffs finalized plans for the assault. On 14 February, Nugent briefed Coningham on the air plan for Grenade, but Coningham's Chief of Staff, Air Vice Marshal Groom did not believe the medium bombers could survive over the flak-heavy targets, based on the high losses in the First Canadian Army sector. On 17 February, Simpson held his final planning conference at Ninth Army headquarters with all his corps and division commanders. Many expressed a desire to attack before the river was fully down in order to take advantage of the element of surprise, and Simpson set a date of 23

February regardless of the river's level. The VII Corps' commander, Maj. Gen. J. Lawton Collins, proposed a night attack to take advantage of the concealment provided by darkness for the hazardous river crossing, but Nugent responded that air could not intervene until sunup. But Simpson was comfortable with this delay in air support and, "stated that the tactical reserves in the neighborhood were practically nil and that he was satisfied that the Germans would not commit the strategic reserves until much later."<sup>73</sup> The final plan set an attack several hours before dawn, both to catch the defenders unaware and provide ample time for crossing the river barrier in the dark. By the time any German mobile forces could counterattack the beachhead, XXIX TAC's fighters would be up and searching for them.

After the preliminary assault, Simpson still held hopes for a breakout that had marked Ninth Army's effort in November. He ordered, "If the violence of our attack should cause disruption of the enemy resistance, each corps will be prepared to conduct relentless pursuit in zone, and phases will be abandoned in favor of taking full advantage of our opportunity."<sup>74</sup> If this happened, the air forces would be back to the halcyon days of September, supporting a mobile breakout with armored column cover. In case the Germans succeeded in their efforts to knock out the temporary Roer bridges after a substantial force had crossed, over 500 C-47s loaded with a day's worth of supplies for a full division stood ready to sustain forces on the eastern bank by airlift.<sup>75</sup>

The river crossings themselves took on a variety of forms. Ideally, the first wave would cross in assault boats and carve out enough of a bridgehead for engineers to bridge the stream with pontoon bridges and eventually more permanent structures. But the high current made assault boats problematic. Lighter, inflatable boats handled the current better, but were prone to tipping. Heavier plywood assault boats had greater stability, but were almost unmanageable. Stringing a heavy wire cable across the river, permitting hand-over-hand crossing, proved effective early on, but failures in several areas led to the use of tracked landing vehicles called LVTs, usually seen on coral atolls in the Pacific, and DUKWs, or amphibious trucks.<sup>76</sup> These vehicles had been hoarded behind the lines for the Rhine crossing but had to be pressed into service on the Roer.

Fortunately, the massive artillery barrage minimized interference with the assault crossing and subsequent bridging efforts. The attacks kicked off with a thirty-minute artillery barrage on all known and suspected defensive positions at 0245, followed by assault crossing in four divisional sectors. In XIII Corps on the army's left flank, the 84th Infantry Division crossed the still narrow river at Linnich, where the steep-sided valley gave the swift-flowing stream less room to expand. By noon, engineers had spanned the crossing with footbridges, eliminating the requirement for continued use of the unmanageable assault boats. But, in an almost exact replay of every maneuver conducted in Tennessee and Louisiana, German aircraft knocked out the first vehicle bridge within hours of completion, meaning no armor could get across to support the infantry. Even unsupported, the "Railsplitters" still managed to advance three to four miles, turning sharply left after crossing the Roer, and beginning to uncover the XVI Corps crossing sites by taking the defenders in that sector in the flank.<sup>77</sup>

Farther south, the 102nd Division had greater difficulty with the fast current, as runaway assault boats and German artillery conspired to delay or knock out several bridging attempts. Again, three German aircraft destroyed the first vehicle bridge in the division's sector just as the first tank destroyers began to cross, leaving the infantry unsupported, but the doughboys still managed

gains of two miles on D-Day.<sup>78</sup> The 29th Infantry Division crossed directly into Julich, in order to secure the terminus of the main highway from the Rhine, the most likely axis of any armored counterattack.<sup>79</sup> The 30th Division had a difficult sector upstream from Julich, where receding floodwaters left soft mud banks for the approach, and thickly strewn mines blocked exits from the crossings, subjecting the stalled columns to heavy interdictory fire.<sup>80</sup> Again, the heavy pre-emptory barrage and the concealment provided by darkness made the difference. The division's history found, "The reduced visibility which characterized night-fighting was the ideal answer for troops skilled enough to maneuver in the moonlight," and allowed the attack's momentum to be sustained in the daylight hours that followed.<sup>81</sup> A more recent history of the 30th Division found, "246 tubes of DIVARTY, reinforced by three 18-piece battalions of the 2nd Armored Division, 36 4.2-inch chemical mortar tubes, and another 36 self-propelled guns of the 823rd Tank Destroyer Battalion—one gun for every 32 yards along the 8,000 feet of the division's zone—sent flames bursting across the river. Flashing blossoms of shells and burning fires created a wasteland of destruction that spread for miles."<sup>82</sup> One soldier recalled, "The entire horizon was bathed in a continuous glow of reddish-orange flames...over our heads we heard the shells, swishing in singles, doubles, some whistling, some shrieking, others simply howling."<sup>83</sup> Heavy bombers would have struggled to match the accuracy and persistence of the bombardment, and could not have done so at night, denying the ground forces the substantial advantages of a night attack. Heavies could substitute for ground-based artillery during ammunition shortages, but ground-based fires were clearly the preferred solution. But neither air nor ground forces could successfully protect all the bridges, and not a single armored vehicle crossed the river on 23 February. Yet the soldiers of "Old Hickory" quickly replicated their successful village-clearing techniques at Hambach, again benefitting from excellent aerial photographs of their target, and soon gained two miles into the Hambach Forest, which planners feared the Germans might turn into a smaller version of the Hurtgen.<sup>84</sup>

Fortunately, XXIX TAC stood ready to temporarily fill the gap in armored support. In the 84th Division sector,

Baal was one of only three places where the Germans on D-day mustered counterattacks. As night was approaching, a battalion of the 183d Division supported by several tanks or assault guns drove south out of Baal at the same time men of the 334th Infantry were trying to break into the village. American artillery and eager Thunderbolts of the XXIX Tactical Air Command broke up the enemy thrust before the opposing forces could actually clash on the ground.<sup>85</sup>

According to the Air Force's official history, the 405th Fighter Group destroyed two and damaged two more of the six German tanks in the attack.<sup>86</sup> The Ninth Army's official history upped the numbers, finding "Fighter-bombers took the place of those tank destroyers and tanks which remained as yet on the west bank of the river," and, at Baal, "claimed the destruction of three tanks and the damage of as many more. In an excellent strike against a motor transport depot, three squadrons of fighter-bombers claimed destruction or damage of large numbers of vehicles."<sup>87</sup> But, as darkness fell, even the aircraft had to withdraw. The German 59th Division hit the 102nd Division at night at Tetz, Gevenich, and Boslar.<sup>88</sup> Fortunately, the heavy interdiction campaign had already limited the size of these counterattacks, and the men of the "Ozark" Division successfully consolidated their gains. In his diary, Nugent reported that the weather had been clear and the ground troops, "made good progress."<sup>89</sup> Though there were few close-

in targets, his armed reconnaissance missions found many trains exposed under the cloudless skies. Overall, XXIX TAC flew 613 sorties on 23 February, a record number for the command. “The entire Ninth Army lost 92 killed, 61 missing, and 913 wounded, a total of just over a thousand” in the crossing, a comparatively small cost given the scale of the effort.<sup>90</sup>

On 24 February, German aircraft again attacked the bridge sites, but anti-aircraft gunners knocked down 18 of 93 attacking aircraft, including several jets, preventing any interference with the buildup across the Roer, allowing armored vehicles to reach all of the assault divisions.<sup>91</sup> “The 405th Fighter-Bomber Group, unable to prevent morning attacks because of the weather, braved a 1500-foot ceiling to maintain constant vigil over the bridge sites for the remainder of the day.”<sup>92</sup> As the 29th and 30th divisions, still driving east for the Erft River to protect the XIX Corps’ right flank during the wheel north, began to diverge, McLain inserted the 83rd Infantry Division to fill the gap between the XIII and XIX to sustain the corps’ momentum.<sup>93</sup> In the XIII Corps sector, the 84th Division’s rapid advance enabled the 35th Infantry Division, to capture an intact bridge at Hilfarth, speeding XVI Corps’ crossing, and the Railsplitters’ capture of the road crossing at Erkelenz on 25 February unhinged the German defenses. That same day, XIX Corps began to shake free of the German defenses and Maj. Gen. Leland Hobbs, commanding the 30th Infantry Division, reported, “It looks like things are beginning to break a bit.”<sup>94</sup>

McLain judged that the time had come for the insertion of the 2nd Armored, and the tankers from the “Hell on Wheels” Division overran a weakened counterattack from the 9th Panzer Division before bounding for the Rhine.<sup>95</sup> On their flank, after serious difficulties with the 8th Infantry Division’s crossing in the VII Corps sector, 3rd Armored had done the same and Simpson no longer had to worry about the security of his right flank as he executed his left wheel to meet the onrushing Canadians. In the days that followed, the armored divisions assigned to Ninth Army’s other two corps did the same, with 8th Armored taking the lead for XVI Corps on 27 February and 5th Armored passing through the 102nd Division in the XIII Corps zone the following day. “Rain on 26 and 27 February grounded tactical aircraft,” but the good weather in the first three days of the offensive meant that the German resistance west of the Rhine was crumbling fast, and there were few roadblocks to arrest the progress.<sup>96</sup> “Returning to the fight after two days of rain, tactical aircraft lent a kind of discordant note with their noisy attacks on fleeing German columns.”<sup>97</sup> The air forces now took over a traditional role of the cavalry arm—punishing a fleeing enemy. As a result of the more mobile operations and the commitment of the tanks, armored column cover took over a greater share of XXIX TAC’s missions.<sup>98</sup>

Prior to 23 February, XXIX TAC had focused almost exclusively on interdiction, and reconnaissance, or preparation of the battlefield, culminating with the escort missions for Clarion on 22 February. But from the 23rd forward, direct support dominated the missions. On that day, the 366th, 370th and 406th Fighter Groups all reported, “Armed reconnaissance within area, dawn to dark,” while the 373rd FG flew corps cover for XIX Corps and the 405th did the same for XIII Corps.<sup>99</sup> In the XIX Corps sector, the 373rd focused its efforts on the towns of Lovenich, Titz, Katzen, Setternich, Hambach, and Padern.<sup>100</sup> This general pattern held for the first three days of the offensive, which coincided with an unusually good period of flying weather, not unlike the same week in 1944, when 8th Air Force took advantage of clear skies to execute Operation Argument, a series of targeted attacks on the Luftwaffe and German aircraft industry.<sup>101</sup> Group responsibilities shifted on 27 February, when the 366th FG took over coverage of

XIII Corps and the 406th assumed responsibility for corps cover and armored column cover in the XIX Corps sector.<sup>102</sup> Nugent's reasoning for making the shifts is unclear, as Ophoven was actually closer to the front (30 miles behind Munchen-Gladbach) as the army executed its left wheel, but the better conditions at Asch may have been a factor in assigning the most critical mission to the groups based there as the wet weather returned. As the ground columns closed up to the Rhine, armed reconnaissance missions increasingly extended east of that barrier in the final days of the assault, and river barges used to evacuate the fleeing Germans provided a welcome addition to the target set.<sup>103</sup>

A correspondent for *Time* magazine captured the critical moment when McLain committed the 2nd Armored division:

From the air in a Piper Cub the tank drive was a thing of sheerest military beauty. First came a long row of throbbing tanks moving like heavy dark beetles over the green cabbage fields of Germany in a wide swath—many tanks in a single row abreast. Then a suitable distance behind, came another great echelon of tanks even broader, out of which groups would wheel from their brown mud tracks in green fields to encircle and smash fire at some stubborn strongpoint. Behind came miles of trucks full of troops, maneuvering perfectly to mop up by-passed tough spots. Then came the field artillery to pound hard knots into submission... And always overhead swung and looped the Thunderbolts keeping the tanks under absolute safety umbrellas and from time to time diving to knock out trouble points beyond the front... This was one of the war's grandest single pictures of united and perfectly functioning military machines in a supreme moment of pure fighting motion.<sup>104</sup>

At this point, 2nd Armored contained over 3,800 vehicles of all types, and such a concentration would have been impossible without command of the air, as the Germans learned on many occasions. After two days of poor weather, on 28 February, XXIX TAC returned to the skies with a vengeance, flying 419 sorties and damaging or destroying 16 tanks, including six Tigers that ambushed an armored column west of Munchen-Gladbach. 2nd Armored, with an RCT from the 83rd Infantry Division attached, gained eight miles and opened up a path to the Rhine. After breaking through the German crust behind the Roer, only small pockets of resistance slowed the advance. The 175th Infantry Regiment of the 29th Infantry Division cleared the city of Munchen-Gladbach, comparable in size to Aachen, which had taken almost a month to clear in October, in less than a day.<sup>105</sup> "It was all along the front a typical pursuit operation, a return at last to the halcyon days of August and early September."<sup>106</sup> Maintaining momentum and not allowing the defenders to prepare fighting positions was paying dividends in time, territory and lives.<sup>107</sup>

On 24 February Air Vice Marshal Coningham paid Nugent a visit to check on progress and begin preliminary deconfliction discussions when the two attacking armies converged. Two days later, Hoyt Vandenberg, the 9th Air Force commander likewise inspected Nugent's operations and "expressed himself as well pleased with the progress of the air operations on the front of the Ninth Army and with the functioning of Combat Operations." As of that date, the five-day total included 2,469 sorties, 2,693 rail cars, 377 rail cuts, 192 locomotives, 1,064 buildings, and 6 rail bridges, and Vandenberg told Nugent, "The results obtained in your close cooperating with attacking ground units and the destructive blows dealt the enemy movements

in the rear areas reflect great credit on the training, technique of operations and superior leadership throughout your command.”<sup>108</sup>

Similar accolades came the following day, when Nugent visited Maj. Gen. Charlie Gerhardt at his 29th Division headquarters, who stated, “he was delighted with the air support which had been furnished, especially with the air action which had destroyed seven out of eight tanks which counter attacked on his flank the day before.”<sup>109</sup> He further reported that the Germans were surrendering and, “due probably to air action the troops on his front were being committed piecemeal.” For the month, XXIX TAC flew 5,062 sorties, dropping 1966.75 tons of general purpose bombs, 155.61 tons of fragmentation bombs and claimed 18 aircraft destroyed and another 22 damaged in the air and four more destroyed on the ground, but lost 31 pilots to all causes. While these losses paled in comparison to those in the ground units, they were still a comparatively high rate for the small and close-knit fighter squadrons.<sup>110</sup> The 363rd TRG covered the battle area extensively during this period. Throughout the month, the group delivered over 42,000 prints to Ninth Army’s artillery alone, and more than 500,000 to the assigned corps and divisions, including up to 450 copies of a single photo.<sup>111</sup> By the end of February, the 29 officers and 88 enlisted men had provided effects far out of proportion to their numbers, successfully completing 660 of 840 assigned sorties. According to the unit’s history, Ninth Army described their efforts as, “the best reconnaissance they have received from any air force unit”<sup>112</sup> On 22 February, the group flew one of the more remarkable reconnaissance missions of the war. The 33rd PRS, with Lt. Col. James M. Smelley leading, departed from Y-10 (Le Culot East) with 13 F-5s (photo P-38s) and then flew on the deck to Y-32, the P-38-equipped 370th FG’s base. From there they climbed and flew a profile that mimicked that of armed fighters on a sweep rather than unarmed reconnaissance aircraft, which would be easy prey for the German defenders. Spreading out to a mile and a half separation, the group filmed the entire Ruhr in a single run, covering over 1,200 square miles before escaping from a tardy interception by twenty-five fighters, including two jets, and returning with their valuable film. The 363rd’s photo lab produced 22,000 prints from the mission, which earned a Distinguished Flying Cross for each pilot and a Silver Star for Lieutenant Colonel Smelley. From 21-25 February, the Group produced 158,028 photographs and Major General McLain of XIX Corps remarked, “It is a rare occasion when an operational request is not filed within 36 hours,” though the average time was less than 18 hours, and debriefs had been streamlined to the point that information arrived at the Ninth Army and corps headquarters less than ninety minutes after the sorties landed. In June 1943, then-Captain Smelley had served as the adjutant of the 73rd Reconnaissance Group at Fort Knox, supporting training in the Tennessee Maneuver Area.<sup>113</sup>

On 1 March, General Simpson assigned the 75th Infantry Division to XVI Corps, strengthened XIX Corps with the 95th Infantry Division, and shifted the 79th Infantry Division from XVI to XIII Corps, as it was moving rapidly across the corps boundary. These moves allowed each corps to maintain its forward momentum while shifting into reserve some of the units that had made the initial assault. The fighter pilots struggled to keep pace with the rapid advance, and found few lucrative targets in front of the advancing columns, though the *Luftwaffe* provided a smaller diversion by sending 100 aircraft into the battle area. XXIX TAC demonstrated some of the rust on their air-air capability, as they claimed the destruction of 14 German aircraft but lost seven of their own.<sup>114</sup> On 2 March, seven German tanks counterattacked the 83rd Infantry Division at Kapellen, but fighter-bombers knocked out three, artillery claimed two

more, and the two survivors fell back across the Rhine.<sup>115</sup> On 3 March, XXIX TAC hosted a delegation from the strategic air forces, including Carl Spaatz and 8th Air Force commander Lt. Gen. Jimmy Doolittle, during which Spaatz, “appeared to approve of the XXIX TAC set-up and spoke highly of the operations which we are conducting.” When Spaatz asked for input, Nugent suggested, “it was a shame to utilize Fighter Bombers for escort during an offensive.” For his part, Doolittle stepped in with an “offer to assist by escorting the mediums at all times when the heavies were not flying.” According to Nugent, “he called up his headquarters and gave the necessary instructions. This should help.”<sup>116</sup>

The fresh divisions took part in the phase of Grenade that became known as the “rush for the bridges,” as Ninth Army sought to capture an intact bridge across the Rhine. Despite several close calls, the retreating Germans were able to drop every bridge in the army’s sector, leaving the capture of the Ludendorff Bridge at Remagen on 7 March in First Army’s zone as the only triumph in this effort. The 83rd Division of XIX Corps reached the Rhine at Neuss on 2 March and the corps had largely closed out combat operations by 5 March, as it was pinched out by both XIII Corps’ advance to the river and the inability to jump the water barrier.<sup>117</sup> Simpson had briefed Montgomery on plans for a “surprise” crossing to take advantage of the disorder among the defenders, with an assault crossing of the apparently undefended barrier just south of Duisberg, but Montgomery, perhaps chastened by previous efforts to extend operations “a bridge too far,” and preferring set-piece battles with adequate preparation, which almost invariably led to victory, denied Simpson’s request.<sup>118</sup> Simpson withdrew the 30th Infantry Division from combat in order to allow that division to prepare for its leading role in the attack across the Rhine. On 11 March, “Old Hickory” took a short break from training to participate in a ceremony in Maastricht to celebrate the division’s liberation of that city the previous September. The division alone captured almost 3,000 prisoner in the advance.<sup>119</sup>

In the XVI Corps zone, 8th Armored, supported by the 35th Infantry Division drove on Rheinberg, taking casualties from stubborn German defenders that cost Combat Command B 39 of 54 tanks. But on 3 March, the corps’ reconnaissance elements had the honor of linking up with the advancing Canadians at Geldern, leaving only a small German bridgehead west of the Rhine opposite Wesel, but manned by 50,000 defenders.<sup>120</sup> Here the compressed nature of the pocket increased the density of the defenders and made 35th Infantry Division’s task more difficult, and ground forces again turned to the air forces to help reduce the resistance. “Upon the request of the 35th Division, 12 pilots of the 366th Fighter-Bomber Group staged a daring mission on 6 March to effect the silencing of 13 gun positions in and around Ossenberg with their bombs, rockets, and machine guns, giving valuable assistance to the reduction of this enemy stronghold.”<sup>121</sup> Continuous attacks by American, British and Canadian forces gradually compressed the perimeter until the Germans finally retreated across the Rhine and blew the bridges on 9 March.

## **Conclusion**

In the Army’s official history, Charles McDonald concluded, “In just over two weeks the Ninth Army had driven approximately 53 miles, from the Roer at Julich to the Rhine at Wesel, and had cleared some 34 miles of the west bank of the Rhine from Dusseldorf to Wesel. In the process the army had captured about 30,000 Germans and killed an estimated 6,000 more while absorbing less than 7,300 casualties.”<sup>122</sup> On their left flank, First Canadian Army advanced an



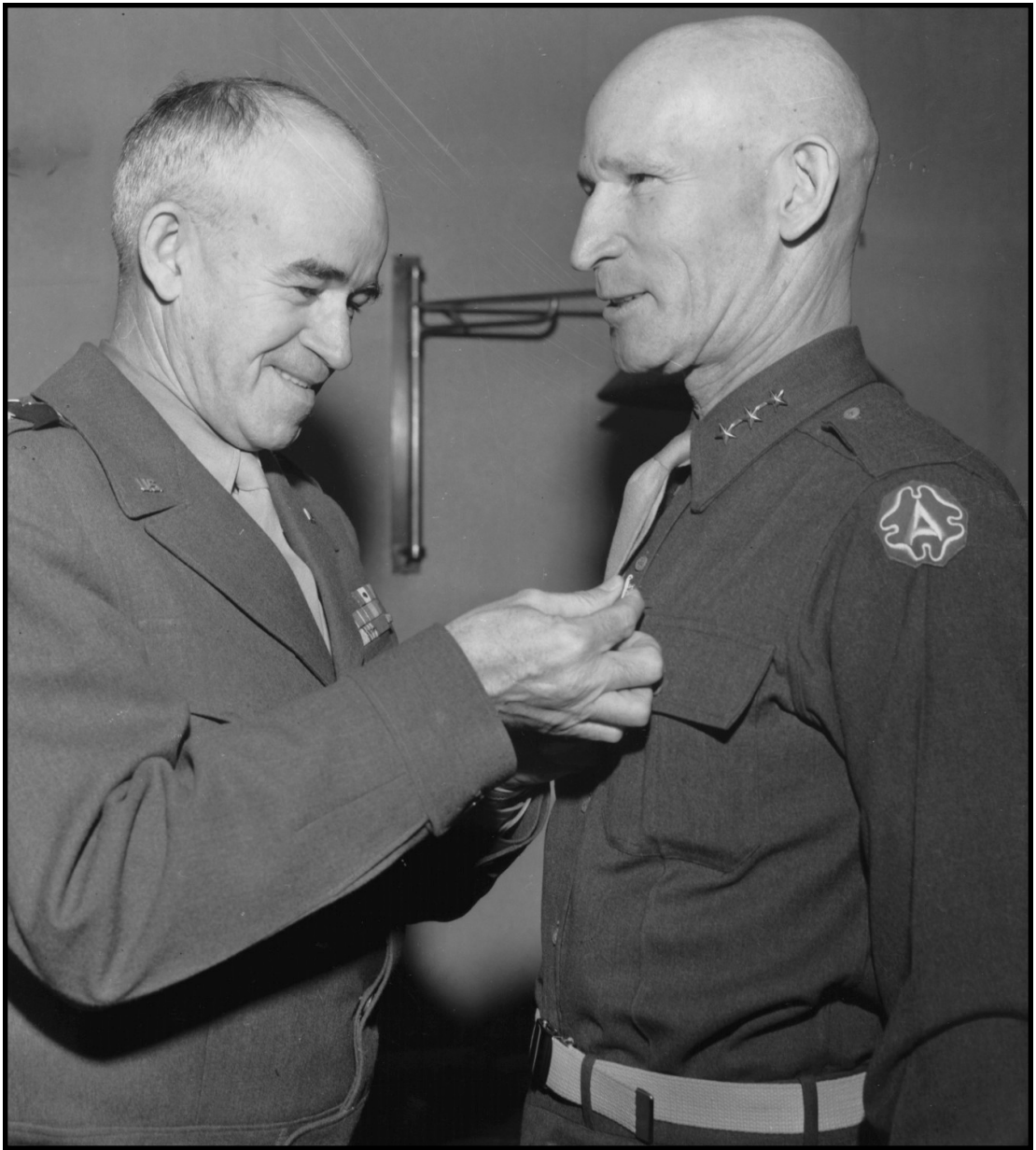

Figure 6.4. Simpson Earned Well-Deserved Recognition for Ninth Army's Efforts to Close Up to the Rhine River.

even more impressive 40 miles, capturing 22,000 Germans while suffering 15,000 casualties.<sup>123</sup> “Thus the two armies’ converging operations had cost the Germans, according to our best figures, approximately 90,000 men.”<sup>124</sup> On 10 March, Montgomery wrote Simpson that, “It has fallen to my lot to be mixed up with a good deal of fighting since I took command of the Eighth Army before Alamein in 1942; and the experience I have gained enables me to judge pretty well the military calibre of Armies. I can truthfully say that the operations of the Ninth Army, since 23 February last, have been up to the best standards. It has been a very great pleasure

to work with you and your staff and to have such a fine Army under my command.”<sup>125</sup> XXIX TAC played a critical role in this success, flying over 7,000 sorties since 1 February, providing air superiority, interdiction and close support, though the interdiction mission dominated the effort.<sup>126</sup> Simpson later reported, “The fighter-bombers of the XXIX Tactical Air Command worked closely with the ground troops. Due to adequate time for planning, good weather, and sufficiency of both troops and supplies concentrated for this battle, this operation was particularly well executed. It was practically completed in 10 days.”<sup>127</sup> The campaign put 21st Army Group in position to jump the Rhine north of the Ruhr industrial region, fulfilling a long-deferred plan for an encirclement of that region by two Army groups. It also set the pattern for the remainder of the war, in which ground forces overran some objectives unopposed but found others fiercely defended, and never knew which to expect. But the pace of progress was unmistakable. As Harry Yeide pointed out, the Roer River had held the Allies up for almost three months. Jumping the much larger Rhine took less than two weeks.<sup>128</sup> The rapid advance meant the combined Ninth Army-XXIX TAC headquarters was now well behind the front lines, and on 10 March it left its comfortable winter quarters and displaced forward to a captured airfield near Munchen-Gladbach.<sup>129</sup> On a site inspection on 8 March, Nugent reported Polish and Russian slave laborers living in the damaged buildings, with epidemic typhus. Civil affairs ordered local residents to begin cleaning up the facility, but this prompted some reprisals by local civilians, who attacked and beat two soldiers to death.<sup>130</sup>

Detailed post-campaign analysis codified a number of “best practices” for air ground cooperation. Among these were the daily targeting conference that is still mirrored in the current Joint Air Tasking Cycle, where a joint committee reviews target nominations for the following day’s sorties, accepting those in consonance with the ground commander’s intent and rejecting those that are not, or for which there are insufficient assets available. Throughout the process, frequent personnel interchanges, including air liaison officers with the ground units and ground liaison officers (GLOs) with the air squadrons facilitated the close coordination. Nugent and his staff remained in close contact with corps and division headquarters and relayed their concerns and requests through air force channels in order to secure additional assets. Most importantly, the airmen who flew the aircraft rendered important support during the advance, both in setting the conditions for success by weakening the German defenders and by facilitating the breakout from the Roer line. While wartime doctrine argued against the “parceling out” of air assets to ground commanders, and airmen preferred to keep them centralized under a separate chain of command, assigning subordinate units, such as XXIX TAC, to work with specific ground units facilitated coordination and achieved important and significant effects in the advance from the Roer to the Rhine. The ground forces destroyed much of Germany’s remaining ground power and moved its artillery batteries into a position from which it could contribute the weight of its own shells to the reduction of German industrial capacity in Ruhr. Most importantly, the campaign set the stage for the final, decisive campaign that finally ended the war in just over a month’s time.

## Notes

1. "363rd Tactical Reconnaissance Group History," GP-RCN-363-HI, AFHRA.
2. XXIX TAC Periodic History, October 1944-April 1945, Record group 538.02, Air Force Historical Research Agency, Maxwell AFB, AL; Nugent's War Diary, 1 January 1945.
3. Nugent's War Diary, 1 January 1945.
4. McDonald, *Siegfried Line*, 128.
5. Parker, *Conquer*, 138
6. Parker, 139.
7. McDonald, *Siegfried Line*, 135, 140; Parker, *Conquer*, 146
8. Harry Franck, *Winter Journey Through the Ninth* (Tucson, AZ: Prince of the Road Press, 2001), 188; Nugent's War Diary, 20 February 1945.
9. Franck, 188.
10. Nugent's War Diary, 10 January 1945.
11. See Christopher M. Rein, *The North African Air Campaign: The US Army Air Forces from El Alamein to Salerno* (Lawrence, KS: University Press of Kansas, 2012).
12. Parker, *Conquer*, 153.
13. McDonald, *Siegfried Line*, 135.
14. Franck, *Winter Journey Through the Ninth*, 189.
15. Franck, 189.
16. Parker, *Conquer*, 139.
17. Yeide, *The Longest Battle*, 239; Parker, *Conquer*, 142.
18. Parker, 148-149.
19. McDonald, *Siegfried Line*, 135, 136; see Figure 4.7. Squadrons Assigned to XXIX TAC on page 100.
20. XXIX TAC Periodic History.
21. Nugent's War Diary, 17 January, 1945.
22. Nugent's War Diary, 17 January, 1945.
23. Nugent's War Diary, 18, 20 January 1945.
24. Nugent's War Diary, 17 February 1945.
25. Maurer, *Air Force Combat Units of World War II*; Nugent's War Diary, 23 February 1945; XXIX TAC Periodic History.
26. Parker, *Conquer*, 152-153.
27. XXIX TAC Periodic History; Nugent's War Diary, 6 February 1945.
28. McDonald, *Siegfried Line*, 137; Parker, *Conquer*, 165.
29. XXIX TAC Group Mission Log, "Report of Operation Air Grenade, 2 Feb.–6 Mar. 1945," Book "XXIX Tactical Air Command," Box 95, Hoyt Vandenberg Papers, Library of Congress, Washington, DC. (Hereafter "XXIX TAC Mission Log.")
30. Nugent's War Diary, 22 February 1945.
31. C. P. Stacey, *Official History of the Canadian Army in the Second World War*, Vol. III, *The Victory Campaign: The Operations in North-West Europe 1944-1945* (Ottawa: The Queen's Printer, 1960), 522.
32. Nugent's War Diary, 4 January 1945.
33. Nugent's War Diary, 5 January 1945.
34. Nugent's War Diary, 9, 17 January 1945.
35. Nugent's War Diary, 23 January 1945.
36. Nugent's War Diary, 25 January 1945.
37. Nugent's War Diary, 5 February 1945.
38. Nugent's War Diary, 31 January 1945.
39. Nugent's War Diary, 1 February 1945.

40. Nugent's War Diary, 1 February 1945.
41. Nugent's War Diary, 2 February 1945.
42. See Williamson Murray and Allan Millet, *A War to be Won: Fighting the Second World War*. (Cambridge, MA: Belknap, 2000) and Steven Ossad, *Omar Nelson Bradley: America's GI General* (Columbia: University of Missouri Press, 2017).
43. Nugent's War Diary, 3 February 1945.
44. Nugent's War Diary, 6 February 1945.
45. Nugent's War Diary, 3 February 1945.
46. Kenn C. Rust, *The 9th Air Force in World War II* (Fallbrook, CA: Aero Publishers, 1967).
47. Nugent's War Diary, 13 February 1945. Nugent did not earn promotion to major general until 1948, well after the end of the war. <http://www.af.mil/About-Us/Biographies/Display/Article/108406/lieutenant-general-richard-e-nugent/>, accessed 20 April 2018.
48. Nugent's War Diary, 4 February 1945.
49. Nugent's War Diary, 7, 8 February 1945.
50. Nugent's War Diary, 9 February 1945.
51. Nugent's War Diary, 9 February 1945.
52. Nugent's War Diary, 11-12 February 1945; McDonald, *Siegfried Line*, 143.
53. Terry Copp, *Cinderella Army: The Canadians in Northwest Europe 1944-1945* (Toronto: University of Toronto Press, 2006), 217; Gordon Brown, "The Battle of Moyland Wood: The Regina Rifle Regiment, 16-19 February 1945," *Canadian Military History*, Vol. 6, No. 1 (Spring 1997): 101-108.
54. Stacey, *Official History of the Canadian Army in the Second World War*, Vol. III, 465, 466, 472; Copp, *Cinderella Army*, 208.
55. Stacey, *Official History of the Canadian Army in the Second World War*; Vol. III, 491-493; McDonald, *Siegfried Line*, 147.
56. Stacey, *Official History of the Canadian Army in the Second World War*; Vol. III, 508.
57. Stacey, 510.
58. Stacey, 516.
59. Stacey, 514.
60. Stacey, 521.
61. Craven and Cate, *The Army Air Forces in World War II*, Vol. III, 757-758.
62. *Mission Accomplished: The Story of the XXIX TAC*.
63. Parker, *Conquer*, 162.
64. See McMillin, *In the Presence of Soldiers*.
65. Parker, *Conquer*, 163.
66. Air Cooperation in Operation Air Grenade (NARA) by Lieutenant Colonel Fagg, G-3 (Air).
67. For an excellent background discussion, see Tami Davis Biddle, *Rhetoric and Reality in Air Warfare* (Princeton: Princeton University Press, 2002).
68. XXIX TAC Mission Logs.
69. Nugent's War Diary, 6 January 1945.
70. Nugent's War Diary, 22 February 1945; Craven and Cate, *The Army Air Forces in World War II*, Vol. III, 734.
71. Craven and Cate, Vol. III, 734.
72. "Air Cooperation in Operation Air Grenade" (NARA) by Fagg, G-3 (Air), 2; Parker, *Conquer*, 164.
73. Nugent's War Diary, 17 February 1945.
74. McDonald, *Siegfried Line*, 143.
75. McDonald, 147; Parker, *Conquer*, 151.
76. McDonald, *Siegfried Line*, 144.
77. McDonald, 145; Parker, *Conquer*, 170.
78. Parker, 170.

79. McDonald, *Siegfried Line*, 147; Parker, *Conquer*, 170.
80. McDonald, *Siegfried Line*, 152.
81. Hewitt, *Work Horse of the Western Front*, 228.
82. McDonald, *Siegfried Line*, 152; Baumer, *Old Hickory, The 30th Division*, 412.
83. Baumer, 412.
84. McDonald, *Siegfried Line*, 156; Parker, *Conquer*, 169, 173.
85. McDonald, *Siegfried Line*, 153.
86. Craven and Cate, *The Army Air Forces in World War II*, Vol. III, 762.
87. Parker, *Conquer*, 172.
88. McDonald, *Siegfried Line*, 155
89. Nugent's War Diary, 23 February 1945.
90. McDonald, *Siegfried Line*, 162; Parker, *Conquer*, 171; Craven and Cate, *The Army Air Forces in World War II*, Vol. III, 762.
91. McDonald, *Siegfried Line*, 164; Parker, *Conquer*, 174.
92. Parker, 175.
93. McDonald, *Siegfried Line*, 164, Parker, *Conquer*, 174.
94. McDonald, *Siegfried Line*, 167.
95. McDonald, 168.
96. McDonald, 172; Parker, *Conquer*, 176.
97. McDonald, *Siegfried Line*, 184.
98. Parker, *Conquer*, 175.
99. XXIX TAC Mission Logs; Craven and Cate, *The Army Air Forces in World War II*, Vol. III, 762.
100. Craven and Cate, Vol. III, 762.
101. See James Holland, *Big Week: The Biggest Air Battle of World War II* (New York: Atlantic Monthly Press, 2018), and John Curatola, "Operation ARGUMENT: "Big Week," February 20-25 1944" in Richard Barbuto and Jonathan House, *Forgotten Decisive Victories* (Fort Leavenworth, KS: Combat Studies Institute Press, 2017).
102. XXIX TAC Mission Logs.
103. Parker, *Conquer*, 188.
104. Parker, 179.
105. Parker, 182.
106. McDonald, *Siegfried Line*, 172.
107. Parker, *Conquer*, 181; Nugent's War Diary, 28 February 1945.
108. Nugent's War Diary, 26 February 1945; *Mission Accomplished: The Story of the XXIX TAC*.
109. Nugent's War Diary, 27 February 1945.
110. XXIX TAC Periodic History.
111. Parker, *Conquer*, 153.
112. "363rd Tactical Reconnaissance Group History."
113. "Observation and Reconnaissance Training," 168.95-1, AFHRA, Maxwell AFB, AL; Lt. Col. James M. Smelley, Headquarters, 363 TRG, "Summary of Operations for 363rd Tactical Reconnaissance Group, Period 21-15 February, 1945," "Appendix IV(a)" to *Tactics and Techniques Developed by the United States Tactical Air Commands in the European Theater of Operations*, Box 1, Elwood Quesada Papers, Eisenhower Presidential Library, Abilene, KS; Rust, *The Ninth Air Force in World War II*, 150; <http://33rdprs.photorecon.org/html/history/Sqdhist5.html>, accessed 30 April 2018. After the war, Smelley changed his name to Shelley and returned to his native Louisiana, living in Ruston until his death. *Shreveport Times*, 13 October 1988, 16.
114. Parker, *Conquer*, 183.
115. Hewitt, *Work Horse of the Western Front*, 231-233.
116. Nugent's War Diary, 3 March 1945.

117. Parker, *Conquer*, 184.
118. McDonald, *Siegfried Line*, 173-175, 178; Parker, *Conquer*, 190; Nugent's War Diary, 5 March 1945.
119. Hewitt, *Work Horse of the Western Front*, 231-233.
120. Parker, *Conquer*, 188-189.
121. Parker, 192.
122. McDonald, *Siegfried Line*, 179. 183; Parker, *Conquer*, 198.
123. McDonald, *Siegfried Line*, 183-184.
124. Stacey, *Official History of the Canadian Army in the Second World War*, Vol. III, 522.
125. Montgomery to Simpson, 10 Mar 1945, Folder 27, Box 2, Simpson Papers, AHEC.
126. Craven and Cate, *The Army Air Forces in World War II*, Vol. III, 763; XXIX TAC Mission Logs.
127. William H. Simpson, "Ninth Army's Operations in Germany," *Army Navy Journal* special issue, "United States at War, December 7, 1944-December 7, 1945," 190. Copy in Folder 3, Box 18, Simpson Papers, AHEC.
128. Yeide, *The Longest Battle*, 257.
129. Parker, *Conquer*, 192.
130. Nugent's War Diary, 8 March 1945.

## Chapter 7

### Operation Flashpoint and the Ruhr, March-April 1945

Once Ninth Army reached the western banks of the Rhine, the Allies finally had an opportunity to implement their long-delayed plan to restrict the flow of materiel from the vital Ruhr industrial region, starving the German armies still in the field. The weakened state of the German military, beset on all sides by victorious foes, with Soviet forces in Poland and Czechoslovakia, and Allied Armies in the Po and Rhine valleys, makes the campaign an afterthought in most military histories of the war.<sup>1</sup> Germany seemed doomed by March of 1945 and the weakened state of the German armed forces, after their destruction in the Battle of the Bulge and the Soviet winter offensive, appeared to make the outcome a foregone conclusion. As Charles McDonald pointed out in the Army's official history, "the military force that might have hoped to defend successfully at the Rhine had ceased to exist, destroyed in the fighting west of the river."<sup>2</sup> But, in terms of air-ground cooperation, the campaign provides a productive example, both of support in a heavily urbanized industrial area, as well as a mobile campaign reminiscent of the breakout across France, when ground forces outstripped both their logistical support and the aircraft assigned to cover their advance. Simpson's Ninth Army first had to conduct a crossing of the massive Rhine River, the greatest water obstacle between Normandy and Berlin, then simultaneously wheel south to contain the Ruhr while breaking out to the east to complete the encirclement, all under the command of Montgomery's 21st Army Group which viewed the American army as a supporting effort to the British Second Army's crossing farther north. The constricted terrain and inability to access vital bridges led to the only serious episodes of friction between Simpson and his British commander during the war, and Ninth Army reverted to American control in Bradley's 12th Army Group shortly thereafter.

For XXIX TAC, the breakout meant a displacement forward from fixed bases in Belgium occupied all winter and a resumption of mobility for the squadrons and command posts. At the same time, an examination of air-ground doctrine reveals some surprising developments and the reemergence of supposedly long-settled doctrinal disputes. Recognizing that German aircraft attacking the bridges provided the only realistic threat to interrupting the crossing, fighter-bombers maintained air "umbrellas" over the bridgehead, a tactic thought to have been dispensed with in North Africa as costly and inefficient. And, despite, greater efforts at centralized control, XXIX TAC operated largely independent of Ninth Air Force, allocating sorties and conducting missions with a great deal of autonomy. Whether this reflects the pernicious influence of the ground forces or is actually an ideal system of "distributed control" that led to greater decentralization and flexibility is open to debate, but the evidence points to the latter. With the conclusion of hostilities and the rush, first to redeploy to the Pacific and then to demobilize, the proper doctrinal "lessons" of this campaign have escaped serious analysis. Sadly, by the time the Army and newly-independent Air Force again united on the battlefield, just over five years later on the Korean Peninsula, many of the lessons had to be re-learned and re-applied, and adapted to a much different situation when tactical airpower dominated events due to the inaccessibility of strategic targets. Thus the campaign offers both a final fulfillment of Allied efforts to develop air-ground doctrine in World War II and a reminder of how quickly this hard-won expertise can be lost, if not continually maintained through careful review and repeated practice in deliberate training exercises.





By the end of Operation Grenade, Ninth Army had less than three weeks to prepare for the Rhine crossing. Simpson, and the XIX Corps commander, Maj. Gen. Raymond McLain, did not even want to wait that long, believing that only light resistance remained on the opposite bank and that a hasty operation, such as that sparked by the seizure of the Ludendorff Bridge at Remagen, had a fair chance of success. McLain had found a location where the ample landing craft stockpiled for the operation could be launched in a secure location in a canal that emptied into the river, providing a jumping-off point for an amphibious assault. But Montgomery had enjoyed uninterrupted success with his meticulous planning and set-piece assaults, and it was too late to change his stripes now. He directed that planning proceed for a simultaneous assault, supported by two airborne divisions, the British 6th and American 17th, to seize vital ground behind the bridgehead, allowing for an orderly and patient buildup before breaking out onto the North German Plain.

For the Air Forces, this brief period during which the ground forces were not in direct contact provided ample opportunity to engage in shaping operations. In addition to the interdiction campaign, aircraft, and even artillery units on the Rhine's western shore, could attack German industrial targets directly. But the heavy anti-aircraft defenses meant this target set remained the province of the higher-flying heavy bombers, and the artillery. Accordingly, XXIX TAC continued to focus on road and rail interdiction, pinning the German forces down and restricting the flow of supplies and reinforcements into the area. At the same time, Nugent's command had to deal with the disruptions of displacing forward from bases in Belgium, as the front lines were now almost 100 miles from the air bases, lengthening response times and restricting bomb loads and loiter times. By the time the war ended, that distance increased to over 300 miles to the Elbe, necessitating additional moves. As the British had first learned in the Western Desert, mobility was an essential capability, not just in transporting personnel, fuel stores, and munitions, but in building up the robust communications network that permitted the command and control system to respond in a timely fashion. While XXIX TAC headquarters settled in alongside Ninth Army HQ at Munchen-Gladbach during the second week of March, the individual groups also began moving onto newly captured German airfields.

The vital 363rd Tactical Reconnaissance Group was the first group to displace forward. On 14 March, it packed up from its home for the past four months at Y-10, Le Culot, Belgium, and moved to airfield Y-55 at Venlo in the Netherlands, liberated by the British Second Army in the Grenade and Veritable offensives, a distance of 74 air miles. They remained at Venlo throughout the Rhine crossing and encirclement of the Ruhr, jumping forward again to Airfield Y-99 at Gutersloh, Germany on 19 April, a distance of 103 air-miles, before finally settling in at R-37 at Waggun, Germany (now the Brunswick Airport) on 25 April. The 373rd Fighter Group also left Le Culot, joining the 363rd TRG at Venlo on 14 March, where it remained until 23 April, when it took up residence at airfield Y-98 at Lippstadt, Germany. The move did not prevent the group from earning a Distinguished Unit Citation on 20 March, when it destroyed 119 German aircraft on the ground in raids on German airfields in the Hamm and Paderborn area, severely limiting the *Luftwaffe's* interference with the Rhine crossing four days later. According to the group's commander, Col. James C. McGehee, "Our boys got tired of waiting for the Krauts to come up and fight so they went down and got the Boch(e)s on the ground."<sup>3</sup>

But the four remaining fighter-bomber groups, the 366th and 406th at Y-29, near Asch, Belgium, and the 370th and 405th groups at Y-32, near Ophoven, Belgium, remained far to the

rear during the ensuing campaign, placing additional strain on the effectiveness of air-group cooperation. In addition to the long flights, the command also suffered interruptions to its radar coverage while those facilities displaced forward. The movement of the three forward director posts resulted in lengthy down periods during which precision terminal strike guidance was unavailable. XXIX TAC's MEW radar moved across the Rhine from Aldekerk to Hoyerleheide, near Osnabruck, between 6 and 9 April, a distance of 143 road miles, resulting in almost 80 hours during which the station was off the air. The MEW was the last FDP to displace forward, as the SCR-584-equipped FDP-1 moved 70 miles from 3-7 April, resulting in 96 hours of down time, while FDP-3 moved 71 miles from 1-2 April, resulting in only 32 hours off the air, but a longer move of 137 miles from 8-12 April cost another 100 hours of air time.<sup>4</sup>

Fortunately for Ninth Army, the requirements for close air support declined throughout the campaign. Other than air cover for the crossings themselves, and armored column cover during the breakout from the bridgehead, the Army's artillery provided the vast majority of fire support. With ample stocks built up during the preceding three months, ground commanders had the luxury of robust artillery support, and needed aircraft to fill in the gaps only while the firing batteries displaced forward. For the crossing itself, Ninth Army amassed 54 field artillery battalions, including division-, corps-, and army-level assets to provide support.<sup>5</sup> Over 2,000 tubes fired 65,000 rounds, neutralizing what little opposition the Germans provided. One company commander in the 30th Infantry Division's 117th Infantry wrote, "There was no real fight to it. The artillery had done the job for us."<sup>6</sup> Combined, both of the assault divisions suffered a total of only 31 casualties, mostly from mines.<sup>7</sup> During the crossing itself, XXIX TAC had little to do, other than protect the bridges from German aircraft, which still consumed 716 sorties, but, as insurance against bad weather, anti-aircraft units crossed in the first wave, and claimed 22 of the 82 German attackers on 24 March, and another 24 out of 68 on 25 March.<sup>8</sup> "So irresolute and spotty was resistance in front of the 79th Division that not once during the day of 24 March did the division call on the fighter-bomber group that was assigned in support."<sup>9</sup> For the airmen, this was an ideal situation. While artillery performed most of the direct support missions, as FM 31-35 had stipulated, fighter-bombers roamed the enemy's rear area, beating up airfields and interdixing road and rail transportation. McDonald's study found, "fighters and fighter-bombers of the British 2d Tactical Air Force and the US XXIX Tactical Air Command (General Nugent) joined the Ruhr campaign. Most of the 7,311 sorties flown by these pilots between 11 and 21 March were directed against the rail and road systems of the Ruhr."<sup>10</sup> In the two days prior to the assault, the fighter-bombers escorted raids by Ninth Air Force's medium bombers against German airfields, especially those at Munster and Handorf, which were effectively neutralized, flying a total of 1,413 sorties during a period of clear weather from 21-23 March.<sup>11</sup>

A typical XXIX TAC operations order from this period outlined the following assignments for 20 March. The 373rd Fighter Group was to conduct training in dive bombing and gunnery, then perform armed recce and attack a suspected fuel dump. The 366th also flew armed recce, concentrating on rail lines and a barracks near Dusseldorf. The 406th also went after petroleum targets and rail lines near Wesel, Hamm, and Paderborn, while the 370th attacked the Phoenix oil refinery, which the order stated was "of greatest importance and all effort to destroy it will be made," demonstrating a blurring of the line between tactical and strategic targets and assets.<sup>12</sup> In addition, the 370th had four P-51s "maintain an air alert over VENLO (Y-55) from first light until last light," demonstrating that the AAF was still using aerial umbrellas,

despite their supposed banishment after the North African campaign.<sup>13</sup> The 405th also conducted armed recce and targeted petroleum sites, while the 363rd Tactical Reconnaissance Group flew a “Cockerel” mission, to calibrate the “Identification, Friend or Foe,” or IFF, system and receivers, to help distinguish between friendly and enemy aircraft on radar screens. The 406th reported the results of their armed recce as strikes on several marshalling yards and the airfields at Gutersloh and Paderborn, demonstrating simultaneous accomplishment of the air superiority and interdiction missions. On 20 March one of the more unusual episodes in the TAC’s history occurred when Lieutenant Mahoney of the 366th led a mission to Dusseldorf but, upon returning, the injured pilot had to bail out of his damaged aircraft over his home airfield. He parachuted into the middle of an awards ceremony, at which the quick-thinking presentation officer pinned on a Purple Heart.<sup>14</sup>

The command continued this effort on 21 March with three missions, the first against rail targets and a military headquarters that was not attacked because it displayed hospital markings, a second against oil storage tanks and a third against trains, marshalling yards and motor transport. The group lost one aircraft on the first mission.<sup>15</sup> The group completed four missions on 22 March, including escort for the medium bombers participating in the beat-down of German airfields, armed recce, which included a V-1 site, and more work on the German railroads. One pilot, Maj. Chester Van Etten, reported, “We were over the Ruhr for two hours from north to south. All we saw in the way of targets was one motorcycle. The whole territory looks dead.”<sup>16</sup> The two missions on D-Day, 24 March, involved dangerous flak suppression and more armed recce. It was not until 28 March that close support missions finally returned to the group’s orders.<sup>17</sup>

During this time, Nugent attended to a myriad of administrative tasks, including a tour of his combat operations center for the commanders of 9th Air Force’s medium bomb groups, in order to better integrate this powerful striking force into Ninth Army’s repertoire. Nugent also worried about the continual decline in dive-bombing and strafing accuracy, and sought a range where he could keep his pilots trained.<sup>18</sup> On 14 March, he met with the XIII Corps staff to investigate rumors that Major General Gillem’s command was unhappy with the air support he had received during Operation Grenade. Nugent was pleased to find the rumors unfounded, as the corps Chief of Staff and G-3 reported that “the Corps Commander was delighted with the air support which he had received and that he had no criticism or recommendations for improvement.”<sup>19</sup> As recognition for his efforts during that campaign, Nugent received a Bronze Star from Lieutenant Generals Simpson and Lear, who had commanded Second Army in maneuvers through 1943 and then taken over General McNair’s post as the commander of the Army Ground Forces after his death. On 16 March, Nugent hosted Generals Spaatz, Vandenberg, and Doolittle again, who remained interested in events on the continent, during which Nugent expressed his desire for a “rest camp” for his pilots, ideally outside of Germany to prevent issues of fraternization. Nugent took a well-deserved leave himself on 18 March, spending a few days in Cannes, along with Major General McLain, as they rested up for the final push. Nugent needed the break after a contentious conference in Brussels with Air Vice Marshal Coningham of 2nd TAF on 17 March, in which Nugent learned he would have to dedicate an entire group to close escort of the airborne force, which Nugent felt he could not afford, alongside demands for high cover, anti-flak, armed reconnaissance, and a group for each assaulting division. He recorded the conference as “unpleasant,” as he had to represent Ninth Army and insist on attacking the army’s targets, without the support of any of the ground commanders or their staff.<sup>20</sup>

Planning for the Rhine crossing had been underway for several months, and the original plan dated to the previous fall, when Eisenhower's Supreme Headquarters envisioned a double-envelopment of the Ruhr, with Montgomery's 21st Army Group crossing the Rhine to the north and linking up with Bradley's 12th Army Group, crossing to the south, at some point east of the industrial region, sealing it off from Germany's war machine. The only significant change to the earlier plan was Ninth Army's transfer to Montgomery's control, which gave him an additional powerful striking force of twelve divisions, including three armored, to make the northern thrust. But Ninth Army planners chafed at what they perceived as their minimal role under British control. Initial plans called for the British Second Army, with eleven divisions, including three armored and two airborne, to make the main effort at Wesel, supported by the airborne forces dropping directly behind that city. Simultaneous crossings by the First Canadian Army to the north, with eight British and Canadian divisions, and Ninth Army to the south protected the main effort's flanks.<sup>21</sup> Montgomery held planning conferences on 27 February and issued the final order on 9 March, two weeks before the assault, with a final check on 19 March.

Altogether, over a million men in 21st Army Group participated in the crossing, code-named Operation Plunder, with Varsity chosen for the airborne drop and Flashpoint for Ninth Army's portion. At first, Ninth Army did not even have an independent role, as early plans called for the attachment of several American divisions to the British Second Army for the operation, but Simpson made it clear that his force was capable of an expanded role, even in the constricted terrain between Wesel and Dusseldorf, and eventually won the right to cross two divisions on a single-corps frontage. To manage limited resources and concentrate the effort, First Canadian Army did not make an amphibious assault, but crossed once the British Second Army had uncovered their crossing sites, just as XIII corps had done for XVI Corps on the Roer. As Charles McDonald found, "Fortunately, staffs and commanders of the Second British and Ninth US Armies had, through long experience in operating side by side, achieved considerable rapport."<sup>22</sup> After Simpson's army had crossed the Rhine, Eisenhower wrote his congratulations and said, "I have been particularly gratified to note that your relationships with our British friends, including your seniors, your associates, and your subordinates, have been based on mutual respect and friendly co-operation. I am truly delighted at the combat record you have made."<sup>23</sup>

Simpson selected Maj. Gen. Leland Hobbs' experienced 30th Infantry Division, a favorite of his since he had served as its commanding general at Fort Jackson in the summer of 1942 and arguably one of the best American divisions in the ETO, to make one assault, while Maj. Gen. Ira Wyche's 79th Infantry Division, fresh from the Seventh Army front in Alsace, supported it with a near-simultaneous crossing just upstream, both under the command of Lt. Gen. John B. Anderson's XVI Corps. The 30th moved back from the Rhine to a training area along the Maas River on 6 March, followed two days later by the 79th.<sup>24</sup> XVI Corps earned the mission because it had wrapped up its portion of Grenade first, after being pinched out of the advance, and therefore had more time available to devote to the planning effort, and because it would wind up holding the sector of the crossing, on the army's left flank.<sup>25</sup> "Old Hickory" crossed on a three-regiment front, with armored support from a company of duplex-drive tanks from the 736th Tank Battalion "swimming" across the Rhine, which fortunately performed much better in the smoother waters of the Rhine than in the choppy English Channel at Nor-

mandy.<sup>26</sup> Additional armor arrived more conventionally, with “light tanks, ferried across the Rhine in LCM’s.”<sup>27</sup> Once these two divisions had carved out a suitable bridgehead, Simpson planned to wheel XVI Corps to the south to contain the Ruhr while sending XIX Corps across as the exploitation force to race east for a junction with First Army well behind the Ruhr. XIII Corps would support this effort by holding the army’s left flank and remaining tied in with the Commonwealth forces on the army’s left. The plan used the same early morning crossing as the effort on the Roer, ferrying the assault troops across the river under the cover of darkness, with aircraft joining the fight once the sun rose. The massive airborne assault, scheduled for mid-morning, had the advantage of daylight to ensure accurate drops, though this significantly increased the casualties for the troop carrier crews and their escorts.

The airdrop, which some recent studies have argued was unnecessary and excessively costly, with casualties running from 12 to 13 percent, required significant coordination with the forces crossing the Rhine by boat, and the air forces supporting them.<sup>28</sup> Artillery shifted fires from supporting the troops on the far shore to flak suppression, in an attempt to minimize casualties while the paratroopers were still on the transports. Supporting aircraft had to stay clear of the area during this barrage, but assisted with flak suppression, as “medium bombers and fighter-bombers of the Ninth Air Force and British Second Tactical Air Force, for half an hour preceding arrival of the first transports, rained fragmentation bombs on antiaircraft batteries in the vicinity of the drop and landing zones.”<sup>29</sup> Medium bombers of IX Bomber Command and 2nd TAF “dropped 800 tons of bombs on 23 known enemy antiaircraft positions, and the 406th Fighter-Bomber Group of the XXIX Tactical Air Command, at a cost of four fighter-bombers [including the 513th’s squadron commander, Lt. Col. Gordon Fowler] flew low over the enemy antiaircraft position area between 9:00 AM and 1:00 P.M. on March 24, claiming the neutralization of 36 light and heavy flak positions.”<sup>30</sup> They also had to provide escorts to keep German fighters from interfering. Once the transports arrived, orders restricted anti-aircraft batteries from firing on *any* aircraft, to prevent friendly fire, making the escort mission of the accompanying fighters even more vital.<sup>31</sup> The force amassed for Varsity constituted an aerial armada, including,

889 escorting fighters, 1,696 transport planes, and 1,348 gliders, bringing to the battlefield 21,680 paratroopers and glidermen, followed closely by 240 four-engine Liberator bombers of the US Eighth Air Force dropping 582 tons of supplies. Another 2,153 fighter aircraft either maintained a protective umbrella over the target area or ranged far over Germany in quest of any German plane that might seek to interfere. None did. In addition, 2,596 heavy bombers (660 of them from the Fifteenth Air Force in Italy) and 821 medium bombers attacked airfields, bridges, marshaling areas, and other targets throughout Germany.<sup>32</sup>

For their part, “The Ninth Army’s usual ally in the sky, General Nugent’s XXIX Tactical Air Command, joined other Allied air units in the pre-D-Day interdiction program and was to expend part of its effort on 24 March in support of the big airborne attack, Operation Varsity. Yet enough planes were left over to provide armed reconnaissance in support of the Ninth Army and to assign a fighter-bomber group to work directly with each of the two assault infantry divisions.”<sup>33</sup> Though the drops were largely successful, with the airborne forces quickly and easily securing their objectives and linking up with the ground forces before dark, the 787 casualties incurred do not compare favorably with the forty-one suffered by the forces crossing the Rhine

by boat.<sup>34</sup> While the British 2nd TAF supplied most of the escorts, IX Troop Carrier Command crews flew the missions, and paid a steep price. “The IX Troop Carrier Command alone lost 41 killed, 153 wounded, 163 missing,” and lost 50 gliders and 44 C-47s destroyed.<sup>35</sup>

One of the primary reasons for the low casualties in the amphibious assault was the widespread prevalence of amphibious craft specially designed for that mission. Benefitting from expertise gained in the many amphibious operations in North Africa, Sicily, Salerno, Anzio, Normandy, and southern France, Allied forces were well trained and had ample resources for the job. Specialized landing craft borrowed from the Navy, with their crews, ferried troops quickly and securely across the 900 to 1,500 foot-wide river with a five mile-per-hour current. In essence, the river crossing became a multi-domain operation, coordinating, air, land and, to a limited extent, naval forces. Ninth Army gained the services of “Naval Unit Number 3, largest of three naval contingents supporting US armies, equipped with 24 LCVP’s and 24 LCM’s (landing craft, medium). A harbor craft company of the Transportation Corps later was attached to the engineer group to instruct in operating Seamules, 38-foot tugs powered by two 143-hp. engines.”<sup>36</sup> These craft greatly increased the speed with which Ninth Army could cross the water barrier and provided trained crews to operate and maintain the craft, increasing reliability and decreasing losses, both to the vessels themselves and to the bridges downstream threatened by any disabled craft carried into them by the current. The crews lost only one LCM and two LCVPs during the entire operation.<sup>37</sup> Andrew Higgins’ boats proved just as valuable on the Rhine as they had at Normandy or across the South Pacific. “They ferried personnel and light equipment and were used as power units for propelling rafts in the construction of bridges.”<sup>38</sup>

Opposing the crossing, the Germans had an estimated 85,000 men and 200 tanks, primarily with the 15th Panzer Division, opposing the British XXX Corps at Rees, and the 116th Panzer Division, the only mobile reserve immediately available in the Ninth Army sector. Due to the continuous presence of fighter-bombers in the battle area, these units could only move at night, severely restricting their mobility.<sup>39</sup> Many of the troops were older men and young boys in the hastily-assembled *Volksgrnadier* and militia units, but a healthy proportion of *fallschirmjagers* (German paratroopers) leavened the formations, and Ninth Army could expect strong resistance in locales where well-trained and equipped forces took advantage of constricted terrain. Ninth Army alone numbered over 120,000 men, outnumbering the defenders by a ratio 1.5:1 alone, before adding in the other two Allied armies. Airmen did their part throughout the preparation phase to reduce the defenders’ effectiveness, including an attack on the German First Parachute Army headquarters that seriously wounded the commander, General Schlemm. The absence of similar attacks by German aircraft on Allied headquarters highlights the nature of Allied air and information superiority, which enabled the airstrikes to have significant effects on the battlefield.<sup>40</sup> In a post-war article in *Air Force* magazine, Simpson reflected on these capabilities afforded by command of the air:

Service and supply installations were enabled to operate freely 24 hours a day. This was a condition without which the relatively short battle of the France, the extremely rapid advances from the Roer to the Rhine, and again from the Rhine to the Elbe, could not have taken place. During the battle of the Bulge major troop movements were made on traffic-jammed highways in broad daylight without serious air interference. Control was maintained without our army being plagued by having important headquarters attacked by enemy air.<sup>41</sup>

XXIX TAC's mission to support this ambitious plan was fourfold. First, they had to ensure the maintenance of air superiority, "preventing the German air force from interfering with the preparation and conduct of the Army's assault crossing."<sup>42</sup> In addition to the 373rd Fighter Group's commendation-worthy attack on 20 March, the AAF's heavy and medium bombers joined in the assault, plastering airfields while their escort fighters picked off any survivors, in the air or on the ground, and continuing up until the morning of the airborne attack. These had the desired effect, as "the Luftwaffe provided little opposition to the airborne operations."<sup>43</sup> Second, the airmen continued the interdiction effort, to restrict the flow of German troops and equipment to the crossing site. Here XXIX TAC received support from heavy and medium bombers, which concentrated on canals while the fighter bombers focused on the rail network.<sup>44</sup> Third, they had to support the XVIII Corps airdrop, including driving off enemy fighters and bombing flak positions and "finally, assisting the advance of the Army by closely coordinated air attacks on the immediate front of the attacking ground troops."<sup>45</sup>

Again, Nugent assigned specific groups to support each division, with the 366th Fighter Group covering the 30th Division and the 373rd Group providing assistance for the 79th Division.<sup>46</sup> XVI Corps headquarters reported that XXIX TAC kept a full squadron over the two crossing sites, relieving the aircraft every hour, totaling a record 829 sorties.<sup>47</sup> In short, air superiority, interdiction and close air support were again the priorities, in that order, with the CAS mission split between the airborne troops and those involved in the amphibious assault. The reconnaissance aircraft had the additional mission of monitoring German airfields for any buildup that might threaten the crossings and patrolling Ninth Army's front.<sup>48</sup> In the week prior to the attack, the reconnaissance squadrons of the 363rd Tactical Reconnaissance Group flew "37 photographic reconnaissance missions and 56 tactical reconnaissance mission," and developed, produced, and distributed 43,497 aerial photographs to Ninth Army artillery units, including the assigned 34th Field Artillery brigade. Ninth Army's AAR reported, "Arrangements were perfected with Tac/R to provide continuous observation for the adjustment and surveillance of long range artillery fire. Numerous targets such as marshalling yards, factories, dumps, and enemy battery positions were observed and taken under fire."<sup>49</sup> In March, the 28 officers and 108 enlisted men of the 363rd Tactical Reconnaissance Group produced a record 1,300 missions, with 1,100 effective, despite moving from Le Culot to Venlo on 9 March. The effort dropped to 675 missions, with 538 effective in April, with the two moves that month, to Gutersloh on 15 April and Brunswick on 22 April.<sup>50</sup>

Operation Flashpoint got underway at 0100 with a one hour barrage on targets in the 30th Infantry Division's sector. According to the Ninth Army's history:

For sixty minutes 2,070 guns averaged better than 1,000 rounds a minute in delivering a stunning attack on the German defenders, their communications facilities, and their defensive positions. In the preparation firing alone, 65,200 rounds—1,820 tons—of artillery ammunition struck the German defenses. From the beginning of the preparation to four hours after the launching of the crossings, 131,450 rounds—nearly 4,000 tons—were fired.<sup>51</sup>

This barrage left the first prisoners in a "stunned or dazed condition."<sup>52</sup> The efforts of the 40,000 artillerymen supporting the assault contributed a much greater weight of fire than even the massed heavy bombers of the AAF could have delivered. After the 30th Division jumped off, the gunners shifted to the defenders in the 79th Infantry Division's sector and gave them

an hour-long treatment. The only significant complication was the ubiquitous “fog of war,” which, in the early morning hours, caused several boat crews to become disoriented and discharge their loads back onto the western bank, where troops of the 79th charged back into the assembly areas they had just left! Fortunately they quickly discovered their error, preventing any episodes of fratricide. Unlike Operation Queen, held hostage almost a week while waiting for good weather, Flashpoint went ahead regardless, even if it resulted in the cancellation of the airdrop and the loss of friendly air cover.<sup>53</sup> By the end of 24 March, the 79th had secured a six-mile by three-mile bridgehead and was already entering the northern fringes of the Ruhr.<sup>54</sup>

The 30th Infantry Division made even better progress the first day, pushing six miles across the Rhine along the Lippe River and adjacent canal with all nine infantry battalions and tank and tank destroyer support.<sup>55</sup> But, by the end of the second day, the ground forces were already outrunning their artillery support, which waited behind the clogged bridges for its turn to enter the bridgehead, and air support again rose in importance as the only fire support that could be delivered in front of the rapidly advancing troops.<sup>56</sup> On 25 March, XXIX TAC flew 829 sorties, again ranging from interdiction well behind the attack area to close support of the ground forces. That same day, Eisenhower’s deputy commander for air, Air Marshal Sir Arthur Tedder, dropped in unannounced at Nugent’s headquarters and “spoke highly of the work of XXIX TAC,” before continuing on to Montgomery’s headquarters.<sup>57</sup> The 406th Group flew three missions, including strikes on an ammunition dump and barracks, motor transport, and a concentration of armor that included Tiger tanks and halftracks. The 514th Fighter Squadron lost one pilot, Captain Sweet, killed while landing.<sup>58</sup> One report claimed 29 tanks destroyed, a number that was surely exaggerated, but the heavy attacks delayed the commitment of the German armored reserves, and reduced the number confronting the advancing ground forces.<sup>59</sup>

Unfortunately, bad weather returned limiting XXIX TAC’s effectiveness for the remainder of the month, with no sorties on 27, 29, or 31 March.<sup>60</sup> Had the P-47s been able to get airborne on 31 March, they were scheduled to perform armored column cover, including the 373rd Group with the 8th Armored Division, the 406th with the 2nd Armored Division and armed recon for the remaining groups, with an admonition not to hit any more railroad rolling stock, to preserve it for postwar use. The P-51s of the 370th Fighter Group began providing escorts for the 363rd Tactical Reconnaissance Group’s F-6s, doubling the number of photographic missions that could be flown by the aircraft assigned to the reconnaissance squadrons.<sup>61</sup> XXIX TAC managed one attack against armor south of Dorsten and another on the *Luftwaffe* airfield at Gutersloh that claimed 56 aircraft and inflicted heavy damage on the future home of several of the command’s groups.<sup>62</sup>

On 26 March, the rebuilt 2nd *Fallschirmjaeger* Division made an appearance, the Ninth Army’s original foe at Brest. The same day, Simpson committed the 35th, 75th, and 8th Armored Divisions into the congested bridgehead, and released the army reserve 95th Infantry Division to XIII Corps. The 30th Division made good progress until the forward units of the 116th Panzer Division finally arrived to contain the attack, which stalled progress. Infantry against tank was a losing proposition, so on 28 March, Simpson committed his two armored divisions, with the 2nd Armored edging north towards Munster while 8th Armored plunged headlong into the 116th Panzer Division at Dorsten, but made little progress against the *Windhunds*. This sparked a busy day for the 406th Fighter Group, working directly with the forward air liaison officers to bomb a woods where German forces had concentrated, where controllers



reported a “good job.”<sup>63</sup> They pressed their attacks against two Tiger tanks, but the appearance of eight Fw-190s and four Bf-109s forced the 512th Fighter Squadron to drop their bombs before attacking and engage the hostile aircraft, with claims of three damaged. The close support continued throughout the day, with subsequent missions by the 514th squadron that hit artillery marked with green smoke between 1230 and 1330, while the 513th followed from 1345-1445 with an attack on 15 tanks. When Simpson committed the rest of the XIX Corps for the exploitation phase, McLain sent the “mechanized” 83rd Infantry Division in the 2nd Armored’s wake. The division had acquired so many vehicles along the way that it was essentially motorized. Simpson later recalled, “up came this ragtag circus, the 83rd Infantry Division. Every time they captured a German vehicle of any kind, they painted it the same color as an American vehicle, put ‘83rd Division’ on it, put somebody in it, and away they went. Pretty soon they were completely mechanized and moved just as fast as the armor did.”<sup>64</sup>

The TAC as a whole had the 366th out of combat, with one squadron training, one squadron preparing for the group’s transition to P-51s, and the third flying escort missions. The 373rd maintained close cover over the bridgehead with eight aircraft from dawn until dusk, guarding against aerial intruders, while also sending eight aircraft to fly armored column cover with the 8th Armored Division (callsign Awaiting) before relieving the bridge patrol. The 406th had a productive day of on-call CAS, while 405th also performed armored column cover with 2nd Armored (callsign Beagle). Ground forces were directed to switch to yellow panels for identification, suggesting that the German had caught on to the fluorescent red (cerise) panels previously in use, but on 30 March pilots of the 406th reported, “panels displayed sparingly.”<sup>65</sup> On that mission, aircraft worked with a controller with the callsign “Loadpipe” who requested a strike on a woods sheltering German troops. The troops attacked and took 100 prisoners of war immediately after the strike, claiming it was the closest support they ever observed.<sup>66</sup>

Simpson became frustrated at the inability to break out of his constricted bridgehead, especially when compared to the success of the British 7th Armoured Division and 6th Guards Armoured Brigade, followed by paratroopers of the 17th Airborne Division carried in “deuces” instead of C-47s, to the north. Montgomery and Simpson had agreed to let Dempsey’s British Second Army use a bridge over the Rhine at Wesel constructed by Ninth Army engineers for the first week of the attack, in order to cross armored support for the far shore. But Simpson became irate when he learned that Dempsey was crossing an entire armored division for the breakout, stalling Simpson’s buildup within his bridgehead. Simpson’s staff complained about the breach to Monty, who ordered the bridge turned over to the Americans on 31 March. At one point Simpson even threatened to push any British vehicles still found on the disputed road into the ditch, but the turnover went smoothly. The same day, Simpson released XIX Corps, with the 30th, 83rd, and 95th Infantry and 2nd and 8th Armored Divisions to penetrate deep into the German rear to complete the encirclement. XIII Corps sent the 84th and 102nd Infantry and 5th Armored towards Munster, with the city’s airfields a “high priority objective. Corps were ordered to report promptly to Army headquarters the location, condition, number, and length of runways of all captured airdromes.”<sup>67</sup>

March was, by far, the busiest month of the year for the fighter groups of XXIX TAC, marked by improving weather and the almost constant pace of operations, from the last week of Grenade, to the intensive two-week preparation period for Flashpoint, to the first hectic

week of operations for the ground forces across the Rhine. In January and February the 406th Fighter Group flew 906 and 955 individual sorties, respectively, but in March that number jumped to 1,618, before dropping back down to 955 in April, as operations wound down at the end of the month and the group completed its long-deferred move forward into Germany at Handorf on 17 April.<sup>68</sup> XXIX TAC overall flew 9,530 successful sorties in March, delivering 2,526.81 tons of general purpose bombs, 307.74 tons of fragmentation bombs, 19.85 tons of white phosphorus 26.25 tons of other incendiaries, and 53.25 tons of napalm. It claimed 22 enemy aircraft destroyed in the air, with two more probables, and 27 damaged. On the ground the numbers were much higher, with 183 destroyed, 17 probables and 257 damaged. This tremendous effort had cost the command 40 aircraft lost. As a concrete sign of the change the organization was helping to bring to Nazi Germany, on 29 March the TAC held a Passover Seder in Munchen Gladbach, attended by over 1,000 soldiers, in which German civilians prepared and served the meal.<sup>69</sup>

On 1 April, the 2nd Armored Division linked up with First Army's 3rd Armored Division at Lippstadt, completing the encirclement of the Ruhr and achieving the initial goal for the crossing. But with most of the German troops on the eastern bank of the Rhine, including three armies (First Parachute, Fifth Panzer, and Fifteenth), seven corps, and 19 divisions with over 300,000 troops now contained within the 30 mile-wide by 75 mile-long pocket, only sporadic resistance prevented further drives to the east, and Ninth Army planners became excited when the extended army boundaries showed Berlin within Ninth Army's sector. Unaware of Allied negotiations to stop at the Elbe and allow the Soviets the honor (or burden, considering the almost one million casualties expended in the effort) of capturing Berlin, Ninth Army continued to push units east as rapidly as possible, ideally, to catch German forces on the move before they could establish strong defensive positions. Meanwhile, most of XVI Corps, with support from XIX Corps turned to the task of reducing the Ruhr pocket. A Ninth Army history produced shortly after the war boasted, "In eight days this corps had crossed the greatest water barrier encountered since the invasion of the Continent, and had driven through unfavorable terrain, well adapted to the enemy's defenses, to establish a bridgehead more than twenty miles deep and ten miles wide and set the stage for the exploitation operations which were soon to result in the unconditional surrender of Germany."<sup>70</sup> Closing the pocket also prompted a reshuffling of the divisions for each corps. On that day, XIX Corps commanded the 30th and 83rd Infantry Divisions and the 2nd and 8th Armored Divisions, and was the primary exploitation force. XIII Corps secured their northern flank with the 17th Airborne and 84th Infantry Divisions, as well as 5th Armored, while XVI Corps pressed into the Ruhr with four infantry divisions, the 29th, 35th, 75th and 79th, as Simpson shifted his available divisions to match the assignments of each corps.

The German forces occasionally launched counterattacks, in a vain attempt to break out of the encirclement, but these were generally so weak that Ninth Army units often did not realize they were being counterattacked.<sup>71</sup> One attempted breakout by the *Panzer Lehr* Division was halted by clearing skies on 31 March, which presaged roaming fighter bombers, as even farmers in the area began working their fields at night to avoid the overzealous fighter pilots.<sup>72</sup> "Splitting the pocket at the Ruhr River gave almost all the heavily built up industrial district to the Ninth Army," but later adjustments gave both armies a more equitable share of the task.<sup>73</sup> To facilitate coordination between the two forces, Ninth Army reverted to 12th Army Group

control on 4 April, ending a successful collaboration with Montgomery's 21st Army Group but relieving several of the Ninth Army staff officers who chafed at British control. Ninth Army's history recorded the challenging missions "in continually diverging lines and of sharply contrasting types—slashing east in armored and motorized infantry operations of extreme rapidity and wide scope, and simultaneously driving to the south and southwest through the thickly populated, highly industrialized Ruhr, fighting from town to town, street to street, and building to building."<sup>74</sup>

The reduction of the pocket itself proceeded methodically, with each division capturing the assigned cities in its sector. The 95th Infantry Division, released from Army reserve, took Hamm, while the 17th Airborne, liberated from its mission with the British 2nd Army on 5 April, captured Duisburg and linked up with the 9th Infantry Division from First Army on 8 April, cutting the pocket in half.<sup>75</sup> The 79th Infantry Division focused on Essen while the 75th took Dortmund. The battle for each city varied, depending on the defenders. Militia and *Volkssturm* generally laid down their arms while many SS fanatics fought to the death.<sup>76</sup> Aircraft were of limited use in the dense urban environment and weather hampered their effectiveness, though, in one instance near Soest they did manage to catch a German formation in the open, killing an estimate 300 soldiers.<sup>77</sup> But,

Beginning on 7 April days of overcast and light rain gave way to warm sunny weather, enabling planes of the IX and XXIX Tactical Air Commands to aid the mop-up. North of the Ruhr River, the aircraft could make few contributions other than those against isolated strongpoints, both because that part of the pocket shrank fairly rapidly and because pilots now were forbidden to hit a usual primary target, railroad rolling stock (the Allies soon would need all boxcars they could get). Although the ban also applied to planes of the IX Tactical Air Command south of the Ruhr River, the area there was vast enough to provide other targets, particularly columns of foot troops and horse-drawn and motor vehicles retreating or shifting positions. In the Ninth Army's sector, notably in the zone of the XVI Corps, artillery operating for the first time with unrationed ammunition supplies more than made up for the restrictions on aircraft.<sup>78</sup>

The allocation of effort made perfect sense to airmen, who were more than happy to let the artillery do its job in an area with one of the densest flak concentrations in the Reich. By 12 April, the proximity of converging First Army units meant XXIX TAC could no longer operate over the pocket at all. The restrictions on the destruction of German railroad cars and locomotives, needed to rebuild the rail system, meant there was little for the pilots to do except guard against forays by the vanishing *Luftwaffe*.<sup>79</sup> One advantage of reducing a pocket is the increasing density of units on the exterior as the perimeter shrinks, which gradually freed up more of Simpson's units for the drive east. Subsequent cuts by units of both armies led to another link-up on 14 April, splitting the pocket further and essentially ending the battle. The following day *Feldmarschall* Walther Model began discharging his soldiers rather than have them surrender, creating the potential for a hostile populace, but the heavy losses inflicted thus far undercut any irregular resistance. By 18 April, resistance inside the pocket collapsed, sending 370,000 prisoners into the Allied cages, at a cost to Ninth Army of 341 killed, almost 2,000 wounded, and 121 missing. Unwilling to suffer the indignity of surrender, Model chose to take his own life on 21 April.<sup>80</sup>

Farther east, the remainder of XIX Corps faced similar resistance but made far more impressive territorial gains, especially after 9 April when XVI Corps took complete responsibility for the entire Ruhr sector, freeing McLain's corps to focus on the exploitation. XIII Corps, after passing through Munster, reached Minden, west of Hanover, on 4 April with the 5th Armored and 84th Infantry Divisions. On that day, under clearing skies, "Thunderbolts of XXIX Tactical Air Command gave invaluable assistance...as the fighter-bombers razed strongpoints near Detmold and Minden."<sup>81</sup> The 30th Infantry Division entered the Teutoberger Wald, a rugged, forested region perched above the surrounding plains that looked to be an ideal spot for stubborn resistance. But the division pushed through the region quickly, and both it and the 2nd Armored established a bridgehead over the Weser River near Hameln (Hamlin) on 6 April, all against light resistance. The next day, XXIX TAC flew 432 sorties, claiming twenty-three armored vehicles and, freed from the restriction in place within the Ruhr, much rolling stock for the railroads.<sup>82</sup> An attack on a suspected supply depot or ammunition dump at Halberstadt resulted in a massive explosion that flattened a portion of the city.<sup>83</sup>

On 10 April the "Railsplitters" of the 84th Infantry Division cleared the major city of Hanover, indicating that German resistance was collapsing.<sup>84</sup> The next day, advanced elements of the 2nd Armored Division reached the Elbe, the first Allied unit to do so, and on 12 April pushed advanced elements across into a narrow bridgehead, as Ninth Army headquarters displaced forward to a former *Luftwaffe* signals facility near Gutersloh.<sup>85</sup> The same day, the 83rd Infantry and 5th Armored divisions also reached the river and began preparations for another crossing, but these proved to be "bridgeheads to nowhere," without a commitment to continuing past the agreed-upon demarcation line. This caused much anguish for the Ninth Army staff, both at the time and decades later. Most accounts agreed with the official history, which stated,



Figure 7.2. P-47s Provide Close Air Support in Marienau, Germany.

“The American armies, the Ninth in particular, could have continued their offensive some fifty more miles at least to the fringe of Berlin. The decision of the Supreme Allied Commander and nothing else halted the Americans at the Elbe and the Mulde,” but S.L.A. Marshall years later asserted, on the basis of one hasty visit to the 83rd ID’s bridgehead, that Ninth Army was “strung out, with its flanks hanging in the air,” and unprepared for further movement, a claim that prompted a vociferous response in the press from Simpson.<sup>86</sup> This was not the first case of shoddy work by Marshall, whose once widely-believed claim that only 20 percent of infantrymen fired their weapons in combat has now been thoroughly debunked, or at least exposed as a fabrication lacking any statistical evidence.<sup>87</sup> The Ninth Army official history reported, “The entire advance had been a striking demonstration of highly skilled, well equipped professional troops performing a task for which they were fully prepared *and admirably trained*. (emphasis added) Everyone knew his job. There was no hesitation.”<sup>88</sup>

The 30th Infantry Division received the assistance of dive bombers who only had to “demonstrate” against Brunswick to induce the city’s surrender. According to Robert Baumer’s recent history of the division, six P-47s circled the city to help induce *Generalleutnant* Veith to surrender, but the German commander elected to evacuate the city instead.<sup>89</sup> The 30th Infantry Division joined the pursuit but heavy artillery fire from within the city of Magdeburg made the crossing untenable.<sup>90</sup> According to Charles McDonald, “Call after call went back for fighter bombers to strike the artillery positions, but so far behind had airfields fallen in the race across Germany that the Elbe was almost beyond range of tactical aircraft. None showed up.”<sup>91</sup> Worse, German units across the Elbe began counterattacking the bridgeheads, pushing back the 2nd Armored and 30th Infantry divisions’ perimeter. Having outrun their support, some troops were even cut off and forced to surrender. “The forward observer called for a blanket of artillery fire on Elbenau to catch the Germans in the open. When the fire lifted, some sixty men made a break for the river. As tanks and tank destroyers fired from the west bank to cover their withdrawal, fighter-bombers of the XXIX Tactical Air Command with auxiliary fuel tanks in place of bombs finally arrived to strafe German positions. Most of the sixty men returned safely,” including the majority of Company L, 119th Infantry, but the Germans captured another 300.<sup>92</sup> Clearly, the range to airfields back in Belgium and the Netherlands was having an effect across 12th Army Group. “Although planes of the IX Tactical Air Command were overhead much of the time, their help generally was limited to strafing because, like planes of the XXIX Tactical Air Command in support of the Ninth Army, they had to carry auxiliary fuel tanks in place of bombs.”<sup>93</sup>

German demolition at airfields near Munster, Gutersloh, Paderborn, and Brunswick left fields that were “destroyed to such an extent that only emergency strips could be made ready without extensive construction and repairs.”<sup>94</sup> Engineers and logisticians were stretched to their limits trying to keep the aircraft fueled, armed and in the air. As early as 24 March, Nugent’s command was running short of .50 caliber ammunition and 500- and 1,000-pound bombs, and had to substitute 500-pound “Composition B” (an inferior explosive) bombs and 260-pound fragmentation bombs.<sup>95</sup> After Nugent presented the army commander with an estimate for the tonnages required to displace his command forward, Simpson made the decision to substitute food and fuel instead, exacerbating Nugent’s difficulties. Even this proved insufficient, and logisticians pressed 9th Air Force’s Troop Carrier Command into action carrying fuel and ammunition forward and conducting medical and POW evacuations to the rear. Over 11,000



Figure 7.3. (front) Ground Commanders Simpson, Patton, Bradley, Hodges, Gerow; Back, Air Commanders Nugent, Weyland, Vandenberg, Stearley, May 1945.

wounded flew to hospitals in the Communications Zone during the month of April, sparing a long ambulance journey from the front and saving many lives.<sup>96</sup> Nugent's planes had to carry fuel tanks instead of bombs and enjoyed a limited loiter time at the front. "Although two emergency refueling strips set up and Munster and Gutersloh aided somewhat in easing the long hauls, the facilities of these two fields could refuel and rearm only a squadron or two at one time,"<sup>97</sup> out of the fifteen or so in the air on a given day, limiting their utility. By the time the squadrons finally displaced forward, the battle had ended.

Things were in better shape in the 83rd Division bridgehead, which Simpson unsuccessfully lobbied to expand as far as Potsdam. Here, "Although an occasional German plane harassed the bridgehead, American fighter-bombers extending their range with auxiliary fuel tanks in place of bombs were active much of the day, artillery and armored support were plentiful, and nobody doubted the 83d Division's ability to break out of the bridgehead at will."<sup>98</sup> With the theater commander holding up a large stop sign, there was little for Ninth Army to do except consolidate its gains, mop up bypassed groups in rear areas, and prepare for the now inevitable junction with Soviet troops moving west from their encirclement of Berlin. The Red Army jumped off across the Oder on 16 April and quickly surrounded the German capital, freeing up units flowing around

the German cauldron. On that day and the following, the fighter bombers had a field day against the few remaining airfields in German hands, as the shrinking area between the two Allies compressed German aircraft onto a few fields, resulting in claims of over two hundred aircraft destroyed and damaged.<sup>99</sup> On 17 April, two fighter groups of XXIX TAC flew escort for a massive three-and-a-half hour raid on Magdeburg by 11 groups of medium bombers dropping 775 tons of bombs that ripped the heart out of the city.<sup>100</sup> The ground forces felt the impressive display, a fitting bookend to similar operations at Brest seven months earlier, did little to assist in the reduction, as most of the bombs fell on the city's center while the defenders had dug in on the perimeter.<sup>101</sup> Nugent sent Simpson a photograph of the ruins, along with a note, which read, "The ruins shown on attached photograph were formerly the city of Magdeburg-until it failed to accept the ultimatum of the Ninth US Army."<sup>102</sup> But the 30th Infantry Division and elements of 2nd Armored quickly reduced the stubborn holdouts the following day. Further operations on German units east of the Elbe risked attacking Soviet formations, and the Allies agreed to a 200-mile bomb line in front of their forward units, which eventually placed an umbrella over the German forces remaining between the two armies, curtailing operations for XXIX TAC and allowing many of the surviving German forces to reach British and American lines on the Elbe. Only the light-artillery spotting aircraft could operate within this restricted airspace, and it was one of these aircraft that finally spotted the approaching Soviet columns.<sup>103</sup> On 25 April, First Army's 69th Infantry Division earned the honor of making first contact at Torgau, a distinction that surely would have gone to Ninth Army absent the stop order.

Behind the Elbe, XIII corps elements had to deal with a counterattack from *Panzer Division von Clausewitz*, a school formation fleeing the British sector for either the safety of the Harz Mountains or other enclaves farther south. But hasty redeployments by the 29th Infantry and 5th Armored divisions resulted in the German formation seeking shelter in a densely wooded area, where the attackers destroyed it.<sup>104</sup> The 366th Fighter Group provided key support on 19 April, with Major General Gillem reporting, "The close cooperation given in this afternoon's attack by squadrons of your group to the armor of my Corps established a new high in air-ground cooperation. Your bombing was so accurate the ground troops were able to close effectively with the Krauts."<sup>105</sup> The going was tougher in the Harz Mountains, where the 83rd Infantry Division requested close air support against "'Mount Olympus,' a rugged mountain-top stronghold where the enemy resisted bitterly," but attacks by 41 dive bombers helped reduce the position.<sup>106</sup> With most of Ninth Army now in position on the Elbe, the headquarters moved forward again on 23 April to Brunswick, in the center of the assigned occupation zone, to await the arrival of the Soviets from the east.<sup>107</sup>

As the campaign wound down, XXIX TAC completed the long awaited forward displacement and began to settle into their new airfields. On 20 April 1945, Col. Holt's 366th group was at Handorf, Giffen's 370th Fighter Group and Smelley's 363rd Tactical Reconnaissance Group were at Gutersloh. McGehee's 373rd remained in Holland at Venlo, and Col. Jackson's 405th group were still at Ophoven in Belgium, but both were preparing for imminent moves. The combined command had a strength of 1,397 officers and 8,266 enlisted men, for a total of 9,803, almost the size of an understrength division. The four P-47 groups had 303 aircraft assigned, with 270 of them operational, while the lone P-51 group, the 370th, had 59 of 73 Mustangs ready to fly. Maintenance was further behind in the hard-used Tactical Reconnaissance Group, with only 24 of 44 assigned F-5s and F-6s operational. XXIX TAC was roughly equal in strength to the other two 9th Air Force Tactical Air Commands, lacking only an assigned P-61

night fighter squadron. In terms of effectiveness, this was probably the peak for the Army Air Forces. The men were all well-trained, experienced, and had crafted both a viable doctrine and a robust command and control network that enabled them to apply airpower wherever it was needed on the battlefield, either with kinetic effects or detailed reconnaissance that the army commander could exploit with other members of the combined arms team. Ninth Army and XXIX TAC formed a highly effective and successful partnership. In his farewell message to Ninth Army on 10 June 1945, before he left for an assignment in the Pacific Theater, Simpson wrote, "I feel that it is appropriate upon this occasion, also, to again acknowledge the superb air cooperation furnished the Ninth Army by the XXIX Tactical Air Command. In recording this acknowledgement, I feel also that I speak on behalf of all the field commanders of the Ninth Army who have benefitted from the cooperation afforded by this splendid organization."<sup>108</sup> For his efforts, Nugent received the "Order of Alexander Nevsky" from the Soviet Union, but the War Department later turned down Simpson's recommendation for a Distinguished Service Medal for his air commander.<sup>109</sup> But from this day forward, their well-honed skills began to atrophy, as first occupation duty, and then redeployment began to erode hard-won skills and expertise among the soldiers and airmen one of the most effective air-ground teams in history.<sup>110</sup>

## Conclusion

At the conclusion of the campaign, Maj. Gen. Sir Percy C. S. Hobart, commander of the British 79th Armoured Division, wrote Simpson to congratulate him on his army's success in the campaign and express his "most sincere admiration for the intelligence and bravery of the American Soldier and the Reliability and helpfulness of their Officers."<sup>111</sup> He told Simpson, "I can assure you that no-one shall ever speak disparagingly of the United States Army to us," a far cry from the early assessments of the US Army after the Battle of Kasserine Pass.<sup>112</sup> Ninth Army's After Action Report found, "The American Air Forces had assisted materially in the rapid advance. Their area cover and strikes on enemy targets proved most helpful in keeping the armored columns moving. They also had done a magnificent job of bringing about the rapid and final isolation of the Ruhr valley from the rest of Germany, a performance second in importance only to the breakup of the enemy's air force and the neutralization of his fuel producing capacity."<sup>113</sup> In his "Order of the Day" of 21 April, Eisenhower wrote,

The battle of the Ruhr has ended with complete success. Following hard upon the final destruction of the German forces west of the Rhine, the Twenty-first Army Group thrust powerfully across that river with the US Ninth Army under its command. Simultaneously, rapid drives across the Rhine and from the Remagen bridgehead by Twelfth and Sixth Army Groups provided the southern arm of a great double envelopment which completely encircled the entire German Army Group "B" and two corps of Army Group "H," whose mobility was rendered almost zero by our magnificent and tireless Air forces. Thereafter, in the pocket thus created the Twelfth Army Group eliminated twenty-one enemy divisions, including three panzer, one panzer grenadier and three parachute divisions.<sup>114</sup>

The aerial armada extended over the Allied forces crossing the Rhine and racing across Germany was truly impressive. In April, "the Allies had 28,000 combat aircraft, of which 14,845 were American, including 5,559 heavy bombers and 6,003 fighters," which made the early, heated debates over allocation appear insignificant.<sup>115</sup> The Army Air Forces now had more than enough





Figure 7.4. Lt. Gen. William H. Simpson thanks Brig. Gen. Richard E. Nugent for Air Support provided by XXIX TAC to Ninth Army.

aircraft to conduct a massive strategic bombing campaign and still build five full Tactical Air Commands, IX, XIX, XXIX and XII with First, Third, Ninth, and Seventh Armies in northern Europe, respectively, and XXII with Fifth Army in Italy. This abundance of resources resolved many doctrinal disputes about allocation of effort, but it also resulted from four years of robust production by the American aircraft industry and training establishment. The early stages of future conflicts are far more likely to approximate the early conditions in North Africa, with too many requirements and too few aircraft, making the proper doctrine far more important.

But, even more impressive than the fielding of this massive force was the close coordination it achieved with ground forces throughout the theater. Through experimentation, careful study, refinement, and finally, extensive training, American soldiers and airmen constructed a highly effective air-ground team that greatly facilitated Allied success in the theater. In an assessment penned shortly after the end of the war, Simpson recalled,

The nature of the enemy's defenses east of the river was such that XXIX TAC was asked to try to isolate the battlefield prior to the actual crossing by our

troops. Air strikes were made to the maximum extent possible on communications facilities leading into and within the anticipated battlefield. Very good results were achieved. On D-day and continually thereafter until the bridgehead was secured, 24 aircraft provided continuous daylight close cover for the bridgehead area, with 12 aircraft cooperating with each of the two assaulting divisions. In addition, a varying force of from 16 to 32 aircraft flew top cover at 15,000 feet over the same general area. The air cooperation was adequate and extremely effective. Attacks were made on the front of one infantry division against an armored build-up which was preparing for a counter-attack against the bridgehead. Claims were 29 enemy tanks destroyed and 29 others damaged. As the bridgehead expanded, antiaircraft artillery assumed full responsibility for protecting the Rhine bridges. This released more aircraft from flying protective bridge cover and allowed their use for close cooperation. When the attack developed its full punch, each of the three army corps had one group flying close cooperation missions.<sup>116</sup>

Thus, XXIX TAC accomplished each of the doctrinally-stipulated missions, air superiority, interdiction, and close support, and easily switched between the three throughout the battle, depending on Ninth Army's immediate needs. Simpson concluded, "the Ninth Army received direct cooperation from the XXIX Tactical Air Command of the 9th Air Force. This efficient air organization, commanded by Brig. Gen. Richard E. Nugent, worked in closest harmony with our ground commanders throughout the campaign across France, Holland, Luxembourg, Belgium, and Germany. It was a partnership that paid profitable dividends."<sup>117</sup>

Despite some lingering issues, Charles McDonald found, "The last offensive was nevertheless a brilliant exercise in controlling masses of men and units and in coordinating the air and all the ground arms—a demonstration of power never before seen, even in the early German campaigns of World War II or in the offensives of the Red Army."<sup>118</sup> American soldiers and airmen, with vital assistance from the British in the early campaigns, and with a successful example from the *Luftwaffe* to build upon, fielded one of the most effective air-ground forces the world has ever seen. It took much effort and hard work to accomplish, including long and frustrating hours in stateside training exercises, but it paid dividends on the battlefield. Unfortunately, these hard-won gains proved perishable, as a postwar establishment failed to maintain the tempo of training and lost much expertise through demobilization. As Gen. O. P. Weyland, commander of XIX TAC, wrote after the Korean War, "What was remembered from World War II was not written down, or if written down was not disseminated, or if disseminated was not read or understood," leading to another steep learning curve in that conflict.<sup>119</sup>

## Notes

1. Only Charles Whiting's *Ike's Last Battle: The Battle of the Ruhr Pocket April 1945* (London: Pen and Sword, 2007) and Derek Zumbro's *The Battle for the Ruhr: The German Army's Final Defeat in the West* (Lawrence: University of Kansas Press, 2006), which adopts a sympathetic view towards the suffering of German civilians during the battle, cover the events in any detail, outside of the official histories written shortly after the war.
2. Charles McDonald, *The Last Offensive* (Washington, DC: Center for Military History, 1973), 294.
3. "Brief History of the 146th Fighter-Bomber Group, 1943-1956," [http://412th.org/archives/373rd\\_background.html](http://412th.org/archives/373rd_background.html), accessed 13 June 2018; *Mission Accomplished: The Story of the XXIX TAC*.
4. XXIX TAC Headquarters, "Movement Statistics, XXIX TAC Combat Operations;" 573rd Signal Aircraft Warning Battalion, "Movement of MEW and FDP's;" XXIX TAC Headquarters, "Report on Operation Flashpoint, 24 March 1945," Box 96, Hoyt Vandenberg Papers, Library of Congress, Washington, DC. The two groups at Asch moved to Y-94 at Handorf, Germany on 14 and 17 April while the groups at Ophoven shifted to Gutersloh on 22 and 24 April.
5. McDonald, *The Last Offensive*, xxx.
6. McDonald, 304-305.
7. McDonald, 307.
8. Craven and Cate, *The Army Air Forces in World War II*, Vol. III, 774; Parker, *Conquer*, 251, 254.
9. McDonald, *The Last Offensive*, 307.
10. McDonald, 300.
11. Craven and Cate, *The Army Air Forces in World War II*, Vol. III, 772.
12. "Report on Operation Flashpoint."
13. "Report on Operation Flashpoint."
14. *Mission Accomplished: The Story of the XXIX TAC*.
15. "Report on Operation Flashpoint."
16. *Mission Accomplished: The Story of the XXIX TAC*.
17. 406th Fighter Group, Mission Reports, Record Group 18, NARA2, College Park, MD.
18. Nugent's War Diary, 11 March 1945.
19. Nugent's War Diary, 14 March 1945.
20. Nugent's War Diary, 18 March 1945.
21. McDonald, *The Last Offensive*, 295.
22. Simpson Diary, Simpson Papers, Army Heritage and Education Center (AHEC), Carlisle Barracks, PA; McDonald, *The Last Offensive*, 295-296.
23. Eisenhower to Simpson, 26 March 1945, Folder 6, Box 3, Simpson Papers, AHEC.
24. Parker, *Conquer*, 214.
25. Parker, 213.
26. McDonald, *The Last Offensive*, 306; Parker, *Conquer*, 215.
27. McDonald, *The Last Offensive*, 308.
28. See Marc Devore, *When Failure Thrives: Institutions and the Evolution of Postwar Airborne Forces* (Fort Leavenworth, KS: The Army Press, 2015).
29. McDonald, *The Last Offensive*, 310; Craven and Cate, *The Army Air Forces in World War II*, Vol. III, 774.
30. Parker, *Conquer*, 239; Nugent's War Diary, 24 March 1945. Fowler earned a Distinguished Service Cross for his efforts.
31. Parker, *Conquer*, 238.
32. McDonald, *The Last Offensive*, 309.
33. McDonald, 304.
34. Devore, *When Failure Thrives*, 24; Stephen Waight, *The Last Drop: Operation Varsity, March 24-25, 1945* (Mechanicsburg, PA: Stackpole, 2008), 287-290.

35. McDonald, *The Last Offensive*, 313.
36. McDonald, 295.
37. Parker, *Conquer*, 246.
38. Parker, 246. On Higgins, see Jerry E. Strahan, *Andrew Jackson Higgins and the Boats that Won World War II* (Baton Rouge: Louisiana State University Press, 1998).
39. McDonald, *The Last Offensive*, 315.
40. McDonald, 301.
41. William H. Simpson, "Partners in Battle," *Air Force* (August 1945): 6.
42. Parker, *Conquer*, 234.
43. Parker, 242.
44. Parker, 235.
45. Parker, 234; "Report on Operation Flashpoint."
46. Parker, *Conquer*, 235.
47. *History of the XVI Corps From Its Activation to the End of the War in Europe* (Washington, DC: Infantry Journal Press, 1947), 48.
48. Parker, *Conquer*, 234.
49. Ninth Army After-Action Reports, in World War II Operations Reports, 1940-1948, Ninth Army, Box 2407, Entry 427, Record Group 407, Records of the Adjutant General's Office, NARA2, College Park, MD; Parker, *Conquer*, 240, 241.
50. "363rd Tactical Reconnaissance Group History."
51. Parker, *Conquer*, 243.
52. Parker, 243.
53. Parker, 237.
54. McDonald, *The Last Offensive*, 307.
55. Parker, *Conquer*, 248.
56. Hewitt, *Work Horse of the Western Front*, 241; McDonald, *The Last Offensive*, 309.
57. Nugent's War Diary, 25 March 1945.
58. 406th Fighter Group, Mission Logs, Folder "406th Fighter Group," Record Group 18, Records of the Army Air Forces, NARA2, College Park, MD.
59. Parker, *Conquer*, 254.
60. "Report on Operation Flashpoint."
61. 406th Fighter Group, Mission Logs, Record Group 18, NARA2, College Park, MD.
62. Parker, *Conquer*, 258-259.
63. 406th Fighter Group, Mission Logs.
64. Parker, *Conquer*, 262; Simpson Oral History Interview, Folder 4, Box 16, 250, Simpson Papers, AHEC; 83rd ID Headquarters, *The Thunderbolt across Europe: Normandy, Ardennes, Brittany, Rhineland, Central Europe : A History of the 83rd Infantry Division, 1942-1945* (Munich: 83rd Infantry Division, 1945).
65. 406th Fighter Group, Mission Logs.
66. 406th Fighter Group, Mission Logs.
67. Simpson Diary; Parker, *Conquer*, 264, 266.
68. 406th Fighter Group, Mission Logs.
69. XXIX TAC Periodic History.
70. Parker, *Conquer*, 268, 269.
71. McDonald, *The Last Offensive*, 359, 360.
72. Zumbro, *Battle for the Ruhr*, 181, 352.
73. McDonald, *The Last Offensive*, 362.
74. Parker, *Conquer*, 270.
75. Parker, 276-276.

76. McDonald, *The Last Offensive*, 364.
77. Parker, *Conquer*, 274.
78. McDonald, *The Last Offensive*, 365.
79. Parker, *Conquer*, 279, 280.
80. McDonald, *The Last Offensive*, 367, 372.
81. Parker, *Conquer*, 292.
82. Parker, 294.
83. Parker, 294.
84. McDonald, *The Last Offensive*, 380, 385-387.
85. Parker, *Conquer*, 292.
86. McDonald, *The Last Offensive*, 406; Simpson to Moore, Simpson Papers.
87. See Roger Spiller, "S.L.A. Marshall and the Ratio of Fire" *RUSI Journal*, 133:4 (Winter 1988): 63-71.
88. Parker, *Conquer*, 300.
89. Baumer, *Old Hickory, The 30th Division*, 479.
90. Hewitt, *Work Horse of the Western Front*, 259.
91. McDonald, *The Last Offensive*, 397.
92. Baumer, *Old Hickory, The 30th Division*, 491; McDonald, *The Last Offensive*, 398.
93. McDonald, *The Last Offensive*, 400.
94. Parker, *Conquer*, 301.
95. Nugent's War Diary, 24 March 1945.
96. Parker, *Conquer*, 311-312.
97. Parker, 301-302.
98. McDonald, *The Last Offensive*, 399.
99. Parker, *Conquer*, 304.
100. Baumer, *Old Hickory, The 30th Division*, 495.
101. Hewitt, *Work Horse of the Western Front*, 266; Parker, *Conquer*, 305-306.
102. Nugent to Simpson, 20 April 1945, Folder 7, Box 3, Simpson Papers, AHEC.
103. McDonald, *The Last Offensive*, 446, 448.
104. McDonald, 400.
105. *Mission Accomplished: The Story of the XXIX TAC*.
106. Parker, *Conquer*, 306.
107. Parker, 310.
108. William H. Simpson, "Farewell Address to Ninth Army," 10 June 1945, Folder 7, Box 3, Simpson Papers, AHEC.
109. "Temporary Certificates issued by 33rd Army of the U.S.S.R., 15 May 1945, Folder 7, Box 3, and "Memo, 'Distinguished Service Medal," Folder 8, Box 3, Simpson Papers, AHEC.
110. "9th Air Force, 1942-1945," Box 54, Vandenberg Papers, Library of Congress, Washington, DC.
111. Hobart to Simpson, 23 April 1945, Simpson Papers, Box 2, Folder 28, AHEC, Carlisle, PA.
112. Hobart to Simpson.
113. Ninth Army After-Action Reports.
114. Headquarters, Ninth US Army, 21 April 1945, Folder 7, Box 3, Simpson Papers, AHEC.
115. McDonald, *The Last Offensive*, 478.
116. Simpson, "Partners in Battle," 6.
117. Simpson, 6.
118. McDonald, *The Last Offensive*, 480.
119. Peter Paret, Gordon Craig, and Felix Gilbert, eds., *Makers of Modern Strategy from Machiavelli to the Nuclear Age* (Princeton, NJ: Princeton University Press), 643.



## Conclusion

The trajectory of American air-ground doctrinal development, training and application appears to be a positive success story, and one of the key innovations undertaken by those Paul Kennedy has labeled “Engineers of Victory” in underwriting Allied success in World War II.<sup>1</sup> On the surface, after the recognition of a variety of problems in North Africa, including technology, training, but also specific doctrine, the US military instituted reforms, more evolutionary than revolutionary, and then implanted the fine-tuned doctrine in a number of combat organizations through intensive, stateside training exercises and field maneuvers before those organizations successfully employed it in Northwest Europe in 1944-1945. Confident that, once war breaks out, the robust US military system can successfully identify failures and improvise and adapt solutions, this study might appear to suggest that all is well within an establishment that retains substantial support for writing and revising doctrine and testing it in large-scale training exercises. The frequent “Green Flag” (formerly known as “Air Warrior”) exercises in air-ground coordination conducted at Fort Polk, Louisiana, essentially within the boundaries of the old Louisiana maneuver area, suggest that there is little cause for concern, and that existing doctrine either is well-suited for, or can be quickly modified to fit, any future conflicts, and a partnership between the Army’s Training and Doctrine Command (TRADOC) and the Air Force’s Air Combat Command (ACC) is continuing efforts to develop and refine air-ground doctrine.<sup>2</sup> But leaders in the early 1940s undoubtedly felt well-prepared for that conflict, only to have many of their assumptions destroyed in the early battles, along with valuable lives and equipment. Thus, a constant reappraisal of current doctrine and, especially, organization, is essential, in order to ensure the shortest possible path to successful modification and victory in the “learning contest” that all wars inevitable devolve into.

Current American air-ground doctrine focuses on robust “Combined Air Operations Centers,” or CAOCs that highly centralize virtually all aspects of the air war. From airspace allocation to air defense to bed-down support and logistical requirements, the Air Component Commander’s central command and control organization is a model in efficiency. It can quickly and effectively produce a daily Air Tasking Order and modify an Airspace Control Order to adjust the Forward Support Control Line (FSCL) and open and close “killboxes” for close air support. It is also highly vulnerable, both to cyber attack, degradation of space-based assets that provide much of the essential reconnaissance and communications, and simple kinetic attack that can easily destroy the large, difficult-to-conceal facilities. In a recent article in *Military Review*, a group of faculty members at the Air Force’s Air Command and Staff College argued for greater decentralization in the current command and control system, arguing, “both the Army and the Air Force need to increase the agility of their respective command-and-control systems to delegate decision making to a lower level,” calls echoed by Gen. Mike Holmes, commander of Air Combat Command.<sup>3</sup> Indeed, Brigadier General Nugent and XXIX TAC were very fortunate that the Germans continued their neglect of C2 nodes, applied disastrously in the Battle of Britain, and failed to effectively target either his MEW radar or his two FDPs, enabling him to retain some sense of control over his sector of the battlespace. In a post-war assessment of Ninth Army’s final campaign, Simpson later said, “The crossing of the Rhine and the rapid exploitation to the Elbe were marked by the two extremes of good military procedure. First, note the months of careful, detailed study and preparation for the Rhine crossings; and second,

witness the flexibility, the initiative, *the decentralization of command*, and the acceptance of considerable risk in the exploitation phase. (emphasis added) Both types of thinking and action are necessary to successful military operations.”<sup>4</sup>

Thus, planners are already exploring concepts of “distributed control,” whereby the CAOC delegates management of certain aspects of the air war, especially the coordination of close air support, down to corps-level Air Support Operations Centers (ASOCs) and subordinate organizations, such as Joint Air Ground Integration Centers (JAGICs) at the division level.<sup>5</sup> These nodes ensure the ability to provide aerospace defense and close air support, even in the absence of a centralized control facility. In essence, it solves the problem of 6 June 1944, when the Allied command centers in the UK became overwhelmed with requests for support that it could not effectively respond to, leaving soldiers and airmen to adapt, improvise and overcome in the weeks ahead. In essence, decentralized control mirrors the system in place in 1945, when numbered army and subordinate commanders had dedicated assets allocated for their support, though the Army Air Forces wisely insisted on centralized command that enabled them to shift these assets among the TACs to the threatened sectors of the front. While *assigning* specific assets to ground force commanders, as is currently done with the Army’s aviation brigades within each division, prevents their concentration, it does provide the commander with responsive support closely integrated with the remainder of his or her combined arms team.

But, as a result of the controversial 1966 Johnson-McConnell Agreement, these assets consist exclusively of less-capable rotary-wing assets, ideal for logistic support or troop transport in an uncontested environment, but proven to be increasingly unsurvivable on the modern battlefield as the “death ride” of the 11th Attack Helicopter Regiment demonstrated in 2003. The regiment’s “deep attack” resulted in heavy damage, much of it inflicted by small-caliber anti-aircraft artillery and simple small arms fire, on virtually every helicopter participating in the attack while failing to achieve its objective and suffering unnecessary casualties. <sup>6</sup> Though that operation featured planning errors mitigated in subsequent operations, the simple fact remains that it was likely the wrong tool for the job. Fixed wing aircraft likely could have completed the deep strike mission with fewer assets and lower costs, as they did elsewhere in the Iraqi theater of operations. Numerous examples suggest there is some reluctance, both historical and contemporary, on the Air Force’s part to conduct the close air support mission, which will only intensify if it means risking any of the incredibly expensive, and scarce, F-35 Joint Strike Fighters in a high-risk environment. CAS rightly remains a clear third behind air superiority and interdiction in the Air Force’s doctrinal priorities which, themselves, lag far behind the “strategic attack” mission that remains the premier mission, even in the modern, fighter-pilot led Air Force. But, as Maj. John Bolton articulated in the May-June 2016 issue of *Military Review*, “air-ground teams remain the most effective employment of military power,” and “Therefore, in the face of concerted efforts by the Air Force to scale back CAS to accommodate other budget priorities—because CAS is vital to combined arms maneuver—the Army should hedge its requirements in this area by developing its own organic CAS assets to augment the Air Force (USAF) CAS.”<sup>7</sup>

In a sense, technology has already made much of the debate moot, as remotely-piloted aircraft (RPA’s, or “drones” in layman’s terminology) have already found their way into the Army’s inventory, though the most capable MQ-9 “Reapers” remain exclusively an Air Force asset. In their response to Major Bolton’s article, published in the March-April 2017 issue of



*Military Review*, Lt. Col. Clay Bartels, an Air Force F-22 pilot, Maj. Jim Tormey, a Marine MV-22 pilot, and Dr. Jon Hendrickson, all of the Air Command and Staff College, argued that the Army's efforts to procure an indigenous fixed-wing capability were "dangerous and foolhardy," because theater commanders integrate service assets in order to operate in a joint environment. But they minimized each service's responsibility to *provide* adequate assets to the theater commanders. Assets will quite obviously be employed jointly, across multiple domains, but they still must be procured, manned, maintained and equipped by the individual service. In 2008, Secretary of Defense Robert Gates chastised the Air Force for not growing its RPA fleet fast enough to meet the global needs of joint force commanders, and complained that securing additional assets was "like pulling teeth."<sup>8</sup> With their limited payload and range, and highest utility in low intensity conflict, the RPA does not fit the Air Force's historic image of itself as a highly technical air and space force capable of delivering devastating firepower anywhere on the globe, creating the perception that the Air Force does not place the same value on the RPA community that it does on its manned fighters and bombers. Beyond RPAs, there appears to be some value in the Army acquiring the Air Force's fleet of A-10 attack planes, should the service elect to retire them from their inventory, given their utility in recent conflicts. The authors conclude, "CAS is truly platform immaterial," which is certainly true.<sup>9</sup> But someone has to provide the platform, in order to conduct CAS. Tactical airlift assets are also split between the services, with the Army's CH-46 and the Air Force's C-130 performing similar missions for the same customers, but on opposite sides of an artificial service divide. It is worth asking if both rotary and fixed-wing theater airlift assets would be better served under the Army's organizational umbrella.

Given the constant tension between roles and missions, such as those I witnessed during my time as a JSTARS crewmember, when ground commanders focused on the "ISR" portion of the mission and the ability to quickly relay information on ground targets to massed artillery forces, while the Air Force insisted on pushing the platform forward into the fight as a "C2" asset, used to assist in the aerial prosecution of specific targets, it is worth asking if the Army should have its own fixed-wing CAS, reconnaissance, and tactical airlift assets, as the Marine Corps currently does. The current Theater Air Ground Control System successfully integrates Marine squadrons into the ATO, assigning both external and indigenous tanker support and escorts, and there is no reason to believe the same could not be done for Army assets, with little additional effort and with great benefit for the ground forces. Squadrons exclusively trained for, and prepared to conduct direct support missions, as Nugent's XXIX TAC was in 1945, offer the best possible option, especially in terms of responsiveness, for ground commanders. As Bolton notes, "the CAB [combined arms brigade] uses similar procedures as those used by the TAC. Its close proximity and regular working relationship with ground units promote unity of command and a common understanding of the operating environment."<sup>10</sup> In addition, the Air Force's dramatic inability to keep its cockpits fully manned, resulting in shortages of over 2,000 pilots that led to a recent call for up to 1,000 retirees to return to active duty to alleviate the manning crisis, suggest that the Army would be wise to invest in its own, fixed-wing CAS capability, among other reforms, to ensure this capability is available, if and when needed.

One of the principal arguments for an independent Air Force was that air assets had the range to extend far beyond the battlefield, and that ground commanders would subordinate assets to their immediate needs and neglect operational missions farther from the battlefield,

such as interdiction, and strategic attack at the expense of tactical considerations. But subsequent developments in missile technology have resulted in a significantly increased range, effectiveness, and lethality of ground-based artillery systems, such as the MLRS and TACMS, undermining the Air Force's claims to exclusive jurisdiction over events well beyond the immediate front. And the two services have never fully resolved the responsibility for air defense, with the Air Force insisting that mission belonged to its manned fighters while the same advances in missile technology have made the Army's ground-based systems, such as the Patriot, even more effective, though significant issues of fratricide have marred even the most recent conflicts.<sup>11</sup> The same issues that plagued Nugent and Simpson in Operation Queen, of misidentification, "friendly fire," and "free fire" zones against V-1s remain in the modern force, even with the presence of electronic identifiers such as Blue Force Tracker far more advanced than the primitive IFF systems of World War II. Parceling out assets, as well as the airspace control function, to subordinate headquarters appears to greatly complicate this important task, but training for it would provide significant redundancy in a degraded environment, ensuring operations could continue in the event of a decapitation strike on the "eyes" and "brain" of an air defense system, such as the one the coalition delivered to the Iraqi air force in 1991. In short, the system may have to become less "spider" and more "starfish."<sup>12</sup>

Thus, the experiences of Ninth Army and XXIX TAC offer far more than an isolated tale of successful adaptation and innovation in wartime. The development, application and training of air ground doctrine in World War II offers both a blueprint for continued experimentation and refinement in the current force, as well as justification for continued joint force training to help quickly and successfully bridge the gap between peacetime theory and wartime reality. While the sacrifices of soldiers and airmen three quarters of a century ago offer a compelling story of American success in large-scale combat operations and leveraging effects from multiple domains on the battlefield, they also provide grist for the mills of future leaders in developing their own operational plans, fielding the proper equipment and organizations, and writing doctrine that informs the next generation of warfighters. They also highlight the vital importance of developing the inter-service teamwork and commitment to accomplishing the joint mission which will enable success on future battlefields.

## Notes

1. Paul Kennedy, *Engineers of Victory: The Problem Solvers Who Turned the Tide in the Second World War* (New York: Random House, 2013).
2. Courtney McBride, “Joint Exercises to Inform Multi-Domain Battle Concept Update,” *Inside Defense*, 2 February 2018, <https://insidedefense.com/inside-army/joint-exercises-inform-multi-domain-battle-concept-update>, accessed 21 June, 2018.
3. Clay Bartels, Tim Tormey, and Jon Hendrickson, “Multi-Domain Operations and Close Air Support: A Fresh Perspective,” *Military Review*, (March-April, 2017): 77; Sydney Freedberg, Jr., “Decentralize the Air Force for high End War: Holmes,” *Breaking Defense*, 13 October 2017, <https://breaking-defense.com/2017/10/decentralize-the-air-force-for-high-end-war-holmes/>, accessed 21 June 2018.
4. Undated speech, pp. 14-15, Folder 4, Box 10, Simpson Papers, AHEC.
5. CALL Handbook 17-04, *Joint Air Ground Integration Center: Lessons and Best Practices* (Fort Leavenworth, KS: Center for Army Lessons Learned, 2017), <https://usacac.army.mil/node/1508>, accessed 21 June 2018.
6. See Gregory Fontenot, E. J. Degen, and David Tohn, eds., *On Point: The United States Army in Operation Iraqi Freedom* (Fort Leavenworth, KS: Army University Press, 2004), 179-192.
7. John Bolton, “Precedent and Rationale for an Army Fixed-Wing Ground Attack Aircraft,” *Military Review* (May-June, 2016): 78-87. On p. 86, Bolton argues, “The Army should fill the gap between its helicopters and USAF CAS with its own FW [fixed-wing] attack aircraft.”
8. “Air Force must do more for war, Gates says” accessed on 21 June 2018. [http://www.nbcnews.com/id/24238978/ns/world\\_news-mideast\\_n\\_africa/t/air-force-must-do-more-war-gates-says/](http://www.nbcnews.com/id/24238978/ns/world_news-mideast_n_africa/t/air-force-must-do-more-war-gates-says/)
9. Bartels, Tormey, and Hendrickson, “Multi-Domain Operations and Close Air Support,” 77.
10. Bolton, “Precedent and Rationale for an Army Fixed-Wing Ground Attack Aircraft,” 83.
11. David Talbot, “Preventing Fratricide: Raytheon’s Troubled Patriot Missile,” *Technology Review* (June 2005), <https://www.technologyreview.com/s/404191/preventing-fratricide/>, accessed 21 June 2018.
12. Ori Brafman and Rod Beckstrom, *The Starfish and the Spider: The Unstoppable Power of Leaderless Organizations* (New York: Penguin, 2006).



## Bibliography

### **Air Force Historical Research Agency, Maxwell AFB, AL**

- 168.95-1, Observation and Reconnaissance Training
- 168.602-1, Richard E. Nugent Biography
- 168.6007, III Reconnaissance Command
- 245.31-1, AAFSAT History, 1943
- 248.411, AAFSAT ANSCOL Course, Class 1943C, v. 5
- 444.01, History of III Tactical Air Division, 1943-1944
- 446.01, History of III Tactical Air Division, 1944
- 447.01, III Reconnaissance Command, 1941-1943
- 448.01, History of III Tactical Air Command, 1944
- 533.13-1, Office Journal, Richard E. Nugent
- 533.13-2, Excerpts from Brig. Gen. Richard E. Nugent's War Diary
- 533.191-4, Brig. Gen. Richard E. Nugent, Deputy Chief of Staff, Operations, Ninth Air Force
- 533.3069-3, 9th Air Force Chronology
- 533-4501-4, Report on Air Ground Support
- 538.02, XXIX TAC Periodic History, October 1944- April 1945
- 538.337, XXIX Tactical Air Command, 8 February 1945
- 650.03-2, Observers Report, Air Operations in Support of Ground Forces in North West Africa (15 March–5 April 1943), VIII Air Support Command
- GP-RCN-68-HI, 68th Reconnaissance Group History
- GP-RCN-75-HI, 75th Reconnaissance Group History
- GP-RCN-68-SU-OR, 68th Reconnaissance Group Operations Reports
- GP-RCN-363-HI, 363rd Tactical Reconnaissance Group History
- GP-RCN-363-SU-RE-D, 363rd Tactical Reconnaissance Group Post-Mission Reports
- K239.0512-1813, Reel 3, Elwood Quesada Oral History Interview
- “Twelve Thousand Fighter-Bomber Sorties: XIX Tactical Air Command's First Month of Operations in Support of Third US Army in France”

## **Army Heritage and Education Center, Carlisle Barracks, PA**

Alvan C. Gillem, Jr. Papers

James E. Moore Papers

William H. Simpson Papers

## **Combined Arms Research Library, Fort Leavenworth, KS**

N-10350, "Report on the Artillery with the VIII Corps in the Reduction of Brest, 22 August–19 September, 1944"

N-10463, Study of Air Ground Cooperation, G-3 (Air) Subsection, Ninth US Army

N-12236, Answers to Questionnaire for Key Commanders on "The Effects of Strategic and Tactical Air Power on Military Operations, ETO"

N-13263-2, AAF Evaluation Board, "The Effectiveness of Third Phase Tactical Air Operations in the European Theater, 5 May 1944-8 May 1945"

N-15631, History of the Third Army, AGF Study No. 17, 1946

N-17500.478, "Brest, 343rd Infantry Division, (May-18 September 1944)"

N-2146.73, Hell on Wheels in the Drive to the Roer, The Employment of the 2nd Armored Division in a Limited Objective Attack

N-2836.1, Third Army Maneuvers, May 5-25, 1940, Sabine Area

N-2836.2-D, Third Army Maneuvers, Feb. 1943, Section IV, Air Ground Support

N-2836.3, HQ, IV Corps, "Final Report Third Army Maneuvers, May 1940"

N-2836.2-D, "Third Army Maneuvers, Feb. 1943, Section IV, Air Ground Support"

N-3287.1, Report on Second and Third Army Maneuvers, 1941

N-3768, Headquarters, 12th Army Group, *Immediate Report No. 65*, "Close Air Support of Ground Forces Around Brest"

N-4007, XIX Corps: Normandy to the Elbe

N-4361, Comments on First Phase—Second Army vs. Third Army Maneuvers, 1941

N-4770, XIX Corps Demonstration, 2nd Armored Division, Tank-infantry Assault of Tactical Locality; 30th Infantry Division: Infantry Assault of Fortified Village

"Age-in-Grade Study," Headquarters, US Army, September, 1942

N-9594, T.A.L.O. Notes, XIX TAC, 1945

N-9817, HQ, 3rd Photo Group, Photo Recon for MATAF and 15th Army Group

R-13332, 21 Army Group, "Report on Operation 'VERITABLE,' 8 February–10 March, 1945

### **Donovan Research Library, Fort Benning, GA**

Lamb, O. M. "The Operations of the 2nd Battalion, 335th Infantry, 84th U.S. Infantry Division, in the Battle for the High Ground in the Area Northwest of the Roer River in the Lindern, Breack, Leiffarth Triangle from 29 Nov. – 2 Dec. 1944."

McArtor, William S. "Operations of Company B, 38th Infantry (2d Infantry Division) During the Battle for Brest, France, 8 September – 10 September, 1944."

Utley, Robert L. "The Operations of Company L, 38th Infantry (2nd Infantry Division) in Attack on Hill 154, Vicinity Brest, France 22-23 August, 1944."

### **Dwight D. Eisenhower Library, Abilene, KS**

Elwood P. Quesada Papers

Lauris Norstad Papers

US Army Records, European and Pacific Theaters, 29th Infantry Division, "Air Support in Operations Against Brest."

William H. Simpson Oral History

### **Library of Congress**

Henry H. Arnold Papers

Carl Spaatz Papers

Hoyt Vandenberg Papers

### **National Archives II, College Park, MD**

Record Group 18: Records of the Army Air Forces

Central Decimal Files, October 1942-May 1944

Headquarters, II Air Support Subcommand, "Report of Air Operations, Tenth Phase, Second Maneuver Period, 201800 thru 231530 May 1943"

"Conference on Air Support to the Assembled Officers of Second Army at Air Support School," 2 July 1943

"Conference on Tactical Air Force to Assembled Officers of Second Army," 10 September, 1943

Maneuver Director Headquarters, Second Army, "Report of Air Support for Maneuvers," 25 February 1944

World War II, Combat Operations Reports

48th Fighter Group, Mission Reports

404th Fighter Group, Mission Reports

406th Fighter Group, Mission Reports

9th Air Force, Operations Reports

Record Group 337: Records of the Headquarters, Army Ground Forces

“Organization and Training, Desert Training Center,” 6 April 1943

“Field Maneuver Confidential File,” 9 January 1943

Record Group 338, Records of the European Theater of Operations

Records of United States Army Commands, 1942-

Ninth Army, G-3 Section, Records Relating to Military Operations, 1944-1945

“Air Cooperation in Operation Grenade”

G-3 Subsection, “A Study of Air-Ground Cooperation,”

“Operation Q, 16 November 1944, A Study in Air Support.”

Record Group 407: Record of the Army Adjutant General’s Office

World War II Operations Reports, 1940-1948, Ninth Army, Headquarters,  
Ninth United States Army, “Study of Air Support Given First and Ninth  
Armies During Operation ‘Q,’ 23 January 1945”

## **Published Primary**

Arnold, Henry. *Global Mission*. New York: Harper Brothers, 1949.

Bradley, Omar. *The Effects of Strategic and Tactical Air Power on Military Operations, ETO*. Washington, DC: Government Printing Office, 1945.

Bradley, Omar. *A Soldier’s Story*. New York: Henry Holt, 1951.

Chandler, Alfred D., Jr., et al, eds. *The Papers of Dwight David Eisenhower*. 21 Volumes. Baltimore: John Hopkins, 1970-.

Eisenhower, Dwight D. *Crusade in Europe*. New York: Da Capo, 1948.

Horrocks, Brian. *A Full Life* London: Collins, 1960.

Slessor, John. *Air Power and Armies*. London: Oxford University Press, 1936.

Tedder, Sir Arthur. *With Prejudice*. Boston: Little, Brown, 1966.



## Government Documents

- Condensed Analysis of the Ninth Air Force in the European Theater of Operations.* Washington, DC: Office of Air Force History, 1946, reprinted 1984.
- The Development of Tactical Doctrine at AAFSAT & AAFTAC.* Study Number 13. Washington DC: Historical Division, Assistant Chief of Air Staff, Intelligence, 1944.
- The Employment of Strategic Bombers in a Tactical Role, 1941-1951.* Study Number 88. Maxwell AFB, AL: USAF Historical Division, Research Studies Institute, 1953.
- Field Manual 1-5, *Employment of Aviation of the Army.* Washington, DC: GPO, 1943.
- Field Manual 1-10, *Tactics and Technique of Air Attack.* Washington, DC: GPO, 1940.
- Field Manual 1-20, *Tactics and Technique of Air Reconnaissance and Observation,* April 20, 1942. Washington, DC: GPO, 1942.
- Field Manual 31-35 *Aviation in Support of Ground Forces.* Washington, DC: GPO 1942.
- Field Manual 100-20, *Command and Employment of Air Power.* Washington, DC: GPO, 1943.
- Ninth Air Force, April to November 1944.* Study Number 36. Washington DC: Historical Division, Assistant Chief of Air Staff, Intelligence, 1944.
- Ninth Air Force in the ETO, 16 Oct 1943 to 16 Apr 1944.* Study Number 32. Washington DC: Historical Division, Assistant Chief of Air Staff, Intelligence, 1944.
- Reconnaissance in the Ninth Air Force: A Report on Reconnaissance Operations during The European Campaigns, 1945,* Report of Operations, Final After Action Report, 12th Army Group, G-2 Section.
- The Tactical Air Force in the European Theater of Operations,* Study Number 54, The General Board, United States Forces, European Theater.
- Tactical Operations of the Eighth Air Force, 6 June 1944-8 May 1945.* Study Number 70. Maxwell AFB, AL: Historical Division, Air University, 1952.
- Tactics and Techniques Developed by the United States Tactical Air Commands in the European Theater of Operations,* AAF Evaluation Board in European Theater of Operations
- Training Regulation 440-15, *Fundamental Principles of the Employment of the Air Service.* Washington, DC: GPO, 1926.

## Books

- Ackerman, Robert. *The Employment of Strategic Bombers in a Tactical Role, 1941-1951*. Washington, DC: Office of Air Force History, 1953.
- Balkoski, Joseph. *From the Beachhead to Brittany: The 29th Infantry Division at Brest, August-September 1944*. Mechanicsburg, PA: Stackpole, 2008.
- Balkoski, Joseph. *Our Tortured Souls: The 29th Infantry Division in the Rhineland, November-December 1944*. Mechanicsburg, PA: Stackpole, 2013.
- Baumer, Robert. *Old Hickory, The 30th Division: The Top-Rated American Infantry Division in Europe in World War II*. Guilford, CT: Stackpole, 2017.
- Bechthold, Michael. *Flying to Victory: Raymond Collishaw and the Western Desert Campaign, 1940-1941*. Norman: University of Oklahoma Press, 2017.
- Biddle, Tami Davis. *Rhetoric and Reality in Air Warfare*. Princeton: University Press, 2002.
- Blumenson, Martin. *Breakout and Pursuit*. Washington, DC: Office of the Chief of Military History, 1961.
- Blumenson, Martin. *Kasserine Pass*. Boston: Houghton Mifflin, 1966.
- Byrd, Martha. *Chennault: Giving Wings to the Tiger*. Tuscaloosa, AL: The University of Alabama Press, 1987.
- Citino, Robert M. *Death of the Wehrmacht*. Lawrence, KS: University Press of Kansas, 2007.
- Clodfelter, Mark. *The Limits of Airpower*. New York: The Free Press, 1989.
- Clodfelter, Mark. *Beneficial Bombing: The Progressive Foundations of American Air Power, 1917-1945*. Lincoln, NE: University of Nebraska Press, 2010.
- Cole, Hugh. *The Ardennes and the Battle of the Bulge*. Washington, DC: Center of Military History, 1965.
- Coleman, John M. *The Development of Tactical Services in the Army Air Forces*. Morningside Heights, NY: Columbia University Press, 1950.
- Cooling, Benjamin, ed. *Case Studies in the Development of Close Air Support*. Washington, DC: Office of Air Force History, 1990.
- Copp, Terry. *Cinderella Army: The Canadians in Northwest Europe 1944-1945*. Toronto: University of Toronto Press, 2006.
- Corum, James S. *The Luftwaffe: Creating the Operational Air War, 1919-1940*. Lawrence, KS: University Press of Kansas, 1997.

- Corum, James S., and Richard Muller, *The Luftwaffe's Way of War: German Air Force Doctrine, 1911-1945*. Baltimore, MD: Nautical & Aviation Pub., 1998.
- Corum, James S., and Wray Johnson, *Air Power in Small Wars*. Lawrence: KS, University Press of Kansas, 2003.
- Cox, Sebastian and Peter Gray, eds. *Air Power History: Turning Points from Kitty Hawk to Kosovo*. London: Frank Cass, 2002.
- Crane, Conrad. *Bombs, Cities and Civilians: Airpower Strategy in World War II*. Lawrence, KS: University Press of Kansas, 1993.
- Craven, Wesley and James Cate, eds. *The Army Air Forces in World War II*, 7 vols. Chicago: University of Chicago Press, 1947-53.
- Davis, Richard G. *Carl A. Spaatz and the Air War in Europe*. Washington, DC: Smithsonian Institute Press, 1994.
- Deichmann, P. *German Air Force Operations in Support of the Army*. (USAF Historical Study 163) Maxwell AFB, AL: Air University Press, 1962.
- D'Este, Carlo. *World War II in the Mediterranean, 1942-45*. Chapel Hill, NC: Algonquin 1990.
- D'Este, Carlo. *Patton: A Genius for War*. New York: Harper Collins, 1995.
- Devore, Marc. *When Failure Thrives: Institutions and the Evolution of Postwar Airborne Forces*. Fort Leavenworth, KS: The Army Press, 2015.
- Dorr, Robert F. and Thomas D. Jones. *Hell Hawks: The Untold Story of the American Fliers Who Savaged Hitler's Wehrmacht*. Minneapolis, MN: Zenith, 2008.
- Doubler, Michael. *Closing with the Enemy: How GIs Fought the War in Europe, 1944-1945*. Lawrence: University Press of Kansas, 1994.
- Dunn, Bill. *Big Wing: The Biography of Air Chief Marshal Sir Trafford Leigh-Mallory*. Shrewsbury, UK: Airlife, 1992.
- Finney, Robert. *History of the Air Corps Tactical School, 1920-1940*. Maxwell AFB, AL 1955.
- Futrell, Robert. *Command of Observation Aviation: A Study in Control of Tactical Airpower*. Maxwell AFB: USAF Historical Division, 1956.
- Futrell, Robert. *Ideas, Concepts, Doctrine: Basic Thinking in the United States Air Force, 1907-1960*. Vol. 1. Maxwell AFB, AL: Air University Press, 1989.
- Franck, Harry. *Winter Journey Through the Ninth*. Tucson, AZ: Prince of the Road Press, 2001.

- Gabel, Christopher. *The U.S. Army GHQ Maneuvers of 1941*. Washington, DC: Center of Military History, 1991.
- Gentile, Gian. *How Effective is Strategic Bombing?* New York: NYU Press, 2001.
- Gladman, Brad W. *Intelligence and Anglo-American Air Support in World War II*. London: Palgrave Macmillan, 2009.
- Gooderson, Ian, *Air Power at the Battlefield*. London: Frank Cass, 1997.
- Greenfield, Kent. *Army Ground Forces and the Air-Ground Battle Team*. Washington, DC: Office of the Chief of Military History, 1948.
- Greer, Thomas. *The Development of Air Doctrine in the Army Air Arm, 1917-1941*. Maxwell, AFB, AL 1955.
- Hall, David Ian. *Strategy for Victory: The Development of British tactical Air Power, 1919-1943*. Westport, CT: Praeger, 2008.
- Hallion, Richard. *D-Day, 1944: Air Power over the Normandy Beaches and Beyond*. Washington, DC: Air Force History and Museums Program, 1994.
- Hallion, Richard. *Strike from the Sky: The History of Battlefield Air Attack, 1911-1945*. Washington, DC: Smithsonian Institution Press, 1989.
- Hardesty, Von and Ilya Grinberg, *Red Phoenix Rising: The Soviet Air Force in World War II*. Lawrence: University Press of Kansas, 2012.
- Hewitt, Robert *Work Horse of the Western Front: The Story of the 30th Infantry Division*. Washington, DC: Infantry Journal Press, 1946.
- History of the XVI Corps from Its Activation to the End of the War in Europe*. Washington, DC: Infantry Journal Press, 1947.
- House, Jonathan. *Combined Arms Warfare in the Twentieth Century*. Lawrence, KS: University Press of Kansas, 2001.
- Hughes, Thomas A. *Overlord: General Pete Quesada and the Triumph of Tactical Air Power in World War II*. New York, The Free Press: 1995.
- Ivie, Thomas. *Aerial Reconnaissance: The 10th Photo Recon Group in World War II*. Fallbrook, CA: Aero Publishers, 1981.
- Johnson, David E. *Fast Tanks and Heavy Bombers: Innovation in the U.S. Army 1919-1945*. Ithaca, NY: Cornell University Press, 1998.
- Jones, David. *Perceptions of Airpower and Implications for the Leavenworth Schools: Interwar Student Papers*. Fort Leavenworth, KS: US Army Command and General Staff College Press, 2014.

- Kretchik, Walter. *U.S. Army Doctrine: From the American Revolution to the War on Terror*. Lawrence: University Press of Kansas, 2011.
- Laslie, Brian. *Architect of Air Power: General Laurence S. Kuter and the Birth of the US Air Force*. Lexington: University Press of Kentucky, 2017.
- Lewis, Adrian. *Omaha Beach: A Flawed Victory*. Chapel Hill: UNC Press, 2001.
- Mansoor, Peter. *The GI Offensive in Europe: The Triumph of American Infantry Divisions, 1941-1945*. Lawrence, KS: University Press of Kansas, 1999.
- Mark, Eduard. *Aerial Interdiction in Three Wars*. Washington, DC: Center for Air Force History, 1994.
- Maurer, *Air Force Combat Units of World War II*. Washington, DC: GPO, 1982.
- McDonald, Charles. *The Last Offensive*. Washington, DC: CMH, 1973.
- McDonald, Charles. *The Siegfried Line Campaign*. Washington, DC: CMH, 1963.
- McMillin, Woody. *In the Presence of Soldiers: The 2nd Army Maneuvers & Other World War II Activity in Tennessee*. Nashville: Horton Heights Press, 2010.
- Mission Accomplished: The Story of XXIX TAC*. Paris: Stars & Stripes, 1945.
- Meilinger, Philip S., ed. *The Paths of Heaven: The Evolution of Airpower Theory*. Maxwell AFB, AL: Air University Press, 1997.
- Meilinger, Philip S. *Air Power: Myths and Facts*. Maxwell AFB, AL: Air University Press, 2003.
- Meller, Sidney. "The Desert Training Center and C-AMA," Study No. 15. Washington, DC: Historical Section, Army Ground Forces, 1946.
- Moenk, Jean. *A History of Large-Scale Army Maneuvers in the United States, 1935-1964*. Fort Monroe, VA: US Continental Army Command, 1969.
- Mortenson, Daniel. *Airpower and Ground Armies: Essays on the Evolution of Anglo-American Air Doctrine, 1940-1943*. Maxwell AFB, AL: Air University Press, 1998.
- Mortenson, Daniel. *A Pattern for Joint Operations: World War II Close Air Support, North Africa*. Washington, DC: Office of Air Force History, 1987.
- Murray, Williamson. *Strategy for Defeat: The Luftwaffe, 1933-1945*. Maxwell AFB, AL: Air University Press, 1983.
- Murray, Williamson, and Allan Millett. *A War to be Won: Fighting the Second World War*. Cambridge, MA: Belknap, 2000.

- Murray, Williamson, and Allan Millett. *Military Innovation in the Interwar Period*. Cambridge, UK: Cambridge University Press, 1996.
- Orange, Vincent. *Coningham*. Washington, DC: Center for Air Force History, 1992.
- Ossad, Steven. *Omar Nelson Bradley: America's GI General*. Columbia: University of Missouri Press, 2017.
- Parker, Theodore. *Conquer: The Story of Ninth Army 1944-1945*. Washington, DC: Infantry Journal Press, 1947.
- Price, Frank. *Troy H. Middleton: A Biography*. Baton Rouge, LA: Louisiana State University Press, 1974.
- Rein, Christopher M. *The North African Air Campaign: The U.S. Army Air Forces from El Alamein to Salerno*. Lawrence, KS: University Press of Kansas, 2012.
- Rust, Kenn C. *The 9th Air Force in World War II*. Fallbrook, CA: Aero Publishers, 1967.
- Shrader, Charles. *Amicide: The Problem of Friendly Fire in Modern War*. Fort Leavenworth, KS: Combat Studies Institute, 1982.
- Smith, Francis. *History of The Third Army*, Army Ground Forces Study No. 17, Washington, DC: Historical Section, Army Ground Forces, 1946.
- Spires, David N. *Air Power for Patton's Army*. Washington, DC: Air Force History and Museums Program, 2002.
- Steadman, Kenneth. *A Comparative Look at Air-Ground Support Doctrine and Practice in World War II*. Fort Leavenworth, KS: Combat Studies Institute, 1982.
- Stacey, C. P. *Official History of the Canadian Army in the Second World War*, vol. III, *The Victory Campaign: The Operations in North-West Europe 1944-1945*. Ottawa: The Queen's Printer, 1960.
- Sylvan, William C., Francis G. Smith, Jr., and John T. Greenwood. *Normandy to Victory: The War Diary of General Courtney H. Hodges and the First U.S. Army*. Lexington: University of Kentucky Press, 2009.
- The Thunderbolt across Europe: Normandy, Ardennes, Brittany, Rhineland, Central Europe: a History of the 83d Infantry Division, 1942-1945*. Munich: 83rd Division, 1945.
- Waight, Stephen. *The Last Drop: Operation Varsity, March 24-25, 1945*. Mechanicsburg, PA: Stackpole, 2008.
- Weinberg, Gerhard. *A World At Arms: A Global History of World War II*. Cambridge: Cambridge University Press, 1994.

Whiting, Charles. *Ike's Last Battle: The Battle of the Ruhr Pocket April 1945*. London: Pen and Sword, 2007.

Yeide, Harry. *The Longest Battle: September 1944 to February 1945: From Aachen to the Roer and Across*. St. Paul, MN: Zenith Press, 2005.

Zumbro, Derek. *The Battle for the Ruhr: The German Army's Final Defeat in the West*. Lawrence: University of Kansas Press, 2006.

## Articles and Chapters

Bechthold, B. Michael. "A Question of Success: Tactical Air Doctrine and Practice in North Africa, 1942-43." *The Journal of Military History* 68 (July 2004): 821-51.

Brown, Gordon. "The Battle of Moyland Wood: The Regina Rifle Regiment, 16-19 February 1945." *Canadian Military History* 6 (Spring, 1997): 101-108.

Corum, James. "The Luftwaffe's Army Support Doctrine, 1918-1941." *The Journal of Military History* 59 (January 1995): 53-76.

Hughes, Thomas. "Normandy: A Modern Air Campaign?" *Air and Space Power Journal* (Winter 2003): 16-29.

Huston, James. "Tactical Use of Air Power in World War II: The Army Experience." *Military Affairs* 14:4 (Winter 1950): 166-185.

Jacobs, William. "Tactical Air Doctrine and AAF Close Air Support in the European Theater, 1944-1945." *Aerospace Historian* (March 1980): 35-49.

Johnston, Paul. "The Question of British Influence on U.S. Tactical Air Power in World War II." *Air Power History* (Spring 2005): 16-33.

Kuter, Laurence. "Goddammit Georgie." *Air Force Magazine* (February 1973): 51-56.

Maycock, Thomas J. "Notes on the Development of AAF Tactical Air Doctrine." *Military Affairs* 14:4 (Winter 1950): 186-91.

Meilinger, Philip S. "The Historiography of Airpower: Theory and Doctrine." *The Journal of Military History* 64 (April 2000): 467-501.

Mets, David R. "A Glider in the Propwash of the Royal Air Force?" In *Airpower and Ground Armies: Essays on the Evolution of Anglo-American Air Doctrine, 1940-1943*. Edited by Daniel R. Mortensen. Maxwell AFB, AL: Air University Press, 1998.

Montgomery, William. "Ground Force uses of Aerial Photography." *Military Review* 24 (January 1945): 24-28.

- Mortensen, Daniel R. "The Legend of Laurence Kuter." In *Airpower and Ground Armies: Essays on the Evolution of Anglo-American Air Doctrine, 1940-1943* edited by Daniel R. Mortensen, ed. Maxwell AFB, AL: Air University Press, 1998.
- Muller, Richard. "Close Air Support: The German, British, and American Experiences, 1918-1941." In *Military Innovation in the Interwar Period* edited by Williamson Murray and Allan Millett. Cambridge, UK: Cambridge University Press, 1996.
- Rein, Christopher. "From 'Observation' to 'Tactical Reconnaissance:' The Development of American Battlefield ISR in World War II." *Air Power History* Vol. 63 (Spring 2016).
- Riccardelli, Richard. "Electronic Warfare in WWII." *Army Communicator* 10:1 (Winter 1985): 40-49.
- Simpson, William H. "Partners in Battle," *Air Force* (Aug 1945): 5-8.
- Simpson, William H. "Rehearsal for the Rhine." *Military Review* 25:7 (October, 1945): 20-28.
- Stone, Thomas R. "General William H. Simpson: Unsung Command of US Ninth Army," *Parameters* 9 (1981): 44-52.

## **Theses and Dissertations**

- Chandler, Michael. "Gen. Otto P. Weyland, USAF: Close Air Support in the Korean War." Thesis, School of Advanced Air and Space Studies, Maxwell AFB, AL, 2007.
- Cox, Gary. "Beyond the Battle Line: US Air Attack Theory and Doctrine, 1919-1941." Thesis, School of Advanced Air and Space Studies, Maxwell AFB, AL, 1995.
- Dengler, David. "Seeing the Enemy: Army Air Force Aerial Reconnaissance Support to US Army Operations in the Mediterranean in World War II." Thesis, Command and General Staff College, Fort Leavenworth, KS, 2009.
- Lynd, William E. "Air Operations in Support of the 89th Division in the St. Mihiel Offensive, 12-16 September, 1918." Thesis, Command and General Staff School, Fort Leavenworth, KS, 1933.
- Stoll, Hans G. "Luftwaffe Doctrine and Air Superiority through World War II." Thesis, Air War College, Maxwell AFB, AL, 1994.
- Stone, Thomas R. "He Had the Guts to Say No: A Military Biography of General William Hood Simpson." Thesis, Rice University, Houston, TX, 1974
- Wielhouwer, Daniel. "Trial by Fire: Forging American Close Air Support Doctrine, World War I through September 1944." Thesis, Command and General Staff College, Fort Leavenworth, KS, 2004.







*An Army University Press Book*  
*US Army Combined Arms Center*  
*Fort Leavenworth, Kansas*



978-1-840804-60-6