



Q3



You say:

“Just right.”

We say:

“Freedom is a great word. Make it even greater.”



The new Audi Q3	04–09	Equipment	28–37
Interior	10–15	Accessories	38–39
Convenience & flexibility	16–19	The fascination of the Audi Q3	40–43
Technology	20–23	Technical data	44–47
Lines & packages	24–27		

The figures for fuel consumption and CO₂ emissions can be found from page 44 onwards. Some of the equipment illustrated or described is optional equipment for which an extra charge is made. Please contact your Audi partner or visit www.audi.com for detailed information about standard and optional equipment.

You say:

“Awesome!”



We say:

“Its character has become more mature, its presence even more confident. The new Audi Q3 is a powerful, dynamic SUV that cuts a fine figure both on the road and off.”

The figures for fuel consumption and CO₂ emissions can be found from page 44 onwards. Some of the equipment illustrated or described is optional equipment for which an extra charge is made. Please contact your Audi partner or visit www.audi.com for detailed information about standard and optional equipment.

You say:
“Wow!”

We say:

“Dynamic lines, excitingly styled surfaces and maximum three-dimensionality make the Audi Q3 stand out from the crowd. The raised front end shows presence, Matrix LED headlights take its brilliance to a new level. Another special feature is the new grille architecture that makes the DNA of the Q family immediately recognisable.”



The figures for fuel consumption and CO₂ emissions can be found from page 44 onwards.
Some of the equipment illustrated or described is optional equipment for which an extra charge is made.
Please contact your Audi partner or visit www.audi.com for detailed information about standard and optional equipment.



You say:

“Well ahead!”

We say:

“Impressive driving dynamics is standard in the new Audi Q3. Its quattro drive and powerful engines ensure driving enjoyment in a matter of seconds, both on the road and off.”

The figures for fuel consumption and CO₂ emissions can be found from page 44 onwards.
Some of the equipment illustrated or described is optional equipment for which an extra charge is made.
Please contact your Audi partner or visit www.audi.com for detailed information about standard and optional equipment.

You say:

“Top!”

We say:

“Size can be found in every dimension in the new Audi Q3. Be it through more space and comfort, the dashboard in 3D look, the 12.3-inch virtual cockpit plus or the new MMI centre display with 10.1-inch touchscreen. It makes operating all convenience and infotainment functions more intuitive than ever before.”

The figures for fuel consumption and CO₂ emissions can be found from page 44 onwards.
Some of the equipment illustrated or described is optional equipment for which an extra charge is made.
Please contact your Audi partner or visit www.audi.com for detailed information about standard and optional equipment.

You say:

“Sounds great!”



We say:

“The Audi smartphone interface connects your smartphone to the vehicle and shows apps on the MMI screen. In this way, music streaming services can be called up at any time. In addition, the Bang & Olufsen Premium Sound System with 3D effect produces a sound as authentic as the original source.”

The figures for fuel consumption and CO₂ emissions can be found from page 44 onwards.
Some of the equipment illustrated or described is optional equipment for which an extra charge is made.
Please contact your Audi partner or visit www.audi.com for detailed information about standard and optional equipment.

You say:

“What can I do online?”

We say:

“The MMI centre display ensures user-friendly operation of familiar online services and functions. The Wi-Fi hotspot connects up to eight mobile devices to the internet. But not only the infotainment makes the time fly by. Predictive route guidance also gets you to your destination as quickly as possible.”

The figures for fuel consumption and CO₂ emissions can be found from page 44 onwards.
Some of the equipment illustrated or described is optional equipment for which an extra charge is made.
Please contact your Audi partner or visit www.audi.com for detailed information about standard and optional equipment.

You say:

“Practical.”

We say:

“Sliding rear seat bench, variable flat loading floor, electric tailgate, available with gesture control in conjunction with the convenience key, two integrated LED spotlights in the tailgate, USB ports and a 12V socket. Just a few of many functions that make the Audi Q3 particularly suitable for everyday use and the ideal companion for your lifestyle.”



The figures for fuel consumption and CO₂ emissions can be found from page 44 onwards. Some of the equipment illustrated or described is optional equipment for which an extra charge is made. Please contact your Audi partner or visit www.audi.com for detailed information about standard and optional equipment.

You say:

“Just the job!”

We say:

“530–1,525 l of luggage space and an extended storage and luggage compartment package. The generous amount of space in the Audi Q3 will please not only the luggage, but also the passengers in the front and back.”

The figures for fuel consumption and CO₂ emissions can be found from page 44 onwards. Some of the equipment illustrated or described is optional equipment for which an extra charge is made. Please contact your Audi partner or visit www.audi.com for detailed information about standard and optional equipment.

We say:

“The intelligent technology in the Audi Q3 means a relaxed drive: Audi pre sense front and numerous assistants provide warnings and can intervene in an emergency – all the way up to automatic full braking. Whether changing lanes or stuck in stop-and-go traffic – the Audi Q3 assists you as far as the rules of engineering allow.”

You say:

“Not stupid at all.”

Please note that the systems can assist the driver with the driving task only within the relevant system limits. However, the driver remains responsible for driving the vehicle and is required to be attentive at all times.

The figures for fuel consumption and CO₂ emissions can be found from page 44 onwards. Some of the equipment illustrated or described is optional equipment for which an extra charge is made. Please contact your Audi partner or visit www.audi.com for detailed information about standard and optional equipment.

You say:
“Yeahh!”

We say:

“Look forward to an intensive driving experience that, thanks to Audi drive select, adapts to suit your personal preferences. Dynamic, efficient or with the new “offroad” driving profile for enhanced off-road suitability. Assisted by progressive steering for increased agility and reduced steering effort.



The figures for fuel consumption and CO₂ emissions can be found from page 44 onwards. Some of the equipment illustrated or described is optional equipment for which an extra charge is made. Please contact your Audi partner or visit www.audi.com for detailed information about standard and optional equipment.

You say:
“Rather stylish!”



We say:

“The Q3 advanced equipment line places the focus on the exterior design: The contrasting paint finish Manhattan grey, metallic and striking highlights catch the eye. Various interior packages make it possible to round off the perfect picture with sport seats, elements in Alcantara, elegant aluminium look and many other details. And the best thing: the various exterior lines can be easily combined with the interior packages.”

The figures for fuel consumption and CO₂ emissions can be found from page 44 onwards.
 Some of the equipment illustrated or described is optional equipment for which an extra charge is made.
 Please contact your Audi partner or visit www.audi.com for detailed information about standard and optional equipment.



Design selection interior



Q3 advanced with contrasting paint finish Manhattan grey, metallic and black styling package



18-inch cast aluminium wheels in 5-arm design, 7J x 18 with 235/55 R 18 tyres



S line interior



Illuminated door sill trims with aluminium inlays and S logo



19-inch cast aluminium wheels in 5-twin-spoke dynamic design (S design), 7J x 19 with 235/50 R 19 tyres

You say:

“Come on,
let’s go!”



We say:

“S line shows the Audi Q3 from its sportiest side. Striking front end, large air inlets and a dynamic rear diffuser indicate from the outside just what it’s capable of. Its interior is every bit as impressive. Elements such as a sport steering wheel in perforated leather, sport seats with cloth/leather/Alcantara surfaces and aluminium trim will make you a fan at top speed.”

The figures for fuel consumption and CO₂ emissions can be found from page 44 onwards. Some of the equipment illustrated or described is optional equipment for which an extra charge is made. Please contact your Audi partner or visit www.audi.com for detailed information about standard and optional equipment.



You say:
“Show your true colours!”

We say:

“Pulse orange, turbo blue or, or, or. Select the paint colour that best suits your personality. Rely on your taste and on the outstanding quality. Because the Audi Q3 is painted not just once, but four times to keep it gleaming for a long time to come.

Citrus yellow,
metallic

Mythos black,
metallic

Turbo blue

Tango red,
metallic

Cosmos blue,
metallic

Glacier white,
metallic

Nano grey,
metallic

Chronos grey,
metallic

The figures for fuel consumption and CO₂ emissions can be found from page 44 onwards. Some of the equipment illustrated or described is optional equipment for which an extra charge is made. Please contact your Audi partner or visit www.audi.com for detailed information about standard and optional equipment.

You say:
**“The bigger,
 the better!”**

We say:

“Its wheels emphasise the powerful, dynamic appearance of the Audi Q3. In an elegant or sporty design and in sizes from 17 to an impressive 20 inches. Regardless of which wheels you choose, they are all of high quality. This is guaranteed by a special test procedure and rigorous inspection.”



19-inch cast aluminium wheels in 5-twin-spoke dynamic design (S design)



18-inch cast aluminium wheels in 5-twin-arm design



20-inch Audi Sport cast aluminium wheels in 5-V-spoke star design in matt titanium look, gloss turned finish¹



18-inch cast aluminium wheels in 5-Y-spoke design, partly polished¹



19-inch Audi Sport cast aluminium wheels in 5-twin-arm design in matt titanium look, gloss turned finish^{1,2}



19-inch Audi Sport cast aluminium wheels in 7-spoke rotor design in gloss anthracite black, gloss turned finish^{1,2}



18-inch cast aluminium wheels in 5-arm design

¹ Please note the special information relating to wheels in wintry road conditions on page 45. ² From Audi Sport GmbH.

The figures for fuel consumption and CO₂ emissions can be found from page 44 onwards. Some of the equipment illustrated or described is optional equipment for which an extra charge is made. Please contact your Audi partner or visit www.audi.com for detailed information about standard and optional equipment.



You say:
“Feels good.”

Sport seats



We say:
 “In your Audi Q3 you sit on standard or sport seats. No matter whether you’re in the front or back, you’ll certainly feel the comfort. This is thanks to high-quality materials and precise workmanship – regardless of which seat upholstery you choose.”

Sport seats

The figures for fuel consumption and CO₂ emissions can be found from page 44 onwards. Some of the equipment illustrated or described is optional equipment for which an extra charge is made. Please contact your Audi partner or visit www.audi.com for detailed information about standard and optional equipment.

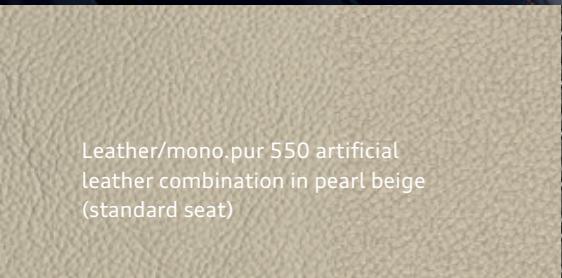

Leather/mono.pur 550 artificial leather combination in pearl beige (standard seat)

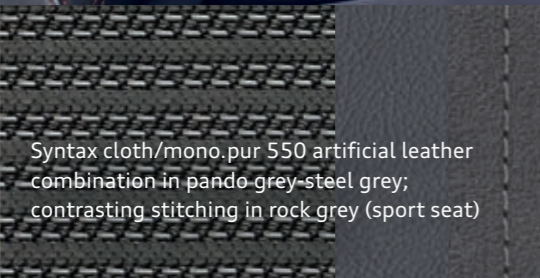

Syntax cloth/mono.pur 550 artificial leather combination in pando grey-steel grey; contrasting stitching in rock grey (sport seat)

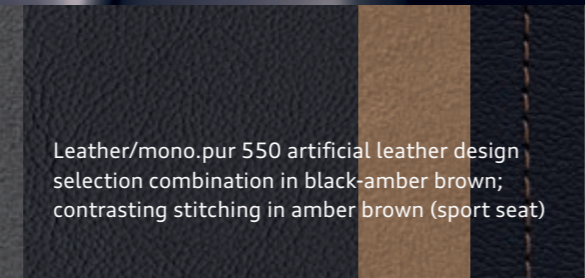

Leather/mono.pur 550 artificial leather design selection combination in black-amber brown; contrasting stitching in amber brown (sport seat)

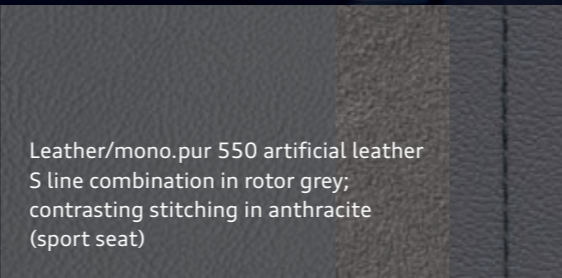

Leather/mono.pur 550 artificial leather S line combination in rotor grey; contrasting stitching in anthracite (sport seat)

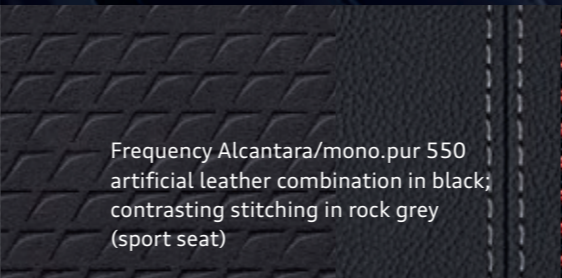

Frequency Alcantara/mono.pur 550 artificial leather combination in black; contrasting stitching in rock grey (sport seat)



Pulse cloth/mono.pur 550 artificial leather combination in black-red; contrasting stitching in rock grey (sport seat)

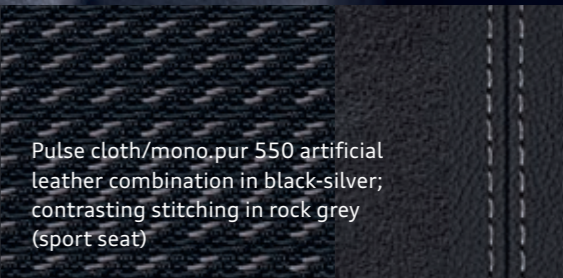

Pulse cloth/mono.pur 550 artificial leather combination in black-silver; contrasting stitching in rock grey (sport seat)

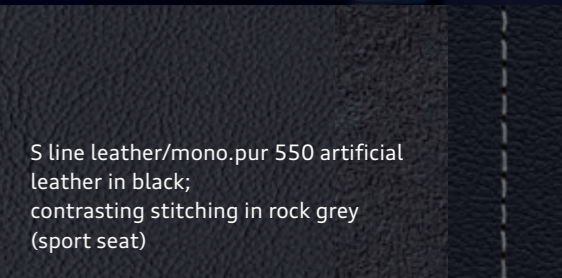

S line leather/mono.pur 550 artificial leather in black; contrasting stitching in rock grey (sport seat)

You say:

“How cool!”

Orange

Steel grey

Amber brown

Aluminium
dimension, silver

Matt brushed
aluminium, dark

Aluminium
dimension, dark

Lime artefact,
natural grey-brown



We say:

“Combine the new Alcantara interior package with inlays and accent surfaces, just as you choose. Whether classic, understated or in a masculine metallic look.”

The figures for fuel consumption and CO₂ emissions can be found from page 44 onwards.
Some of the equipment illustrated or described is optional equipment for which an extra charge is made.
Please contact your Audi partner or visit www.audi.com for detailed information about standard and optional equipment.

You say:

“Could be just the thing!”

We say:

“Easy-to-operate technology, design and comfort. Typical qualities that make the new Audi Q3 particularly suitable for everyday use. One example is the flexible rear seat bench plus that allows you to increase storage space in no time at all.”

The figures for fuel consumption and CO₂ emissions can be found from page 44 onwards. Some of the equipment illustrated or described is optional equipment for which an extra charge is made. Please contact your Audi partner or visit www.audi.com for detailed information about standard and optional equipment.

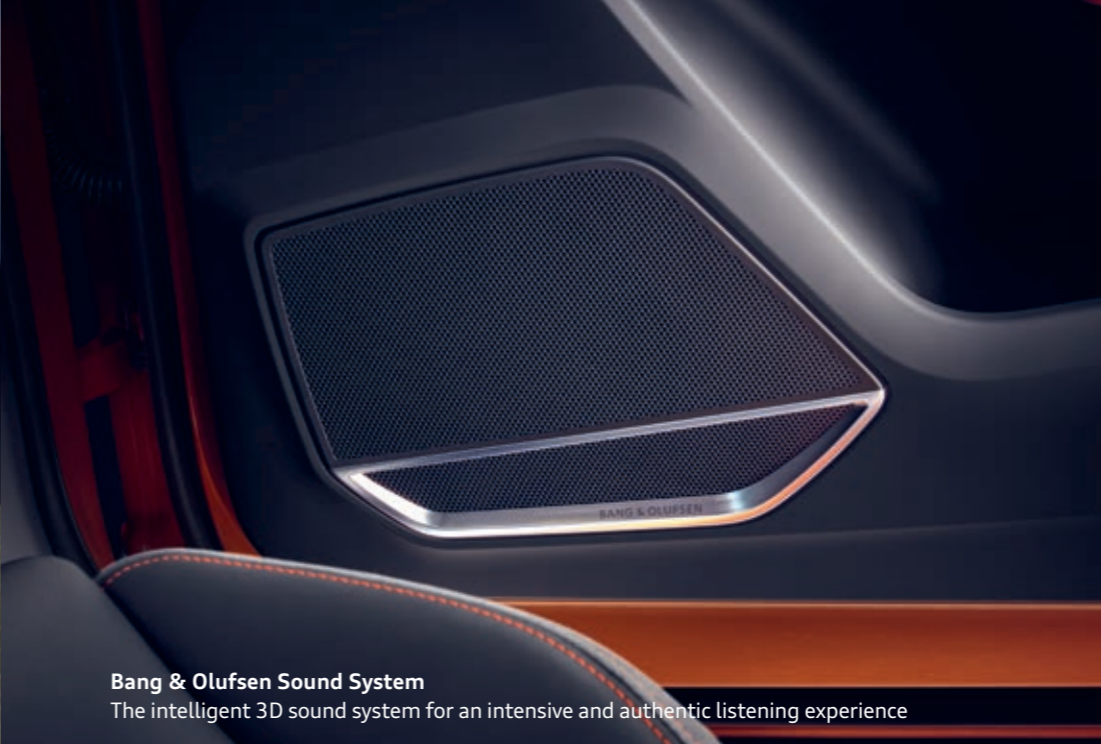

Bang & Olufsen Sound System
The intelligent 3D sound system for an intensive and authentic listening experience



Matrix LED headlights



Audi virtual cockpit plus
Fully digital 12.3-inch instrument cluster that shows a variety of functions, services and displays at a glance.

You say: “Quality time.”

We say:

“Make your Audi look even more dynamic with Audi Genuine Accessories. Custom solutions that offer you the comfort and convenience you are used to from Audi. Be thrilled by functional products with quality you can rely on. In fascinating Audi design, of course, which will make your day – time and again.

The figures for fuel consumption and CO₂ emissions can be found from page 44 onwards. Please note the information relating to Audi Genuine Accessories on page 47.

- Carrier unit for roof rails
- Ski and luggage box
- Cycle rack for trailer towing hitch
- Exterior mirror housings in carbon
- Cast aluminium wheel in 5-arm Serra design, matt black, with contrasting colour matt quartz grey;
- 7J x 19 for 235/50 R 19 tyres



Further information can be obtained from the accessories catalogue and from your Audi partner.



Exterior mirror housings in high-quality carbon – a real eye-catcher.

All-weather floor mats – help protect the vehicle interior against moisture and coarse soiling. With Q3 logo.

Door sill LED – uses LED light to project the Audi rings onto the ground. Also available with the quattro logo.

Cast aluminium winter wheel – in 5-arm Serra design, gloss black; 6.5 J x 17 for 215/65 R 17 size tyres.

You say:

“Just my



thing.”

We say:

“Welcome to your Audi Q3. Now climb into the special model Q3 edition one! Available in sporty pulse orange or elegant chronos grey, metallic – naturally with S line and design selection interior as well as many other exclusive highlights.”

The figures for fuel consumption and CO₂ emissions can be found from page 44 onwards.
Some of the equipment illustrated or described is optional equipment for which an extra charge is made.
Please contact your Audi partner or visit www.audi.com for detailed information about standard and optional equipment.

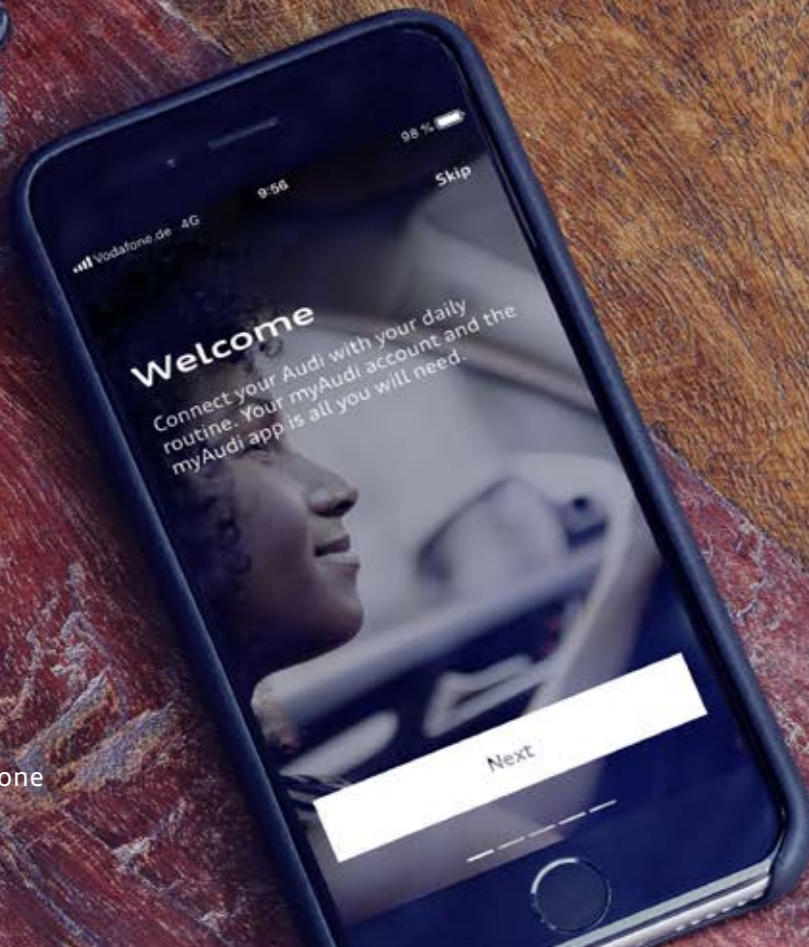

Scan the QR code using your smartphone or tablet.

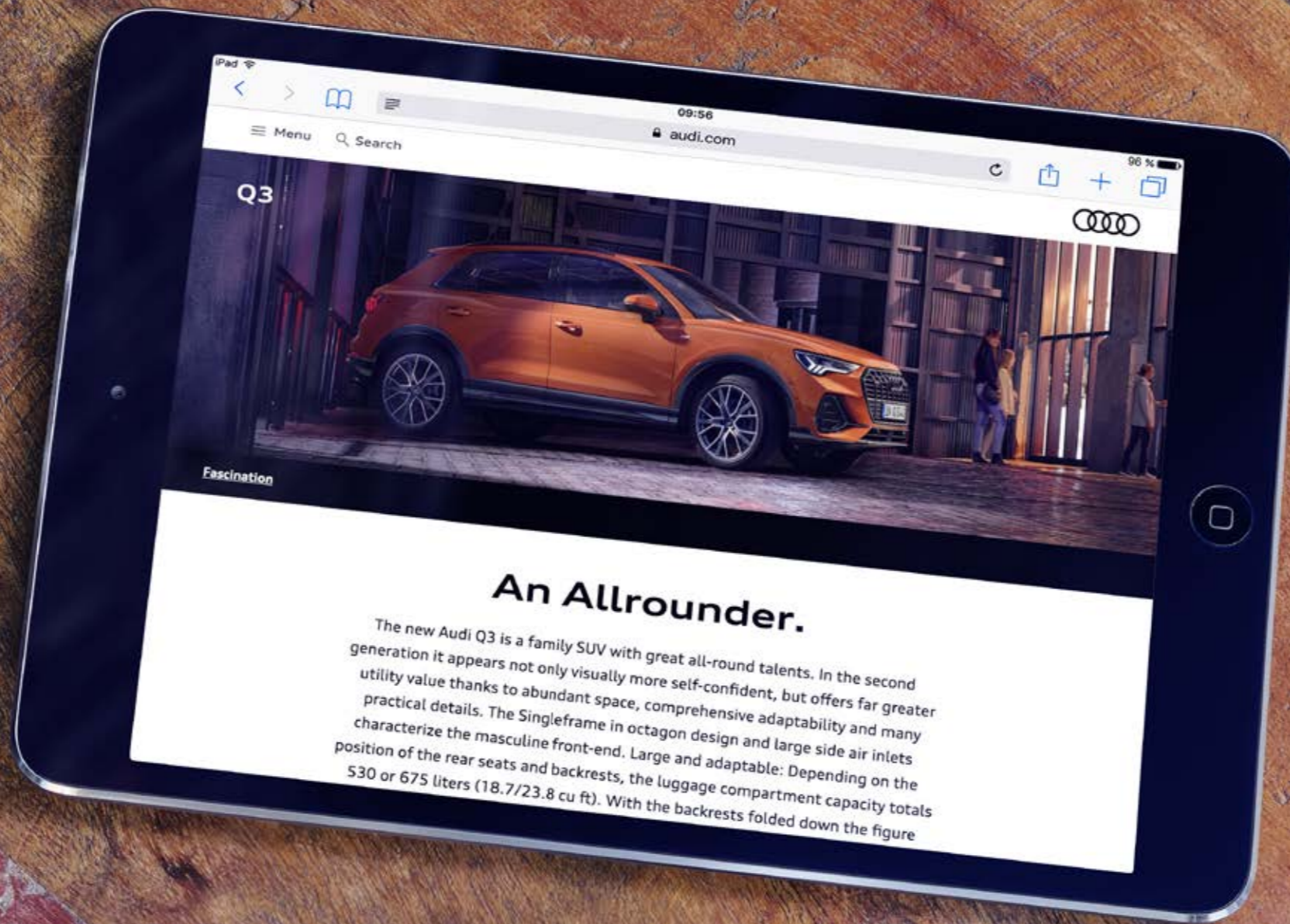

You say:

“Is there more?”

We say:

“The fascination of the Audi Q3. Find out more online, where you can discover the world of the new Audi Q3. More information, more individuality and more exclusivity. Now at www.audi.com/q3.”









Model	Audi Q3 35 TFSI (110 kW)		Audi Q3 40 TFSI quattro (140 kW)	Audi Q3 45 TFSI quattro (169 kW)	Audi Q3 35 TDI (110 kW)
Engine type	4-cylinder inline petrol engine with direct fuel injection and turbocharging		4-cylinder inline petrol engine with direct fuel injection and turbocharging	4-cylinder inline petrol engine with direct fuel injection and turbocharging	4-cylinder inline diesel engine with common rail injection system and turbocharging
Displacement in cc (valves per cylinder)	1,498 (4)		1,984 (4)	1,984 (4)	1,968 (4)
Max. output ¹ in kW at rpm	110/5,000–6,000		140/4,200–6,700	169/5,000–6,700	110/3,500–4,000
Max. torque in Nm at rpm	250/1,500–3,500		320/1,500–4,200	350/1,500–4,400	340/1,750–3,000
Power transmission					
Drive type	Front-wheel drive		All-wheel drive	All-wheel drive	Front-wheel drive
Transmission type	6-speed manual transmission [7speed S tronic]		7-speed S tronic	7-speed S tronic	7-speed S tronic
Weights/capacities					
Unladen weight ² in kg	1,535	[1,570]	1,695	1,695	1,655
Gross vehicle weight in kg	2,000/2,045	[2,025/2,070]	2,150/2,200	2,150/2,200	2,110/2,155
Permissible roof load limit/nose weight in kg	75/90	[75/90]	75/90	75/90	75/90
Trailer load limit ³ in kg					
unbraked	750	[750]	750	750	750
12% gradient	1,800	[1,800]	2,100	2,100	2,000
8% gradient	2,000	[2,000]	2,100	2,100	2,000
Fuel tank capacity, approx. in l	60	[58]	60	60	60/AdBlue® tank: 18
Performance/consumption					
Top speed in km/h	211	[207]	220	233 ⁴	207
Acceleration 0–100 km/h in s	9.6	[9.2]	7.4	6.3	9.2
Fuel grade	Sulphur-free super RON 95 ⁵		Sulphur-free super RON 95 ⁵	Sulphur-free super RON 95 ⁵	Sulphur-free diesel ⁶
Fuel consumption ⁷ in l/100 km					
urban	7.7–7.6	[6.9–6.8]	9.5–9.2	9.7–9.5	5.4
extra-urban	5.4–5.1	[5.3–5.1]	6.4–6.0	6.4–6.1	4.5–4.3
combined	6.3–6.0	[5.9–5.7]	7.5–7.2	7.6–7.3	4.9–4.7
CO ₂ emissions ⁷ in g/km combined	145–139	[134–130]	172–164	173–167	128–123
Emission standard	EU6	[EU6]	EU6	EU6	EU6

Explanatory notes

- ¹ The figure given was calculated using the specified measuring procedure (current version of UN-R 85).
- ² Unladen vehicle weight includes driver (75 kg) and fuel tank 90% full, calculated in accordance with the current version of Reg. (EU) 1230/2012. Optional equipment may increase the car's unladen weight and drag coefficient, whereupon the possible payload limit and the top speed will be reduced accordingly.
- ³ The engine's power output always decreases with increasing altitude. At 1,000 m above sea level, and for every additional 1,000 m, deduct 10% from the weight of the outfit (trailer load limit + gross weight of the towing vehicle). Figure for trailer load limit applies to factory-fitted trailer towing hitch. If using the vehicle with a trailer towing hitch for commercial purposes, a digital tachograph may be required under certain conditions.
- ⁴ Regulated.
- ⁵ We recommend using sulphur-free super unleaded RON 95 fuel complying with DIN EN 228. If this is not available, use sulphur-free regular unleaded RON 91 fuel complying with DIN EN 228; power output will be slightly reduced. Unleaded RON 95 fuel with a maximum ethanol content of 10% (E10) can generally be used. Fuel consumption details refer to operation with RON 95 fuel complying with 692/2008/EC.
- ⁶ We recommend using sulphur-free diesel complying with DIN EN 590. If this is not available, use diesel complying with DIN EN 590.
- ⁷ The specified fuel consumption and emission data have been determined according to the measurement procedures prescribed by law. Since 1 September 2017, certain new vehicles are already being type-approved according to the Worldwide Harmonized Light Vehicles Test Procedure (WLTP), a more realistic test procedure for measuring fuel consumption and CO₂ emissions. Starting on 1 September 2018, the New European Driving Cycle (NEDC) will be replaced by the WLTP in stages. Owing to the more realistic test conditions, the fuel consumption and CO₂ emissions measured according to the WLTP will, in many cases, be higher than those measured according to the NEDC. For further information on the differences between the WLTP and NEDC, please visit our website. We are currently still required by law to state the NEDC figures. In the case of new vehicles which have been type-approved according to the WLTP, the NEDC figures are derived from the WLTP data. It is possible to specify the WLTP figures voluntarily in addition until such time as this is required by law. In cases where the NEDC figures are specified as value ranges, these do not refer to a particular individual vehicle and do not constitute part of the sales offering. They are intended exclusively as a means of comparison between different vehicle types. Additional equipment and accessories (e.g. add-on parts, different tyre formats, etc.) may change the relevant vehicle parameters, such as weight, rolling resistance and aerodynamics, and, in conjunction with weather and traffic conditions and individual driving style, may affect fuel consumption, electrical power consumption, CO₂ emissions and the performance figures for the vehicle. Further information on official fuel consumption figures and the official specific CO₂ emissions of new passenger cars can be found in the "Guide on the fuel economy, CO₂ emissions and power consumption of all new passenger car models" which is available free of charge at all sales dealerships and from DAT Deutsche Automobil Treuhand GmbH, Hellmuth-Hirth-Str. 1, 73760 Ostfildern-Scharnhausen, Germany (www.dat.de).

Classifications of tyre parameters

The table shows the range of fuel efficiency, wet grip and exterior noise emission classes for the different tyre sizes of the Audi Q3.

	Tyre size	Fuel efficiency class	Wet grip class	Exterior noise emission class
Summer tyres	215/65 R 17	B-A	A	71-68 
	235/55 R 18	B	A	71-69 
	235/50 R 19	C	B	71 
	255/45 R 19	E	A	73 
All-season tyres	255/40 R 20	C	A	72 
	235/55 R 18	C	C	71 
Winter tyres	215/65 R 17	C	B	72 
	235/50 R 19	C	C-B	72-70 

It is not possible to order a specific tyre. Ask your Audi partner about the range of tyres available in your country.

Important note

Special information about the wheels: Wheels with gloss turned finish as well as polished or partly polished aluminium wheels must not be used in wintry road conditions. For manufacturing reasons, the rim surface does not have sufficient corrosion protection for such use and can be damaged permanently by road salt or similar.

Audi Q3 edition one (extract from the equipment for the Audi Q3 illustrated, page 2-41):

- exterior colour pulse orange
- S line with contrasting paint finish in Manhattan grey, metallic
- Audi exclusive black styling package as well as Audi rings and logos in gloss black
- 20-inch Audi Sport cast aluminium wheels in 5-V-spoke star design in matt titanium look, gloss turned finish¹
- Matrix LED headlights and LED rear lights with dynamic indicator
- design selection interior
- headlining in cloth, black
- sport contour leather steering wheel in 3-spoke design, flattened at the bottom, with multifunction plus
- sport seats, front
- leather/mono.pur 550 design selection combination in black-steel grey with exclusive contrasting stitching in orange
- interior elements in Alcantara, orange
- key cover

The Audi Q3 edition one is also available in chronos grey, metallic with sport seats in pando grey and exclusive interior elements in Alcantara, lunar silver.

Audi Q3

Dimensions in mm

Dimensions are for unladen vehicle weight.

Luggage capacity² 530/1,525 l (second value with the rear seat backrest folded down and vehicle loaded up to roof height).

Turning circle approx. 11.8 m.

* Without roof aerial the vehicle height is reduced by 31 mm.

** Maximum headroom. *** Elbow room width. **** Shoulder room width.

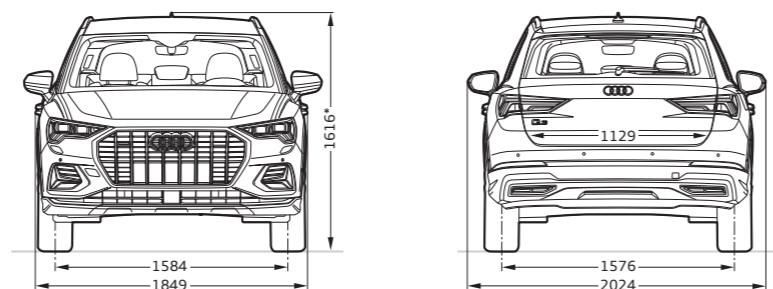
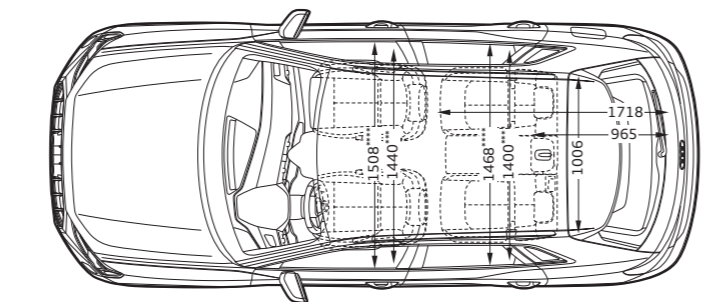
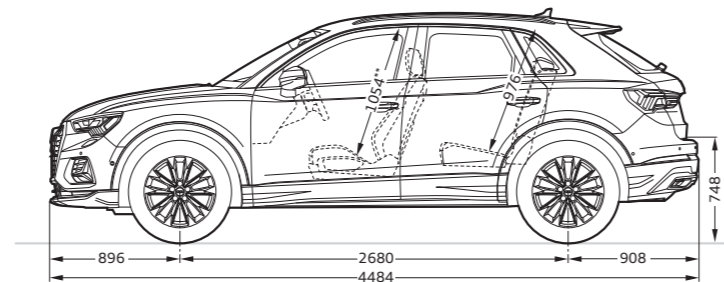

Legal notice about Audi connect

Use of the services supported by Audi connect is possible only in conjunction with a navigation system. Audi connect services are provided through AUDI AG. The data connection for Audi connect services is set up through a mobile services provider via a SIM card installed in the vehicle. The costs of these data connections are included in the price of Audi connect services. The cost of the Wi-Fi hotspot is not included. The data connection for the Wi-Fi hotspot can be arranged with a selected mobile services provider as a payable data tariff. You will find information about tariffs and booking at my.audi.com. Alternatively, an external customer SIM card can be inserted into the card slot to establish a data connection. In conjunction with the optional Audi phone box, a Bluetooth-capable smartphone with remote SIM Access Profile (rSAP) can also be connected in many models to use the integrated car phone function. If an external SIM card is inserted into the card slot or connected via rSAP, all data connections, for both the Audi connect services as well as for the Wi-Fi hotspot, will be established via this external SIM card. In such cases, the costs incurred are attached to those accrued via the external SIM card. The availability of the services supported by Audi connect varies from country to country. Audi connect services are provided for at least 1 year from vehicle delivery. Following a period of 24 months from vehicle delivery, Audi connect services will be extended once free of charge for 12 months. If you do not require this extension, please write to:

AUDI AG

Audi International Customer Care Services

85045 Ingolstadt, Germany

Email: kundenbetreuung@audi.de

Tel.: +49 800 28347378423

Ask your Audi partner about a subsequent extension of the Audi connect services. Depending on the vehicle model, Audi connect provides access to Google and Twitter services. Permanent availability cannot be guaranteed as this is the responsibility of Google and Twitter. Please visit www.audi.com/connect or contact your Audi partner for more detailed information about Audi connect; contact your mobile services provider for information about contract conditions.

Legal notice about Audi connect emergency call & service

The services are provided via a SIM card installed in the vehicle. The costs of calls and data connections are included in the price of the services. The services provided by Audi are available only within the coverage of the mobile phone network of the mobile phone provider chosen by Audi. The Audi connect services emergency call, online roadside assistance and Audi service request are available for 10 years from vehicle delivery in the following countries: Austria, Belgium, Bulgaria, Finland, France, Germany, Gibraltar, Greece, Hungary, Ireland, Italy, Liechtenstein, Lithuania, Malta, Monaco, the Netherlands, Norway, Poland, Portugal, Romania, Spain, Sweden, Switzerland, the UK. Ask your Audi partner about when the services will become available in additional European countries and about the availability of the optional equipment.

General legal notice about the equipment Audi connect emergency call & service and Audi connect

Disruption to the services may occur due to force majeure and official orders as well as technical or other measures carried out on the systems of AUDI AG, suppliers or network operators to ensure their proper function (e.g. maintenance, repairs, system-related software updates, extensions). AUDI AG will make every reasonable effort to end such disruption as quickly as possible or to work towards a resolution.

Legal notice about Audi Genuine Accessories

Audi Genuine Accessories are available from AUDI AG for an extra charge. Accessories are not factored in when calculating the vehicle's fuel consumption and emission figures. As such, accessories can be fitted only after initial registration.

¹Please note the special information relating to wheels on this page. ²Technical specifications refer to a basic vehicle without country-specific features and the selected optional equipment.

AUDI AG

Auto-Union-Strasse 1
85045 Ingolstadt
www.audi.com
Date published: November 2018

Printed in Germany
833/115D.39.18

The vehicles and equipment versions illustrated and described in this brochure and some of the services listed are not available in all countries. Some of the cars illustrated are equipped with optional features for which an extra charge is made. Details concerning the delivery specifications, appearance, performance, dimensions and weights, fuel consumption and running costs of the vehicles were correct to the best of our knowledge at the time of going to press. Deviations from the colours and shapes shown in the illustrations may occur. No liability is accepted for errors and printing errors. The right to introduce modifications is reserved. Not to be reproduced, including in part, without the written approval of AUDI AG.

This brochure is printed on paper made from pulp bleached without the use of chlorine.

