



A7

Audi A7 Sportback
Audi S7 Sportback

Vorsprung durch Technik **Audi** 



Page		
Fascination		
4 Audi A7 Sportback	22 Audi S7 Sportback	
Technology		
34 Innovations	40 quattro®	46 Dynamics
36 Audi ultra	42 Audi Matrix LED headlights	48 Assistance systems
38 Audi connect	44 Performance	50 Simplicity
Equipment		
54 Style guides	68 Audi exclusive	85 Design
56 S model	70 Paint finishes	85 Steering wheels/controls
58 Audi ultra	72 Wheels/tyres	86 Comfort
60 Engines	74 Seats/seat upholstery	89 Infotainment
62 S line	78 Headlinings	93 Assistance systems
64 Audi design selection	82 Inlays	96 Technology/safety
66 Audi exclusive line	84 Lights	97 Audi Extended Warranty
Other		
98 Audi Genuine Accessories	104 Dimensions	114 The fascination of Audi
100 Technical data	106 Index	

Dialogue: Audi QR codes

Experience Audi even more directly: download a QR app to your smartphone and then scan the QR code or follow the given link in your browser.



The equipment for the vehicles illustrated in the Fascination section can be found on page 113.
The fuel consumption and CO₂ emission figures can be found from page 100 onwards.

Nothing is more convincing than a clear line.

One thrilling vehicle combining the purist charm of a saloon, the distinct versatility of an Avant and the passionate dynamism of a coupé. Top sporting performance. Innovative technology. Impressive efficiency. The Audi A7 Sportback. A unique car.

The fuel consumption and CO₂ emission figures can be found from page 100 onwards.





Nothing is more inspiring than the view ahead.

Pure form, clear lines.
Every millimetre of the Audi A7 Sportback is set to impress.

The characteristic dynamic line stretches across the whole length of the vehicle.
Harmoniously in tune with wide side sills. Sporty and taut. The perfect balance
of purist lightness and flowing lines. A statement of dynamism and elegance.

The fuel consumption and CO₂ emission figures can be found from page 100
onwards.

A7

Audi A7 Sportback

Sportiness, progressively interpreted.
By a design that stirs emotions.
From heightened anticipation to
genuine enthusiasm. Enhanced
through extraordinary details.

An initial impression of elegance and
sophistication, emphasised by the Audi
Singleframe with horizontal chrome
struts. Wide. Flat. Giving the headlights
a look of intensity and power. An appearance
that emanates strength.

Radiating confidence all the way back
to the muscular rear with diffuser in
a contrasting colour. Sporty, elegant
tailpipes with a trapezoidal design
and a striking spoiler edge.



The fuel consumption and CO₂ emission
figures can be found from page 100
onwards.



Nothing is more fulfilling than the feeling that you have done everything right.

The A7 Sportback is an impressively innovative vehicle concept. Its coupé-like design is surprisingly practical for everyday use. Take the wide opening tailgate and luggage space of up to 1,390 litres, for example. Emotion meets functionality. A vehicle for everyday use – and for very special moments.

The fuel consumption and CO₂ emission figures can be found from page 100 onwards.



Attractive aluminium wheels create individual highlights.



Streamlined LED rear lights confidently emphasise the vehicle width.
Dynamic indicators included as standard.



With 18 individual diodes, the LED daytime running lights in the headlights ensure powerful illumination. Available as an option: Audi Matrix LED headlights for optimum illumination of the road.

Striking exterior mirrors are stylishly integrated into the dynamic overall appearance.



Nothing is more relaxing than a moment of peace.

Take a seat, stop and enjoy. The interior ambience rounds off the exterior elegance and is further accentuated by exclusive inlays. In high-quality wood if so desired.

Not just a passenger compartment, but also an intelligent interior concept. It embraces both driver and front passenger, giving them a sense of security. The centre console is angled towards the driver. Everything in view and under control. With the aid of aluminium-look buttons, among other things. Now available with the new generation of infotainment, for example MMI navigation plus with MMI touch. In addition, numerous Audi connect services are available and have been integrated in a user-friendly way. And thanks to MMI touch, they can be operated intuitively using just one finger.





Sit back and relax on comfortable seats. Feel their excellent support and high-quality materials. Customised contour seats in leather with memory function are available as an option for the driver and front passenger – these can be adjusted from sporty to comfortable and the settings saved and called up again any time with the memory function. Plenty of room for personal development. Supported by the folding centre armrest and plenty of storage compartments in the frameless doors. The rear seat bench can be easily split and folded forwards, for more comfort or even more luggage space. The rear seat bench fully folded down produces a luggage capacity of up to 1,390 litres. This can be used conveniently thanks to the standard electric tailgate which is large and opens wide.

The fuel consumption and CO₂ emission figures can be found from page 100 onwards.





Nothing is stronger than your own drive.

Delivering efficient yet powerful performance. The TFSI and TDI engines for the Audi A7 Sportback.

With quattro permanent all-wheel drive as an option. Channelling power to where it is needed. To the road. Combining poise with powerful forward momentum. To ensure you stick to your course even with a very sporty driving style. Stability is enhanced by the harmoniously integrated rear spoiler. This extends automatically when the vehicle reaches 130 km/h – or at the push of a button whenever you want. For improved downforce and sporty aesthetics.

The fuel consumption and CO₂ emission figures can be found from page 100 onwards.

Sportiness that can be seen and felt.

The Audi A7 Sportback will win you over with its outstanding dynamism and superb efficiency.

Its intelligent lightweight design helps reduce fuel consumption and cut emissions. Supported when stationary by the start-stop system which switches off the engine automatically. As soon as the stopping process is initiated. The efficiency program also offers tips on how to drive more economically. These appear conveniently in the driver information system.

Audi drive select offers even greater efficiency. Choose your own preferred setup by selecting one of five modes – from comfortable to sporty. Or make particularly energy-saving headway with the efficiency mode. In conjunction with S tronic, there is even a freewheel mode, which switches to neutral early on when you release the accelerator.

An impressive combination of athletic ability and energy efficiency that has been consistently followed through. And accomplished with a clear line in a unique car. The Audi A7 Sportback.

The fuel consumption and CO₂ emission figures can be found from page 100 onwards.





**Design that fascinates.
Power that impresses.**

Passion at the very first glance. The Audi S7 Sportback. Specially designed headlights beam out from underneath the impressive bonnet, flanked at the sides by powerful sills. The result is a look that promises pure dynamics. And that delivers on this promise too – with 8 cylinders and 331 kW. Rounded off with breathtaking performance. Enjoy uncompromising sportiness, without sacrificing comfort or efficiency.

The fuel consumption and CO₂ emission figures can be found on page 102.

S7

Audi S7 Sportback

Top sporting performance. From our engineers.

Irresistible acceleration. Triggered by a brief press of the accelerator. From 0 to 100 km/h in 4.6 seconds. With ease. Powered by a masterpiece of German engineering: the 4.0 litre V8 TFSI engine. With innovative Audi cylinder on demand technology. Intelligent and efficient. Four of the eight cylinders shut down in the partial-load range. Without being noticed. The engine continues to run smoothly and powerfully regardless, reducing fuel consumption and cutting CO₂ emissions in the process.

The fuel consumption and CO₂ emission figures can be found on page 102.





Exceptional sportiness. Down to the last detail. Starting with the Singleframe and horizontal double chrome struts. Refined with the Audi S emblem. And rounded off with the black painted brake callipers that are typical of the S models. Clearly visible between the spokes of the optional 20-inch cast aluminium wheels.

The fuel consumption and CO₂ emission figures can be found on page 102.



Concentrated fascination.

Welcome on board. To high-quality S sport seats in the front. Optionally available in luxurious Valcona leather. And electrically adjustable as standard. Sporty looks included. Accentuated by the embossed S7 logo on the upper backrest. Superb lateral support, even for drivers with a more spirited driving style.

The fuel consumption and CO₂ emission figures can be found on page 102.



The first shot of adrenaline comes when you get in. The spirit of racing in the air. The power lies in your hands. Multifunction sport leather steering wheel in 3-spoke design, with aluminium S7 emblem and aluminium-look shift paddles. Flanked by inlays in matt brushed aluminium. In carbon Atlas on request. Exclusive and sophisticated. Plus intuitive operation of the navigation system, media playback and comfort functions. With a simple swipe of the finger. Thanks to the optionally available MMI navigation plus with MMI touch.

The fuel consumption and CO₂ emission figures can be found on page 102.





The Audi S7 Sportback. Ready for top sporting achievements. If you are. Climb aboard and discover dynamics in its most beautiful form.

The fuel consumption and CO₂ emission figures can be found on page 102.

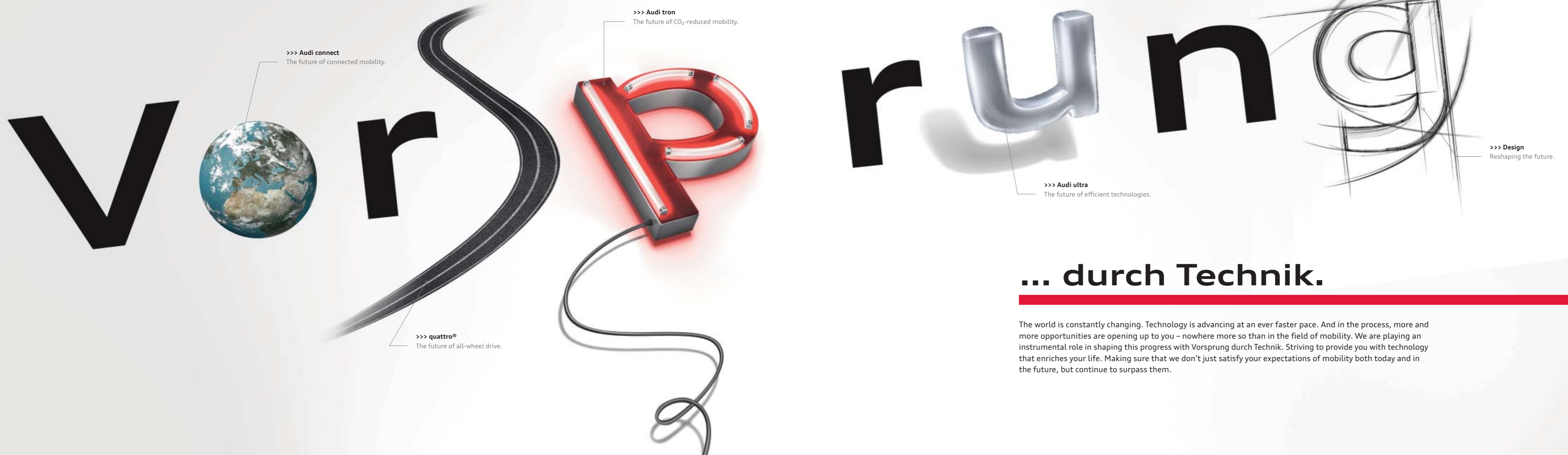

>>> **Audi connect**
The future of connected mobility.

>>> **Audi tron**
The future of CO₂-reduced mobility.

>>> **quattro®**
The future of all-wheel drive.

>>> **Audi ultra**
The future of efficient technologies.

>>> **Design**
Reshaping the future.

... durch Technik.

The world is constantly changing. Technology is advancing at an ever faster pace. And in the process, more and more opportunities are opening up to you – nowhere more so than in the field of mobility. We are playing an instrumental role in shaping this progress with Vorsprung durch Technik. Striving to provide you with technology that enriches your life. Making sure that we don't just satisfy your expectations of mobility both today and in the future, but continue to surpass them.

Audi ultra

Perfectly combined.

The future of efficient technologies.

Building an Audi is an extremely complicated business. And yet a simple principle applies for all models: all vehicle components interlock precisely in order to produce emission-reducing synergies. What started in accordance with this principle at the end of the 1980s with Audi lightweight construction and the revolutionary Audi Space Frame (ASF®) is now known as the reversal of the weight spiral: every lightweight component has an impact on other components, which can in turn be made smaller. In this way, existing forms and materials are continuously being improved with regard to their functionality, the lowest possible weight and their production process. With the goal of building vehicles that are even more efficient and make more sparing use of resources. At the same time, more and more efficiency technologies are being built into an Audi. These include recuperation and the start-stop system. Not to mention progressive, efficient high-tech engines. For greater driving dynamics, high compression, more efficient combustion and lower CO₂ emissions. All this is known as Audi ultra. Today and in the future – towards CO₂-reduced mobility.

>>> Aerodynamics

Less drag, more efficiency. Thanks to the consistently aerodynamic styling of the vehicle's lines, its underbody and spoiler edges – in order to achieve the best possible form for aerodynamic efficiency. Not forgetting tyres with reduced rolling resistance. All tested in the Audi wind tunnel at up to 300 km/h.

>>> Lightweight expertise

Less weight. More savings, power and endurance. Audi lightweight technology. What started with lightweight body construction has now made its way into nearly all areas, combining innovative materials such as aluminium, carbon and magnesium, intelligent design principles and resource-saving manufacturing processes into an overall concept.

>>> Transmission expertise

Improved efficiency values thanks to improved transmission ratios. A higher torque output makes longer ratios possible, especially in higher gears. For powerful torque in the low engine speed range which reduces consumption – yet has no adverse effects on driving performance and sportiness.

>>> Recuperation

Braking that leads to even more efficient driving. With brake energy recovery (recuperation). Part of the kinetic energy produced when braking and coasting is temporarily stored in the vehicle's battery and then used when accelerating. Depending on the driving cycle, this can save up to 3% of fuel.

>>> Engine expertise

Powerfully and efficiently driven. By Audi ultra with efficiency technologies in the engine sector. Such as Audi cylinder on demand and the Audi valvelift system, which both reduce the amount of energy consumed by the engine, or clean diesel technology, which can help to reduce emission.

Mobility & navigation



Point-of-interest (POI) search with voice control
in the Google™¹ database



Traffic information online
dynamic route guidance with real-time traffic flow information



myAudi - special destinations²
The navigation system as a personal road atlas: import individual point-of-interest (POI) lists to the vehicle via the myAudi portal.



Country information²
Display of country-specific information, such as current speed limits or whether it is compulsory to carry a high-visibility vest or purchase a motorway sticker when passing the border.



Picturebook navigation
GPS data from your photos get you to your destination.



Fuel prices
the cheapest petrol stations at your destination or in the vicinity



Parking information
help with looking for car parks and multi-storeys, plus - where available - information on prices and currently vacant spaces



Navigation with Google Earth™¹ and Google Street View™¹
uses high-resolution aerial and satellite images, photos and address information to guide you to your destination even more easily



Map update online²
The map version delivered can be updated free of charge with the first 5 navigation updates which are issued at intervals of 6 months. In conjunction with Audi connect, the update can be carried out online in the vehicle.



Destination entry via myAudi or Google Maps™^{1,3}
If you want, you can plan your navigation destinations from your PC or using a smartphone. myAudi and Google Maps™¹ or the Audi MMI connect app allow individual navigation destinations to be sent to the vehicle. When you start your journey, these can easily be loaded as your destination.

Communication



Wi-Fi hotspot
connects your mobile devices to the internet



Email²
can be transmitted to your Audi MMI and conveniently read out



Text messages⁴
displayed or conveniently read out to you and replies written using the dictation function



Access to Facebook
integrates your personal network into the cockpit. With text-to-speech and other convenient text functions.



Access to Twitter
integrates the Twitter message service into the cockpit. With text-to-speech and other convenient text functions.



Access to smartphone voice control⁵
such as Siri (iPhone 4s and higher). By pressing and holding the voice control button on the multifunction leather steering wheel you can access the voice control function of the Bluetooth-connected smartphone directly even while driving. This can be controlled safely and conveniently via your Audi's microphones and loudspeakers.

Audi connect.

Audi connect

The future of connected mobility.

The world presents you with countless possibilities. The optional Audi connect enables you to make the most of many of them in digital form directly from your Audi. At the push of a button. Tailored to you. Thanks to myAudi and the services supported by Audi connect in your vehicle. In places all over the world. Intuitively, easily and conveniently.

myAudi - your personal control centre

provides you with password-protected access to www.audi.com/myaudi where, following one-off registration, you are able to put together the services supported by Audi connect that you require, and manage and configure them from the comfort of your own home. You can also use many of these services while out and about with your smartphone (Android 4.0 or higher, iOS 6 or higher) via the Audi MMI connect app.

Infotainment



Weather
forecasts and maps for the required destination.



Online media streaming⁶
Access to personal radio services and global radio stations via smartphone app, as well as connection to music streaming services which provide access to millions of songs. In addition, you can access the music stored on your smartphone.



News online (individual)
text and images about current world events, with text-to-speech function, can be configured individually



Travel information
sightseeing information - with a function for importing the destination to the navigation system

¹ Google and the Google logo are registered trademarks of Google Inc. ² Service is part of the optional MMI navigation plus with MMI touch. ³ Destination entry via Google Maps requires a Google account ⁴ Provided the mobile telephone has the Bluetooth profile MAP (Message Access Profile). Please contact your Audi partner or visit www.audi.com/bluetooth for information on compatible mobile phones. ⁵ Requires the optional MMI navigation plus with MMI touch including voice control system and Bluetooth interface as well as multifunction leather steering wheel. ⁶ Depends on country-specific availability. To use this feature you will generally require an account with a media streaming service. Additional costs may be incurred as a result. Availability, screen display and the cost of services vary depending on the country, model, device and tariff. For further legal information and notes on use, please see page 92 or visit www.audi.com/connect.

Have the road completely under control, thanks to permanent distribution of the drive force to all four wheels. Variably controlled by the centre differential. Always depending on the situation. Experience handling stability, dynamism and agility as never before and combat the effects of over- and understeer with quattro with optional sport differential. For increased traction and superior propulsive power. Tame any road. And always keep your eyes set on where you're heading. In bends. On straights. Over any surface. For a fascinating experience that sticks. To the road – and in your mind.



quattro®
**Stick to
the road.**

With quattro®.



Audi Matrix LED headlights

See well.

Darkness is relative. The optional Audi Matrix LED headlights turn night into day. The all-new headlight technology produces a light colour similar to that of daylight. Bends are anticipated to illuminate them more clearly. Vehicles are detected and the light distribution of your Audi A7 adapts according to the situation. This is all made possible by an array of sensors and a camera. As well as dimmable LEDs in an innovative arrangement – which, incidentally, are quite a sight in their own right.



Audi Matrix LED headlights won't thrill you only at night. The new lighting technology is quite a spectacle during the day, too, sometimes appearing as light points, sometimes as a dynamic light strip. Individually controllable LEDs. Perfectly adapted to the situation in hand. Showing the way ahead. An impressive sight, time and time again.

The fuel consumption and CO₂ emission figures can be found from page 100 onwards.

Look good.

Performance

Maximum power. Put to maximum use.

Every movement originates from something. Something that sets it off, an idea. The engine in your Audi A7 Sportback can also be traced back to an initial spark of inspiration: higher power with lower fuel consumption. These apparently conflicting aims are reconciled in two revolutionary drive technologies: TDI and TFSI. Get acquainted with both of them. And then opt for the drive system that you feel most moved by.



TDI®

With their combination of direct injection and turbocharging, Audi TDI engines promise exceptional performance – thanks to their high torque output over the entire engine speed range with constant power build-up. They are renowned for being fuel-efficient and for reducing emissions. But they are incredibly dynamic too – letting you get the maximum out of any road.



TFSI®

Audi TFSI engines attain a particularly high compression rate. The result: outstanding efficiency combined with optimum performance. Substituting supercharging for cubic capacity has the effect of considerably reducing engine size and weight – while performance remains as impressively dynamic as ever. For power delivery that will win you over from the word go.

Audi cylinder on demand

Even cylinder heads can be intelligent, as Audi cylinder on demand proves. Four of the TFSI engine's eight cylinders automatically shut down in the partial-load range. This helps to lower fuel consumption at the same time as reducing emissions. Without the switchover even being noticed or impairing the driving dynamics.



>>> Audi drive select

Audi drive select lets you adapt the driving characteristics of the A7 Sportback to suit your requirements. At the push of a button. Sportier, more comfortable, more balanced, more economical or even individually tailored as you please. It's entirely up to you.

>>> adaptive air suspension

The electronically controlled air suspension acts individually at each of the 4 wheels and makes sure that the handling characteristics are barely affected, even when carrying heavy loads. Also available as a sport version for the S model with even stiffer damping.

>>> Dynamic steering

The dynamic steering enhances handling and driving comfort with speed-sensitive control of the steering ratio.

>>> tiptronic

The 8-speed automatic transmission with Dynamic Shift Program (DSP) ensures faster gear changes without any perceptible break in propulsive power.

>>> S tronic®

The sporty, efficient dual-clutch transmission allows you to switch gears with lightning speed without a noticeable break in propulsive power.

>>> quattro®

The permanent all-wheel-drive system distributes the drive forces to each individual wheel according to the driving situation for extra traction and dynamic performance.

>>> quattro® with sport differential

The quattro permanent all-wheel drive with electronically controlled sport differential guarantees superb agility and thrilling driving dynamics.

>>> Ceramic brake

The ceramic brakes fitted at the front and rear axles ensure excellent braking performance in any driving situation.

Dynamics

Dynamics

that will take hold of you.

Get in. Buckle up. Start the engine. Wherever you're heading, enthralling driving dynamics will power you there. For as you know, the world is your oyster once you get behind the wheel of your Audi A7 Sportback. You decide the direction. The driving style. The pace. And you enjoy the satisfaction of knowing you have plenty in reserve. More than enough to get the very best from every drive.

The fuel consumption and CO₂ emission figures can be found from page 100 onwards.

You can find out which equipment features are available as standard or optional in your model by referring to the index starting on page 106.

>>> Audi pre sense basic

initiates preventive occupant protection measures in the event of an impending accident.

>>> Camera-based speed limit display

recognises speed limits and notifies you of them via the driver information system and head-up display.

>>> Audi active lane assist

helps you to keep in lane by means of gentle steering intervention when lane boundary markings are detected.

>>> adaptive cruise control including Audi pre sense front

monitors the traffic ahead and automatically maintains a constant distance wherever possible.

>>> Audi side assist including Audi pre sense rear

helps you when changing lanes and initiates preventive protection measures when an impending rear-end collision is detected.

>>> Audi Matrix LED headlights

track the road ahead and illuminate it according to the situation with their innovative LED layout for even greater safety.

Assistance systems

Wherever you're heading, peace of mind will be your constant companion.

With the assistance systems in your Audi A7 Sportback.

Each drive is different. Yet they all have one thing in common – the feeling of being protected that you get from every Audi. All driver assistance systems in your Audi A7 Sportback help you during your journey and guarantee even greater comfort when you're on the road. Get to know the most important driver assistance systems.

>>> Night vision assistant

improves convenience at night thanks to its integrated thermal imaging camera, highlighting any pedestrians and larger wild animals detected.

>>> Park assist

helps you to manoeuvre in and out of parking spaces by taking charge of the steering temporarily.

>>> Audi connect

Use all the optional services supported by Audi connect with the MMI navigation plus with MMI touch – quickly and easily. The intuitive operation of the MMI makes accessing internet-based functions remarkably straightforward.

>>> Navigation

With MMI navigation plus with MMI touch you can let yourself be guided to your destinations with even greater ease via the 3D map view and 3-dimensional display of places of interest and landmark buildings.

>>> Car

Control and alter driver assistance systems, vehicle settings as well as climate control and service functions quickly and easily using the MMI radio.

>>> Media

Display the covers of your music collection on all available media sources such as jukebox, inserted SD cards, Audi music interface, CDs or DVDs.

>>> MMI® touch

MMI touch makes operating the individual components of the Multi Media Interface even easier. The touchpad can even be operated using just one finger.

Simplicity**The MMI® – intelligent, individual, intuitive.**

Streamlined. Simple. Logical. The world of mobile infotainment completely redefined: the Multi Media Interface (MMI). Phoning, navigating or surfing the internet via Audi connect: all highly intuitive, highly functional and highly convenient – not least thanks to voice control. With the MMI in your Audi A7 Sportback, everything will be child's play for you.



As unique as you are.
The equipment options.

Sportiness, comfort, design, functionality – whatever you demand of your Audi, it offers you a wealth of custom options. Audi equipment versions are varied and high-quality and you can tailor them entirely to your needs.

Character takes on many forms. Here are two of them.

What makes an Audi your Audi? Vehicle equipment entirely tailored to your needs. There are a wide range of options available to you for giving your vehicle the exact touch you have in mind. More sportiness? More elegance? Let yourself be inspired.

Audi A7 Sportback in mythos black, metallic

Audi Matrix LED headlights

Audi Sport cast aluminium wheels
in 5-spoke blade design in matt titanium look,
gloss turned finish*

Sport seats, front, in Valcona leather, flint grey

Audi exclusive leather package including airbag cover

Inlays in piano finish, black



Audi S7 Sportback in Sepang blue, pearl effect

LED rear lights with dynamic indicators

Audi Sport cast aluminium wheels
in 5-twin-spoke design

S sport seats, front, in Valcona leather, black with
contrasting stitching and S7 embossing on the backrests

Inlays in aluminium/Beaufort wood, black



Sportiness that can be seen and felt. Even when stationary.

S stands for sportiness. Your Audi S7 Sportback is impressive proof of this. With extensive S-specific equipment. For a dynamic look. Sporty comfort. And superior performance. And you also have the option of further enhancing the S-factor. With optional equipment that is equally impressive to the senses.



S7-specific standard equipment

Cast aluminium wheels in 5-parallel-spoke design (S design)
size 8.5 J x 19 with 255/40 R 19 tyres¹

Brake callipers, painted black
with S7 logo at front

Audi Singleframe
radiator grille in platinum grey with horizontal double chrome struts and S7 emblem

Front bumper
in a distinctive sporty design with honeycomb-structure air intake grilles and double chrome struts; includes aluminium-look blade

Exterior mirror housings
in aluminium look

Side sill trims
painted in body colour

Diffuser insert, rear
painted in platinum grey, edged with blade in aluminium look

Exhaust tailpipes
dual-branch design with 2 oval chrome trims on both left and right

Model name/logo

- S7 emblem in the Audi Singleframe, on the luggage compartment lid and on the vehicle key
- V8 T logo on the front wings

Can also be ordered without model name on the rear and logo on the front wings on request.

Door sill trims with aluminium inlays
with S7 logo

Pedals and footrest in stainless steel

Instrument cluster
with grey dials, white needles and S7 logo in the rev counter; dynamic ready-check feature

Driver information system with colour display

Multifunction sport leather steering wheel in 3-spoke design with shift paddles in aluminium look
with S7 emblem and S-specific contrasting stitching

Selector lever knob in aluminium look
with S7 emblem

Engine start-stop button
with red ring

S sport seats, front

S sport seats in the rear
2 individual seats in the rear with shaped seat side bolsters and integrated head restraints, visually matched to the front seats

Seat upholstery in Alcantara/leather, black or lunar silver
with S7 embossing on the front-seat backrests

Front seats, electrically adjustable
including memory function for the driver seat

4-way lumbar support for the front seats

Inlays
matt brushed aluminium

Floor mats, front and rear

4-zone deluxe automatic air conditioning

MMI® radio plus

Audi music interface

Bluetooth interface

Audi sound system

Storage package

Through-loading facility

Anti-theft alarm

quattro® permanent all-wheel drive

adaptive air suspension – sport
with S7-specific tuning

Audi cylinder on demand

Active Noise Cancellation
The Active Noise Cancellation system can compensate noises from individual frequencies depending on the engine speeds.

S7-specific optional equipment (extract)

Paint finish in the special colour Sepang blue, pearl effect

Cast aluminium wheels in 5-parallel-spoke star design (S design)
size 9 J x 20 with 265/35 R 20 tyres¹

Cast aluminium winter wheels in 5-parallel-spoke star design (S design)
size 9 J x 20 with 265/35 R 20 tyres¹, cannot be fitted with snow chains, permissible top speed 240 km/h

Sport exhaust system
for an even greater sound experience; 2-branch design, 2 oval tailpipes each left and right with gloss black trims

Multifunction sport leather steering wheel in 3-spoke design, flattened at the bottom, with shift paddles in aluminium look²
with S7 emblem and S-specific contrasting stitching

Seat upholstery
for S sport seats in Valcona leather, black or lunar silver, each with contrasting stitching and S7 embossing on the front-seat backrests; for customised contour seats in Valcona leather, black or flint grey, without S7 embossing on the front-seat backrests

Inlays
carbon Atlas

Audi design selection Arras red
with inlays in carbon twill, red

quattro® with sport differential
with S7-specific tuning

Dynamic steering
with S7-specific tuning

There's a sign for maximum efficiency at Audi.
The Audi A7 Sportback ultra model –
the most sustainable TDI® model in the range.

Technologies and measures for reducing consumption and emissions without any reduction in driving enjoyment – that's what Audi ultra stands for. Standard in every Audi model. The long-term aim: completely emission-free mobility. To achieve this, we are systematically continuing our development work. On more and more efficient drive technologies, for example. Such as our economical petrol or diesel engines. We award the most sustainable of these with the ultra emblem on the rear of the model, which announces: maximum efficiency ahead. Thanks to combined CO₂ emission figures from 122 g/km for the Audi A7 3.0 TDI ultra model and from 133 g/km for the 1.8 TFSI ultra model. And without having to give up the dynamics typical of Audi. Experience the Audi A7 Sportback ultra model – a vehicle that redefines efficient driving.

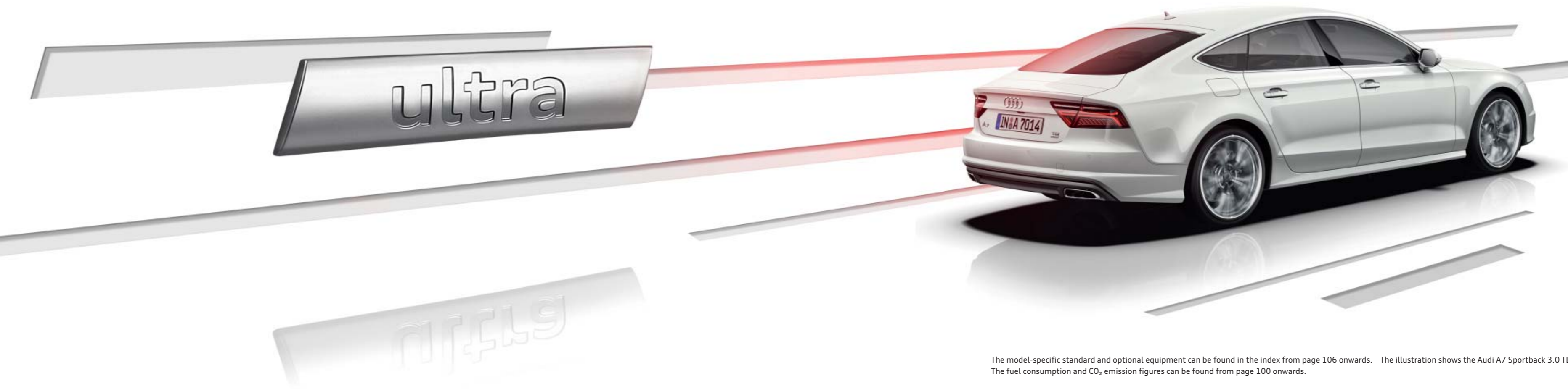

The **1.8 litre TFSI ultra engine** with 140 kW has CO₂ emission figures starting at 133 g/km in the combined driving cycle.

The **3.0 litre TDI ultra engine** with 160 kW has CO₂ emission figures starting at 122 g/km in the combined driving cycle.

The A7 3.0 TDI ultra model and the A7 1.8 TFSI ultra model are available with all equipment without any restrictions.

The model-specific standard and optional equipment can be found in the index from page 106 onwards. The illustration shows the Audi A7 Sportback 3.0 TDI ultra. The fuel consumption and CO₂ emission figures can be found from page 100 onwards.

The right driving force for every personality.

No matter which Audi engine you choose, they all have high compression ratios, highly efficient combustion and outstanding efficiency. In short, they deliver more power whilst using less fuel and producing fewer emissions.



3.0 TDI

TDI®

Audi TDI engines: high torque output over the entire engine speed range – with constant power build-up. They are renowned for being fuel-efficient and for reducing emissions. The 3.0 TDI quattro, for example, has a power output of 235 kW. In the Audi A7 Sportback, it produces a top speed of 250 km/h and accelerates from 0 to 100 km/h in 5.2 seconds. All TDI engines comply with the EU6 emission standard.

- A7 Sportback 3.0 TDI ultra (160 kW)
- A7 Sportback 3.0 TDI quattro (160 kW)
- A7 Sportback 3.0 TDI quattro (200 kW)
- A7 Sportback 3.0 TDI quattro (235 kW)



4.0 TFSI

TFSI®

The Audi TFSI engines offer outstanding efficiency and improved performance whilst at the same time retaining their dynamism. The 4.0 TFSI quattro with 331 kW in the Audi S7 Sportback, for example – from 0 to 100 km/h in 4.6 seconds. All TFSI engines comply with the EU6 emission standard.

- A7 Sportback 1.8 TFSI ultra (140 kW)
- A7 Sportback 1.8 TFSI (140 kW)
- A7 Sportback 2.0 TFSI (185 kW)
- A7 Sportback 2.0 TFSI quattro (185 kW)
- A7 Sportback 3.0 TFSI quattro (245 kW)
- S7 Sportback 4.0 TFSI quattro (331 kW)

Remaining faithful to the sporty line: the S line packages.

The S line packages emphasise the sporty character of your Audi A7 Sportback. Accentuate the dynamic body line, lend the interior even more expression or give the suspension even sportier definition for enhanced driving dynamics. And make a true athlete of your Audi.



The fuel consumption and CO₂ emission figures can be found from page 100 onwards.

S line exterior package

Bumpers, front and rear, side radiator grilles, side sill trims and diffuser insert
in a striking, sporty design

Side sill trims
painted in body colour

Diffuser insert
painted in platinum grey

Door sill trims with aluminium inlays
with S line logo. In conjunction with ambient lighting, door sill trims illuminated and without S line logo

S line emblem
on the front wings

Paint finish in all standard/optional equipment colours and additionally in the special colours Daytona grey, pearl effect and Misano red, pearl effect.



S line sport package

The S line sport package includes the following equipment items:

Audi Sport cast aluminium wheels in 7-twin-spoke design
size 9 J x 19 with 255/40 R 19 tyres*.
From quattro GmbH

S line sport suspension
more dynamic suspension setting and vehicle lowered by 10 mm compared with the sport suspension or by 20 mm compared with the standard dynamic suspension

Door sill trims with aluminium inlays
with S line logo. In conjunction with ambient lighting, door sill trims illuminated and without S line logo

S line emblem
on the front wings

Interior, dashboard and headlining
in black, with contrasting stitching on sport leather steering wheel and selector lever gaiter; for perforated Alcantara/leather additionally with contrasting stitching on seat upholstery, armrests in the door trims (if ordered) and centre armrest, front, in leather; lower part of centre console in leather

Floor mats, front
in black, in conjunction with perforated Alcantara/leather or Valcona leather, lunar silver with piping in a contrasting colour

Sport seats, front
including electric 4-way lumbar support

S line seat upholstery in perforated Alcantara/leather, black
with S line embossing on the front-seat backrests

S line multifunction sport leather steering wheel in 3-spoke design
in black leather (steering wheel grips in perforated leather), with S line emblem

Selector lever knob
in perforated black leather

Inlays
matt brushed aluminium

Pedals and footrest in stainless steel

Optionally available:

further 19-inch or larger wheels

adaptive air suspension

S sport seats, front
including S sport seats in the rear

S line seat upholstery in Valcona leather, black or lunar silver
with S line embossing on the front-seat backrests

S line multifunction sport leather steering wheel in 3-spoke design with shift paddles
optionally heated; in black leather (steering wheel grips in perforated leather), with S line emblem

Inlays
in piano finish, black; fine grain ash, natural brown; Beaufort walnut or aluminium/Beaufort wood, black

Paint finish in all standard/optional equipment colours and additionally in the special colour Daytona grey, pearl effect



*You will find specifications on the technical characteristics of tyres on page 103.

As unmistakable as your own standards: the Audi design selection.

The Audi design selection offers you an aesthetic pre-selection of special materials and colours for the interior. The fine leather upholstery and trim in cedar brown or Arras red with attractive contrasting stitching give the interior an exclusive ambience.



Audi design selection cedar brown

The Audi design selection cedar brown includes the following equipment items:

Customised contour seats, front, optionally with seat ventilation, front

Seat centre panels of the front seats and both outer rear seats in perforated Valcona leather, cedar brown with contrasting stitching in anthracite

Seat side bolsters, centre rear seat and head restraints in Valcona leather, cedar brown with contrasting stitching in anthracite

Door trim inserts in Alcantara, cedar brown

Armrests in the door trims and centre armrest, front, in cedar brown leather with contrasting stitching in anthracite

Lower part of centre console in black leather

Inlays in aluminium/Beaufort walnut

Dashboard and steering wheel in black

Floor mats in black



Audi design selection Arras red

The Audi design selection Arras red includes the following equipment items:

S sport seats, front, with S7 embossing on the backrests

Seat centre panels with diamond pattern, seat side bolsters, head restraints, door trim inserts, armrests in the door trims and centre armrest, front, in Valcona leather, Arras red with contrasting stitching in granite grey

Door trim inserts and lower part of centre console in Alcantara, black

Inlays in carbon twill, red

Floor mats in black

Dashboard in black

Steering wheel in black with contrasting stitching in dark silver

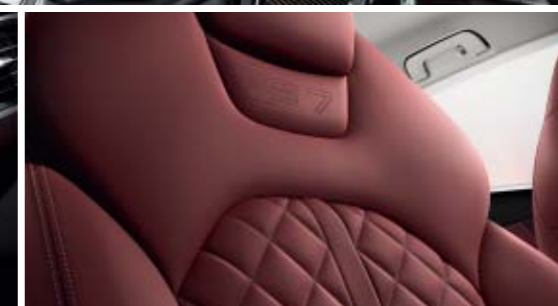
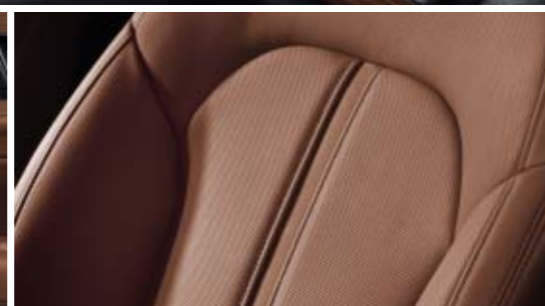

Your personality. Your Audi. The Audi exclusive line.

Every Audi – custom-built for you. With the Audi exclusive line we are offering you the chance to tailor your car. Selected décors and materials are combined into a harmonious whole on the interior. So you can emphasise your own particular style with elegance.



Audi exclusive line is from quattro GmbH.

Audi exclusive line

Customised contour seats, front
optional seat ventilation, front

Seat upholstery
seat side bolsters and head restraints in Valcona leather, alabaster white with contrasting stitching in powder beige; seat centre panels in perforated leather (with Audi exclusive line-specific perforation) in alabaster white with accordion pleat in powder beige; backrest covers and seat attachments to match in alabaster white

Black interior
headlining in cloth, black

Centre armrest, front
in leather, alabaster white with contrasting stitching in powder beige

Door trims
door trim inserts in Alcantara, alabaster white; leather-covered armrests in the doors in alabaster white with contrasting stitching in powder beige

Inlays
eucalyptus, natural

Floor mats
in black with leather piping and stitching in alabaster white

Door sill trims with aluminium inlays with Audi exclusive line logo



You have an exclusive character. So why shouldn't your Audi have one too?

That the Audi exclusive range aspires to exclusivity is already evident from its name. Selected décors and coloured leather can be combined with customised paint finishes from the large selection of Audi exclusive colours to suit your own personal preferences. So you can highlight your car's exceptional character to even better advantage. Your Audi partner and the Audi exclusive Studio of the Audi Forum Neckarsulm await your wishes.



If you want to find out more about the Audi exclusive equipment versions and quality standards, just scan this QR code using your smartphone. Or follow this link in your browser: www.audi.com/exclusivefilm



Audi A7 Sportback with Audi exclusive customised paint finish in classic red, pearl effect and Audi exclusive black gloss package

Audi Sport cast aluminium wheels in 5-arm rotor design in matt titanium look, gloss turned finish*

Audi exclusive leather upholstery and trim (package 2) in Valcona leather in cloudy grey with contrasting stitching and piping in classic red

Audi exclusive extended leather package in classic red with contrasting stitching in cloudy grey and Audi exclusive leather package including airbag cover

Audi exclusive leather controls in classic red with contrasting stitching in cloudy grey

Leather-covered seat trim in cloudy grey with contrasting stitching in classic red

Audi exclusive seat belts in classic red

Audi exclusive carpet and floor mats in cloudy grey with leather piping in classic red

Inlays in aluminium/Beaufort wood, black



Your Audi is painted not just once. But four times.

When you choose a paint colour, choose one that best reflects your own personality. But whichever colour you opt for, you can count on the outstanding quality of our painting process. Though no thicker than a human hair, the layer of paint on an Audi is actually made up of four different coats. So not only do you look radiant in your Audi, the car is also optimally protected from environmental influences and wear. For its entire lifetime.



| Pearl effect paint finishes

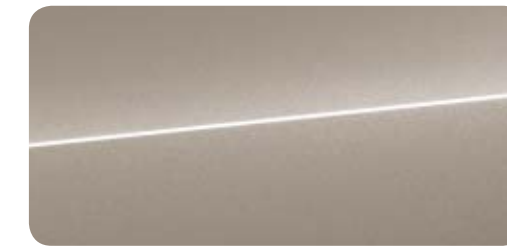

Carat beige, metallic



Misano red, pearl effect



Sepang blue, pearl effect



Garnet red, pearl effect

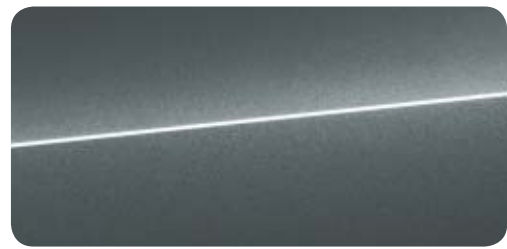

Daytona grey, pearl effect

| Customised paint finishes



Audi exclusive customised paint finishes
From quattro GmbH

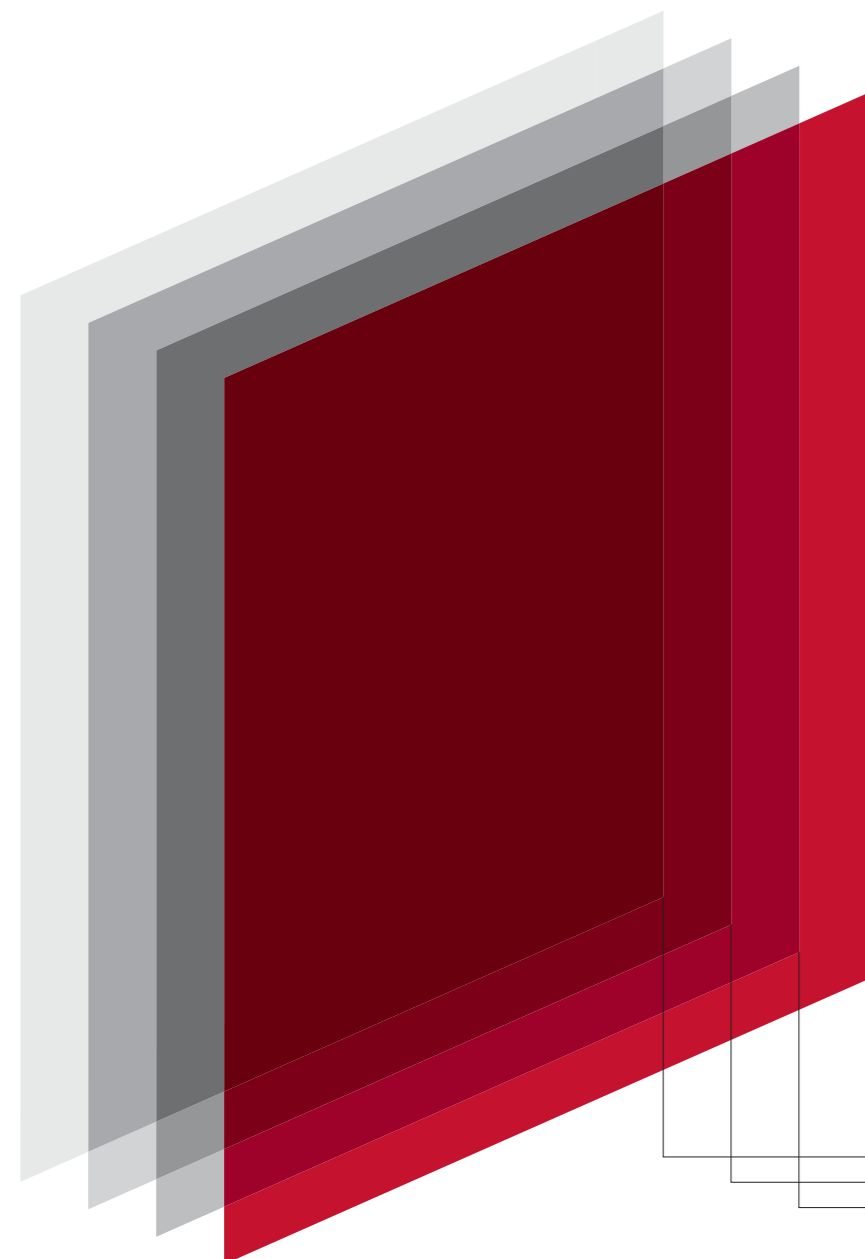

In our view, millimetre precision is simply not enough to ensure you will still be able to enjoy your favourite colour for your Audi even after driving many thousands of kilometres. That is why we deliver precision on the micrometre scale, and why it takes top priority even for the primer coat. The first layer protects the body from rust and other symptoms of old age. The filler layer compensates for even the tiniest of irregularities and has an elastic effect, stopping the paint flaking off if for example gravel is thrown up. The third layer is the visible colour. Then comes a fourth layer of clear varnish, which protects the paint finish from UV rays and gives it a sheen and depth of colour that will ideally last for a long time – until you decide on a new favourite colour.

- Primer coat
- Filler layer
- Coloured paint
- Clear varnish

| Solid paint finishes



Ibis white

| Metallic paint finishes



Glacier white, metallic



Tornado grey, metallic

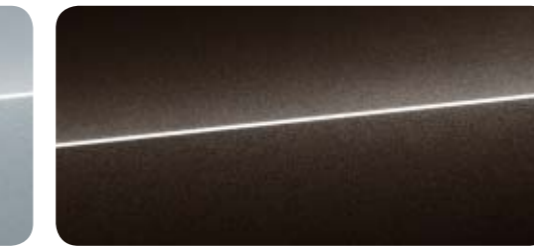

Havana black, metallic

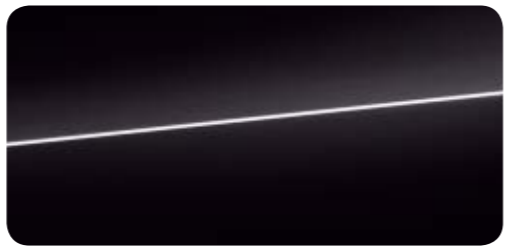

Brilliant black

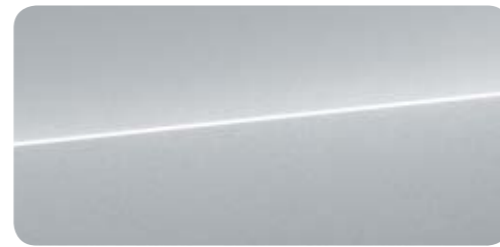

Floret silver, metallic

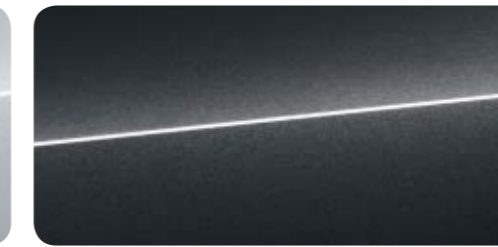

Oolong grey, metallic

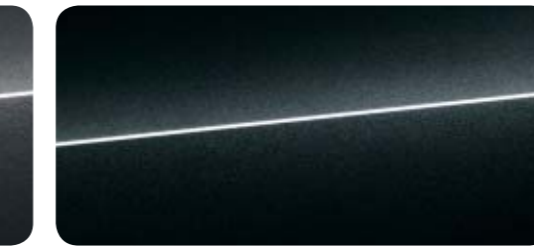

Mythos black, metallic



Cuvée silver, metallic

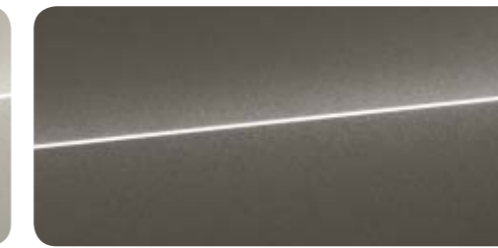

Dakota grey, metallic



Moonlight blue, metallic

| Pearl effect paint finishes

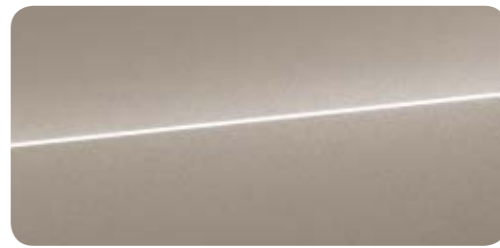

Carat beige, metallic



Misano red, pearl effect



Sepang blue, pearl effect

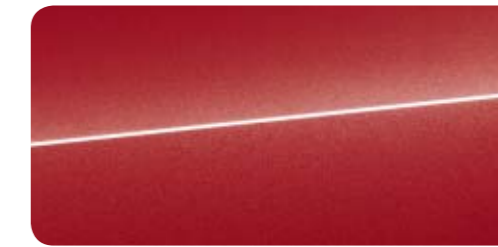

Garnet red, pearl effect

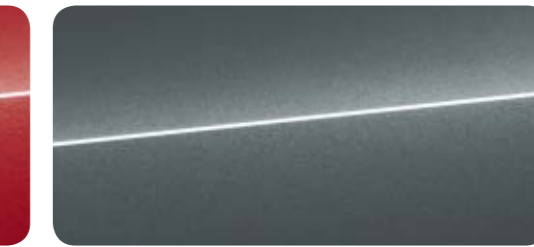

Daytona grey, pearl effect

| Customised paint finishes



Audi exclusive customised paint finishes
From quattro GmbH



Quality given form. And a brilliant finish. Audi wheels.

To make sure you have peace of mind for every metre of your drive, Audi puts its wheels through an exacting series of specialised test procedures. Hardness tests, for example, aim for maximum stability, while a copper accelerated salt spray test – CASS for short – using acetic acid guarantees the greatest possible corrosion protection. Thanks to these and many other measures, we can ensure that every Audi wheel offers maximum quality – even after scores of kilometres. No matter which of the numerous designs you choose.

| Winter wheels



Audi Sport cast aluminium wheels in 5-twin-spoke design in matt titanium look, gloss turned finish^{2,3}
size 9 J x 20 with 265/35 R 20 tyres¹



Audi Sport forged aluminium wheels in 7-twin-spoke design in gloss anthracite black^{2,3}
size 9 J x 20 with 265/35 R 20 tyres¹



Audi Sport cast aluminium wheels in 5-arm rotor design³
size 9 J x 21 with 275/30 R 21 tyres¹



Forged aluminium winter wheels in 6-arm design
size 7 J x 17 with 235/55 R 17 tyres¹, can be fitted with snow chains, permissible top speed 210 km/h



Audi Sport cast aluminium wheels in 5-spoke blade design³
size 9 J x 20 with 265/35 R 20 tyres¹



Audi Sport cast aluminium wheels in 10-Y-spoke design³
size 9 J x 20 with 265/35 R 20 tyres¹



Audi Sport cast aluminium wheels in 5-arm rotor design in matt titanium look, gloss turned finish^{2,3}
size 9 J x 21 with 275/30 R 21 tyres¹



Cast aluminium winter wheels in 10-spoke design
size 8 J x 19 with 235/45 R 19 tyres¹, can be fitted with snow chains, permissible top speed 240 km/h



Audi Sport cast aluminium wheels in 5-spoke blade design in matt titanium look, gloss turned finish^{2,3}
size 9 J x 20 with 265/35 R 20 tyres¹



Audi Sport cast aluminium wheels in 10-Y-spoke design in gloss black, gloss turned finish^{2,3}
size 9 J x 20 with 265/35 R 20 tyres¹



Cast aluminium winter wheels in 5-parallel-spoke star design (S design)
size 9 J x 20 with 265/35 R 20 tyres¹, cannot be fitted with snow chains, permissible top speed 240 km/h

¹You will find specifications on the technical characteristics of tyres on page 103. ²Please note the special information relating to wheels on page 102. ³From quattro GmbH.



The perfect connection between an Audi and the road.

With a wide variety of designs and top-quality workmanship, we have a comprehensive range of wheels to put the perfect finishing touch to your Audi. Each Audi model has a tailored set of wheel options. Emphasise the character of your Audi according to your own individual wishes. Would you perhaps like to give it a more dynamic appearance? Then our special Audi Sport range of wheels is what you're looking for. Just let yourself be inspired. No matter which design you choose, it is you who determines the style.

| Summer wheels



Forged aluminium wheels in 6-arm design
size 8 J x 17 with 235/55 R 17 tyres¹



Cast aluminium wheels in 5-arm Y design
size 8.5 J x 19 with 255/40 R 19 tyres¹



Audi Sport cast aluminium wheels in 7-twin-spoke design²
size 9 J x 19 with 255/40 R 19 tyres¹



Forged aluminium wheels in 5-spoke W design
size 9 J x 20 with 265/35 R 20 tyres¹



Cast aluminium wheels in 7-arm dynamic design
size 8.5 J x 18 with 255/45 R 18 tyres¹



Cast aluminium wheels in 5-spoke V design
size 8.5 J x 19 with 255/40 R 19 tyres¹, optionally available with run-flat tyres



Cast aluminium wheels in 10-spoke design
size 8.5 J x 19 with 255/40 R 19 tyres¹, optionally available with run-flat tyres



Forged aluminium wheels in 5-spoke W design, contrasting grey, partly polished²
size 9 J x 20 with 265/35 R 20 tyres¹



Cast aluminium wheels in 5-parallel-spoke design (S design)
size 8.5 J x 19 with 255/40 R 19 tyres¹



Audi Sport cast aluminium wheels in 5-V-spoke design in matt titanium look, gloss turned finish^{2,3}
size 9 J x 19 with 255/40 R 19 tyres¹



Cast aluminium wheels in 5-parallel-spoke star design (S design)
size 9 J x 20 with 265/35 R 20 tyres¹



Audi Sport cast aluminium wheels in 5-twin-spoke design²
size 9 J x 20 with 265/35 R 20 tyres¹



Audi Sport cast aluminium wheels in 5-twin-spoke design in matt titanium look, gloss turned finish^{2,3}
size 9 J x 20 with 265/35 R 20 tyres¹



Audi Sport forged aluminium wheels in 7-twin-spoke design in gloss anthracite black^{2,3}
size 9 J x 20 with 265/35 R 20 tyres¹



Audi Sport cast aluminium wheels in 5-arm rotor design³
size 9 J x 21 with 275/30 R 21 tyres¹



Audi Sport cast aluminium wheels in 5-spoke blade design²
size 9 J x 20 with 265/35 R 20 tyres¹



Audi Sport cast aluminium wheels in 10-Y-spoke design²
size 9 J x 20 with 265/35 R 20 tyres¹



Audi Sport cast aluminium wheels in 5-arm rotor design in matt titanium look, gloss turned finish^{2,3}
size 9 J x 21 with 275/30 R 21 tyres¹



Audi Sport cast aluminium wheels in 5-spoke blade design in matt titanium look, gloss turned finish^{2,3}
size 9 J x 20 with 265/35 R 20 tyres¹



Audi Sport cast aluminium wheels in 10-Y-spoke design in gloss black, gloss turned finish^{2,3}
size 9 J x 20 with 265/35 R 20 tyres¹

| Winter wheels



Forged aluminium winter wheels in 6-arm design
size 7 J x 17 with 235/55 R 17 tyres¹, can be fitted with snow chains, permissible top speed 210 km/h



Cast aluminium winter wheels in 10-spoke design
size 8 J x 19 with 235/45 R 19 tyres¹, can be fitted with snow chains, permissible top speed 240 km/h



Cast aluminium winter wheels in 5-parallel-spoke star design (S design)
size 9 J x 20 with 265/35 R 20 tyres¹, cannot be fitted with snow chains, permissible top speed 240 km/h

The model-specific standard and optional equipment can be found in the index from page 106 onwards.

¹You will find specifications on the technical characteristics of tyres on page 103. ²Please note the special information relating to wheels on page 102. ³From quattro GmbH.

Premium quality you can rely on.

You have a special place in your Audi. Exclusive comfort can be felt on the front and rear seats: thanks to high-quality materials and first-class workmanship. Regardless of which seat upholstery you choose, or whether you prefer the customised contour seats or sport seats or S sport seats with stable lateral support for dynamic driving: you're sitting in the right place.



Customised contour seats, front 1

including memory function for driver and front-passenger seat as well as exterior mirrors. The illustration shows customised contour seat, front, in Valcona leather, flint grey with seat ventilation.

The model-specific standard and optional equipment can be found in the index from page 106 onwards.



Standard seats, front 2

The illustration shows standard seat, front, in Milano leather, flint grey.



Standard seats, front, with seat ventilation 3

The illustration shows standard seat, front, in Milano leather, flint grey with seat ventilation.



Sport seats, front 4

The illustration shows sport seat, front, in Valcona leather, black.

S sport seats, front 5

including memory function for driver seat and exterior mirrors; rear seats with shaped seat contours, visually matched to the front seats. The illustration shows S sport seat, front, in Valcona leather, black, with contrasting stitching.

The model-specific standard and optional equipment can be found in the index from page 106 onwards.

| Cloth and leather upholstery and trim

Horizon cloth upholstery and trim

for standard seats, front: seat centre panels in horizon cloth and seat side bolsters, head restraints, door trim inserts in black and centre armrest, front, in single-colour cloth

Leather/artificial leather combination

for standard seats, front: seat centre panels of the front seats and both outer rear seats as well as upper side bolster on the driver's side in leather; seat side bolsters, centre rear seat (optional), head restraints, door trim inserts and centre armrest, front, in artificial leather

For standard seats, front, with seat ventilation: seat centre panels of the front seats and non-ventilated seat centre panels of both outer rear seats in perforated leather as well as upper side bolster on the driver's side in leather; seat side bolsters, centre rear seat (optional), head restraints, door trim inserts and centre armrest, front, in artificial leather

Alcantara/leather combination

provides an exclusive and sporty look for sport seats; excellent seating comfort and good seating climate thanks to fast temperature equalisation; particularly hard-wearing, easy to clean and resistant to wear and tear. The Alcantara seat centre panels provide good support, making them especially suitable for dynamic driving styles. Seat side bolsters made from fine leather complete the seat.

For sport seats, front, and S sport seats, front: seat centre panels and door trim inserts in Alcantara as well as seat side bolsters, head restraints, centre armrest, front and lower part of centre console in leather

Milano leather upholstery and trim

Extremely hard-wearing and durable leather that gives a high-quality impression with its fine, grained surface. Fully penetrated with dye and tanned without the use of chromium, the leather provides outstanding surface protection thanks to the painted coat.

For standard seats, front: seat centre panels, seat side bolsters, head restraints and centre armrest, front, in Milano leather; door trim inserts in artificial leather

For standard seats, front, with seat ventilation: seat centre panels of the front seats and non-ventilated seat centre panels of both outer rear seats in perforated Milano leather; seat side bolsters, centre rear seat (optional), head restraints and centre armrest, front, in Milano leather; door trim inserts in artificial leather

For sport seats, front: seat centre panels, seat side bolsters, head restraint centre panels and centre armrest, front, in Milano leather; door trim inserts in artificial leather

Valcona leather upholstery and trim

high-quality leather which contributes to the elegant charisma of the interior. The low use of lacquer allows the material to breathe whilst the non-grained surface underlines the sophisticated character. Tanned without the use of chromium, dyed through and treated with non-fading colour pigments

For customised contour seats, front: seat centre panels, seat side bolsters, head restraints, centre armrest, front, and armrests in the door trim in Valcona leather; door trim inserts in Alcantara; lower part of centre console in leather

For customised contour seats, front, with seat ventilation: seat centre panels of the front seats and non-ventilated seat centre panels of both outer rear seats in perforated Valcona leather; seat side bolsters, centre rear seat (optional), head restraints, centre armrest, front, and armrests in the door trim in Valcona leather; door trim inserts in Alcantara; lower part of centre console in leather

For sport seats, front: seat centre panels, seat side bolsters, head restraints, centre armrest, front, and armrests in the door trim in Valcona leather; door trim inserts in Alcantara; lower part of centre console in leather

For S sport seats, front: seat centre panels, seat side bolsters, head restraint centre panels, centre armrest, front, and armrests in the door trims in Valcona leather; door trim inserts in Alcantara; lower part of centre console in leather

| Leather packages

Leather-covered armrests in the door trims

Leather package

armrests in the door trims, door pull handles and lower part of centre console in leather

Audi exclusive leather upholstery and trim (package 1) in Valcona leather*

seat centre panels, seat side bolsters, head restraints, door trim inserts and centre armrest, front, in Valcona leather; lower part of centre console in leather. Individual choice of colour for the leather and the stitching from the range of Audi exclusive colours.

Audi exclusive leather upholstery and trim (package 1) in Alcantara/Valcona leather*

seat centre panels and door trim inserts in Alcantara; seat side bolsters, head restraints and centre armrest, front, in Valcona leather; lower part of centre console in leather. Individual choice of colour for the Alcantara, the leather and the stitching from the range of Audi exclusive colours.

Audi exclusive leather upholstery and trim (package 2) in Valcona leather*

in addition to package 1: leather-covered armrests in the door trims and backrest covers. Individual choice of colour for the leather and the stitching from the range of Audi exclusive colours. Seat attachments matched to the colour of the leather

* From quattro GmbH.

| Leather packages

Leather package including airbag cover¹

armrests in the door trims and door pull handles in leather; steering wheel airbag cover also in black leather; leather trim for the lower part of centre console, if not already included with the selected equipment

Audi exclusive leather package including airbag cover¹

as leather package including airbag cover. Individual choice of colour for the leather and the stitching from the range of Audi exclusive colours. Additionally, leather trim for the lower part of centre console, if not already included with the selected equipment

Audi exclusive extended leather package¹

dashboard underside including glove compartment, armrests in the door trims, centre console, as well as lower part of centre console in leather. Individual choice of colour for the leather and the stitching from the range of Audi exclusive colours. Steering wheel airbag cover in black leather

Audi exclusive piping for customised contour seats¹

Individual choice of colour for the piping from the range of Audi exclusive colours. Can only be ordered in conjunction with Audi exclusive Valcona leather upholstery and trim package 1 or 2

Audi exclusive leather-covered seat trim¹

for customised contour seats, front, with memory function, electrically adjustable: seat side trims and front trims in fine Nappa leather.

For sport seats, front, and S sport seats, front: seat side trims and trims of the extendable thigh support in fine Nappa leather; seat side trims with stitching, switches and handles for seat adjustment in black (not leather-covered).

Individual choice of colour for the leather and the stitching from the range of Audi exclusive colours.

| Seating comfort



Massage function, front²

massages the muscles of the driver and front passenger using 10 pneumatic cushions; 5 different programs (Wave, Tapping, Stretch, Back, Shoulder) and choice of 5 levels of intensity via multifunction switches on the seat or the optional MMI; display in MMI

Front seats, electrically adjustable, including memory function for the driver seat

with electric adjustment of seat height, fore/aft position, seat and backrest angle and electric 4-way lumbar support; 2 presets for the electrically adjustable driver seat and exterior mirrors

Seat heating, front

heats the seat and backrest centre panels, for leather upholstery and trim and sport seats also heats the seat side bolsters; individually adjustable in several stages for driver and front-passenger side

Seat heating, front and rear

functions as for seat heating, front, also for the outer rear seats, can be adjusted separately in several stages

Seat ventilation, front

Using a fan for standard seats or by drawing in air for customised contour seats, the system ensures a pleasant seating climate even at high ambient temperatures; seat ventilation for the seat and backrest centre panels as well as the thigh support for the driver and front-passenger seats (adjustable in 3 stages); automatic seat heating to prevent cold seats. With seat ventilation, front, the leather on the front and outer rear seats is perforated.

| Rear seats



Rear seat system

2 seats; visually matched to the front seats; 2 L-shaped rear head restraints, height manually adjustable; rear seat backrest can be split-folded 40:60 or fully; including fold-out centre armrest with storage compartment and 2 cup holders

S sport seats in the rear

2 individual seats in the rear with shaped seat side bolsters and integrated head restraints, visually matched to the front seats; including storage tray between the outer rear seats with 2 separate storage compartments; rear seat backrest can be split-folded 40:60 or fully; including fold-out centre armrest with storage compartment



Rear seat system 2 + 1

shaped outer rear seats, visually matched to the front seats, and an additional seating possibility in the centre; 3 L-shaped rear head restraints, height manually adjustable; rear seat backrest can be split-folded 40:60 or fully; including fold-out centre armrest with storage compartment and 2 cup holders

| Headlinings

Headlining in cloth, black

only available in conjunction with black dashboard

Headlining in Alcantara, black¹

headlining, upper pillar trim, rear parcel shelf and sun visors in Alcantara, black, stitching in black

Headlining in Alcantara, black with coloured Audi exclusive stitching¹

headlining, upper pillar trim, rear parcel shelf and sun visors in Alcantara, black. Individual choice of colour for the stitching from the range of Audi exclusive colours

| Cloth



Horizon cloth, black

| Leather/artificial leather



Leather/artificial leather, black



Leather/artificial leather, flint grey



Leather/artificial leather, Atlas beige



Leather/artificial leather, nougat brown



Leather/artificial leather, black perforated³



Leather/artificial leather, flint grey perforated³



Leather/artificial leather, Atlas beige perforated³



Leather/artificial leather, nougat brown perforated³

| Alcantara/leather



Alcantara/leather, black



Alcantara/leather, flint grey



Alcantara/leather, lunar silver



Perforated Alcantara/leather, black with contrasting stitching

| Leather



Milano leather, black

[2] [4]

Milano leather, black perforated¹

[3]

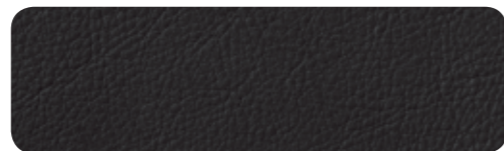

Valcona leather, black

[1] [4]

Valcona leather, black perforated¹

[1]



Milano leather, flint grey

[2]

Milano leather, flint grey perforated¹

[3]



Valcona leather, flint grey

[1] [4]

Valcona leather, flint grey perforated¹

[1]



Milano leather, Atlas beige

[2]

Milano leather, Atlas beige perforated¹

[3]



Valcona leather, Atlas beige

[1] [4]

Valcona leather, Atlas beige perforated¹

[1]



Milano leather, nougat brown

[2]

Milano leather, nougat brown perforated¹

[3]

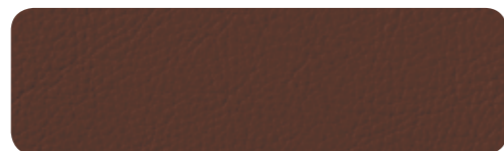

Valcona leather, nougat brown

[1] [4]

Valcona leather, nougat brown perforated¹

[1]

| Audi design selection

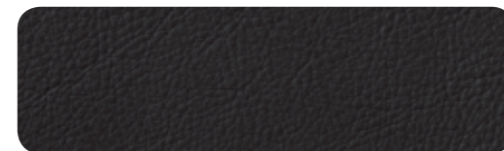

Valcona leather, black

[5]



Valcona leather, cedar brown perforated, with contrasting stitching

[1]

Valcona leather, alabaster white² perforated, with contrasting stitching

[1]

Audi exclusive leather upholstery and trim²

[1] [2] [3] [4] [5]

individual choice of colour for leather/stitching/piping

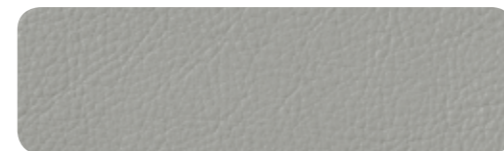

Valcona leather, lunar silver

[5]



Valcona leather, Arras red with diamond pattern and contrasting stitching

[5]



Valcona leather, black with contrasting stitching

[5]



Valcona leather, lunar silver with contrasting stitching

[5]

| Audi exclusive line

| Audi exclusive

| Seat options

[1] Customised contour seats, front

[2] Standard seats, front

[3] Standard seats, front, with seat ventilation

[4] Sport seats, front

[5] S sport seats, front

Experience fascination. Down to the last detail.

Exclusive ambience is a question of style. Your style. A style you can refine right down to the last detail. Create tangible accents with high-quality Audi inlays. Take pleasure in smooth wood that radiates a natural warmth. Experience the fascination of open-pore wood whose exclusivity you can literally feel. Or make a personal statement with combinations of fine woods and aluminium trim – and allow your own personal taste to determine the character.



| Inlays



Satin finish, silver-grey
for interior equipment in flint grey and black



Satin finish, silver-beige
for interior equipment in Atlas beige and nougat brown

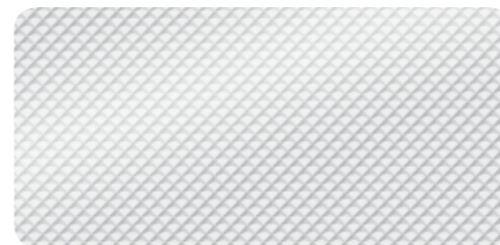

Aluminium delta, silver
surrounds for the all-round inlay and door trims in aluminium look



Matt brushed aluminium
surrounds for the all-round inlay and door trims in aluminium look

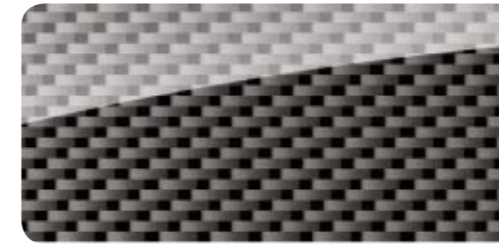

Carbon Atlas
surrounds for the all-round inlay, door trims and centre console in aluminium look



Carbon twill, red
surrounds for the all-round inlay, door trims and centre console in aluminium look



Piano finish, black*
surrounds for the all-round inlay, door trims and centre console in aluminium look



Fine grain ash, natural brown
surrounds for the all-round inlay, door trims and centre console in aluminium look



Walnut, dark brown
surrounds for the all-round inlay, door trims and centre console in aluminium look



Eucalyptus, natural*
surrounds for the all-round inlay, door trims and centre console in aluminium look



Beaufort walnut
surrounds for the all-round inlay, door trims and centre console in aluminium look

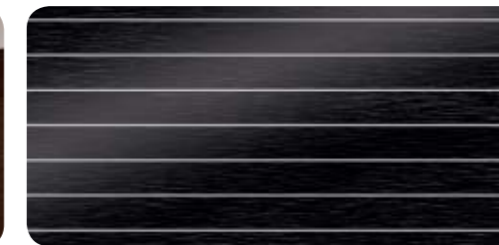

Aluminium/Beaufort wood, black*
surrounds for the all-round inlay, door trims and centre console in aluminium look



Aluminium/Beaufort walnut
surrounds for the all-round inlay, door trims and centre console in aluminium look



Audi exclusive wood inlays*
surrounds for the all-round inlay, door trims and centre console in aluminium look

Inlays
full-surface for the dashboard, door trims, centre console and all-round inlay

Audi exclusive wood inlays*
available in fine grain ash, nougat; oak, sepia; fine grain myrtle, nutmeg; vavona, bronze; modrone, gold; tamo ash, natural dark brown

| **Headlights****LED headlights**

allow precise, near-daylight illumination of the road; combines LED dipped beam, high beam, daytime running lights, motorway light, indicators and static turning light as well as an all-weather light; including headlight cleaning system; motorway light which automatically increases headlight range from a speed of approximately 110 km/h; all-weather light to reduce the risk of the driver being dazzled when visibility is poor; striking light pattern in day and night design configurations; low energy consumption and long service life

Audi Matrix LED headlights

This innovative technology combines a camera system with LED light sources and precision optics for highly adaptive light distribution. The system blanks out light that would otherwise shine directly on oncoming vehicles or vehicles in front but continues to fully illuminate all the other areas in between and alongside. The front lighting thus adapts dynamically, providing the driver with a much wider visual range. The conventional division between dipped and high beam is dispensed with. Familiar convenience functions such as the static turning light, all-weather light, junction light, motorway light and travel mode, which uses GPS data to switch between right- and left-hand drive modes, are integrated into the LED technology. The LEDs of the Audi Matrix LED headlights also perform the dynamic cornering light functions. Using vehicle support based on navigation data, it starts responding shortly before the steering wheel is turned. The marking light cooperates with the optional night vision assistant. If pedestrians are detected, individual LEDs flash briefly three times in succession to mark out the pedestrians clearly from their surroundings. Distinctive features include the crisp lighting pattern, the LED daytime running lights and the dynamic indicators in the headlights and rear lights. Including headlight cleaning system

**LED rear lights with dynamic indicators**

brake lights, tail lights, rear fog lights, indicators and rear number plate lights in low-energy LED technology; with reversing lights and high-mounted third brake light in the rear window; dynamic and quickly recognisable lighting pattern: the segments of the LED light band are illuminated in turn within milliseconds, creating a pulse of light that runs outwards in the direction the car is turning. When operated, the indicators send a distinctive signal to other road users

High-beam assist

improves the driver's visibility and ensures a more relaxed drive thanks to the extra comfort and convenience. Depending on the traffic situation, the high beam is automatically switched on or off. Working within system limits, automatically detects the headlights of oncoming traffic, the rear lights of other road users and light sources in built-up areas. In conjunction with the optional night vision assistant, the connected vehicle functions allow the marking light for detected pedestrians for enhanced safety when driving at night.

| **Interior lighting****Ambient lighting**

with integrated eyewear compartment in the roof module; additional to the interior and exterior lighting package, anti-glare illumination for the passenger compartment in LED technology:

- interior lighting, front and rear, including reading lights
- illuminated vanity mirror
- ambient lighting for centre console
- lighting for door pockets
- illuminated door sill trims (with the optional S line packages the door sill trims are without the S line logo)

Configured via MMI

Interior and exterior lighting package

Interior lighting: ambient light for door inner panels to help occupants better orient themselves, as well as front and rear entrance lighting in LED technology; illuminated vent controls

Exterior lighting: courtesy lighting on the underside of the door handles and door handle lighting in LED technology to facilitate entry and exit in the dark; active internal door reflectors (light bulbs)

| **Exterior design****Exhaust tailpipes**

dual-branch design with 1 tailpipe each left and right with trapezoidal, chrome-plated trims

Model name/logo

A7 logo, ultra emblem (for A7 3.0 TDI ultra 160 kW and for A7 Sportback 1.8 TFSI ultra 140 kW) as well as TDI or TFSI logo on the luggage compartment lid, can be omitted on request

Rear spoiler

integrated in the luggage compartment lid; painted in body colour; automatically extends at 130 km/h, retracts at 80 km/h; can also be controlled manually via a button on the centre console

Gloss package

window slot trims in anodised aluminium, external B-pillar trim in gloss black

Audi exclusive black gloss package*

creates black styling accents around the Audi Singleframe, the front bumper and the trim strips on the side windows

Lights Design Steering wheels/controls Comfort Infotainment Assistance systems Technology/safety Audi Extended Warranty

| **Interior design****Door sill trims with aluminium inlays****Audi exclusive floor mats***

individual choice of colour for the floor mats, the leather piping and the stitching from the range of Audi exclusive colours

Audi exclusive carpet and floor mats*

individual choice of colour for the carpet, the floor mats, the leather piping and the stitching from the range of Audi exclusive colours

| **Steering wheels/controls****Multifunction sport leather steering wheel in 3-spoke design with shift paddles**

same functions as multifunction sport leather steering wheel in 3-spoke design, including shift paddles for changing gear manually with automatic transmission

Multifunction sport leather steering wheel in 3-spoke design

for operating the available infotainment features; adjustable in height and reach; with full-size airbag; colour-coordinated with the selected colour for the top side of the dashboard

Multifunction sport leather steering wheel in 3-spoke design with shift paddles, heated

same functions as multifunction sport leather steering wheel in 3-spoke design with shift paddles, steering wheel rim additionally heated

**Multifunction leather steering wheel in 4-spoke design with shift paddles**

same functions as multifunction leather steering wheel in 4-spoke design, including shift paddles for changing gear manually with automatic transmission

Multifunction leather steering wheel in 4-spoke design

for operating the available infotainment features; adjustable in height and reach; with full-size airbag; colour-coordinated with the selected colour for the top side of the dashboard

Multifunction leather steering wheel in 4-spoke design, heated

same functions as multifunction leather steering wheel in 4-spoke design, additionally heated

Electric steering wheel adjustment

adjustable in height and reach, with automatic entry and exit function; additionally with memory function if front seats, electrically adjustable are ordered

| Steering wheels/controls

**Audi exclusive steering wheel rim with wooden segments***

for multifunction leather steering wheel in 4-spoke design with shift paddles; customised with Audi exclusive wood (not available in tamo ash, natural dark brown) and Audi exclusive leather. Individual choice of colour for the leather and the stitching from the range of Audi exclusive colours. Stitching with specific Audi exclusive seam detail

Steering wheel rim with wooden segments*

for multifunction leather steering wheel in 4-spoke design with shift paddles; available in walnut, dark brown

Audi exclusive leather controls*

Audi exclusive steering wheel rim, selector lever knob and selector lever gaiter in leather. Individual choice of colour for the leather and the stitching from the range of Audi exclusive colours. Stitching on the steering wheel rim with specific Audi exclusive seam detail

Selector lever knob in leather

colour-coordinated with the selected vehicle interior colour and to match the top side of the dashboard

| Mirrors

Exterior mirrors with integrated LED indicator electrically adjustable and heated, convex, flat or aspherical mirror glass; additionally with memory function if front seats, electrically adjustable are ordered; body-coloured housing

Also optionally:

electrically folding

including automatic kerb-side function for the exterior mirror on the passenger side

automatically dimming on both sides

including automatic kerb-side function for the exterior mirror on the passenger side

electrically folding and automatically dimming on both sides

including automatic kerb-side function for the exterior mirror on the passenger side

The automatic kerb-side function tilts the exterior mirror on the passenger side downwards when reverse gear is selected, giving the driver a better view of the kerb.

| Roof system

**Slide-and-tilt glass sunroof**

electric, with tinted single-glazed safety glass and infinitely adjustable sun screen; includes integrated wind deflector; convenience closing/opening from outside with the vehicle key

| Glazing

**Dark-tinted windows (privacy glazing)**

dark-tinted rear window, rear door windows and rear side windows

Heat-insulating glass

tinted green; windscreen and front side windows in acoustic glass for improved exterior noise insulation; rear window heated, with timer

Insulating/acoustic glass

provides improved exterior noise insulation and theft protection thanks to the 2 panes of glass bonded together by a plastic film. An additional reflective coating reduces the build-up of heat in the interior. Windscreen with viewing window for toll collection devices; rear window in standard glass

Insulating/acoustic glass and dark-tinted windows (privacy glazing)

windscreen and front door windows in insulating/acoustic glass; rear window, rear door and rear side windows in dark-tinted standard glass; windscreen with viewing window for toll collection devices

Sun screen

in the luggage compartment cover, extendible, in cloth, black

Lights Design Steering wheels/controls Comfort Infotainment Assistance systems Technology/safety Audi Extended Warranty

| Climate control

**Deluxe automatic air conditioning**

electronically regulates the air temperature, flow rate and distribution; separate defrost button for rapid defrosting of the windscreen and side windows; separate temperature distribution for driver and front-passenger side, automatic recirculation mode, sunlight-dependent control and combined fine particulate filter; with humidity sensor and key-coded settings; ventilation in the rear via the centre console

**4-zone deluxe automatic air conditioning**

in addition to the deluxe automatic air conditioning: air-conditioning controls, front, with digital display, additional air-conditioning controls with digital display for climate control in the rear with separately adjustable temperature and blower controls and air distribution for the right and left sides (rear functions can also be set from the front air-conditioning controls), additional air vents in the B-pillars, automatic recirculation mode by means of air quality sensor, use of residual heat, separate regulation of footwell temperature, ventilated glove compartment. Choice of 3 climates: gentle, medium and intensive

**Auxiliary heating/ventilation**

The auxiliary heating warms up the interior and removes ice from the windows without starting the engine. The auxiliary ventilation system supplies fresh air and reduces the temperature of the interior. Intelligent control function with timer and departure time programming for time- and energy-efficient calculation of heating duration. Separate radio-operated remote control with illuminated display; choice of 2 heating modes: "defrost" (defrosting mode only for the windows), "warm" (warming up mode to additionally preheat the interior)

| Closing systems

**Convenience key with sensor-controlled release of the luggage compartment lid**

doors and luggage compartment lid can be opened and locked without actuating the key carried with you; doors are unlocked automatically by touching the door handles (all door handles have an aluminium-look trim strip, door handles in body colour in conjunction with Audi exclusive black gloss package), the luggage compartment by operating the handle strip on the luggage compartment lid. Moving your foot (in a kicking motion) below the rear bumper causes the luggage compartment lid to swing open automatically when the vehicle key is recognised. The luggage compartment lid can also be opened separately when the vehicle is locked.

Luggage compartment lid, electrically opening and closing

opening via button on the vehicle key or in the driver's door or the soft touch button in the luggage compartment lid handle; additionally by means of foot gesture (kicking motion) if convenience key with sensor-controlled release of luggage compartment lid is ordered; closing via button on the inside of the luggage compartment lid, the button in the driver's door or the optional convenience key (long press). In conjunction with the convenience key, it is possible to close the luggage compartment lid and simultaneously lock the car via an additional button on the inside of the luggage compartment lid. Including power-assisted closing and programmable luggage compartment lid opening angle

Power-assisted door closing

doors that have not completely closed are pulled into the lock automatically

Garage door opener (HomeLink)

programmable radio-operated remote control with operating buttons integrated into the front roof module, can be used to open many garage doors and exterior gates; allows control of security systems and lighting systems; code identification guidance and setup assistance provided by the optional MMI navigation plus. For further information please contact your Audi partner or visit www.eurohomelink.com.

Anti-theft alarm

monitors doors, bonnet and luggage compartment lid; includes interior monitoring (can be deactivated), tow-away protection via a tilt angle sensor and signal horn independent of the vehicle electrical system; with safe-locking function: prevents the doors from being opened from the inside once the vehicle has been locked with the vehicle key

Preparation for tracking system

preparation for connecting a tracking system (available from Audi Genuine Accessories) that enables a stolen vehicle to be located and tracked

| Storage/transport

Storage compartments

storage compartment in the front and rear door trims, e.g. for bottles up to 1 litre, storage net on the back of the front-seat backrests, storage compartment under the front seats (for standard seat, sport seat and S sport seat only); glove compartment on the passenger side, lockable, large, illuminated, with holder for writing utensils; 2 cup holders in the centre console

Storage package

2 cup holders in the centre armrest, rear, luggage compartment net for securing on the lashing points on the luggage compartment floor, plus two 12V sockets in the rear

Provision for trailer towing hitch

includes fitting for the control units and reinforced engine cooling. The trailer towing hitch for retrofitting is available from Audi Genuine Accessories.

Trailer towing hitch

mechanically swivelling, forged steel sphere bar and ball head; operated via pull-button in luggage compartment, control light in luggage compartment and display in instrument cluster to monitor secure attachment of trailer; includes trailer stabilisation function via the Electronic Stabilisation Control (ESC). The integrated swivelling system socket enables continuous operation of electrical equipment in the trailer or caravan during a journey.

**Luggage compartment**

large-volume, with large through-loading width; includes side net and 12V socket on the right-hand side of the luggage compartment as well as bag hooks on the left and right and 4 lashing points on the floor of the luggage compartment; luggage compartment cover

**Through-loading facility with removable ski/snowboard bag**

for the practical transportation of long objects, e.g. up to 4 pairs of skis or 2 snowboards. Ski/snowboard bag can be removed and secured by a strap

Reversible mat

to cover the luggage compartment, also when the rear-seat backrest is folded down; velour on one side, rubber on the other

Non-smoker version

one storage compartment in the front and an additional 12V socket in the rear instead of the cigarette lighter

| MMI®/navigation/display instruments

**Driver information system**

displays a host of useful information on a 5-inch TFT monochrome display in the driver's direct field of vision. Attention assist provides a warning in the driver information system and via acoustic signal if it determines that the driver's attention is lapsing. The system is active from around 65 to 200 km/h and can be deactivated. An integrated efficiency program provides consumption data overviews.

**Driver information system with colour display**

shows the information of the driver information system on a high-resolution 7-inch colour display with an even better overview and readability; also possible to display optional assistance systems and other content from the MMI system

| MMI®/navigation/display instruments

**Head-up display**

Information relevant to the driver from assistance systems, navigation instructions and warnings is projected as required onto the windscreen in the driver's direct field of vision. The height-adjustable head-up display provides a multicoloured display with good contrast and minimal distraction from the road.

**MMI® navigation**

- with navigation data (SD card)¹
- electrically extending 6.5-inch colour display with map representation and numerous display options
- dynamic route guidance with TMC (where available)
- voice control (whole-word input)
- additional arrow display in the driver information system
- MMI radio plus
- CD player and 2 SDHC card readers (up to 32 GB), each MP3, WMA and AAC compatible
- Audi music interface for the connection of portable media players such as Apple iPod, Apple iPhone (music functionality) as well as USB storage media and MP3 players (can only be used in conjunction with special Audi Genuine Accessories adapter cables)
- Bluetooth interface for hands-free calls and audio streaming
- Audi sound system

**MMI® navigation plus with MMI touch**

- navigation system¹ including map updates²
- electrically extending, high-resolution 8-inch colour display
- 3D map representation with display of lots of sightseeing information and city models
- detailed route information: map preview, choice of alternative routes, POIs, lane recommendations, motorway exits, detailed junction maps and much more
- MMI touch: touch-sensitive control panel for quick, intuitive operation, e.g. destination entry by handwriting recognition as well as moving around and zooming on the map
- voice control system with whole-word entry of address in one sentence
- access to smartphone voice control
- driver information system with 7-inch colour display including display of navigation map
- dynamic route guidance with TMCpro (in conjunction with Audi connect: traffic information online³)
- vehicle support based on navigation data and speed limit display
- country information: information on valid speed limits, motorway toll sticker requirement, etc. when crossing a border
- myAudi special destinations: import individual point-of-interest (POI) lists into the vehicle via the myAudi portal
- MMI radio plus
- Audi sound system
- flash memory for music (10 GB)
- DVD drive (MP3, WMA, AAC and MPEG-4 compatible) for music CDs and video DVDs, AUX-IN connection
- 2 SDXC card readers
- Audi music interface for the connection of portable media players via USB interface (including power supply/charging function) or Wi-Fi
- Bluetooth interface for hands-free function and audio streaming
- display of emails and text messages from mobile phone in selected languages plus text-to-speech function⁴
- use of services supported by Audi connect⁵

| Entertainment

MMI® radio

- MMI operating concept with electrically extending 6.5-inch colour display, separate MMI control panel and car menu
- CD player (MP3 and WMA compatible), AUX-IN connection, USB charging function
- radio with phase diversity
- 8 passive loudspeakers, front and rear, total output 80 watts

MMI® radio plus

- MMI operating concept with electrically extending 6.5-inch colour display, separate MMI control panel and car menu
- driver information system
- CD player and 2 SDHC memory card readers (up to 32 GB), each MP3, WMA and AAC compatible
- Audi music interface for the connection of portable media players such as Apple iPod, Apple iPhone (music functionality) as well as USB storage media and MP3 players (can only be used in conjunction with special Audi Genuine Accessories adapter cables)
- phase diversity and speed-dependent volume control
- TP memo function (automatic storage of traffic messages while driving)
- voice control
- Bluetooth interface for hands-free calls and audio streaming
- Audi sound system

Digital Audio Broadcasting

in addition to the range of analogue stations, reception of digitally broadcast radio stations⁶ according to DAB standard, including DAB+ and DMB audio; display of information accompanying the programme (e.g. artist and track, if provided by the radio station) as well as additional information in the form of a slide show (e.g. cover and weather)

Lights Design Steering wheels/controls Comfort **Infotainment** Assistance systems Technology/safety Audi Extended Warranty

**Audi sound system**

impressive sound thanks to 6-channel amplifier with a total output of 180 watts and 10 loudspeakers including centre speaker and subwoofer

Digital TV reception

reception of digitally broadcast, uncoded television stations⁶ (in DVB-T and DVB-T2 standard with MPEG-2 or MPEG-4 standard) as well as DVB-T audio stations; display of information accompanying the programme such as teletext, subtitles and Electronic Programme Guide (EPG); automatic station search; external AV-IN connection via adapter cable; no picture possible when the vehicle is moving

CD changer

for 6 CDs (MP3 and WMA compatible). Music data with digital rights management (DRM) cannot be played. Shock-resistant location in glove compartment and can be operated via MMI

DVD/CD changer

for 6 DVDs or CDs; supports audio CDs and video DVDs; shock-resistant location in glove compartment and can be operated via MMI

**Bose Surround Sound**

impressive surround sound reproduction thanks to 12-channel amplifier with total output of 472 watts and 14 loudspeakers, including centre speaker and subwoofer; noise-dependent volume adjustment thanks to AudioPilot[®] and reproduction of 5.1 surround sound in conjunction with the optional MMI navigation plus with MMI touch; powerful and accurate base reproduction, lifelike sound with natural tone and a feeling of space for an outstanding sound experience

Audi music interface

Portable media players⁷ such as Apple iPod/iPhone (music functionality) and USB storage media and MP3 players may be connected to the vehicle. Located in the centre console; operation via MMI or multifunction leather steering wheel. From MMI navigation plus the Audi music interface has 2 USB connections. Part of MMI radio plus, MMI navigation and MMI navigation plus with MMI touch. Special Audi Genuine Accessories adapter cables for connecting portable media players or USB storage media are required with the equipment MMI radio plus or MMI navigation. Adapter cables suitable for the respective device can also be selected. Further adapter cables are available from Audi Genuine Accessories.

**Bang & Olufsen Advanced Sound System**

captivating surround sound reproduction with 15 loudspeakers, including centre speaker and subwoofer, each with its own amplifier channel. The efficient 15-channel DSP all-digital amplifier with 5 integrated ICE-Power amplifiers for woofers and subwoofers has a total output of over 1,200 watts. Reproduction of 5.1 surround sound in conjunction with the optional MMI navigation plus with MMI touch; polished loudspeaker covers in aluminium and automatically extending acoustic lenses for excellent sound performance and perspective from every seat; with noise-dependent volume adjustment. Privacy function provided by encapsulated loudspeaker casings which minimise the escape of sound to the outside of the vehicle and provide privacy, for example when making phone calls.

Preparation for Rear Seat Entertainment

includes pre-installation wiring and mounts for the holders in the driver and front-passenger seat backrests. The appropriate Audi Entertainment mobile or an Apple iPad adapter are available as a plug-and-play unit from Audi Genuine Accessories.

¹Navigation data available for supported countries on integrated memory (MMI navigation plus) or SD card (MMI navigation). For more information, please contact your Audi partner. ²The map version delivered can be updated with the first 5 updates which are issued at intervals of 6 months. The current navigation data can be downloaded from the myAudi platform at www.audi.com/myaudi and installed in the vehicle via SD card. In conjunction with Audi connect, the update can be carried out online in the vehicle. In addition, it is possible to have the new navigation data installed by an Audi partner at extra cost. ³The Audi connect service traffic information online is available for several countries. For more information, please contact your Audi partner. ⁴Provided the mobile phone has the Bluetooth profile MAP (Message Access Profile). Please contact your Audi partner or visit www.audi.com/bluetooth for information on compatible mobile phones. ⁵Requires the optional equipment Audi connect. ⁶Reception depends on local digital network availability. ⁷Please contact your Audi partner or visit www.audi.com/mp3 for information on compatible media players.

| Communication

Audi connect

convenient connection of your vehicle to the internet for the use of Audi connect via an integrated data module with LTE¹/UMTS support. There is a reader for your SIM card in the surround of the MMI navigation plus with MMI touch.

The following services supported by Audi connect are currently available in your model:

Mobility & navigation

- point-of-interest (POI) search with voice control
- traffic information online²
- picturebook navigation
- fuel prices
- parking information
- navigation with Google Earth™³ and Google Street View™³
- map update online⁴
- destination entry via myAudi or Google Maps™³

Communication

- Wi-Fi hotspot
- text messages^{5,6}
- access to Facebook
- access to Twitter
- access to smartphone voice control⁷

Infotainment

- weather
- online media streaming⁸
- news online (individual)
- travel information

In conjunction with the optionally available Audi phone box, Audi connect contains a car phone function via SIM card slot or SAP profile.

Use of the services supported by Audi connect is possible only with the optional MMI navigation plus with MMI touch and Audi connect. You also require a SIM card with data option and with LTE option¹ to use LTE. The services are available only in conjunction with an existing or separate mobile phone contract and only within the range of the respective mobile phone network. Additional costs may be incurred when receiving data packets from the internet, depending on the terms of your mobile phone contract, particularly when used abroad. Because of the high data volumes involved, a data flat rate is strongly recommended.

The availability of the services supported by Audi connect varies from country to country. The Audi connect services are available for at least 1 year from vehicle delivery. Once 24 months have expired, the Audi connect services will be extended free of charge once for 12 months. If you do not require this free of charge extension, please notify us by writing to the following address:

AUDI AG
Audi International Customer Care Services
85045 Ingolstadt,
Germany
Email: kundenbetreuung@audi.de
Tel.: +49 (0) 800-2834 7378423

The services city events, train and flight information, plus any other services, are available to the customer for a period of 12 months. Ask your Audi partner about a subsequent extension of the Audi connect services.

Audi connect provides access to Facebook, Google and Twitter services. Permanent availability cannot be guaranteed as this is the responsibility of Facebook, Google and Twitter.

Please visit www.audi.com/connect or contact your Audi partner for more detailed information about Audi connect; contact your mobile services provider for information about contract conditions.



Audi phone box⁶

allows phone calls with improved reception quality and charging by placing mobile phone into the universal phone holder near the centre armrest, front; allows 2 mobile phones⁹ to be connected via Bluetooth; hands-free facility and voice control (telephone); low SAR radiation in the interior of the vehicle thanks to connection to vehicle aerial; operation via the radio/navigation systems or the multifunction leather steering wheel; can be charged via USB port. The image on the left shows the Audi phone box for MMI radio plus and MMI navigation; the image on the right shows the Audi phone box for MMI navigation plus with MMI touch.

In conjunction with Audi connect, the Audi phone box includes a car phone function via SIM card slot or rSAP profile.

Bluetooth interface

allows hands-free calls to be made in the vehicle using the microphone and – depending on mobile phone compatibility⁶ – Bluetooth audio streaming. Bluetooth-capable mobile phones can be connected to the vehicle via the interface. Part of MMI radio plus, MMI navigation and MMI navigation plus with MMI touch

Audi MMI® connect app

The Audi MMI connect app available for some smartphones⁶ supports (amongst others) the following

Audi connect services:

- Audi music stream
- point-of-interest (POI) search with voice control
- destination entry via myAudi or Google Maps™³
- traffic information online²

Lights Design Steering wheels/controls Comfort Infotainment Assistance systems Technology/safety Audi Extended Warranty

| Assistance systems



Parking system plus¹⁰

acoustic and visual parking system, front and rear, assists with parking and manoeuvring. Information shown in the MMI display; measurement is by ultrasonic sensors integrated discreetly in the bumpers; can also be optionally ordered with reversing camera or front and reversing cameras; activated when reverse gear is selected or via a button on the centre console



Park assist¹⁰

uses ultrasonic sensors to search for suitable parking spaces along the side of the road and helps the driver to park and exit parking spaces by performing virtually autonomous steering manoeuvres. Calculates the ideal parking path for bay parking spaces and the ideal parking and exiting paths for kerb-side parking spaces. The driver has to accelerate, apply the brakes and monitor the parking process. Also optionally available with reversing camera or front and reversing cameras; activated via a button on the centre console



Reversing camera¹⁰

image of area behind the vehicle shown on the MMI display, with dynamic display modes showing the calculated path depending on steering angle; help lines and guidelines and identification of the point at which to apply opposite lock when parallel parking; reversing camera integrated discreetly in the handle strip of the luggage compartment lid; activated when reverse gear is selected or via the button on the centre console

Front and reversing cameras¹⁰

image of area in front and behind the vehicle shown on the MMI display, for the reversing camera with dynamic display modes showing the calculated path depending on the steering angle; help lines and guidelines and identification of the point at which to apply opposite lock when parallel parking; reversing camera integrated discreetly in the handle strip of the luggage compartment lid; additional display modes for front left/right side and rear left/right side for safe pulling out of tight parking spaces, courtyard entrances or in car parks; activated when reverse gear is selected or via a button on the centre console

Hold assist¹⁰

holds the vehicle stationary for unlimited periods after stopping in traffic on normal uphill and downhill gradients. The system is activated by push-button and allows the driver to drive away smoothly

Cruise control¹⁰

At speeds of from around 30 up to 250 km/h, the system keeps the set speed constant provided that engine power and engine braking effect permit it; operated via separate steering column stalk, set speed displayed in the driver information system

Audi pre sense basic¹⁰

automatically initiates preventive passenger protection measures when required; these include: belt tensioning, activation of the hazard warning lights and closing of slide-and-tilt glass sunroof (if ordered) and windows; categorises different driving situations through the networking of the various vehicle systems

¹Please consult your Audi partner for information on the availability and use of LTE support. ²The Audi connect service traffic information online is available for several countries. For more information, please contact your Audi partner.

³Google and the Google logo are registered trademarks of Google Inc. ⁴The map version delivered can be updated with the first 5 updates which are issued at intervals of 6 months. The current navigation data can be downloaded from the myAudi platform at www.audi.com/myaudi and installed in the vehicle via SD card. In conjunction with Audi connect, the update can be carried out online in the vehicle. In addition, it is possible to have the new navigation data installed by an Audi partner at extra cost. ⁵Provided the mobile phone has the Bluetooth profile MAP (Message Access Profile). ⁶Please contact your Audi partner or visit www.audi.com/bluetooth for information on compatible mobile phones.

⁷Requires the optional MMI navigation plus with MMI touch including voice control system and Bluetooth interface as well as multifunction leather steering wheel. ⁸Depends on country-specific availability. To use this feature you will generally require an account with a media streaming provider. Additional costs may be incurred as a result. ⁹For information on when this feature will be available, please contact your Audi partner. ¹⁰Please note: The systems work only within system limits and support the driver. However, the driver remains responsible for driving the vehicle and is required to be attentive.

| Assistance systems

**adaptive cruise control with Stop&Go function incl. Audi pre sense front¹**

Vehicles ahead are detected with the aid of radar sensors. The distance from the vehicle ahead is kept more or less constant by braking or accelerating (control range 0–250 km/h). Choice of 4 distance levels/driving modes (efficiency, comfort, dynamic and auto). Includes Audi pre sense front: enhanced brake assist function warns of any imminent threat of collision with the vehicle in front. Can initiate partial braking action or boost the driver's braking action if necessary. In addition, maximum braking is initiated at speeds below 30 km/h if there is a danger of collision with a stationary or moving vehicle in order to reduce the speed of the collision or to avoid it if possible. adaptive cruise control is operated via a separate steering column stalk. Audi pre sense front can be deactivated via the MMI car menu.

**Audi side assist including Audi pre sense rear¹**

emits a warning in the form of an LED display in the respective exterior mirror if a situation arises which the system deems will compromise a lane change. 2 radar sensors record the vehicle approaching at the side from behind and measure the distance and the difference in speed. The lane change assistant provides support in the speed range from around 30 to 250 km/h. To detect a possible rear-end collision, Audi pre sense rear also uses the rear sensors of Audi side assist, in addition to Audi pre sense basic. Activated via a button in the mirror quadrant

**Audi active lane assist¹**

helps you keep in lane by means of gentle steering intervention. The lane compliance assistant is triggered when the driver starts to cross detected lane markings without activating an indicator. The system provides assistance in the speed range from around 60 to 250 km/h. Steering wheel vibration can be adjusted if the driver wants; additional display in the optional head-up display; activated via a button on the indicator steering column stalk.

In conjunction with the optional Audi side assist including Audi pre sense rear, a perceptible steering movement is also made before leaving the lane, if changing lane is rated as particularly critical due to a vehicle approaching from behind. This steering movement is made even if the indicator has been activated but only if both systems are activated and ready.

Assistance package including Audi pre sense plus¹

combines the following assistance systems:

- parking system plus
- Audi active lane assist
- Audi side assist
- adaptive cruise control with Stop&Go function
- Audi pre sense basic
- Audi pre sense front
- Audi pre sense rear

The functions mentioned above also include a maximum deceleration function provided by Audi pre sense plus. The systems in the assistance package complement each other and provide mutual assistance. Notes on activation and settings can be found in the description for the respective assistance system.

**Camera-based speed limit display^{1,2}**

recognition and display of speed limits, including temporary speed limit displays; a situational evaluation is carried out when driving in the wet, when there are speed limits for certain times of day, or when towing a trailer³; if a sign has not been recognised by the camera, the speed limit taken from the current navigation data is displayed via Audi connect; additional display in the optional head-up display. The system simply provides information and does not intervene or provide a warning if the displayed speed is exceeded.

**Night vision assistant¹**

assists the driver when driving at night by displaying a thermal image of the surroundings. People and larger wild animals are highlighted in yellow in the colour display of the driver information system. If they move or if the system determines from their position that there is a potential risk, the marking changes to red, a warning triangle appears and a warning tone is emitted.

In conjunction with one of the following lighting systems, a highlighted person is also illuminated with 3 successive brief flashes of the headlights (marking light):

- LED headlights in combination with high-beam assist
- Audi Matrix LED headlights

Additional display of the warnings in the optional head-up display; activated via a button next to the light switch

¹ Please note: The systems work only within system limits and support the driver. However, the driver remains responsible for driving the vehicle and is required to be attentive.

² Only available for Western Europe. ³ Only applies to factory-fitted trailer towing hitch.

| Driving dynamics/brakes



Audi drive select

different modes – auto, comfort, dynamic, efficiency and individual – allow you to adjust the vehicle’s characteristics by adapting the power steering assistance, engine and gear changing characteristics (with S tronic), adaptive air suspension and the settings of other optional equipment. The efficiency mode shifts the engine, transmission (with S tronic), climate control and optional adaptive cruise control or cruise control to a more fuel-efficient basic setting.

Sport suspension

more direct contact with the road and sportier handling thanks to body being lowered by 10 mm, compared with the standard dynamic suspension, and stiffer spring and damper tuning

adaptive air suspension

automatically regulates vehicle ride height and damping by means of electronically controlled air suspension with infinitely variable adaptive damping system on all 4 wheels; includes ride height control and manual lift function; different modes selected via Audi drive select; vehicle ride height lowered by up to 20 mm depending on mode



quattro® with sport differential

The electronically controlled sport differential variably distributes drive force to each wheel and ensures outstanding acceleration performance in corners and stabilises the vehicle’s response to load change. It also improves direct steering characteristics and provides more agile handling that requires less steering effort.

quattro®

permanent all-wheel drive with self-locking centre differential and asymmetric/dynamic torque distribution, as well as wheel-selective torque control and Electronic Differential Lock (EDL) on all driven wheels; distributes the drive force depending on the driving situation to each individual wheel for precisely controlled, sporty handling; quattro emblem in Audi Singleframe, on the luggage compartment lid and on the dashboard on the passenger side

Dynamic steering

When changing lanes, parking and cornering, for example, this system improves handling and ride comfort by dynamically regulating the steering according to the driving situation. In addition to adaptation of the steering effort, the steering angle (steering ratio) is also adapted up to 100 % as a function of the steering wheel angle, the road speed and the Audi drive select position. Vehicle stabilisation via ESC is further supported by the system’s lightning-quick steering movements.



Ceramic brake¹

19-inch high-performance brake system with carbon-fibre reinforced ceramic brake discs and brake callipers painted in gloss anthracite and featuring the “Audi ceramic” logo; logo at rear on a black design trim; ventilated and perforated brake discs with special cooling channels

S tronic®

The 7-speed, electrohydraulically actuated dual-clutch transmission facilitates faster gear changes with virtually no perceptible break in propulsive power. Including coasting mode in efficiency mode: when the accelerator is released, the drivetrain is opened and the engine automatically switches to idling. In automatic mode, the driver can choose between the programs D (Drive) and S (Sport). The S tronic can be operated manually via the selector lever or the optional shift paddles behind the steering wheel.

tiptronic

8-speed automatic transmission with Dynamic Shift Program (DSP) and sport program; option of manual control via shift paddles on the multifunction leather steering wheel or by nudging the selector lever

| Technology/safety

Recuperation

economises on fuel through brake energy recovery; kinetic energy is converted into usable electrical energy by increasing the generator voltage when the vehicle is coasting or braking and relieving the generator during subsequent acceleration

Start-stop system

helps to reduce fuel consumption and CO₂ emissions by automatically switching off the engine when the vehicle is stationary, e.g. at traffic lights. The start process is initiated as soon as the foot brake is released. May be deactivated using a button at any time

Side airbags, rear

to supplement side airbags, front, and head airbag system

Seat belts, crimson red²

Audi exclusive seat belts²

Individual choice of colour for seat belt from the range of Audi exclusive colours.

Audi TDI clean diesel

in addition to the standard equipment with catalytic converter and diesel particulate filter, the exhaust aftertreatment system installed in the models with TDI clean diesel leads to low exhaust emissions. This technology significantly reduces nitrogen oxides by injecting small quantities of the biologically degradable additive AdBlue^{®3} into the exhaust flow. The nitrogen oxides are then broken down into nitrogen and water in the nitrogen oxide catalytic converter (DeNO_x catalytic converter). Refill the separate AdBlue tank as indicated by the information in the display of the instrument cluster. We recommend having the AdBlue tank refilled at your Audi partner.

ISOFIX child seat mounting and top tether for the outer rear seats

Standard mounting for practical attachment of ISOFIX child seat mounting; including additional fastening point (top tether).

Recommended child seats can be obtained from your Audi partner.

ISOFIX child seat mounting for the front-passenger seat

with passenger airbag deactivation switch, includes separate electric child-proof lock for the rear doors

| Audi Extended Warranty

Audi Extended Warranty

The Audi Extended Warranty offers longer-term protection against risk and allows you to control servicing costs even after the first 2 years of the manufacturer’s guarantee. It can only be ordered directly and on purchase of a new car. Choice of 9 service life/total mileage combinations. Ask your Audi partner for more detailed information.

Audi Genuine Accessories. As individual as the life you lead.

The Audi A7 Sportback: dynamic forms combined with sporty elegance. This is how you get from A to B in an expressive way every time. And then, inspired, just keep driving. Not least because your Audi A7 Sportback is prepared for a multitude of individual requirements from A to Z. Thanks to Audi Genuine Accessories: products that will inspire you to new destinations again and again. And keep all our quality promises day in, day out. Benefit from customised solutions with convincing design and functionality. Because creativity in development and high production standards alongside numerous testing procedures are just as decisive for Audi Genuine Accessories as for the Audi vehicles themselves. Discover which tailor-made ideas Audi Genuine Accessories have ready for your lifestyle. A few highlights are illustrated here – please contact your Audi partner for more information on the complete range.



Further information can be obtained from the Audi A7 accessories catalogue, at www.audi.com and from your Audi partner.

Ski and luggage box (405 l)

New Audi design with improved aerodynamics thanks to a flat, sporty look. Platinum grey roof box with brilliant black side blade and chrome-plated Audi rings; high-quality look with no visible rivets. Lockable and can be opened from both sides for easy loading and unloading. With interior handle for closing the box. Simple quick-release fastening system including torque limiting. Suitable for transporting skis up to 1.90 m long. Advanced position allows better access to the luggage compartment. Maximum permissible load 75 kg.



Cast aluminium wheels in 5-arm parabola design, anthracite, gloss turned finish¹, Exceptional design, perfectly matched to your Audi A7. Size 9 J x 20. For tyre size 265/30 R 20.



Cycle rack for trailer towing hitch

Cycle rack (also suitable for e-bikes) for up to 2 bicycles with a maximum load of 60 kg.² Bicycles can be locked to the rack and the cycle rack to the vehicle using the same key. Movable wheel supports offer a secure hold. Unimpaired access to the luggage compartment thanks to practical folding mechanism. The cycle rack can be folded away and stored in the bag provided, taking up little space. An expansion kit for a third bicycle is available as an option.

Audi tracking system plus (not shown)

Enables a stolen vehicle to be located and tracked via GPS/GSM technology in 27 European countries. With automatic driver recognition and intelligent restart inhibitor. For more detailed information, please contact your Audi partner.

Footrest and pedal caps in stainless steel (not shown)

Dazzling and practical at the same time: the footrest and pedal covers are made of brushed stainless steel. The rubber coating on the surface ensures a better grip.

Navigation update (not shown)

Map data containing upgraded contents, e.g. new roads, points of interest and restaurants. For added convenience and a more relaxed driving experience. Our tip: combine the update with your vehicle's next service interval. For more detailed information, please contact your Audi partner.

Audi Entertainment mobile³

The third-generation Audi Entertainment mobile with its 10-inch touchscreen promises superb entertainment with excellent image quality – all finished off in the progressive Audi design. It provides a fantastic stage for videos, photos, games and music. Intuitive software, numerous connection options (SD, USB 2.0, HDMI-IN, etc.) and excellent functionality come as standard. Connection to a Wi-Fi hotspot provides internet access (e.g. via Audi wireless internet access⁴). The unit can be attached in the vehicle to the front-seat backrest or used outside the vehicle. Requires holder for mobile devices and preparation for Rear Seat Entertainment.



¹ Please note the special information relating to wheels on page 102. ² Please note the information in the Owner's Manual on the maximum nose weight and gross weight of your vehicle.

³ For information on when this feature will be available, please contact your Audi partner. ⁴ As a retrofit option from Audi Genuine Accessories. The fuel consumption and CO₂ emission figures can be found from page 100 onwards.

Model	A7 Sportback 1.8 TFSI ultra (140 kW)	A7 Sportback 1.8 TFSI (140 kW)	A7 Sportback 2.0 TFSI (185 kW)	A7 Sportback 2.0 TFSI quattro (185 kW)	A7 Sportback 3.0 TFSI quattro (245 kW)
Engine type	4-cylinder inline petrol engine with direct fuel injection, turbocharging and Audi valvelift system	4-cylinder inline petrol engine with direct fuel injection, turbocharging and Audi valvelift system	4-cylinder inline petrol engine with direct fuel injection, turbocharging and Audi valvelift system	4-cylinder inline petrol engine with direct fuel injection, turbocharging and Audi valvelift system	V6 petrol engine with direct fuel injection and mechanical supercharger
Displacement in cc (valves per cylinder)	1,798 (4)	1,798 (4)	1,984 (4)	1,984 (4)	2,995 (4)
Max. output ¹ in kW at rpm	140/4,200–6,200	140/4,200–6,200	185/5,000–6,000	185/5,000–6,000	245/5,500–6,500
Max. torque in Nm at rpm	320/1,400–4,100	320/1,400–4,100	370/1,600–4,500	370/1,600–4,500	440/2,900–5,300
Power transmission					
Drive type	Front-wheel drive	Front-wheel drive	Front-wheel drive	quattro® permanent all-wheel drive	quattro® permanent all-wheel drive
Transmission type	7-speed S tronic	7-speed S tronic	7-speed S tronic	7-speed S tronic	7-speed S tronic
Weights/capacities					
Unladen weight ² in kg	1,705	1,705	1,730	1,795	1,885
Gross vehicle weight in kg	2,240	2,240	2,265	2,330	2,420
Permissible roof load limit/ nose weight in kg	100/85	100/85	100/85	100/85	100/85
Trailer load limit ³ in kg unbraked	750	750	750	750	750
12 % gradient	1,600	1,600	1,600	1,600	2,100
8 % gradient	1,800	1,800	1,800	1,800	2,100
Fuel tank capacity, approx. in l	65	65	65	65	65
Performance/consumption⁴					
Top speed in km/h	229	229	250 ⁵	250 ⁵	250 ⁵
Acceleration 0–100 km/h in s	8.2	8.2	6.9	6.7	5.3
Fuel grade	Sulphur-free super RON 95 ⁶	Sulphur-free super RON 95 ⁶	Sulphur-free super RON 95 ⁶	Sulphur-free super RON 95 ⁶	Sulphur-free super RON 95 ⁶
Fuel consumption ⁷ in l/100 km					
urban	7.2–7.0	7.2–7.0	7.5–7.4	8.6–8.4	10.2–10.0
extra-urban	5.3–5.0	5.3–5.0	5.3–5.1	6.1–5.9	6.5–6.2
combined	6.0–5.7	6.0–5.7	6.1–5.9	7.1–6.8	7.8–7.6
CO ₂ emissions ⁷ in g/km					
urban	169–163	169–163	176–171	196–191	236–230
extra-urban	122–116	122–116	126–117	141–134	151–144
combined	139–133	139–133	144–137	161–155	182–176
Emission standard	EU6	EU6	EU6	EU6	EU6

Model	A7 Sportback 3.0 TDI ultra (160 kW) ⁸	A7 Sportback 3.0 TDI quattro (160 kW) ⁸	A7 Sportback 3.0 TDI quattro (200 kW) ⁸	A7 Sportback 3.0 TDI quattro (235 kW) ⁸
Engine type	V6 diesel engine with common rail injection system and turbocharging	V6 diesel engine with common rail injection system and turbocharging	V6 diesel engine with common rail injection system and turbocharging	V6 diesel engine with common rail injection system and turbocharging
Displacement in cc (valves per cylinder)	2,967 (4)	2,967 (4)	2,967 (4)	2,967 (4)
Max. output ¹ in kW at rpm	160/4,000–5,000	160/3,250–4,750	200/3,500–4,250	235/3,900–4,600
Max. torque in Nm at rpm	400/1,250–3,750	500/1,250–3,000	580/1,250–3,250	650/1,400–2,800
Power transmission				
Drive type	Front-wheel drive	quattro® permanent all-wheel drive	quattro® permanent all-wheel drive	quattro® permanent all-wheel drive
Transmission type	7-speed S tronic	7-speed S tronic	7-speed S tronic	8-speed tiptronic
Weights/capacities				
Unladen weight ² in kg	1,830	1,900	1,905	1,970
Gross vehicle weight in kg	2,365	2,435	2,440	2,505
Permissible roof load limit/ nose weight in kg	100/85	100/85	100/85	100/85
Trailer load limit ³ in kg unbraked	750	750	750	750
12 % gradient	2,000	2,000	2,000	2,100
8 % gradient	2,100	2,100	2,100	2,100
Fuel tank capacity, approx. in l	73	73	73	73
Performance/consumption⁴				
Top speed in km/h	239	239	250 ⁵	250 ⁵
Acceleration 0–100 km/h in s	7.3	6.8	5.7	5.2
Fuel grade	Sulphur-free diesel ⁹	Sulphur-free diesel ⁹	Sulphur-free diesel ⁹	Sulphur-free diesel ⁹
Fuel consumption ⁷ in l/100 km				
urban	5.6–5.5	6.1–6.0	6.1–6.0	7.6–7.4
extra-urban	4.5–4.3	5.0–4.7	5.0–4.7	5.6–5.4
combined	4.9–4.7	5.4–5.2	5.4–5.2	6.3–6.1
CO ₂ emissions ⁷ in g/km				
urban	145–142	161–156	161–156	200–195
extra-urban	118–111	131–124	131–124	149–142
combined	128–122	142–136	142–136	167–162
Emission standard	EU6	EU6	EU6	EU6

Model	S7 Sportback 4.0 TFSI quattro (331 kW)
Engine type	V8 petrol engine with direct fuel injection, Audi valvelift system and Audi cylinder on demand
Displacement in cc (valves per cylinder)	3,993 (4)
Max. output ¹ in kW at rpm	331/5,800–6,400
Max. torque in Nm at rpm	550/1,400–5,700
Power transmission	
Drive type	quattro® permanent all-wheel drive
Transmission type	7-speed S tronic
Weights/capacities	
Unladen weight ² in kg	2,030
Gross vehicle weight in kg	2,565
Permissible roof load limit/ nose weight in kg	100/85
Trailer load limit ³ in kg unbraked	750
12 % gradient	2,100
8 % gradient	2,100
Fuel tank capacity, approx. in l	75
Performance/consumption ⁴	
Top speed in km/h	250 ⁵
Acceleration 0–100 km/h in s	4.6
Fuel grade	Sulphur-free super RON 95 ⁶
Fuel consumption ⁷ in l/100 km	
urban	13.4–13.2
extra-urban	7.2–7.0
combined	9.5–9.3
CO ₂ emissions ⁷ in g/km	
urban	310–306
extra-urban	169–163
combined	220–215
Emission standard	EU6

Explanatory notes

- ¹ The figure given was calculated using the specified measuring procedure (current version of UN-R 85).
- ² Unladen vehicle weight includes driver (75 kg) and fuel tank 90 % full, calculated in accordance with the current version of Reg. (EU) 1230/2012. Optional equipment may increase the car's unladen weight and drag coefficient, whereupon the possible payload limit and the top speed will be reduced accordingly.
- ³ The engine's power output always decreases with increasing altitude. At 1,000 m above sea level, and for every additional 1,000 m, deduct 10 % from the weight of the outfit (trailer load limit + gross weight of the towing vehicle). Figure for trailer load limit applies to factory-fitted trailer towing hitch. If using the vehicle with a trailer towing hitch for commercial purposes, a digital tachograph may be required under certain conditions.
- ⁴ Fuel consumption and CO₂ emission figures given in ranges depend on the tyre/wheel sets used.
- ⁵ Regulated.
- ⁶ We recommend using sulphur-free super unleaded RON 95 fuel complying with DIN EN 228. If this is not available, use sulphur-free regular unleaded RON 91 fuel complying with DIN EN 228; power output will be slightly reduced. Unleaded RON 95 fuel with a maximum ethanol content of 10 % (E10) can generally be used. Fuel consumption details refer to operation with RON 95 fuel complying with 692/2008/EC.

⁷ The figures given were calculated using the specified measuring procedures. The figures do not refer to one individual vehicle and do not form part of any offer, but rather should be used purely for purposes of comparison between the different vehicle models.

⁸ Refill the separate AdBlue tank as indicated by the information in the display of the instrument cluster. We recommend having the AdBlue tank refilled by your Audi partner.















⁹ We recommend using sulphur-free diesel complying with DIN EN 590. If this is not available, use diesel complying with DIN EN 590.

Important note:

Special information about the wheels: Wheels with gloss turned finish as well as polished or partly polished aluminium wheels must not be used in wintry road conditions. For manufacturing reasons, these wheel surfaces do not have sufficient corrosion protection for such use and they can be damaged permanently by road salt or similar.

Classifications of tyre parameters

The table shows the range of fuel efficiency, wet grip and exterior noise emission classes for the different tyre sizes of the Audi A7 Sportback and Audi S7 Sportback.

	Tyre size	Fuel efficiency class	Wet grip class	Exterior noise emission class
Summer tyres	235/55 R 17	E–C	C–A	71–67  – 
	255/45 R 18	E–C	C–A	72–69  – 
	255/40 R 19	E–C	C–A	73–69  – 
	265/35 R 20	E	C–A	73–69  – 
Winter tyres	275/30 R 21	E	B	73–70  – 
	235/55 R 17	E	E–C	72–70 
	235/45 R 19	E	E–C	72–70  – 
	265/35 R 20	E	C	70 

It is not possible to order a specific tyre.

Ask your Audi partner about the range of tyres available in your country.

Audi A7 Sportback

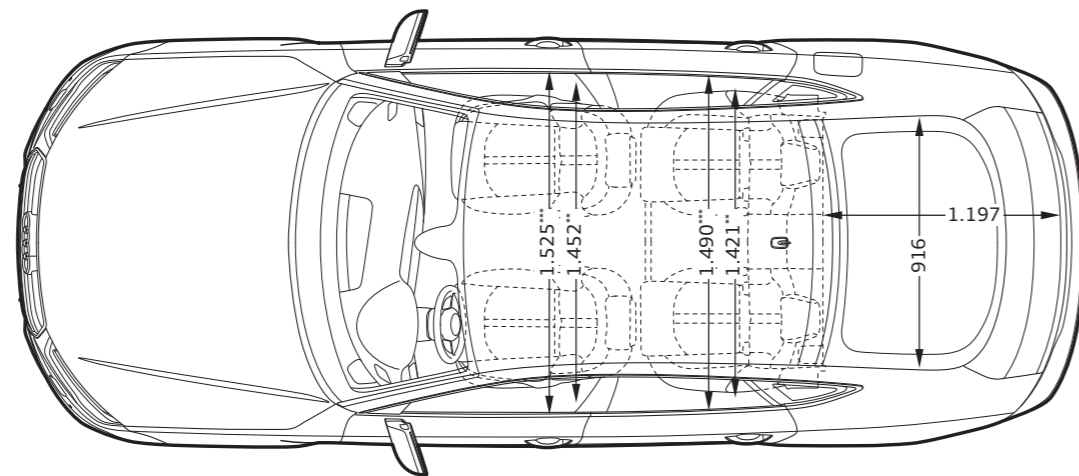
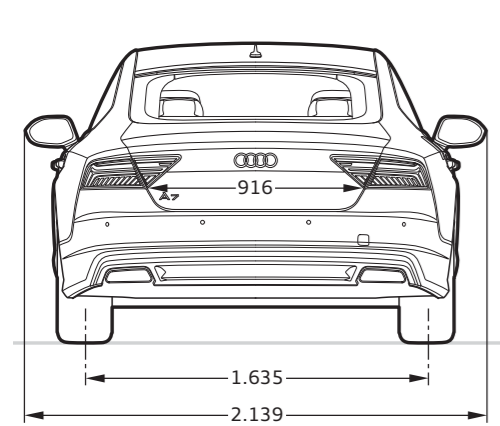
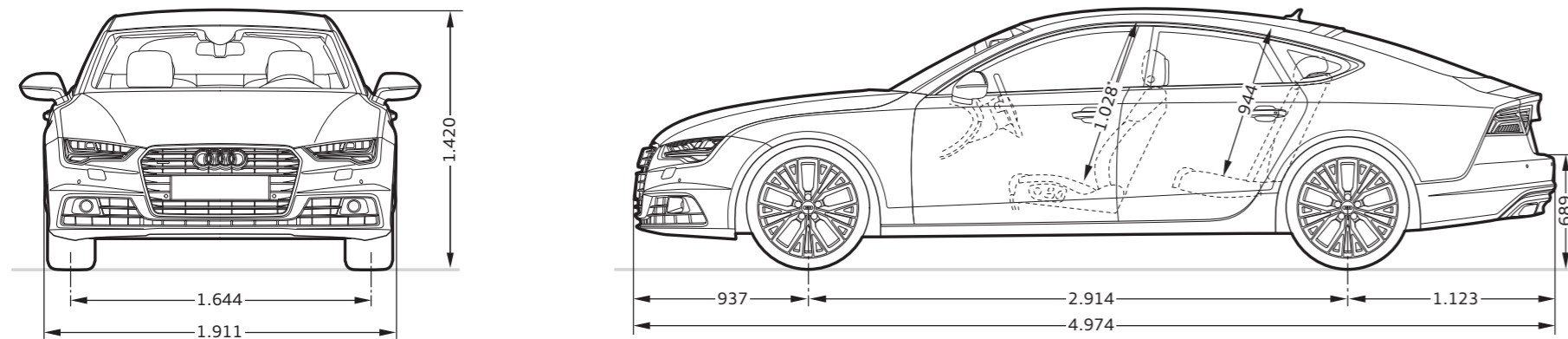

Dimensions in millimetres.

Dimensions are for vehicle at unladen weight.

Luggage capacity 535/1,390 l (second value is with the rear seat backrest folded down and the vehicle loaded up to roof height).

Turning circle approx. 11.9 m.

*Maximum headroom. **Elbow room width. ***Shoulder room width.

Audi S7 Sportback

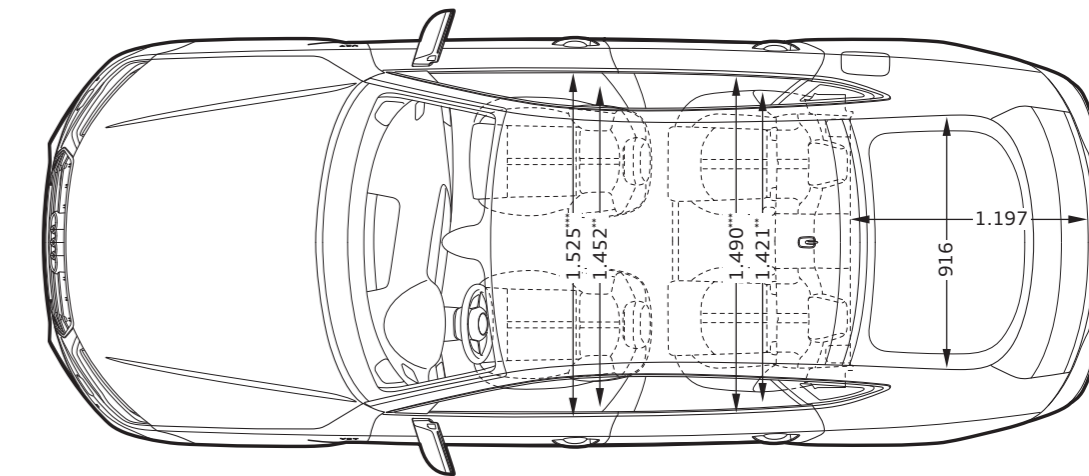
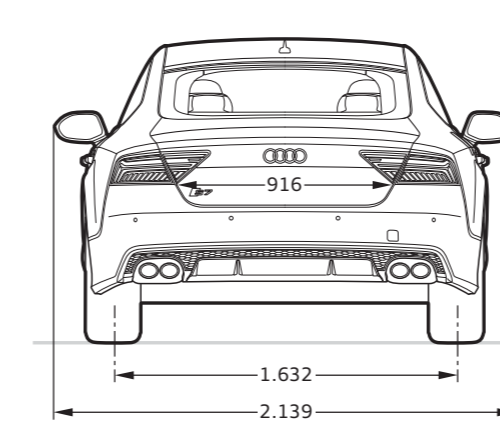
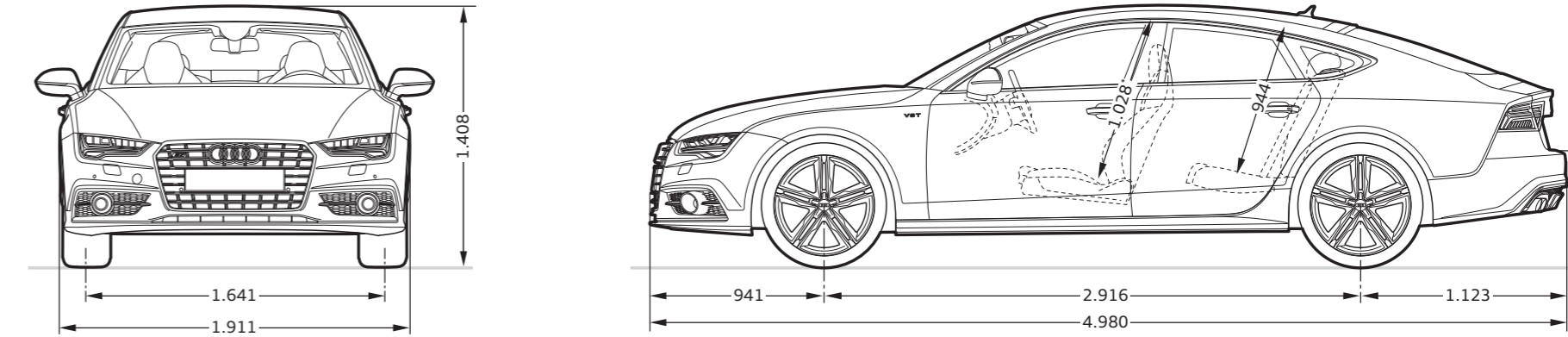















Dimensions in millimetres.

Dimensions are for vehicle at unladen weight.

Luggage compartment volume 535/1,390 l (second value is with the rear seat backrest folded down and the vehicle loaded up to roof height).

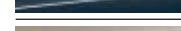
Turning circle approx. 11.9 m.









*Maximum headroom. **Elbow room width. ***Shoulder room width.









	Page	A7 Sportback	S7 Sportback
Lines and packages	62		
S line exterior package		■	—
S line sport package		■	—
Audi design selection cedar brown		■	—
Audi design selection Arras red		—	■
Audi exclusive	66		
Audi exclusive line		■	—
Solid paint finishes	70		
 Ibis white		□	□
 Brilliant black		□	□
Metallic paint finishes	70		
 Glacier white, metallic		■	■
 Floret silver, metallic		■	■
 Cuvée silver, metallic		■	—
 Tornado grey, metallic		■	■
 Oolong grey, metallic		■	■
 Dakota grey, metallic		■	—
 Havana black, metallic		■	■
 Mythos black, metallic		■	■
 Moonlight blue, metallic		■	■
 Carat beige, metallic		■	■
Pearl effect paint finishes	71		
 Misano red, pearl effect		■ ¹	■
 Garnet red, pearl effect		■	—
 Sepang blue, pearl effect		—	■
 Daytona grey, pearl effect		■ ²	■

□ Standard equipment ■ Optional equipment — Not available

Country-specific variations possible. Please find out from your local Audi partner which equipment is standard and what optional equipment is available in your country.







More detailed descriptions of a selection of items from the equipment range can be found from page 52 onwards.













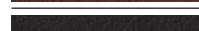
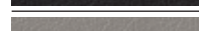

	Page	A7 Sportback	S7 Sportback
Customised paint finishes	71		
 Audi exclusive customised paint finishes		■	■
Wheels/tyres	72		
 17" forged aluminium wheels in 6-arm design		□	—
 18" cast aluminium wheels in 7-arm dynamic design		■	—
 19" cast aluminium wheels in 5-parallel-spoke design (S design)		—	□
 19" cast aluminium wheels in 5-arm Y design		■	—
 19" cast aluminium wheels in 5-spoke V design		■	■
 19" Audi Sport cast aluminium wheels in 5-V-spoke design, matt titanium look, gloss turned finish ³		■	—
 19" Audi Sport cast aluminium wheels in 7-twin-spoke design		□ ⁴	—
 19" cast aluminium wheels in 10-spoke design		■	—

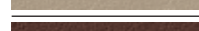
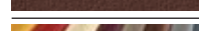



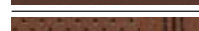
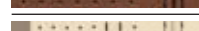
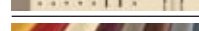





	Page	A7 Sportback	S7 Sportback
 20" cast aluminium wheels in 5-parallel-spoke star design (S design)		—	■
 20" forged aluminium wheels in 5-spoke W design		■	—
 20" forged aluminium wheels in 5-spoke W design, contrasting grey, partly polished ³		■	—
 20" Audi Sport cast aluminium wheels in 5-twin-spoke design		■	■
 20" Audi Sport cast aluminium wheels in 5-twin-spoke design in matt titanium look, gloss turned finish ³		■	■
 20" Audi Sport cast aluminium wheels in 5-spoke blade design		■	■
 20" Audi Sport cast aluminium wheels in 5-spoke blade design, matt titanium look, gloss turned finish ³		■	■
 20" Audi Sport forged aluminium wheels in 7-twin-spoke design in gloss anthracite black ^{3,5}		■	■
 20" Audi Sport cast aluminium wheels in 10-Y-spoke design		■	■





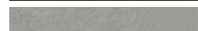

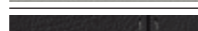
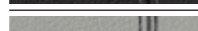
¹ Only available in conjunction with S line exterior package. ² Only available in conjunction with S line sport package or S line exterior package. ³ Please note the special information relating to wheels on page 102.

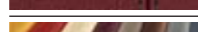



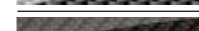

⁴ Standard in conjunction with S line sport package. ⁵ Only available in conjunction with quattro permanent all-wheel drive.

	Page	A7 Sportback	S7 Sportback
 20" Audi Sport cast aluminium wheels in 10-Y-spoke design in gloss black, gloss turned finish ³		■	■
 21" Audi Sport cast aluminium wheels in 5-arm rotor design		■	■
 21" Audi Sport cast aluminium wheels in 5-arm rotor design, matt titanium look, gloss turned finish ³		■	■
 17" forged aluminium winter wheels in 6-arm design		■	—
 19" cast aluminium winter wheels in 10-spoke design		■	■
 20" cast aluminium winter wheels in 5-parallel-spoke star design (S design)		—	■
Tyre repair kit		□	□
Spare wheel, space-saving		■	■
Tyre pressure loss indicator		□	□
Anti-theft wheel bolts		■	■
Vehicle tool kit		□	□
Vehicle jack		■	■
Seats	74		
Standard seats, front		□	—
Customised contour seats, front		■	■

	Page	A7 Sportback	S7 Sportback
Seats (continued)	79		
Sport seats, front		<input type="checkbox"/> ¹	—
S sport seats, front		<input checked="" type="checkbox"/> ²	<input type="checkbox"/>
Seat upholstery for standard seats, front	79		
 Horizon cloth, black		<input type="checkbox"/>	—
 Leather/artificial leather, black ³		<input checked="" type="checkbox"/>	—
 Leather/artificial leather, flint grey ³		<input checked="" type="checkbox"/>	—
 Leather/artificial leather, Atlas beige ³		<input checked="" type="checkbox"/>	—
 Leather/artificial leather, nougat brown ³		<input checked="" type="checkbox"/>	—
 Milano leather, black ³		<input checked="" type="checkbox"/>	—
 Milano leather, flint grey ³		<input checked="" type="checkbox"/>	—
 Milano leather, Atlas beige ³		<input checked="" type="checkbox"/>	—
 Milano leather, nougat brown ³		<input checked="" type="checkbox"/>	—
 Audi exclusive leather upholstery and trim ³		<input checked="" type="checkbox"/>	—
Seat upholstery for customised contour seats, front	79		
 Valcona leather, black ³		<input checked="" type="checkbox"/>	<input checked="" type="checkbox"/>
 Valcona leather, flint grey ³		<input checked="" type="checkbox"/>	<input checked="" type="checkbox"/>
 Valcona leather, Atlas beige ³		<input checked="" type="checkbox"/>	—
 Valcona leather, nougat brown ³		<input checked="" type="checkbox"/>	—
 Valcona leather, cedar brown with contrasting stitching ⁴		<input checked="" type="checkbox"/>	—
 Valcona leather, alabaster white with contrasting stitching ⁵		<input checked="" type="checkbox"/>	—
 Audi exclusive leather upholstery and trim ³		<input checked="" type="checkbox"/>	<input checked="" type="checkbox"/>
Seat upholstery for sport seats, front	79		
 Milano leather, black		<input checked="" type="checkbox"/>	—
 Alcantara/leather, black		<input checked="" type="checkbox"/>	—
 Alcantara/leather, flint grey		<input checked="" type="checkbox"/>	—

	Page	A7 Sportback	S7 Sportback
 Perforated Alcantara/leather, black with contrasting stitching		<input type="checkbox"/> ²	—
 Valcona leather, black		<input checked="" type="checkbox"/>	—
 Valcona leather, flint grey		<input checked="" type="checkbox"/>	—
 Valcona leather, nougat brown		<input checked="" type="checkbox"/>	—
 Audi exclusive leather upholstery and trim		<input checked="" type="checkbox"/>	—
Seat upholstery for S sport seats, front	79		
 Alcantara/leather, black		—	<input type="checkbox"/>
 Alcantara/leather, lunar silver		—	<input type="checkbox"/>
 Valcona leather, black		<input checked="" type="checkbox"/> ²	—
 Valcona leather, lunar silver		<input checked="" type="checkbox"/> ²	—
 Valcona leather, black with contrasting stitching		—	<input checked="" type="checkbox"/>
 Valcona leather, lunar silver with contrasting stitching		—	<input checked="" type="checkbox"/>
 Valcona leather, Arras red with contrasting stitching		—	<input checked="" type="checkbox"/> ⁴
 Audi exclusive leather upholstery and trim		—	<input checked="" type="checkbox"/>
Leather packages	77		
Leather-covered armrests in the door trims		<input checked="" type="checkbox"/>	<input checked="" type="checkbox"/>
Leather package		<input checked="" type="checkbox"/> ⁶	—
Audi exclusive leather upholstery and trim (package 1) in Valcona leather		<input checked="" type="checkbox"/>	<input checked="" type="checkbox"/>
Audi exclusive leather upholstery and trim (package 1) in Alcantara/Valcona leather		<input checked="" type="checkbox"/>	<input checked="" type="checkbox"/>
Audi exclusive leather upholstery and trim (package 2) in Valcona leather		<input checked="" type="checkbox"/>	<input checked="" type="checkbox"/>
Leather package including airbag cover		<input checked="" type="checkbox"/>	<input checked="" type="checkbox"/>
Audi exclusive leather package including airbag cover		<input checked="" type="checkbox"/>	<input checked="" type="checkbox"/>
Extended Audi exclusive leather package		<input checked="" type="checkbox"/>	<input checked="" type="checkbox"/>
Audi exclusive piping for customised contour seats		<input checked="" type="checkbox"/>	<input checked="" type="checkbox"/>
Audi exclusive leather seat trims		<input checked="" type="checkbox"/>	<input checked="" type="checkbox"/>

	Page	A7 Sportback	S7 Sportback
Seating comfort	78		
Front seats, electrically adjustable, including memory function for the driver seat		<input checked="" type="checkbox"/>	<input type="checkbox"/>
4-way lumbar support for the front seats		<input checked="" type="checkbox"/>	<input type="checkbox"/>
Seat heating, front		<input checked="" type="checkbox"/>	<input checked="" type="checkbox"/>
Seat heating, front and rear		<input checked="" type="checkbox"/>	<input checked="" type="checkbox"/>
Seat ventilation, front		<input checked="" type="checkbox"/>	<input checked="" type="checkbox"/>
Massage function, front		<input checked="" type="checkbox"/>	<input checked="" type="checkbox"/>
Centre armrest, front		<input type="checkbox"/>	<input type="checkbox"/>
Rear seats	78		
Rear seat system		<input type="checkbox"/>	<input checked="" type="checkbox"/>
Rear seat system 2 + 1		<input checked="" type="checkbox"/>	—
S sport seats in the rear		<input checked="" type="checkbox"/> ²	<input type="checkbox"/>
Headlinings	78		
Headlining in cloth		<input type="checkbox"/>	<input type="checkbox"/>
Headlining in cloth, black		<input type="checkbox"/> ¹	<input checked="" type="checkbox"/>
Headlining in Alcantara black		<input checked="" type="checkbox"/>	<input checked="" type="checkbox"/>
Headlining in Alcantara black with coloured Audi exclusive decorative stitching		<input checked="" type="checkbox"/>	<input checked="" type="checkbox"/>
Inlays	82		
 Satin finish, silver-grey		<input type="checkbox"/>	—
 Satin finish, silver-beige		<input type="checkbox"/>	—
 Aluminium delta, silver		<input checked="" type="checkbox"/>	—
 Matt brushed aluminium		<input type="checkbox"/> ²	<input type="checkbox"/>
 Carbon Atlas		—	<input checked="" type="checkbox"/>
 Carbon twill, red		—	<input checked="" type="checkbox"/> ⁴
 Piano finish, black		<input checked="" type="checkbox"/>	<input checked="" type="checkbox"/>

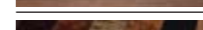
	Page	A7 Sportback	S7 Sportback
 Fine grain ash, natural brown		<input checked="" type="checkbox"/>	<input checked="" type="checkbox"/>
 Walnut, dark brown		<input checked="" type="checkbox"/>	—
 Eucalyptus, natural		<input checked="" type="checkbox"/> ⁵	—
 Beaufort walnut		<input checked="" type="checkbox"/>	<input checked="" type="checkbox"/>
 Aluminium/Beaufort wood, black		<input checked="" type="checkbox"/>	<input checked="" type="checkbox"/>
 Aluminium/Beaufort walnut		<input checked="" type="checkbox"/> ⁴	—
 Inlays in Audi exclusive wood		<input checked="" type="checkbox"/>	<input checked="" type="checkbox"/>
Headlights	84		
LED headlights		<input type="checkbox"/>	<input type="checkbox"/>
Audi Matrix LED headlights		<input checked="" type="checkbox"/>	<input checked="" type="checkbox"/>
Light/rain sensor		<input type="checkbox"/>	<input type="checkbox"/>
LED rear lights with dynamic indicators		<input type="checkbox"/>	<input type="checkbox"/>
High-beam assist		<input checked="" type="checkbox"/>	<input checked="" type="checkbox"/>
Adaptive brake light		<input type="checkbox"/>	<input type="checkbox"/>
Interior lighting	84		
Interior lighting		<input type="checkbox"/>	<input type="checkbox"/>
Interior and exterior lighting package		<input checked="" type="checkbox"/>	<input checked="" type="checkbox"/>
Ambient lighting		<input checked="" type="checkbox"/>	<input checked="" type="checkbox"/>
Exterior design	85		
Model name/logo		<input type="checkbox"/>	<input type="checkbox"/>
Rear spoiler		<input type="checkbox"/>	<input type="checkbox"/>
Exhaust tailpipes		<input type="checkbox"/>	<input type="checkbox"/>
Sport exhaust system		—	<input checked="" type="checkbox"/>
Gloss package		<input type="checkbox"/>	<input type="checkbox"/>
Audi exclusive black gloss package		<input checked="" type="checkbox"/>	<input checked="" type="checkbox"/>

Standard equipment Optional equipment Standard/optional equipment varies by model — Not available

Country-specific variations possible. Please find out from your local Audi partner which equipment is standard and what optional equipment is available in your country.

More detailed descriptions of a selection of items from the equipment range can be found from page 52 onwards.

¹Standard in conjunction with S line sport package. ²Only available in conjunction with S line sport package. ³In conjunction with seat ventilation, front, the leather on the front and outer rear seats is perforated.

⁴Only available in conjunction with Audi design selection. ⁵Only available in conjunction with Audi exclusive line. ⁶Only available in conjunction with Alcantara/leather or leather/artificial leather.

	Page	A7 Sportback	S7 Sportback
Interior design	85		
Aluminium-look interior		<input type="checkbox"/>	<input type="checkbox"/>
Floor mats, front		<input type="checkbox"/>	–
Floor mats, front and rear		<input checked="" type="checkbox"/>	<input type="checkbox"/>
Audi exclusive floor mats		<input checked="" type="checkbox"/>	<input checked="" type="checkbox"/>
Audi exclusive carpet and floor mats		<input checked="" type="checkbox"/>	<input checked="" type="checkbox"/>
Pedals and footrest in stainless steel		<input type="checkbox"/> ¹	<input type="checkbox"/>
Door sill trims with aluminium inlays		<input type="checkbox"/>	<input type="checkbox"/>
Steering wheels/controls	85		
Multifunction leather steering wheel in 4-spoke design		<input type="checkbox"/>	–
Multifunction leather steering wheel in 4-spoke design with shift paddles		<input checked="" type="checkbox"/> ²	–
Multifunction leather steering wheel in 4-spoke design, heated		<input checked="" type="checkbox"/>	–
Multifunction sport leather steering wheel in 3-spoke design		<input checked="" type="checkbox"/> ³	–
Multifunction sport leather steering wheel in 3-spoke design with shift paddles		<input checked="" type="checkbox"/>	<input type="checkbox"/>
Multifunction sport leather steering wheel in 3-spoke design with shift paddles, heated		<input checked="" type="checkbox"/>	<input checked="" type="checkbox"/>
Multifunction sport leather steering wheel in 3-spoke design with shift paddles, flattened at the bottom		–	<input checked="" type="checkbox"/>
Electric steering wheel adjustment		<input checked="" type="checkbox"/>	<input checked="" type="checkbox"/>
Steering wheel rim with wooden segments		<input checked="" type="checkbox"/>	–
Audi exclusive steering wheel rim with wooden segments		<input checked="" type="checkbox"/>	–
Audi exclusive leather controls		<input checked="" type="checkbox"/>	<input checked="" type="checkbox"/>
Selector lever knob in leather		<input type="checkbox"/>	–
Selector lever knob in aluminium look		–	<input type="checkbox"/>
Mirrors	86		
Exterior mirrors, electrically adjustable and heated, with integrated LED indicator		<input type="checkbox"/>	<input type="checkbox"/>
Exterior mirrors, additionally electrically folding		<input checked="" type="checkbox"/>	<input checked="" type="checkbox"/>
Exterior mirrors, additionally automatically dimming on both sides		<input checked="" type="checkbox"/>	<input checked="" type="checkbox"/>

Standard equipment Optional equipment Standard/optional equipment varies by model – Not available

Country-specific variations possible. Please find out from your local Audi partner which equipment is standard and what optional equipment is available in your country.

More detailed descriptions of a selection of items from the equipment range can be found from page 52 onwards.

	Page	A7 Sportback	S7 Sportback
Exterior mirrors, additionally electrically folding and automatically dimming on both sides		<input checked="" type="checkbox"/>	<input checked="" type="checkbox"/>
Exterior mirror housings in aluminium look		–	<input type="checkbox"/>
Interior mirror, manually dimming		<input type="checkbox"/>	<input type="checkbox"/>
Interior mirror, automatically dimming		<input checked="" type="checkbox"/>	<input checked="" type="checkbox"/>
Roof system	86		
Slide-and-tilt glass sunroof		<input checked="" type="checkbox"/>	<input checked="" type="checkbox"/>
Glazing	87		
Heat-insulating glass		<input type="checkbox"/>	<input type="checkbox"/>
Dark-tinted windows (privacy glazing)		<input checked="" type="checkbox"/>	<input checked="" type="checkbox"/>
Insulating/acoustic glass		<input checked="" type="checkbox"/>	<input checked="" type="checkbox"/>
Insulating/acoustic glass and dark-tinted windows (privacy glazing)		<input checked="" type="checkbox"/>	<input checked="" type="checkbox"/>
Sun visors, hinged and swivel-mounted		<input type="checkbox"/>	<input type="checkbox"/>
Sun screen		<input checked="" type="checkbox"/>	<input checked="" type="checkbox"/>
Climate control	87		
Deluxe automatic air conditioning		<input type="checkbox"/>	–
4-zone deluxe automatic air conditioning		<input checked="" type="checkbox"/>	<input type="checkbox"/>
Auxiliary heating/ventilation		<input checked="" type="checkbox"/>	<input checked="" type="checkbox"/>
Closing systems	88		
Remote control key		<input type="checkbox"/>	<input type="checkbox"/>
Engine start-stop button		<input type="checkbox"/>	<input type="checkbox"/>
Luggage compartment lid, electrically opening and closing		<input type="checkbox"/>	<input type="checkbox"/>
Convenience key with sensor-controlled release of the luggage compartment lid		<input checked="" type="checkbox"/>	<input checked="" type="checkbox"/>
Power-assisted door closing		<input checked="" type="checkbox"/>	<input checked="" type="checkbox"/>
Garage door opener (HomeLink)		<input checked="" type="checkbox"/>	<input checked="" type="checkbox"/>
Anti-theft alarm		<input checked="" type="checkbox"/>	<input type="checkbox"/>
Preparation for tracking system		<input checked="" type="checkbox"/>	<input checked="" type="checkbox"/>

	Page	A7 Sportback	S7 Sportback
Storage/transport	88		
Storage compartments		<input type="checkbox"/>	<input type="checkbox"/>
Storage package		<input checked="" type="checkbox"/>	<input type="checkbox"/>
Luggage compartment		<input type="checkbox"/>	<input type="checkbox"/>
Through-loading facility		<input checked="" type="checkbox"/>	<input type="checkbox"/>
Through-loading facility with removable ski/snowboard bag		<input checked="" type="checkbox"/>	<input checked="" type="checkbox"/>
Reversible mat		<input checked="" type="checkbox"/>	<input checked="" type="checkbox"/>
Non-smoker version		<input type="checkbox"/>	<input type="checkbox"/>
Cigarette lighter and ashtray		<input checked="" type="checkbox"/>	<input checked="" type="checkbox"/>
Provision for trailer towing hitch		<input checked="" type="checkbox"/>	<input checked="" type="checkbox"/>
Trailer towing hitch		<input checked="" type="checkbox"/>	<input checked="" type="checkbox"/>
MMI®/navigation/display instruments	89		
Instrument cluster		<input type="checkbox"/>	<input type="checkbox"/>
Driver information system		<input type="checkbox"/>	–
Driver information system with colour display		<input checked="" type="checkbox"/>	<input type="checkbox"/>
Head-up display		<input checked="" type="checkbox"/>	<input checked="" type="checkbox"/>
Attention assist		<input type="checkbox"/>	<input type="checkbox"/>
MMI® navigation		<input checked="" type="checkbox"/>	<input checked="" type="checkbox"/>
MMI® navigation plus with MMI touch		<input checked="" type="checkbox"/>	<input checked="" type="checkbox"/>
Entertainment	91		
MMI® radio		<input type="checkbox"/>	–
MMI® radio plus		<input checked="" type="checkbox"/>	<input type="checkbox"/>
Digital Audio Broadcasting		<input checked="" type="checkbox"/>	<input checked="" type="checkbox"/>
Digital TV reception		<input checked="" type="checkbox"/>	<input checked="" type="checkbox"/>
Audi music interface		<input checked="" type="checkbox"/>	<input type="checkbox"/>

	Page	A7 Sportback	S7 Sportback
CD changer		<input checked="" type="checkbox"/>	<input checked="" type="checkbox"/>
DVD/CD changer		<input checked="" type="checkbox"/>	<input checked="" type="checkbox"/>
Audi sound system		<input checked="" type="checkbox"/>	<input type="checkbox"/>
Bose Surround Sound		<input checked="" type="checkbox"/>	<input checked="" type="checkbox"/>
Bang & Olufsen Advanced Sound System		<input checked="" type="checkbox"/>	<input checked="" type="checkbox"/>
Preparation for Rear Seat Entertainment		<input checked="" type="checkbox"/>	<input checked="" type="checkbox"/>
Communications	92		
Audi connect		<input checked="" type="checkbox"/>	<input checked="" type="checkbox"/>
Bluetooth interface		<input checked="" type="checkbox"/>	<input type="checkbox"/>
Audi phone box		<input checked="" type="checkbox"/>	<input checked="" type="checkbox"/>
Assistance systems	93		
Hold assist		<input type="checkbox"/>	<input type="checkbox"/>
Parking system plus		<input checked="" type="checkbox"/>	<input checked="" type="checkbox"/>
Park assist		<input checked="" type="checkbox"/>	<input checked="" type="checkbox"/>
Reversing camera		<input checked="" type="checkbox"/>	<input checked="" type="checkbox"/>
Front and reversing cameras		<input checked="" type="checkbox"/>	<input checked="" type="checkbox"/>
Cruise control		<input checked="" type="checkbox"/>	<input checked="" type="checkbox"/>
Audi pre sense basic		<input checked="" type="checkbox"/>	<input checked="" type="checkbox"/>
adaptive cruise control with Stop&Go function incl. Audi pre sense front		<input checked="" type="checkbox"/>	<input checked="" type="checkbox"/>
Audi side assist including Audi pre sense rear		<input checked="" type="checkbox"/>	<input checked="" type="checkbox"/>
Audi active lane assist		<input checked="" type="checkbox"/>	<input checked="" type="checkbox"/>
Assistance package including Audi pre sense plus		<input checked="" type="checkbox"/>	<input checked="" type="checkbox"/>
Camera-based speed limit display		<input checked="" type="checkbox"/>	<input checked="" type="checkbox"/>
Night vision assistant		<input checked="" type="checkbox"/>	<input checked="" type="checkbox"/>

¹ Only available in conjunction with S line sport package. ² Standard on A7 3.0 TDI quattro (235 kW). ³ Standard in conjunction with S line sport package.

	Page	A7 Sportback	S7 Sportback
Driving dynamics/brakes	96		
Audi drive select	<input type="checkbox"/>	<input type="checkbox"/>	
Sport suspension	<input checked="" type="checkbox"/>		—
adaptive air suspension	<input checked="" type="checkbox"/>		—
adaptive air suspension – sport	—	<input type="checkbox"/>	
Front-wheel drive	<input type="checkbox"/> ¹	—	
quattro®	<input type="checkbox"/> ¹	<input type="checkbox"/>	
quattro® with sport differential	<input checked="" type="checkbox"/> ²	<input checked="" type="checkbox"/>	
S tronic®	<input type="checkbox"/> ¹	<input type="checkbox"/>	
tiptronic	<input type="checkbox"/> ¹	—	
Electromechanical power steering	<input type="checkbox"/>	<input type="checkbox"/>	
Dynamic steering	<input checked="" type="checkbox"/>	<input checked="" type="checkbox"/>	
Brake system	<input type="checkbox"/>	<input type="checkbox"/>	
Brake callipers, painted black	—	<input type="checkbox"/>	
Ceramic brakes	<input checked="" type="checkbox"/> ³	<input checked="" type="checkbox"/>	
Electromechanical parking brake	<input type="checkbox"/>	<input type="checkbox"/>	
Technology/safety	96		
Body, galvanised, in aluminium hybrid construction	<input type="checkbox"/>	<input type="checkbox"/>	
Audi cylinder on demand	—	<input type="checkbox"/>	
Active Noise Cancellation	—	<input type="checkbox"/>	
Antilock Brake System (ABS) with Electronic Brake Force Distribution (EBD)	<input type="checkbox"/>	<input type="checkbox"/>	
Anti-Slip Regulation (ASR)	<input type="checkbox"/>	<input type="checkbox"/>	
Electronic Differential Lock (EDL)	<input type="checkbox"/>	<input type="checkbox"/>	

	Page	A7 Sportback	S7 Sportback
65 l fuel tank		<input type="checkbox"/> ⁴	—
73 l fuel tank		<input type="checkbox"/> ⁵	—
75 l fuel tank		<input checked="" type="checkbox"/> ⁴	<input type="checkbox"/>
Recuperation		<input type="checkbox"/>	<input type="checkbox"/>
Start-stop system		<input type="checkbox"/>	<input type="checkbox"/>
Audi TDI clean diesel		<input type="checkbox"/> ⁵	—
Airbags		<input type="checkbox"/>	<input type="checkbox"/>
Side airbags, front, and head airbag system		<input type="checkbox"/>	<input type="checkbox"/>
Side airbags, rear		<input checked="" type="checkbox"/>	<input checked="" type="checkbox"/>
Side impact protection in the doors		<input type="checkbox"/>	<input type="checkbox"/>
Integrated head restraint system		<input type="checkbox"/>	<input type="checkbox"/>
Safety steering column		<input type="checkbox"/>	<input type="checkbox"/>
Seat belts		<input type="checkbox"/>	<input type="checkbox"/>
Seat belts, crimson red		<input checked="" type="checkbox"/>	<input checked="" type="checkbox"/>
Audi exclusive seat belts		<input checked="" type="checkbox"/>	<input checked="" type="checkbox"/>
Seat belt reminder		<input type="checkbox"/>	<input type="checkbox"/>
Child-proof lock for the rear doors		<input type="checkbox"/>	<input type="checkbox"/>
ISOFIX child seat mounting and top tether for the outer rear seats		<input type="checkbox"/>	<input type="checkbox"/>
ISOFIX child seat mounting for the front-passenger seat		<input checked="" type="checkbox"/>	<input checked="" type="checkbox"/>
First-aid kit		<input checked="" type="checkbox"/>	<input checked="" type="checkbox"/>
Warning triangle with first-aid kit		<input checked="" type="checkbox"/>	<input checked="" type="checkbox"/>
Audi Extended Warranty	97		
Audi Extended Warranty		<input checked="" type="checkbox"/>	<input checked="" type="checkbox"/>

Equipment for the Audi A7 Sportback illustrated (p. 4–21):

Paint finish: cuvée silver, metallic

Wheels: forged aluminium wheels in 5-spoke W design

Seats/seat upholstery: customised contour seats, front, in Valcona leather, Atlas beige with seat ventilation

Inlays: Beaufort walnut

Equipment for the Audi S7 Sportback illustrated (p. 22–33):

Paint finish: Daytona grey, pearl effect

Wheels: cast aluminium wheels in 5-parallel-spoke star design

Seats/seat upholstery: S sport seats, front, in Valcona leather, Arras red with contrasting stitching

Inlays: carbon twill, red

Standard equipment Optional equipment — Not available

Country-specific variations possible. Please find out from your local Audi partner which equipment is standard and what optional equipment is available in your country.

More detailed descriptions of a selection of items from the equipment range can be found from page 52 onwards.

¹The availability of your desired engine variant can be found in the technical data. ²Only for A7 3.0 TDI quattro (200 kW), A7 3.0 TDI quattro (235 kW) and A7 3.0 TFSI quattro (245 kW).

³Only for A7 3.0 TFSI quattro (245 kW) and A7 3.0 TDI quattro (235 kW). ⁴Only available for TFSI models. ⁵Only available for TDI models.



Responsibility

Living up to our responsibilities is a principle that is firmly anchored in Audi strategy. Alongside commercial success and international competitiveness, our responsibility toward company employees and society as a whole is a key consideration, as is protecting the environment and conserving resources. And what is true in the details – our catalogues are printed on FSC-certified paper – also holds in general: Audi develops cars that are not only sporty and emotive but also ever more efficient. In the long run, Audi wants its products to allow CO₂-neutral

mobility. Seeing to it that production in Audi plants gradually becomes CO₂-neutral is another aspect of our comprehensive approach. Audi is also committed to society – particularly in the fields of education, technology and social projects. At Audi, sustainability is closely linked with how we see the future: the Audi Urban Future Initiative sees Audi working with international experts to get to the root of future urban challenges and trends in mobility.

Discover the world of Audi.

Choosing an Audi means choosing a brand that offers more. More individuality. More exclusivity. More fascination.

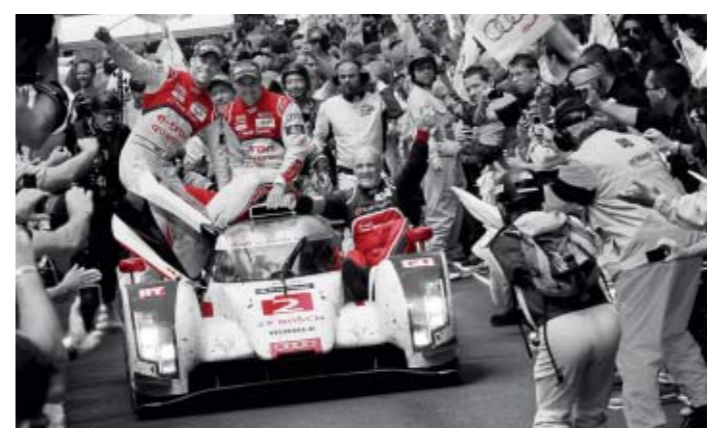

Audi experience

The fascination of Audi can be experienced in many different ways. Audi City Berlin, Audi City London and Audi City Beijing, for example, give you digital access to all models at their actual size and in real time. And of course it is always worth visiting one of the major motor shows. This is where Audi always presents its new models and invites you to take a look at how the future is being shaped with "Vorsprung durch Technik". Anyone interested in seeing how Audi is already putting this into practice will find fascinating insight in the "Vorsprung durch Technik" online special at www.audi.com. But a look back can also be rewarding: at the Audi museum mobile in Ingolstadt, history and high-tech go hand in hand. A total of 130 historic exhibits and state-of-the-art forms of

presentation make for a thrilling symbiosis. Plus, Audi driving experience allows you to live the excitement and countless possibilities of current Audi models. Here, pure driving enjoyment is combined with valuable learning effects. This is ensured by a team of specially trained and highly qualified instructors who provide practical tips to help you optimise your driving skills. All this can now also be enjoyed at the recently opened Audi driving experience center in Neuburg, near Ingolstadt. Facilities here include a circuit of up to 3.4 kilometres that features challenging combinations of bends, a 30,000 m² dynamic driving area and an offroad section where Q models can be put through their paces.



Team spirit

Motorsport is a driving force behind the brand. For years Audi has been among the champions in various racing series, for instance the 24 Hours of Le Mans or the DTM German Touring Car Masters. The values that are crucial in many different areas of sport are also central ones for Audi: precision, passion and technology. No coincidence then that Audi has been sponsoring sporting events for

many years. In the world of winter sports, for example, Audi has been the main sponsor of the German Ski Association (DSV) for almost three decades and has also partnered 16 other national alpine teams. In football, we support national and international teams. And Audi is also a partner for the German Olympic Sports Confederation.

www.audi.com

Information on all the topics mentioned above can be found on our website: www.audi.com.



www.audi.com



configurator.audi.com



www.audi.com/vorsprung-durch-technik



www.audi.com/driving



www.audi.com/cr

The fascination of Audi

Audi A7 Sportback/S7 Sportback equipment			
4-way lumbar support for the front seats	57, 109	Brake system	112
Active Noise Cancellation	57, 112	Bumper, front	57
adaptive air suspension	96	Camera-based speed limit display	95
adaptive air suspension sport	57	CD changer	91
Adaptive brake light	109	Centre armrest, front	109
adaptive cruise control with Stop&Go function including Audi pre sense front	94	Ceramic brake	96
Airbags	96, 112	Child-proof locks	112
Aluminium-look interior	110	Cigarette lighter and ashtray	111
Ambient lighting	84	Cloth and leather upholstery and trim	77
Anti-Slip Regulation (ASR)	112	Convenience key including sensor-controlled release of the luggage compartment lid	88
Anti-theft alarm	57, 88	Cruise control	93
Anti-theft wheel bolts	107	Dark-tinted windows (privacy glazing)	87
Antilock Brake System (ABS) with Electronic Brake Force Distribution (EBD)	112	Deluxe automatic air conditioning	57, 87
Assistance package including Audi pre sense plus	94	Diffuser insert, rear	57
Attention assist	111	Digital Audio Broadcasting	91
Audi active lane assist	94	Digital TV reception	91
Audi connect	92	Door sill trims with aluminium inlays	57, 85
Audi cylinder on demand	57, 112	Driver information systems	57, 89
Audi design selection Arras red	57, 65	DVD/CD changer	91
Audi design selection cedar brown	64	Dynamic steering	57, 96
Audi drive select	96	Electric steering wheel adjustment	85
Audi exclusive	68-69	Electromechanical parking brake	112
Audi exclusive carpet and floor mats	85	Electromechanical power steering	112
Audi exclusive leather controls	86	Electronic Differential Lock (EDL)	112
Audi exclusive line	66-67	Engine start-stop button	57, 110
Audi Extended Warranty	97	Exhaust tailpipes	57, 85
Audi Genuine Accessories	98-99	Exterior mirror housings in aluminium look	57
Audi Matrix LED headlights	84	Exterior mirrors	86
Audi MMI® connect app	92	First-aid kit	112
Audi music interface	57, 91	Floor mats	85, 110
Audi phone box	92	Front and reversing cameras	93
Audi pre sense basic	93	Front seats, electrically adjustable	57, 78
Audi side assist including Audi pre sense rear	94	Front-wheel drive	112
Audi Singleframe	57	Fuel tank	112
Audi sound system	57, 91	Garage door opener (HomeLink)	88
Audi TDI clean diesel	97	Gloss packages	85
Auxiliary heating/ventilation	87	Head-up display	90
Bang & Olufsen Advanced Sound System	91	Headlinings	78, 109
Bluetooth interface	57, 92	Heat-insulating glass	87
Body, galvanised	112	High-beam assist	84
Bose Surround Sound	91	Hold assist	93
Brake callipers, painted black	57	Inlays	57, 82-83
		Instrument cluster	57, 111
		Insulating/acoustic glass	87
		Integrated head restraint system	112
		Interior and exterior lighting package	84

Audi A7 Sportback/S7 Sportback equipment

Interior lighting	109	S line sport package	63
Interior mirror	110	S sport seats, front	57, 76
ISOFIX child seat mountings	97	S sport seats in the rear	57, 78
Leather packages	77, 78	S tronic®	96
LED headlights	84	Safety steering column	112
LED rear lights		Seat belt reminder	112
with dynamic indicator	84	Seat belts	97, 112
Light/rain sensor	109	Seat heating	78
Luggage compartment	89	Seat upholstery	57, 79–81
Luggage compartment lid, electrically opening and closing	88	Seat ventilation, front	78
Massage function, front	78, 109	Seats	57, 74–76
MMI® navigation	90	Selector lever knobs	57, 86
MMI® navigation plus with MMI touch	90	Side airbags	96, 112
MMI® radio	91	Side impact protection	112
MMI® radio plus	57, 91	Side sill trims	57
Model name/logo	57, 85	Slide-and-tilt glass sunroof	86
Night vision assistant	95	Spare wheel, space-saving	107
Non-smoker version	89	Sport exhaust system	57
Paint finishes	57, 70–71	Sport seats, front	76
Park assist	93	Sport suspension	96
Parking system plus	93	Start-stop system	96
Pedals and footrest in stainless steel	57	Steering wheel rims	86
Power-assisted door closing	88	Steering wheels	57, 85
Preparation for Rear Seat Entertainment	91	Storage compartments	88
Preparation for tracking system	88	Storage package	57, 88
Preparation for trailer towing hitch	88	Sun screen	87
quattro®	96	Sun visors, folding and swivelling	110
quattro® with sport differential	57, 96	Through-loading facility	57, 111
Rear seat systems	78	Through-loading facility with removable ski/snowboard bag	89
Rear spoiler	85	tiptronic	96
Recuperation	96	Trailer towing hitch	88
Remote control key	110	Tyre pressure loss indicator	107
Reversible mat	89	Tyre repair kit	107
Reversing camera	93	Vehicle jack	107
S line exterior package	62	Vehicle tool kit	107
		Warning triangle with first-aid kit	112
		Wheels/tyres	57, 72–73



AUDI AG
85045 Ingolstadt
www.audi.com
Valid from April 2015

Printed in Germany
533/1130.72.18

The models and equipment versions illustrated and described in this brochure and some of the services listed are not available in all countries. Some of the cars illustrated are equipped with optional features for which an extra charge is made. Details concerning the delivery specifications, appearance, performance, dimensions and weights, fuel consumption and running costs of the vehicle were correct to the best of our knowledge at the time of going to press. Deviations from the colours and shapes shown in the illustrations may occur. No liability is accepted for errors and printing errors. The right to introduce modifications is reserved. Not to be reproduced, including in part, without the written approval of AUDI AG.

This brochure is printed on paper made from pulp bleached without the use of chlorine.

