



The Audi Q3

Pricing and Specification Guide
Valid from October 2015

Personalising your Audi Q3

This guide has been designed to help you tailor and price your Audi Q3 quickly and logically. At the back, you will find information on CO2 emissions-based taxation and the other services offered by Audi, including Finance and Insurance. You can also configure your Audi Q3 online at audi.co.uk



Get more from this brochure with the free Audi Vision app.

Audi Vision brings our brochures to life through Augmented Reality. It works by recognising images on a page through your device's camera. Suitable for phones or tablets, download it for free from the App Store or Google Play. Once downloaded, simply open the app and scan the cover of your guide. Then look out for any page with the Audi Vision logo, you can then hold your device over the page and watch as you get exclusive access to extra images, information and video content.



The Audi Q3

LED lights	8
quattro®	12
Efficiency	14
Technology	20
Audi Connect	22

Model details and prices

SE model equipment	24
S line model equipment	28
S line Plus model equipment	30
Model prices	32

Colour and upholstery

Paint	34
Upholstery	38
Colour and trim guide	44
Seats	45

Inlays	46
---------------	----

Options

Wheels, tyres and suspension	50
Packages	54
Audio and communication	56
Interior equipment	58
Exterior equipment	60
Safety and security	62

Looking after your Audi

Audi Complete and warranty	64
Accessories	67
Merchandise	68
Audi Difference	69

Technical details

Technical data	70
Dimensions	72
Pricing and Additional information	74





Vorsprung durch Technik

Three words that express the very essence of Audi. Vorsprung durch Technik isn't a slogan. It's our way of seeing the world. It is the driving force behind our history of innovation that continues into the 21st century. Indeed, many technologies that Audi pioneered remain in our cars today. Some are milestones in the history of the motorcar. From our beginnings in 1899, to the Auto Union team's Grand Prix successes in the 1930s and our more recent wins at Le Mans, we have always been at the forefront of the motor industry.

Vorsprung durch Technik makes us who we are. To see more of its influence, just read on.

The Audi Q3. Even more distinctive.

With the same recognisable silhouette as its predecessor, the Audi Q3 maintains its coupé-like appearance. With the addition of subtle design features like the 3D grille, chrome-plated tailpipe and optional LED headlights, it's a car that's now even more eye-catching.

Inside, innovations like Audi drive select and electric lumbar support mean that the Audi Q3 is not only beautiful to look at, it's also comfortable to drive.









LED lights

Look good, see better.

For the first time, the Audi Q3 is available with LED headlights. This innovative technology means that a continuous beam of bright light is emitted, lighting the road ahead with a colour close to daylight and providing an unprecedented clarity of vision. What's more, the sleek and subtle design of Audi LED headlights make them the perfect addition to the Audi Q3. And with dynamic LED indicators at the rear, the striking look is complete.





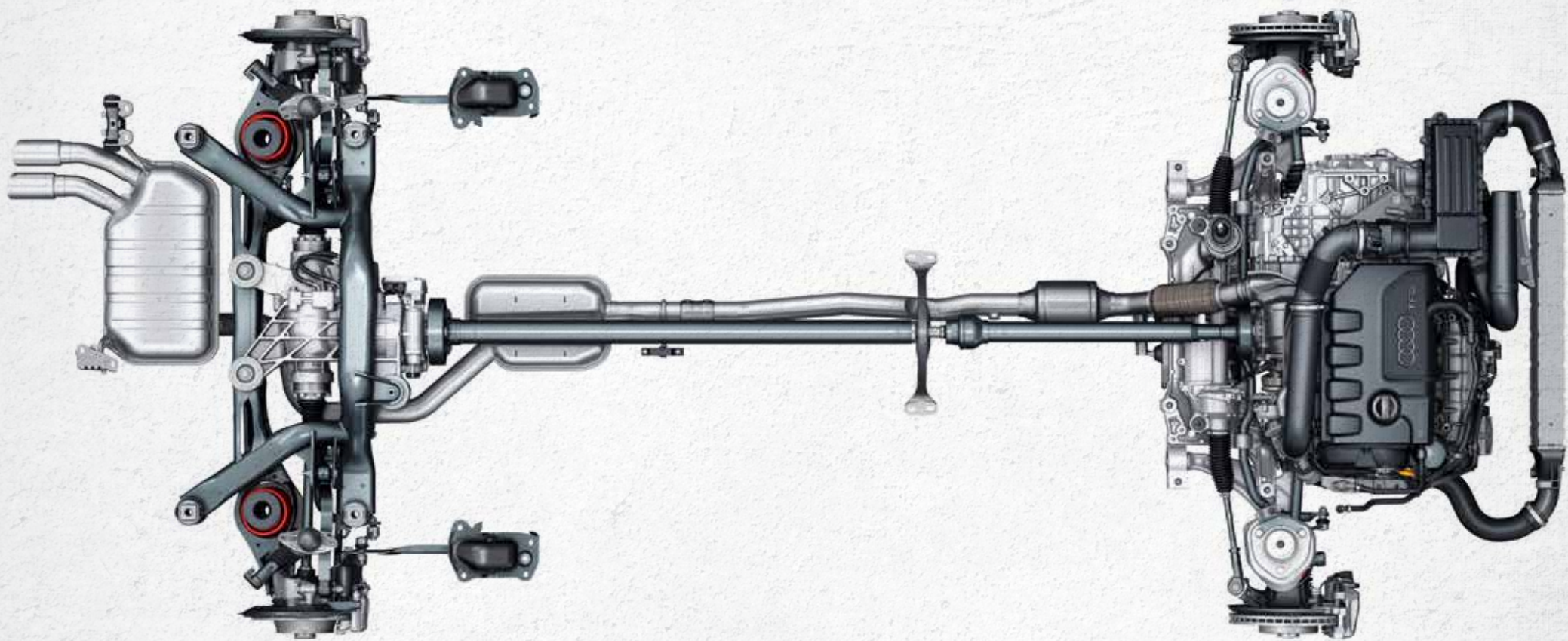

quattro®

Grip, whatever the weather.

The innovative system that helped us secure victories on the track is available with the Audi Q3.

Choose quattro® all-wheel-drive and the power generated by the engine is harnessed, giving you optimised handling and an enhanced driving experience.

In everyday conditions, you'll experience a lighter, more agile drive. And, should conditions change unexpectedly, the Audi Q3 with quattro® will be ready to respond – delivering more power and traction exactly where it's needed.

Efficiency

Sometimes less is more.

At Audi, doing less is something we're trying to do more of. Less waste. Fewer emissions. Lower fuel consumption. It's why we've incorporated a number of efficiency innovations into the Audi Q3.

Under the bonnet, with the introduction of cylinder-on-demand technology to the 1.4 TFSI engine, energy is preserved when cylinders are not needed and unleashes power when they are. And, with more additional economically-friendly engines across the range, we've managed to reduce CO₂ emissions by up to 26g/km.

Efficiency continues with Audi drive select now standard across the Q3 range; allowing the driver to choose from a number of driving modes including an 'Efficiency' mode, to ensure you get the most miles for your penny from your Audi Q3.













Inside the Audi Q3

Step inside the Audi Q3 and you'll find a range of our most luxurious specification yet. Chrome trims and optional leather upholstery add a refined yet modern look.

Its practical qualities are there for all to see, thanks to a spacious 5 seat interior and 420 litres of boot space as standard with optional extras including through load facility and a Storage package. And, so that your drive is as comfortable as can be, we've also incorporated Sport seats and electric lumbar support as standard.



Technology

Technology is advancing at an ever faster pace, and choosing the right technology for your car is an important decision.

Here at Audi we strive to make that choice as easy as possible. To that end we have packaged some of our most popular equipment together (shown below) into a choice of four Technology or Comfort packs. Not only does this make picking your technology options easier but also provides a value for money way of installing combinations that are designed to complement each other. For further details please see page 54.



MMI Navigation Plus

With HDD-based MMI navigation, you'll have access to 3D map view and 3D point-of-interest display. It means you'll be guided to your destination with greater ease. And, because destinations can be entered with both speech and writing, your attention remains firmly on the road.



Audi Side Assist

This assistance system for multi-lane roads helps alert you to other vehicles in your blind spot when changing lanes. Using radar sensors discreetly hidden in the rear bumper, other vehicles are detected and the driver alerted with a visual warning signal in the door mirror.



Colour Driver's Information System (DIS)

A high-resolution 7-inch colour display, located in the instrument cluster, provides key information from the driver assistance systems. The colour DIS can also display information from optional systems such as Audi lane assist.

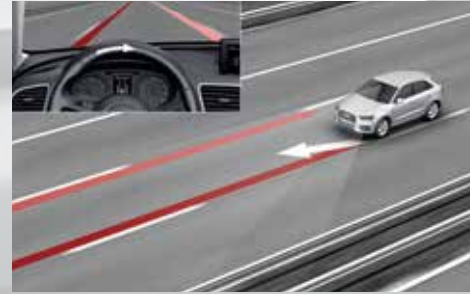

Audi Active Lane Assist

An advanced Audi safety system which helps to keep you in lane using gentle steering intervention when lane boundary markings are detected. There's also an option that vibrates the steering wheel to alert you that you've drifted out of your lane.



Audi parking system advanced with rear reversing camera

Aids parking by acoustically and visually indicating distances to obstacles with guiding lines. Measured by sensors and a rear reversing camera.



Audi parking system advanced with rear reversing camera and park assist

Also searches for and aids parking by indicating distances to obstacles, measured by ultrasonic sensors and a rear reversing camera. System automatically calculates and performs both parallel and perpendicular parking, as well as manoeuvring out of spaces – the driver only needs to accelerate and apply the brakes.



Audi Connect

Stay networked on the move.

Being inside your car shouldn't mean losing touch with the outside world. That's why, with optional Audi Connect, the Audi Q3 creates a link between you and the internet.

With high-speed, 3G internet access in your car, you can go online to access information, entertainment and Google Earth™ navigation maps by scrolling, tapping or speaking your commands. Audi Connect can even find you the cheapest fuel price in your area. And, with a wireless hotspot within the car, passengers can connect their mobile devices enabling them to browse the internet, download emails, or access social media.

With Audi Connect, the world stays at your fingertips.



Wi-fi hotspot

Connects your mobile devices to the internet



Online media streaming

Access to global radio stations via smartphone app and Wi-fi, plus access to your smartphone's media library



Weather information

Gives you forecasts and maps for your chosen destination



News online

Text and images about current world events



City events

Up-to-date information about events happening at your destination



Points of interest

Search Google™ using voice control for points-of-interest to return relevant information such as photos, opening times and visitor ratings



Traffic information online

Complements the dynamic route guidance with real-time traffic flow information for individual stretches of road



Fuel prices

Information on filling stations with the cheapest prices in your selected search area



Country specific information

The legal regulations for a specific country, such as speed limits or whether it is compulsory to carry a high-visibility vest or display a motorway toll sticker, are displayed when crossing a border



Parking information

Helps you find car parks nearby and, where available, information on prices and currently vacant spaces



Navigate with Google Earth™ and Google Street View™

Uses high-resolution aerial and satellite images to guide you to your destination. Photos, terrain information, roads and their names as well as business listings supplement the information. Google Street View provides a virtual run-through of the street views from any angle



Destination entry via myAudi or Google Maps™

If required, navigation destinations can be conveniently planned on your PC or smartphone. myAudi and Google Maps™ allow individual navigation destinations to be sent to the vehicle. When you start your journey, these can be easily loaded as your destination.



Travel information

Sightseeing information – with a function for importing the destination to the navigation system.

Please note that an external data source is required to enable Audi Connect online services. Terms and conditions apply to certain Audi Connect functions. Please see pages 54 and 75 for additional information.

SE model equipment

All Audi Q3 SE models have the following items of standard equipment

Engine and transmission

Efficiency program in the Driver's Information System (DIS) – provides the driver with fuel-saving tips and a gear-change indicator on manual and S tronic models

Start-Stop system with energy recuperation

Wheels, tyres and suspension

17" x 7J '5-spoke-Y' design alloy wheels with 235/55 R17 tyres

Tyre pressure loss indicator – visual and acoustic warning if the pressure drops in one or more tyres

Anti-theft wheel bolts

Audi drive select – with four pre-configured modes (comfort, auto, dynamic and efficiency), allowing the driver to electronically adjust the engine, transmission and steering. The efficiency mode influences the behaviour of the following parts of the car to maximise efficiency: engine, transmission shift program for S tronic (or gear-change indicator with a manual gearbox), electromechanical power steering, dual-zone climate control and cruise control (where fitted)

Dynamic suspension

Electromechanical parking brake – includes parking brake function when the car is stationary, auto-release function to assist when pulling away and emergency braking function on all four wheels

Space-saving spare wheel – for temporary use, radial tyre (5-hole)

Audio and communication

6.5" display screen – manually retractable

8 passive speakers in total, front and rear, with a total output of 80 Watts

Audi Music Interface (AMI) – provides connection to Apple iPod from 4th generation and Apple iPhone, as well as USB storage media and MP3 players

Bluetooth interface – for hands-free mobile phone connectivity and Bluetooth audio streaming (depending on compatibility of mobile phone)

Concert radio which includes:

- Single CD drive and two SDHC memory card readers (up to 32GB) which are MP3, WMA and AAC compatible
- MMI operating logic
- Speed-dependent volume control (GALA)
- TP memo – automatically saves traffic news when driving

DAB digital radio reception – integrated into the MMI, receives digitally-transmitted radio stations in addition to the range of analogue stations. Displays music track, artist and radio program. Capable of 'DAB slideshow' where transmitted. Reception dependent on local digital network. Automatic switch from DAB to FM reception if the network signal is not strong enough

Driver's Information System (DIS) – 3.5" monochrome display in the dashboard binnacle. The DIS shows the radio frequency/station or track title, telephone control menu and other display information from the infotainment system such as navigation (if fitted). Also includes an on-board trip computer with short and long-term trip memory, outside temperature display, digital speedometer, door or boot open warning and efficiency program

Preparation for SD card based navigation system – allows maps to be retro-fitted using parts from Audi Genuine Accessories

Voice control system – for key telephone and radio functions



Interior equipment

3-spoke multi-function Q-design steering wheel with chrome finish on centre spoke (with gear-shift paddles on S tronic models)

Cloth headlining

Door sill trims with aluminium inlays

Dual-zone electronic climate control – temperatures can be selected separately by driver and front passenger and the system will electronically control the air temperature, volume and distribution. Includes separate defroster button for de-icing the windscreen and side windows more quickly, air vents for the rear compartment in the rear centre console and a ventilated glove box

Electric windows, front and rear

Extendable luggage compartment cover

Front and rear floor mats in velour, to match the chosen carpet colour

Front centre armrest which can be moved forwards/backwards with adjustable angle. Also includes folding storage compartment and a 12-Volt socket in the rear centre console

Inlays in micrometallic, flex silver

Luggage compartment sill protection in stainless steel

Reversible luggage compartment floor – one side in high-quality velour, the other with a waterproof, hard-wearing plastic surface. Also includes additional storage compartments under the floor

Smoking package – includes ashtray with chrome-plated lid and a cigarette lighter in the centre console (non-smoking package is available at no charge)

Steering wheel adjustable for height and reach

Washer fluid level indicator

Safety and security

Driver, front passenger, front side and head airbag system with front passenger airbag deactivation switch

Electronic Stability Programme (ESP) – includes ABS, EBD, ASR and EDL

First aid kit

Front and rear fog lights

Light and rain sensor – automatically switches the dipped beam headlights and windscreen wipers on/off depending on the light and rain conditions. Also includes coming home/leaving home function which delays the deactivation of the front and rear lights after locking and automatic activation of the lights when unlocking

Rear parking sensors – facilitate parking by acoustically indicating the distance to obstacles; measurement is by ultrasonic sensors integrated discreetly into the bumper

Remote central locking with two foldaway keys

Seat belt monitoring

Secondary-collision brake assist

Thatcham Category 1 alarm and immobiliser

Tool kit and car jack

Warning triangle



Front Sport seats in 'Sport' cloth upholstery



Driver, front passenger, front side and head airbag system

SE model equipment

(continued)

Seats

Electric 4-way lumbar support – for front seats

ISOFIX child seat mounting – for front passenger (with airbag deactivation) and outer rear seats. Including Top Tether attachment point for the outer rear seats

Split-folding rear seats

Front Sports seats in 'Sport' cloth upholstery – includes manual adjustment of height, forwards and backwards position, backrest angle, head restraints and seat-belt height

Exterior equipment

Aluminium roof rails

Aluminium window trims framing the exterior side windows and the outer B- and C-pillar trims in high-gloss black

Body-coloured door mirrors – electrically adjustable and heated with integrated LED indicator signals

Chrome-plated tailpipe trims

Full body-colour paint finish to the front and rear bumpers, wheel arch trims and lower door trims

Front lip and rear diffuser painted in black

Xenon Plus headlights with LED daytime-running lights with automatic headlight range control. Also includes LED rear lights, brake lights and rear indicators

Heated windscreen washer jets

Tow-bar bracket preparation – includes the wiring to the spare wheel well, control unit and adapted engine cooling. The set of parts for retrofitting is available from Audi Genuine Accessories

Windscreen with sunband for improved insulation of the windscreen and acoustic glass for reduced outside noise



Split-folding rear seats



Xenon Plus headlights



LED rear lights



Image shows the Audi Q3 SE model with optional All-weather LED headlights (PX2), Panoramic sunroof (3FU) and Glacier white, metallic paint (2Y)

S line model equipment

In addition to SE model equipment

Total RRP inc VAT
£2,550.00

Wheels, tyres and suspension

18" x 7J '5-twin-spoke' design alloy wheels with 235/50 R18 tyres

Dynamic suspension (S line Sports suspension, lowered by 20mm, is available as a no cost option)

Seats

Seats upholstered in black 'Sprint' cloth/leather with embossed S line logo in the front seat backrests

Interior equipment

Cloth headlining and dashboard in black

Door sill trims with S line logo

Gear knob in perforated leather

Inlays in matt-brushed aluminium

Exterior equipment

Chrome-plated trims for exhaust tailpipes

Door mirrors – electrically adjustable, folding and heated. Also includes an automatic kerb view dipping function when reverse gear is selected. Mirrors are folded by twisting the interior mirror button on the inside of the cabin

Power-operated tailgate – opens by pressing button on the car key, button in the driver's door trim or soft-touch button in the handle recess on the luggage compartment lid. Including lid-closing assistance unit and programmable angle for the luggage compartment lid

S line radiator grille with horizontal struts in high-gloss black

S line badges on the front wings

S line body styling, comprising of S line front and rear bumpers, air inlets and door trim strips

Front lip and rear diffuser in full paint finish

Rear diffuser insert in platinum grey

All-weather LED headlights. LED technology provides lower energy consumption and enhanced contrast with a colour similar to daylight, for increased safety and good recognition by other road users. Includes all-weather light function to reduce the risk of the driver being dazzled when visibility is poor (in fog, rain or snow). Also includes headlight cleaning system.

LED tail lights including LED Dynamic Rear Indicators



18" x 7J '5-twin-spoke' design alloy wheels



'Sprint' cloth/leather upholstery with embossed S line logo



All-weather LED headlights



Image shows the Audi Q3 S line model with optional Misano red, pearl effect (N9)

S line Plus model equipment

In addition to S line model equipment

Total RRP inc VAT
£2,350.00

Wheels, tyres and suspension

19" x 8.5J '5-segment-spoke' design alloy wheels with 255/40 R19 tyres

Audio and communication

Satellite Navigation system – SD card based. Route planning and guidance using voice, pictogram and 2D mapping shown on the 6.5" colour display screen. Can be operated via the MMI controls, multi-function steering wheel or voice control system. Includes European map data and 7-digit postcode recognition

Interior equipment

Auto-dimming rear-view mirror. A light sensor detects when the headlights behind are too bright and dims the mirror automatically

Safety and security

Audi parking system plus. Acoustic and visual parking aid for the front and rear of the vehicle with on-screen display of distance remaining from obstacles using a graphical representation. Measurement is by ultrasonic sensors integrated discreetly into the bumpers

Cruise control. Maintains any speed above 18mph, provided that the engine power output and engine braking effect permit it; operated via separate steering column stalk, set speed is displayed in the Driver's Information System (DIS)

High-beam assist. Automatically adjusts headlights from high-beam to dipped-beam when another vehicle is approaching

Seats

Seats upholstered in black perforated Alcantara/leather combination

Exterior equipment

Privacy glass. Dark tinted rear and rear-side windows from B-pillar backwards

Metallic paint

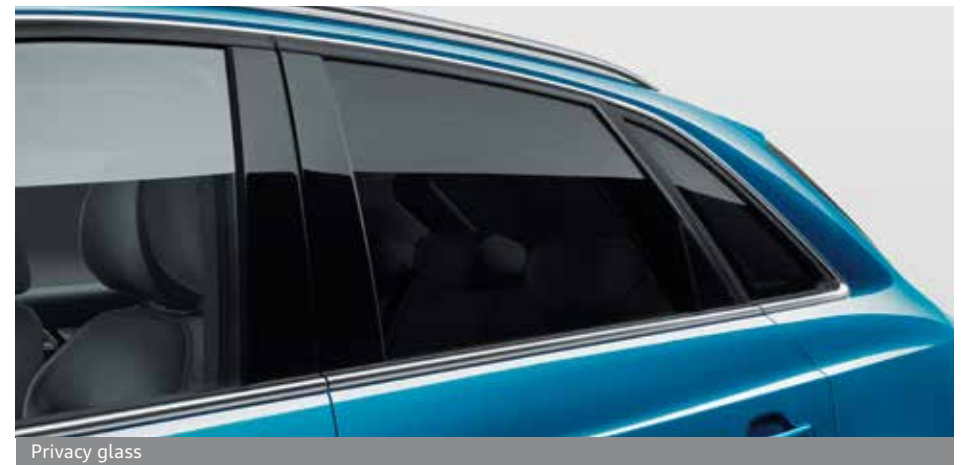



Audi Q3 SE

Engines	Power	Transmissions	CO ₂ g/km	Total RRP inc VAT	Recommended OTR
1.4 TFSI*	150PS	6-speed manual	128**	£24,965.00	£25,650.00
1.4 TFSI*	150PS	6-speed S tronic	136**	£26,545.00	£27,360.00
2.0 TFSI quattro	180PS	7-speed S tronic	152**	£29,045.00	£29,910.00
2.0 TDI	150PS	6-speed manual	119**	£26,505.00	£27,190.00
2.0 TDI quattro	150PS	6-speed manual	131**	£27,935.00	£28,750.00
2.0 TDI quattro	150PS	7-speed S tronic	134**	£29,515.00	£30,330.00
2.0 TDI quattro	184PS	6-speed manual	139**	£28,735.00	£29,550.00
2.0 TDI quattro	184PS	7-speed S tronic	139**	£30,315.00	£31,130.00

Audi Q3 S line

Engines	Power	Transmissions	CO ₂ g/km	Total RRP inc VAT	Recommended OTR
1.4 TFSI*	150PS	6-speed manual	131**	£27,515.00	£28,330.00
1.4 TFSI*	150PS	6-speed S tronic	138**	£29,095.00	£29,910.00
2.0 TFSI quattro	180PS	7-speed S tronic	155**	£31,595.00	£32,460.00
2.0 TDI	150PS	6-speed manual	122**	£29,055.00	£29,740.00
2.0 TDI quattro	150PS	6-speed manual	134**	£30,485.00	£31,300.00
2.0 TDI quattro	150PS	7-speed S tronic	137**	£32,065.00	£32,880.00
2.0 TDI quattro	184PS	6-speed manual	143**	£31,285.00	£32,115.00
2.0 TDI quattro	184PS	7-speed S tronic	141**	£32,865.00	£33,695.00

*With cylinder-on-demand technology.

**Please note – CO₂ emissions can change if a different size alloy is ordered onto the vehicle. This may also lead to a change to the VED amount payable. Please refer to pages 52, 53, 71 & 75 for more information.

Please note: The maximum power output figures are quoted in PS (or Pferdestärke, which is the metric equivalent of brake horsepower). To convert to brake horsepower, divide the PS figure by 1.0139.

Recommended On-The-Road (OTR) retail prices include: delivery charge, half a tank of fuel, number plates at £630.00 (inc. VAT), Road Fund Licence (which may vary depending on model/transmission – see page 75 for details) and first registration fee at £55.00. Vehicle Excise Duty correct at time of going to print, but this may alter to reflect any change in the applicable VED rate.

RRP – Recommended Retail Price. VAT is calculated at 20% but this may alter to reflect any change in the applicable VAT rate.

Audi Q3 S line Plus

Engines	Power	Transmissions	CO ₂ g/km	Total RRP inc VAT	Recommended OTR
2.0 TFSI quattro	180PS	7-speed S tronic	161**	£33,945.00	£34,810.00
2.0 TDI quattro	150PS	6-speed manual	140**	£32,835.00	£33,650.00
2.0 TDI quattro	150PS	7-speed S tronic	144**	£34,415.00	£35,245.00
2.0 TDI quattro	184PS	6-speed manual	148**	£33,635.00	£34,465.00
2.0 TDI quattro	184PS	7-speed S tronic	146**	£35,215.00	£36,045.00



Paint

We believe that every part of your car should have a personal touch, which is why you can choose from a wide range of paint colours and finishes, from standard shades to metallic and pearl effects. We can even mix a customised colour for you to create the perfect fit.

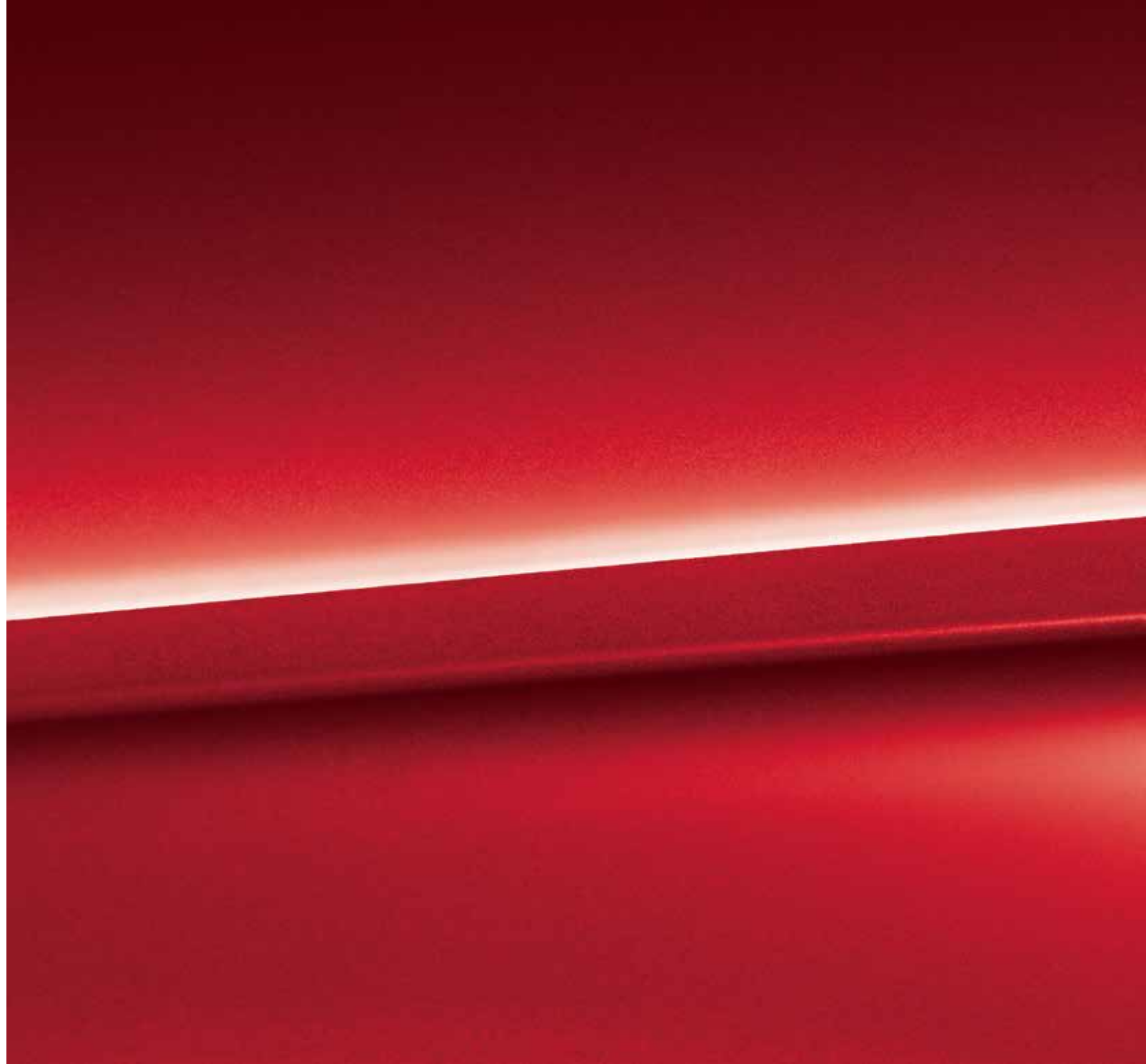

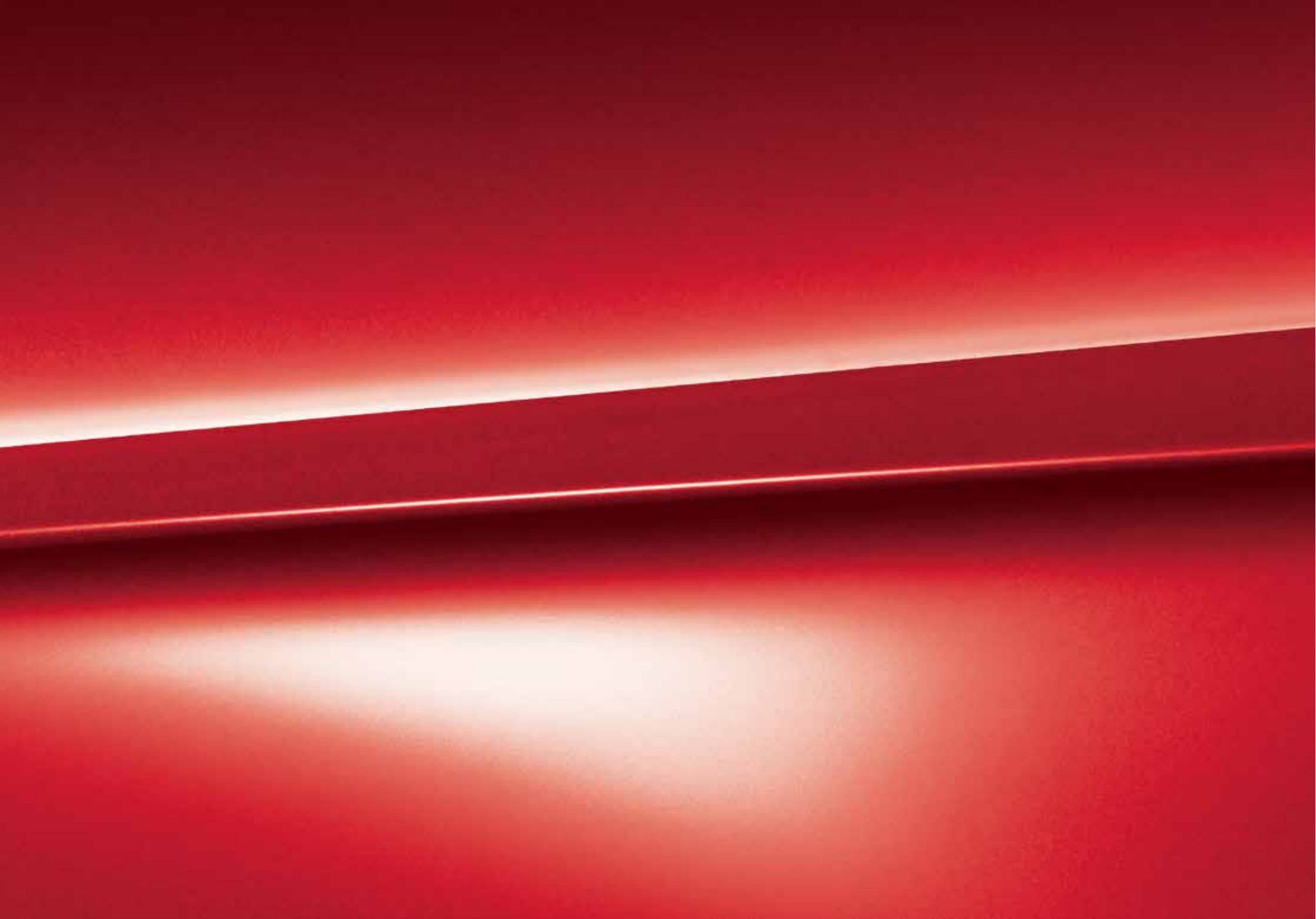

Paint

You can select one of the standard colours shown opposite or, for a different look, choose from a range of optional finishes.

Standard colours



Shell white - B4

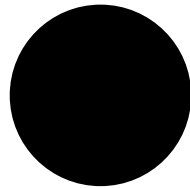

Brilliant black - A2

Optional colours

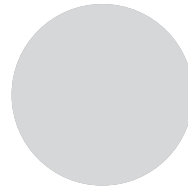

Floret silver, metallic - L5

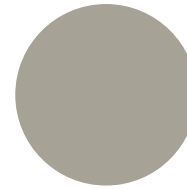

Cuvée silver, metallic - 0D

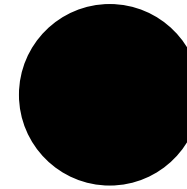

Mythos black, metallic - 0E

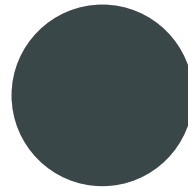

Monsoon grey, metallic - 0C

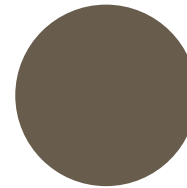

Tundra brown, metallic - 53

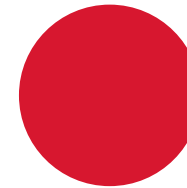

Misano red, pearl effect - N9

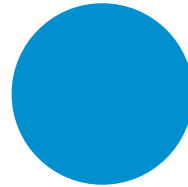

Hainan blue, metallic - F7

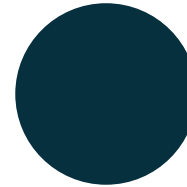

Utopia blue, metallic - D2



Glacier white, metallic - 2Y

S line colour

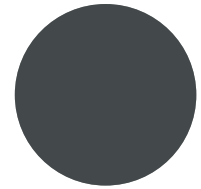

Daytona grey, pearl effect - 6Y

Options are subject to availability and may extend delivery.

*On S line Plus trim the optional colours have no charge.

All the colour swatches on this page are matched as accurately as possible to the actual paint colours used. However, due to print processes, Audi UK cannot guarantee that colours shown are 100% accurate.

Visit your local Audi Centre for a more accurate colour swatch.

RRP - Recommended Retail Price.

VAT is calculated at 20% but this may alter to reflect any change in the applicable VAT rate.

Optional colours⁺

Total RRP inc VAT
£550.00

S line colour⁺

Total RRP inc VAT
£550.00

Paint

Audi exclusive

Everyone has a favourite colour. No matter what yours is, Audi exclusive provides a range of unique colours that have been designed to set your car apart. Choose from the swatches here, or specify any other paint colour in the Audi range. Whether it's Sepang blue from the Audi R8 or Alpine white from the original Audi quattro, the choice is yours.*

Customised

If you have a particular colour in mind, we'll mix the exact metallic or pearl-effect shade you want.**

*Audi exclusive paint is subject to factory approval. Visit your local Audi Centre for colour samples.

**Customised paint is subject to factory approval, and is available for metallic and pearl-effect water-based paints only. Three-colour process colours and two-tone schemes are not available.

All the colour swatches on this page are matched as accurately as possible to the actual paint colours used. However, due to print processes, Audi UK cannot guarantee that colours shown are 100% accurate.

Visit your local Audi Centre for a more accurate colour swatch.

RRP - Recommended Retail Price.

VAT is calculated at 20% but this may alter to reflect any change in the applicable VAT rate.

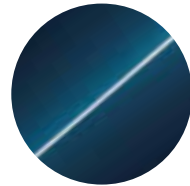

Palace blue, pearl effect

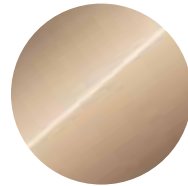

Sand beige, pearl effect

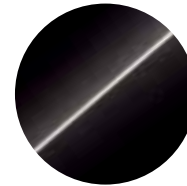

Saddle brown, pearl effect

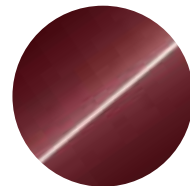

Classic red, pearl effect

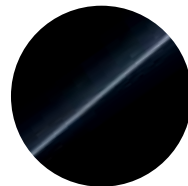

Mamba black, metallic

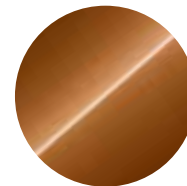

Ipanema brown, metallic



Any colour in the Audi range or 100 exclusive colours to choose from*

Audi exclusive*

Total RRP inc VAT
£2,025.00



Customised paint**

Customised**

Total RRP inc VAT
£2,525.00

Upholstery

It's important to feel comfortable on the road. Just choose from our range of luxury upholstery materials and textures, including additional support and colour options, for complete relaxation while you drive.





Upholstery

Front Sports seats

With prominent side bolsters for better lateral support when cornering and electric lumbar support for driver and front passenger. Manual height adjustment, manually adjustable seat cushion angle and extendable thigh rest.

Options are subject to availability and may extend delivery.





- = Not available
- = Available
- S = Standard

All leather upholstery choices include seats, head restraints, front centre armrest and door panels in leather.

Alcantara/leather includes head restraints, seat side bolster and front centre armrest in leather with the seat centres and door panels in Alcantara.

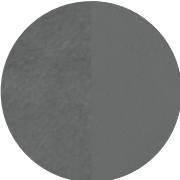
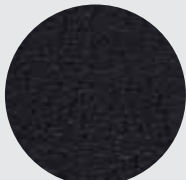

RRP - Recommended Retail Price.

VAT is calculated at 20% but this may alter to reflect any change in the applicable VAT rate.

		SE	S line	S line Plus	Total RRP inc VAT
Sport cloth		S	-	-	No charge
	Black/Silver - FZ				
Alcantara/leather (N7U)		•	-	-	£795.00
	Black - FZ				
					
	Rock grey - XY				
Milano leather (N5W)		•	-	-	£1,150.00
	Black - FZ				
Fine Nappa leather (N3Q)		•	-	-	£1,450.00
	Black - FZ				

Upholstery

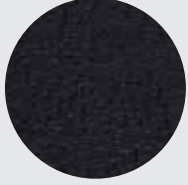
Standard seats with leather upholstery (PN1)

		SE	S line	S line Plus	Total RRP inc VAT
Milano leather (N5W)	 <p>Black - FZ</p>	•	-	-	£1,150.00
Fine Nappa leather (N3Q)	 <p>Black - FZ</p>  <p>Rock grey - XY</p>	•	-	-	£1,450.00

Options are subject to availability and may extend delivery.



- = Not available
- = Available
- S = Standard

RRP - Recommended Retail Price.

VAT is calculated at 20% but this may alter to reflect any change in the applicable VAT rate.

Upholstery

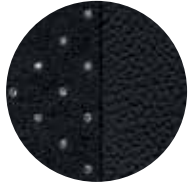
S line Sports seats with S line embossing

	SE	S line	S line Plus	Total RRP inc VAT
Sprint cloth/leather (N7V)  Black - QF	-	S	-	No charge
Perforated Alcantara/leather (N7K)  Black - QF	-	•	S	£485.00
Fine Nappa Leather (N2R)   Black - QE Rotor grey - SL	-	•	-	£795.00
	-	-	•	£645.00

Options are subject to availability and may extend delivery.

- = Not available
- = Available
- S = Standard

All leather upholstery choices include seats, head restraints, front centre armrest and door panels in leather.

Alcantara/leather includes head restraints, seat side bolster and front centre armrest in leather with the seat centres and door panels in Alcantara.

RRP - Recommended Retail Price.

VAT is calculated at 20% but this may alter to reflect any change in the applicable VAT rate.



S line Sports seats with Sprint cloth/leather upholstery

Colour and trim guide

Interior trim colours

Front Sports seats

Order code	Upholstery	Carpet	Dashboard (upper/lower)	Headlining	Sport cloth (N5F)	Alcantara/leather (N7U)	Milano leather (N5W)	Fine Nappa leather (N3Q)
FZ	Black/Silver	Black	Black/Black	Lunar silver	●	—	—	—
FZ	Black	Black	Black/Black	Lunar silver	—	●	●	●
XY	Rock grey	Black	Black/Grey	Lunar silver	—	●	—	—

Standard seats with leather upholstery (PN1)

Order code	Upholstery	Carpet	Dashboard (upper/lower)	Headlining	Milano leather (N5W)	Fine Nappa leather (N3Q)
FZ	Black	Black	Black/Black	Lunar silver	●	●
XY	Rock grey	Black	Black/Grey	Lunar silver	—	●

S line Sports seats with S line embossing

Order code	Upholstery	Carpet	Dashboard (upper/lower)	Headlining	Sprint cloth/leather (N7V)	Perforated Alcantara/leather (N7K)	Fine Nappa leather (N2R)
QE	Black	Black	Black/Black	Black	—	—	●
QF*	Black with Jet grey stitching	Black	Black/Black	Black	●	●	—
SL	Rotor grey	Black	Black/Black	Black	—	—	●

Options are subject to availability and may extend delivery.

— = Not available
 ● = Available
 S = Standard

*Black/Jet grey stitching on seats, steering wheel, gear-lever gaiter and floor mats.

Seats

Choose from a variety of different seat options so you can maintain the right driving posture at all times.

Order Code		SE	S line	S line Plus	Total RRP inc VAT
4A3	Heated front seats. Individually controlled variable temperature adjustment for driver and front passenger seats	●	●	●	£295.00
PV1	Electric front seats. Includes adjustment for height, forwards and backwards position, backrest angle and lumbar support	●	●	●	£765.00
3NU	Through-load facility. For safely transporting long objects. Includes rear centre armrest with cup holders	●	●	●	£175.00

Options are subject to availability and may extend delivery.

- = Not available
- = Available
- S = Standard

RRP – Recommended Retail Price.

VAT is calculated at 20% but this may alter to reflect any change in the applicable VAT rate.



Through-load facility



Electric front seats

Inlays

Attention to detail can make a big impact. From contemporary Aluminium satellite to classic Walnut brown, our selection of inlays make the perfect finishing touch to your car's interior.





HYUNDAI

Inlays

Inlays are the all-important finishing touch that add flair and interest to your car's interior.

Order Code		SE	S line	S line Plus	Total RRP inc VAT
5MA	Micrometallic flex silver	S	-	-	No charge
5MF	Aluminium satellite*	•	-	-	£205.00
5MS	Walnut, balsamic brown*	•	-	-	£300.00
5TG	Matt-brushed aluminium*	-	S	S	No charge

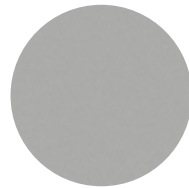

Micrometallic silver - 5MA

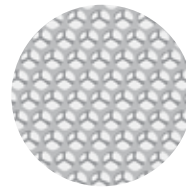

Aluminium satellite - 5MF



Walnut, balsamic brown - 5MS

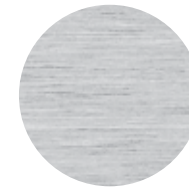

Matt-brushed aluminium - 5TG

Options are subject to availability and may extend delivery.

- = Not available
• = Available
S = Standard

*Also includes elements in aluminium look on rotary light switch, cover on 12-Volt socket, electric window switches and mirror adjustment switch.

RRP - Recommended Retail Price.

VAT is calculated at 20% but this may alter to reflect any change in the applicable VAT rate.



Elements in aluminium-look on electric window switches and mirror adjustment

Inlays

Audi exclusive

Audi exclusive has sourced a wide range of materials which you can select for your inlays, from Oak sepia to Fine grain myrtle.

Order Code		SE	S line	S line Plus	Total RRP inc VAT
YTA S3G	Audi exclusive inlays. Cannot be combined with inlays shown on page 48	●			£910.00



Fine grain myrtle, nutmeg



Fine grain ash, nougat

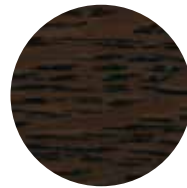

Oak, sepia



Vavona wood, bronze



Modrone wood, gold



Tamo ash, dark brown

Options are subject to availability and may extend delivery.

- = Not available
- = Available
- S = Standard

RRP – Recommended Retail Price.

VAT is calculated at 20% but this may alter to reflect any change in the applicable VAT rate.

Options

Every driver has different needs, which is why we have created some useful options to further enhance your car. For extra comfort, support, style or function, you can choose from a variety of additional features, tailoring everything from your infotainment and audio equipment to your wheels and lighting.





Wheels, tyres and suspension

Choose a set of specially-selected alloy wheels to subtly enhance the way your car looks and drives.



17" x 7J '10-spoke'
design alloy wheels - C2M



18" x 7J '5-spoke dynamic'
design alloy wheels - C1I



18" x 7J '5-double-spoke'
design alloy wheels - C3P



18" x 7J '5-arm Off-road'
design alloy wheels - C3Q



18" x 8J '5-arm Structured'
design alloy wheels - C1J



18" x 7J '5-arm turbine two-tone'
design alloy wheels - V68



19" x 8.5J '10-spoke' design alloy wheels
in matt titanium finish - C8K



19" x 8.5J '5-double-spoke Off-road'
design alloy wheels - C7G



19" x 8.5J '5-segment-spoke'
design alloy wheels - C5E

Please note that choosing an optional wheel may affect the fuel consumption figures and the CO₂ emissions on your Q3. This may result in a change in the subsequent Vehicle Excise Duty payable. Please see pages 71 and 75 for more details.

Wheels, tyres and suspension

Order Code		SE	S line	S line Plus	Total RRP inc VAT
C2M	17" x 7J '10-spoke' design alloy wheels with 235/55 R17 tyres	●	—	—	No charge
C1I	18" x 7J '5-spoke dynamic' design alloy wheels with 235/50 R18 tyres	●	—	—	£900.00
C3P	18" x 7J '5-double-spoke' design alloy wheels with 235/50 R18 tyres	—	●	—	£380.00
C3Q	18" x 7J '5-arm Off-road' design alloy wheels with 235/50 R18 tyres	—	●	—	£380.00
C1J	18" x 8J '5-arm Structured' design alloy wheels with 235/50 R18 tyres	●	—	—	£1,250.00
		—	●	—	£380.00
V68	18" x 7J '5-arm turbine two-tone' design alloy wheels with 235/50 R18 tyres	●	—	—	£1,250.00
C8K	19" x 8.5J '10-spoke' design alloy wheels in matt titanium finish with 255/40 R19 tyres	●	●	—	£1,250.00
		—	—	●	£325.00
		●	—	—	£1,450.00
C7G	19" x 8.5J '5-double-spoke Off-road' design alloy wheels with 255/40 R19 tyres	—	●	—	£595.00
		—	—	●	No charge
C5E	19" x 8.5J '5-segment-spoke' design alloy wheels with 255/40 R19 tyres	●	—	S	£1,450.00
		—	●	S	£595.00
1JT	Damper control – works in combination with Audi drive select to provide electronically controlled adjustment of the suspension to different situations. Comfort, auto, dynamic or efficiency modes can be selected	●	●	●	£680.00
UC3	S line Sports suspension – lowered by 20mm with more firmly tuned springs and dampers for more direct contact with the road	—	●	●	No charge

Options are subject to availability and may extend delivery.

— = Not available
● = Available
S = Standard

Please note that choosing an optional wheel may affect the fuel consumption figures and the CO₂ emissions on your Q3. This may result in a change in the subsequent Vehicle Excise Duty payable. Please see pages 71 and 75 for more details.

RRP – Recommended Retail Price.

VAT is calculated at 20% but this may alter to reflect any change in the applicable VAT rate.

Packages

Some items work well together, which is why we've created these special packages. They provide increased convenience and value by combining several of our most popular options.

Options are subject to availability and may extend delivery.

- = Not available
- = Available
- S = Standard

RRP – Recommended Retail Price.

VAT is calculated at 20% but this may alter to reflect any change in the applicable VAT rate.

Order Code	SE	S line	S line Plus	Total RRP inc VAT
<p>Technology package – includes HDD-based MMI Satellite Navigation Plus, Mobile Phone Preparation – High, with Audi Connect and colour Driver's Information System (9Q8). HDD-based MMI Satellite Navigation Plus includes the following: navigation data saved on hard disk drive, high-resolution 7" colour display screen with high-quality map view. Map with topographical shading and many points-of-interest and city models shown in 3D. A choice of three alternative routes can be selected where possible. Includes a rotary button with integrated joystick function for searching in the map. Route information is displayed on a split screen (route instructions, points-of-interest along motorways, TMC traffic reports en route). Detailed intersection map and lane recommendations. Dynamic route guidance using TMC traffic information. Navigation address can be input using the voice control system. Route arrow instructions displayed in colour in the Driver's Information System. Includes full European map data and 7-digit postcode recognition. Also includes a hard disk drive jukebox function which can be used to store up to 20GB of music (MP3, WMA, AAC and MPEG4 compatible) and a DVD drive for playing music and video DVDs (when the car is stationary). The MMI Satellite Navigation Plus can be operated via the MMI controls, multi-function steering wheel or voice control system</p> <p>WB4</p> <p>Audi Connect provides access to a number of innovative online services via an internal UMTS (3G) module. Audi Connect online services include: navigation using Google Earth images™ and Google Street View™, destination entry via Google Maps™ or myAudi, online point of interest search and information services such as weather forecasts and the latest news. Audi Connect also includes Audi traffic information online, which gives accurate real-time forecasts of the traffic situation along the chosen route. The traffic situation can be displayed on the navigation map or Google Earth image™. Audi Connect can also create a Wi-fi hotspot in the car for convenient internet access using a mobile device (e.g. laptop or tablet). Many Audi Connect features can be simply operated via MMI Navigation Plus, the multi-function steering wheel or the voice control system</p>	•	•	–	£1,495.00
<p>PX2</p> <p>All-weather LED headlights including LED rear lights with Dynamic Rear Indicators. LED technology provides lower energy consumption and enhanced contrast with a colour similar to daylight, for increased safety and good recognition by other road users. Includes all-weather light function to reduce the risk of the driver being dazzled when visibility is poor (in fog, rain or snow). Also includes headlight cleaning system</p>	•	–	–	£1,150.00



MMI Navigation Plus



All-weather LED headlights

Packages

Order Code		SE	S line	S line Plus	Total RRP inc VAT
WBI	Comfort package – includes Audi parking system plus, Cruise control, High beam assist and Auto-dimming rear-view mirror	●	●	S	£670.00
WB0	Comfort package plus – includes all the contents on the Comfort package and also Audi Parking system advanced with reversing camera and Park assist	●	●	–	£1,150.00
		–	–	●	£580.00
WB1	Comfort package advanced – includes all the contents of the Comfort package plus and also Audi side assist and Active lane assist	●	●	–	£1,750.00
		–	–	●	£1,250.00
PKQ	Audi exclusive off-road styling package. Includes Audi exclusive door sill trims, front and rear bumpers, side ventilation grilles, door capping strips and wheel arch trims in striking off-road design, stainless steel underbody guards on the front and rear bumpers and radiator grille with vertical chrome bars. Only in combination with 19" x 8.5J 'S-double-spoke off-road' design alloy wheels (C7G) or 19" x 8.5J 'S-segment-spoke' design alloy wheels (CSE)	●	–	–	£1,795.00

Options are subject to availability and may extend delivery.

- = Not available
- = Available
- S = Standard

RRP – Recommended Retail Price.

VAT is calculated at 20% but this may alter to reflect any change in the applicable VAT rate.

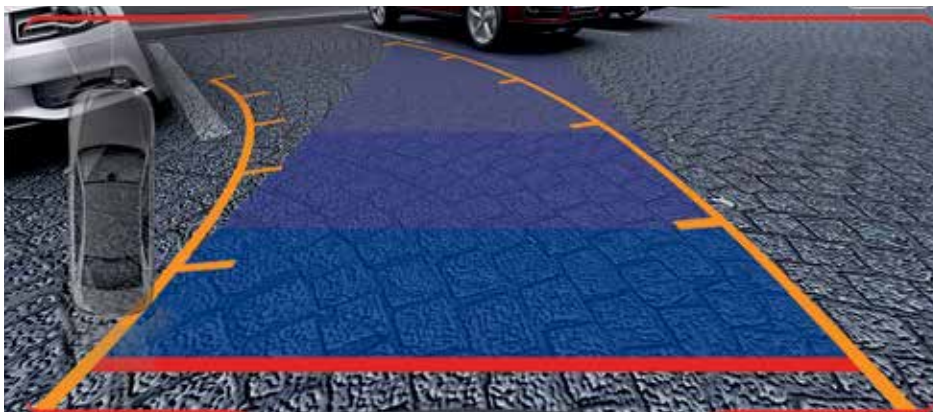

Audi parking system advanced – part of Comfort package plus



Audi side assist – part of the Comfort package advanced

Audio and communication

Stay in touch using our range of communication functions, and give each journey its own soundtrack with our advanced audio equipment.

Options are subject to availability and may extend delivery.

- = Not available
• = Available
S = Standard

RRP – Recommended Retail Price.

VAT is calculated at 20% but this may alter to reflect any change in the applicable VAT rate.

Order Code		SE	S line	S line Plus	Total RRP inc VAT
9Q8	Colour Driver's Information System (DIS) with high-resolution 3.5" TFT colour display. Also available as part of the Technology package (WB4)	•	•	•	£120.00
9VD	Audi sound system , with 10 speakers including centre speaker in the dashboard and subwoofer beneath the luggage compartment floor. Total output of 180 Watts and 6-channel amplifier. Not available in conjunction with the option to increase boot volume to 460 litres (3GA/1G8)	•	•	•	£255.00
9VK	BOSE® surround sound . Surround sound reproduction with 14 speakers including a centre speaker on the dashboard, a subwoofer beneath the luggage compartment floor and front door speakers with edges lit by LEDs. It also includes Audio Pilot for noise-dependent volume adjustment, 10-channel amplifier with a total output of 465 Watts, powerful and accurate bass reproduction which produces an outstanding overall listening experience. 5.1 surround sound reproduction is possible when ordered in conjunction with Technology package. Only in combination with LED interior light package (QQ1). Not available in conjunction with the option to increase boot volume to 460 litres (3GA/1G8)	•	•	•	£690.00
PNU	Satellite Navigation system – SD card based . Route planning and guidance using voice, pictogram and 2D mapping shown on the 6.5" colour display screen. Can be operated via the MMI controls, multi-function steering wheel or voice control system. Includes European map data and 7-digit postcode recognition	•	•	S	£495.00
QU6	Digital TV reception . Receives digital (DVB-T) uncoded television stations (MPEG-2 standard), TV picture, teletext and Electronic Programme Guide (EPG). Facility to connect external AV sources via adaptor cable (available from Audi Genuine Accessories). Please note – TV reception depends on local digital network availability. No AV or TV video output when driving (audio output available). Only in combination with Technology package (WB4)	•	•	•	£870.00
9ZF	Audi Phone Box – enables drivers to use their mobile phone in the car by placing it in the storage compartment provided in the centre console to create a 'wireless' connection to the vehicle aerial. Operated via the MMI control panel or the multi-function steering wheel. Mobile phone can be charged via a USB port	•	•	•	£175.00



Colour Driver's Information System (DIS)



BOSE® surround sound



Interior equipment

Specify every detail of your car's interior with this range of exclusive options.

Options are subject to availability and may extend delivery.

- = Not available
- = Available
- S = Standard

RRP – Recommended Retail Price.

VAT is calculated at 20% but this may alter to reflect any change in the applicable VAT rate.

Order Code		SE	S line	S line Plus	Total RRP inc VAT
4L6	Auto-dimming rear-view mirror. A light sensor detects when the headlights behind are too bright and dims the mirror automatically. Also available as part of the Comfort packages (see page 55 for details)	•	•	S	£295.00
6SJ	Reversible luggage compartment mat. Velour on one side, rubber on the other, this mat folds out to cover the luggage compartment floor, the sill/bumper and the backs of the rear seats when folded down. Not available in conjunction with the option to increase boot volume to 460 litres (3GA/1G8)	•	•	•	£75.00
3GA 1G8	Option to increase boot volume to 460 litres. Replaces space saver spare wheel with a tyre mobility kit and deletes the reversible luggage compartment floor. Not available with Technology package (WB4), Audi sound system (9VD), BOSE surround sound (9VK) or Reversible luggage compartment mat (6SJ)	•	•	•	No charge
6NQ	Cloth headlining in Black	•	S	S	£225.00
QE1	Storage package. Comprising storage nets on front-seat backrests, storage compartments under both front seats, lockable glove box and multi-purpose hook in front passenger footwell	•	•	•	£100.00
QE4	Luggage compartment package. Includes a stretch combi-net for fixing down objects into the luggage compartment, a 12V socket, a movable side net and a second luggage compartment light on the left	•	•	•	£85.00
QQ1	LED interior light package. Glare-free illumination of the interior thanks to energy-saving, durable LED technology. Consists of ambient light LED located in the interior light control unit, door sill illumination, vanity mirrors, storage compartment in the centre console and cup holders. Also features lighting for the door pockets, footwells, inside door handles, uplit centre console and door inner panels and active door reflectors	•	•	•	£245.00
9JA	Non-smoking package. Replaces ashtray and cigarette lighter with a 12V socket and a centre storage compartment	•	•	•	No charge



LED interior light package



Luggage compartment package

Exterior equipment

Make sure your car looks exactly as you want it to by selecting some of the striking exterior options from our detailed list.

Options are subject to availability and may extend delivery.

- = Not available
- = Available
- S = Standard

RRP – Recommended Retail Price.

VAT is calculated at 20% but this may alter to reflect any change in the applicable VAT rate.

Order Code		SE	S line	S line Plus	Total RRP inc VAT
3FU	Panoramic glass sunroof. Two-piece; the front glass element with electric slide-and-tilt control and electric sunblind for front and rear passengers. Automatic close function from outside via the remote central locking. Provides added light and improved air extraction. Only in combination with LED interior lighting package (QQ1). Please note that this option reduces the headroom by 45mm	•	•	•	£1,125.00
4E7	Power-operated tailgate. Opens by pressing button on the car key, button in the driver's door trim or soft-touch button in the handle recess on the luggage compartment lid. Including lid-closing assistance unit and programmable angle for the luggage compartment lid	•	S	S	£385.00
PG3	Advanced key. Access and authorisation system which automatically exchanges data between key and vehicle, allowing the driver to keep the key in their pocket or bag at all times. To unlock and open, simply lift the exterior door handle. To lock, press the button on the handle. Also includes an ignition start/stop button integrated in the centre console to start and stop the engine	•	•	•	£425.00
4KF	Privacy glass. Dark tinted rear and rear-side windows from B-pillar backwards	•	•	S	£360.00
4ZD	Audi exclusive black styling package. Front radiator grille frame, side window trims in high-gloss black with radiator grille and number plate holder in matt black. Only in combination with Black roof rails (3S2). Not available with Mythos black, metallic paint	•	•	•	£395.00
3S2	Black roof rails	•	•	•	No charge



Panoramic glass sunroof



Panoramic glass sunroof

Exterior equipment

Order Code		SE	S line	S line Plus	Total RRP inc VAT
1D4	Towing equipment – ball rod and ball coupling. The ball coupling swings out mechanically and is operated manually via a Bowden cable. Includes an indicator lamp on the Bowden cable and a display in the instrument cluster for checking if the tow bar has locked into place correctly. Also includes a trailer stabilisation programme in the Electronic Stability Programme (ESP)	●	●	●	£625.00
6XE	Door mirrors – electrically adjustable, folding and heated. Also includes an automatic kerb view dipping function when reverse gear is selected (mirrors are folded by twisting the interior mirror button)	●	S	S	£150.00
6XK	Door mirrors – auto-dimming on the driver’s side, electrically adjustable, folding and heated. Must be combined with auto-dimming rear-view mirror (4L6) or Comfort packages (see page 55 for details). Also includes an automatic kerb view dipping function on the passenger side when reverse gear is selected (mirrors are folded by twisting the interior mirror button)	●	–	–	£250.00
		–	●	●	£100.00
2Z0	Deletion of model and technology designation at rear	●	●	●	No charge
2Z7	Deletion of technology designation at rear	●	●	●	No charge

Options are subject to availability and may extend delivery.

- = Not available
- = Available
- S = Standard

RRP – Recommended Retail Price.

VAT is calculated at 20% but this may alter to reflect any change in the applicable VAT rate.

Safety and security

Intelligent technology designed to give you better all-round awareness and safety on the road.

Options are subject to availability and may extend delivery.

- = Not available
- = Available
- S = Standard

RRP – Recommended Retail Price.

VAT is calculated at 20% but this may alter to reflect any change in the applicable VAT rate.

Order Code		SE	S line	S line Plus	Total RRP inc VAT
7X4	Audi parking system plus. Acoustic and visual parking aid for the front and rear of the vehicle with on-screen display of distance remaining from obstacles using a graphical representation. Measurement is by ultrasonic sensors integrated discreetly into the bumpers. Also available as part of the Comfort packages (see page 55 for details)	•	•	S	£325.00
7X5	Audi parking system plus with park assist. Searches for suitable parking spaces along the road by means of ultrasonic sensors, calculates the ideal parking path and performs the steering action automatically. Park assist performs both parallel and perpendicular parking, as well as manoeuvring out of parallel parking spaces. The steering is done by the vehicle – the driver only needs to accelerate and apply the brakes	•	•	-	£500.00
		-	-	•	£175.00
		In combination with Comfort package		•	•
7X8	Audi parking system advanced with rear reversing camera. Aids parking by acoustically and visually indicating distances to obstacles with guiding lines. Measured by sensors and a rear reversing camera	•	•	-	£650.00
		-	-	•	£325.00
		In combination with Comfort package		•	•
8A3	Audi parking system advanced with rear reversing camera and park assist. Searches for suitable parking spaces along the road by means of ultrasonic sensors, calculates the ideal parking path and performs the steering action automatically. Park assist performs both parallel and perpendicular parking, as well as manoeuvring out of parallel parking spaces. The steering is done by the vehicle – the driver only needs to accelerate and apply the brakes. Also aids parking by acoustically and visually indicating distances to obstacles with guiding lines. Measured by sensors and a rear reversing camera. Also available as part of select Comfort packages (see page 55 for details)	•	•	-	£900.00
8T2	Cruise control. Maintains any speed above 18mph, provided that the engine power output and engine braking effect permit it; operated via separate steering column stalk, set speed is displayed in the Driver's Information System (DIS). Also available as part of the Comfort packages (see page 55 for details)	•	•	S	£225.00

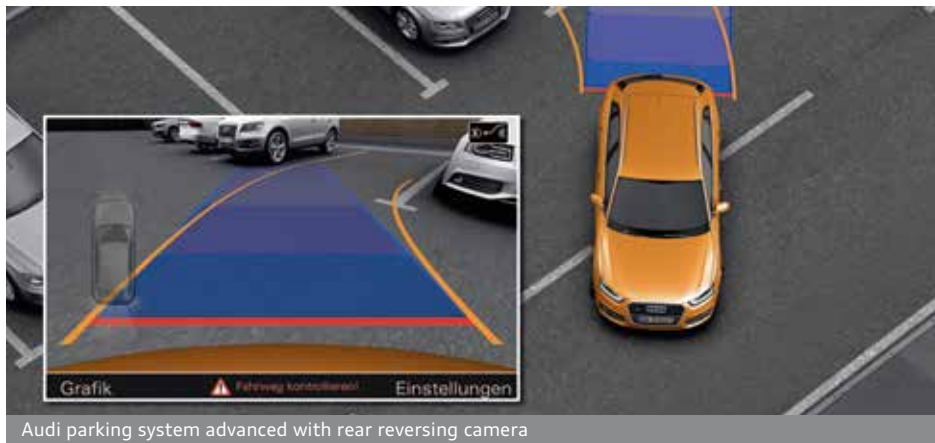

Audi parking system advanced with rear reversing camera



Audi parking system advanced with rear reversing camera and park assist

Safety and security

Order Code		SE	S line	S line Plus	Total RRP inc VAT
4X4	Rear side airbags. Situated in side of rear seats	•	•	•	£300.00
UH2	Audi hill-hold assist. Once the vehicle comes to a stop, Audi hill-hold assist uses either the ESP system or the electromechanical parking brake to hold the vehicle stationary for an unlimited amount of time, thus preventing it from rolling away on uphill or downhill gradients	•	•	•	£90.00
UG5	Hill descent control. Speed control by means of brake intervention and engine drag torque, whilst constantly maintaining speed depending on surface. The driver just has to steer, but does not have to accelerate or brake	•	•	•	£195.00
7Y1	Audi side assist. Aids the driver when changing lane. Audi side assist monitors the area behind your car using radar sensors located discreetly in the rear bumper. It then informs the driver with a visual warning signal in the door mirror if there is a vehicle in their blind spot or approaching quickly from behind. The system is activated using a button in the driver's door. Also available as part of the Comfort package advanced (WB1)	•	•	•	£450.00
7Y4	Audi active lane assist. Lane markings are registered by an optical sensor in the windscreen from speeds of approximately 40mph or above. Camera identifies individual or coloured lane markings, e.g. yellow lines at roadworks. The lane departure warning system warns the driver if a detected lane marking is approached without indicating, and helps the driver to steer back towards the middle of the lane by making gentle steering movements. Steering wheel vibration can be activated as an additional warning when crossing lane markings. System is activated manually by a switch on the turn signal lever. Only available in combination with Comfort package (WB1). When ordered with Technology package, speed limit display is included as a no-cost option. Also available as part of the Comfort package advanced (WB1)	•	•	•	£450.00
QR9	Speed limit display. Camera-based detection and display of speed limits, including temporary speed limit displays. Speed limit signs are recognised by the camera and this enables the current speed limit to be read conveniently in the Driver's Information System (DIS). Should the camera not detect a sign, the speed limit from the navigation system data (if fitted) will be shown. Only available as a no-cost option when Technology package (WB4) and either Audi active lane assist (7Y4) or Comfort package advanced (WB1) are ordered together	•	•	•	No charge

Options are subject to availability and may extend delivery.

- = Not available
- = Available
- S = Standard

RRP – Recommended Retail Price.

VAT is calculated at 20% but this may alter to reflect any change in the applicable VAT rate.



Audi side assist

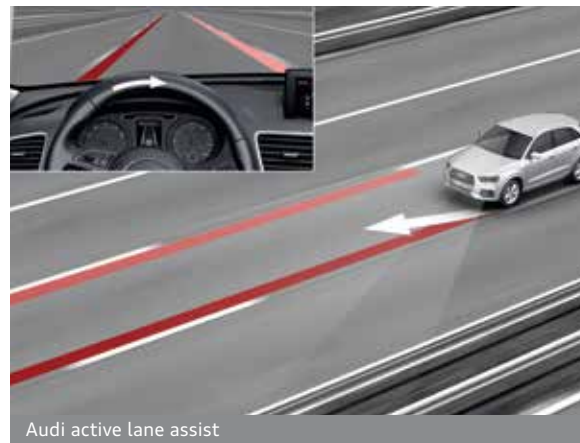

Audi active lane assist



Speed limit display

Looking after your Audi

When you've chosen your ideal model, it's reassuring to know that it will remain in safe hands. That's why we've created products to protect your Audi: from extended warranties to Audi Complete – our comprehensive service and maintenance package. And there's also a range of Audi accessories and merchandise to choose from, enabling you to further enhance and safeguard your car.





Audi Complete

If you drive under 10,000 miles per annum your vehicle will be placed on a Fixed Inspection Service schedule. If your mileage tends to exceed 10,000 miles per annum it will be placed on the Flexible Service schedule.

Warranty

All new Audi models now come with a choice of three, four or five-year warranty.* What's more, if you decide to sell your Audi before the warranty expires, it will be fully transferred to the new owner. So, whichever length of warranty you choose, you can forget about unexpected repair bills and enjoy several years of carefree driving.

Options are subject to availability and may extend delivery.

- = Not available
- = Available
- S = Standard

*Three-year warranty consists of a two-year unlimited mileage warranty and a third year warranty with a 60,000-mile limitation. Four-year warranty consists of a two-year unlimited mileage warranty and two further years' coverage with a 75,000-mile limitation. Five-year warranty consists of a two-year unlimited mileage warranty and three further years' coverage with a 90,000-mile limitation.

**Only available before registration of your Audi Q3. Please speak to your Audi Centre for full details.

RRP - Recommended Retail Price.

VAT is calculated at 20% but this may alter to reflect any change in the applicable VAT rate.

Audi Complete is our fixed-cost maintenance plan, which helps you keep your Audi in top condition and stay in control of your finances. For a simple monthly payment, you could cover your car's servicing, maintenance and, if you want, its tyres too.

So not only will you ensure your car runs smoothly, you'll also protect its future resale value. And because everything's covered by one competitive price, there's no need to go anywhere else.

Pricing is completely tailored to your vehicle and takes into consideration the options you have on your vehicle and your likely annual mileage and resultant service schedule. Please speak to your Audi Centre for a personalised quote for Audi Complete.

Order Code		Q3	Total RRP inc VAT
-	Audi Warranty - covers you for unlimited mileage in the first 2 years of ownership, and up to 60,000 miles in the third year. Transferable between owners**	S	No charge
EA6	Audi Warranty - covers you for up to 4 years or 75,000 miles, whichever comes sooner. Cover includes a 2-year unlimited mileage warranty, and up to 75,000 miles in the third and fourth years. Transferable between owners**	•	£325.00
EA9	Audi Warranty - covers you for up to 5 years or 90,000 miles, whichever comes sooner. Cover includes a 2-year unlimited mileage warranty, and up to 90,000 miles in the third, fourth and fifth years. Transferable between owners**	•	£745.00



Accessories

Choosing an Audi isn't just a matter of deciding on the model you want – it's about creating a car that perfectly suits your needs. That's why we've developed a whole range of accessories to enhance your Audi Q3, enabling you to customise it down to the last detail. Like your Audi, all these accessories are developed to the highest possible standards. They're all available exclusively from Audi.

To find out more, just visit audi.co.uk/accessories or contact your local Audi Centre.

Warranty

All the accessories available on the Audi Q3 are covered by a three-year warranty* if they are ordered and included in the purchase price of the car at date of delivery. Any accessories ordered and installed after delivery include a two-year warranty.*

*Excluding Road Angel products. Audi Accessories warranty terms and conditions can be found at audi.co.uk



Merchandise

From the enthusiasts' motorsport collection to the sophisticated Audi collection, there's a wide variety of adults' and children's clothing, lifestyle accessories and collectables, all of which bear the Audi name.

Please speak to a member of our team at your local Audi Centre to see the full Audi collection and to place an order. A selection of Audi merchandise is also available to buy from audi.co.uk/merchandise



Image shown is the Audi kids' car legends, item number 320.13.004.00

The Audi **Difference**

The experts in Vorsprung durch Technik

Our Audi Approved Master Technicians have undergone an impressive 100,000 hours of training over a 10-year programme to ensure they have the latest technical expertise for maintaining and servicing your Audi. All our Service Advisors undergo a specialist induction and training to ensure they are Audi professionals and able to talk to you about any issues you may have with your Audi vehicle.

Servicing tailored to your needs

Regular servicing is key to safeguarding your Audi's performance and a full Audi service history could help you enhance the future re-sale value. To make servicing easy, the Audi Service Schedules have been designed to work with your individual driving style and vehicle.

We offer two different schedules: the Fixed Inspection Service and the Flexible Service schedule. The conventional Fixed Inspection Service schedule has Fixed intervals for the Oil-change Service and Inspection Service, which are determined by time and distance.

With the Flexible Service schedule, the Inspection Service intervals are also fixed but the Oil-change Service intervals are variable. Sensors take account of driving style and conditions to determine when the Oil-change Service is required and the driver is informed via the on-board service interval display.

The choice of Service Schedule will depend on journey type and mileage as well as individual driving style and conditions. The table to the right can be used for guidance but your Audi Centre will help you to determine the most suitable Service schedule for you based on your individual circumstances and preferences.

Fixed Inspection Service Schedule

Vehicle usage:	
Mileage	Less than 10,000 miles per annum. Mainly city/town centre driving. Short journeys.
Service Intervals:	
Oil-change Service	Fixed to every 9,000+ miles/1 year
Inspection Service	Fixed to every 19,000+ miles/2 years

Flexible Service Schedule

Vehicle usage:	
Mileage	More than 10,000 miles per annum. Motorway and main road driving. Mainly longer distance journeys. Constant speeds.
Service Intervals:	
Oil-change Service	Variable to a maximum of every 19,000+ miles/2 years
Inspection Service	Fixed to every 19,000+ miles/2 years

When a vehicle is frequently used in the following conditions, we recommend the vehicle is on a Fixed Inspection Service Schedule, regardless of mileage:

Uneconomical driving styles, e.g. heavy acceleration and braking and constant use of high revs
High engine-loading conditions, e.g. frequent towing and hill climbs

*As indicated by the service interval display. Mileages are approximate as the Service Indicator system uses kilometres as its distance measurement.

Your convenience comes first

At Audi you can choose from a range of convenient services that suit your needs. Why not book a 'service while you wait' appointment* and enjoy our complimentary refreshments while your car is with us? Or, if you need to be mobile, take advantage of one of our courtesy cars which we can even collect and deliver to you.* We guarantee we can service your Audi within 5 days without a courtesy car or within 10 days if you need transport. We will also ensure your car is returned to you with a full valet.

Audi Genuine Parts

You can rest assured that only Audi Genuine Parts will be used on your vehicle. What's more, Audi parts and labour come with a 2-year guarantee.**

No hidden costs

We believe strongly in transparency when it comes to our prices. For added peace of mind, we will give you a quotation over the phone for the work you have requested and email you the price confirmation. We'll consult you if any additional work on your car is needed when it is with us. We won't carry out any extra work without asking your permission first.

All part of the service

Whenever we see an Audi for a service, we connect it directly to our headquarters in Ingolstadt which enables us to check your car's software and make sure it's as up-to-date as possible. If the factory has released a software upgrade for your model, it can be applied immediately - improving anything from your car's efficiency to the precision of its parking system.

Audi Roadside Assistance

Your new car comes complete with 3 years' complimentary roadside assistance and recovery across the UK, provided by Automobile Association Insurance Services Limited. Also included is roadside assistance throughout Europe, managed by Automobile Association Insurance Services Limited.

For further information and terms and conditions please visit audi.co.uk

*Subject to availability.

**Excludes wear and tear.



Audi Q3 technical data

Engine	Petrol			Diesel				
	1.4 TFSI*	1.4 TFSI*	2.0 TFSI quattro	2.0 TDI	2.0 TDI quattro	2.0 TDI quattro	2.0 TDI quattro	2.0 TDI quattro
Transmission	6-speed manual	6-speed S tronic	7-speed S tronic	6-speed manual	6-speed manual	7-speed S tronic	6-speed manual	7-speed S tronic
Cylinder	4-cylinder	4-cylinder	4-cylinder	4-cylinder	4-cylinder	4-cylinder	4-cylinder	4-cylinder
Displacement, cubic cm (valves per cylinder)	1395 (4)	1395 (4)	1984 (4)	1968 (4)	1968 (4)	1968 (4)	1968 (4)	1968 (4)
Max. power ¹ , PS at rpm	150/5000-6000	150/5000-6000	180/4000-6200	150/3500-4200	150/3500-4200	150/4000	184/3500-4000	184/3500-4000
Max. torque, Nm at rpm	250/1500-3500	250/1500-3500	320/1400-3900	340/1750-2800	340/1750-2800	340/1750-2800	380/1800-3250	380/1800-3250
Top speed, mph	126	126	143	126	126	126	136	136
0-62mph acceleration, seconds	9.2	8.9	7.6	9.6	9.3	9.3	7.9	7.9
ABI insurance group 1-50 ⁺	20E	20E	28E	21E	21E	21E	25E	25E
Unladen weight ² , kg	1385	1405	1540	1485	1570	1605	1605	1625
Gross weight limit, kg	1985	2005	2140	2085	2170	2205	2205	2225
Roof load limit/nose weight, kg	75/80	75/80	75/80	75/80	75/80	75/80	75/80	75/80
Max trailer load ³ unbraked, kg	730	740	750	750	750	750	750	750
Max trailer load ³ with 12% gradient, kg	1800	1800	2000	1800	1800	2000	2000	2000
Max trailer load ³ with 8% gradient, kg	1800	1800	2000	1800	1800	2000	2000	2000
Luggage compartment capacity, rear seats upright, litres	420	420	420	420	420	420	420	420
Luggage compartment capacity, rear seats folded, litres	1325	1325	1325	1325	1325	1325	1325	1325
Fuel tank capacity approx, litres	64	64	64	64	64	64	64	64
Emission standard	EU6	EU6	EU6	EU6 [^]	EU6 [^]	EU6 [^]	EU6 [^]	EU6 [^]

*1.4 TFSI engine with Audi cylinder-on-demand technology.

[^]The addition of AdBlue technology ensures compliance with EU6 emission standards. The AdBlue tank may require refilling between services.

⁺Highest insurance group rating shown. Group may be lower dependent on trim level. Please visit www.thatcham.org/abigrouprating for details.

¹The given value was obtained in accordance with the specified measurement procedure (the respective current version of the Directive 80/1269/EEC).

²Vehicle's unladen weight without driver (calculated in accordance with the current version of Directive 80/1268/EEC). The fitting of additional equipment may increase the vehicle's unladen weight and drag coefficient, whereupon the potential carrying capacity and top speed will be correspondingly reduced.

³The engine's power output always goes down with increasing altitude. At 1,000m above sea level, and for every additional 1,000m, deduct 10% from the weight of the outfit (trailer load limit + gross weight of the towing vehicle).

Please note: The maximum power output figures are quoted in PS (or Pferdestärke, which is the metric equivalent of brake horsepower). To convert to brake horsepower, divide the PS figure by 1.0139.

Audi Q3 technical data

Depending upon your chosen Q3 wheel size, different efficiency figures for CO₂ emissions and fuel consumption will apply (based on EU directive no. 715/2007 effective from 01/09/14). This table is a quick reference guide to assist you in finding the correct values based on wheel sizes and chosen engine.

Engine	Petrol			Diesel					
	1.4 TFSI*	1.4 TFSI*	2.0 TFSI quattro	2.0 TDI	2.0 TDI quattro	2.0 TDI quattro	2.0 TDI quattro	2.0 TDI quattro	
Transmission	6-speed manual	6-speed S tronic	7-speed S tronic	6-speed manual	6-speed manual	7-speed S tronic	6-speed manual	7-speed S tronic	
Max. power, ¹ PS at rpm	150/5000-6000	150/5000-6000	180/4000-6200	150/3500-4200	150/3500-4200	150/4000	184/3500-4000	184/3500-4000	
CO ₂ emissions, ² g/km	17" wheels	128	136	152	119	131	134	139	139
	18" wheels	131	138	155	122	134	137	143	141
	19" wheels	134	143	161	126	140	144	148	146
Benefit in kind (BIK)%	17" wheels	20%	22%	25%	21%	24%	24%	25%	25%
	18" wheels	21%	22%	26%	22%	24%	25%	26%	26%
	19" wheels	21%	23%	27%	23%	26%	26%	27%	27%
Fuel consumption, ² mpg (l/100km) Urban	17" wheels	42.8 (6.6)	39.8 (7.1)	35.3 (8.0)	53.3 (5.3)	47.9 (5.9)	45.6 (6.2)	42.8 (6.6)	44.1 (6.4)
	18" wheels	42.2 (6.7)	39.8 (7.1)	34.4 (8.2)	52.3 (5.4)	47.9 (5.9)	44.8 (6.3)	42.2 (6.7)	43.5 (6.5)
	19" wheels	41.5 (6.8)	38.2 (7.4)	33.6 (8.4)	51.4 (5.5)	46.3 (6.1)	43.5 (6.5)	40.4 (7.0)	42.8 (6.6)
Fuel consumption, ² mpg (l/100km) Extra Urban	17" wheels	57.6 (4.9)	54.3 (5.2)	47.9 (5.9)	68.9 (4.1)	62.8 (4.5)	62.8 (4.5)	61.4 (4.6)	61.4 (4.6)
	18" wheels	55.4 (5.1)	53.3 (5.3)	47.1 (6.0)	67.3 (4.2)	61.4 (4.6)	61.4 (4.6)	60.1 (4.7)	60.1 (4.7)
	19" wheels	54.3 (5.2)	51.4 (5.5)	44.8 (6.3)	64.2 (4.4)	60.1 (4.7)	57.6 (4.9)	57.6 (4.9)	57.6 (4.9)
Fuel consumption, ² mpg (l/100km) Combined	17" wheels	50.4 (5.6)	47.9 (5.9)	42.8 (6.6)	61.4 (4.6)	56.5 (5.0)	55.4 (5.1)	53.3 (5.3)	53.3 (5.3)
	18" wheels	49.6 (5.7)	47.9 (5.9)	42.2 (6.7)	60.1 (4.7)	55.4 (5.1)	54.3 (5.2)	51.4 (5.5)	52.3 (5.4)
	19" wheels	48.7 (5.8)	45.6 (6.2)	40.4 (7.0)	58.9 (4.8)	52.3 (5.4)	51.4 (5.5)	49.6 (5.7)	50.4 (5.6)

*1.4 TFSI engine with Audi cylinder-on-demand technology.

¹The given value was obtained in accordance with the specified measurement procedure (the respective current version of the Directive 80/1269/EEC)

²Fuel consumption and CO₂ emissions figures are obtained under standardised test conditions (Directive 93/116/EEC) using a representative model. This allows direct comparison between different models from different manufacturers, but may not represent the actual fuel consumption achieved in 'real world' driving conditions. More information is available at www.dft.gov.uk/vca

Please note: The maximum power output figures are quoted in PS (or Pferdestärke, which is the metric equivalent of brake horsepower). To convert to brake horsepower, divide the PS figure by 1.0139.

Audi Q3 dimensions

The technical drawings opposite show the exact dimensions of the Audi Q3, so you can check everything – from whether the car will fit in your garage to whether your luggage will fit in the boot.

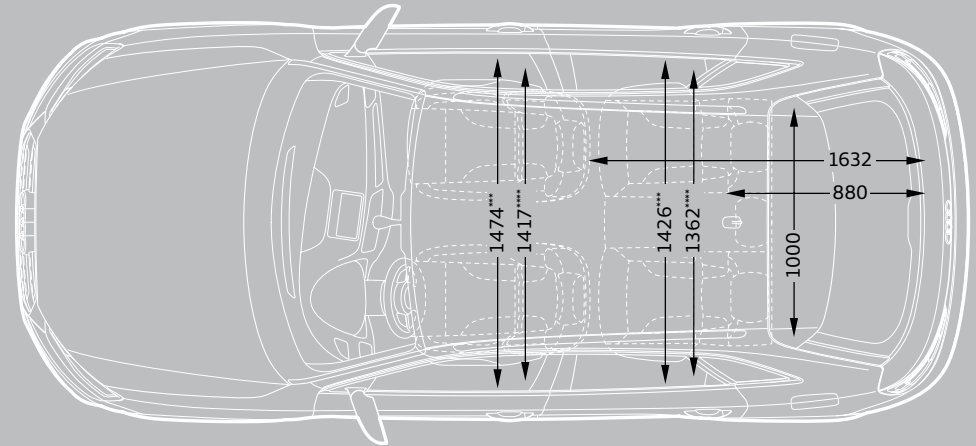
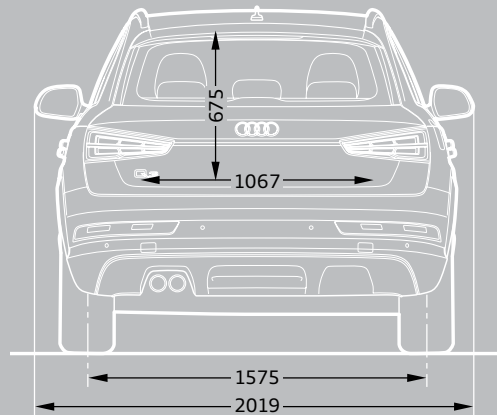
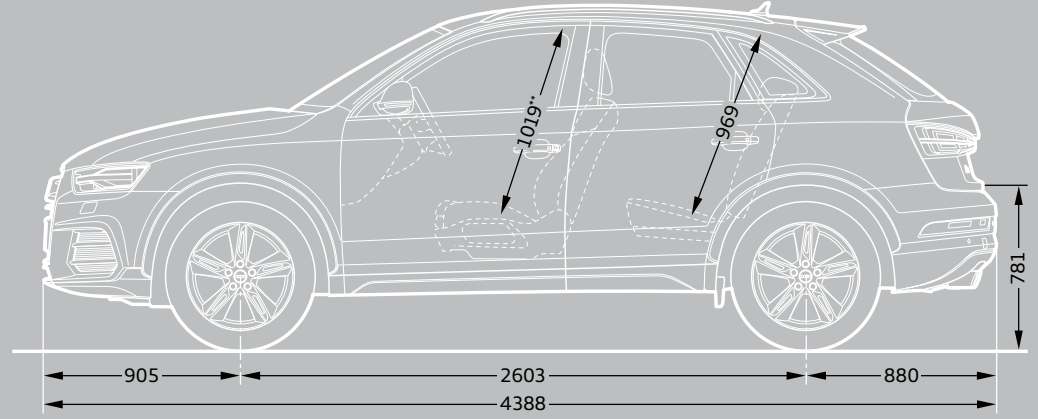
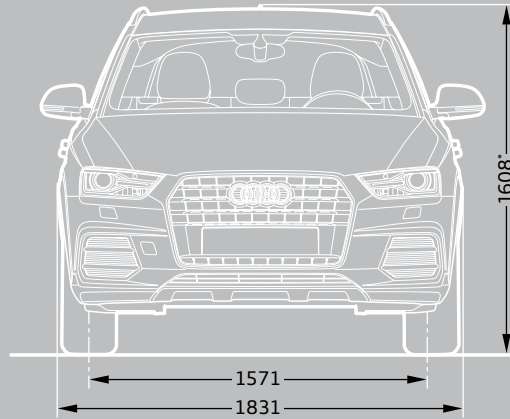

*Without roof aerial the height of the vehicle is 1590mm.

**Maximum headroom.

***Elbow width room.

****Shoulder width room.

Dimensions measured with vehicle at unladen weight.

Turning circle approx 11.8m.

Dimensions in millimetres.



Image shows wheel which is not UK Specification

Pricing and Additional information

Welcome to Audi

By placing an order for your Audi, you're choosing to get behind the wheel of one of the most sophisticated cars on the road. And because we believe the service we offer should be just as advanced, we want to let you know exactly what you can expect from us, now and in the future.

We've agreed a set of standards with all our Centres which governs the way we do business with you. It outlines the kind of service we promise to deliver for every customer, right down to filling each new Audi we sell with half a tank of fuel.

So whether you're interested in the date your car will arrive in the UK or the way we'll dispose of non-biodegradable materials after we service your Audi, you can have total confidence in us.

Audi Promise

Audi Centres

We guarantee that all our Centres will be open as follows:

Sales: Monday to Friday 9am–6pm
Saturday 9am–5pm

Service: Monday to Friday 8am–6pm
Saturday 8.30am–1pm

Sunday opening is at local discretion.

New car delivery

Once we've confirmed a delivery date for your car, we'll keep you informed of progress. Subject to reasonable notice, we'll then deliver it to a place of your choice, whether that's your home or work. In the unlikely event of a delay, we'll provide a courtesy car to minimise inconvenience and keep you mobile.

Environmental commitment

We promise to dispose of all non-biodegradable materials from your vehicle in a responsible manner.

Pricing

Prices and specifications given are correct at the time of printing. Always check details with your Audi Centre as Audi policies are continually developing. We reserve the right to change prices or specifications at any time.

All prices are subject to VAT, currently charged at 20%, but this may alter to reflect any change in the applicable VAT rate.

Delivery charges and number plates are not included in the vehicle price.

Delivery charge	£504.99
Number plate	£20.00
VAT	£105.01
Total	£630.00

Audi Customer Care

Every new Audi benefits from the comprehensive Audi Customer Care Package, which comprises:

- ▶ A 3-year Audi warranty, which covers you for unlimited mileage in the first 2 years of ownership, with a full mechanical and electrical warranty which covers you for up to 60,000 miles in the 3rd year
- ▶ A 3-year paint warranty
- ▶ A 12-year anti-corrosion warranty
- ▶ 3 years' UK roadside assistance and recovery

You also have the option when ordering your new car of choosing a 4-year or 5-year Audi warranty. Speak to a member of the sales team for more information.

Audi tax-free sales

If you are entitled to purchase a vehicle free of VAT, normally through military or diplomatic privilege, please contact your local Audi Centre for full details.

Should you have any difficulty obtaining the information you require, please call 0870 241 5663.

Audi Financial Services

Audi Financial Services specialises in providing funding solutions for Audi drivers. Whether your Audi is for private or business use, there is a range of funding options to choose from.

Below is the full range of finance products, which comprises:

- ▶ Solutions – a Personal Contract Plan
- ▶ Hire purchase
- ▶ Lease purchase
- ▶ Finance lease
- ▶ Contract hire

With all products, you can choose a fixed-cost maintenance plan designed to help you budget accurately.

No matter which Audi model you choose, your local Audi Centre can provide you with a personalised quote designed to fit your budget and motoring needs.

Audi Financial Services is a trading name of Volkswagen Financial Services (UK) Limited. An offer of finance depends on certain conditions. Available to people over 18 in the UK only.

Audi Insurance

We want you to start enjoying your new car from day one and thanks to Audi complimentary five day insurance you can. To activate simply call 0330 303 6900, provide us with a few details, and we'll send a cover note to your Audi Centre. They will then tax your car and you can drive it away. Telephone lines are open Monday to Friday 8am – 8pm and Saturday 9am – 4pm. For details of our full range of Insurance products visit insurewithaudi.co.uk

CO2 data and information

CO2 emissions-based Vehicle Excise Duty

Vehicle Excise Duty (Road Fund Licence) is based upon the amount of Carbon Dioxide (CO2) a vehicle emits, measured in grams per kilometre (g/km).

First year VED rates apply to the first year of ownership. Annual VED rates apply thereafter. The DVLA has created thirteen categories:

Petrol and Diesel engines	First year	Annual rate (second year onwards)
A – up to 100g/km	£0.00	£0.00
B – 101 to 110g/km	£0.00	£20.00
C – 111 to 120g/km	£0.00	£30.00
D – 121 to 130g/km	£0.00	£110.00
E – 131 to 140g/km	£130.00	£130.00
F – 141 to 150g/km	£145.00	£145.00
G – 151 to 165g/km	£180.00	£180.00
H – 166 to 175g/km	£295.00	£205.00
I – 176 to 185g/km	£350.00	£225.00
J – 186 to 200g/km	£490.00	£265.00
K – 201 to 225g/km	£640.00	£290.00
L – 226 to 255g/km	£870.00	£490.00
M – over 255g/km	£1,100.00	£505.00

Vehicle Excise Duty (VED) rates correct at time of going to print, but these may alter to reflect any change in the applicable VED rate.

Audi Connect

An external data source is required to enable Audi Connect online services. One of two can be used:

1. A mobile telephone with Bluetooth SIM Access Profile – to check the compatibility of your mobile phone and whether it has SIM Access Profile compatibility, please visit www.audi.co.uk/phonecompatibility
2. A separate SIM card which can be inserted in the included SIM card reader. When a separate SIM card is used, hands-free phone calls are possible using the SIM card or by connecting a different mobile telephone via Bluetooth Hands-Free Profile

Online services are only available for mobile phone contracts or SIM cards which include a data option. Online services will only be available within the coverage of the mobile phone network; there may be additional costs for the use of these services (charges and billing correspond to the personal mobile phone contract or SIM card contract). Due to high data volumes, a mobile phone contract including an unlimited or high usage data plan is strongly recommended. The content and scope of the online based services offered may vary.

The Audi Connect services are provided for at least one year from vehicle delivery. After 24 months from delivery of the vehicle, the term of the Audi Connect services will be extended free of charge once for 12 months.

Please note that the services received are also dependent on the capability of your mobile phone.

Google and the Google logo are registered trademarks of Google Inc. The availability of services supported by Audi Connect varies from country to country.







Audi UK

Customer Services
Selectapost 29
Sheffield
S97 3FG
0800 699888
audi.co.uk

Specifications and prices subject
to change without notice.

© Audi UK

Printed in the UK
Edition 2.1 10/15
2016 model year

Images are for illustrative purposes only.

