



2014 | A7

Audi of America
Audiusa.com
Facebook.com/Audi

AoA1414206

Note: A word about this brochure. Audi of America, Inc., believes the specifications in this brochure to be correct at the time of printing. However, specifications, standard equipment, options, fabrics, and colors are subject to change without notice. Some equipment may be unavailable when your vehicle is built. Please ask your dealer for advice concerning current availability of standard and optional equipment, and your dealer will verify that your vehicle will include the equipment you ordered. Vehicles in this brochure are shown with optional equipment. See your dealer for complete details on the Audi New Vehicle Limited Warranty, twelve-year limited warranty against corrosion perforation, and Audi 24/7 Roadside Assistance. (Roadside assistance coverage provided by Road America in the U.S. Certain conditions apply; see your dealer for details.) Tires supplied by various manufacturers. "Audi," all model names, "Audi connect," "Audi Sport," "Audi ultra," "ASF," "FSI," "MMI," "quattro," "Sideguard," "Singleframe" and the Singleframe grille design, "S line," "S tronic," "TFSI," "Truth in Engineering," and the four rings logo are registered trademarks of AUDI AG. "AdBlue" is a registered trademark of the Verband der Automobilindustrie. "Bang & Olufsen" is a registered trademark of Bang & Olufsen. "BOSE" and "AudioPilot" are registered trademarks of the BOSE Corporation. The BLUETOOTH word mark and logos are owned by the Bluetooth SIG, Inc., and any use of such marks by AUDI AG is under license. "Google," "Google Earth" and "Google Voice" are trademarks of Google Inc. "HD Radio" and the HD Radio logo are proprietary trademarks of iBiquity Digital Corporation. "HomeLink" is a registered trademark of Johnson Controls Technology Company. "iPod" is a registered trademark of Apple Inc. "SiriusXM" and all related marks and logos are trademarks of Sirius XM Radio Inc. and its subsidiaries. "TDI" is a registered trademark of Volkswagen AG. "Tiptronic" is a registered trademark of Dr. Ing. h.c. F. Porsche AG. "Wi-Fi" is a trademark of the Wi-Fi Alliance. All other trademarks are the property of their respective owners. Some European models shown.

© 2013 Audi of America, Inc. Printed in U.S.A.

A7

Audi A7

Audi
Truth in Engineering 

THE PASSIONS OF AUDI

The story of our collection of obsessions.

Precision. Design. Vision. These are the kind of attributes that we deliver as a company, the kind of passions that go way past getting you from point A to point B. That's because Audi knows that how you get to your destination is only part of the story. And so it is with us as a luxury brand. Our obsessions are our commitments, a collection of inspirations that make up our core truth: That from a foundation of brilliant engineering, we craft more than great vehicles—we tell great stories.



A7

Giving style a good name.



Take a moment to get into the details of Audi. You'll find a vehicle that speaks style as its first language, but it's still just as fluent in performance. Beyond that, you can expect that what you experience on the outside is more than matched on the inside. This is style you can believe in.



BE → CAUSE

Full LED headlight technology

The Audi A7 offers full LED headlight technology. With an approximate life-span of 10,000 hours, these lights are the closest re-creation of daylight yet.¹ Bright and stylish, they offer signature brilliance from Audi.



¹ Based on brightness comparison to the sun and 5,500 K color temperature. Full LED headlights are an optional upgrade. ² Always pay careful attention to the road, and do not drive while distracted. The features and technologies discussed above are optional, may require an additional subscription with separate terms and conditions, and should be used only when it is safe and appropriate. The Wi-Fi[®] hotspot feature is intended for passenger use only.



Design

We do not follow design trends. We set them.

An enduring excuse to never hold back.

There's something to be said for refusing to take things easy. It keeps life interesting—and unpredictable. You can see this expressed boldly in the 2014 Audi A7. Its captivating lines and striking silhouette convey a clear message: Design isn't characterized by convention here. Take notice of the signature Audi Singleframe® grille and sloping roofline. Together they speak volumes about its affection for timeless style. But there's more to this storyline than just attractive sheet metal. An extensive list of available advanced technologies—Audi MMI® touch, Google Earth™ imagery, and an embedded Wi-Fi® hotspot, to name just a few, are taking the automobile far into the 21st century.² And when it comes to performance, you can rest assured the 310-hp supercharged V6 engine and legendary Audi quattro® all-wheel drive will lay to rest any notion that this car will ever sit on the sidelines.



Adaptive rear spoiler

Automatically deployed at speeds over 80 mph, the adaptive rear spoiler helps provide additional downforce to enhance the dynamic performance of the A7.¹



In this book,

the character is the story.

We probably don't need to tell you, a character can make or break a book. Luckily for the Audi A7, it has many compelling characters to choose from. But perhaps its most brilliant one is something we call the Tornado line. Bisecting the body profile, it runs strongly through the middle of the vehicle to give it a bold, progressive stance that tells the world that there's pedigree here, but not a predictable one. From then on, you become the main character.



¹ Obey all speed and traffic laws.



What good is a mold if you don't plan on breaking it?

We think the best way to honor great design is to shatter its conventions completely. This was our mindset when we set out to create the Audi A7. Audi designers were given a blank canvas, and the typical constraints of design were lifted. The result? A sculpted body that was shaped from the ground up instead of molded by conventional, top-down thinking. You see the difference in every curve of the A7. Each line, slope and angle represents a novel approach to design, giving style a muscular profile—and muscle a sleek side. Think of driving one as art appreciation in its most dynamic form.



2014 AUDI A7 PREMIUM PLUS SHOWN IN ICE SILVER METALLIC WITH AVAILABLE EQUIPMENT.



**It's more than a line
when you believe in it.**

These aren't just cars to us. They are a symbol of our passion for exceptional design. That's why our designers held nothing back when it came to creating a unique space, even going so far as to replicate shapes throughout the vehicle, inside and out. Notice how the shape of the decorative inlay around the inside door handle echoes the window behind the rear passenger door. And the way the aluminum trim surrounding the windows closely mirrors the aluminum trim accenting the interior wood inlays. This kind of unique design pairing was done to enhance the connection between the interior and exterior. Now that's something worth believing in.





Audi drive select Owner's man.

Comfort Individual
Auto Dynamic

Car systems Set individual

TMC 5:46 PM Google 3G

Decorative inlays

Beautifully crafted wood or aluminum inlays add a warm and sophisticated touch to an already regal interior. And with numerous finishes available, you can be sure this space will be all yours.



Countless possibilities are well within reach.

If you're going to daydream at the office, we suggest you start here. Take a moment to indulge in the wraparound curve of the Audi A7 dashboard. See how it integrates intuitively with the overall driver-centric layout. Discover how the highly acclaimed fit and finish is reflected in places like the extremely tight panel gaps. Then admire the finely crafted wood inlays and aluminum trim that adorn the door and dash. Now imagine you just shifted into Drive. Welcome to your new reality.

Being practical has some stylish perks.

Whoever said being practical can't turn heads hasn't sat inside an Audi A7. Our innovative design team re-wrote the rules for interior appointments, and built style with purpose in mind. With luxurious materials, and available twelve-way power front seats and four-zone automatic climate control, you literally create a unique cabin environment tailored to the moment at hand. Just consider its split folding 60/40 rear seatbacks and cavernous cargo space as more proof of this. This is true for the smallest details too, like an available heated steering wheel, or heated and ventilated front seats that help keep you comfortable so you can forget how forward thinking your surroundings are, and focus on how much you love every moment in here.

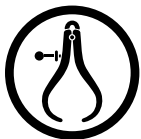

Craftsmanship

We've ensured that every stitch represents the detail that we put into every aspect of an Audi.



Climate control

Personal attention has been taken to new heights in the A7. With the available four-zone automatic climate control, almost every person in the vehicle has the ability to dial in their ideal temperature.

Cargo capacity

With 24.5 cu ft of cargo capacity with the seatbacks in place, you'd be forgiven for thinking the A7 might moonlight as a much larger vehicle. And with all that extra space, you can forget about deciding between bringing an extra golf bag or more clothes. Bring it all.



Power rear tailgate and hands-free release

Carefully integrated into the rear design, the power rear tailgate on the A7 gives you programmable endpoints so you can adjust the opening to the height you choose, better to accommodate personal preferences and tighter spaces.



2014 AUDI A7 PRESTIGE SHOWN WITH VELVET BEIGE LEATHER AND AVAILABLE EQUIPMENT.

2014 AUDI S7 SHOWN IN GLACIER WHITE METALLIC WITH AVAILABLE EQUIPMENT.

4 | 5



S7

Wear your high performance heart on your sleeve.

We don't believe in hiding our true intentions—as with all Audi performance models, the visceral reaction you get at first glance is more than validated when you get behind the wheel. The bold, muscular body and S-specific design cues of the Audi S7 are constant reminders that this is a performance car above all else. A 420-hp, 4.0-liter TFSI® V8, high-performance brakes and the relentless grip of Audi quattro® all-wheel drive make clear the real intent of the S7. One only has to peek at the driver-oriented interior featuring signature sport seats and available Carbon Atlas inlays to know that this is a luxury sports car that doesn't hold anything back. This isn't the model for the faint of heart.



ENGINE // 4.0-liter turbocharged TFSI V8 developing 420 hp and 406 lb-ft of torque

DRIVETRAIN // Audi quattro® all-wheel drive with sport differential
Seven-speed Audi S tronic® dual-clutch transmission

CHASSIS // S7 tuned Audi adaptive air suspension, Audi drive select

BRAKES // 15.7" ventilated front disc brakes with S7 logo, 14" ventilated rear disc brakes

PERFORMANCE // Top track speed of 155 mph¹; acceleration from 0 to 60 mph in 4.5 seconds

Audi Sport

The story doesn't stop here. There's more on the full range of S, RS, and R8 Audi performance models in the **2014 Audi Sport brochure**. See your dealer or go to audiusa.com for details.

¹ Top track speed is electronically limited in the U.S. Obey all speed and traffic laws.

The case for unbreakable bonds.

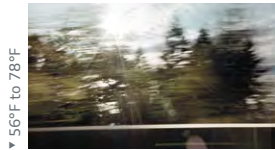
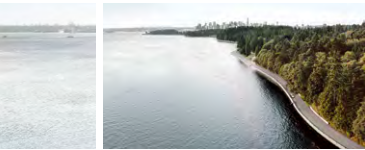

▼ 56°F to 78°F

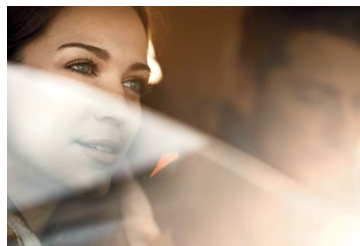

Conventional wisdom may suggest that an all-wheel drive system is there purely to provide confidence in inclement weather, but Audi quattro® all-wheel drive is much more than just a foul-weather friend. It's performance engineering that takes on a dry, twisty mountain road as beautifully as it tracks through powder.¹ In other words, quattro® helps enhance performance by appropriately transferring power to the necessary wheels when accelerating and turning, so you have confidence-inspiring performance for almost any road condition. Inclement weather aside, the really gripping story about quattro® is how it performs overall, forging a bond between you and the road that really connects.¹



All-around confidence

Just like life, the road can throw you a curve. So throw one right back with the superior grip and control of quattro®. It helps provide the performance and confidence you would expect from Audi, no matter if you're commuting in the city or crisscrossing the country. This is advanced engineering you can live with.

¹ When driving during cold, rainy, snowy or icy weather conditions, ensure that your vehicle is equipped with appropriate all-season or winter tires. Even with appropriate tires, you must always drive in a manner appropriate for the weather, visibility and road conditions. ² Obey all speed and traffic laws.



▼ HUMIDITY 95%

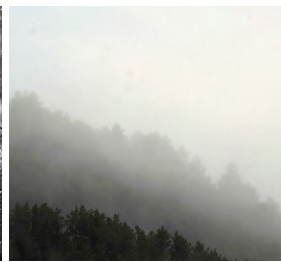

All-weather capability

There is a reason quattro® is considered such a friend in foul weather. Under normal driving conditions, the center differential splits torque at a ratio of 40:60 front to rear, but as conditions change and become more challenging, the ratio is optimized to help maximize grip. And with the ability to transfer the majority of available torque mechanically to the wheels with the most grip, the operation is exceptionally smooth, even under extreme conditions.¹



All-out performance

You don't win races by playing nice.² That's why quattro® features one of the most fierce performance features around—torque vectoring. By taking into account your steering input and desired level of acceleration, it can independently brake the inside wheels through a corner and transfer torque to the outside wheels, helping to promote neutral handling.

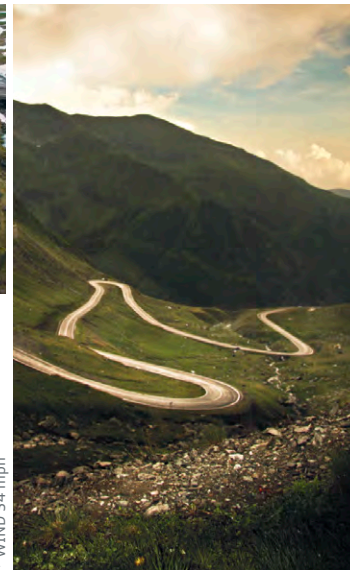

▼ WIND 54 mph

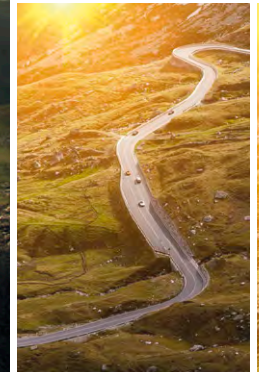

It's about time to put the road in its place.

Sometimes the road can get out of line, but Audi quattro® all-wheel drive¹ is more than an unruly pavement enforcer—it's actually a response to the conditions around our Ingolstadt headquarters. With the weather and the terrain the way they are, all-wheel drive seemed like a smart solution for the problems presented. Since they design mountain roads with hairpin turns, it's only natural that we wanted to keep the road in check. Here's how it works:

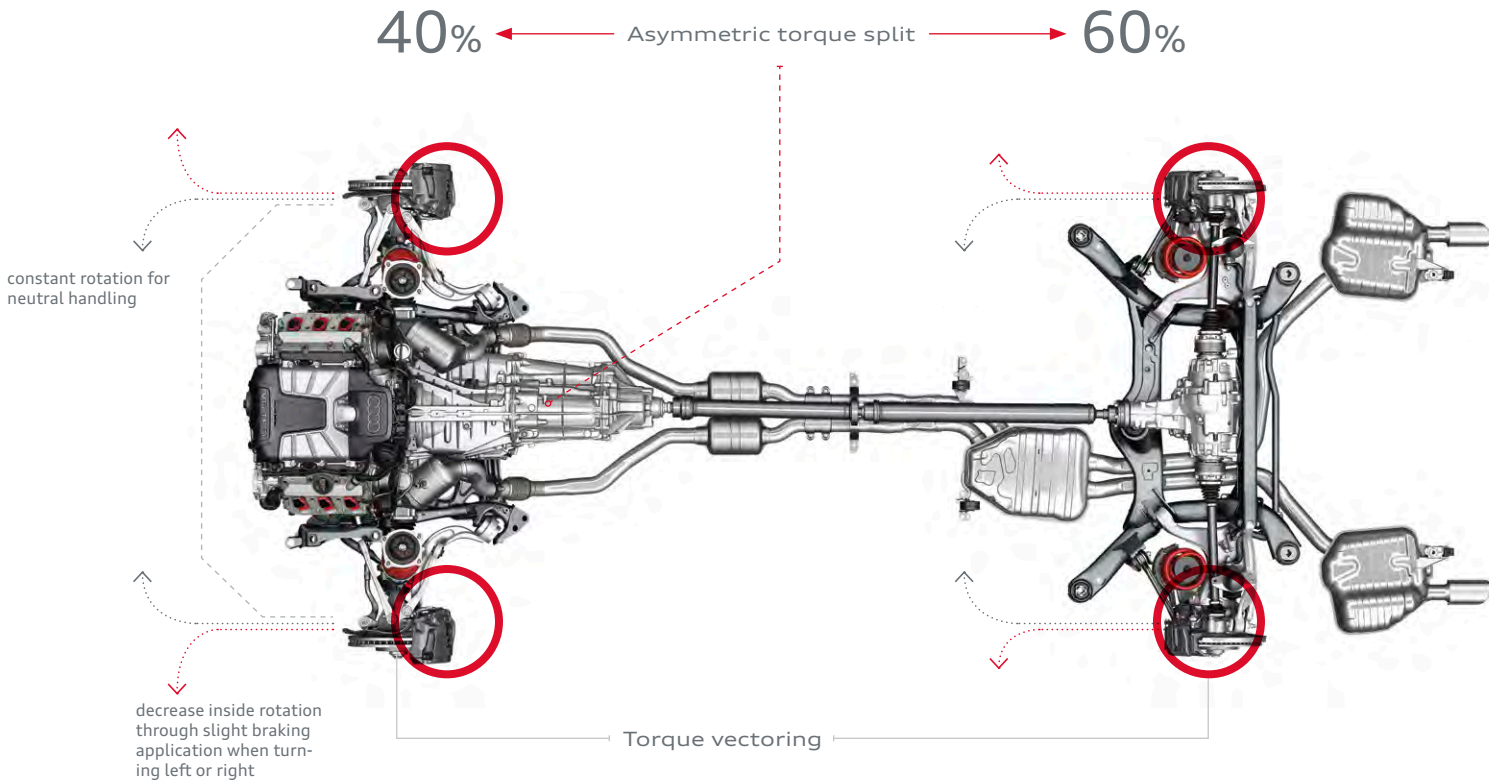

¹ When driving during cold, rainy, snowy or icy weather conditions, ensure that your vehicle is equipped with appropriate all-season or winter tires. Even with appropriate tires, you must always drive in a manner appropriate for the weather, visibility and road conditions.

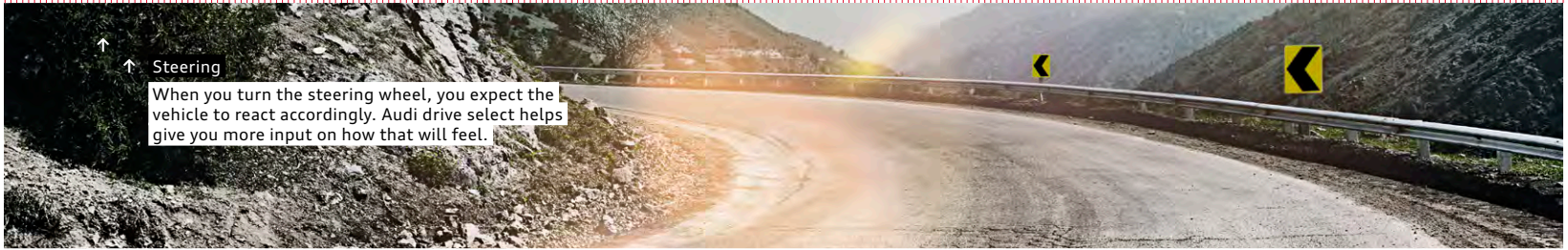

We don't anticipate your response so much as provide it.

At Audi, we believe you should be the ultimate master of your road-going domain. That's why we created the Audi drive select system. It gives you the ability to adjust the vehicle's steering, throttle response and transmission shift characteristics with the utmost of ease. And with four modes to choose from, no matter what kind of road comes into question, Audi drive select will let you answer.

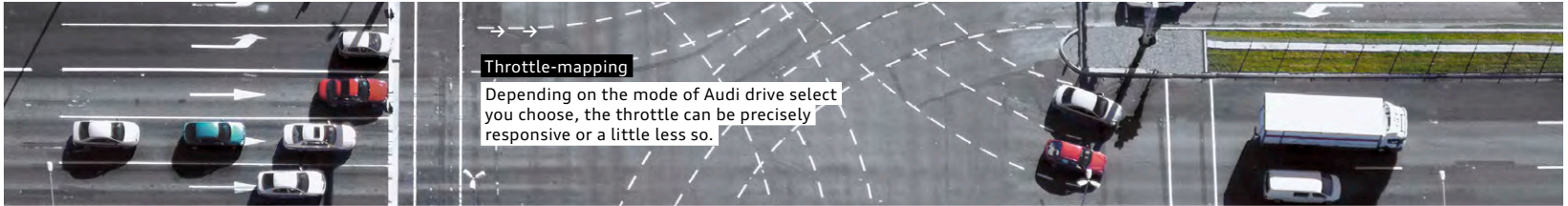
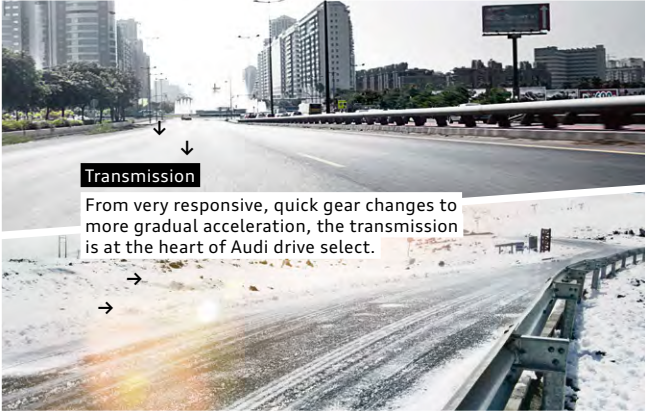

1

Comfort mode

Perfect for less-than-perfect roads, this setting adds optimized steering and a closer shift pattern to help provide a more relaxed drive.

2

Dynamic mode

Tighter steering and a more responsive throttle give this setting an aggressive feel and focused performance.

3

Auto mode

The best of both worlds, dialed to automatically adjust settings for a seamless combination of comfort and responsiveness based on your driving style and road conditions.

4

Individual mode

Take the turn your way—this mode allows you to adjust the steering, throttle and transmission upshifts to your style.



This is how power accelerates.

For us, losing weight has nothing to do with vanity. It's all about making us stronger and more agile. By reducing the weight of the chassis and engine, we are able to harness more power more quickly—and, not incidentally, more efficiently.¹ That means the Audi A7, equipped with the supercharged 3.0-liter TFSI® engine, delivers the potent acceleration of a traditional V8 with the efficiency of a V6.¹ Improved miles per gallon¹ and more beats per minute? We call that a win-win.

Induction technology—TVS supercharger

Compressing the airflow to the engine forces more air into the cylinder and, ultimately, more power from each ignition, significantly improving the engine's power-to-displacement ratio.

Maximum boost pressure up to 11.6 psi



Performance

The adage “good things come in small packages” has never been more true.



Four-vane w/160° twist Three-vane w/60° twist



More twist for power

Modern supercharger rotor-vanes have a 160° twisted shape for higher pressures and improved efficiency.¹ And by using a four-vane design instead of a three-vane design, thermal efficiency and air-handling characteristics are improved without increasing the size of the supercharger unit.

310 horsepower

325 lb-ft of torque

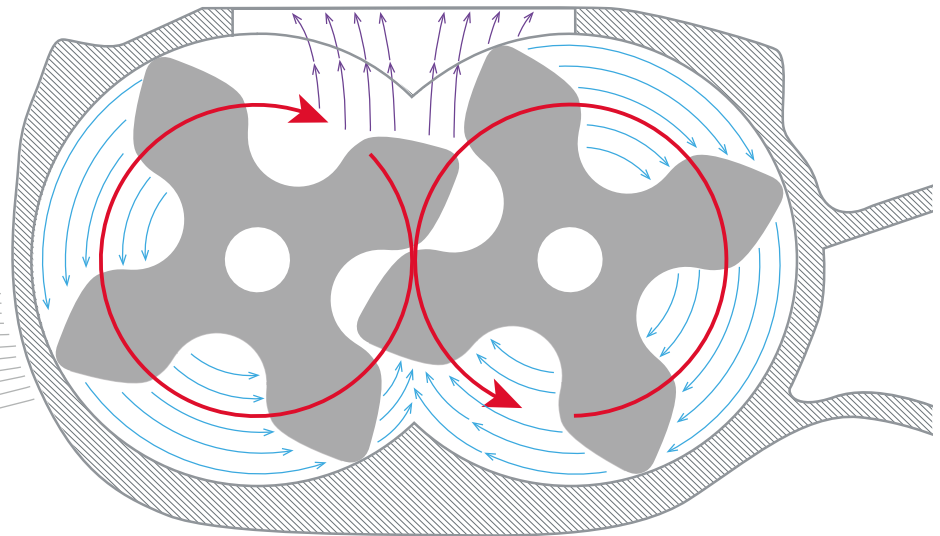

3.0 TFSI® V6

The 310-horsepower 3.0-liter TFSI V6 engine is paired with FSI® direct injection and a belt-driven supercharger that has counter-rotating four-vane rotors that force air through dual intercoolers at boosted pressures of up to 11.6 psi. It is this combination of engineering achievements that allows for nearly instantaneous buildup of 325 lb-ft of torque directly off idle engine speeds.

Start-stop efficiency system

As an intelligent vehicle system, this highly effective engine management program can lower fuel consumption as well as CO₂ emissions by automatically shutting off your engine while you wait at a red light or, perhaps, during certain stop-and-go driving. Once you are ready to resume, or if other critical vehicle systems require it, the engine will restart nearly instantaneously.¹

Eight-speed Tiptronic® automatic transmission

As the perfect compromise between a dedicated manual and an automatic gearbox, the eight-speed Tiptronic® automatic transmission in the Audi A7 offers eight optimized, carefully chosen gear ratios. Selected automatically or via its console-mounted shifter or steering wheel with available shift paddles, precise shifts are delivered without sacrificing the smooth action of the Tiptronic® automatic. A high final drive ratio allows optimization of lower gears, yet the transmission's upper range emphasizes fuel economy—particularly at highway speeds.¹

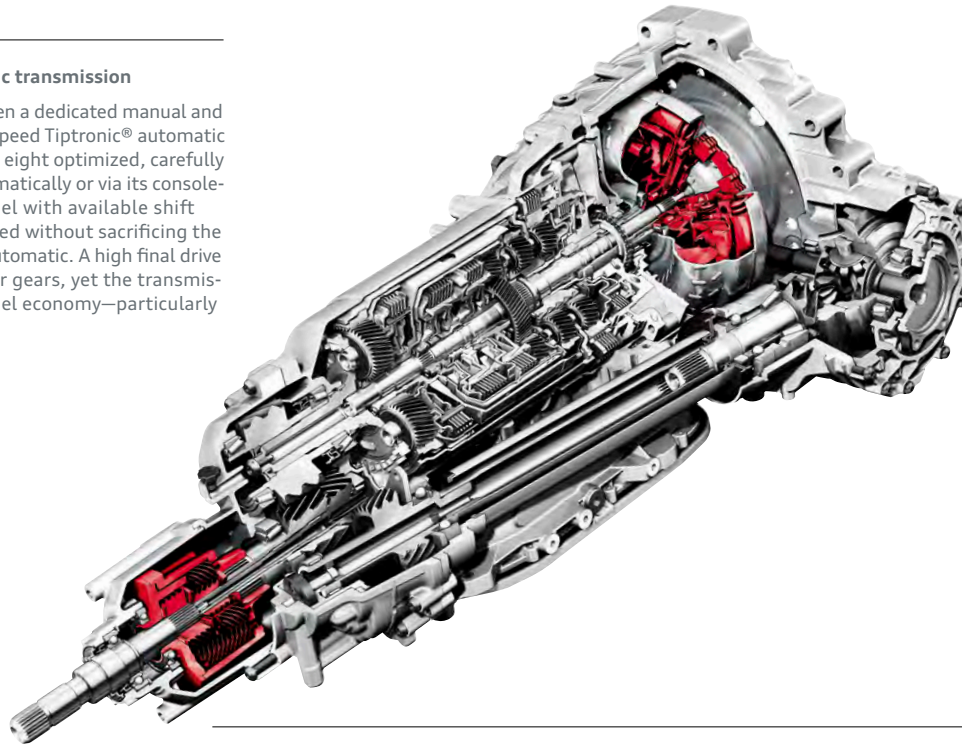

gear	
1ST	4.714:1
2ND	3.143:1
3RD	2.106:1
4TH	1.667:1
5TH	1.285:1
6TH	1.000:1
7TH	0.839:1
8TH	0.667:1

ratio

With efficiency comes great power.

Legendary engineering has shifted gears once again. Not content with a heritage of performance, we've developed an even more responsive and efficient way of applying power.¹ Our revolutionary eight-speed Tiptronic® automatic transmission with Dynamic Shift Program (DSP) helps to enhance performance while also allowing you to command upshifts or downshifts through the available steering wheel-mounted shift paddles. A new gear has been found—what you do with it is your choice.

¹ EPA estimates not available at time of printing. See www.fueleconomy.gov for updated information. Your mileage will vary.

Fuel for thought.

We thought you should know: Diesel sports a greater power density than traditional gasoline, which means that a gallon of diesel fuel has about 15% more energy than a comparable amount of gas, and combusts more efficiently in the engine. The Audi TDI® clean diesel engine has achieved ultra-low emissions vehicle (Bin-5/ULEV II) status in all 50 states while producing approximately 20% fewer CO₂ emissions than the traditional gasoline-fueled engine. And the brainy attributes don't hide the brawn—in fact, Audi has dominated the 24 Hours of Le Mans over the years with Audi TDI® prototype race cars. With these facts in mind, maybe you are thinking that an Audi TDI® might be your choice—which goes to show that clean diesel really is fuel for thought.

→→ → TDI® clean diesel → → →

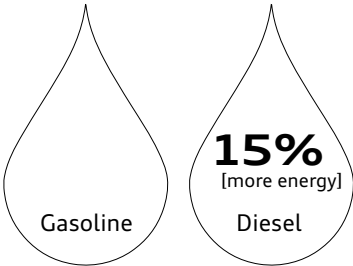

↑ ↑
Diesel packs more energy

On average, one gallon of diesel contains about 147,000 BTUs, versus 125,000 for gasoline.

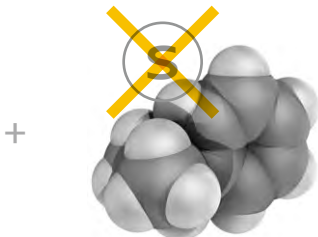

↑ ↑
Making diesel cleaner

A new refinement process binding sulfur molecules to hydrogen has reduced sulfur in diesel fuel by more than 97% in years past.

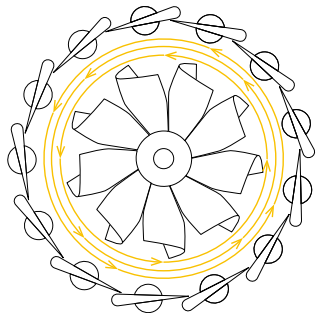

↑ ↑
Variable vane turbocharger

Adding turbo power to clean diesel engines, our adjustable vane turbocharger produces impressive torque punch and mid-range passing speeds.¹

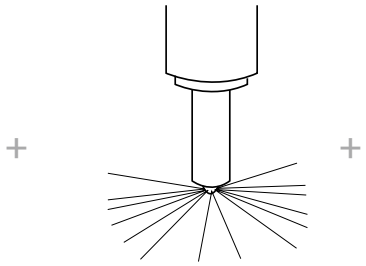

↑ ↑
Piezo direct injection

Precise injections help lower the combustion noise normally associated with diesel engines, while optimizing the distribution of fuel in the combustion chamber, helping to further reduce exhaust emissions.

¹ Obey all speed and traffic laws. 2 24 city/38 highway/29 combined mpg (2014 A7 TDI® clean diesel with eight-speed Tiptronic® automatic transmission). EPA estimates. Your mileage will vary.



Engine

3.0-liter TDI® clean diesel V6 with 240 hp and 428 lb-ft of torque with AdBlue® exhaust after-treatment



Drivetrain

Eight-speed Tiptronic® automatic transmission and Audi quattro® all-wheel drive



Fuel economy

24 city/38 highway/
29 combined²

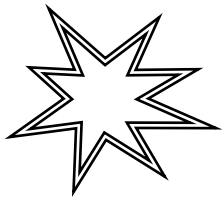

+

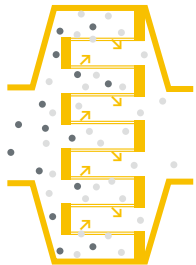

=

up to
20%
more efficiency



Combustion

Combining a high compression ratio with direct injection makes combustion more efficient, and produces emissions cleaner than those of engines with a lower compression ratio.



After-exhaust treatment

With innovative diesel particulate filters and the nontoxic AdBlue® reducing agent, we eliminate up to 95% of diesel NO_x emissions.



Increased fuel efficiency

Another way diesel creates fewer emissions is that it gets better mileage, up to 20% more mpg than comparable gasoline engines, in fact²



There is more information on the Audi TDI® clean diesel model line in the all-new 2014 Audi TDI® clean diesel brochure. See your dealer or go to audiusa.com for details.



Driver Assistance

We're solving problems before you even know you have them.

We shed light on your blind spots.

Audi strives to constantly up the ante on the driver assistance tools built right into the Audi A7, and they're all designed to work in tandem with you, wherever you go. Whether it's advanced technologies like night vision assistant that uses infrared technology to spot pedestrians and other obstacles on the road, or radar sensors that Audi side assist utilizes to inform you of vehicles approaching from the side and rear, you'll find that we've developed them to work together to help keep you in charge of the road. The whole suite of available driver assistance features can be found in the A7. It's another testament to the effort Audi puts into helping ensure that you're not the only one keeping an eye on the road.

Audi adaptive cruise control with stop & go

Not only retains a preset distance from vehicles ahead, but resumes acceleration when you're ready. Using long-range radar and a camera, the available Audi adaptive cruise control with stop & go helps read the traffic conditions and adjusts the speed, helping to bring the vehicle to a full stop before accelerating when traffic flow resumes.



Corner view cameras

Giving you a nearly 360-degree view around the vehicle, the available corner view cameras make parking significantly easier thanks to combined camera images from the front, rear and sides of the vehicle.

Audi pre sense® plus

The available Audi pre sense plus offers comprehensive driving assistance with sensors in the front, side and rear. After visual, physical and aural collision warnings, there are four distinct phases for automatic preparation for the unavoidable: an upsurge of brake pressure, safety belt pre-tensioning, partial braking, and sunroof and window preparation. In severe cases, Audi pre sense plus will engage full braking and deceleration.



Night vision assistant

Using infrared technology to detect what lies ahead, this available feature uses thermal-imaging technology to help you avoid trouble. Pedestrians can be detected over 300 feet in front of the vehicle, while objects can be detected over 900 feet ahead—all shown on the 7" color driver information system.

Audi active lane assist

Operating at speeds above 38 mph, this available system helps detect when the vehicle begins to leave the lane without signaling. Then, through gentle, corrective steering efforts, it helps the vehicle remain in the lane and vibrates the steering wheel as an additional warning. This way, Audi active lane assist complements the driver's decision-making process and further solidifies the bond between driver and machine.



Head-up display

With easy-to-view, accurate visual information right at eye level, this available feature displays important driving information and even pedestrian-detection warnings.

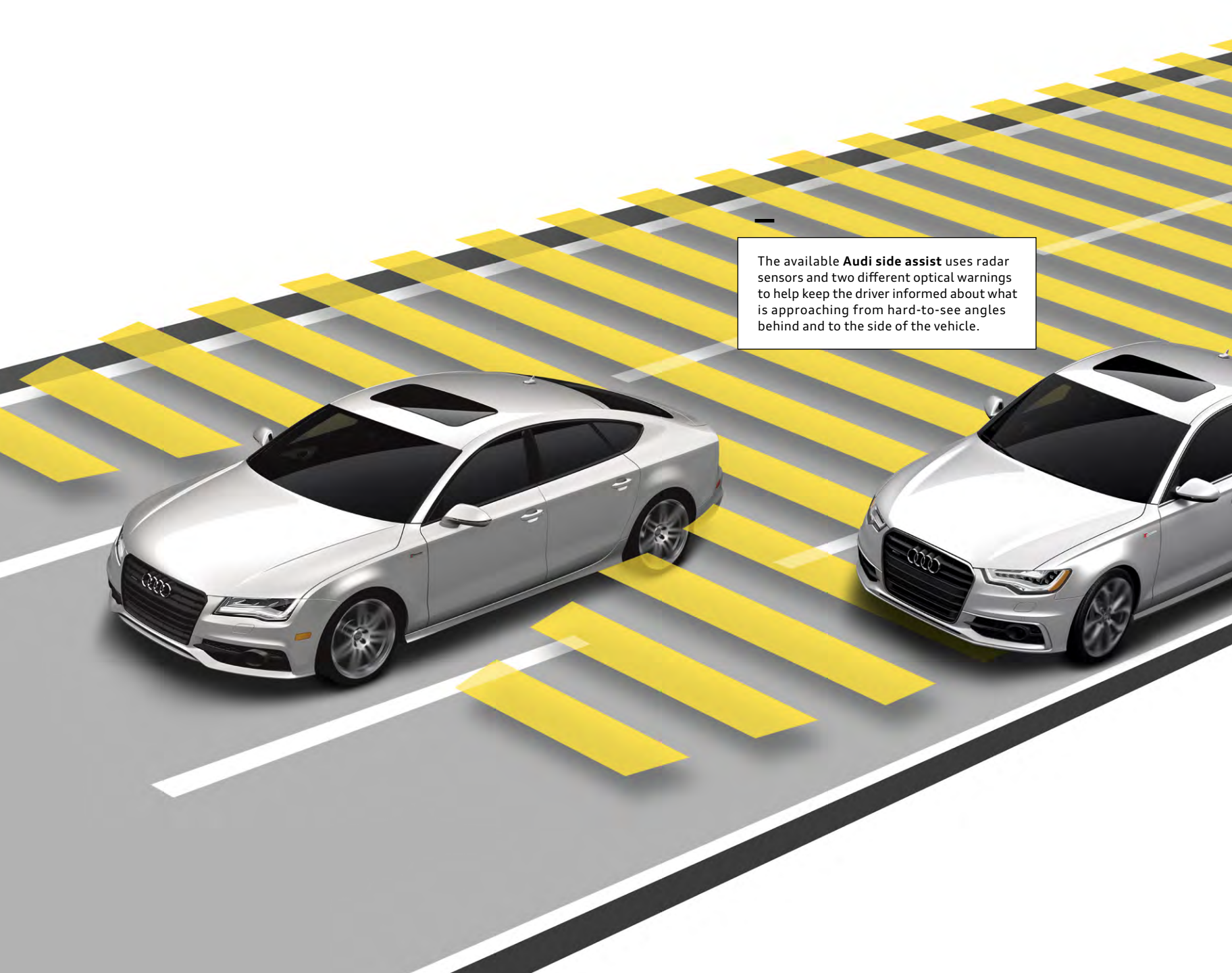
The image shows two silver Audi sedans on a road. The road surface is decorated with diagonal stripes in yellow and black, creating a sense of depth and perspective. The car on the left is an Audi A5, and the car on the right is an Audi A6. Both cars are facing towards the left of the frame. A text box is positioned in the upper right area of the image, containing information about the Audi side assist feature.

The available **Audi side assist** uses radar sensors and two different optical warnings to help keep the driver informed about what is approaching from hard-to-see angles behind and to the side of the vehicle.

We don't see safety as an option, or a luxury.

Audi engineers don't equate strength with size. Big is just big—strong is a more flexible concept. While you may not think about weight savings when it comes to strength, we'd like you to take a second and think again. The aluminum hybrid construction developed by Audi engineers is a lightweight and unyielding revolutionary technology that offers an innovative approach to both weight savings and strength. Airbag technology is designed to respond differently based on seat position, and specially constructed crumple zones give way upon impact to help mitigate potential injury in a collision.¹ All of this, combined with the rigidity of laser seam-welded joints that enhance the strength of every Audi we make, helps diminish the impact of an unavoidable event.



Dramatization²



Safety

Working to spread a “bend, don't break” philosophy.

ESC and ABS

Computerized technology that works in perfect sync with the Anti-lock Brake System (ABS), Electronic Stability Control (ESC) helps minimize any loss of stability, applying brake pressure to individual wheels and reducing throttle input to help counter oversteer or understeer when the vehicle needs it.

Ten airbags

A full complement of ten airbags¹ is available in the A7 to offer additional protection in the event of a collision. Front-impact airbags for both driver and front passenger are designed to specifically target and protect the head during collisions, for added protection.

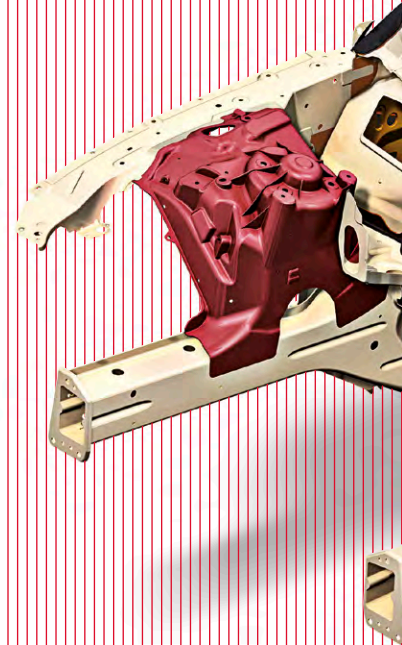

¹ Airbags are supplemental restraints only and will not deploy in all crash circumstances. Always use safety belts and seat children only in the rear, using restraint systems appropriate for their size and age. ² This is a dramatization and does not depict what will happen in a collision. All bags will not inflate simultaneously in real-world collisions, and, if multiple bags do deploy, they will be in various stages of inflating/deflating and will never all be inflated at the same time.

Referring to all dedicated measures that help protect the car's occupants against injury, the **passive safety** measures in the A7 include its safety belt system, ten available airbags, the rigid occupant cell and crumple zones at the front and rear of the vehicle.

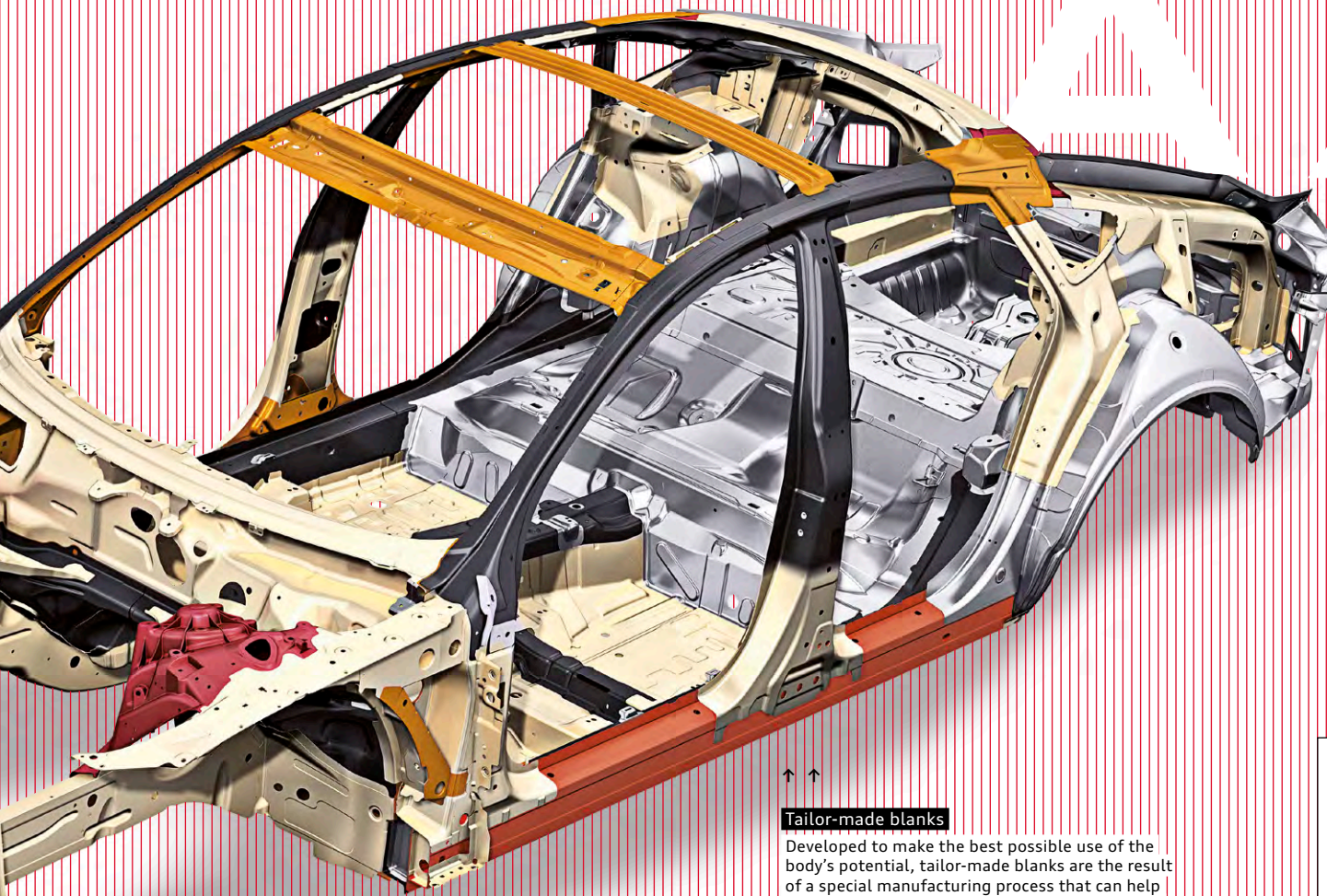

Tailor-made blanks

Developed to make the best possible use of the body's potential, tailor-made blanks are the result of a special manufacturing process that can help strengthen the upper zone of the B-pillars, while the lower zone is designed to help mitigate the impact in the event of a side collision.

- *mild steel*
- *high-strength steel*
- *modern high-strength steel*
- *ultra-high-strength steel*
- *cast aluminum*
- *ultra-high-strength steel (hot-formed)*



MMI System

We've brought the backseat driver front and center.

Get in touch with your needs.

A lot can be said with a simple touch. Case in point, Audi MMI® touch. A revolution in intelligent simplicity, MMI touch with handwriting recognition is a technology that gives you the ability to give commands and retrieve media simply by its recognizing a few strokes of your finger. Access information such as music files, contact information and destinations through the Audi MMI touch—or give input to Audi connect®, an innovative infotainment system with Google Earth™ mapping service. Now staying in touch with your world isn't just a good gesture, it's one simple gesture.^{1,2}

Audi MMI touch

Developed by the Audi Human Machine Interface (HMI) team, Audi MMI touch illustrates why making something simple to use can be so complex. The HMI team designed a system so advanced, it can read almost anyone's handwriting—even if you choose to write with your non-dominant hand.

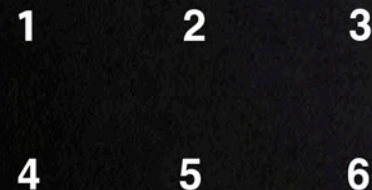

Function buttons

Helping you navigate through the MMI system with ease are four well-placed function buttons. Each button correlates to a command at the corner of the screen and, when pressed, takes you to your desired selection.

NAV

TEL

MENU

¹ Always pay careful attention to the road, and do not drive while distracted. The features and technologies discussed above are optional, may require an additional subscription with separate terms and conditions, and should be used only when it is safe and appropriate. The Wi-Fi® hotspot feature is intended for passenger use only. ² See Infotainment/Technology section of the Featured Content page for important information regarding Audi Navigation plus and required SiriusXM subscriptions. ³ Requires compatible phone.



SiriusXM® Satellite Radio

Go ahead. Crisscross the country. We assure you, you'll never run out of entertainment options, with over 130 channels of music, talk, sports and news.²

Audi media

The media function opens up a world of options with the Audi MMI Navigation plus, allowing you to control the Audi music interface, Secure Digital (SD) card slots, hard disk drive (HDD) audio jukebox or DVD, and BLUETOOTH® streaming audio.^{2,3}

Audi MMI Navigation plus

Count on the advanced navigation system to home in on your destination with stunning precision while putting a little more depth in your journey with help from Google Earth™¹

BLUETOOTH® wireless technology

Unlock your mobile phone's potential through the MMI system. Simply pair them up and start enjoying near complete control at the touch of a button.³

If nothing else, you know your car is listening to you.

Don't reach—relax. While touchscreens are seemingly everywhere, they don't need to be in your vehicle. With available Audi connect®, you may never have to reach out again.¹ Thanks to Google Voice™ Local Search, Audi connect allows you to search Google™ by simple voice commands. The crisp display is nestled farther up, closer to the windshield, so your eyes don't have to focus and refocus between the screen and the road ahead of you. For those times when you are feeling tactile, we've placed toggle buttons near the gear shifter, where your hand naturally rests while you drive. So while other automobile manufacturers still want you to reach out, we've found a few ways for you to make information a lot more accessible while your hands are on the wheel.



SiriusXM® Traffic

Get traffic information overlaid onto 3D satellite imagery to visualize a true aerial view of your route, and let the Audi MMI Navigation plus system reconfigure your route to avoid traffic.²

NEWS

News feeds

Stay on top of the news by having headlines and stories delivered right to your Audi MMI® display.

POI

Point-of-interest

The point-of-interest search with voice control means that the digital world is with you on every journey.

myAudi

myAudi features

Plan travel from your personal computer. Send your desired destinations to your vehicle ahead of time and access your route from your vehicle later.



Mobile Wi-Fi® hotspot

Provides high-speed connectivity for up to eight passenger devices through an onboard wireless hub.



¹ Always pay careful attention to the road, and do not drive while distracted. The features and technologies discussed above are optional, may require an additional subscription with separate terms and conditions, and should be used only when it is safe and appropriate. The Wi-Fi® hotspot feature is intended for passenger use only. ² See Infotainment/Technology section of the Featured Content page for important information regarding required SiriusXM subscriptions.



Google Earth™ with 3D satellite imagery

With Google Earth™ integration, you'll enjoy 3D satellite imagery, including Google Maps Street View, displayed right on the Audi MMI display.



Weather information

Current local conditions and forecasts for your destination can help you prepare for your trip.



Google Voice™ Local Search

Simply tell your Audi what you are in the mood for, then let the cloud-processing power of Google™ speech recognition interpret your request and bring up a list of destinations in the area of your choice.



Google Maps Street View

With Google Maps Street View, your vehicle can show you a driver's-eye view of your destination right before you arrive so it's easy to recognize.



Parking information

Search for parking in your area of interest, check space availability and set your selection as a destination to navigate directly to the garage entrance.



City events

Get information about current events, exciting locations and places of interest at your travel destination, current location or other chosen location instantly.



Travel info

Discover local landmarks in your area of interest, set them as your destinations, and let your vehicle lead the way as you explore the world around you.

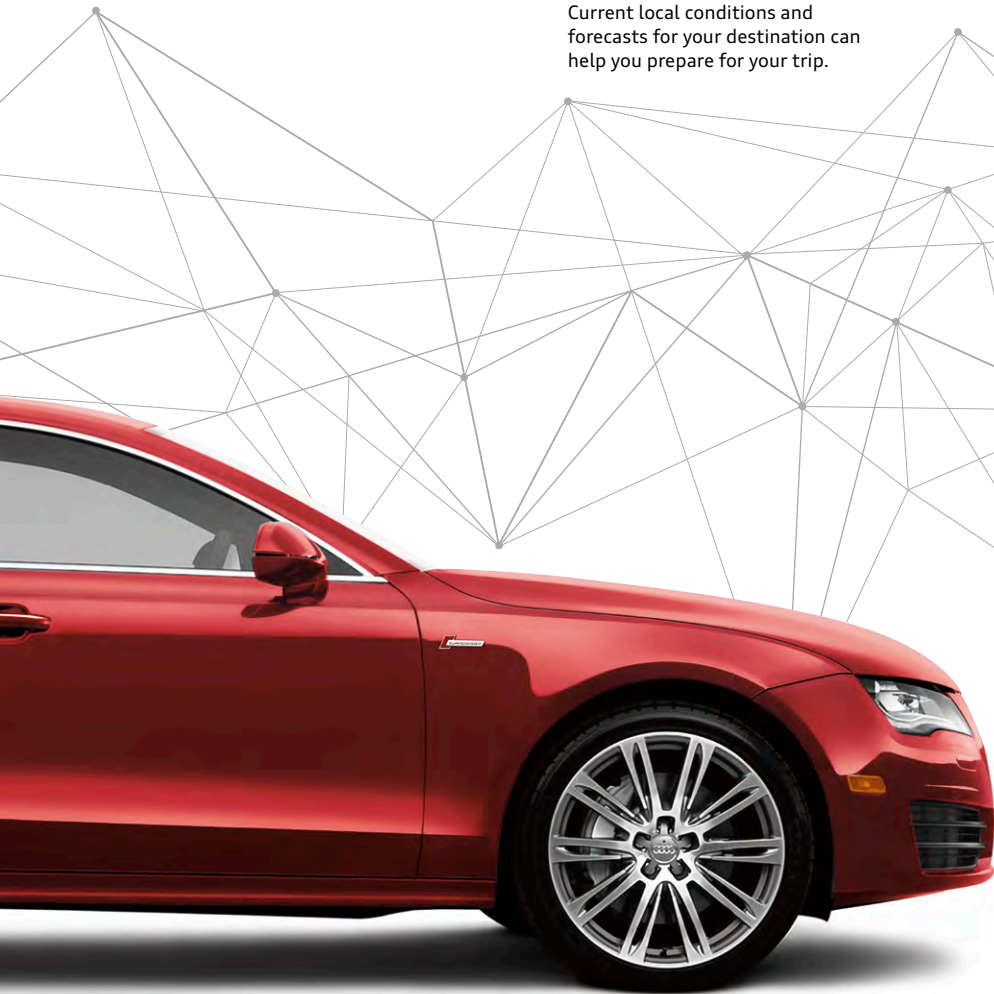



Sound

Audi is Latin for “listen,”
so you know we take sound
very seriously.

When even a German lullaby is an ode to sound engineering.

It would be an interesting challenge, a note-perfect Brahms’ Lullaby delivered through the tuned speakers of an Audi sound system versus the exhilaration of the passing lane. Either way, performance wins. But it goes way beyond the gentle tones of a German composer. Audi sound engineers don’t simply make the cabin acoustics sound perfect for your music, they make the drivetrain sing. Or, if not sing, then put it in harmony with every other element of the driving experience. From the sound of a shutting door, to the click of a turning knob, to the full integration of the available BOSE® or Bang & Olufsen® sound systems, there’s an orchestra of engineering that fills your cabin with faithfully rendered, thrilling sound. Whatever it is you are looking for, Audi sculpts sounds in a way that matches your mood, even when you need soothing while in traffic.

BOSE® Surround Sound System

Hitting the right note on every drive, the available BOSE® Surround Sound System turns your Audi into a 14-speaker powerhouse with the help of innovative sound engineering and optimized speaker placement. Add to that AudioPilot® noise compensation, which helps maintain a consistent volume under varying speeds and road conditions, and you get an acoustic listening environment that rivals any live performance.

Bang & Olufsen® Advanced Sound System

The passion of Bang & Olufsen® matches well with Audi. Just consider the remarkable available Bang & Olufsen® Advanced Sound System. By focusing on design and performance together, it has become the symbol of acoustic perfection. Bang & Olufsen® engineers help to craft meticulously rendered sound through 15 speakers (including two innovative retractable aluminum lenses) and an impressive 1,300 watts of pure power. The result: sound as captivating to your ears as an Audi is on your eyes.



15 speakers

Optimized sound flows through strategically placed speakers around the cabin. Hear it, and you’ll instantly become engrossed in the tiniest detail and warmth of the sound.

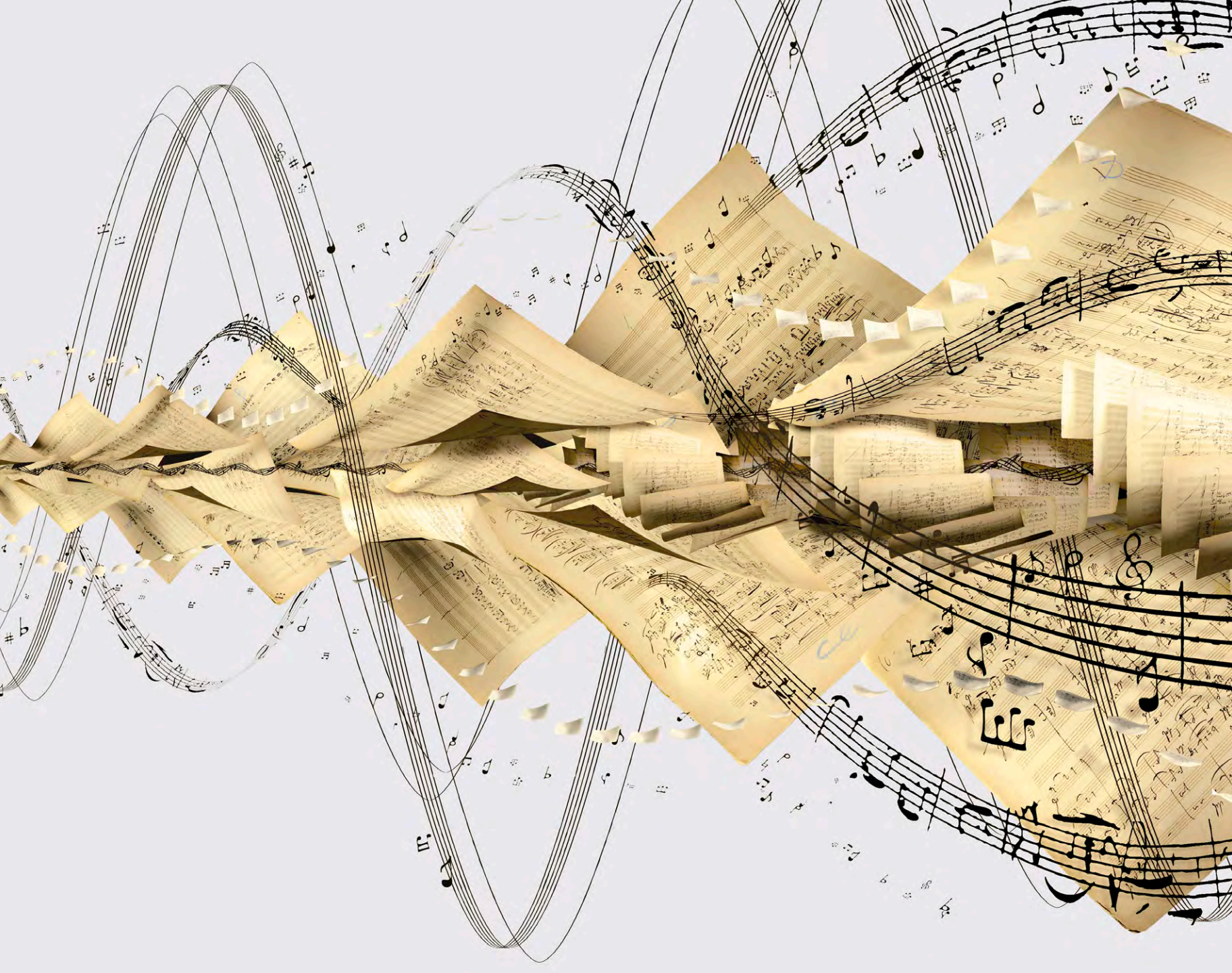





LED taillight technology

Sleek and stylish, these rear light-emitting diodes are brighter and longer-lasting than conventional bulbs and illuminate faster than traditional brake lights, which can help give the driver behind you more time to respond.

We relish goodbyes.

Give that person you just passed something to remember you by.¹ The gorgeous, swooping lines of the Audi A7 culminate in a spectacular finish, highlighted by the unmistakable look of its LED taillight technology. The last thing they'll see will surely leave them pining for more. They just better take it all in while they can, because from this angle you won't be around for long.

¹ Obey all speed and traffic laws.

Exterior Colors

Brilliant Black

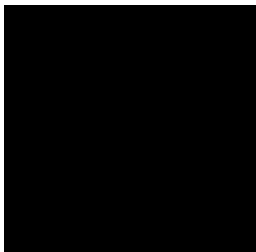

Ibis White



Dakota Gray metallic

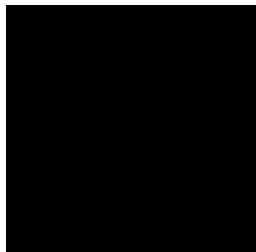

Glacier White metallic

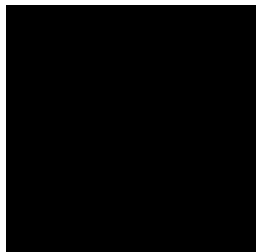

Havanna Black metallic

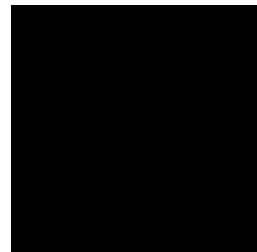

Ice Silver metallic

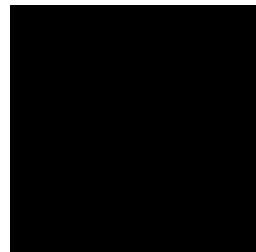

Moonlight Blue metallic



Oolong Gray metallic

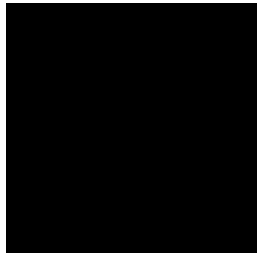

Quartz Gray metallic

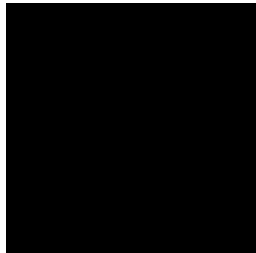

Daytona Gray pearl

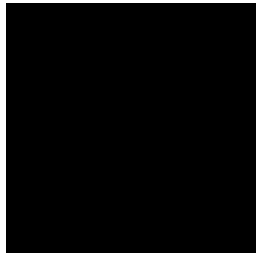

Garnet Red pearl

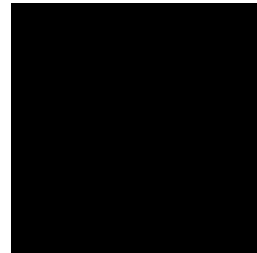

Phantom Black pearl



Prestige only

Interior Colors | Seat Selections

Standard Seat



Comfort Seat¹



Black leather



Standard

Nougat Brown leather



Standard

Titanium Gray leather

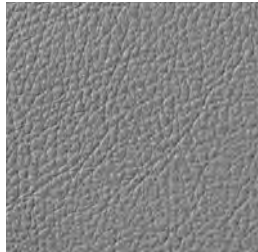

Standard

Velvet Beige leather



Standard

Black perforated leather

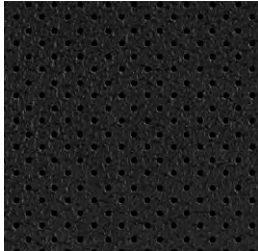

Comfort

Nougat Brown perforated leather

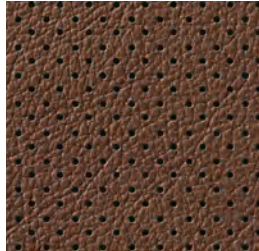

Comfort

Titanium Gray perforated leather

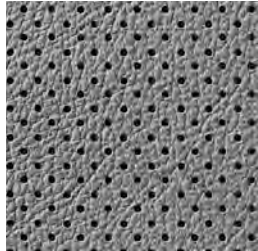

Comfort

Velvet Beige perforated leather



Comfort

¹ Standard on Prestige models.

Decorative Inlays



Fine Grain Ash Natural
Brown Wood inlay¹

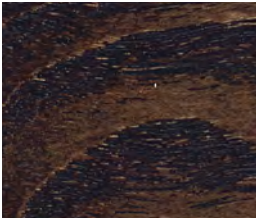

Dark Brown Walnut
Wood inlay¹

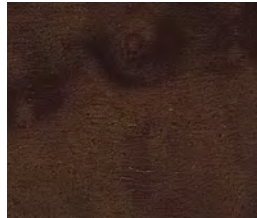

Layered Oak Wood inlay¹



Brushed Aluminum inlay¹



¹ Decorative inlay options will vary based on model and interior color combination. See your dealer for details.

Wheels

19" 10-spoke design
255/40 all-season tires



A7 Premium plus and Prestige

19" 5-double-spoke design
255/40 all-season tires



A7 Premium plus and Prestige (19" Sport package)

20" 10-parallel-spoke design



A7 Premium plus and Prestige (20" Sport package with 265/35 summer performance tires²)
A7 Premium plus and Prestige (optional, with 265/35 all-season tires)

20" 7-double-spoke design (bicolor finish)
265/35 summer performance tires²



A7 Prestige (Black Optic package)

² Tires are supplied and warranted by their manufacturer. High-performance tires are designed for optimum performance and handling in warm climates. They are not suitable for cold, snowy or icy weather conditions. If you drive under those circumstances, you should equip your vehicle with all-season or winter tires, which offer better traction under those conditions. We suggest you use the recommended winter or all-season tire specified for your car or its equivalent. These high-performance tires also have a lower aspect ratio that aids performance and handling; however, in order to avoid tire, rim or vehicle damage, it is important that the inflation pressure is regularly checked and maintained at optimum levels. Please also remember in making your selection that, while these tires deliver responsive handling, they may ride less comfortably and make more noise than other choices. Finally, these tires may wear more quickly than other choices.

Technical Specifications

Engineering | Performance

	A7 3.0T	A7 TDI®
Engine type	Six-cylinder	Six-cylinder
Engine block/Cylinder head	Aluminum-alloy	Cast-iron/Aluminum-alloy
Displacement (cc)/Bore and stroke (mm)	2,995/84.5 x 89.0	2,967/83.0 x 91.4
Horsepower (@ rpm)	310 @ 5,500	240 @ 3,500
Torque (lb-ft @ rpm)	325 @ 2,900	428 @ 1,750
Compression ratio	10.3:1	16.8:1
Valvetrain	24-valve DOHC with variable valve timing	24-valve DOHC
Induction/Fuel injection	Supercharged/TFSI®	Turbocharged/TDI®
Start-stop efficiency system	■	■
Acceleration (0–60 mph)	5.4 seconds	5.5 seconds
Top track speed ¹	130 mph	130 mph

Transmission | Drivetrain

Eight-speed Tiptronic® automatic transmission with Audi quattro® all-wheel drive (Gear ratios: 1st: 4.714, 2nd: 3.143, 3rd: 2.106, 4th: 1.667, 5th: 1.285, 6th: 1.000, 7th: 0.839, 8th: 0.667, Reverse: 3.317, Final drive: 2.848 for 3.0T models, 2.519 for TDI® models)	■	■
--	---	---

Body | Suspension | Chassis

Audi ultra® lightweight technology—aluminum exterior body panels and a steel chassis	■	■
Five-link front suspension	■	■
Trapezoidal-link rear suspension	■	■
Sport suspension calibration	Available	Available
Ventilated front disc/Ventilated rear disc brakes (in)	14.0/13.0	13.6/13.0
Electromechanical power steering system	■	■
Steering ratio	15.9:1	15.9:1
Turning diameter, curb-to-curb (ft)	39.0	39.0

Exterior measurements

	A7 3.0T	A7 TDI®
Wheelbase (in)	114.7	114.7
Length (in)	195.6	195.6
Height (in)	55.9	55.9
Overall width with mirrors (in)	84.2	84.2
Track front/rear (in)	64.7/64.4	64.7/64.4
Curb weight (lb)	4,200	4,266
Drag coefficient (Cw)	.30	.30

Interior measurements

Head room with sunshade (in, front/rear)	36.9/36.6	36.9/36.6
Leg room (in, front/rear)	41.3/37.0	41.3/37.0
Shoulder room (in, front/rear)	57.2/55.9	57.2/55.9
Cargo volume (cu ft, rear seatbacks up)	24.5	24.5
Seating capacity	5	5

EPA mileage estimates | Capacities | Emissions

Tiptronic® automatic transmission (city/highway/combined)	NA ²	24/38/29 ³
Engine oil (qt)	7.2	7.2
AdBlue® (gal)	—	5.0
Fuel (gal)	19.8	19.2
Required fuel	Premium	Ultra-low-sulfur diesel
Emissions rating	ULEV II	ULEV II



Technical specifications and featured content for Audi S7 and RS 7 models can be found in the **2014 Audi Sport brochure**. See your dealer or go to audiusa.com for details.

Featured Content

Safety | Security

	Premium plus	Prestige
Driver and front passenger dual-stage airbags, front thorax side airbags, knee airbags and Sideguard® head curtain airbags ¹	■	■
Rear-passenger thorax side airbags ¹	Available	Available
Front passenger occupant detection for airbags ¹	■	■
Safety belt reminder for driver and front passenger	■	■
Lower Anchors and Tethers for CHildren (LATCH) in rear seats	■	■
Power central locking system with safety unlock feature if airbags deploy	■	■
Electronic Stability Control (ESC) with traction control (ASR)	■	■
Anti-lock Brake System (ABS) with Electronic Brake-pressure Distribution (EBD) and brake assist	■	■
Tire-pressure monitoring system	■	■
Electromechanical parking brake	■	■
Anti-theft alarm system with immobilizer	■	■

Exterior

Audi Singleframe® grille	■	■
Gloss Black Audi Singleframe® grille	—	Available
Xenon plus headlights with LED daytime running light technology	■	—
Adaptive xenon plus headlights with LED daytime running light technology	—	■
Full LED headlight technology	—	Available
Automatic headlights	■	■
LED taillight technology and rear fog lights	■	■
Power-adjustable, auto-dimming, heated exterior side mirrors with memory	■	—
Power-adjustable, power-folding, auto-dimming, heated exterior side mirrors with memory	Available	■
LED turn indicator light technology integrated into the exterior side mirrors	■	■
Heated windshield washer nozzles	■	■
Aluminum trim around exterior windows	■	■
Gloss Black trim around exterior windows	—	Available
Power soft-closing doors	—	Available
Power tailgate open/close and hands-free release	■	■
Adaptive rear spoiler	■	■
Dual exhaust outlets	■	■
Audi S line® exterior appearance	—	■

Interior

	Premium plus	Prestige
Three-zone automatic climate control	■	—
Four-zone automatic climate control	—	■
Four-spoke multifunction steering wheel	■	■
Three-spoke multifunction sport steering wheel with shift paddles	Available	Available
Heated steering wheel	Available	Available
Tilt and telescopic manually adjustable steering column	■	—
Power tilt and telescopic adjustable steering column	—	■
Auto-dimming interior rear view mirror	■	■
Illuminated locking glove box	■	■
Leather-wrapped shift knob	■	■
Four beverage holders	■	■
Decorative interior inlays (see Decorative Inlays page for more detail)	■	■
Aluminum door sill inlays	■	■
Front and rear floor mats	■	■
Ambient LED interior lighting technology	—	■
Black cloth headliner (with Black or Nougat Brown leather)	Available	Available
Dual front sun visors with lighted vanity mirrors	■	■
Power windows with one-touch up/down operation and pinch protection	■	■
Sunroof	■	■

Seating

Leather seating surfaces (perforated on Prestige) (see Interior Colors page for more detail)	■	■
Eight-way power front seats and four-way power lumbar adjustment for driver	■	—
Twelve-way power front seats, including four-way power lumbar adjustment	—	■
Driver seat memory	■	■
Heated front seats	■	■
Ventilated front seats	—	■
Five-seat configuration (rear-bench seat)	■	■
Heated rear seats	Available	Available
Split folding 60/40 rear seatbacks	■	■

Featured Content

Infotainment | Technology

	Premium plus	Prestige
Audi MMI® Navigation plus with voice control system ¹	■	■
Audi MMI® touch with handwriting-recognition technology	■	■
Audi connect® with six-month trial subscription ²	■	■
7" color driver information system	■	■
Audi MMI® Radio plus with ten speakers and single CD player with MP3 playback capability	■	—
BOSE® Surround Sound System with 14 speakers, AudioPilot® noise-compensation and 630 watts	Available	■
Bang & Olufsen® Advanced Sound System with 15 speakers and 1,300 watts	—	Available
HD Radio™ Technology	■	■
SiriusXM® Satellite Radio with 90-day trial subscription ³	■	■
SiriusXM® Traffic with four-year subscription ³	■	■
SD card slot with 32GB operating capacity (dual slots)	■	■
Audi music interface with iPod® integration	■	■
BLUETOOTH® streaming audio ⁴	■	■
BLUETOOTH® wireless technology preparation for mobile phone ⁴	■	■
Three 12-volt power outlets	■	■
Garage door opener (HomeLink®)	■	■
Audi advanced key—keyless start, stop and entry ⁵	■	■
Cruise control with coast, resume and accelerate features	■	■
Audi adaptive cruise control with stop & go	Available	Available
Audi active lane assist	Available	Available
Audi side assist with pre sense® rear	Available	■
Audi pre sense® plus	Available	Available
Night vision assistant with pedestrian detection	—	Available
Head-up display with navigation and assistance systems information	—	Available
Audi drive select	■	■
Parking system plus with rear view camera (front and rear sensors)	■	■
Corner view camera system	Available	Available
Rain/light sensor for automatic windshield wipers and headlights	■	■

■ Standard — Not applicable NA Information not available at time of printing

1 Audi MMI® Navigation plus depends on signals from the worldwide Global Positioning Satellite network. The vehicle's electrical system and existing wireless and satellite technologies must be available and operating properly for the system to function. The system is designed to provide you with suggested routes in locating addresses, destinations and other points of interest. Changes in street names, construction zones, traffic flow, points of interest and other road system changes are beyond the control of Audi of America, Inc. Complete detailed mapping of lanes, roads, streets, toll roads, highways, etc., is not possible, therefore you may encounter discrepancies between the mapping and your actual location. Please rely on your individual judgment in determining whether or not to follow a suggested Audi MMI® Navigation plus route. For mapping updates please see your Audi dealer or call 1-800-FOR-AUDI for details. 2 See the Audi connect® page for important information about Audi connect®. 3 SiriusXM® Satellite Radio and Traffic subscriptions sold separately or as a package after trial expires. SiriusXM® Traffic service available in select markets. Subscriptions are governed by SiriusXM® Customer Agreement (see www.siriusxm.com) and are continuous until you call SiriusXM® to cancel. SiriusXM® U.S. Satellite Service available only to those 18 and older in the 48 contiguous U.S.A., D.C. and Puerto Rico (with coverage limitations). 4 Requires compatible phone. 5 Some Audi models are equipped with a keyless ignition feature. The details as to how the system works can vary, and Audi owners should consult their owner's literature or an authorized Audi dealer if they have further questions about the operation of this feature. Please note that Audi warns against leaving the vehicle unattended with the engine running, particularly in enclosed spaces.

Our answer to a black tie affair.

If the A7 makes a statement, the Audi A7 Prestige with Black Optic package is an outright declaration. First off, unique 20" double-spoke design wheels set this vehicle apart even at a standstill. Add to that a striking Black Audi Singleframe® grille and the already more muscular and sporty look provided by the Prestige model, and you'll see why some things never go out of style.



Accessories

Add a new point of view, a dash of distinction and the ultimate in self-expression with Audi Genuine Accessories. Whether you load the cargo carrier with climbing gear or add a set of sporty new wheels, we've got the accessories that will help enhance every facet of your lifestyle. Designed for seamless compatibility with your Audi,



Aluminum bike rack

This locking holder fits 20- to 80-mm bike frames with both wheels on the bike and helps keep the bike upright as you secure it in place.^{2,3}



Base carrier bars

Attached to strong side brackets, these are the durable foundation of the Audi roof-rack system.²

Ski and snowboard racks

Push-button, keyed locks open and close easily. Rubber-cushioned aluminum bars hold securely. Standard attachment (shown) holds two sets of skis or two snowboards. Deluxe attachment holds up to three sets of skis or four snowboards.^{2,3}

Other accessories not shown

→ Audi Genuine Sport and Design Accessories

→ Your Audi vehicle features a bold, aggressive stance and strong, stunning lines. Enhance it by adding Audi Genuine Sport and Design Accessories. All are carefully scrutinized in the design and development process. So while they're striking in appearance, they've also passed rigorous quality assessments, including corrosion testing. If you're looking for a bolder appearance or a finishing touch, there is a solution designed by Audi that makes every mile more enjoyable—and more yours.

Audi Genuine Alloy Wheels

Strike the perfect balance between breathtaking design and awe-inspiring performance with Audi Genuine Alloy Wheels. Audi experts have meticulously designed these wheels especially for each Audi model. They're engineered to the highest standards and endure rigorous testing to help ensure long-term quality. Experience eye-catching style that is yours and yours alone. Nothing enhances the bold, dynamic look of your Audi vehicle faster.

¹ See dealer for details. ² All roof-rack system attachments require the base carrier bars. All attachments sold separately. ³ Recreational equipment, sporting equipment and luggage not included.

all pieces are backed by your vehicle's 4-year/50,000-mile limited warranty or the accessory's 12-month/12,000-mile limited warranty, whichever extends longer from the accessory purchase date! If you're looking to personalize or protect, Audi offers an intelligent solution.



20" 5-arm parabolic wheels

Add an impressive finishing touch with this eye-catching design. Anthracite with machine-polished spokes.



19" 5-V spoke wheels

Show off the dramatic profile and superior performance of the Diamond Silver 5-V spoke design on the A7.



All-weather cargo mat

Custom fit for the Audi A7. Textured material helps control load shifting. Raised lip helps contain spills and protect cargo-area carpeting from stains.



Valve stem caps

Emblazoned with the iconic Audi rings, these handsome caps complement the unique design of the wheels on your Audi.



All-weather floor mats

Deep-ribbed, channeled design helps protect the floor and carpeting from water, mud, sand and snow. Black mats feature the vehicle logo and are available in sets of two for front or rear.



Load-protection film

This custom-fit transparent film helps protect the rear bumper from scratches while loading and unloading. Outline depicts coverage area.

Audi TravelSpace Transport Accessories

You go almost everywhere. Give your Audi the proper invitation to be part of your adventures. Never leave the necessary gear behind. Bring it with Audi TravelSpace Transport Accessories. The list includes bike racks, ski racks, a variety of watersports equipment carriers and various sizes of cargo carriers. Wherever you go, make sure almost everything fits with a variety of intelligent and innovative solutions. Accessories designed for your life—the passionate, active part.

Audi Genuine Electronics Accessories

The illuminating technology that graces each Audi vehicle provides the inspiration for Audi Genuine Electronics Accessories. Similarly, all of these accessories are impressively advanced and inspiring. Our audio options let you enhance your listening pleasure. Other accessory options help promote more convenient travel. All are designed and tested to help ensure compatibility with the vehicle's electrical systems, allowing you to enjoy every aspect of Audi technology with almost all your senses. Demand the best and drive with added confidence.

Audi Guard Comfort and Protection Accessories

Help protect what you love. Audi Guard Comfort and Protection Accessories offer functional, practical items that help keep your Audi in pristine condition. Choose from such useful items as trunk liners that help make clean-up quick and easy or an easy-to-use storage cover that helps shield the vehicle. Use them all to help reduce wear and tear and keep the vehicle looking like new—inside and out. All are engineered to stringent Audi standards, so you can be assured of their quality and durability.