



HORTICULTURAL SUPPLY

2023 CATALOG





THE LEADER IN GREEN INDUSTRY DISTRIBUTION



GROWER • LAWN & GARDEN • CEA & HYDRO • PLANTS & SEEDS

ABOUT BFG SUPPLY CO.

For over 50 years, BFG has supplied the Green Industry with the broadest product range and premier customer service. Today, BFG is the leader in selling, marketing and distributing Green Industry solutions to professional growers, lawn & garden centers, controlled environment agriculturists and end user consumers around the nation and beyond.

Our robust national distribution network, including 18 warehouses along with our own fleet, supports customers in all 50 states and regions of Canada. Our extensive partnerships with over 800 leading manufacturers, allow us to offer 150,000+ skus to meet every customer's needs.

- Leading the industry with exceptional customer service for over 50+ years
- Focus on the Professional Grower, Independent Lawn & Garden, Controlled Environment Agriculture, and Hydroponic industries
- Professional field sales force dedicated to customer success
- Broad product selection with 20,000+ skus in stock and 100,000+ skus available to order
- Eighteen modern distribution facilities to efficiently serve customers
- Leading technology to improve ordering and delivery efficiency

ONE STOP.
We have you covered.

TABLE OF CONTENTS

Introduction 1-8
BFG Supply Intro, Family of Brands, Credit App

Greenhouse Structures 9-50
Shade Houses, Shade Curtains, Benching

Coverings 51-68
Film Coverings, Shade Products, Ground Cover

Containers 69-184
Hanging Baskets, Plug Trays, Flats, Growing Pots

Media 185-208
Professional Growing Mixes, Additives, Components

Fertilizer 209-254
Water Soluble, Controlled Release, Plant Food

Crop Protection 255-344
Insecticides 256-281
Fungicides 290-313
Herbicides 324-335

Irrigation 345-366
Valves, Tubings, Sprinklers, Regulators and More

Equipment & Supplies 367-426
Heating, Ventilation, Lighting, Carts, Plant Sleeves, Safety Gear, Radios, Labeling

Index 427-448





ONE STOP.

How does BFG source everything you need, when you need it?

ANSWER:

Our partnerships with 800 leading manufacturers allow us to offer over 150,000 SKUs through 18 strategically located warehouses.

**BROWSE ALL ADDITIONAL
CATEGORIES & ITEMS TODAY**

See our full catalog lineup at
visit www.bfgsupply.com

SCAN NOW





FAMILY OF BRANDS

GrowerSelect[®]



Green.tek



GardenerSelect



Michael Carr[™]
DESIGNS





For current pricing and availability, please scan the item using our mobile app, give us a call or visit our website at www.bfgsupply.com

Pac O™ Plant Growth Regulator

by OHP, Inc.

Pac O plant growth regulator is for use on commercially grown ornamental plants grown in containers in greenhouses and nurseries. Long lasting plant growth regulator that can be applied as a liner dip, spray, or drench

- Active Ingredient: Paclobutrazol
- Rate: Varies depending on application method. See label.
- REI: 12 Hrs
- Reduces internode elongation, resulting in more desirable compact plants

Signal Word: Caution

1gal
OHP986192 Min. Buy 1 EA



BARCODE
Tips & Tricks

Having issues reading barcodes? Due to the large amount of products in this catalog it is possible barcodes may read incorrectly. Isolate the intended barcode with paper before scanning.



Terms and Conditions of Sale

BFG Supply Co., LLC referred to as BFG

RELATIONSHIP TO ACCOUNT APPLICATION

These Terms and Conditions together with the Account Application and any fully executed Agreements between the parties contain the entire understanding between the parties as to all matters referred to herein. No other representations, covenants, undertakings or prior or contemporaneous agreements, whether oral or written, regarding any matters that are not specifically contained and incorporated in this Agreement, shall be deemed to have any effect or binding impact upon the parties. The language of this Agreement shall be construed according to its fair meaning and in accordance with its purpose and without regard to whom may have drafted any particular provision herein. For purposes of these Terms and Conditions "Customer" shall mean the legal entity that is a part to any BFG Supply Co. Account Application, or any Order placed with BFG Supply Co. and "Guarantor" shall mean any individual that executes the BFG Supply Co. Account Application as a guarantor.

ACCOUNT APPLICATION

Payment terms are stated on your invoice. Discounts may be offered on certain products in certain situations and will be specified on the invoice. These discounts, if offered, are only available on invoices paid and received into the BFG office within the terms outlined on your invoice via cash or check and payments via credit card are not eligible for discounts. Buyer is responsible for mail time and discounts are only available if BFG actually receives eligible payments during the time frame set forth in these Terms and Conditions. Post marks will not be considered. A finance charge of 2% per month (24% annually) will be assessed on invoices not paid within invoice term date. Payments received towards balance will first be applied to finance charges unless otherwise stated in writing by BFG. BFG reserves the right to assess the maximum amount of finance charges permitted by applicable law. BFG has the absolute discretion to place an account on C.O.D. status until past due balances, including finance charges, are satisfied in full and BFG has determined that Buyer is eligible for the reestablishment of a credit line in BFG's sole discretion. Any failure of the Buyer to satisfy any of its obligations under a Account Application with BFG, including but not limited to the failure to satisfy amounts due within payment terms shall comprise an event of default. In the event of default, if BFG must employ a collection agency or attorney to collect any past due account, Buyer shall be responsible for the satisfaction of all amounts incurred in collection of any past due account including collection costs and attorney fees.

PAYMENTS

Visa, MasterCard, Discover and American Express are acceptable payments at the time of purchase up to \$10,000 or higher as approved by BFG. Payments made after a finalized sale that require (or per request) a change in terms will be charged a 3% convenience fee. Please call BFG Accounts Receivable department at 800-883-0234 Ext 4997. Mail payments by check to BFG Supply Co., 3874 Solutions Center, Chicago, IL 60677-3008. All return checks are subject to a \$35 NSF fee.

ACCOUNT APPLICATION AND TAX EXEMPT FORMS

Account can be established by submitting a completed BFG Supply Co. Account Application. Allow three to four weeks for complete processing. In addition, a tax-exempt form for your state must be on file with BFG or taxes will be charged on all purchases. The Account Application must be completed in its entirety to avoid processing delays. Failure to provide all information will result in adverse action with respect to Buyer's application for credit, including declining the application.

INVOICES/STATEMENTS

Product will be invoiced on the date product is shipped from BFG or when delivery information is received from a manufacturer shipping direct. BFG will make good faith efforts to transmit monthly Account Statements at the beginning of each calendar month. Account Statements are reminders of open invoices, however, Account Statements do not grant an additional amount of time to remit payment. Please follow the terms indicated on your individual invoice. Copies of invoices can be located at www.bfgsupply.com or contact

BFG at 800- 883-0234. All these documents may be mailed, faxed, or e-mailed. Please contact BFG Supply Co., LLC or visit www.bfgsupply.com with your choice preference.

RETURNS

Our merchandise is sold on an outright sale basis and is not subject to return unless mis-shipped, damaged or defective. Any shipments refused for reasons other than freight damage will be subject to freight charges both ways as well as a restocking charge. If merchandise is mis-shipped, please contact our office for return authorization. We will arrange return transport and credit.

DAMAGE/SHORTAGE/DEFECTIVE ITEMS CLAIMS

Damage in shipment claims on items shipped via Fed-Ex/UPS/etc., must be made within one (1) business day (24 hours) of receipt of the merchandise. All claims for shortages and defective items must be reported to us within one (1) business day (24 hours) of delivery. All claims regarding billing errors, (pricing, terms, etc.) must be reported to BFG Supply or our representative within 30 days of delivery. Immediately upon receipt of truck shipments, examine the shipment carefully before signing the freight bill. If damage or shortage is evident, do not accept shipment without notation on the freight bill by the driver. Failure to do so may prevent you from filing a claim with the carrier. If you need assistance regarding damage claims, please contact your nearest BFG service location. A photograph of damaged product needs to be included with any damage claim. Merchandise found to be defective will be picked up (or field destroyed if you are advised to do so) and full credit will be issued provided the merchandise does not look like it has been abused or misused and is in accordance with the manufacturer's warranty policy. BFG Supply is not liable for damages, injuries or loss of revenue as a result of a manufacturer's defective item.

DELIVERIES

BFG delivers to customers in designated delivery areas according to an established daily routing schedule. Although we do our best to run the same routes on the same days each week, unavoidable circumstances may arise which prevent us from adhering to our normal schedule. Please note that we will do our best to make sure you receive the product you need when you need it. BFG delivery charges vary by location. Please contact your local BFG service center for pricing. Or ask your Sales Representative or Customer Service Rep for current delivery charges. Backorders may be subject to delivery charge. Delivery via BFG vehicles or trucks is subject to the equipment available at the BFG Service Center and the ease of access to the destination. Please contact your delivering service center for details. Some orders may be shipped via Fed-Ex/UPS/ Etc. at the buyer's expense and are subject to an additional order handling charge. Deliveries outside of our designated area may not ship via BFG and additional freight charges may apply. Please check with the local BFG location for complete details. Please note: all flower and vegetable seed for plant growers are shipped from our Harrisonburg Facility. No orders may be shipped via UPS for a C.O.D. purchase. These orders must be prepaid. Advanced payment arrangements must be made with your local BFG Service Center for all BFG truck deliveries. BFG drivers do not carry cash. Important: All orders for delivery via BFG tractor-trailer must be phoned or faxed in at least 48 hours prior to your scheduled delivery day. BFG will accept "add-on" orders before 10:00 a.m. on the business day prior to your scheduled delivery day but cannot guarantee that they will fit on the trailer. It is necessary that the customer has appropriate personnel present to assist our drivers in unloading.

WILL CALLS

Customers who wish to pick up merchandise from our warehouses are most welcome to do so. However, merchandise is not available in all locations; please call to verify if item is stocked. To help expedite your order, please call your order in ahead. Orders for pick up in the morning should be called into the office by 5:00 p.m. the day before. You may pick up items between 8:00 am-4:30 pm.

Continued on page 2



RECOMMENDATIONS

All recommendations made by BFG are compiled from recognized horticultural sources or BFG's knowledge of recognized industries. BFG makes no warranties regarding any recommendation made and BFG is not responsible for any alleged losses of Buyer due to any recommendations given by BFG Supply Co. or its personnel.

NOTICE TO PURCHASER

Seller's and manufacturers' only obligations shall be to replace such quantity of product proved to be defective. Before using, users shall determine the suitability of the product for their intended use, and users assume all risk and liability whatsoever in connection therewith.

WARRANTIES

BFG makes no warranty of any kind, whether that be expressed or implied. Except as expressly provided in these Terms and Conditions, all implied warranties or conditions (whether statutory or otherwise) are excluded to the fullest extent permitted by Law. BFG makes no warranty respecting the merchantability of the products or their suitability or fitness for any particular purpose, non-infringement of third-party rights nor does BFG make any warranties against latent defects.

Some product(s) sold by BFG may be accompanied by manufacturer warranties from the party that provided BFG with the product(s). All such warranties shall be the responsibility of the manufacturer of the product(s) purchased from BFG, if any warranties exist.

Credits are limited to the amount of the original sale. Because of varied interpretations of standards at the local level, Seller cannot warrant that the product meets the requirements of the Occupational Safety and Health Act, or of any local acts or codes that may apply. In the event of litigation through the courts arising from any purchase, the Buyer consents to and submits to the jurisdiction and venue of the courts of Marion County, Indiana. Mail, phone, and internet orders accepted are subject to these terms and the Buyer in acceptance of the shipment agrees to these terms.

BFG Supply warrants to the extent of the purchase price that seeds or bulbs sold are as described on the container. Subject to the limitation of liability set forth in the preceding sentence, BFG provides a limited warranty that at the time of delivery, seeds or bulbs sold by BFG are as described on the container, within recognized tolerances. As set forth above, BFG gives no other or further warranty, expressed or implied. Note: Every effort has been made to provide current, accurate product information. Product guides/catalogs are intended to represent the many products offered by BFG Supply Co. Call your servicing BFG warehouse for updated product information or if you don't see a product or size you need. Chances are we can help you. Here are three points to keep in mind as you prepare to place your order:

1. Order early because stock availability of some items is unpredictable.
2. Prices included in any BFG product guides are intended as instructive guidelines only.
3. Prices may change without notice.

FORCE MAJEURE

BFG is not liable for failure to fulfill its obligations for any accepted Order or for delays in delivery due to causes beyond BFG's reasonable control including, but not limited to, acts of God, natural or artificial disaster, riot, war, strike, delay by carrier, shortage of products, acts or omissions of other parties, acts or omissions of civil or military authority, government priorities, changes in law, material shortages, fire, strikes, floods, epidemics, quarantine restrictions, acts of terrorism, delays in transportation or inability to obtain labor, materials or products through its regular sources, which shall be considered as an event of force majeure excusing BFG from performance and barring remedies for non-performance. In an event of force majeure condition, the BFG's time for performance shall be extended for a period equal to the time lost because of the force majeure condition without subjecting BFG to any liability or penalty. BFG may, at its option, cancel the remaining performance, without any liability or penalty, by giving notice of such cancellation to the Buyer.

PROVISION OF AND RELIANCE UPON ACCURATE FINANCIAL INFORMATION

BFG makes all decisions related to the extension of credit to the Customer based upon the disclosures made by the Customer in the BFG Supply Co. Account Application. All parties executing these Terms and Conditions and the Account Application represent and warrant that the information provided to BFG Supply Co. are true and accurate in all respects. BFG Supply Co. is a wholesale distributor and does not as a part of its general practice sell to individuals. All parties executing these Terms and Conditions and the Account Application further represent and warrant that the Customer is a legal entity validly existing and authorized to do business in the State of its formation at the time of the execution of the BFG Supply Co. Account Application and that any changes in the status of the Customer as a legal entity will be disclosed to BFG Supply Co. within ten (10) business days of the occurrence of any changes in the status of the Customer. If Customer is a limited liability company, corporation, or a partnership, Customer must provide BFG Supply Co. with its Tax Identification Number contemporaneous with the execution of these Terms and Conditions. If Customer is a sole proprietorship, Customer shall provide BFG Supply Co. with Schedule C to its tax return.

These Terms and Conditions may be found at www.bfgsupply.com. These Terms and Conditions of Sale are subject to revision and change by BFG Supply Co. without notice, however, the then current Terms and Conditions maintained at www.bfgsupply.com shall be applicable to an given order at the time it is made and shall control.

Customer and, if applicable, all Guarantors hereby execute and agree to these Terms and Conditions and agree to be fully bound by the same.

By its execution of the terms and conditions the applicant affirms and certifies that the information provided on the account application is true and correct. By its execution the applicant acknowledges they have read, understand and agree to be bound by these Terms and Conditions and that they will comply with all of the requirements set forth in these Terms and Conditions.

Unincorporated entity: _____
(Name as appears on driver's license) Signature Printed Name Date

IF ON BEHALF of an INCORPORATED entity: _____
(By an authorized signer or owner of company) Signature Printed Name Title Date





ACCOUNT APPLICATION

ACCOUNT #
SALES REPRESENTATIVE
APPROVED CREDIT LIMIT

OFFICE USE ONLY

COMPANY INFORMATION

COMPLETE LEGAL NAME *BFG Supply Co., LLC is a wholesale distributor and does not sell to individuals.		DBA / PARENT COMPANY (IF DIVISION OF OR OWNED BY ANOTHER COMPANY)		
BILLING ADDRESS		CITY	STATE	ZIP
SHIPPING ADDRESS		CITY	STATE	ZIP
COUNTY	BUSINESS PHONE#	BUSINESS FAX#	E-MAIL ADDRESS	
STORE HOURS		RECEIVING HOURS	RECEIVING CONTACT	
TYPE OF BUSINESS: <input type="checkbox"/> Corporation <input type="checkbox"/> Partnership <input type="checkbox"/> LLC <input type="checkbox"/> Sole Proprietor - <small>Must provide a current Schedule C of tax return.</small>		STATE OF INCORPORATION	FEDERAL ID#	
BUSINESS EST. DATE	YEARS UNDER CURRENT OWNER	DO YOU OWN THIS BUSINESS PROPERTY? IF NOT, WHO DOES?		TAX EXEMPT? <input type="checkbox"/> Yes <input type="checkbox"/> No IF YES, PLEASE ATTACH CERTIFICATE.

By completing the Account Application the applicant affirms and certifies that the information provided is true and correct.

TYPE OF BUSINESS: PLEASE CHECK ALL THAT APPLY OPEN: ALL YEAR SEASONAL OTHER (Please explain) _____

Landscaping Hydroponics Retail/Garden Center Grower Cannabis Production (Please include pdf of license and license #) _____

Order Preferences:

Backorders OK? Yes No Substitutions OK? Yes No P.O. Required? Yes No Pricing on Pick Tickets? Yes No

Lift Gate Required? Yes No Fork Lift Available? Yes No Loading Dock? Yes No Appointment Needed? Yes No

OWNERS/OFFICERS/PARTNER INFORMATION (NOTE: Copy of Driver's License is required for Sole Proprietor Applying for Credit)

NAME #1	Title	NAME #2	Title
SSN#	% OWNED	SSN#	% OWNED
MOBILE	ALT. PHONE #	MOBILE	ALT. PHONE #
ADDRESS (if different from above)		ADDRESS (if different from above)	
CITY	STATE	ZIP	CITY
			STATE
			ZIP

DOCUMENT PREFERENCES - please choose how you would like the following documents to be delivered to you

ACKNOWLEDGMENTS	<input type="checkbox"/> E-MAIL:	<input type="checkbox"/> FAX:	<input type="checkbox"/> U.S. MAIL:
INVOICE/CREDITS	<input type="checkbox"/> E-MAIL:	<input type="checkbox"/> FAX:	<input type="checkbox"/> U.S. MAIL:
STATEMENTS	<input type="checkbox"/> E-MAIL:	<input type="checkbox"/> FAX:	<input type="checkbox"/> U.S. MAIL:

WOULD YOU LIKE TO APPLY FOR A LINE OF CREDIT WITH BFG SUPPLY?

NO - I want to prepay for my orders YES - Please complete references. Credit Limit Desired \$ _____

*Please sign terms and conditions page *Please sign both the terms and conditions and declaration page

BUSINESS CHECKING ACCOUNT REFERENCES

BANK NAME	ACCOUNT NUMBER	CONTACT PERSON	BANK PHONE NUMBER
-----------	----------------	----------------	-------------------

BUSINESS TRADE REFERENCES (include horticulture companies, if possible) - only complete if applying for credit

COMPANY NAME	ACCOUNT #	TELEPHONE #	FAX #	EMAIL

GREENHOUSE SYSTEMS



BFG GREENHOUSE CONSTRUCTION & SOLUTIONS

The BFG Greenhouse Solutions Team assists growers all across the United States with their greenhouse structure needs. Everything from the design, planning, construction and maintenance of new or existing sites, upgrades or remodels, our team is excited and ready to help! We offer a full range of products that include:

- Greenhouse Construction
- Coverings
- Heating & Cooling
- Ventilation
- Climate Control
- Irrigation
- Light Deprivation
- Lighting
- Indoor Grow Rooms

Our experienced team has the technical expertise to guide you through the process and provide the information you need to make the best choice for your operation!

Tap Into Our Resources

Our team is committed to you! Whatever wants or needs you have we are here to help and make the process as seamless as possible. Whether it's a re-cover, improving efficiencies or complete installation, we take pride in providing the resources you need.

Over 4 Decades of Experience

With our team of dedicated professionals, BFG brings decades of experience to each project. Based on our proven success in numerous installation projects we know we can put your mind at ease.

THE BFG & DECLOET ADVANTAGE

- Highly engineered to reduce installation labor
- Wide bay spacing available in order to maximize production greenhouse efficiency
- Superior gutter design to reduce corrosion and maintenance
- 11 Gauge heavy gutter provides added strength and structural integrity
- Posts, gutters and trusses are galvanized after manufacture for longer rust-free life
- One piece oval bows provide consistency in strength and integrity, available on 4ft and 6ft centers
- Custom designs to meet your special requirements and maximize your footprint
- Available in widths of 18ft, 21ft, 24ft, 32ft, 36ft, 42ft and 48ft
- Single, double, triple span up to 48ft wide

DeCloet Greenhouses are a superior option for CEA. They were originally designed with the purpose of growing vegetable crops, hence its heavy-duty design to support hanging systems. Even with the market changes over the last few decades, DeCloet maintained its heavy-duty design making BFG structures perfect for today's changes and CEA providing protection and maintaining optimal growing conditions throughout the development of the crop.

When looking at lights and lighting, Greenhouses are by far the best way to raise and cultivate crops. Greenhouse structures allow growers and cultivators to harness the power of the sun maximizing the natural lighting combined with supplemental lighting.

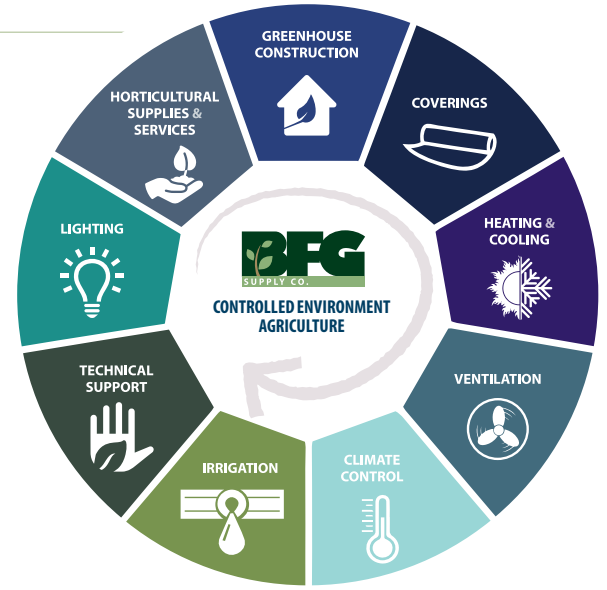

FROM CONCEPT TO COMPLETION

Having control of your growing facility makes all the difference. The BFG approach is to begin with your end goal in mind and work together to design and engineer the perfect structure and systems. With a BFG controlled environment greenhouse you'll have the optimal growing environment for your crop, whatever that maybe.

Consulting

Before you get started, you should know where to start. BFG provides complete solutions and our services span across all phases of operations - from design to growing/cultivation, and we can assist you plan for future expansion saving valuable time and money.

Systems & Controls Integration

The BFG design philosophy revolves around systems Integration: each grow facility corresponds to a system of systems, each one optimized and integrated to work together. Every element must be in perfect balance for the highest level of control so you can consistently raise high-yield crops.



TALK TO ONE OF OUR EXPERTS ABOUT YOUR NEXT GREENHOUSE

Featured project: *Plantpeddler Phase2 Step2 – Cresco, IA*

Structure: Custom DeCloet 8 bays of 43' wide X 216' long double poly roof
 Roof vents & vertical vents – providing EXCELLENT natural ventilation
 Custom connector to existing building
 Growing Facility integrated with Loading Docks
Total Space: 77,000 sf

Pictures below represent – conceptual design, elevation drawing, docks (external and internal) and full rotation of PREMIUM crops: spring, summer/fall crops and poinsettia crop.

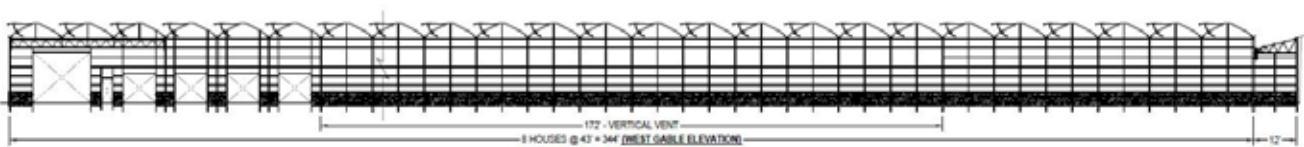



CUSTOMER TESTIMONIALS

Plantpeddler (Cresco, Iowa) "We are a year into our first DeCloet greenhouse structure and have completed the first full rotation of finished crops through the open roof ventilated structures. The quality and consistency of the plants produced in this structure have been spectacular. We have been working with BFG for many years and knew that the combination of the DeCloet structure and the BFG support would not disappoint. From the ease of construction to the terrific communication and support from both BFG and DeCloet, that premonition definitely held true." **Jason Sbiral (Facility Manager)**



PRODUCTION GREENHOUSE



We know that time is money and we can tailor our services to meet your needs. You can spend your time focused on quality plant growth and we'll focus on building you a quality greenhouse! Our goal is to provide you a piece of mind throughout the design, planning and implementation of your project.

Whether you are looking for professional advice OR complete greenhouse solutions, BFG is at your service. Between our exclusive brands and supplier partners we have the latest structures, equipment and controls to make your production facility efficiently produce outstanding crops. In addition, our team also puts emphasis on streamlining product flow in and out of your facility to help ensure a faster return on investment.

RETAIL GARDEN CENTER



BFG understands the importance when it comes to Retail Greenhouses. It's not just about having the best merchandising, it's about providing a comfortable shopping experience in a setting that is pleasant for your customers and efficient for your staff.

Our team and expertise does not stop once construction is done. BFG supplies Garden Centers nationwide with the latest and most innovative products but we all know it starts with a sound design. That is why we begin each project with the full picture in mind, from curb appeal to product flow to environmental impact. The BFG solutions team will guide you from the design stage to the day you open your doors!

CUSTOMER TESTIMONIALS

Meadowridge Inc (Zeeland, MI) – “We have been building DeCloet Greenhouses with BFG for over 20 years, these strong structures are well built and able to withstand the harsh west Michigan winter conditions. DeCloet’s greenhouse design has fewer parts than most making it easier and more efficient to build. We really like the 36ft double peak with 2 roof vents per bay, we also have integrated our production and shipping space easily and efficiently using the same greenhouse frame. We look forward to using BFG and DeCloet for our future structure needs.”

- Jordan Blauwkamp

Darrell Norris Greenhouse (Racine, OH) – “Looking back, selecting BFG & DeCloet Greenhouses was one of the best decisions we made. The DeCloet Greenhouses are tough and built to withstand our climate. They go together easy and when we are ready to add more square footage their expandability is great. The BFG team is truly the best, from providing the greenhouse design to construction, furnishing the proper greenhouse equipment and last but not least plant grower expertise, BFG has the experts we need. We value our relationship and we see BFG as a partner in the supply chain of horticultural supplies, we work together and succeed together. I would recommend the BFG Greenhouse Solutions team to anyone looking for a greenhouse and horticultural supplies.”

- Darrell Norris

Brower Greenhouse (Hudsonville, MI) – “We have been building greenhouses with BFG and DeCloet since 1991, the heavy duty structure from DeCloet combined with the products and services BFG has to offer have been a winning combination for our company. Whether it's construction or supply needs, we truly value our relationship and will continue to do business with DeCloet and BFG Supply in the years to come.”

- Kurt Brower

PRODUCTION GREENHOUSE



GUTTER CONNECTED

DeCloet Gutter Connected Greenhouses are custom designed to meet your needs as well as your crop requirements. Complying with all industry building codes, DeCloet's gutter connected ensures a strong and long lasting growing environment.



- 11 Gauge heavy-duty metal gutters provide added strength to structurally withstand the elements. They are incredibly strong and large enough to walk in, but small enough to minimize shadowing. Posts, gutters and trusses are all galvanized after they've been manufactured to ensure a longer rust-free life.
- One piece oval bows provide consistency in strength, integrity and ease of construction, available on 4ft and 6ft centers
- Highly engineered design for faster and easier assembly and construction
- Exclusive and unique design reduces clutter and maximizes growing space
- Increased light transmission
- Expandability: When you want to expand, you can easily do so without disrupting your existing growing business
- The gutter is designed for expansion and does not require disassembling existing houses
- This is the most economical greenhouse for a large operation
- Custom Sizes Available, including up to 48ft available



Standard Gothic
18ft 21ft 24ft



Twin & Triple Peak Series
28ft 32ft 36ft 42ft 48ft



MAX COOL



Max Cool is DeCloet's solution for growers that want to maximize their productivity and efficiencies. The Max Cool is a gutter connected structure.

- Triple Peak 42ft wide frame
- Similar cooling to an open roof structure
- Raised rack and pinion system
- Leading edge of the vent can be raised from the gutter to above the peak
- Maximum cooling
- Proven reliable rider rack and pinion system
- Easy to cover with 16ft poly tubes
- Up to 35% vent to floor space ratio



VENLO GLASS

DeCloet's world class Venlo Greenhouse combines European design and North American engineering providing a structure with the latest in design for maximum light transmission and a lifetime of successful production. With the tempered glass roof and aluminum glazing system, you get the best value and the least maintenance for your business. It offers our clients a structure capable of withstanding extreme climate conditions with long term protection. The diffused glass option has been a popular option among our latest projects improving the environment climate and increasing production.

THE DECLOET ADVANTAGE

- Hot dipped galvanized steel structure
- Aluminum roof and sidewall glazing bars
- Clear or diffused tempered glass
- Under gutter height up to 24ft
- Up to 42ft wide triple peak
- Push/Pull vent system



WARNING: This product is not available for sale in CA.
For most up to date information please visit bfgsupply.com

800-883-0234
www.bfgsupply.com

FREESTANDING



Freestanding Greenhouses, also called Ground to Ground, are suited for professional growers who require unique environments for different crops. They provide the economical growing space and versatility needed. DeCloet's Freestanding and cold frame greenhouses are affordable and versatile structures. With a wide variety of options and sizes available, these greenhouses are practical and easy to assemble.



SUNMASTER 24ft 27ft 30ft Widths

Used as both a cold frame and grower house, this series represents our most practical and cost-effective greenhouse. It comes with our exclusive oval tubing for the roof and a full selection of options. Available in 4ft and 5ft bow spacing.



GROWERS CHOICE 30ft 35ft Widths

Excellent for both growing and as a retail house. It is stronger than anything else on the market, featuring all welded truss style hoops in the roof, with taller sidewalls. Designed to hold more hanging baskets than any other structure.



GROW MAX 30ft 40ft Widths

This webbed truss design offer more benefits and features. Features include more weight support, standard 50lbs snow load on 6ft centers, 7-12ft high straight sidewall above grade. Increased hanging basket capacity.



COLD FRAMES

These 14ft and 15ft cold frames are designed for overwintering nursery stock or as a temporary growing area. An optional extended stake package is available for extra height. The house can be purchased without stakes and can be made portable by using a baseboard to connect the bows. Most often used with a single purlin with hoop/bow spacing at 4ft O.C. to help eliminate pocketing. (Build your own endwall to complete the structure). Simple design for easy installation. Add-on options include: purlin runs and baseboard clamps.

GrowerSelect®



COLD FRAME BOWS & STRUCTURES

14ft Bow

For Center Height: 6ft 5in Without Stakes - Use 24ft Poly
 For Center Height: 8ft 5in with 48in Stakes - Use 28ft Poly
GSA01540 STOCKED IN KALAMAZOO, MI

15ft Bow

For Center Height: 7ft - Use 24ft Poly
GS98-1000A STOCKED IN BURTON, OH



*For a complete Grower Select cold frame quote
 Please contact your BFG Representative*

HIGH TUNNELS



High tunnels are used to extend the growing season by providing protection for early or late season production, or they may be used for year-round growing. High tunnels are becoming increasingly more popular due to the low start-up cost and quick rate of return on investment. They are a quick and inexpensive way to lengthen your growing season, protect your crop from pests and disease, decrease water usage and increase your crop yield.

Options are available with a roll-up side for optimal ventilation and ease of use. Choose from economical frame-only pricing or standard package pricing to finish your structure. Hoop spacing is available in 4ft or 6ft sections depending on the manufacturer and it can be designed to best fit your use and the needs of your location.



WARNING: This product is not available for sale in CA.
 For most up to date information please visit bfgsupply.com

800-883-0234
www.bfgsupply.com

ROOF & SIDE VENTS



Ventilation is an essential component for the greenhouse growing environment. Types of ventilation can be forced air or passive ventilation. When designing a new greenhouse, we always take into consideration the passive ventilation incorporating roof & side vents to increase air flow and produce excellent quality crops.

We have the leading-edge technology for gutter vents in the greenhouse industry. We offer raised rack and pinion systems to ensure plenty of room for heat retention systems as well as hinged shaft hangers for easy maintenance in your gutter connect or ground to ground greenhouse.

If your greenhouse does not offer satisfactory ventilation, our team can offer retrofitting options to enhance air flow with your existing structures. Our retrofitting packages are easy to install and will provide significant improvements to your existing structure.



REMODELING & IMPROVEMENTS TO INCREASE EFFICIENCY

Our team has the experience to provide options for your existing structures and ways to help improve your efficiencies. We can assist with improving air flow, improving product flow and the presentation of your greenhouse.



BEFORE



AFTER

WHAT ARE YOU LOOKING FOR?

- Retro fit roof vents for your existing structure
- Rollup or vertical side or end vents
- Recover your gable ends & sidewalls
- Connect your freestanding greenhouses with a header house
- Add loading docks
- Replace old doors



WARNING: This product is not available for sale in CA.
For most up to date information please visit bfgsupply.com

800-883-0234
www.bfgsupply.com

RETAIL GARDEN CENTERS

GARDEN CENTERS

Our Retail Garden Center Structures are a combination of beauty and efficiency. The curb appeal alone will make an impression and attract customers but if you combine that with great ventilation and lighting you are sure to create an enjoyable and memorable shopping experience.

Extending beyond the shopping area, we take into consideration the replenishment area making sure that you have an efficient space to stage and replenish inventory. Coverings available include glass, polycarbonate, poly and steel roofing perfect for displays, warehouses, offices, utility rooms and more.



RIMOL MATTERHORN

The Rimol Matterhorn stands alone as our most attractive Garden Center Structure, rugged and traditionally peaked styled gutter-connected greenhouse. The Matterhorn greenhouse is a high-quality, strong and attractive structure ideally suited for garden centers, growers and schools in any climate in North America. The Matterhorn can withstand heavy snow loads and wind loads, which means you can get a good night's sleep during even the worst winter storms. It offers different glazing options to fit your budget and presentation desires.

THE RIMOL MATTERHORN MAKES AN EXCELLENT CHOICE FOR GARDEN CENTERS!



AVAILABLE IN 20FT, 24FT & 30FT WIDTHS

- Lean-to style available in 10ft, 12ft and 15ft widths
- Typical truss spacing on 12ft centers allows for any length in an increment of 12ft
- Super easy to assemble beginning with starter column installation. Four footlong starter column is used for setting the lower section of the column, then the remaining length of column is spliced for an easy installation
- Columns with base plates available
- Columns are 4in x 4in, 13ga galvanized steel
- Non-welded trusses are quality assurance when assembled and allows for easy shipping and assembly
- Trusses consist of 2in, 15ga and 1.5in, 16ga galvanized steel
- Extra purlins near gutter provide additional snow load support in Northern climates. This prevents premature wear on polycarbonate and eliminates leaking
- 6/12 roof pitch
- Large 12ga steel gutter allows easy access to roof and downspouts. They are designed to be located anywhere in the gutter for maximum flexibility
- Can be glazed with 8mm polycarbonate, corrugated polycarbonate, polyethylene film or glass (walls only)



WARNING: This product is not available for sale in CA.
For most up to date information please visit bfgsupply.com

800-883-0234
www.bfgsupply.com

BENCHING

Grower Select® works with some of the largest and most well-known retailers to provide them with benching that is efficient, flexible and presentable. You can no longer afford to use cement blocks and 2ft x 4ft's to produce a quality product and image. We've produced double deck benching, modular benching and benching with re-supply racks underneath. Our retail benching features complete coverage of the sharp expanded metal ends, corner protectors and plastic caps on all legs and tube ends.

Our production benches feature a 20lb/sqft load capacity and have 3/4in pre-galvanized expanded metal tops. Our special aluminum side rails completely cover all of the sharp expanded metal edges, no more torn pants with our corner protectors! We produce thousands of square feet of rolling benches every year. Our benches can be rolling or stationary, freestanding or cemented. We can usually customize to fit your needs at a very economical price.



Production
Benching



Ultra
Bench



Expanded
Metal Bench

POLY-TEX SHADE SYSTEMS & GARDEN CENTER PACKAGES

Permanent Retail Greenhouses

Seasonal Retail Greenhouses

Commercial Greenhouses

The Garden Mart

Designed to be a modular, low-cost, sales building for added spring plant sales. Our most popular selling model has been engineered for superior strength, easy future expansion and simplified setup. It offers protection for your plants and shopping comfort for your customers.

- Width: 21ft
- Length: 24ft-96ft (in 6ft increments)
- Sidewall height: 6ft
- Height to apex: 11ft 4in
- Frame spacing: 6ft
- Door: 6ft wide x 6ft 8in tall

Sun Shadow

The Sun Shadow is designed to be the simple, low-cost shade solution for your seasonal garden center. Protect your plants from the sun and provide a cool, comfortable shopping environment for your customers. The easy-to-assemble, modular design features galvanized steel construction and an extended base plate that allows you to use your palletized product for hold-down.

20ft x 20ft
Custom Sizes Available.

Sunstopper

The Sunstopper will protect your valuable product from over exposure and windburn, while reducing water requirements. It features straightforward assembly, options for future expansion and is built tough with 2.5in x 12 gauge, galvanized steel for years of trouble free service. The Sunstopper is also offered in custom configurations to meet your existing layout.

20ft x 20ft	40ft x 40ft	60ft x 60ft	100ft x 100ft
20ft x 40ft	40ft x 60ft	60ft x 80ft	200ft x 200ft
20ft x 60ft	40ft x 80ft	60ft x 100ft	

Shade W Truss

The W-Truss is a sturdy shade structure for your plants and customers. Increase customer comfort and reduce the amount of water used and time spent keeping your live product in top-selling shape. Its rugged 3in x 3in vertical posts combine with a strong horizontal truss system to give you one of the best built and most attractive shade structures on the market. It comes standard in 20ft x 20ft blocks with 30%-90% shade cloth and can be customized to fit your exact needs.

20ft x 20ft	40ft x 40ft	60ft x 60ft
20ft x 40ft	40ft x 60ft	60ft x 80ft



INSTITUTIONAL RESEARCH AND EDUCATIONAL GREENHOUSES

BFG and its partners design and manufacture education, teaching and research greenhouses. We can help you design your research or education research facility no matter the size. We work with schools around the country and know what is important to the end user: quality, safety and long-lasting performance. We have experience in designing and building state-of-the-art research facilities as well as small greenhouses for a high school program or other educational and developmental programs.

Featured:

Institutional facility in Holland, Michigan
DeCloet Greenhouse Structure
Rimol Matterhorn



 WARNING: This product is not available for sale in CA. For most up to date information please visit bfgsupply.com

800-883-0234
www.bfgsupply.com

CONTROLLED ENVIROMENT AGRICULTURE & HYDROPONICS

Controlled-environment agriculture (CEA) is a technology-based approach toward food production utilizing greenhouses structures or a building/grow room to provide protection and maintain optimal growing conditions throughout the development of the crop. Plants are often grown using hydroponic methods in order to supply the proper amounts of water and nutrients to the root zone. CEA optimizes the use of resources such as water, energy, space, capital and labor.

BFG offers a complete line of systems for CEA/Indoor Growing and can help you design and implement an efficient system where you'll have the optimal growing environment for your crop, whatever that maybe.

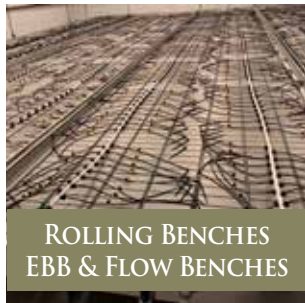

ROLLING BENCHES
EBB & FLOW BENCHES



LIGHT DEPRIVATION



IRRIGATION SYSTEMS



GROWING LIGHTS
LED & HID

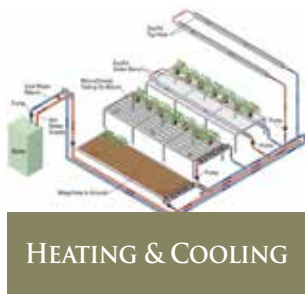

HEATING & COOLING



VENTILATION &
DEHUMIDIFICATION

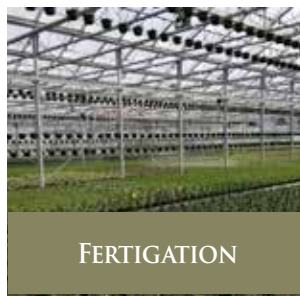

FERTIGATION



WATER TREATMENT

DeCloet Greenhouses are a great option for CEA. They were originally designed with the purpose of growing vegetable crops hence its heavy-duty design to support hanging systems. Even with the market changes over the last few decades, DeCloet maintained its heavy-duty design making our structures perfect for today's changes and CEA providing protection and maintaining optimal growing conditions throughout the development of the crop.

When we look at lights and lighting, Greenhouses are by far the best way to raise and cultivate crops. Greenhouse structures allow growers and cultivators to harness the power of the sun maximizing the natural lighting combined with supplemental lighting.

LIGHTING DESIGN:

BFG partnered with LED cutting edge technology companies to provide you the best lighting solution. We can customize systems to optimize production and minimize costs using new technologies, traditional technologies and a hybrid between the two: HPS/ LED



HID



LED



CONTROLLED ENVIROMENT AGRICULTURE & HYDROPONICS

BFG experience integrating systems really comes handy when connecting greenhouses with buildings and processing facilities. We can apply proven concepts of horticulture and floriculture to new crops; such as efficient ways to handle soil and soilless media, fertilizers, crop protection and plant care.

We bring decades of proven successful practices that can applied to novelty crops allowing you to be more competitive in constantly changing and evolving markets. Talk to one of our Experts about your Next CEA/Indoor Growing Project!

Lighting Deprivation Systems



Cooling Systems With Integrated Lighting Control



Colling Systems /Fertigation Systems / Water Treatment Systems

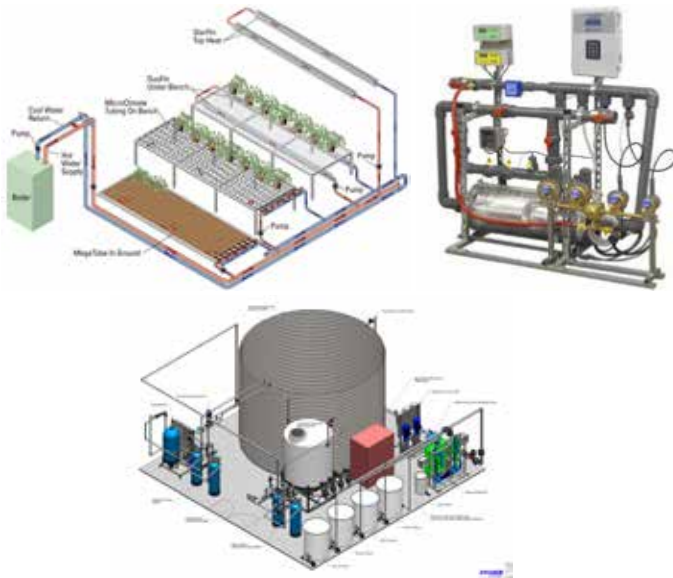

Ventilation Systems



 WARNING: This product is not available for sale in CA. For most up to date information please visit bfgsupply.com

800-883-0234
www.bfgsupply.com

CONTROLLED ENVIROMENT AGRICULTURE & HYDROPONICS

Bench Growing Systems
 EbbFlow | Expanded Metal | Ultra Plastic | Stationary | Rolling



EBB Flow Benching



Ultra Bench



Production Benching

Our team has the ability to provide the best greenhouse structure solution for your needs in:

- Aquaponics
- Hydroponics
- Aeroponics
- Aquaculture
- Vertical Farming

Featured project: DeCloet Venlo with diffused glass

Phase 1 completed Summer 2018 – 50,000 sf
 Phase 2 completed Fall 2020 – 100,000 sf



SPECIAL PURPOSE GREENHOUSE

DeCloet Greenhouse Mfg Ltd has supplied many growers with special custom designed and manufactured greenhouse structures to be used for reasons other than growing. These special houses can be used for a variety of purposes, such as, mechanical rooms, head houses, shipping/staging areas and loading docks.



Custom Options

- Wide post spacing up to 48ft
- High side wall heights
- Multitude of roof coverings may include shaded polycarbonate or steel roofing with insulation
- Natural ventilation or exhaust fans
- Large overhead doors
- Loading docks
- Warehouse & Storage Spaces



TAP INTO OUR RESOURCES



BFG offers a wide variety of resources outside of the design, planning, construction and maintenance of a greenhouse. Our full portfolio of offerings include greenhouse structures, coverings, ventilation and heating equipment, shading systems, benching, environmental controls, lighting, irrigation and fertilization.

BFG has assembled a team of all-stars who, you could say, bring you tried and true growing methods mixed with the perfect dose of cutting edge technology! We can provide you with structures that will have an ideal flow for supplies from the time they come in all the way to the finished crop leaving your doors. BFG has the full array of components providing you with the best available and complete greenhouse projects. After your structure is completed we can provide you with ALL your growing needs, as we have for the last 45 years!

We can provide you the best solutions and service available in the market from start to finish.

GREENHOUSE CONSTRUCTION

The right heating and cooling systems are essential for running your greenhouse evenly and efficiently.

HEATING & COOLING

BFG offers a full range of greenhouse coverings to ensure you have the best option to help your business grow.

COVERINGS

Air movement in a greenhouse not only makes you more comfortable, it can also make a huge difference in keeping your plants healthy and insect and disease free.

VENTILATION





Climate Control - designed to maximize crop yields, help manage energy costs and optimize thermal comfort. Environmental Controllers and Light and Energy Curtains



Choosing the correct lighting configuration is critical for the optimal growth and health of your crops.



We are constantly developing our product line to bring you the best the industry has to offer. Our team welcomes the opportunity to design a system that meets your particular needs.



We have all the equipment and supplies you need to keep growing! Great quality, great pricing.



If you are even thinking about building or remodeling, talk to our experts! We'll help improve your efficiencies.



Scan to watch GHS Videos!



CONTACT YOUR BFG SALES REP TODAY for a comprehensive consultation!
For more information please call (800) 883.0234, email: greenhousesolutions@bfgsupply.com or visit www.bfgsupply.com today!



We've teamed up with **Evergreen Equipment Finance** to offer a financing program for **Carts, Greenhouses, Equipment & More** Terms from 24 to 60 months.

Contact your BFG Sales Representative and inquire about Greenhouse & Equipment Financing options today or call Will Bean direct at 253-988-0808.

CONLEY'S GABLE SERIES



The Conley's Gable Series greenhouse is available in multiple sizes and can be covered with polyethylene or rigid coverings. The galvanized steel frame features roll formed trusses and purlins for superior structural integrity. This greenhouse can be easily adapted to add a head house for storage or shipping. Perfect for all kinds of commercial, growing, or retail applications.

CONLEY'S ARCH SERIES



Conley's Gothic Arch Series greenhouse is available in multiple sizes and is ready to be finished with polyethylene or rigid coverings. Conley's roll formed galvanized steel frame, trusses and purlins for superior structural integrity. The Gothic arched roof is attractive and effective for shedding heavy snow loads.

All Conley's greenhouses feature superior strength roll formed steel. Each truss assembly is made from roll formed component, no splices required, between peak to gutter connection.

This greenhouse is engineered in accordance with International Building Codes for almost any wind or snow load ratings.

Stamped engineered plans can be provided at an extra cost.

All galvanized steel frame insures maximum strength and reliability.



Conley's Gable Series Features

- » Widths: 18'to 50'ft
- Length: 24' to 300'ft
- Sidewalls: 10, 12 or 14'ft
- » Superior roll formed steel trusses & purlins.
All framing members pre-punched and pre-cut.
Condensate control features are built in.
- » Optional coverings:
Polyethylene film, single layer corrugated, or multi-wall
Polycarbonate
- » Equipment available to fully automate this structure



Conley's Arch Features

- » Widths: from 21'to 41.5'ft
- Length: 24' to 300'ft
- Sidewalls: 10, 12' or 14'
- » Superior roll formed steel trusses & purlins.
All framing members pre-punched and pre-cut.
Condensate control features are built in.
- » Optional coverings:
Polyethylene film, single layer corrugated, or multi-wall
Polycarbonate
- » Equipment available to fully automate this
Structure



CONLEY'S RANGER SERIES



The Conley's Ranger Series greenhouse has a 30' wide galvanized steel frame with roll formed trusses and purlins for superior structural integrity. It is available in multiple lengths and can be covered with polyethylene or rigid coverings. Standard sidewalls are 4' or 6'ft tall.

COLD FRAME SERIES



Conley's Cold Frames are non code design, available in the following sizes:
 Cold Frame Series 1000, 16' and 20'ft wide, ground to ground.
 Cold Frame Series 1100, 20' and 24'ft wide with 3.5' or 6'ft Sidewall height.
 Cold Frame Series 1200: 30' to 35'ft wide with 4' or 6'ft Sidewall height.

All Conley's greenhouses feature superior strength roll formed steel. Each truss assembly is made from roll formed component, no splices required, between peak to gutter connection.

The Ranger Series greenhouse is engineered in accordance with International Building Codes for almost any wind or snow load ratings.

Stamped engineered plans can be provided at an extra cost.

All galvanized steel frame insures maximum strength and reliability.



Conley's Ranger Series Features

- » Widths: 30'ft Wide
- Length: 24' to 300'ft
- Sidewalls: 4' and 6'ft
- » Superior roll formed steel trusses & purlins.
All framing members pre-punched and pre-cut.
- » Optional coverings:
Polyethylene film, single layer corrugated, or multi-wall Polycarbonate
- » Equipment available to fully automate this structure



Conley's Cold Frame Features

- » Widths: 16' to 35'ft
- Length: 24' to 300'ft
- Sidewalls: 3.5' to 6'ft
- » Superior roll formed steel trusses & purlins.
All framing members pre-punched and pre-cut.
- » Optional coverings:
Polyethylene film, single layer corrugated, or multi-wall Polycarbonate
- » Equipment available to fully automate this Structure





POLY-TEX
Greenhouse & Display Systems
Permanent Retail Greenhouses
Seasonal Retail Greenhouses
Commercial Greenhouses



Photo shows slide-side ventilation option.

The Garden Mart®

The Garden-Mart® is designed to be a modular, low-cost, sales building for added spring plant sales. Our most popular selling model has been engineered for superior strength, easy future expansion, and simplified setup. It offers protection for your plants and shopping comfort for your customers.

Standard package includes roll-up side ventilation, double sliding door, hanging basket purlins, roof and endwall poly, Wiggle Wire, and hold down system. Options include galvanized bench packages and slide-side ventilation.

FEATURES:

- Width: 21ft
- Length: 24ft-96ft (in 6ft increments)
- Sidewall height: 6ft
- Height to apex: 11ft 4in
- Frame spacing: 6ft
- Door: 6ft wide x 6ft 8in tall
- Roof Cover: clear or white 6 mil UVI treated polyethylene
- End wall cover: clear 6 mil UVI treated polyethylene
- Frame: 2in o.d. 14 gauge galvanized steel tubing

SIZE	BENCHING AREA
21ft x 24ft	360sq ft
21ft x 48ft	864sq ft
21ft x 60ft	1,116sq ft
21ft x 96ft	2,016sq ft
6ft Additional Sections	126sq ft



Kool House™

Tired of everything that you don't get with other cold frames on the market? Our Kool House™ packages have so many standard features you won't have any surprises when it comes to the final price. We think it's the best value on the market and we know your wallet will agree.

- 14ft x 96ft
- 16ft x 96ft
- 18ft x 96ft
- 20ft x 96ft

Priced with 4ft bow spacing.



FieldPro Gable



Gothic High Tunnel

FieldPro® High Tunnels

Extend your growing season with the new FieldPro® Gable or Gothic High Tunnel. High tunnel use in field crop growing has been shown to offer better disease protection and increase yield and profits. The Field Pro is available in two roof styles, three standard widths and can be easily configured to meet your needs.

Call today and start growing like a pro.

FIELD PRO GABLE

- 20ft x 96ft
- 24ft x 96ft
- 30ft x 96ft

Priced with 4ft bow spacing.

GOthic HIGH TUNNEL

- 20ft x 96ft
- 24ft x 96ft
- 30ft x 96ft

Priced with 4ft bow spacing.



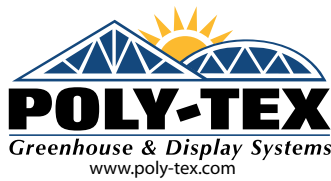

Sunstopper

The Sunstopper will protect your valuable product from over exposure and windburn, while reducing water requirements. It features straightforward assembly, options for future expansion and is built tough with 2.5in x 12 gauge, galvanized steel for years of trouble free service. Available in 10ft x 20ft and 20ft x 20ft standard blocks, the Sunstopper is also offered in custom configurations to meet your existing layout.



SIZE	SQUARE FEET
20ft x 20ft	400
20ft x 40ft	800
20ft x 60ft	1,200
40ft x 40ft	1,600
40ft x 60ft	2,400
40ft x 80ft	3,200
60ft x 60ft	3,600
60ft x 80ft	4,800
60ft x 100ft	6,000
100ft x 100ft	10,000
200ft x 200ft	40,000



Peaked Roof W-Truss



Standard Roof W-Truss

Shadehouse W-Truss

The W-Truss is a sturdy shade structure for your plants and customers. Increase customer comfort and reduce the amount of water used and time spent keeping your live product in top-selling shape. Its rugged 3in x 3in vertical posts combine with a strong horizontal truss system to give you one of the best built and most attractive shade structures on the market. It comes standard in 20ft x 20ft blocks with 30%-90% shade cloth and can be customized to fit your exact needs.

SIZE	SQUARE FEET	SIZE	SQUARE FEET
20ft x 20ft	400	40ft x 60ft	2,400
20ft x 40ft	800	60ft x 60ft	3,600
40ft x 40ft	1,600	60ft x 80ft	4,800

Sun Shadow

The Sun Shadow is designed to be the simple, low-cost shade solution for your seasonal garden center. Protect your plants from the sun and provide a cool, comfortable shopping environment for your customers. The easy-to-assemble, modular design features galvanized steel construction and an extended base plate that allows you to use your palletized product for hold-down.

SIZE	SQUARE FEET
20ft x 20ft	400

(Custom Sizes Available)



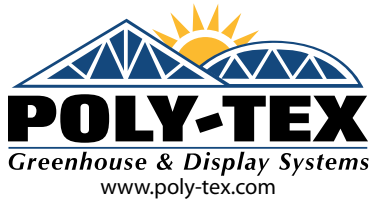

RETAIL MERCHANDISING PRODUCTS

Contact Your BFG Sales Representative for
MORE OPTIONS



Flat Mate Display

PX7025CP W/CASTERS & PURLIN

Designed to solve the problem of displaying your plants in tight quarters. This bench protrudes only 26in from your wall. Holds 21 flats. Optional casters. Specifications: 73.25in W x 26.5in D x 83.75in H



Narrow Basket Hanger Display

BH4000 W/CASTERS

Quickly move this hanging basket display outdoors and back indoors at a moments notice. This display is designed to roll through a 36-inch door and includes casters. Specifications: 72in W x 34in D x 78"H



The Basket Hanger Display

BH3000C W/CASTERS

Display hanging baskets or use the optional wreath kit to convert it to a high-capacity wreath display. Available with or without casters. Specifications: 72in W x 73in D x 82in H

Basket Wave Display

BW3000

This high capacity display provides an elegant way to showcase your hanging baskets in an easy-to-shop wall of color. Start with the 12-foot base unit and easily add 6-foot sections to create an endless sweep of color.

Specifications: 150in W x 79in D x 78in H

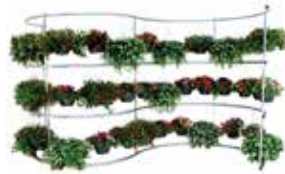

Basket Tower Display

BT3000

Think vertical merchandising that can be shopped from any side. Imagine a tower of hanging baskets or a whorl of wind chimes!

Specifications: 46in W x 46in D x 90in H



PolyTex Double Tri-Step Display Incl Dbl Purlin

The PX7021 gives you all the visual appeal of our Tri-Step Display... times two! Makes a great center aisle display that can be shopped from both sides. Also available with optional 6' sign holder.

Specifications: 73.23in L x 40in W x 44.5in H

With Optional Purlin

Specifications: 73.23in L x 40in W x 98in H



Poly-Tex Double Tri-Step Display Includes Double Purlin

POLTXPX7021P Min. Buy 1 EA

Poly-Tex® Tri-Step Display

Create a cascading display of color with the standard expanded metal bench tops at 18in, 24in and 36in deep. Optional 40in high purlin holds six 10in hanging baskets.

Specifications: 73.25in L x 40in W x 44.5in H

With Optional Purlin

Specifications: 73.23in L x 40in W x 98in H



Includes Casters & Purlin
POLTXPX7020CP Min. Buy 1 EA



PolyTex Plastic Top Grow Benches

Grow and display on our new galvanized steel bench with plastic grid top! Perfect for watering and easy to clean, the plastic grid top lets water and debris through. The heavy-duty galvanized steel frame resists rust while giving excellent support for your trays, flats, or potted plants. Dimensions: 8' x 4' x 32.5" h (additional sizes available).

Specifications: 8ft L x 4ft W x 32.5in H



Poly-Tex Plastic Top Grow Benches
POLTXBD3084 Min. Buy 1 EA



PolyTex Pallet Bridge Display

The galvanized steel frame fits over most standard pallets and the upper tray features flattened, expanded metal to display large and small products for cross-merchandising related items.

Specifications: 48in W x 21.5in D x 48in H



Poly-Tex Pallet Bridge Display
POLTXPB3000 Min. Buy 1 EA



Heat Retention Curtains

HEAT RETENTION CURTAINS

An economical, long lasting heat retention, thermal shading, or blackout system. Save heating and cooling costs with a proven VRE® Shade & Save System.

Benefits for Growers:

- Reduced heating and cooling costs
- Reduced water consumption
- Reduced condensate drip damage
- Improved air and soil temperature control
- More comfortable working environment
- Less plant stretch and stress
- Better quality and more consistent crops
- More balanced environment, i.e. control of light, temperature and humidity

VRE® manufactures and installs both sliding and suspended thermal curtain systems with a patented VRE® seal.

The VRE patented seal offers:

- Positive seal when closed
- Smaller curtain bundles when open
- Support for any system configuration
- Simple installation, no more messy support wires or brackets
- Electrically operated drive unit with gear reduction, built in limit switches, and VRE reversing control

Blackout and Shade Curtain Systems

GREENHOUSE APPLICATIONS

The type of crops grown will generally determine whether a blackout system or a partial shade system will best suit your needs.

1. Blackout or Short Day Length Control Fabrics

These will provide the total light control required to produce crops that require blackout periods to induce flowering. These generally include a porous, two-layer fabric for the top covers with a reflective top surface. Generally fabric for the vertical side walls and gable end coverage are nonporous and are installed as center roll-up walls.

2. Shade Fabrics

These can be utilized for any crop. The most common types are made of alternating strips of clear and aluminized polyester which are available in 15% to 85% shade value percentages to suit the application.



Gutter to Gutter System



Gutter to Gutter Blackout System



VRE designs each curtain system to suit your particular requirement. VRE offers supervisory or complete curtain installation service.

OBSCURA 10070 FR WB+B



OBSCURA 10075 FB A+BW

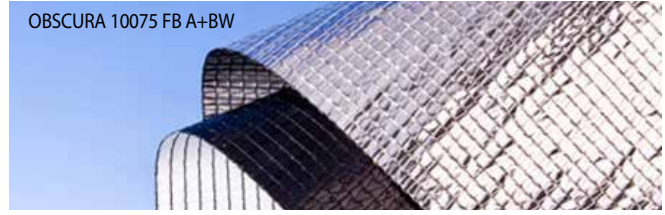

OBSCURA - PRODUCT FAMILY FOR LIGHT RESTRICTION OR TOTAL BLACKOUT

Obscura Screens

The double layered Obscura screen has been giving plants a good night's rest for over 20 years. It does this by providing total blackout from daylight – up to 99.9 percent. And in the last ten years, single layer Obscura has been preventing supplemental lighting from escaping greenhouses at night. This lets neighbors get a good night's sleep and complies with industry legislation. In both cases, the unique knitted structure provides good moisture managing properties.

Twice as versatile

The double layer also allows more options as the top and bottom of the screen can have different surfaces. Aluminium on the top, for example, provides the greatest energy saving at night, whereas white provides better cooling in sunny weather. White is also useful as a bottom layer for intensifying light inside the greenhouse, whereas black is better for absorbing and restricting interior light.

Where and when you can expect to find Obscura

For short-day plants, such as chrysanthemum, Obscura is ideal for delivering flowers in bloom – on time – for important market dates. Obscura is also popular where supplemental lighting is needed and night time light emission is a problem. This has now proven to be a good investment, as the intensified lighting increases productivity.

- Total control over day length for most sensitive plants.
- Effective cooling when a reflective upper surface is chosen.
- High energy savings, especially if one layer is aluminum.
- Light Emission control that satisfies neighbors and legislation.
- Increased productivity when used with supplemental lighting.
- More uniformity from supplemental lighting in the growing area.
- Good moisture management.



LUITEN
GREENHOUSE TECH
SHADING SPECIALISTS
We Put Our Energy Into Saving Yours

Shading systems

We specialize in all kind of shading systems. Utilizing our professional, able and experienced staff to completes each project to the highest standard of satisfaction. Each project must be handled with the highest degree of skill and flexibility during production and installation from start to finish.



Curtain Systems

PowerPull® Energy Curtain System

Reduce energy costs year round. Save 30%-40% on energy consumption. Increase plant quality and worker comfort. For new construction or retrofitting existing greenhouses, Wadsworth systems are flexible in design and easily installed.

FEATURES:

- Superior design virtually eliminates maintenance on systems that lasts for decades.
- Quiet and dependable operation
- Quick and easy install whether new building or retrofitting
- Rack and pinion drive — no cables to re-tension
- Design offers optimal management of cold air spill
- Durable fabric
- Small bundle sizes ensure minimal shade when open
- Available with monofilament or stationary stainless steel lines
- Drive unit centrally positioned in greenhouse for least disruption
- Built-in safety limits protect your system

Each PowerPull energy curtain system is custom designed to offer the best system for your greenhouse.



Dual curtain system (shade and blackout).

Vent Automation

Our drive units set the standard for smooth operation and reliability.



VC-100A & VC-2000

- VC-100A: This ILS, thermal protection, continuous duty unit lifts up to 75ft of 4ft polycarbonate roof ridge vent or 125ft of 4ft polycarbonate side vent
- VC-2000: This ILS thermal protection, continuous duty unit lifts up to 325ft of 4ft polycarbonate roof ridge vent or 400ft of 4ft polycarbonate side vent

WADSM1098	21-0820E	M-1098 VC-100A Motor and Gearbox 1-3/8 in.
WADSM1099	21-0820F	M-1099 VC-100A Motor and Gearbox 1-5/8 in.
WADSM1198	21-0810L	M-1198 VC-2000 Motor and Gearbox 1-3/8 in.
WADSM1199	21-0810M	M-1199 VC-2000 Motor and Gearbox 1-5/8 in.

Rack and Pinion Systems

Connecting the vent to the shaft, the rack pushes the vent open or pulls it closed.

FEATURES:

- Aluminum rack and pinion
- Corrosion-proof pinion gear
- Easy alignment, the rack works even when it's not perfectly square with vent
- Available in straight or curved, to accommodate tight spaces



PowerRack Curved



PowerRack Straight

Wadsworth Driveshaft Coupling

Coupling to join two lengths of drive shaft



1 3/8in

WADSF0909 Min. Buy 1EA

GrowerSelect®



RETAIL & PRODUCTION BENCHING

BFG Grower Select benching represents the most efficient, flexible and presentable benching available in the marketplace. Don't just use "block and board" for your presentation – we produce both double deck and modular benching, with re-supply racks underneath.

Our retail benching features complete coverage of sharp expanded metal edges, corner protectors and plastic caps on all tube ends and legs. A highly efficient and flexible way to enhance the image of your operation and present your products.

BFG Grower Select production benching can be ordered as rolling or stationary benches, in freestanding or cemented styles, even customized to fit your specific needs – all at a very economical price. These production benches are loaded with features designed to maximize your efficiency and assist in your profitability. Available with expanded galvanized top panels or plastic panels.

Production benching available in 3ft to 8ft wide and many custom lengths (widths vary by style). Check with your BFG Sales Representative for the size to maximize your space and footprint.



FOR MORE INFORMATION PLEASE CONTACT YOUR BFG SALES REP OR CUSTOMER SERVICE





Retail Benching

QUALITY PRODUCTS NEED QUALITY DISPLAYS!

Grower Select® works with some of the largest and most well-known retailers to provide them with benching that is efficient, flexible, and presentable. Our retail benching features complete coverage of the sharp expanded metal ends, corner protectors, and plastic caps on all legs and tube ends.

Complete Retail Bench Sets or Bench Tops Only
Available in the Following Sizes:

- 3ft x 8ft
- 3.5ft x 8ft
- 4ft x 8ft
- 5ft x 8ft
- 6ft x 8ft
- 3ft x 10ft
- 3.5ft x 10ft
- 4ft x 10ft
- 5ft x 10ft
- 6ft x 10ft
- 3ft x 12ft
- 3.5ft x 12ft
- 4ft x 12ft
- 5ft x 12ft
- 6ft x 12ft



Ultra Bench



Corner Protector



Freestanding Bench

AVAILABLE IN THE FOLLOWING SIZES:

- 4ft X 8ft Ultra Retail Bench Complete
- 4ft X 12ft Ultra Retail Bench Complete
- 6ft X 8ft Ultra Retail Bench Complete
- 4ft X 8ft Collapsible Ultra Retail Bench

ULTRA Plastic Top Benching

Grower Select® ULTRA benches include all the features of our traditional benching – aluminum side rails, molded corner protectors and plastic caps on all tube ends and legs – combined with durable, smooth, non-porous plastic bench tops that allow trays, flats, and pots to slide across the surface without snagging.

The polypropylene panels feature 1.1in x 2.1in rectangular holes for easy cleaning, and will not rot, crack, or splinter like wood products nor corrode or rust like expanded metal or wire tops.

We produce thousands of square feet of rolling benches every year. Our benches can be rolling or stationary, freestanding or cemented. We can usually customize to fit your needs at a very economical price. Free engineering and layout planning is available along with a full list of references.

Our production benches feature a 20lb/sq ft load capacity and have 3/4in pre-galvanized expanded metal tops. Our special aluminum side rails completely cover all of the sharp expanded metal edges and no more torn pants with our corner protectors. Expanded metal can be flattened for plug trays or left standard. You can also chose plastic panel tops. Anti-tip/roller spacers are optional. Allow four weeks for delivery.



Production Benching

AVAILABLE AS ROLLING OR STATIONARY

Aluminum Side Rails

No exposed expanded metal edges. Extra Strength. Enhances appearance.

1-1/2in Hat Section Crosspieces

Wider base to support the expanded metal. Standard spacing 2ft o.c. (optional 12in or 16in spacing)

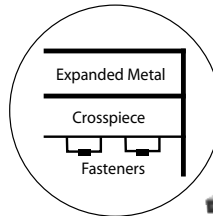

1.315in Rollers
Swaged ends.
Plastic caps.
No connectors to interfere with rolling.

Anti-Tip/Roller Aligner

Wider aisles.
Off loading from either side.
Constantly aligns rollers.

Contact Your BFG Sales Representative for

MORE INFORMATION



WARNING: This product is not available for sale in CA.
For most up to date information please visit bfgsupply.com

BENCHMASTER™



Single-Sided Step Displays



Configurations: 2-Step, 3-Step, 4-Step
Lengths: 36in, 66in, 96in
Add-ons: Plant Hanger Plus, Waterbed™

Pyramid Displays



Configurations: 3-Step, 5-Step, Wide
Lengths: 36in, 66in, 96in
Add-ons: Plant Hanger Plus, Waterbed™



Lifetime Bench Systems by A-V International are constructed of fiberglass frames and plastic bench tops. A-V Bench Systems will not rust, twist, warp, or decay, and are UV protected. The smooth surface and edges provide safe operation and easy movement of trays and pots with no catching or tipping over. A-V Bench Systems are long-lasting, strong, easy to handle, and clean and disinfect readily. Single and multi-tier configurations are available for propagating, growing, display, and retail use.





ADVANCING ALTERNATIVES

Greenhouse Structures

Advancing Alternatives Double WireLock Base

Aluminum extrusion accepts three layers of wires and multi-layers of poly for curtain system roll-up/lock-down. Designed to attach the roof covering to the top clasp and the roll-up curtain to the lower clasp.



12ft
ADVDDL12 Min. Buy 20 EA

8ft
ADVDDL8 Min. Buy 20 EA



Advancing Alternatives Gear Crank

Gear crank 5:1 gear box with internal brake, hand crank and 4 wheel roller guide. Requires 1 in guide pipe. Order guide pie and adapter separately.



5:1 w/ Brake
ADV5GC51B Min. Buy 1 EA

Advancing Alternatives Gears & Adapters

13:1 gear, manual operator with guide wheels, internal brake and input loop.



Gear and Adaptors for roll up walls
ADV63GC131 Min. Buy 1 EA

Advancing Alternatives Gears & Adapters

Short handle, fits over and bolts to input loop.



Gear and Adaptors for roll up walls
ADV64CH Min. Buy 1 EA

Advancing Alternatives Gears & Adapters

Adapter 1/2in Shaft X 2.3in.



Gear and Adaptors for roll up walls

ADV65RBA1223 Min. Buy 1 EA

Advancing Alternatives Posi-Clasp Roll-Lock

Creates a sealed covering at the bottom of the roll-up sides. Designed to clasp single or multi-layer curtain material.



12ft
ADVRL12 Min. Buy 4 EA

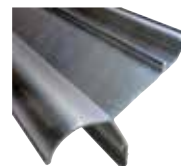

Advancing Alternatives Roll-Bar Cap

Clasp single or double layers of poly for the full length of existing pipe Roll-Bars. The pre-drilled Aluminum Roll-Bar Cap clasps against any standard 1.315" OD pipe with self-drilling Tek Screws (recessed) so curtains can roll uniformly.



12ft
ADVRBC12 Min. Buy 1 EA



Advancing Alternatives Stationary Mounted Gear Crank

Manual rollup curtain system with internal brake. Stationary unit allows for left, right or two sided output. Gear Crank uses a 1.315in OD Guide Pipe (not included).



Gear Ratio 13:1
ADVGC13:1 Min. Buy 1 EA

ROLL-UP/LOCK DOWN CURTAIN SYSTEMS ALWAYS READY TO OPEN ALWAYS READY TO CLOSE

Roll-Up sidewall curtain package for free-standing or gutter connect greenhouses includes:

- **Automated or Manual** vent drives for easy operating of your ventilation curtain.
- **Controllers for automated systems** allows your curtain to roll up or down based
- **Double WireLock** to attach your roof covering to the top clasp and the roll-up curtain to the lower clasp.
- **Roll-Bar options** allow you to clasp your choice of curtain material, single or multi-layer.
- **Continuous Roll-Lock** provides an air-tight seal across the entire bottom.
- **Wind Rope System** with hooks to hold the curtain to the structure, and materials for creating end panels which the curtain laps

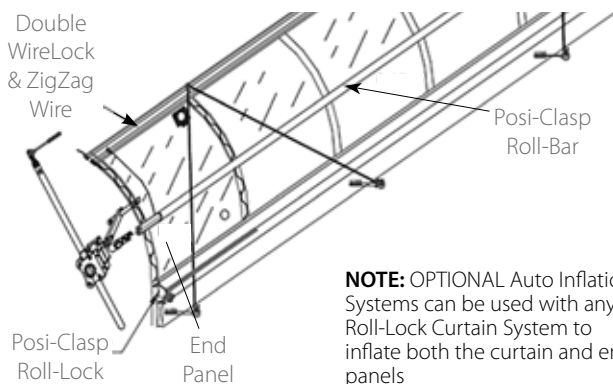

NOTE: OPTIONAL Auto Inflation Systems can be used with any Roll-Lock Curtain System to inflate both the curtain and end panels

DESCRIPTION

Package w/Roll-Bar & top poly clasp but no Roll-Lock
Package w/Roll-Bar & Roll-Lock but no top poly clasp
Package w/Roll-Bar, Roll-Lock and double top poly clasp
All curtains must be ordered in increments of 4ft.

WARNING: This product is not available for sale in CA. For most up to date information please visit bfgsupply.com



Greenhouse Structures

DeCloet® 2 Hole Angle Bracket

2 Hole angle bracket used in greenhouse construction.



2in Square

DECLBRF-9711 Min. Buy 1 EA



DeCloet® 4 Hole Angle Bracket

4 Hole angle bracket used in greenhouse construction.



1-1/2in Square

DECLBRF-9712 Min. Buy 1 EA



2in Square

DECLBRF-9713 Min. Buy 1 EA

DeCloet® Adaptor Plate

Adaptor plate used in greenhouse construction



12ft

DECLGUF-7862 Min. Buy 1 EA



DeCloet® Aluminum Door

Aluminum swinging door with 16mm polycarbonate



37in x 80in

DECLDOF8206 Min. Buy 1 EA



DeCloet® Corner Flashing

Corner flashing used in greenhouse construction



4x4x12'

DECLFLF-8259 Min. Buy 1 EA



DeCloet® Drive Shaft Hanger

Drive shaft hanger used in greenhouse construction



DECLGVF-9611 Min. Buy 1 EA



DeCloet® Energy Truss

Energy truss used in greenhouse construction



24ft

DECLETF-7364 Min. Buy 1 EA



DeCloet® Gutter Vent Pressure Relief Valve

Pressure relief valve used to relieve excess pressure while opening a gutter ventilation system



DECLGVF-9629 Min. Buy 1 EA





Greenhouse Structures

DeCloet® Oval Ground Stake

Oval ground stake used with oval bows in greenhouse construction



30in
DECLGSF-7202 Min. Buy 1 EA



DeCloet® Purlin Bracket

Components to be used for greenhouse structures or for benching. Many sizes to choose from to create the layout of your choice.



1.5in
DECLBRF-9708 Min. Buy 1 EA



2in Square
DECLBRF-9715 Min. Buy 1 EA

DeCloet® Rollup Vent Shaft

Rollup vent shaft used in greenhouse ventilation construction



21ft - 1 1/14in OD
DECLGLF-8575 Min. Buy 1 EA



DeCloet® Single Stack Inflation Kit

Single stack inflation kit used to inflate a double layer of poly film.



DeCLPIF-8550 Min. Buy 1 EA



DeCloet® Stub Post

Stub posts are nailed to trusses and truss supports based upon the truss spacing shown on the truss drawings.



2.5in X 3.5in X 60in
DeCLSPF7131 Min. Buy 1 EA

3in X 4in X 60in
DeCLSPF7145 Min. Buy 1 EA

4in X 4in X 60in
DeCLSPF7151 Min. Buy 1 EA



DeCloet® Standard Gutters

Standard Gutters used in the construction of Gutter Connected Greenhouses 12 ft in length and 6 ft hoop spacing



Used for Greenhouses 18ft - 42 ft wide
DeCLGUF-7850 Min. Buy 1 EA



DeCloet® Swaged Purlin Square

Square swaged purlin.



1.5in x 1.5in x 24ft 4in
DeCLPUF-7719 Min. Buy 1 EA

2in x 2in x 24ft 4in
DeCLPUF-7718 Min. Buy 1 EA



DeCloet® Tek Screw

Self-drilling stainless screws.



#14 x 1in Screw
DeCLHDF-9190 Min. Buy 1 EA



DeCloet® U-Bolt

U-Bolt with nuts



5/16in x 1 5/8in 3 1/4 in
DeCLHDF-9288 Min. Buy 1 EA



DeCloet® Universal Gable Extrusion

Universal gable extrusion holds roof poly and polycarbonate or wood at the gable ends, includes zig zag wire.



17ft
DeCLALF-9663 Min. Buy 1 EA

19ft
DeCLALF-9664 Min. Buy 1 EA

23ft
DeCLALF-9665 Min. Buy 1 EA

27ft
DeCLALF-9666 Min. Buy 1 EA



The Venlo Solution



*Controlled Environment
Agriculture at its best*

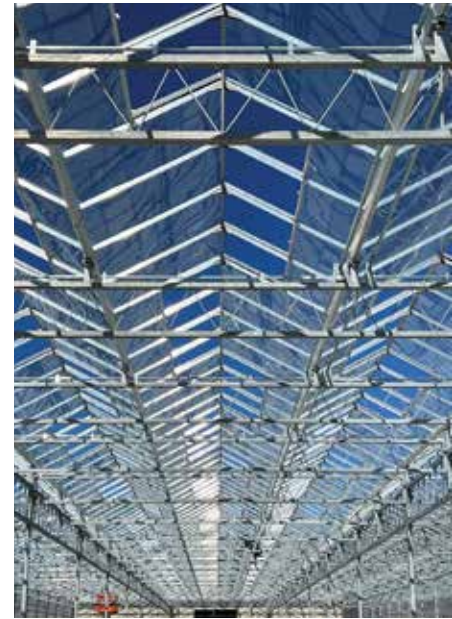

ONE STOP
we have you covered

DeCloet Greenhouses

BFG's world standard Venlo greenhouses are manufactured by DeCloet in Ontario, Canada, combining European design with North American engineering. We offer our clients a structure that will withstand extreme climate conditions while maintaining an indoor environment, with stable temperature, humidity, light, and irrigation.

Venlo greenhouse structures feature a tempered glass roof with an aluminum glazing system, providing maximum light transmission with up to 24' gutter height. This exclusive and unique design reduces clutter and maximizes growing space. Posts and gutters are galvanized for longer rust free life.



Greenhouse Structures

Grower Select® Aluminum H-Profile 8mm

Available in 12ft sections, it is used to splice the panels on sidewalls and gables and is used in conjunction with the U-profile. Fasten to structure with wood screws or self-tapping Tek screws.



Double Splice - 12ft
GSS13693 **Min. Buy 1 PC**



Grower Select® Aluminum U-Profile 8mm

Used as a perimeter cap on sidewalls and gables and is used in conjunction with the H-profile to provide structure for polycarbonate panels. Fasten to the structures (on sidewalls and gable ends) with wood screws or self-tapping Tek screws. When used as a base, weep holes should be drilled every 12in to allow the condensate to drain.



Single Splice - 12ft - 8mm
GSS15102 **Min. Buy 1 PC**



Grower Select® Camlock Insert

Three pieces are needed for single cam lock base and six pieces are needed for double cam lock base. 450 sections per bundle.



4ft Cam Section Only
GSS13699 **Min. Buy 1 PC**



Grower Select® Double Camlock Base

12 foot double cam lock base only. Used for locking multiple sheets of poly film down on the greenhouse. 6 pieces of cam section needed to complete the lock. Usually needed for roll up sides. Sold by the each.



Base Only - 12ft
GSS13697 **Min. Buy 1 EA**

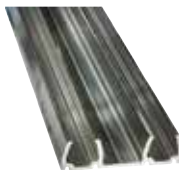

Grower Select® Single Camlock Base

12 foot single cam lock base only. Used for locking multiple sheets of poly film down on the greenhouse. 3 pieces of cam section needed to complete the lock. Sold by the piece. Universal extrusions not only hold roof poly, but they also cap off polycarbonate or wood gable ends.



Base Only - 12ft
GSS13698 **Min. Buy 1 PC**



Grower Select® Spring Lock Base

Spring lock doesn't pinch, bind, or weaken the material it secures and can be formed to the top of curved bows. It can be secured to any structural members, and can be installed around gable ends. Works by pulling the material across the channel and inserting the spring into place in the bottom channel. Can hold from 2 to 20 mil thickness and multiple layers.



Base Only - 12ft
GSS14498 **Min. Buy 1 EA**



Grower Select® Spring Lock Roll-Up Shaft

Aluminum spring lock roll up shaft used for sidewall ventilation. Wires and couplers sold separately. Grower Select® Roll-up Sidewall System has been designed as a low-cost ventilation system with no additional electrical requirements or costs to operate. The customized aluminum roll-up shaft comes in 12ft lengths and has been designed to accept our standard Grower Select® Spring Lock Spring.



12ft
GSS38-0806 **Min. Buy 1 EA**



Grower Select® Aluminum End Cap

Used for top, bottom and side closure in roof applications in conjunction with the Bar Base and Bar Cap for polycarbonate sheets. Fasten to the structure with wood screws or standard tek screws. When used as a base, weep holes should be drilled every 12in to allow the condensate to drain. Sold by the piece.



8mm - 20ft
GSB01720 **Min. Buy 1 PC**



Grower Select® Aluminum F Rail

Components to be used for greenhouse benching.



3ft
GSB06210 **Min. Buy 1 EA**

3.5ft
GSB06220 **Min. Buy 1 EA**

4ft
GSB06230 **Min. Buy 1 EA**

4.5ft
GSB06235 **Min. Buy 1 EA**

5ft
GSB06240 **Min. Buy 1 EA**

6.5ft
GSB06270 **Min. Buy 1 EA**

7ft
GSB06280 **Min. Buy 1 EA**

8ft
GSB06290 **Min. Buy 1 EA**

12ft
GSB06330 **Min. Buy 1 EA**

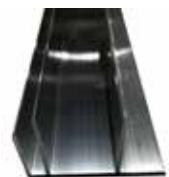

GrowerSelect®

Greenhouse Structures

Grower Select® Bar Base

Used in conjunction with our Bar Cap to splice panels over bows or span purlins with a maximum recommended span of 4ft x 6ft. Fasten to the structure with wood screws or standard tek screws.



8mm - 24ft

GSB01640

Min. Buy 1 PC



Grower Select® Bar Cap

Used to fasten down the polycarbonate once it's been installed within the Bar Base framework. 1/2in cap screws should be used to secure it to the bar base every 12in. Can be used with or without neoprene gaskets which are sold separately.



8mm - 24ft

GSB01600

Min. Buy 1 PC



Grower Select® Cold Frames/High Tunnels

These 14ft cold frames are designed for overwintering nursery stock or as a temporary growing area. An optional extended stake package is available for extra height. The house can be purchased without stakes and can be made portable by using a baseboard to connect the bows. Most often used with a single purlin with hoop/bow spacing at 4ft O.C. to help eliminate pocketing.



1.315in x 48in Stake for Cold Frame or Hoop House - Plain End

GSA01592

Min. Buy 1 EA

1.315in x 48in Stake for Cold Frame or Hoop House - Swage End

GSA01595

Min. Buy 1 EA

15ft Cold Frame Bow

GS98-1000A

Min. Buy 1 EA

3FT Ground Stake - 1in X 15ga X 36in

OHGTBFG 3' GROUND STAKE

Min. Buy 1 EA

Swaged Purlin - 1.315in x 21ft - 17ga

GRFSB08680

Min. Buy 1 EA

Swaged Purlin - 1/315in x 12ft - 17ga

GRFSB08670

Min. Buy 1 EA

Swaged Purlin - 1.25in x 12ft with 3ft Swage (Not Drilled) - 16gauge

GS98-2000

Min. Buy 1 PC

14ft Cold Frame Bow

GSA01540

Min. Buy 1 EA



Grower Select® Round Galvanized Tubing Support Rails

Components to be used for greenhouse structures or for benching. Many sizes to choose from to create the layout of your choice.



14ga, 1.25in x 23ft

OHGT98-1000B Min. Buy 1 PC

17G - 1.315in Diam x 144in L

GRFSB08640 Min. Buy 1 EA

17ga - 1.315in x 96in

GRFSB08625 Min. Buy 1 EA

17ga - 1.315in x 96in

GRFSB08665 Min. Buy 1 EA



Grower Select® Square Galvanized Tubing

Components to be used for greenhouse structures or for benching. Many sizes to choose from to create the layout of your choice.



14ga - 1.25in x 288in

GRFSB07870 Min. Buy 1 EA

14ga - 1.25in x 30in

GRFSB07760 Min. Buy 1 EA

14ga - 1.25in x 40in

GRFSB07780 Min. Buy 1 EA

14ga, 1.25in x 48in

GRFSB07790 Min. Buy 1 EA

14ga, 1.25in x 54in

GRFSB07800 Min. Buy 1 EA

14ga, 1.25in x 96in

GRFSB07850 Min. Buy 1 EA

14ga, 2in x 288in

GSB07730 Min. Buy 1 PC

16ga - 1.5in x 288in

GRFS21-0002 Min. Buy 1 EA

16ga - 1in x 168in

GRFSB07852 Min. Buy 1 EA

16ga - 1in x 195in

GRFSB07853 Min. Buy 1 EA

16ga - 1in x 288in

GRFSB07750 Min. Buy 1 EA

16ga - 1in x 30in

GRFSB07610 Min. Buy 1 EA

16ga - 1in x 36in

GRFSB07620 Min. Buy 1 EA

16ga - 1in x 40in

GRFSB07630 Min. Buy 1 EA

16ga - 1in x 60in

GRFSB07660 Min. Buy 1 EA

16ga - 1in x 66in

GRFSB07670 Min. Buy 1 EA

16ga - 1in x 72in

GRFSB07680 Min. Buy 1 EA

16ga - 1in x 78in

GRFSB07690 Min. Buy 1 EA

16ga - 2in x 288in

GRFSB08200 Min. Buy 1 EA



Grower Select® Carriage Bolt

Components to be used for greenhouse structures or for benching.



.25in x 3.5in

WMNBCRBG025056

Min. Buy 1 EA

5/16in x 2in

BLDF21-2118

Min. Buy 1 EA



Greenhouse Structures

Grower Select® Galvanized Nut

Components to be used for greenhouse structures or for benching.



5/16in

BLDF21-2119DA Min. Buy 1 EA



Grower Select® Hex Nut

Components to be used for greenhouse structures or for benching.



.25in

BLDF98-1533 Min. Buy 1 EA



0.375in

BLDFB05180 Min. Buy 1 EA

Grower Select® Permaseal Washer

Grower Select Permaseal washer is designed for use in the construction of greenhouse structures and benching. Neoprene-backed 1-1/8in black washer.



1.18in - Neoprene Backed

WMNB38-0245 Min. Buy 1 EA



Grower Select® Round Machine Head Screw

Grower Select® hardware components are designed to be used in greenhouse structures or for benching.



0.25 x 0.625in

BLDFB05150 Min. Buy 1 EA



Grower Select® Self-Tapping Tek Screw

Grower Select® hardware components are designed to be used in greenhouse structures or for benching.



0.75in

BLDF45-1200 Min. Buy 1 EA



Grower Select® Tek Screw with Neoprene Washer

Tek Screws are self-drilling screws that can help you tackle fastening jobs more quickly. The Grower Select #14 Tek Screw is designed for use in construction of greenhouse structures and benching. Includes neoprene washer.



#14 Screw x 1in L

WMNBHBT2014016 Min. Buy 1 EA

#14 x 1.25in L

WMNB38-0236 Min. Buy 1 EA



Grower Select® Tek Screw with Zinc Washer

Grower Select® hardware components are designed to be used in greenhouse structures or for benching.



#12 x 1.5in

BLDF26-1103 Min. Buy 1 EA



Grower Select® WoodTite™ Self-Tapping Screws

Grower Select® hardware components are designed to be used in greenhouse structures or for benching.



#10 x .75in - Type-17 Point

BLDFB05210 Min. Buy 1 EA

#10 x 1.5in - Type-17 Point

BLDFB05110 Min. Buy 1 EA



Grower Select® Crossbar Uprights

GS Gothic Style house crossbar uprights



1.315in x 18in

GSA01620 Min. Buy 1 EA



Grower Select® Roll-Up Shaft Splice

Grower Select® Roll-up Sidewall System has been designed as a low-cost ventilation system with no additional electrical requirements or costs to operate. The customized aluminum roll-up shaft comes in 12-inch lengths and has been designed to accept our standard Grower Select® Spring Lock Spring for easy attachment of the poly to the shaft.



1.5in x 12in

GS38-0807 Min. Buy 1 EA



Grower Select® Cold Frames / High Tunnel Ground Stake

14 gauge galvanized round tubing ground stake with drilled holes.



14ga, 1.25in x 3.5ft

OHGT98-0972A Min. Buy 1 EA

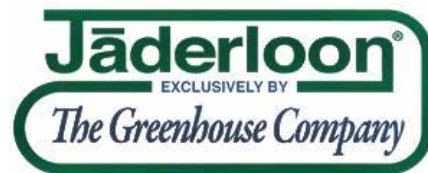

Greenhouse Structures

Jaderloon® Cross Connector

Jaderloon's® unique, 2-piece, aluminum cross connector retains 100% of the frame's strength. Comes complete with bolts and nuts. Use it to connect 1-5/8" tubing or pipe to 1-3/8" tubing or pipe.



1-5/8in x 1-3/8in

JA5PN0001 Min. Buy 1 PR



Greenhouse Benching

AV Plastic Greenhouse Bench Tops

Polypropylene, U.V. Protected. Durable and lightweight. No sagging when properly supported. Can withstand extremely cold and hot temperatures. Installs on any type of frame with screws or pop rivets. Easy interlocking assembly. Flats, plug trays and pots slide easily over surface, no tipping. Easy to clean and disinfect. Will not rust or decay.



18in x 36in x 9/16in
AV18X36 **Min. Buy 1 EA**



24in x 48in x 7/8in
AV24X48 **Min. Buy 1 EA**



Durable Bench Systems

Lifetime Bench Systems by A-V International are constructed of fiberglass frames and plastic bench tops. A-V Bench Systems will not rust, twist, warp, or decay, and are UV protected. The smooth surface and edges provide safe operation and easy movement of trays and pots with no catching or tipping over. A-V Bench Systems are long-lasting, strong, easy to handle, and clean and disinfect readily. Single and multi-tier configurations are available for propagating, growing, display, and retail use.



Greenhouse Benching

Southwest Agri-Plastics Inc Dura-Bench Original

The DURA-BENCH Original Overlap design is 2ft wide by 4ft long panel with connections on all four sides. This design utilizes four interlocking tabs along the 4ft side allowing the parts to be adjoined. The 2ft side uses an overlap connection only requiring one cross support.* Model: DS24X48 BSTO Size: 24in x 49.5in (60.96 cm x 125.73 cm)



Overlap - 24in x 49.5in Top
SWAP45-2011 **Min. Buy 1 EA**



Greenhouse Benching

Grower Select® Anti-Tip Device for Greenhouse Benching

Anti-tip device for use with 1.315 inch roller. Used to prevent accidental tipping of product off benching causing expensive profit loss.



1.315in **1.66in**
DLSNB06480 **Min. Buy 1 EA** **DLSNB06500** **Min. Buy 1 EA**

Grower Select® Baseboard Clamp

Grower's Select Round Baseboard Clamps are designed to be used with the Grower Select Gothic-style greenhouses. Baseboard clamp attaches to the baseboard of the structure.



1.66in
DLSNB05040 **Min. Buy 1 EA**

Grower Select® Round Clamp Half

This 1.3015in clamp is designed for use in the construction of greenhouse benching. Round half clamp design.



1.315in
DLSNB06510 **Min. Buy 1 EA**



Grower Select® Square Clamp Half

This 1in clamp is designed for use in the construction of greenhouse benching. Square half clamp design.



1in
DLSNMD3000 **Min. Buy 1 EA**



Southwest Agri-Plastics Inc Dura-Bench Ultra

The plastic bench top is tougher, smoother, and is a longer lasting growing surface for your plants. With increased airflow, easier installation and a lower cost per square foot, the latest Dura-Bench Ultra will fit your needs and budget. 2ft x 4ft (8sq ft., nominal) high impact abrasion resistant polypropylene plastic panel.



24in x 48in Top
SWAP45-2013 **Min. Buy 1 EA**

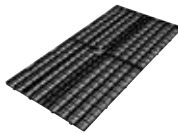

36in x 48in Top
SWAPDBU36X48B **Min. Buy 1 EA**

Southwest Agri-Plastics Inc Dura-Bench Ultra Clips

For use in installation of the Dura-Bench Ultra.



Dura-Bench Ultra Clips
SWAP45-2013A **Min. Buy 1 EA**



GrowerSelect®

Greenhouse Benching

Grower Select® Hat Section for Greenhouse Benching

Galvanized bench top crossbar support.



- 2ft - 18ga
DLSNZ2770E **Min. Buy 1 EA**
- 2.5ft - 18ga
DLSNB06360 **Min. Buy 1 EA**
- 3ft - 18ga
DLSNB06370 **Min. Buy 1 EA**
- 3.5ft - 18ga
DLSNB06380 **Min. Buy 1 EA**
- 4ft - 18ga
DLSNB06390 **Min. Buy 1 EA**
- 5ft - 18ga
DLSNB06400 **Min. Buy 1 EA**
- 5.5ft - 18ga
DLSNB06410 **Min. Buy 1 EA**
- 6ft - 18ga
DLSNB06420 **Min. Buy 1 EA**

- 7ft - 18ga
DLSNB06440 **Min. Buy 1 EA**
- 7.5ft - 18ga
DLSNB06445 **Min. Buy 1 EA**
- 8ft - 18ga
DLSNB06450 **Min. Buy 1 EA**
- 10ft - 18ga
DLSNB06460 **Min. Buy 1 EA**
- 10.66ft - 18ga
DLSNB06465 **Min. Buy 1 EA**
- 12ft - 18ga
DLSNB06470 **Min. Buy 1 EA**

Grower Select® Pre-Galvanized Expanded Metal Section

Components to be used for greenhouse structures or for benching. Many sizes to choose from to create the layout of your choice.



- 14ga, 4ft x 3ft
MDWMB00590 **Min. Buy 1 PC**
- 14ga, 4ft x 3ft 6in
MDWMB00600 **Min. Buy 1 PC**
- 14ga, 4ft x 3ft 6in - Flattened
MDWMB00870 **Min. Buy 1 PC**
- 14ga, 4ft x 4ft
MDWMB00610 **Min. Buy 1 PC**
- 14ga, 4ft x 5ft
MDWMB00630 **Min. Buy 1 PC**
- 14ga, 4ft x 5ft 6in
MDWMB00640 **Min. Buy 1 PC**
- 14ga, 4ft x 7ft
MDWMB00670 **Min. Buy 1 PC**
- 14ga, 5ft x 5ft 6in
MDWMB00750 **Min. Buy 1 PC**
- 14ga, 5ft x 6ft
MDWMB00740 **Min. Buy 1 PC**

Grower Select® Ultra Plastic Top Collapsible Bench

Include all the features of our traditional benching - aluminum side rails, molded corner protectors and plastic caps on all tube ends and legs - combined with durable, smooth, non-porous plastic bench tops that allow trays, flats, and pots to slide across the surface without snagging. The polypropylene panels feature 1.1in x 2.1in rectangular holes for easy cleaning.



- 4ft x 8ft
GSA12250 **Min. Buy 1 EA**



GrowerSelect®

Roll-up Curtains

Grower Select® Manual Roll-Up Sidewall Starter Kit

Kit includes tubing to secure film to, 1in vertical guidepost, shepherds hook to for crank, all the hardware needed for installation and a hand crank that can handle sidewalls up 7ft tall up to 100ft long. The 16:1 ratio gear box with trolley makes for easy cranking. Plastic film for covering is sold separately.



12ft - Manual Starter

GSSIDEWALLMANUAL Min. Buy 1 EA

QTY.	PARTS
1	Grower Select® Spring Lock Base - Base Only - 12ft
1	Grower Select® Spring Lock Roll-Up Shaft - 12ft
1	Grower Select® Spring Lock Spring - 6ft-6in - Sold by Bundle of 20
1	16:1 Roll-Up Gear Box C/W Trolley
1	Gearbox Drive Coupling Assembly Roll-Up Extrusion
1	1/8in x 3/4in Cotter Pin
1	4-1/2ft Crank Handle for 16:1 Gearbox
4	Backer Plate for Roll-up Adapter
2	7ft Roll-Up Guide Tube Suits 10in Roll-Up Opening
2	Roll-Up Ground Stake 1in SQ Tube x 24in
1	Shaft End Collar
2	1/2in x 16in Roll-Up Spring
1	Roll-Up Guide Assembly
1	1.5in x 1.5in 16GA Galvalum Tube 8in
4	#14 x 1in Tek Screw
1	Roll-Up Shaft End Adapter
8	5/16in x 2in Hex Head Bolt
8	5/16in Hex Nut
1	3/32in x 2-1/2in Cotter Pin Zinc
2	5/16in x 4in Hex Head Bolt

Grower Select® Roll-Up Sidewall Extension Kit

Kit includes 12ft piece of tubing and all the hardware needed to expand starter kit in 12ft increments. Plastic film for covering sold separately.



12ft - Extension Kit

GSSIDEWALLEXT Min. Buy 1 EA

QTY.	PARTS
1	Grower Select® Roll-Up Shaft Splice - 1.5in x 12in
1	Grower Select® Spring Lock Roll-Up Shaft - 12ft
1	Grower Select® Spring Lock Base - Base Only - 12ft
1	7ft Roll-Up Guide Tube Suits 10in Roll-Up Opening
1	Roll-Up Ground Stake 1in SQ Tube x 24in

Note: Spring Lock Wire to be purchased according to overall length of extension.

Roll-Up Sidewall Systems

The right environment is imperative for growing healthy plants. Rollup sidewalls help you control airflow, temperature, and humidity in a greenhouse all year long.

Our Rollup Sidewall Kits can be integrated into any greenhouse style and make it easy to naturally vent and change the environment inside the greenhouse quickly.

Choose from our manual or motorized starter kits. Each kit will cover a 12' section on one side of a greenhouse. Add an extension kit to cover each additional 12' of your greenhouse.



Grower Select® Motorized Roll-Up Sidewall Starter Kit

Kit includes tubing, all the hardware needed for installation and a 24V roll up motor that can handle sidewalls 7ft tall up to 100ft long. Plastic film for covering is sold separately.



12ft - Motorized Starter

GSSIDEWALLMOTORIZED Min. Buy 1 EA

QTY.	PARTS
1	Grower Select® Spring Lock Base - Base Only - 12ft
1	Grower Select® Spring Lock Roll-Up Shaft - 12 ft
1	Grower Select® Spring Lock Spring - 6ft-6in - Sold by Bundle of 20
1	Woosung 24V Roll-Up Motor Complete with mounting kit
1	Woosung Stainless Steel Roller Guide
1	1/4in x 2-1/2in" Hex Head Bolt
1	1/4in Hex Nut
1	Motorized Roll-up End Adapter to Aluminum Extrusion
4	Backer Plate for Roll-up Adapter
2	7' Roll-Up Guide Tube Suits 10in Roll-Up Opening
2	Roll-Up Ground Stake 1in SQ Tube x 24in
1	Shaft End Collar
2	1/2in x 16in Roll-Up Spring
1	Roll-Up Guide Assembly
1	1.5in x 1.5in 16GA Galvalum Tube 8in
4	#14 x 1in Tek Screw
1	Roll-Up Shaft End Adapter
8	5/16in x 2" Hex Head Bolt
8	5/16in Hex Nut
1	3/32in x 2-1/2in Cotter Pin Zinc
2	5/16in x 4in Hex Head Bolt



COVERINGS



HELPFUL TIPS ABOUT GREENHOUSE FILMS

Fold Methods

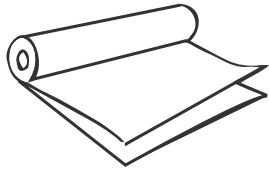

Double-Wound Sheet

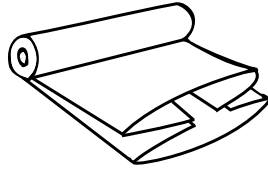

GT: Gusseted Tube

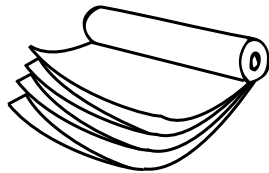

Double Fold

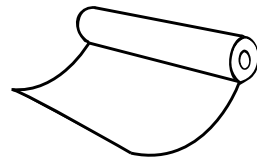

LF: Layflat

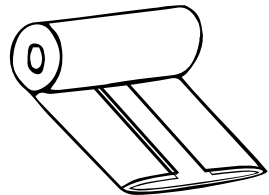

TDF: Tubing Double Folded

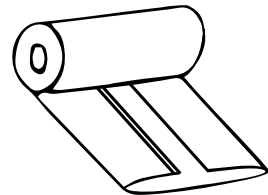

CSTF: Center-Slit Tubing Folded

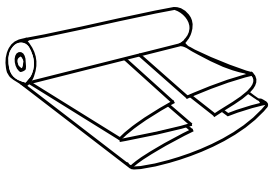

GS: Center-Slit Gusseted

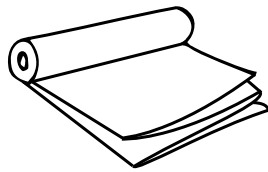

WF: W-Fold Sheet or M-Sheet

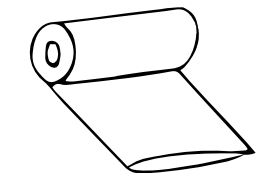

FT: Layflat Tubing

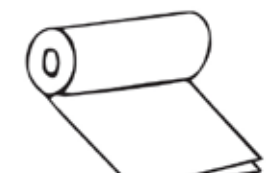

CF: Centerfold

- UFGS: U Fold Center Slit Gusseted Sheet
- UFT: U Fold Tube



INSTALLATION HINTS

- When installing, make certain the film is placed on top of the greenhouse according to the folds.
- The film should be installed during the early morning hours (cooler without wind).
- Do not stretch the film on hot days as it will contract when cool and may weaken.
- Static air pressure between the two layers should be between 0.2 and 0.4 inches of water on a manometer.
- Use outside air to inflate as it's less humid and less likely to contain chemicals.
- Avoid direct spraying of chemicals on film surfaces.
- Paint all metal and wood surfaces touching the poly with white latex paint. Never use oil-base paint. Do not use chemically treated lumber.
- Avoid contact with PVC and vinyl.
- Smooth the surface of metal and wood parts.
- Use only repair tape recommended for poly.

Poly Accessories

BFG also offers a variety of poly accessories



Tough and Versatile



Premium Greenhouse and High Tunnel Solutions from the Leader in Horticulture Polyethylene Film Products.

TuffliteIV™

This clear, 4 year, 6mil, durable greenhouse film was designed for excellent PAR light transmission, exceeding 91%. Tufflite IV is made with a high strength proprietary polymer blend and UV stabilization that will protect and keep a greenhouse operation growing for up to 4 years. Also available in 55% opacity.

THERMAX™

Anti-condensate Film

Thermax™ combines outstanding thermal qualities and exceptional condensation control properties in one revolutionary, diffused greenhouse film. The modified outer layer of the film safeguards condensation control integrity by providing directionality.

www.berryglobal.com





Infra Red Film

AT Films® Dura-Film® Thermax

Every grower strives to produce the best crop they can while keeping production costs to a minimum. AT Films' Dura-Film Thermax greenhouse poly combines all of these extras into one package. Superior drip control, energy savings, and bee compatibility are all packaged together to provide growers with one film at one cost.

- Superior drip control
- Energy savings
- Reduces radiant heat loss
- Bee compatibility
- Guaranteed longer life, 4 years



Tubes

6M 18X150 TUBE
AT8964590 Min. Buy 1TB

6M 24X100 TUBE
AT8963866 Min. Buy 1TB

Sheets

6M 12X100
ATTHERMAX 6M 12X100FT Min. Buy 1EA

6M 24X110
AT8963859 Min. Buy 1RL

6M 32X100
AT8963766 Min. Buy 1RL

6M 36X100
AT8963892 Min. Buy 1RL

6M 40X100
AT8963767 Min. Buy 1RL

6M 42X100
AT8963888 Min. Buy 1RL

6M 48X100
AT8963858 Min. Buy 1RL

6M 48X150
AT8963861 Min. Buy 1RL

Custom lengths can be ordered in a 75ft minimum length and 5ft increments.

Shorter than 75ft will be subject to an upcharge.

The following minimums production requirements apply for custom poly orders per width/gauge/opacity:

- Up to 20ft - 7,500lbs
- 21ft to 31ft - 15,000lbs
- 32ft to 40ft - 20,000lbs
- >40ft - 30,000lbs

Multi Year Film

Dura-Film® Super4™

Dura-Film® Super 4™ offers the best value in a 6-mil, 4-year greenhouse film with the following improved properties over older generations of greenhouse coverings. Superior strength and toughness. Higher light transmission. Guaranteed longer life – 4 years. Folds up to 210% stronger. Tear strength up to 164% higher. Puncture force up to 12% higher. Advanced UV up to 33% longer life.

- Superior strength and toughness
- Higher light transmission
- Guaranteed longer life, 4 years
- Folds up to 210% stronger
- Tear strength up to 164% higher



Standard Width Sizes

Dura-Film® Super 4™ Clear - 6mil / 4-Year

Sheet: 10ft, 12ft, 16ft, 20ft, 24ft, 28ft, 32ft, 40ft, 42ft, 48ft, 50ft

Tube: 5ft, 6ft, 8ft, 10ft, 12ft, 14ft, 16ft, 18ft, 20ft, 21ft, 24ft, 25ft



Tubes

6M 20X150 TUBE
AT6750056 Min. Buy 1TB

6M 24X150 TUBE
AT6750079 Min. Buy 1TB

6M 24X100 TUBE
AT6750080 Min. Buy 1TB

Sheets

6M 12X100
AT6750559 Min. Buy 1RL

6M 32X150
AT6750041 Min. Buy 1RL

6M 16X100
AT6750070 Min. Buy 1RL

6M 36X100
AT6750397 Min. Buy 1RL

6M 20X100
AT6750301 Min. Buy 1RL

6M 36X150
AT6750534 Min. Buy 1RL

6M 24X100
AT6750063 Min. Buy 1RL

6M 40X100
AT6750040 Min. Buy 1RL

6M 24X110
AT6750062 Min. Buy 1RL

6M 40X150
AT6750039 Min. Buy 1RL

6M 24X150
AT6750085 Min. Buy 1RL

6M 42X100
AT6750084 Min. Buy 1RL

6M 28X100
AT6750038 Min. Buy 1RL

6M 42X150
AT6750081 Min. Buy 1RL

6M 28X150
AT6750607 Min. Buy 1RL

6M 48X100
AT6750043 Min. Buy 1RL

6M 32X100
AT6750042 Min. Buy 1RL

6M 48X150
AT6750045 Min. Buy 1RL

6M 32X110
AT6750061 Min. Buy 1RL





Over Wintering Film

Berry Global Tufflite® 3M Greenhouse Film

This Nursery Film will cover all your needs for a single season. This is a tri-layer polyethylene film for maximum protection and ease of installation. Offers high clarity to allow the most light possible.

Standard Width Sizes

Tufflite IV Clear – 6mil / 4-Year

Sheet: 10ft, 12ft, 14ft, 16ft, 20ft, 24ft, 28ft, 32ft, 36ft, 40ft, 42ft, 48ft, 50ft, 56ft

Tubes: 5ft, 6ft, 7ft, 8ft, 10ft, 12ft, 14ft, 16ft, 18ft, 20ft, 21ft, 24ft, 25ft, 28ft



Clear Film



Clear - 24ft x 110ft
BERRYNC324110 Min. Buy 1RL

White Film



- White - 70% - 24ft x 100ft BERRYNW324100
White - 70% - 32ft x 100ft BERRYNW332100
White - 70% - 24ft x 110ft BERRYNW324110
White - 70% - 36ft x 100ft BERRYNW336100
White - 70% - 24ft x 120ft BERRYNW324120
White - 70% - 40ft x 100ft BERRYNW340100
White - 70% - 24ft x 150ft BERRYNW324150
White - 70% - 42ft x 100ft BERRYNW342100

Berry 4, 5, and 6mil over wintering film available please contact your BFG Sales Representative for details.

Custom lengths can be ordered in a 75ft minimum length and 5ft increments.

Shorter than 75ft will be subject to an upcharge.

The following minimums production requirements apply for custom poly orders per width/gauge/opacity:

- Up to 31ft - 5,000lbs
>32ft - 10,000lbs

Horticulture films that help your business grow



Greenhouse Coverings



A high clarity, tri-layer covering for 4 years with UV protection and anti dust additive



Four year covering with UV protection and anti-drip additive that reduces condensation build-up. Also includes an additive that disperses light and helps delay the exit of heat from the greenhouse.

Overwintering Films



Superior protection from the harsh elements. The products are UV stabilized for up to 1 year and are available in a variety of sizes, gauges and opacity.

SUPER4

Greenhouse Film

A super clear, super tough, longlife product that provides the best value in a 6-mil, 4-year greenhouse film.

THERMAX

Anti-condensate Film

Combines outstanding thermal qualities and exceptional condensation control properties in one revolutionary, diffused greenhouse film.

LUMINANCE

Tunnel Film

Specially engineered to give you the results you need from a highly diffused greenhouse and high tunnel film.



www.berryglobal.com

Green-tek

Infra Red Film

Green-Tek® GT 4YR IRAC MAX 6M

New GT IRAC - MAX is the new versatile king of the market. IRTREATMENT: Preserves the sun's IR heat radiation at night. ANTI-CONDENSATE: Reduces/eliminates droplets and light stopping fog on the inside layer from forming. HIGH DIFFUSION: 75% diffusion! New feature spreads light throughout the canopy of your crop. More diffusion = less shadows!



24ft x 100ft
GRTK47-9000 Min. Buy 1RL

32ft x 100ft
GRTK47-9003 Min. Buy 1RL



Multi Year Film

Green-Tek® GT-4

GT4 is produced using advanced technology, resulting in a greenhouse film that is tough and clear long lasting greenhouse film.



Clear - 48ft x 125ft
GRTKGT448125 Min. Buy 1RL

Over Wintering Film

Green-Tek® Overwinter

GT Films offer traditional overwinter poly with protection with 1 season UV life. Offers UV resistance with 2.4 mil and 5.0 mil thickness available in Clear and White. Contact your BFG Sales Rep for custom length sizes and availability



24ft x 110ft
GRTK47-9949 Min. Buy 1ea

32ft x 100ft
GTOCL332100 Min. Buy 1ea

42ft x 100ft
GRTK47-9950 Min. Buy 1ea

42ft x 100ft
GTOCL342100 Min. Buy 1ea

42ft x 110ft
GRTK47-9951 Min. Buy 1ea

White - 24ft x 100ft
GRTK47-9948 Min. Buy 1ea



Check with your BFG rep for volume discounts and minimum order for prepaid freight.

Custom sizes are available

4ft (48in) and 6ft (72in) widths and up to 48ft lengths for all of these items.



GT1200 Unique laminated woven string construction prevents rips and tears. GT1200 can be custom welded to your wide specifications, up to 60 ft. wide. Especially useful for larger applications where the grower is concerned about regular polyfilm not standing up to punishment. Also used everyday on sidewalls, endwalls, and rollup curtains. Bring us your custom need!

GT1200



DESCRIPTION

GT-1200 is a 3-ply laminate combining two layers of linear low density polyethylene and a high-strength cord grid. It is specifically engineered to provide high strength and durability in a lightweight material.

PHYSICAL PROPERTIES AND TYPICAL VALUES

PROPERTY	ASTM TEST METHOD	U.S. VALUE	METRIC VALUE
Weight	D-751	38 LB/1000 FT ²	18.6 KG/100 M ²
3" Load @ Yield	D-882	92 LBF	409 N
3" Load @ Break	D-882	65 LBF	289 N
		3050 PSI	21 MPA
3" Elongation @ Break	D-882	450 %	450 %
Tongue Tear	D-2261	21 LBF	93 N
Trapezoidal Tear	D-4533	25 LBF	111 N
PPT Resistance	D-2582	31 LBF	138 N
Dart Impact Strength	D-1709	1.6 LBS	730 G
Cold Impact Strength	D-1790	-40°F	-40°C
Permeance	E-96	0.047 Grain/Hr•Ft ² •in.Hg	2.70 NG/(PA•S•M ²)

FEATURES AND BENEFITS

- Multiple layers and cord reinforcement resist punctures and tears.
- UV stabilization protects the material from degradation during extended exposure to sunlight.
- Cold-crack resistance eliminates failures in extremely cold temperatures.
- Low permeability greatly inhibits moisture transmission.
- Flexibility and light weight allow for easy handling and quick installation.
- Custom fabrication is available to meet your exact specifications.
- Long life expectancy allows for significant cost savings through reuse and fewer replacements.
- Class C, ASTM E-1745-11 Standard Specification for water vapor retarders used in contact with soil or granular fill under concrete slabs.





GT1210C Heavy Duty 6.7 oz. per sq. yard. Woven/Coated construction is tear resistant, even if cut! Ideal for sidewalls, endwalls, and roll-up curtains. Can be sewn to your specs with pipe hems, zippers, D-rings, grommets, and other fasteners. Commonly used on all types of structures, from cold frames and market stands to roll up curtains on the finest greenhouses.

GT1210C

DESCRIPTION

A premium coated fabric with enhanced UV protection for use in temporary garages, specialized covers, and other applications demanding superior performance.

FABRIC SPECIFICATIONS

Weave: Woven clear HDPE scrim
 Coating: 1.75 mil average both sides
 (42 g/m² average per side)
 Color: Clear or coloured coatings available
 Weight: 6.7 oz/yd² (227 g/m²) +/- 5 %

ROLL SPECIFICATIONS

Cores: 4 inch I.D. or 5 inch I.D. available
 Width: Up to 144 inches (-0, +0.5)
 as ordered
 Length: Minimum 500 yds/roll;
 up to 1000 yds/roll

These values are typical data and are not intended as limiting specifications.

PERFORMANCE PROPERTIES

The following data are typical values based on ASTM standard tests. This data should not be considered specification.

Grab Tensile ASTM D5034	Warp 260 lb, 1154 N / Weft 230 lb, 1021 N
Tongue Tear ASTM D2261	Warp 75 lb, 333 N / Weft 80 lb, 355 N
Mullen Burst ASTM D3786	460 psi / 3169 kPa
Accelerated UV Weathering¹ ASTM G151 ASTM G154	>80% strength retention after 2000 hrs exposure @ 0.77 W/m ² /nm, or 1200 hrs exposure @ 1.35 W/m ² /nm

¹ Q.U.V [A-340 Lamps]; 8 hrs UV @ 60°C; 4hrs condensation @ 50°C

Contact Your BFG Sales Representative for
MORE INFORMATION

***Green-Tek GT1210C is ideal for use in roll-up curtains.
 See page 592 for roll-up curtain kits.***

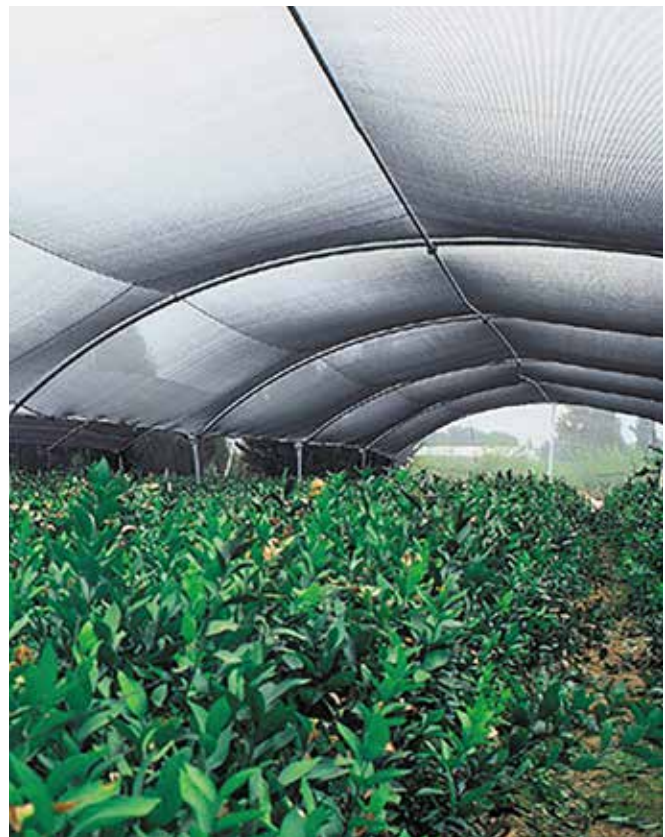



Infra Red Film

RKW Klerks K50 IR-AC Thermal Anti Condensate Film

Special IR additives absorb and re-radiate nighttime infrared heat back down to the crop, saving up to 15% on nighttime heating costs. High light diffusion means uniform plant growth and crop dry down times.

- Tri-layer extrusion with EVA copolymer resin for excellent durability
- Par light transmission of 88% through a single layer of K50 IRAC
- Two directional anti-condensate control means you never have to guess if the drip control side is facing the crop.
- Ultraviolet light stabilized for long life outdoor exposure
- Bee friendly film



6mil - White - 24ft x 150ft

KLK50IRAC624150 Min. Buy 1EA

6mil - White - 24ft x 200ft

KLK50IRAC624200 Min. Buy 1EA

6mil - White - 28ft x 100ft

KLK50IRAC628100 Min. Buy 1EA

6mil - White - 32ft x 100ft

KLK50IRAC632100 Min. Buy 1EA

6mil - White - 36ft x 150ft

KLK50IRAC636150 Min. Buy 1EA

6mil - White - 40ft x 100ft

KLK50IRAC640100 Min. Buy 1EA

6mil - White - 42ft x 100ft

KLK50IRAC642100 Min. Buy 1EA

6mil - White - 48ft x 100ft

KLK50IRAC648100 Min. Buy 1EA

Multi Year Film

RKW Klerks K50 Clear 6mil Film

(K50 - 50 Months Average Life). Tri-layer extrusion with strong EVA copolymer resin for excellent outdoor durability. 92% PAR light transmission per layer of film. Anti-dust additive that resist dirt and dust buildup. Ultraviolet light stabilized for long life outdoor exposure. Bee friendly film: Transmits a small portion of the ultraviolet light spectrum used in bee navigation.

- Tri-layer extrusion with EVA copolymer resin for excellent durability
- 92% Par light transmission per layer of film
- Anti-dust additive that resist dirt and dust buildup
- Ultraviolet light stabilized for long life outdoor exposure
- Bee friendly film



6mil - Clear - 24ft x 100ft

KL47-7001 Min. Buy 1RL

6mil - Clear - 24ft x 150ft

KL47-7006 Min. Buy 1RL

6mil - Clear - 28ft x 100ft

KL47-7021 Min. Buy 1RL

6mil - Clear - 28ft x 100ft

KLK50628150 Min. Buy 1RL

6mil - Clear - 32ft x 100ft

KL47-7000 Min. Buy 1RL

6mil - Clear - 32ft x 150ft

KL47-7000C Min. Buy 1RL

6mil - Clear - 36ft x 150ft

KL47-7031B Min. Buy 1RL

6mil - Clear - 40ft x 100ft

KL47-7041 Min. Buy 1RL

6mil - Clear - 40ft x 150ft

KLK50640150 Min. Buy 1RL

6mil - Clear - 42ft x 100ft

KL47-7055A Min. Buy 1RL

6mil - Clear - 48ft x 100ft

KL47-7061 Min. Buy 1RL

6mil - Clear - 48ft x 150ft

KL47-7061B Min. Buy 1RL



WARNING: This product is not available for sale in CA.
For most up to date information please visit bfgsupply.com

800-883-0234
www.bfgsupply.com



Multi Year Film

Poly-AG Sunview Film

Designed to transmit more light while maintaining superior mechanical properties. The total light transmission of the greenhouse covering is extremely important for photosynthetically active radiation, 400 - 700 nanometers. The intensity of these wave lengths in the PAR range directly influences the growth and development of the plants. These high-technology greenhouse films are based on the latest developments and technologies in the manufacturing process.

- 3-Layer extrusion
- Prime resin proprietary formulation
- 90% light transmission
- 25% light diffusion
- Dart impact (puncture) 900 grams



CLR 6M 32X100 4YR
PASV4CLR321001632 Min. Buy 1RL

CLR 6M 40X100 4YR
PASV4CLR401001640 Min. Buy 1RL

CLR 6M 40X150 4YR
PASV4CLR401501640 Min. Buy 1RL

CLR 6M 42X100 4YR
PASV4CLR421001642 Min. Buy 1RL

CLR 6M 48X100 4YR
PASV4CLR481001648 Min. Buy 1RL



Over Wintering Film

Poly-AG Sunview Overwintering Film - Clear

Greenhouse covering film has high mechanical properties to withstand maximum stress during installation.

- 3-Layer Extrusion
- Prime Resin Proprietary Formulation
- Superior Puncture Resistance
- Excellent Winter Weather Performance



CLR 3M 24X110
PASVOWC24110264 Min. Buy 1RL

CLR 3M 32X100
PASVOWC3210032 Min. Buy 1RL

CLR 3M 42X100
PASVOWC421001342 Min. Buy 1RL

CLR 4M 32X100
PASVOWC32100432 Min. Buy 1RL

Poly-AG Sunview Overwintering Film - White

Overwinter films are tri-layered and specifically formulated for optimum performance related to crop response. Developed to provide protection from harsh winter climates.

- 3-Layer Extrusion
- Prime Resin Proprietary Formulation
- Superior Puncture Resistance
- Excellent Winter Weather Performance



WHT 70PCT 3M 24X100
PASVOW241001324 Min. Buy 1RL

WHT 70PCT 3M 24X110
PASVOW241101324 Min. Buy 1RL

WHT 70PCT 3M 24X120
PASVOW241201324 Min. Buy 1RL

WHT 70PCT 3M 24X150
PASVOW241501324 Min. Buy 1RL

WHT 70PCT 3M 28X100
PASVOW281001328 Min. Buy 1RL

WHT 70PCT 3M 28X110
PASVOW281101328 Min. Buy 1RL

WHT 70PCT 3M 32X100
PASVOW321001332 Min. Buy 1RL

WHT 70PCT 3M 32X150
PASVOW321501332 Min. Buy 1RL

WHT 70PCT 3M 36X100
PASVOW361001336 Min. Buy 1RL

WHT 70PCT 3M 40X100
PASVOW401001340 Min. Buy 1RL

WHT 70PCT 3M 42X100
PASVOW421001342 Min. Buy 1RL



Covering Accessories

Horizontal Foam Closures

This foam strip for use in installation of corrugated polycarbonate sheeting. Sold by the each.



3FT

GRTK26-0812

Min. Buy 1EA



Vertical Foam Closures

This foam strip for use in installation of corrugated polycarbonate sheeting. Sold by the each.



3FT

GRTK26-1962

Min. Buy 1EA



Coverings Accessories

Ken-Bar® Inflation Kit

Inflation pressure between layers of double poly adds insulation without blocking sunlight and reduces condensation between the layers of poly. 148cfm.



Single Stack

KB26D02

Min. Buy 1EA

Double Stack

KB26D03

Min. Buy 1EA



Ken-Bar® Row Cover Support Wire

Use support wire to create low tunnels with slitted or punched row covers, or use wires to support floating row covers. Support hoops keep the row covers off of foliage, protecting plants from frost damage and providing them with better air movement. Pre-cut number 10 smooth galvanized wire in a bundle of 100 wires.



100/Bundle

KB05042-851

Min. Buy 1BD



GrowerSelect®

Coverings Accessories

Grower Select® Spring Lock Spring

Also referred to as wiggle wire, zippers, or zigzag wire. Works with aluminum spring lock base (GSS14498, Sold Separately) to lock single sheet of poly film down on the greenhouse.



6ft 6in - Sold by Bundle of 20

GSE09560

Min. Buy 1BD



Grower Select® Webbing Tape

Black webbed tape is used to hold poly tightly against the greenhouse frame. Prevents flopping of poly during high winds.



2-3/4in x 300ft

PAK234X300WEBBING

Min. Buy 1RL





Coverings Accessories

VIP® Poly Patch™ Tape

Poly Patch™ is a complete first-aid kit for greenhouses. This heavy duty tape temporarily repairs minor tears in polyethylene greenhouse film, and can be used as reinforcement in key areas subjected to extra stress. Designed for interior and exterior applications. This rugged patching tape with backing bonds aggressively to polyethylene film.



with Backing - 10in x 48ft

VIP1560L10X48 Min. Buy 1RL

with Backing - 2in x 48ft

VIP1560L2X48 Min. Buy 1RL

with Backing - 4 in x 48ft

VIP1560L4X48 Min. Buy 1RL

with Backing - 6in x 48ft

VIP1560L6X48 Min. Buy 1RL



without Backing - 2in x 108ft

VIP1460-2X108 Min. Buy 1RL

without Backing - 4in x 108ft

VIP1502X Min. Buy 1RL

without Backing - 6in x 108ft

VIP1460 6X108 Min. Buy 1RL



Green-tek

Poly Carbonate

Greentek Twinwall Clear Polycarbonate

ThermaGlas® multi-wall polycarbonate sheets offer high light transmission, maximum impact resistance, and superior insulation. This combination yields a strong, energy-efficient, and lightweight sheet that is optimum for greenhouse applications. ThermaGlas Plus products feature built-in condensation control so durable and effective it's warranted for 10 years. The result is higher light transmission and reduced moisture-related disease. ThermaGlas 8mm triple-wall polycarbonate offers excellent light transmission, while providing up to 60% more energy efficiency than glass, and 25% more efficiency than 8mm Twinwall acrylic.

- Weather and UV resistant
- Rigid, yet capable of cold-forming to an arch
- Easy to work with and install using ordinary tools
- Rigid, yet capable of cold-forming to an arch



8MM 71.25in x 9ft

GRTKTwin-71.259 Min. Buy 1PC

8MM 71.25in x 11ft

GRTKTwin-71.2511 Min. Buy 1PC

8MM 71.25in x 13ft

GRTKTwin-71.2513 Min. Buy 1PC

8MM 71.25in x 14ft

GRTKTwin-71.2514 Min. Buy 1PC

8mm 71.25in x 15ft

GRTKTwin-71.2515 Min. Buy 1ea

8mm 71.25in x 16ft

GRTKTwin-71.2516 Min. Buy 1ea

8MM 71.25in x 17ft

GRTKTwin-71.2517 Min. Buy 1PC

8MM 71.25in x 20ft

GRTKTwin-71.2520 Min. Buy 1PC

8MM 71.25in x 22ft

GRTKTwin-71.2522 Min. Buy 1PC

8MM 71.25in x 24ft

GRTKTwin-71.2524 Min. Buy 1PC



Poly Carbonate Accessories

Green-Tek® Aluminum Foil Tape

Used to seal the top of twinwall polycarbonate panels to keep out dust and moisture.



1in x 150ft

GRTK26-0823 Min. Buy 1ea





Shade Coverings

DeWitt® Woven Shade Cloth

DeWitt's® woven polypropylene shade cloth protects plants from direct sun and helps reduce water evaporation. Polypropylene shade cloth is ideal for greenhouses, outdoor display areas, or for use as a weed barrier for a variety of applications. Available in a wide range of shade percentages, Resists tearing, puncturing, and weed penetration. UV stabilized to hold up under the most extreme solar conditions.

- Shade Percentages: 30%, 47%, 55%, 63%, 73% and 80%
- Construction: Sewn, Double-Stitched 100% Black Polypropylene
- Applications: Greenhouse, Shade Structure, Nursery, Fish Ponds, Tarpaulin/Product, Containment, Windbreak, Nursery Stock Transport Covers

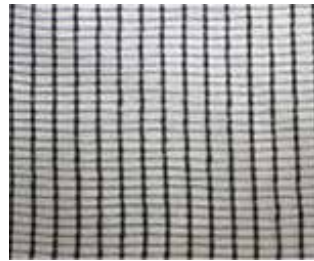

30%



55%



73%

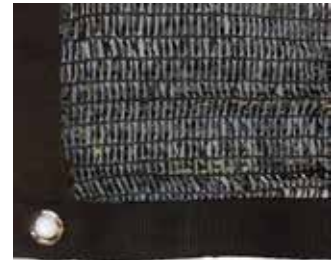

DeWitt shade cloth is available seamed, taped, and grommetted.

**Additional charges apply for orders under 1,000sf.
Please check with your BFG sales rep.**

Item #	Description	Standard Widths*	U/M	Barcode
DEWWS30	30% Black	10ft, 12ft	Square foot	
DEWWS55	55% Black	6ft, 10ft, 12ft, 15ft	Square foot	
DEWWS73	73% Black	4ft, 6ft, 7.5ft, 10ft, 12ft, 15ft	Square foot	
DEWWS80	80% Black	6ft, 10ft, 12ft, 15ft	Square foot	



WARNING: This product is not available for sale in CA. For most up to date information please visit bfgsupply.com

Green-tek

Shade Coverings



Greentek Woven Shade Cloth

Shade Rite Woven shade cloth from Green-Tek offers open lockstitch design for better ventilation and a reduction in wind speed and heat build-up in structures. Shade Rite is available cut-to-size with no minimums. Crop protection for UV and heat sensitive plants. Better ventilation and water permeable. Lightweight and easy to install. U.V. resistant, high density polyethylene. Chemical resistant: resists most horticultural chemicals, sprays, and detergents.



- | | | | |
|------------------------------------|--------------|------------------------------------|--------------|
| Black 30%
GRTK30PCTWSBLK | Min. Buy 1SF | Black 73%
GRTK73PCTWSBLK | Min. Buy 1SF |
| Black 47%
GRTK47PCTWSBLK | Min. Buy 1SF | Black 80%
GRTK80PCTWSBLK | Min. Buy 1SF |
| Black 55%
GRTK55PCTWSBLK | Min. Buy 1SF | Black 95%
GRTK95PCTWSBLK | Min. Buy 1SF |
| Black 63%
GRTK63PCTWSBLK | Min. Buy 1SF | | |

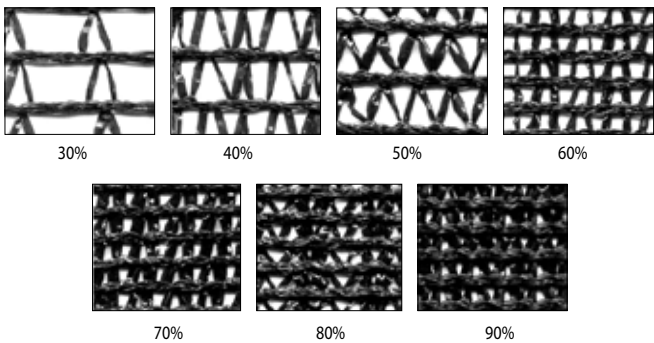

Green-Tek® Shade Rite - Knitted Black Shade Cloth

Shade Rite knitted shade cloth from Green-Tek offers open lockstitch design for better ventilation and a reduction in wind speed and heat buildup in structures. Shade Rite is available cut-to-size with no minimums. Crop protection for UV and heat sensitive plants. Better ventilation and water permeable. Lightweight and easy to install. U.V. resistant, high density polyethylene. Chemical resistant.



- | | | | |
|--|--------------|--|--------------|
| 30% Black by the Square Foot
GRTK30% BLACK | Min. Buy 1ea | 60% Black by the Square Foot
GRTK60% BLACK | Min. Buy 1ea |
| 40% Black by the Square Foot
GRTK40% BLACK | Min. Buy 1ea | 70% Black by the Square Foot
GRTK70% BLACK | Min. Buy 1ea |
| 50% Black by the Square Foot
GRTK50% BLACK | Min. Buy 1ea | 80% Black by the Square Foot
GRTK80% BLACK | Min. Buy 1ea |
| | | 90% Black by the Square Foot
GRTK90% BLACK | Min. Buy 1ea |

Green-Tek® Aluminet “Cool Shade” Shade Cloth

Aluminet is a high quality reflective metallized HDPE knitted screen used as a greenhouse thermal screen and as an alternative to black shade cloth.



- | | | | |
|---|--------------|---|--------------|
| 30% - Order by the Square Foot
GRTK30% ALUMINET | Min. Buy 1ea | 60% by the Square Foot
GRTK60% ALUMINET | Min. Buy 1ea |
| 50% by the Square Foot
GRTK50% ALUMINET | Min. Buy 1ea | 70% by the Square Foot
GRTK70% ALUMINET | Min. Buy 1ea |

Shade Covering Accessories

Greentek Plastic Nylon Grommets



- For Use with Knitted Shade Cloth**
GRTKPLASTIC GROMMET Min. Buy 1EA

Seam Charges

- | | | |
|-------------------------------------|--------------|--|
| Seaming Charge
GRTKE10300 | Min. Buy 1FT | |
| Taping Charge
GRTKE10320 | Min. Buy 1FT | |



Shade Coverings

Kool Ray® Classic Liquid Shade

Kool Ray is specifically designed to effectively lower the inside greenhouse temperatures during the peak growing season while allowing the growth wavelengths of light to pass through. KOOL RAY is a super concentrated formula designed to be diluted with water.

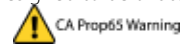

- | | |
|--|---------------|
| 1gal
C09-1316 1G | Min. Buy 1GL |
| 5gal
C09162105 | Min. Buy 15GL |
| 55gal (Special Order)
C09-1316 55G | Min. Buy 1DR |



X-Tra Stick Adhesive Additive

X-TRA Stick increases Kool Ray liquid shade's adhesion, wear, and overall life.



- | | |
|--------------------------------|--------------|
| 32oz (1 qt)
C0741231 | Min. Buy 1QT |
| 1gal
C0741231GL | Min. Buy 1GL |



Shade Coverings

Mardenkro® ReduClean® Shade Remover

ReduClean® removes all Mardenkro® shading coatings from glass, polycarbonate, and plastic film. It must be diluted with clean water before use in a ratio of 1 part ReduClean® to 7 parts water. Add ReduClean® to the water while stirring and Apply ReduClean® evenly to a dry greenhouse surface and allow it to soak in for at least 15 minutes before brushing.



20L Pail - HAZARDOUS
MARDREDCLEAN Min. Buy 1EA



Mardenkro® ReduHeat® Shading Coating

ReduHeat sets itself apart from other, more traditional shading agents due to its different ratio between light transmission and heat reflection. It is a coating that contains a special pigment which has the ability to transmit growth light (PAR) while increasing the reflection of heat radiation (NIR). Another major advantage of ReduHeat is the adjustable shading effect



15kg Pail
MARD29-1069 Min. Buy 1EA



Mardenkro® ReduSol® Shading Coating

ReduSol has been specifically developed for applications where the coat of whitewash applied to the greenhouse must last for a whole season. It provides an attractive white, even shading coat which can be easily removed using ReduClean at the end of the season. ReduSol is exceptionally resistant to the effects of frost and rain, and is UV stabilized.



20kg Pail
MARDREDUSOL Min. Buy 1EA



ALSO AVAILABLE

Mardenkro® Eclipse®

Eclipse® F4 is a removable white shading agent for greenhouse applications. Eclipse F4 protects crops against too much heat and light throughout the season and can be applied on the outside of all standard greenhouse materials.



Contact Your BFG Sales Representative for
MORE INFORMATION

Insect Screen

No Thrip Insect Screen

The most exclusive screen available, with a hole size of only 150 microns. Tough monofilament construction can be fabricated in any size.



75 Mesh
GRTKNO THRIP Min. Buy 1SF



Grower Select®

Ground Cover

Grower Select® Deluxe Ground Cover

Premium 22 x 11 fine weave with tucked and woven edges. Resists tearing, puncturing and weed penetration. It is approved for most government weed control applications. Ideal for greenhouses, outdoor displays and as a weed barrier for plantings without topical coverings where a weed-free environment is a must. Striped every 12in to aid in plant alignment and is UV stabilized to last even in direct sunlight.



- 3ft x 300ft - 3.2oz**
GSSBLT3300D Min. Buy 1ea
- 4ft x 300ft - 3.2oz**
GSSBLT4300D Min. Buy 1ea
- 6ft x 300ft - 3.2oz**
GSSBLT6300D Min. Buy 1ea
- 10ft x 300ft - 3.2oz**
GSSBLT10300D Min. Buy 1ea
- 12ft x 300ft - 3.2oz**
GSSBLT12300D Min. Buy 1ea
- 15.5ft x 300ft - 3.2oz**
GSSBLT155300D Min. Buy 1ea



Wire 8x1 8 Gauge Ground Staple Bright 500/BX

Garden staples are versatile tools that hold down outdoor fabrics like polypropylene ground cover and materials like irrigation tape, chicken wire, synthetic grass mats, and more. They are 8in L and stiff enough to hold fabric in place through heavy rains and winter freezes.



500ct - 8in x 1in
WIREP29-0028B Min. Buy 1BX





Covering Accessories

DeWitt® Deluxe Overwinter Fabric - 0.5oz

This 0.5oz fabric keeps temperatures up to 4° higher than outside conditions and creates an excellent microenvironment for seed germination and seedling growth. In fact, this fabric provides 90%-95% average seed germination compared to 60%-65% with straw.



7ft x 500ft

DEWDELUXE7 Min. Buy 1ea

12ft x 1000ft

DEWDELUXE12-1 Min. Buy 1ea



DeWitt® Deluxe Plus Overwinter Fabric - 1.0oz

This 1.0oz fabric protects vegetation from frost by raising temperatures beneath the fabric by 4° to 6°. In addition to providing protection against cold, wind, birds, insects, and scorching sun, Deluxe Plus helps produce larger, earlier and more bountiful yields.



12ft x 1000ft

DEWDELUXEPLUS12 Min. Buy 1ea



DeWitt® Supreme Crop Cover - 1.5oz

This 1.5oz fabric is ideal for protecting flowering annuals, bedding plants and vegetables from severe cold and freezing. Temperatures underneath the fabric are 6° to 8° warmer than outside conditions. Lengthen harvest time and extend your flowering season.



6ft x 500ft

DEWSUPREME6 Min. Buy 1ea



DeWitt® Ultimate Winter Crop Cover - 2.5oz

This ultimate 2.5oz fabric provides freeze protection or greater plant protection during extreme conditions. Durable and effective for "all winter" protection of your perennials and other ornamentals. Designed to hold in heat and allow irrigation and rain to pass through, this fabric will not cause foliage burn even on sunny days.



3ft x 250ft

DEWULTIMATE3 Min. Buy 1ea

6ft x 250ft

DEWULTIMATE6 Min. Buy 1ea

12ft x 250ft

DEWULTIMATE12 Min. Buy 1ea



See Page 383 for More Information





Shading systems

We specialize in all kind of shading systems. Utilizing our professional, able and experienced staff to completes each project to the highest standard of satisfaction. Each project must be handled with the highest degree of skill and flexibility during production and installation from start to finish.

What we have to offer:

- Tailor-made systems
- Energy-saving systems
- Singular, double and multiple installations
- Two installations on one wire bed

- Shading systems
- Roll-Screens
- Slope flat slope type installations
- Outdoor installations
- Black-out systems
- Twin-roll screens
- Roof-roll screens



We differentiate ourselves with:

- Long Life Span Products
- Great Services
- Professional horticultural solutions



1100 Foster Ave. Kalamazoo, MI 49048
arie@luitenshading.com www.luitenshading.com





Green.tek

WE HAVE YOU COVERED.

- ✔ **Shade Cloths**
- ✔ **Polycarbonate Sheets**
- ✔ **Aluminet**
- ✔ **Polyethylene Films**
- ✔ **Greenhouse Accessories**

CONTAINERS



Grower Select®

Pots & Carry Trays

Grower Select® Round Co-Extruded Standard Pot

Standard round co-extruded pot, economical for the greenhouse. Sturdy pots to fit grower needs, including a dark inner lining to protect plant roots. Custom fit to be a perfect match to our carry trays.



Product	Color	Depth	Outside Diam	Max Liquid Volume	Case Qty	Barcode
RIPHSP400BLK	Black	3.5in	4in	1pt	1900	
RIPHSP500BLK	Black	3.63in	5in	1.75pt	1120	
RIPHSP433BLK1850	Black	3.75in	4.33in	1.25pt	1850	
RIPHSP433WBLK	Black	3.75in	4.33in	1.3pt	1800	
RIPHSP600BLK	Black	4.5in	6in	1.5qt	660	
RIPHSP400TC	Terra Cotta	3.5in	4in	1pt	1900	
RIPHSP433WTC	Terra Cotta	3.75in	4.33in	1.3pt	1800	
RIPHSP433TC1850	Terra Cotta	3.75in	4.33in	1.25pt	1850	
RIPHSP500TC	Terra Cotta	3.63in	5in	1.75pt	1120	
RIPHSP600TC	Terra Cotta	4.5in	6in	1.5qt	660	

Grower Select® Square Co-Extruded Standard Pot

Standard thermoformed (vacuum formed) pot, economical for the greenhouse. Sturdy pots to fit grower needs. Square pots maximize bench and cart space. Custom fit to be a perfect match to the carry trays.



Product	Color	Depth	Outside Diam	Max Liquid Volume	Case Qty	Barcode
RIPHSCP350	Black	3.5in	3.5in	1.08pt	684	
RIPHSCP450	Black	3.62in	4.2in	1.25pt	450	
RIPHSCP450D	Black	4.91in	4.2in	1.72qt	420	



Pots & Carry Trays

Grower Select® Transport Trays

Holds pots upright on benches. Makes it easy to move the smaller pots without tipping within the greenhouse. Thermoformed plastic construction.

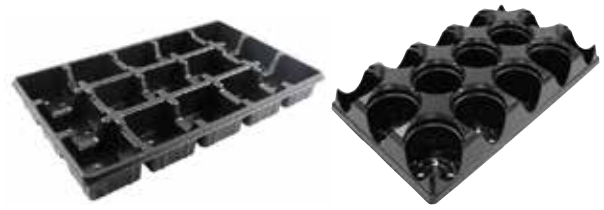

Product	Holds	Length	Width	Depth	Case Qty	Barcode
RIPHST35018	18 Square Pots	21.25in	10.83in	1.97in	110	
RIPHST45015	15 Square Pots	20.86in	12.4in	2.36in	70	
RIPHST350-12TSCS	12 Round Pots	21.25in	7in	3.625in	90	
RIPHST433W-10CS	10 Round Pots	21.63in	8.63in	3.78in	75	
RIPHST433-10CS	10 Round Pots	21.75in	8.675in	3.75in	100	
RIPHST433-15C	15 Round Pots	21.8in	12.38in	4.33in	90	
RIPHST400-15CS	15 Round Pots	20in	12in	3.625in	70	
RIPHST400-10CS	10 Round Pots	20in	8in	3.625in	75	
RIPHST500-8CS	8 Round Pots	19.63in	9.63in	4in	90	
RIPHST600-6CS	6 Round Pots	18in	12in	4.6in	100	

Propagation & Plug Trays

Grower Select® Plug Trays

Features a glossy finish for easy dislodging of your plugs. Standard tray size of 21.25in L x 11in W.



Product	Cells	Length	Width	Depth	Max Liquid Volume	Case Qty	Barcode
BUMS50/135/100	50 Square	21.25in	11in	1.81in	73CC	100	
BUMS72/135/100	72 Square	21.25in	11in	1.97in	34CC	100	
BUMS105/135/100	105 Square	21.25in	11in	1.9in	30CC	100	
BUMS128/165/100	128 Square	21.25in	11in	1.625in	17.5CC	100	
BUMS288CE-165/100	288CE Square	21.25in	11in	1.32in	7.4CC	100	
BUMS512CE-165/80	512CE Square	21.25in	11in	1.02in	3.4CC	80	

Grower Select®

Nursery Containers

Grower Select® Nursery Pot

Nursery pots are great for use indoors or outdoors and they can be cleaned and re-used again and again. These blow-molded pots are heavyweight and offer exceptional durability, strength and value.



Product	Color	Depth	Outside Diam	Max Liquid Volume	Case Qty	Barcode
GSNB001	Black	6.69in	6.49in	.79gal	50	
GSNB002S	Black	8.66in	8.66in	1.78gal	45	
GSNB003N	Black	9.84in	10.63in	3gal	25	
GSNB003	Black	9.84in	11.02in	3.37gal	25	

Mum Pans

Grower Select® Coex Mum Pan

Standard round co-extruded pot, economical for the greenhouse. Sturdy pots to fit grower needs, including a dark inner lining to protect plant roots. Custom fit to be a perfect match to our carry trays.



Product	Color	Depth	Outside Diam	Max Liquid Volume	Case Qty	PL Qty	Barcode
RIPHSP800BK	Black	5in	8in	2.78qt	300		
RIPHSP800BKPL	Black	5in	8in	2.78qt		3220	
RIPHSP900BK	Black	6.25in	9in	1.26gal	240		
RIPHSP900BKPL	Black	6.25in	9in	1.26gal		2760	
RIPHSP800TC	Terra Cotta	5in	8in	2.78qt	300		
RIPHSP800TCPL	Terra Cotta	5in	8in	2.78qt		3220	
RIPHSP900TC	Terra Cotta	6.25in	9in	1.26gal	240		
RIPHSP900TCPL	Terra Cotta	6.25in	9in	1.26gal		2760	



Grower Select®

Hanging Baskets

Grower Select® Dixie Hanging Basket

Decorative hanging baskets coordinate with Dixie Planters, allowing for eye-catching style at multiple levels. Hanging baskets include plastic hanger and cap dish.



Product	Color	Depth	Outside Diam	Max Liquid Volume	Case Qty	Barcode
GS12HBDIXI13	Red Brown Drip	11.97in	6.69in	1.6gal	36	
GS12HBDIXI27	Red Light Blue Drip	11.97in	6.69in	1.6gal	36	
GS12HBDIXI35	Red Green Drip	11.97in	6.69in	1.6gal	36	
GS12HBDIXI23	Red Royal Blue Drip	11.97in	6.69in	1.6gal	36	

Grower Select® Dune Hanging Basket

Elegant wave pattern mimics the natural lines of dune sand on these planters. Hanger is included.



Brushed Champagne - 12in D x 6.7in H
Max Liquid Volume: 2.06gal
GSHG821HBG Min. Buy 1CS/50EA

Warm Copper - 12in D x 6.7in H
Max Liquid Volume: 2.06gal
GSHG821HWC Min. Buy 1CS/50EA



Grower Select® Boxwood Hanging Basket

Decorative boxwood pattern is molded into the outer design of this hanging basket. Includes a coordinating hanger.



Aged Cappuccino - 12in D x 6.6in H
Max Liquid Volume: 2.17gal
GSHG787FAC Min. Buy 1CS/50EA

Mahogany - 12in D x 6.6in H
Max Liquid Volume: 2.17gal
GSHG787FMA Min. Buy 1CS/50EA



Grower Select® Laci Hanging Basket

Attractive, vintage looking pot. Great for flowering plants. The Laci Collection is available in both bowls and hanging baskets. Includes a coordinating hanger.



Aged Cappuccino - 12.39in D x 6.72in H
Max Liquid Volume: 2.0gal
GSLACEY 2 HB AGED CAPP Min. Buy 1CS/36EA

Black/Cappuccino - 12.39in D x 6.72in H
Max Liquid Volume: 2gal
GSLACEY 2 HB CAP/BLK Min. Buy 1CS/36EA



Grower Select® Delta Hanging Basket

Traditional hanging basket with a smooth design.



White - 13in D x 7.6in H
Max Liquid Volume: 2.8gal
GSGGX1168HWH Min. Buy 1CS/34EA



Grower Select® Bella Hanging Basket

Lightweight, durable plastic hanging basket



Green - 6in Diam x 4.4in H
Max Liquid Volume : 0.3gal
GSHGX088X Min. Buy 1CS/46EA



Grower Select® Seneca Planter

Decorative Seneca collection



White - 13in D x 8in H - Max Liquid Volume: 3.4gal
GSHG1239CWH Min. Buy 1CS/63EA



WARNING: This product is not available for sale in CA. For most up to date information please visit bfgsupply.com

800-883-0234
www.bfgsupply.com

Grower Select®

Hanging Baskets

Grower Select® Serenity Hanging Basket

Perfect for cascading flowers and plants in your greenhouse! With a ribbed design and choice of colors, the Serenity hanging basket looks great in every setting. Includes a coordinating hanger.



Product	Color	Depth	Outside Diam	Max Liquid Volume	Case Qty	Barcode
GSLF1119GOLD	Black/Gold	6.5in	11in	1.58gal	72	
GSLF1119SILVER	Black/Silver	6.5in	11in	1.58gal	72	
GSLF1119CHOC	Chocolate	6.5in	11in	1.58gal	72	
GSLF1119MO	Mocha	6.5in	11in	1.58gal	72	

Grower Select® Combo Pot

A great pot that has the versatility to be used as a patio pot or a hanging basket! Hanger sold separately.



Product	Color	Depth	Outside Diam	Max Liquid Volume	Case Qty	Compatible Items	Barcode
GS792000BR	Brown	6.75in	10.5in	1.68gal	50	HZP3E103, HZP3E100 HZS.L170, HZS.L210	
GS792000TC	Clay	6.75in	10.5in	1.68gal	50	HZP3E103, HZP3E100 HZS.L170, HZS.L210	
GS792000GR	Green	6.75in	10.5in	1.68gal	50	HZP3E103, HZP3E100 HZS.L170, HZS.L210	
GS792000BK	Black	6.75in	10.5in	1.68gal	50	HZP3E103, HZP3E100 HZS.L170, HZS.L210	
GS792000MO	Mocha	6.75in	10.5in	1.68gal	50	HZP3E103, HZP3E100 HZS.L170, HZS.L210	
GS792000WH	White	6.75in	10.5in	1.68gal	50	HZP3E103, HZP3E100 HZS.L170, HZS.L210	

Grower Select® Zealand Hanging Basket



Cool Gray - 11.0in D x 6.34in H
Max Liquid Volume : 1.55gal

GSTZ4453 Min. Buy 1CS/50EA



GrowerSelect®

Hanging Baskets

Grower Select® Twist Hanging Basket

Simple twist hanging basket. (Cap dish and hanger sold separately on Bulk Baskets)



Product	Color	Depth	Outside Diam	Max Liquid Volume	Case Qty	Compatible Items	Barcode
GSHB1201BLK	Black	7.24in	11.85in	2.32gal	50		
GSHB1201BLKPL Bulk	Black	7.24in	11.85in	2.32gal	1932/pl		
GSHB1201GRN	Green	7.24in	11.85in	2.32gal	50		
GSHB1201GRNPL Bulk	Green	7.24in	11.85in	2.32gal	1932/pl		
GSHB1201MO	Mocha	7.24in	11.85in	2.32gal	50		
GSHB1201MOPL Bulk	Mocha	7.24in	11.85in	2.32gal	1932/pl		
GSHB1201WHT	White	7.24in	11.85in	2.32gal	50		
GSHB1201WHTPL Bulk	White	7.24in	11.85in	2.32gal	1932/pl		
GSHB1201BRN	Brown	7.24in	11.85in	2.32gal	50		

Grower Select® 4 Strand Hanger

For use with Twist Hanging Basket



Mocha - 22.3in L

GSHG1200MO300CS Min. Buy 1CS/300EA

Grower Select® 4 Strand Hanger

For use with Twist Hanging Basket



White - 22.3in L

GSHG1200WHT300CS Min. Buy 1CS/300EA

Grower Select® Saucer Cap Dish

For use with Twist Hanging Basket



Black - Cap Dish

GSSAUC7400CS Min. Buy 1CS/400EA



Grower Select® Lattice Hanging Basket

Grape leaves line the top and lattice work adorns this planter. An elegant solution for planting combos.



Black/Gold Brush - 14.2in D x 7.9in H
Max Liquid Volume: 2.7gal

STPCF075844 Min. Buy 1CS/50EA



Grower Select® Lattice Hanging Basket

Includes an 18in 4-strand hanger.



Black/Gold Brush - 12in D x 7in H
Max Liquid Volume: 2gal

STPCF023272 Min. Buy 1CS/50EA



Grower Select® Lattice Hanging Basket

Includes an 18in 4-strand hanger.



Black/Gold Brush - 14.2in D x 7.9in H
Max Liquid Volume: 2.7gal

STPCF036463 Min. Buy 1CS/50EA



WARNING: This product is not available for sale in CA.
For most up to date information please visit bfgsupply.com

800-883-0234
www.bfgsupply.com

GrowerSelect®

Hanging Baskets

Grower Select® Tampa Hanging Planter

Lightweight planters, made from recycled plastic.



Eggnog - 12.1in D x 7.7in H
Max Liquid Volume: 2.5gal

STPCF088530 Min. Buy 1CS/36EA



Grower Select® Weave Hanging Basket

Decorative weave pattern is molded into the outer design of this collection. Available as coordinating Low Profile Square Planter, Round Planter and Hanging Basket. Includes coordinating hanger.



Chestnut Brown - 12in Diam x 6.7in H
Max Liquid Volume: 3.91gal

GSHG317HCT Min. Buy 1CS/50EA



Grower Select® Wicker Hanging Basket

Molded wicker design will help this basket stand out from the rest. Includes a coordinating hanger.



Aged Cappuccino - 12in D x 6.69in H
Max Liquid Volume: 2.62gal
GSHG931HAC Min. Buy 1CS/50EA

Chestnut Brown - 12in D x 6.69in H
Max Liquid Volume: 2.62gal
GSHG931HCT Min. Buy 1CS/50EA



Grower Select® Bushel Hanging Basket

Designed to look like wood, but with the durability of plastic. Includes a coordinating hanger.



Tan With Brown Wash - 10in D x 6in H
Max Liquid Volume: 1.19gal
STPCF036500 Min. Buy 1CS/24EA



Grower Select® Flat Bottom Hanging Basket

Rust-resistant, powder coated finish. For indoor or outdoor use. Features a sewn-in poly liner to retain soil moisture and includes a coco liner and wire hanger.



Black - 12in
SSCC41712BK Min. Buy 1CS/25EA

Green - 12in
SSCC41712HG Min. Buy 1CS/25EA

White - 12in
SSCC41712WH Min. Buy 1CS/25EA



Black - 14in
SSCC41814BK Min. Buy 1CS/25EA

Green - 14in
SSCC41814HG Min. Buy 1CS/25EA

White - 14in
SSCC41814WH Min. Buy 1CS/25EA



Black - 16in
SSCC41916BK Min. Buy 1CS/25EA

Green - 16in
SSCC41916HG Min. Buy 1CS/25EA

White - 16in
SSCC41916WH Min. Buy 1CS/25EA



Hanging Baskets

Grower Select® Hanging Basket

Plastic lined for water retention. Comes with wire hanger.



Sphagnum Moss - 14in

GS14MB Min. Buy 1CS/22EA

Sphagnum Moss - 16in

GS16MB Min. Buy 1CS/16EA

Sphagnum Moss - 18in

GS18MB Min. Buy 1CS/12EA

Sphagnum Moss - 24in

GS24MB Min. Buy 1CS/7EA



Grower Select® Grass Hanging Basket

Wire frame wrapped with natural grass. Includes plastic liner, wire hanger and wire stand.



12in Round Cone

GSRA6971 Min. Buy 1CS/20EA

14in Square Cone

GSRA6970 Min. Buy 1CS/20EA



Grower Select® Wire Hanger

Rigid wire hangers works with a variety of hanging baskets.



Black - 20in - 3-Strand

GSGS203BK Min. Buy 1 EA

Green - 20in - 3-Strand

GSGS203GN Min. Buy 1 EA

White - 20in - 3-Strand

GSGS203WH Min. Buy 1 EA

Grower Select® Cone Hanging Basket

Rust-resistant, powder coated finish. For indoor or outdoor use. Features a sewn-in poly liner to retain soil moisture and includes a coco liner and wire hanger.



Black - 12in W x 17in H

SSCHB17B Min. Buy 1CS/12EA



Grower Select® 4 Strand Hanger For Twist Hanging Basket

Plastic hanger to add to pot for versatility.



Green - 22.3in L

GSHG1200GRN300CS Min. Buy 1CS/300EA



Grower Select® Wire Hanger

Rigid wire hangers works with a variety of hanging baskets.



Black - 20in - 4-Strand

GSGS204BK Min. Buy 1 EA

Green - 20in - 4-Strand

GSGS204GN Min. Buy 1 EA

White - 20in - 4-Strand

GSGS204WH Min. Buy 1 EA



WARNING: This product is not available for sale in CA. For most up to date information please visit bfgsupply.com

Grower Select®

Hanging Baskets



Grower Select® 4 Sure Wire S-Hook

For Sure Wire Hooks are galvanized coated, and made of 10-gauge (0.135in diam.) wire. Can be used for many things including hanging baskets and extension hooks. Hooks are packaged 25 per bundle.



6in 4SW35-0050	Min. Buy 1PK/25EA
12in 4SW35-0052	Min. Buy 1PK/25EA
15in 4SW35-0053	Min. Buy 1PK/25EA
18in 4SW35-0054	Min. Buy 1PK/25EA
20in 4SW35-0055	Min. Buy 1PK/25EA
24in 4SW35-0056	Min. Buy 1PK/25EA
36in 4SW35-0059	Min. Buy 1PK/25EA
48in 4SW35-0059A	Min. Buy 1PK/25EA



Not available for sale in CA

Decorative Planters

Grower Select® Adriana

Contemporary cover pot great for use with mum pan drop ins.



Aged Cappuccino - 7.793in D x 6.269in H
Max Liquid Volume: 0.9gal
GSTZ-061CAP Min. Buy 1CS/80EA



Grower Select® Alex Bowl

Subtle yet stylish describes the Alex Bowl, with beautiful detailing that will complement any decor, indoors or out. Durable and lightweight molded polypropylene.



Black/Bronze Wash - 12in D x 4.2in H
Max Liquid Volume: 1.2gal
GSb-Alex12 Bowl CASES Min. Buy 1CS/70EA



Grower Select® Alex Pot

Subtle yet stylish describes the Alex bowl, with beautiful detailing that will compliment any decor, indoors or out. Durable and lightweight polypropylene.



Black/Bronze Wash - 13.5in D x 9in H
Max Liquid Volume: 3.3gal
GSRALEX135 Min. Buy 1CS/30EA



Grower Select® Anaheim Square Planter

Lightweight, durable plastic planter



Antique Slate - 14.5in Diam x 12.0in H
Max Liquid Volume : 6.7gal
GSTSD1716D Min. Buy 1CS/15EA



Grower Select® Anaheim Urn

Lightweight, durable plastic urn



Antique Slate - 13.8in Diam x 15.5in H
Max Liquid Volume : 4.1gal
GSTDU1716H Min. Buy 1CS/7EA



Grower Select® Anaheim Window Box

Lightweight, durable plastic window box



Antique Slate - 20in L x 10in W x 9in H
Max Liquid Volume : 5.4gal
GSTWB1716H Min. Buy 1CS/24EA



Grower Select® Barrel Planter

Wood-look planter with the durability of plastic.



Black/Silver Wash - 16.7in D x 12.09in H
Max Liquid Volume: 6.82gal
GSct430m R-B 16.7BARREL Min. Buy 1CS/25EA





Decorative Planters

Grower Select® Beth Planter

The Beth Planters feature an artsy, modern pattern, rolled rim and washed finish. These durable planters will look great inside or out on a patio, showcasing your favorite plants.

Product	Color	Depth	Outside Diam	Max Liquid Volume	Case Qty	Barcode
GSLF11012GOL	Gold Wash	10.24in	13.11in	3.04gal	24	
GSLF11012GOLBULK	Gold Wash	10.24in	13.11in	3.04gal	2090/pl	
GSLF11012RED	Red Wash	10.24in	13.11in	3.04gal	24	
GSLF11012REDBULK	Red Wash	10.24in	13.11in	3.04gal	2090/pl	
GSLF11012SIL	Silver Wash	10.24in	13.11in	3.04gal	24	
GSLF11012SILBULK	Silver Wash	10.24in	13.11in	3.04gal	2090/pl	
GSLF11012COP	Copper Wash	10.24in	13.11in	3.04gal	24	

Grower Select® Ashbridges Planter

Textured pattern molded into the lightweight plastic planter. Features tagslots.



Chestnut - 12.0in D x 9.6in H

Max Liquid Volume: 3.0gal

GSDP1416HBCT Min. Buy 1CS/31EA

Powdered Taupe - 12.0in D x 9.6in H

Max Liquid Volume: 3.0gal

GSDP1416HDTP Min. Buy 1CS/31EA

Shaded Greystone - 12.0in Diam x 9.6in H

Max Liquid Volume: 3.0gal

GSDP1416HSGT Min. Buy 1CS/31EA



Grower Select® Beth Rope Handle Bushel Basket

The look of wood with the durability of plastic! Large bushel basket with decorative rope handles. Sold in cases of 20.



Aged Cappuccino - 14in D x 11.36in H

Max Liquid Volume: 5.1gal

GSTZ-252CAP Min. Buy 1CS/20EA



Grower Select® Birch Oval Planter

The birch oval planter collection offer a unique shape and finish. These planters are lightweight for easy handling. Weather-resistant to withstand outdoor elements. Durable design is built to last and supports a wide variety of plant types.



Birch - 16in D x 6.5in H

Max Liquid Volume: 2.5gal

GSRB1371C Min. Buy 1CS/24EA

White - 12in D x 5.5in H

Max Liquid Volume: 1.2gal

GSRB1371H Min. Buy 1CS/24EA



Grower Select® Birch Planter

Poly planter with a finish that resembles birch bark. Perfect for creating that natural look at a cabin or cottage.



White - 14in D x 11.7in H

Max Liquid Volume: 4.79gal

GSDP1371D Min. Buy 1CS/26EA



Grower Select® Brenda Pot

Basket weaving makes this pot stand apart from the pack.



Brown - 11.5in D x 9.7in H

Max Liquid Volume: 2.5gal

GSTZ-080 BRENDA CASE Min. Buy 1CS/46EA



WARNING: This product is not available for sale in CA. For most up to date information please visit bfgsupply.com

Grower Select®



Decorative Planters

Grower Select® Calabria Grapevine Pot

Calabria Grapevine Pots are beautifully detailed with a raised grapevine design on the outside of the pot. Lightweight polypropylene plastic makes these pots weather resistant and durable for use indoors or outdoors.

Product	Color	Depth	Outside Diam	Max Liquid Volume	Case Qty	Barcode
GSGP0502BLK	Black	16in	21in	12gal	1	
GSGP0502-735	Blue Wash/Black	16in	21in	12gal	1	
GSGP0502-744	Bronze Wash/Black	16in	21in	12gal	1	
GSGP0502-742	Gold Wash/Black	16in	21in	12gal	1	
GSGP0502-0737	Red Wash/Black	16in	21in	12gal	1	
GSGP0502 - TERRACOTTA	Terra Cotta	16in	21in	12gal	1	
GSGP0501735	Blue Wash/Black	18.11in	18.11in	10.3gal	1	
GSGP0501744	Bronze Wash/Black	18.11in	18.11in	10.3gal	1	
GSGP0501742	Gold Wash/Black	18.11in	18.11in	10.3gal	1	
GSGP05010737	Red Wash/Black	18.11in	18.11in	10.3gal	1	

Grower Select® Cask Planter

Enjoy the the traditional look of wood these durable plastic planters offer, without the weight! Multiple sizes and colors to enhance any landscape.



Product	Color	Depth	Outside Diam	Max Liquid Volume	Case Qty	Barcode
GSDP1094MACP	Aged Cappuccino	6.6in	9.8in	1.58gal	35	
GSDP1094MCT	Chestnut Brown	6.6in	9.8in	1.58gal	35	
GSDP1094KACP	Aged Cappuccino	8in	11.8in	2.3gal	25	
GSDP1094KCT	Chestnut Brown	8in	11.8in	2.3gal	25	
GSDP1094DACP	Aged Cappuccino	11in	15.7in	3.83gal	25	
GSDP1094DCT	Chestnut Brown	11in	15.7in	3.83gal	25	



Decorative Planters



Grower Select® Castella Planter

Traditional design in a lightweight, durable plastic planter.

Product	Color	Depth	Outside Diam	Max Liquid Volume	Case Qty	Barcode
GSPN099AAB	Aged Black	12.6in	17.3in	7gal	29	
GSPN099AAC	Aged Cappuccino	12.6in	17.3in	7gal	29	
GSPN099ABG	Brushed Champagne	12.6in	17.3in	7gal	29	
GSPN099AAAB	Aged Black	15in	21in	12.6gal	15	
GSPN099AAAC	Aged Cappuccino	15in	21in	12.6gal	15	
GSPN099AABG	Brushed Champagne	15in	21in	12.6gal	15	
GSPN099AAGS	Galvanized Look	15in	21in	12.6gal	15	

Grower Select® Cromarty Planter

Lightweight planters, made from recycled plastic.



Black/Silver - 12.00in D x 9.8in H

Max Liquid Volume: 3.1gal

GSCF087908 Min. Buy 1CS/16EA

Black/Gold Brush - 12.00in D x 9.8in H

Max Liquid Volume: 3.1gal

GSCF087885 Min. Buy 1CS/16EA



Grower Select® Deb Lattice Pot

Distinctive lattice design sets this tough polypropylene pot apart.



Black/Silver Wash - 11.8in D x 9.5in H

Max Liquid Volume: 2.5gal

GSTZ-031 CASES Min. Buy 1CS/40EA



Grower Select® Decorative Round Trio Planter

Lightweight planters, made from recycled plastic. Feature a classic, round-shaped design and an antique wash finish that is fade resistant.



Aged Black - 13in D x 9.5in H

Max Liquid Volume: 2.9gal

GS11301301-AGED BLK Min. Buy 1CS/36EA

Aged Terra Cotta - 13in D x 9.5in H

Max Liquid Volume: 2.9gal

GS11301301-AGED TC Min. Buy 1CS/36EA

Gold Wash - 13in Diam x 9.5in H

Max Liquid Volume: 2.9gal

STPCF036470 Min. Buy 1CS/36EA



Grower Select® Diane Pot

Features raised drainage. Great for mums.



Aged Cappuccino - 11in D x 7.17in H

Max Liquid Volume: 2.0gal

GSDiane TZ-071 Min. Buy 1CS/60EA



Grower Select®

Decorative Planters

Grower Select® Dixie Planter

The stylish drip design of the Dixie Planter is perfect for adding a pop of color! Available in multiple sizes and colors for all your planting needs. Coordinates with the Dixie Hanging Planter.



Product	Color	Depth	Outside Diam	Max Liquid Volume	Case Qty	Barcode
GS4.35DIXI3533QT23	Red Royal Blue Drip	5.75in	8.5in	4.35qt	40	[Barcode]
GS4.35DIXI3533QT13	Red Brown Drip	5.75in	8.5in	4.35qt	40	
GS4.35DIXI3535QT35	Red Green Drip	5.75in	8.5in	4.35qt	40	
GS4.35DIXI3533QT27	Red Light Blue Drip	5.75in	8.5in	4.35qt	40	
GS2.23GDIXIE23	Red Royal Blue Drip	7.125in	11in	2.23gal	40	[Barcode]
GS2.23GDIXIE13	Red Brown Drip	7.125in	11in	2.23gal	40	
GS2.23GDIXIE35	Red Green Drip	7.125in	11in	2.23gal	40	
GS2.23GDIXIE27	Red Light Blue Drip	7.125in	11in	2.23gal	40	
GS4.13GDIXI23	Red Royal Blue Drip	10.47in	13.07in	4.13gal	36	[Barcode]
GS4.13GDIXI13	Red Brown Drip	10.47in	13.07in	4.13gal	36	
GS4.13GDIXI35	Red Green Drip	10.47in	13.07in	4.13gal	36	
GS4.13GDIXI27	Red Light Blue Drip	10.47in	13.07in	4.13gal	36	

Grower Select® Dune Flat Rim Planter

Elegant wave pattern mimics the natural lines of dune sand on these planters.



Brushed Champagne - 12in D x 10.2in H
Max Liquid Volume: 3.0gal

GSTF821HBG Min. Buy 1CS/25EA

Warm Copper - 12in D x 10.2in H
Max Liquid Volume: 3.0gal

GSTF821HWC Min. Buy 1CS/25EA



Grower Select® Dune Rolled Rim Planter

Elegant wave pattern mimics the natural lines of dune sand on these planters.



Brushed Champagne - 12in D x 9.4in H
Max Liquid Volume: 2.5gal

GSDP821MBG Min. Buy 1CS/35EA

Warm Copper - 12in D x 9.4in H
Max Liquid Volume: 2.5gal

GSDP821MWC Min. Buy 1CS/35EA



Decorative Planters

Grower Select® Enviroblend™ Handled Jar Planter

Made from 38% stone powder, 32% porcelain powder, 30% recycled plastic and coated with 100% lead-free water-based paint. These planters are lightweight for easy handling. Weather-resistant to withstand outdoor elements. Durable design is built to last and supports a wide variety of plant types.



Stone - 16in D x 11in H
Max Liquid Volume: 5.34gal
STPCF036609 Min. Buy 1CS/8EA

Stone - 20in D x 16in H
Max Liquid Volume: 11.44gal
STPCF036616 Min. Buy 1CS/8EA

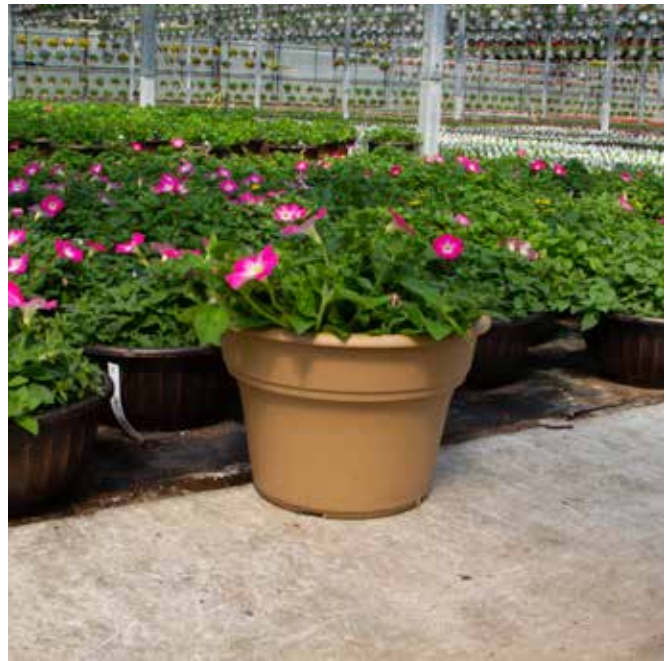

Grower Select® Enviroblend™ Handled Urn

Made from 38% stone powder, 32% porcelain powder, 30% recycled plastic and coated with 100% lead-free water-based paint. These planters are lightweight for easy handling. Weather-resistant to withstand outdoor elements. Durable design is built to last and supports a wide variety of plant types.



Stone - 16in D x 21in H
Max Liquid Volume: 8.11gal
STPCF036630 Min. Buy 1CS/4EA



Grower Select® Enviroblend™ Lattice Planter

Made from 38% stone powder, 32% porcelain powder, 30% recycled plastic and coated with 100% lead-free water-based paint. These planters are lightweight for easy handling. Weather-resistant to withstand outdoor elements. Durable design is built to last and supports a wide variety of plant types.



Weathered Black - 15.75in D x 13in H
Max Liquid Volume: 3.9gal
GS66014 Min. Buy 1CS/12EA



Weathered Black - 20in D x 14in H
Max Liquid Volume: 8.9gal
STPCF036586 Min. Buy 1CS/6EA

Grower Select® Enviroblend™ Tumbled Scroll Planter

Made from 38% stone powder, 32% porcelain powder, 30% recycled plastic and coated with 100% lead-free water-based paint. These planters are lightweight for easy handling. Weather-resistant to withstand outdoor elements. Durable design is built to last and supports a wide variety of plant types.



Earth - 15.75in D x 13in H
Max Liquid Volume: 3.9gal
GS86414 Min. Buy 1CS/12EA

Terra Cotta - 15.75in D x 13in H
Max Liquid Volume: 3.9gal
GS6644 Min. Buy 1CS/12EA

Stone - 15.75in D x 13in H
Max Liquid Volume: 3.9gal
GS5014 Min. Buy 1CS/12EA



Stone - 20in D x 14in H
Max Liquid Volume: 8.9gal
STPCF023302 Min. Buy 1CS/6EA



Grower Select® Enviroblend™ Tumbled Scroll Urn

Made from 38% stone powder, 32% porcelain powder, 30% recycled plastic and coated with 100% lead-free water-based paint. These planters are lightweight for easy handling. Weather-resistant to withstand outdoor elements. Durable design is built to last and supports a wide variety of plant types.



Stone - 16in D x 21in H
Max Liquid Volume: 5gal
STPCF023296 Min. Buy 1CS/4EA

Weathered Black - 16in D x 21in H
Max Liquid Volume: 5gal
STPCF036579 Min. Buy 1CS/4EA



Grower Select®

Decorative Planters

Grower Select® Euro Square Plastic Planter (Fused Rim)

Lightweight, durable planter designed to look like galvanized metal for that industrial look.



Gray - 10.8in D x 12.2in H
Max Liquid Volume: 3.7gal

GSSD102HGLM Min. Buy 1CS/6EA



Grower Select® Euro Tall Planter

Lightweight, durable plastic planter. Smooth finish. Soil saver design creates a tall elegant shape without all the extra required soil. Also available in a square planter



Faux Concrete - 15.0in D x 20.0in H
Max Liquid Volume: 9.0gal

GSTP102EFCC Min. Buy 1CS/4EA

Galvanized Look - 15.0in D x 20.0in H
Max Liquid Volume: 9.0gal

GSTP102EGS Min. Buy 1CS/4EA



Grower Select® Fancy Rolled Rim Planter

Decorative planter features a rolled rim, washed finish and cross-hatch patterned band. An elegant addition to any container garden.



Black/Copper Wash - 17.75in D x 12in H
Max Liquid Volume: 7.5gal

GSLF1106BLKCOP Min. Buy 1CS/12EA

Black/Copper Wash - 17.75in D x 12in H
Max Liquid Volume: 7.5gal

GSLF1106BLKCOPBULK Min. Buy 1PL/690EA

Black/Silver Wash - 17.75in D x 12in H
Max Liquid Volume: 7.5gal

GSLF1106BLKSIL Min. Buy 1CS/12EA

Black/Silver Wash - BULK - 17.75in Diam x 12in H
Max Liquid Volume: 7.5gal

GSLF1106BLKSILBULK Min. Buy 1PL/690EA

Black/Gold Wash - 17.75in D x 12in H
Max Liquid Volume: 7.5gal

GSFL1106BLKGOLD Min. Buy 1CS/12EA



Grower Select® Gala Tall Planter

Create a high-end contemporary look with these high gloss duo-tone finish planters. Durable, lightweight plastic.



High Gloss Black w/Chalk Rim - 14.0in D x 15.0in H
Max Liquid Volume: 7.0gal

GSTP1132DGBKCK Min. Buy 1CS/9EA

High Gloss White w/Chalk Rim - 14.0in D x 15.0in H
Max Liquid Volume: 7.0gal

GSTP1132DGWHCK Min. Buy 1CS/9EA

Glossy Pewter - 14in D x 15in H
Max Liquid Volume: 7.0gal

GSTP1132DGPCK Min. Buy 1CS/9EA

Glossy Burgundy - 14in D x 15in H
Max Liquid Volume: 7.0gal

GSTP1132DGBUCK Min. Buy 1CS/9EA

Grower Select® Grapevine Pot

Attractive Tuscan design on this pot styled with grapevines.



Black/Bronze Wash - 18in D x 14.2in H
Max Liquid Volume: 8.8gal

GSR-GRAPE 18CS Min. Buy 1CS/12EA



Grower Select® Harvest Garden Square Planter

Wood-look planter with the durability of plastic.



Mahogany - 17in D x 13.5in H
Max Liquid Volume: 8.3gal

GSTSD117EMA Min. Buy 1CS/12EA



Grower Select® Harvest Garden Window Box

Wood-look planter with the durability of plastic.



Mahogany - 24in L x 13.5in H
Max Liquid Volume: 14.5gal

GSTWD117HMA Min. Buy 1CS/12EA



GrowerSelect®

Decorative Planters



Grower Select® Jessie Rolled Rim Pot

Lightweight, durable plastic planter with a rolled rim.

Product	Color	Depth	Outside Diam	Max Liquid Volume	Case Qty	Barcode
GSR-JESSIE 760 AGED CAPP	Aged Cappuccino	7.4in	13.5in	3.67gal	20	
GSR-JESSIE 760	Black	7.4in	13.5in	3.67gal	20	
GSR-JESSIE BLACK/BRONZE	Black/Bronze Wash	7.4in	13.5in	3.67gal	20	
GSR-JESSIE760 16 AGED CA	Aged Cappuccino	12in	15.75in	5.75gal	12	
GSR-JESSIE760 16BLK	Black	12in	15.75in	5.75gal	12	
GSR-JESSIE760 16 BLK/BRO	Black/Bronze Wash	12in	15.75in	5.75gal	12	

Grower Select® Kacey Planter

An elegant design makes the Kacey Planter great for indoor or outdoor use. Available in multiple wash finishes.

Product	Color	Depth	Outside Diam	Max Liquid Volume	Case Qty	Barcode
GSLF1209GOL	Gold Wash	11.22in	15.98in	4.76gal	24	
GSLF1209GOLBULK	Gold Wash	11.22in	15.98in	4.76gal	1020/pl	
GSLF1209RED	Red Wash	11.22in	15.98in	4.76gal	24	
GSLF1209REDBULK	Red Wash	11.22in	15.98in	4.76gal	1020/pl	
GSLF1209SIL	Silver Wash	11.22in	15.98in	4.76gal	24	
GSLF1209SILBULK	Silver Wash	11.22in	15.98in	4.76gal	1020/pl	
GSLF1209COP	Copper Wash	11.22in	15.98in	4.76gal	24	

Grower Select® Jane Bowl

Versatile contemporary container for your bowl crop offering.



Black/Copper - 11.5in D x 6in H

Max Liquid Volume: 2.46gal

GSJANE 6 CASES Min. Buy 1CS/40EA



Grower Select® Helen Hexagon Planter

Soil volume galore for your floor plants! This lightweight, decorative container is made from recycled plastic and features a hexagon-shaped design with an antique wash finish that is fade resistant.



Terra Cotta - 14in D x 9.9in H

Max Liquid Volume: 3.95gal

GSHELEN HEX14 Min. Buy 1CS/25EA



WARNING: This product is not available for sale in CA.
For most up to date information please visit bfgsupply.com

800-883-0234
www.bfgsupply.com

GrowerSelect®

Decorative Planters

Grower Select® Hendrix Tall Square Planter

Elegant two-tone durable, plastic planter



Antique White Top/Aged Black Bottom
- 17.01in D x 19.0in H - Max Liquid Volume: 15.19gal

GSTS1555CAWAB Min. Buy 1CS/13EA



Brown/White - 17.01in D x 19.0in H

Max Liquid Volume: 15.19gal

GSTS1555CFWI Min. Buy 1CS/13EA

Grower Select® Honey Pot Planter

Lightweight planters, made from recycled plastic.



Dapple Blue - 12.01in D x 9.65in H
Max Liquid Volume: 2.8gal

STPCF088073 Min. Buy 1CS/24EA



Dapple Blue - 16.0in D x 12.8in H

Max Liquid Volume : 6.6gal

STPCF088486 Min. Buy 1CS/12EA



Dapple Cream - 12.01in D x 9.65in H

Max Liquid Volume: 2.8gal

STPCF088080 Min. Buy 1CS/24EA

Dapple Cream - 16.0in D x 12.8in H

Max Liquid Volume : 6.6gal

STPCF088493 Min. Buy 1CS/12EA



Grower Select® Kim Pot

The rustic look to this charming pot is great for your summer and fall plants.



Aged Cappuccino - 10.1in D x 7.3in H

Max Liquid Volume: 1.56gal

GSR-KIM10- AGED CAPPUCCI Min. Buy 1CS/70EA



Grower Select® Laci Pot

Attractive, vintage looking pot. Great for flowering plants. The Laci Collection is available in both bowls and hanging baskets.



Aged Cappuccino - 11.09in D x 5.53in H

Max Liquid Volume: 1.5gal

GSLACEY 1 AGED CAPPUCCINO Min. Buy 1CS/40EA



Black/Cappuccino - 11.09in D x 5.53in H

Max Liquid Volume: 1.5gal

GSLACEY 1 BLK/CAP Min. Buy 1CS/40EA



Grower Select® Marissa Pot

A classic, traditional design with an aged-copper finish for a modern twist. Fade-resistant and weatherproof for extended outdoor life.



Black/Copper Wash - 10in D x 8.4in H

Max Liquid Volume: 1.6gal

GSTL-1181COP CASES Min. Buy 1CS/60EA



Grower Select® Morris Planter

Versatile planter works in just about any décor setting - contemporary or traditional. A great planter for growers to plant up due to its nice patio planter size.



Sandalwood - 15.2in D x 11.7in H

Max Liquid Volume: 6.0gal

GSDP1426CSW Min. Buy 1CS/32EA



Grower Select® Naomi

Combination of round shape and vintage look. This lightweight, decorative container is made from recycled plastic and features a round shape design with an antique wash finish that is fade-resistant.



Aged Cappuccino Tan Brush - 13.2in D x 10.2in H x 7.12 B - Max Liquid Volume: 2.95gal

GSWRR13226AC Min. Buy 1CS/12EA



Gold Brush - 13.2in D x 10.2in H x 7.12 B

Max Liquid Volume: 2.95gal

GSWRR13226GB Min. Buy 1CS/12EA



Silver Brush - 13.2in D x 10.2in H x 7.12 B

Max Liquid Volume: 2.95gal

GSWRR13226SB Min. Buy 1CS/12EA



Grower Select® Norm "Wood" Barrel Planter

Get the look of a classic wood bucket with the outdoor hardiness you need. Wood-grained plastic in an authentic-looking brown finish.



Aged Cappuccino - 12in D x 9.8in H

Max Liquid Volume: 2.9gal

GSNorm12 aged cappuc Min. Buy 1CS/40EA





Decorative Planters

Grower Select® Lattice Flowerpot

Grape leaves line the top and lattice work adorns this planter. An elegant solution for planting combos.

Product	Color	Depth	Outside Diam	Max Liquid Volume	Case Qty	Barcode
GSRACFP1225ACP	Aged Cappuccino	9.2in	12.25in	2.5gal	40	
GSR-A-CFP-12.25brz	Black/Bronze Wash	9.2in	12.25in	2.5gal	40	
GSRACFP1225COPPER	Black/Copper Wash	9.2in	12.25in	2.5gal	40	
GSRACFP1225SILVER	Black/Silver Wash	9.2in	12.25in	2.5gal	40	
GSR-a-cfp-014 Age/ Capp	Aged Cappuccino	10.3in	13.8in	3.5gal	30	
GSR-A-CFP-014	Black/Bronze Wash	10.3in	13.8in	3.5gal	30	
GSRACFP014COPPER	Black/Copper Wash	10.3in	13.8in	3.5gal	30	
GSRACFP014SILVER	Black/Silver Wash	10.3in	13.8in	3.5gal	30	
GSR-18LATTICEAGECAPPCS	Aged Cappuccino	14.1in	17.71in	7.45gal	15	
GSR-18LATTICE BLACK BRON	Black/Bronze Wash	14.1in	17.71in	7.45gal	15	
GSR18LATTBLKCOPP	Black/Copper Wash	14.1in	17.71in	7.45gal	15	
GSR-18LATTICE BLACK SILV	Black/Silver Wash	14.1in	17.71in	7.45gal	15	
GSR-18LATTICE BLACK CAPP	Black/Cappuccino Wash	14.1in	17.71in	7.45gal	15	

Grower Select®

Decorative Planters

Grower Select® Nondas Lattice Pot

These durable, yet elegant planters with a lattice pattern will add a touch of class to any porch or patio. Made of weather resistant plastic with a rolled rim.



Product	Color	Depth	Outside Diam	Max Liquid Volume	Case Qty	Barcode
TZ20991ACCS	Aged Cappuccino	8.734in	10.827in	1.9gal	50	
TZ20991BBCS	Black/Bronze Wash	8.734in	10.827in	1.9gal	50	
TZ20991BCCS	Black/Copper Wash	8.734in	10.827in	1.9gal	50	
TZ20991BSCS	Black/Silver Wash	8.734in	10.827in	1.9gal	50	

Grower Select® Octagon Planter

This lightweight, decorative container is made from recycled plastic and features an octagon-shaped design with an antique wash finish that is fade-resistant.



Product	Color	Depth	Outside Diam	Max Liquid Volume	Case Qty	Barcode
GSOPS11020AC	Aged Cappuccino	7.5in	11in	1.64gal	45	
GSOPS11020SB	Silver Brush	7.5in	11in	1.64gal	45	
GSOPS11020GB	Gold Brush	7.5in	11in	1.64gal	45	
GS11121301-TC	Washed Terra Cotta	9.1in	13.6in	3.17gal	36	
GS11121301-AGED BLK	Aged Black	9.1in	13.6in	3.17gal	36	





Decorative Planters

Grower Select® Orbit Deco Planter

These pots make an attractive addition to any outdoor container garden. A nice decorative grower's pot. Constructed of a polypropylene plastic.

Product	Color	Depth	Outside Diam	Max Liquid Volume	Case Qty	Barcode
GSMSL10BLKCOPPER	Black/Copper Wash	7.625in	10.375in	1.91gal	48	
GSMSL10BLKGOLD	Black/Gold Wash	7.625in	10.375in	1.91gal	48	
GSMSL10BLKSILVER	Black/Silver Wash	7.625in	10.375in	1.91gal	48	
GSMSL10 - MOCHA	Mocha	7.625in	10.375in	1.91gal	46	
GSMSL10 - TERRACOTTA	Terra Cotta	7.625in	10.375in	1.91gal	46	
GSMSL12BLKCOPPER	Black/Copper Wash	9.18in	12.44in	3.4gal	36	
GSMSL12BLKGOLD	Black/Gold Wash	9.18in	12.44in	3.4gal	36	
GSMSL12BLKSILVER	Black/Silver Wash	9.18in	12.44in	3.4gal	36	
GSMSL12 - MOCHA	Mocha	9.18in	12.44in	3.4gal	45	
GSMSL12 - TERRACOTTA	Terra Cotta	9.18in	12.44in	3.4gal	45	
GSMSL12 - CHOCOLATE	Chocolate	9.18in	12.44in	3.4gal	45	
GSMSL14BLKCOPPER	Black/Copper Wash	10.3in	14.06in	5.5gal	24	
GSMSL14BLKGOLD	Black/Gold Wash	10.3in	14.06in	5.5gal	24	
GSMSL14BLKSILVER	Black/Silver Wash	10.3in	14.06in	5.5gal	24	
GSMSL14 - MOCHA	Mocha	10.3in	14.06in	5.5gal	33	
GSMSL14 - TERRACOTTA	Terra Cotta	10.3in	14.06in	5.5gal	33	

Grower Select®

Decorative Planters

Grower Select® Pedestal Urn

Dress up your container plantings with this fluted pedestal urn. Lightweight polypropylene construction provides weather resistance and durability.



Black/Bronze Wash - 12in D x 10.87in H

Max Liquid Volume: 1.64gal

GSR-CZ305H URN Min. Buy 1CS/38EA

White - 12in D x 10.87in H

Max Liquid Volume: 1.64gal

GSCZ305HWHITE Min. Buy 1CS/24EA



Grower Select® Piper Planter

Display your plants in style with this decorative planter.



Brushed Champagne - 16.5in D x 11.8in H

Max Liquid Volume: 5.7gal

GSDP1304DBG Min. Buy 1CS/40EA

Antique White - 16.5in D x 11.8in H

Max Liquid Volume: 5.7gal

GSDP1304DAW Min. Buy 1CS/40EA

Vintage Copper - 16.5in D x 11.8in H

Max Liquid Volume: 5.7gal

GSDP1304DVC Min. Buy 1CS/40EA



Grower Select® PW3 Bulb / Succulent Pan

Versatile bowl design for your bulb and succulent offering. Elegant leaf design decorates the side of this container.



Aged Cappuccino - 12in D x 3.85in H

Max Liquid Volume: 1.19gal

GSTZ750CASESACP Min. Buy 1CS/30EA

Aged Cappuccino - 8in D x 2.93in H

Max Liquid Volume: .4gal

GSTZ749CASESACP Min. Buy 1CS/30EA

Black/Copper Wash - 12in D x 3.85in H

Max Liquid Volume: 1.19gal

GSTZ-750CASE Min. Buy 1CS/30EA



Grower Select® Randy-Lynn 3pk Planter

Three pack of planters with a coordinating tray. Perfect for a window herb garden or succulents.



Aged Cappuccino - 4.5in D x 3.5in H

Max Liquid Volume: 0.2gal

GSTZ458RANDILYNNACP Min. Buy 1CS/108EA

Black - 4.5in D x 3.5in H

Max Liquid Volume: 0.2gal

GSTZ458RANDILYNNBLK Min. Buy 1CS/108EA



Grower Select® Rattan Bowl

The Rattan collection features a brushed texture finish with a rattan band. Available in a variety of shapes and sizes including: Rattan Bowl, Rattan Square Planter and a Rattan Rolled Rim Planter.



Aged Cappuccino - 12in D x 5.87in H

Max Liquid Volume: 1.6gal

GSBL919MAC Min. Buy 1CS/50EA



Grower Select® Rattan Rolled Rim Planter

The Rattan collection features a brushed texture finish with a rattan band. Available in a variety of shapes and sizes including: Rattan Bowl, Rattan Square Planter and a Rattan Rolled Rim Planter.



Antique Brass - 17.2in D x 12in H

Max Liquid Volume: 6.5gal

GSDP929DBA Min. Buy 1CS/20EA



Antique Brass - 20in D x 15.2in H

Max Liquid Volume: 10.87gal

GSDP919BAN Min. Buy 1 CS/12EA



Decorative Planters

Grower Select® Rolled Rim Planter

These rolled rim planters will look anything but basic when they are filled with flowers and plants! Versatile, durable and stylish, the rolled rim planter comes in multiple sizes and colors.



Black/Gold - 14in D x 9.84in H
Max Liquid Volume: 4.0gal
GSAB380BLACKGOLD Min. Buy 1EA

Black/Silver - 14in D x 9.84in H
Max Liquid Volume: 4.0gal
GSAB380BLACKSILVER Min. Buy 1EA

Mocha - 14in D x 9.84in H
Max Liquid Volume: 4.0gal
GSAB380 - MOCHA Min. Buy 1 EA

Terra Cotta - 14in D x 9.84in H
Max Liquid Volume: 4.0gal
GSAB380 - TERRACOTTA Min. Buy 1EA



Black/Gold - 16in D x 12.01in H
Max Liquid Volume: 6.81gal
GSAB460BLACKGOLD Min. Buy 1EA

Black/Silver - 16in D x 12.01in H
Max Liquid Volume: 6.81gal
GSAB460BLACKSILVER Min. Buy 1EA

Mocha - 16in D x 12.01in H
Max Liquid Volume: 6.81gal
GSAB460 - MOCHA Min. Buy 1EA

Terra Cotta - 16in D x 12.01in H
Max Liquid Volume: 6.81gal
GSAB460 - TERRACOTTA Min. Buy 1EA



Grower Select® Round Cove Planter

A large rim and a elegant brushed, lightly textured surface on these planters set them apart.



Warm Copper - 14.5in D x 12in H
Max Liquid Volume: 4.66gal
GSDP292FWC Min. Buy 1CS/30EA

Brushed Champagne - 14.5in D x 12in H
Max Liquid Volume: 4.66gal
GSDP292FBG Min. Buy 1CS/30Ea



Grower Select® Square Cove Planter

A large rim and an elegantly brushed surface on these planters set them apart.



Warm Copper - 14in D x 12in H
Max Liquid Volume: 5.4gal
GSSD292FWC Min. Buy 1CS/20EA



Grower Select® Sandthatch Bowl

For indoor and outdoor use.



Powdered Ginger - 14in D x 6in H
Max Liquid Volume: 2.8gal
GSTBL339ECPG Min. Buy 1CS/20EA



Powdered Ginger - 17in D x 6in H x 10.6in B
Max Liquid Volume: 2.2gal
GSBV339FCPG Min. Buy 1CS/20EA

Grower Select® Sandthatch Planter

For indoor and outdoor use.



Powdered Ginger - 14in D x 15in H
Max Liquid Volume: 7.6gal
GSTTP339HPG Min. Buy 1CS/5EA



Grower Select® Scalloped Flare Planter

Lightweight, durable plastic planter with a decorative flared top.



Antique Concrete - 13.0in D x 11.5in H
Max Liquid Volume: 4.1gal
GSTDTP903EVCON Min. Buy 1CS/25EA

Vintage Copper - 13.0in D x 11.5in H
Max Liquid Volume: 4.1gal
GSTDTP903EVC Min. Buy 1CS/25EA



Antique Concrete - 16.0in D x 14.2in H
Max Liquid Volume: 7.7gal
GSTDTP903CVCON Min. Buy 1CS/18EA

Vintage Copper - 16.0in D x 14.2in H
Max Liquid Volume: 7.7gal
GSTDTP903CVC Min. Buy 1CS/18EA



Antique Concrete - 20.0in D x 16.0in H
Max Liquid Volume: 11.1gal
GSDP903ABVCON Min. Buy 1CS/11EA

Vintage Copper - 20.0in D x 16.0in H
Max Liquid Volume: 11.1gal
GSDP903ABVC Min. Buy 1CS/11EA

Grower Select®

Decorative Planters

Grower Select® Scalloped Flare Planter

Lightweight, durable plastic planter with a decorative flared top.



Warm Copper - 13.0in D x 11.5in H
Max Liquid Volume: 4.1gal
GSTD903EWC Min. Buy 1CS/25EA



Warm Copper - 16.0in D x 14.2in H
Max Liquid Volume: 7.7gal
GSTD903CWC Min. Buy 1CS/18EA



Warm Copper - 20.0in D x 16.0in H
Max Liquid Volume: 11.1gal
GSDP903ABWC Min. Buy 1CS/11EA

Grower Select® Serenity Bowl

Lightweight, durable plastic planter bowl. Excellent for planting up succulents or pansies. Also available in coordinating hanging basket.



Black/Gold Wash - 12in Diam x 5.43in H
Max Liquid Volume: 1.24gal
GSLF11012BLKGOLD Min. Buy 1CS/72EA



Black/Silver Wash - 12.0in Diam x 5.43in H
Max Liquid Volume: 1.24gal
GSLF11012BLKSILVER Min. Buy 1CS/72EA



Aged Cappuccino - 12in O x 5.43in H
Max Liquid Volume: 1.24gal
GSLF11012AGECAP Min. Buy 1CS/72EA



Black Copper - 12in O x 5.43in H
Max Liquid Volume: 1.24gal
GSLF11012BLKCOP Min. Buy 1CS/72EA



Grower Select® Sienna Square

"A knockout for pansies." Sold by 60 pots per case.



Black/Green Wash - 9.5in D x 5.9in H
Max Liquid Volume: 1.4gal
GSSienna SLF-975 Min. Buy 1CS/60EA



Grower Select® Sloan Square Planter

Durable plastic planter with a contemporary ribbed design.



Black/Bronze Wash - 10.25in D x 12in H
Max Liquid Volume: 3.5gal
GSTZ1541915SMALLBLKBNZ Min. Buy 1CS/36EA



Black - 10.25in D x 12in H
Max Liquid Volume: 3.5gal
GSTZ1541915SMALLBLK Min. Buy 1CS/36EA



Black - 12.25in D x 15in H
Max Liquid Volume: 6.58gal
GSS-A-915BLK Min. Buy 1CS/15EA

Grower Select® Stout Planter

Lightweight planters, made from recycled plastic. Feature a classic, round-shaped design and full rings with brush tones making an elegant solution for planters.



Copper Brush - 13.3in D x 9.5in H x 8in B
Max Liquid Volume: 2.94gal
GSSRFR13020CB Min. Buy 1CS/15EA



Gold Brush - 13.3in D x 9.5in H x 8in B
Max Liquid Volume: 2.94gal
GSSRFR13020GB Min. Buy 1CS/15EA



Silver Brush - 13.3in D x 9.5in H x 8in B
Max Liquid Volume: 2.94gal
GSSRFR13020SB Min. Buy 1CS/15EA



Grower Select® Sugared Sand Bowl

Decorative bowls are great for pansies, succulents and bulbs. For indoor and outdoor use.



Brushed Teal - 12in D x 5.5in H
Max Liquid Volume: 1.6gal
GSBL913HBT Min. Buy 1 CS/51EA



Wisteria - 12in D x 5.5in H
Max Liquid Volume: 1.6gal
GSBL913HWI Min. Buy 1CS/15EA



Brushed Teal - 16.9in D x 6.3in H
Max Liquid Volume: 3.3gal
GSBL913CBT Min. Buy 1CS/50EA

Wisteria - 16.9in D x 6.3in H
Max Liquid Volume: 3.3gal
GSBL913C Min. Buy 1CS/50EA



Grower Select®

Decorative Planters

Grower Select® Sugared Sand Rimless Planter

With a finish that resembles a sugary sand, these planters will have you thinking of sunny days at the beach. Fill them with colorful flowers to bring your patio alive!



Brushed Teal - 16.1in D x 11.4in H

Max Liquid Volume: 6.5gal

GSDP913EBT Min. Buy 1CS/27EA

Wisteria - 16.1in D x 11.4in H

Max Liquid Volume: 6.5gal

GSDP913EWI Min. Buy 1CS/27EA



Grower Select® Sydney Plain Square Pot

Display your patio plants in style with this durable planter. Molded from polypropylene in an attractive finish. Includes a sturdy plastic sign on a 10in high arched loop.



Black/Copper - 9.75in D x 8.3in H

Max Liquid Volume: 2.0gal

GS10.00 SYDNEY SQ BLK/CO Min. Buy 1CS/40EA



Grower Select® Tall Dune Planter

Elegant wave pattern mimics the natural lines of dune sand on these planters.



Brushed Champagne - 14in D x 15in H

Max Liquid Volume: 6.6gal

GSTP821JBG Min. Buy 1CS/14EA

Warm Copper - 14in D x 15in H

Max Liquid Volume: 6.6gal

GSTP821JWC Min. Buy 1CS/14EA

White - 14in D x 15in H

Max Liquid Volume: 6.6gal

GSTP821JWH Min. Buy 1CS/14EA



Grower Select® Tampa Urn

Lightweight planters, made from recycled plastic.



Eggnog - 13.01in D x 15.57in H

Max Liquid Volume: 3.1gal

STPHDR086642 Min. Buy 1CS/6EA



Grower Select® Tara Planter

Attractive, durable planters available in three different wash finishes to complement every landscape.



Copper Wash - 10.83in D x 7.68in H

Max Liquid Volume: 1.72gal

GSLF1102COP Min. Buy 1CS/48EA

Copper Wash - 10.83in D x 7.68in H

Max Liquid Volume: 1.72gal

GSLF1102COPBULK Min. Buy 1PL/3520EA

Gold Wash - 10.83in D x 7.68in H

Max Liquid Volume: 1.72gal

GSLF1102GOL Min. Buy 1CS/48EA

Gold Wash - 10.83in D x 7.68in H

Max Liquid Volume: 1.72gal

GSLF1102GOLBULK Min. Buy 1 PL/3520EA

Silver Wash - 10.83in D x 7.68in H

Max Liquid Volume: 1.72gal

GSLF1102SIL Min. Buy 1CS/48EA

Silver Wash - 10.83in D x 7.68in H

Max Liquid Volume: 1.72gal

GSLF1102SILBULK Min. Buy 1PL/3520EA



Grower Select® Wave Planter

Lightweight planters, made from recycled plastic. Feature a classic, round-shaped design and full rings with brush tones that mimics waves making an elegant solution for planters.



Copper Brush - 16in D x 11.8in H x 8.56in B

Max Liquid Volume: 4.65gal

GSWPR16020CB Min. Buy 1CS/25EA

Gold Brush - 16in D x 11.8in H x 8.56in B

Max Liquid Volume: 4.65gal

GSWPR16020GB Min. Buy 1CS/25EA

Silver Brush - 16in D x 11.8in H x 8.56in B

Max Liquid Volume: 4.65gal

GSWPR16020SB Min. Buy 1CS/25EA



Grower Select® Weave Round Planter

Decorative weave pattern is molded into the outer design of this collection. Available as coordinating Low Profile Square Planter, Round Planter and Hanging Basket.



Chestnut Brown - 11in D x 8.5in H

Max Liquid Volume: 2.0gal

GSDP317HCT Min. Buy 1CS/25EA



Grower Select®

Decorative Planters

Grower Select® Whale Tail Round Planter



Cappuccino with White - 17.6in D x 14.19in H
Max Liquid Volume : 8.7gal
GSTZ4456 Min. Buy 1CS/13EA



Grower Select® Whale Tail Window Box



Cappuccino with White - 14.87in D x 7.07in H
Max Liquid Volume : 2.48gal
GSTZ4470 Min. Buy 1CS/20EA



Grower Select® Wicker Bowl

Lightweight and decorative bowl with excellent wicker-look design.



Coffee Cream - 10.8in Diam x 5.5in H
Max Liquid Volume : 1.5gal
GSBL934H Min. Buy 1CS/53EA



Grower Select® Wicker Planter

Lightweight and decorative planter with excellent wicker-look design. Also available as coordinating hanging basket.



Coffee Cream - 17in Diam x 14.5in H
Max Liquid Volume: 9.0gal
GSTP931H Min. Buy 1CS/22EA



Grower Select® Wicker Planter

Lightweight and decorative planter with excellent wicker-look detailing.



Coffee Cream - 21.9in D x 18.7in H
Max Liquid Volume: 20.5gal
GSTP931C Min. Buy 1CS/15EA



Grower Select® Winchester Square Planter

Lightweight, durable plastic planter



Aged Black - 10.2in Diam x 9.3in H
Max Liquid Volume : 2.5gal
GSSQ1582M Min. Buy 1CS/58EA



Grower Select® Wine Barrel

With a down-home, country-style feel, this wine barrel creates the perfect combination of elegance and simplicity to your outdoor or indoor living space. HDR construction for a lightweight and durable planter that will last longer than traditional wooden barrels and can withstand outdoor seasonal elements and everyday use. They also include UV protectors to increase resistance to cracking and fading. Your vibrant colored flower or vegetable arrangements will provide a pleasing pop of color in these dark, faux-wood planters.



Kentucky Walnut With Black Band - 17.7in D x 12.8in H, Max Liquid Volume: 8.5gal
STPCF023319 Min. Buy 1CS/8EA



Grower Select® Welcome Rope Planter with Sign

Display your patio plants in style with this durable planter. Molded from polypropylene in an attractive finish. Includes a sturdy plastic sign on a 10in high arched loop.



Black/Bronze - 12in D x 8.3in H
Max Liquid Volume: 2.2gal
GSA-SAY ANYTHING 718 Min. Buy 1CS/30EA



Black/Silver - 12in D x 8.3in H
Max Liquid Volume: 2.2gal
GSA-SAY ANYTHING 718.BLK Min. Buy CS/30EA

Grower Select® Welcome Weave Planter with Sign

Display your patio plants in style with this durable planter. Molded from polypropylene in an attractive finish. Includes a sturdy plastic sign on a 10in high arched loop.



Black/Bronze - 12in D x 8.3in H
Max Liquid Volume: 2.2gal
GSA-SAY ANYTHING 516BRZ Min. Buy 1CS/30EA



Black/Silver - 12in D x 8.3in H
Max Liquid Volume: 2.2gal
GSA-SAY ANYTHING 516SIL Min. Buy 1CS/30EA

Grower Select® American Flag Planter

Display your patio plants in style with this durable planter. Molded from polypropylene in an attractive finish. Includes a sturdy plastic flag on a 10in high arched loop.



Black - 12in D x 8.3in H
Max Liquid Volume: 2.2gal
GSA-AMERICANFLAGBLK Min. Buy 1CS/30EA



GrowerSelect®

Decorative Planters

Grower Select® Bushel Pot Planter

10in top outside diameter x 6in high. 1.4gal Liquid Volume.



Tan With Brown Wash - 10in D x 6in H
Max Liquid Volume: 1.19gal
STPCF023289 Min. Buy 1CS/24EA



Grower Select® Fall Cover Pot

Great for use with pre-planted baskets as drop ins for fall mums. Fits 10in pots.



Black/Copper Wash - 10.75in D x 6.73in H
Max Liquid Volume: 1.75gal
GSHH-TZ078-FALL1 BLK/CO Min. Buy 1CS/50EA



Grower Select® Halloween Cover Pots

Get ready for Halloween with this Frankenstein plastic cover pot; perfect for use with mum pan drop-ins. Sold by 100 pots per case.



Green - 8.5in D x 5.72in H
Max Liquid Volume: 1.06gal
GSBig Frankie #1 Min. Buy 1CS/100CS



Purple - 8.5in D x 5.72in H
Max Liquid Volume: 1.06gal
GShh-Fun Freddy Min. Buy 1CS/100EA



Grower Select® Fall Cover Pots

Great for use with pre-planted baskets as drop ins for fall mums. Fits 8in pots.



Black/Bronze Wash - 8.66in D x 5.5in H
Max Liquid Volume: 1.06gal
GSHH-TZ128-FALL2 BLK/BRO Min. Buy 1CS/124EA



Black/Copper Wash - 8.66in D x 5.5in H
Max Liquid Volume: 1.06gal
GSHH-TZ128-Fall2 8 Blk/C Min. Buy 1CS/124EA



Grower Select® Little Harvey Pumpkin Cover Pot

Get ready for fall with this pumpkin cover pot; perfect for use with mum pan drop-ins.



Orange With Face - 9.17in D x 5.9in H
Max Liquid Volume: 1.15gal
GSHHLITTLEHARV9 Min. Buy 1CS/90EA



Orange No Face - 9.17in D x 5.9in H
Max Liquid Volume: 1.15gal
GSLITTLE HARV CASES Min. Buy 1CS/90EA



Grower Select® Snowflake Cover Pot

Spruce up your winter plants with this seasonal cover pot. Great for use with 10in hanging basket drop-ins. No drain hole.



Black/Silver - 10.75in D x 6.73in H
Max Liquid Volume: 1.75gal
GS84-0295A Min. Buy 1CS/60EA



Grower Select®

Specialty Containers

Grower Select® Tee Pee Pot

Attractive trellis planter. Height with Trellis is 20.827in.



Aged Cappuccino - 13.217in D x 8.996in H

Max Liquid Volume: 3.3gal

GSC-TEEPPE ACP CASES

Min. Buy 1CS/12EA

Bronze - 13.217in D x 8.996in H

Max Liquid Volume: 3.3gal

GSC-TEEPPE BLK/BRONZE CA

Min. Buy 1CS/12EA



Grower Select® Katie Square Tower Cage Pot

Attractive trellis planter. Cage height is 19in.



Black - 9.84in D x 9in H

Max Liquid Volume: 2.0gal

GSC-KATIE212BLK

Min. Buy 1CS/40EA



Grower Select® Square Floor Planter With Ball Feet

Rust-resistant, powder coated finish. For indoor or outdoor use. Features a sewn-in poly liner to retain soil moisture and includes a coco liner and wire hanger.



Black - 9in D x 15in H

Max Liquid Volume: 2.77gal

SSC793594

Min. Buy 1CS/5EA



Grower Select® Diedra Pot with Veggie Cage

Subdued finish on the Diedra Pot makes your plants the focus. Comes complete with vegetable cage for easy container gardening.



Black - 9.84in D x 6.12in H

Max Liquid Volume: 2gal

GSC-TZ-013BLKCS

Min. Buy 1CS/30EA

Black - BULK - 9.84in D x 6.12in H

Max Liquid Volume: 2gal

GSC-TZ-013

Min. Buy 1PL/1700EA



Grower Select® Trellis Square Pot

Decorative planter to compliment your climbing plants. Great for flowering vines. Height with trellis is 17.6in.



Black - 8in D x 6.16in H

Max Liquid Volume: 1.0gal

GSC-TRELLISX8

Min. Buy 1CS/40EA

Black - 10in D x 8.27in H

Max Liquid Volume: 2.0gal

GSC-TRELLISX10

Min. Buy 1CS/40EA

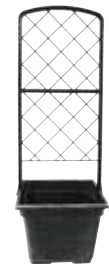

Grower Select® Grab-n-Go Trellis

The Grab-n-Go trellis is the perfect product for your climbing plants! Pick up your plants by the trellis without any spilling, separation or risk of destroying the plant. Easily snaps onto co-ex pot rims.



Small - 7.281in Top W x 7.5in Base W x 15.75in H

GST-TZ-229

Min. Buy 1CS/10EA

Medium - 9.014in Top W x 7.5in Base W x 15.75in H

GST-TZ-230

Min. Buy 1CS/10EA

Large - 10.903in Top W x 9.5in Base W x 18.0in H

GST-TZ-231

Min. Buy 1CS/10EA



Grower Select® Kathy Caged Pot

Tomatoes love this strong, attractive trellis planter. Cage height is 14.73in.



Black - 11.5in D x 8.39in H

Max Liquid Volume: 2.5gal

GSC-6622

Min. Buy 1CS/40EA



Grower Select®

Specialty Containers

Grower Select® Untreated Wood Baskets

Wood packaging has been used primarily in farming for thousands of years. Since 1950, wood packaging (baskets) was the main package used to ship fresh fruits and vegetables.



Brown - 11in x 7in
GSRB-001BNH Min. Buy 1CS/12EA

Natural - 11in x 7in
GSRB-001NNH Min. Buy 1CS/12EA



Grower Select® Untreated Wood Baskets

Wood packaging has been used primarily in farming for thousands of years. Since 1950, wood packaging (baskets) was the main package used to ship fresh fruits and vegetables.



Brown - 14.5in x 9.425in
GSHBUS-B Min. Buy 1CS/12EA

Natural - 14.5in x 9.425in
GSHBUS-N Min. Buy 1CS/12EA



Grower Select® Untreated Wood Baskets

Wood packaging has been used primarily in farming for thousands of years. Since 1950 wood packaging (baskets) was the main package used to ship fresh fruits and vegetables.



Green With Red Band - 17.5in x 11.5in
GS04032G Min. Buy 1CS/12EA

Brown - 17.5in x 11.5in
GS04032B Min. Buy 1CS/12EA

Natural - 17.5in x 11.5in
GS04032N Min. Buy 1CS/12EA

Grower Select® Untreated Wood Baskets

Wood packaging has been used primarily in farming for thousands of years. Since 1950, wood packaging (baskets) was the main package used to ship fresh fruits and vegetables.



Brown - 8in x 6in
GSRB-002BNH Min. Buy 1CS/12EA

Natural - 8in x 6in
GSRB-002NNH Min. Buy 1CS/12EA



Grower Select® Watering Can Planter

Durable galvanized zinc construction with an Acid Wash finish. Sprinkling can planter features a detachable spout and handle for easy shipping. A pre-planted azalea pot fits directly into this container. 10.125in x 8.25in High. 2.09gal Liquid Volume. 12 per Case.



Acid Wash - 10.125in D x 8.25in H
Max Liquid Volume: 2.09gal
GS0049 Min. Buy 1CS/12EA

Copper - 10.125in D x 8.25in H
Max Liquid Volume: 2.09gal
GS0047 Min. Buy 1CS/12EA

Green - 10.125in D x 8.25in H
Max Liquid Volume: 2.09gal
GS850002A Min. Buy 1CS/12EA

Orange - 10.125in D x 8.25in H
Max Liquid Volume: 2.09gal
GS850003A Min. Buy 1CS/12EA

Yellow - 10.125in D x 8.25in H
Max Liquid Volume: 2.09gal
GSCS10KBFG004 Min. Buy 1CS/12EA

Fuschia - 10.125in D x 8.25in H
Max Liquid Volume: 2.09gal
GS850001A Min. Buy 1CS/12EA

Assorted Colors - 10.125in D x 8.25in H
Max Liquid Volume: 2.09gal
GS0045 Min. Buy 1CS/12EA



Acid Wash - 7.5in D x 6.125in H
Max Liquid Volume: 3.875qt
GS0048 Min. Buy 1CS/12EA

Copper - 7.5in D x 6.125in H
Max Liquid Volume: 3.875qt
GS0046 Min. Buy 1CS/12EA

Green - 7.5in D x 6.125in H
Max Liquid Volume: 3.875qt
GS850006B Min. Buy 1CS/12EA

Orange - 7.5in D x 6.125in H
Max Liquid Volume: 3.875qt
GS850007B Min. Buy 1CS/12EA

Yellow - 7.5in D x 6.125in H
Max Liquid Volume: 3.875qt
GS850008B Min. Buy 1CS/12EA

Fuschia - 7.5in D x 6.125in H
Max Liquid Volume: 3.875qt
GS850005B Min. Buy 1CS/12EA

Assorted Colors - 7.5in D x 6.125in H
Max Liquid Volume: 3.875qt
GS0044 Min. Buy 1CS/12EA



Growing Containers

Square & Round | Decorative | Hanging Baskets | Trays, Flats & Sheets | Support Systems | Sustainable



Browse all of HC's growing containers by visiting hc-companies.com/products

From Grower to Gardener,
Improving Our World.

Sign up for HC's monthly e-newsletter!
hc-companies.com/newsletter



Contact your BFG Sales Representative today for more information on purchasing HC's growing containers!



Leader in Horticultural Containers

Pots & Carry Trays

HC Companies® Azalea Pot

Multiple options in style, size, color, and packaging. Made from high-grade polypropylene. Bulk packaging available for most sizes, making shipping and storage more efficient. Features four levels of drainage that are water mat compatible and superior denesting for filling and spacing automation.



Product	Color	Depth	Outside Diam	Max Liquid Volume	Case Qty	Compatible Items	Barcode
DLNAZA06000G18C352	Black	4.25in	6in	1.39qt	352		
DLNAZA06000B66C352	Green	4.25in	6in	1.39qt	352		
DLNAZA06500G18C438	Black	4.62in	6.5in	1.81qt	438	TRS06650	
DLNAZA06500B66C438	Green	4.62in	6.5in	1.81qt	438	TRS06650	
DLNAZN06501G18C240	Black	4.93in	6.5in	2.01qt	240	TCA665J2 TIA06500	
DLNAZN06501B66C240	Green	4.93in	6.5in	2.01qt	240	TCA665J2 TIA06500	

HC Companies® Elite Azalea Pot

Made from high-grade polypropylene. Bulk packaging available for most sizes, making shipping and storage more efficient and providing additional savings to the grower. Designed to hold less soil volume than the traditional azalea pots. Features a dual-drain bottom for optimum drainage and aeration.



Product	Color	Depth	Outside Diam	Max Liquid Volume	Case Qty	Compatible Items	Barcode
DLNAZE05000B66C750	Green	3.5in	5in	.81qt	750	TRS08510	
DLNAZE04500B66K100	Green	3.25in	4.5in	1.28pt	1000	TRS15450, TCG12450	
DLNAZE07000B66C250	Green	5in	7in	2.20qt	250		
DLNAZE07500B66C200	Green	5.5in	7.5in	2.73qt	200		
DLNAZE08000B66C270	Green	5.62in	8in	3.27qt	270		
DLNAZE10001B66C150	Green	7.25in	9.87in	1.58gal	150		
DLNAZE10000G18C100	Black	7.14in	10in	1.65gal	100		

WARNING: This product is not available for sale in CA. For most up to date information please visit bfgsupply.com



Leader in
Horticultural
Containers

Pots & Carry Trays

The HC Companies® Azalea Thinwall Pot

Made from high-grade polypropylene. Bulk packaging available for most sizes, making shipping and storage more efficient and providing additional savings to the grower. Designed to hold less soil volume than traditional azalea pots. Features a dual drain bottom for optimum drainage and aeration.



Product	Color	Depth	Outside Diam	Max Liquid Volume	Case Qty	Compatible Items	Barcode
DLNAZJ06001B66C528 Jumbo	Green	4.99in	6.06in	1.7qt	528	TCA06602, TIS60060, TIS60061, TIS60060	
DLNAZG08501B66C130 with TagSlot	Green	5.81in	8.31in	3.85qt	130		
DLNAZG08501G18C130 with TagSlot	Black	5.81in	8.31in	3.85qt	130		

The HC Companies® Azalea Traditional Thinwall Pot

Made from high-grade polypropylene. Bulk packaging available for most sizes, making shipping and storage more efficient and providing additional savings to the grower.



Product	Color	Depth	Outside Diam	Max Liquid Volume	Case Qty	Compatible Items	Barcode
DLNAZM06000G18C544 Traditional	Black	4.56in	5.4in	1.36qt	544	TCA08550, TCA08552, TIS60060, TIS60061	

The HC Companies® Azalea Traditional Pot

Co-extruded with dual color layering with a dark interior for maximum root protection from light. Lightweight, yet durable polypropylene for greater cost efficiency. Multi-level drain holes for efficient drainage. Strong rims for efficient use in high-speed automated systems.



Product	Color	Depth	Outside Diam	Max Liquid Volume	Case Qty	Compatible Items	Barcode
DLNXAZ05000G18C675 Short	Black	3.75in	5in	1.76pt	675	TCA08503	
DLNXAZ05500G18C496	Black	4.5in	5.25in	1.25qt	496	TCA08551, TCA06551	
DLNXAZ05500X03C496	Green	4.5in	5.25in	1.25qt	496	TCA08551, TCA06551	
DLNXAL05000G18C600 Tall	Black	5.75in	5in	1.25qt	600	TRS5T800	





Leader in Horticultural Containers

Pots & Carry Trays

The HC Companies® Geranium Pot

Co-extruded with dual color layering with a dark interior for maximum root protection from light. Lightweight, yet durable polypropylene for greater cost efficiency. Multi-level drain holes for efficient drainage. Strong rims for efficient use in high-speed automated systems.



Product	Color	Depth	Outside Diam	Max Liquid Volume	Case Qty	Compatible Items	Barcode
DLNXGR04500G18C720	Black	3.75in	4.5in	1.26pt	720	XTG15450, XTG12450, XTG10450, TCG10450, TCG10450	
DLNXGR04500X18C720	Terra Cotta	3.75in	4.5in	1.26pt	720	XTG15450, XTG12450, XTG10450, TCG10450, TCG10450	
DLNXGR04500G18B357 with TagSlot	Black	3.75in	4.5in	1.26pt	35712/PL	XTG15450, XTG12450, XTG10450, TCG10450	
DLNXGR04500X03C720 with TagSlot	Green/Black	3.75in	4.5in	1.26pt	720	XTG15450, XTG12450, XTG10450, TCG10450	

The HC Companies® Geranium Thinwall Pot

Made from high-grade polypropylene. Bulk packaging available for most sizes, making shipping and storage more efficient and providing additional savings to the grower. Various sizes are created and customizable with offset printing capabilities.



Product	Color	Depth	Outside Diam	Max Liquid Volume	Case Qty	Compatible Items	Barcode
DLNSTG04500G18C850	Black	3.81in	4.5in	1.26pt	850	TCG15450, TCG12450, TCG08450	
DLNSTG04500B66C850	Green	3.81in	4.5in	1.26pt	850	TCG15450, TCG12450, TCG08450	
DLNSTG04500B66B344 Bulk	Green	3.81in	4.5in	1.26pt	34410/pl	TCG15540, TCG12450, TCG08450	
DLNSTG04501B66C850 with TagSlot	Green	3.81in	4.5in	1.26pt	850	TCG15450, TCG12450, TCG08450	



Leader in
Horticultural
Containers

Pots & Carry Trays

The HC Companies® Euro Greenhouse Pot

Co-extruded with dual color layering with a dark interior for maximum root protection from light. Lightweight, yet durable polypropylene for greater cost efficiency. Multi-level drain holes for efficient drainage. Strong rims for efficient use in high-speed automated systems.



Product	Color	Depth	Outside Diam	Max Liquid Volume	Case Qty	Compatible Items	Barcode
DLNEU170S50G18C300 17CM	Black	5in	6.62in	2.0qt	300	TRS06171, TIS66650	
DLNEU170S50X03C300 17CM	Green	5in	6.62in	2.0qt	300	TRS06171	
DLNEU190T51G18C132 19CM	Black	7.37in	7.5in	1gal	132		

The HC Companies® Thinwall Pot

Made from high-grade polypropylene. Bulk packaging available for most sizes, making shipping and storage more efficient and providing additional savings to the grower. Various sizes are created and customizable with offset printing capabilities.



Product	Color	Depth	Outside Diam	Max Liquid Volume	Case Qty	Compatible Items	Barcode
DLNSTG03500G18K122	Black	3.25in	3.5in	.698pt	1225	TCR12350	
DLNSTG03500B66K122	Green	3.25in	3.5in	.698pt	1225	TCR12350	
DLNSTG06000B66C440	Green	5.75in	6in	1.87qt	440	TCR06600	

The HC Companies® Standard Thinwall Pot

Made from high-grade polypropylene. Bulk packaging available for most sizes, making shipping and storage more efficient and providing additional savings to the grower. Various sizes are created and customizable with offset printing capabilities.



Product	Color	Depth	Outside Diam	Max Liquid Volume	Case Qty	Compatible Items	Barcode
DLNSTG04000G18K155	Black	3.5in	4in	1.01pt	1550	TRS15400, TCR10400	
DLNSTG04000B66K155	Green	3.5in	4in	1.01pt	1550	TRS15400, TCR10400	
DLNSTG06000G18C440	Black	5.75in	6in	1.87qt	440	TCR06600	





Leader in Horticultural Containers

Pots & Carry Trays

The HC Companies® Co-Extruded Round Pot

Co-extruded with a barrier layer for maximum opacity. Sizes to fit existing benches, carts, and handling systems for added convenience. Customize with offset printing to create unique packaging solutions.



Product	Color	Depth	Outside Diam	Max Liquid Volume	Case Qty	Compatible Items	Barcode
DLNEU170T50G18C294 17CM	Black	6in	6.62in	2.58qt	294	TRS06170, TIS66651, TRI06110	
DLNEU170T50X18C294 17CM	Terra Cotta	6in	6.62in	2.58qt	294	TRS06170, TIS66651, TRI06110	

The HC Companies® Perennial Pot

Co-extruded with dual color layering with a dark interior for maximum root protection from light. Lightweight, yet durable polypropylene for greater cost efficiency. Multi-level drain holes for efficient drainage. Strong rims for efficient use in high-speed automated systems.



Product	Color	Depth	Outside Diam	Max Liquid Volume	Case Qty	Compatible Items	Barcode
DLNXNT0TQT3G18C432 Thermoform Pot	Black	5.25in	4.62in	1.0qt	432	TRS12QD0, TRS10QD0, TCR081Q5, TCR081Q3	
DLNXRD16002G18C200 Prop Co-Ex Pot	Black	6.29in	6.29in	2.50qt	200	YAT06160, YAT06161	
DLNVRT001Q1G18C475 Perennial Pot	Black	4.75in	4.75in	1.0qt	475	TCR121Q0, TCR018Q4	



Leader in
Horticultural
Containers

Pots & Carry Trays

The HC Companies® Short Pot

HC Companies® Coextruded Pots feature a barrier layer for maximum opacity. Constructed from polypropylene for a durable, yet lightweight design for greater cost efficiency. Multi-level drain holes offer efficient drainage, and strong rims for efficient use in high-speed automated systems.



Product	Color	Depth	Outside Diam	Max Liquid Volume	Case Qty	Compatible Items	Barcode
DLNXPR15CS1G18C680	Black	4.17in	6in	1.3qt	680	TSR06150	
DLNXPR15CS1X03C680	Green/ Black	4.17in	6in	1.3qt	680	TSR06150	
DLNXST04002X18K126 with TagLocator	Terra Cotta/ Black	4in	4in	1.0pt	1260	XTR15400, XTR10400, TCR10405, TIS40120	

The HC Companies® Squat Pot

Injection molded containers made of Polypropylene. Durable and rigid construction delivers consistent handling performance and is designed for consistent performance in automated filling and handling equipment. Available with custom coloring and printing.



Product	Color	Depth	Outside Diam	Max Liquid Volume	Case Qty	Barcode
DLNXNS0T1G3G18C140 1gal Trade	Black	6.5in	6.5in	2.5qt	140	

The HC Companies® Deep Perennial Systems Pot

Designed with large soil capacity to specifically accommodate perennial root systems. Use in conjunction with trays to assist in handling and labor savings.



Product	Color	Depth	Outside Diam	Max Liquid Volume	Case Qty	Compatible Items	Barcode
DLNSQL03501G18C832	Black	3.93in	3.5in	1.01pt	832	TCS18350, TCS12330	
DLNSQL04501G18C441	Black	4.93in	4.21in	1.03qt	441	TCS15452, TCS10450	
DLNSQL05502G18C256	Black	5.93in	5.25in	2.04qt	256	TCS05881	





Leader in Horticultural Containers

Pots & Carry Trays



HC Companies® Deep Press Fit Pot (Square)

Co-extruded with dual color layering with a dark interior for maximum root protection from light. Lightweight, yet durable polypropylene for greater cost efficiency. Multi-level drain holes for efficient drainage. Strong rims for efficient use in high-speed automated systems

Product	Color	Depth	Outside Diam	Max Liquid Volume	Case Qty	Compatible Items	Barcode
DLNSVP03001G18C800	Black	3.5in	2.62in	9.47oz	800	TCS32300, TCS25300	
DLNSVP03252G18C450	Black	3.62in	3.25in	15.5oz	450	TCS18330	
DLNSVP04001G18C450	Black	3.5in	3.5in	1.08pt	450	TCS18401	
DLNSVP0450DG18C375	Black	5in	4.12in	1.2qt	375	TCS15452, TCS10452, TCS12450	
DLNSVP04501G18C375	Black	3.62in	4.12in	1.65pt	375	TCS15452, TCS10452, TCS12450	

HC Companies® Deep Pot

Co-extruded with dual color layering with a dark interior for maximum root protection from light. Lightweight, yet durable polypropylene for greater cost efficiency. Multi-level drain holes for efficient drainage. Strong rims for efficient use in high-speed automated systems.



Product	Color	Depth	Outside Diam	Max Liquid Volume	Case Qty	Compatible Items	Barcode
DLNSVP03250G18K120	Black	3.62in	3.25in	1pt	1200	TCS12330	

The HC Companies® Lite Pot (Square)

High quality construction for maximum root protection from light penetration.



Product	Color	Depth	Outside Diam	Max Liquid Volume	Case Qty	Compatible Items	Barcode
DLNSQK04005G18C960	Black	3.5in	4in	1.36pt	960	TRK15400, TRK15400 (K) TCS15401, TRK10400	
DLNSQK04005B66C960	Green	3.5in	4in	1.36pt	960	TRK15400, TRK15400 (K) TCS15401, TRK10400	



Leader in
Horticultural
Containers

Pots & Carry Trays

The HC Companies® Pot (Square)

Co-extruded with dual color layering with a dark interior for maximum root protection from light. Lightweight, yet durable polypropylene for greater cost efficiency. Multi-level drain holes for efficient drainage. Strong rims for efficient use in high-speed automated systems.



Product	Color	Depth	Outside Diam	Max Liquid Volume	Case Qty	Compatible Items	Barcode
DLNXSQM60S0G18C585	Black	4.5in	5in	1.25qt	585	TCS08M60	
DLNXSQ00M60G18C468	Black	5.37in	5in	1.5qt	468	TCS08M60	
DLNXSQ05500G18C200	Black	6in	5.25in	2qt	200	TCS08551	

HC Companies® Quick Lock Pot

Four levels of drainage that are water mat compatible. Features WaveLock tag slots on all four sides (top and bottom insertion keeps tags in place). Can be easily inserted into Quick Lock trays for manual automation. Designed to allow for ease of denesting in automated filling equipment.



Shown in Black

Product	Color	Depth	Outside Diam	Max Liquid Volume	Case Qty	Compatible Items	Barcode
DLNSQQ04500G18C660	Black	3.84in	4.25in	1.6pt	660	TRK1540, TRK1541, TRK12450, TRK10450	
DLNSQQ04500B66C660	Green	3.84in	4.25in	1.6pt	660	TRK1540, TRK1541, TRK12450, TRK10450	
DLNSQQ04500B66B348	Green	3.835in	4.25in	1.6pt	34848/pl	RK1540, TRK1541, TRK12450, TRK10450	





Leader in
Horticultural
Containers

Pots & Carry Trays



The HC Companies® Thinwall Pot

High quality construction for maximum root protection from light penetration.

Product	Color	Depth	Outside Diam	Max Liquid Volume	Case Qty	Compatible Items	Barcode
DLNSQA04000B66C900	Green	3.37in	3.87in	1.16pt	900	TCS15400	
DLNSQA04500B66C765	Green	3.5in	4.12in	1.35pt	765	TCS15450	
DLNSQK04001G18C846 with TagLocator	Black	3.62in	3.96in	1.35pt	846	TRK15400, TRK15400 (K) TCS15401, TRK10400	
DLNSQK04001B66C846 with TagLocator	Green	3.62in	3.96in	1.35pt	846	TRK15400, TRK15400 (K) TCS15401, TRK10400	
DLNSQJ05502G18C288 with TagLocator	Black	5.62in	5.03in	1.89qt	288	TCS08M60	
DLNSQJ05502G18B100 with TagLocator	Black	5.62in	5.03in	1.89qt	10,000/pl	TCS08M60	



The HC Companies® Kord Traditional Pot

Economically designed with a smooth sidewall. Specially adapted for automatic filling equipment and handling by mass merchandisers. Used in conjunction with Kord Quick Lock trays for easy, positive pick-up of pots.

Product	Color	Depth	Outside Diam	Max Liquid Volume	Case Qty	Compatible Items	Barcode
DLNSQN03500B66C504	Green	3in	3.5in	12.2oz	504	TKP18350, TKP12350	



The HC Companies® Kord Sheet of Pots

Create a cost-efficient system from growing to retail. Smooth finish ideal for easy label adhesion. Provides an economic alternative to single pots.

Compatible Trays/Hangers/Accessories: TKP18350, TKP18350

Product	Color	Depth	Outside Diam	Max Liquid Volume	Case Qty	Compatible Items	Barcode
DLNSQN03500B66C504	Black	20.5in	10.25in	.48qt	504	TKP18350, TKP18350	



Leader in
Horticultural
Containers

Pots & Carry Trays

The HC Companies® Pocket Carry Tray

Durable and rigid construction delivers consistent handling performance in every step of the supply chain. Self-orienting features rotate the pots to best display printed graphics. Flat-filler trays fit pots securely for easy evening of soil. Designed to work on roller conveyors and automated potting systems. Lowered sidewall ledge for added strength and greater profile of branded pots. Works well in automated tray dispensers.



DLNTRC06600G18C050 DLNTCA06605G18C050 DLNTCA06600G18C050 DLNTRC06TG0G18C050 DLNTRC081Q4G18C050 DLNTCA08500G18C050 DLNTCA08503G18C050
DLNTRC08450G18C050 DLNXTG10450G18C050 DLNXTG10450G18B015 DLNXTR10400G18C050 DLNTRC10430G18C050 DLNTRS10450G18D050 DLNTRS15459G18D050

Product	Length	Width	Depth	Case Qty	Compatible Items	Barcode
DLNTRC06600G18C050 6-Pocket Tray	18.5in	12.37in	5in	50	ST606000, XST06000	
DLNTCA06605G18C050 6-Pocket Tray	18.5in	12.37in	4.25in	50	XAZ06001	
DLNTCA06600G18C050 6-Pocket Tray	18.5in	12.37in	4.37in	50	AZG06000, STG06000	
DLNTRC06TG0G18C050 6-Pocket Tray	20.62in	13.88in	7.12in	50	NRTOT1G3	
DLNTCA08500G18C050 8-Pocket Tray	19.87in	9.87in	3.75in	50	AZG05001	
DLNTCA08503G18C050 8-Pocket Tray	19.87in	9.87in	3.75in	50	XAZ05000	
DLNTRC08450G18C050 8-Pocket Tray	19.62in	10in	4in	50	STG04500, STG04501	
DLNXTG10450G18C050 10-Pocket Tray	23in	9.5in	3.75in	50	XGR04500	
DLNXTG10450G18B015 10-Pocket Tray	23in	9.5in	3.75in	1500/pl	XGR04500	
DLNXTR10400G18C050 10-Pocket Tray	20.62in	8.25in	4in	50	XST04002	
DLNTRC10430G18C050 10-Pocket Tray	21.5in	8.37in	4.25in	50	STG04253	
DLNTRS10450G18D050 10-Pocket Tray	23.25in	9.37in	4in	50	XGR04500, STT04501	
DLNTRS15459G18D050 12-Pocket Tray	22.5in	13.75in	4in	50	STT04501	





Leader in Horticultural Containers

Pots & Carry Trays

The HC Companies® Pocket Carry Tray

Durable and rigid construction delivers consistent handling performance in every step of the supply chain. Self-orienting features rotate the pots to best display printed graphics. Flat-filler trays fit pots securely for easy evening of soil. Designed to work on roller conveyors and automated potting systems. Lowered sidewall ledge for added strength and greater profile of branded pots. Works well in automated tray dispensers.



Product	Length	Width	Depth	Case Qty	Compatible Items	Barcode
DLNTRS15459G18D050 15-Pocket Tray	18.25in	14in	3.75in	50	STG04500, STG04501	
DLNTRS15459G18D050 15-Pocket Tray	20.25in	12.12in	3.62in	50	STT04001	
DLNTCG15450G18C050 15-Pocket Tray	22.75in	13.75in	4in	50	STG04500, STG04501	
DLNTCG15450G18C050 15-Pocket Tray	20.55in	12.29in	4in	50	XST04002	

The HC Companies® Carry Tray

Durable and rigid construction delivers consistent handling performance in every step of the supply chain. Designed to work on roller conveyors and automated potting systems. Works well in automated tray dispensers.



Product	Length	Width	Depth	Case Qty	Barcode
DLNXTG15450G18C050 15-Pocket Co-Ex Tray	23in	14in	3.75in	50	
DLNXTG10430G18C050 10-Pocket Co-Ex Tray	21in	8.5in	5.5in	50	
DLNTCG10450G18C050 10-Pocket Co-Ex Tray	21.25in	8.5in	5.38in	50	

The H.C. Companies® 6-Pocket Euro Pot Tray

The HC Companies® 6-Pocket Euro Tray is designed for use with 15cm Euro short pots. Durable rigid construction that delivers consistent handling performance in every step of the supply chain. Self-orienting features rotate the pots to best display printed graphics. Flat-filler trays fit pots securely for easy evening of soil. Designed to work on roller conveyors and automated potting systems. Lowered sidewall ledge for added strength and greater profile of branded pots. Works well in automated tray dispensers.



Product	Length	Width	Depth	Case Qty	Barcode
DLNTRS06150G18D050 6-Pocket Euro Pot Tray	17.87in	11.87in	4.37in	50	



Leader in
Horticultural
Containers

Pots & Carry Trays

The HC Companies® Universal Spacer Tray

Open design provides optimal air circulation which prevents algae bloom and stimulates plant growth. Lock pots safely inside the tray making them ideal for multiple transport, growing, and shipping applications. Also perfect for capillary mats, ebb and flood, or flooded floor watering systems



DLNTRS06170G18D050

DLNTIS66651G18D025
DLNTIS66651G18B013

Product	Length	Width	Depth	Case Qty	Compatible Items	Barcode
DLNTRS06170G18D050 6-Pocket Tray	20.25in	13.25in	6.25in	50		
DLNTIS66651G18D025 6-Pocket Tray	19in	12.6in	2.6in	25	XRD16000, EU170S50, EU170T50	
DLNTIS66651G18B013 6-Pocket Tray - Bulk	19in	12.6in	2.6in	1350/pl		

The HC Companies® Carry Tray (Injection Spacer Trays - Round Pots)

Open design provides optimal air circulation which prevents algae bloom and stimulates plant growth. Lock pots safely inside the tray making them ideal for multiple transport, growing, and shipping applications. Also perfect for capillary mats, ebb and flood, or flooded floor watering systems



DLNTIS40120G18D025

DLNTIS45120G18D025

Product	Length	Width	Depth	Case Qty	Compatible Items	Barcode
DLNTIS40120G18D025 8 or 12-Pocket Tray	15in	2.375in	2in	25		
DLNTIS45120G18D025 8 or 12-Pocket Tray	21.62in	16in	2in	25	XGRO4500, STT04501, AZE04500, STG04500, STG04501, STD04500	

The HC Companies® Space Saving Footprint Carry Tray

Durable and rigid construction delivers consistent handling performance in every step of the supply chain. Self-orienting features rotate the pots to best display printed graphics. Flat-filler trays fit pots securely for easy evening of soil. Designed to work on roller conveyors and automated potting systems. Lowered sidewall ledge for added strength and greater profile of branded pots. Works well in automated tray dispensers.



Product	Length	Width	Depth	Case Qty	Compatible Items	Barcode
DLNTCF06SG0G18C050 6-Pocket Tray	20in	13in	2.5in	50	XNSOT162, 01.00 T1G 2 WDTL, 01.00 T1G Squat PRP Coex	

The HC Companies® Open Web Carry Tray

Features a large open mesh bottom. Durable utility product for handling pots in the greenhouse and nursery.



Product	Length	Width	Depth	Case Qty	Barcode
DLNTIU12190G18D025	19.38in	12in	2.88in	25	





Leader in Horticultural Containers

Pots & Carry Trays

The HC Companies® Ribbed Carry Tray

Durable and rigid construction delivers consistent handling performance in every step of the supply chain. Designed to work on roller conveyors and automated potting systems. Works well in automated tray dispensers.



DLNTCS08M60G18C050 DLNTCS08551G18C050 DLNTCS10450G18C050



DLNTCS12330G18C100 DLNTCS15450G18C050 DLNTRK15450G18C050 DLNTCS15401G18C050 DLNTRK15400G18D050 DLNTRK18350G18C050

Product	Length	Width	Depth	Case Qty	Compatible Items	Barcode
DLNTCS08M60G18C050 8-Pocket Tray	19.75in	9.875in	3.75in	50	XSQ00M60	
DLNTCS08551G18C050 8-Pocket Tray	21.25in	10.62in	3.87in	50	SQL5501	
DLNTCS10450G18C050 10-Pocket Tray	21in	8.5in	3in	50	SQL04501	
DLNTRK18350G18C050 12-Pocket Tray	19.5in	6.62in	1.87in	50	XSQ03500	
DLNTCS15450G18C050 15-Pocket Tray	20.62in	12.5in	3.5in	50	SQA04500	
DLNTRK15450G18C050 15-Pocket Tray	21.25in	12.75in	2in	50	SQN04500	
DLNTCS15401G18C050 15-Pocket Tray	20.25in	12.25in	2in	50	SQK04001	
DLNTRK15400G18D050 15-Pocket Tray	21in	13in	2in	50	SQV00940	
DLNTRK18350G18C050 15-Pocket Tray	20.5in	10.5in	2.25in	50	SQN03500	

The HC Companies® Square Pot Tray

Durable and rigid construction delivers consistent handling performance in every step of the supply chain. Designed to work on roller conveyors and automated potting systems. Works well in automated tray dispensers.



DLNTCS15452G18C050 DLNTCS18351G18C050

Product	Length	Width	Depth	Case Qty	Compatible Items	Barcode
DLNTCS15452G18C050 15-Pocket Tray	21.25in	13in	2in	50	SQK04501	
DLNTCS18351G18C050 18-Pocket Tray	19.87in	9.87in	1.87in	50	SQL03501, SVP03250, XSQ03500, IJT18010	



Leader in
Horticultural
Containers



DLNTCS10452G18C050



DLNTCS18330G18C050



DLNTCS15451G18C050

Pots & Carry Trays

The HC Companies® Press Fit Tray

Durable and rigid construction delivers consistent handling performance in every step of the supply chain. Designed to work on roller conveyors and automated potting systems. Works well in automated tray dispensers.



DLNTCS18401G18C050



DLNTCS32300G18C050

Product	Length	Width	Depth	Case Qty	Compatible Items	Barcode
DLNTCS10452G18C050 10-Pocket Tray	21.25in	8.62in	2in	50	SVP04501	
DLNTCS18330G18C050 18-Pocket Tray	19.87in	9.87in	1.87in	50	SVP03250, SVP03252	
DLNTCS15451G18C050 18-Pocket Tray	21in	12.62in	2.37in	50	SVP04501, SVP0450D	
DLNTCS18401G18C050 18-Pocket Tray	21.25in	10.62in	2.37in	50	SVP04001	
DLNTCS32300G18C050 24-Pocket Tray	21.12in	10.62in	1.87in	50	SVP03001	

The HC Companies® Pocket Carry Tray

Durable and rigid construction delivers consistent handling performance in every step of the supply chain. Designed to work on roller conveyors and automated potting systems. Works well in automated tray dispensers. Select trays are ideal for water mat irrigation systems, see the "WM" symbol for exact compatibility.



DLNTCS12450G18C050



DLNTRT184T0G18D050

Product	Length	Width	Depth	Case Qty	Barcode
DLNTCS12450G18C050 12-Pocket Tray	16.75in	12.5in	2.37in	50	
DLNTRT184T0G18D050 18-Pocket Tray	20in	10in	2.25in	50	

The HC Companies® Jr Market Basket

Injection molded polypropylene. Holds up to eight 3.5in square traditional pots.



Product	Length	Width	Depth	Case Qty	Barcode
DLNMPB08350A103050 8-Pocket Basket	15in	15in	4in	50	





Leader in Horticultural Containers

Trays, Inserts & Flats

The HC Companies® Standard Insert

Vacuum formed, high quality bedding plant containers. Precision burned holes and die cut trims deliver consistent performance.



Product	Length	Width	Depth	Case Qty	Compatible Items	Barcode
DLNINA12010G18C100 1201 Std	21in	10.5in	2.25in	100	TWA10200, TWA10201 TWA10203	
DLNINA12020G18C100 1202 Std	21in	10.5in	2.25in	100	TWA10200, TWA10201 TWA10203	
DLNINA12060G18C100 1206 Std	21in	10.5in	2.25in	100	TWA10200, TWA10201 TWA10203	
DLNINA12030G18C100 1203 Std	21in	10.5in	2.25in	100	TWA10200, TWA10201 TWA10203	
DLNINA12040G18C100 1204 Std	21in	10.5in	2.25in	100	TWA10200, TWA10201 TWA10203	
DLNINA18010G18C100 1801 Std	21in	10.5in	2.25in	100	TWA10200, TWA10201 TWA10203	
DLNINA24010G18C100 2401 Std	21in	10.5in	2.25in	100	TWA10200, TWA10201 TWA10203	
DLNINA06060G18C100 606 Std	21in	10.5in	2.25in	100	TWA10200, TWA10201 TWA10203	
DLNINA08010G18C100 1801 Std	21in	10.5in	2.25in	100	TWA10200, TWA10201 TWA10203	
DLNINA08040G18C100 804 Std	21in	10.5in	2.25in	100	TWA10200, TWA10201 TWA10203	
DLNINA08060G18C100 806 Std	21in	10.5in	2.25in	100	TWA10200, TWA10201 TWA10203	
DLNINA08090G18C100 809 Std	21in	10.5in	2.25in	100	TWA10200, TWA10201 TWA10203	
DLNIJA06060G18C100 606 Jumbo	20in	10in	3.25in	100	TWA10200, TWA10201 TWA10203	

WARNING: This product is not available for sale in CA. For most up to date information please visit bfgsupply.com

800-883-0234
www.bfgsupply.com



Leader in
Horticultural
Containers

Trays, Inserts & Flats

The HC Companies® Slim Jim Inserts

Vacuum formed, high quality bedding plant containers. Precision burned holes and die cut trims deliver consistent performance.

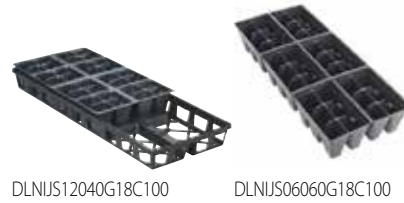

DLNIJS12040G18C100

DLNIJS06060G18C100

Product	Length	Width	Depth	Case Qty	Compatible Items	Barcode
DLNIJS12040G18C100 1204 Slim Jim	19.5in	8.5in	3.12in	100	TVS.R121,TVS.R6.0,TVS.R8.0,TVS85200,TVS.RG1	
DLNIJS06060G18C100 606 Slim Jim	20in	8.5in	3.12in	100	TVS.R121,TVS.R6.0,TVS.R8.0,TVS85200,TVS.RG1	

The HC Companies® Slim Jim Web Flat

Narrow inserts to fit Slim Jim trays. A perfect space saving option when display footprint is a challenge. The open design provides optimal air circulation which prevents algae blooms and stimulates plant growth.



Product	Length	Width	Depth	Case Qty	Barcode
DLNTWSR62G18D050	20in	8.19in	2in	50	

The HC Companies® Standard Open Web Carry Tray

Injection flats deliver increased flexibility and are economically constructed using quality, blended, recycled raw material with additives. Designed for consistent performance in automated filling and handling equipment.

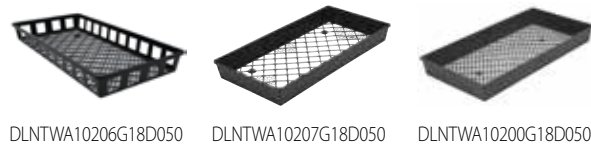

DLNTWA10206G18D050

DLNTWA10207G18D050

DLNTWA10200G18D050

Product	Length	Width	Depth	Case Qty	Barcode
DLNTWA10206G18D050	20in	10in	2.5in	50	
DLNTWA10207G18D050 Medium Weight	21.125in	10.5in	2.5in	50	
DLNTWA10200G18D050 Heavy Weight	21.125in	10.5in	2.5in	50	

The HC Companies® Traditional Open Web Carry Tray (Kord® Daisy)

Open web flats, can be used to shuttle both round and square pots. The open design provides optimal air circulation which prevents algae bloom and stimulates plant growth.



Product	Length	Width	Depth	Case Qty	Barcode
DLNTND10200G18D050 Kord® Daisy	21in	10.75in	2.38in	50	





Leader in Horticultural Containers

Trays, Inserts & Flats

The HC Companies® True Series Insert

Vacuum formed, high quality bedding plant containers. Precision burned holes and die cut trims deliver consistent performance.



Product	Length	Width	Depth	Max Liquid Volume	Case Qty	Compatible Items	Barcode
DLNINT12060G18C100 1206 True	20in	10in	2.5in	11.8oz	100	TWT10200, TWT10201	
DLNINT12040G18C100 1204 True	20in	10in	2.5in	13.5oz	100	TWT10200, TWT10201	
DLNINT12040G18B050 1204 True	20in	10in	2.5in	13.5oz	5000/pl	TWT10200, TWT10201	
DLNINT12030G18C100 1203 True	20in	10in	2.5in	15.20oz	100	TWT10200, TWT10201	
DLNINT08060G18C100 806 True	20in	10in	2.5in	1.16pt	100	TWT10200, TWT10201	
DLNINT08040G18C100 1804 True	20in	10in	2.5in	1.31pt	100	TWT10200, TWT10201	
DLNIJT06060G18C100 606 True Jumbo	20in	10in	3.5in	1.19qt	100	TVT.R6.1, TWT.R6.0	
DLNIJT03060A10C300 T306 True	10in	6.75in	3.5in	2.21qt	300	SPH2DPC0, SPH3DPC0 TVT.R3.0	
DLNIJT18010G18D100 1801 True Deep	20in	10in	3.13in		100	TWT10200, TWT10201	

The HC Companies® True Series Open Web Carry Tray

Injection flats deliver increased flexibility and are economically constructed using quality, blended, recycled raw material with additives. Designed for consistent performance in automated filling and handling equipment.



Product	Length	Width	Depth	Case Qty	Barcode
DLNTWT10201G18D050	20in	10in	2.5in	50	
DLNTWT10201G18B030	20in	10in	2.5in	3000/pl	
DLNTWT10200G18D050 Medium Weight	20in	10in	2.5in	50	

WARNING: This product is not available for sale in CA. For most up to date information please visit bfgsupply.com



Leader in
Horticultural
Containers

Trays, Inserts & Flats

The HC Companies® Perennial Sheet of Pots (Deep Square Cells)

Create a cost-efficient system from growing to retail. Smooth finish ideal for easy label adhesion. Sheet of Pots an economic alternative to single pots.



DLNINP45150G18C050



DLNINP45101G18C050

Product	Length	Width	Depth	Max Liquid Volume	Case Qty	Compatible Items	Barcode
DLNINP45150G18C050 12-Tray	20.75in	12.5in	4.75in	1.75pt	50	TCS15451	
DLNINP45101G18C050 10-Tray	21.62in	8.25in	5in	1.67pt	50	TCS10450	

The HC Companies® Standard Perennial Sheet of Pots

Vacuum formed, high quality bedding plant containers. Precision burned holes and die cut trims deliver consistent performance.



Product	Length	Width	Depth	Max Liquid Volume	Case Qty	Compatible Items	Barcode
DLNINP18010G18C100 18-Tray	21in	10.5in	3.5in	14.5oz	100	TCS18401	

The HC Companies® True Perennial Sheet of Pots

Vacuum formed, high quality bedding plant containers. Precision burned holes and die cut trims deliver consistent performance.



Product	Length	Width	Depth	Max Liquid Volume	Case Qty	Compatible Items	Barcode
DLNINP18012G18C100 18-Tray	20in	10in	3.5in	13.5oz	100	TVT.P180, TRT184T0	

The HC Companies® Annual Sheet of Pots

Create a cost-efficient system from growing to retail. Smooth finish ideal for easy label adhesion. Sheet of Pots an economic alternative to single pots.



Product	Length	Width	Depth	Max Liquid Volume	Case Qty	Compatible Items	Barcode
DLNINP45100G18C050 10-Tray	21.62in	8.25in	4in	1.37pt	50	TCS10450	





Leader in Horticultural Containers

Trays, Inserts & Flats

The HC Companies® Traditional Sheet of Pots

Vacuum formed, high quality bedding plant containers. Precision burned holes and die cut trims deliver consistent performance. Compatible with traditional trays.



Product	Length	Width	Depth	Max Liquid Volume	Case Qty	Compatible Items	Barcode
DLNIJA18010G18C100 1801	21in	10.5in	3.25in	13oz	100	TWA10200, TWA10201 TWA10203	

The HC Companies® Full Depth Flat

Vacuum formed flats are constructed from sturdy gauge polystyrene material for durability. Designed for consistent performance in automated filling and handling equipment.



DLNTVA11210G18C100 DLNTVA11210G18C100J DLNTVAR60G18C100

Product	Length	Width	Depth	Case Qty	Barcode
DLNTVA11210G18C100	21in	10.5in	2.375in	100	
DLNTVA11210G18C100J Open/No Holes	21in	10.5in	2.375in	100	
DLNTVAR60G18C100	21in	10.5in	2.37in	100	

The HC Companies® Vacuum Flat

Vacuum formed flats are constructed from sturdy gauge polystyrene material for durability. Designed for consistent performance in automated filling and handling equipment.



DLNTVTR61G18C100 DLNTVTR81G18D100 DLNTVTR120G18C100

Product	Length	Width	Depth	Case Qty	Barcode
DLNTVTR61G18C100 1020 R6	20in	10in	2.625in	100	
DLNTVTR81G18D100 1020 R8	20in	10in	2.62in	100	
DLNTVTR120G18C100 1020 R12	20in	10in	2.625in	100	

The HC Companies® Utility Handle

Injection molded polypropylene handles for basket packs. Compatible Packs: US01201, US02240, UT01080.

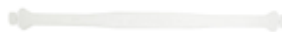

16.25in L - White - 1000/cs
DLNSPH2DPC0A10K100

Min. Buy 1 CS

WARNING: This product is not available for sale in CA. For most up to date information please visit bfgsupply.com



Leader in
Horticultural
Containers

Propagation & Plug Trays

The HC Companies® Propagation

Unmatched variety, quality and economy for any grower requirement. Ideal for seed germination or vegetative propagation. Precision punched holes guarantee optimal drainage and air pruning performance. Trays available with stacking notches for quick and easy de-nesting in automated equipment.



DLNPGA288C0G18C050

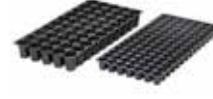

DLNPRO050R0G18C100



DLNPGA105H0G18C050

Product	Length	Width	Depth	Max Liquid Volume	Case Qty	Barcode
DLNPGA288C0G18C050 288 Common Element Plug Tray	20.5in	10.25in	1.06in	3.04qt	50	
DLNPRO050R0G18C100 50 - Sheet of Pots	20.75in	10.31in	2.37in	4.76qt	100	
DLNPGA105H0G18C050 Strip Plug Trays (Hexagon Cells)	20.75in	10.25in	1.75in	2.66qt	50	

Nursery Containers

HC Companies® Whiteridge Nursery Pot

Nursery pots are great for use indoors or outdoors and they can be cleaned and reused again and again. Pots are blow-molded and feature a top lip for a sure grip. Designed with consistency and durability in mind.



Product	Color	Depth	Outside Diam	Max Liquid Volume	Case Qty	Barcode
DLNBW00075G18D028 7gal Trade	Black	12in	13.75in	6.49gal	28	
DLNBW00100G18D015 10gal Trade Squat	Black	11.75in	17.75in	9.72gal	15	
DLNBW00150G18D015 15gal True	Black	15.75in	17.75in	15gal	15	
DLNBW00250G18D005 25gal Trade	Black	18in	23in	26.5gal	5	

HC Companies® Elite Nursery Pot

Nursery pots are great for use indoors or outdoors and they can be cleaned and reused again and again. Pots are blow-molded and feature a top lip for a sure grip. Ideal for small to medium shrubs and ornamentals. Designed with consistency and durability in mind.



Product	Color	Depth	Outside Diam	Max Liquid Volume	Case Qty	Barcode
DLNBMS03000G18D060 Elite 300 - Squat	Black	6.37in	6.5in	2.49qt	60	
DLNBM03000G18D065 Elite 300	Black	7in	6.5in	.74gal	65	
DLNBM04000G18D075 Elite 400	Black	7.25in	7.5in	1gal	75	
DLNBMS12000G18D050 Elite 1200 - Squat	Black	7.62in	11in	2.5gal		
DLNBM20000G18D050 Elite 2000	Black	11in	11.87in	3.9gal	50	





Leader in
Horticultural
Containers

Nursery Containers

The HC Companies® ProCal Dillen® Trade Nursery Pots

Injection and thermoformed containers made of Polypropylene. Durable and rigid construction delivers consistent handling performance and is designed for consistent performance in automated filling and handling equipment. Available with custom coloring and printing.

Product	Color	Depth	Outside Diam	Max Liquid Volume	Case Qty	Compatible Items	Barcode
DLNNRT0T1G3G18C128 1gal Injection	Black	7in	6.5in	2.88qt	128	TCR06TG0 TCF06SG0 TRPTGAL0 TCW03TG0	
DLNNSR001G0G18D025 1gal Injection Side Drain	Black	7in	6.5in	2.9qt	25		
DLNNSR001G0G18B065 1gal Injection Side Drain	Black	7in	6.5in	2.9qt	6500/pl		
DLNNBB001G0G18B065 1gal Injection	Black	7in	6.5in	2.94qt	6500/pl		
DLNNSB002G0G18D050 2gal Injection Side Drain	Black	8.56in	9in	1.74gal	50		
DLNNSB002G0G18B027 2gal Injection Side Drain	Black	8.56in	9in	1.74gal	2700/pl		
DLNNS003G0G18D035 3gal Squat Injection	Black	8in	10in	2.14gal	35		
DLNNS003G0G18B014 3gal Squat Injection	Black	8in	10in	2.14gal	1400/pl		
DLNNS005G2G18D030 5gal Squat Injection	Black	9in	12.5in	3.75gal	30		
DLNNS005G2G18E960 5gal Squat Injection	Black	9in	12.5in	3.75gal	960/pl		
DLNNBB005G0G18B014 5gal Squat Injection	Black	12.12in	11in	3.67gal	1440/pl		
DLNNS015G0G18E360 15gal Squat Injection	Black	15in	19.25in	12.7gal	360/pl		
DLNTFR001G0G18B075 1gal TF	Black	7in	6.5in	2.87qt	7500/pl		
DLNTFR002G1G18B032 Bulk	Black	8.5in	8.8in	1.74gal	3240/pl		
DLNTFR003G0G18B018 3gal TF	Black	9.12in	10.25in	2.58gal	1800/pl		
DLNTFT003G0G18B026	Black	11.75in	10.5in	3gal	2600/pl		
DLNTFR005G0G18B015 5gal TF	Black	12in	11in	3.58gal	1584/pl		



Leader in
Horticultural
Containers

Nursery Containers

HC Companies® Nursery Pot

Blow mold nursery growing containers. Tapered side walls for added strength. Lightweight alternative to injection molded.



Product	Color	Depth	Outside Diam	Max Liquid Volume	Barcode
DLNAMK06000G18D060 600 Series	Black	8.5in	8.75in	1.72gal	
DLNAMK10000G18D050 1000 Series	Black	9in	10in	2.33gal	
DLNAMK12000G18D050 1200 Series	Black	9.62in	11in	3gal	

Mum Pans

The HC Companies® Round Co-Extruded Thermoformed Mum Pan Bulk

Co-extruded with dual color layering with a dark interior for maximum root protection from light. Lightweight, yet durable polypropylene for greater cost efficiency. Multi-level drain holes for efficient drainage. Strong rims for efficient use in high-speed automated systems. The colored exterior can be customized by offset printing to create immediate brand recognition.



Product	Color	Depth	Outside Diam	Max Liquid Volume	Case Qty	Barcode
DLNXAM08000X18B097	Terra Cotta/ Black	5in	8in	2.78qt	9720/pl	
DLNXAM08000G18B097	Black	5in	8in	2.78qt	9720/pl	





Leader in Horticultural Containers

Mum Pans

The HC Companies® Mum Pan

Co-extruded with dual color layering with a dark interior for maximum root protection from light. Lightweight, yet durable polypropylene for greater cost efficiency. Multi-level drain holes for efficient drainage. Strong rims for efficient use in high-speed automated systems. The colored exterior can be customized by offset printing to create immediate brand recognition.



DLNXAM08000G18C170



DLNXAM08000X18C170



DLNAZM08000G18C150



DLNXAM09001G18C090
DLNXAM09001G18B027



DLNXAM09001X18C090
DLNXAM09001X18B027



DLNAZM09000G18C054

Product	Color	Depth	Outside Diam	Max Liquid Volume	Case Qty	Compatible Items	Barcode
DLNXAM08000G18C170	Black	5in	8in	2.78qt	170		
DLNXAM08000X18C170	Terra Cotta/Black	5in	8in	2.78qt	170		
DLNAZM08000G18C150	Black	5.06in	8in	2.78qt	150	TCA04800	
DLNXAM09001G18C090	Black	6.25in	9in	1.2gal	90		
DLNXAM09001G18B027 Bulk	Black	6.25in	9in	1.2gal	2700/pl		
DLNXAM09001X18C090	Terra Cotta/Black	6.25in	9in	1.2gal	90		
DLNXAM09001X18B027 Bulk	Terra Cotta/Black	6.25in	9in	1.2gal	2700/pl		
DLNAZM09000G18C054	Black	6.56in	9in	1.25gal	54		



The HC Companies® Mum Thinwall Pan (Round)

Made from high-grade polypropylene. Bulk packaging available for most sizes, making shipping and storage more efficient and providing additional savings to the grower.

Product	Color	Depth	Outside Diam	Max Liquid Volume	Case Qty	Barcode
DLNAZM09000E24C054	Terra Cotta	6.56in	9in	1.25gal	54	
DLNAZM09000E24B053 Bulk	Terra Cotta	6.56in	9in	1.25gal	5300/pl	



Leader in
Horticultural
Containers

Hanging Baskets

The HC Companies® Cascade Saucerless Hanging Basket

Renowned for its stylish swirled design, this saucerless hanging basket has an internal capillary dish that creates a reservoir to promote longer plant life. Accommodates metal or plastic hangers - sold separately.



Product	Color	Depth	Outside Diam	Max Liquid Volume	Case Qty	Compatible Items	Barcode
DLNHCA10000B661100	Green	6.12in	10in	1.34gal	100	HZP3E103, HZP3E100, HZS.L170, HZS.L210	
DLNHCA10000A101100	White	6.12in	10in	1.34gal	100	HZP3E103, HZP3E100, HZS.L170, HZS.L210	
DLNHCA10000A10B048 Bulk	White	6.12in	10in	1.34gal	4800/pl	HZP3E103, HZP3E100, HZS.L170, HZS.L210	

The HC Companies® Centabella Collection Hanging Basket

Classic, fluted design. Engineered for high volume production in commercial grower applications.



Product	Color	Depth	Outside Diam	Max Liquid Volume	Case Qty	Compatible Items	Barcode
DLNCBH11000E221100	Clay	7in	10.87in	1.81gal	100	HZP3LSN0, HZP3MSN0	
DLNCBH12000E221050	Clay	7in	12.37in	2.30gal	50	HZP4LSN0, HZP4MSN0	
DLNCBH12000E261050	Sandstone	7in	12.37in	2.30gal	50	HZP4LSN0, HZP4MSN0	

The HC Companies® Color Saucerless Hanging Basket

Flexible yet sturdy plastic container with drainage holes in bottom. Perfect for patio, porch or deck.S.L240



Product	Color	Depth	Outside Diam	Max Liquid Volume	Case Qty	Compatible Items	Barcode
DLNCPH12000E221025	Clay	7.25in	12.18in	2.29gal	25	HZP4E120, HZS.L240	
DLNCPH12000E321025	Mocha	7.25in	12.18in	2.29gal	25	HZP4E120, HZS.L240	





Leader in Horticultural Containers

Hanging Baskets

The HC Companies® Euro Hanging Basket

These saucerless hanging baskets are renowned for their stylish swirled design. Hangers sold separately. Large hooks easily snap onto basket rim for secure hanging and clean merchandising.



Product	Color	Depth	Outside Diam	Max Liquid Volume	Case Qty	Compatible Items	Barcode
DLNHSI06000B661100	Green	4.25in	6.5in	1.59qt	100	HZP3E100, HZS.L170	
DLNHSI06000A101100	White	4.25in	6.5in	1.59qt	100	HZP3E100, HZS.L170	
DLNHSI08008B661050	Green	5.56in	8in	3.23qt	50	HZP3E103, HZP3E100, HZS.L170, HZS.L210	
DLNHSI08008A101050	White	5.56in	8in	3.23qt	50	HZP3E103, HZP3E100, HZS.L170, HZS.L210	
DLNHSI1000BB661050	Green	5.56in	10in	3.23qt	50		
DLNHSI1000BA101050	White	5.56in	10in	3.23qt	50		
DLNHSI12000B661050	Green	7.25in	11.75in	2.39gal	60	HZP3E103, HZP3E100, HZS.L170, HZS.L210	
DLNHSI12000B66B020 Bulk	Green	7.25in	11.75in	2.39gal	2080/pl	HZP4E120, HZS.L240	
DLNHSI12000A101050	White	7.25in	11.75in	2.39gal	60	HZP3E103, HZP3E100, HZS.L170, HZS.L210	
DLNHSI12000A10B020 Bulk	White	7.25in	11.75in	2.39gal	2080/pl	HZP4E120, HZS.L240	

The HC Companies® Kord Hanging Basket

Traditional design basket that includes a large water reservoir for better plant performance and superior aeration with high-chimney capillary dish side air vents.



Product	Color	Depth	Outside Diam	Max Liquid Volume	Case Qty	Compatible Items	Barcode
DLNHNI10000A102100	White	6.75in	10.75in	1.66gal	100	HZP3LSN0	
DLNHNI10000B662100	Green	6.75in	10.75in	1.66gal	100	HZP3LSN0	
DLNHNI12000B662050	Green	7.5in	12.75in	2.74gal	50	HZP4LSN0, HZP4MSN	

WARNING: This product is not available for sale in CA. For most up to date information please visit bfgsupply.com



Leader in
Horticultural
Containers

Hanging Baskets

The HC Companies® Traditional Hanging Basket

Traditional and classic design. Includes inside divider, featuring center drain with water reservoir. Greater soil volume for larger plants.



Product	Color	Depth	Outside Diam	Max Liquid Volume	Case Qty	Compatible Items	Barcode
DLNHTI10754A10B024 Bulk	White	6.93in	10in	1.64gal	2400/pl	HZP3LSN0, HZP3E100, HZP3E103, HZS21002, HZP3LSN0, HZP3E106	
DLNHTI10002B661050	Green	6.93in	10in	1.64gal	50	HZP3LSN0, HZP3E100, HZP3E103, HZS21002, HZP3LSN0, HZP3E106	
DLNHTI10754B66B024 Bulk	Green	6.93in	10in	1.64gal	2400/pl	HZP3LSN0, HZP3E100, HZP3E103, HZS21002, HZP3LSN0, HZP3E106	
DLNHTS10000A101050	White	5.87in	10.75in	1.47gal	50	HZP3LSN0, HZP3E100, HZP3E103, HZS21002, HZP3LSN0, HZP3E106	
DLNHTS10000B661050	Green	5.87in	10.75in	1.47gal	50	HZP3LSN0, HZP3E100, HZP3E103, HZS21002, HZP3LSN0, HZP3E106	
DLNHTS11002A101050	White	6.5in	10.75in	1.73gal	50	HZP3E100, HZP3E103, HZS21002, HZP3MSN0, HZP3LSN0, HZP3E106	
DLNHTS11002B661050	Green	6.5in	10.75in	1.73gal	50	HZP3E100, HZP3E103, HZS21002, HZP3MSN0, HZP3LSN0, HZP3E106	
DLNHTI12000A101050	White	7.12in	12in	2.21gal	50	HZP4E120, HZS.L240	
DLNHTI12000B661050	Green	7.12in	12in	2.21gal	50	HZP4E120, HZS.L240	
DLNHTI12000B66B018 Bulk	Green	7.12in	12in	2.21gal	1800/pl	HZP4E120, HZS.L240	
DLNHTI12000E321050	Mocha	7.12in	12in	2.21gal	50	HZP4E120, HZS.L240	
DLNHTS12000A101050	White	7.5in	13in	2.77gal	50	HZP4E120, HZS.L240	
DLNHTS12000A10B018 Bulk	White	7.5in	13in	2.77gal	1800/pl	HZP4E120, HZS.L240	
DLNHTS12000B661050	Green	7.5in	13in	2.77gal	50	HZP4E120, HZS.L240	
DLNHTI10754A101050 with TagSlot	White	6.93in	10.75in	1.64gal	50		
DLNHTI10754B661050 with TagSlot	Green	6.93in	10.75in	1.64gal	50		





Leader in Horticultural Containers

Hanging Baskets

The HC Companies® Traditional Hanging Basket with Saucer

Traditional and classic design. Includes inside divider, featuring center drain with water reservoir. Greater soil volume for larger plants. With saucer. Hanger not included.



Product	Color	Depth	Outside Diam	Max Liquid Volume	Case Qty	Compatible Items	Barcode
DLNHTO08750A101050	White	5.06in	8.85in	2.86qt	50	HZP3E103, HZP3E100, HZS.L170, HZS.L210	
DLNHTO08750B661050	Green	5.06in	8.85in	2.86qt	50	HZP3E103, HZP3E100, HZS.L170, HZS.L210	
DLNHTO10751A101050	White	6.9in	10.75in	1.6gal	50	HZS.L170, HZS.L210 HSP3E102, HZP3E100, HZS21002	
DLNHTO10752A10B024WS Bulk	White	6.9in	10.75in	1.6gal	2400/pl	HZS.L170, HZS.L210 HSP3E102, HZP3E100, HZS21002	
DLNHTO10752B661050	Green	6.9in	10.75in	1.6gal	50	HZS.L170, HZS.L210 HSP3E102, HZP3E100, HZS21002	
DLNHTO10752B66B024WS Bulk	Green	6.9in	10.75in	1.6gal	2400/pl	HZS.L170, HZS.L210 HSP3E102, HZP3E100, HZS21002	
DLNHTO11501A101050WS	White	6.5in	11.7in	1.77gal	50	HZP4E120, HZS.L240	
DLNHTO11501B661050WS	Green	6.5in	11.7in	1.77gal	50	HZP4E120, HZS.L240	

The HC Companies® Tuscan Saucerless Hanging Baskets

A “fluted” design gives this hanging basket a bold, impressive appearance. Features a bottom water reservoir and center drain. Elite Hanging Baskets are available with in-rim hanger. Includes cap dish, hangers sold separately.



Product	Color	Depth	Outside Diam	Max Liquid Volume	Case Qty	Compatible Items	Barcode
DLNTUH10000A101100	White	5.75in	24.5in	1.27gal	100	HZP3E103, HZP3E100 HZS.L170, HZS.L210	
DLNTUH10000B661100	Green	5.75in	24.5in	1.27gal	100	HZP3E103, HZP3E100 HZS.L170, HZS.L210	



Leader in
Horticultural
Containers

Hanging Baskets

The HC Companies® Ultra Series Hanging Basket

Classic style with a rough textured finish, featuring large soil volume for larger plants. Inside divider featuring center drain water reservoir. TagSlot for plant identification details. Hangers sold separately.



Product	Color	Depth	Outside Diam	Max Liquid Volume	Case Qty	Compatible Items	Barcode
DLNULH11000E26C100	Sand	6.5in	11in	1.65gal	100	HZP3LSN0	
DLNULH12000E261050	Sand	7in	12in	2.15gal	50	HZP4LSN0, HZP4MSN0	

The HC Companies® Wrapt Hanging Basket

Renowned for its stylish swirled design, this saucerless hanging basket has an internal capillary dish that creates a reservoir to promote longer plant life. Constructed of polypropylene. Hangers not included.



Product	Color	Depth	Outside Diam	Max Liquid Volume	Case Qty	Barcode
DLNHWA11005G181025	Black	6.55in	11in	1.70gal	25	
DLNHWA11005E211025	Chocolate	6.55in	11in	1.70gal	25	
DLNHWA11005E261025	Sandstone	6.55in	11in	1.70gal	25	
DLNHWA11005B661025	Green	6.55in	11in	1.70gal	25	
DLNHWA13001G181025	Black	7.75in	13in	2.73gal	25	
DLNHWA13001E211025	Chocolate	7.75in	13in	2.73gal	25	
DLNHWA13001E261025	Sandstone	7.75in	13in	2.73gal	25	
DLNHWA13001B661025	Green	7.75in	13in	2.73gal	25	

The HC Companies® Cordova Collection Hanging Basket

Flexible, sturdy containers are perfect for patio, porch, or deck use, adding charm to any location. Constructed from convenient and durable lightweight resin for easy care. Accommodate metal or plastic hangers.



Product	Color	Depth	Outside Diam	Max Liquid Volume	Case Qty	Compatible Items	Barcode
DLNCDH12000E221025	Clay	8.5in	13in	3.14gal	25	HZP4E120, HZS12HA0	





Leader in
Horticultural
Containers

Hanging Baskets

The HC Companies® Decostone Collection Hanging Basket

Flexible, sturdy containers are perfect for patio, porch, or deck use, adding charm to any location. Constructed from convenient and durable lightweight resin for easy care. Accommodates metal or plastic hangers.



Product	Color	Depth	Outside Diam	Max Liquid Volume	Case Qty	Compatible Items	Barcode
DLNSHH12000E261050	Sandstone	7in	12.87in	2.17gal	50	HZP4LSN0	

The HC Companies® Elite Series Hanging Basket

A “fluted” design gives this hanging basket a bold, impressive appearance. Features a bottom water reservoir and center drain. Hangers sold separately.



Product	Color	Depth	Outside Diam	Max Liquid Volume	Case Qty	Compatible Items	Barcode
DLNHES10001B66B032 Bulk	Green	5.62in	10in	1.3gal	3200/pl	HZP3E103, HZP3E100 HZS.L170, HZS.L210	

The HC Companies® Mojave Hanging Basket - Includes Hangers & Disc

Authentic look and texture of stone with a classic swirl design. Finish is UV protected and can be used indoor or outdoors. Includes inner reservoir disk and hanger.



Product	Color	Depth	Outside Diam	Max Liquid Volume	Case Qty	Compatible Items	Barcode
DLNMOH14000A05C012	Sandstone	7.75in	15in	3.38gal	12	HZPAW140	

The HC Companies® Traditional Saucerless Hanging Basket with Inside Saucer/Disk



Product	Color	Depth	Outside Diam	Max Liquid Volume	Case Qty	Compatible Items	Barcode
DLNHTS12000B66B018 Bulk	Green	7.5in	12in	2.77gal	1800/pl	HZP4E120, HZS.L240	

WARNING: This product is not available for sale in CA. For most up to date information please visit bfgsupply.com

800-883-0234
www.bfgsupply.com



Leader in
Horticultural
Containers

Hanging Baskets

The HC Companies® East Wind RiverStone Hanging Basket

East Wind series hanging baskets come in a number of classic styles and finishes. Baskets features chimney style drainage. Inspired by natural and robust textures with a premium high-quality, glossy finish. Made from durable polypropylene.



Product	Color	Depth	Outside Diam	Max Liquid Volume	Case Qty	Compatible Items	Barcode
DLNYVH12000Y166025	Rosso	7in	12in	2.5gal	25	HZP4E120	
DLNSH13500E22C025	Sulfur	7in	12in	2.5gal	25	HZP4E120	



The HC Companies® E-10L Long 3-Strand Plastic Hanger

The E-10L Long 3-Strand Hanger fits a variety of pots - and lets them hang a little longer. Clip hanger is made from injection molded plastic to be both lightweight and durable. Available in a variety of Colors.



19.5in - Black - 3-Strand - Clip Hanger
DLNHZP3E103G18D050 Min. Buy 50 EA

19.5in - Brown - 3-Strand - Clip Hanger
DLNHZP3E103E21D050 Min. Buy 50 EA

19.5in - Clay - 3-Strand - Clip Hanger
DLNHZP3E103E22D050 Min. Buy 50 EA

19.5in - Green - 3-Strand - Clip Hanger
DLNHZP3E103B66D050 Min. Buy 50 EA

19.5in - Mocha - 3-Strand - Clip Hanger
DLNHZP3E103E32D050 Min. Buy 50 EA

19.5in - White - 3-Strand - Clip Hanger
DLNHZP3E103A10D050 Min. Buy 50 EA

19.5in - White - 3-Strand - Clip Hanger - Bulk
DLNHZP3E103A10C450 Min. Buy 450 EA

The HC Companies® Long Snap Plastic Hangers

Plastic 3-strand clip hanger fits a variety of pots.



Green 3-strand - 18in
DLNHZP3LSN0B66D025 Min. Buy 25 EA

White 3-strand - 18in
DLNHZP3LSN0A10C500 Min. Buy 500 EA

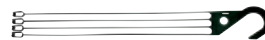

The HC Companies® 4-Strand Plastic Hanger

This plastic hanger can be added to corresponding planters for added display versatility.



22in L - Black
DLNHZP4E120G18D025 Min. Buy 25 EA





Leader in
Horticultural
Containers

Hanging Baskets



The HC Companies® Plastic Hangers

Plastic 3-strand clip hanger fits a variety of pots.



Mocha 3-strand - 16in
DLNHZP3E100E32D050 Min. Buy 50 EA

Green - 3-strand - 16in L
DLNHZP3E100B66D050 Min. Buy 50 EA

Green - 3-strand - 16in L
DLNHZP3E100B66C800 Min. Buy 800 EA

White - 3-strand - 16in L
DLNHZP3E100A10D050 Min. Buy 50 EA

White - 3-strand - 16in L
DLNHZP3E100A10C800 Min. Buy 800 EA



White - 3-strand - 18in L
DLNHZP3LSN0A10C025 Min. Buy 25 EA

Sandstone - 3-strand - 18in L
DLNHZP3LSN0E26D025 Min. Buy 25 EA



The HC Companies® Plastic Hangers

Plastic 4-strand clip hanger fits a variety of pots.



Mocha - 22in L - 4-strand
DLNHZP4E120E32D025 Min. Buy 25 EA

Green - 22in L - 4-strand
DLNHZP4E120B66D025 Min. Buy 25 EA

White - 22in L - 4-strand
DLNHZP4E120A10D025 Min. Buy 25 EA

Clay - 22in L - 4-strand
DLNHZP4E120E22D025 Min. Buy 25 EA



The HC Companies® Metal Hanger

Wire 3-strand hanger. Sold by 50 hangers per bag.



17in L - 3-strand
DLNHZSL170D050 Min. Buy 1 BG



The HC Companies® Metal Hanger

Wire 4-strand hanger. Sold by 50 hangers per bag.



24in L - 4-strand
DLNHZSL240D050 Min. Buy 1 BG



The HC Companies® Wire Hangers

Wire 3-strand hanger. Sold by 50 hangers per bag.



Metal 3-strand - 21in
DLNHZSL210D050 Min. Buy 1 BG



The HC Companies® Wire Hangers

Wire 4-strand hanger. Sold by 50 hangers per bag.



21in L - 4-strand - Metal
DLNHZSL4W0D050 Min. Buy 1 BD

The HC Companies® Capillary Dish

A plastic disc that goes inside of a basket to promote drainage on the soil but keep the moisture within the basket.



12in Diam - Black
DLNSDD12000G18C300 Min. Buy 300 EA



The HC Companies® Reversible Cap Dish

Both sides are identical. No need to determine the top or bottom before dropping in the hanging basket. Saves time for the grower!



Black - 800/CS
DLNSDD10001G18C800 Min. Buy 1 CS

Black - 1600/CS
DLNSDD10001G18K160 Min. Buy 1 CS

WARNING: This product is not available for sale in CA. For most up to date information please visit bfgsupply.com



Leader in
Horticultural
Containers

Decorative Planters

The HC Companies® Centabella Planter

Classic, fluted design that fits most any setting. Features an extra wide base for stability, sturdy heavy rim and a dual-drain bottom for root aeration and increased airflow. De-nests easily. Engineered for high-volume production in commercial growing applications.



Product	Color	Depth	Outside Diam	Max Liquid Volume	Case Qty	Barcode
DLNCBU12500E22C024	Clay	9.5in	12.5in	3.25gal	24	
DLNCBU15500E22C012	Clay	12.5in	15.5in	6.19gal	12	
DLNCBU19000E22C012	Clay	15in	19in	11.4gal	12	

The HC Companies® Color Collection

Flexible yet sturdy plastic container with drainage holes in bottom. Perfect for patio, porch or deck.



Product	Color	Depth	Outside Diam	Max Liquid Volume	Case Qty	Barcode
DLNCPP12000E22C088 Oval Pot	Clay	5in	12.96in	1.06gal	88	
DLNCPP16000E22C043 Oval Pot	Clay	5.87in	16.93in	2.06gal	43	
DLNCPP20000E22C028 Oval Pot	Clay	6in	20.87in	2.72gal	28	
DLNCPS08000E22C056 Square Pot	Clay	7.06in	20.32in	1.3gal	56	
DLNCPS12000E22C032 Square Pot	Clay	10in	11.37in	3.08gal	32	
DLNCPS15000E22C010 Square Pot	Clay	12.37in	14.37in	6.5gal	10	
DLNCPS15000E32C010 Square Pot	Mocha	12.37in	14.37in	6.5gal	10	





Leader in Horticultural Containers

Decorative Planters



The HC Companies® Color Collection

Flexible yet sturdy plastic container with drainage holes in bottom. Perfect for patio, porch or deck.

Product	Color	Depth	Outside Diam	Max Liquid Volume	Case Qty	Barcode
DLNCPB10001E22C082 Bowl	Clay	4.75in	9.93in	1.02gal	82	
DLNCPB12000E22C042 Bowl	Clay	5.18in	12.68	1.85gal	42	
DLNCPB12000E32C042 Bowl	Mocha	5.18in	12.68	1.85gal	42	
DLNCPB14000E22C045 Bowl	Clay	5.62in	14.75in	2.57gal	45	
DLNCPA06003E22C098 Round Pot	Clay	5.5in	6.81in	2.12qt	98	
DLNCPA10002E22C050 Round Pot	Clay	7.87in	9.87in	1.67gal	50	
DLNCPA08002E22C058 Round Pot	Clay	6.06in	8.93in	1.01gal	58	
DLNCPA10002E32C050 Round Pot	Mocha	7.87in	9.87in	1.67gal	50	
DLNCPA10003E22C058 Round Pot	Clay	7.75in	11in	2gal	58	
DLNCPA10003E22B024 Round Pot - Bulk	Clay	7.75in	11in	2gal	2400/pl	
DLNCPA10003E32C058 Round Pot	Mocha	7.75in	11in	2gal	58	
DLNCPA12001E22C040 Round Pot	Clay	9.5in	11.81in	2.87gal	40	
DLNCPA12000E22C028 Round Pot	Clay	9.5in	13.37in	3.62gal	28	
DLNCPA12000E22B015 Round Pot - Bulk	Clay	9.5in	13.37in	3.62gal	1500/pl	
DLNCPA12000E21C028 Round Pot	Chocolate	9.5in	13.37in	3.62gal	28	
DLNCPA12000E32C028 Round Pot	Mocha	9.5in	13.37in	3.62gal	28	
DLNCPA14000E22C020 Round Pot	Clay	11.31in	15.53in	5.66gal	20	
DLNCPA08002E32C058 Round Pot - w TagLocator	Mocha	6.06in	8.93in	1.01gal	58	
DLNCPA12001E32C040 Round Pot - w TagLocator	Mocha	9.5in	11.81in	2.87gal	40	



Leader in
Horticultural
Containers

Decorative Planters

The HC Companies® Decostone Collection Planter

Distinctively designed texture has a stone-like appearance. Create an upscale look for combos, tropicals and foliage. Extra-wide base for stability.



Product	Color	Depth	Outside Diam	Max Liquid Volume	Case Qty	Barcode
DLNSH11500E22C050 Round Pot	Clay	8.5in	11in	2gal	50	
DLNSH13500E22C025 Round Pot	Clay	10in	13.37in	3.38gal	25	
DLNSH13500E26C025 Round Pot	Sandstone	10in	13.37in	3.38gal	25	
DLNSH16000E22C020 Round Pot	Clay	12in	15.75in	5.28gal	20	
DLNSH16000E26C020 Round Pot	Sandstone	12in	15.75in	5.28gal	20	

The HC Companies® Panterra Pot

Features a dual-drain bottom for drainage and aeration.



Product	Color	Depth	Outside Diam	Max Liquid Volume	Case Qty	Compatible Items	Barcode
DLNPAB08000E22C250 Bowl	Clay	3.87in	8in	2.17qt	250	SPA08000	
DLNPAB10000E22C100 Bowl - w TagGrip	Clay	4.87in	10in	1.06gal	100	SPA10000	
DLNPA09000E22C100 Pot	Clay	7.75in	10in	1.56gal	100		
DLNPA10000E22C100 Pot	Clay	7.75in	11.12in	1.92gal	100	SPA10000, SPC10000	
DLNPA12000E22C058 Pot	Clay	9.5in	13.25in	3.35gal	58		
DLNPA14000E22C025 Pot	Clay	11.37in	15.62in	5.54gal	25		

The HC Companies® Cordova Collection Pot (Round)

Flexible, sturdy containers are perfect for patio, porch, or deck use, adding charm to any location. Constructed from convenient and durable lightweight resin for easy care.



Product	Color	Depth	Outside Diam	Max Liquid Volume	Case Qty	Barcode
DLNCDA14000E22C022	Clay	10in	15in	5.20gal	22	





Leader in Horticultural Containers

Decorative Planters

The HC Companies® East Wind Canyon Tall Planter (Square)

The paint finish on these pots accentuates the engrained texture of the container. Inspired by natural and robust textures, these durable containers are designed to complement your home from the inside and out. Premium finish includes high-quality, glossy finish. Made from durable polypropylene.



Product	Color	Depth	Outside Diam	Max Liquid Volume	Case Qty	Barcode
DLNYMT14000Y43C012	Black Cherry	16in	14in	8.5gal	12	

The HC Companies® Kord Bulb Pan

Durable construction to accommodate most bulb crops and withstand cold temperatures.



Product	Color	Depth	Outside Diam	Max Liquid Volume	Case Qty	Barcode
DLNPAN10001B66C096	Black	5.06in	10.06in	1.32gal	96	

The HC Companies® Standard Thinwall Pot

Made from high-grade polypropylene. Bulk packaging available for most sizes, making shipping and storage more efficient and providing additional savings to the grower. Various sizes are created and customizable with offset printing capabilities.



Product	Color	Depth	Outside Diam	Max Liquid Volume	Case Qty	Barcode
DLNSTS08000G18C100	Black	7.12in	8.43in	1.01 gal	100	
DLNSTS08000B66C100	Green	7.12in	8.43in	1.01 gal	100	

The HC Companies® Wire Hanging Basket Hoop Assembly

Metal wire hoop hanger assembly for 14in hanging pots. Sold by 22 hangers per bag.



Metal - 25.5in
DLNHZS14HA0000C022

Min. Buy 1 CS





Leader in Horticultural Containers

Specialty Containers

The HC Companies® Azalea Cages

Designed to aid in healthy, upright growth of a wide range of top-heavy plants. Cage systems fit The HC Companies® Thinwall pots, Hanging Poinsettia Pots, Standard Stock Pots and 10 Color Pot 3 for added convenience. Support rings are a cost-effective alternative for tall plant support and are compatible with any pot size.



Green - 8in D x 4.75in H
DLNSPG06501B66C060

Min. Buy 60 EA

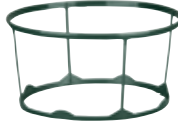

The HC Companies® Azalea Support Rings

Designed to aid in healthy, upright growth of a wide range of top-heavy plants. Cage systems fit The HC Companies® Thinwall pots, Hanging Poinsettia Pots, Standard Stock Pots and 10 Color Pot 3 for added convenience. Support rings are a cost-effective alternative for tall plant support and are compatible with any pot size.



Green - 7in D x 4.37in H

DLNSR07000B66C720 Min. Buy 1 CS

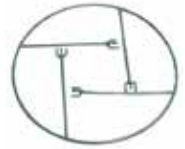

The HC Companies® Support Trellis

Designed to aid in healthy, upright growth of a wide range of top-heavy plants. Cage systems fit The HC Companies® Thinwall pots, Hanging Poinsettia Pots, Standard Stock Pots and 10 Color Pot 3 for added convenience. Support rings are a cost-effective alternative for tall plant support and are compatible with any pot size.



4.125in Diam x 17in H - Black
DLNSPT001G0G18C128

Min. Buy 128 EA

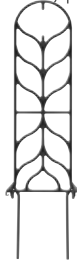

The HC Companies® Point Cages

Designed to aid in healthy, upright growth of a wide range of top-heavy plants. Cage systems fit The HC Companies® Thinwall pots, Hanging Poinsettia Pots, Standard Stock Pots and 10 Color Pot 3 for added convenience. Support rings are a cost-effective alternative for tall plant support and are compatible with any pot size.



Green - 10in D x 5in H
DLNSPG08001B66C100

Min. Buy 100 EA



Fiber Containers

The HC Companies® Fiber WaxTough Beehive Hanging Basket w/Grommets

FiberGrow® products are molded using a slurry of fibers and binding agents in order to increase their strength and durability. A wax coating increases the containers longevity.



Product	Depth	Outside Diam	Max Liquid Volume	Case Qty	Barcode
ITMLFHE12XL0WAXD012GR	6in	12in	1.87gal	12	
ITMLFHE14000WAXD006GR	8.75in	14.25in	3.43gal	6	





Leader in Horticultural Containers

Fiber Containers

The HC Companies® EcoGrow Pot

Manufactured with the environment in mind in our North American, closed loop water recycling production facility. Automation friendly carry trays available in all sizes. Built-in denesting lugs for ease of handling. EcoGrow pots hold up for retailers, yet biodegrade quickly when planted in the ground. An ideal choice for vegetables, herbs, annuals, and more!



Product	Depth	Outside Diam	Max Liquid Volume	Case Qty	Compatible Items	Barcode
ITMLFRS03501RBIC720 Round Pot	3.25in	3.5in	9.3oz	720	TCR12350	
ITMLFRS03750RBIC625 Round Pot	3.88in	3.88in	12.04oz	625	FCT10400	
ITMLFRS04000RBIC625 Round Pot	3.5in	4in	14.04oz	625	TCR12350	
ITMLFRS04500RBIC322 Round Pot	3.75in	4.5in	1.27pt	322	TRS10450	
ITMLFRS05000RBIC272 Round Pot	4.75in	5in	1.92pt	272	TRS08510	

The HC Companies® FiberGrow® Beehive Hanging Baskets

Natural and biodegradable. Manufactured using recycled materials. These basket provides season-long durability in moist and humid growing conditions. WaxTough fortified with a aesthetically pleasing, rich, dark, earth tone color. FiberGrow® insulates roots from extreme variations in temperature. An easy to assemble, attractive and cost effective alternative to coco or moss.



Product	Depth	Outside Diam	Max Liquid Volume	Case Qty	Barcode
ITMLFHE12000WAXD012GR	6in	12in	1.87gal	12	

The HC Companies® FiberGrow® Balcony Planters (Rectangle)

Superior Growing Containers that breathe like clay, improve aeration and promote healthier root systems by insulating them from temperature fluctuations. Attractive FiberGrow Planters enhance patios, pools and garden settings.



Product	Depth	Outside Diam	Max Liquid Volume	Case Qty	Barcode
ITMLFPP16060RBRC024	5.5in	7.5in	2.53gal	24	
ITMLFPP24060RBRC012	5.75in	6in	3.56gal	12	



Leader in
Horticultural
Containers

Fiber Containers

The HC Companies® FiberGrow® Garden Pak

Promote healthy root development for optimal plant growth. Manufactured using recycled materials. Easy de-nesting with no sharp corners.



Product	Depth	Outside Diam	Max Liquid Volume	Case Qty	Barcode
ITMLFPK01440RBRC250	2.75in	7.75in	1.35qt	250	
ITMLFPK01350RBRC500	2.5in	7in	1.98qt	500	

The HC Companies® FiberGrow® Hanging Baskets

Natural and biodegradable. Manufactured using recycled materials. These basket provides season-long durability in moist and humid growing conditions. WaxTough fortified with a aesthetically pleasing, rich, dark, earth tone color. FiberGrow® insulates roots from extreme variations in temperature. An easy to assemble, attractive and cost effective alternative to coco or moss.



Product	Depth	Outside Diam	Max Liquid Volume	Case Qty	Barcode
ITMLFHB10000WAXD012GR Round Basket	6in	11in	1.64gal	12	
ITMLFHB12000WAXD012GR Round Basket	7in	12.5in	2.12gal	12	
ITMLFHS12000WAXD012GR Square Basket	7in	13.25in	2.79gal	12	
ITMLFHS12500WAXD012GR Square Basket	7.25in	12in	2.79gal	12	
ITMLFHF12000WAXD012GR Floral Basket	7in	12.75in	2.12gal	12	

The HC Companies® FiberGrow® Round Shallow Patio Planter

FiberGrow® products are molded using a slurry of fibers and binding agents in order to increase their strength and durability in such applications as planters, hanging baskets and other large containers.



Product	Depth	Outside Diam	Max Liquid Volume	Case Qty	Barcode
ITMLFPP10040SBRD070	4in	10in	3.31qt	70	
ITMLFPP15060RBRD025	6in	15in	3.19gal	25	





Leader in Horticultural Containers



Fiber Containers

The HC Companies® FiberGrow® Pot

Superior Growing Containers that breathe like clay, improve aeration and promote healthier root systems by insulating them from temperature fluctuations. Attractive FiberGrow Planters enhance patios, pools and garden settings.

Product	Depth	Outside Diam	Max Liquid Volume	Case Qty	Barcode
ITMLFRA05050RBRC250 Round Pot	3.75in	5in	1qt	250	
ITMLFNP07070RBRD070 Round Pot	7in	7.5in	1.04gal	70	
ITMLFNP10110RBRD025 Round Pot	10.5in	10.9in	2.9gal	25	
ITMLFNP11120RBRD020 Round Pot	11.5in	11.5in	3.79gal	20	
ITMLFNP12110RBRD020 Round Pot	10.75in	12in	4.13gal	20	
ITMLFNP13120RBRD020 Round Pot	11.25in	13in	5.21gal	20	
ITMLFNP15120RBRD015 Round Pot	11.75in	15.5in	6.85gal	15	
ITMLFNP15140RBRD015 Round Pot	13.25in	15in	7.69gal	15	
ITMLFNP06060RBRD070TW Round Thinwall Pot	6.5in	5.75in	2.23qt	70	
ITMLFRP09060RBRB008TW Round Thinwall Pot - Bulk	6.5in	9.5in	1.75gal	860/pl	
ITMLFRP08550RBRD050 Mum Pan	5.25in	9in	1.05gal	50	
ITMLFRP08550RBRB012 Mum Pan - Bulk	5.25in	9in	1.05gal	1200/pl	
ITMLFPP12050RBRD060 Pan	5in	12in	1.48gal	60	
ITMLFRP09060RBRD025 Pan	6.5in	9.25in	1.75gal	25	
ITMLFSQ04040RBRC400 Square Pot	4in	4.25in	1.22pt	400	



Leader in
Horticultural
Containers

Fiber Containers

The HC Companies® FiberGrow® WaterSaver Hanging Basket

FiberGrow® products are molded using a slurry of fibers and binding agents in order to increase their strength and durability. Features a water reservoir to help conserve excess moisture for roots to draw as needed.



Product	Depth	Outside Diam	Max Liquid Volume	Case Qty	Barcode
ITMLFHR12000WAXD012GR With Grommets	6in	12.88in	2.12gal	12	
ITMLFHR14000WAXD006GR	9in	15.5in	4.61gal	6	
ITMLFHR16000RBRD006	10in	16.13in	6.62gal	6	

The HC Companies® WaxTough WaterSaver Hanging Basket

FiberGrow® products are molded using a slurry of fibers and binding agents in order to increase their strength and durability. A wax coating increases the containers longevity. Features a water reservoir to help conserve excess moisture for roots to draw as needed.



Product	Depth	Outside Diam	Max Liquid Volume	Case Qty	Barcode
ITMLFHR14000WA1D006	9in	15.5in	4.61gal	6	
ITMLFHR16000WA1D006	10in	17.13in	6.2gal	6	
ITMLFHR18000WA1D006	9.75in	19in	7.3gal	6	



The HC Companies® 4 Strand Plastic FiberGrow Hanger Brown w/Tag Barb

Hanger for fiber pots



20.00in - 24/bg

ITMLHZP4LFG6E28D024

Min. Buy 1 BG

The HC Companies® FiberGrow® Hangers

For 16in hanging baskets w/out grommets. 16in wire cage and 23in swivel clip-on hanger included. 36 per case.



23in

ITMLFHZA160C036CA

Min. Buy 36 EA





Nursery Containers



Nursery Supplies® Blow-Molded Custom™ Trade Pot

An economy line of blow-molded containers. These containers are designed to get your plants to market efficiently. Durable, flexible, and easy on the budget.

Product	Depth	Outside Diam	Max Liquid Volume	Case Qty	Barcode
NS01-00200-1361 300SCU Trade 1 Squat	6.5in	6.5in	.63gal	106	
NS01-00300-0900 400CU TRD 1GAL	7in	7.75in	1gal	70	
NS01-00510-0130 11000SCU SQUAT TRD 2GAL	7.5in	10.12in	1.95gal	75	
NS01-00540-0361 1200SCU SQUAT TRD 2GAL	7.5in	11in	2.32gal	60	
NS01-00590-0251 1600SCU SQUAT TRD 3GAL	7.88in	11.88in	2.87gal	47	
NS01-00580-0521 1600CU TRD 5GAL	10.12in	11.88in	3.58gal	47	
NS01-00620-0400 2100CU TRD 5GAL	9.88in	14in	5.17gal	31	
NS01-00650-0661 2800CU TRD 7GAL	11.5in	14in	6.08gal	31	

Nursery Supplies® “Air Root Pruning System™” Accelerator® Container

Accelerator® containers produce premium trees, shrubs, and plants. They reduce circling of roots, improve survivability and extend shelf life, including in controlled environment agriculture (CEA), earning you more green.



Product	Depth	Outside Diam	Max Liquid Volume	Case Qty	Barcode
NS01-30003-0100 AP-3 TRD 3GAL	8in	12in	2.68gal	41	
NS01-30015-0100 AP-15 TRD 15GAL	15.5in	18in	12gal	19	

Nursery Supplies® Classic Blow-Molded Pot

Blow molded container with a heavy weight and rigidity. Offers exceptional durability, strength and value. Made in the USA.



Product	Depth	Outside Diam	Max Liquid Volume	Case Qty	Barcode
NS01-00900-0100 18000 TRD 45GAL	20.12in	30in	45.28gal	5	
NS01-00920-0100 C26000 TRD 65GAL	23.12in	30.75in	60.67gal	5	



Nursery Containers

Nursery Supplies® Classic Custom™ Blow-Molded Pot

An economy line of blow-molded containers. These containers are designed to get your plants to market efficiently. Durable, flexible, and easy on the budget.



Product	Depth	Outside Diam	Max Liquid Volume	Case Qty	Barcode
NS01-00250-0291 300CU TRD 1GAL	7.25in	6.38in	.73gal	100	
NS01-00450-1381 600CU TRD 2GAL	8.5in	9in	1.5gal	105	
NS01-00490-0331 900CU TRD 2GAL	9.12in	9.5in	1.94gal	83	
NS01-00550-1111 1200CU TRD 3GAL	9.5in	11in	3gal	56	
NS01-00600-0561 2000CU TRD 5GAL	11in	11.88in	3.84gal	44	
NS01-00500-0861 1000CU TRD 10 FOLIAGE	9.12in	10.12in	2.25gal	70	
NS01-00270-0301 350CU 8X5 MUMPAN	5.12in	8in	.77gal	130	
NS01-00430-0551 550CU 9X6 MUMPAN	6.12in	9in	1.21gal	97	

Nursery Supplies® Classic Blow-Molded Pot

Heavy weight, durable, flexible, and easy on the budget. Side ribs and flutes give strength while a unique bottom-edge corrugation design adds further to column rigidity on many of these wide-bottomed containers. Molded-in handles on the top rim on all #5 pots and above insure ease of handling to the field, out of the field, during shipping and at retail. Blow-molded containers are a viable, cost-effective alternative to injection-molded pots.



Product	Depth	Outside Diam	Max Liquid Volume	Case Qty	Barcode
NS01-00700-0211 4000BXL TRD 10GAL	15in	15.75in	9.63gal	27	
NS01-00730-0171 6900SXL SQUAT TRD 10GAL	12.12in	17.25in	10.66gal	19	
NS01-00740-0301 6900BXL TRD 15GAL	15.12in	17.25in	13.35gal	18	
NS01-00850-0200 10000SXL SQUAT TRD 20GAL	18.12in	23.75in	27.17gal	10	
NS01-00680-0171 4000SXL SQUAT TRD 7GAL	12.5in	15.75in	7gal	21	











Nursery Containers

Nursery Supplies® Econo-Grip® Blow-Molded Pot

Economy line of blow-molded containers that offer exceptional durability, strength, value and are label hot stamp and printing compatible. Features a top lip that makes it easy to grip and is automation friendly.









Product	Depth	Outside Diam	Max Liquid Volume	Case Qty	Barcode
NS01-04600-0261 EG2000 TRD 5GAL	11.12in	10.88in	3.93gal	35	
NS01046500031 EG2800 TRD 7GAL	12in	13.75in	6.08gal	20	
NS01047400301 EG6900 TRD 15GAL	15.12in	17.25in	13.19gal	17	
NS01-04800-0141 EG8000 TRD 20GAL	17in	19.5in	19.5gal	16	
NS01-04850-0100 EG10000 TRD 25GAL	18.12in	22.75in	27.58gal	10	
NS01-04700-0041 EG4000 TRD 10GAL	14.25in	17.25in	9.16gal	19	
NS01-04730-0271 EG6900S SQUAT TRD 10GAL	12.12in	17.25in	10.69gal	17	
NS01-04820-0141 EG10000S SQUAT TRD 20GAL	13.12in	22.75in	20.51gal	14	

Nursery Supplies® Grip-Lip® Blow-Molded Pot

Blow-Molded container with a heavy weight and rigidity. Offers exceptional durability, strength and value and are label hot stamp and printing compatible. Features a top lip that makes it easy to grip and is automation friendly. Made in the USA.



Product	Depth	Outside Diam	Max Liquid Volume	Case Qty	Barcode
NS01046500541 GL2800 TRADE 7GAL	12in	13.75in	6.08gal	20	
NS01-04700-0561 GL4000 TRD 10GAL	14.25in	14.25in	9.16gal	19	
NS01047400801 GL6900 TRD 15GAL	15.12in	17.25in	13.19gal	17	
NS01-04800-0101 GL8000 TRD 20GAL	17in	19.5in	19.5gal	16	
NS01-04850-0500 GL10000 TRD 25GAL	18.12in	22.75in	27.59gal	10	
NS01-04820-0551 GL10000S SQUAT TRD 20GAL	13.12in	22.75in	20.51gal	14	



Nursery Containers

Nursery Supplies® PI-PC Nursery Container

Economical PI injection-molded containers. Strong and rigid. Tier stacking. Label, hot stamp and printing compatible



Product	Depth	Outside Diam	Max Liquid Volume	Case Qty	Barcode
NS01-05400-0111 PC-2 TRD 2GAL	8.375in	8.375in	1.75gal	61	
NS01-05450-0100 PC-3 TRD 3GAL	9.25in	10in	2.77gal	45	
NS01055500411 PC-5S SQUAT TRD 5GAL	10.5in	10.75in	4.08gal	42	
NS01-05650-0100 PC-7S SQUAT TRD 7GAL	11.25in	14in	6.92gal	39	
NS01-05700-0100 PC-10 TRD 10GAL	14.5in	15.25in	10.26gal	27	
NS01-05850-0100 PC-15S SQUAT TRD 15GAL	18.25in	13.5in	13.47gal	38	

Nursery Supplies® PC Nursery Container

Economical PI injection-molded containers. Strong and rigid. Tier stacking. Label, hot stamp and printing compatible



Product	Depth	Outside Diam	Max Liquid Volume	Case Qty	Barcode
NS01057000201 PC-10 TRD 10GAL	14.5in	15.25in	10.27gal	27	
NS01052500111 PC-1H TRD 1GAL	7in	6in	.69gal	64	

Nursery Supplies® CA-5 Nursery Container

Economical PI injection-molded containers. Strong and rigid. Tier stacking. Label, hot stamp and printing compatible



Product	Depth	Outside Diam	Max Liquid Volume	Case Qty	Barcode
NS0105550311 CA-5 TRD 5 EGG CAN	11.75in	10in	3.62gal	46	





Nursery Containers

Nursery Supplies® Premier® Pressure-Formed Container

The Pressure-Formed container represents a new generation of nursery containers. Pressure-forming creates a product that's tougher than blow-molded containers and has the rigid rim qualities similar to injection molded containers. Pressure-Formed containers are light, strong and resilient, consistent in weight, and uniform in design. They offer quality and economy that is unmatched in the industry.



Product	Depth	Outside Diam	Max Liquid Volume	Case Qty	Barcode
NS01081700011 PF250CU TRD 1GAL	6.125in	6.125in	.63gal	90	
NS01-08250-0061 PF310 PS TRD 1GAL	6.5in	6.125in	.63gal	80	
NS01-08300-0211 PF400CU TRUE 1GAL	7.12in	7.5in	1gal	85	
NS01-08450-0101 PF600CU TRD 2GAL	8.5in	8.5in	1.5gal	90	
NS01-08400-0181 PF800 TRUE 2GAL	9.375in	8.875in	2gal	87	
NS01-08550-0721 PF1200CU TRUE 3GAL	9.38in	10.5in	3gal	71	
NS01083500223 PF550CU 9X6 MUMPAN TS	6in	9.5in	1.55gal	91	



Nursery Supplies® Dec-Grow® Blow-Molded Pot

Decorative container tough enough to grow in. Choice of side or bottom holes. Versatile nursery container that easily moves from field to retail shelf.

Product	Depth	Outside Diam	Max Liquid Volume	Case Qty	Barcode
NNS01-02500-0691 10 TRD 2GAL	8.75in	9.88in	2.12gal	45	
NS01-02600-0451 12 TRD 5GAL	10.75in	11.88in	3.78gal	36	



- ✓ Largest selection of nursery container sizes and styles in the country!
- ✓ Inventory is on hand and ready to ship on many of our most popular sizes and styles.
- ✓ Lead times have returned to normal on most items and are only a couple of weeks out.
- ✓ An additional pressure formed machine has been added to meet both your black & color branded container needs.

PROVIDING SOLUTIONS FOR MORE THAN 60 YEARS

JānorPot.

3D Direction
Dimension
Display

SYSTEMS









From Summit Plastic Co.



Pots & Carry Trays
Summit Plastic® JanorPot®

Thermoformed, thinwalled round pots. Each JanorPot® container is designed with a dual-drainage system to ensure optimum air/water exchange to maximize plant growth potential. The wide bottom offers stability in and out of a tray and each pot has a black interior also promoting an ideal rooting environment. The smooth rolled lip, ease in de-nesting and no sharp edges or projections make these containers perfect for automation. Every pot is Duo™ - two layers of polypropylene in each pot. The exterior layer may be customized with any color while the interior is always a black layer made from recycled materials.





Product	Color	Depth	Outside Diam	Max Liquid Volume	Case Qty	Barcode
SUM05-3012B 9CM H	Black	3.5in	3.5625in	12.2oz	2340	
SUM090H50BTCCB 9CM H	Terra Cotta/Black	3.5in	3.5625in	12.2oz	2340	
SUMJJ110H80BTCCB 12CM H	Terra Cotta/Black	3.56in	4.375in	1.10pt	2000	
SUMJJ120H80BBKCB 12CM H	Black	3.94in	4.5in	1.58pt	1425	
SUMJJ170H50BBKCB 17CM H Trade Gallon	Black	6.09in	16in	2.75qt	360	
SUMJJ170H50BTCCB 17CM H Trade Gallon	Terra Cotta/Black	6.09in	16in	2.75qt	360	
SUM190L50BTCCB 19cm L	Terra Cotta/Black	6in	7.5in	3qt	360	
SUM05-3031B 19 T True Gallon	Black	7.25in	7.5in	1gal	270	
SUMJJ120H80BWTCB 12CM H	Black	3.9375in	4.75in	1.58pt	1425	

Summit Plastic® NuPot™

NuPot™ sets are an industry standard – people ask for them by name! All pots contain generous amounts of media and feature side and bottom drainage with side-flutes – a Summit innovation – minimizes root circling.



Product	Color	Depth	Outside Diam	Max Liquid Volume	Case Qty	Barcode
SUM52300BKBKNSC #4 Nu Pot	Black	3.88in	3.25in	1pt	1600	
SUM05-0024B #5 Nu Pot	Black	4.75in	4.375in	1qt	450	



Pots & Carry Trays

Summit Plastic® Filling Tray

Snug interiors for pot stability in the greenhouse, field, on trucks and on display. Opened-up sides give an improved graphics viewing area - a tray and a merchandiser. These trays feature a soil deflecting design which means less wasted media while the bottom design guarantees easy-slide transfer onto racks and store presentation. These trays meet the needs with numerous built-in elements - side and end landing areas and slits and slots for labels and large and small locking tags. Minimizing the foot-print, while still supporting the pots, means savings efficiencies during the grow stage and then when shipping and merchandising. Plant, grow and ship in Summit's filling trays.

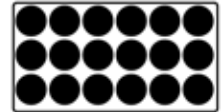
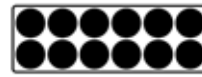
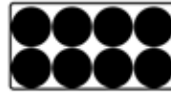

Product	Filling Tray Ct	Length	Width	Depth	Case Qty	Barcode
SUM05-0043 12CM H - 8 Count Tray	8	18.5in	9in	4.12in	100	
SUM05-0016A 9CM H - 12 Count Tray	12	21in	7in	3.5in	100	
SUM51050BKBKNSC 9CM H - 18 Count Tray	18	21in	10.5in	3.5in	50	

Summit Plastic® NuTray™

NuTray™ are designed to fit perfectly with NuPot™ greenhouse containers and are offered in a variety of sizes from pints through trade gallon.

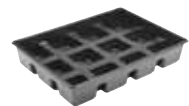
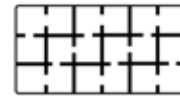

Product	Length	Width	Depth	Case Qty	Barcode
SUM53250BKBKNSC NuTray #4 12 Count Tray	20in	6.75in	2in	130	
SUM05-0023A NuTray #4 18 Count Tray	19.5in	10in	2in	90	
SUM53250BKBKNSC NuTray #5 12 Count Tray	17.5in	13in	3.25in	75	





Summit Plastic Company



GROWER SOLUTIONS

Innovative products • Superior Quality • World-Class Service, Design & Engineering

JānorPot
3D Direction
Dimension
Display
SYSTEMS
From Summit Plastic Co.

MARKET PACKS



INSERTS & FLATS



HANDLER TRAYS



PROPAGATION



GROWER POTS



 **Summit
Plastic
Company**

sales@summitplastic.com
www.summitplastic.com
Ph. 800.814.3496

 **Nursery
Supplies**

sales@nurserysupplies.com
www.nurserysupplies.com
Ph. 800.523.8972



T.O. PLASTICS

Pots & Carry Trays

T.O. Plastics Deep Pot

100% Recycled resins that are extruded, then formed into high-impact polystyrene square plant pots. Durable, dependable and environmentally responsible plant pots with the efficiency of T.O.'s Press-Fill system.



Product	Length	Width	Depth	Max Liquid Volume	Case Qty	Barcode
T070003C SVD-250 Black	2.6in	2.6in	3.44in	7.84oz	800	
T0700014C SVD-325 Black	3.31in	3.31in	3.5in	1pt	450	
T0700022C SVD-325 Black	3.31in	3.31in	3.5in	1pt	900	
T0700026C SVD-350 Black	3.52in	3.52in	3.5in	1.08pt	450	
T0700035C SVD-355 Black	3.52in	3.52in	5in	1.5pt	450	
T0700042C SVD-450 Black	4.2in	4.2in	4.91in	1.13qt	300	
T0700062C SVD-450 Black	4.2in	4.2in	4.91in	1.13qt	500	
T0700051C SVD-450 Black	4.2in	4.2in	4.91in	1.13qt	375	
T0700099C SVD-550 Black	5.36in	5.36in	6in	2.06qt	200	

T.O. Plastics Square Pot Plastic Carry Tray

T.O. Plastics Square Pot Plastic Carry Trays are made of 100% recycled resins to create a durable, environmentally responsible horticulture product that you can depend on. For added ease and efficiency, these plastic carry trays can be paired with T.O.'s square plant pots for a simple, efficient potting system. You can get an extra boost in your efficiency by using this innovative press-fill system to load your carry trays. This simple system allows you to load the necessary number of pots into a tray all at the same time, instead of placing each pot individually. The Press-Fill System can save you up to 75% in labor time and costs. Standard tray colors are black, green, and terra cotta. Great for bedding plants, nursery stock, perennials, and edibles.



Product	Length	Width	Depth	Case Qty	Barcode
T0705193C SPT-550-8 (Fits 8 - SVD-550 Pots)	21.44in	10.94in	3.03in	25	
T0705151C SPOT-450-10-Press Fill (Fits 10 - 450 Series Pots)	21.19in	8.75in	2.13in	50	
T0705129C SPT-350-18-Press Fill (Fits 18 - 350 Series Pots)	21.25in	10.81in	1.93in	50	
T0705104C SPT-250-32-Press Fill (Fits 32 - 250 Series Pots)	21.19in	27.31in	2.5in	50	





T.O. PLASTICS

Pots & Carry Trays



T.O. Plastics 4.5in Traditional Pot

100% recycled resins that are extruded, then formed into high-impact polystyrene square plant pots. Durable, dependable and environmentally responsible plant pots with the efficiency of our Press-Fill system.

Product	Length	Width	Depth	Max Liquid Volume	Case Qty	Barcode
T0700070C SVT-400 Black	3.66in	3.66in	3.11in	1.13pt	500	
T0700074C SVT-400 Black	4in	4in	3.11in	1.13pt	375	
T0700076C SVT-450 Black	4.2in	4.2in	3.62in	1.72pt	300	
T0700087C SVT-450 Black	4.2in	4.2in	3.62in	1.72pt	375	
T0700081C SVT-450 Black	4.2in	4.2in	3.62in	1.72pt	500	

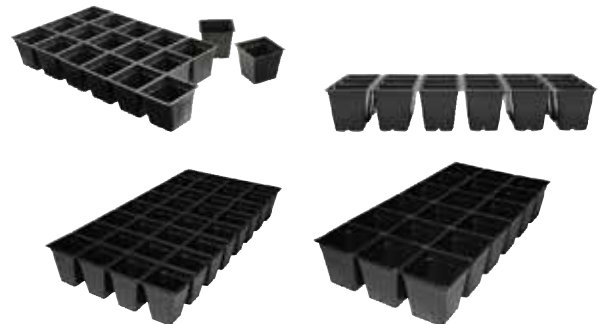

T.O. Plastics Sheet Pots

Ideal for nursery propagation and landscape groundcovers. High quality economical pots are connected in one sheet and easily separate for individual use. Sheet pots and liner trays are designed to de-nest easily, saving you time and effort.

Product	Length	Width	Depth	Case Qty	Barcode
T0730645C SOP18	21.06in	10.56in	3.14in	100	
T0730654C SOP32DP	21.06in	10.56in	3in	100	
T0730630C SOPT18	19.69in	9.69in	3in	100	
T0730649C SOP-18-DP	21.06in	10.56in	3.55in	50	

T.O. Plastics Deep Market Pack Sheet Pots

Product	Length	Width	Depth	Case Qty	Barcode
T0760746C SOP-0306-Deep-White	21.06in	10.56in	3.54in	50	

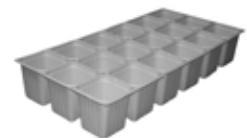

WARNING: This product is not available for sale in CA.
For most up to date information please visit bfgsupply.com

800-883-0234
www.bfgsupply.com



T.O. PLASTICS

Pots & Carry Trays

T.O. Plastics Press Fill Carry Tray

100% Recycled resins extruded into high impact carry trays. You are sure to save time and money with the ease of T.O.'s Press-Fill system.=



Product	Length	Width	Depth	Case Qty	Barcode
T0705125C SPT-325-20-Press Fill	16.75in	13.5in	1.88in	45	
T0705119C SPT-325-18-Press Fill	20in	10in	1.88in	50	
T0705137C SPT-325-20-Press Fill	21.25in	10.81in	3.5in	50	
T0705142C SPT-400-15-Press Fill	18.75in	11.25in	1.94in	50	
T0705144C SPT-400-20-Press Fill	18.75in	15in	1.88in	50	
T0705155C SPT-400-12-Press Fill	17in	12.88in	2.13in	50	
T0705165C SPT-450-15-Press Fill	21.19in	12.88in	2.13in	50	

T.O. Plastics Round Pot Carry Trays

Designed to fit most manufacturer's round standard pots.

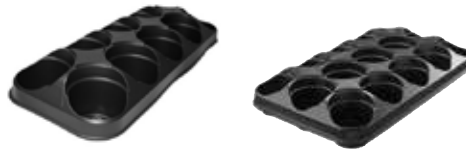

Product	Length	Width	Depth	Case Qty	Barcode
T0755830C RPT-450-G-10-Black (Holds 10 - 450 Series Pots)	23.02in	9.19in	4.05in	75	
T0755838C RPT-450-G-15-Black (Holds 15 - 450 Series Pots)	23.02in	13.8in	4.05in	50	

T.O. Plastics Display Tray without Holes



Product	Length	Width	Depth	Case Qty	Barcode
T0760247C	21.25in	10.81in	1.29in	36	



Trays, Inserts & Flats

T.O. Plastics Standard Insert

Straight wall offers greater soil capacity for a larger, healthier crop.

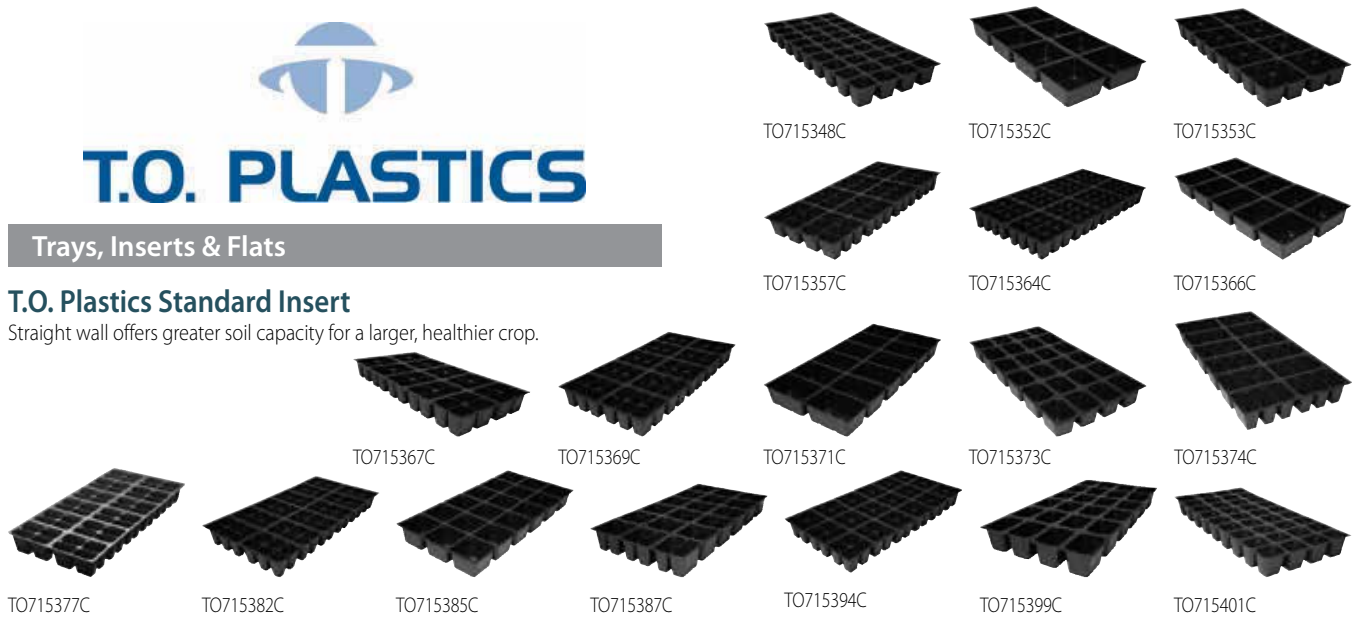

Product	Length	Width	Depth	Max Liquid Volume	Case Qty	Barcode
TO715348C 606 Insert	2.23in	1.94in	2.23in	1.3pt	100	
TO715352C 801 Insert	4.86in	4.86in	2.27in	1.58pt	100	
TO715353C 804 Insert	2.4in	2.4in	2.23in	1.23pt	100	
TO715357C 806 Insert	2.38in	1.5in	2.25in	4.05oz	100	
TO715364C 812 Insert	1.59in	1.15in	2.25in	1.01pt	100	
TO715366C 1001 Insert	4.8in	3.73in	2.25in	1.16pt	100	
TO715367C 1004 Insert	1.81in	2.35in	2.24in	18.88oz	100	
TO715369C 1006 Insert	1.77in	1.5in	5.25in	12.17oz	100	
TO715371C 1201 Insert	4.88in	3.13in	3.13in	1.05pt	100	
TO715373C 1202 Insert	2.28in	3.1in	2.27in	13.86oz	100	
TO715374C 1203 Insert	1.5in	3.38in	2.27in	12.34oz	100	
TO715377C 1204 Insert	2.38in	1.5in	2.26in	13oz	100	
TO715382C 1206 Insert	1.5in	1.5in	2.23in	11.8oz	100	
TO715385C 1801 Insert	3.11in	3.11in	2.25in	9.08oz	100	
TO715387C 1802 Insert	3.11in	1.49in	2.27in	7.78oz	100	
TO715394C 1804 Insert	1.55in	1.55in	2.27in	7.54oz	100	
TO715399C 2401 Insert	3in	2.19in	2.25in	6.93oz	100	
TO715401C 3601 Insert	2.23in	1.94in	2.23in	4.05oz	100	



T.O. PLASTICS

Trays, Inserts & Flats

T.O. Plastics Standard Deep Insert

Straight wall offers greater soil capacity for a larger, healthier crop.



TO715405C

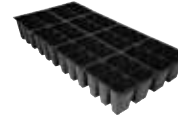

TO715408C

Product	Length	Width	Depth	Max Liquid Volume	Case Qty	Barcode
TO715405C 606 Deep Jumbo Insert	2.25in	2in	3.25in	1.3qt	100	
TO715408C 806 Deep Insert	2.36in	1.56in	3.13in	1.6pt	100	

T.O. Plastics True Insert

Optimum cell size for greater soil capacity.
Community watering prevents dry cells.
Designed for easy nesting. For use with true size tray.

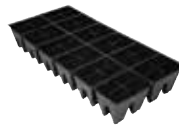

TO715335C

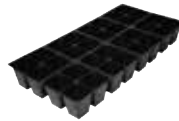

TO715320C



TO715323C



TO715325C



TO715328C

Product	Length	Width	Depth	Max Liquid Volume	Case Qty	Barcode
TO715335C 606 Deep Insert	2.12in	2in	3.31in	1.84pt	100	
TO715320C 804 Deep Insert	2.18in	2.15in	2.63in	1.33pt	100	
TO715323C 1203 Insert	2.88in	1.42in	2.63in	13.63oz	100	
TO715325C 1204 Insert	2.22in	1.43in	2.63in	1.47pt	100	
TO715328C 1803 Strip Insert	1.75in	1.5in	2.65in	6.69oz	100	

T.O. Plastics Tri Pack Standard Insert

Straight wall offers greater soil capacity for a larger, healthier crop. For use with 1020 standard size tray.



TO715389C

Product	Length	Width	Depth	Max Liquid Volume	Case Qty	Barcode
TO715389C 1803 Tri Pack Insert	1.59in	2.42in	2.27in	8.12oz	100	

T.O. Plastics Germination Trays

Sturdy, yet lightweight for easy handling.



TO745731C



TO745730C

Product	Length	Width	Depth	Case Qty	Barcode
TO745731C 1000 Series - without holes	21.25in	10.81in	1.29in	100	
TO745730C 1000 Series - with holes	21.25in	10.81in	1.29in	100	





Trays, Inserts & Flats



TO710280C



TO710245C



TO710251C



TO710341C



TO710342C



TO710274C



TO790900C



TO710222C



TO710225C

T.O. Plastics Flat

Flats are a good choice if you're planning to transplant seedlings in clumps. With this flat you can scoop out a grouping of seedlings all at once. The thermoformed trays are sturdy, yet lightweight for easy handling.

Product	Length	Width	Depth	Case Qty	Barcode
TO710341C Half Flat - with Holes	10.13in	10.13in	2.3in	100	
TO710342C Half Flat - without Holes	10.13in	10.13in	2.3in	100	
TO710274C Standard Series	21.44in	10.94in	2.44in	100	
TO710280C Standard Series	21.25in	10.81in	2.56in	100	
TO710245C Standard Series with Holes	21.44in	10.94in	2.44in	100	
TO710251C Standard Series without Holes	21.44in	10.94in	2.44in	100	
TO790900C Standard Series Web Flat Tray	21.26in	10.75in	2.37in	50	
TO710222C True Series	20in	10in	2.88in	100	
TO710225C True Series	20in	10in	2.88in	100	

T.O. Plastics Liner Sheet

Thermoformed high-quality, multi-purpose liner trays are an economical choice. They are produced as a solid sheet with no perforations and fit many of our standard trays. They are available in standard and true formats as well as deep. Available in heavy weight version by special order.



TO735680C



TO735683C

Product	Length	Width	Depth	Max Liquid Volume	Case Qty	Barcode
TO735680C 24 Liner Sheet	21.06in	10.56in	3in	8.43oz	100	
TO735683C 32 Liner Sheet	21.06in	10.56in	3in	6.42oz	100	

T.O. Plastics Slim Handle



White - 0.75in W x 17.88in L

TO795979C

Min. Buy 1 CS/100 EA



WARNING: This product is not available for sale in CA.
For most up to date information please visit bfgsupply.com

800-883-0234
www.bfgsupply.com



T.O. PLASTICS

Propagation & Plug Trays

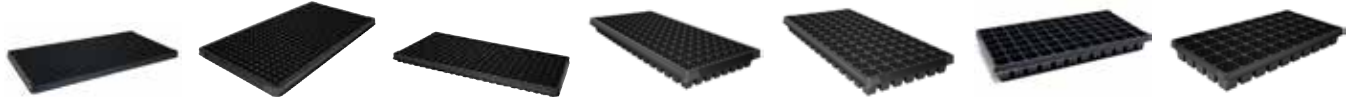

T0720542C

T0720539C

T0720528C

T0720487C

T0720477C

T0720469C

T0720463C

T.O. Plastics Standard Plug Tray

Maximum cell sizes for optimum soil capacity. Optional ventilation holes for greater air movement. Larger label ramps to meet most grower requirements. Precisely centered, punched drain holes. Feet on the bottom of the cells slightly elevate trays on benches. Cell wall "root ribs" and star trays for enhanced downward root growth.

Product	Width	Depth	Max Liquid Volume	Case Qty	Barcode
T0720542C 512 Cells	.55in	.94in	.14oz	50	
T0720539C 406 Cells	.67in	1.15in	.17oz	50	
T0720528C 288 Cells	.76in	1.25in	.24oz	50	
T0720487C 128 Cells	1.19in	2in	.85oz	100	
T0720477C 98 Cells	1.34in	2in	1.25oz	100	
T0720469C 72 Cells	1.52in	2.25in	1.99oz	100	
T0720463C 50 Cells	1.9in	2.37in	3.75oz	100	

T.O. Plastics Square Plug Tray

Maximum cell sizes for optimum soil capacity. Optional ventilation holes for greater air movement. Larger label ramps to meet most grower requirements. Precisely centered, punched drain holes. Cell bottom buttons slightly elevate trays on benches. Cell wall "root ribs" and star trays for enhanced downward root growth.

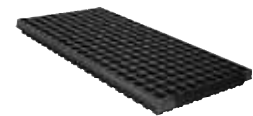

Product	Width	Depth	Max Liquid Volume	Case Qty	Barcode
T0720507C 200 Cells	.86in	1.5in	.37oz	50	
T0720532C 288 Cells	.76in	1.5in	.37oz	50	
T0720536C 392 Cells	.7in	1.15in	.2oz	50	





T.O. PLASTICS

Propagation & Plug Trays

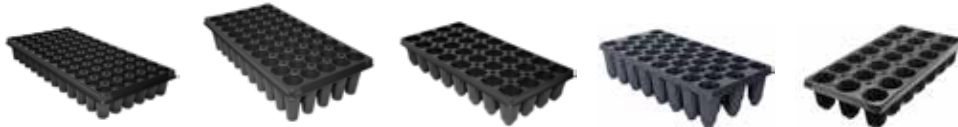

TO720582C

TO720568C

TO720556C

TO720562C

TO720549C

T.O. Plastics Star Deep Plug Tray

Maximum cell sizes for optimum soil capacity. Optional ventilation holes for greater air movement. Larger label ramps to meet most grower requirements. Precisely centered, punched drain holes. Feet on the bottom of the cells slightly elevate trays on benches. Cell wall "root ribs" and star trays for enhanced downward root growth. Star plug trays.

Product	Width	Depth	Max Liquid Volume	Case Qty	Barcode
TO720582C 72 Cells	1.56in	3in	2.37oz	50	
TO720568C 50 Cells	1.94in	4.5in	4.8oz	50	
TO720556C 32 Cells	2.22in	4in	5.58oz	50	
TO720562C 38 Cells	2.13in	5in	7.44oz	25	
TO720549C 21 Cells	2.72in	4in	9.2oz	50	

T.O. Plastics 38 Star Plug Tray

Maximum cell sizes for optimum soil capacity. Optional ventilation holes for greater air movement. Larger label ramps to meet most grower requirements. Precisely centered, punched drain holes. Cell bottom buttons slightly elevate trays on benches. Cell wall "root ribs" and star trays for enhanced downward root growth.



Product	Width	Depth	Max Liquid Volume	Case Qty	Barcode
TO720578C 38 Cells	2.13in	4in	5.74oz	50	
TO720557C 36 Cells	2.12in	3in	4.06oz	50	

T.O. Plastics SureRoots® Plug Trays

SureRoots® containers provide the consistency your growing operation demands. The V-shaped ribs from top to bottom prevent root wrapping and pushes roots down for increased transplant success. Recommended for edibles and nursery stock.



Product	Width	Depth	Max Liquid Volume	Case Qty	Barcode
TO720700C 50 Cells	2in	5in	6.59oz	25	
TO720720C 15 Cells	3.55in	4.59in	19.07oz	25	



WARNING: This product is not available for sale in CA.
For most up to date information please visit bfgsupply.com

800-883-0234
www.bfgsupply.com



T.O. PLASTICS

Propagation & Plug Trays

T.O. Plastics Propagation Sheet

Multi-purpose liner trays and sheet pots are ideal for nursery propagation and landscape groundcovers. Designed to de-nest easily, saving you time and effort!

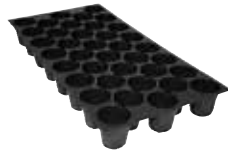

Product	Width	Depth	Max Liquid Volume	Case Qty	Barcode
T0725601C 38 Cells	2.25in	2.31in	3.99oz	100	
T0725602C 50 Cells	1.93in	2.31in	2.71oz	100	
T0725607C 72 Cells	1.46in	2.31in	1.39oz	100	
T0725610C 98 Cells	1.34in	1.5in	.91oz	100	

T.O. Plastics Plastic Dome

T.O.'s clear plastic dome is perfectly designed for seed starting. The clear dome fits 1020 standard size trays.



Product	Length	Width	Depth	Case Qty	Barcode
T0760525C Adjustable Vents	21.52in	10.02in	7.04in	25	
T0760549C	21.5in	11in	2.1in	50	

Specialty Containers

T.O. Plastics Plant Pie

Product	Depth	Outside Diam	Max Liquid Volume	Case Qty	Barcode
T0790968C	3.03in	11.04in	140.33oz	50	
T0790967C	3.04in	7.79in	67.63oz	50	



T.O. Plastics Muffin Tray

Product	Length	Width	Depth	Max Liquid Volume	Case Qty	Barcode
T0790980C	21.44in	10.94in	3.04in	28oz	50	





Fiber Containers

Western Pulp® Round Fiber Pot

Premium Quality Fiber Pots Ideal For Potting Bareroot Roses And Small Fruit, Shade Or Flowering Trees. Popular For Patio And Balcony Gardening. Packaged In Moisture-Resistant Sleeves.

Product	Depth	Outside Diam	Max Liquid Volume	Case Qty	Barcode
WP100127 6X6 RD	5.12in	7in	2.48qt	44	
WP100327 7X7RD	7in	7in	1.03gal	44	
WP100927 8X6RD	6.12in	9in	1.04gal	68	
WP100527 7X9RD	9.5in	8.25in	1.28gal	30	
WP101127 8X8RD	8.62in	9.25in	1.62gal	40	
WP101227 9X9IN DEEP RD	8.875in	10.125in	1.80gal	40	
WP101627 10X10RD	10in	11.25in	2.55gal	36	
WP102127 12X8RD	8in	12.5in	2.74gal	40	
WP102327 12X11RD	11in	12.375in	3.4gal	32	
WP103127 15X10RD	10.12in	16.125in	4.28gal	20	
WP102927 13X12RD	12.75in	13.75in	5.52gal	28	
WP103327 15X13RD	13.38in	16.125in	6.55gal	16	
WP103527 15X16 RD	15.88in	16.125in	7.97gal	14	
WP103727 18X12IN RD	12.38in	19.5in	9.9gal	12	
WP103927 18X16IN RD	15.62in	19.87in	12.15gal	10	
WP104037 21X12IN RD	11.63in	22in	12.15gal	10	
WP104147 21X16IN RD	16in	22in	16.11gal	8	
WP104309 24X18IN RD	18in	24in	23.38gal	10	

Western Pulp® Square Fiber Pot

Premium Quality Fiber Pots Ideal For Potting Bareroot Roses And Small Fruit, Shade Or Flowering Trees. Popular For Patio And Balcony Gardening. Packaged In Moisture-Resistant Sleeves.

Product	Depth	Outside Diam	Max Liquid Volume	Case Qty	Barcode
WP101927 11x11SQ	11.12in	12.375in	3.77gal	36	





Fiber Containers

Western Pulp® Round Fiber Patio Planter

Premium Unwaxed Containers. Great For Color Bowls And Patio Planters. Popular For Decks, Patios, Windows And Balconies. Featured In Sunset Magazine For Vegetable Gardening. Ideal Way To Merchandise Flowers, Vegetables And Shrubs.



Product	Depth	Outside Diam	Max Liquid Volume	Case Qty	Barcode
WP102227 12x5 RD PATIO	5.12in	13.25in	1.56gal	50	
WP105427 15X6 RD PATIO	6in	16.125in	2.98gal	40	
WP103627 18X8 RD PATIO	8.12in	19.25in	5.65gal	20	
WP106027 21X8 RD PATIO	8in	22.125in	7.21gal	16	

Western Pulp® Traditional Series Fiber Garden Planter

Made with fully wax-permeated fiber for extended life and strength. Planter has attractive sculptured sides.



Product	Depth	Outside Diam	Max Liquid Volume	Case Qty	Barcode
WP107327 10 TRADITIONAL PLANTER	9in	11.25in	2.13gal		
WP103227 12 TRADITIONAL PLANTER	10.25in	13.25in	3.3gal	16	
WP103427 14 TRADITIONAL PLANTER	11.75in	15.25in	5.2gal	16	

Western Pulp® Bell Series Fiber Garden Planter

The Bell Series give the appearance of classic Italian Pottery. Fully wax-permeated.



Product	Depth	Outside Diam	Max Liquid Volume	Case Qty	Barcode
WP109627 10 BELL	8.62in	11.125in	1.9gal	16	
WP1097027 12 BELL	10.25in	13.375in	3.3gal	16	
WP109837 14 BELL	11.5in	15.125in	5.28gal	16	





Fiber Containers

Western Pulp® Fiber Hanging Basket

Premium quality fully wax-permeated fiber basket for extended life and strength. Extra-strong nylon hanger sold separately.



Product	Depth	Outside Diam	Max Liquid Volume	Case Qty	Barcode
WP105127 10.00 10RD Basket W/Eyelets Extra-Strong Nylon H-D Hooked Wire Hanger Sold Separate	6.25in	11.125in	1.34gal	22	
WP107727 10.00 XL 10XLRD Basket W/Eyelet Takes Extra-Strong Nylon H-D Hooked Wire sold separate	10.12in	11.125in	1.59gal	22	
WP105527 12RD Basket W/Eyelets Extra-Strong Nylon H-D Hooked Wire Hanger sold separate	6.88in	12.75in	2.09gal	22	
WP110377 12RD w/Reservoir No Eyelets Clip-On Nylon Hanger sold Separate	6.88in	12.75in	2.09gal	22	
WP107127 14XLRD Basket W/Eyelet H-D Hooked Wire Hanger Sold Separate	8.75in	14in	3.96gal	20	
WP104527 10SQ Basket W/Eyelet Extra-Strong Nylon H-D Hooked Wire Hanger Sold Separate	7.25in	11in	1.84gal	22	
WP105927 12SQ Basket W/Eyelets Extra-Strong Nylon H-D Hooked Wire Hanger sold Separate	7in	12in	2.8gal	22	
WP107777 10XLRD Basket No Eyelets Takes Clip-On Nylon Hanger Sold Separate	7.88in	11.125in	1.59gal	22	
WP105577 12RD Basket No Eyelets Takes Clip-On Nylon Hanger Sold Separate	6.88in	12.75in	2.09gal	22	
WP107867 12XLRD-II No Eyelets Clip-On Nylon Hanger Sold Separate	8.88in	12.875in	2.69gal	22	

Western Pulp® Round Fiber Garden Hanging Basket

Premium Quality Fully Wax-Permeated Fiber Basket For Extended Life And Strength. Wp888227 Heavy-Duty Metal Hangers Sold Separately.



Product	Depth	Outside Diam	Max Liquid Volume	Case Qty	Barcode
WP106927 16x8 Garden Basket No Eyelet Use w/ 16in Hanger , Assembly Sold Separate	8.88in	17in	4.43gal	20	
WP103827 18x10 Garden Basket No Eyelet 18in Hanger Assembly Sold Separate	9in	19.75in	5.99gal	20	



Fiber Containers

Western Pulp® Cascade Fiber Hanging Basket

Used For Foliage Plants And Interior Landscaping. 10, 12 And 14 Baskets Are Fully Wax-Permeated For Extended Life And Strength, Fitted With Attractive Rust-Free Eyelets. Featuring 7 Side-Planting Holes; More Holding Power For Larger Hanging Gardens. Hangers Sold Separately.



Product	Depth	Outside Diam	Max Liquid Volume	Case Qty	Barcode
WP106627 12 Cascade W/Eyelet Extra-Strong Nylon H-D Hooked Wire Sold Separate	7.62in	12.75in	2.34gal	22	

Western Pulp® 4-Strand Wire Hoop Hanger

Heavy-Duty Wire Hanger That Swivels 360 Degrees.



18in - Fits 18in x 10in Garden Baskets (20/CS)
WP888227 Min. Buy 1 CS



Western Pulp® 16in 4-Strand Wire Hoop Hanger

Fits 16X8 Garden Baskets -Heavy-Duty Hanger That Swivels 360 Degrees.



20pk - Fits 16X8 Basket Garden Baskets
WP888127 Min. Buy 1 CS



Western Pulp® 4-Strand Nylon Clip-On Hanger

Attaching Clip-On Hangers Significantly Saves Time. Just Attach 2 Opposing Clips At Once And Snap On The Other 2. Notches Built Into The Rolled Rim Make Positioning Easy. Can Be Easily Removed And Reused.



Fits 10in And 12in Baskets Without Eyelets (22/CS)
WP888534 Min. Buy 1 BG



Western Pulp® Heavy Duty Hooked Wire Hanger

Heavy-Duty Wire Hanger. Recommended For Use With 14X1rd Basket. May Also Be Used With Eyeleted 10 And 12 Hanging Baskets.



26in - Fits 10in, 12in And 14in Baskets With Eyelets 100/Cs
WP888899 Min. Buy 1 EA



Western Pulp® 4-Strand Nylon Barbed Hanger

Extra-Strong, Attractive, Easy-To-Install Snap-In Hanger.



For 10in And 12in Hanging Basket With Eyelets (22/CS)
WP888514 Min. Buy 1 BG



Western Pulp® Heavy Duty 4-Strand Wire Swivel Hangers

Heavy-Duty Wire For Use With Eyelet Pots Like 14X1rd. Swivels 360 Degrees.



26in - 20/Case
WP888612 Min. Buy 1 BG



Pots & Carry Trays



Landmark® Transport Tray

Durable, tear resistant trays with bottom drainage and easy, finger-tip extraction. Includes de-nesting notches for automation equipment.

Product	Length	Width	Depth	Case Qty	Barcode
LNDX-6TPPPB Holds 6ea 6in Azalea Pots	17.64in	11.5in	4.25in	100	
LNDX-6.5TPPPB Holds 6ea 6.5in Azalea Pots	19.63in	13in	5.25in	100	
LNDX-T13TPPPB Holds 8ea 5in Pots	20in	10in	4.74in	100	
LNDX-QTPP8 Holds 8ea Quart Size Pots	19.5in	10in	5.3in	50	
LNDX-T5TPPB Holds 8ea 5in Azalea Pots	20in	10in	3.75in	100	
LNDC-LN4TP10B Holds 10ea 4in Round Pots	20.38in	8.13in	3.72in	75	
LNDX-4TP15B-T	20.25in	12.13in	3.5in	50	
LNDX-43TPB Holds 10ea 4in Round Pots	21.63in	8.63in	4.06in	100	
LNDX-4.5TP10B Holds 10ea 4.5in Round Pots	22.4in	8.9in	4.19in	75	
LNDX-45SPT10 Holds 10ea 4.5in Square Pots	8.44in	20.94in	2.02in	90	
LNDX-4.5TPB12 Holds 12ea 4.5in Round Pots	18.99in	14.11in	3.96in	75	
LNDX-4.5TPPPB Holds 15ea 4.5in Round Pots	23.06in	14.06in	3.94in	90	
LNDX-3PXDT20 Holds 20ea 3in Round Pots	15.19in	12.19in	2in	100	
LNDX-2SPT32 Holds 32ea 2.25in Square Pots	18.1in	9.12in	2.25in	100	

Not available for sale in CA

Not available for sale in CA

Not available for sale in CA

Not available for sale in CA

Not available for sale in CA

Not available for sale in CA

Not available for sale in CA

Not available for sale in CA



Pots & Carry Trays

Landmark® Thermoformed Square Pot

Thermoformed square pots are part of an economical, easy-to-use growing system for virtually any crop. Easily accommodates automation equipment. Precision-formed pots with uniform drainage.



Product	Color	Width	Depth	Max Liquid Volume	Case Qty	Barcode
LNDX-225P1920	Black	2.19in	3in	4.9oz	1920	
LNDX-3PD Deep	Black	2.63in	3.5in	9.5oz	800	
LNDX-3P800 Press-Fit Pot	Black	2.63in	2.25in	1pt	800	
LNDX-4P	Black	3.5in	3.5in	1.05pt	450	
LNDX-4PXD Extra Deep	Black	3.5in	5.02in	1.52pt	450	
LNDX-4.5P375E Economy	Black	4.19in	3.63in	1.69pt	375	
LNDX-4.5P300/cs new 04-5	Black	4.19in	3.63in	1.69pt	300	
LNDX-4.5P	Black	4.19in	3.63in	1.69pt	375	
LNDX-4.5PD Deep	Black	4.19in	3.63in	1.15qt	375	
LNDX-3PXD400 Extra Deep	Black	3in	4.25in	13.3oz	400	
LNDX-TP900E Economy	Black	3.25in	3.5in	14.4oz	900	

Landmark® Square Press Fit Tray

Durable, tear resistant trays with bottom drainage and easy, finger-tip extraction. Includes de-nesting notches for automation equipment.



Product	Length	Width	Depth	Case Qty	Barcode
LNDL-4.5PF12 Holds 12ea 4.5in Pots	12.75in	16.97in	2.31in	100	
LNDL-PF15TRAY Holds 15ea 4.5in Pots	12.1in	12.71in	2.31in	50	
LNDL-TPT18 Holds 18ea Pots	10in	20in	2.31in	100	
LNDL-PF18TRAY Holds 18ea 4in Pots	10.79in	21.23in	2.31in	100	
LNDL-PF32TRAY Holds 32ea 3in Pots	21.23in	10.79in	1.5in	100	





Pots & Carry Trays

Landmark® Nursery Carrying Trays

Durable, tear-resistant trays with bottom drainage and easy, finger-tip extraction. Includes de-nesting notches for automation equipment.



Product	Length	Width	Depth	Case Qty	Barcode
LNDX-3QTCTPP Holds 6ea Trade Gallon Pots	19.5in	12.75in	2.5in	50	



Landmark® Thermoformed Round Maxi-Grow Pot

Protect your roots with our co-extruded thermoformed round pots. Features bi-level drainage that promotes air pruning and discourages root circling and a large surface area for labeling and printing. Ideal for use in automation equipment.



Product	Color	Width	Depth	Max Liquid Volume	Case Qty	Barcode
LNDX-4RMGTB	Black	4in	3.49in	1pt	825	
LND43RMGT100CT	Black	4.33in	3.9in	1.25pt	765	
LND45RMGT100CT	Black	4.5in	4.2in	1.37pt	450	
LNDX-5RMGT	Black	5in	4.57in	1.06qt	360	

Landmark Plastic Dual Use Handle

This Dual Use Handle from Landmark Plastic can be used with either a 1/2in half moon slot or 1/2in round slots. 1000/CS.



19in - White - 1.25in x 19.76in - Works with 1/2in Moon Slots or 1/2in Round

LNDN1481103CT Min. Buy 1 CS/100 EA



WARNING: This product is not available for sale in CA.
For most up to date information please visit bfgsupply.com

800-883-0234
www.bfgsupply.com



Pots & Carry Trays

Landmark® Thermoformed Azalea Pot

Protect your roots with our co-extruded thermoformed round pots. Features bi-level drainage that promotes air pruning and discourages root circling and a large surface area for labeling and printing. Ideal for use in automation equipment.



Product	Color	Width	Depth	Max Liquid Volume	Case Qty	Barcode
LNDX-6AMGT	Black	6in	5in	2.5qt	220	
LNDX-65AMGT	Black	10in	5in	2.08qt	240	

Landmark® Maxi-Grow™ Geranium Pot

Injection molded pot made of high-quality polypropylene resin and glossy finish for easy labeling. Maxi-Grow™ pots feature a bi-level drainage holes allow excellent drainage and inhibit seal off.



Product	Color	Width	Depth	Max Liquid Volume	Case Qty	Barcode
LNDI-G450MGBK-N	Black	4.5in	4in	1.27pt	900	

Landmark® Thermoformed Pot Pack

Each cell is 3.13in diameter x 3.16in deep, 11.5oz(340.10ml). Manufactured with high quality, tear-resistant materials. Features integrated water channels that ensure all cells receive even water distribution.



Product	Color	Length	Width	Depth	Case Qty	Barcode
LNDC-TPP6W 6 Pack White	White	10in	6.73in	3.5in	300	
LNDC-TPP6 6 Pack Black	Black	10in	6.73in	3.5in	300	





Pots & Carry Trays

Landmark® Sheet of Pots

Thermoformed pots feature bi-level drainage to promote air pruning and discourage root circling, for healthier plants. All pots are engineered to work precisely with automation equipment.



Product	Width	Depth	Case Qty	Barcode
LNDX-4.5SP15 Holds 15 Pots - Fits 10in x 20in Tray	4.09in	3.65in	100	
LNDX-3.5SPWB Holds 18 Pots	3.53in	3in	100	
LNDX-3.5SPD Holds 18 Pots	3.49in	3.23in	100	
LNDX-3SQSP Holds 32 Pots	2.45in	3.05in	100	

Trays, Inserts & Flats

Landmark® L Series Injection Molded Web Tray

1020 Standard Series injection molded web tray, made of high-quality plastic resins for easy de-nesting, specifically designed to accommodate automation equipment.



L1020 ALT Solid Side - 21.13in L x 10.67in W x 2.39in D - Black

LNDI-L1020ISS-T Min. Buy 1 CS/50 EA



Landmark® Dome

7in Clear Dome used with Carry Tray 1020. Has 2 vents that open and close.



Clear - 7in D x 10.80in W x 21.22in L
LNDDOMELPC245CT Min. Buy 1 CS/40 EA



Landmark® Seeder Trays (Open)

High-quality tray manufactured for trouble-free use in seedling and transplanting equipment. Features root channels and step-bottom drainage, ideal for deciduous and evergreen ornamentals.



Open Seeder Tray
21.23in L x 10.80in W x 1.38in D

LNDP-OPENST Min. Buy 1 CS/100 EA





Trays, Inserts & Flats

Landmark® L Series Pack

Made of high-quality plastic resins for easy de-nesting. Precision perforation between packs. Specifically designed to accommodate automation equipment.



Product	Length	Width	Depth	Max Liquid Volume	Case Qty	Barcode
LNDL-1801 18 Cells - 20.85in x 10.42in	3.1in	3.1in	2.33in	2.33	100	
LNDL-2401 24 Cells - 20.85in x 10.42in	3.1in	2.25in	2.33in	2.33	100	
LNDL-804 32 Cells - 20.85in x 10.42in	2.35in	2.35in	2.33in	2.33	100	
LNDL-606 36 Cells - 20.85in x 10.42in	2.35in	2.15in	2.33in	2.33	100	
LNDL-1203 36 Cells - 20.85in x 10.42in	3.15in	1.55in	2.33in	2.33	100	
LNDL-1004 40 Cells - 20.85in x 10.42in	1.85in	2.4in	2.33in	2.33	100	
LNDL-1204 48 Cells - 20.85in x 10.42in	2.35in	1.45in	2.33in	2.33	100	
LNDL-806 48 Cells - 20.85in x 10.42in	2.35in	1.55in	2.33in	2.33	100	
LNDL-1006 60 Cells - 20.85in x 10.42in	1.85in	1.75in	2.33in	2.33	100	
LNDL-1206 72 Cells - 20.85in x 10.42in	1.55in	1.55in	2.33in	2.33	100	

Landmark® L Series Pack Super Jumbo/Deep Packs

Made of high-quality plastic resins for easy de-nesting. Precision perforation between packs. Specifically designed to accommodate automation equipment.



Product	Length	Width	Depth	Max Liquid Volume	Case Qty	Barcode
LNDL-804SJ 32 Cells - 20.85in x 10.42in	2.46in	2.47in	3.05in	3.05	100	
LNDL-606SJ 36 Cells - 20.85in x 10.42in	2.35in	2.15in	3.13in	3.13	100	
LNDL-806SJ 48 Cells - 20.85in x 10.42in	2.35in	1.6in	3.12in	3.12	100	
LNDL-1204D 48 Cells - 20.85in x 10.42in	2.63in	1.72in	2.75in	2.75	100	



Trays, Inserts & Flats

Landmark® L Series Tray

L Series tray, made of high-quality plastic resins for easy de-nesting, specifically designed to accommodate automation equipment.

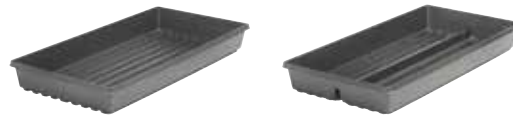

Product	Length	Width	Depth	Max Liquid Volume	Case Qty	Barcode
LNDL1020NCRNNOHOLE No Holes	21.22in	10.8in	2.33in	2.33	100	
LNDL1020NCRWITHHOLE With Drainage Holes	21.22in	10.8in	2.33in	2.33	100	
LNDL-1020CR Center Rib Tray	21.22in	10.8in	2.33in	2.33	100	

Landmark® True Series Insert

True series insert ideal for filling, growing and transporting. Made of high-quality plastic resins for easy de-nesting, specifically designed to accommodate automation equipment, precision perforation between pack.



Product	Length	Width	Depth	Max Liquid Volume	Case Qty	Barcode
LNDC-T804 32 Cells - 20in x 10in	2.28in	2.24in	2.61in	2.61	100	
LNDC-T1203 36 Cells - 20in x 10in	3.03in	1.53in	2.61in	2.61	100	
LNDC-T1203-N 36 Cells - 20in x 10in	3.03in	1.53in	2.61in	2.61	4500/pl	
LNDC-T806 48 Cells - 20in x 10in	2.28in	1.5in	2.61in	2.61	100	
LNDC-T1203 36 Cells - 20in x 10in	2.28in	1.5in	2.61in	2.61	3600/pl	
LNDC-T1202SJ-B 24 Cells - 20in x 10in	3in	2.13in	3.25in	3.25	100	
LNDC-T606SJ 36 Cells - 20in x 10in	2.21in	2.03in	3.25in	3.25	100	

Landmark® True Series Tray

True series tray, made of high-quality plastic resins for easy de-nesting, specifically designed to accommodate automation equipment.



Product	Length	Width	Depth	Max Liquid Volume	Case Qty	Barcode
LNDC-TR8XD 8 Cells	20in	10in	2.71in	2.71	100	
LNDC-TR12NXD 12 Cells	20in	10in	2.71in	2.71	100	
LNDC-TR18IXDE-B 18 Cells	20in	10in	2.71in	2.71	100	

LANDMARK PLASTIC

Trays, Inserts & Flats

Landmark® Landscape Tray

True series tray, made of high-quality plastic resins for easy de-nesting, specifically designed to accommodate automation equipment.



Product	Length	Width	Depth	Max Liquid Volume	Case Qty	Barcode
LNDC-TLF18 18 Cells	2.5in	2.98in	3.47in	3.47	100	

Landmark® True Series Sheet of Pots

Thermoformed pots per sheet feature bi-level drainage to promote air pruning and discourage root circling, for healthier plants. All pots are engineered to work precisely with automation equipment.



Product	Length	Width	Depth	Max Liquid Volume	Case Qty	Barcode
LNDC-T1801SP 18 Pots per Sheet	3.18in	3.14in	3.27in	3.27	100	
LNDC-T1801SPE 18 Pots per Sheet	3.18in	3.14in	3.27in	3.27	100	

Landmark® TSS Series Packs (7.5in x 20in)

Made of high-quality plastic resins for easy de-nesting, specifically designed to accommodate automation equipment.



Product	Length	Width	Depth	Max Liquid Volume	Case Qty	Barcode
LNDC-TSSR6NCR 6 Ribs	19.88in	7.5in	1.75in	1.75	100	
LNDC-TSS306 18 Cells	3.1in	2.3in	3.34in	3.34	100	





Propagation & Plug Trays

Landmark® Burned Drainage Plug Sheet

Ideal for perennial and liner production. Each cell has a burned drainage hole.



Product	Length	Width	Depth	Max Liquid Volume	Case Qty	Barcode
LNDX-38PS 38 Cells	20.85in	10.42in	2.38in	2.38	100	
LNDX-50PS 50 Cells	20.85in	10.42in	2in	2	100	
LNDX-72PS 72 Cells	20.85in	10.42in	1.5in	1.5	100	
LNDX-72SPS 72 Cells	20.85in	10.42in	1.63in	1.63	100	

Landmark® Hexagon Series Plug Tray

Ideal for perennial and liner production.



Product	Length	Width	Depth	Max Liquid Volume	Case Qty	Barcode
LNDC-102HX 102 Cells	20.99in	10.67in	1.63in	1.63	100	
LNDC-105SSNL 105 Cells	20.99in	10.68in	1.5in	1.5	100	

Landmark® Seedling Trays

High-quality tray manufactured for trouble-free use in seedling and transplanting equipment. Features root channels and step-bottom drainage, ideal for deciduous and evergreen ornamentals.



Product	Length	Width	Depth	Max Liquid Volume	Case Qty	Barcode
LNDX-21STPP 21 Cells	21.23in	10.8in	3.5in	3.5	65	
LNDX-38ST 38 Cells	21.23in	10.8in	5in	5	50	
LNDX-50ST 50 Cells	21.23in	10.8in	4.5in	4.5	55	
LNDX-72ST 72 Cells	21.23in	10.8in	3.25in	3.25	50	

Landmark® Seeder Trays

High quality plug trays represent true innovation. Precision manufactured for trouble free use in seedling and transplanting equipment.

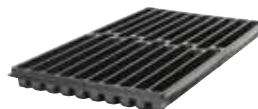

Product	Length	Width	Depth	Max Liquid Volume	Case Qty	Barcode
LNDP-SEED20 20 Rows	21.5in	11in	1.25in	1.25	100	

WARNING: This product is not available for sale in CA.
For most up to date information please visit bfgsupply.com

800-883-0234
www.bfgsupply.com



Propagation & Plug Trays

Landmark® Square Plug Tray

High quality plug trays represent true innovation. Precision manufactured for trouble free use in seedling and transplanting equipment.



Product	Length	Width	Depth	Max Liquid Volume	Case Qty	Barcode
LNDP-50 50 Cells	21.38in	11.05in	2.25	2.25	100	
LNDP-72SQ 72 Cells	21.38in	11.05in	1.75in	1.75	100	
LNDP-72SQD 72 Cells	21.38in	11.05in	2.38in	2.38	100	
LNDP-98 98 Cells	21.38in	11.05in	2in	2	100	
LNDP-128 128 Cells	21.38in	11.05in	2in	2	100	
LNDP-200CR 200 Cells	21.38in	11.05in	1.75in	1.75	100	
LNDP-288SQ 288 Cells	21.38in	11.05in	1in	1	100	
LNDP-288SQD 288 Cells	21.38in	11.05in	1.75in	1.75	100	
LNDP-392 392 Cells	21.38in	11.05in	1in	1	100	
LNDP-512 512 Cells	21.38in	11.05in	1in	1	100	

Landmark® Square Plug Tray with Feet

Ideal for perennial and liner production.

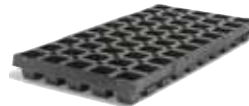

Product	Length	Width	Depth	Max Liquid Volume	Case Qty	Barcode
LNDC-T50 50 Cells	20in	10in	1.63in	1.63	70	

Landmark® Octagon Plug Tray

Ideal for perennial and liner production. Each cell has a burned drainage hole.



Product	Length	Width	Depth	Max Liquid Volume	Case Qty	Barcode
LNDC-144OCT 144 Cells	20.82in	10.54in	1.5in	1.5	100	





Hanging Baskets

Landmark® Deco-Swirl Saucerless Hanging Basket

Attractive, functional and ready to use by both growers and consumers. Featuring a Maxi-Mizer® drainage system, a saucerless basket that lets water flow through while providing a water reservoir at the bottom.



Product	Depth	Outside Diam	Max Liquid Volume	Case Qty	Barcode
LNDI-DS12WH25CS White	11.71in	11.71in	2.25gal	25	
LNDI-DS12GR25CS Green	11.71in	11.71in	2.25gal	25	
LNDI-DS12GRBB Green	11.71in	11.71in	2.25gal	950/pl	

Not available for sale in CA

Landmark Plastic® Double Clip Auto Hanger

Sold by 25 hangers per bag, K-22ACL.



22in - Green
LNDK-22ACLGR Min. Buy 25 EA



Landmark® Wrapped Wire Hanger

For use with 12in hanging baskets.



24in - 4-Strand
LNDZ-24164STW Min. Buy 50 EA



Landmark® Double Clip Auto Hanger

Landmark 22" double clip auto hanger, white, sold by 25 hangers per bag.



22in - White
LNDK-22ACLWH Min. Buy 25 EA



Mum Pans

Landmark® Thermoformed MaxiGrow Mumpan Pot

Protect your roots with our co-extruded thermoformed round pots. Features bi-level drainage that promotes air pruning and discourages root circling and a large surface area for labeling and printing. Ideal for use in automation equipment.



Product	Depth	Outside Diam	Max Liquid Volume	Case Qty	Barcode
LNDX-8MPMGTB Black	5in	8in	3.04qt	300	
LNDX-9MPMGTB Black	5.9in	9in	1.18gal	100	

WARNING: This product is not available for sale in CA. For most up to date information please visit bfgsupply.com



Nursery Containers

Landmark® Nursery Container

Injection-molded nursery containers that are stackable, sturdy and smooth. Features Maxi-Grow Plus Rim-Lok bottoms that allow secure, easy stacking and transport and tag locks in the rim to help growers clearly and securely identify plants. The Smooth sidewalls allow compatibility with automated labeling and printing equipment.







Product	Depth	Outside Diam	Max Liquid Volume	Case Qty	Barcode
LNDX-65NTGTBK Black	6.5in	6.5in	2.5qt	200	
LNDX-65NTGTBK-N11550 Black	6.5in	6.5in	2.5qt	11550/pl	
LNDI-NCSGALBK-S Black	7in	7.15in	1gal	75	
LNDI-NCT2GALBK Black	8.5in	8.04in	1.47gal	65	
LNDX-85NT2GBK Black	8.5in	8.5in	1.5gal	100	
LNDI-NCTGALBK Black	6.87in	6.13in	2.64gal	68	



Pots & Carry Trays
Pöppelmann TEKU® Azalea Round Pot

Fast watering and drainage and optimum pot machine properties – these small details are often what makes a big difference. In other words: precision work. This is a decisive factor for the quality of the TEKU® plant pots. And it's the decisive factor for something else: your success. Multi-hole profile bottom.







Product	Color	Depth	Outside Diam	Max Liquid Volume	Case Qty	Barcode
PPTO6DBLK3660 TO 6 D Black	Black	1.875in	2.375in	2.67oz	3660	
PPTO6DTC3660 TO 6 D Terra Cotta	Terra Cotta	1.875in	2.375in	2.67oz	3660	
PPVCD165BLK VCD 16.5 Black	Black	5in	6.5in	2.04qt	530	
PPVCD21D0825BLK VCD 21 D Black	Black	5in	8.25in	3qt	288	

Pöppelmann TEKU® Round Pot

Fast watering and drainage and optimum pot machine properties – these small details are often what makes a big difference. In other words: precision work. This is a decisive factor for the quality of the TEKU® plant pots. And it's the decisive factor for something else: your success. Has a multi hole, profile bottom.





Product	Depth	Outside Diam	Max Liquid Volume	Case Qty	Barcode
PPVCC10F BLK VCC 10 F Black	3.625in	4in	1pt	2668	
PPVCC110450BLK VCC 11 Black	3.75in	4.33in	1.31pt	1896	
PPVCC12FUS-0475BLK VCC 12 Black	4.75in	4.75in	1qt	1440	
PPVCC165KBLACK VCC 16.5 K w/Tag Slot Black	6.125in	6.5in	2.5qt	430	
PPVCC165KBLACKBULK9856 VCC 16.5 K w/Tag Slot Black	6.125in	6.5in	2.5qt	9856/pl	

Pöppelmann TEKU® Square Pot

Rapid growth, healthy plants, outstanding machinability – Pöppelmann TEKU® is not only characterized by the leading product range, but also offers the optimal solution for your culture. Has a multi hole, profile bottom.



Product	Depth	Outside Diam	Max Liquid Volume	Case Qty	Barcode
PPVQF8585952352 VQF 8.5X8.5X9.5 Black	3.75in	3.33in	1pt	2352	
PPVQF111115CS840 VQF 11X11X11.5 Black	4.5in	4.33in	1.25qt	840	



PÖPPELMANN

Pots & Carry Trays

Pöppelmann Translucent Pot

Translucent orchid pot

Product	Depth	Outside Diam	Max Liquid Volume	Case Qty	Barcode
PPMCO12TRNS MCO 12	4.25in	4.5in	1.55pt	666	
PPMCO15TRNS MCO 15	4.875in	6in	1.39qt	385	

Pöppelmann TEKU® Transport Tray

Transport and Cultivations trays have innovative bottom designs for every application. Punched bottom holes.



Product	Length	Width	Depth	Outside Diam	Case Qty	Barcode
PPUT12/8F UT12/8F Fits VCC 12 F	19.25in	9.625in		4.875in	58	
PPST2254AZDCS56 ST 2254 Fits VCC 11	21.25in	8.5in	4.63in	3.125in	56	
PPUT1656STD UT 16.5/6 STD PACK Fits VCC 16.5 K	16.5in	6in			50	
PPUT10/10F UT 10/10 F US PACK Fits VCC 10	12in	8.12in		3.75in	48	

Pöppelmann TEKU® Nursery Plant Tray

Rapid growth, healthy plants, outstanding machinability – Pöppelmann TEKU® is not only characterised by the leading product range, but also offers the optimal solution for your culture. With bottom for plugs.



Product	Length	Width	Depth	Case Qty	Barcode
PPJP305028BLK JP 3050/28	19.67in	11in	2in	192	





PÖPPELMANN

Hanging Baskets

Pöppelmann TEKU® Hanging Basket

Rapid growth, healthy plants, outstanding machinability – Pöppelmann TEKU® is not only characterised by the leading product range, but also offers the optimal solution for your culture. Water overflow with tag lock. Hangers sold separate.



Product	Color	Depth	Outside Diam	Max Liquid Volume	Case Qty	Compatible Items	Barcode
PPMAL271065MOCHA	Mocha	6.5in	10.625in	1.57gal	50	MHJ 40 Hanger	
PPMAL27ZMOCHABULK Bulk	Mocha	6.5in	10.625in	1.57gal	3264/pl	MHJ 40 Hanger	
PPMAL271065BLACK	Black	6.5in	10.625in	1.57gal	50	MHJ 40 Hanger	
PPMAL27ZBLACKBULK Bulk	Black	6.5in	10.625in	1.57gal	3264/pl	MHJ 40 Hanger	
PPMAL271065WHITE	White	6.5in	10.625in	1.57gal	50	MHJ 40 Hanger	
PPMAL27ZWHITEBULK Bulk	White	6.5in	10.625in	1.57gal	3264/pl	MHJ 40 Hanger	
PPMAL27ZCHOCCS	Chocolate	6.5in	10.625in	1.57gal	50	MHJ 40 Hanger	
PPMAL27ZCHOCCBULK Bulk	Chocolate	6.5in	10.625in	1.57gal	3264/pl	MHJ 40 Hanger	
PPMAL27GRN	Green	6.5in	10.625in	1.57gal	50	MHJ 40 Hanger	
PPMAL27ZGREENBULK Bulk	Green	6.5in	10.625in	1.57gal	3264/pl	MHJ 40 Hanger	

Pöppelmann TEKU® 3-Strand Hanger

The stable hanger ensures secure hanging both in the greenhouse and for the end customer. Quick and easy hanger assembly, due to its universal fixing method, reduces labour costs.



Mocha - 18in

PPMHJ40MOCHA Min. Buy 1 CS/348 EA

Black - 18in

PPMHJ40BK Min. Buy 1 BD/58 EA

White - 18in

PPMHJ40WHT Min. Buy 1 CS/348 EA

Chocolate - 18in

PPMHJ40CHOC Min. Buy 1 CS/348 EA

Green - 18in

PPMHJ40 Min. Buy 1 BD/58 EA



WARNING: This product is not available for sale in CA. For most up to date information please visit bfgsupply.com



Hanging Baskets

Belden Plastics® Classic Hanging Basket With Wire Hanger

Made in the U.S.A. injection molded round plastic pots. Superior in quality, provide innovative grower friendly features all with 100% recycled materials. Removable saucer and hangers included.



Product	Color	Depth	Outside Diam	Max Liquid Volume	Case Qty	Compatible Items	Barcode
BP690502 10 Classic	Green	5.5in	10in	1.32gal	50	Inside Saucer and Hanger Included	
BP690501 10 Classic	White	5.5in	10in	1.32gal	50	Inside Saucer and Hanger Included	

Belden Plastics® Hanging Basket with Plastic Hanger

Made in the U.S.A. injection molded round plastic pots. Superior in quality, provide innovative grower friendly features all with 100% recycled materials. Removable saucer and hangers included.



Product	Color	Depth	Outside Diam	Max Liquid Volume	Case Qty	Compatible Items	Barcode
BP6903021 6in Hanging Basket	Green	4.25in	6in	.38gal	50	Inside Saucer and Hanger Included	
BP690404 8in Hanging Basket	Green	5in	8in	.84gal	50	Inside Saucer and Hanger Included	

Belden Plastics® POP® Basket with Plastic Hanger

Fluted design, yet smooth surface for easily wiping excel soil or water spots. Best soil volume of any Belden 10in basket. Allows for great root growth. When used as a hanging basket, saucer is left down for excellent soil drainage during cultivation and POP the saucer up for retail ready presentation. Can be used as a Hanging Basket or Urn (lovely at the cemetery). Unique patented product.



Product	Color	Depth	Outside Diam	Max Liquid Volume	Case Qty	Compatible Items	Barcode
BP690523 10 POP Basket	Green	6.5in	10in	1.53gal	50	Attached Saucer & Hanger Included	
BP690522 10 POP Basket	White	6.5in	10in	1.53gal	50	Attached Saucer & Hanger Included	

Belden Plastics® Hanging Basket with Wire Hanger

Made in the U.S.A. injection molded round plastic pots. Superior in quality, provide innovative grower friendly features all with 100% recycled materials. Removable saucer and hangers included.



Product	Color	Depth	Outside Diam	Max Liquid Volume	Case Qty	Compatible Items	Barcode
BP6903025 6in Hanging Basket	White	4.25in	6in	.38gal	50	Inside Saucer and Hanger Included	













Hanging Baskets

Belden Plastics® Saucerless Hanging Basket

Made in the U.S.A. injection molded round plastic pot with a sleek, contemporary design. Superior in quality, provide innovative grower friendly features all with 100% recycled materials. Internal disc allows for great water reservoir. So sturdy that holes can be drilled into the sides, if desired.



Product	Color	Depth	Outside Diam	Max Liquid Volume	Case Qty	Compatible Items	Barcode
BP690717 10 IN Saucerless With Flexible Hanger	Green	5.75in	9.5in	1.24gal	50	Inside Saucer and Hanger Included	
BP690702 10 IN Saucerless With Wire Hanger	Green	5.75in	9.5in	1.24gal	50	Hanger & Inside Saucer Included	
BP690602 12 Saucerless With Wire Hanger	Green	7in	11.75in	2.28gal	25	Hanger & Inside Saucer Included	
BP690625 12 Saucerless With Flexible Hanger	Green	7in	11.75in	2.28gal	25	Inside Saucer and Hanger Included	
BP690611 12 Saucerless With Wire Hanger	Black	7in	11.75in	2.28gal	25	Inside Saucer and Hanger Included	
BP690623 12 Saucerless With Flex Hanger	Black	7in	11.75in	2.28gal	25	Inside Saucer and Hanger Included	
BP690808 14IN Saucerless With Flex Hanger	Green	8.25in	14in	3.96gal	25	Inside Saucer and Hanger Included	
BP690816 14IN Saucerless With Flex Hanger	Black	8.25in	14in	3.96gal	25	Inside Saucer and Hanger Included	
BP690809 14IN Saucerless With Flex Hanger	White	8.25in	14in	3.96gal	25	Inside Saucer and Hanger Included	
BP690901 16IN Saucerless With Flex Hanger	Green	9.75in	16in	5gal	15	Inside Saucer and Hanger Included	
BP690933 16IN Saucerless With Flex Hanger	Black	9.75in	16in	5gal	15	Inside Saucer and Hanger Included	

Belden Plastics® Contemporary Smooth Basket With Wire Hanger

Made in the U.S.A. injection molded round plastic pots. Superior in quality, provide innovative grower friendly features all with 100% recycled materials. Removable saucer and hangers included.



Product	Color	Depth	Outside Diam	Max Liquid Volume	Case Qty	Compatible Items	Barcode
BP6905180 10 IN Contemporary With Wire Hanger	Green	5.75in	10in	1.4gal	50	Hanger & Inside Saucer Included	



Pots & Carry Trays

Belden Plastics® Round Azalea Pot

Made in the U.S.A. injection molded square plastic pots. Superior in quality, provide innovative grower friendly features all with 100% recycled materials.



Product	Color	Depth	Outside Diam	Max Liquid Volume	Case Qty	Barcode
BP692108 6IN	Black	4.5in	6in	.40gal	300	
BP692107 6IN	Green	4.5in	6in	.40gal	300	
BP692213 6.5IN	Black	4.75in	6.5in	.49gal	300	
BP692408 7.5IN	Black	5in	7.5in	.74gal	200	
BP692508 8IN	Black	6in	8in	.92gal	100	
BP692606 8.5IN	Black	6.5in	8.5in	1.05gal	100	
BP692772 10IN	Black	7.5in	10in	1.76gal	40	

Belden Plastics® Jumbo Square Pot

Made in the U.S.A. injection molded square plastic pots. Superior in quality, provide innovative grower friendly features all with 100% recycled materials.



Product	Depth	Outside Diam	Max Liquid Volume	Case Qty	Barcode
BP6915150 Jumbo Black	5.25in	5.25in	.44gal	200	
BP691525 Jumbo Terra Cotta	5.25in	5.25in	.44gal	375	
BP691535 Senior Black	6.5in	5.25in	.53gal	200	
BP691705 Maxi Black	3.5in	3.5in	.13gal	540	

Belden Plastics® Square Plastic Pots

Made in the U.S.A. injection molded square plastic pots. Superior in quality, provide innovative grower friendly features all with 100% recycled materials.



Product	Depth	Outside Diam	Max Liquid Volume	Case Qty	Barcode
BP691405 4 IN Square Black	3.5in	4.12in	.2gal	450	



Pots & Carry Trays

Belden Plastics® Round Geranium Pot

Made in the U.S.A. injection molded round plastic pots. Superior in quality, provide innovative grower friendly features all with 100% recycled materials.



Product	Depth	Outside Diam	Max Liquid Volume	Case Qty	Barcode
BP693405 4.5 IN Black	3.875in	4.5in	.17gal	600	

Belden Plastics® WEBFIT 4515® Tray

Made in the U.S.A. injection molded plastic tray with convenient tag slots. Superior in quality, provide innovative grower friendly features all with 100% recycled materials. Holds fifteen 4.5in Standard pots.



Product	Length	Width	Depth	Case Qty	Compatible Items	Barcode
BP694214 WEBFIT 4515 15 Count Tray	21.25in	13in	2in	30	4.5in Square & Jumbo Jr are Sized for this tray	

Trays, Inserts & Flats

Belden Plastics® 1020 Web Flat Heavy Tray

Made in the U.S.A. injection molded plastic tray with convenient tag slots. Superior in quality, provide innovative grower friendly features all with 100% recycled materials. Holds 8 Jumbo or Senior Squares each.



Product	Length	Width	Depth	Case Qty	Barcode
BP694213 Web Flat Heavy Tray	21in	11in	2in	50	

Specialty Containers

Belden Plastics® Cut Flower Bucket

Made in the U.S.A. injection molded round plastic bucket. Superior in quality, provide innovative grower friendly features all with 100% recycled materials.



Product	Depth	Outside Diam	Max Liquid Volume	Case Qty	Barcode
BP696804 3 GAL No Hole Black	9in	9.62in	2.24gal	50	



Propagation & Plug Trays

Jiffypot® Poly-Pak Preloaded Peat Pots

Preloaded Jiffy poly paks provide quick and easy handling. They are all natural pots, made from Canadian sphagnum peat moss and wood pulp. 100% biodegradable. Provides better root system through root pruning. Strips can be easily broken apart and can be planted 'pot 'n all' resulting in zero transplant shock at the time of transplanting. OMRI Listed.

Product	Depth	Outside Diam	Max Liquid Volume	Case Qty	Barcode
JIF70000486 50/Sheet	2in	2in	79ml	2300	
JIF70000468 50/Sheet	3in	2in	98ml	2000	
JIF70000507 18/Sheet	4in	3.5in	465ml	558	
JIF70001480	2.48in	1.65in	91ml	1000	



Jiffystrip® Peat Pot Strips

Manufactured from raw materials, consisting of a minimum of 50% sphagnum peat, wood fiber and lime to adjust the pH. The peat content provides a combination of superior root penetration, good drainage and aeration while the wood fibers strengthen the pot. The strips can be easily broken apart and can be planted 'pot 'n all' resulting in zero transplant shock at the time of transplanting. Approved for organic gardening, biodegradable & fully sustainable. OMRI® Listed.



Product	Length	Width	Depth	Case Qty	Barcode
JIF70000365 6 Strip	3in	3in	3in	1260	
JIF70000552 8 Strip	2.25in	2.25in	2.25in	2304	
JIF70000509 10 Strip	1.75in	1.75in	2in	5100	
JIF70000428 12 Strip	1.25in	1.25in	2in	7488	
JIF70000510 12 Strip	2in	2in	2in	4680	
JIF70000513 12 Strip	2.25in	2.25in	2in	2520	



Fiber Containers

Jiffypot® Peat Pots

Manufactured from raw materials, consisting of a minimum of 50% sphagnum peat, wood fiber, and lime to adjust the pH. The peat content provides a combination of superior root penetration, good drainage and aeration while the wood fibers strengthen the pot. The pots can be planted 'pot 'n all' resulting in zero transplant shock at the time of transplanting. They are also well-suited to mechanical handling thanks to newly-added de-stacking features. Plus you can save on labor with peat pots because you don't need to de-pot: simply pot on or plant out. Approved for organic gardening, biodegradable & fully sustainable. OMRI® Listed.

Product	Depth	Outside Diam	Max Liquid Volume	Case Qty	Barcode
JIF70000494 Round	2.25in	2.25in	99ml	2816	
JIF70000503 Round	3in	3in	260ml	1404	
JIF70000871 Round	3.9in	4.33in	570ml	950	
JIF70000293 Round	3.75in	4in	431ml	1100	
JIF70000479 Round	5in	6in	1294ml	198	
JIF70000504 Square	2in	2in	79ml	3500	
JIF70000362 Square	3in	3in	330ml	1260	
JIF70000461 Square w/ Slits	4in	3.5in	465ml	800	





SMITHERS-OASIS COMPANY

Propagation & Plug Trays

Oasis® FERTISS® Plant Propagation System

Ready-to-use plugs in a pre-filled propagation strip. Consistent and even media blend, pH adjusted. The loose, open mix makes it easy to insert and stick cuttings and the uniquely developed trays promote natural air pruning, encouraging development of a dense, fibrous root system. Ideal for slow-to-root cultivars. A long-lasting wetting agent is added to enhance water-holding capabilities. Easy to transplant and transport. Stacked trays do not compress the plug media.



Product	Plug Shape	Cells per Tray	Plug Width	Plug Height	Tray Length	Tray Width	Case Qty	Barcode
SM55326C	Round	26-Strip	3cm	4cm	20.79in	3.43in	60	
SM55372P2 Bulk	Square	72-Tray	3cm	3cm	53.5cm	27.5cm	480/pl	
SM55305C2	Square	105-Tray	3cm	4cm	53cm	27cm	14	
SM55305P2 Bulk	Square	105-Tray	3cm	4cm	53cm	27cm	400/pl	

OASIS® WEDGE® Growing Medium

Designed to improve the rooting performance of poinsettias. By tailoring the media to address the specific rooting needs of poinsettias, propagation time can be reduced by five days. Features a unique, tapered shape that directs root growth downward for healthy, rapid development. When it's time to transplant, you'll find minimal need for dibbling, no transplant delay and plants that establish quickly and easily.



Product	Plug Shape	Cells per Tray	Plug Width	Plug Height	Tray Length	Tray Width	Case Qty	Barcode
SM8750010	Wedge	10	1.25 inch	2inch	20inch	1.25inch	224	
SM8750013	Wedge	13	1.25inch	2 inch	21.5inch	1 9/16 inch	224	
SM55625	Wedge	34	1 inch	1 3/4inch	20.75 inch	3.50 inch	2488	
SM55643	Wedge	102	1 inch	1.75 inch	20.25 inch	10inch	1020	
SM55615	Wedge	34	1 inch	1 3/4inch	Does Not Have a Tray		60	

Oasis 5015 Rootcubes® Growing Medium

Rootcubes® growing medium offers a versatile system that has multiple applications for those crops that require high water usage. Hydroponic seed germination and foliage plant propagation are good examples. This medium is designed to drain off excess water from the base of the cutting or seed, yet provide for the proper balance of air and water needed for good root development. Rootcubes are commonly used for hydroponic lettuce, tomato, herb, and onion seed germination. Sterile media arrives pathogen-free, to help reduce disease and insect problems.

Provides ideal air to water ratio.

Superior cutting hydration: Less need for misting simplifies growing process.

Roots remain undisturbed during transplant, eliminating plant shock.

Low cation exchange properties: Improves the speed, precision and availability of nutrients.



1.5in - 50ct Sheet - 10in x 20in

SM5015

Min. Buy 1 CS



Specialty Containers

Al's Flower Pouch™

Expand niche planter programs and optimize greenhouse space with Al's Flower Pouch™, the original vertical garden that brings fresh, cascading color to entryways, backyards, fences, balconies and more. Plant with all kinds of bedding plants and annuals, tropicals, succulents, fall mums, herbs and leafy greens, strawberries, tomatoes, decorative chilies and more.

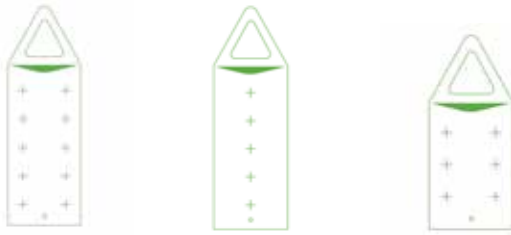

Al's Flower Pouch™ 10-Hole Pouch

10 Hole Pouch for most annuals, strawberries, fall mums. Holes form two rows of five down the length of the pouch.



29.5in L x 8.5in W, 1.59gal/6L Max Volume

AF000012-02 Min. Buy 1 EA

Al's Flower Pouch™ 5-Hole Pouch

5 Hole Pouch for premium annuals like new guinea impatiens, wave petunias. Holes are down the centre of the pouch.



29.5in L x 8.5in W, 1.59gal/6L Max Volume

AF000013-02 Min. Buy 1 EA

Al's Flower Pouch™ Mini 6-Hole Pouch

6 hole pouch, approximately 2/3 the size of the 10 Hole Pouch. Great for herbs, annuals, mums. Holes form two rows of three down the length of the pouch.



22.75in L x 8.5in W, 1.06gal/4L Max Volume

AF000014-02 Min. Buy 1 EA



Al's Flower Pouch™ Thirst Quencher Watering Spout

The Thirst Quencher Watering Spout makes watering Al's Flower Pouch easy. It funnels water all the way down to the bottom of the pouch. It's reusable season after season. Great for large pots, too!



AF00000801

Min. Buy 1 EA



Ellepots by A.M.A. Plug Tray

Made-to-order, shipped fresh and ready-to-stick. Precise specifications: Ellepot Standard Mix - 80% high-quality Canadian peat, 10% fine perlite, 10% coir, starter charge, wetting agent and RootShield. Ellepot Grow Mix - 70%/20%/10%. Target pH Ranges: 5.4 - 5.9; Target EC Ranges: 0.5-1.0. No mud balls! Paper allows root penetration and is stable throughout the propagation, finishing and retailing process, typically degrading in within 24 months depending on soil and weather conditions. Ellepots by A.M.A. promote fast, healthy rooting, greater take rates, even growth, easy sorting and grading, faster transplanting, reduced labor costs and less plastics use. Additional paper and mix options available including organic. Packaging options: Tower (no boxes, trailer height); Bulk (no boxes, about 5' high); Cased. Minimum order: 1 case.



25mm x 40mm Ellepots 105 Octagon

Vented Ellepot Tray - Standard Mix (Bulk)

AF812519SBB Min. Buy 1 CS / 13 Trays

25mm x 40mm Ellepots 105 Octagon

Vented Ellepot Tray - Standard Mix (Tower)

AF812519STB Min. Buy 1 PL / 1365 Trays

30mm x 44mm Ellepots 3 x 26 Strip Vented

Ellepot Tray (78 count) - Standard Mix (Bulk)

AF803019SBB Min. Buy 1 CS / 11 Trays

30mm x 44mm Ellepots 3 x 26 Strip Vented

Ellepot Tray (78 count) - Standard Mix (Tower)

AF803019STB Min. Buy 1 PL / 858 Trays

40mm x 40mm Ellepots 50 Octagon Vented

Ellepot Tray - Grow Mix (Bulk)

AF804002NBB Min. Buy 1 CS / 13 Trays

40mm x 40mm Ellepots 50 Octagon Vented

Ellepot Tray - Grow Mix (Tower)

AF804002NTB Min. Buy 1 PL / 650 Trays



Eckert's Greenhouse

Specialty Containers

Eckert H2O Labor Saver Hanging Planter

Takes the worry out of going away. Established plants are nourished when root moisture absorption occurs. Therefore, only requiring watering every 3 to 4 days. Designed with an innovative wicking system that makes it easier for non established or plants that are normally shallow rooted to receive water from the reservoir. Withstands heat to 220°F and cold to -40°F and has an overflow feature to prevent over watering. Made in the USA and is 100% recyclable.



Black - 23in W x 11.75in D with 4-Strand Swivel Hanger or Chrome Chain - 2.46gal Water Reservoir

EGH79-2600

Min. Buy 6 EA



Eckert Weekender Hanging Planter

Takes the worry out of going away. Established plants are nourished when root moisture absorption occurs. Therefore, only requiring watering every 3 to 4 days. Designed with an innovative wicking system that makes it easier for non established or plants that are normally shallow rooted to receive water from the reservoir. Withstands heat to 220°F and cold to -40°F and has an overflow feature to prevent over watering. Made in the USA and is 100% recyclable.



Black - 16in W x 10in D with 3-Strand Galvanized Steel Swivel Hanger - 1gal Water Reservoir

EGH79-2626

Min. Buy 12 EA



Eckert 28" Wrap Around

The Wrap Around is great for municipal and commercial applications looking to create 360° views on their designated poles. The design makes this container functional as a window box or adaptable for a bridge hanger as well. With a removable liner; you can create year round baskets to beautify any streetscape.



Black - 28in

ECKWAWBLKBLK

Min. Buy 1 EA



Eckert Adjustable Laser Cut Scroll Bracket Iron Accessories

Adjustable Laser Cut Scroll Bracket provides a more decorative touch. This bracket will accommodate either the 16" Weekender or the 23" H2O Labor Saver. The adjustable mount will leave no "holes in your poles". Standard brackets fit poles with a diameter between 3-8" but custom mounts are available.



Black - 20in

EGHLASERSROLL

Min. Buy 1 EA



Eckert Iron Accessories

Take your project to another level by adding our iron to your existing poles or create a whole new "flower tower" with our customizable display poles. All our iron is hot rolled and powder coated black (unless specially ordered). Our iron brackets and hangers can fit existing poles from 3.5" to 8" in diameter or they can be customized for larger poles.



Black - 23in H2O Labor Saver Hoop Bracket

EGH79-2643

Min. Buy 1 EA



Eckert Iron Accessories Mini Tower



3ft

ECK3FTWEEKENDERTOWER

Min. Buy 1 EA



MEDIA



GrowerSelect®

Bark Mixes

Grower Select® H2 Professional Mix

H2 Professional Mix is a heavy-weight bark mix formulated for use in larger containers and longer term crops, both in greenhouses and outdoors. H2's higher ratio of bark: peat gives it an excellent balance of porosity and water holding capacity. 55% Bark, 30% Peat Moss, 15% Perlite.



2.8cu ft - Loose Fill (42/PL)
PRBBFGGSH228 Min. Buy 1 EA

2.8cu ft - Loose Fill (42/PL) - Northern
PRBBFGGSH228N Min. Buy 1 EA

60cu ft - Loose Fill Tote - (2/PL)
PRBBFGGSH260 Min. Buy 1 EA



Grower Select® M2 Professional Mix

M2 Professional Mix is a versatile medium-weight growing medium designed for growing in anything from small pots to large containers and hanging baskets. Approximately 55% Canadian Peat Moss, 30% Pine Bark, 15% Perlite, with wetting agent and starter charge.



2.8cu ft - Loose Fill (48/PL)
PRBBFGGSM228 Min. Buy 1 EA

2.8cu ft - Loose Fill (48/PL) - Northern
PRBBFGGSM228N Min. Buy 1 EA

60cu ft - Loose Fill (2/PL)
PRBBFGGSM260 Min. Buy 2 EA





PRO-MIX®

Peat Mixes

PRO-MIX® BX General Purpose Professional Media

General purpose peat-based professional growing medium designed for general greenhouse use and transplanting applications. Perlite and vermiculite provide a balance of moisture and nutrient retention along with good drainage creating an ideal growing environment.

- Answers the needs of most growing applications
- Light-weight, low bulk-density
- High water-holding capacity
- Vermiculite improves nutrient retention

BX Mixes All Contain

- 75-85% Peat Moss
- Perlite
- Dolomitic & Calcitic Limestone
- Wetting Agent

Crops

- Foliage Plants
- Potted Flowers
- Greenhouse Vegetables
- Young Plant Propagation
- Vegetable Transplants
- Indoor Gardening
- Annuals
- Perennials

Also Available in
BULK SIZES

Contact Your BFG Sales Representative for More Information

Benefits of BIOFUNGICIDE™

(Bacillus amyloliquefaciens MBI-600) is a bacteria which colonizes developing root systems. It helps to prevent root disease and suppress disease causing organisms such as *Pythium*, *Rhizoctonia* and *Fusarium*.

- Enhanced germination
- Better plant growth
- Broad spectrum of action against diseases
- Protection against damping-off, crown and root rots caused by *Pythium*, *Rhizoctonia* and *Fusarium*

Benefits of MYCORRHIZAE™

(Glomus intraradices) is a Biological Growth Enhancer that increases the yield of flower, fruit and vegetable plants by extending the root system to acquire the most of available nutrients in the soil. Mycorrhizae also improve resistance to root diseases and stresses.

- Improves fertilizer uptake; reduces fertilizer costs
- Increases plant's resistance to stresses; reduces maintenance costs
- Optimizes results without changing growing practices



PRO-MIX® BX



2.8cu ft - Loose Fill (57/PL)
PRB10280RG Min. Buy 1 EA

3.8cu ft - Compressed (30/PL)
PRB10380RG Min. Buy 1 BG

135cu ft - Compressed - 1/PL
PRB11350RG Min. Buy 1 EA



PRO-MIX® BX BIOFUNGICIDE™ + MYCORRHIZAE™



2.8cu ft - Loose Fill (57/PL)
PRB1028500RG Min. Buy 1 BG

3.8cu ft - Compressed (30/PL)
PRB1038500RG Min. Buy 1 BG

80cu ft - Compressed (2/PL)
PRB1080500RG Min. Buy 1 BG



PRO-MIX® BX MYCORRHIZAE™



2.8cu ft - Loose Fill (57/PL)
PRB10281RG Min. Buy 1 EA

3.8cu ft - Compressed (30/PL)
PRB10381RG Min. Buy 1 EA



PRO-MIX®

Peat Mixes

PRO-MIX® HP® High Porosity Grower Mix

High porosity peat-based growing medium. Perlite ensures optimum growth, especially when high air capacity and extra drainage are required. An ideal formulation for growers in need of a media adapted to watering flexibility and crop seasonality.

- Greater frequency of dry-down periods (compared to general purpose peat-based mixes)
- Grower can more easily leach fertilizer salts during crop cycle
- Difficult to over-water
- Well suited for undesirable, year-round weather conditions

HP Mixes All Contain

- 65-75% Canadian Sphagnum Peat Moss
- Perlite
- Dolomitic & Calcitic Limestone
- Wetting Agent

Crops

- Annuals
- Greenhouse Vegetables
- Foliage Plants
- Young Plant Propagation
- Potted Flowers
- Vegetable Transplants

Also Available in
BULK SIZES

Contact Your BFG Sales Representative for More Information

Benefits of BIOFUNGICIDE™

(Bacillus amyloliquefaciens MBI-600) is a bacteria which colonizes developing root systems. It helps to prevent root disease and suppress disease causing organisms such as *Pythium*, *Rhizoctonia* and *Fusarium*.

- Enhanced germination
- Better plant growth
- Broad spectrum of action against diseases
- Protection against damping-off, crown and root rots caused by *Pythium*, *Rhizoctonia* and *Fusarium*

Benefits of MYCORRHIZAE™

(Glomus intraradices) is a Biological Growth Enhancer that increases the yield of flower, fruit and vegetable plants by extending the root system to acquire the most of available nutrients in the soil. Mycorrhizae also improve resistance to root diseases and stresses.

- Improves fertilizer uptake; reduces fertilizer costs
- Increases plant's resistance to stresses; reduces maintenance costs
- Optimizes results without changing growing practices



PRO-MIX® HP BIOFUNGICIDE™ + MYCORRHIZAE™



2.8cu ft - Loose Fill (57/PL)
PRB2028500RG Min. Buy 1 BG

3.8cu ft - Compressed (30/PL)
PRB2038500RG Min. Buy 1 EA



PRO-MIX® HP MYCORRHIZAE™



2.8cu ft - Loose Fill (57/PL)
PRB20281RG Min. Buy 1 BG

3.8cu ft - Compressed (30/PL)
PRB20381RG Min. Buy 1 EA



PRO-MIX® HP® MYCORRHIZAE™ Open Top Grow Bag



0.5cu ft - Loose Fill Open Top Grow Bag (294/PL)

PRB20051RG Min. Buy 1 BG

1cu ft - Loose Fill Open Top Grow Bag (135/PL)

PRB20101RG Min. Buy 1 EA



P PREMIER
TECH

PRO-MIX®

Peat Mixes

PRO-MIX® LP15 Multi-Purpose Grower Mix

Designed to provide growing environment that offers good water retention with fibrous peat-moss and a low perlite formulation. Offers growers the needed flexibility for multiple purposes.

- Answers the needs for short-term crops
- Light-weight, low bulk-density
- High water-holding capacity
- Economic alternative for basic use

LP15 Mixes All Contain

- 85-95% Canadian Sphagnum Peat Moss
- Perlite
- Dolomitic & Calcitic Limestone
- Wetting Agent

Crops

- Vegetable Transplants
- Greenhouse Vegetables
- Potted Flowering Plants
- Foliage plants
- Annuals
- Perennials



PRO-MIX® LP15



2.8cu ft - Loose Fill (57/PL)
PRB60280RG Min. Buy 1 BG

3.8cu ft - Compressed (30/PL)
PRB60380RG Min. Buy 1 EA

135cu ft - Compressed (1/PL)
PRB61350RG Min. Buy 1 EA

Also Available in
BULK SIZES

Contact Your BFG Sales Representative for More Information

PRO-MIX® HPCC MYCORRHIZAE™

High Porosity Coir Grower Mix

A lightweight, high-porosity peat-based growing mix containing chunk coir for balanced drainage, moisture retention and increased resistance to compaction. Contains Mycorrhiza.

- Greater frequency of dry-down periods (compared to general purpose peat-based mixes)
- Grower can more easily leach fertilizer salts during crop cycle
- Difficult to over-water
- Well suited for undesirable, year-round weather conditions

HPCC Mix Contains

- 65-75% Peat Moss
- Perlite
- Chunk Coir
- Dolomitic and Calcitic Limestone
- Wetting Agent

Crops

- Annuals
- Foliage Plants
- Potted Flowers
- Greenhouse Vegetables
- Young Plant Propagation
- Vegetable Transplants



PRO-MIX® HPCC MYCORRHIZAE™



2.8cu ft - Loose Fill (57/PL)
PRB2028130RG Min. Buy 1 EA

3.8cu ft - Compressed (30/PL)
PRB2038130RG Min. Buy 1 EA

PRO-MIX® HPCC BIOFUNGICIDE™ + MYCORRHIZAE™



2.8cu ft - Loose Fill (57/PL)
PRB2028530RG Min. Buy 1 EA

3.8cu ft - Compressed (30/PL)
PRB2038530RG Min. Buy 1 EA



WARNING: This product is not available for sale in CA.
For most up to date information please visit bfgsupply.com

800-883-0234
www.bfgsupply.com



PRO-MIX®

Peat Mixes

PRO-MIX® MP Organik

OMRI Listed® organic multi-purpose growing medium with well balanced air/water qualities. Designed to meet crop requirements for organic growers of herbs and vegetables. Enhanced with MYCORRHIZAE™ to expand root system, enhance nutrient and water uptake and increase resistance to stress.

- Consistent formulation without the variability of products with compost
- Suitable for seed starting and will not burn seedlings
- Conforms and approved to organic standards for certified organic growers

MP Mixes All Contain

- 60-70% Canadian Sphagnum Peat Moss
- Coir - horticulture grade
- Perlite - horticultural grade
- Limestone
- Wetting Agents

Crops

- Vegetable Transplants
- Greenhouse Vegetables
- Organic Crops



PRO-MIX® MP ORGANIK™ MYCORRHIZAE™



2.8cu ft - Loose Fill (57/PL) - OMRI Listed®

PRB8028101RG Min. Buy 1 BG

3.8cu ft - Compressed (30/PL) - OMRI Listed®

PRB8038103RG Min. Buy 1 BG

Germination Mixes

PRO-MIX® FPX Plug & Germination Mix

A fine textured plug and germination mix well adapted for water-sensitive crops by providing low water retention levels and good air porosity for developing seedlings. BIO-FUNGICIDE™ is included to suppress root pathogens (Fusarium, Pythium and Rhizoctonia) that cause root diseases.

FPX Mixes All Contain

- 80-90% Canadian Sphagnum Peat Moss
- Perlite
- Dolomitic & Calcitic Limestone
- Wetting Agent

Crops

- Plug & Germination
- Vegetable Transplants
- Young Plant Propagation



PRO-MIX® FPX BIOFUNGICIDE™



2.8cu ft - Loose Fill (57/PL)

PRB40282RG Min. Buy 1 EA

3.8cu ft - Compressed (30/PL)

PRB40382RG Min. Buy 1 EA

Also Available in
BULK SIZES

Contact Your BFG Sales Representative for More Information





Bark Mixes

Also Available in
BULK SIZES

Contact Your BFG Sales Representative for More Information

PRO-MIX® BRK & BRK20**Bark Grower Mixes**

BRK Mix is designed for long term crops such as hardy mums, offering flexibility. Combining the quality of aged pine bark and professional quality sphagnum peat moss, creates a balanced environment that will adapt to the season changes. BRK20 is a medium weight growing medium. Peat and bark based formula adds weight, reduces water retention and ensures optimal balance between air and water. Resists long-term compaction and improves container stability.

- Increased drainage
- High bulk density ensures good pot stability
- Growers can use fertilizer regimes similar to peat-based mixes, unlike other bark-based mixes

Crops

- Annuals
- Perennials
- Potted Flowering Plants
- Potted Trees & Shrubs

**BRK Peat/Bark Mixes**

- 40-50% Canadian Sphagnum Peat Moss
- 35-45% Processed Bark
- Perlite
- Dolomitic & Calcitic Limestone
- Wetting Agent

BRK20 Peat/Bark Mixes

- 60-70% Canadian Sphagnum Peat Moss
- 15-25% Processed Bark
- Perlite
- Dolomitic & Calcitic Limestone
- Wetting Agent

PRO-MIX® BRK

2.8cu ft - Loose Fill (48/PL)

PRB50280RG Min. Buy 1 EA

PRO-MIX® BRK20

2.8cu ft - Loose Fill (48/PL)

PRB50280GLB Min. Buy 1 EA

PRO-MIX® BRK MYCORRHIZAE™

2.8cu ft - Loose Fill (48/PL)

PRB50281RG Min. Buy 1 BG

PRO-MIX® BRK20 MYCORRHIZAE™

2.8cu ft - Loose Fill (48/PL)

PRB50281RGLB Min. Buy 1 EA

PRO-MIX® BRK BIOFUNGICIDE™ + MYCORRHIZAE™

2.8cu ft - Loose Fill (48/PL)

PRB5028500RG Min. Buy 1 EA

PRO-MIX® BRK20 BIOFUNGICIDE™ + MYCORRHIZAE™

2.8cu ft - Loose Fill (48/PL)

PRB5028540RGLB Min. Buy 1 EA



WARNING: This product is not available for sale in CA.
For most up to date information please visit bfgsupply.com

800-883-0234
www.bfgsupply.com



PRO-MIX®

Bark Mixes

PRO-MIX® BK25 Peat / Bark Mix

A medium-weight growing medium designed for the cultivation of greenhouse and nursery crops. The combination of bark, sphagnum peat and perlite create a general purpose mix that offers good drainage and low water retention.

- 50-60% Canadian Sphagnum Peat Moss
- 25% Processed Pine Bark
- Perlite
- Dolomitic & Calcitic Limestone
- Wetting Agent

Also Available in
BULK SIZES

Contact Your BFG Sales Representative for More Information

PRO-MIX® BK55 Peat / Bark Mix

A medium-weight growing medium designed for the cultivation of long-term greenhouse crops and perennials grown outdoors. The combination of processed pine bark, sphagnum peat moss and perlite makes for a good air/water balance. The high percent of bark adds weight, which is perfect for growers looking for container stability.

- 25-35% Canadian Sphagnum Peat Moss
- 55% Processed Pine Bark
- 15% Perlite
- Dolomitic & Calcitic Limestone
- Wetting Agent

PRO-MIX® BK25



2.8cu ft - Loose Fill (48/PL)
PRB5028025RG Min. Buy 1 EA



PRO-MIX® BK55



2.8cu ft - Loose Fill (42/PL)
PRB5028055RG Min. Buy 1 EA



PRO-MIX® BK25 MYCORRHIZAE™



2.8cu ft - Loose Fill (48/PL)
PRB5028125RG Min. Buy 1 EA
60cu ft Loose Fill - (2/PL)
PRB5060125RG Min. Buy 1 EA



PRO-MIX® BK55 MYCORRHIZAE™



2.8cu ft - Loose Fill (42/PL)
PRB5028155RG Min. Buy 1 EA



PROMIX[®]

ALWAYS EXPECT
QUALITY
CONSISTENCY
SERVICE



DISCOVER ALL OUR PRODUCTS



Celebrating 100 years, and beyond.



1 800 667-5366

VISIT PTHORTICULTURE.COM

PRO-MIX[®] is a registered trademark of Premier Horticulture Ltd. BIOFUNGICIDE[™] and MYCORRHIZAE[™] are trademarks of Premier Tech Ltd. and are used under license by Premier Horticulture Ltd.





Grodan®

Rockwool

Grodan® Gro-Smart Tray

Grodan's Gro-Smart Tray fits a standard 10x20 flat and serves dual purpose. Use the 78-cell side for 1.5 A-OK Starter Plus or Macro Plugs. Use the mesh side for sheets of A-OK, Mini-Blocks or Gro-Blocks. Durable heavy plastic tray.



78-cells - Double sided - Fits Standard 10in x 20in Flats

GRD233550 Min. Buy 1 CS



Grodan® Macroplugs™

Grodan's Macroplugs™ are a Slit 1.5in round plug for easy use. Designed to fit perfectly in a Gro-Block. 35 plugs per bag, with 50 bags per case.



1.5in - Round - 1in Diam x 1.57in H

GRD70038 Min. Buy 1 CS



1.5in - Round - 1.5in x 1.57in - Bulk

GRD31581 Min. Buy 1 CS



Grodan® Grow-Chunks

Grow-Chunks are a larger alternative to the Grow-Cubes. The larger 1/2in size chunks allow for a lighter weight media which can be mixed with other growing medias such as coconut fiber. Retail friendly bags.



1/2in - Large

GRD70039 Min. Buy 1 CS



Grodan® Gro-Wool™

Grodan's Gro-Wool™ can be used alone as it's own growing media or mixed with other loose media like coconut fiber.



45lb - 3.5cu ft - Loose

GRD115848 Min. Buy 1 CS



Grodan® Delta Blocks

Grodan's Delta Blocks allow for smaller plants to be fully grown without transplant. Can be utilized as an alternative to a container.



8in - 8in x 8in x 8in - No Hole

GRD241003 Min. Buy 1 CS



Grodan® A-OK Starter Plugs™

Grodan's A-OK Starter Plugs™ for starting seeds and rooting of cuttings. Shrink Wrapped strip that fits a 10in x 20in tray.



1in - 1in x 1in x 1.6in - Shrink Wrapped Strips - Fits Standard 10in x 20in Trays

GRD290336 Min. Buy 1 CS



1.5in - 1.4in x 1.4in x 1.6in - Shrink Wrapped - Fits Standard 10in x 20in Trays

GRD298490 Min. Buy 1 CS



2in - 2in x 2in x 1.6in - Shrink Wrapped - Fits Standard 10in x 20in Trays

GRD293826 Min. Buy 1 CS



2in - Strips - Shrink Wrapped Strip - 2in x 2in x 1.5in

GRD295572 Min. Buy 1 CS



1.5in - Pro - 2in x 2in x 1.6in - Unwrapped - Fits Standard 10in x 20in Trays

GRD293824 Min. Buy 1 CS



2in - Pro - 2in x 2in x 1.6in - Unwrapped - Fits Standard 10in x 20in Trays

GRD293845 Min. Buy 1 CS

Grodan® Grow-Cubes™

Grodan's Grow-Cubes™ are for use as a loose growing media. Allows for a lighter weight media which can be mixed with other growing medias such as coconut fiber.



1.5in - Medium

GRD32289 Min. Buy 1 CS

2cu ft - Large

GRD30298 Min. Buy 1 CS



5.07cu ft - Loose

GRD31580 Min. Buy 1 CS





Grodan®



Rockwool

Grodan® Improved Gro-Block™

Grodan's Improved Gro-Blocks™ utilize improved hydrophilic technology and density for better water distribution and root development. Shrink Wrapped.



**3in - Small - GR4 - 3in x 3in x 2.6in
No Hole - Shrink Wrapped Strip**
GRD286656 Min. Buy 1 CS



**4in - Small - GR6.5 - 4in x 4in x 2.6in
Strips - Pre-Cut Holes**
GRD286605 Min. Buy 1 CS



**4in - Large - GR10 - 4in x 4in x 4in
Loose**
GRD274993 Min. Buy 1 CS



**3in - Small - GR4 - 3in x 3in x 2.6in
Pre-Cut Holes - Shrink-wrap/Strip**
GRD286617 Min. Buy 1 CS



**4in - Small - GR6.5 - 4in x 4in x 2.6in
Strips - Pre-Cut Holes - Shrink Wrapped**
GRD286610 Min. Buy 1 CS



**6in - Hugo - 6in x 6in x 6in
Pre-Cut Holes**
GRD274999 Min. Buy 1 CS



**3in - Small - GR4 - 3in x 3in x 2.6in
Strips with Hole**
GRD287055 Min. Buy 1 CS



**4in - Medium - GR7.5 - 4in x 4in x 3in
with Hole - Shrink-wrap/Strip**
GRD286658 Min. Buy 1 CS



**6in - Hugo - 6in x 6in x 6in
Pre-Cut Holes - Loose Pallet - Bulk**
GRD286616 Min. Buy 1 CS



**3in - Large - GR5.6 - 3in x 3in x 4in
with Hole - Shrink-wrap/Strip**
GRD286657 Min. Buy 1 CS



**4in - Large - GR10 - 4in x 4in x 4in
Shrink-wrap/Strip with Hole**
GRD286661 Min. Buy 1 CS



**6in - Jumbo - 6in x 6in x 4in
Pre-Cut Holes**
GRD286613 Min. Buy 1 CS



**4in - GR40 - 8in x 8in x 4in
No Hole**
GRD287461 Min. Buy 1 CS



**4in - Large - GR10 - 4in x 4in x 4in
Strips - Pre-Cut Holes - Shrink Wrapped**
GRD286612 Min. Buy 1 CS



6in x 6in x 4in
GRD327710 Min. Buy 1 PL

Grodan® Improved Gro-Block™ Mini-Blocks™

Grodan's Improved Mini-Blocks™ utilize improved hydrophilic technology and density for better water distribution and root development. Non-Shrink Wrapped. The Shrink Wrapped version can be ordered with item# GRD294712.



**1.5in - Strips - Not Shrink Wrapped -
1.5in x 1.5in x 1.5in**
GRD294713 Min. Buy 1 CS



**1.5in - Strips - Shrink Wrapped Strip -
1.5in x 1.5in x 1.5in**
GRD294712 Min. Buy 1 CS



**2in - Strips - Shrink Wrapped Strip - 2in x 2in
x 1.5in**
GRD294714 Min. Buy 1 CS

Grodan® Cress Plate

Uniform density allows for uniform water levels throughout the product resulting in even crop growth. Consistent structure results in quick and easy germination.



20in - Bare Sheets - 19.5in x 9.4in x 0.4in
GRD244090 Min. Buy 1 CS



Grodan® Uni-Slab™

Enjoy maximum versatility over plant spacing throughout the lifecycle while enjoying all the benefits of growing in slabs with Grodan Gro-Slab™, Grodan's Single Plant Slab solution- ideal for growing a large size plant to its full potential.



9.5in x 8in x 4in
GRD97028 Min. Buy 1 CS



WARNING: This product is not available for sale in CA.
For most up to date information please visit bfgsupply.com

800-883-0234
www.bfgsupply.com



Grodan®

Rockwool

Grodan® Improved Gro-Slab™

Grodan's Improved Gro-Slab™ utilizes Improved hydrophilic technology for better water distribution and root development. Offers a more uniform distribution throughout the Gro-Slab.



6in - 6in x 6in x 3in
(3) 10in x 10in Pre-Cut Holes
GRD324521 Min. Buy 1 EA



6in - 6in x 6in x 4in
(3) 10in x 10in Pre-Cut Holes
GRD324517 Min. Buy 1 EA



8in - 36in x 8in x 3in
(3) 10in x 10in Precut Holes
GRD327258 Min. Buy 1 EA



8in - 36in x 8in x 3in
(3) 15in x 15in Pre-Cut Holes
GRD325067 Min. Buy 1 EA



6in - 36in x 6in x 3in
GRD320562 Min. Buy 1 CS



8in - 36in x 8in x 3in
GRD320565 Min. Buy 1 CS



6in - Wide - 36in x 6in x 4in
GRD320561 Min. Buy 1 CS



10in - 9.5in x 8in x 4in
GRD321147 Min. Buy 1 CS



12in - 36in x 12in x 3in
GRD320566 Min. Buy 1 CS

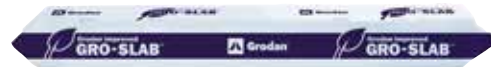

GROWING MEDIA for Professional Growers

ASB

PROFESSIONAL

- **Wood Fiber Mix** – more natural and sustainable
- **Superior porosity** – more available water for better root development
- **Greater value** – more mix per bale with better yields



Growth is our Strength
ASB Greenworld Inc.
asbprofessional.com
sales@asbgreenworld.com





Media

About ASB Greenworld:

ASB Greenworld has several peat moss bogs that supply the best quality blonde sphagnum peat moss, the most preferred by horticultural growers for its coarseness and water holding properties when making growing media mixes. With peat bogs around the world, ASB Greenworld can manage the supply of peat moss on a global basis to ensure the supply of horticultural mixes for its customers. Our Canadian peat moss bog and horticultural media production plant is located in Pointe Sapin, New Brunswick, which has multiple production lines that package 2.8's, 3.8's, totes or super sacks, 110cf big bales, and retail sizes. Because our peat bog and all these production lines are together at one of the largest production facilities in the industry, we can ship mixed loads of all these products on one truck. ASB Greenworld quality, consistency, service and value supplies thousands of growers throughout North America and the world.

Always Improving:

ASB Greenworld is continually upgrading our equipment and processes to ensure your product is delivered to you as ordered on time. New screener added to our operation removes even smaller particles from our mix and cuts down on sticks. Small baler upgrades allow for better compression and better fit on the pallet. Mixing station upgrades completed in summer of 2019 ensure consistency of mix.



Custom Mixes:

If you have a mix that works just right for you, we can match it! ASB Greenworld has access to a wide variety of raw materials and substrates that either can enhance your present mix or duplicate it. Just ask your sales representative for a quote and we can get your custom blend to you when you need it.

**Testing:**

Quality has always been a big part of ASB's history and we support that with on-site quality control laboratories to ensure your mix is given the "green light" before it leaves our facility. We test for pH, EC, particle size, porosity and moisture content. Along with our own on-site testing, each batch produced is sent to an independent lab where another set of comprehensive testing is completed. We will not ship any load unless it meets our high standards and will stand behind every load we produce.

**Support:**

We have a team of experienced technicians lead by Richard Goetze who are dedicated to improving substrate quality and performance. Richard takes pride in continuous improvement of process and product, always with attention and dedication to customers' requirements and expectations. Our team is available to answer your questions about your mix and/or any other questions you may have in regard to the growing process.





Peat Mixes

ASB Greenworld® GM Grow Mix 15% Perlite

All purpose growing medium with perlite. Specially formulated substrate for general greenhouse use, containers and bedding plants.

- 85% Peat Moss
- 15% Coarse perlite



2.8cu ft - Loose Fill (45/PL)
ASB310830 Min. Buy 1 EA

3.8cu ft - Compressed (30/PL)
ASB310909 Min. Buy 1 EA

110cu ft-Compressed (1/PL)
ASB302846 Min. Buy 1 EA



Peat Mixes

ASB Greenworld® GM Grow Mix 25% Perlite

All purpose growing medium with perlite. Specially formulated substrate for general greenhouse use, containers and bedding plants.

- 75% Canadian Sphagnum Peat
- 25% coarse perlite



110cu ft - Compressed (1/PL)
ASB30284625 Min. Buy 1 EA



Germination Mixes

ASB Greenworld® Seed & Plug Mix

Suitable for germination and plug production. High quality mix of triple screened sphagnum peat moss and perlite.

- 80% Canadian sphagnum peat moss.
- 15% fine perlite.
- 5% fine vermiculite.



2.8cu ft - Loose Fill (45/PL)
ASB313847 Min. Buy 1 EA

3.8cu ft - Compressed (30/PL)
ASB313845 Min. Buy 30 EA



ASB Greenworld® GM + 15% Hydrfiber

Growing mix with sustainable wood fiber that offers water retention and aeration without the addition of perlite.

- 85% Canadian Sphagnum Peat
- 15% HydraFiber
- Fertilizer Charge
- Wetting Agent



110cu ft - Compressed (1/PL)
ASB314973 Min. Buy 1 EA

2.8cu ft - Loose Fill (45/PL)
ASB314970 Min. Buy 1 EA

3.8cu ft - Compressed (30/PL)
ASB313653 Min. Buy 1 EA



ASB Greenworld® Hydrfiber 30%

Growing mix with sustainable wood fiber that offers water retention and aeration without the addition of perlite.

- 70% Canadian Sphagnum Peat
- 30% HydraFiber
- Fertilizer Charge
- Wetting Agent



110cu ft - Compressed (1/PL)
ASB315495 Min. Buy 1 EA



WARNING: This product is not available for sale in CA.
 For most up to date information please visit bfgsupply.com

800-883-0234
www.bfgsupply.com



Peat Mixes

Lambert® LM-111 All Purpose Mix

A blend of coarse Canadian Sphagnum peat moss, chunks and perlite. Formulated by combining the major components of both LM-3 and LM-6.

- 80-90% Canadian sphagnum peat moss
- 10-20% Coarse perlite



3cu ft - Loose Fill (48/PL)

LP52515 Min. Buy 1 BG

3.8cu ft - Compressed (30/PL)

LP52510 Min. Buy 1 BG

74cu ft - Loose Fill (2/PL)

LP52512 Min. Buy 1 EA



Lambert® LM-3 All Purpose Mix

A blend of coarse Canadian sphagnum peat moss, coarse perlite and coarse vermiculite. This substrate is an excellent general or all purpose media.

- 80-90% Canadian sphagnum peat moss
- 5-15% Coarse perlite
- Coarse vermiculite



3.8cu ft - Compressed (30/PL)

LP02330 Min. Buy 1 EA



Peat Mixes

Lambert® LM-6 High Porosity Mix

A high porosity growing media with long-fibered Canadian Sphagnum peat moss including the addition of large peat chunks and coarse perlite. Designed for crops that require higher air capacity and drainage.

- 75-85% Canadian sphagnum peat moss
- 15-25% Coarse perlite



3.8cu ft - Compressed (30/PL)

LP02360 Min. Buy 1 EA



Lambert® White Premium High Yield Peat Moss

This coarse grade particle size peat moss is the perfect choice for growers who formulate their media. The physical properties of this peat allows optimum water-holding capacity and drainage. This peat has a high compression ratio resulting in higher yields per bale than most standard peat grades. OMRI listed.

- 100% Canadian sphagnum peat moss
- Long fibered grower grade
- OMRI listed



3.8cu ft - Compressed (30/PL)

LP02152 Min. Buy 1 EA



Germination Mixes

Lambert® LM-1 Germination Mix

A blend of fine-fibered Canadian sphagnum peat moss along with fine vermiculite and perlite to help promote aeration and ideal water holding capacity.

- 80-90% Canadian sphagnum peat moss
- 5-15% Fine perlite
- Fine vermiculite



3cu ft - Loose Fill (48/PL)

LP02313 Min. Buy 1 EA

3.8cu ft - Compressed (30/PL)

LP02310 Min. Buy 1 EA





lambert
At the root of your success

95
1928-2023



SUPERIOR AND CONSISTENT GROWING MEDIA

Lambert offers premium quality peat-based substrates for all the needs of the professional grower.



Germination, Plugs & Seedlings Mixes



All Purpose Mixes



High Porosity Mixes

Formulated with selected grade of Canadian sphagnum peat moss which may contain perlite, vermiculite and/or **ECOPEAT PLUS+**, they provide:

Exceptional combination of water holding capacity and air space – essential characteristics for excellent root development.

Substrates are available in 3.0 & 74 cu ft loose filled bags and 3.8, 55, 110 & 120 cu ft compressed bales.

SUCCESSFUL GROWING STARTS AT THE ROOT WITH LAMBERT PROFESSIONAL SUBSTRATES

Visit our new website at www.lambertpeatmoss.com



Our Expertise is Growing®

Bark Mixes

Sun Gro® Fafard® 52 / Metro-Mix® 852 Mix with RESILIENCE®

(Fafard 52 / Metro-Mix® #852 now share a dual label.) Heavyweight mix with a high percentage of bark specifically formulated for outdoor containers and large interior pots. It is also excellent for the production of perennials, roses and nursery containers. Contains; Canadian Sphagnum Peat Moss, Bark, Perlite, Dolomitic Limestone and RESILIENCE®.



2.8cu ft - Loose Fill (42/PL)
SUN5103CFL0028P Min. Buy 1 EA



Sun Gro® Fafard® 3B / Metro-Mix® 830 Mix with RESILIENCE®

(Fafard 3B / Metro-Mix® #830 now share a dual label.) A versatile middle-weight formula that is a popular bark based mix for expert growers. It is fit for a wide variety of crop plants grown in many container sizes from cell flats to larger pots. Contains; Canadian Sphagnum Peat Moss, Bark, Perlite, Dolomitic Limestone and RESILIENCE®.



2.8cu ft - Loose Fill (48/PL)
SUN5102CFL0028P Min. Buy 1 EA



Germination Mixes

Sun Gro® Sunshine® #5 Propagation Mix with RESILIENCE®

Sunshine® Mix #5 is designed to enhance root development in the propagation of ornamental and vegetable transplants. The #5 propagation mix is designed for liner/propagation trays, cultivation, cell packs, flats, seeds or cuttings, and vegetables. It has low drainage and high water retention and is a fine particle size.



2.8cu ft - Loose Fill (54/PL)
SUN1342CFL0028P Min. Buy 1 EA



Peat Mixes

Sun Gro® Sunshine® #1 / Fafard® 1P Mix with RESILIENCE®

The most versatile and popular professional mix SunGro offers. Recommended for the production of a wide variety of container-grown crops, from vegetables to bedding plants and cuttings. It offers a good balance of sphagnum peat moss, perlite and nutrients that professional growers rely on year after year.



2.8cu ft - Loose Fill (54/PL)
SUN5101CFC0028P Min. Buy 1 EA



Sun Gro® Sunshine® #4 Aggregate Plus Professional Growing Mix

Contains coarse perlite for high air capacity and fast drainage. Ideal for water and salt sensitive crops or where frequent leaching is required. Highly recommended for nursery stock, perennials, cutting propagation, hanging baskets and interiorscapes. Contains RESILIENCE® a silicon-enriched additive – may improve trichome results, resistance to wilting and enhance plant growth and flowering.



3.8cu ft - Compressed (30/PL)
SUN50438CFP Min. Buy 1 BL



Sun Gro® Sunshine® Mix #4 with Mycorrhizae

A premium mix for indoor growing, Sunshine® Mix #4 with Mycorrhizae contains a higher amount of horticultural perlite for plants that prefer greater air porosity. Its our classic #4 boosted with endomycorrhizae. This product contains RESILIENCE®, which may improve resistance to wilting. Low phosphorus fertilizer has been included to better support mycorrhizae establishment and growth.



3cu ft - Compressed (35/PL)
SUN5047040CFC003P Min. Buy 1 EA



Sun Gro® Sunshine® Advanced Mix #4

Recommended for indoor growing. This Myco-active mix retains moisture while providing improved root aeration and drainage. Contains RESILIENCE® our silicon-enriched additive – may improve trichome results, resistance to wilting and enhance plant growth and flowering. OMRI Listed® - for organic gardening.



3cu ft - Compressed (35/PL)
SUN504500cfc003p Min. Buy 1 EA



MICHIGAN PEAT COMPANY

Peat Mixes

Michigan Peat® BACCTO® Professional Planting Mix

Pre-moistened and formulated to enhance the growth of bedding and potted crops in flats, pots and hanging baskets where higher moisture reserves and shelf life are needed.

- Canadian sphagnum peat moss
- Coarse perlite



2.0cu ft - Loose Fill (50/PL)

MPC1732 Min. Buy 1 EA

60cu ft - Loose Fill (2/PL)

MPC3532 Min. Buy 2 EA



WARNING: This product is not available for sale in CA.
For most up to date information please visit bfgsupply.com

800-883-0234
www.bfgsupply.com



Hydroponic Substrates

Riococo® Closed Bottom Propagation Plugs

Propagation plug is a super washed coir pellet with compressed coir fiber natural pith material. Our CBOP 2346 plug is made with carefully selected fine grade coir raw material. The key feature of this plug is that it's a bottom sealed coir plug wrapped with biodegradable paper cellulose. It can be used to grow in the propagation trays.



32mm

RCP32

Min. Buy 2500 EA



Riococo® Expanded Loose Coir

OMRI listed organic coco coir mix consisting of a blend of coir pith and chips. High porosity with excellent aeration requires no additional amendments. 5x washed to remove salts, this product is ready to use and ideal for hydroponic growing systems with a wide range of crops.

- 100% organic coco coir
- OMRI



50L - OMRI® Listed - (70/PL)

PCM50L

Min. Buy 1 EA



Riococo® Grow Bag Slab

A special blend of coir chip and natural material. The selected raw materials are five times washed, blended without fine dust particles to make grow slabs for the required sizes. Slab has very high air fill porosity, moderate water holding capacity and balanced pH with very low EC and Sodium (Na) content. Grow slab has evenly distributed martial mix packed in U.V. stabilized co-extruded bags.



15L - 40in x 6in x 4in

PMGCB01

Min. Buy 1 EA

18L - 40in x 6in x 5in

PMGCB02

Min. Buy 1 EA



Riococo® PCM 4.5kg Coir Block

The PCM mix coir block is made from coir fiber and crushed chips blended together and compressed to a 4.5kg/10lb size. It is a heat-treated and washed five times. PCM coir mix can be use straight without adding perlite or other components to increase aeration.



10lb - 14.5gal

PCMB02

Min. Buy 1 EA



Riococo® PCM Open Top Bag

Riococo® PCM OTBs (Open Top Bags) are produced with a special blend of coconut fiber raw materials, which provides the ideal coco medium characteristics to the plants. The selected raw materials are five times washed, blended without fine dust particles to make PCM OTBs for the required sizes. This product is specially designed to reach the optimum water holding capacity and air-filled porosity.



1gal

PMCOTB01

Min. Buy 44 EA

2gal

PMCOTB02

Min. Buy 18 EA

3gal

PMCOTB03

Min. Buy 9 EA

5gal

PMCOTB05

Min. Buy 6 EA



Riococo® PCM Starter Block

Propagate faster and produce healthy plants. Excellent water holding and equal distribution of water throughout the starter block ensures optimum management of the air and water. PCM Starter block is made from 100% coir fiber without fine dust particles and its compressed to a square disc and packed in a biodegradable cellulosus sack.



4in x 4in

PCMSB01

Min. Buy 275 EA



Components and Aggregates

PVP Industries® Coarse Horticultural Perlite

Used primarily in soil mixes, hydroponics and gardening. Horticultural perlite is clean, sterile, pH neutral, non-flammable, odorless, non-toxic and neither decays nor shrinks even pests such as insects and fungi can't destroy it.



4cu ft - Coarse (33/PL) - OMRI® Listed
PVP105408 Min. Buy 1 BG



PVP Industries® Medium Horticultural Vermiculite

Preferred for seeding, plugs, small cells and moisture retentive soil mixes. Horticultural vermiculite is permanent, clean, odorless, non-toxic, sterile and pH neutral. It will not deteriorate, turn moldy or rot. Mixed with soil, peat, composted pine bark, fertilizers, pesticides and herbicides and promotes faster root growth and quick anchorage to young roots.



4cu ft - Medium (33/PL) - OMRI® Listed
PVP107402 Min. Buy 1 BG



PVP Industries® Medium Horticultural Perlite

Used primarily for plugs, small cells, hanging baskets and gardening. Horticultural perlite is clean, sterile, pH neutral, non-flammable, odorless, non-toxic and neither decays nor shrinks even pests such as insects and fungi can't destroy it.



4cu ft - Medium (33/PL) - OMRI® Listed
PVP105705 Min. Buy 1 BG



PVP Industries® Coarse Horticultural Vermiculite

Horticultural vermiculite is permanent, clean, odorless, non-toxic, sterile and pH neutral. It will not deteriorate, turn moldy or rot. Mixed with soil, peat, composted pine bark, fertilizers, pesticides and herbicides and promotes faster root growth and quick anchorage to young roots. Vermiculite granules attract and hold ammonium, potassium, calcium and magnesium needed for the growing plants.



4cu ft - Coarse (33/PL) - OMRI® Listed
PVPVCH/4/EA Min. Buy 1 BG



PVP Industries® Super Coarse Horticultural Perlite

Excellent as a substrate for hydroponics. Super coarse grade expanded perlite is clean, sterile, pH neutral, non-flammable and nontoxic. Increases aeration and drainage of growing media and helps anchor roots of young plants.



4cu ft - Super Coarse (33/PL) - OMRI® Listed
PVP105040 Min. Buy 1 EA



PVP Industries® Super Coarse Horticultural Vermiculite

Preferred for hydroponics and high porosity soil mixes. Horticultural vermiculite is permanent, clean, odorless, non-toxic, sterile and pH neutral. It will not deteriorate, turn moldy or rot. Mixed with soil, peat, composted pine bark, fertilizers, pesticides and herbicides and promotes faster root growth and quick anchorage to young roots.



4cu ft - Super Coarse (33/PL) - OMRI® Listed
PVPVSC4EA Min. Buy 1 EA





Componentenets and Aggregates

Therm-O-Rock® Coarse Perlite

Coarse texture adds aeration and improves drainage in growing media. Helps to support root development. Suitable for use in hydroponic substrates.



4cu ft - Coarse (36/PL) - OMRI® Listed

TROCK6510H-W Min. Buy 1 EA



Therm-O-Rock® Medium Horticultural Vermiculite

Lightweight, moisture and nutrient retentive. Finer texture is suitable for use in germination, plug and rooting mixes. OMRI® Listed.



4cu ft - Medium (36/PL) - OMRI® Listed

TROCK3A-HORT Min. Buy 1 BG



Therm-O-Rock® Coarse Horticultural Vermiculite

Lightweight, moisture and nutrient retentive. Good for when higher aeration is required. Increases lateral water movement in growing media. OMRI® Listed.



4cu ft - Coarse (36/PL) - OMRI® Listed

TROCK2X-HORT Min. Buy 1 EA



Therm-O-Rock® Super Coarse Horticultural Vermiculite

Therm-O-Rock® Vermiculite is a soil additive that uses its accordion-like particles to amend soil by retaining water, improving aeration and prolonging nutrient release. Its ability to retain both air and water makes vermiculite ideal for conditioning container soils. Vermiculite can also be used for seed germination, bulb storage and flower arranging. OMRI® Listed.



4cu ft - Super Coarse (36/PL) - OMRI® Listed

TROCK1X-HORT Min. Buy 1 EA



Componentenets and Aggregates

Midwest Perlite® Horticultural Course Perlite

Course, lightweight perlite that provides excellent aeration and moisture retention when mixed in with other soil materials. Perlite supports root growth by retaining the moisture, air, and nutrients which it releases as the plants grow. Also suitable for hydroponics greenhouses.



4.0cu ft - Bag (33/PL)

MWP12-0090 Min. Buy 1 BG

64cu ft - Bag (2/PL)

MWPL00595 Min. Buy 1 BG



Midwest Perlite® Plug Grade Horticultural Perlite

Medium grade used primary for plug mixes. Its water retention capabilities are ideal for germination and propagation. It is also widely used in hanging baskets and other small cell applications.



4.0cu ft - Bag (33/PL)

MWPL00575 Min. Buy 33 EA





Componentes and Aggregates

Riceland® Parboiled Rice Hulls

PBH Nature's Media Amendment is a processed rice hull product from Riceland Foods, Inc. with multiple uses in the greenhouse and nursery environment. For greenhouse growers, PBH is the perfect replacement for perlite in the growing media. Advantages include dramatically less dust, plus optimum porosity, drainage and stability with little or no adjustment to fertility and irrigation.



4cu ft - Bag - Direct Ship (16/PL)
RCLND3520020237P001 Min. Buy 16 BL
Other Info *SHIPS DIRECT*

30cu ft - Tote - Direct Ship (3/PL)
RCLND3520020242P001 Min. Buy 3 BG



Componentes and Aggregates

HydraFiber® EZ Blend

Offers an alternative to other raw materials and has an appearance similar to peat. Extensively trialed before introduction, EZ Blend delivers many of the same cost relief benefits as HydraFiber Ultra without adding specialized equipment to your existing line. OMRI® Listed.



40lb
CFHFEZBSF40 Min. Buy 1 EA



How Many Containers Will a Bag or Bale of Media Fill?

Container Size	Per Cubic Foot	Per 3.8 Cubic Foot Compressed Bale	Per 2.8 Cubic Foot Loose Fill Bags
Azalea Pots			
4in	63	451	184
5in	30	219	91
6in	19	134	54
6.5in	14	104	43
7in	11	78	33
8in	7	52	21
10in	4	29	12
Flats			
11in x 21in / 804	6	41	17
11in x 21in / 806	7	47	19
11in x 21in / 1203	6	44	18
11in x 21in / 1204	6	46	19
11in x 15in / 601	6	44	18
13in x 14in / 806	8	58	23
Geranium Pots			
4.5in	38	278	115
Hanging Baskets			
6in	25	180	75
8in	12	85	37
10in	6	44	19
Perennial & Nursery Pots			
Quart	30	225	90
.5 Gallon	15	108	43
1 Gallon	9	60	30
2 Gallon	4	31	14
3 Gallon	3	22	10

Container Size	Per Cubic Foot	Per 3.8 Cubic Foot Compressed Bale	Per 2.8 Cubic Foot Loose Fill Bags
Round Pots			
2.25in	276	1,994	827
3in	128	912	376
3.25in	93	698	279
4in	52	369	147
5in	25	183	76
6in	15	109	45
7in	10	75	30
10in	3	22	9
12in	2	15	6
Square Pots			
2.5in	235	1,642	704
3in	136	973	417
3.5in	91	638	294
4in	55	391	173
4.5in	46	318	150
5in	29	217	87
Jumbo Squares			
5.5in	17	124	50



FERTILIZER



Grower Select®

Water Soluble Fertilizer

Grower Select® Water Soluble Fertilizers

Grower Select fertilizers are manufactured in North America and feature the highest quality components. Each blend is based on the most popular formulations with excellent solubility and a complete micronutrient package. Save money without compromising on performance!

Grower Select® Cal-Mag Triple Iron 16-3-16

Similar to 17-5-17 but with lower P to prevent stretching and three forms of chelated iron to ensure Fe is available to plants even at a high substrate pH. A versatile utility player with balanced calcium and magnesium and neutral potential acidity.



25lbs

PLNTX12482 Min. Buy 1 EA



Value-Based Products You Can Grow With!

We created the BFG Grower Select line of products to bring popular products to market with value-pricing. The expanding BFG Grower Select line includes growing media, carts, pots, benches, greenhouses, specialty items, and more.

Ask your sales rep about the complete BFG Grower Select line of products. It's just one more way you can count on us to keep you growing!

Grower Select® Fertilizer 20-10-20

Grower Select 20-10-20 serves as the backbone to a cost effective fertility program. Over 60% of nitrogen comes in nitrate form and includes magnesium as well as a complete micronutrient package featuring chelated iron. Lower phosphorous content minimizes plant stretching, making this ideal for growing in low light conditions.



25lb

PLNTX12480 Min. Buy 1 EA



Grower Select® 17-5-17

An economical all-in-one fertilizer featuring high levels of nitrate and no urea. You'll get 5 macronutrients in one bag (N, P, K, Ca, Mg) as well as a complete micronutrient package with chelated iron. This neutral formulation will have minimal impact on soil & water pH, making it a great option in many growing situations.



25lbs

PLNTX12481 Min. Buy 1 EA
Shipping Info **SHIPS HAZARDOUS**



Grower Select® 20-20-20

A classic blend with a balanced formula that is effective on all types of plants and can be used for general feeding when a specific formula is not called for. Like all Grower Select fertilizers, 20-20-20 has a complete micronutrient fertilizer featuring chelated iron for optimal plant availability.



25lbs

PLNTX12479 Min. Buy 1 EA



Grower Select® Mag Triple Iron 18-6-18

Great choice for Petunias, Calibrachoa, Pansies, Vinca, Verbena and other plants that benefit from extra iron. Three sources of chelated iron, potential acidity of 339lbs CaCO₃, and extra magnesium ensure your plants have dark green foliage. Excellent if you have high alkalinity irrigation water because it acidifies and also adds Mg to keep your Ca to Mg ratio in balance.



25lbs

PLNTX12483 Min. Buy 1 EA
Shipping Info **HAZARDOUS**





Water Soluble Fertilizer

FeED Water Soluble Fertilizers

The FeED line features our most advanced chelating system and boosted levels of micronutrients to fit the specific needs of today's crops. Each product contains increased levels of iron, derived from three chelate sources (EDDHA, EDTA and DTPA) extra magnesium, low ammonium, and no urea. The proprietary blend of iron level is guaranteed to deliver iron at a much broader range of pH over the entire crop cycle.

Jack's Professional® 15-2-20 Spring Pansy FeED Fertilizer

Designed specifically for the pansies and violas grown in the winter into spring. This product combines 3.5% calcium and 1.75% magnesium and the elevated boron, iron and manganese levels that pansies, salvias and vincas require. The 84% nitrate nitrogen and low phosphorus content control stretch.. (SHIPS HAZ)

- For use on: Fertility programs that require additional Ca, Mg, B & Mn.
• Basicity: 195 lbs CCE
• No Urea
• Contains increased levels of iron from 3 chelate sources



25lb (80/PL)
JRP77720 Min. Buy 1 EA
Other Info SHIPS HAZ

Jack's Professional® 17-3-19 Fall Pansy FeED Fertilizer

Designed specifically for pansy production in late summer and early fall. A nitrate/ammonium nitrogen system is more efficient in warmer weather. This results in a potentially acidic product that will lower media pH over time. Also contains an iron chelate system plus additional magnesium and boron which is necessary to produce a consistent, high quality crop.

- For use on: Designed specifically for pansy production in late summer and early fall.
• Acidic: 231 lbs CCE
• No Urea
• Contains increased levels of iron from 3 chelate sources



25lb (80/PL)
JRP77730 Min. Buy 1 EA

Jack's Professional® 17-5-19 Poinsettia FeED +Mg Fertilizer

Designed to fit the needs of the poinsettia cultivars that require micronutrients, but a lesser amount of macronutrients, containing 50% more iron, manganese, copper and zinc than found in typical poinsettia peat-lite formulations. Low boron levels help prevent toxicity problems.

- For use on: Dark leaved Varieties
• Acidic: 275 lbs CCE
• No Urea
• Contains increased levels of iron from 3 chelate sources



25lb (80/PL)
JRP77760 Min. Buy 1 EA

Jack's Professional® 15-4-15 Poinsettia FeED +CaMg Fertilizer

Designed to fit the needs of the poinsettia cultivars that require micronutrients, but a lesser amount of macronutrients, containing 50% more iron, manganese, copper and zinc than found in typical poinsettia peat-lite formulations. Low boron levels help prevent toxicity problems. Extra soluble molybdenum added to the formula to reduce or eliminate the extra step of adding molybdenum to each stock tank.

- For use on: Dark leaved Varieties, Light leaved varieties.
• Basicity: 77 lbs CCE
• No Urea
• Contains increased levels of iron from 3 chelate sources



25lb (80/PL)
JRP77750 Min. Buy 1 EA

Jack's Professional® 20-3-19 Petunia FeED Fertilizer

A proprietary blend of iron chelates are used to increase the availability of iron over a broad range of pH. Contains double the iron found in typical peat-like formulations. Contains additional magnesium for optimum crop performance, low phosphorus level that help prevent excessive elongation, high nitrate nitrogen, moderately high potential acidity and no urea.

- For use on: Petunia, Calibrachoa, Bacopa.
• Acidic: 420 lbs CCE
• No Urea
• Contains increased levels of iron from 3 chelate sources



25lb (80/PL)
JRP77770 Min. Buy 1 EA

Jack's Professional® 22-5-16 Mum FeED Fertilizer

Mums are heavy feeders that respond well to additional magnesium, sulfur and iron. Additional 2% Nitrogen in this formula reduces your fertilizer usage by approximately 10%, making this product not only nutritionally effective, but cost effective as well.

- For use on: Garden Mums, Iron loving warm weather plants.
• Acidic: 573 lbs CCE
• No Urea
• Contains increased levels of iron from 3 chelate sources



25lb (80/PL)
JRP77740 Min. Buy 1 EA



Water Soluble Fertilizer

LX Water Soluble Fertilizers

The LX™ system utilizes proven acidifying solutions to keep N, P, K, Ca and Mg in concentrated form together! All formulations in this enhanced line of fertilizers are fully mixable to tailor customized blends for individual growers and water supplies. The LX system provides a peat-lite micronutrient package that is balanced throughout the product line. This ensures a consistent micronutrient level is supplied when products are tank-mixed.

Jack's Professional® 13-2-13 Plug LX Fertilizer

A water-soluble fertilizer ideal for plug production with 6% calcium and 3% magnesium. It is formulated with 94% nitrate nitrogen and a low phosphorus content to promote compact, sturdy plugs.

- For use on: All Plants
- Basicity: 319 lbs CCE
- No Urea



25lb (80/PL)

JRP77490

Min. Buy 1 EA



Jack's Professional® 15-5-15 +CaMg LX Fertilizer

A truly comprehensive formulation containing all of the macro and micro nutrients. Contains 4% calcium and 2% magnesium, which makes it an ideal choice for use with water that is low in those nutrients. Formulated with 80% nitrate nitrogen and contains a Peat-Lite level of micronutrients.. (SHIPS HAZ)

- For use on: All plants
- Basicity: 69 lbs CCE
- Urea: 3.72



25lb (80/PL)

JRP77940

Min. Buy 1 EA

Other Info SHIPS HAZ



Jack's Professional® 17-4-17 Pure Water LX Fertilizer

Blended for growers desiring a 4:1:4 ratio for pure water. This formulation will not cause pH crash in media. Calcium is supplied at 3% with magnesium at 1.5% to add what pure water does not supply.

- For use on: All bedding plants, plugs and young plants and vegetables as finished or transplants.
- Neutral: 0 lbs CCE
- No Urea



25lb (80/PL)

JRP77560

Min. Buy 1 EA



Jack's Professional® 20-5-19 Poinsettia LX Fertilizer

Ideal fertilizer for poinsettia production with moderate to high alkalinity waters. The peat-lite level of micronutrients is adjusted to provide higher zinc and molybdenum and lower boron with over 60% nitrate nitrogen.. (SHIPS HAZ)

- For use on: Light and Dark Leaved poinsettia varieties.
- Acidic: 379 lbs CCE
- No Urea



25lb (80/PL)

JRP77590

Min. Buy 1 EA

Other Info SHIPS HAZ



Jack's Professional® 21-5-20 All Purpose LX Fertilizer

A water-soluble fertilizer ideal for moderate to high alkalinity waters. It is formulated with over 60% nitrate nitrogen and a peat-lite level of micronutrients.(SHIPS HAZ)

- For use on: All bedding and potted plants, can be used for plugs at low rates.
- Acidic: 407 lbs CCE
- No Urea



25lb (80/PL)

JRP77990

Min. Buy 1 EA

Other Info SHIPS HAZ





Water Soluble Fertilizer

Professional Water Soluble Fertilizers

Premier grade fertilizers formulated with highest quality components and manufacturing controls. Bob Peters improved his special blend of growth enhancing "goodies" that are included in every batch of the Jack's Professional brand.

Jack's Professional® 15-0-15 Dark Weather Fertilizer

A no phosphate water soluble fertilizer that contains calcium nitrate (CaNO₃), an essential tool for regulating growth when the weather is cool with little sunlight. This will greatly reduce the potential for damage to the roots of the plant and provide solid, balanced nutrition under these conditions.

- For use on: All Plants, especially useful for plants that have a higher Ca requirement like Poinsettias and Tomatoes.
- Basicity: 319 lbs CCE
- No Urea



25lb (80/PL)

JRP77190

Min. Buy 1 EA



Jack's Professional® 15-0-15 Dark Weather Peat-Lite Fertilizer

A no phosphate water soluble fertilizer that contains calcium nitrate (CaNO₃), an essential tool for regulating growth when the weather is cool with little sunlight. This will greatly reduce the potential for damage to the roots of the plant and provide solid, balanced nutrition under these conditions.

- For use on: All Plants, especially useful for plants that have a higher Ca requirement like Poinsettias and Tomatoes.
- Basicity: 344 lbs CCE
- No Urea



25lb (80/PL)

JRP77180

Min. Buy 1 EA



Jack's Professional® 15-16-17 Peat-Lite Fertilizer

A water-soluble fertilizer designed to be mixed with water for the most accurate and effective nutrient delivery to the plant. Similar to 20-20-20 but with over 60% nitrate nitrogen, boosted micronutrient levels and much less acidic reaction in the root media. The balanced N-P-K ratio is excellent for producing fast-growing plants or for maintaining plants in a sales environment.

- For use on: All plants especially the geranium. Great choice when trying to maintain finished plants in a garden center.
- Acidic: 122 lbs CCE
- Urea: 46.6



25lb (80/PL)

JRP77220

Min. Buy 1 EA



Jack's Professional® 9-45-15 Plant Starter Fertilizer

If initially used when transplanting into cells or beds, supplies the high-phosphorus ratio designed to boost root growth prior to shoots. Can also be used to correct or supplement low phosphorus situations, especially in outdoor production.

- For use on: Field grown vegetables.
- Acidic: 965 lbs CCE
- Urea: 218.2



25lb (80/PL)

JRP77140

Min. Buy 1 EA



Jack's Professional® 10-30-20 Blossom Booster Fertilizer

High phosphorus formula used during periods of bud set to increase the number and size of blossoms. Great for vegetable production.

- For use on: Flowering plants.
- Acidic: 347 lbs CCE
- Urea: 130.9



25lb (80/PL)

JRP77160

Min. Buy 1 EA



Jack's Professional® 15-11-29 Peat-Lite Fertilizer

A water-soluble fertilizer that can be alternated into many fertility programs. Nitrogen to potassium ratio 1:2 is excellent for use as a finisher. Additional level of micronutrients provides necessary elements from most commercially made peat-lite potting media

- For use on: Greenhouse tomatoes, and other high potassium crops.
- Acidic: 58 lbs CCE
- Urea: 32.0



25lb (80/PL)

JRP77230

Min. Buy 1 EA

Other Info SHIPS HAZ



Jack's Professional® 21-8-18 Mag Mum Fertilizer

Mums are heavy feeders that respond well to additional magnesium, sulfur and iron. Additional 2% Nitrogen in this formula reduces your fertilizer usage by approximately 10%, making this product not only nutritionally effective, but cost effective as well.

- For use on: Garden Mums
- Acidic: 446 lbs CCE
- No Urea



25lb (80/PL)

JRP71440

Min. Buy 1 EA



Jack's Professional® 21-7-7 Acid Fertilizer

A water-soluble fertilizer ideal for acid-loving plants in the nursery and landscape. Provides a rapid correction of a high pH situation. Contains no harmful chlorides.

- For use on: Acid loving plants in nursery and landscape, such as rhododendrons, azaleas, and evergreens
- Acidic: 1539 lbs CCE
- Urea: 14.5



25lb (80/PL)

JRP77130

Min. Buy 1 EA





Water Soluble Fertilizer

Professional Water Soluble Fertilizers

Premier grade fertilizers formulated with highest quality components and manufacturing controls. Bob Peters improved his special blend of growth enhancing "goodies" that are included in every batch of the Jack's Professional brand.

Jack's Professional® 15-15-15 Geranium Fertilizer

Ideal for geraniums and other neutral pH loving plants. The high phosphorus content promotes strong root growth and bud set. Great for pink hydrangeas. The high nitrate nitrogen content (56%) and the general-purpose level of micronutrients help minimize nutritional toxicities on geraniums.

- For use on: Geraniums, marigolds, and other plants with media pH requirements above 6.2
- Acidic: 151 lbs CCE
- Urea: 43.6



25lb (80/PL)

JRP77020

Min. Buy 1 EA



Jack's Professional® 20-10-20 General Purpose Fertilizer

A water-soluble fertilizer designed to be mixed with water for the most accurate and effective nutrient delivery to the plant. It contains the traditional micronutrient levels needed for general production including propagation and all types of bedding plants. High nitrate nitrogen levels (60% of the total) provides for green foliage and more compact growth.. (SHIPS HAZ)

- For use on: All Plants
- Acidic: 555 lbs CCE
- No Urea



25lb (80/PL)

JRP77840

Min. Buy 1 EA



Jack's Professional® 15-10-30 Pot Mum Fertilizer

A smart formulation choice to finish many different crops. The nitrogen to potassium ratio (1:2) is excellent for pot mum production and for other crops with high potassium requirements. This fertilizer has the traditional micronutrient levels found in general purpose formulations.

- For use on: Pot Mums, also great as a finisher for many other spring into summer crops
- Acidic: 98 lbs CCE
- Urea: 29.1



25lb (80/PL)

JRP77110

Min. Buy 1 EA



Jack's Professional® 20-20-20 General-Purpose Fertilizer

Great for maintaining plants in garden center and growing facilities. It provides fast green-up and great foliar expansion due to the high percentage of ammonium and urea Nitrogen plus balanced phosphorus and potassium for excellent root and shoot growth.

- For use on: All outdoor grown plants
- Acidic: 555 lbs CCE
- Urea: 43.6



25lb (80/PL)

JRP77010

Min. Buy 1 EA



Jack's Professional® 20-10-20 Peat-Lite Fertilizer

A water-soluble fertilizer that has approximately twice the level of micronutrients as the general purpose formulation. The additional level of micronutrients provides necessary elements absent from most commercially made peat-lite potting media.. (SHIPS HAZ)

- For use on: All greenhouse plants grown in peat-lite mixes
- Acidic: 401 lbs CCE
- No Urea



25lb (80/PL)

JRP77860

Min. Buy 1 EA

Other Info SHIPS HAZ



Jack's Professional® 25-5-15 High Performance Fertilizer

High efficiency formula designed to maximize your NPK delivery while keeping a balance of macro secondary and micronutrients for optimum plant growth. Delivers an efficient, balanced formula even when you use less fertilizer.

- For use on: All bedding plants and vegetable transplants
- Acidic: 608 lbs CCE
- No Urea



25lb (80/PL)

JRP77900

Min. Buy 1 EA



16-4-17 Oasis Hydroponic FeEd Fertilizer

An innovative formula that provides all the macro, secondary and micronutrients in a one-part system. Designed specially for hydroponically grown herbs (basil, cilantro, chives, parsley etc.), as well as, lettuce and most vegetables. Includes a proprietary blend of iron chelates that keeps iron available even as the pH varies up to a high of 8.0.

- For use on: Herbs, all types lettuce, Hydro garden crops
- Neutral: 0 lbs CCE
- No Urea
- Contains increased levels of iron from 3 chelate sources



25lb (80/PL)

JRP71750

Min. Buy 1 EA



LOOKING FOR *Jack's*[®] NUTRIENTS PRODUCTS?

You can find the whole Jack's Nutrients lineup in the **BFG CEA/ Hydro Catalog** and at **bfgsupply.com**



COULDN'T FIND A SPECIFIC JACK'S FERTILIZERS PRODUCT IN THE CATALOG?



BFG Supply has what you need. Call your BFG rep today for pricing and availability.



PPM & EC

Use this chart to compare the nutrient composition of Jack's Professional products at a consistent rate of 100 ppm nitrogen.

Water Soluble Fertilizer

Jack's FeEDs® Water-Soluble Fertilizers

These are the newest additions to the Jack's Professional line of fertilizers. Featuring our most advanced chelating system and boosted levels of micronutrients to fit the specific needs of today's crops. Each product contains increased levels of iron, derived from three chelate sources, EDDHA, EDTA and DTPA, to keep it available over a wide range of pH values, magnesium and low ammonium, no urea nitrogen.

Name	Item #	NO ³	NH ⁴	Urea	P	K	Ca	Mg	B	Cu
22-5-16 Mum FeED®	77740	57.0	43.0	0.0	9.9	60.6	0.0	2.3	0.091	0.045
20-3-19 Petunia FeED Plus Mg	77770	59.8	40.2	0.0	6.5	78.9	0.0	6.7	0.100	0.050
17-5-19 Poinsettia FeED Plus Mg	77760	63.5	36.5	0.0	12.8	92.8	0.0	17.6	0.040	0.075
15-4-15 Poinsettia FeED Ca-Mg	77750	80.8	19.2	0.0	11.6	83.0	26.7	13.3	0.045	0.075
17-3-19 Fall Pansy FeED	77730	65.3	34.7	0.0	7.7	93.6	0.0	17.6	0.200	0.075
15-2-20 Spring Pansy FeED	77720	84.3	15.7	0.0	5.8	111.1	23.3	11.7	0.204	0.047
16-4-17 Oasis Hydroponic	71750	78.0	21.9	0.0	10.6	86.0	24.4	12.2	0.100	0.050

Name	Item #	Fe	Mn	Mo	Zn	CCE LBS	A/B	E.C. @ 100 PPM
22-5-16 Mum FeED®	77740	0.910	0.227	0.045	0.227	573	Acidity	0.67
20-3-19 Petunia FeED Plus Mg	77770	1.000	0.250	0.050	0.250	420	Acidity	0.64
17-5-19 Poinsettia FeED Plus Mg	77760	0.750	0.375	0.500	0.450	275	Acidity	0.78
15-4-15 Poinsettia FeED Ca-Mg	77750	0.750	0.375	0.500	0.450	77	Basicity	0.76
17-3-19 Fall Pansy FeED	77730	1.000	0.375	0.075	0.375	231	Acidity	0.74
15-2-20 Spring Pansy FeED	77720	0.500	0.333	0.047	0.250	195	Basicity	0.74
16-4-17 Oasis Hydroponic	71750	1.230	0.300	0.050	0.310	0	Neutral	0.78

Labels

Use these charts to compare the guaranteed analyses of Jack's Professional Products.

Products			% Nitrogen				%P	%K	%Ca	%Mg	%B
Name	Item #	Total	NO ³	NH ⁴	Urea	P ² O ⁵	K ² O				
22-5-16 Mum FeED®	77740	22.00	12.54	9.46	0.00	5.00	16.00	0.00	0.50	0.0200	
20-3-19 Petunia FeED Plus Mg	77770	20.00	11.96	8.04	0.00	3.00	19.00	0.00	1.34	0.0200	
17-5-19 Poinsettia FeED Plus Mg	77760	17.00	10.79	6.21	0.00	5.00	19.00	0.00	3.00	0.0068	
15-4-15 Poinsettia FeED Ca-Mg	77750	15.00	12.12	2.88	0.00	4.00	15.00	4.00	2.00	0.0068	
17-3-19 Fall Pansy FeED	77730	17.00	11.10	5.90	0.00	3.00	19.00	0.00	3.00	0.0340	
15-2-20 Spring Pansy FeED	77720	15.00	12.64	2.36	0.00	2.00	20.00	3.50	1.75	0.0306	
16-4-17 Oasis Hydroponic	71750	16.00	12.80	3.60	0.00	4.00	17.00	4.00	2.00	0.0160	





Labels

Use these charts to compare the guaranteed analyses of Jack's Professional Products.

Water Soluble Fertilizer

Jack's FeEDs® Water-Soluble Fertilizers

These are the newest additions to the Jack's Professional line of fertilizers. Featuring our most advanced chelating system and boosted levels of micronutrients to fit the specific needs of today's crops. Each product contains increased levels of iron, derived from three chelate sources, EDDHA, EDTA and DTPA, to keep it available over a wide range of pH values, magnesium and low ammonium, no urea nitrogen.

Products			%Cu	%Fe	%Mn	%Mo	%Zn	CCE LBS	A/B
Name		Item #							
22-5-16	Mum FeED®	77740	0.0100	0.2000	0.0500	0.0100	0.0500	573	Acidity
20-3-19	Petunia FeED Plus Mg	77770	0.0100	0.2000	0.0500	0.0100	0.0500	420	Acidity
17-5-19	Poinsettia FeED Plus Mg	77760	0.0128	0.1275	0.0638	0.0850	0.0765	275	Acidity
15-4-15	Poinsettia FeED Ca-Mg	77750	0.0112	0.1125	0.0563	0.0750	0.0675	77	Basicity
17-3-19	Fall Pansy FeED	77730	0.0128	0.1700	0.0638	0.0128	0.0638	231	Acidity
15-2-20	Spring Pansy FeED	77720	0.0070	0.0750	0.0500	0.0070	0.0375	195	Basicity
16-4-17	Oasis Hydroponic	71750	0.0090	0.1000	0.0500	0.0080	0.0400	0	Neutral

Jack's LX™ Water-Soluble Fertilizers

The LX™ system utilizes proven acidifying solutions to keep N, P, K, Ca and Mg in concentrated form together! All formulations in this enhanced line of fertilizers are fully mixable to tailor customized blends for individual growers and water supplies. The LX system provides a peat-lite micronutrient package that is balanced throughout the product line. This ensures a consistent micronutrient level is supplied when products are tank mixed.

PPM & EC

Use this chart to compare the nutrient composition of Jack's Professional products at a consistent rate of 100 ppm nitrogen.

Name		Item #	NO ³	NH ⁴	Urea	P	K	Ca	Mg	B	Cu
21-5-20	All Purpose	77990	62.3	37.7	0.0	10.4	79.1	0.0	0.7	0.100	0.050
20-5-19	Poinsettia	77590	62.8	37.2	0.0	10.9	78.9	0.0	3.0	0.050	0.050
17-4-17	Pure Water	77560	78.1	21.9	0.0	10.3	83.0	17.6	8.8	0.100	0.050
16-2-15	Hi Alkalinity Water Plug	77600	75.0	25.0	0.0	5.5	77.8	18.8	9.4	0.100	0.050
15-5-15	CA - MG	77940	80.0	20.0	0.0	14.5	83.0	26.7	13.3	0.100	0.050
13-2-13	Plug	77490	94.0	6.0	0.0	6.7	83.0	46.2	23.1	0.100	0.050
10-0-0	Mag-Trate	79190	100.0	0.0	0.0	0.0	0.0	0.0	90.0	0.100	0.050

Name		Item #	Fe	Mn	Mo	Zn	CCE LBS	A/B	E.C. @ 100 PPM
21-5-20	All Purpose	77990	0.500	0.250	0.050	0.250	407	Acidity	0.62
20-5-19	Poinsettia	77590	0.500	0.250	0.500	0.300	379	Acidity	0.64
17-4-17	Pure Water	77560	0.500	0.250	0.050	0.250	0	Neutral	0.72
16-2-15	Hi Alkalinity Water Plug	77600	0.500	0.250	0.050	0.250	76	Acidity	0.78
15-5-15	CA - MG	77940	0.500	0.250	0.050	0.250	69	Basicity	0.76
13-2-13	Plug	77490	0.500	0.250	0.050	0.250	319	Basicity	0.82
10-0-0	Mag-Trate	79190	0.500	0.250	0.050	0.250	348	Basicity	0.80



Labels

Use these charts to compare the guaranteed analyses of Jack's Professional Products.

Water Soluble Fertilizer

Jack's LX™ Water-Soluble Fertilizers

The LX™ system utilizes proven acidifying solutions to keep N, P, K, Ca and Mg in concentrated form together! All formulations in this enhanced line of fertilizers are fully mixable to tailor customized blends for individual growers and water supplies. The LX system provides a peat-lite micronutrient package that is balanced throughout the product line. This ensures a consistent micronutrient level is supplied when products are tank mixed.

Products			% Nitrogen				%P	%K	%Ca	%Mg	%B
Name		Item #	Total	NO ³	NH ⁴	Urea	P ² O ⁵	K ² O			
21-5-20	All Purpose	77990	21.00	13.08	7.92	0.00	5.00	20.00	0.00	0.15	0.0210
20-5-19	Poinsettia	77590	20.00	12.56	7.44	0.00	5.00	19.00	0.00	0.60	0.0100
17-4-17	Pure Water	77560	17.00	13.27	3.73	0.00	4.00	17.00	3.00	1.50	0.0170
16-2-15	Hi Alkalinity Water Plug	77600	16.00	12.00	4.00	0.00	2.00	15.00	3.00	1.50	0.0160
15-5-15	CA - MG	77940	15.00	12.00	3.00	0.00	5.00	15.00	4.00	2.00	0.0150
13-2-13	Plug	77490	13.00	12.22	0.78	0.00	2.00	13.00	6.00	3.00	0.0130
10-0-0	Mag-Trate	79190	10.00	10.00	0.00	0.00	0.00	0.00	0.00	9.00	0.0100

Products			%Cu	%Fe	%Mn	%Mo	%Zn	CCE LBS	A/B
Name		Item #							
21-5-20	All Purpose	77990	0.0105	0.1050	0.0525	0.0105	0.0525	407	Acidity
20-5-19	Poinsettia	77590	0.0100	0.1000	0.0500	0.1000	0.0600	379	Acidity
17-4-17	Pure Water	77560	0.0085	0.0850	0.0425	0.0085	0.0425	0	Neutral
16-2-15	Hi Alkalinity Water Plug	77600	0.0080	0.0800	0.0400	0.0080	0.0400	76	Acidity
15-5-15	CA - MG	77940	0.0075	0.0750	0.0375	0.0075	0.0375	69	Basicity
13-2-13	Plug	77490	0.0065	0.0650	0.0325	0.0065	0.0325	319	Basicity
10-0-0	Mag-Trate	79190	0.0050	0.0500	0.0250	0.0050	0.0250	348	Basicity





Water Soluble Fertilizer

PPM & EC

Use this chart to compare the nutrient composition of Jack's Professional products at a consistent rate of 100 ppm nitrogen.

Jack's Professional® Water-Soluble Fertilizers

Premier grade fertilizers formulated with highest quality components and manufacturing controls. Special blend of growth enhancing "goodies" that are included in every bag of the Jack's Professional brand.

Name	Item #	NO ³	NH ⁴	Urea	P	K	Ca	Mg	B	Cu
27-15-12 Foliar Feed	77521	13.7	11.0	75.3	24.2	36.9	0.0	0.4	0.093	0.231
25-5-15 High Performance	77900	57.0	43.0	0.0	8.7	50.0	0.0	0.4	0.100	0.050
24-8-16 Tropical Foliage	77930	34.9	24.5	40.6	14.5	55.3	0.0	2.1	0.014	0.083
21-8-18 MagMum	71440	59.0	40.9	0.0	16.6	71.1	0.0	4.7	0.100	0.050
21-7-16 Interiorscape Special	73000	28.9	23.0	48.0	14.5	63.2	0.0	4.7	0.010	0.240
21-7-7 Acid	77130	0.0	54.6	45.4	14.5	27.7	0.0	3.3	0.032	0.017
20-20-20 General Purpose	77010	30.3	19.2	50.5	43.6	83.0	0.0	0.3	0.034	0.018
20-10-20 General Purpose	77840	60.0	40.0	0.0	21.8	83.0	0.0	0.8	0.034	0.018
20-10-20 Peat-Lite	77860	60.0	40.0	0.0	21.8	83.0	0.0	0.8	0.100	0.050
20-0-20 Hi Cal Peat-Lite	77660	54.0	1.7	44.3	0.0	83.0	30.0	0.0	0.100	0.050
17-5-24 Low Acid Peat-Lite	77430	68.6	31.4	0.0	12.8	117.2	0.0	11.8	0.100	0.050
15-30-15 Hi Phosphate	77080	27.7	35.2	37.1	87.3	83.0	0.0	1.7	0.045	0.024
15-16-17 Peat-Lite	77220	61.7	21.0	17.3	46.6	94.1	0.0	0.08	0.100	0.050
15-15-15 Geranium	77020	56.0	19.2	24.6	43.6	83.0	0.0	0.3	0.045	0.024
15-11-29 Peat-Lite	77230	71.5	28.5	0.0	32.0	160.5	0.0	0.8	0.100	0.050
15-10-30 Pot Mum Finisher	77110	52.6	11.1	36.3	29.1	166.0	0.0	1.7	0.045	0.024
15-5-25 Poinsettia Peat-Lite	77790	71.9	28.1	0.0	14.5	138.4	0.0	17.7	0.045	0.500
15-0-15 Dark Weather	77190	80.8	3.9	15.3	0.0	83.0	73.3	0.0	0.045	0.024
15-0-15 Dark Weather Peat-Lite	77180	90.0	10.0	0.0	0.0	83.0	71.3	0.0	0.100	0.050
10-30-20 Blossom Booster	77160	50.0	50.0	0.0	130.9	166.0	0.0	20.3	0.068	0.036
9-45-15 Plant Starter	77140	0.0	100.0	0.0	218.2	138.4	0.0	0.6	0.076	0.040
5-12-26 Part A	79030	100.0	0.0	0.0	104.7	431.7	0.0	126.4	1.000	0.300
15-0-0 Cal-Trate	79170	93.0	7.0	0.0	0.0	0.0	120.0	0.0	0.100	0.050



! WARNING: This product is not available for sale in CA. For most up to date information please visit bfgsupply.com

800-883-0234
www.bfgsupply.com



Water Soluble Fertilizer

PPM & EC

Use this chart to compare the nutrient composition of Jack's Professional products at a consistent rate of 100 ppm nitrogen.

Jack's Professional® Water-Soluble Fertilizers

Premier grade fertilizers formulated with highest quality components and manufacturing controls. Special blend of growth enhancing "goodies" that are included in every bag of the Jack's Professional brand.

Name	Item #	Fe	Mn	Mo	Zn	CCE LBS	A/B	E.C. @ 100 PPM
27-15-12 Foliar Feed	77521	0.463	0.231	0.002	0.231	923	Acidity	0.22
25-5-15 High Performance	77900	0.500	0.252	0.050	0.252	608	Acidity	0.57
24-8-16 Tropical Foliage	77930	0.208	0.104	0.004	0.083	737	Acidity	0.40
21-8-18 MagMum	71440	0.480	0.250	0.050	0.250	446	Acidity	0.72
21-7-16 Interiorscape Special	73000	0.480	0.240	0.000	0.240	672	Acidic	0.60
21-7-7 Acid	77130	0.714	0.119	0.004	0.012	1539	Acidity	0.60
20-20-20 General Purpose	77010	0.250	0.125	0.005	0.013	555	Acidity	0.42
20-10-20 General Purpose	77840	0.250	0.125	0.005	0.013	407	Acidity	0.64
20-10-20 Peat-Lite	77860	0.500	0.250	0.050	0.250	401	Acidity	0.64
20-0-20 Hi Cal Peat-Lite	77660	0.500	0.250	0.050	0.250	0	Neutral	0.48
17-5-24 Low Acid Peat-Lite	77430	0.500	0.250	0.050	0.250	133	Acidity	0.76
15-30-15 Hi Phosphate	77080	0.333	0.167	0.006	0.017	696	Acidity	0.58
15-16-17 Peat-Lite	77220	0.500	0.250	0.050	0.250	122	Acidity	0.68
15-15-15 Geranium	77020	0.333	0.167	0.006	0.017	151	Acidity	0.70
15-11-29 Peat-Lite	77230	0.500	0.250	0.050	0.250	58	Acidity	0.96
15-10-30 Pot Mum Finisher	77110	0.333	0.167	0.006	0.017	98	Acidity	0.70
15-5-25 Poinsettia Peat-Lite	77790	0.500	0.280	0.500	0.333	46	Acidity	0.82
15-0-15 Dark Weather	77190	0.333	0.167	0.006	0.017	319	Basicity	0.74
15-0-15 Dark Weather Peat-Lite	77180	0.500	0.250	0.050	0.250	344	Basicity	0.78
10-30-20 Blossom Booster	77160	0.500	0.250	0.009	0.025	347	Acidity	0.98
9-45-15 Plant Starter	77140	0.556	0.278	0.010	0.028	965	Acidity	1.20
5-12-26 Part A	79030	6.000	1.000	0.200	0.300	211	Basicity	2.10
15-0-0 Cal-Trate	79170	0.500	0.250	0.050	0.250	367	Basicity	0.74





Labels

Use these charts to compare the guaranteed analyses of Jack's Professional Products.

Water Soluble Fertilizer

Jack's Professional® Water-Soluble Fertilizers

Premier grade fertilizers formulated with highest quality components and manufacturing controls. Special blend of growth enhancing "goodies" that are included in every bag of the Jack's Professional brand.

Products			% Nitrogen				%P	%K	%Ca	%Mg	%B
Name		Item #	Total	NO ³	NH ⁴	Urea	P ² O ⁵	K ² O			
27-15-12	Foliar Feed	77521	27.00	3.71	2.96	20.33	15.00	12.00	0.00	0.10	0.0250
25-5-15	High Performance	77900	25.00	14.25	10.75	0.00	5.00	15.00	0.00	0.10	0.0250
24-8-16	Tropical Foliage	77930	24.00	8.37	5.89	9.74	8.00	16.00	0.00	0.50	0.0034
21-8-18	MagMum	71440	21.00	12.40	8.60	0.00	8.00	18.00	0.00	1.00	0.0210
21-7-16	Interiorscape Special	73000	21.00	6.08	4.83	10.09	7.00	16.00	0.00	1.00	0.0030
21-7-7	Acid	77130	21.00	0.00	11.47	9.53	7.00	7.00	0.00	0.70	0.0068
20-20-20	General Purpose	77010	20.00	6.07	3.83	10.10	20.00	20.00	0.00	0.05	0.0068
20-10-20	General Purpose	77840	20.00	12.00	8.00	0.00	10.00	20.00	0.00	0.15	0.0068
20-10-20	Peat-Lite	77860	20.00	12.00	8.00	0.00	10.00	20.00	0.00	0.15	0.0200
20-0-20	Hi Cal Peat-Lite	77660	20.00	10.79	0.34	8.87	0.00	20.00	6.00	0.00	0.0200
17-5-24	Low Acid Peat-Lite	77430	17.00	11.67	5.33	0.00	5.00	24.00	0.00	2.00	0.0170
15-30-15	Hi Phosphate	77080	15.00	4.15	5.28	5.57	30.00	15.00	0.00	0.25	0.0068
15-16-17	Peat-Lite	77220	15.00	9.25	3.15	2.60	16.00	17.00	0.00	0.12	0.0150
15-15-15	Geranium	77020	15.00	8.40	2.88	3.72	15.00	15.00	0.00	0.05	0.0068
15-11-29	Peat-Lite	77230	15.00	10.73	4.27	0.00	11.00	29.00	0.00	0.12	0.0150
15-10-30	Pot Mum Finisher	77110	15.00	7.89	1.67	5.44	10.00	30.00	0.00	0.25	0.0068
15-5-25	Poinsettia Peat-Lite	77790	15.00	10.79	4.21	0.00	5.00	25.00	0.00	2.65	0.0068
15-0-15	Dark Weather	77190	15.00	12.12	0.58	2.30	0.00	15.00	11.00	0.00	0.0068
15-0-15	Dark Weather Peat-Lite	77180	15.00	13.50	1.50	0.00	0.00	15.00	10.69	0.00	0.0150
10-30-20	Blossom Booster	77160	10.00	5.00	5.00	0.00	30.00	20.00	0.00	2.03	0.0068
9-45-15	Plant Starter	77140	9.00	0.00	9.00	0.00	45.00	15.00	0.00	0.05	0.0068
5-12-26	Part A	79030	5.00	5.00	0.00	0.00	12.00	26.00	0.00	6.32	0.0500
15-0-0	Cal Nit Part B	79080	15.50	14.42	1.08	0.00	0.00	0.00	18.00	0.00	0.0000
	MOST	77391	N/A	N/A	N/A	N/A	N/A	N/A	N/A	0.40	1.3500
	MOST NO BORON	77392	N/A	N/A	N/A	N/A	N/A	N/A	N/A	2.00	0.0000
	Ammonium Molybdate	77743	N/A	N/A	N/A	N/A	N/A	N/A	N/A	N/A	N/A



Labels

Use these charts to compare the guaranteed analyses of Jack's Professional Products.

Water Soluble Fertilizer

Jack's Professional® Water-Soluble Fertilizers

Premier grade fertilizers formulated with highest quality components and manufacturing controls. Special blend of growth enhancing "goodies" that are included in every bag of the Jack's Professional brand.

Products			%Cu	%Fe	%Mn	%Mo	%Zn	CCE LBS	A/B
Name		Item #							
27-15-12	Foliar Feed	77521	0.0625	0.1250	0.0625	0.0006	0.0625	923	Acidity
25-5-15	High Performance	77900	0.0125	0.1250	0.0630	0.0125	0.0630	608	Acidity
24-8-16	Tropical Foliage	77930	0.0200	0.0500	0.0250	0.0009	0.0200	737	Acidity
21-8-18	MagMum	71440	0.0110	0.1050	0.0530	0.0110	0.0530	446	Acidity
21-7-16	Interiorscape Special	73000	0.0500	0.1000	0.0500	0.0009	0.0500	672	Acidity
21-7-7	Acid	77130	0.0036	0.1500	0.0250	0.0009	0.0025	1539	Acidity
20-20-20	General Purpose	77010	0.0036	0.0500	0.0250	0.0009	0.0025	555	Acidity
20-10-20	General Purpose	77840	0.0036	0.0500	0.0250	0.0009	0.0025	407	Acidity
20-10-20	Peat-Lite	77860	0.0100	0.1000	0.0500	0.0100	0.0500	401	Acidity
20-0-20	Hi Cal Peat-Lite	77660	0.0100	0.1000	0.0500	0.0100	0.0500	0	Neutral
17-5-24	Low Acid Peat-Lite	77430	0.0085	0.0850	0.0425	0.0085	0.0425	133	Acidity
15-30-15	Hi Phosphate	77080	0.0036	0.0500	0.0250	0.0009	0.0025	696	Acidity
15-16-17	Peat-Lite	77220	0.0075	0.0750	0.0375	0.0075	0.0375	122	Acidity
15-15-15	Geranium	77020	0.0036	0.0500	0.0250	0.0009	0.0025	151	Acidity
15-11-29	Peat-Lite	77230	0.0075	0.0750	0.0375	0.0075	0.0375	58	Acidity
15-10-30	Pot Mum Finisher	77110	0.0036	0.0500	0.0250	0.0009	0.0025	98	Acidity
15-5-25	Poinsettia Peat-Lite	77790	0.0075	0.0750	0.0420	0.0750	0.0500	46	Acidity
15-0-15	Dark Weather	77190	0.0036	0.0500	0.0250	0.0009	0.0025	319	Basicity
15-0-15	Dark Weather Peat-Lite	77180	0.0075	0.0750	0.0375	0.0075	0.0375	344	Basicity
10-30-20	Blossom Booster	77160	0.0036	0.0500	0.0250	0.0009	0.0025	347	Acidity
9-45-15	Plant Starter	77140	0.0036	0.0500	0.0250	0.0009	0.0025	965	Acidity
5-12-26	Part A	79030	0.0150	0.3000	0.0500	0.0100	0.0150	211	Basicity
15-0-0	Cal Nit Part B	79080	0.0000	0.0000	0.0000	0.0000	0.0000	400	Basicity
	MOST	77391	2.3000	7.5000	8.0000	0.0400	4.5000	N/A	N/A
	MOST NO BORON	77392	2.3000	7.5000	8.0000	0.0400	4.5000	N/A	N/A
	Ammonium Molybdate	77743	N/A	N/A	N/A	54.3000	N/A	N/A	N/A



Jack's FERTILIZERS

Jack's FeED

		Nitrogen Breakdown			A/B	To deliver 100 ppm N	Urea Free	Extra Mg	Low P	Extra Fe	with Ca	Plugs	Hard Water	Root & Bloom	Foliar Feeding	Boosted Micro
		NO ₃	NH ₄	%Fe												
Mum FeED®	22-5-16	12.54	9.46	0.2000	Acidity	6.1 oz/100 gallons	x	x	x	x			x			x
Petunia FeED Plus Mg	20-3-19	11.96	8.04	0.2000	Acidity	6.8 oz/100 gallons	x	x	x	x			x			x
Boosted Base FeED	18-2-18	6.55	11.5	0.2529	Acidity	7.5 oz/100 gallons	x	x	x	x						x
Poinsettia FeED Plus Mg	17-5-19	10.79	6.21	0.1275	Acidity	7.9 oz/100 gallons	x	x	x	x			x			x
Poinsettia FeED Ca-Mg	15-4-15	12.12	2.88	0.1125	Basicity	9.0 oz/100 gallons	x	x	x	x	x					x
Fall Pansy FeED	17-3-19	11.10	5.90	0.1700	Acidity	7.9 oz/100 gallons	x	x	x	x			x			x
Spring Pansy FeED	15-2-20	12.64	2.36	0.0750	Basicity	9.0 oz/100 gallons	x	x	x	x	x					x

Jack's LX

		Nitrogen Breakdown			A/B	To deliver 100 ppm N	Urea Free	Extra Mg	Low P	Extra Fe	with Ca	Plugs	Hard Water	Root & Bloom	Foliar Feeding	Boosted Micro
		NO ₃	NH ₄	%Ca												
All Purpose	21-5-20	13.08	7.92	0.00	Acidity	6.4 oz/100 gallons	x		x				x			x
Poinsettia	20-5-19	12.56	7.44	0.00	Acidity	6.8 oz/100 gallons	x		x				x			x
Pure Water	17-4-17	13.27	3.73	3.00	Neutral	7.9 oz/100 gallons	x	x	x		x					x
Hi Alkalinity Water Plug	16-2-15	12.00	4.00	3.00	Acidity	8.4 oz/100 gallons	x	x	x		x	x				x
CA - MG	15-5-15	12.00	3.00	4.00	Basicity	9.0 oz/100 gallons	x	x	x		x	x				x
Dark Weather Plus Mag	15-0-14	12.40	2.60	5.00	Basicity	9.0 oz/100 gallons	x	x	x		x					x
Plug	13-2-13	12.22	0.78	6.00	Basicity	10.4 oz/100 gallons	x	x	x		x					x

Jack's Professional

		Nitrogen Breakdown			A/B	To deliver 100 ppm N	Urea Free	Extra Mg	Low P	Extra Fe	with Ca	Plugs	Hard Water	Root & Bloom	Foliar Feeding	Boosted Micro
		NO ₃	NH ₄	%Ca												
High Performance	25-5-15	14.25	10.75	0.00	Acidity	5.4 oz/100 gallons	x		x				x			
MagMum	21-8-18	12.40	8.60	0.00	Acidity	6.4 oz/100 gallons	x	x		x			x			x
Acid	21-7-7	0.00	11.47	0.00	Acidity	6.4 oz/100 gallons				x			x			
GP	20-20-20	6.07	3.83	0.00	Acidity	6.8 oz/100 gallons							x		x	
GP	20-10-20	12.00	8.00	0.00	Acidity	6.8 oz/100 gallons	x						x			
Peat-Lite	20-10-20	12.00	8.00	0.00	Acidity	6.8 oz/100 gallons	x			x			x			
Peat-Lite	15-16-17	9.25	3.15	0.00	Acidity	9.0 oz/100 gallons										
Geranium	15-15-15	8.40	2.88	0.00	Acidity	9.0 oz/100 gallons										
Dark Weather	15-0-15	12.12	0.58	11.00	Basicity	9.0 oz/100 gallons			x					x		
Dark Weather Peat-Lite	15-0-15	13.50	1.50	10.69	Basicity	9.0 oz/100 gallons	x		x					x		
Blossom Booster	10-30-20	5.00	5.00	0.00	Acidity	13.5 oz/100 gallons	x	x						x	x	
Plant Starter	9-45-15	0.00	9.00	0.00	Acidity	15 oz/100 gallons	x							x		
Media Mix Plus III	10-5-10					13.5 oz/100 gallons										
Mix of Soluble Traces (MOST)							x									
Oasis Hydroponic	16-4-17	12.80	3.60	0.1000	Neutral	8.4 oz/100 gallons	x	x	x	x	x					x





Water Soluble Fertilizer

Plantex Solutions® 17-5-17 Complete Fertilizer

The convenience of an all-in-one nutritional program, in one tank. This balanced formulation has high nitrate, complete calcium and magnesium alongside an enhanced micronutrient package, and little impact on media pH.

- For use on: Garden Mums, Bedding Plants, Pansies and Poinsettia
- Acidic: 105 lbs CCE
- No Urea

**25lb (80/PL)****PLNTX10132**

Min. Buy 1 EA

Other Info

**Plantex Solutions® 18-9-18 pH Reducer Fertilizer**

A high nitrate fertilizer that works to decrease media pH levels while providing enhanced micronutrients. Eliminates or reduces the need for acid when water bicarbonate levels are 100-150 ppm.

- For use on: Pansy, Garden Mums, Bedding Plants
- Acidic: 716 lbs CCE
- No Urea

**25lb (80/PL)****PLNTX11076**

Min. Buy 1 EA

Other Info SHIPS HAZ

**Plantex Solutions® 19-2-19 Fertility Plus Fertilizer**

A high nitrate fertilizer ideal for heavy feeders. With elevated magnesium, enhanced micronutrients, and a lower phosphorus content, this maximum performance formulation is designed for modern heavy feeding.

- For use on: Pansies, Garden Mums, Bedding Plants
- Acidic: 309 lbs CCE
- No Urea

**25lb (80/PL)****PLNTX11078**

Min. Buy 1 EA

Other Info SHIPS HAZ

**Plantex Solutions® 19-8-13 Complete Plus Fertilizer**

A modification of the Complete formulation with more acidic potential. A complete nutritional program in one bag reduces the need to alternate formulations. Includes an enhanced micronutrient package.

- For use on: Poinsettia, Pansy, Garden Mums, Bedding Plants
- Acidic: 300 lbs CCE
- No Urea

**25lb (80/PL)****PLNTX11242**

Min. Buy 1 EA

**Plantex® 20-20-20 Classic Fertilizer**

Very effective on all types of plants. This balanced formulation may be used whenever a more general feed program is required. Its high percentage of ammoniacal and urea nitrogen provides rapid green up and leaf expansion, while the balanced phosphorous and potassium encourages root and shoot growth.

- For use on: Annuals, Green Plants
- Acidic: 570 lbs CCE

**25lb (80/PL)****PLNTX10392**

Min. Buy 1 EA

**Plantex® 20-10-20 All Purpose High Nitrate Fertilizer**

This all purpose formulation has 60% of its nitrogen in the nitrate form, and a complete micronutrient package including a higher level of molybdenum, as required for soilless mixes. This is an ideal formulation for use in low light conditions.

- For use on: Bedding Plants, Garden Mums and Pansies
- Acidic: 437 lbs CCE
- No Urea

**25lb (80/PL)****PLNTX10388**

Min. Buy 1 EA

Other Info SHIPS HAZ

**Plantex® 10-52-10 High Phosphate Fertilizer**

A fully soluble starter formulation that supplies the necessary high phosphorus levels for young plants to initiate rapid root development. A very safe fertilizer with a low salt index, contains no sulfates or harmful chlorides. Use when transplanting seedlings or bedding plants or whenever a high phosphorus fertilizer is required.

- For use on: Hydrangeas
- Acidic: 900 lbs CCE

**25lb (80/PL)****PLNTX10368**

Min. Buy 1 EA

**Plantex® 21-7-7 Acid Fertilizer**

A potential acidity powerhouse. This formulation is ideal for when irrigation water has a high bicarbonate level and for use with acid loving plants, such as azaleas, rhododendrons, and evergreens. If used in a continuous feeding program, the pH should be monitored to ensure that it does not go below the desired level.

- For use on: Rhododendrons, Azaleas
- Acidic: 1580 lbs CCE

**25lb (80/PL)****PLNTX10394**

Min. Buy 1 EA

**Plantex® 18-6-20 Poinsettia Plus Fertilizer**

A great choice for the production of poinsettias for its balance of nutrients. Contains over 60% of its nitrogen in the nitrate form, a high level of magnesium, an increased level of molybdenum, a low boron level and chelated micronutrients.

- For use on: Poinsettias
- Acidic: 304 lbs CCE
- No Urea

**25lb (80/PL)****PLNTX11675**

Min. Buy 1 EA

Other Info SHIPS HAZ



Water Soluble Fertilizer

Plantex[®] 12-2-14 Cal Mag + P Fertilizer

Designed to optimize the growth of seedlings in multiple cells. Contains a complete micronutrient package including high molybdenum. More than 97% of its nitrogen is in the form of nitrate.

- For use on: Bedding Plants, Garden Mums, Plugs, Orchids
- Basicity: 383 lbs CCE
- No Urea



25lb (80/PL)

PLNTX10370

Min. Buy 1 EA



Plantex[®] 14-0-14 Cal Mag Fertilizer

A completely soluble prilled formulation specifically for growing in multiple cells or when a higher level of calcium and magnesium is required. Calcium to magnesium ratio is 2:1.

- For use on: Bedding Plants
- Basicity: 326 lbs CCE
- No Urea



25lb (80/PL)

PLNTX10372

Min. Buy 1 EA



Plantex[®] 15-0-15 Cal Plus Fertilizer

A completely soluble prilled formulation with a high calcium level. This calcium nitrate and potassium nitrate mixture includes chelated micronutrients. Cal Plus Special is very effective under low light conditions, especially during winter months.

- For use on: Poinsettia
- Basicity: 325 lbs CCE
- No Urea



25lb (80/PL)

PLNTX10375

Min. Buy 1 EA



Plantex[®] 20-2-20 Acidic High N Low Phosphate Fertilizer

Helps keep the pH low and contributes very little phosphorus. This formulation in combination with Plantex 14-0-14 is ideal for plugs and bedding plants. Because of its high potential acidity it is useful in maintaining an ideal pH balance in plug media. Can also be used for production of blue hydrangeas and Easter lilies when excess phosphorus is not required.. (SHIPS HAZ)

- For use on: Plugs, Bedding Plants, Blue Hydrangeas, Easter Lilies
- Acidic: 535 lbs CCE
- No Urea



25lb (80/PL)

PLNTX10386

Min. Buy 1 EA

Other Info SHIPS HAZ



Plantex[®] 28-14-14 High Nitrogen Fertilizer

Can be used for foliar feeding due to its very low salt index and high level of urea nitrogen. Use during periods of vegetative growth when plants have a high nitrogen requirement. Use to correct nitrogen deficiency where soil or tissue tests show low nitrogen.

- For use on: Cut flowers, Container nursery stock and Field grown vegetables
- Acidic: 910 lbs CCE



25lb (80/PL)

PLNTX10397

Min. Buy 1 EA



Plant Prod MJ Finisher 4-31-37 Fertilizer

Plant-Prod MJ Finisher 4-31-37 is a finishing formulation with elevated phosphorus and potassium to encourage fullness and density of buds. During these last few weeks of production, this elevated potassium supports plant turgidity and disease resistance, while the phosphorus optimizes photosynthesis. The added Nitrogen ensures no signs of deficiency.



25lb (80/PL)

PLNTX12280

Min. Buy 1 EA



Plant Prod MJ Bloom 10-30-20 Fertilizer

Plant-Prod MJ Bloom 10-30-20 is an essential formulation during weeks 5-10 for optimal bud formation and fill. This high phosphorous, moderate potassium formulation encourages full bud set and improves bud filling. The added magnesium ensures no signs of deficiency. Bloom also contains an enhanced micronutrient package with additional EDDHA iron to ensure efficient uptake at a wide range of pH levels.



25lb (80/PL)

PLNTX12206

Min. Buy 1 EA



Plant Prod MJ Grow 12-8-26 Fertilizer

This ideal ratio of nitrogen, phosphorus and potassium promotes optimal growth to ensure a sufficient plant structure to support target yields. The added magnesium ensures no signs of deficiency. Grow contains an enhanced micronutrient package with additional EDDHA iron to ensure efficient uptake at a wide range of pH levels. Feed during weeks 2 and 3 for steady growth.



25lb (80/PL)

PLNTX12279

Min. Buy 1 EA

Other Info SHIPS HAZ



Plant Prod MJ Cal Kick 15-0-14 Fertilizer

Plant-Prod MJ Cal Kick is a high calcium formulation that should be used as the main calcium source throughout the production cycle when levels in water source are not adequate. Calcium is vital to plant rigidity and bud formation.



25lb (80/PL)

PLNTX12305

Min. Buy 1 EA



WARNING: This product is not available for sale in CA. For most up to date information please visit bfgsupply.com



Water Soluble Fertilizer

Plant Prod MJ Boost 15-30-15 Fertilizer

Plant-Prod MJ Boost 15-30-15 is a high phosphorus formulation that supplies the necessary phosphorus for transplants and bud sizing. When plants are of a sufficient level of maturity or when buds are pea sized, feeding with 15-30-15 provides a boost of phosphorus to promote vigorous bud setting and sizing. Feed during week 1 to establish a healthy root system, and during week 4 to boost bud formation.

**25lb (80/PL)****PLNTX12278**

Min. Buy 1 EA

**Plantex[®] and Plantex Solutions[™] EC (mmhos)**

Plantex [®]								
Parts Per Million (ppm) Nitrogen	Hydroponic 7-11-27	High P 10-52-10	Cal Mag +P 12-2-14	Cal Mag 14-0-14	Cal Plus 15-0-15	Poinsettia Plus 18-6-20	All Purpose High Nitrate 20-10-20	Classic 20-20-20
50	0.75	0.40	0.46	0.41	0.46	0.44	0.37	0.24
100	1.75	0.81	0.89	0.84	0.84	0.86	0.73	0.49
150	2.15	1.21	1.24	1.24	1.22	1.28	1.09	0.74
200	2.84	1.61	1.68	1.61	1.60	1.69	1.45	0.98
250	3.50	2.00	2.12	2.00	1.98	2.10	1.80	1.21
300	4.14	2.39	2.72	2.35	2.35	2.50	2.15	1.45
350	4.77	2.78	2.97	2.72	2.73	2.89	2.50	1.68
400	5.36	3.16	3.37	3.08	3.11	3.29	2.84	1.90
450	5.95	3.53	3.78	3.42	3.49	3.67	3.18	2.12

Total soluble salts is a measure, in the form of electrical conductivity, of the amount of fertilizer in solution. Most nutrients or other elements that are soluble will contribute to the conductivity of the solution. The electrical conductivity (EC) increases as the fertilizer concentration is increased.

Electrical conductivity is measured in mhos. The conductivity of fertilizer solutions is sufficiently small that it is measured in terms of millimhos (mmhos, one one-thousandth of a mho) or micromhos (μ mhos, one one-millionth of a mho). Conductivity meters measure in either mmhos or μ mhos. Since most meters used by our growers are calibrated in mmhos, the data given here on our fertilizers uses the same measurement. Meters that are calibrated to millisiemens (mS) do not require adjustment as mmhos and mS are interchangeable.

By knowing the electrical conductivity (EC) of a fertilizer blend, you can predict the parts per million (ppm) of nutrients your plants are receiving, or that remain in your run off water. The following table can be used to measure the accuracy of fertilizer injector systems by following these steps:

1. Take a conductivity reading of clear irrigation water.
2. Take a conductivity reading of final fertilizer solution.
3. Subtract the conductivity reading value of clear water from the conductivity reading of fertilizer solution.
4. Compare the answer found in 3 to the corresponding value in the table in order to find the concentration of fertilizer.



Water Soluble Fertilizer

Plantex[®] and Plantex Solutions[™] EC (mmhos)

Plantex [®]		Plantex Solutions [™]					
Acid 21-7-7	Foliage 24-8-16	High Capacity High Nitrate 25-4-15	Complete 17-5-17	pH Buffer 18-6-24	pH Reducer 18-9-18	Fertility Plus 19-2-19	CompletePlus 19-8-13
0.40	0.25	0.41	0.36	0.38	0.44	0.39	0.28
0.78	0.49	0.82	0.69	0.76	0.88	0.78	0.56
1.15	0.73	1.23	1.02	1.14	1.30	1.16	0.85
1.52	0.97	1.63	1.35	1.51	1.72	1.54	1.12
1.89	1.20	2.03	1.67	1.88	2.14	1.92	1.40
2.25	1.44	2.42	2.00	2.26	2.55	2.29	1.67
2.61	1.67	2.81	2.33	2.62	2.95	2.65	1.94
2.96	1.90	3.20	2.66	2.99	3.35	3.02	2.21
3.31	2.13	3.58	2.98	3.35	3.74	3.38	2.47

Example:

Conductivity of clear irrigation water is 0.60 mmhos / mS.

Conductivity of the final fertilizer solution using 20-10-20 is 2.05 mmhos / mS.

The conductivity due to the fertilizer is 2.05 mmhos / mS - 0.60 mmhos / mS = 1.45 mmhos / mS.

For 20-10-20, a conductivity reading of 1.45 mmhos / mS corresponds to a feeding rate of roughly 200 ppm of Nitrogen (N).

Note: The values on this chart were obtained under laboratory conditions using distilled water and a Plant-Prod[®] conductivity meter. The values obtained by the grower under field conditions could therefore vary slightly (+/-10%) from the values listed here. EC values are available for reference on product label.

Plantex, Plantex Solutions and No-Stretch are registered trademarks of Master Plant-Prod Inc.
© Master Plant-Prod Inc. 2021. All Rights Reserved.



Water Soluble Fertilizer

Plantex[®] and Plantex Solutions[™] Nutrient Concentrations (ppm)

Plantex [®]																		
Nutrients (ppm)	Hydroponic 7-11-27		High P 10-52-10		Cal Mag +P 12-2-14		Cal Mag 14-0-14		Cal Plus 15-0-15		Pansy 17-4-19		Poinsettia Plus 18-6-20		All Purpose High Nitrate 20-10-20		Classic 20-20-20	
Total Nitrogen (N)	100	200	100	200	100	200	100	200	100	200	100	200	100	200	100	200	100	200
Nitrate N	36	72	0	0	97	193	91	182	89	179	64	130	64	128	60	120	30	59
Ammoniacal N	3	7	69	138	2	5	9	17	11	21	35	71	36	72	40	80	20	39
Urea N	0	0	28	57	0	0	0	0	0	0	0	0	0	0	0	0	51	102
Available Phosphate (P ₂ O ₅)	62	124	507	1014	17	33	0	0	0	0	23	47	33	67	50	100	100	200
Soluble Phosphorus (P)	27	54	220	441	7	13	0	0	0	0	10	20	14	29	22	43	44	87
Soluble Potash (K ₂ O)	152	304	98	195	116	231	100	200	100	200	111	224	111	222	100	200	100	200
Soluble Potassium (K)	126	252	81	162	96	191	83	165	83	166	91	183	92	184	83	166	83	166
Calcium (Ca)	71	214	0	0	50	99	42	84	73	147	0	0	0	0	0	0	0	0
Magnesium (Mg)	21	43	0	0	25	50	21	41	0	0	19	38	11	22	1	1	0	0
Sulfur (S)	33	65	0	0	0	0	0	0	0	0	23	47	14	28	1	2	0	0
Iron (Fe)	0.563	1.125	0.975	1.950	0.825	1.650	0.713	1.425	0.668	1.335	1.053	2.120	0.555	1.110	0.503	0.998	0.503	0.998
Manganese (Mn)	0.478	0.956	0.488	0.975	0.413	0.825	0.356	0.713	0.334	0.668	0.293	0.589	0.278	0.555	0.251	0.499	0.251	0.499
Zinc (Zn)	0.169	0.338	0.488	0.975	0.413	0.825	0.356	0.713	0.334	0.668	0.293	0.589	0.278	0.555	0.251	0.499	0.251	0.499
Copper (Cu)	0.023	0.046	0.488	0.975	0.413	0.825	0.356	0.713	0.334	0.668	0.293	0.589	0.278	0.555	0.251	0.499	0.251	0.499
Boron (B)	0.154	0.307	0.195	0.390	0.165	0.330	0.143	0.285	0.134	0.267	0.205	0.412	0.056	0.111	0.101	0.200	0.101	0.200
Molybdenum (Mo)	0.051	0.101	0.005	0.010	0.124	0.248	0.107	0.214	0.100	0.200	0.088	0.177	0.333	0.666	0.075	0.150	0.003	0.005
Potential Acidity / Basicity (lb. CaCO ₃ / ton)	B 176		A 900		B 383		B 326		B 325		A 265		A 304		A 437		A 570	
oz. of fertilizer / gal. of water (1:100)	7.5	15																
	5 oz. Calcium Nitrate (GG)	10 oz. Calcium Nitrate (GG)	13	26	11	22	9.5	19	8.9	17.8	7.8	15.7	7.4	14.8	6.7	13.3	6.7	13.3

Plantex, Plantex Solutions and No-Stretch are registered trademarks of Master Plant-Prod Inc.
© Master Plant-Prod Inc. 2021. All Rights Reserved.





Water Soluble Fertilizer

Plantex[®] and Plantex Solutions[™] Nutrient Concentrations (ppm)

Nutrients (ppm)	Plantex [®]						Plantex Solutions [™]													
	High Nitrate Low P 21-5-20		Acid 21-7-7		High Capacity High Nitrate 25-4-15		Cal-Mag Royal 13-2-13		No-Stretch 15-0-20		Complete 17-5-17		pH Buffer 18-6-24		pH Reducer 18-9-18		Fertility Plus 19-2-19		Complete Plus 19-8-13	
Total Nitrogen (N)	100	200	100	200	100	200	100	200	100	200	100	200	100	200	100	200	100	200	100	200
Nitrate N	61	123	10	20	57	115	92	185	81	163	71	142	65	131	47	94	64	127	64	127
Ammoniacal N	38	77	62	126	43	86	8	15	19	37	29	58	34	69	53	105	36	72	36	72
Urea N	0	0	27	54	0	0	0	0	0	0	0	0	0	0	0	0	0	0	0	0
Available Phosphate (P₂O₅)	24	48	33	67	16	32	15	31	0	0	29	59	33	67	50	100	11	21	42	84
Soluble Phosphorus (P)	10	20	14	29	7	14	6	12	0	0	12	25	14	29	22	43	4	8	18	36
Soluble Potash (K₂O)	95	191	33	67	60	120	100	200	134	267	100	200	133	266	100	200	100	200	68	137
Soluble Potassium (K)	78	158	27	55	49	100	82	165	111	222	82	166	110	221	83	165	82	165	56	112
Calcium (Ca)	0	0	0	0	0	0	46	92	20	40	18	35	0	0	0	0	0	0	13	26
Magnesium (Mg)	1	1	0	0	1	1	23	46	10	20	6	12	0	0	1	2	8	16	5	11
Sulfur (S)	1	2	61	124	1	2	0	0	0	0	0	0	0	0	31	61	10	20	0	0
Iron (Fe)	0.591	1.191	0.473	0.953	0.497	1.003	0.612	1.230	1.669	3.338	0.585	1.178	0.555	1.110	1.388	2.775	1.313	2.625	1.313	2.625
Manganese (Mn)	0.236	0.476	0.236	0.476	0.199	0.401	0.459	0.923	0.501	1.001	0.293	0.589	0.278	0.555	0.416	0.833	0.394	0.788	0.394	0.788
Zinc (Zn)	0.236	0.476	0.236	0.476	0.199	0.401	0.153	0.308	0.501	1.001	0.293	0.589	0.278	0.555	0.416	0.833	0.394	0.788	0.394	0.788
Copper (Cu)	0.236	0.476	0.236	0.476	0.199	0.401	0.077	0.154	0.334	0.668	0.293	0.589	0.278	0.555	0.278	0.555	0.263	0.525	0.263	0.525
Boron (B)	0.095	0.191	0.095	0.191	0.080	0.161	0.092	0.185	0.134	0.267	0.117	0.236	0.111	0.222	0.111	0.222	0.105	0.210	0.105	0.210
Molybdenum (Mo)	0.071	0.143	0.002	0.005	0.060	0.120	0.008	0.017	0.100	0.200	0.088	0.177	0.083	0.167	0.083	0.167	0.079	0.158	0.079	0.158
Potential Acidity / Basicity (lb. CaCO ₃ / ton)	A 440		A 1580		A 643		B 324		B 154		A 105		A 296		A 716		A 309		A 300	
oz. of fertilizer / gal. of water (1:100)	6.3	12.7	6.3	12.7	5.3	10.7	10.2	20.5	8.9	17.8	7.8	15.7	7.4	14.8	7.4	14.8	7	14	7	14

Plantex, Plantex Solutions and No-Stretch are registered trademarks of Master Plant-Prod Inc.
© Master Plant-Prod Inc. 2021. All Rights Reserved.

WARNING: This product is not available for sale in CA.
For most up to date information please visit bfgsupply.com

800-883-0234
www.bfgsupply.com



Peters Excel®

Water Soluble Fertilizer

Peter's Excel Water Soluble Fertilizer

Featuring unique formulations providing the ability to deliver complete plant nutrition using only a single-concentrate stock tank, taking into account the quality of the irrigation water. This will decrease labor and overall costs. All Peters Excel products are completely water soluble, keeping your emitters clean.

Peters® Excel 13-2-13 Plug & Bedding Plant Special Fertilizer

Ideal for plugs, liners, bedding plants and vegetable transplants with high nitrate and low phosphate levels to encourage healthy, compact growth. This all-purpose formulation provides constant, balanced nutrition. Contains calcium, magnesium and other minor elements.

- For use on: All plugs, liners, bedding plants and vegetable transplants
- Basicity: 335 lbs CCE
- Urea: 6.9



25lb (80/PL)

EVR99120

Other Info

Min. Buy 1 EA



Peters® Excel pHLow™ 19-11-21 Multi-Purpose Fertilizer with Black Iron

Provides your plants with the nutrition they need to thrive while easily and conveniently managing alkalinity of your irrigation water. pHLow products are different from the other Peters Excel products. They contain Pekacid® and combat alkalinity in a different manner. (SHIPS HAZ)

- Acidic: 290 lbs CCE
- No Urea



25lb (80/PL)

EVRE99008

Other Info SHIPS HAZ

Min. Buy 1 EA



Peters® Excel 15-2-20 Pansy, Salvia & Vinca Fertilizer

Ideal for compact growth and bright blossoms on pansy, salvia, vinca, etc. with high nitrate, low phosphate and extra boron. This all-purpose formulation provides constant, balanced nutrition. Contains calcium, magnesium and other minor elements.. (SHIPS HAZ)

- For use on: Pansy, Salvia & Vinca
- Basicity: 234 lbs CCE
- Urea: 5.3



25lb (80/PL)

EVR99130

Other Info SHIPS HAZ

Min. Buy 1 EA



Peters® Excel 21-5-20 Multi-Purpose Fertilizer

A moderately acidic formulation that serves as an excellent all-purpose fertilizer for Types 2, 3 and 4 irrigation water. Contains a complete range of essential micronutrients. (SHIPS HAZ)

- For use on: demanding plants like petunia.
- Acidic: 377 lbs CCE
- Urea: 5.2



25lb (80/PL)

EVRE99150

Other Info SHIPS HAZ

Min. Buy 1 EA



Peters® Excel 15-5-15 Cal-Mag Special Fertilizer with Black Iron

Water soluble fertilizer with an excellent all-purpose formulation that combines high nitrate and low phosphate with extra calcium and magnesium. This all-purpose formulation provides constant, balanced nutrition. Contains a complete range of essential micronutrients. M-77 Black Iron chelating formula for fast, efficient nutrient uptake.

- For use on: A broad range of plants, especially effective when irrigation water is alkaline
- Basicity: 131 lbs CCE
- Urea: 14.0



25lb (80/PL)

EVR99140

Other Info SHIPS HAZ

Min. Buy 1 EA



Peters® Excel pHLow™ 21-7-7 Acid Hammer

Feeds acid loving plants and reduces growing Media pH levels

- Acidic: 1218 lbs CCE
- No Urea



25lb (80/PL)

ICL99002

Other Info SHIPS HAZ

Min. Buy 1 EA



Water Soluble Fertilizer

Peter's Professional Water Soluble Fertilizer

Peters Professional fertilizers are the world's leading 100% water-soluble fertilizers. The exclusive M-77 chelating formula of Peters Professional assures that nutrients and trace elements remain readily available for fast and easy uptake. M-77 "unlocks" the rooting area, allowing an effective increase in the absorption of nutrients.

Peters® Professional 5-11-26 Hydroponic Special Fertilizer

Designed exclusively for hydroponic culture, this classic formula is ideal for most hydroponic crops, especially tomatoes, cucumbers, and lettuce. Effective for all water types. Buffered to help maintain correct working solution pH.

- Basicity: 215 lbs CCE
- No Urea



25lb (80/PL)

EVR99390

Min. Buy 1 EA



Peters® Professional 22-5-16 Mum Special Black Iron

An effective formulation of three chelated irons specifically designed for mums and other high iron demanding plants. Black iron is the most effective iron chelate used for growing ornamentals, effective over the widest range of media pH levels. Specifically formulated for mums and other high iron demanding plants. Effective for all water types.



25lb (80/PL)

EVR99334

Other Info

Min. Buy 1 EA



Peters® Professional 10-30-20 "Bloom Booster" Fertilizer

A specially developed water soluble fertilizer designed exclusively for flowering plants. It particularly stimulates the development of flowering buds.

- Acidic: 365 lbs CCE
- No Urea



25lb (80/PL)

EVR99350

Min. Buy 1 EA



Peters® Professional 15-3-25 Flowering Crop Special plus Black Iron

A water-soluble fertilizer with a formulation of three chelated Irons, including black Iron. This new M-77® chelated system is specifically designed for petunias and other high Iron demanding plants. Black Iron is the strongest iron chelate used for growing ornamentals, making iron available to plants over the widest range of pH.

- For use on: Bedding plants and hanging baskets
- Acidic: 34 lbs CCE
- No Urea



25lb (80/PL)

EVRE99321

Other Info SHIPS HAZ

Min. Buy 1 EA



Peters® Professional 15-16-17 Peat-Lite® Special Fertilizer

A professional grade, water-soluble fertilizer used for soilless mixes with low or no trace element additions. Reduced ammonium toxicity potential. A non-acidifying high nitrate source (53%) formula. Sufficient molybdenum for poinsettias. Use as a general purpose feed for bedding plants, pot plants and nursery stock in soilless mixes with little or no trace element additions.

- For use on: Geraniums and Poinsettias
- Acidic: 202 lbs CCE
- Urea: 26.7



25lb (80/PL)

EVR99210

Other Info SHIPS HAZ

Min. Buy 1 EA



Peters® Professional 15-5-25 Peat-Lite® Flowering Crop Special Fertilizer

Proven high-nitrate, low-phosphate formula for poinsettias and many other flowering crops that are sensitive to boron. Effective for all Water Types. Contains extra magnesium plus a full range of essential micronutrients.. (SHIPS HAZ)

- For use on: Bedding plants and general use.
- Acidic: 48 lbs CCE
- No Urea



25lb (80/PL)

EVR99220

Other Info SHIPS HAZ

Min. Buy 1 EA



WARNING: This product is not available for sale in CA. For most up to date information please visit bfgsupply.com



Water Soluble Fertilizer

Peters® Professional 15-0-15 Peat-Lite® Dark Weather Fertilizer

Classic high-nitrate formula for bulbs or any crop that needs extra calcium and magnesium, lower phosphate and slightly higher growing media pH. Ideal for Water Types 1 and 2. Provides a full range of micronutrients.

- Basicity: 221 lbs CCE
- No Urea

**25lb (80/PL)****EVR99260**

Min. Buy 1 EA

**Peters® Professional 17-3-17 Peat-Lite® Neutral Cal-Mag Fertilizer**

Premium all-purpose formulation produces a nearly neutral reaction to help maintain steady pH in growing media. An all-purpose formulation for constant, balanced nutrition. Ideal for Water Types 1 and 2. Contains calcium, magnesium and other minor elements.

- For Use on: A wide variety of plants, because it is neutral formulation many use this in low alkalinity water
- Basicity: 27 lbs CCE
- No Urea

**25lb (80/PL)****EVR99230**

Min. Buy 1 EA

**Peters® Professional 18-8-17 Peat-Lite® High Mag Special Fertilizer**

Highly effective stand-alone fertilizer with extra magnesium to maintain deep green foliage. Formulation for constant, balanced nutrition. Excellent stand-alone for Water Types 3 and 4; use as a base in Water Types 1 and 2. Contains a complete range of essential micronutrients.. (SHIPS HAZ)

- Acidic: 381 lbs CCE
- No Urea

**25lb (80/PL)****EVR99240**

Min. Buy 1 EA

**Peters® Professional 14-0-8 Hydroponic Boost**

Is designed to be added to Peters Professional 5-11-26 Hydroponic Special base feed to provides vital supplemental N, K, Ca & Mg levels needed by common hydroponic crops .

- Basicity: 417.6 lbs CCE
- No Urea

**25lb (80/PL)****EVR99395**

Min. Buy 1 EA

Peters Professional®

Peters® Professional 20-10-20 General Purpose Fertilizer

Crops that are sensitive to excess micronutrients thrive with this classic formula with its acidifying action that corrects an overload of growing media pH. Effective for all Water Types. Contains a full range of essential micronutrients.. (SHIPS HAZ)

- For use on: All Plants
- Acidic: 404 lbs CCE
- No Urea

**25lb (80/PL)****EVR99300**

Min. Buy 1 EA

Other Info SHIPS HAZ

**Peters® Professional 21-7-7 Acid Special Fertilizer**

Specifically formulated for acid-loving plants. Provides a rapid correction of high pH conditions; ideal for acid-loving plants in the nursery and landscape. Promotes lush vegetation and better blooms. A favorite for azaleas and rhododendrons!

- Acidic: 1518 lbs CCE
- Urea: 50.5

**25lb (80/PL)****EVR99330**

Min. Buy 1 EA

Other Info

**Peters® Professional 20-3-19 Petunia Special with Black Iron**

A water-soluble fertilizer with a formulation of three chelated Irons, including black Iron. This new M-77® chelated system is specifically designed for petunias and other high Iron demanding plants. Black Iron is the strongest iron chelate used for growing ornamentals, making iron available to plants over the widest range of pH.

- For us on: Petunia's
- Acidic: 378 lbs CCE
- No Urea

**25lb (80/PL)****EVR99091**

Min. Buy 1 EA

Other Info SHIPS HAZ

**Peters® Professional 20-20-20 General Purpose Fertilizer**

All purpose water soluble fertilizer. It is a balanced blend of Nitrogen, Phosphorus and Potassium with fully chelated trace elements that works on all plant materials as a general-purpose fertilizer.

Indoors it is especially effective on foliage plants to keep leaves green and happy.

- For use on: All Plants
- Acidic: 576 lbs CCE
- Urea: 52.0

**25lb (80/PL)****EVR99290**

Min. Buy 1 EA

Other Info



Water Soluble Fertilizer

Peters® Professional 20-10-20 Peat-Lite® Fertilizer

Designed to be mixed with water for the most accurate and effective nutrient delivery to the plant. Contains an increased level of micronutrients to provide the necessary elements absent from most commercially made peat-lite potting media. (SHIPS HAZ)

- For use on: All Plants
- Acidic: 415 lbs CCE
- No Urea



25lb (80/PL)

EVR99250

Min. Buy 1 EA

Other Info SHIPS HAZ



Peters® Professional 25-5-15 High Performance Fertilizer

high efficiency formula designed to maximize your NPK delivery while keeping a balance of macro secondary and micronutrients for optimum plant growth. Best as a continuous feed for heavy feeding plants in moderate to warm temperatures. Micronutrient levels are comparable to Peat-Lite formulas. Can be used as a nutrient booster for great green-up for almost all varieties. (SHIPS HAZ)

- Acidic: 593 lbs CCE
- No Urea



25lb (80/PL)

EVRE99087

Min. Buy 1 EA

Other Info SHIPS HAZ



We've got you covered.



Peters®
The clear choice

Osmocote®
Success is in the bag



Look to ICL for the world's best plant nutrition products. Whether it's Osmocote, the original controlled release fertilizer that created an industry, or Peters, the world's purest water-soluble fertilizer—ICL has got you covered.

growwithpeters.com



growwithosmocote.com



WARNING: This product is not available for sale in CA. For most up to date information please visit bfgsupply.com

800-883-0234
www.bfgsupply.com

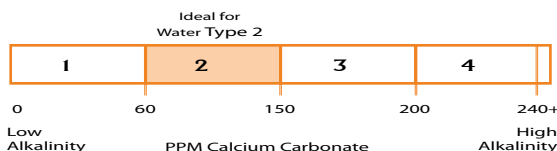

Water Soluble Fertilizer

Peters® makes choosing the right fertilizer as easy as A-B-C

For more than 60 years, the original Peters® water soluble fertilizer has been the right choice. Now they are also the easiest, with the revolutionary pending Peters® A-B-C Selection System. This new system quickly identifies the best formulations for your crops, making it easy to select the right product for efficient and effective plant nutrition.

Easy: Water quality is the heart of this system of fertilizer selection. Once you know if your water Type is 1,2,3 or 4 you can quickly identify the best Peters® formulations for the plants you are growing.

Efficient: Formulas have been refined to provide the most effective mix of N-P-K ratios for the broadest range of crop nutrition. Plus the M-77® minor element package improves performance by promoting a favorable root zone and making micronutrients more consistently available to plants.

Flexible: All Peters® products are categorized into A, B or C formulations.

ICL Water Soluble Fertilizer Summary Chart

Brand	Product Name	New Stock #	Icon	Ideally Suited for Water Type(s)	Potential Acidity (A) / Basicity (B) (CCE/ton)	Maximum Solubility (lb/gal)	EC per 100 ppm N (mS/cm)	Oz/100 gal to obtain 100 ppm N	1 level tsp/gal = approx. ppm N	Elemental ppm contained in a 100 ppm N solution													
										NH ₄ -N	Urea-N	NO ₃ -N	P	K	Ca	Mg	S	B	Cu	Fe	Mn	Mo	Zn
Peters Excel® pH/low	19-11-21 Multi-Purpose with black iron	G99008	B	2 to 4*	378 A	4.30	0.80	7.1	283	36.8	0.0	63.2	25.2	92.1	0.0	0.8	1.1	0.105	0.105	0.500	0.237	0.050	0.237
	18-18-18 Multi-Purpose with black iron	G99010	B	2 to 4*	505 A	4.30	0.65	7.5	276	41.7	0.0	58.3	43.5	83.3	0.0	0.0	0.0	0.122	0.122	0.500	0.250	0.050	0.250
	15-7-25 High Mag/High K with black iron	G99009	A	2 to 4*	87 A	3.30	0.99	9.0	235	27.3	0.0	72.7	20.3	138.9	0.0	16.7	22.0	0.117	0.117	0.467	0.233	0.047	0.233
	21-7-7 Acid Hammer	G99002	C	3 to 4*	1218 A	3.50	0.85	6.4	276	66.7	0.0	33.3	14.5	27.8	0.0	1.9	48.1	0.128	0.128	0.767	0.243	0.050	0.262
Peters Excel®	21-5-20 Multi Purpose	G99150	B	2 to 4	390 A	4.00	0.63	6.4	320	34.8	5.2	60.0	10.4	79.4	0.0	0.0	0.0	0.125	0.125	0.500	0.250	0.0500	0.250
	21-5-20 Multi Purpose No Boron	G99152	B	2 to 4	377 A	4.00	0.63	6.4	320	34.3	5.2	60.5	10.4	79.4	0.0	0.0	0.0	0.125	0.125	0.500	0.250	0.0500	0.250
	15-5-15 Cal-Mag Special with black iron	G99145	A	2	133 B	3.00	0.56	9.0	194	9.3	13.3	77.4	14.5	83.3	33.3	13.3	0.0	0.125	0.125	0.500	0.250	0.0500	0.250
	15-2-20 Pansy, Salvia & Vinca	G99130	A	1 to 2	234 B	3.50	0.83	9.0	169	10.7	5.3	84.0	5.8	111.1	25.0	13.3	0.0	0.200	0.125	0.667	0.333	0.0500	0.250
	13-2-13 Plug & Bedding Plant Special	G99120	A	1 to 2	335 B	5.00	0.75	10.4	168	0.0	6.9	93.1	6.7	83.3	46.2	23.1	0.0	0.125	0.125	0.500	0.250	0.0500	0.250
	10-0-0 Mag-Nitrate Special	G99160	C	1 to 4	357 B	5.00	0.70	13.5	35	0.0	0.0	100.0	0.0	0.0	0.0	90.0	0.0	0.125	0.125	0.500	0.250	0.0500	0.250
Peters Professional®	25-5-15 High Efficiency	G99087	B	1 to 4	593 A	5.50	0.57	5.3	355	43.2	0.0	56.8	8.7	50.0	0.0	0.0	0.0	0.156	0.140	0.600	0.300	0.060	0.300
	24-8-16 Foliage Special	G99720	B	1 to 4	726 A	3.00	0.45	5.6	285	29.6	34.2	36.3	14.5	55.6	0.0	1.5	8.3	0.063	0.063	0.250	0.125	0.0250	0.125
	22-5-16 Mum Special with black iron	G99334	B	1 to 4	502 A	5.00	0.57	6.1	319	41.4	0.0	58.6	9.9	60.6	0.0	4.6	5.9	0.091	0.055	0.915	0.23	0.046	0.228
	21-7-7 Acid Special	G99330	C	3 to 4	1518 A	4.00	0.52	6.4	245	49.5	50.5	0.0	14.5	27.8	0.0	2.9	61.9	0.125	0.125	0.714	0.238	0.0476	0.238
	20-20-20 GP	G99292	B	2 to 4	576 A	3.50	0.41	6.8	238	20.5	52.0	27.5	43.5	83.3	0.0	0.3	0.0	0.063	0.063	0.250	0.125	0.0250	0.125
	20-20-20 GP No Dye	G99291	B	2 to 4	576 A	3.50	0.41	6.8	238	20.5	52.0	27.5	43.5	83.3	0.0	0.3	0.0	0.063	0.063	0.250	0.125	0.0250	0.125
	20-10-20 GP	G99300	B	1 to 4	404 A	3.50	0.62	6.8	305	40.0	0.0	60.0	21.7	83.3	0.0	0.8	0.0	0.063	0.063	0.250	0.125	0.0250	0.125
	20-3-19 Petunia Special with black iron	G99090	B	1 to 4	379 A	4.00	0.77	6.8	305	39.0	0.0	61.0	6.5	79.2	0.0	8.0	14.0	0.13	0.12	1.000	0.250	0.0550	0.260
	13-2-13 Plug & Bedding Plant Special, No Minors, No Dye	G99340	B	1 to 2	356 B	3.00	0.74	10.4	160	3.1	0.0	96.9	6.7	83.3	46.2	23.1	0.0	0.000	0.000	0.000	0.000	0.0000	0.000
	14-0-8 Hydroponic Boost	G99395	C	1 to 4	418 B	5.50	0.95	9.6	5	0.0	0.0	95	0.0	47.6	97.1	6.4	0.0	0.000	0.000	0.000	0.000	0.000	0.000
Peters Professional® Peat-Lite	5-11-26 Hydroponic Special	G99310	B	1 to 4	215 B	3.00	1.45	27.0	0.0	0.0	100.0	95.7	433.3	0.0	120.0	160.0	0.000	0.300	6.000	1.000	0.2000	0.300	
	20-10-20 Peat-Lite Special	G99250	B	1 to 4	415 A	3.00	0.59	6.8	284	40.5	0.0	59.5	21.7	83.3	0.0	0.8	0.0	0.125	0.125	0.500	0.250	0.0500	0.250
	20-10-20 Peat-Lite Special No Boron	G99252	B	1 to 4	402 A	3.00	0.57	6.8	284	40.0	0.0	60.0	21.7	83.3	0.0	0.8	0.0	0.000	0.125	0.500	0.250	0.0500	0.250
	20-2-20 Peat-Lite Low Phosphorus Special	G99270	B	1 to 4	290 A	3.00	0.60	6.8	305	36.0	0.0	64.0	4.3	83.3	0.0	5.5	0.0	0.125	0.125	0.500	0.250	0.0500	0.250
	18-8-17 Peat-Lite High Mag Special	G99240	B	1 to 4	381 A	3.00	0.65	7.5	267	40.6	0.0	59.4	19.3	78.7	0.0	13.9	5.6	0.125	0.125	0.500	0.250	0.0500	0.250
	17-3-17 Peat-Lite Neutral Cal-Mag	G99230	A	1 to 2	27 B	5.00	0.65	7.9	216	23.5	0.0	76.5	7.7	83.3	23.5	7.4	0.0	0.125	0.125	0.500	0.250	0.0500	0.250
	15-16-17 Peat-Lite Special	G99210	B	2 to 4	202 A	4.25	0.62	9.0	197	20.7	26.7	52.7	46.4	94.4	0.0	0.7	0.0	0.125	0.125	0.500	0.250	0.0500	0.250
	15-5-25 Peat-Lite Flowering Crop Special	G99220	B	1 to 4	48 A	2.50	0.77	9.0	225	28.7	0.0	71.3	14.5	138.9	0.0	16.7	6.7	0.045	0.125	0.500	0.250	0.5000	0.250
	15-3-25 Peat-Lite Flowering Crop Special with black iron	G99321	B	1 to 4	33 A	3.00	0.98	9.0	232	27.3	0.0	72.7	8.7	138.9	0.0	22.7	29.3	0.127	0.127	1.000	0.250	0.0480	0.260
	15-0-15 Peat-Lite Dark Weather Feed	G99260	C	1 to 2	221 B	5.00	0.71	9.0	188	13.3	0.0	86.7	0.0	83.3	33.3	13.3	0.0	0.125	0.125	0.500	0.250	0.0500	0.250
Peters® Specialty	10-30-20 Peat-Lite Plant Starter	G99350	B	2 to 4	365 A	3.25	0.86	13.5	129	50.0	0.0	50.0	130.4	166.7	0.0	13.0	0.0	0.125	0.125	0.500	0.250	0.0500	0.250
	30-10-10 Hi Nitrogen Foliar Feed	G99710	-	-	1043 A	4.25	0.18	4.5	300	7.0	82.7	10.3	14.5	27.8	0.0	0.0	0.0	0.067	0.167	0.333	0.167	0.0017	0.167
	20-20-20 Ag & Landscape Special	G99700	-	-	572 A	570 A	3.50	0.51	6.8	242	24.0	49.0	27.0	43.5	83.3	0.0	0.0	0.100	0.250	0.500	0.250	0.0025	0.250

Peters® A-B-C Selection System

Since water quality is the single most important factor in determining solubility and nutrient availability for plants, water quality is the heart of Peters® A-B-C Selection System. Once you know your water, you can automatically narrow your options to the water soluble fertilizers that perform best in your operation.

To make the system easy to use, all Peters® products now carry a water type designation, so growers can quickly identify which formulations to use with various irrigation water sources. Plus, the entire Peters Excel® and Peters Professional® product lines have been restructured into clearly defined application categories.



Some formulations are labeled "A" for All Purpose. Each is a one-bag solution that eliminates labor and storage issues. When correctly matched to your water type, "A" formulations ensure perfectly balanced and constant nutrient uptake.

One "A" formulation can take the place of several crop-specific fertilizers, because each has been tested and proven to work over a broad range of plant types. Plus, Peters Excel® can still be tank mixed with other Peters Excel® formulas for a single-tank solution.

Growers can also opt for the added flexibility of using "B" Base formulations with one or more "C" Customizing components.

Base formulations include Peters® products that can be rotated and sometimes tank-mixed with one of the customizing components to meet specific nutrition or water quality needs, or used alone. Each Customizing Component provides a unique, prescriptive boost of specified nutrients for healthy results.





Water Soluble Fertilizer

Sustane® Hi-N® WDF Fertilizer 12-0-1

A high analysis, water dispersible, nitrogen fertilizer. Specifically formulated to promote rapid and durable greening and plant growth. Efficiently delivers a unique blend of soluble organic nitrogen sources to support plant growth. It can be used on diverse plants produced in a wide variety of growing systems.



20lb (48/PL)

SNF70552011

Min. Buy 1 EA

Haifa Micro™

A complete range of chelated micronutrients for all your crop needs.



www.haifa-group.com



WARNING: This product is not available for sale in CA. For most up to date information please visit bfgsupply.com

800-883-0234
www.bfgsupply.com



Controlled Release Fertilizer

Osmocote® Plus 15-9-12

Is a complete fertilizer solution that will continue to feed the plants after they are sold and will improve the customer's overall success. Works great on hanging baskets and potted plants grown in greenhouse production, as well as container grown nursery plants and in landscape containers and beds. Allows you to fertilize all the other plants with a standard water soluble program.

- For use on: Greenhouse, nursery and foliage production, container gardens, interiorscapes and landscapes
- Resin-coated N-P-K
- Micronutrients



3-4 Month Standard Release Fertilizer



50lb
EVRE903206 Min. Buy 1 EA



5-6 Month Standard Release Fertilizer



50lb
EVRE903226 Min. Buy 1 EA



8-9 Month Standard Release Fertilizer



50lb
EVRE903246 Min. Buy 1 EA



Osmocote Plus

Designed for general nursery and greenhouse production, high value crops, and dibbling equipment. Osmocote Plus can be incorporated or surface applied. Get the best return on your fertilizer investment, safely and consistently, by matching the nutrient release patterns with plant needs for optimal quality.





Patterned Release Formulations;

- Hi-Start - Commonly used on perennials and other fast growing plants as nutrients release at a high rate earlier in the growth cycle.
- Standard Release - Releases at a even release rate over the determined release period.
- Lo-Start - Releases small amounts of nutrients early in the growth cycle and more toward the end of the stated release period

8-9 Month Hi-Start Fertilizer



50lb
EVRE90583 Min. Buy 1 EA



8-9 Month Lo-Start Fertilizer



50lb
EVRE903266 Min. Buy 1 EA



12-14 Month Fertilizer



50lb (40/PL)
EVRE903306 Min. Buy 1 EA

Osmocote® Plus 15-8-11 Tablets Plus Minors

Provides all the nutrition plants need in a single application, including two sources of iron, making it ideal for high value color. Cores are glued together with water-soluble glue for convenient, ready to use, easy application to containers or beds. Can also be used in conjunction with water soluble programs or as an all in one growing solution.

- Coated Micronutrients



7.5g Tablets - 1000ct
EVRE90336 Min. Buy 1 EA



Controlled Release Fertilizer

Osmocote® Classic 13-13-13 8-9mo. Fertilizer

General purpose formulation for a wide variety of plant types. Is excellent as a base feed for heavy feeding greenhouse crops in combination with Peters water-soluble fertilizer. Ideal for topdressing established hanging baskets, perennials and foliage plants. Safe and easy long-term feeding of interior foliage plants. Great for combination planters, container gardens & landscape beds requiring N-P-K.

- For use on: Greenhouse production, nurseries, foliage, container gardens, interiorscapes and landscapes
- Homogeneous Osmocote resin coated N-P-K



50lb (40/PL)

EVRE90552

Min. Buy 1 EA



Osmocote® Classic 14-14-14 3-4mo. Fertilizer

General purpose formulation for a wide variety of plant types especially those needing a boost of phosphorus. Excellent as a base feed for heavy feeding greenhouse crops in combination with Peters water-soluble. Ideal for topdressing established hanging baskets, perennials and foliage plants. Safe and easy long-term feeding of interior foliage plants.

- For use on: Nursery, foliage, greenhouse production, container gardens, interiorscapes and landscapes
- Homogeneous Osmocote resin coated N-P-K



50lb (40/PL)

EVRE90550

Min. Buy 1 EA



Osmocote® Classic 18-6-12 8-9mo. Fertilizer

For use in nursery, foliage and greenhouse production, container gardens, interiorscapes and landscapes. Homogeneous Osmocote® N-P-K delivers nutrition consistently within specified longevities. For optimum results, incorporate in combination with Micromax® Micronutrients.



50lb (40/PL)

EVRE90555

Min. Buy 1 EA



Osmocote® Blend Fertilizers by ICL Specialty Fertilizers®

This selection of products include blends of various fertilizer technologies designed to meet specific growing needs. Some are designed to be used in greenhouse production, some in nurseries, a couple that stick to the surface of the pot and stay put if the fall over and some are quick responding topdress products. All our blends are high quality performers.

Controlled Release

- Blended product – may contain coated, uncoated and/or slow release components
- Now available: blends with 100% coated, homogeneous N-P-K prills – no Urea
- Added micronutrients
- Specified longevity of N-P-K
- Designed for general nursery production and outdoor applications. Can be incorporated or surface applied.
- Osmocote controlled release fertilizer delivers dependable, safe performance for a good cost-in-use value.



Osmocote® Blend 18-5-12 Fertilizer Enhanced with QuickStart® Nutrients

Works great in container grown nursery plants and is commonly used in landscape containers and flower beds. The quickstart portion of the blend helps the plants in newly planted flower beds and containers establish and fill in quickly. The 100% resin-coated nutrient cores take in moisture and slowly feed the plants for up to 6 months.

- For use on: Nurseries, landscape containers and flower beds
- Resin-coated N-P-K
- STEP Hi-Mag micronutrients
- Quickstart



5-6 Month Release Fertilizer

50lb

EVRE98620

Min. Buy 1 EA



8-9 Month Release Fertilizer

50lb

EVRE98605

Min. Buy 1 EA



Osmocote® Blend 23-4-8 Fertilizer Enhanced with both E-Max Technology™ & QuickStart®

The addition of the E-Max Coated urea allows for an enhanced release of Nitrogen earlier in the growth cycle that will support the quick-growing plants and get them up to size sooner. The resin-coated N-P-K backbone takes over and gently feeds the plants until they finish growing. It contains urea, not recommend its use in covered greenhouse production.

- For use on: Nursery stock, foliage and in landscape
- Resin-coated N-P-K
- STEP Hi-Mag micronutrients
- E-Max Coated Urea



5-6 Month Fertilizer

50lb

EVRE90249

Min. Buy 1 EA



8-9 Month Fertilizer

50lb

EVRE90250

Min. Buy 1 EA



WARNING: This product is not available for sale in CA. For most up to date information please visit bfgsupply.com



Controlled Release Fertilizer

Osmocote® Blend 22-3-8 5-6mo. Fertilizer Enhanced with QuickStart® Nutrients

A popular general purpose product as an inexpensive base fertilizer mixed into the media or topdressed onto nursery containers. Fast-growing perennials, grasses and foliage plants respond very well to this formulation. It also make a versatile topdress for overwintered plants once they have been uncovered or lined out in the nursery. Another popular use is on container-grown conifers.

- For use on: Nursery stock, foliage and in landscape
- Resin-coated N-P-K
- Poly-S coated Urea
- Poly-S coated Nitrogen
- STEP Hi-Mag micronutrients



**50lb (40/PL)
EVRE90152**

Min. Buy 1 EA



Osmocote® Blend Fertilizers by ICL Specialty Fertilizers®

This selection of products include blends of various fertilizer technologies designed to meet specific growing needs. Some are designed to be used in greenhouse production, some in nurseries, a couple that stick to the surface of the pot and stay put if the fall over and some are quick responding topdress products. All our blends are high quality performers.

Controlled Release

- Blended product – may contain coated, uncoated and/or slow release components
- Now available: blends with 100% coated, homogeneous N-P-K prills – no Urea
- Added micronutrients
- Specified longevity of N-P-K
- Designed for general nursery production and outdoor applications. Can be incorporated or surface applied.
- Osmocote Pro controlled release fertilizer delivers dependable, safe performance for a good cost-in-use value.



Osmocote® Blend 18-5-8 Fertilizer Enhanced with E-Max Technology™

Latest blended formulation which combines our Osmocote 100% resin coat prills with our newest E-max polymer coated technologies. Micronutrients are derived from multiple sources to provide a starter charge and two different controlled release coated forms for sustained delivery throughout the predefined product release period. Great when growing with high alkalinity irrigation water.

- For use on: Greenhouse, Nurseries, and Landscape
- Resin-coated N-P-K
- Micromax
- 18% Nitrogen
- High Sulfur



3-4 Month Release Fertilizer

**50lb
ICL90175**

Min. Buy 1 EA



5-6 Month Release Fertilizer

**50lb
ICL90176**

Min. Buy 1 EA



8-9 Month Release Fertilizer

**50lb
ICL90177**

Min. Buy 1 EA



Osmocote® Blend 17-5-11 Fertilizer

Generally blended into the growing media, but it can be topdressed in the pot, subdressed or dibbled. It is recommended that the pot is thoroughly watered before or directly after planting to release the minor nutrients from the Micromax granules and disperse it into the media. This product is widely used as a single source of nutrients in both greenhouses and nursery container grown plants.

- For use on: Greenhouse, nursery and landscape
- Resin-coated N-P-K
- Micromax
- No urea



3-4 Month Release Fertilizer

**50lb
EVRE90179**

Min. Buy 1 EA



5-6 Month Release Fertilizer

**50lb
EVRE90180**

Min. Buy 1 EA



8-9 Month Release Fertilizer

**50lb
EVRE90181**

Min. Buy 1 EA



Controlled Release Fertilizer

Osmocote® Blend Topdress Special 22-5-6 4-5mo Fertilizer Enhanced with QuickStart® Micronutrients

Is a great topdress in cooler weather. The response after application to this product is not immediate, but it is able to hold color and boost the plant earlier in the season compared with coated fertilizers. The Poly-S® extends the Nitrogen release out to 4 to 5 months. The most common applications of this topdress are on conifers, perennials and grasses.

- For use on: Nursery stock, foliage and in landscape
- Poly-S
- IBDU
- Phosphorous
- STEP Hi-Mag micronutrients



50lb (40/PL)

EVRE90174

Min. Buy 1 EA



Osmocote® Blend Fertilizers by ICL Specialty Fertilizers®

This selection of products include blends of various fertilizer technologies designed to meet specific growing needs. Some are designed to be used in greenhouse production, some in nurseries, a couple that stick to the surface of the pot and stay put if the fall over and some are quick responding topdress products. All our blends are high quality performers.

Controlled Release

- Blended product – may contain coated, uncoated and/or slow release components
- Now available: blends with 100% coated, homogeneous N-P-K prills – no Urea
- Added micronutrients
- Specified longevity of N-P-K
- Designed for general nursery production and outdoor applications. Can be incorporated or surface applied.
- Osmocote Pro controlled release fertilizer delivers dependable, safe performance for a good cost-in-use value.

Osmocote® Blend 19-5-8 8-9mo. Fertilizer

Used in outside container nurseries as a multi-purpose fertilizer. It is used on a wide variety of plants that are grown in bark mixes. Nursery stock and foliage plants do well with this blend. It is also used in landscapes beds and in large outdoor containers.

- For use on: Nursery stock, foliage and in landscape
- Resin-coated N-P-K
- Poly-S coated Urea
- STEP Hi-Mag micronutrients



50lb (40/PL)

EVRE901316

Min. Buy 1 EA



Osmocote® Blend 20-4-7 8-9mo. Fertilizer with Fusion Technology™

Is intended to be topdressed in arc-shaped piles on the surface of the media away from the plant's stem. Putting it on in a thicker pile, helps the Fusion Technology® bind the fertilizer to the surface. The intended use is on trees that have been grown in the pot for a while, so the media is filled with roots and is stable. The fertilizer portion is formulated to give the plant a quick boost.

- For use on: Nurseries
- Fusion Technology
- QuickStart
- Resin-coated N-P-K
- STEP Hi-Mag micronutrients



50lb (40/PL)

EVRE99410

Min. Buy 1 EA



Osmocote® Blend Topdress Special 12-6-8 2-3Mo Fertilizer Enhanced with E-Max Technology™ & QuickStart® Micronutrients

Primarily intended to be surface applied to established plants to provide a quick green up to chlorotic plants or feed for a short period of time. Can also be used to provide a quick burst of late summer fertilization that will run out before plants go dormant as weather cools. This product is not recommended for use in covered production areas or in propagation.

- For use on: Nursery stock, foliage and in landscape
- E-Max Coated Urea
- Soluble Nitrogen, Phosphorous and Potassium
- STEP Hi-Mag micronutrients



50lb (40/PL)

EVRE90280

Min. Buy 1 EA

Osmocote® Blend 19-6-9 5-6mo. Fertilizer with Fusion Technology™

Is intended to be topdressed in arc-shaped piles on the surface of the media away from the plant's stem. Putting it on in a thicker pile, helps the Fusion Technology® bind the fertilizer to the surface. The intended use is on trees that have been grown in the pot for a while, so the media is filled with roots and is stable. The fertilizer portion is formulated to give the plant a quick boost.

- For use on: Nurseries
- Fusion Technology
- QuickStart
- Resin-coated N-P-K
- STEP Hi-Mag micronutrients



50lb (40/PL)

EVRE99400

Min. Buy 1 EA



Osmocote® Blend 20-4-8 8-9mo. Fertilizer

Is used in outside container nurseries, foliage plants, and landscapes as a multi-purpose fertilizer. It does well when used on a wide variety of plants that are grown in bark mixes. The IBDU starts the earliest in the cool season. The Poly-S® in this formulation releases a bit stronger push of Nitrogen in the earlier stages of the re-lease period and the resin-coated fertilizer continues the feed.

- For use on: Nursery stock, foliage and in landscape
- Resin-coated N-P-K
- Poly-S coated Urea
- IBDU
- STEP Hi-Mag micronutrients



50lb (40/PL)

EVRE90170

Min. Buy 1 EA





Controlled Release Fertilizer

Osmocote® Bloom 12-7-18 2-3mo.

Contains a complete package of N-P-K, blended with magnesium and essential micronutrients encouraging faster, stronger root development, resulting in more compact, consistently sized plants. This provides more nutrition to the plant and not down the drain. This smaller size provides better uniformity and even distribution of nutrition in smaller containers, optimizing plant utilization.

- For use on: Plants grown in smaller containers
- N-P-K
- Coated Micronutrients



50lb (40/PL)

EVRE90100 Min. Buy 1 EA

50lb (40/PL)

EVRE90102 Min. Buy 1 EA



The power of Osmocote—right at your fingertips

Download the *Osmocote Explorer Mobile App* and get the product and rate information you need faster and easier than ever.

Agriform® 20-10-5 Planting Tablets Plus Minors

Two-year planting tablets for root zone feeding of trees, shrubs and ground covers. Contains a high-nitrogen formula specifically engineered to help deliver bigger, greener plants.



5g Tablets - 2,100ct (80/PL)

EV90915 Min. Buy 1 CS

Other Info

10g Tablets - 1000ct (80/PL)

EVRE90805 Min. Buy 1 CS

Other Info

21g Tablets - 500ct (80/PL)

EVRE90026 Min. Buy 1 CS

Other Info



Controlled Release Fertilizer

Item #	Size/ # Per Pallet	Brand	Formulation	Release Months @ 70° F	Application	Micros
EVRE903206	50 Lb (40/PI)	Osmocote Plus	15-9-12	3-4	Top Dress/Media Incorporation	Coated
EVRE903226				5-6		
EVRE903266				8-9		
EVRE903246	50 Lb (40/PI)	Osmocote Plus	15-9-12	8-9	Top Dress/Media Incorporation	Coated
EVRE90583	50 Lb (40/PI)	Osmocote Plus Lo-Start	15-9-12	8-9	Top Dress/Media Incorporation	Coated
EVRE90336	1000/Cs (80/PI)	Osmocote Plus 7.5G Tablets	15-8-11	8-9	Insertion Into Media	Coated
EVRE90100	50 Lb (40/PI)	Osmocote Bloom	12-7-18	2-3	Top Dress/Media Incorporation	Coated
EVRE90550	50 Lb (40/PI)	Osmocote	14-14-14	3-4	Top Dress/Media Incorporation	No
EVRE90555	50 Lb (40/PI)	Osmocote Lo-Start	18-6-12	8-9	Top Dress/Media Incorporation	No
ICL90175	50 Lb (40/PI)	Osmocote Blend	18-5-8	3-4	Top Dress/Media Incorporation	Coated & Granular
ICL90176				5-6		
ICL90177				8-9		
EVRE90179	50 Lb (40/PI)	Osmocote Blend	17-5-11	3-4	Top Dress/Media Incorporation	Yes
EVRE90180				5-6		
EVRE90181				8-9		
EVRE90170	50 Lb (40/PI)	Osmocote Blend	20-4-8	8-9	Top Dress/Media Incorporation	Yes
EVRE90152	50 Lb (40/PI)	Osmocote Blend	22-3-8	5-6	Top Dress/Media Incorporation	Yes
EVRE901316	50 Lb (40/PI)	Osmocote Blend	19-5-8	8-9	Top Dress/Media Incorporation	Yes
EVRE90249	50 Lb (40/PI)	Osmocote Blend	23-4-8	5-6	Top Dress/Media Incorporation	Yes
EVRE90250				8-9		
EVRE98620	50 Lb (40/PI)	Osmocote Blend w/ Quickstart	18-5-12	5-6	Top Dress/Media Incorporation	Yes
EVRE98605				8-9		
EVRE99400	50 Lb (40/PI)	Osmocote Blend w/ Fusion	19-6-9	5-6	Top Dress	Yes
EVRE99410	50 Lb (40/PI)	Osmocote Blend w/ Fusion	20-4-7	8-9	Top Dress	Yes
EVRE90174	50 Lb (40/PI)	Osmocote Blend Topdress	22-5-6	4-5 (N only)	Top Dress	Yes
EVR90915	2100/Cs (80/PI)	Agriform 5G Tablets	20-10-5	Up to 2 Years	Insertion Into Soil	Yes
EVRE90805	1000/Cs (80/PI)	Agriform 10G Tablets				
EVRE90026	500/Cs (80/PI)	Agriform 21G Tablets				



WARNING: This product is not available for sale in CA.
For most up to date information please visit bfgsupply.com



Controlled Release Fertilizer

Green-house Crops	Outdoor Potted Crops	In-ground Production	Land-scapes	Interior-scapes	Comments
4"+ Pots, Baskets	Yes	Yes	Yes	Yes	Great for greenhouse crops at lower rates with or without supplemental Peters WSF.
4"+ Pots, Baskets	Yes	Yes	Yes	Yes	Lo-Start pattern release. Commonly used in propagation and when planting stock to be overwintered. Helps maintain low salt levels during storage and rooting.
4"+ Pots, Baskets	Yes	Yes	Yes	Yes	Hi-Start pattern release distributes more fertilizer earlier in the growth cycle.
Qt+ Pots, Baskets	Yes	Yes	Yes	Yes	Easy to apply. Add to containers at the point of sale for several months of ongoing fertilization.
4"-12" Pots	Yes	Yes	Yes	Yes	For small container plants with a production time of 6-12 weeks. Prill size is 1/5 standard Osmocote—more prills per gram for better distribution in small containers.
4"+ Pots, Baskets	Yes	Yes	Yes	Yes	Excellent for a wide variety of crops with micronutrient supplementation from Micromax or Peters WSF.
No	Yes	No	No	No	Used with woody plants and perennials to be propagated or overwintered. Needs to be supplemented with micros.
4"+ Pots, Baskets	Yes	Yes	Yes	Yes	Our best blend—great for crops prone to chlorosis and environments with high alkalinity irrigation water, or high media pH.
4"+ Pots, Baskets	Yes	Yes	Yes	Yes	Safe, reliable formulation contains homogenous NPK resin-coated CRF blended with Micromax micronutrients.
No	Yes	Yes	Yes	No	Multi-purpose fertilizer ideal for use on a wide variety of plants grown in bark mixes.
No	Yes	Yes	Yes	No	General purpose product commonly used as base fertilizer mix or topdressed in nursery containers. Great for fast-growing perennials, grasses and foliage plants.
No	Yes	Yes	Yes	No	Multi-purpose product formulated for use in outside container nurseries. Can be used on a wide variety of plants grown in bark mixes.
No	Yes	Yes	Yes	No	For general purpose production of nursery stock, foliage and landscapes. Great for second year topdress applications.
No	Yes	Yes	Yes	No	Quick Start formulation provides fast initial release for quick green-up. Coated prills continue to release as crop matures.
No	Yes	No	No	No	Fusion bonding technology prevents loss of CRF on outdoor potted crops exposed to high winds and tip-overs.
No	Yes	No	No	No	Fusion bonding technology prevents loss of CRF on outdoor potted crops exposed to high winds and tip-overs.
No	Yes	Yes	Yes	No	Cool weather topdress for use on conifers, perennials and grasses. Works well on ground covers, perennials and shrubs.
No	No	Yes	Yes	No	Complete plant nutrition program feeds trees, shrubs and ground covers for up to two years. Compact, easy-to-use tablets eliminate the need for repeated fertilizer applications.
				Yes	
				Yes	





PART OF THE
PROFILE PRODUCTS FAMILY

Controlled Release Fertilizer

GAL-XeONE® Controlled Release Fertilizer

GAL-XEONE® is a controlled-release fertilizer with a new, advanced polymer coating technology. It delivers optimal nutrients to the plant at a daily rate that matches a plant's uptake requirements.

GAL-XEONE® reactive layer coating was created with support from NASA. It allows water to seep into the prill and then carry the nutrients out through a semi-permeable membrane and into the soil.

Benefits

- Nutrient availability to match a plant's uptake pattern
- Controlled nutrient release from 2 months to 18 months
- Reduced losses from volatilization and leaching
- Reduced labor and logistics costs from fewer applications

Florikan® Gal-XeOne® 12-4-11 Advantage Fertilizer Is

designed specifically for nursery operations specializing in crops desiring long term calcium. With a unique level of polymer coated calcium nitrate, it will provide the essential nutrients for the entire crop cycle. The balanced nitrogen and potassium along with low phosphorus to reduce plant stretch makes it ideal for crops striving on calcium.

- For use on: Boxwood, hydrangea, roses, perennials, flowering ornamentals, young trees, tomato citrus and hydroponics
- 100% Polymer Coated NPK plus Micronutrients
- Contains Florikan Polymer Coated Calcium Nitrate
- Very High Rate of Nitrate Nitrogen for Readily Available Nitrogen

100 Day Release



50lb (40/PL)

FLOR12-4-11-100 Min. Buy 1 EA



180 Day Release



50lb (40/PL)

FLOR12-4-11-180 Min. Buy 1 EA

Florikan® Gal-XeOne® 17-5-11 NPK Plus Fertilizer

Is a 100% polymer coated fertilizer providing the grower a complete nutritional program. Each longevity is designed to provide plant nutrients from the beginning to end of the crop cycle.

- For use on: Trees, flowering ornamentals, woody ornamental, perennials, ferns, greenhouse, ground cover, mum and hanging baskets
- Total Fertilizer Containing NPK and Micronutrients
- 100% Polymer Coated Fertilizer
- Coating Technology Provides Predictable Release
- No Urea

140 Day Release



50lb (40/PL)

FLOR17-5-11-140 Min. Buy 1 EA



180 Day Release



50lb (40/PL)

FLOR17-5-11-180 Min. Buy 1 EA

Florikan® Gal-XeOne® 14-14-14 NPK Fertilizer - 90 Day Release

GAL-XeONE™ is a controlled-release fertilizer with an advanced polymer coating technology. It delivers optimal nutrients to the plant at a pace that matches a plant's uptake requirements. Provides gradual release of plant nutrients to match a plant's growth cycle as needed. It improves efficiency, limits plant damage and reduces nutrient loss.



50lb (40/PL)

FLOR14-14-14-090 Min. Buy 1 EA



Florikan® Gal-XeOne® 16-5-11 NANO™ Advantage Fertilizer - 90 Day Release

Is a controlled-release fertilizer with an advanced polymer coating technology. It delivers optimal nutrients to the plant at a pace that matches a plant's uptake requirements. Provides gradual release of plant nutrients to match a plant's growth cycle as needed. It improves efficiency, limits plant damage and reduces nutrient loss.



50lb (40/PL)

FLOR16-5-11-090-NANO Min. Buy 1 EA



Florikan® Gal-XeOne® 18-5-12 Top-dress Fertilizer - 140 Day Release

Is a polymer coated and granular blended fertilizer providing the grower a complete nutritional package with an up front start maximizing grow time. The product is designed to provide essential plant nutrients from the beginning to the end of the crop cycle.

- For use on: Premium Ornamentals, flowering shrubs, flowering trees, ferns, ground cover, perennials, ornamentals grasses, deciduous shrubs and trees
- Complete Fertilizer Containing NPK Plus Micronutrients
- Homogeneous Micronutrient Package Including Chelated Iron
- Polymer Coated Nutrients Provides a Predictable Release



50lb (40/PL)

FLOR18-5-12-140-NV Min. Buy 1 EA



Florikan® 12-6-8 NPK Pro Fertilizer

Is a blend of controlled release fertilizer and granular fertilizer that provides macro-nutrients for the majority of container or field grown crops. Additional micro-nutrients are provided in the blend to help adjust for deficiencies. Is excellent as a kicker/starter, maintenance feed or finisher providing a quick green up.

- For use on: Ixora, Hibiscus, Gardenia, Ornamental Grass, Madevilla, Palms, Bougainvillea, Clusia and Landscape Shrubs
- Nitrogen in Granular and Coated Form
- Innovative GAL-XeONE Coated N Provides Predictable Release
- Coated and Uncoated NPK and Homogeneous Micronutrients

90 Day Release



50lb

FLOR12-6-8-090 Min. Buy 1 EA



90 Day Release with Fast Start



50lb

FLOR12-6-8-090-FS Min. Buy 1 EA



WARNING: This product is not available for sale in CA. For most up to date information please visit bfgsupply.com



PART OF THE
PROFILE PRODUCTS FAMILY

Product	% Coated	N	Nirate	Ammoniacal N	Urea	Insoluble N	P	K	Ca	Mg	S	B	Cu	Fe	Chelated Fe	Mn	Mo	Zn
12-4-11 180-Day	100%	12%	7.50%	4.50%			4%	11%	5.50%	1.14%	3%		0.046%	0.44%	0.34%	0.045%		0.03%
12-4-11 100-Day	100%	12%	7.50%	4.50%			4%	11%	5.50%	1.14%	3%		0.046%	0.44%	0.34%	0.045%		0.03%
12-6-8 90-Day	10%	12%		2.30%	6.70%	3%	6%	8%	4.10%	3.80%	10%		0.1%	3.40%		0.650%		0.14%
12-6-8 90-Day Fast Start	22%	12%		3.60%	7.70%	0.70%	6%	8%		2.90%			0.05%	2%	0.08%	0.09%		0.05%
14-14-14 90-Day	100%	14%	5.90%	8.10%			14%	14%			5.50%							
16-5-11 90-Day Nano	100%	16%	7.50%	8.50%			5%	11%		1.20%	6%		0.05%	0.6%		0.1%		0.05%
17-5-11 140-Day	100%	17%	8%	9%			5%	11%		1%	5.50%			0.5%	0.34%	0.050%		0.05%
17-5-11 180-Day	100%	17%	8%	9%			5%	11%		1%	5.50%			0.5%	0.34%	0.050%		0.05%
Max	0%	0%					0%	0%		14%	7.60%	0.02%	0.680%	17.81%	1.43%	1.33%	0.190%	0.02%
Sapphire Coated Aluminum Sulfate	100%	0%					0%	0%			12%							
Iron Sulfate 180-Day	100%										17%			28%				





Controlled Release Fertilizer

Nutricote® Total Control Released Fertilizer with Minor Nutrients

Blends of Nutricote Total controlled release homogenous fertilizers with minor nutrients for nursery and greenhouse uses.

Every particle is homogenous, coated with a unique pliable resin that allows very predictable release rates.

Release period is specified by TYPE. A Type 100 means it will release over a period of 100 days at 77°F. Warmer temperatures will shorten release time and cooler temperatures will extend release time.

- Nutricote NPK = Slow release fertilizer containing NPK only
• Nutricote Total = our slow release fertilizer containing NPK and minor/micro nutrients.
• Nutricote Total Blends = a blend of at least 2 different "Nutricote Totals".

Nutricote® Total 18-6-8 Fertilizer with Minors

A blend of nutricote controlled release fertilizer with minor nutrients for nursery and greenhouse uses. Every particle is homogenous, meaning N, P, K and minor nutrients are contained in each individual prill. Nutricote's coating is a pliable resin that provides very predictable release rates. Warmer temperatures will shorten release time and cooler temperatures will extend release time.



T140

50lb (40/PL)

AGRVTOTAL 18-6-8 T140 Min. Buy 1 EA

T180

50lb

AGRV14-2380 Min. Buy 1 EA

Nutricote® NPK 14-13-13 Fertilizer

A blend of nutricote controlled release fertilizer for nursery and greenhouse uses. Every particle is homogenous, meaning N, P, K nutrients are contained in each individual prill. Nutricote's coating is a pliable resin that provides very predictable release rates. Warmer temperatures will shorten release time and cooler temperatures will extend release time. NPK only; no micronutrients.



T100

50lb (40/PL)

AGRVNPK 14-13-13 T100 Min. Buy 1 EA

T140

50lb (40/PL)

AGRVNPK 14-13-13 T140 Min. Buy 1 EA

Nutricote® Total 13-11-11 Fertilizer with Minors

A blend of nutricote controlled release fertilizer with minor nutrients for nursery and greenhouse uses. Every particle is homogenous, meaning N, P, K and minor nutrients are contained in each individual prill. Nutricote's coating is a pliable resin that provides very predictable release rates. Warmer temperatures will shorten release time and cooler temperatures will extend release time.



T100

50lb

AGRVTOTAL131111T100 Min. Buy 1 EA

T140

50lb

AGRVTOTAL131111T140 Min. Buy 1 EA

T180

50lb

AGRVTOTAL131111T180 Min. Buy 1 EA





Controlled Release Fertilizer

Sustane® 4-6-4 All-Purpose Fertilizer

A natural organic all purpose professional landscape fertilizer. For plant establishment, greenhouse and nursery growing and organic crop production. Adds approximately 10% humates by volume and increases the nutrient and water holding capacity of the soil. Also strengthens plants tolerance against hot dry conditions, provides greater root development, improves buffering against changes in soil pH.

- For use on: Landscaped areas, overseeding and turf establishment, certified organic crops, rapid vegetative establishment
- OMRI Listed



50lb (40/PL) - OMRI Listed®

SNF30201111 Min. Buy 1 EA



Sustane® 8-2-4 All Natural Fertilizer

Provides 6 - 12 weeks of nitrogen in the organic slow release form. Sustane replenishes the soil with a rich supply of humus (stabilized organic matter) and all of the essential nutrients required for quality growth. Also provides a combination of plant nutrients and organic substances derived from biologically stable compost plus natural sulfate of potash and feather meal.

- For use on: Certified organic crops, turfgrass and landscape maintenance, greenhouse bedding plants and annual establishment
- OMRI Listed
- Rich in humic acids



50lb (40/PL) - OMRI Listed®

SNF30551111 Min. Buy 1 EA



Sustane® 16-4-8 Fertilizer

Was developed as a combination fertilizer to provide nursery stock with a time released 4-1-2 nutrient package blended with a 50% Sustane humus rich, premium organic base. Derived from aerobically composted turkey litter, polymer coated urea, polymer coated MAP, and polymer coated potassium nitrate.

- For use on: Perennials and Woody ornamentals Azalea, Holly, Weigelia, Crape Myrtle, Cotoneaster, Boxwood, Spiraea, Salvia, Hibiscus, and Daylily.
- Rich in humic acids
- Strengthens plants tolerance against hot dry conditions



120 Day Release

50lb (40/PL)

SNF50551111 Min. Buy 1 EA



180 Day Release

50lb (40/PL)

SNF50501111 Min. Buy 1 EA



Sustane® 12-12-12 Controlled Release Fertilizer - 90 Day Release

Developed as a combination fertilizer to provide all floral and nursery stock with a complete, balanced and controlled release nutrient package. Provides plant essential nutrients in both controlled release and slow release organic form by combining coated CRF with nutrient rich aerobically composted turkey litter.

- For use on: Production of bedding plants other short term annuals, Begonias, Petunias, Impatiens, Geraniums, Caladiums, Chrysanthemums, herbs and vegetable crops
- Rich in humic acids
- Strengthens plants tolerance against hot dry conditions



50lb (40/PL)

SNF50451111 Min. Buy 1 EA



Sustane® 18-1-8 +Fe Topdress Fertilizer - 90 Day Release

Is a two-part blend combining Sustane organic with four-way release of nitrogen for enhanced and long lasting color. The most economical coverage of any organic based fertilizer.

- For use on: golf course fairways and roughs, lawns, and sports fields
- Combines 4 different forms of nitrogen: 3 types of slow release including Sustane organic N, PCSCU, methylene urea and 1 form of quick release nitrogen from ammonium sulfate.
- 15.3% (85% of total N) is slow release nitrogen



50lb (40/PL)

SNF40901111 Min. Buy 1 EA



Sustane® Root Zone 4-6-4 Feeder Pak Fertilizer

This permeable fertilizer pack can be left to steep in a watering can overnight to make a Compost Tea brew for topical application; or installed in the soil or potting mix as a Root Zone Feeder Pack. Sustane 4-6-4 Root Zone Feeder Packs provide single dose applications of Sustane organic slow release nitrogen fertilizer. Sustane Feeder Packs are designed to provide lasting plant nutrition.

- For use on: all flowers, trees, shrubs and perennial plantings including landscape areas, potted plants and hanging baskets
- Assures controlled dose applications
- Made from Sustane nutrient dense compost based fertilizer



250ct - 21g Packs

SNF80202020 Min. Buy 1 CS



Sustane® Root Zone 16-4-8 Feeder Pak Fertilizer

Sustane 16-4-8 Root Zone Feeder Paks provide single dose applications of Sustane Organic + CRF designed to provide long-lasting plant nutrition in a completely biodegradable paper filter pack. This product is designed to provide a continuous release of nutrients for up to 8 months at 70° F (23° C) soil temperature.

- For use on: all flowers, trees, shrubs and perennial plantings including landscape areas, potted plants and hanging baskets
- 50% Sustane All Natural Compost Based Fertilizer
- 50% coated 6-month Controlled Release Fertilizer



250ct - 21g Packs

SNF80502020 Min. Buy 1 CS



Liquid

Nature's Source Organic[®] Plant Food 3-1-1

Organic liquid fertilizer that provides consistent toned growth and for quick green-up when needed, providing sustainability in your organic greenhouse, nursery or farm. Promotes rapid nutrient response and hearty plant growth.

- Organic



4.7gal (40/PL)

DANL7546US

Min. Buy 1 EA



Nature's Source[®] 10-4-3 Professional Plant Food

Nature's Source Professional 10-4-3 is sustainable in that it contains oilseed extract, a renewable source of plant nutrition. It's easier on plants in that it's lower in salts than most commonly used water-soluble fertilizers and can be used as a foliar mist without burning or stretch. It's versatile and can be direct injected by pulling it straight from the container or easily diluted even in cold water.



Twin Pack - 2.5gal

DANL7548US

Min. Buy 1 CS

4.7gal (40/PL)

DANL7510US

Min. Buy 1 EA

55gal Drum (4/PL)

DANL7547US

Min. Buy 1 EA



Liquid

CalOx[®] FT 8-0-0

CalOx FT is an advanced liquid nutritional and crop enhancement product for a wide range of agricultural and horticultural crops. CalOx FT optimizes overall plant growth and development, plus bolsters yield and quality.

- Improves calcium mobility with more uniform distribution
- Active ingredient: Calcium and Nitrogen
- Systemic response with elevated calcium concentration in cells
- Provides better storage and shelf life



1gal Bottle

BSF45001

Min. Buy 1 EA

2.5gal - Bottle

BSF450025

Min. Buy 1 EA



WARNING: This product is not available for sale in CA.
For most up to date information please visit bfgsupply.com



Liquid

BioAg Bio-SuperSil Supplement

Bio-SuperSil™ is a soluble liquid that provides beneficial silicon and should be used as part of a complete fertilizer program. It is a unique and proprietary formulation which uses non-ionic, nanostructured silica, which is silica containing at least one external dimension between 1 to 100 nm. Recommended for use in pivot or drip fertigation, with foliar sprays, at planting, and in hydroponic systems.



1gal
BAGBIO0001 **Min. Buy 4 EA**

2.5gal
BAGBIO0002 **Min. Buy 1 EA**

5gal
BAGBIO0005 **Min. Buy 1 EA**



BioAG Ful-Power®

Purified fulvic acid made via a special enzymatic reaction. Works in all pH ranges and all systems. Clean and Powerful! Improves plant biological functions from roots to flowers to fruits. Best use: great for hydro/aeroponics, foliar and soils. Use a little all the time, from seeds, cutting throughout flush/harvest! OMRI Listed®



32oz (1qt)
BAGBA70004 **Min. Buy 12 EA**

1gal
BAGBA70010 **Min. Buy 4 EA**

2.5gal
BAGBA70025 **Min. Buy 1 EA**

5gal
BAGBA70050 **Min. Buy 1 EA**



Micronutrients

Sprint® 138 6% EDDHA Iron Chelate

Sprint® 138 is a 6% DTPA chelated iron micronutrient that can be applied as a soil application or as a foliar spray to correct iron deficiencies. It prevents iron from binding with other compounds in the soil, allowing it to stay in a form readily available for plants and turfs to use. One of the strongest chelates available for the most challenging alkaline or calcareous soils.

- For correction of iron deficiency in alkaline and calcareous soils. Can be used in nurseries, gardens, landscape planting and turf.
- Rate: Varies depending on application method.
- 6% fully chelated EDDHA iron for the most challenging alkaline soil.



5lb
BAS59013436 **Min. Buy 1 EA**



Sprint® 330 10% DTPA Iron Chelate

A 10% DTPA chelated iron micronutrient that can be applied as a soil application or as a foliar spray to correct iron deficiencies. Provides an iron source that is readily available to plants, even at higher than ideal soil pH.

- For correction of iron deficiency in slightly acid to slightly alkaline soils. Can be used in nurseries, gardens, landscape planting and turf.
- Rate: Varies depending on application method.
- Prevents iron from binding with other compounds in the soil, allowing it to stay in a form readily available for plant and turf use.



5lb
BAS59013439 **Min. Buy 1 EA**

50lb
BAS59013097 **Min. Buy 1 EA**





Micronutrients

ON-Gard® 5-0-0 Fertilizer

ON-Gard is a 100% plant derived fertilizer that increases stress tolerance, increases growth and enhances nutrient uptake and overall absorption. It is suitable for all plants. OMRI listed®.

- Active ingredient: Nitrogen and Soy Protein
- Rate: 16 to 64 oz per acre
- Supports a robust plant



2.5gal

BW1FR102A24 **Min. Buy 1 EA**
 Other Info *SHIPS DIRECT*



ON-Gard® Calcium Fertilizer

ON-Gard® Calcium is an organic liquid calcium formulated with plant derived soy protein hydrolysate for the treatment and prevention of calcium deficiency in crops.

- Active ingredient: Calcium Chloride and Soy Protein
- Rate: 8 to 16 oz per 100 gal
- Prevents calcium deficiencies



2.5gal

BW1FR110A24 **Min. Buy 1 EA**



Micronutrients

BioAG Cytoplus™

Give your plants all the benefits of kelp and micronutrients in an enhanced formula. Concentrated humic/fulvic powder has been added for increased absorption and efficacy. Best to use during key transitional periods such as growing from vegetative to bloom.



300g

BAGBA76003 **Min. Buy 12 EA**



BioAG Ful-Humix®

Concentrated Humic/Fulvic Soluble Powder. 1# of Ful-Humix = 1 - 2 gallons of competitors liquid. Improves soil nutrient retention and uptake for strong, healthy plants. Best use; throughout growing cycle indoor/outdoor soils. OMRI Listed®



300g - OMRI Listed®

BAGBA72003 **Min. Buy 12 EA**

1kgs - OMRI Listed®

BAGBA72022 **Min. Buy 4 EA**



BioAG TM-7™

TM-7™ contains seven micronutrients critical for plant success, plus concentrated humic/fulvic powder for increased absorption and efficacy. Best to use throughout the season. Use in indoor or outdoor soil, and with or without compost tea.



300g

BAGBA74003 **Min. Buy 12 EA**



BioAG VAM Endo-Mix™

VAM Endo-Mix™ is a blend of endomycorrhizal fungi. In nature these fungi form symbiotic relationships with plant roots; increasing the plants ability to access water and nutrients in the soil system. This blend was designed to cover a wide array of plants that are compatible with the endomycorrhizal fungi. The fungi are mixed with humic acids as a start-up food source.



300g

BAGBA78003 **Min. Buy 12 EA**



BRANDT®

florikan CRF



 PART OF THE
 PROFILE PRODUCTS FAMILY

Micronutrients

BRANDT® Sequestar Iron Chelate 6% Fe EDDHA

Sequestar is a water soluble form of iron EDDHA that is readily available to plants. It can be applied to prevent or correct iron deficiency. Sequestar can be used on vegetable crops, vine and berry crops, fruit and nut trees, and ornamental shrubs, bedding plants and groundcovers.

- For correction of iron deficiency in alkaline and calcareous soils. Can be used in nurseries, gardens, landscape planting and turf.
- Prevents iron from binding with other compounds in the soil, allowing it to stay in a form readily available for plant and turf use.
- Rate: Varies depending on application method.



CA Prop65 Warning

5lb
BRANDT2955-01-050 Min. Buy 1 EA

25lb
BRANDT2955-01-025 Min. Buy 1 EA

BRANDT® Sequestar® 7.5% Cu EDTA liquid

BRANDT SEQUESTAR 7.5% Cu is a fully chelated solution recommended for the prevention and/or correction of copper deficiency in all crops when used as a part of a balanced fertility program.

- Liquid EDTA Chelated Micronutrient
- Active Ingredient: 7.5% Chelated Copper
- Signal Word: Warning
- Rate: varies according to application. See Label



CA Prop65 Warning

2.5gal
BRANDT22021BRN100

Min. Buy 1 EA

Micronutrients

Florikan® Iron 28% - 180 Day Release

Designed to reduce soil Ph over an extended period of time, while providing the essential elements of iron and sulfur.

- Contains: 28% Ferrous Sulfate

50lb (40/PL)
FLORFE-SO4-180

Min. Buy 1 EA

Florikan® Max Micronutrients

Features homogenous micronutrient package, 8 essential minerals for plant growth. For uniform homogenous prill to aid in distribution, multiple forms of iron and magnesium for green color and formulated for better color even under challenging Ph conditions. Includes chelate, sulfate, and succrate forms for better adsorption across a wider range of ph.

50lb (40/PL)
FLOR-MAX

Min. Buy 1 EA



Florikan® Sapphire Aluminum Sulfate

Is designed to increase the development of the blue flower color in blue Hydrangeas. Florikan's patented polymer coating technology sustains the release of nutrients to reduce the potential nutrient runoff and leaching into the environment. The controlled release technology also reduces the need for multiple applications..

- For use on: Hydrangeas

50lb (40/PL)
FLORAL-SO4-090

Min. Buy 1 EA



Micronutrients

Blue Max™ Coated Aluminum Sulfate

Specially formulated for use in the production of blue variety Hydrangeas. Blue-Max shines in helping maintain the growing media pH in an acceptable range for the plant to take up Aluminum and store it in the buds. Providing a steady supply of Aluminum and aiding in keeping the root zone at the proper pH is exactly what is needed to produce blue flowers.

- For use on: Hydrangea flowers
- E-Max Release



50lb (40/PL)

EVRE90191

Min. Buy 1 EA



Micromax® Micronutrients Fertilizer

Micromax granular formulation is designed to increase the efficiency of the major nutrient program and to maximize plant growth by boosting micronutrient levels in the root zone.



50lb (40/PL)

EVRE90505

Min. Buy 1 EA



Peters® Professional S.T.E.M. Soluble Micronutrients

A fully water soluble fertilizer and broad spectrum minor element product that is ideal for "quick fixes" on ornamental plants. Can be used for corrective purposes on micronutrient deficient crops. It can also be applied as a remedial foliar spray on ornamental plants like: potted tropical foliage, flowering plants, cut flowers and orchids.



25lb (80/PL)

EV99900

Min. Buy 1 EA



Peters® S.T.E.M. Fertilizer

Ready-to-mix liquid formulation. Goes from the jug to the tank in one easy step with no solubility issues. This fertilizer and broad-spectrum minor element product is ideal for "quick fixes" on ornamental plants and micronutrient deficient crops. It can also be applied as a remedial foliar spray on tropical foliage, flowering plants, cut flowers and orchids.



2.64gal

EVRE99068

Min. Buy 1 EA



STEP® Hi-Mag Micronutrients

Specially formulated to improve the overall performance of your major nutrient program. Provides important secondary and micronutrients to support initial and continued growth of container-grown and landscape ornamentals. Formulation provides a higher level of magnesium, in addition to a combination of readily available and slowly available forms of micronutrients.



50lb (40/PL)

EVR8435

Min. Buy 1 EA



Micronutrients

Jack's Professional® M.O.S.T. No Boron Trace Element Fertilizer

A water-soluble fertilizer that can be used to correct micronutrient deficiencies detected by growing medium or foliar analysis

- For use on: All plants being grown hydroponically.



25lb (80/PL)

JRP77392

Min. Buy 1 EA



Jack's Professional® M.O.S.T. Trace Element Fertilizer

A water-soluble fertilizer with a full package of micronutrients required for greenhouse and nursery production. Fully soluble and mixable with fertilizers not containing calcium.

- For use on: All plants being grown hydroponically.



25lb (80/PL)

JRP77391

Min. Buy 1 EA



Jack's Elementals® Calcium Chloride Dihydrate

Calcium Chloride can be used to correct a calcium deficiency detected by growing media or foliar analysis. It is most commonly used as a foliar application.



11b

JRP74374

Min. Buy 1 EA



25lb (80/PL)

JRP74371

Min. Buy 1 EA

Jack's Elementals® Ammonium Molybdate

Ammonium Molybdate can be used to correct a Molybdenum deficiency detected by media or foliar analysis. It is an essential part of any Poinsettia fertility program.



11b

JRP74742

Min. Buy 1 EA



WARNING: This product is not available for sale in CA. For most up to date information please visit bfgsupply.com



Micronutrients

Biomin® Calcium

Biomin® Calcium contains chelated calcium designed for soil and foliar application. It is completely bioavailable and non-phytotoxic to plants when applied in accordance to directions. Designed to prevent and correct micronutrient deficiencies and to boost crops during critical or fast growing periods. May be applied with nitrogen fertilizer.

• OMRI listed®



2.5gal
JH051005 **Min. Buy 1 EA**



Biomin® Copper

Biomin® Copper contains chelated copper for soil and/or foliar application. Completely bioavailable and non-phytotoxic to plants when applied in accordance to directions. Designed to prevent and correct copper deficiencies and to boost crops during critical or fast growing periods. May be applied with nitrogen fertilizers.

• OMRI listed®



2.5gal
JH051008 **Min. Buy 1 EA**



Biomin® Iron

Biomin® Iron contains chelated iron for soil and/or foliar application. Completely bioavailable and non-phytotoxic to plants when applied in accordance to directions. Designed to prevent and correct iron deficiencies and to boost crops during critical or fast growing periods. May be applied with nitrogen fertilizers.

• OMRI listed®



2.5gal
JH051010 **Min. Buy 1 EA**



250gal Tote
JH51010 **Min. Buy 1 EA**

Biomin® Manganese

Biomin® Manganese contains nitrogen and chelated manganese for soil and/or foliar applications. It is completely bioavailable and non-phytotoxic to plants when applied in accordance to directions. Biomin® Manganese is designed to prevent and correct manganese deficiency and to boost crops during critical or fast growing periods. Biomin® Manganese may be applied with nitrogen fertilizers.

• OMRI listed®



2.5gal
JH051012 **Min. Buy 1 EA**



Biomin® Boron

Biomin® Boron contains boron for soil and/or foliar application. Completely bioavailable and non-phytotoxic to plants when applied in accordance to directions. Designed to prevent and correct boron deficiencies and to boost crops during critical or fast growing periods. May be applied with nitrogen fertilizers.

• OMRI listed®



2.5gal
JH051001 **Min. Buy 1 EA**



Biomin® Molybdenum

Biomin® Molybdenum contains molybdenum for soil and/or foliar application. Completely bioavailable and non-phytotoxic to plants when applied in accordance with directions. Designed to prevent and correct molybdenum deficiencies and to boost crops during critical or fast growing periods. May be applied with Nitrogen fertilizers.



2.5gal
JH051014 **Min. Buy 1 EA**



Biomin® Zinc

Biomin® Zinc contains chelated zinc for soil and/or foliar application. Completely bioavailable and non-phytotoxic to plants when applied in accordance to directions. Designed to prevent and correct zinc deficiencies and to boost crops during critical or fast growing periods. May be applied with nitrogen fertilizers.

• OMRI listed®



2.5gal
JH051021 **Min. Buy 1 EA**



Usalco LLC

Micronutrients

Aluminum Sulfate

Used to lower the soil pH and supplement with additional aluminum in order to turn Hydrangea macrophylla flowers from pink to blue.



50lb (40/PL)
USALASRICE50P **Min. Buy 1 EA**



Basic Nutrients

Dolomite S-Fine

Used to raise pH, that is decrease acidity and increase alkalinity, apply ground limestone and incorporate it into the soil. Dolomitic limestone contains 21% calcium and 12% magnesium



50lb (56/PL)
PLNTX10985

Min. Buy 1 EA



Mono-Potassium Phosphate 0-52-34

Often used as a nutrient source in greenhouses while minimizing the escape of ammonia by keeping the pH at a relatively low level.



55lb
PLNTX10279

Min. Buy 1 EA



Potassium Bicarbonate

For use in raising or stabilizing the pH of hydroponic solutions.



55lb (44/PL)
PLNTX10404

Min. Buy 1 EA



Magnesium Nitrate Magnific 11-0-0

A soluble fertilizer that provides Nitrogen and magnesium.



50lb (42/PL)
PLNTX10267

Min. Buy 1 EA



Magnesium Sulfate Epsom Salts

Epsom salts is a source of magnesium for plant nutrition.

- OMRI listed



50lb (49/PL) - OMRI[®] Listed
PLNTX11029

Min. Buy 1 EA



Soluble Urea 46-0-0

Highly concentrated and highly efficient source of available nitrogen. Provides strong, sustained and green growth.



50lb (40/PL)
PLNTX10426

Min. Buy 1 EA



Basic Nutrients

Haifa Multi-K[™] GG Potassium Nitrate Greenhouse Grade

For Nutrigation[™] and foliar feeding of greenhouse crops. Contains 100% plant macronutrients: potassium (K) and nitrate nitrogen (N-NO₃). Multi-K GGTM is free of chloride, sodium and any other elements which are detrimental to plants. The nitrate enables plants to minimize their uptake of chloride, whenever this harmful anion is present in the soil solution or in the irrigation water.



55lb (48/PL)
HN14-0225A

Min. Buy 1 PL



Basic Nutrients

Yara Calcium Nitrate 15.5-0-0 Greenhouse Grade

A fully water soluble Nitrogen and calcium fertilizer. It is a free flowing, fine granular or prilled material which dissolves quickly in water without any residues. Suited to application through all fertigation systems.



50lb (49/PL)
YARA6031 CN

Min. Buy 1 EA



WARNING: This product is not available for sale in CA.
For most up to date information please visit bfgsupply.com



Media Starter Charge

Peters® Professional Uni-Mix® 11-5-11 Growing Media Nutrient Charge

Nutrient charge contains all essential major, secondary and micro-elements. Flexible granular formula can be incorporated in growing media. Provides immediate and slow release nutrient characteristics. Granular nature allows easy, uniform distribution when incorporated into growing media.



50lb (40/PL)

EVR99930

Min. Buy 1 EA

Media Starter Charge

Plantex® 1-3-4 Premix Fertilizer

Designed to be incorporated into the media prior to planting.



50lb (60/PL)

PLNTX10588

Min. Buy 1 EA



CROP PROTECTION



REFERENCE GUIDE for GREENHOUSE and NURSERY PRODUCTION INSECTICIDES / MITICIDES

RESISTANCE MANAGEMENT

Pest populations that are over exposed to a single pesticide may develop resistance to that pesticide. Resistance is due to the innate ability of some individuals in the pest population to survive even after being treated with a pesticide. When using pesticides repeatedly for crop protection, it is important to manage pesticide resistance by rotating chemicals with different modes of action (MOA) on the target pest or combining chemicals with different modes of action in the tank/spray mix.

When labels permit, make two (2) applications of a product or tank mix in sequence, then rotate to products with different modes of action to improve coverage on target life stages of the pest. Try to avoid applying pesticides with the same mode of action to more than one generation of the pest per cycle.

Good resistance management starts with accurate identification of the pest problem and good record-keeping of all pesticide applications.

Time pesticide applications to coincide with the susceptible life stage of the pest based on their life cycle.

The appropriate and labeled (legal) method of application is also a very important factor to consider.

Low volume (L.V.) applications (smoke generator, thermal fog, cold fog, aerosol, and electrostatic) are commonly used in greenhouses. Low volume sprays generally are more effective against adults than immature stages. Use high volume sprays, directed under the leaves for best results against insect and mite eggs and nymphs.

Always read the label and check with your state or county extension specialists for further information regarding resistance management.

**Use Site(s) Key: GH = Greenhouse N = Nursery

Resources Provided By



(by Mode of Action Group and Class)

MOA Group*	Class	Common Name	Trade Name	REI	Use Site(s)**	Company
1A	Carbamates	Carbaryl	Sevin®	12	N	Bayer Environmental Science
		Methiocarb	Mesuro®	24	GH/N	Gowan Company
1B	Organophosphates	Acephate	Orthene® TT&O	24	GH/N	Amvac Chemical Corp.
			Orthene® T	24	GH	BASF
		Chlorpyrifos	DuraGuard® ME	24	GH/N	BASF
			Dursban® 50 WP	24	N	Corteva Agriscience
		Malathion	Gowan Malathion 8F	12	N	Gowan Company
	Phosmet	Imidan® 70W	24	N	Gowan Company	
2B	Phenylpyrazoles	Fipronil	TopChoice™	24	N	Bayer Environmental Science
3	Pyrethroids	Bifenthrin	Talstar®	12	GH/N**	FMC Corp
			OnyxPro®	12	N	FMC Corp.
			Attain® TR	12	GH	BASF
		Cyfluthrin	Decathlon®	12	GH/N	OHP, Inc.
		Fenpropathrin	Tame®	24	GH/N	Nufarm
		Fluvalinate	Mavrik® Aquaflow	12	GH/N	Wellmark International
		Lambda-Cyhalothrin	Scimitar® GC	24	GH/N	Syngenta
		Permethrin	Astro®	12	GH	FMC Corp.
			Permethrin 3.2 EC	12	GH/N***	Helena / Agri-Enterprise
			Ambush®	12	GH/N***	Amvac Chemical Corp.
		*** Greenhouse roses only				
	Botanicals	Pyrethrins	Pyrethrum® TR	12	GH	BASF
			PyGanic®	12	GH/N	Mycorrhizal Applications

* Depends on Greenhouse ventilation

** Greenhouse and/or nursery uses depend on the formulation. Check labels for uses.



Insecticides / Miticides

(by Mode of Action Group and Class)

MOA Group*	Class	Common Name	Trade Name	REI	Use Site(s)**	Company
4A	Neonicotinoids	Acetamiprid	TriStar®	12	GH/N	Nufarm
		Dinotefuran	Safari®	12	GH/N	Nufarm
		Imidacloprid	Marathon®	0-12	GH/N	OHP, Inc.
			Coretect Tree & Shrub Tablets™	12	GH/N	Bayer Environmental Science
	Thiamethoxam	Flagship®	12	GH/N	Syngenta	
4D	Butenolides	Flupyradifrone	Altus™	4	GH/N	Bayer Environmental Science
5	Spinosyns	Spinosad	Conserve®	4	GH/N	Corteva Agriscience
			Entrust®	4	GH/N	Corteva Agriscience
6	Glycosides	Abamectin	Avid®	12	GH/N	Syngenta
		Milbemectin	Ultiflora®	12	N	Gowan Company
7A	Juvenile hormone mimics	s-Kinoprene	Enstar® AQ	12	GH	Wellmark International
7B	Juvenile hormone mimics	Fenoxycarb	Award®	12	N	Syngenta
7C	Pyridine - Insect Growth Regulators	Pyriproxyfen	Distance®	12	GH/N	Nufarm
			Fulcrum®	12	GH/N	OHP, Inc.
9A	Pyridine azomethines	Pymetrozine	Endeavor®	12	GH/N	Syngenta
9B	Pyridine azomethines	Pyrifluquinazon	Rycar®	12	GH	SePRO Corp.
10A	Tetrazines	Clofentezine	Notavo®	12	GH/N	OHP, Inc.
	Thiazolidinones	Hexythiazox	Hexygon® IQ	12	GH/N	Gowan Company
10B	2, 4-Diphenyloxzoline Derivatives	Etoxazole	TetraSan®	12	GH/N	Nufarm
			Beethoven™ TR	4-24*	GH	BASF
11	Biopesticides	<i>Bacillus thuringiensis</i> Kurstaki	DiPel® Pro DF	4	GH/N	Nufarm
		<i>Bacillus thuringiensis</i> Israelensis	Gnatrol®	4	GH/N	Nufarm
13	Pyrroles	Chlorfenapyr	Pylon®	12	GH	BASF
15	Benzoylureas - Insect Growth Regulators	Diflubenzuron	Adept®	12	GH	OHP, Inc.
			Dimilin® WP	12	GH/N**	OHP, Inc.
		Novaluron	Pedestal®	12	GH/N	OHP, Inc.
16	Buprofezin	Buprofezin	Talus®	12	GH/N	SePRO Corp.
17	Cyromazine - Insect Growth Regulators	Cyromazine	Citation®	12	GH/N	Syngenta

* Depends on Greenhouse ventilation

** Greenhouse and/or nursery uses depend on the formulation. Check labels for uses.



WARNING: This product is not available for sale in CA.
For most up to date information please visit bfgsupply.com

Insecticides / Miticides

(by Mode of Action Group and Class)

MOA Group*	Class	Common Name	Trade Name	REI	Use Site(s)**	Company
18	Diacylhydrazines	Tebufenozide	Confirm®	4	N	Gowan Company
		Methoxyfenozide	Intrepid®	4	GH/N	Corteva Agriscience
20A	Trifluoromethyl Aminohydrazone	Hydramethylnon	Amdro® Pro	12	N	BASF
20B	Napthoquinone Derivatives	Acequinocyl	Shuttle® O	12	GH/N	OHP, Inc
20D	Carbazates	Bifenazate	Floramite®	12	GH/N	OHP, Inc.
21A	METI Acaricides and Insecticides	Pyridaben	Sanmite®	12	GH/N	Gowan Company
		Fenpyroximate	Akari®	12	GH	SePRO Corp.
		Tolfenpyrad	Hachi-Hachi®	12	GH	SePRO Corp.
		Fenazaquin	Magus™	12	GH/N	Gowan Company
22B	Semicarbazone	Metaflumizone	Siesta™	12	GH/N	BASF
23	Tetronic acids	Spiromesifen	Savate®	12	GH/N	Bayer Environmental Science
	Tetramic acids	Spirotetramat	Kontos®	0-24	GH/N	Bayer Environmental Science
25A	Beta-ketonitrile	Cyflumetofen	Sultan™	12	GH/N	BASF
28	Anthranillic diamide	Cytraniliprole	Mainspring®	4	GH/N	Syngenta
		Chlorantraniliprole	Acelepryn®	4	GH/N	Syngenta
	Diamide	Cyclaniliprole	Sarisa®	4	GH/N	OHP, Inc.
29	Pyridine carboxamides	Flonicamid	Aria®	12	GH/N	FMC Corp.
UN	Biopesticide Insect	Azadirachtin	Azatin® O	4	GH/N	OHP, Inc.
	Pyridalyl	Pyridalyl	Overture®	12	GH	Nufarm
UNB	Biopesticide: Bacterial Agents	Chromobacterium Subtsugae	Grandevo® WDG	4	GH/N	Marrone Bio Innovations
		Burkholderia ssp. strain A39	Venerate® XC	4	GH/N	Marrone Bio Innovations
UNF	Biopesticides: Fungal Agents	<i>Beauveria bassiana</i>	BotaniGard®	4	GH/N	BioWorks Inc.
			BioCeres WP®	4	GH/N	Biosafe Systems
			Mycotrol® O	4	GH/N	BioWorks, Inc.
		<i>Isaria fumosorosea</i> Apopka Strain 97 (ATCC20874)	Ancora®	4	GH/N	OHP, Inc.
UNE	Oils	Botanical oil	Captiva®	4	GH/N	Gowan Company
		Clarified hydrophobic extract of neem oil	Triact 70®	4	GH/N	OHP, Inc.

* Depends on Greenhouse ventilation

** Greenhouse and/or nursery uses depend on the formulation. Check labels for uses.



Insecticides / Miticides

(by Mode of Action Group and Class)

MOA Group*	Class	Common Name	Trade Name	REI	Use Site(s)**	Company
UNM	Soaps	Potassium salts of fatty acids	AllPro® Insecticidal Soap	12	GH/N	Value Garden Supply
			Kopa™ Insecticidal Soap	12	GH/N	OHP, Inc.
			M-Pede®	12	GH/N	Gowan Company
			Ultra-Pure™ Oil	4	GH/N	BASF
			Suffoil-X™	4	GH/N	BioWorks, Inc
3+UN	Pyrethrins + Oils	Pyrethrins + Canola Oil	Pycana®	12	GH/N	OHP, Inc.
	Pyrethrins	Pyrethrins + Piperonyl butoxide	Evergreen® Pro 60-6	12	GH/N	Mycorrhizal Applications
1+3	Organophosphate + Pyrethroid	Chlorpyrifos + Cyfluthrin	DuraPlex® TR	24	GH	BASF
3+4A	Pyrethroid + Neonicotinoid	Cyfluthrin + Imidacloprid	Discus® L	12	GH/N	OHP, Inc.
4C+5	Sulfoximines + Spinosyns	Sulfoxaflor + Spinetoram	Xxpire	12	GH/N	Corteva Agriscience
6 + 20D	Glycoside+Carbazate	Abamectin + Bifenazate	Sirocco®	12	GH/N	OHP, Inc.
28 + 29	Diamide + Pyridine carboxamides	Cyclaniliprole + Flonicamid	Pradia®	12	GH/N	OHP, Inc.

*Insecticides / Miticides Mode of Action

1. Acetylcholinesterase inhibitors. Inhibition of the enzyme acetylcholinesterase, interrupting the transmission of nerve impulses
2. GABA-gated chloride channel blockers: Interferes with GABA receptors of insect neurons, leading to repetitive nervous discharges
3. Sodium channel modulators: Acts as an axonic poison by interfering with the sodium channels of both the peripheral and central nervous system stimulating repetitive nervous discharges, leading to paralysis.
4. Nicotinic acetylcholine receptor (nAChR) agonists. Binds to nicotinic acetylcholine receptor disrupting nerve transmission.
5. Nicotine acetylcholine receptor allosteric modulators- Site I
6. Glutamate-gated chloride channel allosteric modulators
7. Juvenile hormone mimics (Insect growth regulator): Mimic juvenile hormones, which prevent molting from the larval to the adult stage.
9. Chordotonal organ TRPV channel modulators.
10. Mite growth inhibitors affecting CHS1
11. Microbial disruptors of insect midgut membranes.
12. Inhibitors of mitochondrial ATP synthase.
13. Uncouplers of oxidative phosphorylation via disruption of the proton gradient
15. Inhibitors of chitin biosynthesis affecting CHS1
16. Inhibit chitin biosynthesis – type 1
17. Molting disruptor, Dipteran
18. Ecdysone receptor agonists.
20. Mitochondrial complex III electron transport inhibitors. Energy metabolism
21. Mitochondrial complex I electron transport inhibitors
22. Voltage-dependent sodium channel blockers: Nerve action
23. Inhibitors of acetyl CoA carboxylase
25. Mitochondrial complex II electron transport inhibitors
28. Ryanodine receptor modulators
29. Chordotonal organ Modulators – undefined target site: Nerve
 - UN Products with unknown or uncertain MoA
 - UNE Botanical essence including synthetic, extracts and unrefined oils with unknown or uncertain MoA
 - UNF Fungal agents of unknown or uncertain MoA
 - UNM Non-specific mechanical disruptors

This list is from the U.S Environmental Protection Agency, in cooperation with the Insecticide Resistance Action Committee (IRAC). IRAC is a technical working group within the Global Crop Protection Federation (GCPF). More information on the Insecticide Resistance Action Committee and the Mode of Action Classification is available from: www.irac-online.org.



WARNING: This product is not available for sale in CA.
For most up to date information please visit bfgsupply.com

800-883-0234
www.bfgsupply.com

Insecticide Reference Chart

Always Refer to Product Label!

Product	Active Ingredient	OMRI Listed	Aphids	Beetles	Borers	Caterpillars	Fungus Gnats	Leafhoppers	Leafminers	Leafrollers	Mealybugs	Mites	Plant Bug	Scale	Shore Flies	Slugs & Snails	Thrips	Whiteflies
Acelepryn	Chlorantraniliprole		X	X	X	X			X									
Acephate 97 WDG	Acephate		X	X	X	X		X	X	X	X		X	X			X	X
Adept	Diflubenzuron						X		X						X			
Akari 5SC	Fenpyroximate										X	X						X
Altus	Flupyradifurone		X	X				X	X		X		X	X			X	X
Ancora	Isaria fumosorosea Apopka Strain 97	OMRI	X			X			X		X	X	X				X	X
Aria	Flonicamid		X					X			X		X	X			X	X
Astro	Permethrin		X	X	X	X	X	X	X	X	X		X				X	X
Attain TR	Bifenthrin		X			X	X			X	X	X	X	X			X	X
Avalon	Bifenthrin		X	X	X	X	X	X	X	X	X	X	X	X			X	X
Avid	Abamectin		X						X			X					X	X
Aza-Direct	Azadirachtin	OMRI	X	X	X	X	X	X	X	X	X	X		X	X		X	X
AzaGuard	Azadirachtin	OMRI	X	X	X	X	X	X	X	X	X	X		X	X		X	X
Azatin O	Azadirachtin	OMRI	X	X	X	X	X	X	X	X	X	X		X	X		X	X
Beethoven TR	Etoxazole											X						X
Benefit 60WP	Imidacloprid		X	X	X		X	X	X		X			X			X	X
BioCeres WP	Beauveria bassiana		X	X	X								X				X	X
BotaniGard	Beauveria bassiana		X	X				X			X		X				X	X
Botanigard Maxx	Beauveria bassiana, Pyrethrins		X	X	X	X	X	X		X	X	X	X				X	X
Captiva Prime	Capsicum, Garlic Oil, Soybean Oil	OMRI			X	X		X			X	X	X				X	X
Citation	Cyromazine						X		X						X			
Conserve SC	Spinosad			X		X			X	X					X		X	
CoreTect	Imidacloprid		X	X	X			X	X	X	X		X	X			X	X
Deadline M-Ps	Metaldehyde															X		
Debug TURBO & TRES	Azadirachtin, Fats and Glyceridic Oils	OMRI	X	X	X	X	X	X	X	X	X	X		X			X	X
Decathlon 20WP	Cyfluthrin		X	X		X	X	X		X	X		X				X	X
Dimilin 25W	Diflubenzuron					X	X		X						X			X
DiPel Pro DF	Bacillus thuringiensis kurstaki	OMRI			X	X				X								
Discus L	Cyfluthrin, Imidacloprid		X	X		X	X	X	X		X	X	X	X			X	X
Distance IGR	Pyriproxyfen		X				X		X		X			X	X			X
Ecotec Plus	Rosemary & Peppermint Oil, Geraniol		X	X		X	X	X	X		X	X		X	X		X	X
Endeavor	Pymetrozine		X															X
Engulf GHN	Bifenazate											X						
Enstar AQ	S-Kinoprene		X				X		X		X			X			X	X
Entrust SC	Spinosad	OMRI		X		X			X	X					X		X	
EverGreen Pro	Pyrethrins, Piperonyl butoxide		X	X	X	X	X	X		X	X		X				X	X
Flagship 25WG	Thiamethoxam		X	X			X	X	X		X		X	X			X	X
Floramite SC & SC/LS	Bifenazate											X						
Forbid 4F	Spiromesifen											X						X
Fulcrum	Pyriproxyfen						X		X		X			X	X			X
Gnatrol WDG	Bacillus Thuringiensis israelensis	OMRI					X											
Grandevo	Chromobacterium	OMRI	X	X	X	X		X	X	X	X	X	X	X			X	X
Hachi-Hachi SC	Tolfenpyrad		X			X		X			X			X			X	X
Hexygon IQ	Hexythiazox											X						



Insecticide Reference Chart

Always Refer to Product Label!

Product	Active Ingredient	OMRI Listed																
			Aphids	Beetles	Borers	Caterpillars	Fungus Gnats	Leafhoppers	Leafminers	Leafrollers	Mealybugs	Mites	Plant Bug	Scale	Shore Flies	Slugs & Snails	Thrips	Whiteflies
ImidaStar 2L	Imidacloprid		X	X	X		X	X	X		X			X			X	X
IronFist	Sodium Ferric EDTA															X		
Kontos	Spirotetramat		X					X			X	X	X				X	X
Kopa	Potassium salts Fatty Acid	OMRI	X	X		X		X			X	X	X	X				X
LALGUARD M52	Metarhizium brunneum		X								X						X	X
Mainspring GNL	Cyantraniliprole		X	X	X	X			X				X	X			X	X
Magus	Fenazaquin										X							X
Mallet .5G	Imidacloprid		X	X	X		X	X	X		X		X				X	X
Mallet 2F	Imidacloprid		X	X	X		X	X	X		X		X				X	X
Marathon 1G	Imidacloprid		X	X	X		X	X	X		X		X				X	X
Marathon II	Imidacloprid		X	X	X		X	X	X		X		X				X	X
Mavrik Aquaflow	Tau-fluvalinate		X	X		X		X			X	X	X				X	X
Millenium	Steinernema carpocapsae						X							X				
Minx 2	Abamectin		X						X		X						X	X
Molt-X	Azadirachtin	OMRI	X	X	X	X	X	X	X	X	X	X	X	X	X		X	X
M-Pede	Potassium salts Fatty Acid	OMRI	X	X		X		X			X	X	X	X				X
Mycotrol	Beauveria bassiana	OMRI	X	X				X			X		X				X	X
Nemashield	Steinernema feltiae						X										X	
Nemasys	Steinernema feltiae						X										X	
NoFly WP	Isaria fumosorosea FE 9901	OMRI	X	X			X	X			X	X	X				X	X
Notavo	Clofentezine										X							
Onyx Pro	Bifenthrin		X	X	X	X	X	X	X	X	X	X	X	X			X	X
Orthene	Acephate		X	X		X	X	X	X	X	X	X	X				X	X
Overture	Pyridalyl					X											X	
Pedestal	Novaluron					X			X				X				X	X
Pradia	Cyclaniliprole, Flonicamid		X	X	X	X			X	X	X		X	X			X	X
Pycana	Pyrethrins, Canola oil	OMRI	X	X	X	X	X	X	X	X	X	X	X	X			X	X
Pyronyl Crop Spray	Pyrethrins, Piperonyl butoxide		X	X	X	X	X	X	X	X	X		X				X	X
Pyganic Specialty	Pyrethrins	OMRI	X	X	X	X	X	X	X	X	X	X	X	X	X		X	X
Pylon	Chlorfenapyr					X	X				X						X	
Pyrethrum TR	Pyrethrins		X	X		X	X	X		X	X		X				X	X
Rycar	Pyriproxyfen		X					X			X						X	X
Safari 20SG	Dinotefuran		X	X	X	X	X	X		X		X	X				X	X
Sanmite SC	Pyridaben		X					X			X							X
Sarisa	Cyclaniliprole		X	X	X	X			X	X	X		X				X	X
Savate	Spiromesifen										X							X
Scimitar GC	Lambda-cyhalothrin		X	X		X		X	X	X	X	X	X	X			X	X
Shuttle O	Acequinocyl										X							
Sirocco	Bifenthrin, Abamectin		X						X			X					X	X
Spear-T	GS-Omega/Kappa-HXTA-HV1A		X								X						X	X
Suffoil-X	Mineral Oil	OMRI	X	X			X	X		X	X	X	X	X			X	X
Sultan	Cyflumetofen										X							
Talstar	Bifenthrin		X	X	X	X	X	X	X	X	X	X	X	X			X	X

 WARNING: This product is not available for sale in CA. For most up to date information please visit bfgsupply.com

800-883-0234
www.bfgsupply.com

Insecticide Reference Chart

Always Refer to Product Label!

Product	Active Ingredient	OMRI Listed	Aphids	Beetles	Borers	Caterpillars	Fungus Gnats	Leafhoppers	Leafminers	Leafrollers	Mealybugs	Mites	Plant Bug	Scale	Shore Flies	Slugs & Snails	Thrips	Whiteflies
Talus 70DF	Buprofenzin						X				X			X				X
Tame 2.4EC	Fenpropathrin		X	X		X	X	X	X	X	X	X	X	X			X	X
TetraCURB MAX	Castor, Rosemary, Clove, Peppermint	OMRI	X								X	X					X	X
TetraSan 5WDG	Etoxazole											X						
Triact 70	Neem oil	OMRI	X					X			X	X		X				X
Tristar 8.5SL	Acetamiprid		X	X	X	X	X	X	X	X	X		X	X			X	X
Ultra-Pure Oil	Mineral Oil		X	X			X	X	X	X	X	X	X	X			X	X
Velfifer	Beauveria bassiana strain PPRI 5339		X								X	X					X	X
Venerate CG	Burkholderia spp. Strain A396 cells	OMRI	X		X	X		X	X	X	X	X	X	X			X	X
Ventigra	Afidopyropen		X								X			X				X
XXpire	Spinetoram, Sulfoxaflor		X	X		X				X	X	X	X	X	X		X	X

LALSTOP K61 WP is item #LAL162510 in the BFG Horticultural Supplies Catalog

GET TO THE ROOT OF THE PROBLEM

LALSTOP K61 WP is a proven biofungicide that offers:

- Broad spectrum control of root diseases, including *Fusarium*.
- No known resistance due to multiple modes of action.
- Compatibility with organic and conventional IPM programs with a favorable application cost.

About Lallemand Plant Care

Since the beginning of the 20th Century, LALLEMAND has been an expert in yeast and bacteria manufacturing. The family-owned company is now a global leader in the development, production, and marketing of microorganisms for various agri-food industries. Using sound science and know-how, LALLEMAND PLANT CARE (LPC) works closely with clients to deliver the right technology, in the right formulation, for the right application. LPC is committed to solving grower challenges, significantly improving yield and crop vitality.



EPA REGISTERED

Microbial by nature

LALLEMANDPLANTCARE.COM



APHID PROBLEM?

CONTROL STRATEGIES

There are many different species of Aphids (*Aphis* sp.) that are pests of horticultural crops and landscape plants. Most are small, soft bodied, pear shaped insects with piercing and sucking mouthparts that are used to suck out plant fluids. Aphids can be many colors from green, brown, or black, sometimes covered in a waxy or wooly secretion. One common identifier are the cornicles, two protrusions on their hind end. Adults are usually wingless, although they will produce wings when feeding opportunities decline so they can disperse to other crops.

Aphids can mature from newborn to adult in as little as one week, so populations can explode quickly. They are also capable of reproducing asexually and can give birth to 12 or more live nymphs per day. They typically inhabit newer shoots, leaves and stems. Aphid feeding can cause leaf yellowing, curling and distorted leaves and shoots. This insect exudes a honeydew waste that often turns black with sooty mold. Aphids are also known vectors of plant viruses.

Brand Name	BFG Item #	Active Ingredient	Mode of Action Group	Notes
Rycar	SEPRO1056.128	Pyrifluquinazon	UN	Contact & Translaminar Soft on Beneficials Greenhouse Only Vegetable Label
Altus	BYR84989509	Flupyradifurone	4D	Translaminar & Systemic Foliar or Drench Application Soft on Beneficials
Pradia	OHP986300	Cyclaniliprole, Fonicamid	28, 29	Contact Soft on Beneficials
Mainspring	SYN58664 SYN66345	Cyantraniliprole	28	Translaminar & Systemic Foliar or Drench Application Soft on Beneficials
AzaGuard	BSF7000-32OZ BSFTO70001	Azadirachtin	UN	Insect Growth Regulator Labeled for Fruits & Vegetables
Enstar AQ	WLMK100502416 WLMK100502900	S-Kinoprene	7	Insect Growth Regulator Greenhouse only
BotaniGard 22WP	CERT141104	Beauveria bassiana	UN	Fungal Spore that infects insects Soft on Beneficials, Vegetable label

Always read and follow label directions before applying any pesticide and follow state and local regulations

EFFECTIVE SOLUTIONS

Rycar

8oz SEPRO1056.128



Pradia

32oz OHP986300



AzaGuard

32oz BSF7000-32OZ

1gal BSFTO70001



Altus

64oz BYR84989509



Mainspring

1pt SYN58664

1gal SYN66345



BotaniGard 22WP

1lb CERT141104



Enstar AQ

1qt WLMK100502416

1gal WLMK100502900



ALWAYS BE SURE TO
READ THE LABEL

**& CHECK WITH
LOCAL REGULATIONS**
BEFORE USING ANY PESTICIDE.

CONTROLS

Aphid control can be challenging when using contact insecticides if thorough coverage of the plant and the pest is not achieved. Proper spray volume, pressure, and the use of a spray adjuvant can improve results.

SYSTEMIC INSECTICIDES

Growers can benefit by using systemic or translaminar insecticides when good spray coverage is difficult. Soil applications of systemic insecticides can give longer term control by moving to growing shoots and remaining in the plant tissue.

BIOLOGICAL CONTROLS

The main agents are *Aphidius colemani* for smaller species of Aphids and *Aphidius ervi* for larger species of Aphids. Chrysoperla (Lacewings) are another agent that can be used.

THRIPS PROBLEM?

CONTROL STRATEGIES

Importance

Western Flower Thrips (*Frankliniella occidentalis*) are known to vector plant pathogens such as Impatiens necrotic spot virus, and tomato spotted wilt virus. They cause stippling, scarring, silvering of the leaf surface, distorted leaves, and corky lesions on fruits by piercing leaves with one mouthpart and sucking the plant fluids through a stylet.

Control

Chemical control is challenging due to larvae deep inside buds being protected from insecticide sprays. Some growers add irritants like Captiva Prime to their tank mix in order to draw the thrips from hiding and into contact with insecticides. Soil applied systemics may not control thrips inhabiting flower buds and blooms, as movement of these materials into flower tissues is limited. Practicing resistance management is vitally important with this pest due to rapid life cycles and the potential of resistance development to overused control agents. Avoid resistance by rotating across the mode of action groups (MOA's).

Brand Name	BFG Item #	Active Ingredient	Mode of Action Group	Notes
Overture	VAL62120.084	Pyridalyl	UN	Contact and ingestion. Greenhouse use only. Soft on beneficials.
Hachi-Hachi SC	SEPRO1159.464	Tolfenpyrad	21A	Contact. Greenhouse use only.
Pylon	BAS59012156 BAS59024027 BAS59012595	Chlorfenarpyr	13	Contact and stomach. Greenhouse use only. Vegetable label.
Mainspring	SYN58664 SYN66345	Cyantraniliprole	28	Translaminar & Systemic. Foliar or Drench Application. Soft on Beneficials.
Pedestal	OHP986195	Novaluron	15	Insect growth regulator, excellent on immatures. Tomato label.
Safari	VAL69712.430 VAL69712.261	Dinotefuran	4A	Translaminar & Systemic. Foliar or Drench Application. Vegetable label.
Conserve	DOW19-0007Z	Spinosad	5	Contact. Fruit and Vegetable label.

EFFECTIVE SOLUTIONS

Overture

1lb VAL62120.084



Pylon

2oz BAS59012595

16oz BAS59012156

32oz BAS59024027



Safari

3lb VAL69712.430

12oz VAL69712.261



Conserve

1qt DOW19-0007Z



Mainspring

1pt SYN58664

1gal SYN66345



Hachi-Hachi SC

64oz SEPRO1159.464



ALWAYS BE SURE TO
READ THE LABEL

**& CHECK WITH
LOCAL REGULATIONS**
BEFORE USING ANY PESTICIDE.

IDENTIFICATION

Thrips are minute insects that have an elongated body shape. Adults have fringed wings while the immature stages are wingless, off white to translucent in color, 1/20 inch long. Feeding is evidenced by black specks of frass excrement. Scouting can be as simple as smacking a leaf over a white paper, or using yellow or blue sticky cards, then examining with at least a 10X hand lens.

LIFE CYCLE

A typical life cycle is 21 days but can be as little as 14 days in high temperatures. Eggs are inserted into leaf tissue and deep in flower buds, followed by two larval stages, two non-feeding pupal stages which drop to the soil media, then adulthood.

BIOLOGICAL CONTROLS

The main agents are *Aphidius colemani* for smaller species of Aphids and *Aphidius ervi* for larger species of Aphids. Chrysoperla (Lacewings) are another agent that can be used.

Pedestal

1qt OHP986195



Insecticides & Miticides

Acelepryn Insecticide

by Syngenta Crop Protection

Acelepryn insecticide provides season long grub control with a single application in April or May. Also controls many surface feeding pests including beetles and weevils. Liquid formulation for foliar ornamental applications. Hazardous via air and water.

- Active ingredient: Chlorantraniliprole
- Rate: 2 to 8 oz per 100 gal
- REI: 4 hours
- Controls: White Grub, Japanese beetles, Caterpillars, Black cutworms, Sod webworms, Bluegrass weevil
- Signal Word: Caution

**4oz****SYN70042** Min. Buy 1 EA**64oz AGENCY****SYN57749** Min. Buy 1 EA**Acelepryn® G Insecticide**

by Syngenta Crop Protection

Acelepryn turf insecticide provides season long grub control with a single application in April or May. Also controls many surface feeding pests including beetles and weevils.

- Active Ingredient: Chlorantraniliprole
- Rate: 50-100lbs per Acre
- REI: 4 Hrs
- Controls: White Grub, Caterpillars, Black Cutworms, Sod Webworms, Bluegrass Weevil.
- Signal Word: Caution

**25lb****SYN53199** Min. Buy 1 EA**Acephate® 97UP Insecticide**

by United Phosphorus, Inc.

Acephate 97UP is an insecticide that provides systemic control of pests on selected agricultural crops and ornamentals. Crop use includes beans, brussel sprouts, cauliflower, celery, and more. Acephate is also labeled for use on non-crop areas such as field borders, fencerows, roadsides and ditch banks.

- Active Ingredient: Acephate
- Rate: Varies according to application. See label.
- REI: 24 hours
- Controls: Aphids, Cabbage Looper, Grasshopper, Thrips, Whitefly, and more.
- Signal Word: Caution



Not available for sale in CA

1lb**PROKZ742011** Min. Buy 1 EA**Adept® WSP Insecticide**

by OHP, Inc.

An effective tool for controlling fungus gnats, shore flies and foliar feeding pests found in ornamental crops grown in greenhouses, shade houses and interiorscapes.

- Active Ingredient: Diflubenzuron
- Rate: 2oz per 100gal
- REI: 12 Hrs
- Controls: Armyworms, Leafminers, Fungus Gnats, Shore Flies.
- Signal Word: Caution



CA Prop65 Warning

16ct - 1oz Packet**OHP981012** Min. Buy 1 EA**Akari® 5SC Miticide**

by Sepro Corporation

A unique "stop-feeding action" not only stops further damage to your plants but also halts the laying of eggs immediately after application. Mites are dead in 4 to 7 days. Active on all life stages, but especially effective on the plant damaging larvae, nymph and adult stages, Akari provides residual action of 21-28 days.

- Active Ingredient: Fenpyroximate
- Rate: 16 to 24oz per 100gal
- REI: 12 Hrs
- Controls: Mites, Mealybugs, Whiteflies
- Signal Word: Warning

**1qt****SEPROAKARI** Min. Buy 1 EA**Altus® Insecticide**

by Envu

Altus Insecticide is used for the control of insect pests in a wide variety of greenhouse vegetable and ornamental crops and in outdoor nursery and landscape ornamentals. A broad-spectrum insecticide that is acropetally systemic, moving from roots to the leaves in the case of soil applications. Moves translaminarily through the leaf tissue in the case of foliar applications.

- Active Ingredient : Flupyradifurone
- Rate : Foliar : 7 to 14oz per 100gal Drench : 21-28oz/ Acre
- REI : 4 Hrs
- Controls : Adelgids, Aphids, Leafhoppers, Mealybugs, Scales and more.
- Signal Word : Caution

**64oz AGENCY****BYR84989509** Min. Buy 1 EA**Ancora® Insecticide**

by OHP, Inc.

Ancora contains a naturally occurring fungus that infects both foliage and soil insect pests. Ancora is compatible with beneficial arthropods and is labeled for use on herbs, vegetables and ornamentals. Ancora has a 4-hour REI and can be used in organic production.

- Active Ingredient: Isaria fumosorosea Apopka strain 97
- Rate: 14 to 28 oz per 100gal
- REI: 4 Hrs
- Controls: Aphids, Leafminers, Mealybugs, Thrips, Mites and more.
- Signal Word: Caution

**1lb****OHP981070** Min. Buy 1 EA

WARNING: This product is not available for sale in CA. For most up to date information please visit bfgsupply.com

800-883-0234
www.bfgsupply.com

Insecticides & Miticides

Aria® Insecticideby *FMC*

Through contact and ingestion, the active ingredient in Aria stops both adult and immature aphids from feeding within one hour of treatment and eliminates them within three to five days as a result of dehydration and starvation. Effectively controls many species of aphids that attack greenhouse plant investments. Designed for minimized impact on birds and honeybees.

- Active Ingredient: Flonicamid
- Rate: 80 to 100grams per 100gal
- REI: 12 hours.
- Controls: Aphids, Thrips, Whiteflies, Mealybugs and more.
- Signal Word: Caution

**160g****FMC19-0303B** Min. Buy 1 EA**Astro® Insecticide**by *FMC*

Astro insecticide controls insect pests on lawns, ornamental trees and shrubs, ornamental plants grown in greenhouses and perimeters of residential, industrial and commercial landscaped areas.

- Active Ingredient: Permethrin
- Rate: 4 to 8oz per 100gal
- REI: 12 Hrs
- Controls: Aphids, Adelgids, Beetles, Leafhoppers and more.
- Signal Word: Caution

**1gal****FMC19-1001C** Min. Buy 1 EA**Attain® TR Insecticide**by *BASF Corp*

A ready-to-use, ultra-low-volume insecticide fogger that controls a variety of greenhouse insect pests, including aphids, fungus gnats, mealybugs, mites, thrips, and whiteflies, along with several other secondary insect pests.

- Active Ingredient: Bifenthrin
- Rate: One 2 oz can treats up to 3,000sq ft.
- REI: 12 Hrs
- Controls: Aphids, Thrips, Caterpillars, Armyworms, Mealy bugs and more
- Signal Word: Warning

**2oz****BAS59011825** Min. Buy 1 EA**Avalon® GN Insecticide**by *Prokoz, Inc*

Provides long-lasting residual control of aphids, black vine weevils, scale and other nursery and greenhouse pests without the risk of damaging sensitive plants. It is non-staining and contains no odorous or plant-damaging solvents, so it can be applied to open blooms and colored bracts right up to the day of shipment.

- Active Ingredient: Bifenthrin
- Rate: 5 to 10oz per 100gal
- REI: 12 Hrs
- Controls: Aphids, Black Vine Weevil, Lace Bugs, Fungus Gnats and many more. See label for complete list.
- Signal Word: Caution

**1gal****PROKZ10064852** Min. Buy 1 EAOther Info **RESTRICTED USE****Avid® + Mainspring® GNL Insecticides**by *Syngenta Crop Protect (Agency)*

Avid and Mainspring GNL Multipak offers a complete, non-neonic insecticide solution for nursery and greenhouse growers. Contains one gallon Avid 0.15EC and four pints of Mainspring GNL. Minimum buy – 1 case.

- Active Ingredient: Avid - Abamectin, Mainspring GNL - Cyantraniliprole
- Rate: Varies according to application. See label.
- REI: 12 Hrs
- Controls: Aphids, Thrips, Whiteflies and more
- Signal Word: Warning/Caution



Multipack - Contains 1gal Avid® 0.15EC & 4ea 1pt Mainspring® GNL AGENCY

SYN60499 Min. Buy 1 CS**Avid® 0.15EC Miticide**by *Syngenta Crop Protection*

For control of leaf miners and mites and suppression of aphids, whiteflies, and thrips on ornamental plants. Rain fast within hours of application, offering outdoor application flexibility and is odorless. Also leaves no unsightly residue on plants.

- Active Ingredient: Abamectin
- Rate: 4 to 8oz per 100gal
- REI: 12 Hrs
- Controls: Leafminers, Mites and suppresses Aphids, Whiteflies and Thrips
- Signal Word: Warning

**8oz****SYN25873** Min. Buy 1 EA**1qt****SYN81141** Min. Buy 1 EA**1gal AGENCY****SYN15128** Min. Buy 1 EA

Insecticides & Miticides

Aza-Direct® Insecticideby *Gowan*

Aza-Direct is a broad spectrum biological insecticide that controls key insect pests on greenhouse and outdoor food crops, ornamental plants and shrubs and nursery crops. Its primary mode of action is as an insect growth regulator which inhibits molting and the development of immature insects into healthy adults. Effective repellent and antifeedant thereby affecting both immature and adult insect pests.

- Active Ingredient: Azadirachtin
- Rate: 16 to 32oz per Acre
- REI: 4 Hrs
- Controls: Aphids, Thrips, Fungus Gnat, Whitefly and more.
- Signal Word: Caution

**2.5gal****GOW14022** Min. Buy 1 EAOther Info **SHIPS DIRECT****AzaGuard® Insecticide**by *BioSafe Systems*

Control over 400 insect species. The primary mode of action of this product is as a growth regulator, preventing immature insects from developing into adults. However, AzaGuard can also be used as an oviposition deterrent, antifeedant, repellent, molting inhibitor, sterilant and growth retardant. Proudly made in the USA.

- Active Ingredient: Azadirachtin
- Rate: Varies according to application method. See label.
- REI: 4 Hrs
- Controls: Insects in the larval, pupal and nymphal stages.
- Signal Word: Caution

**1qt****BSF7000-32OZ** Min. Buy 1 EA**1gal****BSFTO70001** Min. Buy 1 EA**2.5gal****BSF700025** Min. Buy 1 EA**Azatin® O Insecticide**by *OHP, Inc.*

Azatin O is a biological insect growth regulator used to control the larval stage of a broad-spectrum of greenhouse and nursery pests. Azatin O is OMRI Listed® for organic production and is soft on beneficial insects. Suitable for use on crops such as ornamentals, vegetables, herbs and berries grown in the greenhouse, nurseries, interiorscapes, hydroponics and turf.

- Active Ingredient: Azadirachtin
- Rate: 4 to 16 oz per 100gal
- REI: 4 Hrs
- Controls: larval stages of many insect pests. See label.
- Signal Word: Caution

**1qt****OHP981221** Min. Buy 1 EA**Beethoven® TR Miticide**by *BASF Corp*

Beethoven TR provides control of mites including two-spotted spider mites and suppresses whiteflies. Total release fogger. Beethoven offers quick and easy application, thorough coverage, and excellent plant safety.

- Active Ingredient: Etoxazole
- Rate: 1 Can per 3,000sq ft
- REI: 12 Hrs
- Controls: Mites, Whitefly (Suppression)
- Signal Word: Caution

**2oz****BAS5902321** Min. Buy 1 EA**Benefit® 60WSP Insecticide**by *ICL*

A nursery and greenhouse insecticide in a wettable powder formula that controls the most common insect problems. Controls white grub larvae, aphids, mealybugs and other common insects and can be applied as a foliar spray or drench.

- Active Ingredient: Imidacloprid
- Rate: 20g per 100gal
- REI: 12 Hrs
- Controls: Adelgids, Aphids, Japanese Beetles (adults), Fungus Gnat (larvae), Lacebugs, Leaf Beetles, (including Elm and Viburnum Leaf Beetles), Leafhoppers, Leafminers, Mealybugs, Psyllids, Sawfly larvae, Soft Scale, Thrips (suppression), Whiteflies
- Signal Word: Caution

**100g****EVR956601E** Min. Buy 1 EA**BioCeres WP Insecticide**by *BioSafe Systems*

BioCeres WP uses a proprietary strain of *Beauveria bassiana* fungus to target foliar feeding or soil-borne insect pests and is perfectly suited for reducing insecticide resistance in IPM programs. Can integrate into existing programs and works well with beneficial insects.

- Active Ingredient: *Beauveria bassiana*
- Rate: 1 to 3lbs per Acre
- REI: 4 Hrs
- Controls: Whitefly, Aphid and Thrips.
- Signal Word: Caution

**1lb****BSF68001** Min. Buy 1 EA**BotaniGard® 22WP Mycoinsecticide**by *Certis USA LLC*

BotaniGard® 22WP contains *Beauveria bassiana* spores that infect directly into the pest and germinate to produce enzymes that dissolve the cuticle, destroying the insect from the inside out. It will infiltrate targeted pests within 16-24 hours after application and eliminate them after 4-5 days. Wettable powder formulation.

- Active Ingredients : *Beauveria bassiana* strain GHA, 22%
- Rate: 0.5 to 2 lbs per 100 gals
- REI: 4 Hrs / PHI: 0 Days
- Controls : whiteflies, aphids, thrips, psyllids, mealybugs, scarab beetles, leafhoppers and planthoppers, plant bugs, weevils, and more
- Signal Word: Caution

**1lb****CERT141104** Min. Buy 1 EA

WARNING: This product is not available for sale in CA.
For most up to date information please visit bfgsupply.com

800-883-0234
www.bfgsupply.com

Insecticides & Miticides

BotaniGard® ES Mycoinsecticide

by Certis USA LLC

BotaniGard ES is a mycoinsecticide for the control of whitefly, aphids, thrips and more. Labeled for use on ornamentals and vegetables in greenhouses, nurseries, commercial landscapes, interiorscapes and turf. This formulation contains Beauveria bassiana spores that infect directly into the pest and germinate to produce enzymes that dissolve the cuticle, destroying the insect from the inside out.

- Active Ingredients : Beauveria bassiana strain GHA, 11.3%
- Rate: 0.5 to 1 EA per 100 gals
- REI: 4 Hrs / PHI: 0 Days
- Controls : whiteflies, aphids, thrips, psyllids, mealybugs, leaf-feeding beetles, leafhoppers and planthoppers, plant bugs, acari, lepidoptera, weevils, and more
- Signal Word: Caution

**1qt****CERT145004B** Min. Buy 1 EA**1gal****CERT145005** Min. Buy 1 EA**BotaniGard® Maxx Insecticide**

by Certis USA LLC

BotaniGard® MAXX acts by contact. This biologically-based insecticide combines myco- and botanical insecticides. There is a synergistic interaction between Beauveria bassiana strain GHA and natural botanical pyrethrins which results in multiple modes of action and pest control results. Quick knock-down and control of thrips, spider mites, weevils, whiteflies and more.

- Active Ingredients : Beauveria bassiana strain GHA, 0.06% and Natural Pyrethrins, 0.7%
- Rate: 1 to 2 qts per 100 gals
- REI: 12 Hrs / PHI: 0 Days
- Controls : aphids, thrips, whiteflies, psyllids, spider mites, mealybugs, leafhoppers, weevils, plant bugs, borers, lepidoptera, other leaf-feeding insects, and more
- Signal Word: Warning

**1qt****CERT145008** Min. Buy 1 EA**1gal****CERT145007** Min. Buy 1 EA**2.5gal****CERT145006** Min. Buy 1 EA**BT NOW® Insecticide**

by BioSafe Systems

A water-based biological insecticide that offers broad-spectrum control of Lepidoptera populations on a wide variety of crops. Labeled for outdoor food, non-food, and greenhouse crops. BT NOW quickly incapacitates a pest's ability to feed, resulting in death from starvation or septicemia days after.

- Active ingredient: Bacillus thuringiensis ssp. kurstaki
- Rate: Varies depending on application. See label.
- REI: 4 Hrs
- Controls: Armyworm, loopers, leafrollers, moths, caterpillars and more.

**1gal****BSF70501** Min. Buy 1 EA**Captiva Prime® Insecticide**

by Gowan

Captiva Prime botanical insecticide agitates Mites and Thrips, flushing them from cover and enhancing contact with the pest. Captiva® Prime can be used as a stand-alone product to repel thrips and mites, stop their feeding and inhibit ovipositing. When used as a tank mix partner with traditional insecticides, it will enhance their activity.

- Active Ingredient: Capsicum extract, Garlic Oil, Canola Oil
- Rate: 16 to 32oz per Acre
- REI: 4 Hrs
- Controls: Thrips, mites, whitefly
- Signal Word: Caution

**1qt****GOW65700** Min. Buy 1 EA**Citation® 75W Insect Growth Regulator**

by Syngenta Crop Protection

Citation is an insect growth regulator that is highly effective against major dipterous pests in ornamentals. Labeled for use on greenhouse crops including ornamentals and vegetable transplants, landscape and container grown ornamentals and bedding plants.

- Active Ingredient: Cyromazine
- Rate: 2.66oz per 100gal
- REI: 12 Hrs
- Controls: Leafminers, Fungus Gnats, Shoreflies.
- Signal Word: Caution

**1lb****SYN52855** Min. Buy 1 EA**Conserve® SC Insecticide**

by Corteva

A turf and ornamental insect control with a unique mode of action derived from a naturally occurring organism. Makes a great rotational insecticide and is highly active at very low use rates. Great for control of thrips and lepidopterans larvae on herbaceous and woody ornamentals grown outdoors, in nurseries or in greenhouses; tree farms or plantations; and turf grass.

- Active Ingredient: Spinosad
- Rate: Varies depending on application method. See label for complete information.
- REI: 4 Hrs
- Controls: Thrips, lepidopterous larvae, foliage feeding worms and many more. See label for complete list.
- Signal Word: Caution

**1qt****DOW19-0007Z** Min. Buy 1 EA**CoreTect® Insecticide Tablets**

by Envu

CoreTect Tree and Shrub Tablets Insecticide will control or significantly reduce populations of insects that attack containerized, newly planted or established trees and shrubs. For use in landscape, interiorscapes and forested areas.

- Active Ingredient : Imidacloprid
- Rate : One to two tablets per gallon container
- REI : 12 Hrs
- Controls : Adelgids, Aphids, Leafhoppers, Mealybugs, Scales and more.
- Signal Word : Caution

**250 Tablets****BYR79283261** Min. Buy 1 EA

Insecticides & Miticides

DeBug® Trés Insecticide

by Mycorrhizal Applications LLC

Get killing power and application flexibility with DeBug® Trés. Take advantage of the IGR effects of the active ingredient Azadirachtin; This all-in-one product works as an insecticide, miticide, nematocide and fungicide, saving you time with short re-entry and pre-harvest intervals. This OMRI listed product is labeled for use on over 200 species of plants, trees and crops and a broad-spectrum of pests.?

- Active ingredient: Azadirachtin and Fats and Glyceridic Oils Margosa
- Rate: Varies according to application. See label for rate information.
- REI: 4 hours
- Controls: Various Pests, complete list on label
- Signal Word: Caution

**1gal****MGKAS1750904011** Min. Buy 1 EA**DeBug® Turbo Insecticide**

by Mycorrhizal Applications LLC

Get killing power and application flexibility with DeBug® Turbo. This all-in-one insecticide, miticide, nematocide and fungicide is designed to save you time in the field with short re-entry and pre-harvest intervals. This chemically diverse and structurally complex OMRI listed product is long-lasting (up to 14 days) and protects over 200 species of plants, trees and crops from a wide variety of pests.

- Active ingredient: Azadirachtin and Fats and Glyceridic Oils Margosa
- Rate: Varies according to application. See label for rate information.
- REI: 4 hours
- Controls: Various Pests, complete list on label
- Signal Word: Caution

**1qt****MGKAS1750804012** Min. Buy 1 EA**1gal****MGKAS1750804011** Min. Buy 1 EA**Decathlon® 20WP Insecticide**

by OHP, Inc.

A wettable powder insecticide effective for broad spectrum control of crawling and flying insect pests on ornamental and nursery stock. Will not stain.

- Active Ingredient: Cyfluthrin
- Rate: 1.3 to 1.9 oz per 100gal
- REI: 12 Hrs
- Controls: Aphids, Armyworms, Bagworms, Beetles, Caterpillar, Cutworm, Fungus Gnats, Gypsy Moths, Lace Bugs, Leaf Hopper; Mealybugs, Scales, Thrips, Webworm, Whiteflies
- Signal Word: Caution

**8oz****OHP981789** Min. Buy 1 EA**Dimilin® 25W Insect Growth Regulator**

by OHP, Inc.

Offers control of a variety of insect pests found on trees and shrubs grown in public and private forests, forest plantings and forest nurseries and Christmas tree and conifer nurseries. Dimilin is effective on foliar feeding insects like armyworms and lepidopterous leafminers.

- Active Ingredient: Diflubenzuron
- Rate: 2 to 8 oz per acre
- REI: 12 Hrs
- Controls: Fungus Gnat, Shorefly, Sciarid Fly and more.
- Signal Word: Caution

**5lb****OHP982380** Min. Buy 1 EAOther Info **RESTRICTED USE****DipeL® PRO DF Insecticide**

by Nufarm Americas Inc.

DipeL Pro is a biological insecticide for control of lepidopterous worms in greenhouse vegetables and ornamentals and landscape plantings.

- Active Ingredient: Bacillus thuringiensis
- Rate: Varies according to application method. See label.
- REI: 4 Hrs
- Controls: Armyworms, Loopers, Budworms and many more.
- Signal Word: Caution

**1lb****VAL89030.169** Min. Buy 1 EA**Discus® L Insecticide**

by OHP, Inc.

Discus L Insecticide's two active ingredients provide fast knockdown and broad-spectrum control on ornamentals and non-bearing fruit and nut trees in greenhouses and nurseries.

- Active Ingredient: Cyfluthrin and Imidacloprid
- Rate: 25 to 50oz per 100gal
- REI: 12 Hrs
- Controls: Armyworms, Japanese beetles, Ticks, Aphids, Thrips, Whitefly and more.
- Signal Word: Caution

**1gal****OHP982420** Min. Buy 1 EA**Distance® Insect Growth Regulator**

by Nufarm Americas Inc.

Distance insect growth regulator controls whiteflies, fungus gnats, scales and other insects by preventing eggs, larvae and pupae from maturing into adults. Labeled for use on greenhouse and outdoor ornamentals, groundcovers, shrubs and ornamental trees.

- Active Ingredient: Pyriproxyfen
- Rate: 6 to 8oz per 100gal
- REI: 12 Hrs
- Controls: Fungus Gnat, Leafminers, Scales, Shore flies, Whitefly.
- Signal Word: Caution

**1qt****VAL69730.915** Min. Buy 1 EA

WARNING: This product is not available for sale in CA.
For most up to date information please visit bfgsupply.com

Insecticides & Miticides

Ecotec Plus Insecticideby *BRANDT Consolidated Inc.*

Ecotec Plus is a botanical insecticide that offers broad spectrum control of many greenhouse pests. Suitable for use on ornamental and vegetable crops, herbs, fruit and berries and plants grown for medicinal purposes. OMRI® listed

- Active Ingredient: Rosemary Oil, Geranoil and Peppermint Oil
- Rate: 16 to 64oz per 100gal
- REI: 0 Hrs
- Controls: Aphids, beetles, mites, mealybugs, thrips, whitefly and many more.
- Signal Word: Warning

**2.5gal****BRANDT102601101** Min. Buy 1 EA**Endeavor® Insecticide**by *Syngenta Crop Protection*

Safely eliminates sap-sucking aphids and whiteflies with its unique mode of action. When sprayed on the plant, there is some initial contact activity, but the primary mode of action and residual control occurs through insect feeding inhibition. Works in tandem with biological pest control programs to further protect plants.

- Active Ingredient: Pymetrozine
- Rate: 3 to 5oz per 100gal
- REI: 12 hours
- Controls: Aphids and Whiteflies.
- Signal Word: Caution



CA Prop65 Warning

15oz**SYN62959** Min. Buy 1 EA**Engulf™ GHN Miticide**by *Nufarm Americas Inc.*

Delivers effective mite control with an advanced, higher concentration formula.

- Active Ingredient: Bifenazate
- Rate: 2 to 4 oz per 100 gals
- REI: 12 Hrs
- Controls: Various Mites
- Signal Word: Caution

**1pt****NTS10728806** Min. Buy 1 EA**Entrust® SC Insecticide**by *Corteva*

Entrust SC insecticide provides control of lepidopterous larvae, leafminers, thrips and fire ants. Labeled for use on vegetable crops, fruit, herbs, turf, ornamentals and more.

- Active Ingredient: Spinosad
- Rate: 4 to 8oz per Acre.
- REI: 4 Hrs
- Controls: Caterpillars, worms, leafminers, thrips and more.
- Signal Word: Caution

**1qt****SA33253** Min. Buy 1 EA**Evergreen® Pro 60-6 Insecticide**by *Mycorrhizal Applications LLC*

Evergreen® Pro 60-6 is a botanical based multi-purpose insecticide for use on growing crops, ornamentals, stored products, and harvested fruits and vegetables. Can be also used as a water system treatment for hydroponically grown vegetables.

- Active ingredient: Pyrethrins and Piperonyl butoxide
- Rate: 12 to 24 oz per 100 gallons
- REI: 12 hours
- Controls: Most insect pests. See label for complete list.
- Signal Word: Caution

**1gal****MAAS1750204012** Min. Buy 1 EA**Flagship® 25WG Insecticide**by *Syngenta Crop Protect*

Flagship 25WG is a broad spectrum insecticide that is effective against many sucking and chewing insects when applied to the foliage and soil. Flagship has rapid translaminar movement and is readily taken up by the plant roots.

- Active Ingredient: Thiamethoxam
- Rate: 4 to 8oz per 100gal
- REI: 12 Hrs
- Controls: Aphids, Thrips, Whiteflies, Leaf Beetles and many more.
- Signal Word: Caution

**2lb AGENCY****SYN27748** Min. Buy 1 EA**Floramite® SC Miticide**by *OHP, Inc.*

Produces quick knockdown through contact activity and long residual control of more than 21 days. Soft on predacious mites and beneficial insects. Provides outstanding control of a variety of mite pests on ornamental plants. Labeled for commercial greenhouses and nurseries.

- Active Ingredient: Bifenazate
- Rate: 4 to 8oz per 100gal
- REI: 12 Hrs
- Controls: Spider mites
- Signal Word: Caution

**1qt****OHP982718** Min. Buy 1 EA**Floramite® SC/LS Miticide**by *OHP, Inc.*

Produces quick knockdown through contact activity and long residual control of more than 21 days. Soft on predacious mites and beneficial insects. Provides outstanding control of a variety of mite pests on ornamental plants. Labeled for interiorscapes, landscapes and residential (not for plants grown for resale).

- Active Ingredient: Bifenazate
- Rate: 4 to 8oz per 100gal
- REI: 12 Hrs
- Controls: Spider mites
- Signal Word: Caution

**8oz****OHP982714** Min. Buy 1 EA

Insecticides & Miticides

Forbid® 4F Miticideby *Envu*

Offers outstanding knockdown and residual control of mites and all stages of whiteflies for four to eight weeks. Excellent translaminar activity for easier coverage and has minimal effects on beneficial insects when used according to label directions.

- Active Ingredient : Spiromesifen
- Rate : 1.4 to 4oz per 100gal
- REI : 12 Hrs
- Controls : Spider mites, Tarsonemid mites, Whiteflies.
- Signal Word : Caution

**8oz****PROKZ19-0522W** Min. Buy 1 EA**Fulcrum® Insect Growth Regulator**by *OHP, Inc.*

Fulcrum Insecticide is highly effective against a broad-spectrum of greenhouse and nursery insects. Fulcrum controls nymphs/larvae and pupae and negatively affects development of viable eggs. Use sites include: shrubs, ornamentals, flowering and foliage plants, ground covers and non-bearing fruit and nut trees.

- Active Ingredient: Pyriproxyfen
- Rate: 2 to 8oz per 100gal
- REI: 12 Hrs
- Controls: Aphids, Fungus Gnats, Leafminers, Whiteflies and more.
- Signal Word: Caution

**1qt****OHP982840** Min. Buy 1 EA**Gnatrol® WDG Insecticide**by *Nufarm Americas Inc.*

Gnatrol biological insecticide offers effective control of fungus gnat larvae in greenhouse ornamentals and vegetable plants and nurseries. Gnatrol is OMRI listed for organic production.

- Active Ingredient: Bacillus thuringiensis
- Rate: 3.2 to 26oz per 100gal
- REI: 4 Hrs
- Controls: Fungus Gnat larvae.
- Signal Word: Caution

**16lb****VAL60215.146** Min. Buy 1 EA**Grandevo® CG Insecticide**by *Pro Farm*

Grandevo® is a microbial-based insecticide. Grandevo contains several active compounds that repel, stop feeding, reduce reproduction and induce mortality to prevent the development of damaging populations of sucking and chewing insects, flies and mites. Grandevo can be used on a wide range of organic and conventional crops, including fruits, vegetables, nuts and turf and ornamentals.

- Active Ingredient: Chromobacterium subsugae strain PRAA4-1
- Rate: Varies depending on application. See label.
- REI: 4 hours
- Controls: Aphids, Whitefly, Psyllids, Mealybugs, Thrips, and more.
- Signal Word: Caution

**1lb - OMRI Listed®****MB10085** Min. Buy 1 EA**4lb****MB10082** Min. Buy 1 EA**Grandevo® WDG Insecticide**by *Pro Farm*

Grandevo® is a microbial-based insecticide. Grandevo contains several active compounds that repel, stop feeding, reduce reproduction and induce mortality to prevent the development of damaging populations of sucking and chewing insects, flies and mites. Grandevo can be used on a wide range of organic and conventional crops, including fruits, vegetables, nuts and turf and ornamentals.

- Active Ingredient: Chromobacterium subsugae strain PRAA4-1
- Rate: 1 to 3lbs per 100gal
- REI: 4 Hr
- Controls: Mites, whitefly, mealybug, thrips, aphids
- Signal Word: Caution

**6lb****MB10047** Min. Buy 1 EA**Hachi-Hachi® SC Insecticide**by *Sepro Corporation*

Hachi-Hachi SC provides superior thrips and aphid control with no known resistance and excellent efficacy on scale, leafhoppers and early instar lepidopteran insects.

- Active Ingredient: Tolfenpyard
- Rate: 14 to 32oz per 100gal
- REI: 12 Hrs
- Controls: Thrips, Aphids, Scale, Leafhoppers, Lepidopteran Insects, Whiteflies
- Signal Word: Warning

**64oz AGENCY****SEPRO1159.464** Min. Buy 1 EA

WARNING: This product is not available for sale in CA.
For most up to date information please visit bfgsupply.com

800-883-0234
www.bfgsupply.com

Insecticides & Miticides

Hexygon IQ Ovicide/Miticideby *Gowan*

Hexygon miticide provides long-lasting control of mites in ornamental plants and nonbearing fruit trees grown in greenhouses and nurseries. Other use sites include greenhouse tomatoes and select peppers, established ornamental landscape plantings and turf.

- Active Ingredient: Hexythiazox
- Rate: 4 to 8 oz per 100 gal
- REI: 12 hours
- Controls: Many species of spider mite
- Signal Word: Caution

**1qt****GOW76283**

Min. Buy 1 EA

**LALGUARD M52 OD Insecticide**by *Lallemand Plant Care*

LALGUARD M52 OD (formerly Met52) is an effective and versatile bioinsecticide for foliar and soil pest management. Composed of spores of the fungus *Metarhizium brunneum* strain F52 (formerly *Metarhizium anisopliae*), provides proven pest control efficacy with minimum impact to applicators, non-targets, and the surrounding environment. A Leading choice for Mites, Root Aphids and Thrips.

- Active Ingredient: *Metarhizium brunneum* strain F52
- Rate Varies Per Crop
- REI: 4 Hrs
- Controls: Whiteflies, Aphids, Thrips, Mites
- Signal Word: Caution

**1liter****LAL100212**

Min. Buy 1 EA

**Kontos® Insecticide**by *Envu*

Highly effective control of sucking pests including adelgids, aphids, leafhoppers, mealybugs, psyllids, scales, thrips, and whiteflies. Can be applied by spray or drench application and offers up to 30 days of residual control. For use in nurseries, greenhouses and interior plantscapes on ornamentals, vegetable transplants and non-bearing fruit trees.

- Active Ingredient: Spirotetramat
- Rate : 1.7 to 3.4oz per 100gal
- REI : 24 Hrs
- Controls : Adelgids, Aphids, Leafhoppers, Mealybugs, Scales and more.
- Signal Word : Warning

**250ml AGENCY****BYR84915440**

Min. Buy 1 EA

**Magus® Miticide**by *Gowan*

A highly effective broad-spectrum miticide with excellent contact and ingestion activity against tetranychid, eriophyid and other key mite pests. It provides quick knockdown and residual activity against mites on a wide range of ornamental crops. Magus is also highly effective at controlling powdery mildew in susceptible crops.

- Active Ingredient: Fenazaquin
- Rate: 12 to 24oz per 100gal
- REI: 12 Hrs
- Controls: Mites and Whitefly.
- Signal Word: Warning

**1qt****GOW54293**

Min. Buy 1 EA

Other Info **SHIPS HAZ****Kopa® Insecticidal Soap**by *OHP, Inc.*

Kopa insecticidal soap for control of insect and mite pests on vegetables, fruits and ornamental plants grown in greenhouses and outdoors.

- Active Ingredient: Potassium salts of fatty acids
- Rate: 1 to 3gal per 100gal
- REI: 12 Hrs
- Controls: Wide variety of soft bodied insects
- Signal Word: Warning

**2.5gal****OHP985025**

Min. Buy 1 EA

**Mainspring® GNL Insecticide**by *Syngenta Crop Protect (Agency)*

Mainspring GNL insecticide guards greenhouse and nursery crops from key chewing and sucking pests, including thrips, whiteflies, aphids, caterpillars, leafminers, leaf-feeding beetles, soft scales and lacebugs. Controls multiple key pests as a spray or drench, providing extended protection through its systemic and translaminar movement to prevent pest populations from building to damaging levels

- Active Ingredient: Cyantraniliprole
- Rate: Foliar- 1 to 12 oz per 100 gal. Drench- 12oz per 100 gal
- REI: 4 hours
- Controls: Leafminers, Thrips, Whiteflies, Beetles and more.
- Signal Word: Caution

**1pt AGENCY****SYN58664**

Min. Buy 1 EA

1gal AGENCY**SYN66345**

Min. Buy 1 EA



Insecticides & Miticides

Mallet® .5G Insecticide

by Nufarm Americas Inc.

Mallet 0.5G Insecticide protects plants from within, providing fast knock-down, broad-spectrum control, long-lasting grub and insect control with preventative and curative properties. Labeled for use on greenhouse ornamentals, nursery, landscape and turfgrass.

- Active ingredient: Imidacloprid
- Rate: 1 to 2 lbs per 1,000 sq ft
- REI: 12 hours.
- Controls: Most turf insect pests including Weevils, June bugs, European Chafer, Crickets, and more.
- Signal Word: Caution

**30lb****NTS10176032** Min. Buy 1 EA**Mallet® 2F T&O Insecticide**

by Nufarm Americas Inc.

Mallet 2F Insecticide is a liquid concentrate for the contact and systemic control of insect pests in nearly all residential and commercial settings. Mallet 2F is a neonicotinoid insecticide with long-lasting, residual control in ornamentals, turfgrass, nurseries, vegetable plants in greenhouses and more.

- Active Ingredient: Imidacloprid
- Rate: 2oz per 100gal
- REI: 12 Hrs
- Controls: Aphids, Lace bugs, Mealybugs, Thrips, Whitefly and more.
- Signal Word: Caution

**1gal****NTS10432041** Min. Buy 1 EA**2.5gal****NTS10432225** Min. Buy 1 EA**Marathon® G Insecticide**

by OHP, Inc.

A highly-active insecticide that demonstrates systemic activity in plants and offers residual control on ornamental plants. A granular formula when applied to the soil surface or incorporated into the media offers up to 8 weeks of residual control.

- Active Ingredient: Imidacloprid
- Rate: Varies depending on application method. See label.
- REI: 12 Hrs
- Controls: Aphids, Fungus Gnat, Whitefly and more.
- Signal Word: Caution

**5lb****OHP985495** Min. Buy 1 EA**50lb****OHP985350** Min. Buy 1 EA**Marathon® II Insecticide**

by OHP, Inc.

A highly-active insecticide that demonstrates systemic activity in plants and offers residual control on ornamental plants for resale grown in the greenhouse, nursery, and interior plantscapes. A flowable formulation that allows for a foliar spray application. At very low rates Marathon II as a spray offers 3 to 4 weeks of control on sucking and piercing insects.

- Active Ingredient: Imidacloprid
- Rate: 50ml per 100gal
- REI: 12 Hrs
- Controls: Aphids, Fungus Gnat, Whitefly and more.
- Signal Word: Caution

**250ml****OHP985250** Min. Buy 1 EA**Merit® 75WSP Insecticide**

by Bayer Cropscience Lp

Merit 75 insecticide provides foliar and systemic control of insect pests in turfgrass, landscape ornamentals, fruit and nut trees, and interior plantscapes. Packaged in 1.6 ounce water soluble packets for easy measuring.

- Active Ingredient: Imidacloprid
- Rate: One 1.6oz water soluble packet per 300gal.
- REI: 12 hours.
- Controls: Aphids, Adelgids, Beetles, Leafhoppers, and more.
- Signal Word: Caution

**4 x 1.6oz Packs****PROKZ19-0121** Min. Buy 1 EA**Minx 2® Insecticide**

by Nufarm Americas Inc.

Delivers quick and broad-spectrum mite and leafminer control in a new low volatile organic compound (VOC), water-based formula. It also works to suppress aphids, whiteflies and thrips. Compared to many other Abamectin products, Minx 2 offers added application flexibility and applicator comfort.

- Active Ingredient: Abamectin
- Rate: 4 to 8oz per 100gal
- REI: 12 Hrs
- Controls: Mites, Leafminers, Thrips, Aphids, Whiteflies
- Signal Word: Warning

**1qt****NTS10666432** Min. Buy 1 EA**1gal****NTS10666041** Min. Buy 1 EA

WARNING: This product is not available for sale in CA.
For most up to date information please visit bfgsupply.com

800-883-0234
www.bfgsupply.com

Insecticides & Miticides

Molt-X® Insect Growth Regulatorby *BioWorks Inc.*

Molt-X is an insect growth regulator for control of a wide variety of greenhouse pests. Safe for beneficial insects. Labeled for use on greenhouse vegetable and ornamental crops, nursery, turf, trees and shrubs.

- Active Ingredient: Azadirachtin
- Rate: 8 to 10oz per 100gal
- REI: 4 Hrs
- Controls: Aphids, Thrips, Whiteflies and more
- Signal Word: Caution

**1qt****BW1MX27A22** Min. Buy 1 EA**1gal****BW1MX27A23** Min. Buy 1 EA**M-Pede® Insecticide**by *Gowan*

Natural, safe, insecticide, miticide and fungicide that provides excellent contact control of various soft bodied insects, mites and powdery mildew throughout their life cycles.

- Active Ingredient: Potassium Salts of Fatty Acids
- Rate: Varies depending on application method. See label.
- REI: 12 Hrs
- Controls: Aphids, Thrips, Fungus Gnat, Whitefly and more. Effective against Powdery Mildew.
- Signal Word: Warning

**2.5gal****GOW52822** Min. Buy 1 EA**Mural® + Mainspring® GNL Fungicide / Insecticide**by *Syngenta Crop Protect (Agency)*

Mural fungicide and Mainspring GNL insecticide together in one multipak offers protection from ornamental diseases and pests. Multipak contains 3lbs of Mural and 2 pts of Mainspring.

- Active Ingredient: Mainspring-Cyantraniliprole, Mural-Azoxystrobin, Benzovindiflupyr
- Rate: Varies according to application. See label.
- REI: 12 Hrs
- Controls: Aphids, Thrips, Whiteflies and more as well as ornamental diseases.
- Signal Word: Caution



Multipack / Contains 3ea 1lb Mural® & 2ea 1pt Mainspring® GNL AGENCY

SYN60500 Min. Buy 1 CS**Mycotrol® ESO Mycoinsecticide**by *Certis USA LLC*

Mycotrol® ESO is tough on the early stages of insects to prevent population outbreaks and the need for rescue treatments. This versatile formulation can be used as a stand-alone, in a tank mix, or as a rotational partner in an IPM program. Ideal for resistance management with a unique mode of action for the toughest pests. Liquid formulation.

- Active Ingredients : Beauveria bassiana strain GHA, 11.3%
- Rate: 0.5 to 3 qts per 100 gals
- REI: 4 Hrs / PHI: 0 Days
- Controls : aphids, thrips, whiteflies, psyllids, mealybuas, leafhoppers & planthoppers, weevils, plant bugs, borers, orthoptera, scarab beetles, and more
- Signal Word: Caution

**1qt****CERT145004C** Min. Buy 1 EA**1gal****CERT145004D** Min. Buy 1 EA**NoFly® WP Insecticide**by *Blacksmith BioScience*

NoFly WP mycoinsecticide is a high concentration of the active ingredient *Isaria fumosoroseus* strain FE 9901, a naturally occurring insecticidal microorganism. This aggressive fungus is a natural predator to select insect pests while non-pathogenic to beneficials. NoFly WP is also compatible with many chemicals and is effective against Whitefly, Thrips, Aphids, and Mealy bugs.

- Active Ingredient: *Isaria fumosoroseus*
- Rate: 1 to 4lbs per Acre
- REI: 4 Hrs
- Controls: Eggs and larvae of Whiteflies, Aphids, Thrips and Mealy bugs.
- Signal Word: Caution

**2lb****BBSLGNF0022** Min. Buy 1 EAOther Info **SHIPS DIRECT****20lb****BBSLGNF0020** Min. Buy 1 EAOther Info **SHIPS DIRECT****Notavo® Ovicide/Miticide**by *OHP, Inc.*

Notavo Ovicide/Miticide is highly effective at controlling eggs and early instar mite stages. Notavo may be used for mite management on commercial ornamental plants grown in greenhouses, saran and shade houses, outdoor containers and field-grown nursery stock.

- Active Ingredient: Clofentezine
- Rate: 2 to 8oz per 100gal
- REI: 12 Hrs
- Controls: Spider mites
- Signal Word: Caution

**1pt****OHP981081** Min. Buy 1 EA

Insecticides & Miticides

Onyx Pro® Insecticide

by FMC

Onyx Pro insecticide prevents beetles and borers in Christmas trees and nursery grown trees. Also labeled for use on outdoor ornamentals, lawns, sod farms and golf courses to control a wide range of insect pests. Application can be made as a foliar spray or media drench.

- Active Ingredient: Bifenthrin
- Rate: Varies depending on application method. See label for complete information.
- REI: 12 hours.
- Controls: Beetles and borers plus a wide range of other turf and ornamental insect pests.
- Signal Word: Caution



1qt

FMC19-0032 Min. Buy 1 EA

Other Info **RESTRICTED USE****Overture® 35WP Insecticide**

by Nufarm Americas Inc.

A wettable powder that fights resistance and controls thrips at all life stages, including tough western flower thrips, while also controlling lepidopteran insects. Safe on most beneficial insects.

- Active Ingredient: Pyridalyl
- Rate: 8oz per 100gal
- REI: 12 Hrs
- Controls: Thrips, Budworm and Cabbage Looper larvae and more.
- Signal Word: Caution



11b

VAL62120.084 Min. Buy 1 EA

**Pedestal® Insect Growth Regulator**

by OHP, Inc.

Effective in controlling a variety of insect pests on ornamental plants. Provides an effective means for controlling whiteflies, thrips, leaf miners, armyworms and certain other foliar feeding insects on container and field grown ornamentals in greenhouses, shade houses and nurseries. Applied as a foliar spray to control immature stages of the target pests.

- Active Ingredient: Novaluron
- Rate: 6 to 8oz per 100gal
- REI: 12 Hrs
- Controls: Whitefly, Thrips, Leafminers, lepidoptera
- Signal Word: Caution



1qt

OHP986195 Min. Buy 1 EA

**Pradia™ Insecticide**

by OHP, Inc.

Pradia™ insecticide is a combination of two active ingredients for control of a wide variety of pests on ornamental and nursery crops. Pradia™ delivers quick knockdown and lasting residual control of Aphids, Thrips, Whiteflies, Lepidopteran species and many more.

- Active Ingredient: Cyclaniliprole and Fonicamid
- Rate: 10 to 17 oz per 100 gallons.
- REI: 12 hours
- Controls: Adelgids, Gypsy Moth, Japanese Beetles, Aphids, Leafminers, Mealybugs, and many more.
- Signal Word: Caution



1qt

OHP986300 Min. Buy 1 EA

**ImidaStar® 2L T&O Insecticide**

by Albaugh, LLC

ImidaStar® 2F T&O is a liquid formulation of Imidacloprid labeled for golf courses, lawncare and commercial turf as well as ornamentals for the control of grubs as well as many sucking and chewing insects. The residual insecticide may be both foliar and soil applied.

- Active Ingredient: Imidacloprid
- Rate: 2oz per 100gal
- REI: 12 hours
- Controls: Aphids, Lace bugs, Mealybugs, Thrips, Whitefly and more.
- Signal Word: Caution



1gal

ALB84502AL0041 Min. Buy 1 EA

Pycana® Insecticide

by OHP, Inc.

Pycana™ is a OMRI Listed Insecticide/Miticide combination product containing pyrethrins and canola oil. Pycana provides quick knockdown of many insects and mites including aphids, leafhoppers, earwigs, plant bugs, psyllids, mealybugs, thrips, whiteflies and spider mites. May be used on ornamentals, fruits, vegetables and herbs grown in greenhouses, shade houses, hoop houses and container grown nurseries.

- Active Ingredient: Canola oil and pyrethrins
- Rate: 1 to 2% Concentration
- REI: 12 Hrs
- Controls: Aphids, Leafminers, Mealybugs, Thrips, Mites and more.
- Signal Word: Caution



1gal

OHP986400 Min. Buy 1 EA

**PyGanic® Gardening Insecticide**

by Mycorrhizal Applications LLC

Pyganic Gardening is a botanical insecticide designed for the home gardener. Pyganic rapidly knocks down and kills the most damaging garden pests. Labeled for use on vegetables, herbs, fruit and nut trees, and ornamental plants grown in gardens.

- Active Ingredient: Pyrethrins (1.4 EC)
- Rate: See label
- REI: 0 hours
- Controls: Aphids, Cabbage Loopers, Fungus Gnats, Whiteflies, and many more.
- Signal Word: Caution



8oz

MGK7443G20 Min. Buy 1 EA

1qt

MGK7448AD30B Min. Buy 1 EA



WARNING: This product is not available for sale in CA. For most up to date information please visit bfgsupply.com

Insecticides & Miticides

PyGanic® Specialty Insecticide*by Mycorrhizal Applications LLC*

Pyganic Specialty is a professional botanical insecticide that rapidly knocks down and kills pests in greenhouses and nurseries. Labeled for use on ornamental plants, vegetables, fruit and nut trees.

- Active Ingredient: Pyrethrins (5.0 EC)
- Rate: 2 to 8 oz per 100 gal
- REI: 12 hours
- Controls: Aphids, Cabbage Loopers, Fungus Gnats, Whiteflies, and many more.
- Signal Word: Caution

**1qt****MGK7444-D30A** Min. Buy 1 EA**1gal****MGK19-0545M** Min. Buy 1 EA**Pylon® Miticide***by BASF Corp*

Pylon® is a broad-spectrum miticide & insecticide that provides control of mites, thrips, and adult fungus gnats. Controls the target insect or mite by interfering with the energy production of pests. Its translaminar movement and mode of action results in mortality of most pests within 72 hours.

- Active Ingredient: Chlorfenapyr
- Rate: 2 to 10oz per 100gal
- REI: 12 Hrs
- Controls: Mites, Thrips, Foliar Nematodes, Caterpillars, Fungus Gnats
- Signal Word: Caution

**1pt****BAS59012156** Min. Buy 1 EA**1qt AGENCY****BAS59024027** Min. Buy 1 EA**Pylon® TR Miticide***by BASF Corp*

Pylon® is a broad-spectrum miticide & insecticide that provides control of mites, thrips, and adult fungus gnats. Controls the target insect or mite by interfering with the energy production of pests. Its translaminar movement and mode of action results in mortality of most pests within 72 hours.

- Active Ingredient: Chlorfenapyr
- Rate: One can treats up to 3,000sq ft.
- REI: 12 Hrs
- Controls: Mites, Thrips, Foliar Nematodes, Caterpillars, Fungus Gnats
- Signal Word: Warning

**2oz****BAS59012595** Min. Buy 1 EA**Pyrethrum® TR Insecticide***by BASF Corp*

Total release insecticide fogger for indoor use in Garden Centers, Greenhouses, and Nurseries. Fast and easy control of many pests including aphids, beetles, fungus gnats, caterpillars and many more. Use on ornamentals, flowering plants, vegetables, hanging baskets, bedding plants and more.

- Active Ingredient: Piperonyl butoxide and Pyrethrins
- Rate: One can treats up to 3,000sq ft.
- REI: 12 Hrs
- Controls: Aphids, Caterpillars, Beetles, Fungus Gnats and more.
- Signal Word: Caution

**2oz****BAS59011861** Min. Buy 1 EA**Rycar® Insecticide***by Sepro Corporation*

Excellent for controlling whiteflies and aphids. It also has extremely good activity on chili thrips, mealybugs and leafhoppers. Perfect alternative to traditional neonicotinoids. Rycar is very gentle on both beneficial insects and pollinators.

- Active Ingredient: Pyrifluquinazon
- Rate: 1.6 to 6.4 fl oz per 100gal
- REI: 12 Hrs
- Controls: Mealybugs and Leafhoppers
- Signal Word: Caution

**8oz AGENCY****SEPRO1056.128** Min. Buy 1 EA

Insecticides & Miticides

Safari® 20SG Insecticide

by Nufarm Americas Inc.

A super-systemic insecticide with quick uptake and knockdown. Controls a broad spectrum of pests including Q- and B-biotype whitefly. Used for indoor and outdoor ornamentals. Can be applied by foliar spray, soil drench, soil injection, or bark application.

- Active Ingredient: Dinotefuran
- Rate: Varies according to application method. See label.
- REI: 12 Hrs
- Controls: Q- and B-biotype whitefly, Hemlock woolly adelgid, emerald ash borer, mealybug, leafminer, fungus gnat, black vine weevil, glassy-winged sharpshooter, armored and soft scales and aphids
- Signal Word: Caution



CA Prop65 Warning

**12oz****VAL69712.261** Min. Buy 1 EA**3lb****VAL69712.430** Min. Buy 1 EA**Sanmite® SC Insecticide**

by Gowan

Sanmite insecticide controls a broad spectrum of pests including aphids, mites, whitefly and leafhoppers on ornamental plants, flowers and foliage crops. Also labeled for use on greenhouse tomatoes and cucumbers. Sanmite provides residual control for 30-45 days.

- Active Ingredient: Pyridaben
- Rate: 6 to 9oz per Acre
- REI: 12 Hrs
- Controls: Aphids, Thrips, Fungus Gnat, Whitefly and more.
- Signal Word: Caution

**1qt****GOW76279** Min. Buy 1 EAOther Info **SHIPS HAZ****Sarisa™ Insecticide**

by OHP, Inc.

Sarisa™ insecticide delivers broad spectrum control of pests on greenhouse ornamentals and nursery crops. Sarisa™ controls leaf feeding beetles and chewing-sucking insects.

- Active Ingredient: Cyflumetofen
- Rate: 10 to 27 oz per 100 gallons.
- REI: 4 hours
- Controls: Adelgids, Gypsy Moth, Japanese Beetles, Aphids, Leafminers, Webworms, and many more.
- Signal Word: Caution

**64oz****OHP987100** Min. Buy 1 EA**Savate® Miticide**

by Envu

Savate is a staple in a spider mite rotational program and controls all stages of Mites and Whiteflies including eggs and immature stages. The translaminar movement protects upper and lower leaf surfaces and Savate's unique mode of action group (23) makes it a great rotational tool to combat resistance. Up to 30 days of residual control.

- Active Ingredient : Spiromesefen
- Rate : 1 to 4 oz per 100gal
- REI : 12 Hrs
- Controls : Whiteflies and mites.
- Signal Word : Caution

**8oz AGENCY****BYR84907898** Min. Buy 1 EA**Scimitar® GC Insecticide**

by Syngenta Crop Protection

Scimitar GC insecticide is a microencapsulated pyrethroid formulation that provides time-release control on both surface and subsurface insects. Labeled for use on turf, greenhouse grown ornamentals and outdoor landscapes and ornamentals.

- Active Ingredient: Lambda-cyhalothrin
- Rate: 3 to 5oz per 100gal
- REI: 24 Hrs
- Controls: Ants, Aphids, Leafminers and many more.
- Signal Word: Caution

**1qt****SYN73419** Min. Buy 1 EAOther Info **RESTRICTED USE****Shuttle O® Miticide**

by OHP, Inc.

An excellent choice as a rotational tool for control of two-spotted spider mites, spruce spider mites and other mites. For use on ornamentals grown in greenhouses, container and field nurseries, lath and shade houses, arboretums, interiorscapes and on greenhouse grown fruiting vegetables.

- Active Ingredient: Acequinocyl
- Rate: 6 to 12oz per 100gal
- REI: 12 Hrs
- Controls: Two spotted spider mites, Spruce spider mites, Strawberry spider mites and more.
- Signal Word: Caution

**1pt****OHP987400** Min. Buy 1 EA**Sirocco® Miticide**

by OHP, Inc.

Provides quick knockdown and long residual control of a wide variety of insects and pests such as thrips and mites. May be used in greenhouse, shade houses, nurseries including Christmas tree and conifer plantations, landscapes and interiorscapes.

- Active Ingredient: Bifenazate
- Rate: 3 to 4oz per 100gal
- REI: 12 Hrs
- Controls: Mites, thrips, aphids, whiteflies
- Signal Word: Warning



CA Prop65 Warning

8oz**OHP987832** Min. Buy 1 EA

WARNING: This product is not available for sale in CA.
For most up to date information please visit bfgsupply.com

Insecticides & Miticides

Spear-T® Insecticide

by Vestaron Corporation

Spear-T® Liquid Concentrate is a biological insecticide/miticide for treatment of thrips, whiteflies, two spotted spider mites, broad mites and aphids in vegetables in greenhouses. Environmentally friendly and safe for honeybees. Can be sprayed or fogged, labeled for greenhouse use only.

- Active Ingredient: GS-omega/kappa-Hxtx-Hv1a
- Rate: 25% v/v
- REI: 4 Hr
- Controls: Thrips, whiteflies, two-spotted spider mites, broad mites, aphids, spotted wing drosophila
- Signal Word: Caution



1gal

VESBT128

Min. Buy 1 EA

**SuffOil-X® Insecticide**

by BioWorks Inc.

Suffocates and kills eggs, larvae, nymphs and adult soft bodied insects and mites and controls fungi including powdery mildew. The unique spray oil emulsion formulation stays in suspension better than other oils and the smaller oil particles provide uniform coverage with less chance of phytotoxicity. Use on vegetables, nursery, landscape, ornamental and greenhouse crops.

- Active Ingredient: Mineral Oil
- Rate: 1 to 2gal per 100gal
- REI: 4 Hrs
- Controls: Many pests and diseases. See label.
- Signal Word: Caution



2.5gal

BW1SX25A24

Min. Buy 1 EA

30gal

BW1SX25A38

Min. Buy 1 EA

Other Info **SHIPS DIRECT****Sultan® Miticide**

by BASF Corp

Sultan is a contact miticide for rapid spider mite control on ornamentals grown in greenhouses, shade houses, nurseries and residential and commercial landscapes. Sultan has excellent plant safety and has shown no adverse effects on beneficial insects.

- Active Ingredient: Cyflumetofen
- Rate: 1.3oz per 100gal
- REI: 12 Hrs
- Controls: Spider mites
- Signal Word: Caution



1pt AGENCY

BAS59013978

Min. Buy 1 EA

Other Info **SHIPS HAZ****Talstar® Nursery Granular Insecticide**

by FMC

Talstar Nursery granular insecticide penetrates soil to control target pests without altering the pH. balance of the soil. Talstar Nursery features a light stable active ingredient in a sand granule allowing optimal distribution in the soil with a long lasting residual effect. Granular formulation for incorporation into potting media.

- Active Ingredient: Bifenthrin
- Rate: 1 to 2lbs per 200cu yd of media.
- REI: 12 hours.
- Controls: Fungus Gnat larvae, Mealybugs, Black Vine Weevil, White Grub, and more.
- Signal Word: Caution



50lb

FMC19-0303H

Min. Buy 1 EA

**Talstar® Pro Insecticide**

by FMC

Controls pests indoors and outdoors on residential, commercial and industrial buildings, greenhouses, lawns, ornamentals and more. Talstar Pro Insecticide provides broad-spectrum control of the toughest lawn and ornamental pests.

- Active ingredient: Bifenthrin
- Rate: 2 to 4 gal per 1,000 sq ft
- REI: 12 hours.
- Controls: Caterpillars, Beetles, Aphids, Thrips, Mites, and many other insect pests
- Signal Word: Caution



1qt

FMC19-0303F

Min. Buy 1 EA

1gal

FMC10056776

Min. Buy 1 EA

**Talstar® Select Insecticide**

by FMC

Talstar Select provides long-lasting residual control of aphids, black vine weevils, scale and other nursery pests without the risk of damaging sensitive plants. It is non-staining and contains no odorous or plant-damaging solvents, so it can be applied to open blooms and colored bracts right up to the day of shipment.

- Active Ingredient: Bifenthrin
- Rate: 5 to 40oz per Acre
- REI: 12 hours.
- Controls: Aphids, caterpillars, scale, mites, fungus gnats, mealybugs, thrips, whiteflies and many more
- Signal Word: Caution



1gal

FMC19-0303G

Min. Buy 1 EA

Other Info **RESTRICTED USE**



Sultan®

miticide

An innovative miticide that is hard on spider mites and soft on beneficials.

Sultan miticide delivers a unique mode of action for rotation and integrated pest management programs.

- Contact efficacy against all life stages of Tetranychid mites
- Rapid, targeted knock-down and long residual activity
- Compatible with beneficials, including predatory mites
- Excellent plant safety with no observed phytotoxicity

Learn more – betterplants.basf.us

Always read and follow label directions.
Sultan is a registered trademark of BASF.
©2023 BASF Corporation.



TetraCURB™ MAX



"ADD TETRACURB MAX IN ROTATION IN YOUR IPM PROGRAM TODAY!"

BOTANICAL OIL-BASED MITICIDE-INSECTICIDE & REPELLENT



- Active Ingredients: Proprietary blend of rosemary, peppermint, clove & castor oils
- Smart blend: Contains emulsifiers, surfactants, and synergistic solvents
- Target pets: TSSM, small soft-bodied insects like thrips, whiteflies, aphids, mealybugs
- MoA: Contact kill, paralysis, suffocation, desiccation, and repellency
- Helps reduce the development of pesticide resistance



LEARN MORE
KEMIN.COM/TETRACURBMAX



Always read and follow label directions. FIFRA 25(b) exempt pesticide. This product is exempt from registration with the U.S. Environmental Protection Agency under FIFRA section 25(b) regulations. ©Kemin Industries, Inc. and its group of companies 2023. All rights reserved. ** Trademarks of Kemin Industries, Inc., USA.

! WARNING: This product is not available for sale in CA.
For most up to date information please visit bfgsupply.com

800-883-0234
www.bfgsupply.com

Insecticides & Miticides

Talus® 70DF Insect Growth Regulatorby *Sepro Corporation*

Talus delivers toxicity to pests via contact, ingestion and vapor activity. There is little or no systemic movement of Talus in plants, but its vapor activity allows it to reach leaf undersides where many pest species dwell and it helps protect new growth. In addition to its primary mode of action, Talus also suppresses egg-laying and causes egg sterility in treated adults.

- Active Ingredient: Buprofezin
- Rate: 6 to 14oz per 100gal
- REI: 12 Hrs
- Controls: Whiteflies, Mealybugs, Leafhoppers, Planthoppers, Scales
- Signal Word: Caution



CA Prop65 Warning

**3lb****SEPRO19-0307B** Min. Buy 1 EA**Tame® 2.4EC Insecticide**by *Nufarm Americas Inc.*

Broad spectrum insecticide that can be used in commercial lath houses, shade houses and greenhouses, as well as outdoors. It's gentle on delicate ornamentals and it's deadly to whitefly, aphid, scale and mites. Can be used on most ornamentals without fear of phytotoxicity.

- Active Ingredient: Fenpropathrin
- Rate: 5-1/3 to 10-2/3oz per 100gal
- REI: 12 Hrs
- Controls: Aphids, Glassy-winged sharpshooters, Mites, Whitefly and more.
- Signal Word: Warning



CA Prop65 Warning

**1qt****VAL69670.928** Min. Buy 1 EAOther Info **SHIPS HAZ RESTRICTED USE****TetraCURB™MAX Miticide**by *Kemin Industries Inc*

Botanical oil-based, contact biopesticide, for all crops. Multiple MoA: Paralysis, suffocation, desiccation & repellency. Interval: 5-7 days (no restrictions).

- Active ingredients: Rosemary oil 10%, Clove oil 3%, Peppermint oil 2%, Castor oil 20%.
- Spray rates: 32-256 fl.oz./100 gal, Dip rates: 3.2-6.4 fl.oz./10 gal.
- REI: 0-hour
- Target pests: Spider mites, russet mites and small soft-bodied insects like aphids, thrips, whiteflies, and mealybugs.
- Signal Word: Warning



Not available for sale in CA

**1gal****KEM018411103** Min. Buy 1 EA**TetraSan® WDG Insecticide**by *Nufarm Americas Inc.*

With contact and translaminar movement, TetraSan controls spider mites on the underside of leaves, even when it's difficult to get good under-leaf spray coverage. Formulated to affect all stages of the mite life cycle, offers residual control up to five weeks and is safe to most beneficials.

- Active Ingredient: Etoxazole
- Rate: 8 to 16oz per 100gal
- REI: 12 Hrs
- Controls: Mites
- Signal Word: Caution

**1lb****VAL69760.084** Min. Buy 1 EA**Triact 70® Botanical Oil**by *OHP, Inc.*

A broad-spectrum fungicide, miticide and insecticide. Highly effective and economical botanical oil that may be used indoors as well as outdoors on ornamental flowering plants, trees, shrubs and foliage grown in greenhouses, interiorscapes and commercial landscapes. As a fungicide, it is a preventative as well as a curative. It coats fungal spores and then dehydrates them to stop the disease cycle.

- Active Ingredient: Neem oil
- Rate: .5 to 2gal per 100gal
- REI: 4 Hrs
- Controls: Wide range of insect pests. See label for complete list.
- Signal Word: Caution

**2.5gal****OHP988500** Min. Buy 1 EA**TriStar® 8.5SL Insecticide**by *Nufarm Americas Inc.*

An odorless, water-based formulation that mixes easily and works with contact, systemic and translaminar activity to protect plants. Absorbs and spreads within the plant to provide quick knockdown of a wide spectrum of insects, in as little as 15 minutes as a direct spray. Up to 4 weeks residual control on bedding plants, 4 to 6 weeks on woody ornamentals and trees.

- Active Ingredient: Acetamiprid
- Rate: 8 to 16oz per 100gal
- REI: 12 Hrs
- Controls: Aphids, Lace bugs, Mealy bugs, Thrips, Whitefly and more.
- Signal Word: Warning

**1qt****NTS10520432** Min. Buy 1 EA**1gal****NTS10520041** Min. Buy 1 EA

Insecticides & Miticides

Ultra Pure® Horticultural Oil

by BASF Corp

Ultra Pure Oil is a year round spray oil for control of insects, mites and fungus. 98% mineral oil labeled for use on fruit and nut crops, outdoor and greenhouse vegetables, flowering and foliage ornamentals, trees and shrubs. OMRI.

- Active Ingredient: Mineral Oil
- Rate: 0.5 to 2gal per 100gal
- REI: 4 Hrs
- Controls: Adult, larval and egg stages of soft-bodied insects and mites. Effective on powdery mildew.
- Signal Word: Caution



2.5gal

BAS59011962 Min. Buy 1 EA

30gal

BAS59011963 Min. Buy 1 EA



Velifer® Fungal Contact Insecticide

by BASF Corp

Velifer fungal contact insecticide/miticide provides control of tough greenhouse pests through direct contact and application. Product is compatible with beneficial insects.

- Active ingredient: Beauveria bassiana strain PPRI 533
- Rate: 3 to 13 oz per 100 gallons
- REI: 12 hours
- Controls: Aphid, Whitefly, Thrips, Mites, Mealybug, and more.
- Signal Word: Caution



1qt

BAS59018345 Min. Buy 1 EA



Ventigra® Insecticide

by BASF Corp

Ventigra provides effective control of piercing/sucking insect pests in production and landscape ornamentals and vegetable transplants. A unique mode of action subgroup allows control of pests that have developed resistance to other insecticides. Ventigra exhibits low acute toxicity to beneficial insects and pollinators. Labeled for use in multiple sites.

- Active ingredient: Afidopyropen
- Rate: 4 to 7 oz per 100 gal.
- REI: 12 hours
- Controls: Aphids, Whitefly, Mealybugs
- Signal Word: Caution



20oz AGENCY

BAS59014680 Min. Buy 1 EA



Venerate® CG Insecticide

by ProFarm

Venerate Bio-Insecticide features multiple modes of action is effective against a wide variety of chewing and sucking insects and mites, yet easy on beneficials. The unique and novel modes of action will complement and improve integrated pest management and insect resistance management programs.

- Active ingredient: Burkholderia spp. Strain A396 cells
- Rate: 2 to 3 oz per 1,000 sq ft.
- REI: 4 hours
- Controls: Aphids, Mites, Thrips, Whitefly, Mealy bug and more
- Signal Word: Caution



1qt

MB10086 Min. Buy 1 EA

1gal

MB10083 Min. Buy 1 EA

2.5gal

MB10097 Min. Buy 1 EA



XXpire™ WG insecticide

by Corteva

Effective on 39 pests, and seven of the top 10 most troublesome ornamental insects. Controls chewing and sap-feeding insects commonly found in nurseries, greenhouses and commercial landscapes.

- Active ingredient: sulfoxaflor and spinetoram
- Rate: 4 to 7 oz per acre
- REI: 12 hours
- Controls: aphids, lepidopterous larvae, mealy bugs, thrips, whiteflies, and more.
- Signal Word: Caution



1lb

DOW11080911 Min. Buy 1 EA



WARNING: This product is not available for sale in CA.
For most up to date information please visit bfgsupply.com

BIOLOGICAL CONTROL AGENTS

	Aphids	Fungus Gnat	Leafminer	Shore Fly	Mealybug	Mites	Thrips	Whitefly
<i>Amblyseius andersoni</i>						X		
<i>Aphidoletes aphidimyza</i>	X							
<i>Amblyseius californicus</i>						X		
<i>Amblyseius cucumeris</i>						X	X	
<i>Amblyseius swirskii</i>							X	X
<i>Aphidius colemani</i>	X							
<i>Aphidius ervi</i>	X							
<i>Cryptolaemus montrouzieri</i>					X			
<i>Dalotia (Atheta) coriaria</i>		X (larvae)		X (larvae)				
<i>Diglyphus isaea</i>			X					
<i>Encarsia formosa</i>								X
<i>Eretmocerus eremicus</i>								X
<i>Hypoaspis miles</i>		X (larvae)					X (larvae)	
<i>Orius insidiosus</i>							X	
<i>Phytoseiulus persimilis</i>						X		
<i>Steinernema carpocapsae</i>		X (larvae)		X (larvae)				
<i>Steinernema feltiae</i>		X (larvae)					X	



Biological Controls

Amblyline™ Amblyseius cucumeris Thrips Controlby *Bioline Agrosiences, Inc.*

Amblyseius cucumeris sachets on a stick are perfect for early propagation protection. Place one sachet on a stick in each propagation tray, pot or hanging basket. Your crop will be protected before the Thrips larvae have a chance to become a problem. Amblyseius cucumeris is a predator that feeds on a wide range of small arthropod prey.

- Active Ingredient: Amblyseius cucumeris
- Rate: One per Tray or Pot
- Controls: Thrips, Broad mites, Cyclamen mites.



Not available for sale in CA

**1,000 Controlled Release Mini Sachets on Sticks****BIOLNP0011-50** Min. Buy 1 EA**2,000 Controlled Release Mini Sachets on Sticks****BIOLNP0011-49** Min. Buy 1 EA**50,000 Loose Mites per Bottle****BIOLNP0011-04** Min. Buy 1 EA**250,000 Loose Mites per Bag****BIOLNP0011-13** Min. Buy 1 EA**Amblyseius Cucumeris**by *BioWorks Inc.*

Amblyseius cucumeris is a predator that feeds on a wide range of pests including Thrips, Broad mites, and Cyclamen mites.

- 500 sachets on sticks, each containing 250 mites
- Rate: Varies, please reference BCA guides
- Ships direct from the manufacturer.
- Controls: Thrips, Broad mites and Cyclamen mites

**500 sachets on sticks, each containing 250 mites****BWNC5K** Min. Buy 1 EA**500 sachets with hooks each containing 250 mites.****BWNC5H** Min. Buy 1 EA**1000ct - Sachets on Sticks - 250 Mites per Sachet****BWNC1K** Min. Buy 1 EA**1000ct - Sachets with Hooks - 250 Mites per Sachet****BWNC1H** Min. Buy 1 EA**250,000 mites per bag in vermiculite****BWNCVG** Min. Buy 1 EA**Amblyseius Andersoni**by *BioWorks Inc.*

Amblyseius andersoni is a predatory mite for control of mite pests. This predator is ideal for vegetables, hardy ornamentals and fruit crops, controlling red or two-spotted spider mite, fruit-tree red spider mite, and russet mites. It is active at lower temperatures than other predatory mites and can be introduced much earlier in the growing season than some other predators.

- 25,000 mites in a tube.
- Rate: Varies, please reference BCA guides
- Ships direct from the manufacturer.
- Controls: Two spotted spider mites, red spider mites, and russet mites

**250 sachets with hooks containing 250 mites each.****BWA12H** Min. Buy 1 EA**25,000 mites in a tube.****BWA125** Min. Buy 1 EA**Amblyseius Californicus**by *BioWorks Inc.*

Amblyseius californicus is an active predatory mite that feeds on mites in the family Tetranychidae including the common Red Spider Mite or Two-Spot Mite, and the Carmine Mite. Where few spider mites are present, it is able to survive by feeding on alternative sources of food, and so can persist in a crop longer.

- 500 sachets with hooks containing 100 mites each.
- Rate: Varies, please reference BCA guides
- Ships direct from the manufacturer.
- Controls: Two spotted spider mites, red spider mites, and russet mites

**500 sachets with hooks containing 100 mites each.****BWCA5H** Min. Buy 1 EA**25,000 loose mites in a bottle.****BWCA25** Min. Buy 1 EA**Amblyseius Swirskii**by *BioWorks Inc.*

Amblyseius swirskii is a predatory mite for control of Whitefly and Thrips. Establishment will be fastest on crops with ample pollen as the pollen acts as an alternative food source. Recommended for vegetable, ornamentals, fruit trees, citrus, and berries.

- 1,000 sachets on sticks, each containing 250 mites each.
- Rate: Varies, please reference BCA guides
- Ships direct from the manufacturer.
- Controls: Whitefly, Thrips and more.

**1,000 sachets on sticks, each containing 250 mites each.****BWAS1K** Min. Buy 1 EA**1,000 sachets with hooks, each containing 250 mites each.****BWAS1H** Min. Buy 1 EA

WARNING: This product is not available for sale in CA.
For most up to date information please visit bfgsupply.com

800-883-0234
www.bfgsupply.com

HEALTHY ROOTS. HEALTHY BUSINESS.

ROOTSHIELD® PLUS:
MORE THAN A BIOLOGICAL FUNGICIDE

- + SHIELDS ROOTS FROM DISEASES UNDER A WIDER RANGE OF CONDITIONS
- + INCREASES WATER AND NUTRIENT UPTAKE
- + DELIVERS HIGHER QUALITY CROPS
- + LABELED FOR ORGANIC USE

BIOWORKSINC.COM

ABOVE AND BEYOND IS WHERE WE BEGIN



Biological Controls

Anderline™ Amblyseius andersoni Spider Mite & Rust / Russet Mite Control

by *Bioline Agrosiences, Inc.*

Amblyseius andersoni is a predatory mite that can be used in the control of a range of mite pests. This predatory mite is ideal for vegetables, hardy ornamentals and fruit crops, controlling red or two-spotted spider mite, fruit-tree red spider mite and russet mites. It is active at lower temperatures than other predatory mites.

- Active Ingredient: Amblyseius andersoni
- Rate: Covers up to 2,500sq ft
- Controls: Spider mites, Russet mites



Not available for sale in CA

25,000 Loose Mites per Tube
BIOLNP0016-03 Min. Buy 1 EA

200 Controlled Release Mini Sachets with Hooks
BIOLNP0016-31 Min. Buy 1 EA

125,000 Loose Mites per Bag
BIOLNP0016-02 Min. Buy 1 EA



Aphidius colemani

by *BioWorks Inc.*

Aphidius colemani are natural aphid parasites and very useful and effective for the management of larger Aphid species. 10 blisters cover one acre as a preventative measure. Once Aphids are found 10 blisters will cover one half acre.

- 10 blister packs each containing 100 colemani
- Rate: Varies, please reference BCA guides
- Ships direct from the manufacturer.
- Controls: Smaller Aphid species such as Green Peach and Melon



10 Blisters with 100 mummies and adults per blister
BWAC10BP Min. Buy 1 EA
Other Info [SHIPS DIRECT](#)

50 Blisters with 100 mummies and adults per blister
BWAC50BP Min. Buy 1 EA
Other Info [SHIPS DIRECT](#)



Biological Controls

Aphidius colemani/erviby *BioWorks Inc.*

Aphidius colemani and ervi mix for control of larger aphid species in vegetable and ornamental crops. These 2-3 millimeter mini-wasps are best used for preventing the establishment of aphid infestations. 10 blisters cover one acre as a preventative measure.

- 10 blister packs each containing 50 colemani and 50 ervi
- Rate: Varies, please reference BCA guides
- Ships direct from the manufacturer.
- Controls: Aphids

**10 blisters with 100 mummies in each blister****BWACE1KBP** Min. Buy 1 EA**Aphidius ervi**by *BioWorks Inc.*

Aphidius ervi is a tiny braconid wasp that stings and parasitizes large aphid species. Works very well in conjunction with Aphidius colemani. Useful and effective for the prevention and low-infestation management of various aphid species. 10 blisters cover one acre as a preventative measure.

- 10 blister packs each containing 100 ervi
- Rate: Varies, please reference BCA guides
- Ships direct from the manufacturer.
- Controls: Aphids

**10 blisters with 100 mummies in each blister****BWAE1KBP** Min. Buy 1 EAOther Info **SHIPS DIRECT****Aphidius matricariae**by *BioWorks Inc.*

Predatory wasp for control of Aphids. Use in combination with Aphidius colemani for effective aphid control.

- 500 wasps per bottle
- Rate: Varies, please reference BCA guides
- Ships direct from the manufacturer.
- Controls: Aphids

**500 mummies and adults****BWAMAT5** Min. Buy 1 EA**Aphiline™ Aphelinus abdominalis + Aphidius colemani + Aphidius ervi Aphid Control**by *Bioline Agrosiences, Inc.*

Aphid parasite mix, ideal for ornamental producers and professional nurseries, as well as hobby gardeners. Mix contains 3 parasites (Aphelinus abdominalis, Aphidius colemani and Aphidius ervi) in one pack providing multiple control of all important aphids, more than 25 species of aphids targeted. Adults begin to emerge in transit ready for action.

- Active Ingredient: Aphidius ervi, Aphidius colemani, Aphelinus abdominalis
- Rate: Covers up to 2,500 sq ft
- Controls: Aphids

**500 Loose Larvae per Bottle****BIOLNP0181-01** Min. Buy 1 EA**Aphiline™ Aphidius colemani + Aphidius ervi Aphid Control**by *Bioline Agrosiences, Inc.*

Aphid parasite mix, ideal for ornamental producers and professional nurseries, as well as hobby gardeners. Mix contains 2 parasites (Aphidius colemani and Aphidius ervi) in one pack providing multiple control of all important aphids. Adults begin to emerge in transit ready for action.

- Active Ingredient: Aphidius ervi and Aphidius colemani
- Rate: Covers up to 2,500 sq ft
- Controls: Aphids

**500 Loose Parasites per Bottle****BIOLNP0182-01** Min. Buy 1 EA**Californiline™ Amblyseius californicus Spider Mite Control**by *Bioline Agrosiences, Inc.*

Amblyseius (Neoseiulus) californicus is an active predatory mite that has specialized in feeding on mites in the family Tetranychidae. This includes the common Red Spider Mite or Two-Spot Mite Tetranychus urticae and the Carmine Mite Tetranychus cinnabarinus. It is less specialized than Phytoseiulus persimilis and while it prefers to feed on spider mites, it can feed and reproduce on other arthropod prey or pollen.

- Active Ingredient: Amblyseius californiline
- Rate: One sachet covers 0.5 - 1 sq yd.
- Controls: Spider Mites, Carmine Mites, Broad Mites

**200 Controlled Release Mini Sachets with Hooks****BIOLNP0013-31** Min. Buy 1 EA**Chrysoline™ Chrysoperla carnea (Lacewing) Aphid Control**by *Bioline Agrosiences, Inc.*

Chrysoperla carnea larvae are predators of aphids and other pests before developing into Lacewing adults. Chrysoline arrives as young larvae with full feeding potential. One larvae can eat 200 aphids. As adults they disperse and hunt down aphid colonies. Easy to observe and monitor.

- Active Ingredient: Chrysoperla carnea
- Rate: Covers up to 1,000 sq ft
- Controls: Aphids

**1000ct Larvae per bag****BIOLNP0301-04** Min. Buy 1 EA

WARNING: This product is not available for sale in CA.
For most up to date information please visit bfgsupply.com

800-883-0234
www.bfgsupply.com

Biological Controls

Chrysoperla Rutilabrisby *BioWorks Inc.*

Chrysoperla rutilabris (Green Lacewing) are aphid predators. Lacewing adults feed only on nectar, pollen and honeydew but the Lacewing larvae are voracious predators of aphids and other small soft bodied insects, larvae and eggs. One larvae can consume up to 200 aphids. Lacewing eggs and larvae should be dispersed within aphid colonies. Adult Lacewing will find and lay their eggs within the aphid colony.

- 5,000 Lacewing eggs per bottle.
- Rate: Varies, please reference BCA guides
- Ships direct from the manufacturer.
- Controls: Aphids and other small insect larvae and eggs.

**5,000 Lacewing eggs on cards****BWLWCD** Min. Buy 1 EA**Chrysoperla Rutilabris**by *BioWorks Inc.*

Chrysoperla rutilabris is a species of green lacewing in the family Chrysopidae.

- 1,000 per tube
- Rate: Varies, please reference BCA guides
- Ships direct from the manufacturer.
- Controls: Aphids and generalist predator

**1k tube Lacewing adults****BWLWA3** Min. Buy 1 EA**Dalotia Coriaria**by *BioWorks Inc.*

Dalotia (Atheta) coriaria is a generalist predator of soil and compost pests. This rove beetle is particularly good at feeding on the larvae of Sciarid flies, Shore flies, and Thrips pupae. Introduce early in the season to give Dalotia time to build up a good population.

- 1,000 beetles per bottle.
- Rate: Varies, please reference BCA guides
- Ships direct from the manufacturer.
- Controls: Sciarid flies, Shore flies

**1,000 beetles per bottle****BWDC10** Min. Buy 1 EA**3,000 beetles per bucket****BWDCBK** Min. Buy 1 EA**5000****BWDC5K** Min. Buy 1 EAOther Info **SHIPS DIRECT****Exhibitline sf™ Steinernema feltia Fungus Gnat and Thrips Control**by *Bioline Agrosciences, Inc.*

Steinernema feltia nematodes help control Fungus Gnat and Thrips. Harmless to the ornamental crops, humans, the environment and other beneficial insects, these nematodes actively seek out fungus gnat larvae by swimming in the thin film of water on soil particles. They locate hosts by detecting carbon dioxide and other waste products.

- Active Ingredient: Steinernema feltia
- Rate: Varies
- Controls: Fungus Gnat and Thrips.



Not available for sale in CA

**Sea of 250 Million per Tray****BIOLNP1011-03** Min. Buy 1 CS**Hypoline™ Hypoaspis miles Fungus Gnat Control**by *Bioline Agrosciences, Inc.*

Hypoaspis miles attacks and kills the larvae of sciarid flies and will also consume thrips larvae that drop to the growing medium to pupate, making it a useful addition to other Western Flower Thrips control products. Also attacks and kills larvae of Fungus Gnats, but not eggs or pupae. Up to eight, first instar larvae may be attacked and consumed each day by adult Hypoaspis.

- Active Ingredient: Hypoaspis miles
- Rate: Covers up to 2,500sq ft
- Controls: Fungus Gnat, Shore Fly and Thrips pupae.



Not available for sale in CA

**25,000 Loose Larvae per Tube****BIOLNP0091-03** Min. Buy 1 EA**125,000 Loose Larvae per Tub****BIOLNP0091-04** Min. Buy 1 EA**Millenium® Beneficial Nematodes**by *BASF Corp*

Millenium (Steinernema carpocapsae) beneficial nematodes protect plants from damage from Shore flies and other soil dwelling insects. They attack and kill targeted pests without affecting any other organisms. Sold in a tray of 250 million nematodes. The minimum purchase is 5 trays.

- Active Ingredient: Steinernema carpocapsae
- Rate: 250 Million Will Treat 2,750 to 5,400sq ft
- REI: 0 Hrs
- Controls: Shore flies

**1 Tray of 250 Million****BAS58067388** Min. Buy 1 EAOther Info **SHIPS DIRECT**

Biological Controls

NemaShield® Steinernema Beneficial Nematodesby *BioWorks Inc.*

Provides excellent biological control of fungus gnats by eliminating damaging fungus gnat larvae. A single application is sufficient for preventing fungus gnat outbreaks or for control in the beginning phase of an outbreak. Effective in a Western Flower Thrips control program for treatment of pupae and pre-pupae. It will also control thrips species.

- Active Ingredient: *Steinernema feltiae*
- Rate: Varies depending on application method. See label.
- REI: 0 Hrs
- Controls: Fungus Gnat, Thrips.

**100 Million Pack****BW1N20A26** Min. Buy 1 EAOther Info *SHIPS DIRECT***250 Million Pack****BW1N20A27** Min. Buy 1 EAOther Info *SHIPS DIRECT***Nemasys® Beneficial Nematodes**by *BASF Corp*

Nemasys (*Steinernema feltiae*) beneficial nematodes provide biological control of Thrips and the soil dwelling stages of Fungus Gnats. They attack and kill targeted pests without affecting any other organisms. Sold in a box containing 5 trays, 50 million nematodes per tray.

- Active Ingredient: *Steinernema feltiae*
- Rate: 50 Million Will Treat Approximately 1,100sq ft
- REI: 0 Hrs
- Controls: Thrips and Fungus Gnats.

**1 Tray of 50 Million****BAS59014493** Min. Buy 5 EAOther Info *SHIPS DIRECT***5 Trays of 250 Million****BAS59014486** Min. Buy 1 CSOther Info *SHIPS DIRECT***Nemasys® L Beneficial Nematodes**by *BASF Corp*

Nemasys L (*Steinernema kraussei*) beneficial nematodes provide biological control of the larval stage of Black Vine Weevil. Can be applied by spray or drench. They attack and kill targeted pests without affecting any other organisms. Sold in a tray containing 250 million nematodes. Minimum order is 2 trays.

- Active Ingredient: *Steinernema kraussei*
- Rate: 250 Million Will Treat Approximately 5,500sq ft
- REI: 0 Hrs
- Controls: Black Vine Weevil.

**2 Trays of 250 Million****BAS59014482** Min. Buy 5 EAOther Info *SHIPS DIRECT***Oriline i™ Orius insidiosus Thrips Control**by *Bioline Agrosciences, Inc.*

Orius insidiosus is the only biological control agent that kills adult Thrips. A single Orius bug can kill up to 80 Thrips per day. Orius populations establish well on pollen rich crops. Feeding *Ephestia* eggs will enhance the establishment of Orius. It takes 4 to 6 weeks to establish a population.

- Active Ingredient: *Orius insidiosus*
- Rate: Varies
- Controls: Thrips and others.



! Not available for sale in CA

**1,000 per Bottle****BIOLNP1102-06** Min. Buy 1 EA**2,000 per Bottle****BIOLNP1102-07** Min. Buy 1 EA**Orius Insidiosus**by *BioWorks Inc.*

Orius insidiosus is an aggressive Thrips predator and one of the few beneficial insects that can kill adult thrips. Orius takes a little longer to establish a population which makes it a good follow up treatment after *Amblyseius cucumeris* or *Amblyseius swirskii* releases.

- 1,000 per bottle
- Rate: Varies, please reference BCA guides
- Ships direct from the manufacturer.
- Controls: Thrips

**1,000 per bottle****BWOIM** Min. Buy 1 EA**2,000 per bottle****BWOIM2** Min. Buy 1 EA**Phytoline™ Phytoseiulus persimilis Mite Control**by *Bioline Agrosciences, Inc.*

Phytoline biological control agent contains the predatory mite, *Phytoseiulus persimilis*. This well-known predator will eat large numbers of two-spotted spider mite. Recommended for spider mite control in many crops, particularly tomatoes, cucumbers, strawberries and ornamentals.

- Active Ingredient: *Phytoseiulus persimilis*
- Rate: One Bottle Covers 2,000sq ft
- Controls: Spider mites



! Not available for sale in CA

**2,000 per Bottle****BIOLNP1201-01** Min. Buy 1 EA**20,000 per Bottle****BIOLNP1201-21** Min. Buy 1 EA

WARNING: This product is not available for sale in CA. For most up to date information please visit bfgsupply.com

800-883-0234
www.bfgsupply.com

Biological Controls

Phytoseiulus Persimilis

by *BioWorks Inc.*

Phytoseiulus persimilis is an active spider mite predator. This species has become the standard spider mite treatment in a wide variety of crops. Persimilis develops twice as fast as the spider mite which allows a rapid control of outbreaks.

- 10,000 per bottle
- Rate: Varies, please reference BCA guides
- Ships direct from the manufacturer.
- Controls: Two Spotted Spider mites



10,000 per bottle
BWPP10 Min. Buy 1 EA

25,000 per 1L bottle
BWP25L Min. Buy 1 EA

Staphyline™ Atheta coriaria Fungus Gnat and Shore Fly Control

by *Bioline Agrosiences, Inc.*

Staphyline biological control agent contains the predatory beetle, Atheta coriaria. It can be used in crops such as herbs and ornamentals to protect against soil and compost pests. This rove beetle is a generalist arthropod feeder, but the adults and young stages are particularly good at feeding on the larvae of Fungus Gnat and Shore Flies.

- Active Ingredient: Atheta coriaria
- Rate: Covers up to 2,000sq ft
- Controls: Fungus Gnat and Shore Flies.



Not available for sale in CA



500 Loose Larvae per Tube
BIOLNP0061-01 Min. Buy 1 EA

Starskii™ Amblyseius swirskii Whitefly Control

by *Bioline Agrosiences, Inc.*

Swirskii biological control agent contains the predatory mite, Amblyseius swirskii. It is primarily used to control whiteflies and thrips but it will provide some reduction in other small pest species. In the absence of prey it can survive by feeding on pollen, allowing it to survive longer in the crop. They breed extremely quickly under warm, humid conditions.

- Active Ingredient: Amblyseius swirskii
- Rate: One sachet covers 0.5 - 1 sq yd.
- Controls: Whiteflies, Thrips and More



Not available for sale in CA



500ct Controlled Release Larvae Mini Sachets on Sticks

BIOLNP0015-50 Min. Buy 1 EA

6ea of 328ft Buglines - A Continuous String of Controlled Release Sachets

BIOLNP0015-07 Min. Buy 1 EA

25,000 Loose Larvae per Tube

BIOLNP0015-03 Min. Buy 1 EA

125,000 Loose Larvae per Bag

BIOLNP0015-02 Min. Buy 1 EA

Stratiolaelaps scimitus

by *BioWorks Inc.*

Stratiolaelaps scimitus (Hypoaspis miles) attacks and kills the larvae of sciurid flies and will also consume thrips larvae that drop to the growing medium to pupate, making it a useful addition to other Western Flower Thrips control products. Also attacks and kills larvae of Fungus Gnats. Normally found within the top half inch of soil / growing media, females lay eggs which hatch after six days.

- 25,000 mites per bottle
- Rate: Varies, please reference BCA guides
- Ships direct from the manufacturer.
- Controls: Fungus gnat, Shore fly, Thrips



25,000 mites per bottle
BWSS25 Min. Buy 1 EA

125,000 per bucket
BWSSBK Min. Buy 1 EA



Pest Monitoring

Catchmaster® Sticky Cards

by Catchmaster

These pest identification cards are ideal for greenhouses, offices, florists or any other indoor plant locations. The double-sided adhesive cards target whitefly, leaf-miner, aphids, thrips and fungus gnats. Non-toxic and pesticide-free. Twist ties and stands are included.

- Ideal for greenhouses
- Targets: Whitefly, Leafminer, Aphid, Thrips, and Fungus Gnats



! Not available for sale in CA

72pk
CM980Y

Min. Buy 1 EA

Insect Monitoring Sticky Cards

by BioWorks Inc.

These insect monitoring cards feature a unique double sided yellow/blue format. The yellow side attracts flying adult aphids, whitefly, fungus gnats, leaf miners and more. The blue side attracts flying adult thrips. Each card is 4in x 5in with 1in grid on both sides for easy monitoring. Weather resistant with an easy peel-off backing as well as a hole punched for hanging.

- Perfect scouting tool
- Ships direct from the manufacturer.
- Capture and keep track of greenhouse pests



100ct

BW1GS40A41 Min. Buy 1 EA
Other Info SHIPS DIRECT

Sensor® Sticky Cards

by BASF Corp

Durable, long-lasting pest monitoring and trapping cards are designed to catch a variety of pests, including aphids, leafminer, thrips, whiteflies, fungus gnat and other flying insects. Offers growers the best way to eliminate guesswork and evaluate if insect control programs are working. Features non-sticky edges for easier handling.

- Printed with a grid to make pest counting and monitoring easier.
- Rate: One card per 500 sq feet.
- Controls: Greenhouse insect pests.



50pk

BAS45182529 Min. Buy 1 EA

Trapline T Yellow Roller Trap

by Bioline Agrosiences, Inc.

Trapline T Yellow Roller Trap is a non toxic, double-sided sticky tape for trapping and monitoring flying pests. The yellow color is especially attractive to Whitefly.

- Target Crops: Vegetables, Ornamentals, and Berries
- Target Life Stage: Adult
- Target Pests: Thrips, Whitefly, and Aphid



! Not available for sale in CA



6in W x 328ft L - Can Be Cut to Any Size
BIOLNP8051-05 Min. Buy 1 EA

Wire Holder for Sticky Cards

by Olson Products Inc

Wire holders designed for use with sticky pest monitoring cards. Holds cards above plants and off the ground.

- 12 Inch long Galvanized Wire With Loop End
- For Holding Sticky Insect Traps
- 100 Per Box



100ct

OP100SS12 Min. Buy 1 CS

1000ct

OP1000SS12 Min. Buy 1 CS



Yellow Sticky Tape

by Olson Products Inc

Monitor and reduce populations of Whiteflies, Aphids, Thrips and Fungus Gnats. Tape is coated on both sides with safe non toxic adhesive.

- Yellow, double-sided adhesive coated polyethylene tape
- Useful for capturing crop damaging insects
- One acre of crop requires approximately 7200 lineal feet of tape for every double row
- Often used in larger agricultural, horticulture environments



6in x 530ft

OPPCR5306 Min. Buy 1 EA



WARNING: This product is not available for sale in CA.
For most up to date information please visit bfgsupply.com

800-883-0234
www.bfgsupply.com

REFERENCE GUIDE for GREENHOUSE and NURSERY PRODUCTION FUNGICIDES

RESISTANCE MANAGEMENT

As with other pesticides, fungicides must be used in a program to avoid or delay resistance. Do not rely on products with the same mode of action. Rotation of products with different modes of action, and using product combinations with different modes of action are parts of a resistance management strategy. Be especially careful when using products considered to be high risk for resistance development. This category includes many of our newer products. See the explanation of resistance risk at the end of the fungicide section.

Most fungicides work more effectively to prevent disease from becoming established, rather than eradicating disease that is already present. Constant monitoring – and modification where possible – of environmental conditions and scouting crops for signs of disease symptoms are vital parts of effective fungicide use and resistance management.

Always read the label and check with local authorities for further information regarding resistance management.

**Use Site(s) Key: GH = Greenhouse, N = Nursery



(by Mode of Action Group and Class)

MOA Group*	Class	Common Name	Trade Name	REI	Use Site(s)**	Company			
1	Thiophanates	Thiophanate-methyl	OHP 6672 [®]	12	GH/N	OHP, Inc.			
			3336 [™]	12	GH/N	Nufarm			
MBC-fungicides (Methyl Benzimidazole Carbamates)									
Resistance risk: High (See explanation of resistance risk following the mode of action listing)									
2	Dicarboximides	Iprodione	OHP Chipco [®] 26019	12	GH/N	OHP, Inc.			
			Chipco [®] 26019 FLO	12	GH/N	Bayer Environmental Science			
Resistance risk: Medium to High									
3	Imidazoles	Triflumizole	Terraguard [®]	12	GH/N	OHP, Inc.			
			Pyrimidines	Fenarimol	Banner [®] MAXX [®] II	12	N	Gowan Company	
				Triazoles (includes conazole)	Propiconazole	Eagle [®] 20 EW	12	N	Syngenta
					Myclobutanil	Avelyo [™]	24	GH/N	Corteva Agriscience
					Mefentrifluconazole	Trinity [®]	12	GH/N	BASF
Triticonazole	Trinity [®] TR	4-12	GH	BASF					
DMI-fungicides (DeMethylation Inhibitors)w									
Resistance risk: Medium									
4	Acylamines	Metalaxyl-M (=Mefenoxam)	Subdue [®] MAXX [®]	0-48	GH/N	Syngenta			
PA-fungicides (PhenyAmides)									
Resistance risk: Medium to High									
5	Piperadines	Piperalin	Pipron [®]	12	GH	SePRO Corp.			
Amines ("Morpholines")									
Resistance risk: Low to Medium									
7	Thiopene amides	Isofetamid	Astun [®]	12	GH/N	OHP, Inc.			
	Phenyl-Benzamides	Flutolanil	ProStar [®]	12	GH/N	Bayer Environmental Science			
SDHI (Succinate dehydrogenase inhibitors)									
Resistance risk: Medium to High									

* Depends on Greenhouse ventilation

** Greenhouse and/or nursery uses depend on the formulation. Check labels for uses.



Fungicides



(by Mode of Action Group and Class)

MOA Group*	Class	Common Name	Trade Name	REI	Use Site(s)**	Company	
11	Oximino-acetates	Trifloxystrobin	Compass [®] O	12	GH/N	Bayer Environmental Science	
	Methoxy-acrylates	Azoxystrobin	Heritage [®]	4	GH/N	Syngenta	
	Methoxy-carbamates	Pyraclostrobin	Empress [™] Intrinsic	12	GH/N	BASF	
	Imidazolinones	Fenamidone	FenStop [®]		12	GH	Gowan Company
		Fluoxastrobin	Fame SC		12	GH/N	FMC
QoI-fungicides (Quinone outside inhibitors)							
Resistance risk: High							
12	Phenylpyrroles	Fludioxonil	Medallion [®]	12	GH/N	Syngenta	
			Spirato	12	GH/N	Nufarm	
PP-fungicides (PhenylPyrroles)							
Resistance risk: Low to Medium							
14	Aromatic Hydrocarbons	PCNB	Terraclor[®]	12	GH/N	OHP, Inc.	
	Thiadiazole	Etridiazole	Terrazole[®]	12	GH/N	OHP, Inc.	
			Truban [®]	12	GH/N	ICL Specialty Fertilizers	
AH fungicides (Aromatic Hydrocarbons)							
Resistance risk: Low to Medium							
17	Hydroxylanilides	Fenhexamid	Decree [®]	12	GH/N	SePRO Corp.	
(SBI: Class III)							
Resistance risk: Low to Medium							
19	Polyoxins	Polyoxin-D	Affirm [™]	4	GH/N	Nufarm	
Polyoxins							
Resistance risk: Low to Medium							
21	Cyano-imidazole	Cyazofamid	Segway[®] O	12	GH/N	OHP, Inc.	
Qil-fungicide (Quinone inside inhibitor)							
Resistance risk: Medium to High							
28	Carbamates	Propamocarb	Banol [®]	24	GH/N	Bayer Environmental Science	
Carbamates							
Resistance risk: Low to Medium							
40	Cinnamic Acid Amides	Dimethomorph	Stature [®] SC	12	GH/N	BASF	
	Mandelic Acid Amides	Mandipropamid	Micora [™]	4	GH/N	Syngenta	
CAA-fungicides (Carboxylic Acid Amides)							
Resistance risk: Low to Medium							
43	Pyridinylmethyl-benzamides	Fluopicolide	Adorn [®]	12	GH/N	Nufarm	
Benzamides							
Resistance risk: Unknown							
49	Piperidinyl-thiazole-isoxazolines	Oxathiapiprolin	Segovis [®]	4	GH/N	Syngenta	
Piperidinyl-thiazole-isoxazolines- Resistance risk: Medium to High							
50	Benzoylpyridine	Pyriofenone	Seido [™]	4	GH/N	OHP, Inc.	
Benzoylpyridine Resistance risk Medium							
BM 01	Fungal	Extract from the cotyledons of lupine plantlets ("BLAD") C108	Regime [™]	4	GH/N	FMC Corporation	
Resistance risk: Unknown							

WARNING: This product is not available for sale in CA. For most up to date information please visit bfgsupply.com

Fungicides

Resources Provided By



(by Mode of Action Group and Class)

MOA Group*	Class	Common Name	Trade Name	REI	Use Site(s)**	Company
BM 01	Biopesticide	<i>Singlea glutinosa</i>	EcoSwing™	4	GH/N	Gowan Company
Resistance risk: Unknown						
BM 02	Bacillus sp. and the fungicidal lipopeptides produced	<i>Bacillus amyloliquefaciens</i> strain D747	Triathlon® BA	4	GH/N	OHP, Inc.
		<i>Bacillus subtilis</i> GB03	Companion®	4	GH/N	Growth Products
		<i>Bacillus subtilis</i> MBI600	Subtilex™ NG	4	GH	BASF
		<i>Bacillus subtilis</i> QST713	Cease®	4	GH/N	BioWorks, Inc
		<i>Bacillus amyloliquefaciens</i> F727	Stargus™	4	GH/N	Marone Bio Innovations
	Biopesticide	<i>Streptomyces lydicus</i> WYEC108	Actinovate® SP	4	GH/N	Mycorrhizal Applications
	Polypeptide (lectin)	<i>Trichoderma asperellum</i> (ICC 012) <i>Trichoderma gamsii</i> (ICC 080)	Obtego™	4	GH/N	SePRO Corp.
	Biopesticide	<i>Trichoerma harzianum</i> T22	PlantShield® HC	0	GH/N	BioWorks, Inc.
			RootShield®	0	GH/N	BioWorks, Inc.
			<i>Trichoderma harzianum</i> T22 + <i>Trichoderma virens</i> G41	RootShield® Plus	0	GH/N
Resistance risk: Unknown						
M 01	Inorganic	Copper octanoate	Grotto™	4	GH/N	OHP, Inc.
		Copper sulfate	Cuproxat®	24	GH/N	Nufarm
			Phyton® 27	24	GH/N	Phyton Corp.
			Phyton® 35	24	GH/N	Phyton Corp.
		Copper hydroxide	CuPro™ 5000 T/N/O	48	GH/N	SePro Corp.
		Kalmor®	24	GH/N	OHP, Inc.	
	Inorganic	Cuprous Oxide	Nordox 75WG	12	GH/N	Nordox AS
Resistance risk: Low						
M 03	Dithiocarbamates and relatives	Mancozeb	Dithane®	24	GH/N	Corteva Agriscience
			Fore®	24	GH/N	Corteva Agriscience
			Junction™	24	GH/N	SePRO Corp.
	Dithiocarbamates and relatives		Pentathlon™	24	GH/N	SePRO Corp.
Resistance risk: Low						
M 05	Chloronitriles (phthalonitriles)	Chlorothalonil	Daconil® Ultrex®	12	GH/N	Syngenta
	Dithiocarbamates and relatives		AllPro® Exotherm Termil	*	GH	Value Garden Supply
Resistance risk: Low						
P 05	Ethanol Extract	<i>Reynoutria sachalinensis</i>	Regalia®	4	GH/N	Marrone Bio Innovations
Resistance risk: Unknown						
P 07	Ethyl Phosphonates	Fosetyl-Al	Alliette®	12	GH/N	Bayer Environmental Innovations
			Areca®	12	GH/N	OHP, Inc.
Phosphonates	Phosphite	Phosphorous acid	Alude™	4	GH/N	Nufarm
Resistance risk: Low						



Fungicides



(by Mode of Action Group and Class)

MOA Group*	Class	Common Name	Trade Name	REI	Use Site(s)**	Company
NC	Biopesticide	<i>Ulocladium oudemansii</i> (U3 Strain)	BotryStop™	4	GH/N	BioWorks, Inc.
			Actino Iron	4	GH/N	Mycorrhizal Applications
	Biocarbonate	Potassium bicarbonate	Carb-O-Nator™	4	GH/N	Certis USA, LLC
	Hydrogen Dioxide/Peroxide	Hydrogen dioxide + peroxyacetic acid	MilStop®	1	GH/N	BioWorks, Inc
			ZeroTol®	0-1	GH/N	Biosafe Systems
	Oils	Hydrogen dioxide + peroxyacetic acid + octanoic acid	X3™	0-2	GH/N	Phyton Corp.
			Carified hydrophobic extract of neem oil (also classified by EPA as a biopesticide)	Triact® 70	4	GH/N
	Quaternary Ammonium	Petroleum Oil	Suffoil-X™	4	GH/N	BioWorks, Inc.
		Quaternary Amines	Greenshield®	0	GH	BASF
	Soaps	Potassium salts of fatty acids	Kopa™ Insecticidal Soap	12	GH/N	OHP, Inc.
			Resistance risk: Unknown	potassium salts of fatty acids	M-Pede®	12
1+2	Thiophanate + Dicarboxamide	Thiophanate-methyl + Iprodione	26/36™	12	GH/N	Nufarm
1+14	Thiophanate + Thiadiazole	Thiophanate-methyl + Etridiazole	Banrot®	12	GH/N	IC Specialty Fertilizers
1+ M 05	Thiophanate + Chloronitrile	Thiophanate -methyl + Chlorothalonil	Spectro® 90	12	GH/N	Nufarm
3+11	Demethylation Inhibitors (DMI fungicides) + Strobilurins	Triadimefon + Trifloxystrobin	Trigo™	12	GH/N	Bayer Environmental Science
3+M 05	Demethylation inhibitor + Chloronitrile	Propiconazole + Chlorothalonil	Concert® II	12	N	Syngenta
7+11	SDHI + Strobilurin	Boscalid + Pyraclostrobin	Pageant® Intrinsic™	12	GH/N	BASF
		Fluopyram + Trifloxystrobin	Broadform™	12	GH/N	Bayer Environmental Science
		Benzovindiflupyr + Azoxystrobin	Mural™	12	GH/N	Syngenta
		Fluxapyroxad + Pyraclostrobin	Orchestra™ Intrinsic®	12	GH/N	BASF
45+40	Triazolo-pyrimidylamines + Cinnamic Acid Amides	Ametoctradin + Dimethomorph	Orvego™	12	GH/N	BASF
9+12	Anilo-pyrimidine +	Cyprodinil + Fludioxinil	Palladium™	12	GH/N	Syngenta

* Depends on Greenhouse ventilation

** Greenhouse and/or nursery uses depend on the formulation. Check labels for uses.



WARNING: This product is not available for sale in CA. For most up to date information please visit bfgsupply.com

*Fungicides Modes of Action

1. Inhibition of tubulin formation in mitosis
2. MAP histidine-kinase in osmotic signal transduction, E3
3. DMI (DeMethylation Inhibitors) Demethylase in sterol biosynthesis
4. Phenylamidoes-Affect RNA synthesis
5. Inhibition of reductase and isomerase in sterol biosynthesis
7. Inhibitors of succinate-dehydrogenas (SDHIs) and respiration
11. Quinone outside inhibitors (Qo)
12. MAP histidine-kinase in osmotic signal transduction E2
14. Cell peroxidation (proposed)
17. 3-keto reductase during C4 demethylation
19. Chitin synthase inhibition in cell wall development
21. Quinone inside inhibitors (Qil)
28. Affect cell membrane permeability, fatty acids (proposed)
40. Cell wall biosynthesis: cellulose synthase
43. Delocalization of spectrin-like proteins
45. Respiration Complex III: cytochrome bc1 (ubiquinone reductase) at Qo site
49. Lipid homeostasis and transfer/storage
- BM. Biologicals with multiple modes of action.
- BM 02. Microbial disruptors of pathogen cell membranes (Biologicals)
- M. Multi-site activity. Chemicals that act at several sites, which may differ among the group members.
- NC. Unknown: *The mode of action cannot be placed within any other defense*
- P. Host plant defense induction

Explanation of Resistance Risk

This list is from the U.S. Environmental Protection Agency, in cooperation with the Fungicide Resistance Action Committee (FRAC). FRAC is a technical working group within the Global Crop Protection Federation (GCPF). More information on the Fungicide Resistance Action Committee and the Mode of Action Classification is available from: www.frac.info. Resistance risk categories were developed by FRAC. There are ways to estimate the potential for resistance development. The resistance risk is generally based on whether the fungicide mode of action (MOA) is single or multi-site. Single site MOA products have a higher resistance risk than multi site MOA products. The pathogen types targeted by the fungicides also are factors.

Fungicides should always be used by rotating MOA types. Users need to be especially careful not to rotate or alternate among fungicides in any one high resistance risk category. Follow resistance management instructions on product labels.



Fungicide / Bactericide Reference Chart

Always Refer to Product Label!

Product	Active Ingredient	OMRI Listed	Altemaria	Anthracoze	Bacterial spots	Black Spot	Botrytis	Cylindrocladium	Downy Mildew	Fire Blight	Fusarium	Leaf Spot	Phytophthora	Powdery Mildew	Pseudomonas	Pythium	Rhizoctonia	Rust	Scab	Thielaviopsis	Xanthomonas	
3336	Thiophanate-Methyl			X	X	X	X	X		X	X	X		X			X	X	X	X		
6672	Thiophanate-Methyl			X	X	X	X	X		X	X	X		X			X	X	X	X		
Actinovate	Streptomyces lydicus	Yes	X	X			X		X		X	X	X	X		X	X	X				
Adorn	Fluopicolide								X				X			X						
Affirm	Polyoxin D zinc salt		X	X			X		X			X		X			X		X	X		
Agri-mycin 50	Streptomycin sulfate				X					X	X			X								X
Aliette	Aluminum tris		X	X	X				X	X			X	X		X	X		X			X
Areca	Aluminum tris		X		X		X		X	X	X	X	X			X						X
Astun	Isofetamid						X															
Avelyo	Mefenfluoconazole		X	X				X				X		X				X	X	X		
Badge SC	Copper Oxchloride, Copper Hydroxide		X	X	X	X	X		X	X		X	X	X	X			X	X			X
Banner Maxx	Propiconazole		X	X	X						X	X		X			X	X	X			
Banol	Propamocarb hydrochloride												X			X						
Banrot	Etridiazole, Thiophanate-Methyl										X	X				X	X			X		
Botrystop WP	Ulocladium Oudemansii						X															
Broadform	Fluopyram, Trifloxystrobin		X	X		X	X		X			X	X	X			X	X	X			
Camelot O	Copper Octanoate	Yes	X	X	X		X		X	X		X		X	X		X	X				X
Cease	Bacillus subtilis	Yes	X	X	X	X	X		X		X	X	X	X	X	X	X	X	X	X		X
Chipco 26GT	Iprodione		X				X	X			X	X					X					
26019	Iprodione		X				X	X			X	X					X					
Compass	Trifloxystrobin		X	X		X	X	X	X			X	X	X		X	X	X	X	X		X
Daconil	Chlorothalonil		X	X		X	X	X			X	X	X	X			X	X	X			
Decree	Fenhexamid						X							X								
Eagle	Myclobutanil			X	X						X	X		X			X	X	X			
EcoSwing	Extract of Swinglea glutinosa	Yes	X				X					X		X								
Empress	Pyraclostrobin										X	X				X	X					
Fame	Fluoxastrobin		X	X			X		X		X	X	X	X		X	X	X				
Fenstop	Fenamidone								X				X			X						
Grotto	Copper Octanoate	Yes	X	X	X	X	X		X	X		X	X	X	X		X	X	X			X
Guarda	Thyme Oil		X	X	X	X	X		X	X	X	X	X	X	X	X	X	X	X			X
Heritage	Azoxystrobin		X	X		X	X	X	X		X	X	X	X		X	X	X	X			
Junction	Mancozeb, Copper Hydroxide		X	X	X	X	X		X	X		X	X	X	X			X	X			X
Kalmor	Copper Hydroxide	Yes	X	X	X	X	X		X	X		X	X	X	X		X	X	X			X
Kleengrow	Didecyl dimethyl ammonium chloride				X		X		X		X	X	X	X	X	X	X				X	X
Medallion	Fludioxonil		X				X	X			X	X					X				X	
Micora	Mandipropamid								X				X									

 WARNING: This product is not available for sale in CA. For most up to date information please visit bfgsupply.com

Fungicide / Bactericide Reference Chart

Always Refer to Product Label!

Product	Active Ingredient	OMRI Listed	Alternaria	Anthracnose	Bacterial spots	Black Spot	Botrytis	Cylindrocladium	Downy Mildew	Fire Blight	Fusarium	Leaf Spot	Phytophthora	Powdery Mildew	Pseudomonas	Pythium	Rhizoctonia	Rust	Scab	Thielaviopsis	Xanthomonas
MilStop SP	Potassium Bicarbonate	Yes	X	X		X	X		X			X		X				X	X		
Mural	Azoxystrobin, Benzovindiflupyr		X	X		X	X	X	X		X	X	X	X		X	X	X	X		
Obtego	Trichoderma Asperellum, gamsii	Yes									X		X			X	X				X
Orkestra	Fluxapyroxad, Pyraclostrobin		X	X			X	X	X		X	X	X	X		X	X	X	X	X	X
Orvego	Ametoctradin, Dimethomorph								X				X								
OxiPhos	Hydrogen peroxide, Phosphorous acid				X		X		X	X	X	X	X	X	X	X			X		X
Pageant	Pyraclostrobin, Boscalid		X	X			X	X	X		X	X	X	X		X	X	X	X		
Palladium	Cyprodinil, Fludioxonil		X	X			X	X			X	X		X			X		X		
Phostrol	Mono and dibasic sodium, potassium, and ammonium phosphites			X	X	X			X	X			X		X	X	X		X		X
Phyton 27, 35	Copper Sulphate Pentahydrate				X	X	X	X	X					X	X				X		X
Pipron	Piperalin													X							
Postiva	Pydiflumetofen, Difenconazole		X	X	X	X	X				X	X		X	X		X	X	X		X
Protect DF	Mancozeb		X	X	X	X	X	X	X		X	X	X			X	X	X	X		
Regalia	Extract of Reynoutria sachalinensis	Yes	X	X	X		X		X	X	X	X	X	X	X	X	X	X	X		X
Rhapsody	Bacillus subtilis	Yes	X	X	X	X	X		X		X	X	X	X	X	X	X	X	X		X
RootShield	Trichoderma harzianum	Yes						X			X					X	X				X
RootShield Plus	Trichoderma harzianum & virens	Yes						X			X		X			X	X				X
Segovis	Oxathiapiprolin								X				X								
Segway O	Cyazofamid								X				X			X					
Seido	Pyriofenone													X							
Spectro 90WDG	Chlorothalonil, Thiophanate methyl		X	X		X	X	X	X		X	X	X	X			X	X	X		
Spirato	Fludioxonil		X				X	X			X	X		X			X				X
Stargus	Bacillus amyloliquefaciens Strain F727	Yes			X	X	X		X		X	X	X	X		X	X				X
Stature SC	Dimethomorph								X				X								
Subdue Maxx	Mefenoxam								X				X			X					
Terraclor 400	Pentachloronitrobenzene (PCNB)											X					X				
Terraguard SC	Triflumizole		X				X	X	X		X	X		X			X	X	X	X	
Terrazole L	Etridiazole												X			X					
Terrazole WP	Etridiazole												X			X					
Transom	Thiophanate-Methyl			X		X	X	X		X	X	X		X			X	X	X	X	
Triathlon BA	Bacillus amyloliquefaciens	Yes	X	X	X	X	X		X	X	X	X	X	X	X	X	X	X	X		X
Trinity TR	Triticonazole		X				X	X	X		X			X							
Truban	Etridiazole												X			X					
Zerotol	Hydrogen Peroxide, Peroxyacetic Acid	Yes	X	X	X	X	X		X		X	X	X	X	X	X	X	X	X	X	X



BOTRYTIS PROBLEM?

CONTROL STRATEGIES

Background

Botrytis affects numerous ornamentals and vegetables. Botrytis can also cause many problems such as stem cankers, damping off, leaf spots and blighting. Botrytis belongs to the family Sclerotiniaceae. There are about 30 different species. The most common species is Botrytis cinerea.

Symptoms

Botrytis produces large areas of gray spores that usually infect lower leaves that are close to the moist soil and underneath the plant canopy. It can also infect dead plant parts that are either in the pot or on the table or floor that can then be a source of future infections. It can start out as a small spot and then get larger and kill the leaf and then it can spread into the stem and kill the entire plant.

Favorable Development

Conditions/Disease Cycle

The favorable conditions for the development of Botrytis are when there is high humidity, cool temperatures and moisture present. Water is needed for the spores to germinate and then to infect the plant. Botrytis quickly produces spores that infect the plant, grow, and then produce more spores which can start the cycle again. It has a repeating disease cycle that can last the life of the plant and allows it to build up disease pressure. In some cases the spores can lie dormant on a plant for the life of the plant.



ALWAYS BE SURE TO
READ THE LABEL

**& CHECK WITH
LOCAL REGULATIONS**
BEFORE USING ANY PESTICIDE.

CULTURAL CONTROL

There are several ways to help prevent Botrytis. Prune lower leaves so that there is better air circulation underneath the plant canopy. Water in the morning so plants have a chance to dry out before nightfall. Space plants farther apart so that the humidity between them is lower and air circulation is better. After the crop has left make sure to clean up any leaves or dead plants that are left so that Botrytis doesn't have a chance of starting on them. All these ways would be possibilities to help prevent Botrytis.

CHEMICAL CONTROL

There are a number of fungicides that are labeled and are effective for Botrytis.

EFFECTIVE SOLUTIONS

Daconil Ultrex

5lb SYN71416



BotryStop WP

12lb BW2U98A61

30lb BW2U98A07



Affirm WDG

2.4lb NTS10500324



Pageant Intrinsic

1lb BAS59012349

12lb BAS59012429

TR BAS59012766



26GT

2.5gal PROKZ4250930



Chipco 26019

2lb OHP981462

2.5gal PROKZ4251007



Decree

2.5lb SEPRO19-0460



Palladium

2lb SYN38781



ROOT ROT PROBLEM?

CONTROL STRATEGIES

Background

Pythium infects a wide host range and is more common in the greenhouse. Phytophthora is less common in the greenhouse and more common in the nursery and is more host-specific. Phytophthora has been shown to be more aggressive than Pythium. Both of them can survive for many years in the soil and on debris in the greenhouse. Pythium and Phytophthora are referred to as the water molds and they are both in the family Pythiaceae.

Symptoms

Pythium can cause damping off, and crown/stem rots. Phytophthora causes root/crown rots as well as foliar blight. Symptoms on the leaves are the first to show because the roots are too compromised to take up the nutrients needed for the plant. The leaves could be yellow, stunted or wilted. When the roots are examined they will be soft and mushy and may appear to be water soaked, glassy, and dark brown. The outer covering of the root will separate easily from the inner root by gently pulling on it and it will appear slimy. Healthy roots are white and hard, so it is very easy to tell when you have Pythium or Phytophthora. To differentiate between the two though a sample will need to be sent to a lab for identification.

Favorable Development Conditions/Disease Cycle

The favorable conditions for Pythium and Phytophthora are wet soils, mild temperatures, high soil EC and low oxygen in the soil. They can be spread by fungus gnats and shore flies. They can also be spread by using spore contaminated media, supplies or water. Recirculation of contaminated irrigation water in an irrigation system can spread the disease as well. The spores can last a long time until the roots are stressed and then that allows the spores to infect the roots and then the disease will spread.



**ALWAYS BE SURE TO
READ THE LABEL**

**& CHECK WITH
LOCAL REGULATIONS
BEFORE USING ANY PESTICIDE.**

CULTURAL CONTROL

Previously used pots or supplies need to be washed and disinfected before use. If using field soil, have it disinfected before use. Throw away infected plants as soon as possible to limit the spread of the disease. If using recycled irrigation water, have it tested and treat if necessary. Sanitation of all areas is key to limiting the spread of the disease.

CHEMICAL CONTROL

There are a number of fungicides that are labeled and are effective for Pythium/Phytophthora root rots. Some species of Pythium in the greenhouse have been shown to be resistant to Subdue Maxx. All fungicides for Pythium and Phytophthora control should be applied as a drench.

EFFECTIVE SOLUTIONS

Aliette WDG

5lb BYR84956465



Subdue Maxx

32oz CH149

1gal SYN53195



Segway O

16oz OHP987280

64oz OHP987245



RootShield Plus WP

1lb BW2HR45A02

3lb BW2HR45A03

30lb BW2HR45A07



Phostrol

2.5gal NTS10264225



Terrazole 35WP

2lb OHP988472



Empress

24oz BAS59014402



Adorn

32oz VAL61510.928



Fungicides & Bactericides

26GT® Fungicide*by Envu*

A broad spectrum fungicide that can be applied to a wide range of ornamental plants, either as a foliar spray, dip, or drench. Provides 14 days or longer control with quick knockdown.

- Active Ingredient : Iprodione
- Rate : 32 to 80oz per 100gal
- REI : 12 Hrs
- Controls : Rhizoctonia, Fusarium, Botrytis, Alternaria
- Signal Word : Caution

**2.5gal****PROKZ4250930** Min. Buy 1 EA**3336® EG Fungicide***by Nufarm Americas Inc.*

A broad-spectrum disease control for turf and ornamental plants. Combines the power of thiophanate-methyl with the convenience of an extruded granular formulation for control of troublesome plant diseases such as Rhizoctonia. A low-dust extruded granule with quick-dissolve properties, 3336 EG extends many benefits to the user including easy measuring and easy mixing.

- Active ingredient: Thiophanate-methyl
- Rate: Varies according to application method. See label.
- REI: 12 hours.
- Controls: Anthracnose, Brown Rot, Leaf Scabs, Fusarium, Rhizoctonia, and many more.
- Signal Word: Caution

**5lb****NTS10556045** Min. Buy 1 EA**3336® F Fungicide***by Nufarm Americas Inc.*

3336 F is a broad spectrum fungicide for control of a wide range of diseases in turf and ornamentals. Use for annual and perennial flowers, bedding and foliage plants, turf, trees and evergreens.

- Active ingredient: Thiophanate-methyl
- Rate: 2 to 6 oz per 1,000 sq ft
- REI: 12 hours.
- Controls: Anthracnose, Brown Rot, Leaf Scabs, Fusarium, Rhizoctonia, and many more.
- Signal Word: Caution

**1qt****NTS10498121** Min. Buy 1 EA**2.5gal****NTS10498225** Min. Buy 1 EAOther Info **SHIPS HAZ****Actinovate® SP Fungicide***by Mycorrhizal Applications LLC*

Actinovate® SP Biological Fungicide suppresses and controls root rot, damping-off fungi and foliar fungal pathogens. When used as a soil drench, it also suppresses and controls soil-borne fungi.

- Active Ingredient: Streptomyces lydicus
- Rate: Varies according to application method. See label.
- REI: 4 Hrs
- Controls: Phythium, Phytophthora, Verticillium, Fusarium, Rhizoctonia, Powdery Mildew, Downy Mildew, Botrytis and other root and foliar fungi.
- Signal Word: Caution

**18oz****NOVZ5000-725** Min. Buy 1 EA**Adorn® Fungicide***by Nufarm Americas Inc.*

Adorn fungicide controls ornamental plant diseases such as Downy Mildew, Phytophthora and Pythium in greenhouse ornamentals, outdoor nurseries, landscape ornamentals and shrubs. Can be used as a spray or drench.

- Active Ingredient: Fluopicolide
- Rate: 1 to 4oz per 100gal
- REI: 12 Hrs
- Controls: Downy Mildew, Phytophthora, Pythium.
- Signal Word: Caution

**1qt****VAL61510.928** Min. Buy 1 EA**Affirm™ WDG Fungicide***by Nufarm Americas Inc.*

A concentrated, easy-to-mix water dispersible granule formulation that delivers excellent disease control and minimal spray residues. Use for disease control on turf, ornamentals, Christmas trees and various crops including: cucurbit vegetables, fruit vegetables, pome fruits, strawberries, non-bearing fruit vines and non-bearing fruit and nut trees.

- Active Ingredient: Polyoxin D
- Rate: 4 to 8oz per 100gal
- REI: 4 Hrs
- Controls: Alternaria, Anthracnose, Apple scab, Botrytis, Powdery mildew, Rhizoctonia aerial blight, Rhizoctonia, Scabs
- Signal Word: Caution

**2.4lb****NTS10500324** Min. Buy 1 EA**Agri-Mycin® 50 Fungicide***by Nufarm Americas Inc.*

Agri-Mycin 50 is a bactericide for control of bacterial blight, soft rot, bacterial spot and more on select vegetable and fruit crops.

- Active ingredient: Streptomycin sulfate
- Rate: Varies according to application method. See label.
- REI: 12 hours.
- Controls: Bacterial diseases.
- Signal Word: Caution

**3lb****NTS10719063** Min. Buy 1 EA

WARNING: This product is not available for sale in CA.
For most up to date information please visit bfgsupply.com

800-883-0234
www.bfgsupply.com

Fungicides & Bactericides

Aliette® WDG Fungicideby *Envu*

Provides long lasting Phytophthora and Downy Mildew control. Aliette has a unique upward and downward systemic activity to protect the entire plant for up to 30 days.

- Active Ingredient : Aluminum Tris
- Rate : 2.5 to 5lbs per 100gal
- REI : 12 Hrs
- Controls : Phytophthora, Pythium, Downy Mildew and more.
- Signal Word : Warning

**5lb****BYR84956465** Min. Buy 1 EA**Areca® Fungicide**by *OHP, Inc.*

Areca is an up-and-down systemic fungicide that may be applied to a wide range of ornamental flowering and foliage plants for control of diseases caused by Pythium, Phytophthora and Downy Mildew pathogens. Areca may be used on ornamentals and bedding plants grown in field nursery, greenhouse, landscape and conifer nurseries.

- Active Ingredient: Aliminum tris
- Rate: Varies depending on application method. See label.
- REI: 12 Hrs
- Controls: Pythium, Phytophthora, Downy Mildew and more.
- Signal Word: Caution

**5lb****OHP981145** Min. Buy 1 EA**Astun® Fungicide**by *OHP, Inc.*

Astun Ornamental Fungicide provides preventative and early curative activity on botrytis diseases of plants grown in commercial greenhouses and nurseries. Astun is most effective when used as a protectant fungicide and applied before the disease damages the crop.

- Active Ingredient: Isofetamid
- Rate: 10 to 17oz per 100gal
- REI: 12 Hrs
- Controls: Botrytis
- Signal Word: Caution

**1qt****OHP981150** Min. Buy 1 EA**Avelyo™ Fungicide**by *BASF Corp*

Avelyo™ Fungicide delivers broad-spectrum disease control with exceptional plant safety. Key benefits are strong preventative control of foliar, crown and root disease, extended residual activity with excellent rainfastness, a dynamic rotation partner, and proven plant safety at any stage in the protection cycle.

- Active Ingredient: Mefentrifluconazole
- Rate: Varies depending on application method. See label for complete information.
- REI: 12 Hrs
- Controls: Anthracnose, Black spot, Leaf spots, Rust, and Stem Blights
- Signal Word: Caution

**60oz AGENCY****BAS59024736** Min. Buy 1 EA**Badge® SC Fungicide**by *Gowan*

Badge fungicide controls a wide range of fungal diseases on vegetable crops, fruit and nut trees, ornamental plants, herbs in greenhouses and nurseries.

- Active Ingredient: Copper Oxychloride and Hydroxide
- Rate: Varies depending on application method. See label.
- REI: 24 hours in enclosed structures.
- Controls: Phytophthora, Pythium, Powdery Mildew, and more.
- Signal Word: Caution

**2.5gal****GOW60903** Min. Buy 1 EA**Banner® Maxx® II Fungicide**by *Syngenta Crop Protect (Agency)*

Banner Maxx II provides broad-spectrum control of foliar diseases on ornamentals grown in the landscape and outdoor nurseries. Works quickly and controls diseases for up to 28 days.

- Active Ingredient: Propiconazole
- Rate: Varies depending on application method. See label.
- REI: 12 Hrs
- Controls: Rusts, Phomopsis, Alternaria, Cercospora, Septoria leaf spots, Anthracnose, Scabs, Rhizoctonia
- Signal Word: Warning

**1gal AGENCY****SYN39961** Min. Buy 1 EA**Banol® Fungicide**by *Envu*

Banol is an outstanding control product for Pythium and Phytophthora. Labeled for turf applications and as a drench in greenhouse and container grown ornamentals.

- Active Ingredient : Propamocarb hydrochloride
- Rate : 2 to 4oz per 1,000sq ft
- REI : 24 Hrs
- Controls : Pythium and Phytophthora.
- Signal Word : Caution

**2.5gal AGENCY****BYR79895402** Min. Buy 1 EA**Banrot® 40WP Fungicide**by *ICL*

A broad spectrum fungicide for use in commercial greenhouses and nurseries to control damping-off, root and stem rot diseases of ornamental and nursery crops caused by Pythium, Phytophthora, Rhizoctonia, Fusarium and Thielaviopsis. 40 WP is a wettable powder formulation for liquid applications

- Active Ingredient: Etridizaole, Thiophanate Methyl
- Rate: 4 to 8oz per 100gal
- REI: 12 Hrs
- Controls: Pythium, Phytophthora, Thielaviopsis, Fusarium, Rhizoctonia
- Signal Word: Danger

**2lb****EVR957252E** Min. Buy 1 EA

Fungicides & Bactericides

Banrot® 8G Fungicide

by ICL

A broad spectrum fungicide for use in commercial greenhouses and nurseries to control damping-off, root and stem rot diseases of ornamental and nursery crops caused by Pythium, Phytophthora, Rhizoctonia, Fusarium and Thielaviopsis. Banrot 8G is a granular formulation for incorporation into growing media

- Active Ingredient: Etridizaole, Thiophanate Methyl
- Rate: 8oz per 1cu yd
- REI: 12 Hrs
- Controls: Pythium, Phytophthora, Thielaviopsis, Fusarium, Rhizoctonia
- Signal Word: Danger

**40lb****EVR950241E** Min. Buy 1 EA**Biomin® Mildew Cure**

by JH Biotech, Inc.

Attain organic control of Powdery Mildew on many types of crops such as melons, squash, tomatoes, cucumbers, trees crops, grapes and flowers. Mildew Cure is an FIFRA 25b exempt fungicide (Rule 40 CFR 152.25). Mildew Cure has shown the ability in replicated field and greenhouse trials to control Powdery Mildew for 7-10 days with a 1% spray solution.

- OMRI listed

**2.5gal - OMRI Listed®****JH011008** Min. Buy 1 EA**BotryStop WP Fungicide**

by BioWorks Inc.

BotryStop WP is a biological fungicide approved for organic use and developed specifically to protect blossoms, fruit, and plant tissue from the destructive fungal forces of Botrytis.

- Active Ingredient: Ulocladium oudemansii strain U3
- Rate: Varies depending on application method. See label.
- REI: 4 Hrs
- Controls: Botrytis cinerea, Sclerotinia sclerotiorum and Monilinia spp.
- Signal Word: Warning

**12lb****BW2U98A61** Min. Buy 1 EA**30lb****BW2U98A07** Min. Buy 1 EA**Camelot™ O Fungicide**

by Sepro Corporation

A liquid copper formulation using proven technology to provide broad-spectrum bacterial and fungal disease control on a wide variety of ornamental plants, greenhouse vegetable / herb crops and turf grass. Formulated with fixed copper combined with fatty acids to form a true soap providing outstanding performance. Requires minimal elemental copper for excellent disease control.

- Active Ingredient: Copper Octanoate
- Rate: 0.5 to 2gal per 100gal
- REI: 4 Hrs
- Controls: Bacterial and Fungal pathogens.
- Signal Word: Caution

**1gal****SEPRO19-0452A** Min. Buy 1 EA**Broadform™ Fungicide**

by Envu

Broadform is a broad spectrum fungicide that helps maximize foliar disease control on key pathogens including Botrytis, leaf spot and dieback diseases. Two modes of action control multiple diseases that could be attacking the plant at a given time. Labeled for use on greenhouse and nursery-grown ornamentals, including fruits, nuts and Christmas trees.

- Active Ingredient : Fluopyram and Trifloxystrobin
- Rate : 2 to 8oz per 100gal
- REI : 12 Hrs
- Controls : Botrytis, Diplodia, Botryosphaeria and Phomopsis black spot, anthracnose, rusts, powdery mildew
- Signal Word : Caution

**12oz AGENCY****BYR85758497** Min. Buy 1 EA**CEASE® Fungicide**

by BioWorks Inc.

Cease microbial fungicide controls a wide array of fungal and bacterial pathogens, both foliar and soil-borne. For use on ornamentals, trees, shrubs and greenhouse vegetables. OMRI Listed®.

- Active Ingredient: Bacillus subtilis
- Rate: 96 to 192oz per 100gal
- REI: 4 Hrs
- Controls: Botrytis, Powdery Mildew, Fusarium, Pythium and more.
- Signal Word: Caution

**1gal****BW300100** Min. Buy 1 EA**2.5gal****BW1C19A24** Min. Buy 1 EA

WARNING: This product is not available for sale in CA.
For most up to date information please visit bfgsupply.com

800-883-0234
www.bfgsupply.com

Fungicides & Bactericides

Chipco® 26019 Fungicideby *Envu*

Broad spectrum fungicide for use as a spray, drench, or dip for the control of diseases on a wide range of ornamental plants and turf applications.

- Active Ingredient : Iprodione
- Rate : 32 to 80oz per 100gal
- REI : 12 Hrs
- Controls : Phytophthora, Pythium, Downy Mildew, Brown Patch, Fusarium Blight and more.
- Signal Word : Warning

**2.5gal****PROKZ4251007** Min. Buy 1 EA**Compass® 50WG Fungicide**by *Envu*

Compass is a broad spectrum fungicide for the prevention and treatment of foliar and soil pathogens. Mesostemic and translaminal movement provides disease control in and around the plant tissue.

- Active Ingredient : Trifloxystrobin
- Rate : 2oz per 100gal
- REI : 12 Hrs
- Controls : Fusarium, Rhizoctonia, Black Spot, Botrytis, Downy Mildew, Powdery Mildew and more. See label.
- Signal Word : Warning

**1lb****BYR2584569** Min. Buy 1 EA**Daconil Weatherstik® Fungicide**by *Syngenta Crop Protect (Agency)*

Weatherstik™ is a contact flowable fungicide that exhibits a multi-site mode of action which can delay or prevent resistance to single-site fungicides. It contains a built-in surfactant to provide superior sticking power for extended coverage and unsurpassed protection on the crown and sheath of grass blades, even after heavy rains or watering, for control of turf and ornamental diseases.

- Active Ingredient: Chlorothalonil
- Rate: Varies according to application. See label.
- REI: 12 Hours
- Controls: Leaf spots, Botrytis, Powdery mildew, and many other diseases
- Signal Word: Caution

**2.5gal AGENCY****SYN71418** Min. Buy 1 EA**Daconil ZN® Fungicide**by *Syngenta Crop Protect (Agency)*

For control of turf and ornamental diseases. Works as a contact fungicide for the control of many turf and ornamental diseases and has low resistance risk. Registered for control of 50 diseases on more than 75 ornamental plants. Provides residual control for 14 to 21 days.

- Active Ingredient: 38.5% Chlorothalonil
- Rate: 5oz per 1,000gal
- REI: 12 Hrs
- Controls: Dollar Spot, Leaf Spot, Brown Patch, Anthracnose and more.
- Signal Word: Danger

**2.5gal AGENCY****SYN31214** Min. Buy 1 EA**Eagle® 20EW Fungicide**by *Corteva*

Systemic protectant fungicide for use on ornamentals in greenhouses, nurseries, and landscapes as well as turf and golf applications. Controls key diseases like powdery mildew, rust, scab, and anthracnose.

- Active ingredient: Myclobutanil
- Rate: 1 to 3 oz per 1,000 sq ft
- REI: 24 hours
- Controls: Thrips, lepidopterous larvae, foliage feeding worms and many more. See label for complete list.
- Signal Word: Caution

**1pt****DOW173917** Min. Buy 1 EA**1gal****DOW19-2505B** Min. Buy 1 EA**EcoSwing® Fungicide**by *Gowan*

EcoSwing botanical fungicide controls fungal diseases on outdoor and greenhouse food crops, ornamental plants, flowers, trees and shrubs.

- Active Ingredient: Swinglea glutinosa
- Rate: 24 to 32oz per Acre
- REI: 4 Hrs
- Controls: Botrytis, Powdery Mildew, Alternaria, Stem rots
- Signal Word: Caution

**1qt****GOW76811** Min. Buy 1 EA**Empress® Intrinsic® Fungicide**by *BASF Corp*

Drench application with Empress fungicide will protect young, susceptible plants from root-infecting pathogens in rooted plug, propagation and transplant stages of production. Intrinsic brand fungicides enhance growth efficiency for strong, dense root growth.

- Active Ingredient: Pyraclostrobin
- Rate: 3 to 6oz per 100gal
- REI: 12 Hrs
- Controls: Fusarium, Phytophthora, Pythium, Rhizoctonia.
- Signal Word: Warning

**24oz****BAS59014402** Min. Buy 1 EA

Fungicides & Bactericides

Fame® SC Fungicide
by FMC

Fame fungicide for the control of foliar, stem and root diseases in turf and ornamentals. Foliar spray or soil drench applications providing fast penetration into leaf tissues and rain fast within 15 minutes. For commercial production and in landscape areas around residential, municipal and commercial properties, field grown ornamentals and ornamentals in greenhouses, and more.

- Active Ingredient: Fluoxastrobin
- Rate: 1 to 4oz per 100gal
- REI: 12 hours.
- Controls: Anthracnose, Brown Spot, Dollar Spot, Fusarium, Powdery Mildew and more.
- Signal Word: Caution



1pt AGENCY

FMC10064759 Min. Buy 1 EA

Fenstop Fungicide
by Gowan

Fenstop fungicide is used for the prevention and control of downy mildew, Phytophthora and Pythium on commercially grown ornamentals in greenhouses. It can be applied as a drench or foliar application.

- Active Ingredient: Fenamidone
- Rate: 7 to 14oz per 100gal
- REI: 12 hours
- Controls: Downy mildew, Phytophthora and Pythium and more.
- Signal Word: Warning



1qt

GOW85239 Min. Buy 1 EA

Fosphite®
by JH Biotech, Inc.

For control of Phytophthora, Pythium, and Downy Mildew on food crops, turf, and ornamentals. Fosphite® is an effective systemic fungicide. Approved by the EPA as a 'Reduced Risk Pesticide' for control of Phytophthora, Pythium, and Downy Mildew on food crops, ornamentals and bedding plants, Phytophthora in conifers and Pythium in turf.



2.5gal

JH011005 Min. Buy 1 EA

Grotto™ Fungicide
by OHP, Inc.

Grotto™ is a liquid copper fungicide for broad spectrum control of fungal and bacterial diseases on greenhouse and shadehouse vegetables and herbs, ornamentals and turf. OMRI listed for organic production.

- Active ingredient: Copper Octanoate
- Rate: Varies according to application. See label.
- REI: 4 hours
- Controls: Anthracnose, Powdery Mildew, Downy Mildew and more.
- Signal Word: Caution



1gal

OHP982900 Min. Buy 1 EA

Heritage SC Fungicide

by Syngenta Crop Protection

Heritage SC fungicide protects plants from root to leaf tip, providing exceptional disease control for extended intervals. Broad-spectrum control of over 25 turf diseases and over 30 ornamental diseases. Hazardous via air.

- Active ingredient: Azoxystrobin
- Rate: Varies by application. See label.
- REI: 4 hours
- Controls: Phomopsis Blight, Alternaria Leaf Spot, Downy Mildew, Anthracnose, Botrytis, Rhizoctonia, and more.
- Signal Word: Caution



4oz

SYN69643 Min. Buy 1 EA

Heritage® WDG Fungicide

by Syngenta Crop Protect (Agency)

Heritage WDG is a broad-spectrum fungicide for control of more than 33 diseases including all four classes of pathogens. Labeled for use on greenhouse ornamentals, vegetable and herb plants, fruit and nut trees.

- Active Ingredient: Azoxystrobin
- Rate: 1 to 4oz per 100gal
- REI: 4 Hrs
- Controls: Phomopsis Blight, Alternaria Leaf Spot, Downy Mildew, Anthracnose, Rose Blackspot, Powdery Mildews, Rusts, Botrytis, Rhizoctonia, Sclerotium, Fusarium
- Signal Word: Caution



1lb AGENCY

SYN74240 Min. Buy 1 EA

6lb AGENCY

SYN74818 Min. Buy 1 EA

Kalmor® Fungicide

by OHP, Inc.

A copper-hydroxide based product that controls a number of diseases in both greenhouses and nurseries including bacterial diseases. The high-quality formulation allows for gradual release of copper and may be used on ornamentals, fruits, and vegetables.

- Active Ingredient: Copper Hydroxide
- Rate: 1 to 2lbs per 100gal
- REI: 24 Hrs
- Controls: Anthracnose, Botrytis, Bacterial and fungal leaf spot, and more.
- Signal Word: Caution



2.5lb

OHP984900 Min. Buy 1 EA

Fungicides & Bactericides

PACE KleenGrow™ Fungicideby *Pace 49 Inc.*

A multi-use, EPA registered product for the control of diseases and algae on crops and in irrigation water. It is also indicated for the control of disease, virus, and algae on surfaces. The broad-spectrum preventative and curative activity provides 14 to 30 days of residual disease and algae control for an effective program to keep plants healthy and reduce cross-contamination.

- Active Ingredient: Didecylmethyl ammonium chloride
- Rate: 1.0-2 fl oz/gal Hard Surface Disinfecting and Cleaning, 0.34-1.20 fl oz/ 100gal in Irrigation Water
- REI: 0 Hrs - For Intermittent Injection in Irrigation Water, 48 Hrs - For Overhead Use On Crops, 0 Hrs for cleaning and disinfecting
- Controls: Algae, foliar diseases, crown and root rots, Powdery Mildew, Botrytis, Pythium, Phytophthora, Fusarium, Erwinia and Xanthomonas
- Signal Word: Danger

**2.5gal****PACKLNGRW25** Min. Buy 1 EAOther Info *SHIPS HAZ***30gal****PAC4919-0603K** Min. Buy 1 EAOther Info *SHIPS HAZ***55gal****PAC4919-0603B** Min. Buy 1 EAOther Info *SHIPS HAZ***LALSTOP G46 WG Fungicide**by *Lallemand Plant Care*

A biological fungicide used in the production of vegetables, fruits, herbs, and ornamentals. LALSTOP provides effective control on a wide range of plant diseases.

- Active ingredient: Gliocladium catenulatum Strain J1446
- Rate: Varies depending on application. See label.
- REI: 4 hours
- Controls: Botrytis, Powdery Mildew, Pythium, and Rhizoctonia
- Signal Word: Caution

**2lb****LAL101210** Min. Buy 1 EAOther Info *SHIPS DIRECT***LALSTOP K61 WP Fungicide**by *Lallemand Plant Care*

LALSTOP K61 is a biofungicide that thrives in the rhizosphere for several weeks. When applied as a drench or spray, the spores and mycelium of the Streptomyces culture germinate and grow on and around the root system creating a biological defense against seed and soil-borne pathogens.

- Active ingredient: Streptomyces sp. Strain K61
- Rate: Varies depending on application. See label.
- REI: 4 hours
- Controls: Rhizoctonia, Fusarium, Phytophthora, and Pythium
- Signal Word: Caution

**2lb****LAL162510** Min. Buy 5 EAOther Info *SHIPS DIRECT***Manzate Max T&O Fungicide**by *United Phosphorus, Inc.*

For superior control of key diseases in turfgrass, sod farms, and ornamentals, rely on Manzate T&O fungicide. Manzate T&O (flowable) formulation deliver multi-site control, preventing pathogenic organisms from adapting and mutating. This means that after decades of use, fungal strains have not developed resistance to Manzate T&O.

- Active Ingredient: Mancozeb
- Rate: 1.5 qts per 100 gals
- REI: 24 hours
- Controls: Botrytis, Leaf spots, and many other diseases
- Signal Word: Caution

**2.5gal****UPL6020408** Min. Buy 1 EA**Manzate® Pro-Stick™ Fungicide**by *United Phosphorus, Inc.*

Manzate® Pro-Stick™ T&O Fungicide can be used as a spray to control many plant diseases such as Botrytis, Alternaria, Rhizoctonia, Fusarium and more. Labeled for use on flowers, foliage, ornamentals, nursery crops, grasses, and more.

- Active Ingredient: Mancozeb
- Rate: Varies depending on application. See label for details.
- REI: 24 hours
- Controls: Rust, Leaf Spot, Red Thread, Copper Spot, Fusarium and more.
- Signal Word: Caution

**6lb****SA46250** Min. Buy 1 EAOther Info *SHIPS HAZ***Medallion® WDG Fungicide**by *Syngenta Crop Protect (Agency)*

Formulated as a water dispersible granule, providing growers with a more user-friendly way to control major foliar, root and stem diseases. Delivers 21-28 day residual control as a drench and 7-14 day residual control as a foliar spray. Labeled for use in greenhouses, shade houses, outdoor nurseries, interiorscapes and landscapes.

- Active Ingredient: Fludioxonil
- Rate: 1 to 4oz per 100gal
- REI: 12 Hrs
- Controls: Botrytis, Fusarium, Rhizoctonia and more.
- Signal Word: Caution

**8oz AGENCY****SYN51008** Min. Buy 1 EA

Fungicides & Bactericides

Mefenoxam 2AQ Fungicide

by *Control Solutions, Inc.*

Water-based formulation features low odor. Systemic mode of action and translocation through the plant can provide up to 3 weeks protection. Flowable formulation is effective for the control of numerous diseases in various ornamental, nursery and turf crops caused by the Oomycete class of fungi.

- Active Ingredient: Mefenoxam
- Rate: Varies depending on application method.
- REI: 48 Hrs
- Controls: Pythium, Phytophthora, Downy Mildew
- Signal Word: Warning



Not available for sale in CA



1qt
QCM83013851 Min. Buy 1 EA

1gal
QCM83013852 Min. Buy 1 EA

2.5gal
QCM83013861 Min. Buy 1 EA

Micora® Fungicide

by *Syngenta Crop Protect (Agency)*

Provides immediate contact protection and long-lasting disease control by locking to the leaf surface and slowly flowing into the leaf over an extended period of time. May be used as a spray to control downy mildew diseases and stem blights caused by Phytophthora spp. or as a drench to control Phytophthora crown and root rots on a variety of crops

- Active Ingredient: Mandipropamid
- Rate: 4 to 8oz per 100gal
- REI: 4 Hrs
- Controls: Downy Mildew and Phytophthora.
- Signal Word: Caution



1qt AGENCY
SYN47280 Min. Buy 1 EA

MilStop® SP Fungicide

by *BioWorks Inc.*

MilStop® SP is a broad-spectrum foliar fungicide. Highly effective on powdery mildews, it also helps prevent other foliar diseases. Use sites include greenhouse, nursery and field crops. It can also be used on interiorscapes and woody herbs.

- Active Ingredient: Potassium bicarbonate
- Rate: 1 to 5 lbs per 100 gallons
- REI: 1 hours
- Controls: Powdery Mildew and other foliar diseases.
- Signal Word: Caution



5lb
BW1M112B04 Min. Buy 1 EA

25lb
BW1M112B06 Min. Buy 1 EA

Other Info *SHIPS DIRECT*

Mural® Fungicide

by *Syngenta Crop Protect (Agency)*

Two active ingredients provide broad-spectrum disease control in one versatile solution. Powered by an advanced generation SDHI and Heritage® fungicide to control the widest range of root diseases in ornamental and vegetable plants. Mural provides control of key foliar, stem and root diseases including Botrytis, Rhizoctonia and leaf spots like powdery mildew and anthracnose.

- Active Ingredient: Azoxystrobin, Benzovindiflupyr
- Rate: 4 to 7oz per 100gal
- REI: 12 Hrs
- Controls: Botrytis, Fusarium, Rhizoctonia and more.
- Signal Word: Warning



1lb AGENCY
SYN56731 Min. Buy 1 EA

OHP 6672® 4.5F Fungicide

by *OHP, Inc.*

OHP 6672 4.5F fungicide controls a broad spectrum of diseases of bedding, flowering, herbaceous, vegetable plants, shrubs and trees grown in the greenhouse, nursery, landscapes and interiorscapes.

- Active Ingredient: Thiophanate-methyl
- Rate: 10 to 20oz per 100gal
- REI: 12 Hrs
- Controls: Anthracnose, Botrytis, Fusarium and many more.
- Signal Word: Caution



CA Prop65 Warning



2.5gal
OHP986125 Min. Buy 1 EA
Other Info *SHIPS HAZ*

OHP 6672® 50WP Fungicide

by *OHP, Inc.*

OHP 6672 50WP fungicide controls a broad spectrum of diseases of bedding, flowering, herbaceous, vegetable plants, shrubs and trees grown in the greenhouse, nursery, landscapes and interiorscapes.

- Active Ingredient: Thiophanate-methyl
- Rate: 10 to 20oz per 100gal
- REI: 12 Hrs
- Controls: Anthracnose, Botrytis, Fusarium and many more.
- Signal Word: Caution



CA Prop65 Warning



2lb
OHP986188 Min. Buy 1 EA

OHP Chipco® 26019 N/G Fungicide

by *OHP, Inc.*

Chipco 26019 is a broad spectrum fungicide that may be applied safely to a wide range of ornamental flowering and foliage plants, either as a foliar spray, drench, or dip.

- Active Ingredient: Iprodione
- Rate: 1 to 2lbs per 100gal
- REI: 12 Hrs
- Controls: Rhizoctonia, Fusarium, Botrytis and more.
- Signal Word: Caution



CA Prop65 Warning



2lb
OHP981462 Min. Buy 1 EA

WARNING: This product is not available for sale in CA. For most up to date information please visit bfgsupply.com

Fungicides & Bactericides

Orkestra® Intrinsic® Fungicideby **BASF Corp**

Orkestra Intrinsic brand fungicide provides nursery and greenhouse growers with fast, long-acting disease control during production, resulting in healthier, more consistent, high quality plants. Orkestra Intrinsic brand fungicide provides preventive, early curative and residual protection against key ornamental diseases, quickly stopping the growth of fungal cells.

- Active Ingredient: Fluxapyroxad & Pyraclostrobin
- Rate: 4 to 10oz per 100gal
- REI: 12 Hrs
- Controls: Botrytis, rust, powdery mildew, downy mildew, anthracnose, leaf spots, thielaviopsis, aerial phyophthora
- Signal Word: Warning

**1pt AGENCY****BAS59014379** Min. Buy 1 EA**80oz AGENCY****BAS59016487** Min. Buy 1 EA**Orvego® Fungicide**by **BASF Corp**

Controls Phytophthora and Downey Mildew on ornamentals. Orvego offers a quick knockdown of spores to stop the disease from spreading. Use in greenhouses, lathouses, container and field nurseries and interiorscapes.

- Active Ingredient: Amectotradin & Dimethomorph
- Rate: 11 to 14oz per 100gal
- REI: 12 Hrs
- Controls: Phytophthora, Downey Mildew.
- Signal Word: Caution

**28oz****BAS59012736** Min. Buy 1 EA**OxiDate® 2.0 Fungicide**by **BioSafe Systems**

A concentrated, EPA-registered chemistry uniquely positioned to strengthen foliar spray programs. Its formula utilizes BioSafe Systems' proprietary peroxyacetic acid (PAA) chemistry to eradicate plant pathogens on contact with no harmful residues and no known resistance.

- Active Ingredients: Hydrogen Peroxide and Peroxyacetic Acid
- Rate: 32 to 64oz per 100gal.
- REI: 1-hour spray, 0-hour non-sprays
- Controls: Bacterial and Fungal pathogens.
- Signal Word: Danger

**2.5gal****BSF510025** Min. Buy 1 EAOther Info **SHIPS HAZ****OxiPhos® Fungicide**by **BioSafe Systems**

A systemic bactericide/fungicide for use on greenhouse and nursery crops, turf, and fruits, vegetables, and herbs. OxiPhos targets Pythium, Phytophthora, bacterial blights, downy mildew, and more! Use throughout the growing season to prevent and control plant pathogens. OxiPhos has a dual mode of action (systemic and contact) and can be applied as a foliar spray, root drench, or tank-mixed.

- Active Ingredients: Phosphorus Acid and Hydrogen Peroxide
- Rate: Varies depending on application method. See label for complete information.
- REI: 4-hour spray
- Controls: Pythium, Phytophthora, and Downy Mildew.
- Signal Word: Danger

**2.5gal****BSF7700-2.5** Min. Buy 1 EAOther Info **SHIPS HAZ****Pageant® Intrinsic® Fungicide**by **BASF Corp**

Pageant is a broad-spectrum fungicide that is effective on many plant diseases. Pageant Intrinsic brand fungicide also provides plant health benefits such as improved tolerance to stress and increased efficiency of plant processes.

- Active Ingredient: Boscalid & Pyraclostrobin
- Rate: 4 to 18oz per 100gal
- REI: 12 Hrs
- Controls: Alternaria, Botrytis, Cercospora, Cladosporium, Cylindrocladium, Fusarium, Helminthosporium, Phomopsis, Phytophthora, Pythium, Rhizoctonia, leaf spots.
- Signal Word: Caution

**11b AGENCY****BAS59012349** Min. Buy 1 EA**121b AGENCY****BAS59012429** Min. Buy 1 EA**Pageant® TR Intrinsic® Fungicide**by **BASF Corp**

Pageant is a broad-spectrum fungicide that is effective on many plant diseases. Pageant Intrinsic brand fungicide also provides plant health benefits such as improved tolerance to stress and increased efficiency of plant processes. Total release fogger. Can also be used in the cargo area of trucks to protect plants during transportation.

- Active Ingredient: Boscalid & Pyraclostrobin
- Rate: One can Covers up to 3,000sq ft. Must be used in a closed greenhouse or truck.
- REI: 12 Hrs
- Controls: Alternaria, Botrytis, Cercospora, Cladosporium, Cylindrocladium, Fusarium, Helminthosporium, Phomopsis, Phytophthora, Pythium, Rhizoctonia, leaf spots.
- Signal Word: Caution

**3oz****BAS59012766** Min. Buy 1 EA

Fungicides & Bactericides

Palladium® Fungicide*by Syngenta Crop Protect (Agency)*

Combines two active ingredients to provide contact and systemic activity. Effective on a wide range of foliar and stem diseases found in the nursery and greenhouse, including Botrytis, Rhizoctonia, powdery mildew and certain leaf-spotting and stem rot pathogens. Provides preventive and curative disease control with 7-14 days of residual activity.

- Active Ingredient: Cyprodinil and Fludioxonil
- Rate: 2 to 4oz per 100gal
- REI: 12 Hrs
- Controls: Botrytis, Fusarium, Rhizoctonia and more.
- Signal Word: Caution

**2lb AGENCY****SYN38781**

Min. Buy 1 EA

**PerCarb® Fungicide***by BioSafe Systems*

PerCarb uses peroxide as its initial kill step, with sodium carbonate creating a strong residual component with a high pH to prevent mildew regrowth. It stops spores from germinating, controls and prevents liverwort on soil surfaces, and is designed to treat and control plant pathogenic diseases on greenhouse vegetables, cannabis, ornamentals, and turf.

- Active Ingredients: Sodium Carbonate Peroxyhydrate
- Rate: Varies depending on application method. See label for complete information.
- REI: 1-hour spray, 0-hour non-sprays
- Controls: nostoc algae, bacteria, moss, liverworts, and more.
- Signal Word: Danger

**50lb****BSF420050**

Min. Buy 1 EA

**Phostrol Fungicide***by Nufarm Americas Inc.*

Phostrol provides both preventive and curative treatments for pythium and yellow tuft diseases in a clear, odorless liquid formulation. Combining easily with other fungicides, Phostrol is an essential component of any broad spectrum fungicidal program.

- Active ingredient: Mono- and dibasic sodium, potassium and ammonium phosphites
- Rate: 2 to 5 pints per acre
- REI: 4 hours
- Controls: Phytophthora, Downy mildew, Pythium
- Signal Word: Caution

**2.5gal****NTS10264225**

Min. Buy 1 EA

**Phyton 27® Fungicide***by Phyton Corp*

Phyton 27 is a broad spectrum bactericide/fungicide effective against many pathogens including Botrytis, Leaf Spot, Powdery Mildew, and more. The active ingredient works systemically and provides residual control for up to 21 days. Labeled for use on turf, greenhouse and field grown ornamentals, and nursery stock.

- Active Ingredient: Copper Sulfate Pentahydrate.
- Rate: Varies depending on application.
- REI: 24 hours
- Controls: Botrytis, Leaf Spot, Downy Mildew, Anthracnose, Powdery Mildew and many more.
- Signal Word: Danger

**1liter****PHTNP27-101031**

Min. Buy 1 EA

1gal**PHTNP27-101011**

Min. Buy 1 EA

**Phyton 35® Fungicide***by Phyton Corp*

A broad-spectrum systemic bactericide + fungicide labeled for use on fruit, vegetables, and herbs, as well as ornamentals. Quickly absorbed into plants, enabling the active ingredient to move throughout the plant and be retained in the plant. Leaves no visible residue and won't clog spray nozzles. Formulated for use from propagation up to the time of harvest.

- Active Ingredient: Copper Sulfate Pentahydrate.
- Rate: Varies depending on application.
- REI: 48 hours
- Controls: Botrytis, Leaf Spot, Downy Mildew, Anthracnose, Powdery Mildew and many more.
- Signal Word: Danger

**1liter****PHTNP35-300034**

Min. Buy 1 EA

1gal**PHTNP35-300128**

Min. Buy 1 EA



WARNING: This product is not available for sale in CA.
For most up to date information please visit bfgsupply.com

800-883-0234
www.bfgsupply.com



PERFECT YOUR PROGRAM WITH POSTIVA

Complete your disease management strategy with the unique formulation in Postiva® fungicide.



Powered by two active ingredients (FRAC groups 3+7), making it an excellent addition to disease management programs.





Rapidly absorbed into plant tissue creating a rainfast barrier of protection to prevent infection and disease progression.



Provides long-lasting control of Fusarium, powdery mildew, Botrytis, leaf spots, black spot and rust, as well as suppression of certain bacterial diseases.

Learn more at [GreenCastOnline.com/Postiva](https://www.GreenCastOnline.com/Postiva)

 @SyngentaOrnamentalsUS  @SyngentaOrnamentals



Postiva[®]
Fungicide

syngenta.

All photos are either the property of Syngenta or are used with permission.

© 2022 Syngenta. **Important: Always read and follow label instructions. Some products may not be registered for sale or use in all states or counties and/or may have state-specific use requirements. Please check with your local extension service to ensure registration and proper use.** GreenCast®, Postiva®, the Purpose Icon, the Alliance Frame and the Syngenta logo are trademarks of a Syngenta Group Company.

®

Fungicides & Bactericides

Postiva™ Fungicide

by Syngenta Crop Protect (Agency)

Postiva fungicide is powered by ADEPIDYN® technology, the first member of a subclass of SDHIs, and difenoconazole, a DMI fungicide. With two modes of action, Postiva provides strong protection and reliable control of difficult diseases such as Fusarium, leaf spots, Botrytis, powdery mildew, as well as bacterial suppression.

- Active Ingredient: Pydiflumetofen, Difenoconazole
- Rate: 10-28oz per 100 gallons
- REI: 12 Hours
- Controls: Foliar and Soilborne fungal diseases, bacterial disease suppression
- Signal Word: Caution

**28oz AGENCY****SYN69240** Min. Buy 1 EA**Protect™ DF Fungicide**

by Nufarm Americas Inc.

Protect DF fungicide provides control of many key diseases in commercial turf, field ornamentals and shade trees, golf courses, groundcovers and herbaceous plants.

- Active Ingredient: Mancozeb
- Rate: 6 to 8oz per 1,000sq ft
- REI: 24 Hrs
- Controls: Rust, Leaf Spot, Red Thread, Copper Spot, Fusarium and more.
- Signal Word: Caution

**6lb****NTS10506660** Min. Buy 1 EA**Regalia® CG Fungicide**

by ProFarm

Regalia's unique mode of action of Induced Systemic Resistance (ISR) brings a sustainable option to help simplify and extend your IPM program. It can be used as a stand-alone product, in rotation with or in combination with other fungicides to strengthen IPM programs and to help manage resistance in organic & conventional crops, and turf and ornamentals.

- Active Ingredient: Reynoutria sachalinensis
- Rate: 6 to 11 oz per 100 gal
- REI: 4 hours
- Controls: Anthracnose, Downy Mildew, Botrytis, Powdery Mildew, and more.
- Signal Word: Caution

**1qt****MB10084** Min. Buy 1 EA**1gal****MB10081** Min. Buy 1 EA**2.5gal****MB10096** Min. Buy 1 EA**RootShield® Granules Fungicide**

by BioWorks Inc.

RootShield biological fungicide formulated as granules for media incorporation. RootShield grows on roots, "shielding" them against fungi. One application protects for up to 12 weeks. OMRI listed.

- Active Ingredient: Trichoderma harzianum Rifai strain T-22
- Rate: Varies depending on application method. See label.
- REI: 0 Hrs
- Controls: Soilborne plant pathogens and root diseases.
- Signal Word: Caution

**40lb****BW2H03A08** Min. Buy 1 EAOther Info [SHIPS DIRECT](#)**500lb****BW2H03A10** Min. Buy 1 EAOther Info [SHIPS DIRECT](#)**1,000lb****BW2H03A11** Min. Buy 1 EAOther Info [SHIPS DIRECT](#)**RootShield® PLUS+ Granules Fungicide**

by BioWorks Inc.

Preventative control of major root diseases including Phytophthora, Rhizoctonia, Pythium, Fusarium, Thielaviopsis and Cylindrocladium. Grows on roots "shielding" them against root damaging fungi. One application provides up to 12 weeks of protection. Contains two active ingredients (Trichoderma harzianum strain T-22 and Trichoderma virens strain G-41).

- Active Ingredient: Trichoderma harzianum Rifai strain T-22 and Trichoderma virens strain G-41
- Rate: Varies depending on application method. See label.
- REI: 0 Hrs
- Controls: Pythium, Rhizoctonia, Fusarium, Cylindrocladium, Thielaviopsis
- Signal Word: Caution

**40lb****BW2HR46A08** Min. Buy 1 EAOther Info [SHIPS DIRECT](#)**500lb****BW2HR46A10** Min. Buy 1 EAOther Info [SHIPS DIRECT](#)**1,000lb****BW2HR46A11** Min. Buy 1 EA

WARNING: This product is not available for sale in CA.
For most up to date information please visit bfgsupply.com

800-883-0234
www.bfgsupply.com

Fungicides & Bactericides

RootShield® PLUS+ WP Fungicideby *BioWorks Inc.*

RootShield Plus biological fungicide formulated as wettable powder for drench or dip. RootShield Plus grows on roots, shielding them against fungi. Two active ingredients for enhanced disease control. One application protects for up to 12 weeks.

- Active Ingredient: Trichoderma harzianum Rifai strain T-22 and Trichoderma virens strain G-41
- Rate: Varies depending on application method. See label.
- REI: 0 Hrs
- Controls: Pythium, Rhizoctonia, Fusarium, Cyliandrocladium, Thielaviopsis
- Signal Word: Caution

**1lb****BW2HR45A02** Min. Buy 1 EAOther Info *SHIPS DIRECT***3lb****BW2HR45A03** Min. Buy 1 EAOther Info *SHIPS DIRECT***30lb****BW2HR45A07** Min. Buy 1 EAOther Info *SHIPS DIRECT***RootShield® WP Fungicide**by *BioWorks Inc.*

RootShield biological fungicide formulated as wettable powder for drench or dip. RootShield grows on roots, shielding them against fungi. One application protects for up to 12 weeks.

- Active Ingredient: Trichoderma harzianum Rifai strain T-22
- Rate: Varies depending on application method. See label.
- REI: 0 Hrs
- Controls: Soilborne plant pathogens and root diseases.
- Signal Word: Caution

**1lb****BWRSWP1** Min. Buy 1 EAOther Info *SHIPS DIRECT***3lb****BW2H02A03** Min. Buy 1 EAOther Info *SHIPS DIRECT***30lb****BW2H02A07** Min. Buy 1 EAOther Info *SHIPS DIRECT***Segovis® Fungicide**by *Syngenta Crop Protection*

Segovis® fungicide sets a higher standard for control of downy mildew and Phytophthora spp. diseases. Its strong activity and systemic properties provide long-lasting control when applied as a drench or foliar spray at low use rates. Novel mode of action provides a good tool for growers to diversify rotation programs and manage resistance concerns.

- Active Ingredient: Oxathiapiprolin
- Rate: 0.6 to 3.2oz per 100gal
- REI: 4 Hrs
- Controls: Downy Mildew, Phytophthora.
- Signal Word: Warning

**1pt****SYN58199** Min. Buy 1 EA**Segway O® Fungicide**by *OHP, Inc.*

A flowable suspension concentrate formulation that controls Pythium, crown and root rots, and aerial phytophthora and downy mildews on ornamental plants and vegetables and herbs grown in commercial greenhouses and nurseries. Should be utilized as a protectant fungicide and applied before conditions are favorable for disease development.

- Active Ingredient: Cyazofamid
- Rate: 1.5 to 6oz per 100gal
- REI: 12 hours
- Controls: Pythium, Phytophthora, Downy Mildew.
- Signal Word: Caution

**1pt****OHP987280** Min. Buy 1 EA**64oz****OHP987245** Min. Buy 1 EA**Seido™ Fungicide**by *OHP, Inc.*

Seido™ provides preventative and early-curative activity of powdery mildew on ornamentals and bedding plants grown in commercial greenhouses and nurseries. Seido™ is most effective when used as a preventative fungicide before disease damages the crop. As the only member of MOA Group 50, Seido™ is an excellent resistance management tool.

- Active Ingredient: Pyriofenone
- Rate: 4 to 5 oz per 100gals
- REI: 4 Hrs
- Controls: Powdery Mildew and other diseases
- Signal Word: Caution

**1qt****OHP987340** Min. Buy 1 EA**Spirato® GHN Fungicide**by *Nufarm Americas Inc.*

Spirato GHN fungicide controls foliar, stem and root diseases in ornamentals grown in greenhouses and landscapes. Also labeled for control of certain diseases on select vegetable plants.

- Active Ingredient: Fludioxanil
- Rate: 2 to 4oz per 100gal
- REI: 12 Hrs
- Controls: Rhizoctonia, Botrytis, Fusarium and more.
- Signal Word: Caution

**1lb****NTS10726861** Min. Buy 1 EA

Fungicides & Bactericides

Stargus® Fungicide

by ProFarm

Stargus® is a biological fungicide for control of fungal and bacterial plant diseases. Use sites include field and greenhouse crops. Can be used on bushberries and caneberries, bulb vegetables, citrus crops and most vegetables.

- Active ingredient: bacillus amyloliquefaciens strain F727
- Rate: Varies according to application. See label for rate information.
- REI: 4 hours
- Controls: Downy Mildew, Black Spot, Botrytis, Fusarium, Pythium, Rhizoctonia and more.
- Signal Word: Caution

**2.5gal****MB10077**

Min. Buy 1 EA

**Subdue® G Fungicide**

by Syngenta Crop Protection

A granular formulation of Subdue Maxx. Use on bedding plants, flowers, perennials, shrubs and other ornamental plants in outdoor landscapes and interiorscapes to control damping-off, downy mildew and root and stem rot diseases caused by Pythium and Phytophthora. Apply either as a soil surface application or incorporate into the soil at the time of seeding and transplanting.

- Active Ingredient: Mefenoxam
- Rate: 1.6 to 8oz per cubic yard
- REI: 48 Hrs
- Controls: Phytophthora, Pythium, Downy Mildew.
- Signal Word: Caution

**25lb****SYN53181**

Min. Buy 1 EA

**Stature® SC Fungicide**

by BASF Corp

Stature SC fungicide is a flowable formulation of dimethomorph. Proven performance for preventative control of Phytophthora and Downy mildew diseases. Can be applied as a spray, drench, or through chemigation.

- Active Ingredient: Dimethomorph
- Rate: 3.06 to 12.25oz per 100gal
- REI: 12 Hrs
- Controls: Downy Mildew, Aerial Phytophthora, Phytophthora Root/Crown/Stem Rot
- Signal Word: Caution

**25oz****BAS59011288**

Min. Buy 1 EA

**TeNet WP Fungicide**

by Blacksmith BioScience

TeNet WP biofungicide protects crops from attack by fungal diseases including Phytophthora, Pythium, Rhizoctonia and more. TeNet can be used on most greenhouse and field grown crops including fruiting vegetables, leafy vegetables and cucurbits.

- Active ingredient: Trichoderma asperellum + Trichoderma gamsii
- Rate: 2 to 7 oz per 100 gallon
- REI: 4 hours
- Controls: Fusarium, Pythium, Phytophthora, Rhizoctonia, and other soil borne diseases
- Signal Word: Caution

**1lb****BBSLGTNT0012** Min. Buy 1 EAOther Info [SHIPS DIRECT](#)**Subdue MAXX® Fungicide**

by Syngenta Crop Protection

Subdue MAXX is a systemic fungicide that provides control of damping off, root and stem diseases caused by Pythium and Phytophthora as well as foliar diseases including Downy Mildew. Labeled for use on ornamentals, foliar and flowering plants, non bearing fruit and nut trees and landscapes and interiorscapes.

- Active Ingredient: Mefenoxam
- Rate: 1oz per 100gal
- REI: 48 Hrs
- Controls: Phytophthora, Pythium, Downy Mildew.
- Signal Word: Caution

**1qt****CH149**

Min. Buy 1 EA

1gal AGENCY**SYN53195**

Min. Buy 1 EA

10gal Link Pak AGENCY**SYN53185**

Min. Buy 1 EA

**Terraclor 400® Fungicide**

by OHP, Inc.

An effective ornamental soil fungicide for prevention and control of soil borne diseases caused by Rhizoctonia solani and other soil borne diseases. For use on ornamentals and vegetable bedding plants. Works primarily as a preventative agent through contact activity and should be applied before disease symptoms appear in order to achieve optimum results.

- Active Ingredient: PCNB
- Rate: 6 to 12oz per 100gal
- REI: 12 Hrs
- Controls: Root Rot/Stem Rot, Bulb Rot/Crown Rot, Magnolia Leaf Spot.
- Signal Word: Caution

**1gal****OHP988464**

Min. Buy 1 EA



WARNING: This product is not available for sale in CA.
For most up to date information please visit bfgsupply.com

Fungicides & Bactericides

Terraguard® SC Fungicide

by OHP, Inc.

A locally systemic fungicide that provides protection of hard to control diseases. Can be used as a cutting soak, soil drench, foliar spray or through chemigation for control of diseases on ornamental plants and greenhouse grown tomatoes and cucumbers in enclosed commercial structures, shade houses and interiorscapes. It prevents diseases from attacking leaf surfaces as it penetrates the plant.

- Active Ingredient: Triflumizole
- Rate: 2 to 16oz per 100gal
- REI: 12 Hrs
- Controls: Rhizoctonia, Powdery Mildew, Thiellaviopsis and more.
- Signal Word: Caution



1qt

OHP988466 Min. Buy 1 EA



Terrazole® 35W Fungicide

by OHP, Inc.

An effective soil fungicide for prevention and control of damping-off, root rot and stem diseases caused by Pythium and Phytophthora species in ornamental, nursery crops and golf course tees and greens.

- Active Ingredient: Etridiazole
- Rate: 3.5 to 10 oz per 100gal
- REI: 12 Hrs
- Controls: Pythium and Phytophthora.
- Signal Word: Caution



2lb

OHP988472 Min. Buy 1 EA



Terrazole® L Fungicide

by OHP, Inc.

An effective soil fungicide for prevention and control of damping-off, root rot and stem diseases caused by Pythium and Phytophthora species in ornamental, nursery crops and golf course tees and greens.

- Active Ingredient: Etridiazole
- Rate: 2.5 to 7 oz per 100gal
- REI: 12 Hrs
- Controls: Pythium and Phytophthora.
- Signal Word: Danger



1qt

OHP988478 Min. Buy 1 EA



Torque™ Fungicide

by Nufarm Americas Inc.

Torque™ provides long-lasting curative and preventive control against tough ornamental diseases such as scabs, phomopsis, mildews and rusts. Torque™ fungicide provides disease control in field, nursery and container ornamentals, and golf course turf.

- Active Ingredient: Tebuconazole
- Rate: 4 to 10 oz per acre
- REI: 12 hours
- Controls: Black Spot, Powdery Mildew, Anthracnose, Scab, and more
- Signal Word: Caution



1gal

NTS10492051 Min. Buy 1 EA

Other Info HAZARDOUS BY AIR



Tourney® Fungicide

by Nufarm Americas Inc.

Controls a broad spectrum of diseases affecting outdoor woody ornamental plants in nursery and landscape settings, including powdery mildew, apple scab, rusts, leaf spots, anthracnose and Rhizoctonia root and crown rot-all with just one product. Also takes out tough diseases in turf like anthracnose, brown patch, summer patch, take-all patch, fairy ring, and more.

- Active Ingredient: Metconazole
- Rate: 1 to 4oz per 100gal
- REI: 12 Hrs
- Controls: Anthracnose, Brown Rot, Leaf Scabs, Fusarium, Rhizoctonia and many more.
- Signal Word: Caution



5lb

VAL19-0401A Min. Buy 1 EA



Transom™ 4.5F Fungicide

by Prokoz, Inc

A liquid flowable systemic turf and ornamental fungicide for control of a broad spectrum of diseases of herbaceous, bedding, flowering and tropical foliage plants, shrubs, trees and flowers in the landscape, Interiorscape, nursery and greenhouse, containerized woody shrubs and trees and turf grass.

- Active Ingredient: Thiophanate-Methyl
- Rate: 12 to 20oz per 100gal
- REI: 12 Hrs
- Controls: Anthracnose, Botrytis, Powdery Mildew, Rhizoctonia and more.
- Signal Word: Danger



2.5gal

PROKZ10349225 Min. Buy 1 EA

Other Info SHIPS HAZ



Fungicides & Bactericides

Triathlon BA® Fungicide

by OHP, Inc.

A broad-spectrum preventative biofungicide for control of a wide variety of fungal and bacterial diseases on ornamentals, fruits, vegetables, herbs and spices grown in greenhouses, nurseries and shade houses, Triathlon BA is approved for use in organic production.

- Active Ingredient: Bacillus amyloliquefaciens strain D747
- Rate: Varies depending on application method. See label.
- REI: 4 Hrs
- Controls: Botrytis, Powdery Mildew, Downy Mildew and more.
- Signal Word: Caution

**1gal****OHP988544** Min. Buy 1 EA**Trinity® TR Fungicide**

by BASF Corp

Provides broad spectrum control of several key diseases. Total release fogger. for use in greenhouses on bedding plants, cut flowers, flowering hanging baskets, foliage, potted flowering plants, ornamentals, and perennials.

- Active Ingredient: Triticonazole
- Rate: One can Covers 1,500sq ft
- REI: 12 Hrs
- Controls: Alternaria, Botrytis, Downy Mildew, Fusarium, Powdery Mildew.
- Signal Word: Caution

**4oz****BAS59012781** Min. Buy 1 EA**Truban® 25EC Fungicide**

by ICL

Soil fungicide for the control of damping off, root and stem rot diseases caused by Pythium and Phytophthora in bedding plants, ornamental and nursery crops. Labeled for use in commercial greenhouses and nurseries. Liquid formulation.

- Active Ingredient: Etridiazole
- Rate: 4 to 8oz per 100gal
- REI: 12 Hrs
- Controls: Damping Off, Stem and Root Rot Diseases caused by Pythium and Phytophthora
- Signal Word: Warning

**1qt****EVR950441E** Min. Buy 1 EA**Truban® 30 WP Fungicide**

by ICL

Soil fungicide for the control of damping off, root and stem rot diseases caused by Pythium and Phytophthora in bedding plants, ornamental and nursery crops. Labeled for use in commercial greenhouses and nurseries. Wettable powder formulation.

- Active Ingredient: Etridiazole
- Rate: 3 to 10oz per 100gal
- REI: 12 Hrs
- Controls: Damping Off, Stem and Root Rot Diseases caused by Pythium and Phytophthora
- Signal Word: Warning

**2lb****EVR957001E** Min. Buy 1 EA**ZeroTol® 2.0 Fungicide**

by BioSafe Systems

Disrupt plant pathogen life cycles and reduce disease incidence and severity. ZeroTol 2.0 provides immediate on-contact activity with no harmful residues making it ideal for food crops, cannabis, and more. Apply as a foliar spray or drench.

- Active Ingredients: Hydrogen Peroxide and Peroxyacetic Acid
- Rate: Varies depending on application method. See label for complete information.
- REI: 1-hour spray, 0-hour non-sprays
- Controls: Botrytis, Downy and Powdery Mildew, and many other diseases
- Signal Word: Danger

**2.5gal****BSF600025** Min. Buy 1 EAOther Info [SHIPS HAZ](#)**30gal****BSFT0600030** Min. Buy 1 EAOther Info [SHIPS HAZ](#)**55gal****BSFT0600055** Min. Buy 1 EAOther Info [SHIPS HAZ](#)**275gal****BSF6000275** Min. Buy 1 EAOther Info [SHIPS HAZ](#)**ZeroTol® HC Fungicide**

by BioSafe Systems

Eliminate plant pathogens such as powdery mildew, Botrytis, and Pythium on-contact. ZeroTol HC is ideal for the indoor or hydroponics grower with under 500 sq. ft. Use as a foliar spray, hard surface treatment, and in hydroponics or aquaponics systems.

- Active Ingredients: Hydrogen Peroxide and Peroxyacetic Acid
- Rate: .75 to 1 oz per gallon
- Controls: Algae, Powdery Mildew, Botrytis, and more
- Signal Word: Danger

**1gal****BSF62001** Min. Buy 1 EA

WARNING: This product is not available for sale in CA.
For most up to date information please visit bfgsupply.com

A woman with red hair, wearing a white t-shirt and a yellow apron, is smiling and using a spray wand in a greenhouse. The wand is silver with a blue handle and a blue nozzle. She is holding it with both hands, and it is spraying water onto a plant. The background shows rows of plants in a greenhouse setting.

Max hydration.
Less irrigation.

H₂Pro[®]

You work hard. Your water should, too.

Available in liquid or granular formulations, H₂Pro Greenhouse and Nursery Surfactant optimizes the water penetration and holding capacity of soilless growing media. The wetting effects can last up to a year and the moisture distributing action reduces wilting and dry spots. Maximum hydration from reduced irrigation—that's the power of H₂Pro.



Mycorrhizae & Soil Inoculants

Armory Soil Inoculant

by Blacksmith BioScience

Armory is a high concentration of Bacillus and Streptomyces bacteria that will increase the beneficial microbial population of soils for maximum plant vigor, growth, and yield. Armory can be tank mixed with chemicals, fertilizers, and other biologicals. Apply as a drench, foliar spray, or soil incorporation. For use on fruits, vegetables, herbs and medicinal herbs, turf, and ornamentals and more.

- Active ingredients: Bacillus subtilis, Bacillus amyliliquefaceans, Bacillus licheniformis, Bacillus thuringiensis, and Streptomyces griseus
- Rate: 8 oz per 100 gallon
- REI: 0 hours
- Increase beneficial soil microbes



200oz

BBSLGR0200 Min. Buy 1 EA

Other Info SHIPS DIRECT



MycoApply® EndoThrive™

by Mycorrhizal Applications LLC

MycoApply® EndoThrive™ contains propagules of multiple species of endomycorrhizae, or arbuscular mycorrhizal fungi (AMF) on a non-aqueous liquid carrier. These AMF colonize the root systems of plants in a symbiotic manner, expand out beyond the plant roots or rhizosphere region of the soil surrounding the plant roots to acquire nutrients and water, and actively deliver these resources to the plant's vascular system.

- Active ingredient: 4 species of Glomus
- Rate: 8 oz per 100 gals
- REI: 0 hours
- Signal Word: Caution



1pt

MASAS1011704016 Min. Buy 1 EA

1gal

MASAS1011704011 Min. Buy 1 EA



MycoApply® Endo

by Mycorrhizal Applications LLC

MycoApply Endo is a granular material containing mycorrhizal propagules, which colonize roots and extend into the surrounding soil forming an essential link between plants and soil resources. Increasing the rooting area allows improved access to water and nutrients, promoting plant quality and crop performance.

- Active Ingredient: 4 species of Endomycorrhizae. Glomus intraradices, Glomus mosseae, Glomus aggregatum, Glomus etunicatum
- Rate: See label
- REI: 0 hours
- 60,000 Endomycorrhizal Propagules per lb.
- Signal Word: Caution



CA Prop65 Warning

40lb

MAFMAEN40 Min. Buy 1 EA

Other Info SHIPS DIRECT



MycoApply® Injector Endo Organic

by Mycorrhizal Applications LLC

MycoApply® Injector Endo Organic is an OMRI Listed® concentrated suspendable powder that contains propagules of multiple species of arbuscular mycorrhizal fungi (AMF) on a soluble Humic carrier. The arbuscular mycorrhizal fungi colonize the root systems of plants in a symbiotic manner, expand out beyond the plant roots or rhizosphere region of the soil surrounding the plant roots to acquire nutrients and water.

- Active ingredient: 4 species of Glomus and Humic acids
- Rate: 20 grams per 100 gals
- REI: 0 hours
- Signal Word: Caution



100g

MASAS1011604455 Min. Buy 1 EA



MycoApply® Endo / Ecto

by Mycorrhizal Applications LLC

MycoApply Endo/Ecto is a granular mycorrhizal inoculum consisting of 4 species of endomycorrhizal fungi and 7 species of ectomycorrhizal fungi. These beneficial fungi greatly increase the effective rooting area of plants, thereby enhancing plant growth, vigor, and tolerance of environmental extremes.

- Active Ingredient: 4 species of Endomycorrhizae. Plus 7 species of Ectomycorrhizae.
- Rate: See label
- REI: 0 hours
- 110 million Ectomycorrhizal Propagules per Lb.
- Signal Word: Caution



CA Prop65 Warning

40lb

MAFMAENEC40 Min. Buy 1 EA

Other Info SHIPS DIRECT



MycoApply® Soluble MAXX

by Mycorrhizal Applications LLC

MycoApply Soluble Maxx is a suspendable powder mycorrhizal inoculum consisting of 9 species of endomycorrhizal fungi and 10 species of ectomycorrhizal fungi. Plus, specially formulated amendments including kelp and humic acids, well-suited to a variety of soils, climates, and plants.

- Active Ingredient: 9 species of Endomycorrhizae. Plus 10 species of Ectomycorrhizae. Plus 12 species of beneficial bacteria and 2 species of Trichoderma.
- Rate: See label
- REI: 0 hours
- 1.5 billion Ectomycorrhizal Propagules per Lb.
- Signal Word: Caution



11b

MAFMASOLMX10 Min. Buy 1 EA



WARNING: This product is not available for sale in CA. For most up to date information please visit bfgsupply.com

Mycorrhizae & Soil Inoculants

MycoApply® Ultrafine Endo

by Mycorrhizal Applications LLC

MycoApply Ultrafine Endo is a suspendable powder mycorrhizal inoculum consisting of 4 species of endomycorrhizal fungi. These beneficial fungi greatly increase the effective rooting area of plants, thereby enhancing plant growth, vigor and tolerance of environmental extremes. OMRI Listed®.

- Active Ingredient: 4 species of Endomycorrhizae.
- Rate: See label
- REI: 0 hours
- Particle size less than 300 microns. Will pass a #50 mesh screen.
- Signal Word: Caution

**20lb****MAFMAUEN20** Min. Buy 1 EAOther Info [SHIPS DIRECT](#)**MycoApply® Ultrafine Endo / Ecto**

by Mycorrhizal Applications LLC

MycoApply Ultrafine Endo/Ecto is a suspendable powder mycorrhizal inoculum consisting of 4 species of endomycorrhizal fungi and 7 species of ectomycorrhizal fungi. These beneficial fungi greatly increase the effective rooting area of plants, thereby enhancing plant growth, vigor and tolerance of environmental extremes. OMRI Listed®.

- Active Ingredient: 4 species of Endomycorrhizae.
Plus 7 species of Ectomycorrhizae.
- REI: 0 hours
- Signal Word: Caution

**1lb****MAAS1050204455** Min. Buy 1 EA**PerFect Amendment Soil Additive**

by Al-Par Peat Co.

Patented beneficial Streptomyces on an iron and humic acid carrier that when added to the soil produces healthier plants that more effectively resist stress and may reduce or eliminate the need for chemical fungicides. PerFect Amendment allows for faster and stronger rooting, more robust root zones, larger, healthier plants, long term greening and vigor.

- Active Ingredient: Iron, Humic Acid, and Streptomyces
- Rate: 5lbs per cuyd

**50lb****ALP10020** Min. Buy 1 EA**Sustane® Bolster® MycoBio™**

by Sustane Natural Fertilizer Inc

Bolster® MycoBio™ is a blend of endo mycorrhizae species and beneficial bacteria, with humic acid and compost to support the proliferation of soil micro-organisms. This mix is used for inoculating soils and growing media with beneficial microbiology for improved nutrient cycling and to amend soil to improve seedling success and promote vigorous plant establishment.

**40lb****SNF60606060** Min. Buy 1 EA**TerraGrow® Liquid Soil Inoculant**

by BioSafe Systems

A specialty blend of beneficial microbial organisms formulated to bolster plant health. When applied to the soil, it quickly establishes beneficial microbes in the root zone and improves nutrient availability. When applied to foliage, it enhances plant vigor and bolsters stress tolerance.

- Active Ingredients: Blend of five Bacillus spp.
- Rate: Varies according to application method. See label.
- Improves plant stress tolerance
- Increases plant growth
- Promotes healthy roots and improves nutrient availability

**1gal****BSF71011** Min. Buy 1 EAOther Info [SHIPS DIRECT](#)**2.5gal****BSF710125** Min. Buy 1 EAOther Info [SHIPS DIRECT](#)**275gal****BSF7101275** Min. Buy 1 EAOther Info [SHIPS DIRECT](#)**TerraGrow® Soil Inoculant**

by BioSafe Systems

Improve soil characteristics and plant stress tolerance. TerraGrow quickly re-establishes beneficial bacteria/fungal populations in and around the root zone.

- Active Ingredients: Blend of five Bacillus spp.
- Rate: 1 to 4oz per 100gal
- Improves plant stress tolerance
- Increases plant growth
- Promotes healthy roots and improves nutrient availability

**10lb****BSF710010** Min. Buy 1 EAOther Info [SHIPS DIRECT](#)**25lb****BSF710025** Min. Buy 1 EAOther Info [SHIPS DIRECT](#)



25 YEARS OF POSITIVE CHANGE

BioSafe Systems has adapted and progressed by using expert knowledge, diligent research, and customer communication to solve problems for a stronger future.



CELEBRATE WITH US

BioSafe Systems

1-888-273-3088 | BioSafeSystems.com



GROWING MEDIA for Professional Growers



PROFESSIONAL

- **Wood Fiber Mix** – more natural and sustainable
- **Superior porosity** – more available water for better root development
- **Greater value** – more mix per bale with better yields



Growth is our Strength
ASB Greenworld Inc.
 asbprofessional.com
 sales@asbgreenworld.com



! WARNING: This product is not available for sale in CA. For most up to date information please visit bfgsupply.com

800-883-0234
www.bfgsupply.com

REFERENCE GUIDE for GREENHOUSE and NURSERY PRODUCTION PLANT GROWTH REGULATORS

Resources Provided By



Plant Growth Regulators (PGRs)

**Use Site(s) Key: GH = Greenhouse N = Nursery

(by Mode of Action Group and Class)

MOA Group*	Class	Activity Level**	Common Name	Trade Name	REI	Use Site(s)**	Company
1	Pyrimidine	Medium	Ancymidol	A-Rest [®]	12	GH/N	SePRO Corp
			Flurprimidol	Topflor [®]	12	GH/N	SePRO Corp.
	Quaternary Ammonium	Medium	Chlormequat chloride	Altercel[®]	12	GH/N	OHP, Inc.
	Hydrazide	Low	Daminozide	B-Nine[®]	24	GH/N	OHP, Inc.
	Triazole	High	Paclobutrazol	PAC O[™] *formerly Paczol	12	GH/N	OHP, Inc.
			Bonzi [®]	12	GH/N	Syngenta	
			Uniconazole-p	Sumagic [®]	12	GH	Nufarm
2	Cyclohexaketone	Medium	Dikegulac-sodium	Atrimmec	12	GH/N	PBI Gordon Crop.
3	Fatty acid	Medium	Methyl esters of fatty acids	Off-Shoot-O	0	GH/N	Cochran Corp.
4	Gibberellin (GA)	High	Gibberellic acid (A3)	ProGibb [®] T&O	12	GH/N	Mycorrhizal Applications
	Synthetic Cytokinin/ Gibberellin	High	Cytokinin/ Gibberellic acid	Fascination [®]	4	GH	Nufarm
	Synthetic Cytokinin	High	N-(phenylmethyl)-IH-purine-6-amine	Configure [®]	12	GH	Fine Agrochemicals
5	Organophosphorus	Medium	Ethephon	Florel Brand Pistill	48-72	GH/N	Monterey Chemical
				Florel Brand Ethephon	48-72	GH/N	Southern Agricultural
6	Rooting Hormones Synthetic Auxin		IBA	Hormodin[®]	0	GH/N	OHP, Inc
			IBA + NAA	Dip'N Grow	0-24	GH/N	Dip'N Grow, Inc.

** PGR activity varies greatly depending on product class; e.g. the triazole class is very active. The low, medium and high ratings are guides to product activity. The higher the level of activity the more care must be taken when using.

Thank you to Dr. Joyce Latimer, Virginia Tech, for help in preparing the PGR chart.

*Plant Growth Regulators Modes of Action

- | | | |
|--|-----------------------|---------------------------|
| 1. Gibberellic Acid synthesis inhibitors | 4. Growth promoter | 7. ABA abscisic acid |
| 2. DNA synthesis inhibitor | 5. Ethylene generator | UN. Unkown mode of action |
| 3. Chemical pincher | 6. Rooting hormones | |



Plant Growth Regulators

Abide® Plant Growth Regulatorby *Fine Americas, Inc.*

Abide is a plant growth regulator for use on commercially grown ornamentals in nurseries, greenhouses, and shadehouses. Can be applied by spray or drench.

- Active Ingredient: Ancyimidol
- Rate: Varies, see label for more information.
- REI: 12 hours
- Controls: Plant growth.
- Signal Word: Caution

**2.5gal****FINE190637** Min. Buy 1 EA**A-Rest™ Plant Growth Regulator**by *Sepro Corporation*

A-Rest provides just the right amount of growth regulation. Gentle enough on tender plugs and transplants yet strong enough to adequately regulate perennials. A-Rest reduces internode elongation resulting in a more compact plant with darker green leaves. A-Rest has no adverse effects on flowers including no flower delay, no residue and no phytotoxicity.

- Active Ingredient: Ancyimidol
- Rate: Varies. See label for specific crops
- REI: 12 Hrs
- Controls: Plant growth.
- Signal Word: Caution

**2.5gal AGENCY****SEPRO1012.225** Min. Buy 1 EA**Advocate™ Plant Growth Stimulant**by *Fine Americas, Inc.*

Advocate is a plant biostimulant which can improve the rooting of plant cuttings for plant propagation. For use on annual, perennial, and woody ornamental cuttings.

- Active Ingredient: IBA (Indole-butyric acid)
- Rate: Varies, see label for more information.
- REI: 12 hours
- Controls: Plant growth.
- Signal Word: Caution

**1qt****FINE190639** Min. Buy 1 EA**B-Nine® WSG Plant Growth Regulator**by *OHP, Inc.*

Reduces plant height in ornamental plants by reducing internode length. Other benefits include a deeper green color and reduced breakage during shipping. When applied to plant foliage is absorbed into the leaf, moves within the plant to the growing points to reduce internode elongation.

- Active Ingredient: Daminozide
- Rate: Varies depending on application method. See label.
- REI: 24 Hrs
- Reduces internode elongation, resulting in more desirable compact plants
- Signal Word: Caution

**1lb****OHP981312** Min. Buy 1 EA**5lb****OHP981318** Min. Buy 1 EA**Alesco® Ethylene Inhibitor**by *Chrysal Americas*

Chrysal Alesco® is a foliar spray to apply before shipping to avoid ethylene damage. It prevents shrinkage and premature dropping of buds, leaves and flowers. Ensures top quality plants throughout the chain. Ethylene sensitive potted plants that have been treated with Chrysal Alesco® have more blooms in retail.

- Active Ingredient: Silver nitrate
- Rate: 1 ml per 1 liter of water

**200ml****CHRYSALEB250** Min. Buy 1 EA**Bonzi® Plant Growth Regulator**by *Syngenta Crop Protection*

The leading ornamental plant growth regulator (PGR), Bonzi® keeps plants uniformly compact, hardy and looking their best. It results in one consistent crop after another, with well-proportioned plants achieving identically ideal form and color. While a small amount may be taken in through leaves, it is primarily absorbed through the stems and roots.

- Active Ingredient: Paclobutrazol
- Rate: Varies according to application. See label.
- REI: 12 Hrs
- Reduces internode elongation, resulting in more desirable compact plants
- Signal Word: Caution

**1qt****SYN13869** Min. Buy 1 EA

Other Info

2.5gal AGENCY**SYN27714** Min. Buy 1 EA

Other Info

**Altercel® Plant Growth Regulator**by *OHP, Inc.*

Altercel® plant growth regulator may be used on any crop in the greenhouse or nursery including, but not limited to, poinsettias, hibiscus, azaleas, and geraniums. Reduces stem elongation, induces early flowering, and improves flowering to produce compact plants with multiple buds per shoots.

- Active Ingredient: Chlormequat Chloride
- Rate: Varies depending on application method. See label.
- REI: 12 hours
- Limits internode elongation
- Signal Word: Caution

**1gal****OHP981050** Min. Buy 1 EA

WARNING: This product is not available for sale in CA.
For most up to date information please visit bfgsupply.com

Plant Growth Regulators

Citadel® Plant Growth Regulatorby *Fine Americas, Inc.*

Citadel is an effective growth regulator for use on a wide variety of ornamental crops. It reduces plant height by limiting internode elongation, resulting in more desirable, compact and marketable plants.

- Active Ingredient: chlormequat
- Rate: Varies depending on application method. See label.
- REI: 12 Hrs
- Limits internode elongation
- Signal Word: Caution



1gal
FINE19-0731A Min. Buy 1 EA

**Configure® Plant Growth Regulator**by *Fine Americas, Inc.*

Increases lateral branching and flowering in a number of popular ornamental species. Applications may reduce the height of treated plants, resulting in more compact and marketable crops. Labeled for use on containerized annual and perennial flowering and foliage crops as well as tropical plants.

- Active Ingredient: Benzylaminopurine
- Rate: Varies depending on application method. See label.
- REI: 12 Hrs
- Increases lateral branching and flowering
- Signal Word: Warning



64oz
FINE19-0163D Min. Buy 1 EA

**Collate® Plant Growth Regulator**by *Fine Americas, Inc.*

Used to increase lateral branching in many popular ornamental varieties, including azaleas, chrysanthemums, geraniums, lantana, petunias and verbena. It is also ideal for controlling plant height and stem topple in daffodils and hyacinth, as well as delaying flowering in a wide range of ornamental crops.

- Active Ingredient: ethephon
- Rate: Varies depending on application method. See label.
- REI: 12 Hrs
- Removes undesirable blooms and fruit from plants
- Signal Word: Danger



1gal
FINE19-0638 Min. Buy 1 EA
Other Info **SHIPS HAZ**

**Crest™ Plant Growth Stimulant**by *Fine Americas, Inc.*

Crest is a plant biostimulant which can improve the germination of seed, plant emergence in cool conditions, root growth, seedling development, and plant growth and development throughout the growing season.

- Active Ingredient: Cytokinin, Indole Butyric Acid, Gibberellic Acid
- Rate: Varies, see label for more information.
- REI: 4 hours
- Controls: Plant growth.
- Signal Word: Caution



1gal
FINE190638 Min. Buy 1 EA

**Concise® Plant Growth Regulator**by *Fine Americas, Inc.*

Concise is an effective growth regulator for use on a wide variety of ornamental crops. It reduces plant height by limiting internode elongation, resulting in more desirable, compact and marketable plants.

- Active Ingredient: Uniconazole
- Rate: Varies depending on application method. See label.
- REI: 12 Hrs
- Limits internode elongation
- Signal Word: Caution



1gal
FINE19-0636C Min. Buy 1 EA

15gal
FINE19-0636D Min. Buy 1 EA

**Dazide® 85WSG Plant Growth Regulator**by *Fine Americas, Inc.*

Provides greener, stronger and more compact ornamental plants. Effective growth control that helps growers manage plant growth and development to ensure plants are more compact, stronger and better suited to cope with transportation and transplanting.

- Active Ingredient: Daminozide
- Rate: Varies depending on application method. See label.
- REI: 12 Hrs
- Reduces internode elongation, resulting in more desirable compact plants
- Signal Word: Caution



5lb
FIN403 Min. Buy 1 EA



Plant Growth Regulators

Dip N Grow Rooting Hormone

by *Dip 'N Grow*

Dip N' Grow liquid rooting hormone for rooting new plants from cuttings. Easy to use liquid formulation.

- Active Ingredient: Indole 3 Butyric acid and 1 Naphthaleneacetic acid
- Rate: Varies depending on application method.
- REI: 24 Hrs
- Promote Rooting on Un-Rooted Cuttings
- Signal Word: Caution



2oz

DIPNDG00212 Min. Buy 12 EA

1pt

DIPNDG01612 Min. Buy 1 EA

1gal

DIPNDG12804 Min. Buy 1 EA

Other Info SHIPS HAZ



Ethylene Buster Sachets

by *Chrysal Americas*

Ethylene Buster is a post-harvest product for ethylene sensitive flowers and potted plants. The Ethylene buster prevents dropping of buds and helps to improve the vase life of flowers and shelf life of plants. Sachets can be placed in individual boxes or cartons to protect plants during transportation.

- Blocks ethylene receptors, thus protecting against internally as well as externally produced ethylene
- Reduces wastage and extend the distribution and sales period
- Improves bud opening
- Prevents premature shrinking and dropping of buds, leaves and blooms



1000ct

CHRYSALEBSACH Min. Buy 1 EA



Fascination® Plant Growth Regulator

by *Nufarm Americas Inc.*

Fascination plant growth regulator for Lilies, Poinsettias and other ornamentals. Fascination delays leaf yellowing, increases flower size and number and prolongs flowering.

- Active Ingredient: Cytokinin/Gibberellic Acid
- Rate: Varies according to application method. See label.
- REI: 12 Hrs
- Promote plant growth and stem elongation
- Signal Word: Caution



64oz

VAL89020.922 Min. Buy 1 EA



Floralife® EthylBloc® Truck Kit

by *Smithers-Oasis USA*

EthylBloc inhibits the negative effects of ethylene. For use by professional greenhouse and nursery growers and retail florists to protect crops from ethylene damage during handling, staging, and shipping. Truck kits protect whole trailer shipments. Also available in sachets for in-box use.

- Protects against leaf yellowing and premature flower aging. Reduces flower, bud, and leaf drop.
- Easy to use and nontoxic.
- Effective in both refrigerated and room-temperature conditions.
- Protects cut and potted flowers, foliage plants, and bedding flowers and plants.



75gr

SM5FL9075K Min. Buy 1 EA



Florgib® 4L Plant Growth Regulator

by *Fine Americas, Inc.*

Florgib enhances stem elongation and flowering in ornamental plants.

- Active Ingredient: Gibberellic Acid
- Rate: Varies depending on application method. See label.
- REI: 4 Hrs
- Helps manage plant growth and development
- Signal Word: Warning



1gal

FINE19-0760A Min. Buy 1 EA

Other Info SHIPS HAZ



Fresco® Plant Growth Regulator

by *Fine Americas, Inc.*

Provides a reduction of lower leaf yellowing in lilies and promotes bract expansion on poinsettia. Maybe used to counteract Gibberellin inhibiting PGR applications if needed.

- Active Ingredient: Cytokinin/Gibberellic Acid
- Rate: Varies, see label
- REI: 4 Hrs
- Promote plant growth and stem elongation
- Signal Word: Caution



1qt

FINE19-0736A Min. Buy 1 EA



WARNING: This product is not available for sale in CA.
For most up to date information please visit bfgsupply.com

Plant Growth Regulators

Hormodin® 1 Rooting Hormone

by OHP, Inc.

Hormodin 1 rooting hormone is a general purpose powder designed for the grower who propagates plants such as roses, carnations, poinsettias, some shrubs and most soft herbaceous plants. (00.1% (IBA). Hormodin enhances rooting, which reduces propagation bench time and plant loss. Hormodin is easy to use, yielding steadfast performance of rooted cuttings and zero disease migration.

- Active Ingredient: Indole-3-butyric acid
- Rate: 1lb treats 35,000 cuttings
- REI: 0 Hrs
- Promote Rooting on Un-Rooted Cuttings
- Signal Word: Caution



1lb

OHP983111 Min. Buy 1 EA

**Florel East Plant Growth Regulator**

by BRANDT Consolidated Inc.

Applied as a foliar spray, Florel will increase lateral branching, prevent flower initiation and development and inhibit internode elongation on greenhouse ornamentals.

- Active Ingredient: Ethephon
- Rate: Varies according to crop
- REI: 48 Hrs
- Removes undesirable blooms and fruit from plants
- Signal Word: Caution



1gal

MLGNLG4110 Min. Buy 1 EA

2.5gal

MLGNLG4120 Min. Buy 1 EA

**Hormodin® 2 Rooting Hormone**

by OHP, Inc.

Hormodin 2 rooting hormone is prepared specially for propagating many woody and semi-woody plants, including some of the evergreens. (00.3% (IBA) Hormodin enhances rooting, which reduces propagation bench time and plant loss. Hormodin is easy to use, yielding steadfast performance of rooted cuttings and zero disease migration.

- Active Ingredient: Indole-3-butyric acid
- Rate: 1lb treats 35,000 cuttings
- REI: 0 Hrs
- Promote Rooting on Un-Rooted Cuttings
- Signal Word: Caution



1lb

OHP983221 Min. Buy 1 EA

**Florel Pistill Plant Growth Regulator**

by BRANDT Consolidated Inc.

Applied as a foliar spray, Florel will increase lateral branching, prevent flower initiation and development and inhibit internode elongation on greenhouse ornamentals.

- Active Ingredient: Ethephon
- Rate: Varies according to crop
- REI: 48 Hrs
- Removes undesirable blooms and fruit from plants
- Signal Word: Caution



1gal

MLGNLG4124 Min. Buy 1 EA

2.5gal

MLGNLG4126 Min. Buy 1 EA

**Hormodin® 3 Rooting Hormone**

by OHP, Inc.

Hormodin 3 rooting hormone is prepared specially for propagating the more difficult to root varieties, including many of the evergreens and dormant leafless cuttings. (00.8% (IBA) Hormodin enhances rooting, which reduces propagation bench time and plant loss. Hormodin is easy to use, yielding steadfast performance of rooted cuttings and zero disease migration.

- Active Ingredient: Indole-3-butyric acid
- Rate: 1lb treats 35,000 cuttings
- REI: 0 Hrs
- Promote Rooting on Un-Rooted Cuttings
- Signal Word: Caution



0.5lb

OHP983380 Min. Buy 1 EA

**Pac O™ Plant Growth Regulator**

by OHP, Inc.

Pac O plant growth regulator is for use on commercially grown ornamental plants grown in containers in greenhouses and nurseries. Long lasting plant growth regulator that can be applied as a liner dip, spray, or drench

- Active Ingredient: Paclobutrazol
- Rate: Varies depending on application method. See label.
- REI: 12 Hrs
- Reduces internode elongation, resulting in more desirable compact plants
- Signal Word: Caution



1gal

OHP986192 Min. Buy 1 EA



Plant Growth Regulators

Piccolo® 10XC Plant Growth Regulatorby *Fine Americas, Inc.*

Brings out the best in ornamentals by producing compact, consistent quality plants. Piccolo 10 XC contains 4% paclobutrazol formulation for compact, consistent quality plants as well as easier handling and mixing. Since it comes in a crystal clear solution instead of a murky suspension, Piccolo 10 XC mixes quickly and evenly for unmatched consistency.

- Active Ingredient: paclobutrazole
- Rate: Varies according to application method
- REI: 12 hours
- Reduces internode elongation, resulting in more desirable compact plants
- Signal Word: Danger



1qt
FINE19-0636E Min. Buy 1 EA

Sumagic® Plant Growth Regulatorby *Nufarm Americas Inc.*

Offers a broad label for use on numerous plants, from bedding plants to woody ornamentals to poinsettias. Applications produce plants with denser, more consistent compact growth with increased plant shelf life and no phytotoxicity when used according to label directions.

- Active Ingredient: Uniconazole-p
- Rate: Varies according to application method. See label.
- REI: 12 Hrs
- Limits internode elongation
- Signal Word: Warning



1gal
VAL85100.935 Min. Buy 1 EA

15gal
VAL85100.939 Min. Buy 1 EA
Other Info **SHIPS DIRECT**

Piccolo® Plant Growth Regulatorby *Fine Americas, Inc.*

Featuring the popular active ingredient paclobutrazol, Piccolo brings out the best in ornamentals by producing compact, consistent quality plants. By delivering outstanding height and radius control, this formula enhances the quality of your plants making them easier to get to market and more profitable to produce. Works especially well for bedding plants, flowering and foliage crops, bulb crops, perennials and woody ornamentals.

- Active Ingredient: paclobutrazole
- Rate: Varies according to application method
- REI: 12 hours
- Reduces internode elongation, resulting in more desirable compact plants
- Signal Word: Caution



1gal
FINE190636 Min. Buy 1 EA

Topflor™ Plant Growth Regulatorby *Sepro Corporation*

Topflor is a versatile PGR for ornamentals including bedding, annual and perennial plants, bulb crops and woody ornamentals. It has the strength to regulate vigorous species yet provides the proper amount of growth control for slower growing crops. Topflor can be applied using spray, drench, or pre-plant soak applications.

- Active Ingredient: Fluprimidol
- Rate: Varies. See label for specific crops
- REI: 12 Hrs
- Reduces internode elongation, resulting in more desirable compact plants
- Signal Word: Caution



2liter AGENCY
SEPRO1035.42 Min. Buy 1 EA

5gal AGENCY
SEPRO1035.5 Min. Buy 1 EA

ProGibb® LV Plus T&O Plant Growth Regulatorby *Mycorrhizal Applications LLC*

ProGibb® Plus plant growth regulator can be used to enhance fruit and vegetable quality and growth. It provides fast consistent results on many crops including lettuce, celery, peppers, strawberries, blueberries, and many more. New formulation has a higher percentage of the active ingredient Gibberellic acid allowing you to use less.

- Active ingredient: Gibberellic acid
- Rate: 4 to 12 oz per acre
- REI: 4 hours
- Improve plant quality and value
- Signal Word: Caution



1qt
MAA5602160402 Min. Buy 1 EA



WARNING: This product is not available for sale in CA.
For most up to date information please visit bfgsupply.com

800-883-0234
www.bfgsupply.com

REFERENCE GUIDE for GREENHOUSE and NURSERY PRODUCTION HERBICIDES

RESISTANCE MANAGEMENT

Herbicide rotation is just as important as the rotation of other pest control products. Herbicide mode of action (MOA) groups are listed by the Herbicide Resistance Action Committee (HRAC). Rotating MOAs on a regular basis is key to controlling weeds and maintaining the effectiveness of herbicides.

Please read and follow all label directions and precautions.

**Use Site(s) Key:

PO = post emergence
A = Annual Grasses
S = Sedges

PR = pre emergence
BW = Broadleaf Weeds
WO = Certain Woody
Ornamentals

SF = Soil fumigant
P = Perennials

GH = registered for use in greenhouses
MA = Most annuals

Resources Provided By



Herbicides

(by Mode of Action Group and Class)

MOA Group*	Class	Common Name	Trade Name	REI	Use Site(s)**	Company
1	Aryloxyphenoxy propionate 'FOPs'	Fenoxaprop-p-ethyl	Acclaim [®] Extra	24	PO; A, P	Bayer Environmental Science
		Fluazifop-P-butyl	Fusilade [®] II	12	PO; A, P	Syngenta
	Cyclohexanedione 'DIMs'	Clethodim	Envoy Plus [®]	24	PO; A, P	Nufarm
		Sethoxydim	Segment [®]	12	PO; A, P	BASF
2	Imidazolinone	Imazaquin	Image [®]	12	PR/PO; A, P, BW, S	BASF
3	Pyridine	Dithiopyr	Dimension [®]	12	PR;A,BW	Corteva Agriscience
	Benzamide	Pronamide	Kerb [®]	24	PR/PO; A, BW	Corteva Agriscience
	Dinitroaniline	Pendimethalin	Pendulum [®]	24	PR; A, BW	BASF
			Corral [®]	24	PR; A,BW	ICL Specialty Fertilizers
	Benzoic acid	Prodiamine	Barricade [®]	12	PR; A, BW	Syngenta
DCPA	Dacthal [®]	12	PR; A,BW	Amvac Chemical Corp		
4	Pyridine carboxylic acid	Clopyralid	Lontrel [®]	12	PO; WO	Corteva Agriscience
5	Triazine	Simazine	Princep [®]	12	PR; A, BW	Syngenta
6	Benzothiadiazinone	Bentazon	Basagran [®] T/O	48	PO; BW, S	BASF
9	Glycine	Glyphosate	Roundup Pro [®]	4	PO; A, P, BW, GH	Bayer Environmental Science
			Refuge [®]	12	PO; A, P, BW, GH	Syngenta
10	Phosphinic acid	Glufosinate	Finale [®]	12	PO; MA, P, GH	Bayer Environmental Science
12	Pyridazinone	Norflurazon	Predict [®]	12	PR; A, BW	Syngenta
14	Diphenylether	Oxyfluorfen	Goal [®]	24	PR; PO, A, BW	Corteva Agriscience
			Ronstar [®]	12	PR; A, BW	Bayer Environmental Science
	Oxadiazole	Oxadiazon	BroadStar [®]	12	PR; A, BW	Nufarm
			SureGuard [®]	12	PR; PO, A, BW	Nufarm
N-phenylphthalimides	Flumioxazin					
15	Acetamide	Napropamide	Devrinol [®]	12-24	PR; A, BW	United Phosphorous
	Chloroacetamide	S-metolachlor	Pennant [®] Magnum	24	PR; A, BW	Syngenta
		Dimethenamid-P	Tower [®]	12	PR; A, BW, S	BASF
20	Nitrile	Dichlobenil	Casoron[®]	12	PR; A, P	OHP, Inc.
21	Benzamide	Isoxaben	Gallery [®]	12	PR, A, BW	Corteva Agriscience



Herbicides

Resources Provided By



(by Mode of Action Group and Class)

MOA Group*	Class	Common Name	Trade Name	REI	Use Site(s)**	Company
22	Bipyridylum	Paraquat	Gramoxone [®] Inteon	12-24	PO; MA, P, BW	Syngenta
		Diquat	Reward [®]	24	PO; MA, P, GH	Syngenta
26	Unknown	Dazomet	Basamid [®]	24	SF; MA, P	Certis USA, LLC
		Metam	Vapam [®]	48	SF; MA, P	Amvac ChemicaCorp.
		Pelargonic acid	Scythe [®]	12	PO; MA, P, GH	Gowan Company
29	Alkylazines	Indaziflam	Marengo [®]	12	PR; A, GH, BW	Bayer Environmental Science
			Marengo [®] G	12	PR; A, BW	Bayer Cropscience Science
3+21	Diphenylether + Benzamide	Prodiamine + Isoxaben	Gemini [®] G	12	PR; A, BW	ICL Speciality Fertilizers
14+3	Diphenylether + Dinitroaniline	Oxyfluorfen + Pendimethalin	OH2 [®]	24	PR; A, BW	ICL Speciality Fertilizers
14+3	Diphenylether + Dinitroaniline	Oxyfluorfen + Prodiamine	Biathlon	24	PR; A, BW	OHP, Inc.
4+3	N-phenylphthalimides + Dinitroaniline	Flumioxazin + Prodiamine	Fuerte[®]	12	PR; A, BW	OHP, Inc.
4+3	Oxadiazole + Dinitroaniline	Oxadiazon + Prodiamine	RegalStar [®] II	12	PR; A, BW	Regal Chemical Co.
14+14	Diphenylether + Oxadiazole	Oxyfluorfen + Oxadiazon	Regal O-O [®]	24	PR; A, BW	Regal Chemical Co.
15+3	Chloroacetamide + Dinitroaniline	Dimethenamid-P + Pendimethalin	Freehand [®]	12	PR; A, BW, S	BASF
21+3	Benzamide + Pyridine	Isoxaben + Dithiopyr	Fortress[®]	12	PR; A, BW	OHP, Inc.
21+3	Benzamide + Dinitroaniline	Isoxaben + Trifluralin	Snapshot [®] TG	12	PR; A, BW	Coreteva Agriscience
M	Soaps	Ammonium Nonanoate	Axxe [®]	24	PO; GH	BioSafe Systems
		Caprylic + Capric Acid	FireWorxx	24	PO; GH	OHP, Inc.

*Herbicides Modes of Action

1. Inhibition of acetyl CoA carboxylase (ACCase)
2. Inhibition of acetolactate synthase ALS (acetohydroxyacid synthase AHAS)
3. Microtubule assembly inhibition
4. Action like indole acetic acid (synthetic auxins)
5. Inhibition of photosynthesis at photosystem II (C1)**
6. Inhibition of photosynthesis at photosystem II (C3)**
7. Inhibition of photosynthesis at photosystem II (C2)**
9. Inhibition of EPSP synthase
10. Inhibition of glutamine synthetase
12. Bleaching: inhibition of carotenoid biosynthesis at the phytoene desaturase step (PDS)
14. Inhibition of protoporphyrinogen oxidase (PPO)
15. Inhibition of VLCFAs (Inhibition of cell division)
20. Inhibition of cell wall (cellulose) synthesis
21. Inhibition of cell wall (cellulose) synthesis
22. Photosystem -I- electron diversion
26. Unknown
29. Inhibit cellulose biosynthesis
- M. Miscellaneous

**Subclasses with different binding behavior at the binding protein D1, or different classes

*This mode of action listing is based on the Herbicide Resistance Action Committee (HRAC) and the Weed Science Society of America (WSSA).

More information on the Herbicide Resistance Action Committee and the Mode of Action Classification is available from: www.hracglobal.com.



WARNING: This product is not available for sale in CA. For most up to date information please visit bfgsupply.com

Always Refer to Product Label!

Herbicides Quick Reference Chart

Product	Pre-Emergent	Post-Emergent	Broadleaves	Grasses	Sedges	Greenhouse Label	Spray (S) or Granular (G)	
Axxe		X	X	X		X	S	Ammonium Nonanoate OMRI listed herbicide labeled for greenhouse use. Nonselective contact burndown of weeds
Barricade	X		X	X			S	Proflamifone Preemergent sprayable herbicide for use in nurseries, turf, landscapes & noncrop areas
Basagran T&O		X	X		X		S	Bentazon Contact herbicide for use in turf, nurseries, ornamentals & noncrop areas
Biathlon	X		X	X			G	Oxyfluorfen, Proflamifone 2 active ingredients that control broadleaf & grassy weeds in nurseries and noncrop areas
Broadstar G	X		X	X			G	Flumioxazin Granular for use in nurseries and landscapes. Same active ingredient as Sureguard
Casoron G	X	X	X	X	X		G	Dichlobenil Controls tough weeds like Thistle, Horsetail, and Nutsedge. For use on woody ornamentals and noncrop areas
Cheetah Pro		X	X	X	X	X	S	Glufosinate Ammonium Contact non-selective herbicide for use in nurseries, greenhouses, turf & noncrop areas
Confront		X	X				S	Clopyralid, Triclopyr Broadleaf turf herbicide
Dimension	X		X	X			S	Dithiopyr Sprayable for use in nurseries, turf, landscapes & noncrop areas
Envoy Plus		X		X		X	S	Clethodim Postemergence control of annual & perennial grasses
Finale XL		X	X	X	X	X	S	Glufosinate Ammonium Contact non-selective herbicide for use in nurseries, greenhouses, turf & noncrop areas
FireWorxx		X	X	X		X	S	Capric and Caprylic Acid Rapid contact non-selective herbicide for use in nurseries, greenhouses, landscape & noncrop areas
Fortress	X		X	X			G	Isoxaben, dithiopyr Combination product with the active ingredients from Gallery and Dimension. Broad spectrum control of weeds, but with a safe profile for sensitive shrubs and perennials
Freehand G	X		X	X	X		G	Dimethenamid-P, Pendimethalin 2 active ingredients that control broadleaf & grassy weeds and yellow nutsedge
Fuerte	X		X	X			G	Flumioxazin, Proflamifone Preemergent granular herbicide with two active ingredients for use in nurseries and landscape ornamentals
Fusilade II		X		X			S	Fluazifop Postemergence control of annual & perennial grasses
Gallery SC	X		X				S	Isoxaben Sprayable for use in nurseries, turf, landscapes & noncrop areas. Excellent crop safety
Gemini SC	X		X	X			S	Isoxaben, Proflamifone Combination product to control wide array in containers and field ornamentals.
Goal	X	X	X	X			S	Oxyfluorfen For use on conifers & certain woody ornamentals. Contact burn and preemergence control
Lontrel T&O		X	X				S	Clopyralid Excellent on thistle. Sprayable for use in landscapes, nurseries & turf
Marengo SC	X		X	X		X	S	Indaziflam Long lasting preemergent control of weeds in nurseries and greenhouses.
Marengo G	X		X	X			G	Indaziflam Long lasting herbicide for broadcast applications in nurseries
OH2	X		X	X			G	Oxyfluorfen, Pendimethalin Granular for container and field grown ornamentals
Pendulum Aquacap	X		X	X			S	Pendimethalin Sprayable for use in landscapes, nurseries & noncrop areas
Pennant Magnum	X		X	X	X		S	Metolachlor Sprayable for use in nurseries, landscapes & noncrop areas. Preemergent control of yellow nutsedge
Pramitol 25E	X	X	X	X			S	Prometon Long lasting vegetation management. Residual control of most weeds for 1+ years
Preen Plus	X		X	X			G	Isoxaben, Trifluralin Granular herbicide with 2 active ingredients. Labeled for use in nurseries, landscapes
Ranger Pro		X	X	X	X	X	S	Glyphosate Sprayable nonselective systemic postemergent control of most weeds. Roundup equivalent
Reward		X	X	X		X	S	Diquat Sprayable non-selective contact control of most weeds. Rapid burndown
Ronstar FLO	X		X	X			S	Oxadiazon Active on shoots only with no root activity
Roundup Custom		X	X	X			S	Glyphosate Labeled for aquatic applications. Addition of spray adjuvant required
Roundup Pro Concentrate		X	X	X	X	X	S	Glyphosate Sprayable nonselective systemic postemergent control of most weeds. Roundup equivalent
Roundup ProMax		X	X	X	X	X	S	Glyphosate Improved formulation of glyphosate with concentrated surfactant
Roundup QuikPro		X	X	X			S	Glyphosate, Diquat Contains Roundup for systemic control and diquat to deliver rapid burndown
Scythe		X	X	X		X	S	Pelargonic acid Sprayable non-selective contact control of most weeds
Sedgehammer Plus		X			X		S	Halosulfuron-methyl Postemergence control of Nutsedge for use in turf, landscapes, & noncrop areas
Segment II		X		X			S	Sethoxydim Selective control of grassy weeds in nursery and landscape crops
Snapshot	X		X	X			G	Isoxaben, Trifluralin Granular for use in nurseries, landscapes, & noncrop areas
Sureguard SC	X	X	X	X		X	S	Flumioxazin Labeled for use in nurseries, landscapes & noncrop areas. Contact burndown and preemergence control
Tower	X		X	X	X		S	Dimethenamid-P Controls broadleaf & grassy weeds and sedges in nurseries and landscapes
Treflan G	X		X	X			G	Trifluralin Granular for use in nurseries, landscapes, & noncrop areas
Vessel		X	X				S	2,4-D, Dicamba 3-Way broadleaf herbicide for turf and noncrop sites



Herbicides

AXXE® Broad Spectrum Herbicideby *BioSafe Systems*

Control grasses and broadleaf weeds, mosses, liverworts and lichens around facilities to deter cross-contamination from pests. AXXE Broad Spectrum Herbicide burns down weeds within hours of application and leaves no harmful residues. This product does not volatilize or migrate through soil and is ideal for use in all areas of production inside and outside.

- Active Ingredient: Ammonium Nonanoate
- Rate: Varies according to application method. See label.
- REI: 4 hours
- Controls: Most grassy and broadleaf weeds. See label for complete list.
- Signal Word: Warning

**2.5gal****BIOS7600-2.5** Min. Buy 1 EA**Barricade® 4FL Herbicide**by *Syngenta Crop Protection*

Barricade 4FL for preemergence control of grasses and broadleaf weeds in established turfgrasses, container grown and landscape ornamentals, nurseries and commercial landscapes.

- Active ingredient: Proflaminate
- Rate: Varies by application. See label.
- REI: 12 hours
- Controls: Many broadleaf and grassy weeds.
- Signal Word: Caution

**4oz****SYN70648** Min. Buy 1 EA**1gal AGENCY****SYN37150** Min. Buy 1 EA**Barricade® 65WG Herbicide**by *Syngenta Crop Protect (Agency)*

Barricade 65 WG for preemergence control of grasses and broadleaf weeds in established turfgrasses, container grown and landscape ornamentals, nurseries and commercial landscapes.

- Active Ingredient: Proflaminate
- Rate: 0.5-1.5lbs per acre
- REI: 12 Hrs
- Controls: Many broadleaf and grassy weeds. See label for complete list.
- Signal Word: Caution

**5lb AGENCY****SYN51637** Min. Buy 1 EA**Basagran® T/O Herbicide**by *BASF Corp*

A turf and ornamental herbicide that offers reliable, post-emergent control of tough broadleaf weeds, yellow nutsedge and annual sedges in turf and ornamentals.

- Active Ingredient: Bentazon
- Rate: 24 to 32oz per Acre
- REI: 48 Hrs
- Controls: Broadleaf weeds, yellow nutsedge, annual sedges and more. See label for complete list
- Signal Word: Caution

**1gal****BAS59011636** Min. Buy 1 EA**Biathlon® G Herbicide**by *OHP, Inc.*

A pre-emergent granular herbicide for control of a wide range of problem grass and broadleaf weeds. Works by creating a barrier in the soil and is active for several months. Biathlon works by inhibiting cell division and disrupting cell wall formation in shoots and roots of emerging seedling weeds.

- Active Ingredient: Oxyfluorfen and Proflaminate
- Rate: 100lb per Acre
- REI: 24 Hrs
- Controls: Broadleaf and grassy weeds. See label for complete list.
- Signal Word: Caution

**50lb****OHP981350** Min. Buy 1 EA**BroadStar® Herbicide**by *Nufarm Americas Inc.*

BroadStar herbicide controls tough broadleaf and grassy weeds with a long lasting residual activity. Low odor and dust free granular formulation for easy broadcast spreading. For use on container and field grown ornamentals, landscape ornamentals and non-bearing fruit and nut trees.

- Active Ingredient: Flumioxazin
- Rate: 150lb per Acre
- REI: 12 Hrs
- Controls: Broad spectrum of annual broadleaf and grassy weeds such as spurge, bittercress, oxalis, common groundsel and crabgrass
- Signal Word: Caution

**50lb****VAL88560.29** Min. Buy 1 EA**Casoron® 4G Fine 16-30 Mesh Herbicide**by *OHP, Inc.*

A pre-emergent herbicide which easily handles many troublesome weeds in and around established woody landscape ornamentals, non-crop areas, fruit and nut trees and respective nurseries. It develops a vapor barrier and is active for 9-10 months after application. Applications should be made under cool weather conditions in late fall or very early spring.

- Active Ingredient: Dichlobenil
- Rate: Varies depending on application method. See label.
- REI: 12 Hrs
- Controls: Broadleaf and grassy weeds. See label for complete list.
- Signal Word: Caution

**25lb****OHP981520** Min. Buy 1 EA

WARNING: This product is not available for sale in CA.
For most up to date information please visit bfgsupply.com

Herbicides

Cheetah® Pro Herbicide*by Nufarm Americas Inc.*

Cheetah Pro is a non-selective, post-emergent herbicide that provides fast, effective control of the toughest broadleaf and grassy weeds including those resistant to glyphosate. Minimal soil residue makes it an effective pre-plant treatment for turf, ornamentals, and greenhouses.

- Active ingredient: glufosinate-ammonium
- Rate: 5 to 20 oz per 100 gal
- REI: 12 hours
- Controls: Many grassy and broadleaf weeds.
- Signal Word: Caution

**1gal****NTS10761041** Min. Buy 1 EA**2.5gal****NTS10761225** Min. Buy 1 EA**64oz****NTS10761464** Min. Buy 1 EA**30gal****NTS10761030** Min. Buy 1 EA**Confront® Herbicide***by Corteva*

Confront herbicide offers broad-spectrum control of tough broadleaf weeds in public areas including golf courses, parks and other non-residential sites.

- Active Ingredient: Triclopyr + Clopyralid
- Rate: 1 to 2 pints per acre.
- REI: 48 hours.
- Controls: Clovers, Chickweed, Dandelions and more.
- Signal Word: Danger

**1gal****DOW19-2505D** Min. Buy 1 EA**Crossbow® Herbicide***by Corteva*

Controls most kinds of unwanted trees and brush as well as annual and perennial broadleaf weeds in pastures, rangeland, fence rows, and other non-crop sites.

- Active Ingredient: 2,4-D and Triclopyr
- Rate: 1.5gal per 100gal.
- REI: 12 hours.
- Controls: Broadleaf weeds, brush and trees.
- Signal Word: Caution

**1gal****DOW19-2506** Min. Buy 1 EA**2.5gal****DOW336041** Min. Buy 1 EA**Devrinol® 2-XT Herbicide***by United Phosphorus, Inc.*

Devrinol® 2-XT is a selective pre-emergent herbicide for use on container-grown ornamentals, field grown nursery stock, berry crops, ground covers, and turfgrass. Weeds controlled include Crabgrass, Foxtails, Wild Barley and many more grassy and broadleaf weeds.

- Active ingredient: Napropamide
- Rate: Varies according to application method. See label for details.
- REI: 24 hours
- Controls: Many varieties of grassy and broadleaf weeds.
- Signal Word: Caution

**2.5gal****UPL933040** Min. Buy 1 EA**Dimension Ultra® WP Herbicide***by Corteva*

Dimension herbicide provides pre-emergence control of more than 45 grassy and broadleaf weeds as well as post-emergence control of crabgrass. Use sites include turf, landscape and container grown ornamentals. It is safe to use on established turfgrasses and most ornamental plants.

- Active ingredient: Dithiopyr
- Rate: Varies depending on application method. See label for complete information.
- REI: 12 hours
- Controls: Broadleaf weeds.
- Signal Word: Caution

**40oz****DOW19-0008D** Min. Buy 1 EA**Dimension® 2EW Herbicide***by Corteva*

A specialty selective herbicide provides pre-emergence and early post-emergence control of crabgrass, and season-long control of crabgrass, goose grass, foxtail, spurge and bluegrass annual (Poa Annua). It also is proven effective for more than 45 other grassy and small-seeded broadleaf weeds.

- Active ingredient: Dithiopyr
- Rate: Varies depending on application method. See label for complete information.
- REI: 12 Hrs
- Controls: Broadleaf weeds
- Signal Word: Caution

**2.5gal****DOW19-0008A** Min. Buy 1 EA

Herbicides

Drive® XLR8 Herbicide

by BASF Corp

Drive XLR8 turf herbicide provides control of crabgrass, torpedo grass, several broadleaf weeds and more. Drive delivers quicker uptake by the plant and is rainfast in less than an hour. Labeled for use in residential, industrial, and commercial turfgrasses, sod farms, sports and recreation fields. Active Ingredient: Quinclorac.

- Active Ingredient: Quinclorac
- Rate: varies, see label
- REI: 4 hours
- Controls: crabgrass and broadleaf weeds in turf grass
- Signal Word: Caution



64oz

BAS59011404 Min. Buy 1 EA

**Envoy Plus® Herbicide**

by Nufarm Americas Inc.

Envoy Plus herbicide provides effective post-emergent control of grassy weeds. It provides over-the-top control of both annual and perennial grasses with excellent plant safety. For use on garden flowers and plants, groundcovers and ornamental trees and shrubs.

- Active Ingredient: Clethodim
- Rate: 9 to 32oz per Acre
- REI: 12 Hrs
- Controls: Many annual and perennial grassy weeds. See label for complete list.
- Signal Word: Caution



1gal

VAL86793.935 Min. Buy 1 EA

**Finale® XL Herbicide**

by BASF Corp

Provides fast, effective control of a broad spectrum of emerged annual and perennial grasses, broadleaf weeds, woody species and controls even the toughest weeds, like poison ivy, dandelion and thistle. Only kills what you spray it on and produces results in 1 to 4 days under many conditions. Shows rapid control without the regrowth of typical burndowns, has a long application window, and is effective in spring and fall.

- Active Ingredient: Glufosinate Ammonium
- Rate: Varies depending on application method. See label for complete information.
- REI: 12 Hrs
- Controls: Broadleaf weeds
- Signal Word: Warning



2.5gal

BAS59024131 Min. Buy 1 EA

**Fortress® Herbicide**

by OHP, Inc.

Fortress is a pre-emergent herbicide containing two active ingredients that is formulated on a dust and odor-free granule. May be used on many ornamental grasses and perennials. Controls a wide range of both grassy and broadleaf weeds by creating a barrier in the soil. Fortress works by inhibiting cell division and disrupting cell wall formation in roots and shoots of emerging weed seedlings.

- Active Ingredient: Isoxaben and Dithiopyr
- Rate: 150lb per Acre
- REI: 12 Hrs
- Controls: Many broadleaf and grassy weeds. See label for complete list.
- Signal Word: Caution



50lb

OHP982800 Min. Buy 1 EA

**FreeHand® 1.75G Herbicide**

by BASF Corp

Features two active ingredients; Pendimethalin and Dimethenamid-P. This unique combination makes the perfect tool for pre-emergent weed control of annual grasses, sedges and many broadleaf weeds. Use sites include nurseries, residential and commercial landscapes, turfgrass.

- Active Ingredient: Dimethenamid-P + Pendimethalin
- Rate: 100 to 200lb per Acre
- REI: 24 Hrs
- Controls: Annual grasses, sedges and many broadleaf weeds. See label for complete list.
- Signal Word: Caution



50lb AGENCY

BAS59011296 Min. Buy 1 EA

**Fuerte™ Herbicide**

by OHP, Inc.

Fuerte is a selective pre-emergent herbicide for control of grassy and broadleaf weeds in field and container ornamentals. Fuerte combines two selective herbicides in a dust free granular form to provide broad spectrum weed control.

- Active ingredients: Flumioxazin and Prodiamine
- Rate: 100 lbs per acre
- REI: 12 hours
- Controls: Most grassy and broadleaf weeds. See label for complete list.
- Signal Word: Caution



50lb

OHP982825 Min. Buy 1 EA

**Fusilade® II Herbicide**

by Syngenta Crop Protection

Fusilade II herbicide is a selective post emergent herbicide for control of perennial and annual grass weeds. Can be applied over-the-top or as a directed spray without damaging ornamental plants and shrubs.

- Active Ingredient: Fluazifop-P-Butyl
- Rate: 32oz per Acre
- REI: 12 Hrs
- Controls: Grassy weeds
- Signal Word: Caution



1qt

SYN73215 Min. Buy 1 EA



WARNING: This product is not available for sale in CA.
For most up to date information please visit bfgsupply.com

800-883-0234
www.bfgsupply.com

Herbicides

Gallery® SC Herbicideby *Corteva*

Pre-emergent herbicide that provides excellent plant tolerance and long-lasting control of more than 95 species of broadleaf weeds for up to 6-8 months. Labeled for use on all established turf grasses and can be applied with confidence on more than 700 labeled nursery, landscape and ornamentals.

- Active ingredient: Isoxaben
- Rate: 16 oz per acre
- REI: 12 hours
- Controls: Broadleaf weeds.
- Signal Word: Caution

**1qt****DOW11079207** Min. Buy 1 EA**2gal****DOW11103357** Min. Buy 1 EA**Gemini® Herbicide**by *ICL*

Gemini G is a pre-emergent herbicide for control of over 120 grassy and broadleaf weeds. Use sites include container, field grown and landscape ornamentals and Christmas tree farms. Granular formulation for easy broadcast application.

- Active Ingredient: Prodiamine, Isoxaben
- Rate: 100 to 200lbs per Acre
- REI: 12 Hrs
- Controls: Listed grass and broadleaf weeds
- Signal Word: Caution

**50lb****EVRE95765** Min. Buy 1 EA**Lontrel® Herbicide**by *Corteva*

A specialty herbicide that provides postemergence control of hard-to-manage weeds around labeled ornamentals, golf course fairways and roughs without injuring even the most sensitive turfgrasses.

- Active Ingredient: Clopyralid
- Rate: 3 to 8oz per 1,000sq ft
- REI: 12 Hrs
- Controls: Broadleaf weeds.
- Signal Word: Caution

**1qt****DOW19-1043** Min. Buy 1 EA**Marengo® G Herbicide**by *Envu*

Marengo is a preemergent herbicide that provides up to 8 months control of over 70 different weeds. Features a Verge carrier for uniform, virtually dust-free application. Marengo G is labeled for use in outdoor nurseries only.

- Active Ingredient : Indaziflam
- Rate : 100 to 200lb per Acre
- REI : 12 Hrs
- Controls : Over 70 grassy and broadleaf weed species
- Signal Word : Warning

**50lb AGENCY****BYR84922757** Min. Buy 1 EA**Marengo® SC Herbicide**by *Envu*

Marengo is a preemergent herbicide that provides up to 8 months control of over 70 different weeds. Effective on hard to control weeds and labeled for weed control in greenhouses and outdoor nurseries.

- Active Ingredient : Indaziflam
- Rate : 7 to 15oz per Acre
- REI : 12 Hrs
- Controls : Over 70 grassy and broadleaf weed species
- Signal Word : None

**18oz****BYR84927600** Min. Buy 1 EA**64oz AGENCY****BYR84967874** Min. Buy 1 EA**OH2® Herbicide**by *ICL*

OH2 is a pre-emergent herbicide for container and field grown ornamentals in nurseries. OH2 combines two selective herbicides on one granule, giving the user a broad spectrum of weed control and ornamental plant tolerance. No dust, granular formulation for easy broadcast application.

- Active Ingredient: Pendimethalin, Oxyfluorfen
- Rate: 100lb per Acre
- REI: 24 Hrs
- Controls: Bittercress, Common Chickweed, Cudweed, Dandelion, Eclipta, Fleabane, Fireweed, Groundsel, Marestalk, Oxalis, Pearlwort, Pepperweed, Pigweed, Shepherdspurse, Sowthistle, Spurge Garden- Prostrate-Spotted
- Signal Word: Caution

**50lb****EVR95715** Min. Buy 1 EA**OHP Fireworxx™ Herbicide**by *OHP, Inc.*

Fireworxx is a non-selective herbicidal soap containing a fatty acid blend of caprylic and capric acids. Controls weeds, grasses, and moss on contact. Fireworxx is non-systemic. Labeled for use in greenhouses, nurseries, landscapes, and outdoor areas. Fireworxx can be used around bedding plants, vegetables, trees and shrubs.

- Active Ingredient: Caprylic and Capric Acids
- Rate: 3 to 9 gallons per 100 gallons water.
- REI: 12 hours
- Controls: Weeds, grasses, moss
- Signal Word: Caution

**1gal****OHP982644** Min. Buy 1 EA**Pendulum® Aqua cap Herbicide**by *BASF Corp*

Pendulum Aqua cap is a pre-emergent herbicide effective in many broadleaf and grassy weeds. Labeled for use in nurseries, turf and landscape or grounds maintenance applications.

- Active Ingredient: Pendamethalin
- Rate: 24 to 32oz per Acre
- REI: 24 Hrs
- Controls: Many broadleaf and grassy weeds. See label for complete list.
- Signal Word: Caution

**2.5gal****BAS59049276** Min. Buy 1 EA

Herbicides

Pennant Magnum® Herbicide

by Syngenta Crop Protection

Pre-emergent herbicide offering long-lasting residual control of yellow nutsedge, tough annual grasses and broadleaf weeds. Can be used in a wide range of ornamentals and can be tank mixed with other herbicides for broader control.

- Active Ingredient: S-metolachlor
- Rate: 20.8oz to 41.6oz per Acre
- REI: 24 Hrs
- Controls: Yellow nutsedge, Crabgrass and more.
- Signal Word: Caution

**1gal****SYN38782** Min. Buy 1 EA**30gal****SYN23182** Min. Buy 1 EA**Pramitol® 25E Herbicide**

by Control Solutions, Inc.

Bare ground weed control around buildings, storage areas, fences, pumps, machinery, fuel tanks, recreational areas, roadways, guardrails, airports, military installations, highway medians, pipelines, railroads, lumberyards, industrial sites, and right-of-way.

- Active Ingredient: Prometon
- Rate: 4-10gal per acre
- Controls: Unwanted vegetation.
- Signal Word: Caution

**2.5gal****QCM306365** Min. Buy 1 EAOther Info **SHIPS HAZ****Princep® Herbicide**

by Syngenta Crop Protection

Princep liquid is a pre-emergent herbicide that controls a wide variety of annual broadleaf and grassy weeds in outdoor nurseries.

- Active Ingredient: Simazine
- Rate: Varies according to application. See label.
- REI: 12 hours.
- Controls: Many broadleaf and grassy weeds. See label.
- Signal Word: Caution

**2.5gal****SYN59200** Min. Buy 1 EA**Ranger Pro® Herbicide**

by Bayer CropScience Lp

Ranger Pro is a post-emergent systemic herbicide with no residual soil activity. Ranger Pro provides broad spectrum control of many annual and perennial weeds, woody brush and trees. 41% Glyphosate with surfactant.

- Active Ingredient: Glyphosate
- Rate: Varies depending on application method. See label for complete information.
- REI: 4 Hrs
- Controls: Annual, perennial grassy and broadleaf weeds, woody brush and trees.
- Signal Word: Caution

**2.5gal****MON339020** Min. Buy 1 EA**30gal****MON50030** Min. Buy 1 EA**Resolute® 65WG Herbicide**

by Syngenta Crop Protection

Resolute 65 WG for preemergence control of grasses and broadleaf weeds in established turfgrasses, container grown and landscape ornamentals, nurseries and commercial landscapes.

- Active Ingredient: Prodiamine
- Rate: 0.5-1.5lbs per acre
- REI: 12 Hrs
- Controls: Many broadleaf and grassy weeds. See label for complete list.
- Signal Word: Caution

**5lb****SYN34443** Min. Buy 1 EA**Reward® Herbicide**

by Syngenta Crop Protection

Fast-acting, non-selective, contact herbicide for control of weeds in the greenhouse, nursery and aquatic environments. Superior formulation for fast burndown.

- Active Ingredient: Diquat dibromide
- Rate: 32 to 64oz per 100gal
- REI: 24 Hrs
- Controls: Aquatic, turf and landscape weeds.
- Signal Word: Warning

**1gal****SYN73711** Min. Buy 1 EAOther Info **SHIPS HAZ****2.5gal AGENCY****SYN73710** Min. Buy 1 EAOther Info **SHIPS HAZ**

WARNING: This product is not available for sale in CA.
For most up to date information please visit bfgsupply.com

Herbicides

Ronstar® FLO Herbicide

by Envu

Offers exceptional root safety on container and field-grown ornamentals. Can be applied to newly transplanted ornamentals and liners. Doesn't inhibit root growth or recovery from stress. Controls difficult to control weeds including bittercress, groundsel and oxalis.

- Active Ingredient : Oxadiazon
- Rate : 80 to 120oz per Acre
- REI : 12 Hrs
- Controls : Crabgrass, Goosegrass, Annual Bluegrass and Annual Sedge.
- Signal Word : Danger



2.5gal AGENCY

BYR80847505 Min. Buy 1 EA

**Roundup Pro® Concentrate Herbicide**

by Bayer CropScience Lp

Roundup Pro Concentrate is a post-emergent systemic herbicide with no residual soil activity. Roundup Pro Concentrate provides broad spectrum control of many annual and perennial weeds, woody brush and trees. 50% Glyphosate with surfactant.

- Active Ingredient: Glyphosate
- Rate: Varies depending on application method. See label for complete information.
- REI: 4 Hrs
- Controls: Annual, perennial grassy and broadleaf weeds, woody brush and trees.
- Signal Word: Caution



2.5gal

BYR86749696 Min. Buy 1 EA

30gal

MON86706954 Min. Buy 1 EA

265gal

MON19-1056B Min. Buy 1 EA

**Roundup ProMax® Herbicide**

by Bayer CropScience Lp

Roundup ProMax® controls a broad spectrum of weeds with virtually no re-growth. The surfactant system of Roundup PROMAX allows the solution to penetrate weed leaf surfaces faster, which means it is rain fast in half the time of Roundup PRO®. Roundup ProMax® has a concentrated potassium salt formulation, so one gallon of Roundup ProMax® contains the glyphosate equivalent of 6 quarts of Roundup PRO®.

- Active Ingredient: Glyphosate
- Rate: Varies depending on application method. See label for complete information.
- REI: 4 Hrs
- Controls: Annual, perennial grassy and broadleaf weeds, woody brush and trees.
- Signal Word: Caution



1.67gal

MON19-1058A Min. Buy 1 EA

**Roundup QuikPRO™ Herbicide**

by Bayer CropScience Lp

Roundup QuikPro is a post-emergent systemic herbicide with no residual soil activity. Roundup Pro provides broad spectrum control of many annual and perennial weeds, woody brush and trees. 73% Glyphosate with Diquat and surfactant. Rainfast in one hour.

- Active Ingredient: Glyphosate
- Rate: Varies depending on application method. See label for complete information.
- REI: 4 Hrs
- Controls: Annual, perennial grassy and broadleaf weeds, woody brush and trees.
- Signal Word: Caution



5 x 1.5oz Pack

MON88603 Min. Buy 1 EA

6.8lb

MONCH362 Min. Buy 1 EA

**Roundup® Custom Herbicide**

by Bayer CropScience Lp

Custom is a complete broad-spectrum postemergence herbicide for aquatic crop, non-agricultural crop, industrial, turf, ornamental, forestry, roadside, and utility rights-of-way weed control. Group 9 herbicide.

- Active Ingredient: Glyphosate, 53.8%
- Rate: Varies depending on application method. See label for complete information.
- REI: 4 Hrs
- Controls: Aquatic weeds and annual, perennial grassy and broadleaf weeds, woody brush and trees.
- Signal Word: Caution



2.5gal

MON12151770 Min. Buy 1 EA

**Scythe® Herbicide**

by Gowan

A non-selective, contact herbicide composed of Pelargonic Acid and related fatty acids. Readily mixes with water to be applied as a foliar spray for the burn down of actively growing, emerged green vegetation of both annual and perennial broadleaf and grassy weeds as well as most mosses and cryptogams.

- Active ingredient: Pelargonic Acid
- Rate: Varies depending on application method. See label.
- REI: 12 Hrs
- Controls: Broadleaf and grassy weeds
- Signal Word: Warning



2.5gal

GOW52823 Min. Buy 1 EA

**SedgeHammer® Herbicide**

by Gowan

SedgeHammer® turf herbicide is a selective herbicide for control of nutsedge and other weeds in turfgrass, ornamentals, and landscaped areas.

- Active Ingredient: Halosulfuron-methyl
- Rate: one 1.33 oz pouch per 1,000 sq ft.
- REI: 12 hours
- Controls: Nutsedge, Wild Mustard, Pigweed, and many more.
- Signal Word: Caution



10x1.33oz

GOW35720 Min. Buy 1 EA



Herbicides

Sedgehammer® Plus Herbicideby *Gowan*

Sedgehammer plus turf herbicide is a selective herbicide for control of nutsedge and other weeds in turfgrass, ornamentals and landscaped areas.

- Active Ingredient: Halosulfuron-methyl
- Rate: 1 to 2 pouches per 1,000 sq ft.
- REI: 12 hours
- Controls: Nutsedge, Wild Mustard, Pigweed, and many more.
- Signal Word: Caution

**12pc Box of 13.5g Packet****GOW51516** Min. Buy 1 EA**Segment® II Herbicide**by *BASF Corp*

Segment II is a post-emergent herbicide for control of grassy weeds. For use on bedding plants, ground covers, field and container nurseries.

- Active Ingredient: Sethoxydim
- Rate: 36oz per Acre
- REI: 12 Hrs
- Controls: Grassy weeds
- Signal Word: Warning

**2.5gal****BAS59014427** Min. Buy 1 EA**Snapshot® 2.5TG Herbicide**by *Corteva*

A granular pre-emergence herbicide for the control of certain annual grasses and broadleaf weeds. Controls or suppresses more than 111 broadleaf weeds and annual grasses. It can be used over the top of 413 field-grown and 235 container-grown ornamentals.

- Active ingredient: trifluralin and isoxaben
- Rate: 100 to 200 lbs per acre
- REI: 12 hours
- Controls: Broadleaf weeds.
- Signal Word: Caution

**50lb****DOW19-1067H** Min. Buy 1 EA**SureGuard® SC Herbicide**by *Nufarm Americas Inc.*

SureGuard SC provides long-lasting pre-emergent and post-emergent control on a wide variety of grassy and broadleaf weeds. Use sites include established woody landscape ornamentals, bare ground applications and cracks and crevices.

- Active Ingredient: Flumioxazin
- Rate: 8 to 12oz per Acre
- REI: 12 Hrs
- Controls: Broadleaf, grassy and aquatic weeds. See label for complete list.
- Signal Word: Caution

**1pt****NTS10698861** Min. Buy 1 EA**64oz****NTS10698464** Min. Buy 1 EA**Tenacity® Herbicide**by *Syngenta Crop Protection*

Manage weeds, both broadleaves and grasses, without limiting other key aspects of turf management. Systemic, selective pre- and post-emergence herbicide. Safe on established and newly seeded turf. Controls 46 broadleaf weed and grass species and kills crabgrass.

- Active Ingredient: Mesotrione
- Rate: 5 to 8oz per Acre
- REI: 12 Hrs
- Controls: Many broadleaf and grassy weeds, including pre and post-emergence control of crabgrass
- Signal Word: Caution

**8oz****SYN46256** Min. Buy 1 EA**Tower® Herbicide**by *BASF Corp*

Tower is a pre-emergent herbicide for the control of numerous weeds that cause problems in field-grown and landscape ornamentals. It provides unsurpassed control of yellow nutsedge and effectively controls more than 50 other troublesome weeds.

- Active Ingredient: Dimethenamid-P
- Rate: 0.5 to 0.75oz per 1,000sq ft
- REI: 12 Hrs
- Controls: Annual sedges, yellow nutsedge, nightshade, spurge, carpetweed, crabgrass and more.
- Signal Word: Danger

**2.5gal AGENCY****BAS59014247** Min. Buy 1 EA**Treflan™ 500G Herbicide**by *Knox Fertilizer Company Inc*

A pre-emergence herbicide which provides long lasting control of a wide range of annual grasses and broadleaf weeds. Recommended for use on a wide variety of ornamental trees, shrubs and flowers.

**40lb****SW1103409** Min. Buy 1 EA

WARNING: This product is not available for sale in CA.
For most up to date information please visit bfgsupply.com

Herbicides

Vessel™ Herbicide

by Prokoz, Inc

Vessel is a post-emergent systemic herbicide for control of a wide range of broadleaf weeds. The combination of three active ingredients provide effective control of troublesome weeds in turfgrass sites including residential, commercial and industrial.

- Active ingredient: 2, 4 D, Propionic acid, and Dicamba
- Rate: Varies depending on application.
- REI: 48 hours
- Controls: Numerous broadleaf weeds
- Signal Word: Danger



2.5gal

PROKZ9921126 Min. Buy 1 EA

Woodace® Preen Plus®

by Lebanon Seaboard Corp-Prof

Combines the power of two active ingredients (Trifluralin and Isoxaben) for unsurpassed control of both grassy and broadleaf weeds. One application can prevent over 150 weeds from invading shrub beds and other landscape areas for up to eight months.

- REI: 12 Hrs
- Active Ingredient: Trifluralin, Isoxaben
- Signal Word: Caution
- Rate: 133-267lbs per acre
- Controls: Wide variety of broadleaf weeds and annual grasses



20lb (30/PL)

WO2456320 Min. Buy 1 EA

We've got you covered.



Peters®
The clear choice

Osmocote®
Success is in the bag



Look to ICL for the world's best plant nutrition products. Whether it's Osmocote, the original controlled release fertilizer that created an industry, or Peters, the world's purest water-soluble fertilizer—ICL has got you covered.

growwithpeters.com



growwithosmocote.com



Herbicides

choosing between spray and granular products

	Spray	Granular
Cost/Acre	Less \$	Cost more due to bulk
Ease of Use	Most growers already have sprayers and are well trained to calibrate and spray herbicides.	Requires a calibration pan to check rate. Most growers don't have a herbicide spreader attached to a tractor where speed can be controlled. Belly grinder rates vary due to walking and hand crank speed.
Flexibility	Ability to tank mix preemergents together and option to add post-emergents to control existing weeds.	Cannot be mixed with other herbicides.
Weed Control- Shrubs, Large Trees	Stronger herbicides like Marengo SC and Sureguard SC can be applied as a directed spray near the stem. Also can add post-emergent herbicides to tank mix to kill existing weeds.	Effective, but costs more per acre and can't be combined with post-emergent herbicides.
Weed Control- Shrubs, Small Trees	Over the top spray options are limited to softer herbicides that won't harm foliage but also don't control weeds as well.	Over the top of shrubs and small trees, Granulars are the best way to deliver a stronger herbicide (ex:Broadstar, Marengo G) safely through the canopy to the soil surface.
Weed Control - Perennials	Softer herbicides like Gallery SC + Barricade can be safely sprayed over the top of many varieties, particularly early before they leaf out and late in the season.	Granulars (ex: Snapshot, Freehand) are a good choice mid-season when spraying herbicides onto foliage is a concern
Weed Control - Evergreens	Evergreens are generally tolerant of sprays of Sureguard SC or Marengo over the top. However, sprays can be blocked from making contact with soil by larger evergreens.	Granulars can potentially give better coverage of soil surface in large canopied evergreens due to horizontal angle of entry

WHEN TO APPLY & HOW OFTEN

Many nurseries delay applying herbicides to new plantings until they're rooted. This is not necessary for most crops and leads to unnecessary weediness. The goal is to apply as soon as possible after planting.

Growers in the South make as many as 6 herbicide applications per year. Nurseries in the Northern states often get by with 2-3 applications due to the shorter growing season and cold weather killing annual weeds.

Key application windows:

- After planting
- Summer: One or several summer mid-season applications depending on weed pressure.
- Fall: Early Fall to prevent fall germinating weeds. Late Fall applications will carry over for spring weed prevention.



WARNING: This product is not available for sale in CA.
For most up to date information please visit bfgsupply.com

800-883-0234
www.bfgsupply.com

Aquatics

GreenClean® Pond Blockby *BioSafe Systems*

A proprietary blend of naturally occurring aerobic and facultative bacterial strains and enzymes formulated to increase water quality and overall health of pond ecosystems. The high counts of beneficial bacteria packed in each block were scientifically selected and tested under actual field conditions. GreenClean Pond Block is completely nonpathogenic and contaminant-free.

- Active Ingredients: Beneficial Bacteria and Surfactants
- Rate: 1 Block per 5 acres of water
- Effective over a wide range of pH and temperature conditions
- Reduces organic debris accumulation on the floor and shoreline of ponds



5lb

BSF30064

Min. Buy 1 EA

Sanitizers, Cleaners, & Disinfectants

PACE AgH PRO™ Cleanerby *Pace 49 Inc.*

Multi-purpose environmentally friendly, biodegradable, non-corrosive cleaner, designed to effectively remove algae, soils, heat-set grease, biological spills, and sap found in agricultural areas. Safe on all indoor and outdoor surface found in areas such as packing facilities, greenhouses and CEA growing areas, warehouses, and heavy equipment.

- Active Ingredient: Trade secret
- Rate: 5-8 fl oz/gal for heavy cleaning, 1.5-4 fl oz/gal for light cleaning
- REI: 0 Hrs
- Environmentally friendly cleaner of all surfaces found in indoor growing areas.
- Signal Word: Warning



2.5gal

PACAGHPRO2.5 Min. Buy 1 EA

Other Info *SHIPS HAZ*

30gal

PACAGHPRO30 Min. Buy 1 EA

Other Info *SHIPS HAZSHIPS DIRECT*

55gal

PACAGHPRO55 Min. Buy 1 EA

Other Info *SHIPS HAZSHIPS DIRECT***BioMat™**by *BioSafe Systems*

A durable foot pad that controls plant pathogens at entryways when used with BioSafe Systems' sanitizing solutions, like SaniDate® 5.0. One BioMat holds 2.5 gallons of disinfecting solution to clean the soles of shoes/boots, reducing the risk of cross-contamination.

- Promotes active biosecurity and is easily integrated into any sanitation program
- Sustainable and durable, made of recycleable material
- Easy to use, simple to fill, move, and maintain
- Holds 2 gallons of diluted solution



Holds 2.5gal of Disinfectant

BSFN09574

Min. Buy 1 EA

Sanitizers, Cleaners, & Disinfectants

Floralife® Strip-It® Cleanerby *Smithers-Oasis USA*

Strip-It cleaner is designed for between season cleaning of greenhouse structures and irrigation lines as well as water storage tanks and sunshade wash.

- Active Ingredient: Sulfuric Acid, Ammonium Bifluoride
- Rate: 2.5 fl oz/gal for Irrigation line cleaning, 5 fl oz/gal for hard surface cleaning
- REI: 0 Hrs
- Powerful Greenhouse and Outdoor Cleaner
- Signal Word: Danger



30gal

SMFL6161A

Min. Buy 1 EA

Other Info *SHIPS HAZ***GreenClean® Acid Cleaner**by *BioSafe Systems*

A specialty blend of mineral acid and wetting agents that quickly removes greenhouse whitewash coatings, biofilm, organic deposits, calcium and other hard mineral deposits.

- Active Ingredient: Sulfuric Acid, Surfactant Blend
- Rate: 5 to 10gal per Surface Acre
- REI: 0-1 Hrs
- Controls: stubborn calcium and rust deposits
- Signal Word: Danger



5gal

BSF7500-5

Min. Buy 1 EA

Other Info *SHIPS HAZ*

55gal

BSF750055

Min. Buy 1 EA

Other Info *SHIPS HAZ***GreenClean® Alkaline Cleaner**by *BioSafe Systems*

Lift away organic deposits and emulsify grease and oils on hard surfaces with this hard surface cleaner. Follow up with SaniDate® 5.0 for a comprehensive cleaning and sanitation program.

- Active ingredient: Sodium Hydroxide and Tripolyphosphate, and Surfactant Blend
- Rate: 4 to 8oz of 1 gal
- Removes Soil, Calcium, Lime, and Whitewash
- Signal Word: Danger



5gal

BSF73005

Min. Buy 1 EA



Sanitizers, Cleaners, & Disinfectants

GreenClean® PRO Sanitizerby *BioSafe Systems*

Eradicate algae, moss, and other organic deposits on hard surfaces. Use during production to improve workplace safety by minimizing slip and fall hazards on walkways and floors caused by algae and slime molds. Additionally, GreenClean PRO can be used to treat water storage tanks and irrigation ponds to reduce algae and waterborne pathogens.

- Active Ingredient: Sodium Carbonate Peroxyhydrate
- Rate: 1 to 2lb per 1,000sq ft
- REI: 0-hour for granular applications, 1-hour for liquid and foam applications
- Controls: Algae
- Signal Word: Danger

**50lb****BSF3300-50** Min. Buy 1 EAOther Info *SHIPS HAZ***PERpose Plus® Sanitizer**by *BioWorks Inc.*

A broad-spectrum algaecide and fungicide for the prevention, suppression and control of fungus and algae on equipment and hard surfaces, in all stages of crop production, and for post-harvest and storage applications. Labeled for use in greenhouses, garden centers, landscapes, agricultural crops, nurseries and interiorscapes.

- Active ingredient: Hydrogen peroxide and Hydrogen dioxide
- Rate: 1 oz per gallon of water,
- REI: 0 to 1 hour
- Controls: algae and fungus
- Signal Word: Danger

**5gal****BW1HP44A55** Min. Buy 1 EAOther Info *SHIPS HAZ***55gal****BW1HP44A57** Min. Buy 1 EAOther Info *SHIPS HAZ***Green-Shield® II Disinfectant**by *BASF Corp*

Provides greenhouse and nursery growers a biodegradable, cost-effective way to control unwanted plant pathogens and algae on hard surfaces. EPA-registered for broad-spectrum control of pathogens and algae in and around greenhouses and causes no damage to clothing from splashes. Lasts four times longer in solution than bleach and provides residual control as long as treated surfaces stay wet.

- Active Ingredient: Quaternary ammonium
- Rate: 1.5oz per 5gals
- REI: 12 Hrs
- For General Disinfection
- Signal Word: Danger

**1gal****BAS59014302** Min. Buy 1 EAOther Info *SHIPS HAZ***30gal****BAS59014303** Min. Buy 1 EAOther Info *SHIPS HAZ***Phyton X3® Sanitizer**by *Phyton Corp*

Triple-powered, broad-spectrum formula for efficient, cost-effective disease control and sanitation. A powerful, highly concentrated bactericide / fungicide / algaecide / sanitizer with a zero-hour re-entry and a low risk of phytotoxicity, when used as directed. Labeled for use as a fungicide/bactericide on greenhouse bedding plants, ornamentals, and flowering plants, nursery stock and trees.

- Active Ingredient: Hydrogen Peroxide, Peroxyacetic acid, and Octanoic acid
- Rate: Varies depending on application.
- REI: 0 to 2 hours
- Controls: Algae and many plant and soil pathogens.
- Signal Word: Danger

**96oz****PHTNX3-31096** Min. Buy 1 EAOther Info *SHIPS HAZ***12gal****PHTNX3-31012** Min. Buy 1 EAOther Info *SHIPS HAZSHIPS DIRECT***PACE MHW™ Cleaner**by *Pace 49 Inc.*

PACE MHW™ is a powdered detergent that easily emulsifies dirt, oils and organic material, leaving surfaces spotless. It is designed to work without producing excessive foam in high-agitation environments. The low-foaming characteristics make it ideal for removing deposits from plastic and Styrofoam plug trays and pots, using automated washing equipment.

- Active Ingredient: Sodium Metasilicate, Sodium Carbonate, Sodium Alkylbenzene Sulfonate
- Rate: 2-6 tbs of powder/gal
- REI: 0 Hrs
- Softens hard to remove fertilizer and soil build-up from plastic and Styrofoam growing trays & pots.
- Signal Word: Danger

**45lb****PAC4919-0600A** Min. Buy 1 EAOther Info *SHIPS HAZ***SaniDate® 12.0 Sanitizer**by *BioSafe Systems*

A high-strength, peroxyacetic acid-based microbicide formulated as an alternative to chlorine treatments in irrigation water. Use SaniDate 12.0 to control water-borne pathogens and their dormant spores caused by algae, bacteria and biofilm to prevent the spread of disease in the greenhouse. This product's highly concentrated formula guarantees economical dilution rates.

- Active Ingredients: Hydrogen Peroxide and Peroxyacetic Acid
- Rate: Varies depending on application method. See label for complete information.
- REI: 1-hour spray,

**30gal****BSF200630** Min. Buy 1 EAOther Info *SHIPS HAZ***275gal****BSF2006275** Min. Buy 1 EAOther Info *SHIPS HAZ*

WARNING: This product is not available for sale in CA.
For most up to date information please visit bfgsupply.com

800-883-0234
www.bfgsupply.com

Sanitizers, Cleaners, & Disinfectants

SaniDate® 15.0 Sanitizerby *BioSafe Systems*

Control human health pathogens on raw, postharvest fruits and vegetables, processing waters, and on hard, non-porous food contact surfaces. SaniDate 15.0 is also approved to control the growth of microorganisms that cause decay and/or spoilage on raw and processed fruits and vegetables surfaces

- Active Ingredients: Hydrogen Peroxide and Peroxyacetic Acid
- Rate: Versatile; multitude of use sites and applications
- REI: 1-hour spray,

**55gal****BSF200655** Min. Buy 1 EAOther Info *SHIPS HAZ***SaniDate® 5.0 Sanitizer**by *BioSafe Systems*

The ideal cleaner, sanitizer, and disinfectant for hard, non-porous surfaces and equipment with no rinse required. Foam, fog, or apply solution with a mop, cloth, sponge, brush, scrubber, or coarse spray device or by soaking. SaniDate 5.0 brings peace of mind to management, staff, and consumers with its no residue formula and minimal a 4-hour REI.

- Active Ingredients: Hydrogen Peroxide and Peroxyacetic Acid
- Rate: Varies according to application method. See label.
- REI: 1-hour spray/fog,

**2.5gal****BSF200325** Min. Buy 1 EAOther Info *SHIPS HAZ***5gal****BSF20035** Min. Buy 1 EAOther Info *SHIPS HAZ***30gal****BSF200330** Min. Buy 1 EAOther Info *SHIPS HAZ***55gal****BSF200355** Min. Buy 1 EAOther Info *SHIPS HAZ***275gal****BSF2003275** Min. Buy 1 EAOther Info *SHIPS HAZ*

Sanitizers, Cleaners, & Disinfectants

PACE STRIP-IT PRO® Cleanerby *Pace 49 Inc.*

Use during crop rotation to clean outdoor and greenhouse growing areas, including irrigation lines. Foaming action dissolves mineral build-up and biofilm and helps dislodge compacted soil and algae staining found on any surface. Eliminate emitter clogging and cross-contamination to crops by keeping all water and surfaces that contact crops clean.

- Active Ingredient: Sulfuric Acid, Ammonium Bifluoride
- Rate: 2.5 fl oz/gal for Irrigation line cleaning, 5 fl oz/gal for hard surface cleaning
- REI: 0 Hrs
- Powerful Greenhouse and Outdoor Cleaner
- Signal Word: Danger

**2.5gal****PACSTRPITPRO25** Min. Buy 1 EAOther Info *SHIPS HAZ***30gal****PAC4919-0603E** Min. Buy 1 EAOther Info *SHIPS HAZ***55gal****PAC4919-0604** Min. Buy 1 EAOther Info *SHIPS HAZ*

Adjuvants

CapSil® Spray Adjuvantby *Aquatrols Corp Of America*

Waxy leaf surfaces can cause spray droplets to bead up, resulting in coverage gaps that can reduce the efficacy of foliar sprayed materials. CapSil® allows foliar sprays to spread evenly over the entire leaf surface, giving you full coverage with every application. CapSil is a 100% active blend of organo-silicone and non-ionic surfactants that enables solutions to spread over the entire leaf surface evenly.

- Active Ingredient: Polyether-polymethylsiloxanecopolymer
- Rate: 6 to 16 fl oz per 100gal
- Signal Word: Caution

**1gal****AQCAP-4X1** Min. Buy 1 EA**Indicate 5® pH Indicator**by *BRANDT Consolidated Inc.*

Indicate 5 is multi-functional adjuvant and water conditioner that counters the detrimental effects of high pH and hard water on sensitive pesticides. It adjusts water pH and contains a patented, built-in pH indicator that turns the spray water pink as soon as the optimum pH is reached. It also acts as a wetting/spreading agent that helps create an even film of spray over the plants surface.

- Active Ingredient: Alkyl Aryl Ethoxylates & Water Conditioning Agents
- Rate: 5 to 30 fl oz per 100gal
- Signal Word: Warning

**1gal****PROKZ19-0409** Min. Buy 1 EA

Adjuvants

Pentra-Bark® Penetrating Surfactantby *Quest Products Corporation*

Nonionic surfactant that improves penetration into the plant stems, leaves and through woody plant bark surfaces enabling translocation of systemic fungicides, insecticides, herbicides and fertilizers.

- Active Ingredient: Alkylphenol ethoxylate, polysiloxane polyether copolymer, propylene glycol
- Rate: 1.5-2.5% by volume
- Improves penetration through bark of water based basal applications
- Signal Word: Caution



! Not available for sale in CA

**4oz****QPC040** Min. Buy 1 EA**1qt****QPC100** Min. Buy 1 EA**1gal****QPC200** Min. Buy 1 EA**Super 7 Surfactant**by *BRANDT Consolidated Inc.*

Super 7 is an all-in-one spreader, acidifier, deposition aid and penetrant. A non-ionic, low foam surfactant that enhances the activity and effectiveness of pesticides and foliar nutrients. Provides more uniform coverage by decreasing surface tension of spray solutions, thus aiding in penetration. It may be used as an acidifying agent to lower pH of spray solutions.

- Active Ingredient: Alcohol Ethoxylate, Lecithin and Propanoic Acid
- Rate: 8 to 64oz per 100gal
- REI: 0 Hrs
- Enhances the activity and effectiveness of pesticides
- Signal Word: Warning

**1gal****BRANDTSUPER71.0** Min. Buy 1 EA**2.5gal****BRANDTSUPER72.5** Min. Buy 1 EA**Torpedo® Adjuvant**by *BRANDT Consolidated Inc.*

Torpedo® is a non-ionic, low foaming adjuvant used to enhance the activity and effectiveness of herbicides, insecticides, fungicides and plant growth regulators. More uniform coverage is achieved by decreasing the surface tension of spray solutions.

- Active Ingredient: methyl soyate, lecithin and polyethylene
- Rate: varies according to application. See label.
- REI: 4 hours
- Enhances the activity and effectiveness of pesticides
- Signal Word: Warning

**2.5gal****BRANDT05009BRN100** Min. Buy 1 EA**Ultra 90 Surfactant**by *BRANDT Consolidated Inc.*

Ultra 90 Spreader is a low cost 90% non-ionic adjuvant that improves wetting of foliage and enhances the effectiveness of spray applications. May be used on agricultural, aquatic, forestry, turf and ornamental crops.

- Active ingredient: Branched alkyl phenol ethoxylate, Propylene glycol, and Tall oil fatty acids
- Rate: 8 to 64 oz per 100 gals
- Improves wetting of foliage and enhances the effectiveness of spray applications
- Signal Word: Warning

**2.5gal****BRANDT01037BRN100** Min. Buy 1 EA**UpTake PRO® Adjuvant**by *Pace 49 Inc.*

A wetting agent, penetrant and spreader sticker to add to tank mixes or inject into irrigation water that enhances the wettability of water. Use as a water conservation management tool, for effective soil absorption and distribution of water and additives from foliage to roots. Use in all outdoor, greenhouse or indoor growing areas.

- Active Ingredient: Didecyl dimethyl ammonium chloride
- Rate: 6-25oz per 100 gallon for spray applications, 0.34-1.7 oz per 100 gallon for overhead/ sub-irrigation system applications, 1-4ppm for intermittent injection: for misting or hydroponics, 2-10ppm for intermittent outdoor injection. 6-25 oz per 100 gallons for bulb, rooted or unrooted cutting dip
- REI: 0 Hrs
- Adjuvant, surfactant, deposition aid, wetting agent
- Signal Word: Danger

**2.5gal****PACUPTPRO2.5** Min. Buy 1 EAOther Info *SHIPS HAZ***30gal****PACUPTPROE** Min. Buy 1 EAOther Info *SHIPS HAZ***55gal****PACUPTPROF** Min. Buy 1 EAOther Info *SHIPS HAZ***275gal****PACUPTPROG** Min. Buy 1 EA

WARNING: This product is not available for sale in CA.
For most up to date information please visit bfgsupply.com

Wetting Agents

AquaGro® 2000 G Media Surfactantby *Aquatrols Corp Of America*

AquaGro® G ensures the continual wettability of your bark or peat based mix. It provides faster, more uniform water distribution and better moisture retention.

- Active Ingredient: Ethoxylated Alkyl Phenols and Fatty Acid Esters
- Rate: 1lb per cu yd
- Signal Word: Warning

**120lb****AQ2KG-120** Min. Buy 1 EA**AquaGro® L Media Surfactant**by *Aquatrols Corp Of America*

AquaGro® L ensures the continual wettability of your bark or peat based mix. It provides faster, more uniform water distribution and better moisture retention.

- Active Ingredient: Alkoxyated Polyols
- Rate: 2 to 7fl oz per cubic yard
- Signal Word: Caution

**2.5gal****AQAGPSI-2X2.5** Min. Buy 1 EA**55gal****AQAGPSI-55** Min. Buy 1 EA**H2Pro® Wetting Agent**by *ICL*

H2Pro is a unique blend of surfactants with long residual activity for use in containers, pots, hanging baskets, flats, trays and more. Uniform moisture distribution creates a better root environment, eliminates dry spots and allows for an even distribution of fertilizer and or pesticide solutions added during the growing cycle. Liquid formulation for easy spray and drench application.

- Active Ingredient: Ethylene oxide-propylene oxide copolymers
- Rate: 5.5 to 16oz per 100gal
- Optimizes water holding capacity of soil
- Signal Word: Caution

**2.5gal****EVRG95830** Min. Buy 1 EA**55gal****EVRG95835** Min. Buy 1 EA**H2Pro® Wetting Agent**by *ICL*

H2Pro is a unique blend of surfactants with long residual activity for use in containers, pots, hanging baskets, flats, trays and more. Uniform moisture distribution creates a better root environment, eliminates dry spots and allows for an even distribution of fertilizer and or pesticide solutions added during the growing cycle. Granular formulation for incorporation into growing media.

- Active Ingredient: Ethylene oxide-propylene oxide copolymers
- Rate: 13.5 to 27oz per cubic yard
- Optimizes water holding capacity of soil
- Signal Word: Caution

**50lb - Granular****EVRG95850** Min. Buy 1 EA**Soax® Granular Wetting Agent**by *Smithers-Oasis USA*

Soax wetting agent helps to achieve consistency in growing media by aiding in the even dispersion of water and nutrients throughout the entire root zone.

- Reduces the occurrence of spot drying.
- Helps growing media overcome the resistance of initial wetting.
- Liquid and granular formulations available.

**120lb****SM55936** Min. Buy 1 EAOther Info [SHIPS DIRECT](#)**Soax® Wetting Agent**by *Smithers-Oasis USA*

Soax wetting agent helps to achieve consistency in growing media by aiding in the even dispersion of water and nutrients throughout the entire root zone.

- Reduces the occurrence of spot drying.
- Helps growing media overcome the resistance of initial wetting.
- Liquid and granular formulations available.

**1gal****SM55900** Min. Buy 1 EAOther Info [SHIPS DIRECT](#)**5gal****SM55905** Min. Buy 1 EAOther Info [SHIPS DIRECT](#)**55gal****SM55930** Min. Buy 1 EAOther Info [SHIPS DIRECT](#)**Suffusion® Surfactant**by *OHP, Inc.*

An effective blend of surfactants for use on all types of growing media in nurseries, greenhouses, interior plantscapes and soil production. Suffusion works by reducing surface tension of applied water, penetrating into dry and water repellent areas and linking together water-repellent soil and water. Peat, bark or alternative compost substrates are typically candidates for Suffusion.

- Active Ingredient: Blend of 3 surfactants
- Rate: 4 to 6oz per cubic yard
- REI: 0 Hrs
- Improve water penetration and retention of optimum moisture levels
- Signal Word: Caution

**2.5gal****OHP988425** Min. Buy 1 EA**30gal****OHP988430** Min. Buy 1 EA

Spray Additives

Super Wetter Wetting Agent

by BRANDT Consolidated Inc.

Super Wetter is an organosilicone spreader that can be tank mixed with spray oils and EC formulations. Increases coverage of fungicides, insecticides, etc. by spreading the formulation across leaf and stem surfaces for complete coverage.

- Active Ingredient: Siloxane polyalkyleneoxide copolymer and polyalkyleneoxide
- Rate: 3 to 16oz per 100gal
- REI: 0 Hrs
- Reduce spray volume and promotes rapid uptake of spray solution
- Signal Word: Warning

**1gal****BRANDT1047BRN101** Min. Buy 1 EA

Spray Additives

CAL-FLO® Liquid Lime

by Burnett Lime Company, Inc.

CAL-FLO liquid limestone soil can be used to increase the pH. of your soilless media. It also provides a source of calcium and magnesium for plants.

- Active Ingredient: Calcium Carbonate
- Rate: Varies depending on application method. See label for complete information.
- REI: 0 Hrs
- Raises pH of planting soils
- Signal Word: Caution

**2.5gal****SA44298**

Min. Buy 1 EA

CalOx® FT Spray Additive

by BioSafe Systems

CalOx FT is an advanced liquid nutritional and crop enhancement product for a wide range of agricultural and horticultural crops. CalOx FT optimizes overall plant growth and development, plus bolsters yield and quality.

- Active ingredient: Calcium and Nitrogen
- Rate: varies. See label
- REI: 4 hours
- Improves calcium mobility with more uniform distribution
- Signal Word: Danger

**1gal****BSF45001**

Min. Buy 1 EA

2.5gal**BSF450025**

Min. Buy 1 EA



Spray Additives

AgSil® 16H Potassium Silicate 0-0-32

by Certis USA LLC

AgSil® 16H potassium silicate powder serve as fertilizers for use in turf and crop applications as a source of soluble potassium and silicon. Agsil® 16H helps plants to resist toxicity from phosphorous, manganese, aluminum and iron and increases tolerance to salt. Also aids in resistance to drought by reducing water loss, and in some cases it may increase growth and yield.

- Active Ingredient: Potassium Silicate
- Rate: Varies depending on application method. See label for complete information.
- Provides source of silicon and potassium
- Signal Word: Caution

**50lb****SA16388**

Min. Buy 1 EA

**BioFoamer Foaming Agent™**

by BioSafe Systems

Additive for use in foaming equipment to enhance foam during application. Ensures that foam delivers thorough coverage and extended contact time on treated surfaces.

- Produces a thick foam for longer contact time on porous and non-porous surfaces
- Great for vertical surfaces or irregular areas.
- Improves application visibility for full coverage

**5gal****BSF9005-5**

Min. Buy 1 EA

**CalOx® pH Spray Additive**

by BioSafe Systems

A micronized flowable lime made up of over 70% active ingredient and is specifically formulated to immediately raise soil pH. Ideal product for crops like geraniums, poinsettias, and greenhouse tomatoes. Since it won't clog lines, it is easily direct injected as a drench application, stabilizing the soil pH for more than 35 days.

- Active Ingredient: Calcium Carbonate
- Rate: Varies depending on application method. See label for complete information.
- REI: 0 Hrs
- Raises pH of planting soils
- Signal Word: Caution

**2.5gal****BSF201125**

Min. Buy 1 EA

Other Info **SHIPS DIRECT**

WARNING: This product is not available for sale in CA.
For most up to date information please visit bfgsupply.com

Spray Additives

Moisture-Loc

by Zorro Technology Inc

Moisture-Loc plant protector is a foliar antitranspirant that forms a strong prophylactic membrane shield on leaves that significantly cuts water loss and lowers plant stress.

- Foliar antitranspirant that forms a strong prophylactic membrane shield on leaves that significantly cuts water loss and lowers plant stress
- Rate: Varies based on application, see label
- This formulation is a water-conserving, multi-purpose, clear liquid spray-on plant coating

**5gal****CAWML023**

Min. Buy 1 EA

Zorro Seal & Shield

by Zorro Technology Inc

A superior sealant that protects concrete and other hard surfaces while making for easy cleaning and preservation.

- Superior sealant that protects concrete and other hard surfaces while making for easy cleaning and preservation
- Rate: One gallon of Zorro Seal & Shield with three gallons of water
- Made with acrylic polymers designed for long-lasting and durable wear



CA Prop65 Warning

5gal**CAWZS031**

Min. Buy 1 EA

Other Info **SHIPS DIRECT****Evofactor™**

by Verano 365, LLC

EVOFACOR is an adjuvant that improves fertilizer efficiency. The OpusMAX formula creates supramolecular structures of the active ingredients in water-soluble fertilizers, promoting nutrient availability to plants when used as part of a regular fertigation schedule.

- Active Ingredient: Isotridecanol
- Rate: Varies by application. See label.

**2.5gal****VER900025**

Min. Buy 1 EA

55gal**VER900055**

Min. Buy 1 EA

Other Info **SHIPS DIRECT****Pesticide Equipment Cleaner**

by BRANDT Consolidated Inc.

Pesticide equipment & tank cleaner will remove and deactivate residual pesticide contamination from storage tanks and spray equipment. Use before changing from one pesticide to another, or before storing equipment.

- Active ingredient: Potassium Hydroxide, anticorrosion compounds, surfactants and polydimethylsiloxane
- REI: 0 Hrs
- Signal Word: Danger

**1qt****BRANDTTANKCLEAN** Min. Buy 1 EA**PlantCoatPro™**

by PlantCoatPro

PlantCoatPro™ is designed to reduce the transpiration of water from plants. By locking in some of the moisture, plants can be protected from sudden environmental changes that can cause damage to foliage and overall plant health. For ornamental plants, trees and shrubs. Not labeled for fruit, vegetable or other crops intended for human consumption.

- Active ingredient: Emulsified acrylic polymers
- Rate: 4 to 5 gal per 100 gallon.
- Reduces the effects of winter burn or summer drought.

**2.5gal****DP44319**

Min. Buy 1 EA

Prime Source Defoamer

by Albaugh, LLC

Defoamer is a water-based, silicone emulsion, antifoam and defoamer that can be used to prevent foam formation or knock down existing foam. Reducing and eliminating foam during tank mixing, allows the product to be more thoroughly agitated during the process and reduces the threat of chemical spills.

- Active Ingredient : Dimethylpolysiloxane
- Rate: 1/2 to 1oz per 100gals
- Controls: Foam
- Signal Word: Caution



Not available for sale in CA

1qt**ALBADEFOAM1QT**

Min. Buy 1 EA

Prime Source Turf Marker Blue

by Albaugh, LLC

Turf Marker products dissipate quickly in wet and dry weather and mixes completely with water soluble pesticides and fertilizers without affecting chemical efficacy.

- Active Ingredient : Blue Dye
- Rate: 16 to 24oz per 100gals
- Signal Word: Caution



Not available for sale in CA

1qt**ALBATURF1QT**

Min. Buy 1 EA



Slug and Snail Control

Deadline® M-Ps™ Molluscicide

by Amvac Chemical Co.

Molluscicide effectively controls slugs and snails in various, field, tree and vegetable crops. It's colored with a high-visibility blue dye to help monitor coverage and consumption levels. Can be applied every 3 to 4 weeks during the growing season, and works well in field crops with no-till or reduced till practices. These mini pellets provide five times the number of bait particles compared to regular size pellets.

- Active Ingredient : Metaldehyde
- Rate: 25lbs per acre
- REI: 12 hours
- Controls: Slugs and Snails
- Signal Word: Caution



50lb

AMVC13874 Min. Buy 1 EA



Deadline® Ornamental Molluscicide

by Amvac Chemical Co.

Ornamental labeled specifically for use as a barrier around gardens or plants. Deadline uses SNARE, a powerful attractant, to lure slugs and snails to Deadline and away from plants. It is formulated into mini-pellets that are rain fast and can withstand as much as six inches of rain or heavy watering over 14 days.

- Active Ingredient: Metaldehyde
- Rate: 0.25lb per 1,000sq ft
- Controls: Slugs and Snails
- Signal Word: Caution



25lb

AMVC11534 Min. Buy 1 EA



IronFist™ Slug & Snail Bait

by Belchim Crop Protection Usallc

Kills snails and slugs on turf, ornamentals, vegetables and fruit. Slug and snails ingest the bait, causing them to stop feeding and die. Immediate plant protection will be observed through the decrease in feeding. Safe to pets and wildlife.

- Active Ingredient: Sodium Ferric EDTA
- Rate: 10 to 40lb per Acre
- REI: 0 Hrs
- Controls: Snails, slugs.
- Signal Word: Caution



50lb

RNG700001.050 Min. Buy 1 EA



Animal Repellents and Controls

Hawk® All-Weather Rodent Bait Chunx

by Motomco Ltd.

Made with bromadiolone, Hawk is a single-feed anticoagulant rodenticide with Patented gnawing edges. Use with confidence for unsurpassed control, even against warfarin resistant "super-rats." The superior formulation is irresistible to rats and mice and kills them in 4 or 5 days after eating just a single-feeding. Highly weatherable.

- Active Ingredient: Bromadiolone
- Controls: Norway Rats, Roof Rats, House Mice
- Signal Word: Caution



9lb

MTO312705 Min. Buy 1 EA



Animal Repellents and Controls

Hawk® All-Weather Rodent Bait Place Packs

by Motomco Ltd.

Made with bromadiolone, Hawk is a single-feed anticoagulant rodenticide with Patented gnawing edges. Use with confidence for unsurpassed control, even against warfarin resistant "super-rats." The superior formulation is irresistible to rats and mice and kills them in 4 or 5 days after eating just a single-feeding. Highly weatherable.

- Active Ingredient: Bromadiolone
- Controls: Norway Rats, Roof Rats, House Mice
- Signal Word: Caution



150 x 1.5oz Place Packs

MTO311654 Min. Buy 1 EA



Rampage® Rodent Bait Chunx

by Motomco Ltd.

Rampage is a key component in the fight against resistance as it contains Bromethalin, a non-anticoagulant capable of killing even anticoagulant resistant rats and mice. It delivers a proven combination of bait acceptance and speed of kill. In fact its formula can kill rodents in as little as two days after consuming a toxic dose. Using Rampage also reduces the amount of bait required for control.

- Active Ingredient: Bromethalin
- Controls: Norway Rats, Roof Rats, House Mice
- Signal Word: Warning



9lb

MTO222912 Min. Buy 1 EA



Rampage® Rodent Bait Place Packs

by Motomco Ltd.

Rampage is a key component in the fight against resistance as it contains Bromethalin, a non-anticoagulant capable of killing even anticoagulant resistant rats and mice. It delivers a proven combination of bait acceptance and speed of kill. In fact its formula can kill rodents in as little as two days after consuming a toxic dose. Using Rampage also reduces the amount of bait required for control.

- Active Ingredient: Bromethalin
- Controls: Norway Rats, Roof Rats, House Mice
- Signal Word: Warning



121 x 15g Place Packs

MTO221212 Min. Buy 1 EA



Selontra® Rodenticide

by BASF Corp

Selontra rodent bait offers effective control of mice and rats, even anti-coagulant resistant rodents. Labeled for use in/around agricultural buildings, warehouses, homes, industrial buildings and transport vehicles. Single Feed and Stop Feed mode of action. Contains Bitrex to prevent harm to non-target animals.

- Active Ingredient: Cholecalciferol
- Controls: Mice and rats
- Signal Word: Caution



8lb - Approximately 182 Baits per 8lb Pail

BAS59014503 Min. Buy 1 EA



WARNING: This product is not available for sale in CA.
For most up to date information please visit bfgsupply.com

800-883-0234
www.bfgsupply.com

Animal Repellents and Controls

Spring/Summer Animal Repellent*by DeerPro*

DeerPro animal repellent reduces browsing and chewing damage from deer, rabbits, and voles. One application will protect treated plants from 3 to 6 weeks.

- Active Ingredient: Putrescent whole egg solids
- Rate: See label
- REI: 24 hours
- Use during the spring and summer growing season.
- Signal Word: Caution

**2.5gal****DP44320**

Min. Buy 1 EA

Talpid Mole Worms Bait*by Bell Laboratories Inc*

A worm-shaped mole bait that kills moles in lawns and gardens. Moles usually die in their tunnels, often within 12-24 hours of ingesting the bait.

- Active Ingredient: Bromethalin
- Controls: Moles

**20pk****BLI7150**

Min. Buy 1 EA

Tomcat® All-Weather Bait Chunx*by Motomco Ltd.*

Tomcat baits are manufactured with food-grade ingredients and enhancers, resulting in a palatable bait with consistent results. All-weather 1oz block is mold and moisture resistant and can be secured in a bait station. Peanut flavored for maximum bait acceptance and performance.

- Active ingredient: Diphacinone
- Unique block shape and edges preferred by rodents that like to gnaw
- Contain holes for placing on rods in a bait station, or can be secured using nails or wire
- Controls: Norway Rats, Roof Rats, House Mice
- Signal Word: Caution

**18lb****MTO32448**

Min. Buy 1 EA

Tomcat® Bait Chunx*by Motomco Ltd.*

Tomcat baits are manufactured with food-grade ingredients and enhancers, resulting in a palatable bait with consistent results. All-weather 1oz block is mold and moisture resistant and can be secured in a bait station. Peanut flavored for maximum bait acceptance and performance.

- Active ingredient: Diphacinone
- Unique block shape and edges preferred by rodents that like to gnaw
- Contain holes for placing on rods in a bait station, or can be secured using nails or wire
- Controls: Norway Rats, Roof Rats, House Mice
- Signal Word: Caution

**4lb****MTO32444**

Min. Buy 1 EA

Tomcat® Bullet Rodent Bait Station*by Motomco Ltd.*

Tier-1 tamper-resistant bait station with a secure, low-profile design. Easy to clean and easy to open. Holds 4 1oz Bait Chunx on 4 vertical rods.

- Tomcat Bait stations keep rodent bait safely out of reach of children and pets.
- Fully lockable with a single key

**For Use with Bait Chunx****MT033432**

Min. Buy 6 EA

Winter Animal Repellent*by DeerPro*

DeerPro animal repellent is a long lasting solution to winter foraging animals. Can be applied as early as October and it will still be protecting shrubs and trees in early spring. Reduces browsing and chewing damage from deer, rabbits, and voles.

- Active Ingredient: Thiram
- Rate: See label
- REI: 24 hours
- For winter protection only. Do not use during the growing season.
- Signal Word: Caution

**2.5gal****DP44318**

Min. Buy 1 EA



IRRIGATION



DRAMM

Irrigation Components & Tips

Dramm® Water Breaker® Nozzle

This plastic water breaker features micro-fine holes. Made of plastic with a stainless steel disk.



Red - 7gpm - 40psi - 3/4in Hose Thread
DRM2072602 Min. Buy 1 EA



Dramm® Water Breaker® Nozzle

This plastic water breaker is designed for small containers (hanging baskets) and is an excellent choice for watering in areas with low water pressure. Adjust water flow to 50% of its possible volume.



Blue - 7gpm - 40psi - 3/4in Hose Thread
DRM1072349 Min. Buy 1 EA



Dramm® Water Breaker® Nozzle

This water breaker has over 1,000 micro holes that create an ultra-soft flower shower which will not disturb delicate soil or harm tender plants. Made in USA from ABS plastic and stainless steel.



Red - 7gpm - 40psi - 3/4in Hose Thread
DRM1071000 Min. Buy 1 EA



Orange - 7gpm - 40psi - 3/4in Hose Thread - Wide Pattern, Large Coverage
DRM1071200 Min. Buy 1 EA



Green - 7gpm - 40psi - 3/4in Hose Thread - More Controlled, Focused Watering
DRM1071100 Min. Buy 1 EA

Dramm® Water Breaker® Nozzle

Plastic water breaker designed to offer a low, soft flow that allows for more precise watering. The 750PL has 25% less hole surface area which offers a lower flow that can be regulated by a shut-off valve for minimal water and still retain a pattern.

- Soft shower pattern at 7gpm



Yellow - 7gpm - 40psi - 3/4in Hose Thread
DRM1071400 Min. Buy 1 EA



Dramm® Water Breaker® Nozzle

The original full-flow shower head nozzle. Provides fast, full-flow watering without damage to your plants or disturbing soil. Cast aluminum and hand machined with 3/4 inch brass hose threads.

Narrow pattern with flow at 7gpm



Aluminum - 7gpm - 40psi
DRM1072343 Min. Buy 1 EA



Dramm® Water Breaker® Nozzle

Stainless steel disk. Micro-fine holes. Wider pattern.



Aluminum - 7gpm - 40psi - 3/4in Hose Thread
DRM2072601 Min. Buy 1 EA



Dramm® Water Breaker® Nozzle

The original full-flow shower head nozzle. Provides fast, full-flow watering without damage to your plants or disturbing soil. Cast aluminum and hand machined with 3/4 inch brass hose threads.

- Gentle, full flow at 11.1gpm



Aluminum - 11.1gpm - 40psi
DRM1072342 Min. Buy 1 EA



Dramm® Water Breaker® Nozzle

Provides fast, full-flow watering without damage to your plants. Patterned after the original 400 Aluminum water breaker, this product is made from high-impact ABS plastic and aluminum to provide a lightweight alternative.

- Gentle, full flow at 11.1gpm



Blue - 11.1gpm - 40psi - 3/4in Hose Thread
DRM1072346 Min. Buy 1 EA



Full Flow Spray, Blue Plastic, 40psi, 3/4in Thread, Rubber Bumper
DRM2072646 Min. Buy 1 EA

Dramm® Screen-Aire Water Breaker® 350PL Nozzle

Designed to water nursery containers with a gentle, concentrated aerated flow of water. A fine-mesh screen and an array of internal components combine air and water to produce a very soft, unrestricted spray. Use a Dramm In-Line Hose Filter to keep the nozzle from clogging. Made in the U.S.A.



3/4in Brass Hose Thread - 40psi
DRM2072550 Min. Buy 1 EA



Dramm® 540 Brass Rose Nozzle

Brass Rose features an extra wide spray pattern, which allows you to increase the speed of hand watering. Great for watering bedding plants, pots, or market packs. Includes protective rubber guard and metric to inch hose thread converter. Made in Germany.



3/4in Hose Thread - 40psi
DRM1072540 Min. Buy 1 EA



DRAMM

Irrigation Components & Tips

Dramm® Fogg-It Nozzle

Designed for misting delicate seedlings or for raising humidity around wilting plants. This nozzle has three mist jets which create a conical spray pattern. Available in four different discharge rates. Made in the U.S.A. from solid brass. 3/4 hose threads.



1/2gpm, Super Fine
DRM2072505 Min. Buy 1ea



1gpm, Fine
DRM2072506 Min. Buy 1ea



2gpm
DRM2072507 Min. Buy 1ea



4gpm - Heavy
DRM2072508 Min. Buy 1ea



Dramm® Seedling Nozzle

The Seedling Nozzle allows you to water fragile plants, delicate seedlings, or plant cuttings. This high-quality nozzle produces an extra fine, hollow cone mist pattern and sprays 1/2 gallon of water per minute. Made in the U.S.A. from solid brass.



0.75in Thread
DRM2072350 Min. Buy 1 EA



Dramm® Handi-Reach™ Handle

Designed to eliminate the stretching and stooping associated with hand watering. Made in the USA from extruded aluminum tubing, forged brass hose couplings and a comfort EPDM hand-Grip. 0.75 male and female hose threads.



16in - 0.75 Threads
DRM116GC Min. Buy 1 EA

24in - 0.75 Threads
DRM124GC Min. Buy 1 EA

30in - 0.75 Threads
DRM130GC Min. Buy 1 EA

36in - 0.75 Threads
DRM136GC Min. Buy 1 EA

48in - 0.75 Threads
DRM13485 Min. Buy 1 EA

48in - 0.75 Threads
DRM148GC Min. Buy 1 EA

72in - 0.75 Threads
DRM172G Min. Buy 1 EA



Dramm® Telescoping Handi-Reach Handle

The Telescoping Handi-Reach Handle allows growers to reach over wide benches or plants that are higher with ease. The Telescoping Handle extends to 80". Storing the wand is easy as it compresses down to 50" in length when closed. Available in either a standard bend or hanging basket bends.



Standard Bend
DRM1022375 Min. Buy 1ea

Hanging Basket Bend
DRM1022376 Min. Buy 1 EA



Dramm® Hanging Basket Handle

Offers a 90degree bend in the top of the handle to water directly into a hanging basket. Made in the U.S.A. from extruded aluminum tubing, forged brass hose couplings and a comfort EPDM hand grip. 3/4 male and female hose threads.



36in. 3/4 Threads
DRM136GBC Min. Buy 1 EA

48in. 3/4 Threads
DRM148GBC Min. Buy 1 EA



Dramm® Shut-Off Valve

Aluminum shut-off that offers unmatched durability and flow in a light weight package. Depending on water quality and other fittings used corrosion may result. The new valve holds up to high EC, low pH water with no trouble.

- Cast brass handle



Aluminum - .75in Male-Female
DRM1073301 Min. Buy 1 EA



Dramm® One Touch Valve

Fingertip water control. Zinc die-cast body & nylon valve components for long life. Flow can be adjusted from off to full flow with thumb-tip precision. Flow rate 8gpm at 40 PSI.



8gpm
DRM1014700 Min. Buy 1 EA



Dramm® Twin Shut Off Valve

Water two places at one time. Connect the valve to your faucet to create two male connections, with each connection independently controlled. Molded from high quality ABS plastic.



Twin Cyclolac - 10gpm
DRM235C Min. Buy 1 EA



DRAMM

Irrigation Components & Tips

Dramm® Touch'N Flow PRO™ with Trigger

Full flow valve specialty designed for durability and ease of use. Features a one-touch lever activated valve and an ergonomic insulated-Grip. Offers up to 11gpm at 40psi. Made in the USA.

- Works well with 400 water breaker



11gpm

DRM1073065

Min. Buy 1 EA



Dramm® QAV Shut-Off Valve

The QAV uses a unique, patent-pending valve design includes a single-piece ball, stem, and handle assembly to reduce the time to assemble while strengthening the structure. The QAV Valve replaces our 35 Shut-Off, keeping only its price-point. The QAV offers greater durability and a larger handle for easier watering.



Blue - 13gph

DRM1072318

Min. Buy 1 EA



Dramm® OneTouch™ High-Flow Valve

Fingertip water control. Zinc die-cast body and nylon valve components for long life. Flow can be adjusted from off to full flow with thumb-tip precision. Larger opening for more flow. Offers up to 16gpm at 40psi.

- Easy slide valve



16gpm

DRM1074800

Min. Buy 1 EA



Dramm® Brass Shut-Off Valve

Simply the best shut-off valve available. Provides fingertip water control at the end of a greenhouse hose. A quarter turn of the large ergonomic handle and the water is off. Full water flow design. Made in the USA from brass, durable seals and a hard chrome plated ball to provide years of service. 3/4 threads.



17gpm

DRM1073300

Min. Buy 1 EA



Dramm® #74 Full Flow Shut-Off Valve

Full flow valve specialty designed for durability and ease of use. Features a one-touch lever activated valve and an ergonomic insulated-Grip. Offers up to 11gpm at 40psi. Made in the USA.

- 5/8 inch ball opening for full water flow



18gpm

DRM1073074

Min. Buy 1 EA



Irrigation Components & Tips

Dramm® Brass Hose Swivel

The Brass Hose Swivel is a live swivel that allows for unencumbered movement between the hose and attachments under pressure. Reduces hose twisting.



18gpm

DRM1072700

Min. Buy 1 EA



Dramm® Quick Disconnect

Heavy-duty quick hose connection offers full-flow (pair) without water-stop. Made in the USA.



Brass

DRM740C

Min. Buy 1 EA



Dramm® #300 Full Repair Kit

Full repair kit for the 300 Brass Shut-Off valve. Includes handle and ball assembly.



DRMRKBB

Min. Buy 1 EA



Dramm® Inline Filter

Inline Filter 80 mesh screen filters out unwanted dirt and debris.



ILF-175 - 10gpm - 40psi

DRM2072630

Min. Buy 1 EA



Other Irrigation



Dramm® DTL-E Eyelet

Used to install Dramm Dribble Tubes and Dribble Rings.



Brass - For .060 & .045ID

DRMDTMSE

Min. Buy 1 EA

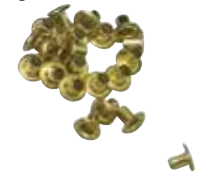

Brass - For .075ID

DRMDTLE

Min. Buy 1ea

Dramm® Pressure Compensated Dribble Ring

The Dramm PC Dribble Ring offers even watering of trees and nursery stock. Dramm pressure compensating emitters ensure accurate watering from pot to pot. Contact your BFG representative for assistance in selecting the correct size. Available ring diameters are 4in, 6in, 8.5in, 10in and 13in

Dramm® Anchor Stake for Dribble Ring

Holds ring in place in pot. Use one per ring.



DRMS3ANCHOR

Min. Buy 1ea



DRAMM

Other Irrigation

Type	ID	OD	Color
DTS	0.045in	0.100in	Green
DTM	0.060in	0.100in	Brown
DTL	0.075in	0.125in	Blue

Dramm® Dribble Tube

Offers a simple way to water plants automatically by dripping water into each pot directly. Permanently attached always ON weight emitters. Works with other systems. Available in various standard lengths.



Green - 18in

DRMDTS18 Min. Buy 1 EA

Blue - 24in

DRMDTL24 Min. Buy 1 EA

Blue - 36in

DRMDTL36 Min. Buy 1 EA

Brown - 18in

DRMDTM18 Min. Buy 1 EA

Brown - 24in

DRMDTM24 Min. Buy 1 EA

Brown - 42in

DRMDTM42 Min. Buy 1 EA

Dramm® Pressure Compensated Dripper

Drip irrigation system is designed for even watering with a greater range of operating pressure. Silicone diaphragms last longer. Slim, zinc-aluminum weight is easy to harvest. Durable nylon body. Available in 18in, 24in, 36in, 42in and 48in.



2 lph Drip Assembly, 18in

DRMPCAS2L18 Min. Buy 1 EA

2 lph Drip Assembly, 24in

DRMPCAS2L24 Min. Buy 1 EA

2 lph Drip Assembly, 36in

DRMPCAS2L36 Min. Buy 1 EA



Dramm® ii ri Bluetooth Smart Irrigation Controller

Irrigation controller with Bluetooth connectivity, the ii ri Smart Controller can operate one solenoid valve without wiring. Use your smartphone to create watering schedules you can easily change according to your needs. CR123 battery operated, works with different valves.



DRMIIRISVB075 Min. Buy 1ea

DRMIIRISVB100 Min. Buy 1 EA



Dramm® Proline Irrigation Controller

Offers basic irrigation control and advanced features in a easy-to-program and affordable unit. With up to 4 programs that can run independently or simultaneously, with up to 8 start times per day and day selection capability, the ProLine provides flexibility in your watering. This modular controller starts with 4 outputs, but is expandable up to 24.



4 Station Controller

DRMPL160004 Min. Buy 1ea

8 Station Controller

DRMPL160008 Min. Buy 1ea

12 Station Controller

DRMPL160012 Min. Buy 1ea

24 Station Controller

DRMPL160024 Min. Buy 1ea



Dramm® ii ri Bluetooth Smart Irrigation Controller with Coil

Irrigation controller with Bluetooth connectivity, the ii ri Smart Controller can operate one solenoid valve without wiring. Use your smartphone to create watering schedules you can easily change according to your needs. CR123 battery operated, works with different valves.



DRMIIRI3V Min. Buy 1ea



Dramm® Mistime Misting Controller

The Dramm 10 zone MistTime Controller is perfect for time or temperature based control of misting valves. With the ability to program each valve independently, the MistTime offers unmatched flexibility. The timing is variable with the duration operating between 1 second and 60 minutes and interval timing operating between 1 minute and 12 hours.



10 Zones

DRMMT10 Min. Buy 1ea



WARNING: This product is not available for sale in CA. For most up to date information please visit bfgsupply.com

DRAMM

Other Irrigation

Dramm® ColorStorm™ Professional Rubber Hose

This reinforced hose is hexagonal in shape to reduce kinking. The design of the hose allows a user to easily pull free any kinks that may occur. The hexagonal Sure-Grip™ cover creates a softer surface for a more comfortable grip. Each hose has crush-proof, nickel plated, brass fittings for an exact fit that will survive years of use.

- Sure grip technology
- Crush proof fitting
- Kink resistant
- Hot water resistant to 160 degrees F
- Bright yellow for visibility



Yellow - .625 x 75ft

DRM17203 Min. Buy 1 EA

Yellow - .625 x 100ft

DRM17303 Min. Buy 1 EA

Master Roll - .625in x 330ft - Yellow

DRM17999330 Min. Buy 1 SP

Bulk - .625in x Per Foot - Yellow

DRM17999FT Min. Buy 1 EA

Yellow - .75in

DRM17989FT Min. Buy 1 EA

Yellow - .75in x 50ft

DRM17013 Min. Buy 1 EA

Yellow - .75in x 75ft

DRM17213 Min. Buy 1 EA

Yellow - .75in x 100ft

DRM17313 Min. Buy 1 EA

Master Roll - .75in x 330ft - Yellow

DRM17989330 Min. Buy 1 SP



Dramm Floraplus/Vivaplus Capillary Mat

Dramm Capillary Mat delivers a safe supply of water & nutrients while reducing runoff at the same time. The matting provides optimal dispersion of solution across the growing area and vertically within the pot. For use with overhead watering to maximize water usage or for use with Dramm PCAS Drippers to deliver exact amounts of water. Dramm offers capillary mat for lower water demand and younger crops (Floraplus) or higher water demand for more mature plants (Vivaplus). Available with or without poly backing depending on bench type. Use with Dramm Aquafoil cover to keep mat clean and extend life. Contact your BFG representative with questions on sizing and type.



Dramm® ColorStorm™ Custom Hose Starter Kit

Make your own hose lengths easily and quickly with this custom hose starter kit. This kit makes it easier to get started cutting your own length of hose. The kit includes the DrammPress, this easy to use hose crimper, with one set of jaws, two spools of 330' ColorStorm Hose and 12 male and 12 female fittings with ferrules - enough to make 12 hoses.

- Sure grip technology
- Crush proof fitting
- Kink resistant
- Hot water resistant to 160 degrees F
- Bright yellow for visibility



Yellow - .625

DRM17626
Min. Buy 1 EA

Yellow - .75

DRM17750
Min. Buy 1 EA

Dramm® Jaws

Insert jaws for DrammPress.



3/4in Jaws

DRMDPJ750 Min. Buy 1 EA

Dramm® Press Hose Crimper

Insert jaws for DrammPress. Works with all Dramm ColorStorm fittings and ferrules.



.625in Jaws Only

DRMDPJ625 Min. Buy 1 EA

Dramm® Press Hose Crimper

Secures fitting/ferrule to hose end. Crimper can be fitted with either 5/8 or 3/4 jaws (sold separately). Works with all Dramm ColorStorm fittings and ferrules.



Frame Only

DRMDPFRAME Min. Buy 1 EA

Dramm® Fitting & Ferrule Set

Fitting and Ferrule set for use with the DrammPress Hose Crimper and ColorStorm Hose. Comes with (12) fittings and (12) ferrules.



0.625in Female - Includes : (12) Fittings and (12) Ferrules

DRM1017815 Min. Buy 1 PK

0.75in Female - Includes : (12) Fittings and (12) Ferrules

DRM1017825 Min. Buy 1 PK

0.625in Male - Includes : (12) Fittings and (12) Ferrules

DRM1017810 Min. Buy 1 PK

0.75in Male - Includes : (12) Fittings and (12) Ferrules

DRM1017820 Min. Buy 1 PK





NETAFIM™

GROW MORE WITH LESS



Choose more with Screenguard™ Automatic Screen Filter

Durable and versatile, offering a wide range of flow rates.



FlexNet™



Same quality and reliability you have learned to trust, now available in any custom spacing.



Fast and simple
installation & retrieval



Lightweight and
portable



Versatile



Leak-proof



Irrigation Components & Tips

Netafim™ Pressure Compensating Spray Stakes

All units stop and start at the same time. Features one directional spray. The 8in spray stake fits firmly into the media and can be angled to adjust the spray pattern according to the pot size.



3.2gph - Plum - 36in Line
NET40201-002020 Min. Buy 1 EA



Netafim™ PC Pressure Compensating Single Spray Stake

Netafim's standard single spray pressure compensating stakes are available in a variety of flow rates to match your dripper assembly. Each stake is color-coded to the match up with the corresponding Netafim® dripper assembly. Plum stakes are designed for 3.2gph dripper assemblies #40201-002020 and #40201-024700.



7in L - Plum - Single Spray - for 3.2gph Dripper Assemblies -
NET22500-002030 Min. Buy 1 EA



Netafim™ Slimline EZ Close™ Weight Assembly

One-hand, EZ close shut-off of individual baskets - prevents water and fertilizer spillage and waste. Snag-free slim design for easy retrieval from plants at harvest - no more lost weights. 94% flow uniformity from the first basket to the last in any system. Each pre-assembled SlimLine EZ Close™ Weight assemblies include: .5gph WPCJ Dripper with built-in check valve, Super Flex U.V. White™ PE tubing and weight.



Pre-Assembled - 18in L
NET40201-015402 Min. Buy 1 EA

Pre-Assembled - 24in L
NET40201-015403 Min. Buy 1 EA

Pre-Assembled - 36in L
NET40201-015405 Min. Buy 1 EA

Pre-Assembled - 48in L
NET40201-015406 Min. Buy 1 EA



Netafim™ Woodpecker Pressure Compensating Junior Dripper

Pressure compensating dripper.



0.5gph - Red - Nipple Outlet
NET21520-001040 Min. Buy 1 EA



Netafim™ Woodpecker Pressure Compensating Junior Dripper

Netafim™ Woodpecker Pressure Compensating Junior Dripper



1gph - Grey - Nipple Outlet
NET21520-001540 Min. Buy 1 EA



Netafim™ Woodpecker Pressure Compensating Junior Dripper

Pressure compensating dripper.



1gph - Black - Barbed Outlet
NET21520-001410 Min. Buy 1 EA



Netafim™ Woodpecker Pressure Compensating Junior Dripper

Pressure compensating dripper.



2gh - Green - Nipple Outlet
NET21520-001740 Min. Buy 1 EA



Netafim™ Woodpecker Pressure Compensating Junior Dripper

Features patented pressure differential system that maintains uniform flow rate at different inlet working pressures (within the recommended range) ensuring exact distribution of water and nutrients. Industry's widest flow path and wider dripper cross section allow large particles through the drippers short flow path.



2gph - Green - Barbed Outlet
NET21520-001640 Min. Buy 1 EA



Netafim™ Woodpecker Pressure Compensating Junior Dripper with Post Outlet

For use with PC Spray Stake.



3.2gph - Plum - Barbed Outlet
NET21520-001690 Min. Buy 1 EA



Netafim™ Dripper for 4-Way Assembly

The CNL feature is an internal check valve or non-draining mechanism that eliminates refill and drainage effects. Non-Pressure Compensating Drippers are designed with a barb inlet for easier installation. Features exclusive Turbonet flow path, an innovative concept that provides the dripper's with a very large water passage, allowing contaminants to pass easily through the dripper virtually eliminating clogging.



2gph - Pressure Compensating - CNL
NET21020-001510 Min. Buy 1 EA



Netafim™ Dripper Angle Barbed Stake Assembly

Pressure Compensating with CNL Check Valve Feature; Standard with Super Flex U.V. White PE Tubing. Sold in packs of 25.



0.5gph - White - 36in L - Pressure Compensating - CNL
NET40201-021000 Min. Buy 1 EA





Irrigation Components & Tips

Netafim™ NetBow Container Irrigation Ring

User-friendly, most accurate uniform water distribution with evenly spaced emitters, superior clog resistance Typhoon emitters.







- NetBow 5in**
NET77470-000004 Min. Buy 1 EA
- NetBow 5" Foldable Legs**
NET77470-000142 Min. Buy 1 EA
- NetBow 10in**
NET77470-000106 Min. Buy 1 EA

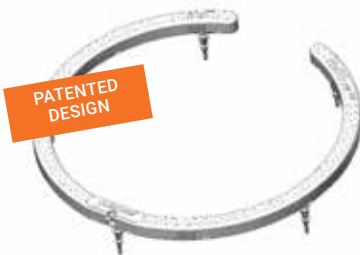

NetBow™

An innovative user-friendly container irrigation ring with multi-outlet emitters. Featuring Typhoon™, our superior clog resistant emitter for maximum water distribution. Specially designed for irrigating containerized crops.



- 
 Uniform Water Distribution
- 
 Superior Clog Resistance
- 
 User Friendly

Benefits & Features

- ✓ Superior clog resistance with Netafim Typhoon™ emitter.
- ✓ Specially designed micro-tubing with 8 evenly spaced emitters distributes water uniformly.
- ✓ Uniform surface wetting provides optimal rootzone development
- ✓ Quick action installation - place ring in the container, then connect the pre-cut micro tubing
- ✓ NetBow™ is patented by U.S. Design App. No. 29/709,373
- ✓ Multiple connection options to hub drippers: PCJ, PC, or Uniram™ with Dr. Zip™

Specs. & Recommendations

- Compatible with 5-10g (20-40L) containers
- Diameter: 10" in (250mm)
- Flow Rate: 8 emitter outlets with flow of 0.53 GPH (2.0 l/h) each at 14.5 psi (1.0 bar)
- The flow from each emitter outlet will be determined by the hub dripper, based on the pressure developed in the NetBow inlet
 - We recommend that the flow of the hub dripper to be 0.53-2.11 GPH (2-8 l/h). If your flow is out of this determined range please follow Netafim guidelines for on-line emitter design.
- Chemical and UV resistance for durability
- Colored light gray for improved light reflection
- Max. operating pressure for hub drippers - 58.0 psi (4.0 bars)

→ CONNECTION OPTIONS

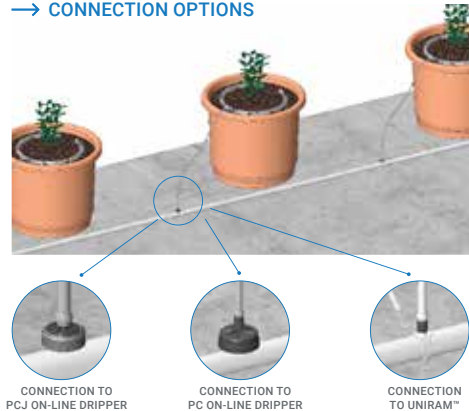

www.netafimusa.com

! WARNING: This product is not available for sale in CA. For most up to date information please visit bfgsupply.com

800-883-0234
www.bfgsupply.com



Irrigation Components & Tips

Netafim™ Multi Outlet Drinkers (MOD)

Feature both pressure compensation and a built-in check valve. This combination of features (referred to as PCNL) is the highest level of technology available in drippers today. This technology ensures that every plant will receive exactly the same amount of water and fertilizer regardless of where the plant is located within the system. Each dripper adjusts itself automatically to the system pressure and elevation so that even on rolling or sloped ground, the uniformity of watering is 94%. The built-in check valve prevents unwanted drainage of the system onto the lowest plants when the watering cycle is completed.

Manifold Versatility

When many small pots are to be watered, two manifold assemblies can be stacked together to create an 8-Way assembly. The flow per pot is then 0.25 gallons per hour (GPH).

For every 10 gallons per minute (GPM) available, 2,000 pots can be watered.

Regular set up of 4 way is preferred, requires less microtubing.

Flexible and Portable

The flat manifold separates for easy storage or transport in a box or bundle. The dripper supply tubing (with the dripper attached) can then be rolled up without tangling the spaghetti tubes. If a different plant spacing is desired, simply change the manifold.

Flat 4-Way MOD Assemblies

For complete assembly order one Manifold Assembly and one Woodpecker Pressure Compensating Junior Dripper.

Item #	Model #	Arrow Dripper	Tube Lengths	Qty	Barcode
NET40201-003200	014DM-1830F	Standard	(2) at 18in & (2) at 30in	25/pk	
NET40201-005000	014DM-4848F	Standard	(4) at 48in	25/pk	
NET40201-004400	014DM-3030F	Standard	(4) at 30in	25/pk	
NET40201-003600	014DM-2424F	Standard	(4) at 24in	25/pk	
NET40201-003800	014DM-02424FS	Short	(4) at 24in	25/pk	
NET40201-004100	014DM-2448FS	Short	(2) at 24in & (2) at 48in	25/pk	

Netafim™ Angle Barbed Stake

Netafim's spikes ensure accurately targeted irrigation. Features a barb connector at one end into which a micro-tube is securely inserted.



6in - Black

NET32000-001806 Min. Buy 1 EA

Netafim™ Mod Angle Arrow Stake

Netafim's spikes ensure accurately targeted irrigation. The Mod Angle Arrow Stake features a barb connector at one end into which a micro-tube is securely inserted.



6.375in L - Black - Mod Angle

NET22000-001320 Min. Buy 1 EA

Netafim™ Angle Arrow Dripper

Short angle arrow dripper.



Short Angle Arrow Dripper 3 3/4in

NET22000-000920 Min. Buy 1 EA

Netafim™ Slimline EZ Close Weight

Weight for hanging basket.



White

NET00130-000033 Min. Buy 1 EA

Netafim™ Non PC Spray Stake

Non-pressure compensating spray stake.



Green - 5gph - Non-Pressure Compensating

NET22500-001120 Min. Buy 1 EA





Irrigation Components & Tips

Netafim™ Insert Connector

Insert & Barb.



5mm - Barbed

NET32500-001125 Min. Buy 1 EA

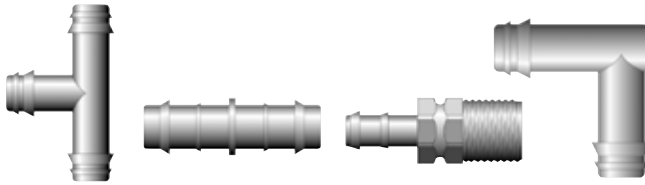
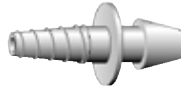

Netafim™ Insert Fittings

Dripline and polyethylene fittings.



16mm

NET32500-010720 Min. Buy 1 EA



16mm Insert Adapter .75in MIPT

NET32500-011020 Min. Buy 1 EA



16mm Insert Elbow

NET32500-012530 Min. Buy 1 EA



16mm Insert Tee

NET32500-011330 Min. Buy 1 EA

Netafim™ Inline Shut-Off Valve

Netafim's inline .520 inch plastic shut-off valve works with standard 16mm irrigation tubing.



.520in Valve - for Standard 16mm Irrigation Tubing

NET00005-008960 Min. Buy 1 EA

0.75in

NET00005-008990 Min. Buy 1 EA



Netafim™ Aqua Pro Control Valve

1-inch Series 80 Globe Control Valve with Controller.



1in - Series 80

NET71610-013969 Min. Buy 1 EA



Netafim™ Manual Disc Filter

Grooves in the disc rings crisscross to form a network that traps debris between and on the outside of the discs.



0.75in

NET70640-001200 Min. Buy 1 EA



1in

NET70641-001600 Min. Buy 1 EA



1.5in

NET70641-003420 Min. Buy 1 EA

Netafim™ Electric Valves

Simple to operate and maintain. Robust flow control stem and manual override. Reliable even in harsh conditions. Stable solenoid. Tight sealing valve with fully supported diaphragm. Integral stainless steel EasyClean® filter.



0.75in - 24V - Threaded

NET71640-007355 Min. Buy 1 EA

1in - 24V - Threaded

NET71640-007406 Min. Buy 1 EA

1.5in - 24V - Threaded

NET71640-007425 Min. Buy 1 EA



Netafim™ Meganet Sprinkler Stand

Stake adapter, female x barb connector and 1/2in FIPT.



Connects to PE or Oval tube 8mm Barb

NET64520-002305 Min. Buy 1 EA



Netafim™ Colmet Pro Fogger Head Assembly

Humidifying or cooling. 4 nozzles with check valve purple pin.



8.1gph - 60psi (Opening Pressure 28psi)

NET63100-058397 Min. Buy 1 EA





Design Help for Sprinkler & Fogger Systems

Step 1 Visualize the Greenhouse

Evaluate the location of obstacles such as curtains or hanging baskets. Consider aisles and whether they can be wetted. Review cultural practices which might impact the height at which the sprinklers should be placed.

Step 2 Select a Sprinkler Head for Watering Applications (go to Step 2b for Misting, Propagation or Cooling Applications)

All sprinkler solutions are based on an average sprinkler working pressure of 30 psi and spacing between the sprinklers of three feet.



Single Bench with VibroNet Sprinklers

Bench Width (ft)	Spacing Between Sprinklers (ft)	Height Above Crop	
		2' - 3'	3' - 5'
4	3	VN-BL or VN-GN	VN-BL or VN-GN
5	3	VN-BL or VN-GN	VN-BL or VN-GN
6	3	VN-BL or VN-GN	VN-BL or VN-GN

For multiple benches or bays, use 7', 8' or 9' between lines.

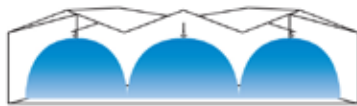

One Line for Single Bay or Quonset with SpinNet Sprinklers

Bay Width (ft)	Spacing Between Sprinklers (ft)	Height Above Crop		
		2' - 3'	4' - 5'	6' - 7'
10	3	R-R-BL	-	-
12	3	R-R-BL	R-R-BL	-
14	3	BR-BR-BL	BR-BR-BL	R-R-BL
15	3	R-R-GY	BR-BR-BL	R-R-BL
16	3	R-R-GY	BR-Y-GY	R-R-BL
18	3	R-R-GN	BR-Y-GY	BR-Y-GY
20	3	-	R-R-GN	BR-BR-GN
22	3	-	R-R-GN	BR-BR-GN
24	3	-	-	BR-BR-GN

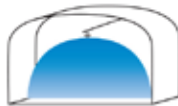

Two Line for Single Bay or Quonset with SpinNet Sprinklers

Bay Width (ft)	Spacing Between Sprinklers (ft)	Spacing Between Sprinkler Lines (ft)	Height Above Crop		
			3'	4' - 5'	6' - 7'
20	3	11	R-R-BL	-	-
22	3	12	R-R-BL	R-R-BL	-
24	3	12	R-R-BL	R-R-BL	R-R-BL
26	3	14	BR-BR-BL	R-R-BL	R-R-BL
28	3	15	BR-BR-BL	R-R-BL	R-R-BL
30	3	16	R-R-GY	R-R-GY	BR-BR-BL
32	3	17	R-R-GN	R-R-GY	BR-BR-BL
34	3	18	R-R-GN	R-R-GY	BR-BR-BL
36	3	19	R-R-GN	R-R-GY	R-R-GN
38	3	20	BR-BR-GN	R-R-GN	R-R-GN



Ordering Guide

Code	Description	Model Number	Flow* (GPH)
VN-BL	VibroNet Blue Nozzle w/Check Valve	0354040L-B	9.2
VN-GN	VibroNet Green Nozzle w/Check Valve	0354050L-B	11.7
R-R-BL	SpinNet Red Mist Control, Red Body, Blue Spinner w/Check Valve	0355120070BL-B	18.4
BR-BR-BL	SpinNet Brown Mist Control, Brown Body, Blue Spinner w/Check Valve	0355160090BL-B	23.4
R-R-GY	SpinNet Red Mist Control, Red Body, Grey Spinner w/Check Valve	03551200070L-B	18.4
BR-Y-GY	SpinNet Brown Mist Control, Yellow Body, Grey Spinner w/Check Valve	03552000090L-B	23.4
R-R-GN	SpinNet Red Mist Control, Red Body, Green Spinner w/Check Valve	03551200070GL-B	18.4
BR-BR-GN	SpinNet Brown Mist Control, Brown Body, Green Spinner w/Check Valve	03551600090GL-B	23.4

*Average flow at 32 psi.





Irrigation Components & Tips



Netafim™ SpinNet Sprinkler Head Assembly & Check Valve

SpinNet Sprinklers offer drip-less operation – the plants below are not damaged from water dripping off the sprinkler. Sprinklers hang below the supply pipe, preventing wetting of the pipe and dripping onto the plants below. SpinNet Sprinklers with Check Valve consist of a mist control, body, and spinner. The mist control determines the flow rate and eliminates misting that distorts the sprinkler pattern.



18.4gph - Red with Blue Spinner
NET64200-032030 Min. Buy 1 EA

18.4gph - Red with Green Spinner
NET64200-010805 Min. Buy 1 EA

23.4gph - Brown with Blue Spinner
NET64200-033030 Min. Buy 1 EA

23.4gph - Brown with Green Spinner
NET64200-014005 Min. Buy 1 EA

Netafim™ VibroNet Misting Sprinkler Head

Ideal for germination in nurseries and green houses, VibroNet's innovative vibration technology delivers a perfect distribution of fine droplets across the germination table - helping you achieve significantly higher germination rates and healthy seedlings.



9.2gph - Blue Nozzle - 32psi
NET64300-001010 Min. Buy 25 EA



Netafim™ Hanging Assembly for Sprinklers, Misters or Foggers

For connection to polyethylene (PE) pipe. Sold in packs of 25.



18in L
NET63000-004460 Min. Buy 1 EA

24in L
NET63000-005870 Min. Buy 1 EA

36in L
NET63000-007170 Min. Buy 1 EA

48in Extension Barb & Tube
NET63000-008461 Min. Buy 1 EA

48in L
NET63000-008361 Min. Buy 1 EA



Netafim™ Pressure Regulator

Pressure Regulators are manufactured with non-corrosive, high quality plastic and brass, that withstands all fertilizers and chemicals in common use providing years of trouble-free operation. The one-piece sealed regulating unit - different for each pressure option - is field replaceable and easy to maintain. Instant response to variations in pressure assuring that outlet pressure will remain constant.



3/4in - 35psi - Low Flow .25-4.5gpm
NET31000-001200 Min. Buy 1 EA



1.5in - 12psi - 11-35gpm
NET30520-001100 Min. Buy 1 EA



Netafim™ Shut-Off Valves Barbed

Plastic shut off for irrigation tubing.



16mm Shut-Off Valve
NET00005-008970 Min. Buy 1 EA



Netafim™ Space-It™ Dripline Fittings End Plug with Ring

Line end plug with ring.



Blue
NET32500-016490 Min. Buy 1 EA



Netafim™ Thinwall Dripline Fittings & Connectors

Space-it barb connector with grommet and shut-off valve.



0.636in
NET00115-006251 Min. Buy 1 EA



Netafim™ TWD Fittings With Blue Rings

For use with polyethylene (PE) pipe.



0.400 Barb with Grommet
NET00115-005150 Min. Buy 1 EA



WARNING: This product is not available for sale in CA. For most up to date information please visit bfgsupply.com



Irrigation Components & Tips

Netafim™ Weight

Has a shut-off feature.



Red - Plastic

NET32000-002220 Min. Buy 1 EA



Netaim ScreenGuard Filter

Most effective self-cleaning mechanism for screen filtration with various flow sizes. AV 3" Thread 120 Mesh AQTIV DCL



ScreenGuard Filter Vertical

NET71960000173 Min. Buy 1 EA

Irrigation Tubing



Netafim™ Space-It™ Dripline

Drip system for watering potted plants. It's a thinwall dripper line with pre-spaced drippers designed to be placed directly over the top of pots with the location of each dripper visibly marked on the tubing. Positioning of the pots (plants) is quick and easy - just place the pot under the mark on the dripper line - saving up to 20% in installation labor costs.



12in Spacing - 8ml - .2gph - 9,000ft per Roll

NET16424-000055 Min. Buy 1 RL

14in Spacing - 8ml - .4gph - 9,000ft per Roll

NET16424-000056 Min. Buy 1 RL

16in Spacing - 8ml - .4gph - 9,000ft per Roll

NET16424-000057 Min. Buy 1 RL

18in Spacing - 8ml - .4gph - 9,000ft per Roll

NET16424-000058 Min. Buy 1 RL

20in Spacing - 8ml - .4gph - 9,000ft per Roll

NET16424-000059 Min. Buy 1 RL

24in Spacing - 8ml - .4gph - 9,000ft per Roll

NET16424-000060 Min. Buy 1 RL



Netafim™ Tubing

Polyethylene Tubing is UV and acid resistant, made from the highest quality resins available. Together with Netafim's stringent quality controls - every reel of material undergoes a battery of tests and over 30 quality checks before leaving the factory - assuring the highest quality manufacturing standards, delivering the industry's best products. Available in black or white color, multiple diameters, and various coil lengths

Polyethylene Tubing

Black PE Tubing

Pre-Punched Tubing

White PE Tubing

UniRam

is the most advanced technology available today since its dripper design maximizes uniformity, making it the ultimate solution for subsurface applications.

Oval Tubing

Netafim Oval Tube is a durable and reliable round manifold which unrolls for easy installation and rolls up for relocation. Tubing is black in color with orange stripes. Available in 1.25", 1.5", 2", 2.5", 3" and 4".

Micro Tubing

Micro-Tubing Elevate your landscape irrigation with Netafim's micro tubing and drip irrigation tubing. UV AND ACID RESISTANT POLYETHYLENE RESIN MATERIALS Withstands hot and cold weather better than vinyl. Provides excellent hold characteristics on point source drip emitter barbed outlets and fittings in any kind of weather.

Super Flex Tubing

Super Flex UV White Polyethylene (PE) Tubing (5/3 mm)

A soft, 5/3mm tubing with improved flexibility and all the advantages of PE tubing - UV resistant, completely opaque to prevent algae growth and able to withstand heat and harsh chemicals. The 5/3mm tubing is used with all dripper and spray stake assemblies.





Contact Your BFG Sales Representative for
MORE INFORMATION

Netafim™ Tubing

Polyethylene Tubing is UV and acid resistant, made from the highest quality resins available. Together with Netafim's stringent quality controls- every reel of material undergoes a battery of tests and over 30 quality checks before leaving the factory - assuring the highest quality manufacturing standards, delivering the industry's best products. Available in black or white color, multiple diameters, and various coil lengths

Type of Tubing	Item Number	Inside Diameter	Outside Diameter	Size	Roll Length	Pre Punch Spacing Pressure Rating	Stock Code
Uniram Tubing	NET14201-000003			18mm	1000	24"	N
Uniram Tubing	NET14201-000005			18mm	1000	36"	N
Uniram Tubing	NET14201-000037			18mm	1000	18"	N
Black PE Tubing	NET19951-000013	.520"	.620"	16mm	1000		WSF
Black PE Tubing	NET19951-000022	1.06"	1.20"	1"	500		WSF
Black PE Tubing	NET19951-000025	.820"	.940"	3/4"	100		WSF
Black PE Tubing	NET19951-000048	.820"	.940"	3/4"	250		N
Black PE Tubing	NET19951-000060	.820"	.940"	3/4"	500		WSF
Black PE Tubing	NET19951-000061	.520"	.620"	16mm	500		WSF
Black PE Tubing	NET19951-000063	1.06"	1.20"	1"	100		WSF
Black PE Tubing	NET19951-000093	.520"	.620"	16mm	100		WSF
Pre-Punched Tubing	NET19953-000009	.520"	.620"	16mm	1000	12"	N
Pre-Punched Tubing	NET19953-000021	.520"	.620"	16mm	1000	18"	WSF
Pre-Punched Tubing	NET19953-000003	.520"	.620"	16mm	1000	24"	WSF
Pre-Punched Tubing	NET19953-000008	1.06"	1.20"	1"	500	36"	OA
Pre-Punched Tubing	NET19953-000024	.820"	.940"	3/4"	500	36"	OA
Pre-Punched Tubing	NET19953-000087	.520"	.620"	16mm	1000	36"	OA
Bright White PE Tubing	NET19953-000111	1.06"	1.20"	1"	500		OA
Bright White PE Tubing	NET19953-000115	.520"	.620"	16mm	1000		N
Bright White PE Tubing	NET19953-000118	.520"	.620"	16mm	500		WSF
Bright White PE Tubing	NET19953-000132	.820"	.940"	3/4"	1000		N
Bright White PE Tubing	NET19953-000134	.820"	.940"	3/4"	500		N
Oval Tubing	NET19953-000177			1-1/2"	350	42 PSI	OA
Oval Tubing	NET19953-000179			2"	250	43 PSI	N
Oval Tubing	NET19953-000183			1"	660	44 PSI	N
Micro Tubing	NET40001-001980			5/3mm	1000		N
Super Flex Tubing	NET40005-000100			5/3mm	1000		WSF



GREENHOUSE CULTIVATION

PRECISION ROCKWOOL APPLICATIONS

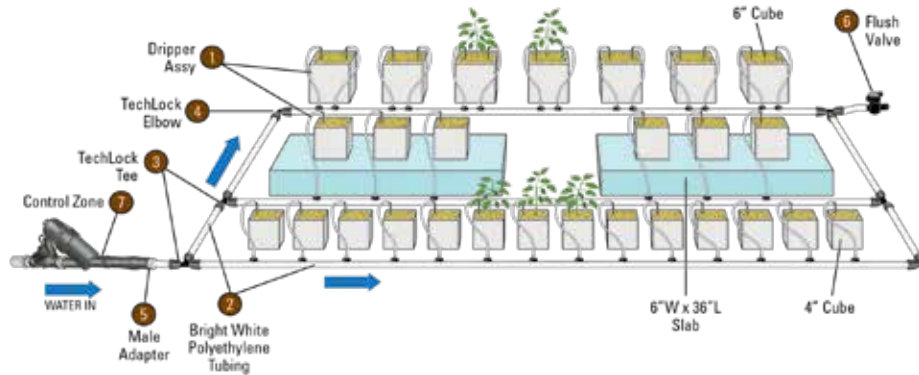

Model Number	Description	Quantity Needed
01WPCJL1.2AW-30	1200 ML/HR Dripper Stake Assembly, 25 Per Bundle	1 PER 4in AND SMALLER CUBES 2 PER 6in AND LARGER CUBES 3 PER 39in LONG SLAB
14BW056066-05	17MM Bright White UV Polyethylene Tubing, 500ft Roll	EITHER 1 RUN PER ROW OF PLANTS OR 1 RUN DOWN THE CENTER OF EVERY 2 ROWS OF PLANTS DOWN THE TABLE/TRAY
TLCKTEE	17MM TechLock Tee (25 per bag)	AS NEEDED
TLCKELL	17MM TechLock Elbow (25 per bag)	AS NEEDED
TLCK075MA	3/4in MPT x 17MM TechLock Male Adapter (25 per bag)	AS NEEDED
58ISV600	17MM Barbed Line Flush Valve (25 per bag)	1 AT THE END OF EVERY PE LINE OR AT THE END OF A TABLE MANIFOLDED TOGETHER AS SHOW IN DIAGRAM ABOVE
LVCZS8010075-LF	Control Zone: Zone Valve, Filter, Pressure Regulator Pre-Assembled, 1 Per Zone upto 4.4 GPM	1 CAN BE USED FOR UP TO 800 OF THE 1200 ML/HR DRIPPERS

Grodan Product	Substrate Volume (L)	Recommended Irrigation Volume (ML)	Number of Drippers Per Cube/Slab	Runtime to Achieve Recommended Irrigation Volume
MM50	0.10	3.00	1	9 Seconds
Small 3in (D4)	0.37	10.97	1	33 Seconds
Large 3in (D5.6)	0.56	16.88	1	50 Seconds
Small 4in (D6.5)	0.65	19.50	1	1 Minute
Medium 4in (D8)	0.80	24.00	1	1 Minute 12 Seconds
Large 4in (D10)	1.00	30.00	1	1 Minute 30 Seconds
Jumbo	2.36	70.80	2	1 Minute 47 Seconds
Hugo	3.38	101.25	2	2 Minutes 32 Seconds
MAMA	8.00	240.00	2	6 Minutes
Uni-Slab 6in	4.80	144.00	3	2 Minutes 24 Seconds
Gro-Slab 6in	10.13	303.75	3	5 Minutes
Gro-Slab 6in FAT	13.50	405.00	3	6 Minutes 45 Seconds
Gro-Slab 8in	13.50	405.00	5	4 Minutes
Gro-Slab 12in	20.25	607.50	5	6 Minutes





Other Irrigation

Amiad® Ball Valve Shut Off

Controls water flow in the irrigation system. Can be used in a variety of systems.



.75in - Blue

AMIAD8-1000-0101 Min. Buy 1 EA



Amiad® Scanaway Filter

Semi-automatic filter eliminates the need for turning off the water and extracting the filter screen for rinsing. Provides low pressure loss with no interruption of the process water flow during cleaning. Fitted with a clogging indicator.



2in - 155 Mesh - 100 micron - Yellow

AMIAD30002000025 Min. Buy 1 EA



Other Irrigation

Grower Select® Aluminum Casing

This product is used by inserting 3/4 inch polyethylene irrigation tubing into the casing for mounting in your greenhouse structure to allow for a clean and straight run.



3/4in x 100ft

GSS13695 100IN Min. Buy 1 PC

1in x 100in

GSS13692 Min. Buy 1 PC



Irrigation Components & Tips

Grower Select® Round Galvanized Tubing Support Rails

Components to be used for greenhouse structures or for benching. Many sizes to choose from to create the layout of your choice.



17ga - 1.315in x 120in

GSB08630 Min. Buy 1 EA

17ga - 1.315in x 126in

GRFSB08630 Min. Buy 1 EA

17ga - 1.315in x 180in

GSB08650 Min. Buy 1 EA



Grower Select® Square Galvanized Tubing

Components to be used for greenhouse structures or for benching. Many sizes to choose from to create the layout of your choice.



16ga - 1in x 48in

GSB07650 Min. Buy 1 EA

16ga - 1in x 96in

GSB07720 Min. Buy 1 EA

14ga - 1.25in x 60in

GSB07810 Min. Buy 1 EA

14ga - 1.25in x 168in

GSB07855 Min. Buy 1 EA



! WARNING: This product is not available for sale in CA. For most up to date information please visit bfgsupply.com

800-883-0234
www.bfgsupply.com



Irrigation Components & Tips

Jain Chapin On/Off Tube Weight Assembly

Ideal tubing for all your pot irrigation applications. The slender design makes it easy to pull in and out of pots, you can even remove the pots allowing the weight to remain without damaging the plants. The twist-on / twist-off action makes it easy to turn the weights on and off without kinking or damaging the tubing.



100pk - 36in - .060 Inside Diam - 128x060-PE Tubing

JAIN12771236

Min. Buy 1 EA

Jain Compression Series 600 x Swivel Adapter with screen

Historically one of the more popular emitterline fitting options, compression fittings are a quick, low cost alternative to a locking fitting. Jain compression fittings come with easy to reference color coded inserts to assist in determining size on an already installed system.



3/4in F Hose

JAIN12010232

Min. Buy 1 EA

Jain Low Pressure Female LPD



Low pressure LPD

JAIN11990308

Min. Buy 1 EA

Jain Dan Mini Sprinkler

Manufactured from good quality virgin raw material, easy to install, reliable performance, interchangeability of nozzle and good application efficiency. Includes LPD (leak prevention device).



Black-Green with LPD

JAIN16119200

Min. Buy 1EA



Yellow-Green with LPD

JAIN16179200

Min. Buy 1 EA



Green Kiwi-Orange with LPD

JAIN16159500

Min. Buy 1EA



Other Irrigation

Phytotronics® Capmat™II Capillary Matting

An economical yet highly efficient method to evenly water potted plants. Using an absorbent, resilient spunbond fabric, Capmat™ II Capillary Matting wicks water rapidly to the roots of the plant by capillary action. Besides saving time by watering all your plants at the turn of a valve, sensitive or delicate foliage is not spotted by overhead watering.



4ft x 100ft

PHT7000

Min. Buy 1 EA



Phytotronics® Hi-Hose Watering System

The Hi-Hose Watering System is a simple, efficient way to remove the drudgery of dragging a hose over paths and around plants. Includes hoses and all cable and fittings.



50ft System with 65ft 5/8in hose

PHT6320

Min. Buy 1 EA



75ft System with 90ft 5/8in hose

PHT6322

Min. Buy 1 EA



Irrigation Components & Tips

Senninger[®] Upright/Inverted T-Spray[™]

Gold T-Stem - Flow Range 0.98 - 1.63gpm - Pressure Range 15 - 40psi - Coverage Area 17.5-22ft (at 3ft in height) - Pattern Spacing Up to 10ft - Connection 1/2in NPT (M)



300/cs

SENNTPRAYNOZZLE6

Min. Buy 1 EA







Irrigation Components & Tips

Senninger[®] Pressure Regulators

Uncontrolled pressure fluctuations into emission devices result in unwanted flow deviations and lower distribution uniformities. Common causes of pressure variation include changes in system demand and/or water supply and friction loss through pipe and fittings. Proper use of pressure regulators helps maintain the overall efficiency of an irrigation system and sprinkler performance.

- Above or below ground installation
- Maintains a constant preset outlet pressure with varying inlet pressures
- Withstands severe water hammer
- Low hysteresis and friction loss
- Maximum flow path resists plugging
- 100% pressure tested for accuracy (no adjustments ever needed)









Item #	Flow Range	Preset Operating Pressure	Max Inlet Pressure	Inlet Size NPT (F)	Outlet Size NPT (F)	Flow	Barcode
SENNPRL123F3F	0.1 - 8GPM	12PSI	90PSI	3/4in	3/4in	Low	
SENNPMR15MF	2-20GPM	15PSI	95PSI	3/4in	3/4in	Mid	
SENNPRL203F3F	0.1 - 8GPM	20PSI	100PSI	3/4in	3/4in	Low	
SENNPMR40MF	2 - 20GPM	40PSI	120PSI	1in BSPT	1in BSPT	Mid	

Senninger[®] Sprinklers

The Senninger mini-Wobbler[™] employs a unique off-center rotary-action as the standard Wobbler[®]. It provides instantaneous and extremely uniform coverage over a large diameter at low pressures. Creates droplets resistant to wind-drift and evaporation and is constructed entirely of engineering-grade thermoplastics for excellent corrosion resistance.

- Low evaporative loss
- Multi-level throw, approximate angle: 0° inverted, 10° upright
- Color-coded nozzles for easy size identification
- Flow rates: 0.42 to 2.18GPM
- Operating pressures: 15 to 25PSI
- Standard inlet: 1/2in NPT male



Item #	Model Type	Nozzle Color/Size	Flow Range	Pressure Range	Diameters of Coverage	Pattern Spacing	Connection	Barcode
SENNWOB08M200	Upright	Lavender #8 1/2in	1.67-2.18GPM	15-25PSI	41.5-43ft	Up to 20ft	1/2in M NPT	
SENNWOB06M250	Inverted	Gold #6 - 3/32in	1.10-1.25GPM	20-25PSI	31-31.4ft	Up to 12ft	1/2in M NPT	
SENNWOB08M250	Inverted	Lavender #8 - 1/8in	1.95-2.18GPM	20-25PSI	31.5-32ft	Up to 12ft	1/2in M NPT	
SENNWOB06M200	Upright	Gold #6 - 3/32in	0.95-1.25GPM	15-25PSI	39.5-42ft	Up to 20ft	1/2in M NPT	
SENNWOB04M200	Upright	Light Blue #4 - 1/16in	0.42-0.56GPM	15-25PSI	31-34ft	Up to 20ft	1/2in M NPT	
SENNMINIWOBBLER	Inverted	Beige Nozzle #5	0.75-0.84GPM	20-25PSI	30-31ft	Up to 20ft	1/2in M NPT	

Senninger[®] Drain Stop Plus[™]

Innovative three-in-one design. The multiple functions of Senninger's Drain Stop Plus make it an excellent choice for overhead irrigation! Specially designed for overhead irrigation to prevent draining from applicators when system is shut down. Protects plants beneath applicators from damage due to overwatering. Allows lines to remain full to help expedite system start-up time. Twist dial to select: Check-Open-Closed. Easy-clean feature for debris removal. High-impact, engineering-grade thermoplastic construction for durability.



0.25-5gpm - Minimum Opening Pressure 22psi - Minimum Closing Pressure 6.5psi - Connection 1/2in NPT (M) x 1/2in NPT (F) 200/cs

SENNDSP2M2F

Min. Buy 1 EA



WARNING: This product is not available for sale in CA. For most up to date information please visit bfgsupply.com



Reduce water consumption



Faster plant growth



Labor savings

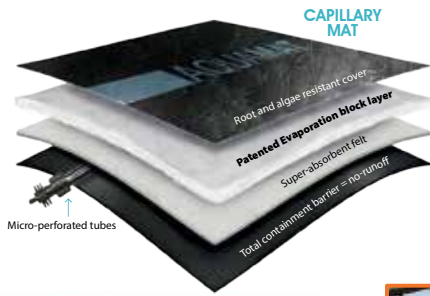

«Aquamat® has been a great tool for us: labor and water savings, less foliar diseases and flower damages, less shrinkage while having a consistent crop and a faster growth.»

Rob Swanekamp
V.P. Sales and Production
Kube-Pak Growers
Allentown NJ

aquamatsystem.com

Contact Your BFG Sales Representative for **MORE INFORMATION**



Conservation Systems

FOGCO products are becoming standard equipment for all greenhouse applications. FOGCO has become an industry leader in humidification and cooling by developing innovative products to meet environmental needs.

Fog systems are proven to positively impact growing operations by regulating the temperature, humidity, and moisture content within the greenhouse. Fog systems are ideal for addressing and correcting the problems associated with high temperatures and/or low humidity levels. This promotes increased health and productivity within the greenhouse by eliminating plant water stress, one of the most significant factors in the growth of all plants. Plants lose their moisture through evaporation from the leaves. They also gather carbon needed for growth in the form of carbon dioxide through the leaves. By controlling the plants' pores through the use of a properly designed fog system, the results are stronger and healthier plants with optimum growth potential. Fog systems can also be used to introduce fertilizers by injecting nutrients directly into the atmosphere. The moisture and the nutrients are absorbed by the leaves of the plant.

Features:

- Revolution Fan system provides 360 degree fog distribution.
- Ensures proper humidity levels.
- Reduces demand for moisture.
- Maintains favorable conditions.
- Creates in-house propagation stock.
- Reduces need for shading/whitewashing.
- Reduces irrigation/water consumption.



Odor Control

FOGCO has teamed up with Cannabusters to develop and deliver the industry's first 24/7 monitoring, reporting, and self-adjusting system. Independently tested and proven at 98.7% efficacy, odor concerns are now a thing of the past. FOGCO offers custom designs and solutions from large scale commercial greenhouses to hobby houses and any size or type of application in between.

Features:

- Odorless odor control technology - no additional VOCs or residual oils/smells like other systems that use enzymes or fragrances for masking.
- Nontoxic, environmentally friendly, no contamination impact.
- Designated as best available control technologies (BACT) by a professional engineer and certified industrial hygienist.



Crop Level Airflow™

FOGCO has reengineered horizontal airflow technology to improve plant health while reducing energy costs by up to 70%. The Snap-Fan EC20 Max is a variable speed fan specifically designed to provide the proper air speed at the plant's stomata resulting in increased CO2 uptake and photosynthesis.

Features:

- 4370 thrust CFM **** Tested at BESS Lab.
- 220% wider air cone at 40' compared to industry leading HAF.
- Brushless electronically commutated (EC) Motor.
- IP 54 water resistant.
- Discrete or variable speed.
- Patented mounting system reduces vibration and noise.
- Made in USA.



Creating more with less.

Less water and nutrients.



Grodan[®]

Learn the practice of precision irrigation
and grow sustainably at [Grodan101.com](https://www.grodan101.com)

Disclaimer: Neither Grodan nor its employees are cultivators or manufacturers of cannabis. Neither Grodan nor its employees advocate for or encourage the cultivation of marijuana. Grodan and its employees shall only engage with those state-licensed or state-approved marijuana businesses who maintain active licenses and constant compliance with the respective state and local licensing authorities.



EQUIPMENT & SUPPLIES



GrowerSelect®

Greenhouse Ventilation

Grower Select® Convection Tubes

The convection tube is a polyethylene tube that runs the length of the house and forces air through holes spaced along the tube. This system is best suited for houses that have a lot of obstructions. Convection tube systems can be designed for a number of different uses.

Cooling/Air Circulation

Fan and shutter kits allow outside air to be introduced into the greenhouse environment and distributed evenly throughout the house. They can also be used with the fan alone to provide air movement throughout the house instead of HAF fans.

Heating

Heat Kits allow use of gas fired, electric, steam or hot water unit heaters without outside air passing through the heat exchanger. These kits use a fan system to attach to the convection tube and allow heated air from a heat source to be forced down the length of the house through the tube.

Our convection tube is available in standard stock diameters of 18in, 24in and 30in x 100ft punched. Our 4 mil UV-inhibited clear polyethylene tubing is engineered for uniform distribution and proper mixing of air to produce the best aerodynamic effect in the greenhouse. All of our convection tube is made from a UV stabilized greenhouse film.

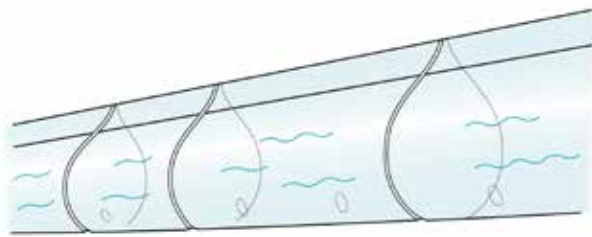

Standard Punch



18in x 100ft with Standard Punch
GS22-9077 Min. Buy 1 EA

24in x 100ft with Standard Punch
GS22-9083 Min. Buy 1 EA

30in x 100ft with Standard Punch
GS22-9089 Min. Buy 1 EA

Unpunched



18in x 1500ft
WA22-9080 Min. Buy 1ea

24in x 1500ft Unpunched
WA22-9084A Min. Buy 1ea

30in x 1500ft Unpunched
WA22-9090 Min. Buy 1ea

Custom Punching Options

Please specify the length and punching pattern and we'll figure your hole size and hole spacing. Please allow 7-10 days for delivery on custom punched rolls.

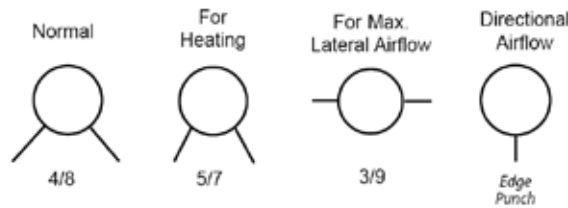

Custom Punch



18in Custom Punch
GS22-9076 Min. Buy 1 EA

24in Custom Cut
GS22-9082 Min. Buy 1 EA

30in Custom Cut
GS22-9088 Min. Buy 1 EA



Green-tek

Greenhouse Ventilation

Green-Tek® High-Performance HAF Fan

Great performance, energy efficiency and an air pattern that is designed for heat de-stratification. The OSHA approved guard means the fan can be mounted at any height. The totally enclosed air over motor can be used in the harshest greenhouse environments. GT HAF Fans are easy to install and will give years of trouble free service. The ideal spacing is every 50'. Comes with a 9ft cord.



12in - with 9ft Cord

GRTKHVB12110C Min. Buy 1 EA

20in - 1/10HP - 9ft Cord

GRTKHAF20110C Min. Buy 1 EA



Greenhouse Ventilation

ACME Ventilation Motorized Shutter

Shutter motor for single and double panel shutter. Includes motor, mounting bracket, cam assembly, retainer spring and hardware.



Model #316675C

ACME316675C Min. Buy 1 EA

ACME Ventilation Motorized Shutter

This shutter/damper motor #697470C and spring set is designed for use with both single and double panel shutters. This set replaces ACMEMKCAM Motor Only 1 and ACME697474.

Fits both single and double panel shutters.

Replaces ACMEMKCAM MOTOR ONLY 1 and ACME697474



Model #697470C - for Use with Single or Double Shutters

ACME697470C Min. Buy 1 EA



DRAMM

Greenhouse Ventilation

Dramm® AME Horizontal Air Flow System

The Dramm AME Horizontal Air Flow (HAF) Fans offer efficiency, flexibility, and simplicity. Utilizing an aerodynamic design and a high-efficiency motor, the AME fan is equipped to maximize the air flow potential of any situation. When combined with speed controllers, the AME Fans offer unmatched flexibility in air flow as plants grow and mature.



350mm

DRM350 Min. Buy 1 EA

400mm

DRM400 Min. Buy 1 EA

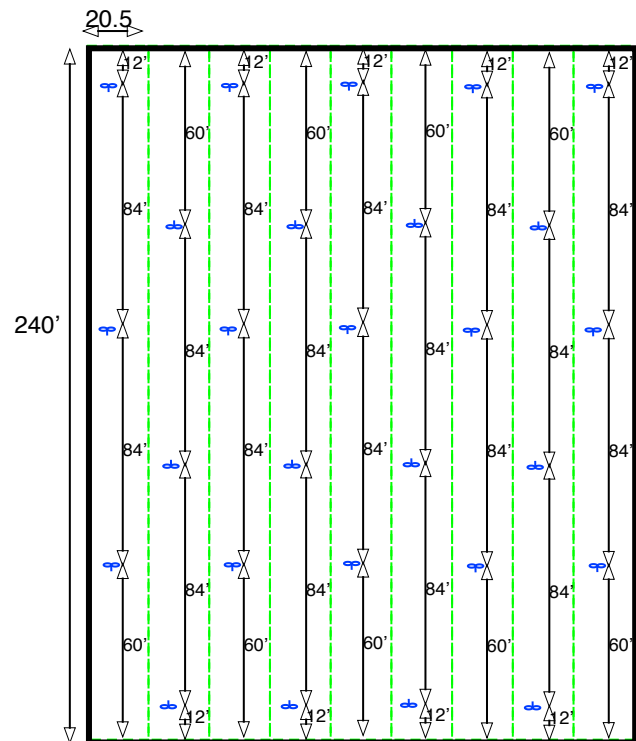



Greenhouse Ventilation

Schaefer® Versa-Kool® H.A.F. Barrel Fan

Increase safety and productivity with Versa-Kool circulation fans. The patented guard design allows for greater air movement at very low noise levels. Improve air quality and working conditions by strategically placing Versa-Kool circulation fans using optional wall or ceiling mounts. The airflow ranges from gentle to powerful and the fans have the variable speed capability which allows you to select a perfect airflow pattern.

- Available in 8in to 24in diameters
- Extremely rugged guards and housings for long life
- Guard spacing and engineered blades result in greater air movement at lower noise levels
- Depth of front guard makes fan extremely safe, but not OSHA compliant if mounted below seven feet.
- Guards are powder coated over steel for corrosion resistance.
- Heavy-duty totally enclosed, maintenance free North American motors.
- Two-year limited warranty.



**12in Diam / 1.3/.65 Amps @
115/230 Volts 60hz
SVEVK12**

Min. Buy 1ea



**20in Diam / 3.8/1.9 Amps @
115/230 Volts 60hz
SVEVK20**

Min. Buy 1ea



**8in Diam - 1550 Max RPM - <1000 CFM Range - 0.6 Nameplate
Amps -3 Wings -1/100 Hp -8lb -Single Speed -60Hz -115 Volts
SVEVK8**

Min. Buy 1 EA

Typical Schaefer VK12 Pattern

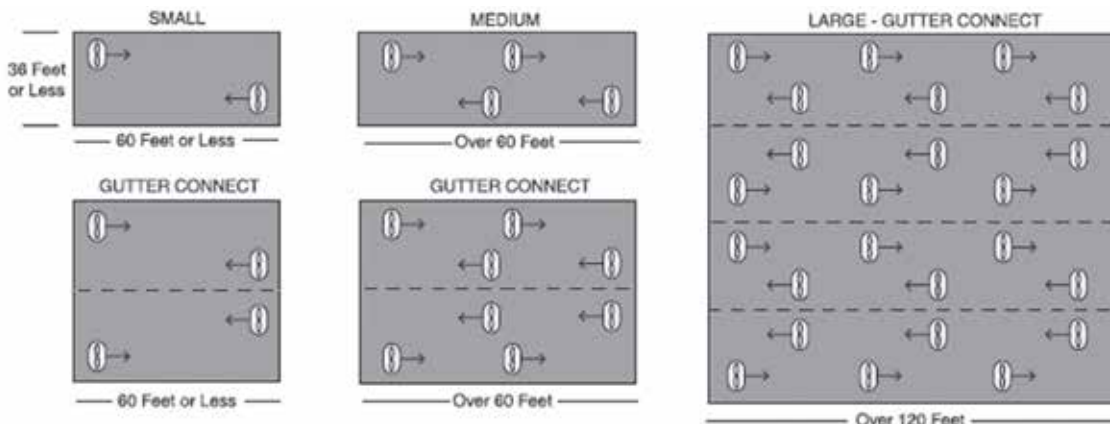

Schaefer® Shade Pole Inflation Blower

Shaded pole inflation blowers have forward curved wheels and energy efficient, open drip proof motors. These blowers are frequently used for inflating air between two layers of greenhouse polyethylene to provide better insulation.

Large Inflation



**148CFM - For Greenhouses Larger than 30x100
SVEB148**

Min. Buy 1ea



**148CFM - For Greenhouses Larger than 30x100
SVEB148-E**

Min. Buy 1ea

Small Inflation



**60CFM - For Greenhouses Less than 30x100
SVEB60**

Min. Buy 1ea



**60CFM - For Greenhouses Less than 30x100
SVEB60-E**

Min. Buy 1ea





Greenhouse Ventilation

Schaefer® Versa-Kool® High Efficiency Circulation Fan

The same legendary fans you are used to, now featuring the latest in motor efficiency technology. Multiple fans can easily be controlled via the 0-10 VDC control wire connection. Permanent magnet, electronically commutated motor for maximum energy savings. Which means higher efficiency, lower noise level, and less heat generation.



20in Diam - 4.4/2.8-2.4 Amp @ 115/208-277 Volts 60/50hz - High Efficiency
SVEK20HE Min. Buy 1 EA

24in Diam - 6.7/4.1-3.4 Amp @ 115/208-277 Volts 60/50 hz - High Efficiency
SVEK24HE Min. Buy 1 EA



Schaefer® Belt Drive Galvanized Box Fan

Maintain a safe and productive work environment by exchanging hot or contaminated air using Schaefer low cost galvanized, box exhaust fans. These low cost, high volume exhaust fans are protected from the elements with outlet side aluminum shutters and mount in walls of almost any thickness, typically with the outlet shutter flush, or nearly flush with the outside wall.



54in Diam Exhaust Fan - 6-5.8/2.9 Amp @208-230/460 Volt 60/50hz - 3 Phase - 5 Wings - Light Trap Capable - Partially Assembled
545B2G-3-LT-PA Min. Buy 1 EA



Schaefer® Galvanized Slantwall Exhaust Fan

First choice of growers and other building owners looking for very low cost, high volume exhaust fans that flush-mount from inside the building and shed water and snow, once installed. Designed for high airflow and high efficiency and available in many sizes and configurations to meet application requirements. Fans ship fully assembled.



48in Diam - 8.4/4.2 Amps @ 115/230 Volts 60/50hz - Phase 1 - 5 Wings
SVE48551 Min. Buy 1 EA



Schaefer® Aluminum Shutter

Allow airflow in a single direction and are used as building air inlets to feed exhaust fans, or on exhaust fans to prevent air entry when the fan is not operating. Aluminum shutters are built tough for long life in the most demanding environments, all at an affordable price. Constructed of heavy-duty brushed aluminum for corrosion resistance and greater durability.



60.5in W x 61in H
SVEWS-600 Min. Buy 1 EA



Schaefer® Large Shutter Motor

For use with Schaefer shutters over 48 inch.



For Shutter Over 48 in
SVESHUTTERMOTOR-LG Min. Buy 1 EA



Greenhouse Ventilation

J&D Mfg. Destratification Fan

The JD360 is an effective destratification fan that mixes the heavy, cool, dense air that is sunk to ground level with the warm, light, thin air that lingers toward the top of your facility. This provides a comfortable and uniform healthy environment from the top of the peaks to the ground of your house. It's the perfect vertical, low-air-speed circulator.

3 Year Warranty
 3 Hanging Options
 Single Speed



18in
JDMJD360 Min. Buy 1 EA



Greenhouse Meters & Test Kits

Thermostat 1 Stage Heat Cool

Our broad range of sensors and manual/automatic controls allow dairymen, greenhouse operators, plant managers and others to control fans and heaters and optimize thermal comfort in their facilities.



Thermostat 1Stage Heat Cool SPDT 30 110F NEMA4X 16 12A at 120 240V
SVETP518 Min. Buy 1 EA



! WARNING: This product is not available for sale in CA. For most up to date information please visit bfgsupply.com

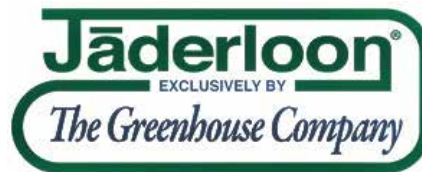

Greenhouse Ventilation

Horizontal Air Flow Fan

BioTherm's BAF line aims to bring reliability and energy-efficiency into one convenient package. Coming standard with EC motor technology, the BAF series can be integrated into your current environmental control system and can vary speeds based on sensory input.



14in
BTFANGAF14 Min. Buy 1 EA

20in
BTFANGAF20 Min. Buy 1 EA



Craft TOOB Oxygen Infuser

The BioTherm TOOB is a revolutionary, efficient method of increasing the dissolved oxygen (DO) content of irrigation water, significantly improving plant health, yield, and productivity.



2ft dissolved oxygen infuser
BTO2TOOB Min. Buy 1 EA



Vertical Air Flow Fan

BioTherm's BRV-220 is the counterpoint to the BAG series -- it allows for a destratification approach to air circulation. Instead of shooting air linearly through a grow space, it pulls air upwards and broadcasts it downward long the roof and sidewalls of your greenhouse. BRV-220 also comes standard with EC motor tech.



20in - 220V
BTFANGRV220 Min. Buy 1 EA



Greenhouse Ventilation

Jaderloon® Inflation Blower Mounting Bracket

Large square inflation blower bracket with deflector. Blower sold separately.



For 148CFM Blowers
JA4PN0035 Min. Buy 1 EA



Jaderloon® Inflation Blower Mounting Bracket

Small inflation blower bracket with deflector. Blower sold separately.



For 60CFM Blower
JA4PN0030 Min. Buy 1 EA



Jaderloon® Jumper Hose

Jumper kits are designed to pass pressure from one section of double poly to an adjoining section. Ideal for inflating sides and endwalls.



36in
JA4PN0024 Min. Buy 1 EA





Greenhouse Ventilation

Contact Your BFG Sales Representative to
ORDER TODAY

Fans ship fully assembled with aluminum inlet shutters and PVC coated outlet guards



Coolair MAL Aluminum Slantwall Exhaust Fans

Coolair's all aluminum exhaust fans are the best option for growers looking for decades of low maintenance use.

- Available in sizes 24" through 54".
- Available motor options from .25HP to 1.5HP.
- MAL fan is capable of ventilating structures big or small.
- C-Drive belt drive system centers belt forces directly over the bearings for industry leading bearing life.

Coolair PVC Evaporative Cooling Systems

- Available in lengths from 5' to 110' and heights from 3' to 6'.
- Perfect for cooling incoming air by over 25 degrees, when properly ventilated with Coolair exhaust fans.
- Systems up to 70' in length incorporate self-contained submersible pumps to reduce leaks.





Greenhouse Heaters

Modine Effinity™ High Efficiency Heater

At 93-97% thermal efficiency, the Effinity® condensing unit heater features one of the highest efficiency available in North America for commercial and industrial, as well as residentially certified (sizes 110 and smaller) gas-fired unit heaters. This industry leading efficiency is a result of coupling Conservicore® secondary heat exchanger technology with a robust tubular primary heat exchanger design. The technology features a secondary recuperative heat exchanger fabricated from AL29-4C® stainless steel. Designed with aluminized steel heat exchanger/burner, direct spark ignition, 115V/60Hz/1 phase power and natural gas, single stage.

	PTC Model Sizes									
	55 ³	65 ³	85 ³	110 ³	135	156	180	215	260	310
BTU/Hr Input¹	55,000	65,000	85,000	110,000	135,000	155,000	180,000	215,000	260,000	310,000
BTU/Hr Output¹	51,150	60,450	79,050	102,300	125,550	144,150	167,400	199,950	241,800	288,300
Condensate Production (Gal/Hr)	0.3	0.4	0.5	0.7	1.0	1.1	1.3	1.6	1.9	2.3
Entering Airflow (CFM) @ 70°F²	1097	1141	1650	1750	2160	2600	3020	3865	4585	5400
Air Temp Rise (°F)	43	49	44	54	54	51	51	48	49	49
Max. Mounting Height (ft)²	12	12	13	13	14	18	15	17	20	19
Heat Throw (ft) @ Max. Mtg. Height	43	43	48	46	51	62	53	60	70	67

- 1 - Ratings shown are for elevations up to 2,000ft. For elevations above 2,000ft, ratings should be reduced at the rate of 4% for each 1,000ft above sea level. Reduction of ratings requires use of a high altitude kit.
- 2 - Data taken at 65°F ambient and unit fired at full-rated input. Mounting height as measured from bottom of unit, and without deflector hoods
- 3 - Also certified for residential installations.



Natural Gas - 310,000 Btu/Hour Input

MODINPTC310AS-0111 Min. Buy 1ea

310,000 Btu/Hour Input

MODINPTC310AS-0121 Min. Buy 1ea

Corrosion-resistant Conservicore™

Contractor Convenience Package for easier installation and troubleshooting

Quick connection for combustion air

Quick connection for PVC-vented exhaust air

Condensate drain

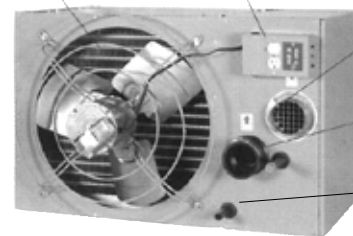

Modine Effinity® Blower Units are Now Available!

Built on the same successful platform as the Model PTC, these models include the same great features with the application flexibility of a blower unit heater.

Exclusive Conservicore™ Technology

Designed specifically for the highly corrosive environments found in greenhouses, Modine's Conservicore technology features a high-grade stainless steel secondary heat exchanger built to withstand acidic condensate. The result? Significantly longer heater life when compared to competitive units built with aluminum secondary exchangers.

The Effinity⁹³ condensing unit heater utilizes a bent tube heat exchanger and is ready for quick PVC pipe connections.

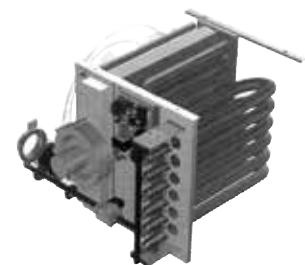



Greenhouse Heaters

Modine Low Profile Heater

The Hot Dawg® heater is efficient and economical and can be used in parking lot houses, potting rooms, garages and even warehouses. May be installed just one inch below the ceiling. Features: 82% thermal efficiency, quick, easy install with knockouts for access to gas and electricity, power vented propeller, standard power exhauster allows the unit to be vented vertically or horizontally.



Natural Gas - 125,000 BTU/Hour Input
MODINHD125SS-0111 Min. Buy 1 EA

Modine Power Vented Propeller Heater

This power vented propeller heater is inexpensive to install, easy to use and offers excellent in-service economy. Features include: thermal efficiency of 83%, power exhaust that can be rotated 180 degrees, 100% shut-off, intermittent pilot-ignition system with continuous retry and a safety pressure switch to assure safe venting conditions.

115V/60Hz/1 Phase Power & 115V/24V IPI 1 Stage Natural Gas



Natural Gas - 150,000 BTU/Hour Input
MODINPDP150AE0130 Min. Buy 1ea

200,000 Btu/Hour Input
MODINPDP200AE0130 Min. Buy 1ea

Natural Gas - 250,000 BTU/Hour Input
MODINPDP250AE0130 Min. Buy 1ea

Propane Gas - 250,000 BTU/Hour Input
MODINPDP250AE0185 Min. Buy 1ea

Natural Gas - 300,000 BTU/Hour Input
MODINPDP300AE0130 Min. Buy 1ea



	HD Model Sizes						PDP Model Sizes						
	30	45	60	75	100	125	150	175	200	250	300	350	400
BTU/Hr Input¹	30,000	45,000	60,000	75,000	100,000	125,000	150,000	175,000	200,000	250,000	300,000	350,000	400,000
BTU/Hr Output¹	24,600	36,900	49,200	61,500	82,000	102,500	124,500	145,250	166,000	207,500	249,000	290,500	332,000
Entering Airflow (CFM) @ 70°F²	505	720	990	1160	1490	1980	2180	2550	2870	3700	4460	4870	5440
Air Temp Rise (°F)	44	46	45	48	50	47	51	51	52	50	50	53	54
Max. Mounting Height (ft)²	10	10	12	14	12	16	16	17	15	19	21	20	19
Heat Throw (ft) @ Max. Mtg. Height	25	27	36	38	42	56	55	59	51	67	74	70	69

Modine Tubular Natural Gas Heater

Well suited to greenhouse applications with its corrosion resistant heat exchanger but can still perform well other environments. Tubular heat exchanger design. Stainless steel heat exchanger protected by a full 10-year warranty. Electric knockouts. Permanently lubricated motor. Power venting system. Baked polyester paint, providing excellent corrosion resistance and durability.



Natural Gas - 150,000 BTU/Hour Input
MODINPTP150SS-0111 Min. Buy 1ea

Natural Gas - 175,000 BTU/Hour Input
MODINPTP175SS-0111 Min. Buy 1ea

Natural Gas - 200,000 BTU/Hour Input
MODINPTP200SS-0111 Min. Buy 1ea

LP Gas - 200,000 BTU/Hour Input
MODINPTP200SS-0121 Min. Buy 1ea

Natural Gas - 250,000 BTU/Hour Input
MODINPTP250SS-0111 Min. Buy 1ea

LP Gas - 250,000 BTU/Hour Input
MODINPTP250SS-0121 Min. Buy 1ea

Natural Gas - 300,000 BTU/Hour Input
MODINPTP300SS-0111 Min. Buy 1ea

LP Gas - 300,000 BTU/Hour Input
MODINPTP300SS-0121 Min. Buy 1ea

Natural Gas - 350,000 BTU/Hour Input
MODINPTP350SS-0111 Min. Buy 1ea

Natural Gas - 400,000 BTU/Hour Input
MODINPTP400SS-0111 Min. Buy 1ea



	PTP Model Sizes						
	150	175	200	250	300	350	400
BTU/Hr Input¹	150,000	175,000	200,000	250,000	300,000	350,000	400,000
BTU/Hr Output¹	123,000	143,500	164,000	205,000	246,000	287,000	328,000
Entering Airflow (CFM) @ 70°F²	2140	2725	2870	3995	4545	5280	5995
Air Temp Rise (°F)	53	48	52	47	50	50	51
Max. Mounting Height (ft)²	15	14	15	18	19	18	21
Heat Throw (ft) @ Max. Mtg. Height	51	50	53	62	69	65	74



WARNING: This product is not available for sale in CA. For most up to date information please visit bfgsupply.com



Greenhouse Heaters

Siebring Mfg Quantum Gas Heater

All controls are wired for installation. Alumina-Silica Refractor. Lightweight design offers versatile mounting options (ceiling or floor). Designed to work with a horizontal air flow pattern in large buildings. High fuel efficiency.



Model QT180 - 180,000 BTU / Natural Gas / 3.5in W.C. / 36in W x 41in L x 50in H / 1/3hp Motor / 24in Prop

SMKQT180 NG Min. Buy 1 EA

Siebring Mfg Oil Furnace

All controls are wired for installation. Alumina-Silica Refractor. Lightweight design offers versatile mounting options (ceiling or floor). Designed to work with a horizontal air flow pattern in large buildings. High fuel efficiency.



**200,000 BTU / 1.25gph
26in W x 77in L x 38in H / 3/4hp Motor
2800cfm Blower**

SMKHM203 Min. Buy 1 EA

**300,000 BTU / 2gph
33in W x 88in L x 36in H / 3/4hp Motor
3600cfm Blower**

SMKHM304 Min. Buy 1 EA

**400,000 BTU / 2.75gph
47in W x 85in L x 45in H / 1hp Motor
3600cfm Blower**

SMKHM404 Min. Buy 1 EA



Anden

Other Equipment

Anden Dehumidifier



**70 Pints Day
ANDENA70** Min. Buy 1 EA

**130 Pints Day w/Wheels
ANDENA130F** Min. Buy 1 EA

**320 Pints Day 240V
ANDENA320V1** Min. Buy 1 EA

**320 Pints Day 277V
ANDENA320V3** Min. Buy 1 EA

**710 Pints Day 240V
ANDENA710V1** Min. Buy 1 EA

**710 Pints Day 277V
ANDENA710V3** Min. Buy 1 EA



Other Equipment

Packaged Standalone Dehumidifier

Made with the modern grower in mind, the BT-530 outperforms the leading competitors as shown in independent lab testing, and at a better price. The BT-530 is the optimal choice for minimizing costs and crop loss while maximizing your bottom line.



**Ability to pull up to 530 ppd (80°F/60%RH)
BTDHBT530** Min. Buy 1 EA



Upstart Heater Module

The Upstart™ head unit is attached to your locally-acquired domestic hot water heater. Hot water is pumped through BioTherm's Roll'N Grow® Mat. Plants are placed directly on the mat. The media temperature sensor tells the head unit when to cycle on & off to maintain optimum media temperature. Includes: Upstart Head Unit 1 - 4ft x 25ft Roll'N Grow mat, 1 - Piping & fitting pack (25ft distance).



**Heat your plants directly at the root, where they need it most.
BTUPHM500-V1** Min. Buy 1 EA



Quietaire

Contact Your BFG Sales Representative to
ORDER TODAY

Other Equipment

Stainless Steel Evap System

The Stainless Steel Evap System is designed for the user who wants the ultimate self-contained system. The highly corrosion resistant system has an almost unlimited service life. The stainless steel trough has enough water capacity that no sump is required, thus producing a completely self-contained system.

- Stainless Steel Cooling System.
- Self-contained water trough.
- No troublesome installation and maintenance of the sump.
- Standard bleed line to prevent buildup of salts and minerals in recirculating water.
- Float Valve water hose attachment automatically refills trough as evaporation occurs.
- Supplied in 10' sections.



Available for 4" or 6" Pads



Evaporative Cooling Pads

The Evaporative Cooling Pads are a high efficiency evaporative cooling media. Constructed with high absorption cellulose Kraft paper and treated with wetting additives and anti-rot agents, the Evaporative Cooling Pads are built for a long-lasting and low maintenance life. High quality adhesives and rigidifying agents have been added to the 110 grams per square meter virgin Kraft paper for increased resistance. Additionally, the air inlet side of the Cooling Pads have been dipped in specialized black plastic resin which helps reduce scaling and mineral buildup.

- Top Quality Pads and Media - proven success since 1990.
- Consistent performance - high-efficiency and low-pressure drop.
- Durable construction for longer life - heavier paper and higher resin content.
- Easy to install and maintain - self-cleaning and self-supporting design.
- Customized cooling - variety of sizes and flute angles available.





FLIP THE SWITCH

Since 2013, Fluence has been assisting growers around the world in retrofitting from HPS to LED. Whether you're looking to switch, swap, or supplement with LED, trust that Fluence has the solutions and services you need.



RETURN ON INVESTMENT IN <2 YEARS



SEAMLESS 1:1 INSTALLATION



TAILOR YOUR ENERGY CONSUMPTION

Contact your BFG rep today to learn more about Fluence lighting solutions.



HELPING THE WORLD GROW SMARTER

@Fluence_LED © Copyright 2023. Fluence Bioengineering, Inc.



Greenhouse Lighting

Fluence RAZR Modular Array LED Grow Lights



4-Tier - Retail Display Kit

FLURAZR4TLV Min. Buy 1 EA



Fluence SPYDR 2i Grow Light

The SPYDR 2i is a high-performance top-lighting solution for commercial cannabis growers who want to push the envelope with high-PPFD cultivation practices and experimental applications or treatments.



33in - 32.5in L x 42.80in W x 1.26in H

Input Power : 500W @277V

FLUSPYDR2I33LV Min. Buy 1 EA

47in - 47in L x 42.80in W x 1.26in H

Input Power : 638W @277V

FLUSR2II100MSHS Min. Buy 1 EA



Fluence SPYDR 2x Grow Light

SPYDR 2x is an early-development top-lighting solution for commercial cannabis cultivation, or a full-cycle top-lighting solution for home hobbyists cultivating without CO2 supplementation at ambient conditions around 400 ppm. SPYDR 2x is comparable to the previous generation's SPYDRx and delivers an average of 550 $\mu\text{mol}/\text{m}^2/\text{s}$ of highly-uniform light over a 4'x4' area at only 6" above canopy.



33in - 32.50in L x 42.80in W x 1.26in H

Input Power : 294W @277V

FLUSPYDR2X33LV Min. Buy 1 EA

47in - 47in L x 42.80in W x 1.26in H

Input Power : 348W @277V

FLUSPYDR2X47LV Min. Buy 1 EA



Fluence SPYDR Fang Grow Light

SPYDR Fang is a high-performance top-lighting solution for small to medium sized horticulture cultivation environments. Command your grow with efficiency optimized output, PhysioSpec™ indoor spectrum and integrated 0-100% dimming. Allows for easy control and full-cycle cultivation.

Input Power 636W @ 120V

PPF : 1600 $\mu\text{mol}/\text{s}$

Efficacy : 2.6 $\mu\text{mol}/\text{J}$

Dial Dimmer Cable attached to fixture. 120V power cord and hanging hardware included.

IP66 Rated. 3-year warranty.



47in L - PhysioSpec Broad R4 - 120-277V - 6ft AC Cord - NEMA 6-15P - No DC Extension - 2-Point Lance Hanger Kit - External Dimmer

FLUSPYDRFANG47 Min. Buy 1 EA



Fluence VYPR 3p Broad R3 LED Top Light

Featuring multiple spectra and high efficacy, the VYPR series is Fluence's advanced solution for greenhouse supplemental lighting and indoor sole-source applications. Built upon patented thermal management technologies, the latest VYPR top lights feature market-leading efficacies and high light output per fixture. Thus, helping reduce the fixture count and system cost per lit area.



R3 Spectrum - 43in

42.33in L x 2.91in W x 3.23in H

Input Power : 620W @277V

FLUVYPR3PLV Min. Buy 1 EA



R4 Spectrum - 43in

42.33in L x 2.91in W x 3.23in H

Input Power : 620W @277V

FLUVR3PBW4LVG000003PSAR Min. Buy 1 EA

Fluence Waterfall Twisted "V" Wire Hanger

Provides a four point mounting solution for waterfall decking. Available in two sizes.

Part No. AMS2-10348-20

Connection : 4-Point Mounting Option

Compatibility : SPYDR 2

Cable/Cord Length : Long - 8.375in



8.375in - Compatible with SPYDR 2

FLUAMS21034820 Min. Buy 1 EA



WARNING: This product is not available for sale in CA. For most up to date information please visit bfgsupply.com



Greenhouse Lighting

Fluence Adjustable Hanger Kit

Provides a two point mounting solution. Includes 5ft of braided stainless steel wires and carabiners.

Part No. AMS2-10310-10

Connection : Adjustable Carabiners

Compatibility : SPYDR 2

Cable/Cord : 5ft



5ft - Adjustable - Compatible with SPYDR 2

FLUAMS21031010 Min. Buy 1 EA



Fluence AC/DC Whisper 2.0 Dimmer

The Fluence Dimmer is a reliable, user-friendly dimmer that controls the light intensity from 0-100% for Fluence light fixtures. This device allows growers to control the light intensity of their Fluence light fixtures via an easy-to-use up/down arrow function, and clearly shows the user their light output intensity percentage via a digital display.

Part No. C-W-U

Electrical : AC/DC - 120AC/12VDC

Compatibility : VYPR 3, RAZRm, RAZR 2/3/4, RAZRx, RAY, SPYDR 2, and SPYDR 1

0-100% Light Intensity

Controls Up to 50 Devices with



Controls up to 50 Devices - 0-100% Light Intensity - Compatible with VYPR 3, RAZRm, RAZR 2/3/4, RAZRx, RAY, SPYDR 2, and SPYDR 1 - 3.92in L x 3.43in W x 1.35in H

FLUCWU

Min. Buy 1 EA



Fluence DC 1-T Flex Dimming Cable

Part No. CDMA-71557-10

Electrical : DC

Compatibility : RAZRm and RAZR 2/3/4

Connection : M12 Threaded Connector

Cable/Cord : 5ft



5ft - DC - M12 Threaded Connector - Compatible with RAZRm and RAZR 2/3/4

FLUCDMA7155710 Min. Buy 1 EA

Fluence DC 4-T Flex Dimming Cable

Part No. CDMA-71558-01

Electrical : DC

Compatibility : RAZRm and RAZR 2/3/4

Connection : M12 Threaded Connector

Cable/Cord : 20ft



20ft - DC - M12 Threaded Connector - Compatible with RAZRm and RAZR 2/3/4

FLUCDMA7155801 Min. Buy 1 EA

Fluence DC Extension Cable

The SJTW thermoplastic-coated DC extension cable is compatible with SPYDR2 and VYPR2 Lights with a PSU1 power supply. Cable features 14-gauge AWG wire with a PVC jacket and are suitable for damp and wet locations. Ideal for indoor greenhouse and vertical farming environments. Part No. CDCG-70720-10

Electrical : DC Max 15A, 54V

Compatibility : VYPR 3 and SPYDR 2

Connection : M19 Push Lock Connector

Cable/Cord : 3ft



3ft - DC Max : 15A, 54V - M19 Push Lock - Compatible with VYPR 3 and SPYDR 2

FLUCDCG7072010 Min. Buy 1 EA



Fluence DC Flex Dimming Terminator Cable

Part No. CDMA-71682-10

Electrical : DC

Compatibility : VYPR 3 and RAZRm

Connection : M12 Threaded Connector



42in - DC - M12 Threaded Connector - Compatible with VYPR 3 and RAZRm

FLUCDMA7168210 Min. Buy 1 EA



5ft - DC - M12 Threaded Connector - Compatible with VYPR 3 and RAZRm

FLUCDMA7161310 Min. Buy 1 EA

Fluence DC Flex Dimming Trunk Extension Cable

Part No. CDMA-71610-01

Electrical : DC

Compatibility : VYPR 3 and RAZRm

Connection : Pigtail to M12 Threaded Connector

Cable/Cord : 75ft



75ft - DC - Pigtail to M12 Threaded Connector - Compatible with VYPR 3 and RAZRm

FLUCDMA7161001 Min. Buy 1 EA

Fluence DC PSU2 Dimming Signal Cable

Part No. CDMA-71561-10

Electrical : DC

Compatibility : VYPR 3 and RAZRm

Connection : Pigtail to M12 Threaded Connector

Cable/Cord : 11in



11in - DC - Pigtail to M12 Threaded Connector - Compatible with VYPR 3 and RAZRm

FLUCDMA7156110 Min. Buy 1 EA





Greenhouse Lighting

Fluence AC 1-T Ferrite Flex Wire Cable

Part No. CAFA-71541-10

Electrical : AC

Compatibility : VYPR 3, RAZRm, and SPYDR 2

Connection : M25 to M19 Push Lock Connector

Cable/Cord : 5ft



5ft - AC - M25 to M19 Push Lock Connector - Compatible with VYPR 3, RAZRm, and SPYDR 2

FLUCAFA7154110 Min. Buy 1 EA

Fluence AC 3-T Ferrite Flex Wire Cable

Part No. CAFA-71540-05

Electrical : AC

Compatibility : VYPR 3, RAZRm, and SPYDR 2

Connection : M25 to M19 Push Lock Connector

Cable/Cord : 15ft



15ft - AC - M25 to M19 Push Lock Connector - Compatible with VYPR 3, RAZRm, and SPYDR 2

FLUCAFA7154005 Min. Buy 1 EA

Fluence AC Ferrite Flex Wire Terminal Cable

Part No. CAFA-71543-10

Electrical : AC

Compatibility : VYPR 3, RAZRm, and SPYDR 2

Connection : M25 to M19 Push Lock Connector

Cable/Cord : 3ft



3ft - AC - M25 to M19 Push Lock Connector - Compatible with VYPR 3, RAZRm, and SPYDR 2

FLUCAFA7154310 Min. Buy 1 EA

Fluence AC Flex Wire Terminal Cable



3ft L

FLUCAFA7154301 Min. Buy 1 EA

Fluence AC Flex Wire for Junction Box Panel

Part No. CAFA-70925-10

Electrical : AC Max 20A

Compatibility : VYPR 3, RAZRm, and SPYDR 2

Connection : Pigtail to M25 Push Lock Connector

Cable/Cord : 6in



6in - AC Max : 20A - Pigtail to M25 Push Lock Connector - Compatible with VYPR 3, RAZRm, and SPYDR 2

FLUCAFA7092510 Min. Buy 1 EA



Fluence AC Flex Wire Trunk Extension Cable

Part No. CAFA-70928-05

Electrical : AC Max 16A

Compatibility : VYPR 3, RAZRm, and SPYDR 2

Connection : M25 Push Lock Connector

Cable/Cord : 15ft



15ft - AC Max : 16A - M25 Push Lock Connector - Compatible with VYPR 3, RAZRm, and SPYDR 2

FLUCAFA7092805 Min. Buy 1 EA



Fluence AC Flex Wire Trunk Extension Cable

Part No. CAFA-70927-10

Electrical : AC Max 16A

Compatibility : VYPR 3, RAZRm, and SPYDR 2

Connection : M25 Push Lock Connector

Cable/Cord : 6ft



6ft - AC Max : 16A - M25 Push Lock Connector - Compatible with VYPR 3, RAZRm, and SPYDR 2

FLUCAFA7092710 Min. Buy 1 EA



Fluence AC Extension Cord

The Fluence AC power supply extension cable is compatible with SPYDR 2 and VYPR 2 lights with PSU1 power supply. Cable features a NEMA 6-15P plug connector on one end, with 3-PIN female M19 Pushlock connector on the other. Connectors provide a reliable plug-and-play, error-free, secure installation, and work in damp and wet locations.



6ft - AC Max : 7A, 120V - NEMA 5-15P Plug to M19 Push Lock Connector - Compatible with VYPR 3, RAZRm, and SPYDR 2

FLUCACA7074810 Min. Buy 1 EA



6ft - AC Max : 7A, 240V - NEMA 6-15P Plug to M19 Push Lock Connector - Compatible with VYPR 3, RAZRm, and SPYDR 2

FLUCACA7075010 Min. Buy 1 EA

6ft - AC Max : 7A, 277V - NEMA L7-15P Plug to M19 Push Lock Connector - Compatible with VYPR 3, RAZRm, and SPYDR 2

FLUCACA7075210 Min. Buy 1 EA

15ft - AC Max : 7A, 120V - NEMA 5-15P to 3Pin Female M19 Pushlock Connector - Compatible with VYPR 3, RAZRm, and SPYDR 2

FLUCACA7074905 Min. Buy 1 EA

15ft - AC Max : 7A, 240V - NEMA 6-15P Plug to M19 Push Lock Connector - Compatible with VYPR 3, RAZRm, and SPYDR 2

FLUCACA7075105 Min. Buy 1 EA



WARNING: This product is not available for sale in CA. For most up to date information please visit bfgsupply.com

Current

Greenhouse Lighting

GE Arize Greenhouse Pro

Arize Greenhouse Pro Photoperiodic LED Lamp - The GE Arize™ Greenhouse Pro LED lamp is designed to facilitate greenhouse photoperiod control. Photoperiod control allows growers to manage vegetative growth or rapid flowering throughout the year by extending or shortening day-length. This lamp will help control plant growth, so the production is ready at the precise time.



Flowering Lamp

HA93042116 Min. Buy 1 EA

GE Arize Elem L1000

Arize Element L1000- Toplighting for efficient growth at an industrial scale. Cover large areas with fewer fixtures, reducing capital investment.



627 watt 120-277V
HA93151511 Min. Buy 1 EA

GE Arize Elem L2000

Arize Element L2000-Arize Element L2000 is a powerful LED top lighting solution for year-round productivity in greenhouses and indoor farms.



1000W 277-480V
HA93301851 Min. Buy 1 EA

GE Arize Factor ML300

Arize Factor ML300- Highly versatile and scalable LED lighting fixtures engineered specifically to power professional propagation, vertical, and multi-tier cultivation



600 watt 120-277V
HA93161668 Min. Buy 1 EA

GE Arize Factor ML900

Arize Factor ML900- Current's flagship professional indoor LED solution for full lifecycle and flowering cannabis as well as other high-density indoor flowering and fruiting crops



600 watt 120-277V
HA93162614 Min. Buy 1 EA

GE Arize Life2

Arize Life2- High-efficiency professional LED grow lights designed to power vegetative growth in high density indoor cultivation spaces.



10ct
HA93137762 Min. Buy 1 EA





**Total Energy Group
provides custom,
professional
grade Greenhouse
systems.**



Complete Shade/Blackout
Systems & Installations

Drive Systems & Motors

Energy Efficient Fans & Heaters

Boiler Systems & Installations

LED Lighting

Air Filtration & Odor Mitigation



Contact Your BFG Sales Representative for More Information



total grow

Greenhouse Lighting



TotalGrow™ High Intensity Top-Light 620W Bar

The TotalGrow HI-Top generates an ideal light spectrum for diverse supplemental and sole source applications with a versatile output pattern including optional side-reflector add-on for edge lighting, exceptional efficiency and profound total value in a pleasant work environment. It is simple to implement and low on upfront and ongoing costs.



620W - 1720 $\mu\text{mol/s}$ - 2.8 $\mu\text{mol/J}$ - 44"

TG62B320328D1K0BA6

Min. Buy 1 EA



TotalGrow™ High Intensity Top-Light 320W Bar

The TotalGrow HI-Top generates an ideal light spectrum for diverse supplemental and sole source applications with a versatile output pattern, exceptional efficiency and profound total value in a pleasant work environment. It is simple to implement and low on upfront and ongoing costs.



320W - 895 $\mu\text{mol/s}$ - 2.8 $\mu\text{mol/J}$ - 24"

TG32B320328D1K0BJ6

Min. Buy 1 EA

TotalGrow™ Pure Flowering 200 Lamp (Trigger Long Days)

The most efficient and effective solution for simulating long days to control the timing of flowering. Perfect balance of red and far-red light output for night interruption/day length extension. No wasted light output in non-photoperiodic regions. Minimal power consumption and electrical infrastructure needs with simple installations.



17W - 100-240V - Life Hours : 50,000 - Typical Coverage : 200sq ft

TG1B-3A-1104-BA4 Min. Buy 1 EA



TotalGrow Stratum 20W Clone LED

TotalGrow Stratum lights feature exceptionally thin profiles to maximize space, a full spectrum and modular design for exceptional versatility, and simple mounting and electrical installation to save time and costs. Ideal for grow racks of clones, greens, herbs, seedlings, and more.



Each Bar: 20W - 48 $\mu\text{mol/s}$ - 2.4 $\mu\text{mol/J}$ - 45"

TG2B90324D016BA3PK

Min. Buy 1 EA



TotalGrow Mezzo 100W, 43" Light Bar with hangers

The TotalGrow Mezzo generates an ideal light spectrum for diverse supplemental and sole source applications with a versatile output pattern, exceptional efficiency and profound total value in a pleasant work environment. Simple installation and daisy-chaining allow easy implementation for low-height greenhouses, small grow spaces, side-lighting, and more.



100W - 260 $\mu\text{mol/s}$ - 2.6 $\mu\text{mol/J}$ - 43"

TG10B20326D0J2CH6

Min. Buy 1 EA

TotalGrow™ Pure Flowering Lamp Socketed Cord

Socket cord for the Installation of TotalGrow™ Pure Flowering 200 Lamps. Socket Base Size: E26. Voltage: 100-240V. Approximate Max Power: 500W. Cable Gauge: AWG16. Plug: NEMA 1-15P



180ft - 15ft socket spacing - 12 sockets

CS-180-180-12 Min. Buy 1 EA



Other Equipment



B-Line Flat and Pot Filler (Model 5343)

The B-Line is the most popular Kase Flat Filler, supporting the container sizes used by most greenhouses and nurseries. It is ideal for peat moss-based soils, is easy to operate, quiet and easily maintained.

With its generous 1.5-yard hopper, the B-Line offers a production rate up to 1,200 flats per hour, and it handles containers up to 18in wide x 12in tall. Feed your B-Line with a Kase 3561 Gobbler or 3538 Small Bale Buster.

Additional Filler Models include the high production N-Line, large capacity Super-B, and Minor-B for plug trays and smaller containers.



Gobbler (Model 3561)

The Gobbler is designed to process large 135 cu. ft. compressed bales (as well as smaller bales) into a fluffed and moistened potting soil, with a production rate up to 75 cubic yards per hour. The hydraulic lift gate platform is easily loaded via forklift or pallet jack. Basic start/stop controls or automated sensors allow the Gobbler to integrate with other processing equipment, such as a Kase Filler or 4300 Series Soil Conveyor. The Optional TopHopper dispenses an amendment of your choice directly into soil as it is processed through the Gobbler.



Modular Belt Conveyors (4100 Series)

If you are looking for versatility and portability without sacrificing durability, the Kase Modular Conveyor's simple design allows these conveyors to be easily networked to cover extended distances without sacrificing power. Conveyors are available with 10" and 15" wide belts and variable speed or reversing controls. Optional adjustable height stands are available to suit your production line.

Soil Mixers (3400 Series)

Kase offers four sizes of Batch Mixers to meet your needs for rapid, complete and uniform soil mixing. The 3/4 yard unit has a center discharge, while all other Kase Mixers have an end discharge. Each Mixer includes a spray apparatus for moistening soil and a safety grate with splash guard shielding the top of the unit. The 2 and 4 yard models incorporate a bolted replaceable bottom barrel, available in heavy duty abrasive resistant material.



Kase Water Tunnel

Watering Tunnels are used to water plant material that is planted in flats, pots, hanging baskets or other containers. Watering tables have smaller Drip Nozzles placed over the conveying unit to moisten plug trays. Watering Tunnels have water Spray Nozzles. They are self-contained using an open mesh Polyethylene conveying belt to move the product thru the machine at a variable speed rate, which is selected by the operator. The adjustable speed feature will help control the amount of water that is dispensed on your plant material. Different size nozzles are available also to control the amount of water flow. These units have water drip pans to catch all of the excess water into a drain at one end of the unit, which may be plumbed into an existing drain. The collection pans are longer than the spray area to catch the excess spray and have a area to place the plant material on the unit and an area to take the plant material away. Features: Stainless steel enclosure, Quad spray heads variety of nozzle size available, High impact poly chain and sprockets, Electric operated solenoid valve, Brass Ball Valve, Stainless slide racks Optional electronic control of water spray Variable drive speed Water Volume: 4gpm to 16gpm Belt Width: 12in, Maximum Flat Width: 16, Adjustable Height of Conveyor: 24in to 36in.



KASE2211

Kase Horticulture

Other Equipment

Kase Production Lines

With over thirty years of experience designing and manufacturing Horticulture equipment, Kase provides custom solutions like the large pot Filling Lines and Mix Line shown below. Visit kaseworks.com to see the full line of Kase Horticulture equipment.



3400 Series Batch Mixer

4300 Series Soil Conveyor

5661 N-Line Filler



4100 Series Modular Conveyor

2211 Water Tunnel

5343 B-Line Filler



Simple Mix Line with Metering Hopper, Fertilizer Dispenser, and Mixing Head



Other Equipment



Single Rail Boom

Cherry Creek's Single Rail Boom is a cost-effective automatic system, designed with simplicity and efficiency in mind and ideally suited for smaller bays with simple watering requirements. Its rugged, compact housing is built to move up and down a greenhouse on one rail. It's spray bar is turned on or off by a single solenoid, and the boom waters the full width of the bay.

Walking (Navigator) / Tower Booms

Cherry Creek's Tower Boom is designed to be a workhorse for all of your irrigation, maintenance and crop inspection needs. It is almost completely pre-assembled at the factory, and is supported by rails mounted off the gutter posts on both sides of the bay that span the width of the greenhouse.

- Rugged construction
- Precise application of water and chemicals
- Water savings and reduction in labor
- Adaptable for conveyors and scaffolding
- Pre-assembled for easy installation
- Transportation system for equipment & humans.

NEW TIC (Touch Irrigation Controller)

Boom automation allows for controlled application rates of water and chemicals, which reduces overspray and results in long-term savings. Automatic irrigation will also significantly reduce labor costs.

The new TIC is available on the Double Rail Booms, Walking (Navigator) Booms and Tower Booms. The TIC has the following enhancements:

- 16 Crops with their own 8 Areas that can Water, Mist and/or SSW all within the same Crop, 4 Schedules with 7 days of the week options. (ssw = step, stop, water).
- Auto Mode / Manual Mode with Queue position over-ride
- Touch Screen with Grower Friendly Menus
- Wifi capability for cell phone/iPad & remote access.

Double Rail Boom

Cherry Creek's Double Rail Boom offers the versatility of independent watering of the right, left, or both sides of the greenhouse, along with walk-through for walkways. With the stability of two running rails, boom sway is eliminated. Combined with the New TIC, the Double Rail Boom handles the most complicated application requirements, assuring precise rates of water and chemicals. Save significantly on both water and labor costs. Booms are nearly fully assembled and simple to install.

ECHO Hanging Basket System – Water By Weight

The ECHO System allows for accurate measurements of water to each basket. Additionally, fertilizer applications can be consistently controlled, resulting in faster production times, higher yields, and more crop turns per season.

The NEW WBW (Water By Weight) Controller has the following features:

- 10" Touch Screen with Wifi capability for cell phones & iPads
- Water By Time Mode / Water By Weight Mode, 7 Day Schedule with Repeat Cycle every "X" hrs., 16 Schedules.
- WBW mode has a dry weight and wet weight setting for optimal root growth.

The gentle movement of the plants as they go through the watering mode allows them to experience various lighting exposures and air movement over the surface, which promotes healthier growth. The ECHO leaves the factory fully assembled, making installation fast and simple.

Contact Your BFG Sales Representative for
PRICING & CUSTOMIZED
Solutions for Your Operation

Touch Irrigation Controller TIC



Water By Weight Controller (WBW)





Other Equipment

A BioTherm system is an ecosystem of integrated products specifically optimized for maximizing efficiency and production. BioTherm's mission is to create the perfect environment for optimized plant growth.

With over 40 years of experience, BioTherm is the leader of providing efficient climate solutions to growers. Their systems are designed to work together within the greenhouse, creating the perfect ecosystems for plants to not simply grow, but thrive.

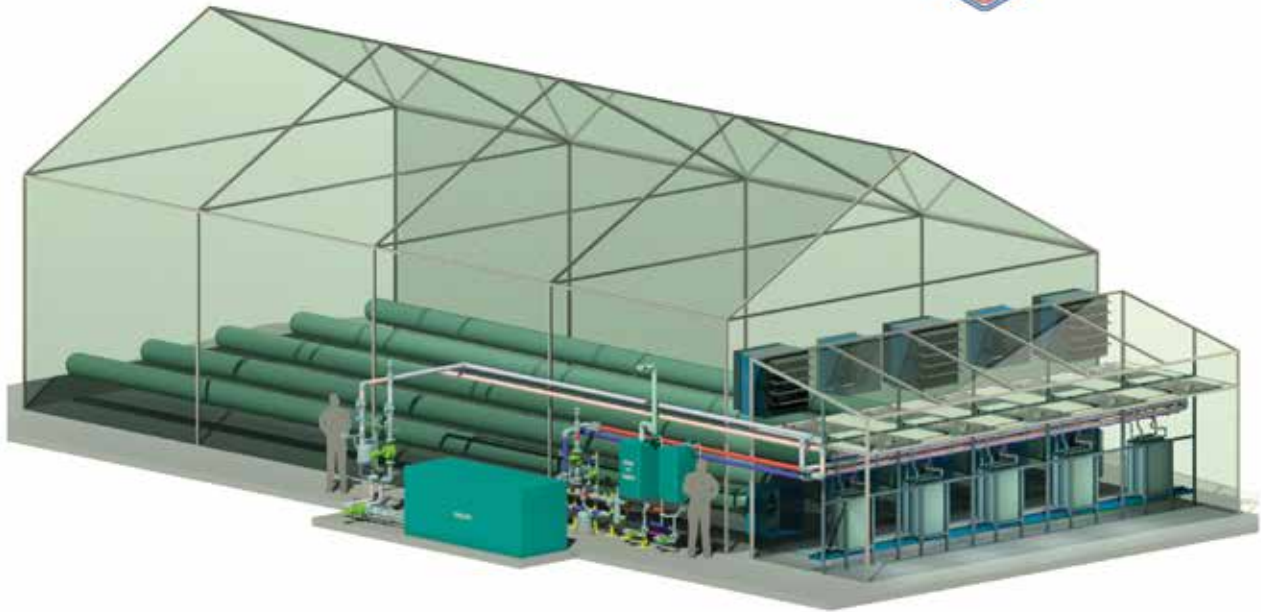
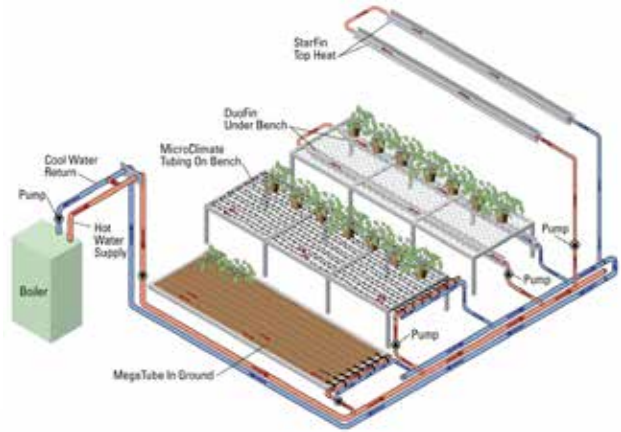

Plantcentric Controlled Environment Arcade (CEA)

BioTherm believes that greenhouses are for growing, not to be used as equipment rooms.

This controlled environment arcade attaches separately to your greenhouse to allow for complete climate control. Plantcentric CEA is a complete engineered modular solution for your greenhouse climate needs to provide the optimal growing conditions for indoor plant propagation. Ideal environmental setpoints are used to design the appropriate equipment required to maintain these values.

The PCEA is available to run over 10 modes, ranging from 100% recirculation, heating, cooling, dehumidification, CO2 enrichment, and more.

Contact Your BFG Sales Representative for
NEW SYSTEM UPGRADES
and Replacement Parts!



BioTherm is the leading provider of efficient greenhouse heating to the CEA, Horticulture and Cannabis Industries.

Other Equipment

With over 40 years of experience, BioTherm has an extensive history of developing and manufacturing high-quality heating systems for a wide range of applications, including commercial greenhouses, indoor grow rooms and vertical farms. This has allowed them to accumulate a wealth of experience and knowledge in the field, which has led to the development of cutting-edge cultivation climate technologies that meet the unique needs of growers in the CEA, horticulture, and cannabis industries.



Roll'N Grow™

Roll'N Grow is the perfect way to apply Root Zone Heating (RZH) to growing beds or benches! Like a carpet, your growing surfaces can now be covered with growth-enhancing gentle heat in a fraction of the time it used to take.



Fun Pipe - DuoFin & StarFin

BioTherm DuoFin is the lowest heat output finned pipe commonly used for under-bench, perimeter, and in-crop heating. Its unique tapered vertical fin delivers a combination of convective and radiant heating quietly and efficiently.

BioTherm StarFin is a high heat output finned pipe commonly used for bench, perimeter, top, and gutter heating. Its tapered six-fin design provides maximum heat output while producing a soft, gentle heat.



Raypak Boilers

The central part of hydronic heating systems! BioTherm is proud to be the exclusive provider of Raypak products to the CEA industry. Raypak's diverse boiler offerings provide capabilities such as: modulating up and down to different heat loads, easily daisy-chaining to combine heat outputs, provide clean CO2 with our enrichment systems, and cascading boiler systems to follow the seasonal changes for optimal boiler efficiencies.

BioTherm Hydro Sciences has one simple focus... to enhance your irrigation system and boost plant growth using cutting edge technologies with efficiency in mind. Our products are proven to increase yields, improve plant vigor, and increase resistance to diseases and pests.



Dissolved Oxygen Infusion

BioTherm's dissolved oxygen systems are an efficient method of increasing the dissolved oxygen (DO) content of irrigation water, significantly improving plant health and productivity. Dissolved oxygen is proven to increase nutrient uptake, root growth, and plant yield.



Flood & Cascade Floors

BioTherm's innovative sub-irrigation technology provides a quick-responding irrigation cycle time which is critical to greater control of nutrient uptake, timing, and prevents oversoaking. BioTherm's Flood and Cascade Floor systems save water, energy, fertilizer and reduce labor costs by up to 95%.



Irrigation Tempering

Experience optimal plant growth with tempering solutions customized to your operation. The use of BioTherm's pre-heating and pre-cooling systems will prevent thermal shock, increase rooting, and prevent disease.



WARNING: This product is not available for sale in CA. For most up to date information please visit bfgsupply.com



Other Equipment

BioTherm has proven systems designed to optimize the air inside your facility and enhance your growing conditions so that even crops not normally grown in your region can flourish. They can take the temperature and humidity down just a touch, or they can close the access to outside air and bring those factors way down. It is all in the design, and BioTherm's experienced team knows how to engineer and deliver systems made specifically for rugged cultivation environments using special air handlers or standalone dehumidifiers.

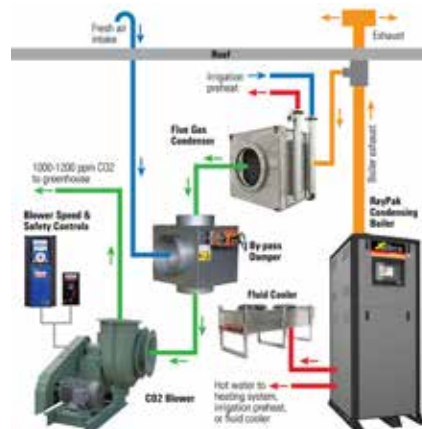

CO2 Enrichment

CO2 levels are naturally low in a greenhouse environment as plants use available CO2 as part of the photosynthetic process. Increasing CO2 levels above ambient conditions promotes increased plant growth and health.

With the right condensing boiler system in place, a BioTherm CO2 system can easily be integrated to achieve elevated CO2 levels in the greenhouse environment. BioTherm's system pulls CO2 directly from the boiler's exhaust gases, cleans it, and distributes it uniformly into the growing space. The CO2 system delivers clean, safe, and dry CO2 to your growing environment.



AC/Dehu Systems - Centralized 4-Pipe Systems

BioTherm understand the demands of indoor gardening and greenhouse crops. A major issue is moisture control & humidity management. BioTherm has developed a line of pragmatic dehumidification and air temperature control solutions for agricultural applications without compromising performance. These systems run off hydronic circuits connected to pumps & high-efficiency Raypak boilers and chillers—all located remotely.



Standalone Dehumidifiers

BioTherm AC/Dehu systems can be customized to accommodate your greenhouse design, saving you space, cutting costs, and conserving energy.

Moisture control and humidity management are fundamental needs within any growing environment. BioTherm's newest greenhouse and grow room AC/Dehu systems allows them to meet the needs of any grower while providing efficient solutions without compromising performance. From standalone units to fully engineered system designs, BioTherm can help provide the optimal air environment for your growing operation.





Drive Systems

Climate Screens

Water Treatment

Intelligent Greenhouse Technology

Labour Tracking

Climate Control

ridder.com +1 855 322 1400 (toll-free)

DRAMM

Other Equipment

Dramm® Thermostat

The Dramm Microfan mechanical thermostats are designed with rough environments in mind. These high quality thermostats are perfect for any situation where harsh conditions may damage less durable equipment. Protected in sealed PVC housings, these thermostats offer stainless steel coiled sensors and accuracy to 1_ C. The SPDT switch contact is a no load contact and offers superior accuracy.

Single Stage



120/208/240V

DRMT41

Min. Buy 1 EA

Two Stage



DRMT42

Min. Buy 1 EA



WADSWORTH

Control Systems



Other Equipment

Wadsworth Driveshaft Coupling

Coupling to join two lengths of drive shaft.



1 3/8in

WADSF0909

Min. Buy 1 EA



WADS VC 2000/ILS

Wadsworth's most powerful drive unit. It meets the challenge of long vent runs and heavy vents. With its quiet running, low current, high output motor, the VC-2000 keeps your utility bills low. It can lift 325 feet of 4 foot polycarbonate roof ridge vent with aluminum frame on rack and pinion. 1.2 RPM final output.



1.2rpm - 1-3/8in O.D. Shaft

WADSM1190

Min. Buy 1 EA

3.2rpm - 1-3/8in O.D. Shaft

WADSM1550

Min. Buy 1 EA



Other Equipment

Growlink® Panel



Small

GLXSMALLFIELDPANEL

Min. Buy 1 EA

Standard

GLXSTANDARDPANEL Min. Buy 1 EA



Link4 CORPORATION

Other Equipment

Link4 iGrow 1800 Advanced Indoor or Greenhouse Controller

The iGrow 1800 offers the finest in greenhouse and indoor growing experience. Used for larger and more complex grow situations, the iGrow 1800, you can increase productivity while reducing energy use and operating costs. The iGrow 1800 series offers 24VAC intelligent controlled outputs that can be expanded up to 144 outputs for fans, heaters, vents, irrigation, supplemental light and DLI, shade curtains (blackout curtains), and more. Combine the iGrow 1800 with the iDoser to automate dosing and fertigation. Integral panels available upon request.

- Advanced control, affordable price
- 24VAC intelligent controlled outputs expandable up to 144 outputs
- Advanced irrigation (VDP or Soil Moisture Content)
- Advanced lighting control (DLI)
- Auxiliary controls are flexible and user defined to control conditions to fit your unique growing requirements
- UL Listed for safety and easy permits
- Runs off Linkconn software or with the new 1800 Cloud for remote accessibility



L990180000 Min. Buy 1 EA

Link4 Sapphire Commercial Irrigation Controller/ Mist Controller

The Sapphire irrigation controller series is ideal for applications requiring misting, flood, drip or standard irrigation for greenhouses, nurseries, or other commercial applications.



L990091000 Min. Buy 1 EA

Link4 Topaz Environmental Controller

The Topaz controller is an environmental controller for simple single zone control. A perfect choice for controlling only a few outputs such as heaters, fans and curtain systems for outdoor nursery structures, retail or small greenhouses, and simple indoor growing operations.



L000801000 Min. Buy 1 EA

Link4 iOptimizer Smart Motor Control

Link4's iOptimizer is built for optimal energy savings. Various functions are provided to minimize energy consumption when it's operating. This makes the iOptimizer suitable for applications like pumps, fans, and air conditioners. Designed with both OWMs and System Integrators' needs in mind. It has a compact design and is preconfigure for out of the box integration in most applications.



L9733000201 Min. Buy 1 EA

Link4 iGrow 800 Greenhouse Controller

Get real-time energy use and track run-time on greenhouse heating and cooling equipment with this easy-to-use controller system.



L4990080002 Min. Buy 1ea



WARNING: This product is not available for sale in CA. For most up to date information please visit bfgsupply.com



Other Equipment

Phytotronics® Redi-Heat™ Heavy-Duty Propagation Mats

Redi-Heat™ Heavy-Duty Propagation Mats are constructed from thick, flexible, rubberized PVC in Phyto Blue color. These mats provide even, constant heat to bottom of flats and pots for superior germination. RDT-4 Thermostat is required for use.



21in x 6ft
PHT8606

Min. Buy 1 EA



DRAMM

Other Equipment

Dramm® Hanging Basket Remover Ring

Conveniently remove hanging baskets from hard-to-reach areas above.



36in Handle with 10in Ring

DRMHBRC

Min. Buy 1 EA

7ft Handle

DRMHBRP

Min. Buy 1 EA



Antal/Cayson Equipment

Other Equipment

Antal / Cayson Equipment

Easy to use and handles any tray with the swap of an insert. Produces neat, easy-to-handle plugs with no damaged roots or stems. Operates smoothly with a foot pedal and can dislodge up to 10 trays per minute. Plugs pop up easily and cleanly regardless of moisture content or root mass.



Plug Popper
ANTAL34-0221

Min. Buy 1 EA



Antal / Cayson Equipment

Interchangeable insert for use with the Antal/Cayson Plug Popper.



Plug Popper Insert
ANTALD07171

Min. Buy 1 EA

Antal / Cayson Equipment

Custom built seeders and seed plates for various greenhouse growing trays. Easy out of the box 5 to 10 minute set up time. There are no confusing brackets, stops, tubes with nozzles, gauges or height adjustments to malfunction. This seeder self centers itself over top of the plug tray, for accurate seed location.

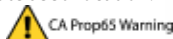

Vacuum Seeder
ANTALVACSEEDER

Min. Buy 1 EA



Other Equipment

Ezi-Action® Drum Pump

Ezi-action® Drum Pumps are dependable manual dispensing systems for bulk containers. The drum pump used with BioSafe Systems' 5-gallon, 30 or 55-gallon containers, or 275-gallon tote, evenly dispenses a consistent volume per press.

Easily distributes chemistry from a drum or tote to a siphoning system

Easy to use and minimizes worker safety hazards



Drum Pump

BSF9016

Min. Buy 1 EA

Other Equipment

TAPKIT Cucumber Hydroponic System

A hydroponic system, designed for growing cucumbers. Developed in Israel utilizing over 20 years of experience in CEA with heavy emphasis on NFT hydroponics. TAPKIT's mission is to make hydroponic micro-farming accessible and affordable for agripreneurs to produce fresh and clean vegetables, with a reliable supply throughout the year.

Full Kit - Includes Structure and NFT system

35ft x 168ft

7,000 Planting Holes



35ft x 168ft - 7,000 Planting Holes

TAPKITCU

Min. Buy 1 EA



Global Horticulture

Other Equipment

Jobu Pinch Clip

The Jobu Clip Ring is used to fasten pot plants, small vegetable plants and little trees to a stick or other support. The Jobu clip ring is made of very flexible polypropylene to ensure quick installation and easy locking. Extra wide finger contact surfaces ensure a better grip without damage to the fingers.



20mm

GH792001012

Min. Buy 1000 EA

TAPKIT Hydroponic System

A turnkey hydroponic system, designed for growing leafy vegetables and culinary herbs. Developed in Israel utilizing over 20 years of experience in CEA with heavy emphasis on NFT hydroponics. TAPKIT's mission is to make hydroponic micro-farming accessible and affordable for agripreneurs to produce fresh and clean leafy vegetables, with a reliable supply throughout the year.

Full Kit - Includes Structure and NFT system

35ft x 168ft

22,272 Planting Holes



35ft x 168ft - 22,272 Planting Holes

TAPKIT

Min. Buy 1 EA



TAPKIT Retrofit Hydroponic System

A hydroponic system, designed for growing leafy vegetables and culinary herbs. Developed in Israel utilizing over 20 years of experience in CEA with heavy emphasis on NFT hydroponics. TAPKIT's mission is to make hydroponic micro-farming accessible and affordable for agripreneurs to produce fresh and clean leafy vegetables, with a reliable supply throughout the year.

Retrofit Kit - Designed for use with Existing Greenhouse Structures

30ft x 90ft

9,568 Planting Holes



30ft x 90ft - 9,568 Planting Holes

TAPKITRETRO

Min. Buy 1 EA



Bluelab

Greenhouse Meters & Test Kits

Bluelab® 4.0 Calibration Solutions

The Bluelab® calibration and conductivity standard solutions are essential for, and specifically manufactured for use with all Bluelab® products. Solutions ensure your products last longer and maintain accuracy.



250ml

BLBPH4250BL Min. Buy 6 EA

500ml

BLBPH4500BL Min. Buy 6 EA



Bluelab® 2.77EC Conductivity Solutions

Bluelab calibration solution EC 2.77 18ml sachet in box of 30 count



18ml

BLBBLEC27718B Min. Buy 1 EA

Bluelab® 4.0 Calibration Solutions

Bluelab calibration solution pH 4 18ml sachet in box of 30 count



18ml

BLBBLPH418B Min. Buy 1 EA

Bluelab® 7.0 Calibration Solutions

The Bluelab® calibration and conductivity standard solutions are essential for, and specifically manufactured for use with all Bluelab® products. Solutions ensure your products last longer and maintain accuracy.



250ml

BLBPH7250BL Min. Buy 6 EA

500ml

BLBPH7500BL Min. Buy 6 EA



Bluelab® 7.0 Calibration Solutions

Bluelab calibration solution pH 7 18ml sachet in box of 30 count



18ml

BLBBLPH718B Min. Buy 1 EA

Bluelab® Conductivity Standard Solution

Bluelab® conductivity standard solutions are essential for use with all Bluelab® products. Bluelab® Solutions are manufactured specifically for Bluelab® products and are referenced to high laboratory standards to ensure your products last longer and maintain accuracy. The 2.77EC solution is used as a reference or checking solution to ensure you have adequately cleaned the EC/ppm probe.



120ml - 2.77EC

BLBSTSOL120BL Min. Buy 6 EA

250ml - 2.77EC

BLBEC277250BL Min. Buy 6 EA

500ml - 2.77EC

BLBEC277500BL Min. Buy 6 EA



Bluelab® Calibration KCl storage solution

Bluelab calibration KCl pH storage solution



18ml

BLBBLSTOL18B Min. Buy 1 EA

Bluelab® pH Probe KCl Storage Solution

The perfect solution to store and hydrate pH probes. pH probes are sensitive glass instruments which age through everyday use. Bluelab® pH Probe KCl Storage Solution is made specifically for use with Bluelab® pH probes and pens. It is designed to increase response time and maximize the life of Bluelab® pH pens and pH probes.



250ml

BLBSTSOL250BL Min. Buy 6 EA



Bluelab® Mix calibration solutions

Bluelab calibration solution MIX box x10 pH 7, x10 pH4, x5 KCl storage, x5 EC2.77 - 18ml sachets in box of 30 count



BLBMIX18B

Min. Buy 1 EA



Bluelab

Greenhouse Meters & Test Kits

Bluelab® Connect™ Range Extender

Simply plug the Bluelab® Connect™ Range Extender into a power supply between Bluelab® Connect™ Devices and Bluelab® Connect™ Stick to increase the range or signal strength between Bluelab® Connect™ products. For extra-long distances, multiple range extenders can be used. Installation instructions included.



for Bluelab® Connect™ Devices and Connect™ Stick

BLBCONEXTEND Min. Buy 1 EA



Bluelab® Combo Meter

A convenient and portable all-in-one solution. This meter measures pH, conductivity, and temperature. The easy to read screen and push button operation makes it simple to choose your preferred parameter to display. This meter can be used anytime and anywhere to help manage your plants daily nutrient requirements with no external power supply required.



Probe Cable : 2m L (6.5ft)

BLBMETCOM Min. Buy 1 EA



Bluelab® Combo Meter Plus

An all-in-one, convenient portable solution for accurate measurement of pH, conductivity, and temperature in nutrient solution. The battery-powered, lightweight unit can be used anywhere, anytime to measure critical parameters related to nutrient uptake in plants. The Bluelab Leap pH probe also allows fast and accurate pH measurements direct from the rootzone in a wide range of growing media.



Measures pH, Conductivity & Temperature

BLBMETCOMPLUS Min. Buy 1 EA



Bluelab® Combo Meter pH Replacement Probe

Dependable double-junction pH probe technology that's built to last. Double-junction probe reduces reference contamination, extending longevity. Fast sensor response ensures quick and accurate measurements. Effective in solutions of 0.2 EC and above.



pH probe

BLBPROBPH Min. Buy 1 EA



Bluelab® Commercial Truncheon® Nutrient Meter

An EC meter that is built to last a lifetime, and specially designed for hydroponic crops that have higher-than-normal EC during their growing cycle. The Truncheon meter is a brilliantly simple meter that allows you to measure and adjust nutrient levels on the go. The robust, reliable, waterproof construction ensures long-lasting value and is easy to clean and disinfect.



Measures EC, CF, & PPM

BLBTRUNCMV2 Min. Buy 1 EA



Bluelab® Conductivity Pen Meter

The go-to for hand held conductivity pens. The Bluelab® Conductivity Pen measures conductivity and temperature and simply tells you the amount of nutrients in your solution. Conductivity is automatically compensated with the integrated temperature sensor. Provides a compact, quick, and accurate way to measure two key parameters for crop health.



Measures Conductivity and Temperature

BLBPENCON Min. Buy 1 EA



Bluelab® Guardian Monitor

Monitoring your crops 24 hours a day, with the ability to set high and low alarms for each parameter. A flashing display lets you know if your parameters move away from the optimum, allowing you to make the important adjustments quickly and effectively. The large, clear display allows readings to be viewed from a distance. The Bluelab® Guardian Monitor is mains powered.



Probe Cable : 2m L (6.5ft)

BLBMONGUA Min. Buy 1 EA



Bluelab® Guardian Monitor Connect

A constant indicator of pH, conductivity, and temperature, enabling you to optimize these parameters. Monitor and wirelessly data log the essential nutrient solution parameters - pH, conductivity, and temperature - when teamed up with a Bluelab® Connect™ Stick and local computer. Keeping track of the growth history on your computer will give you the blueprint for crop success.



Probe Cable : 2m L (6.5ft)

BLBMONGUACON Min. Buy 1 EA



Bluelab® Guardian Monitor In-Line Connect

Threaded probe heads allow for simple installation direct into an irrigation line for effective in-line measurements. Suitable for use before or after mechanical injectors. Both conductivity and pH probes can screw directly into female 1in NPT pipe fittings using the included adapter.



In-line pH probe cable : 3 meters L - 10 ft L

BLBMONGUACONIN Min. Buy 1 EA



WARNING: This product is not available for sale in CA. For most up to date information please visit bfgsupply.com

Bluelab

Greenhouse Meters & Test Kits

Bluelab® Leap pH Probe

Get the fundamentals of growing right by getting accurate, direct pH measurements in any substrate in a matter of seconds. The reinforced spear-tip allows fast, direct measurement in soil, coco coir blends, rockwool, potting mixes and solution. The double-junction probe reduces reference contamination, extending the longevity. BNC connector is covered to prevent corrosion.



For Bluelab® Combo Meter - Bluelab® Combo Meter Plus - and Bluelab® Multimedia pH Meters
BLBPROBPHLEAP Min. Buy 1 EA



Bluelab® Multimedia pH Meter

Combine the Bluelab® Multimedia pH Meter and Bluelab® Leap pH Probe to take fast accurate measurements in nutrient solution, soil, coco coir, rockwool, potting mix and many other media types. Calibration is simple with one push button on the meter and fresh Bluelab® Calibration Solutions. Successful calibration indicator is displayed on screen for 30 days.



Standard Cable : 2m L (6.6 ft)
BLBMETMULTI Min. Buy 1 EA



Bluelab® pH Controller

This controller fine-tunes the reservoir pH levels for you. It offers automatic measuring and adjusting to pre-set pH levels with optional alarms. Provides consistent control of pH in growing systems with intuitive "on time" and "off time" which allows the solution to dose and mix before the controller measures and doses again. Get some reassurance with safety lockouts to prevent over delivery of pH. It has the capacity to control pH levels in systems with reservoirs up to 200gal (760L). The plant-safe green backlit LCD has adjustable brightness and an easy to read display.



Probe Cable : 2m L (6.5ft) - Dose pH Up or pH Down
BLBCONTPH Min. Buy 1 EA



Bluelab® pH Pen Meter

Handheld pH meter provides a compact, quick, and handy way to manage the success of your crops to ensure maximum uptake of nutrients. A key parameter that affects nutrient uptake is whether your solution is acid or alkaline - this is measured in the pH. Measures pH and temperature, with selectable units for temperature.



Measures pH and Temperature
BLBPENPH Min. Buy 1 EA



Bluelab® pH Probe Inline

A replaceable double-junction pH probe for your Bluelab Guardian Monitor Connect Inline. Double-junction probe reduces reference contamination, extending longevity. Fully waterproof, fast sensor response ensures quick and easy accurate measurements and a 3 meter cable for measuring in hard to reach locations. Effective in solutions of 0.2 EC and above.



3/4in NPT Thread - Use with 1in Adapter
BLBPROBPHIN Min. Buy 1 EA



Bluelab® Probe Care Kit

This kit has everything you need to clean, calibrate, hydrate, and maintain your pH and conductivity probes. With the pH + conductivity probe cleaning kit, you will be maximizing your conductivity probe's longevity & accuracy, by keeping your probe clean, calibrated, and hydrated.



for Bluelab® pH & Conductivity Probes
BLBCAREKITPHCONL Min. Buy 1 EA



Bluelab® Probe Care Kit

With Bluelab's® pH probe cleaning kit, you have everything you need to clean, calibrate, and hydrate your probes. The pH probe care kit comes with probe care instructions, 20 ml single-use Bluelab Solution Sachets - two each of: pH 7.0, pH 4.0 and KCl solutions, three plastic cups, a Bluelab® pH Probe Cleaner, and a toothbrush for cleaning your pH probe.



for Bluelab® pH Probes
BLBCAREKITPH Min. Buy 1 EA



Bluelab® Pulse Multimedia EC & MC Meter

All-in-one device measures EC, moisture, and temperature with a single click, and in under ten seconds. Simply and easily spot check moisture and temperature directly from the root zone, or nutrient solution to allow early identification of results over or under range. Spot check, correct, and achieve better yield and grow healthier plants across a wide range of growing media.



Measures EC, Moisture & Temperature
BLBMETPULSE Min. Buy 1 EA



Bluelab® Truncheon® Nutrient Meter V2

Displaying all the conductivity scales EC, CF, PPM 500 & PPM 700 on a single line. Each time you feed your plants it's essential to know the nutrient levels of your solution. Simply done with the Bluelab Truncheon Nutrient Meter. Flashing lights indicate your conductivity reading, which is automatically compensated with the integrated temperature sensor. Removable shroud for easy cleaning.



40cm L - 16 in. L
BLBTRUNV2 Min. Buy 1 EA



Greenhouse Meters & Test Kits

Hanna® DiST®6 EC / TDS / Temperature Tester

This tester includes features such as: a replaceable graphite electrode, adjustable TDS ratio, °C or °F measurement, Automatic Temperature Compensation (ATC) with adjustable battery level indicator, stability indicator, automatic shut-off and automatic calibration.



Not available for sale in CA

High Range EC Measurement

HIH198312 Min. Buy 1 EA

Hanna® GroLine Waterproof Combo Meter for pH, EC, TDS

Designed to bring simplicity to nutrient testing, the HI9814 Portable GroLine Meter is designed specifically for Hydroponic growers. The specialized electrode combines 3 sensors in a single rugged probe featuring a polypropylene body, integrated temperature sensor, and cloth junction.



Not available for sale in CA

HIH19814 Min. Buy 1 EA

Hanna® GroLine Waterproof Combo Tester for pH, EC, TDS

A slim, lightweight, and waterproof pocket tester that measures pH, conductivity (EC), TDS (ppm), and temperature. Simple, two-button meter operation and advanced features, including a selectable EC to TDS conversion factor (0.5 - 500 ppm and 0.7 - 700 ppm), for your essential testing.



Not available for sale in CA

HIH198131 Min. Buy 1 EA

Hanna® GroLine Waterproof Hydroponic pH Tester

The GroLine HI98118 pH/temperature tester is our latest pocket meter for measuring the pH of a hydroponic nutrient solution. This modern looking meter is only 0.7" thick and extremely ergonomic, fitting comfortably in your hand. The HI98118 has a very large easy to read LCD display that shows both pH and temperature along with calibration, stability and low battery indicators.



Not available for sale in CA

HIH198118 Min. Buy 1 EA

Hanna® pH, EC & TDS Tester

A waterproof tester that offers high accuracy pH, EC/TDS, and temperature measurements in a single tester! No more switching between meters for your routine measurements. This floating, waterproof combination tester has an easy to read, LCD and an automatic shut-off. pH and EC/TDS readings are automatically temperature compensated.



Not available for sale in CA

High Range

HIH198130 Min. Buy 1 EA

Hanna® 4.01 pH Buffer Solution

Solution is prepared according to precise formulas and is standardized with a pH meter calibrated according to the NIST standards. Batch number, expiration date and correlation table between pH and temperature included.



Not available for sale in CA

500ml

HIH17004L Min. Buy 1 BT

1 gallon

HIH170041G Min. Buy 1 GL



Hanna® 7.01 pH Buffer Solution

pH 7.01 is the most widely used among all buffer solutions. Solution is NIST standardized.



Not available for sale in CA

20ml - 25pk

HIH170007P Min. Buy 1 PK

500ml

HIH17007L Min. Buy 1 BT

1 gallon

HIH170071G Min. Buy 1 GL



Hanna® EC Conductivity Calibration Solution

The 1413 µS/cm calibration solution is best suited for general use. This solution is also available in combined kits with HANNA® pH 7 buffer for easy calibration of multiparameter instruments.



Not available for sale in CA

1, 413 µS/cm

HIH17031L Min. Buy 1 BT



Hanna® Electrode Storage Solution

To minimize clogging and ensure fast response time, always keep the glass bulb and the junction of your pH electrode moist. Store the electrode with a few drops of HI 70300 storage or pH 7 buffer solution in the protective cap.



Not available for sale in CA

HIH170300L

Min. Buy 1 BT



Hanna® General-Purpose Cleaning Solution

HI7061M is a general purpose cleaning solution that can be used for a variety of applications. Electrodes can become dirty from use and will produce inaccurate results even as they read correctly in a pH buffer. Hanna's® cleaning solutions eliminate impurities and residues that are left on electrode surfaces when immersed in samples during measurement or when stored incorrectly.



Not available for sale in CA

230ml

HIH17061M Min. Buy 1 BT



Dilution™ SOLUTIONS

An Ingersoll Rand Business

Greenhouse Meters & Test Kits

Dilution Solutions™ EC Calibration Solution

The EC Calibration Solution works with both ECO and PRO models. Includes individual liquid calibration packets. Ready-to-Use.



20pc Box
DILCP1000

Min. Buy 1 EA

Dilution Solutions™ PH Calibration Solution

The PH Calibration and storage solution works with both ECO and PRO models. Includes individual liquid calibration packets and ready-to-use.



20pcs
DILPHP7

Min. Buy 1 EA

Dilution Solutions™ PH Storage Solution

The PH storage solution that keeps probe balanced, contains fungicide, helps probe last longer and works with both ECO and PRO models.



60cc
DILPHSTOR

Min. Buy 1 EA

Dilution Solutions™ HM Digital EC Tester

The Eco HM digital EC meter will help you get your desired results. Easily measure conductivity and TDS. Used for testing and monitoring.



6in x 1.7in x .7in
DILCOM80

Min. Buy 1 EA



Dilution Solutions™ HM Digital pH Tester

The Eco HM digital pH tester will help you get your desired results. Easily measure conductivity, pH, and temperature of water.



6in x 1.7in x .7in
DILPH80

Min. Buy 1 EA



Dilution Solutions™ HM Digital Meter

The Pro HM digital EC meter measures conductivity, TDS, temperature of water.

Easy, automatic calibration
Replaceable features
Waterproof, they float



7.3in x 1.3in x 1.3in
DILCOM100

Min. Buy 1 EA



Dilution Solutions™ Pro HM Digital pH Meter

The Pro HM digital pH meter with get you the results you are looking for. The pH meter is designed for testing and monitoring your precious crop. Easily measure pH and temperature of water.



7.3in x 1.3in x 1.3in
DILPH200

Min. Buy 1 EA





MOTOROLA SOLUTIONS
BUSINESS RADIO RESELLER

DISCOVER THE POWER OF COMMERCIAL.

**ASK YOUR BFG REP
FOR A QUOTE TODAY.**

Now available at BFG!

Discover the Power of Motorola Solutions Commercial Two-Way Radios.

Built tough, these radios are durable and made to stand up to every day wear and tear and go the distance. BFG is now selling EVX, SL, BPR, and CP Series Commercial Two-Way Radios.

Ask your rep how you can get a quote or request a demo today!

Speaker Mics and
Multi-Unit Chargers
available



WATERPROOF!
EVX SERIES

EVX SERIES



SL300 SERIES



BPR40 SERIES



CP185 SERIES



CP100d SERIES



CP200d SERIES

MOTOROLA, MOTO, MOTOROLA SOLUTIONS and the Stylized M Logo are trademarks or registered trademarks of Motorola Trademark Holdings, LLC and are used under license. All other trademarks are the property of their respective owners © 2021 Motorola Solutions, Inc. All rights reserved.



MOTOROLA SOLUTIONS

VALUE ADDED RESELLER

Other Equipment

ProMarketing Motorola® Two-Way Commercial Radios

Durable, lightweight and long-lasting, MOTOTRBO R2 proves the right choice for all-day reliability, even in challenging work environments.



4 watt 16 Channel UHF Radio/Covers up to 300,000sq ft or 25 floors indoors

PIMCP100DUA Min. Buy 1 EA

ProMarketing Motorola® 2-Way 3 Watt Radio

EVX-S24 BLACK 2 Watt Analog 3 Watt Digital, 256 Channel, Analog & Digital, UHF 403-470 MHz Display with Limited Keypad Model AC146U502-MOT-NA



256 channels
PMIEVXS24UB

Min. Buy 1 EA



ProMarketing Motorola® CLS Series Two-Way Radio

Durable but lightweight, this two way radio delivers versatility of expanded communications by enhancing safety and security, improving response time and maximizing productivity. With little or no training required, these two way radios are remarkably simple to use, making them ideal for high employee turnover industries. FCC license is required.



1 Watt 1 Channel UHF Radio / Covers up to 200,000sq ft or 15 floors indoors / Battery life up to 14 hours per charge / 2 Year Warranty

PMICLS1110 Min. Buy 1 EA



1 Watt 4 Channels UHF Radio / Covers up to 200,000sq ft or 15 floors indoors / Battery life up to 14 hours per charge / 2 Year Warranty

PMICLS1410 Min. Buy 1 EA



ProMarketing Motorola® CP Series Two-Way Commercial Radios

The CP100d Series radios meet demanding specifications, including IP54 for dust and water and U.S Military Standard 810C, D, E, F and G for exceptional durability.



4 watt 16 Channel UHF Radio/Covers up to 300,000sq ft or 25 floors indoors

PMIR2 Min. Buy 1 EA



ProMarketing Motorola® RM Series Two-Way Business Radios

RM Series two-way radios have the business smarts to help you work better together. They combine outstanding quality with excellent affordability. With crisp, clear audio throughout the workplace and exceptional durability, RM Series radios won't quit in high noise, harsh conditions and hard use. The RM Series meet Military Standard 810C, D, E, F plus G and IP54/55 standards.



Covers up to 250,000sq ft / 4 Channels
PMIRMU2040 Min. Buy 1 EA

Covers up to 220,000sq ft / 8 Channels
PMIRMV2080 Min. Buy 1 EA

Covers up to 250,000sq ft / 8 Channels
PMIRMU2080 Min. Buy 1 EA

ProMarketing Motorola® DLR Series Digital Two-Way Radio

Digital, 900 MHz, license free radios leverage frequency hopping technology. This technology enables the radio to continually change frequencies, making it virtually impossible for others to listen to your private conversations. Enhance radio fleet privacy by simply setting a unique 4 digit Profile ID number. No FCC license required, 2 Year Warranty.



Operates on 900 MHZ / 2 Channels / Covers up to 300,000sq ft or 25 floors indoors / Battery life up to 14 hours per charge / Not Compatible with analog radios (CLS, XTN, RM or RDX)

PMIDL1020 Min. Buy 1 EA



Operates on 900 MHZ / 6 Channels / Covers up to 300,000sq ft or 25 floors indoors / Battery life up to 14 hours per charge / Not Compatible with analog radios (CLS, XTN, RM or RDX)

PMIDL1060 Min. Buy 1 EA





MOTOROLA SOLUTIONS

VALUE ADDED RESELLER

Other Equipment

ProMarketing Motorola® Heavy-Duty Spring Action Belt Clip

Provides extra durability for your portable two-way radio.



PMIRLN6307 Min. Buy 1 EA

ProMarketing Motorola® Multi Unit Charging Tray

Keep your workstation organized with the universal multi-unit charger. Six-radio charger unit charges up to six two-way radios at one time. Charges in six hours.



CL5 series / 6 unit
PMI56531 Min. Buy 1 EA

RDX series / 6 unit
PMIRLN6309 Min. Buy 1 EA

RM series / 6 unit
PMIPMLN6384 Min. Buy 1 EA

ProMarketing Motorola® Rechargeable Battery

A standard Original Li-Ion battery for two-way portable radios.



DLR Series Battery
PMIHKNN4013 Min. Buy 1 EA

ProMarketing Motorola® Swivel Earpiece

This earpiece features an in-line microphone and push-to-talk button that makes communication easy when your radio is not readily accessible.



w/ Clip PTT
PMIHKLN4604 Min. Buy 1 EA

SENSAPHONE®

Other Equipment

Sensaphone® 400 Auto-Dialer Remote Monitoring System

Previously called "auto dialers," these systems notify you if they sense undesirable temperatures or other conditions which offers small-business owners, vacation property owners, and other property managers an easy and inexpensive way to monitor a remote facility. Notifies up to four people by voice phone call in the event of an alarm.



4-Zone - Temperature-Sensing Range of -20° to 150° F - Custom Voice Alerts & Alarm Notifications
SENSFPGD-0400 Min. Buy 1 EA



Sensaphone® Sentinel Remote Monitoring System

The Sentinel remotely monitors greenhouses and other sensitive areas to prevent loss of valuable assets. The system is ideal for greenhouse operators, commercial growers and retailers. The Sentinel system monitors up to 12 different environmental and equipment status conditions including temperature, humidity, power failure and water detection.



12-Zone - Temperature-Sensing Range of -109° to 168° F - Custom Voice Alerts & Alarm Notifications
SENSPSCD1200 Min. Buy 1 EA



WARNING: This product is not available for sale in CA. For most up to date information please visit bfgsupply.com



**ADVANCING
ALTERNATIVES**

Other Equipment

**Roll-Up/Lock Down Curtain Systems
Always Ready to Open
Always Ready to Close**

Roll-Up sidewall curtain package for free- standing or gutter connect greenhouses includes:

- **Automated or Manual** vent drives for easy operating of your ventilation curtain.
- **Controllers for automated systems** allows your curtain to roll up or down based on your temperature setpoint
- **Double WireLock** to attach your roof covering to the top clasp and the roll-up curtain to the lower clasp.
- **Roll-Bar options** allow you to clasp your choice of curtain material, single or multi-layer.
- **Continuous Roll-Lock** provides an air-tight seal across the entire bottom.
- **Wind Rope System** with hooks to hold the curtain to the structure, and materials for creating end panels which the curtain laps

**Environmental
Controller**

Every perfect climate starts with control. Use our all-in-one touchscreen controllers to automate your low voltage motors, fans, and heaters! They come equipped with climate and timed controls with optional weather overrides. Remote access available option with Aegis TEC Plus.

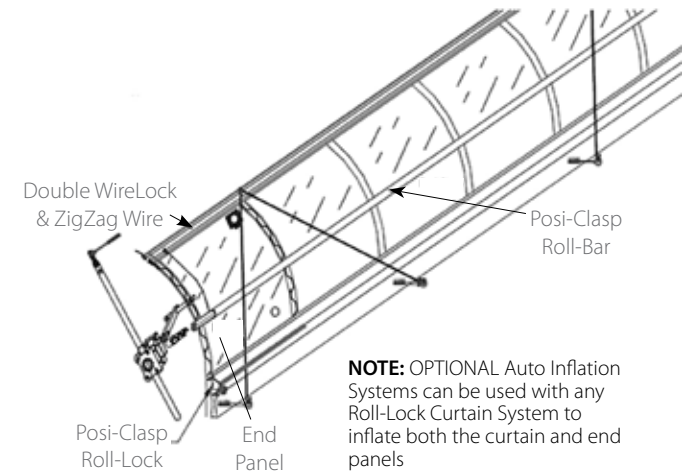

NOTE: OPTIONAL Auto Inflation Systems can be used with any Roll-Lock Curtain System to inflate both the curtain and end panels

Description

Package w/Roll-Bar & top poly clasp but no Roll-Lock
Package w/Roll-Bar & Roll-Lock but no top poly clasp
Package w/Roll-Bar, Roll-Lock and double top poly clasp
All curtains must be ordered in increments of 4ft.

Contact Your BFG Sales Representative for
MORE INFORMATION

Low Voltage Motors

Our low voltage vent drive line is specially designed to meet the unique demands of your greenhouse or high tunnel. They provide the torque to drive roof or sidewall ventilation, shade, and light deprivation systems.



Soft Handle

Fits over and bolts to input loop



ADV64CH

Min. Buy 1EA

Guide Pipe

Hole at one end for mounting hardware (order guide pipe hardware separately)



7ft Long

ADVGP7

Min. Buy 1EA

**Adapter 1/2in Shaft X
2.3in**



ADV65RBA1223

Min. Buy 1EA

Gearbox 7:1 Ratio

Gray color with loop handle & (4) 8 x 14MM metric bolts



Gear is 1.5in W x 2.25in deep x 3.125in H

ADV63G71

Min. Buy 1EA

13:1 Gear

Manual operator with guide wheels, internal brake and input loop



ADV63GC131

Min. Buy 1EA

**Grower Select® Spring Lock
Roll-Up Shaft**

Aluminum spring lock roll up shaft used for sidewall ventilation.



12ft

GS38-0806

Min. Buy 1EA

**Grower Select® Roll-Up
Shaft Splice**

Designed as a low-cost ventilation system with no additional electrical requirements or costs to operate.



1.5in x 12in

GS38-0807

Min. Buy 1EA



DRAMM

Sanitizers, Cleaners, & Disinfectants

Dramm® PulsFOG® Cleaning Solution

PulsFOG Cleaning Solution should be used after each application to neutralize chemicals and clean the chemical injection system of all PulsFOG® foggers. To Use : Simply run the cleaning solution through the solution lines and nozzles.



1gal - PFC #2 Blend - for PulsFOG Equipment

DRMPFC1

Min. Buy 1 EA



Sprayers & Parts

Dramm® Back Pack Sprayer with Lithium Ion Battery

The Dramm BP-4 Back Pack Sprayer is a rechargeable, battery powered, high-pressure sprayer that fits comfortably on your back. Operating at a maximum of 150 psi, the BP-4 atomizes spray solutions for excellent coverage. The battery operated pump ensures even flow rates. The 4 gallon capacity is just the right size. Perfect for spot treatments or concentrated applications.



150psi

DRMBP4LI

Min. Buy 1 EA



Dramm® ChemDose™

Portable solution for precise dosing of chemical solutions directly to the pot or root zone. Cart mounted with a 20gal tank, an 18 inch width and a rechargeable battery. Includes three different wand lengths.



20gal

DRMCD120

Min. Buy 1 EA



Dramm® ChemDose™

A portable, hose end unit that connects to either an injector or hydraulic sprayer below 100 psi. This eliminates problems with hose length and power. Tank not included.



DRMCD2

Min. Buy 1 EA



Dramm® Coldfogger™

The large tank holds enough spray solution to provide up to 70,000 sq ft of coverage in as little as 70 minutes. The powerful high pressure fog projects a plume of 30-60 micron diameter spray droplets 20 - 25ft from the hand held spray gun. The quality of spray is a tremendous improvement over conventional hydraulic sprayers that produce droplets that vary in size.



3,000psi

DRMCFAR20150

Min. Buy 1 EA



Sprayers & Parts

Dramm® Extension Lance

To complete your heavy duty sprayer, add an optional extension lance. The undersides of leaves can be reached with lance, therefore applying spray solution where it is needed. Excellent for whitefly control.



For MSO, CS-5AGS or MS-GAS

DRMLS

Min. Buy 1 EA



Dramm® MSO Heavy-Duty Hydraulic Sprayer

Model MSO is a hydraulic sprayer with fully adjustable pressures, making it a highly flexible tool for the application of pesticides, fungicides, wetting agents, cleaning solutions and disinfectants. By simply twisting the spray gun knob you can adjust the pressure from a stream that throws up to 20 feet to an eight foot diameter mist. Pneumatic Turf tires are available on special order.



500psi - 0.5gpm - 1/4hp Electric Motor - 100ft Discharge Hose - 20gal Tank

DRMMS20100

Min. Buy 1 EA



Dramm® Hydra™ 50 Sprayer

The Dramm Hydra Multi-spray Hydraulic Sprayer is a high volume hydraulic sprayer capable of performing a variety of tasks. The Hydra is perfect for the application of insecticides, fungicides, growth regulators, fertilizers, disinfectants, and other chemicals. With a pump output of 4gpm, the Hydra offers enough volume to utilize a choice of guns and agitate the tank at the same time.



Electric Motor - Single Reel - 150ft 1/4in Hose - 50gal Tank

DRMHYDRA50150

Min. Buy 1 EA



Dramm® Hydra™ SprayTrax®

Capitalizes on years of experience in chemical applicator design to make a powerful sprayer that is easy to use. Stainless inner sleeved, triplex piston pump coupled to a 5.5hp Honda gasoline motor producing 7 gallons per minute. The SprayTrax offers enough volume to utilize a choice of guns or drenching equipment and agitate the tank simultaneously.



Gas Engine - Single Reel - 150ft Hose 50gal Tank

DRMHYDRAGST50150

Min. Buy 1 EA



Dramm® MSO Heavy-Duty Hydraulic Sprayer

Model MSO is a hydraulic sprayer with fully adjustable pressures, making it a highly flexible tool for the application of pesticides, fungicides, wetting agents, cleaning solutions and disinfectants. By simply twisting the spray gun knob you can adjust the pressure from a stream that throws up to 20 feet to an eight foot diameter mist. Pneumatic Turf tires are available on special order.



500psi - 0.5gpm - 1/4hp Electric Motor - 100ft Discharge Hose - 20gal Tank

DRMMS20100

Min. Buy 1 EA



WARNING: This product is not available for sale in CA. For most up to date information please visit bfgsupply.com

DRAMM

Sprayers & Parts

DRAMM® AutoFog™ Automatic Chemical Application

The Dramm Autofog automatically sprays areas up to 70,000 square feet (area varies by model) with no applicator present. The ultra-fine cloud of droplets penetrates deep into the plant canopy covering all surfaces, ensuring excellent control of greenhouse pests and diseases.

The Autofog saves time and money by eliminating the labor needed to spray while reducing the amount of chemical needed to control your pests. By creating billions of tiny spray droplets, the Autofog treats large areas with less chemical solution.

Just set the timer, mix the chemical and leave. The Autofog does the rest. The next morning, ventilate the greenhouse, clean up the Autofog. **Optional stainless steel nozzle available for use with oxidizers.**



Item #	Model	Coverage Area		Power	Type	Barcode
		Machine Alone	With HAF			
DRMMLVH10A	Mini AutoFog™	Up to 5,000sq ft	Up to 7,000sq ft	120V AC	Single Nozzle	
DRMMLVH10ASS	Mini AutoFog™	Up to 3,000sq ft	Up to 5,000sq ft	120V AC	Single Nozzle	
DRMSLVH20A	AutoFog™	Up to 12,000sq ft	Up to 26,000sq ft	120V AC	Air Assist	
DRMSLVH20ASS	AutoFog™	Up to 12,000sq ft	Up to 26,000sq ft	120V AC	Air Assist	
DRMLVH20ASS	AutoFog™	Up to 30,000sq ft	Up to 70,000sq ft	220V AC	Air Assist	

DRAMM® K-10 Portable PulsFOG®

Rapidly applies chemicals as a fog. The ultra-fine cloud of droplets penetrates deep into the plant canopy covering all surfaces, ensuring excellent control of greenhouse pests and diseases. for greenhouses. Fogs 10L in 45 minutes. Propels fog up to 65ft.



25hp - 10L

DRMK10

Min. Buy 1 EA



DRAMM® K-22 Standard PulsFOG®

Rapidly applies chemicals as a fog. The ultra-fine cloud of droplets penetrates deep into the plant canopy covering all surfaces, ensuring excellent control of greenhouse pests and diseases. for greenhouses. Fogs 10L in 30 minutes. Propels fog up to 120ft.



50hp - 10L

DRMK22

Min. Buy 1 EA



DRAMM® PulsFOG® Turbo Hybrid Coldfogger

The PulsFOG Turbo Hybrid is an electrically powered, pneumatic coldfogger. Its high-performance turbine creates a powerful, warm flow of air that atomizes and propels the fog up to 75ft, depending on the nozzle and particle size. The output and droplet size of the Turbo Hybrid may be altered by changing the nozzle for a variety of applications and results.



5L Capacity

DRMTULV110

Min. Buy 1 EA



DRAMM® Foaming Sprayer

Foam improves disinfection by increasing contact time. Air is pumped by hand into the chamber, pressurizing the spray solution. Some of that compressed air mixes with the spray solution in the nozzle to create an air-rich foam. The aerated foam slowly degrades over time, allowing for more contact time. The Foam 8L comes with three different mixing valves to allow for different air/solution ratios.

60 PSI Maximum
Five Liter Tank
Relief valve auto opens at 60PSI
Treats up to 500 Square Feet



8lt Compression Foamer

DRMFoam8L

Min. Buy 1 EA



DRAMM® FM Line Foamers

The FM line of foamers uses compressed air (not included) to propel and create a rich, aerated foam for the application of disinfectants. When connected to a compressor, the FM units can throw a foam up to 15 feet, providing excellent coverage and a persistent foam. A foam created with compressed air is much richer and will last on surfaces longer.



20gal with 50ft Hose

DRMF2050

Min. Buy 1 EA

50gal with 50ft Hose

DRMF5050

Min. Buy 1 EA

50gal with 50ft Hose Big Foot

DRMF5050BF

Min. Buy 1 EA

100gal SprayTrax with 50ft Hose

DRMF1001R50

Min. Buy 1 EA



DRAMM

Jacto

Sprayers & Parts

Dramm® FertiCart

With years of experience in building carts for greenhouse chemical application systems, Dramm offers our portable injector carts. Utilizing the popular MSO cart and tank, the Dramm Injector Cart can be used with a variety of injectors. Available in a single 20 gallon tank model or in a three, 7 gallon tank model, the FertiCart offers portability and flexibility in injection.

Made from rubber coated steel with a plastic mounting plate, the Dramm Injector Cart can stand up to all greenhouse chemicals, including disinfectants and acids with no trouble. The FertiCart includes all fittings and connections. Unions on either side of the injector allow for easy installation or removal for service. Combine the Injector Cart with any of Dramm's line of watering tools to complete the package.



Three 7gal Tanks

DRMFC3X7DT Min. Buy 1ea

Three 7gal Tanks with D14 Dosatron Injector

DRMFC3X7DTD14MZ2VFBPII Min. Buy 1ea



20gal Tank with D14 Dosatron Injector

DRMFC20DTD14MZ2VFBPII Min. Buy 1ea



50gal Agitation with 20gpm Dosatron Injector

DRMFC50AD45RE15VFI Min. Buy 1ea



100gal with Agitation

FST100AD40MZ2BPVFI Min. Buy 1ea



Dramm® Stainless Steel Nozzle

Dramm's stainless steel nozzle is designed to work exclusively for their AutoFog™ MLVH and SLVH models. This stainless steel nozzle is intended to replace the standard brass nozzle for the application of corrosive chemicals. Fits the Dramm® AutoFog™ 120V and Dramm® Mini AutoFog™ 120V machines.



For AutoFog™ Models SLVH & MLVH - 45ml/min

DRM129J753A2 Min. Buy 1 EA



Sprayers & Parts

Jacto Battery Backpack Sprayer

The Jacto PJB16 is the most innovative sprayer in its class. It features a long-life lithium-ion battery, digital display with soft touch buttons, 5 pressure settings, pace meter, battery level indicator, onboard diagnostics, auto shut off and lockable pressure setting. The Jacto PJB16 allows the user to select 5 different pressure settings.



**4 gallon
JACPJB16**

Min. Buy 1 EA



SIEBRING

Sprayers & Parts

Siebring Mist'R Drencher Sprayer

The Mist'R Drench Sprayer provides the versatility you need - allowing for a gas or electric power supply. Includes : 3pc nozzle for high or low misting, a drenching water breaker screen nozzle, (2) 18in wands, (1) 12in wand, (1) 12in curved (hook) extension, a back flush connector for easy cleaning, and 100ft of wire braid hose.



**Electric or Gas Power - 0-15° Pressure Nozzles
- 800psi - 3gpm Flow - 10in "No-Flat" Tires**

SMKMD83BW

Min. Buy 1 EA



Siebring Kruser Sprayer

The Kruser Sprayers are built to last, and are used by growers in greenhouses, nurseries, vegetable farms, fruit orchards, and flower gardens. The bottom tank features a drain and sump for maximum usage. Includes : mist nozzle assembly, 18in wand, 100ft of 1/4in wire braid hose, hose reel and high pressure gun. The constant agitation suspends wetttable powders.



**1hp Gas Engine - 750psi - 1.5gpm Flow
25gal Tank - 10in "No-Flat" Tires**

SMKKS-750-100

Min. Buy 1 EA



**Electric
SMKKS750**

Min. Buy 1 EA



WARNING: This product is not available for sale in CA. For most up to date information please visit bfgsupply.com



Fertilizer Injectors

Dosatron® Injector

This non-electrical proportional injector provides the perfect solution for: fertilizers, insecticides, fungicides, algicides, acids, wetting agents, disinfectants, spraying. The water-activated injector includes mounting bracket, suction hose, weighted strainer, and operating manual.



6.125in x 14in - 11gpm
Pipe Size : .75in NPT Thread
DOSATD25F1VFII Min. Buy 1 EA



6.3125in x 19.125in - 14gpm
DOSATD14MZ2VFII Min. Buy 1 EA



8.5in x 25.25in - 40gpm
DOSATD40MZ2VFII Min. Buy 1 EA



7.5in x 24in - 20gpm
DOSATD45RE15VFII Min. Buy 1 EA



Dosatron® Li'l Bud-D

Portable fertilization system is perfect for spot treatments. Includes 5gal bucket with lid. Accommodates the 11 and 14gpm injectors. Injector and hook-up kit sold separately.



22in D x 19in W x 44 1/2 H. Tank Size : 5gal. Tire Size : 10in No-Flat
DOSATHS15-5 Min. Buy 1 EA



Dosatron® Li'l Bud-D Quick Hook-Up Kit

For use with the Li'l Bud-D portable fertilizer system. Fits 11gpm and 14gpm injectors. Includes: Filter, check valve, clamp, 5/8in hoses, elbows, a straight 5/8in barb to 3/4in NPT, Velcro strap and Teflon tape. Dosatron injector not included.



DOSATHSPK58LB Min. Buy 1 EA



Dosatron® Eco-Cart with Plumbing

Portable fertilization system is perfect for garden centers and ideal for spot treatments. Includes 5gal bucket with lid, 11gpm injector and plumbing.



15in D x 13.5in W x 40in H. - 5gal Tank (Bucket with Lid Included) - 7in No-Flat Tire
DOSATHSECOD25F1 Min. Buy 1 EA



15in x 42in without Legs - 15in x 55in with Legs - 100gpm - Pipe Size : 2in NPT Thread
DOSATD20SVFII Min. Buy 1 EA



Fertilizer Injectors

Dosatron® Dilution Solutions™ Filter Kit

200 mesh (80 micron) filter kit includes a filter with cleanout valve and hose couplings for quick hook-up.



For Dosatron® Systems - 200 Mesh (80 micron) Filter - 0.75in - 0.79gpm
DOSATAKF5AP11KIT-A Min. Buy 1 EA

Dosatron® Filter Kit

This Filter kit is designed for use with the Dosatron® Chemical Injector Model D45RE. The 1-inch Y-filter kit is made from durable polypropylene and includes Schedule 80 unions along with a cleanable, permanent, stainless steel filter. No replacement cartridges are necessary. 200 mesh/80 micron Screen.



200 Mesh/80 Micron Stainless Steel Screen - for Dosatron® Injector Model D45RE
DOSATAKF5AP20KIT Min. Buy 1 EA

Dilution Solutions™ Ultrasonic Micro-Doser Kits

The Ultrasonic Micro-Doser Hi-Flow kit gives you the capability to inject water treatment products, plant health additives, acids and bases. The system proportionally injects directly into the water line with flow rates up to 400gpm using an ultrasonic flow meter. Max injection rate 3.5oz/100gal.

Kit Includes:

- eOne Pump with acid-resistant wetted parts
- Chemical Suction and Injection Kit
- Ultrasonic Flow Meter
- Plumbing Saddle



Ultrasonic Micro-Doser 2in Kit with eOne MF 0710
DOSMDE0710MF2KITUS



Ultrasonic Micro-Doser 2.5in Kit with eOne MF 1012
DOSMDE1012MF2.5KITUS



Ultrasonic Micro-Doser 3in Kit with eOne MF 2007
DOSMDE2007MF3KITUS



Ultrasonic Micro-Doser 4in Kit with eOne MF 3005
DOSMDE3005MF4KITUS



SYSTEM FEATURES	
Easy to read digital display	Designed for simple installation
Proportionally injects into variable flow rates	PVDF wetted parts, high chemical resistance
Minimizes spills and employee exposure	Ultrasonic Sensor calculates flow from outside of the water line
Simple to program and adjust	Multi-directional



WARNING: This product is not available for sale in CA. For most up to date information please visit bfgsupply.com



Fertilizer Injectors



J+ Advanced

H.E. Anderson J+Advanced Series Ratio:Feeder® Injection Systems

J+Advanced Ratio:Feeder® Injector Systems can inject almost any liquid chemical into a water line at a set ratio. Most common uses include fertilizer injection, acid injection for pH stabilization, chlorination, and sanitization.

All J+ Advanced Injectors can be configured to pump multiple chemicals or solutions at different ratios. Systems can be configured to work with flows ranging from 1/4 gallon per minute to 10,000 gallons per minute. Common injection rates range from 1:100 to 1:10,000. Injectors require at least 30 psi to operate with a maximum of 125psi or 100psi depending on which blend tank is utilized. Controllers can be powered using 120VAC or 12VDC.

J+Advanced injectors can be purchased as complete assembled units which fit most common applications or as individual components sized especially for your specific application.

- J+ Advanced CONTROLLER - Connects to the water meter and pilot valve/manifold. It measures the water flow using the water meter then turns the pilot valve on and off to stroke the pump heads at the proper rate to maintain the set ratio.

- WATER METER - Used by J controller to measure water flow. Many different models are available which can measure flows from 1/4 GPM up to 10,000 GPM.

- MANIFOLD/PILOT VALVE - Pump Heads are mounted to the manifold. The Pilot Valve, which is controlled by the J Controller, provides water pressure to the pump heads to make them pump.

- PUMP HEADS - Pump Heads are what actually pump the chemicals. Many different models and sizes a available to handle almost any liquid and feed ratio.

- BLEND TANK - Ensures the chemical injected into the water line is blended uniformly ensuring even distribution and allowing for accurate measurements to be made.

H.E. Anderson® J+Advanced Controller

Connects to the water meter and pilot valve/manifold. It measures the water flow using the water meter then turns the pilot valve on and off to stroke the pump heads at the proper rate to maintain the set ratio. Includes latest features, new backlit display and full keypad.



120VAC
HEAN15008

Min. Buy 1ea

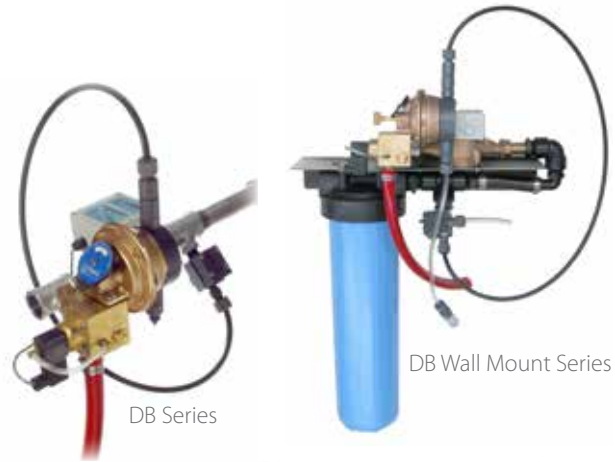

DB Series

DB Wall Mount Series



DD Series

H.E. Anderson D Series Ratio:Feeder® Injector Systems

The DB & DD Series offer an inexpensive way inject almost any liquid into a water line at an adjustable ratio. Built with the same quality and pride as the J Plus, these pumps will inject one chemical up to a 1:100 ratio with models rated for 20 or 50 GPM. These models feature an adjustable feed ratio which makes fine tuning the injection ratio as easy as twisting a knob. Injectors can be turned down to 1/10th of their maximum feed ratio.

- Industry leading quality - legendary dependability helps save time on maintenance
- Easy installation and operation
- Positive Displacement - extremely accurate injection helps save money on chemicals
- Diaphragm Operation - No sliding seals, accuracy does not degrade over time
- Volume proportioning - constant chemical levels regardless of flow rates
- Adjustable feed rate - change the feed rate while unit is operating and without recalibrating
- Filter not required
- Extremely low pressure loss
- Low power consumption
- On/Off and Pulse Button

BFG Item#	Model	Water Flow Range	Maximum Feed Rate	Typical Use
HEANDB100	DB100	1/4 to 20 GPM	1:100 or 1%	Fertilizer
HEANDB1000	DB1000	1/4 to 20 GPM	1:1000 or 0.1%	pH Adjustment/Sanitizer
HEANDB100W	DB100W	1/4 to 20 GPM	1:100	Fertilizer
HEANDB1000W	DB1000W	1/4 to 20 GPM	1:1000	pH Adjustment/Sanitizer
HEANDD100	DD100	3/4 to 50 GPM	1:100	Fertilizer
HEANDD1000	DD1000	3/4 to 50 GPM	1:1000	pH Adjustment/Sanitizer



Fertilizer Injectors

H.E. Anderson® A3 Teflon® Diaphragm Kit

A3 Pumper Diaphragm Kit Includes: 1 of 16510 A3 CS w/ Teflon Diaphragm, 1 of 18036 A3 WS Diaphragm, and a spare parts kit.



HEAN17032 Min. Buy 1 EA



H.E. Anderson® Diaphragm Kit

These kits include everything you need to replace worn out diaphragms. They even include replacement screws in case any were damaged or lost during installation. Diaphragm kit #4 (08939) is manufactured from EPDM which provides excellent chemical resistance.



#4 - H4 Standard - Replacement Part #08939
HEAN8939 Min. Buy 1 EA

A3/T4 CS - Teflon Face - Replacement Part #16510
HEAN16510 Min. Buy 1 EA



H.E. Anderson® Check Valve Set

Check valve set Includes: 1 ea 09812 Suction Valve and 1 ea 09275 Discharge Valve.



HEAN02534 Min. Buy 1 EA



H.E. Anderson® Hosebarb with O-Ring

Replacement 0.5in hosebarb with o-ring. Designed for high capacity liquid ends using valve module combo type 3 (VMC3). Pair with the #21210 VMC3 Block 4 Seat housing for a complete seat housing assembly. Complete assembly #21176 VMC3.



0.5in
HEAN11741 Min. Buy 1 EA



H.E. Anderson® Injection Point Feeder

The 1/2in Universal IPF Assembly performs multiple functions. It prevents discharge from the water line in case of a break in the discharge line, it vents the discharge line to allow easier priming of the metering pump, and the anti-siphoning valve shuts to prevent siphoning whenever there is a negative pressure at the injection point. The limited gravity restriction provides a nominal 7psi restriction to the chemical side of the IPF. Vented to atmospheric pressure, and is necessarily thin and delicate.



0.5in - Universal IPF Assembly #04094
HEAN4094 Min. Buy 1 EA



H.E. Anderson® Injection Point Feeder Repair Kit

The IPF Repair Kit is designed for use with the 1/2in Universal Assembly #04094. Kit includes : O-ring #01701, (2) O-rings #05420, and diaphragm #04416. Repair Kit #05404.



0.5in - For Universal IPF Assembly
HEAN5404 Min. Buy 1 EA

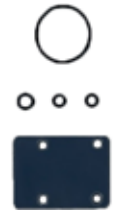

H.E. Anderson® VMC3 Valve Set

VMC3 valve set



HEAN20998 Min. Buy 1 EA



DOSMATIC[®]

Fertilizer Injectors



Dosmatic™ SuperDos Injector

The SuperDos mid-high flow, water-driven proportional injectors are a low-cost alternative to traditional electric technology. Designed with a patented internal mixing chamber that promotes homogeneous mixing, while segregating harsh chemicals from critical internal components. Proportional positive displacement ensures that just the right amount of chemical is injected each and every time.

	Item #	GPM	Ratio	Pressure	Percentage Rate	Barcode
SuperDos 20 2.5%	DOSM113205	0.05 - 20GPM	1:500 - 1:40	5 - 100PSI	0.20 - 2.5%	
SuperDos 30 2.5%	DOSM113209	0.15 - 30GPM	1:500 - 1:40	5 - 100PSI	0.20 - 2.5%	
SuperDos 45 2.5%	DOSM113212	0.25 - 45GPM	1:500 - 1:40	5 - 100PSI	0.2 to 2.5%	



Dosmatic™ MiniDos Injector

The MiniDos low-mid flow, fluid (water)-driven proportional injectors offer an ideal alternative to traditional, non-electric technology. These injectors are compact and offer the widest range of injection ratios.

	Item #	GPM	Ratio	Pressure	Percentage Rate	Barcode
MiniDos 2.5%	DOSM112602	0.03 - 12GPM	1:200 - 1:40	6 - 140PSI	0.50 - 2.5%	



Dosmatic™ Chemilizer

An industry-leading chemical injector that utilizes years of proven diaphragm technology. Powered by the existing water supply, the internal motor drives the chemical pump, injecting very precise amounts of chemical.

	Item #	GPM	Ratio	Pressure	Percentage Rate	Barcode
Chemilizer - Fixed	DOSMCH9000	0.02-11GPM	1:128 Fixed	3-85PSI	0.78%	



Dosmatic™ Advantage 30 Injector

The Advantage 30 operates without electricity to precisely inject liquid concentrates into a water supply line using fluid flow as the power source. Features: chemicals are thoroughly mixed before output, ratio easily adjustable and composite body construction.

	Item #	GPM	Ratio	Pressure	Percentage Rate	Barcode
Advantage 30 2.5%	DOSMSPV0182	30GPM	—	—	2.5%	



Fertilizer Injectors

Dosmatic™ Wear Parts Kit A

Kit includes dosage piston and O-ring for SuperDos and Advantage Injectors.



For SuperDos and Advantage injector
DOSM011850V Min. Buy 1 EA



Dosmatic™ Wear Parts Kit C

Kit includes dosage piston, inner Cylinder and O-ring for SuperDos and Advantage Injectors.



For SuperDos and Advantage injector
DOSM011850CV Min. Buy 1 EA



Sprayers & parts

Dosmatic™ HydroFoamer Hose-End

Hose end hydro foamer for Strip-It. The HydroFoamer's unique injection concept mixes the proper amount of concentrate with both air and water to produce a thick, rich foam for longer soak time.



For Strip-It
DOSM481

Min. Buy 1 EA



Fertilizer Injectors

Dema® Mixrite



.2-2% FERT INJECTOR 22GPM
DEMTF5-002ON/OFF Min. Buy 1 EA



Dema® Mixrite



.2-2% FERT INJECTOR 45GPM
DEMTF10-002ON/OFF Min. Buy 1 EA



Dema® Mixrite



.2-2.5% FERT INJECTOR 110GPM
DEMTF25-002ON/OFF Min. Buy 1 EA



Other Equipment

Motor Gearboxes

De Gier Drive Systems produce a complete range of robust and durable gear motors. The GW and GXP gear motors create a solid base for complete drive systems. The various versions of gear motors are used in ventilation, screening, heating tube lifting systems, and drink and feed lines in agriculture, greenhouse horticulture and non-residential construction.

Product characteristics of the GW and GXP gear motors:

- Self-braking due to the application of a worm-worm gear transmission. This means that, when the gear motor is stopped, the system stays in the desired position.
- Extremely silent during use, compact, powerful, reliable and maintenance-free.
- Continuous operation S3-30% (continuous operation is limited to max. 25 minutes)
- Torque range from 10 to 2,700Nm
- RPM range from 1.3 to 30 rotations/min



WARNING: This product is not available for sale in CA.
 For most up to date information please visit bfgsupply.com

GrowerSelect®



Retail & Production Benching

BFG Grower Select benching represents the most efficient, flexible and presentable benching available in the marketplace. Don't just use "block and board" for your presentation – we produce both double deck and modular benching, with re-supply racks underneath.

Our retail benching features complete coverage of sharp expanded metal edges, corner protectors and plastic caps on all tube ends and legs. A highly efficient and flexible way to enhance the image of your operation and present your products.

BFG Grower Select production benching can be ordered as rolling or stationary benches, in freestanding or cemented styles, even customized to fit your specific needs – all at a very economical price. These production benches are loaded with features designed to maximize your efficiency and assist in your profitability. Available with expanded galvanized top panels or plastic panels.



Retail Benching

Quality Products Need Quality Displays!

Grower Select® works with some of the largest and most well-known retailers to provide them with benching that is efficient, flexible, and presentable. Our retail benching features complete coverage of the sharp expanded metal ends, corner protectors, and plastic caps on all legs and tube ends.

Complete Retail Bench Sets or Bench Tops Only
Available in the Following Sizes:

- 3ft x 8ft
- 3.5ft x 8ft
- 4ft x 8ft
- 5ft x 8ft
- 6ft x 8ft
- 3ft x 10ft
- 3.5ft x 10ft
- 4ft x 10ft
- 5ft x 10ft
- 6ft x 10ft
- 3ft x 12ft
- 3.5ft x 12ft
- 4ft x 12ft
- 5ft x 12ft
- 6ft x 12ft



Corner Protector



Freestanding Bench



Ultra Bench

Available in the Following Sizes:

- 4ft X 8ft Ultra Retail Bench Complete
- 4ft X 12ft Ultra Retail Bench Complete
- 6ft X 8ft Ultra Retail Bench Complete
- 4ft X 8ft Collapsible Ultra Retail Bench



ULTRA Plastic Top Benching

Grower Select® ULTRA benches include all the features of our traditional benching – aluminum side rails, molded corner protectors and plastic caps on all tube ends and legs – combined with durable, smooth, non-porous plastic bench tops that allow trays, flats, and pots to slide across the surface without snagging.

The polypropylene panels feature 1.1 in x 2.1 in rectangular holes for easy cleaning, and will not rot, crack, or splinter like wood products nor corrode or rust like expanded metal or wire tops.

We produce thousands of square feet of rolling benches every year. Our benches can be rolling or stationary, freestanding or cemented. We can usually customize to fit your needs at a very economical price. Free engineering and layout planning is available along with a full list of references.

Our production benches feature a 20lb/sq ft load capacity and have 3/4in pre-galvanized expanded metal tops. Our special aluminum side rails completely cover all of the sharp expanded metal edges and no more torn pants with our corner protectors. Expanded metal can be flattened for plug trays or left standard. You can also chose plastic panel tops. Anti-tip/roller spacers are optional. Allow four weeks for delivery.



Production Benching

Available as Rolling or Stationary

Aluminum Side Rails

No exposed expanded metal edges. Extra Strength. Enhances appearance.

1-1/2in Hat Section Crosspieces

Wider base to support the expanded metal. Standard spacing 2ft o.c. (optional 12in or 16in spacing)

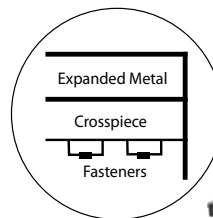

1.315in Rollers

Swaged ends. Plastic caps. No connectors to interfere with rolling.

Anti-Tip/Roller Aligner

Wider aisles. Off loading from either side. Constantly aligns rollers.

Contact Your BFG Sales Representative for
MORE INFORMATION



See Greenhouse Structures for More Benching Options.



WARNING: This product is not available for sale in CA. For most up to date information please visit bfgsupply.com

800-883-0234
www.bfgsupply.com

Grower Select®

Display Carts



Grower Select® Sliding Shelf Display Cart

Cart can serve double duty for product transportation and retail display. All steel construction with a hot-dip galvanized finish, an expanded metal mesh base and three solid sheet metal shelves. Features two rigid casters, two swivel wheels, tow bar, two curved ladder end panels and shelves that slide out from either side.



3 Shelves, 59in L x 22in W x 80.5in H, 68lb
GS48-6520 Min. Buy 1 EA



East Region - 57in L x 21in W x 80.5in H, 68lb
GS2157 SSTC Min. Buy 1 EA



Grower Select® All-Purpose Transport Cart

The workhorse of the Grower Select cart line. The All-Purpose Transport Cart features all steel construction with a hot-dip galvanized finish, a welded wire base and three expanded metal mesh shelves. Connect multiple All-Purpose Transport Carts together using the heavy-duty drawbar and post system.



3 Shelves - 5in Rigid Casters
59in L x 22in W x 82.5in H - 77lb
GSGS2259 Min. Buy 1 EA



Grower Select® Hi-Cube Transport & Display Cart

A heavy-duty solution for long-distance or rough transportation, this cart features all steel construction with a hot-dip galvanized finish, solid sheet metal shelves and a cable braking system for safety.



4 Shelves - Hybels - Colson Casters
GSSHYBELSHICUBE4 Min. Buy 1 EA



Cart with 5 Adjustable Shelves
GS45-6507 Min. Buy 1 EA



6 Shelves - Hybels - Colson Casters
GSSHYBELSHICUBE6 Min. Buy 1 EA



7 Shelves - Hybels - Colson Casters
GSSHYBELSHICUBET7 Min. Buy 1 EA

Sliding Shelf Replacement Parts

Shelf

Hot dipped galvanized sliding shelf. Shelf Only! Sold by the each. For use with Grower Select® Sliding Shelf Display Cart.



21.5in x 54.5in
GS48-6520B Min. Buy 1 EA

All-Purpose Replacement Parts

Expanded Metal Hook Shelf

Additional shelf made with hot dipped galvanized expanded metal for the Transport Cart. Added shelving makes cart even more valuable in the busy season!



For the Grower Select® #2259 Transport Cart
GS48-6500A Min. Buy 1 EA

Replacement Post

Hot dipped galvanized metal construction.



Replacement Post Only
GS48-6500B Min. Buy 1 EA

Hi-Cube Replacement Parts

Eye Bolts



Eye Bolt for Hi-Cube Cart
GS456510 Min. Buy 1 EA

Turn Buckle



Turn Buckle for Hi-Cube Cart
GS456512 Min. Buy 1 EA

Brake Assembly



Brake Assemble for Hi-Cube Cart
GS486541 Min. Buy 1 EA



Display Carts

Grower Select® Retail Nesting Shopping Cart

Nesting shopping cart perfect for customer shopping in greenhouses and garden centers. Perfect for carrying bedding plants, perennials, hanging baskets and pots. Features all steel construction with a hot-dip galvanized finish. Carts can be nested to save space when not in use.



37in L x 24in W x 43.5in H

GSGS4000

Min. Buy 1 EA



Nesting Replacement Parts

Corner Guard



Corner Guard Only

GSGS4000CC

Min. Buy 1 EA

Bottom Shelf

Shelf only. For use with the retail nesting cart.



Bottom Shelf Only

GS486501B

Min. Buy 1 EA

Replacement Wheels

Grower Select® Retail Nesting Cart Replacement Rigid Wheel

Replacement rigid wheel designed to repair the Retail Nesting Shopping Cart Models: GSGS4000 & GS48-6501S



GSGS4000RIG

Min. Buy 1ea



Grower Select® Retail Nesting Shopping Cart Caster Wheels

Improved! Includes 2 Swivel and 2 Rigid Wheels.



Set of 4

GS486550

Min. Buy 1ea

Replacement Wheels

Grower Select® Black Rubber Swivel Caster

This 5in x 2in Black Rubber Swivel Caster (Thermoplastic Rubber) features a shock-absorbing cushioned ride, while providing good floor protection and quiet rolling operation. Featuring weight capacities of 75 to 1100 pounds per wheel, the 75 Shore A TPR wheel tread is chemically bonded to a polyolefin core and has an operating temperature range of -40° to +180° Fahrenheit. It is resistant to cleaning chemicals, acids, alcohol, and water, TPR wheels are an excellent choice for wash-down applications.



5in x 2in Wheel - 6-1/2in Overall Height - Sold by The Each

GS5-81-455

Min. Buy 1ea



Grower Select® Black Rubber Rigid Caster

This 5in x 2in Black Rubber Rigid Caster (Thermoplastic Rubber) features a shock-absorbing cushioned ride, while providing good floor protection and quiet rolling operation. Featuring weight capacities of 75 to 1100 pounds per wheel, the 75 Shore A TPR wheel tread is chemically bonded to a polyolefin core and has an operating temperature range of -40° to +180° Fahrenheit. It is resistant to cleaning chemicals, acids, alcohol, and water, TPR wheels are an excellent choice for wash-down applications.



5in x 2in Wheel - 6-1/2in Overall Height - Sold by The Each

GS5-82-455

Min. Buy 1ea



Pneumatic Swivel Caster Wheel

Swivel caster wheel



8in, 4in x 4.5in plate

GS00316

Min. Buy 1ea

Pneumatic Rigid Caster Wheel

Rigid caster wheel



8in, 4in x 4.5in plate

GS00315

Min. Buy 1ea

Pneumatic Wheels with Rims

Pneumatic wheels - Tire Mounted on Rim



Pneumatic Wheels Only - Set of 4

GS486555

Min. Buy 1ea

Grower Select® Flat Free Tire

Flat free tire



8in x 2.5in, 3.5in centered hub

GSAN80PNPF12

Min. Buy 1 EA



Swivel Wheel

Replacement swivel wheel designed to repair the Retail Nesting Shopping Cart Models: GSGS4000 & GS48-6501S



GSGS4000SW

Min. Buy 1ea



WARNING: This product is not available for sale in CA. For most up to date information please visit bfgsupply.com



Display Carts

VRE Systems® Handi Cart with Solid Wheels

Durable and built to last with hot dip galvanized steel. The VRE systems Handi Cart is ideal for moving or transporting product or plants in any production growing facility, retail nursery or garden center. Different wheel options available.



22in W x 48in L Top Deck, 22in W x 36in L Bottom Deck, 8in Solid Yellow Wheels, 500lb Capacity
VREHANDIS Min. Buy 1 EA



VRE Systems® Carts

Engineered and designed for customer service and retail nursery garden center transportation and moving plants and product efficiently. Our carts are designed to hold a maximum number of plants for increased sales.

VRE Systems® Husky Cart with Flat Free Wheels

Heavy duty applications require customer service carts with extra strength and capacity. Our Husky Cart is designed to handle all of your heavy duty needs. The handle can be mounted on either end of the cart based on your preference.



22in W x 56in L, Two 10in Swivel & Two 16in Flat Free Wheels, 600lb Capacity
VREHUSKYFF Min. Buy 1 EA



Display Carts

Millside Industries® Plastic Deck Wagon

Deck is made of an attractive green, high impact polypropylene material. The poly anti-tip steering provides effortless turning and the handle is long with a comfort-grip. The deck has a 4in high cargo lip all the way around to help keep items in place. All the metal framework has a black powder-coated finish for durability.



20in x 38in Deck / 4in x 10in Flat Free Tires
MSI03548FF Min. Buy 1ea

20in x 38in Deck / 4in x 10in Pneumatic Tires
MSI03548 Min. Buy 1ea

20in x 38in Deck / 4in x 10in Pneumatic Tires
MSI03562 Min. Buy 1ea



Millside Industries® Metal Deck Wagon

Ideal for garden centers, greenhouses and nurseries. Easily hauls anything that needs relocated. The long easy-grip metal handle and metal anti-tip steering provides effortless movement and turning and the 2in high cargo lip around deck helps to keep items in place. Each cart has a deep green powder-coated finish for durability.



20in x 38in Deck / 4in x 10in Flat Free Tires
MSI20X38WFF Min. Buy 1ea

24in x 48in Deck / 4in x 10in Flat Free Tires
MSIEFRWGFF Min. Buy 1ea

24in x 48in Deck / 4in x 10in Pneumatic Tires
MSIEFRWG Min. Buy 1ea



Millside Industries® 2-Wheel Metal Push Cart

Ideal for garden centers, greenhouses and nurseries. Easily hauls anything that needs relocated. The long, easy-grip, metal handles provides effortless movement and turning and the 2in high cargo lip around deck helps to keep items in place. Each cart has a deep green powder-coated finish for durability. Can carry 300lbs.



24in x 48in Deck / 16in Pneumatic Tires
MSI2WGC Min. Buy 1ea



Millside Industries® Heavy-Duty Express Wagon

Wagon has beefy pneumatic tires for a gentle quiet ride. The comfortable, large, easy-grip D-handle and metal anti-tip steering provides effortless movement and turning. Easily remove the hardwood racks if they are not needed for the job at hand.



20in x 38in Deck / 4in x 10in Pneumatic Tires
MSIHDW Min. Buy 1EA



Millside Industries® Flat Free Wheel

Replacement wheels with white hub. 10in with 5/8in bearings.



4in x 10in
MSI02211FF Min. Buy 1ea



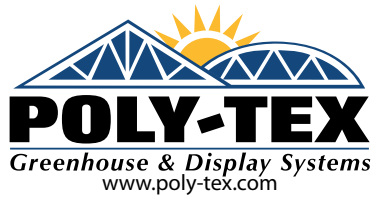

RETAIL MERCHANDISING PRODUCTS

Contact Your BFG Sales Representative for
MORE OPTIONS



Flat Mate Display PX7025CP W/CASTERS & PURLIN

Designed to solve the problem of displaying your plants in tight quarters. This bench protrudes only 26in from your wall. Holds 21 flats. Optional casters.

Specifications: 73.25in W x 26.5in D x 83.75in H



Narrow Basket Hanger Display BH4000 W/CASTERS

Quickly move this hanging basket display outdoors and back indoors at a moments notice. This display is designed to roll through a 36-inch door and includes casters.

Specifications: 72in W x 34in D x 78"H



The Basket Hanger Display BH3000C W/CASTERS

Display hanging baskets or use the optional wreath kit to convert it to a high-capacity wreath display. Available with or without casters.

Specifications: 72in W x 73in D x 82in H

Basket Wave Display BW3000

This high capacity display provides an elegant way to showcase your hanging baskets in an easy-to-shop wall of color. Start with the 12-foot base unit and easily add 6-foot sections to create an endless sweep of color.

Specifications: 150in W x 79in D x 78in H



Basket Tower Display BT3000

Think vertical merchandising that can be shopped from any side. Imagine a tower of hanging baskets or a whorl of wind chimes!

Specifications: 46in W x 46in D x 90in H



PolyTex Double Tri-Step Display Incl Dbl Purlin

The PX7021 gives you all the visual appeal of our Tri-Step Display... times two! Makes a great center aisle display that can be shopped from both sides. Also available with optional 6' sign holder.

Specifications: 73.23in L x 40in W x 44.5in H
With Optional Purlin
Specifications: 73.23in L x 40in W x 98in H



Poly-Tex Double Tri-Step Display Includes Double Purlin
POLTXPX7021P Min. Buy 1 EA

Poly-Tex® Tri-Step Display

Create a cascading display of color with the standard expanded metal bench tops at 18in, 24in and 36in deep. Optional 40in high purlin holds six 10in hanging baskets.

Specifications: 73.25in L x 40in W x 44.5in H
With Optional Purlin
Specifications: 73.23in L x 40in W x 98in H



Includes Casters & Purlin
POLTXPX7020CP Min. Buy 1 EA

PolyTex Plastic Top Grow Benches

Grow and display on our new galvanized steel bench with plastic grid top! Perfect for watering and easy to clean, the plastic grid top lets water and debris through. The heavy-duty galvanized steel frame resists rust while giving excellent support for your trays, flats, or potted plants. Dimensions: 8' x 4' x 32.5" h (additional sizes available).

Specifications: 8ft L x 4ft W x 32.5in H



Poly-Tex Plastic Top Grow Benches
POLTXBD3084 Min. Buy 1 EA

PolyTex Pallet Bridge Display

The galvanized steel frame fits over most standard pallets and the upper tray features flattened, expanded metal to display large and small products for cross-merchandising related items.

Specifications: 48in W x 21.5in D x 48in H



Poly-Tex Pallet Bridge Display
POLTXPB3000 Min. Buy 1 EA



Bamboo Trellises, Stakes & Supports

Bamboo Supply® Natural Bamboo Fan Trellis

Support your favorite vining plants with these lightweight, inexpensive yet strong trellises that weather well and last several seasons in the garden.



- 18in**
BAMBBFT18 Min. Buy 1 BD
- 24in**
BAMBBFT24 Min. Buy 1 BD
- 30in**
BAMBBFT30 Min. Buy 1 BD
- 36in**
BAMBBFT36 Min. Buy 1 BD
- 48in**
BAMBBFT48 Min. Buy 1 BD



Bamboo Supply® Natural Bamboo Stake

High-quality, all-natural stakes are extremely versatile. Most commonly used in gardening as simple plant supports, these stakes can also be fashioned into fences, frames, arbors, trellises, or used as garden edging. Available in a variety of lengths.



- 2ft - 6-8mm Diam.**
BAMBBN0206 Min. Buy 1 BD
- 2.5ft - 8-10mm Diam.**
BAMBBN02508 Min. Buy 1 BD
- 3ft - 8-10mm Diam.**
BAMBBN0308 Min. Buy 1 BD
- 3ft - 12-14mm Diam.**
BAMBBN0312 Min. Buy 1 BD
- 4ft - 8-10mm Diam.**
BAMBBN0408 Min. Buy 1 BD
- 4ft - 10-12mm Diam.**
BAMBBN0410 Min. Buy 1 BD
- 4ft - 12-14mm Diam.**
BAMBBN0412 Min. Buy 1 BD
- 6ft - 12-14mm Diam.**
BAMBBN0612 Min. Buy 1 BD
- 6ft - 15-17mm Diam.**
BAMBBN0615 Min. Buy 1 BD
- 6ft - 18-20mm Diam.**
BAMBBN0618 Min. Buy 1 BD
- 8ft - 24-26mm Diam.**
BAMBBN0824 Min. Buy 1 BD
- 10ft - 26-28mm Diam.**
BAMBBN1026 Min. Buy 1 BD



Bamboo Supply® Natural Bamboo Flair Trellis

Natural bamboo flair trellis with two vertical stakes.



- 18in**
BAMBBNFT18 Min. Buy 1 BD
- 24in**
BAMBBNFT24 Min. Buy 1 BD
- 30in**
BAMBBNFT30 Min. Buy 1 BD



Bamboo Supply® Bamboo Stake

High-quality, all-natural stakes that are extremely versatile and can be used for many things, including plant support. Poles are dyed forest green to blend into landscapes.



- 4-6mm Diam x 18in L - Green**
BAMBBG01504 Min. Buy 1 BD
- 4-6mm Diam x 2ft L - Green**
BAMBBG0204 Min. Buy 1 BD
- 4-6mm Diam x 3ft L - Green**
BAMBBG0306 Min. Buy 1 BD
- 5-7mm Diam. x 2.5ft L - Green**
BAMBBG02505 Min. Buy 1 BD
- 8-10mm Diam x 4ft L - Green**
BAMBBG0408 Min. Buy 1 BD
- 10-12mm Diam. x 5ft L - Green**
BAMBBG0510 Min. Buy 1 BD
- 10-12mm Diam. x 6ft L - Green**
BAMBBG0610 Min. Buy 1 BD



Bamboo Supply® Green Split Pointed Bamboo

Round solid bamboo stakes with points, ideal for staking potted plants including orchids and other exotic plants.



- 12in L, 4-4.5mm Diam.**
BAMBBS12 Min. Buy 1 BD
- 18in L, 5-5.5mm Diam.**
BAMBBS18 Min. Buy 1 BD
- 24in L, 5-5.5mm Diam.**
BAMBBS24 Min. Buy 1 BD



Bamboo Supply® Natural Bamboo "U" Trellis

Upside down "U" for climbing plant support.



- 18in**
BAMBBTN18 Min. Buy 1 BD
- 24in**
BAMBBTN24 Min. Buy 1 BD
- 30in**
BAMBBTN30 Min. Buy 1 BD
- 36in**
BAMBBTN36 Min. Buy 1 BD
- 48in**
BAMBBTN48 Min. Buy 1 BD



Bamboo Supply® Rubber Trellis Teepee Cap

For making your own teepee with three bamboo stakes up to 1/2in diameter.



- Green**
BAMBRTC100 Min. Buy 1 CS





Labels, Signs & Laminators

Greenhouse & Garden Center Label & Tag Printers

Printer Features:

- **Longer Ribbon (984ft vs. 244ft)**
Save money with fewer ribbons & less changeovers
- **More Efficient Calibration**
No labels or tags wasted
- **Integrated Unwinder**
Supports both 1in & 3in cores
- **Faster Printer Speed**
More labels & tags in less time
- **Adjustable Media Sensor**
Supports gap, black mark and side & center notches
- **Practically Indestructible Keyboard**
Full size, waterproof keyboard
- **Reduced Cost of Ownership**
2 year Warranty! Print head – 6 months

Printer Models:

GC-Select STA

- GC-Select Printer & Keypad
- 3 Formats

GC-Select DLX

- GC-Select Printer & USB Cable
- Label Design Software – Basic

GC-Select Pro

- GC-Select Printer & USB Cable
- Label Design Software – Professional

GC-Select DLX TOTAL

- GC-Select Printer & Keypad
- Label Design Software - Basic
- 3 Formats

GC-SELECT PRO TOTAL

- GC-SELECT Printer and Keyboard
- Label Design Software - Professional
- 3 Formats

Total Select

Standalone plus PC Software

- Easily upgrade to Total Select from Standalone or PC Software.
- Quickly & conveniently print waterproof & UV Resistant labels & tags.



Ask your BFG Sales Rep for details & pricing

Three label or tag formats
MANY MORE AVAILABLE!
Many colors are available for most labels & tags



Prints Outdoor Vinyl
Tags & Labels...
Waterproof & Sun Resistant!

Printer Models:

Item	Description
1009158	GC Select-Sta - Stand Alone Printer
1009159	GC Select-DLX - Printer with PC Basic Software
1009161	GC Select-PRO - Printer with PC Pro Software
1009166	GC Select-DLX - Stand Alone Printer with Basic Software
1009168	GC Select-PRO - Stand Alone Printer with Pro Software

Labels:

Item	Description
1004901	3" x 2-3/8" White Waterproof Stick on Label 7,200/cs
1005827	0.75" x 5" White 4 Across Pot Stakes 6,000/cs
1005797	0.75" x 5" Yellow 4 Across Pot Stakes 6,000/cs
1005800	1" x 7" White Wrap Around Tags 8,400/cs
1005801	1" x 7" Yellow Wrap Around Tags 8,400/cs
1005808	1" x 10" White Wrap Around Tags 6,000/cs
1005787	1" x 10" Yellow Wrap Around Tags 6,000/cs
1005786	2" x 1" White Waterproof Stick-On Label 16,560/cs
1008310	4" x 2" White Waterproof Stick-On Labels 9,000/cs
1010709	4" x 2" Yellow Waterproof Stick-On Labels 9,000/cs
1007051	4" x 6" White Waterproof Stick-On Label 900/cs
1005788	0.50" x 3" White Waterproof Stick-On Plug Tray Label 5,000/cs
1011848	0.625" x 7" Wrap Around Tree Tag 12,600/cs

Ribbons:

Item	Description
1005841	3.3" x 244' Black Transfer Ribbon 12 Rolls/cs *For GC-1
1006393	GC-FLEX / SELECT Printer Ribbon (6 rolls/cs)

Pricing Gun:

Item	Description
1000075	Monarch Pricing Gun
1000441	0.75" x .5" Labels Outdoor for Monarch Price Gun 12,000/slv
1008575	Monarch Large Pricing Gun
1008573	Outdoor Waterproof Labels for Large Pricing Gun 8,000/slv



Labels, Signs & Laminators

DP Industries® Metal Stake Markers

Long lasting Zinc writing surface with metal legs for support. 1" x 2-1/2" Zinc writing plate. Mark with DPI's fade/water resistant Garden Pen. Ideal long term solution to identifying plant varieties, garden rows, garden sections, etc.



Copper Plate 10in - 120pk
DPIMM10C Min. Buy 1 PK

DP Industries® Blank Vinyl Sign Card

Can mark these vinyl cards with garden pens or liquid chalk.



7in L x 5in H - 25pk
DPIC57000 Min. Buy 1 PK



DP Industries® Economy Plastic Bedding Labels

Economy roll of white 0.015in thick bedding labels. Best used to identify plantings in seedling trays and bedding flats. Made from recycled styrene. Can also be used for potted plants. Mark with fade/water resistant garden pens.



White - 1in W x 4-1/2in H - 1000 per Roll
DPISL451M Min. Buy 1 CS



DP Industries® Plastic T-Stake Signs

Molded plastic T-Stakes provide signs for multiple use. Larger writing surface and reader friendly. To clean wipe with a wet paper towel or clean with alcohol based sanitizer.



100ct - White - Straight Top Sign - 2.25in W x 3.75in H - Leg - 9.75in H
DPITL10 Min. Buy 1 CS

100ct - White - Straight Top Sign - 3.25in W x 2.25in H - Leg - 13in H
DPITL13W Min. Buy 1 CS



DP Industries® Economy Plastic Garden Markers

Made from high impact recycled styrene for a smooth writing surface. They can be used for potted plants, seedling trays and bedding flats.



White - 5/8in W x 4in H - 1000pk
DPITC458M Min. Buy 1 CS

White - 5/8in W x 5in H - 1000pk
DPITC558M Min. Buy 1 CS

White - 5/8in W x 6in H - 1000pk
DPITC658M Min. Buy 1 CS

White - 5/8in W x 8in H - 500pk
DPITC858M Min. Buy 1 CS

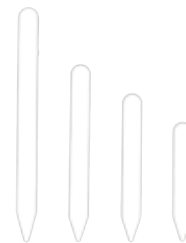

DP Industries® Molded Plastic Garden Marker

Formed in convenient sets of 8 each for easier writing. Made from recycled styrene, can be used for potted plants.



White - 5/8in W x 4in H - 1000pk
DPIM458MW Min. Buy 1 CS

White - 5/8in W x 5in H - 1000pk
DPIM558MW Min. Buy 1 CS

White - 5/8in W x 6in H - 1000pk
DPIM658MW Min. Buy 1 CS

White - 5/8in W x 8in H - 500pk
DPIM858C5W Min. Buy 1 CS

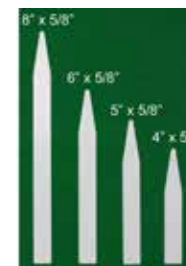

DP Industries® Economy Vinyl Wrap-Around Tag

Designed to easily wrap around tree or shrub branches. Best suited for use on larger plants and shrubs.



White - 5/8in W x 7in H - 1000 per Roll
DPITT758M Min. Buy 1 RL



DP Industries® Coated Wood Garden Markers

Wood labels that are covered with a water borne non-toxic coating which extends the useful life of the labels while maintaining the biodegradable and environmentally friendly properties.



White - 5/8in W x 6in H - 1000pk
DPITPL658M Min. Buy 1 CS

White - 1-1/8in W x 12in H - 250pk
DPITGL12118C2 Min. Buy 1 CS



DP Industries® Natural Wood Field Stakes

1/4" thickness wooden stakes. Shipped 100 per case. Mark with DPI's fade/water resistant Garden Pen. Biodegradable. Renewable. Sustainable. Environmentally Friendly.



18in x 1-1/8in x 1/4in - 100pk
DPIFS18118C Min. Buy 1 CS



Labels, Signs & Laminators

DP Industries® Natural Wood Garden Markers

Wood labels that are not coated. These labels will biodegrade more rapidly than coated ones.



1-1/8in W x 12in H - 250ct

DPIGL12118C2 Min. Buy 1 CS

5/8in W x 10in H - 500pk

DPIPL1058C5 Min. Buy 1 CS

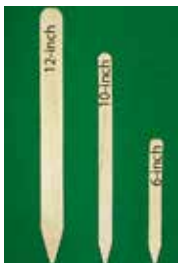

DP Industries® Thermal Transfer Vinyl Wrap-Around Tag

Thermal transfer printer compatible, vinyl material, best for use on larger plants and shrubs. Can be marked with garden pens.



White - 1in W x 9in H - 1000 per Roll

DPIWRAP91W Min. Buy 1 RL



DP Industries® Garden Pen

Garden pens that are fast drying, waterproof, and contain a UV filter for maximum fade resistance. Will easily write on wood, plastic, metal, and more. Permanent garden pens that will last!



Black - 0.8mm Tip

DPIGM08BLK Min. Buy 1 EA

Black - 1.2mm Tip

DPIGM77BLKBULK Min. Buy 1 EA



DP Industries® Vinyl Wrap-Around "SOLD" Tag

Designed to easily wrap around tree or shrub branches. Preprinted "SOLD"; space available to write name, date or other information.



Red - 3/4in W x 7in H - 1000 per Roll

DPIST734R Min. Buy 1 RL



Worker Protection

St George Company® Kasco ZA1/P3 Helmet Respirator Filter

Replacement filter for PROF 88 Kasco helmet system only.



For Use with PROF 88 System Only

STG0601047 Min. Buy 1 EA



St George Company® Kasco Respirator Clear Visor

flip-up, Lexan visor with a tough fiberglass shell and adjustable headband for sizes up to 8. Can be worn with beards and spectacles. Clear visor for all K80S model (T-1 through T-9) Kasco helmets and Prof 88 Kasco helmets.



For Use with K80S & PROF 88 Helmet Respirator

STG1903005 Min. Buy 1ea



St George Company® Kasco Battery Powered Helmet Respirator

Personal respiratory protection used while spraying pesticides and herbicides, ideal for orchard and vineyard use. Can be used with Kasco suit. High quality, fiberglass, powered air-purifying helmet respirator provides NIOSH-approved protection against organic pesticides. The helmet features a flip-up, Lexan visor with a tough fiberglass shell and adjustable headband for sizes up to 7. Can be worn with beards and spectacles. The blower/fan unit and battery are worn on a belt around the waist. 12 volt power cord plugs into the tractors cigarette lighter socket for power to operate blower/fan unit and/or charge four hour battery. Helmet is pressurized by positive pressure with 8 CFM and is vented by one-way valves. System Includes: SP8 cigarette lighter power cord, helmet blower/fan unit, air hose, belt, battery, two ZA2/P3 filters and instructions.



STG0313195 Min. Buy 1ea



WARNING: This product is not available for sale in CA. For most up to date information please visit bfgsupply.com

GrowerSelect®

Pot Covers & Foil

Grower Select® Sleeves

Pot sleeve that protects plant and creates a decorative look to enhance the appeal and add some personality to potted plants. Made of HDPE material that is see through but has a milky white haze to it. Each size features an easy to use drop and tear design on a wood header with vents which allows moisture to escape to prevent disease.



Grower Select® Satin Sleeves



Fits 4in Pot

4.5in Bottom W x 16in Top W x 18in H, 1,000/cs

GS09-0678 Min. Buy 1 CS

Fits 6in Pots

8in Bottom W x 24in Top W x 30in H, 1,000/cs

GS09-0674 Min. Buy 1 CS

Fits 6in-6.5in Pot

8in Bottom W x 20in Top W x 20in H, 1,000/cs

GS09-0675 Min. Buy 1 CS

Fits 6in 6.5in Pot

8in Bottom W x 24in Top W x 24in H, 1,000/cs

GS09-0676 Min. Buy 1 CS

Fits 6in-6.5in Pots

8in x 20in x 24in with 50 Vents 1000/cs

GS09-0677 Min. Buy 1 CS

Fits 7in-8in Pots

9in Bottom W x 30in Top W x 24in H, 1,000/cs

GS09-0673 Min. Buy 1 CS

Fits 8in Pot

10in Bottom W x 30in Top W x 30in H, 1000/cs

GS09-0671 Min. Buy 1 CS

Fits 10in Pots

13.25in Bottom W x 22in Top W x 24in H, 500/cs

GS09-0670 Min. Buy 1 CS

Fits 10in Pot

14in Bottom W x 24in Top W x 26in H, 1,000/cs

GS14x24x26 Min. Buy 1 CS

Fits 10.5in Pot

14.5in Bottom W x 30in Top W x 30in H, 500/cs

GS09-0669 Min. Buy 1 CS

Fits 10.5in-11in Pot

15in Bottom W x 30in Top W x 30in H, 500/cs

GS09-0672A Min. Buy 1 CS

1,000pk - for 12in Hanging Baskets

15in x 24in x 24 w/50 Maxivent

GSxx Min. Buy 1 CS

Grower Select® Clear Sleeves



Fits 10in Pots, 13.25in Bottom W x 22in Top W x 24in H, 50 Vents - 500pk

GS09-770 Min. Buy 1 CS



Pot Covers & Foil

FloPak® Luster Pot Covers

Economically enhance the appeal and add a colorful decorative touch to potted plants. These pre-formed covers help to attractively display and boost plant sales by just adding some color and style to pots. Choose from a selection of colors and sizes.



Evergreen

- Evergreen - 4.5in**
FPK45EGL Min. Buy 1 CS
- Evergreen - 6in**
DW962264 Min. Buy 1 CD
- Evergreen - 6.5in**
FPK65EGL Min. Buy 1 CS
- Evergreen - 7in**
FPK7EGL Min. Buy 1 CS
- Evergreen - 8in**
FPK8EGL Min. Buy 1 CS



Gold

- Gold - 4.5in**
FPK45GL Min. Buy 1 CS
- Gold - 6.5in**
FPK65GL Min. Buy 1 CS
- Gold - 7in**
FPK7GL Min. Buy 1 CS
- Gold - 8in**
FPK8GL Min. Buy 1 CS

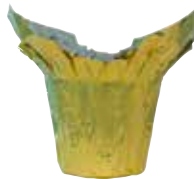

Red

- Red - 6.5in**
FPK65RL Min. Buy 1 CS
- Red - 8in**
FPK8RL Min. Buy 1 CS



FloPak® Classic Pot Covers

Economically enhance the appeal and add a colorful decorative touch to potted plants. These pre-formed covers help to attractively display and boost plant sales by just adding some color and style to pots. Choose from a selection of colors and sizes.



- Evergreen - 6.5in**
FPK65EGC Min. Buy 1 CS
- Evergreen - 7in**
FPK7EGC Min. Buy 1 CS
- Evergreen - 8in**
DW962551 Min. Buy 1 CS



FloPak® Laminated Foil Roll

Economically enhance the appeal and add a colorful decorative touch to potted plants. These pre-formed covers help to attractively display and boost plant sales by just adding some color and style to pots. Choose from a selection of colors and sizes.



- Evergreen - 20in x 20in Sheet**
500 per Bundle
DW961929 Min. Buy 1 BD
- Evergreen - Calypso Pattern**
20in x 30ft Roll
FPKFR2030EG Min. Buy 1 RL
- Gold - 20in x 20in Sheet**
500 per Bundle
FPKFS20QGD Min. Buy 1 BD
- Red - 20in x 20in Sheet**
500 per Bundle
DW961927 Min. Buy 1 BD



WARNING: This product is not available for sale in CA.
For most up to date information please visit bfgsupply.com



R3
RELIABLE
REDISTRIBUTION
RESOURCE.

Worker Protection

**R3 Safety™ Disposable Particulate N95 Respirator
14110444**

Strong and rigid outer shell. Form-fitted mask with a molded nose bridge. Electrostatic non-woven polypropylene polyester fibers. Dual welded head straps. Latex free woven suspension straps. Lightweight construction. Soft inner lining for extended comfort. Hypo-allergenic.



20/Box
R3341557865 **Min. Buy 1 BX**



AirWave® Disposable Respirator

Dura-Mesh® shell provides bi-directional protection from dirt on the outside and moisture on the inside. Softspun® lining for increased comfort and durability.



Med/Lrg - 10pk
CCP4200N95 **Min. Buy 10 BX**

**R3 Safety™ Moldex® 7000 Series Reusable Half Mask
Respirator**

Light weight design plus extra-wide sealing area provides all-day comfort. Mask drops down for convenient storage around the neck or locks down for custom fit. Adjustable head cradle and curved neck buckles for extra comfort. Low profile, compact design allows a wide field of vision, fits well under welding helmets and with safety glasses. NIOSH approved. Filters sold separately.



Medium
R322270021 **Min. Buy 1 EA**



**R3 Safety™ Moldex® 9000 Series Full Face Mask
Respirator**

Mask boasts an extra-wide viewing lens, with an over-molded flange design. At less than 13 ounces, the respirator is ultra-lightweight and has a convenient ratchet fastening strap system and a stand-away head harness that make putting the mask on and taking it off quick and easy. The strap tabs are securely molded directly to the flange for rugged use.



Medium
R322290021 **Min. Buy 1 EA**

Large
R322290031 **Min. Buy 1 EA**



**R3 Safety™ Moldex® Replacement Organic Vapors
Filter Cartridge for Mask Respirator**

100% PVC-Free® charcoal filter cartridge. Can be used with both 7000 and 9000 series respirators. NOISH approved.



**Fits : 7000 & 9000 Series Respirators - NOISH
approved**
R322271001 **Min. Buy 1 PR**



R3® Safety™ Chemical Resistant Glove

Versatile chemical protection that performs across a diverse range of applications. High performance nitrile compound provides an outstanding combination of chemical resistance and strength. Offers superior snag, puncture and abrasion protection over rubber or neoprene gloves. Features straight cuff and sand patch grip. Suitable for heavy-duty cleaning applications.



X-Large - Box of 12
R33715510 **Min. Buy 1 BG**

R3 Safety™ Best® Nitrile Disposable Gloves

Powder free disposable glove that features a 4mil thickness, rolled cuff for easy donning, blue textured finish and industry standard 9.5in length. These gloves have a comfortable fit and feel, perfect for a variety of uses.



4mil Thickness - Medium - 100pk
CCP97008-MED **Min. Buy 1 BX**
4mil Thickness - X-Large - 100pk
CCP97008-XLARGE **Min. Buy 1 BX**



R3 Safety™ Canner Gloves



Sz 9-Dozen
R3220139295 **Min. Buy 1 DZ**



R3 Safety™ DuPont™ Tyvek® Coverall

Delivers an ideal balance of protection, durability and comfort. Attached hood, elastic wrists and ankles all provide an effective barrier against hazardous drip particles and light non-hazardous liquid splash. Comfort fit design offers greater range of movement. Serged seams have multiple interlocking threads that are sewn around the raw edges of garment material to create a strong, stress-resistant seam.



Medium - White
BMC31710485 **Min. Buy 1 EA**
Large - White
BMC31710484 **Min. Buy 1 EA**
X-Large - White
BMC31710487 **Min. Buy 1 EA**
XX Large
BMC31710479 **Min. Buy 25 EA**



INDEX



A	
26GT®	299
3336®	299
6672®	305
A.M.A. Horticulture Inc.	183
Abide®	319
Acelepryn®	265
Acephate®	265
Acid Cleaner	336
Acidifer	338-339
ACME Engineering & Mfg	369
Actinovate®	299
Adept®	265
Adorn®	299
Advancing Alternatives	41, 404
Advocate™	319
Affirm™	299
AgH™	336
Agri of Virginia	48
Agriform®	240
Agri-Mycin®	299
AgSil®	341
AirWave®	426
Akari®	265
Albaugh, LLC	275, 342
Alesco®	319
Algaecides	304, 313, 336, 337
Algaecides - Organic	313, 337
Aliette®	300
Al-Par Peat Co.	316
Altercel®	319
Altus®	265
Aluminum Sulfate Fertilizer	250, 252
Amblyline™	283
American Coolair	371
Amfac	343
Amiad®	361
Amvac Chemical Co.	343
Ancora®	265
Anden®	376
Anderline™	284
Animal Control	343-344
Animal Repellents	275, 344
ANTAL/CAYSON EQUIPMENT	394
Anti-Transpirants	342
Ap&g Co., Inc	289
Aphid Control	265-278, 280-281
Aphidius colemani	284-285
Aphiline™	285
AquaGro®	340
Aquatic Herbicides	331-332
Aquatrols	338, 338
Areca®	300
A-Rest™	319
Aria®	266
Armory Soil Inoculant	315
ASB Greenworld®	199
Astro®	266
Astun®	300
AT Films®	54
Attain®	266
AutoFog™	406
Avalon®	266
Avelyo™	300
Avid®	266
AXXE®	327
AzaGuard®	267
Azalea Pots	70, 99-100, 108-109, 134, 161, 164, 173, 178
B	
BACCTO®	203, 206
Backpack Sprayers	405, 407
Bactericides	299, 301, 303-304, 306-307, 309, 311, 313, 337
Organic	301, 303, 306, 309, 311, 313, 337
Badge®	300
Bait	343-344
Ball Valves	347, 348, 361
Bamboo Supply®	420
Banner®	300
Banol®	300
Banrot®	300-301
Bark Mixes	186, 191-192
Barrel Planters	78, 86
Barricade®	327
Basagran®	327
Baseboard Clamps	48
BASF®	248, 266-267, 276, 278, 281, 286-287, 289, 300, 302, 306, 311, 313, 316, 327, 329-330, 333, 336-337, 343
Baskets	73-77, 97, 112, 122-129, 175-177, 184



B

Bayer®265, 268, 271-273, 277, 299-302, 330-332

Beethoven® 267

Belchim Crop Protection 343

Belden Plastics® 176-179

Bell Laboratories Inc 344

Benching..... 45-49, 414-415

Benching Components 43, 45-49

Beneficial Nematodes.....286-287

Benefit® 267

Berry Global 55

Best® 426

Biathlon® 327

BioAg.....248-249

BioCeres WP 267

BioFoamer Foaming Agent™ 341

Bioline AgroSciences283-289

Biological Control Agents.....283-288

 Aphids..... 284, 285, 286

 Black Vine Weevils.....287

 Fungus Gnats.....286-288

 Mites.....283-285, 287-288

 Shore Flies.....286, 288

 Thrips.....283, 286-288

 Whiteflies.....283, 288

Biological Fungicides...299, 309, 310, 311, 313

Biological Insecticides 267-269, 271, 274, 278, 281

BioMat™ 336

Biomim® 252, 301

Biosafe Systems® 247, 267-268, 306-307, 313, 316, 327, 336-338, 341, 395

Bio-SuperSil™ 248

BioTherm Solutions 372, 376, 386-388

BioWorks®249, 274, 278, 283-289, 301, 305, 309, 310, 337

Blacksmith Bioscience ...274, 311, 315

Blow Molded Containers 72, 140, 142

Blow-Molded Custom™ 139

Blue Max™ 251

Bluelab® 396-398, 426

B-Nine® 319

Bolster® 316

Bonzi® 319

BotaniGard®267-268

BotryStop® 301

Bowl Planters 90-95, 131-132

BRANDT® 250, 270, 338-339, 341-342

Broadform™ 301

BroadStar® 327

BT NOW® 268

Bulb Pans133

Burnett Lime Co 341

Bushel Baskets79, 95

C

CAL-FLO® 341

Californiline™ 285

Cal-Mag Fertilizers210

CalOx® 247, 341

Camelot™ 301

Capillary Mats.....362

Capmat™ 362

CapSil® 338

Captiva Prime® 268

Carry Trays71, 108-112, 117, 134, 146, 148, 150, 161-163, 174, 179

Carts.....407, 416-419

 Display416-417, 419

 Flatbeds.....418

 Transport.....416-418

Casoron® 327

Catchmaster® 289

CEASE® 301

Certis 267-268, 274, 341

Cheetah® 328

ChemDose™ 405

Chemical Solutions.....396

Chemical Sprayers.....405-406

Cherry Creek Systems385

Chipco® 302, 305

Chrysal Americas 319, 321

Chrysoline™ 285

Chrysoperla rufilabris 286

Citadel® 320

Citation® 268

Classic Custom™ 140

Classic Olympian™ 140

Cleaners.....336-338, 342

 Acid.....336

 Equipment342

 Organic.....338

 Structures.....338

Climate Control Systems.....393

CoExtruded Containers.....100, 101-106, 108-109, 120-121, 145, 162-165, 168, 171-173

Cold Foggers405-406

Cold Frames46, 47

Coldfogger™ 405

Collate® 320

ColorStorm™ 350

Compass® 302

Compressed Media187-190

Concise® 320

Conductivity Pens397

Configure® 320

Confront® 328

Conserve® 268



WARNING: This product is not available for sale in CA.
For most up to date information please visit bfgsupply.com

800-883-0234
www.bfgsupply.com

C

Containers.....	72, 78, 142, 148-149
Blow Molded.....	72
Hooks.....	78
Injection Molded.....	142
Round Pot.....	142
Continental Products	64
Contollers	393
Control Solutions.....	331
Controlled Release Fertilizer	210
Organic.....	246
Controllers.....	349, 371, 385
Climate	393
Environment	368, 398, 404
Irrigation	349, 385, 393, 410
Temperature.....	371
Ventilation	393
Convection Tubing.....	368
Conveyors	See Equipment
CoreTect®	268
Corteva.....	268, 270, 281, 302, 328, 330, 333
Coveralls	426
Covering Accessories	56, 61-66
Closure Strips.....	61
Insect Screen	65
Liquid Shade	64-65
Spring Locks.....	61
Support Wire.....	61
Tape.....	61-62
Coverings.....	54, 59-60, 62, 64, 66
Clear	60
Coverings - Infra Red Film	54, 59
Coverings - Multi Year.....	54, 60
Coverings - Over Wintering.....	55-56, 60, 66
Coverings - Poly.....	60, 62
Coverings - Shade	63, 64
Coverings - White.....	60
Crest™	320
Crop Cover.....	66
Crossbow®	328
Curtain Systems.....	41, 368, 404
Motors.....	368, 404
Cytoplus™	249

D

Daconil.....	302
Dalotia Atheta	286
Dazide®	320
De Gier Drive Systems	411
Deadline®	343
Debug®	269
Decathlon®	269
Dec-Grow®	143
DeCloet®	42-43
Decorative Containers	78-97, 128,



130-133, 143, 169	
Deer Repellent.....	344
DeerPro®	344
Defoamer	342
Dema®	413
Deposition Aid	339
Devrinol®	328
DeWitt®	63, 66
Diaphragm Kits	411
Diaphragm Pumps.....	411
Dillen®	119
Dilution Solutions™	400, 409
Dimension®	328
Dimilin®	269
Dip 'N Grow®	321
DiPel®	269
Disc Filters	355
Discus®	269
Disease Control.....	301, 336
Disinfectants.....	304, 336-338
Display Carts	416-417, 419
Disposable Gloves.....	426
Dosatron®	408-409, 413
Dosmatic™	412-413

DP Industries®	422-423
Dramm®	346-350, 369, 392, 394, 405-407
Drip Irrigation.....	348-349, 352-355, 357-359
Connectors	355
Dribble Rings	348
Dribble Tube	349
Dripline.....	349, 358-359
Drippers	349, 352-354
Eyelets	348
Fittings	357
Manifolds.....	354
takes	352, 354
Weight Assembly	352, 354
Drive®	329
DuPont™ Tyvek®	426
Dura-Bench.....	48
Dura-Film®	54
DuraPlas	48

E

Eagle®	302
EC Meters.....	397-400





GREENHOUSE SOLUTIONS

FROM CONCEPT TO COMPLETION



FAMILY OF BRANDS



Green.tek

E	
Eckert's Greenhouse	184
Econo-Grip®	141
EcoSwing®	302
Ecotec®	270
Ectomycorrhizae	315
Empress®	302
Endeavor®	270
Endomycorrhizae	315-316
EndoThrive®	315
Engulf™	270
Entrust®	270
Envoy Plus®	329
Envu™	268
Epsom Salt	253
Equipment.....	339, 368, 383-384, 392, 394, 409, 411
Convection Tubes.....	368
Conveyors.....	383-384
Filters.....	409
Gear Motors.....	411
Panels.....	392
Propagation Mats.....	394
Soil Mixers.....	383-384
Water Tunnel.....	383-384
Ethylene.....	321
Ethylene Inhibitor.....	319, 321
Evergreen®	270
Evofactor™	342
Exhaust Fans	371
Exhibitline sf™	286
Extension Cords.....	380-381, 397
Ezi-Action®	395
F	
Fafard®	202
Fame®	303
Fans.....	369-371
Fascination®	321
Fenstop.....	303
Fertigation Systems.....	413
Fertilizer Injectors	407-409, 412-413
Fertilizers.....	210-214, 224-226, 230-233, 235-240, 243, 245-253
Aluminum Sulfate	250, 252
Cal Mag.....	210-213, 225, 230, 232
Geraniums	214
Hydroponic.....	214
Iron Chelate	250, 252
Mums.....	211, 213, 224, 231
Organic.....	252-253
Pansy.....	211, 224, 230
Peat-Lite	213-214, 231-233
Petunia.....	211, 232
Poinsetta	211-12, 224
Water Soluble	210
FERTISS®	182
Fiber Containers.....	94, 134-138, 157-158, 180-181
FiberGrow®	135-138
Filing Trays.....	146
Filters	348, 355, 358, 361
Disc Filters.....	355
Inline	348
Filters.....	See Equipment
Finale®	329
Fine Americas, Inc.....	319-321, 323
Fireworxx™	330
Fittings.....	350, 355, 357
Hoses.....	350
Tubing.....	355
Flagship®	270
Flats	110, 114, 115, 117, 151-153, 156, 164-168, 174, 179
FloPak®	425
Floralife®	321, 336
Floramite®	270
Florel	322
Florgib®	321
Florikan®	243, 250
Flow Valves	347, 348, 355
Fluence Bioengineering Inc...379-381	
FMC	266, 275, 278, 303
Foaming Agent Indicator	341
Foaming Sprayer	406, 413
Foggers.....	355, 405-407
Forbid®	271
Fortress®	329
Fosphite®	303
FreeHand®	329
Fresco®	321
Fuerte™	329
Fulcrum®	271
Ful-Humix®	249



F

Ful-Power® 248
 Fungicides..... 274, 278, 280-281, 299-307, 309-313, 337
 Organic..... 299, 301-303, 305-306, 309-311, 313, 337
 Fungus Gnat Control... 265-269, 271, 273, 276-278
 Furnaces - See Heaters.....
Fusilade® 329

G

Gallery®..... 330
Gal-XeOne® 243
GE..... 382
 Gearboxes 404
Gemini® 330
 Geranium Pots.....101, 108-109, 164, 179
 Germination Mixes 199-200
Global Horticulture 395
 Gloves 426
Gnatrol® 271
Gowan.... 267-268, 272, 274, 277, 300, 302-303, 332-333
Grandevo®..... 271
Great Oak, Inc...... 342, 344
GreenClean® 336-337
 Greenhouse Components 4-43, 45-47,

50, 361, 386
 Adaptor Plates..... 42
 Benching 46-48
 Brackets..... 42-43
 Camlock Base 45
 Corner Flashing 42
 Coverings..... 54-56, 59-60
 Doors 42
 Gables 43
 Gutters 43
 Purlin..... 43
 Screws..... 43, 45
 Stakes 43, 47
 Stub Posts..... 43
 Truss 42
 Greenhouse Film..... See Coverings
 Greenhouse Structure Cleaners 338
 Greenhouse Structures... 41-43, 45-47, 50
 Greenhouse Ventilation..... 368, 404
Green-Shield® 337
Green-Tek® 56, 61-62, 64-65, 369
Grip-Lip® 141
Grodan® 194-196
Grotto™ 303
 Ground Cover 65
Grow-Cubes™ 194
 Grower Media Mixes - See Soil.....
Grower Select® 45-50, 61, 65, 70-97, 186, 210, 361, 368, 416-417, 424, 414-415

Growlink® 392
Gro-Wool™ 194
 Grub Control..... 265

H

H.E. Anderson® 408, 410-411
H2Pro® 340
Hachi-Hachi® 271
 HAF Fans 369-370, 372
Haifa 253
Handi-Reach™ 347
 Handles See Watering Components
 Hanging Baskets
 73-78, 122-129, 134-136, 138, 159, 160, 171, 175-177, 184
 Decorative..... 73, 76
 Fiber 159-160
 Hangers.....
 73-78, 122-123, 127-129, 133, 138, 153, 159-160, 163, 171, 175-177, 184
 Moss 77
 Saucers 125
Hanna® 399
Hawk® 343
 Heaters..... 374-376, 387
 Gas..... 374-376
 Herbicides 319, 322-323, 327-334
 Organic..... 327, 330
Heritage® 303





- ✔ **Structure Design**
- ✔ **Installation**
- ✔ **Heating & Ventilation Systems**
- ✔ **Rolling Benches**



EXPERIENCE AND INNOVATION.

H

Hexygon	272
High Tunnels.....	46
Hormodin ®	322
Hort Americas LLC	382
Hoses.....	348, 350, 362
Connectors	348
Custom	350
Ferrule	350
Fittings	350
Swivels	348
Tools	350
HydraFiber ®	207
Hydra ™	405
Hydraulic Sprayers	405
Hydroponic Systems.....	395
Hypoline ™	286

I

ICL Specialty Fertilizers 230-233, 240, 251, 254, 267, 300-301, 313, 330, 340	
iGrow	393
ImidaStar ®	275
Indicate 5 ®	338
Inflation Components	43
Inflation Fans	370
Inflation Kits	43, 61
Infra Red Film	59
Injection Molded Containers	99-107, 111-112, 119, 121, 133, 142, 145, 164, 172, 178-179
Injection Spacer Tray	110
Injectors.....	407-409, 411-413
Inline Filters	348
Insect Control.....	267-268, 271, 274-275, 280, 289, 341
Insect Growth Regulator.....	268-269, 271, 274-275, 280
Insect Monitoring Sticky Cards	289
Insect Screen	65
Insect Traps.....	289
Insecticides... 265-278, 280-281, 285, 341, 343	
Botanical.....	275
Fogger.....	266-267, 276
Organic.....	265, 267-271, 274-276, 278, 280-281
Tablets.....	268
Inserts	113-115, 117, 151-153, 156, 164-168, 174, 179
Intrinsic ®	302, 306
Inverted Mini Wobbler ®	363
Iron Chelate Fertilizers.....	210, 248, 250, 252
IronFist ™	343



Irrigation Component.....	347-348, 352-355, 357-359, 361-363
Adaptor	362
ilters	348, 355, 358, 361
Fittings	355
Foggers.....	355
Hanging Assembly.....	347, 357, 362
Misters.....	357
Pressure Regulators	357, 363
Sprinklers.....	357, 362-363
Tubing.....	358-359
Valves.....	347-348, 355, 357, 361, 363
Weight Assemblies.....	352, 358, 362
Irrigation Control	387, 410
Irrigation Controllers.....	349, 355
Irrigation Systems.....	362, 385, 387, 413
Irrigation Tube Casing.....	361

J

J&D Manufacturing	371
Jack's Elementals ®	251
Jack's Professional ®	211-214, 251
JACTO, INC.	407
Jaderloon ®	47, 372
Jain	362
JanorPot ®	145
JH Biotech, Inc.	252, 301, 303
Jiffypot ®	180-181
JR Peters	211-214, 251

K

Kalmor ®	303
Kase Horticulture	383-384
Kemin Industries, Inc.	280
Ken-Bar ®	61
KleenGrow ™	304
Klerks	59
Knox Fertilizer Company Inc	333
Kontos ®	272
Kool Ray ®	64
Kopa ®	272

L

Labels	421-423
LALGUARD	272
Lallemand Plant Care	272, 304
LALSTOP	304
Lambert ®	200
Landmark ® Plastic	161-172
Leafminer Control	265-273, 275, 277
Lebanon Seaboard Corp.	334
Lighting	379-382, 384
Bulbs	382
Fixtures	379-380, 382, 384



WARNING: This product is not available for sale in CA.
For most up to date information please visit bfgsupply.com

L

Lime.....341
Link4 Corporation **393**
 Liquid Fertilizer.....210, 247, 249, 251
 Liquid Shade.....64-65
Lontrel®..... **330**
 Loose Fill Media187-190, 199

M

Macroplugs™ **194**
Magus® **272**
Mainspring® **266, 274, 272**
Mallet® **273**
 Manifold354
Manzate® **304**
Marathon® **273**
Mardenkro® **65**
Marengo® **330**
 Markers..... See Labels
Marrone Bio Innovations **271, 281, 309, 311**
 Masks.....426
Master MHW™ **337**
Maxx® **300**
 Mealybug Control265-269, 272-273, 275-278, 280-281
Medallion® **304**

Mefenoxam..... **305**
Merit® **273**
 Meters.....396-400
 Conductivity.....396-397
 EC.....397-400
 Nutrient.....398
 pH.....397-400
 TDS.....399
 Temperature.....397, 399
Michigan Peat® **203, 206**
Micora® **305**
Micromax® **251**
 Micronutrients210, 232, 239
Midwest Perlite® **206**
Millenium® **286**
Millside Industries® **418**
MilStop® **305**
Mini Wobbler® **363**
Mini-Blocks™ **195**
Minx 2® **273**
 Misters357
 Miticides 265-268, 270-278, 280-281, 341
 Fogger.....276
 Organic.....268, 274-275, 278, 280-281
Modine Manufacturing Co...... **374-375**
Moisture-Loc **342**
Moldex® **426**
 Mole Bait344
Molt-X® **274**

Monitoring Systems.....397, 403
Monterey® **322**
 Motomco Ltd343-344
Motorola® **402-403**
 Mouse Control.....343
M-Pede® **274**
M-Ps™ **343**
Multi-K™ **253**
 Multi-Year Film Coverings.....54
 Mum Pans72, 120-121, 137, 140, 143
Mural® **274, 305**
MycoApply® **315-316**
 Mycorrhizae315, 316
Mycorrhizal Applications **269-270, 275-276, 299, 315-316, 323**
Mycotrol® **274**

N

Nature's Source® **247**
NemaShield® **287**
 Nematicide.....267
 Nematodes.....286-287
Netafim™ **350-357**
Notavo® **274**
 Nozzles346, 347, 363
Nufarm Americas Inc...... **269-271, 273, 275, 277, 280, 299, 307, 309-310, 312, 321, 323, 327-329, 333**





**With new varieties yearly,
Plant Connection is here
to color your world!**

We've got your connection to seeds,
unrooted cuttings, rooted liners and plugs!

Your #1 trusted
plant broker.

THE PLANT CONNECTION[®]
A Division of BFG Supply Co.

BFG SUPPLY FAMILY OF BRANDS

Call us at **800.883.0234** or email
plantconnection@bfgsupply.com
to get started!

N

Nursery Containers.. 70, 72, 118-120, 137,
139, 140-141, 143, 163, 172
Nursery Supplies® 139-143
Nutricote® 245

O

Oasis® 182
OH2® 330
OHP, Inc.. 265, 267, 269, 270-275, 277,
280, 289, 300, 303, 305, 310-313,
319, 322, 327, 329, 330, 340
Olson Products Inc 289
OneTouch™ 347-348
ON-Gard® 249
Onyx Pro® 275
Organic Crop Protection
265, 267-272, 274-276, 299, 302, 305,
309-310, 315-316, 327, 330, 337-338,
341
Fungicides 299, 301-303, 306, 309-310,
313, 337
Herbicides..... 327, 330
Insecticides 265, 267-272, 274, 276
Mycorrhizae..... 316
Soil Inoculant..... 315, 316
Wetting Agents..... 341
Fungicides 305
Santizers..... 338
Organic Fertilizers..... 249
Organic Soils..... 190
Oriline i™ 287
Orkestra® 306
Orvego® 306
Osmocote® 236-240
Over Wintering Film 55-56, 66
Overture® 275
OxiPhos® 306

P

Pac O™ 322
Pace 49, Inc. 304, 336-339
Pageant® 306
Palladium® 307
Peat Pots..... 180-181
Pedestal® 275
Pendulum® 330
Penetrant..... 339
Pennant Magnum® 331
Pentra-Bark® 339
PerCarb® 307
PerFect..... 316
Perlite..... 192, 199-200, 205-206
PERpose Plus® 337



Pest Monitoring 289
Pesticide Equipment Cleaner..... 342
Peters® 230-233, 251, 254
pH Adjustment..... 341
pH Meters..... 397-400
pH Solution 399, 400
Phostrol 307
Phytoline™ 287
Phyton 27® 307
Phyton Corp..... 307, 337
Phytoseiulus Persimilis 288
Phytotronics® 362, 394
Piccolo® 323
Plant Growth Regulators..... 319, 320, 321,
322, 323
Plant Growth Stimulant 320
Plant Sleeves..... 424-425
Plant Support 134, 184, 395, 420, 422
Bamboo 420
PlantCoatPro™ 342
Planters 78-107, 119, 121, 128, 130-138,
157-158, 174
Plantex® 224-226, 253-254
Plug Trays 71, 118, 154-156, 165, 169-170,
182-183
Poly Carbonate..... 61-62
Poly Patch™ 62
Poly Tape 62
Poly-Ag Corp..... 60
Polyethylene Film Coverings..... 60
Polyethylene Tubing..... 359
Poly-Tex® 419
Pöppelmann Plastics Inc 173-175
Post Emergent Weed Control 327-334
Postiva™ 309
Pot Covers 395, 424-425
Pot Labels 422-423
PPE 423, 426
Pradia™ 275
Pramitol® 331
Pre Emergent Weed Control..... 327-334
Pressure Master Regulator® 363
Pressure Regulators..... 357, 363
Princep® 331
Production Equipment 392, 394
Professional Mix..... 186
ProGibb® 323
Prokoz 266, 312, 334
ProMarketing 402-403
PRO-MIX® 187-192





P	
Propagation Sheets.....71, 118, 154-156, 165, 169-170, 182	
Pro-Stick™304	
Protect™.....309	
PulsFOG®.....405-406	
PVP Industries®205	
Pycana®.....275	
PyGanic®.....275-276	
Pylon®276	
Pyrethrum®276	
Q	
Quali-Pro305	
Quest Products Corporation339	
Quietaire375	
R	
R3 Safety™426	
Rabbit Repellent.....344	
Radios402, 403	
Rampage®343	
Ranger Pro®331	
Redi-Heat™394	
Regalia®309	
Resolute®331	
Respirator Mask.....423, 426	
Respirator Visor423	
Retail Service Company.....421	
Reward®331	
Rice Hulls.....207	
Riceland®207	
Riococo®204	
RKW Klerks59	
Rodent Control343-344	
Ronstar®332	
Rootcubes®182	
Rooting Hormone.....321-322	
RootShield®309-310	
Round Pots73-74, 76-96, 97, 102-104, 108-110, 119, 128, 130, 131-133, 135-137, 139-143, 145-146, 150, 157-158, 163, 171, 173, 181	
Roundup®332	
Rycar®276	
S	
Safari®277	
SaniDate®337-338	
Sanitizer See Solutions	
Sanmite®277	
Schaefer®370-371	
Scimitar®277	
Screen-Aire Water Breaker®346	
Scythe®332	
Seal & Shield342	
SedgeHammer®332-333	
Seeder Trays71, 165, 169	
Segment®333	
Segway O®310	



With over 110 years of experience, Wetsel Seed keeps you growing!

Not all seeds are created equal.
Our premium seeds are carefully cultivated
to produce reliable results, everytime.

The perfect garden begins
with Wetsel Seed!



BFG SUPPLY FAMILY OF BRANDS

Visit [bfgsupply.com](https://www.bfgsupply.com) for
more information



S

- Selontra®** 343
Senninger® 361
Sensaphone® 403
Sensor® 289
Sepro Corporation 265, 271, 276, 280, 301, 319, 323
Sequestar® 250
 Shade Cloths 63, 64
 Shade Coverings 63-65
 Sheet Pots 116, 149
 Shopping Carts 417
 Shore Fly Control 265, 268-269
 Shut-Off Valves 347-348, 355, 357, 361, 363
 Shutter Motors 369
 Shutters 371
Shuttle O® 277
Siebring 376, 407
 Sign Labels 422-423
Sirocco® 277
Slimline EZ Close™ 352, 354
 Slug Control 343
Smithers-Oasis USA 182, 321, 336, 340
Snapshot® 333
Soax® 340
 Soil .186-192, 194-196, 199-200, 202-204, 206-207
 Organic 190
 Soil Amendments 205-207, 316
 Soil Inoculant 315-316
 Soil Mixers See Equipment
 Solutions 396, 399-400
Southwest Agri-Plastics 48
Space-It™ 358
 Spacer Trays 110
Spear-T® 278
 Specialty Containers .78, 94-97, 139, 165, 183-184
 Sphagnum Peat Moss.. 188-189, 191-192, 200, 203
Spirato® 310
 Spray Adjuvants 338-339, 341-342
 Sprayers 405-407, 413
 Accessories 405
 Backpack 405, 407
 Foaming 406, 413
 Hydraulic 405
 Spreading Agent 338-339
 Sprinkler Stand 355
 Sprinklers 357, 362-363
Sprint® 248
SPYDR 379
 Square Pots 70, 84-86, 90-94, 96, 104-107, 111-112, 119, 130, 133, 137, 145, 148-150, 161-162, 165, 168, 173, 178, 180, 181
St George Company® 423
 Stake Supports 420, 422
 Standard Pots 70, 113, 161
Staphyline™ 288
Stargus® 311
Starskii™ 288
Starter Plugs™ 194
Stature® 311
STEP® 251
Stratiolaelaps scimitus 288
Strip-It® 336, 338
Subdue® 311
 Succulent Pans 90
SuffOil-X® 278
Suffusion® 340
Sultan® 278
Sumagic® 323
Summit Plastic® 145-146
Sun Gro® 202
Sunshine® 202
Super 7 339
Super Wetter 341



WARNING: This product is not available for sale in CA.
 For most up to date information please visit bfgsupply.com

S	
SureGuard®	333
SureRoots®	155
Surfactant	339-340
Sustâne®	235, 246, 316
Syngenta Crop Protection Inc.	
265-266, 268, 270, 272, 274, 277,	
300, 302-305, 307, 309-311, 319,	
327, 329, 331, 333	
T	
T.O. Plastics	148-156
Talpid Mole Worms.....	344
Talstar®	278
Talus®	280
TAPKIT.....	395
TDS Meters.....	399
Teflon®	411
TEKU®	173-175
Temperature Meters	397, 399
Tenacity®	333
TerraGrow®.....	316
Terraguard®.....	312
TetraCURB™	280
The Greenhouse Company of SC ..	372
The HC Companies®	99-138
Thermoformed Containers.....	100-106,
120-121, 145, 148-149, 153, 162-165,	
168, 171-173	
Therm-O-Rock®	206
Thermostats.....	392
Thrips Control	265-278, 280-281
TM-7™	249
Tomcat®	344
Tools.....	394
Topflor™	323
Torpedo®	339
Torque™	312
TotalGrow™	384
Touch'N Flow PRO™	348
Tourney®	312
Tower®	333
Transom™	312
Transport Carts.....	416, 417
Transport Trays	161, 163, 174
Trapline	289
Trays 71, 109, 112, 148, 150-156, 164-168,	
174	
Treflan™	333
Trellis.....	420
Trellis Containers.....	96, 134
Triact 70®	280
Triathlon BA®	313
Trinity®	313
TriStar®	280
Truban®	313
Tube Fittings.....	355
Tubing	349, 358, 359
Tufflite®	55
Turf Marker Blue	342
Two-Way Radios	402, 403
Tyvek®	426
U	
Ultra 90	339
Ultra Pure®	281
Uni-Slab™	195
United Phosphorus Inc.....	304, 328
UPI	265
UpTake PRO®	339
Urn Planters.....	78, 83, 93
V	
Valves	347-348, 355, 357, 363
VAM Endo-Mix™	249



GROWING MEDIA

for Professional Growers

ASB

PROFESSIONAL



- **Wood Fiber Mix** – more natural and sustainable
- **Superior porosity** – more available water for better root development
- **Greater value** – more mix per bale with better yields



Growth is our Strength
ASB Greenworld Inc.

asbprofessional.com / sales@asbgreenworld.com



V

Ventgra® 281
 Ventilation....42-43, 45, 368-369, 370-372, 375-376, 388, 393
 Controller393
 Convection Tubing368
 Dehumidifier.....376, 388
 HAF Fans..... 369, 370, 372
 Dehumidifer376
 Oxygen Infuser372
Verano 365, Llc..... 342
 Vermiculite.....200, 205-206
Versa-Kool®370-371
Vessel™ 334
Vestaron Co...... 278
VIP® 62
 Vole Repellent.....344
VRE Systems® 407, 418
VYPR..... 379

W

Wadsworth Control Systems 392
 Wagons.....418
Water Breaker® 346
 Water Soluble Fertilizer210
 Water Treatment..... 321, 336, 338
 Watering Wands.....347

Weatherstik® 302
 Web Trays..... 110, 114-115, 153
 Webbing Tape..... 61
WEDGE® 182
 Weight Assemblies352, 354, 358, 362
Western Pulp® 157-160
 Wetting Agents.....338-341
 White Fly Control265-267, 269-278, 280-281
 Window Box78, 84
 Wine Barrel Planter 94
 Wire Holder.....289
Woodace® 334

X

X3® 337
XXpire™ 281

Y

Yara.....253
Yellow Sticky Tape 289

Z

ZeroTol® 313
Zorro Technology Inc 342



Growing Containers

Square & Round | Decorative | Hanging Baskets | Trays, Flats & Sheets | Support Systems | Sustainable



Browse all of HC's growing containers by visiting [hc-companies.com/products](https://www.hc-companies.com/products)

From Grower to Gardener,
Improving Our World.

Sign up for HC's monthly e-newsletter!
[hc-companies.com/newsletter](https://www.hc-companies.com/newsletter)



Contact your BFG Sales Representative today for more information on purchasing HC's growing containers!



ONE STOP.

How does BFG source everything you need, when you need it?

ANSWER:

Our partnerships with 800 leading manufacturers allow us to offer over 150,000 SKUs through 18 strategically located warehouses.

**BROWSE ALL ADDITIONAL
CATEGORIES & ITEMS TODAY**

See our full catalog lineup at
visit www.bfgsupply.com

SCAN NOW







Green.tek

WE HAVE YOU COVERED.

- ✔ **Shade Cloths**
- ✔ **Polycarbonate Sheets**
- ✔ **Aluminet**
- ✔ **Polyethylene Films**
- ✔ **Greenhouse Accessories**

BFG IS A NATIONAL SUPPLIER

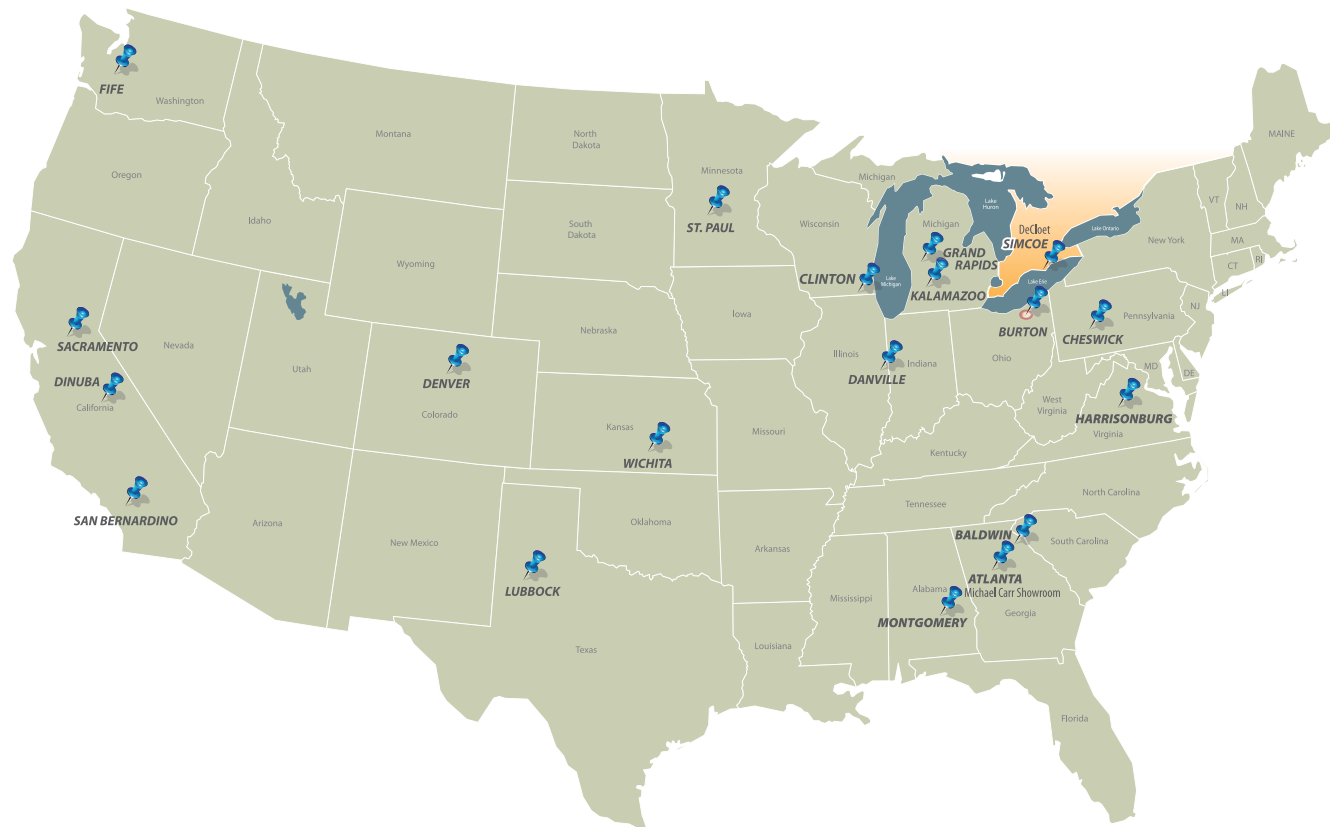

HEADQUARTERS

BURTON, OH
14500 Kinsman Rd.
P.O. Box 479
Burton, OH 44021
800-883-0234
FAX: 800-645-6126

CHESWICK, PA
460 Nixon Road, Suite 140
Cheswick, PA 15024
800-821-4351
FAX: 866-551-6929

DENVER, CO
12770 East 39th Ave
Denver, CO 80239
303-371-9790
FAX: 303-371-4729

FIFE, WA
2507 Frank Albert Rd
Ste. C-130
Fife, WA 98424
800-624-2517

GRAND RAPIDS, MI
4660 East Paris Ave., SE
Grand Rapids, MI 49512
800-224-5328
FAX: 616-541-3010

HARRISONBURG, VA
961 N Liberty St.
Harrisonburg, VA 22802
800-572-4018
FAX: 888-434-4894

KALAMAZOO, MI
1144 River St.
Kalamazoo, MI 49048
800-883-7234
FAX: 866-551-6927

LUBBOCK, TX
1400 E. Loop 289
Lubbock, TX 79403
806-744-8894

SAN BERNARDINO, CA
2552 Shenandoah Way
San Bernardino, CA 92407
1-800-624-2517

ST. PAUL, MN
711 Vandalia Street
St. Paul, MN 55114
800-798-2891
FAX: 866-393-5440

WICHITA, KS
1515 E. 29th St. North
Wichita, KS 67219
316-838-1474
FAX: 316-838-6104

**MICHAEL CARR
SHOWROOM**
3065 Chastain Meadows Pkwy
Bldg 200
Marietta, GA 30066
866-358-9998

DECLOET GREENHOUSES
1805 Charlottesville West Qtr. Line
Simcoe, ON N3Y 4J9
888-786-4769

GREENHOUSE MEGASTORE
70 Eastgate Dr.
Danville, IL 61834
1-888-281-9337
FAX: 1-217-443-0611

GREENHOUSE MEGASTORE
3740 Seaport Blvd, Suite 10
West Sacramento, CA 95691
1-888-281-9337
FAX: 1-916-372-7949

GREEN-TEK INC.
10084 Avenue 416
Dinuba, CA 93618
559-651-9888

GREEN-TEK INC.
5560 E Buss Rd
Clinton, WI 53525
608-754-7336

GREEN-TEK INC.
420 Industrial Blvd.
Baldwin, GA 30511
706-608-5911

GROSOUTH
620 N McDonough St
Montgomery, AL 36104
334-265-8241

HORTICULTURAL SUPPLY

2023 CATALOG



14500 Kinsman Road
PO Box 479
Burton, OH 44021
800-883-0234
bfgsupply.com

Structures, Coverings, Irrigation,
Containers, Media, Fertilizer, Crop Protection,
Equipment & Supplies,
and More!