

# FORD TRANSIT



Go Further



Visionary. Ingenious. Remarkable.  
Every vehicle bears his signature.

*Henry Ford*





## Built to carry the heaviest loads.

Whatever you need from a van, you'll find it in the new Ford Transit. Three load lengths, two roof heights, a choice of FWD, RWD and AWD powertrains, GVMs between 2,900 kg and 4,700 kg, and GTMs up to 7,000 kg. Plus a choice of seating and bodystyle configurations to meet your needs.

### Towing ability

Ford Transit's appetite for hard work extends beyond its loadspace. The 350HD and 470 versions with high-rated suspension and 7,000 kg GTM can pull up to 3.5 tonnes of braked trailer load. (Commercial users may need a digital tachograph) (Option, standard on 470)



# Loading made easy.

Behind Transit's metal bulkhead, you'll find up to 15.1 cu.m\* of secure cargo space. Near-vertical side walls, a flat load floor and load lengths of up to 4217 mm in the L4 version mean standard-length items, such as pipes, boards and rolls of carpet can be carried with ease. Access is quick and simple, thanks to a wide-opening sliding side door, full-height rear doors and a built-in rear bumper step. While the tough, Easy To Clean Load Floor helps to protect your van and your load. (Standard)



## Sidewall tie-downs

Transit has DIN/ISO compliant tie-down points positioned just above the floor on the side wall of the load space. This makes it easier to secure loads, while keeping the floor clear of obstructions, eliminating dirt traps and allowing the installation of the Easy To Clean Load Floor. (Standard)



Model shown is a Ford Transit Base L4 H3 with glazed metal bulkhead (option) and LED loadspace lighting (option).  
\*Measured in cubic metres in the L4 H3 Van.



## Double Cab-in-Van. The adaptable load carrier.

For an even more versatile Transit, look no further than the Double Cab-in-Van. Capable of carrying up to seven people, its standard bulkhead safely separates the load space from the passenger area.

### Hard-working versatility

There's plenty of space for you, your crew and equipment in Transit Double Cab-in-Van. Carry a work team onsite in comfort with their tools stored safely in the versatile loadspace. A rubberised floor covering and half-height side trim reinforce its tough working credentials.



# Your office on the move.

Light, bright and easy to drive, Transit sets new standards for vehicles in its class. With exceptional levels of finish and refinement, smart driver-oriented technology, plus a range of practical and thoughtful features – like a fold-down table that’s integrated into the dual front passenger’s seat and large enough to hold a laptop computer – it’s the best equipped office on the road.

Model shown is a Ford Transit Van Trend with radio/SD-navigation system (option), Lane Keeping Alert (option) and front passenger’s airbag (option).

Note: A rear-facing child seat should never be placed in the front passenger seat when the Ford vehicle is equipped with an operational front passenger’s airbag.

## SelectShift automatic transmission

Transit’s new six-speed SelectShift automatic transmission delivers a smooth, relaxing driving experience, especially in busy stop-start traffic. The transmission allows you to change gear manually if you prefer, using the facia-mounted gearshift, and provides the ability to lockout gears in more challenging driving conditions, e.g. on slippery surfaces or steep gradients. (Option on front-wheel drive models, available in 2017)



# Use your voice like another pair of hands.

Ford SYNC 3 lets you select music, control navigation and make hands-free calls – all with simple voice commands or via the 6" colour touchscreen. It will even read out your incoming text messages. And, in the event of an accident, the Ford Emergency Assistance\* feature can assist you to contact the emergency services. (Option)

\*Compatible mobile phone required. You can browse a list of AppLink-compatible apps from your regional Ford website, or via the Ford App Catalog available in iOS and Android stores. SYNC AppLink and Emergency Assistance are not supported by all European languages.



| SYNC

“Read message”

“Call Chris”

“Call office”

“Play artist Men at Work”

“Call depot”

“Shuffle”

“What's playing?”

“Call home”





# All-wheel drive confidence.

When the going gets tough, nothing beats the sure-footed traction of All-wheel drive. Available on selected models\*, Transit's intelligent AWD system senses the level of grip available to each wheel and actively distributes the torque from the engine to wherever it's most effective.

## Optimise your drive.

Transit's latest 2.0 TDCi diesel engine is offered with a choice of three power outputs, each driving through a 6-speed manual transmission. All engines comply with strict EU Stage 6LDT III emission standards. Selected engines are available with Front-, Rear- or All-wheel drive.



### Front-wheel drive

- Engine availability: 105 PS/360 Nm; 130 PS/385 Nm; or 170 PS/405 Nm
- Larger loadspace, extra interior height and lower load height
- Lower kerbweight for greater payload and fuel efficiency



### Rear-wheel drive

- Engine availability: 105 PS/360 Nm; 130 PS/385 Nm; or 170 PS/405 Nm
- Superior traction when heavily laden
- Best suited for heavier duty applications and towing



### All-wheel drive

- Engine availability: 130 PS/385 Nm; or 170 PS/405 Nm
- Driver-selectable AWD provides extra traction in difficult terrain conditions
- Under normal conditions drive is directed to the rear wheels. When engaged, the system automatically increases engine torque to the wheel(s) with the most grip

## All-wheel drive for all-weather working

Transit's electro-hydraulic actuator enables torque to be applied to the front wheels in a controlled manner, according to the road conditions. Working with the vehicle's ESC system, sensors constantly evaluate data to identify low friction road surfaces, such as ice or wet leaves, and can automatically direct more drive to the front axle for optimum traction. AWD can also be applied pre-emptively to avoid wheel slip occurring by monitoring the driver's actions, for example, pressing down the accelerator pedal whilst turning the steering wheel.

\*All-wheel drive will be offered on 350 L2/L3 Van; and Double Cab-in-Van 350 L2/L3.





# Less fuel, more power.

Engineered to meet strict Euro6 emissions standards, Transit's next generation 2.0L TDCi diesel engine range provides more power and torque with reduced fuel consumption. Each engine in the range – 105 PS, 130 PS and 170 PS – uses state-of-the-art design to deliver outstanding fuel efficiency with excellent driveability and refinement. What's more, service intervals have been extended to 60,000 km (or two years) to further reduce the cost of ownership.

**55% less  
NOx than the  
previous  
standard.**

Greater  
performance,  
fewer emissions.

Transit's next generation 2.0L TDCi diesel engines comply with the stringent Euro6 emissions standard. A Selective Catalytic Reduction (SCR) system uses AdBlue®, a urea/water-based fluid to convert nitrogen oxide (NOx) emissions in the exhaust gas into nitrogen and water. A particulate filter then reduces more than 99% of emitted solid particulates from the vehicle's exhaust.

# Choose the engine that's right for you.

More torque.  
More pulling power.

Transit's new powertrain options allow you to match the engine to your operational requirements. Each engine in the range provides excellent performance, both in terms of fuel economy and flexibility, while offering a range of power and torque outputs to suit the demands of every job.

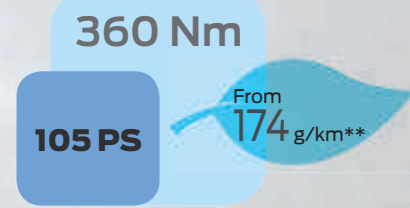

## More efficient

### 2.0L next generation TDCi 105 PS

Engineered to meet strict Euro6 emissions standards, Transit's next generation TDCi 105 PS (77 kW)/360 Nm diesel engine combines outstanding fuel efficiency (from as low as 6.7 L/100 km\* (42.1 mpg\*) combined) with excellent driveability and refinement. Its state-of-the-art design helps to keep running costs down without compromising on payload or performance.

\*NEDC test figures.

\*\*NI, MI from 184 g/km.

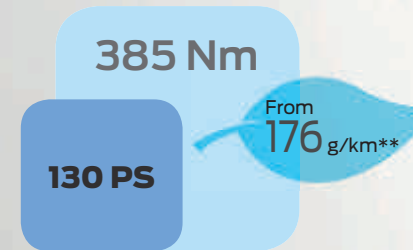

## More flexible

### 2.0L next generation TDCi 130 PS

The 130 PS (96 kW)/385 Nm Euro6 engine strikes a balance of delivering extra power and torque necessary to enhance Gross Train Mass (GTM) without compromising emissions.

\*\*NI, MI from 184 g/km.

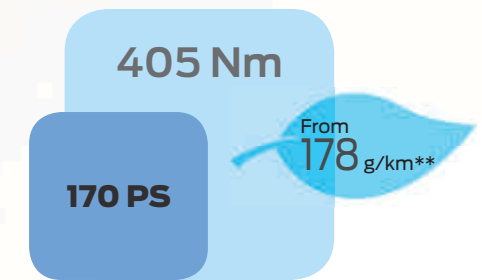

## More powerful

### 2.0L next generation TDCi 170 PS

The outstanding new 170 PS (125 kW) Euro6 engine develops an extraordinary 405 Nm of torque. As the most powerful engine in the range, its hard-working character makes it the ideal choice for moving heavy loads and towing, while still delivering outstanding fuel efficiency (from as low as 6.9 L/100 km\* (40.9 mpg\*) combined).

\*\*NI, MI from 184 g/km.

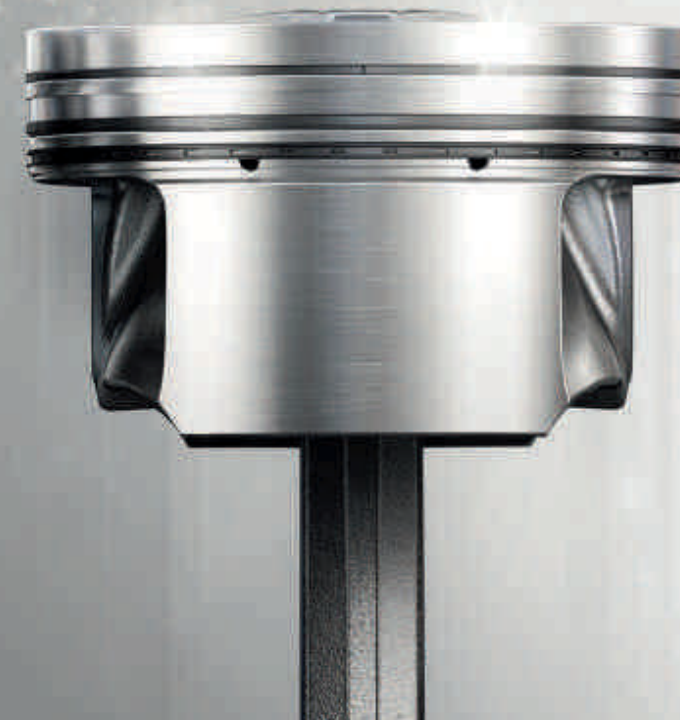

105 PS (77 kW) 2.0L next generation TDCi

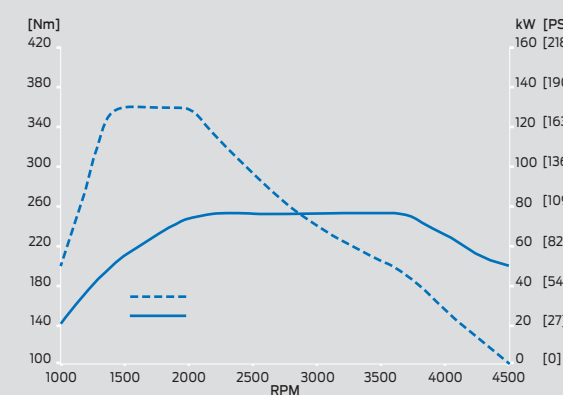

130 PS (96 kW) 2.0L next generation TDCi

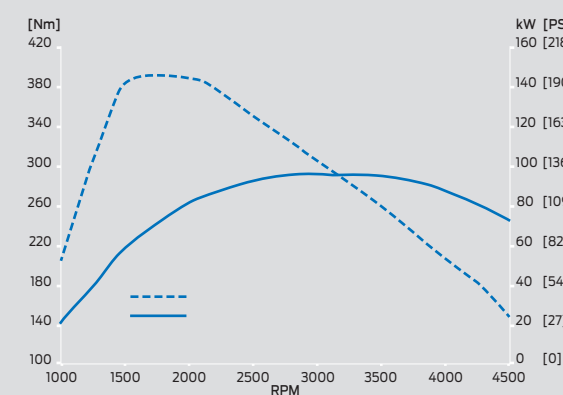

170 PS (125 kW) 2.0L next generation TDCi

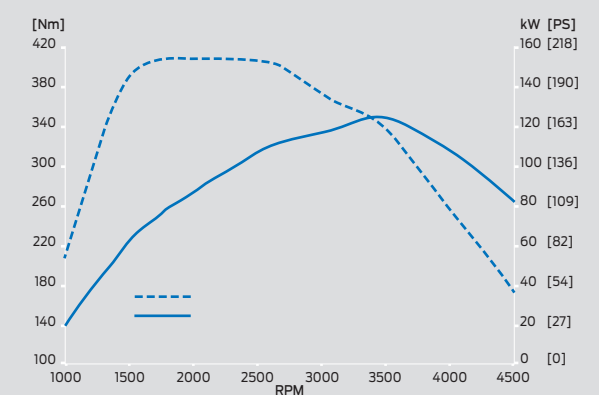



## The sum of all parts adds up to less cost.

Quality and durability are built into the Transit at every step. After many years of service it will feel as good, and be as rewarding to drive, as the day you picked it up.

**1. Extended service intervals** of up to 60,000 km (or two years) further reduce your running costs. (Standard)

**2. Auto-Start-Stop** automatically switches off the engine when you come to a halt and put the vehicle in neutral. Restarts smoothly when you want to move off, reducing fuel consumption and exhaust emissions. (Option on Van models. Standard on Bus models)

**3. Engine oil monitor** warning light will illuminate if the condition of the engine oil deteriorates between services. (Standard)

**4. High-level light units** are mounted above the bumper line, to help keep them out of harm's way and protect them from low speed accident damage. (Standard)

**5. Brake pad wear sensors** warn when the pads are due for renewal. (Standard)

**6. Fuel filter sensor** warns of water ingress or a blockage of the fuel system. (Standard)

**7. Ford Easy-Fuel capless refuelling system** – a unique safeguard ensures that nobody can accidentally fill up with the wrong fuel. Plus, no dirty fuel caps to touch. (Standard)

**8. 12-year perforation warranty** provides reassurance against perforation of the bodywork from the inside of the panel. (Standard)

**9. Multi-piece rear bumper design** helps to keep repair costs low. (Standard)

## Go further for less.

New Transit's EcoBlue diesel engines are among the most refined and efficient available. Featuring the latest common rail technology, they not only offer strong, dependable performance, but deliver excellent fuel consumption and CO<sub>2</sub> emissions too.

### Ford ECONetic Technology

Ford ECONetic Technology brings together a range of vehicle features and technologies to deliver improved fuel economy, reduced emissions and lower cost-of-ownership, without compromising on performance or functionality.

### Ford ECONetic Technologies include

- Ford EcoBlue advanced diesel engines – provide exceptional fuel economy and low CO<sub>2</sub> emissions
- Ford Auto-Start-Stop – switches off the engine when the vehicle is stationary
- Ford Smart Regenerative Charging – charges the battery only when needed
- Shift Indicator light – advises driver of optimum time to change gear
- Ford Eco Mode – encourages economical driving behaviour
- Switchable 110 km/h Speed Limiter – reminds driver that higher speeds are less fuel efficient
- Acceleration Control – prevents excessive acceleration when the vehicle is unladen
- Ford Battery Management System – improves battery life, fuel consumption and ensures ready-to-go reliability

Model shown is a Ford Transit ECONetic L3 H2 in Moon dust Silver metallic paint. (option)

**Note** The availability of Ford ECONetic Technology varies by model. Please ask your Ford Transit Specialist Dealer for details. For more information on our sustainability initiatives visit [ford.com/go/sustainability](http://ford.com/go/sustainability)

# When there's no time to think, Transit's already reacted.

## Using radar and a camera, **Pre-Collision Assist**<sup>(2)</sup>

keeps a watchful eye on the road ahead for other vehicles. The system is designed to read the road conditions and can alert you to a potential collision. If you don't respond to the system's warning signals, **Active Braking**<sup>(2)</sup> pre-charges the braking system and can automatically apply the brakes to help avoid or reduce the effect of any impact. (Option)



## **Driver Alert**<sup>(2)</sup>

Designed to warn you if the system detects driving behaviour that indicates a drop in alertness levels. Initially, a warning icon is displayed in the instrument cluster, followed by a warning chime if driving alertness further declines. (Option as part of a pack)

<sup>1</sup>Uses sensors.  
<sup>\*</sup>Operates at speeds over 70 km/h on multi-lane roads with clearly visible lane markings.  
<sup>†</sup>Safety feature.  
<sup>‡</sup>Driver assistance feature.



## **Lane Keeping Alert**<sup>(2)</sup>

It only takes a momentary slip in concentration to drift out of your lane when driving on the highway. Lane Keeping Alert<sup>(2)</sup> is designed to recognise when you approach the road markings without using the indicator, and alerts you with vibrations through the steering wheel. (Option)



## **Adaptive Cruise Control**

Set your desired speed and Adaptive Cruise Control maintains a pre-set distance from the vehicle in front. If the sensors detect traffic slowing ahead, your vehicle automatically slows down. When traffic has cleared, your vehicle accelerates back to cruising speed. (Option on Trend and as part of a pack on Base)



## **Traffic Sign Recognition**<sup>(2)</sup>

Designed to automatically read standard format road-speed signs and display the posted speed limit in the instrument cluster.



# Delivers with confidence.

Ford Transit is fitted with our innovative new Curve Control technology. The feature – part of Transit's standard Electronic Stability Control system – senses when a driver takes a curve too quickly and can rapidly reduce engine torque, and apply brakes to individual wheels, to help keep the vehicle safely under control.

## Further ESC features include

1. Curve Control
2. Traction Control System
3. Hill Start Assist
4. Trailer Sway Control
5. Load Adaptive Control (LAC)
6. Emergency Brake Assist (EBA)
7. Emergency Brake Warning
8. Roll Stability Control (RSC)
9. Torque Vectoring Control

## Side Wind Stabilisation<sup>®1)</sup>

Helps the driver to stay in lane in strong, gusty conditions by using the ESC system to sense when the vehicle is being affected by crosswinds.

<sup>®</sup>Uses sensors.

<sup>®1)</sup>Safety feature.

<sup>®2)</sup>Driver assistance feature.



## ISOFIX child seat fixing points

Second-row seats incorporate ISOFIX child seat fixing points with top tether mounts for extra security. (Standard on Kombi) Choose a Britax Roemer<sup>®</sup> ISOFIX child seat for additional child safety. (Accessory)

+Item covered by third party supplier's warranty, please see back cover for details.

## Side curtain airbags<sup>®1)</sup>

Designed to help protect the driver and front passenger's heads from injury. (Option)



Van  
Medium wheelbase L2

Standard roof H2  
FWD  
**10.0**  
cu.m\*  
RWD/AWD  
**9.5**  
cu.m\*



High roof H3  
FWD  
**11.2**  
cu.m\*  
RWD/AWD  
**10.7**  
cu.m\*

**2/3**  
seats



Van  
Long wheelbase L3

Standard roof H2  
FWD  
**11.5**  
cu.m\*  
RWD/AWD  
**11.0**  
cu.m\*



High roof H3  
FWD  
**13.0**  
cu.m\*  
RWD/AWD  
**12.4**  
cu.m\*

**2/3**  
seats

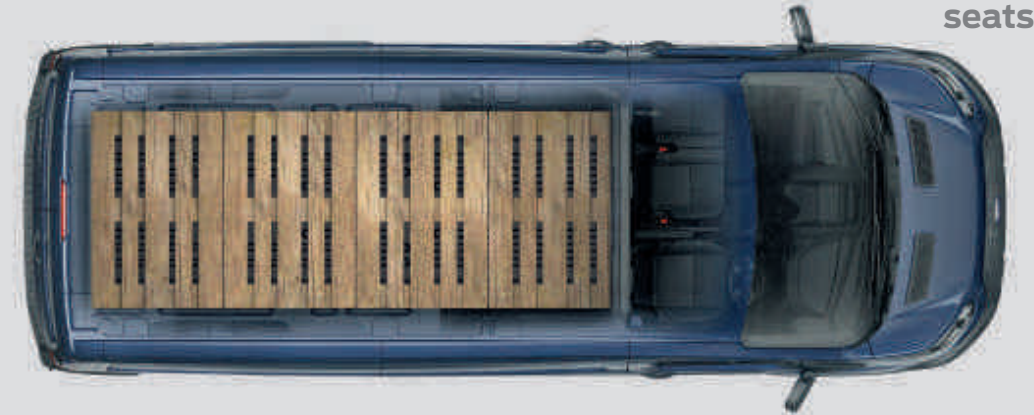

Van  
Long wheelbase EF L4



High roof H3  
RWD  
**15.1**  
cu.m\*

**2/3**  
seats

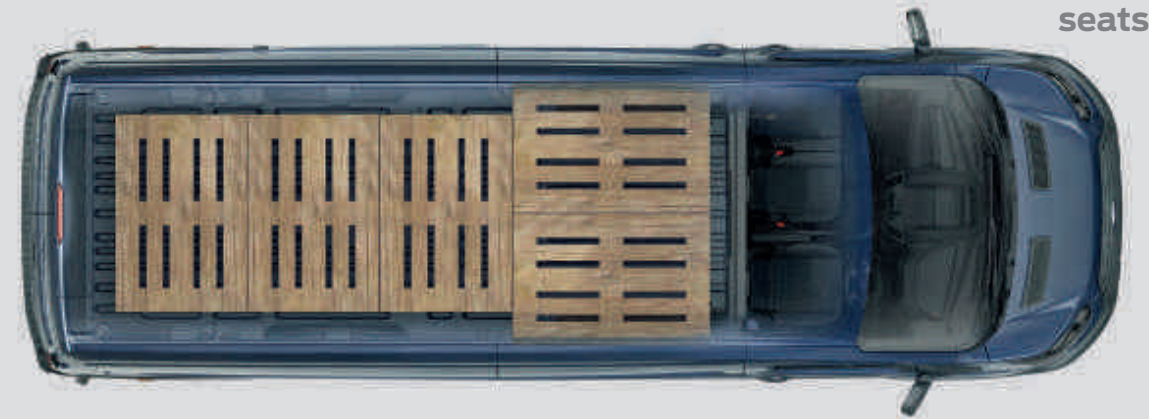

Transit Van.  
Maximum load-carrying space and capacity.

New Ford Transit Van clearly means business. Choose from three load lengths, plus a range of GVMs and driveline configurations.



\*FWD/RWD and AWD. Maximum load volume measured in cubic metres and with a full bulkhead fitted.

Double Cab-in-Van  
Medium wheelbase L2

Standard roof H2  
FWD  
**6.1**  
cu.m\*  
RWD/AWD  
**5.7**  
cu.m\*



High roof H3  
FWD  
**6.7**  
cu.m\*  
RWD/AWD  
**6.4**  
cu.m\*

**5-7**  
seats

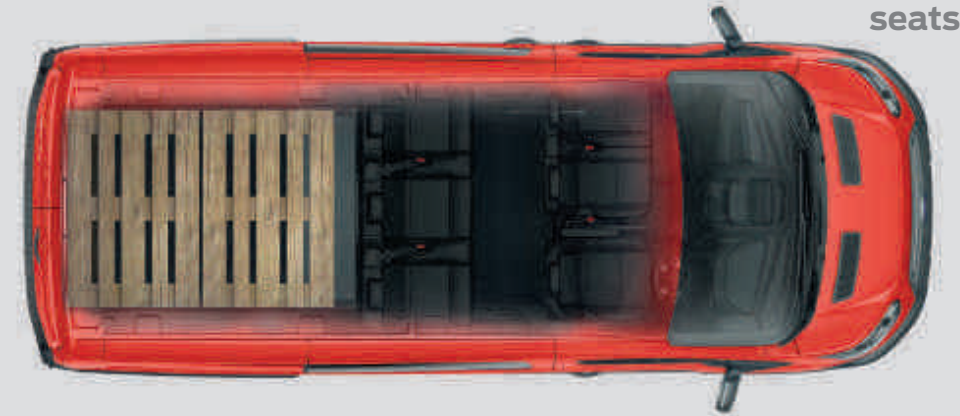

Double Cab-in-Van  
Long wheelbase L3

Standard roof H2  
FWD  
**7.6**  
cu.m\*  
RWD/AWD  
**7.2**  
cu.m\*



High roof H3  
FWD  
**8.4**  
cu.m\*  
RWD/AWD  
**8.0**  
cu.m\*

**5-7**  
seats

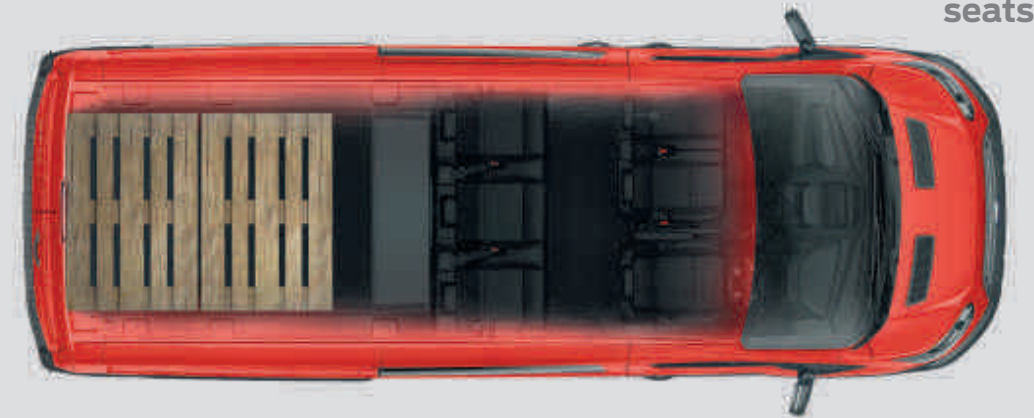

Double Cab-in-Van  
Long wheelbase EF L4



High roof H3  
RWD  
**10.6**  
cu.m\*

**5-7**  
seats

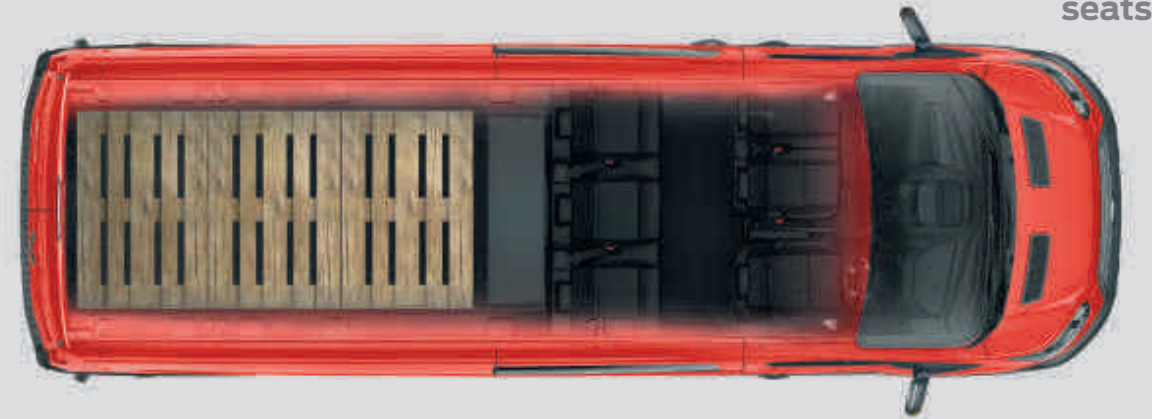

Double Cab-in-Van.  
Secure transportation for people and their gear.

There's simply no finer crew-van than Ford Transit Double Cab-in-Van. Purpose-built to carry up to 7 people in combination with up to 10.6 cu.m of flexible loadspace behind a secure bulkhead, it can tackle virtually any task that comes its way.



\*FWD/RWD and AWD. Maximum load volume measured in cubic metres and with a full bulkhead fitted.





**Ford Easy-Fuel capless refuelling system**  
(Standard. Available as an option for capped systems)



**Image above** Ford Transit Van Ambiente in Moondust Silver metallic paint (option).

# Base

## Exterior features

- Door mirrors with large blind spot eliminator
- Door mirrors with integrated side indicators
- Passenger's sliding side load door and step
- Half cap wheel covers
- Headlight courtesy delay
- Integrated rear bumper step
- Wide bodyside mouldings

## Interior features

- Trip computer
- My Connection radio with AUX, Bluetooth®, USB/iPod® connectivity and remote controls
- Driver's 4-way seat adjust
- Rake- and reach-adjustable steering column
- Dual passenger's seat with underseat stowage compartment
- Electrically-operated front windows
- Remote central locking
- Shift Indicator light
- Courtesy lights with theatre dimming
- Easy-clean rubber floor covering in cab
- Easy To Clean Load Floor
- Full metal bulkhead
- DIN 75410 compliant tie-down loops

## Option Packs

- Visibility Pack 1 – Quickclear heated windscreen, washer fluid sensor, and electrically-operated and heated door mirrors
- Visibility Pack 2 Quickclear heated windscreen, washer fluid sensor, electrically-operated and heated, power-foldable door mirrors, automatic headlights, autowipers, front fog lights, and variable cluster dimming
- Lane Keeping Alert Pack (contents include Ford SYNC radio/CD, high series instrument cluster, cruise control and leather-trimmed steering wheel) (standard on N2 models, option on N1)

For further option availability, please refer to the specification section.

## Engines

- 2.0 Ford EcoBlue 105 PS (Stage VI)
- 2.0 Ford EcoBlue 130 PS (Stage VI)
- 2.0 Ford EcoBlue 170 PS (Stage VI)

**Image right** Ford Transit Van Ambiente with Traxon and Max in Charcoal Black interior.





Parking distance sensors, front and rear  
(Standard)



Image above Ford Transit Van Trend in Tectonic Silver metallic paint (option).

# Trend

## Exterior features

- Front fog lights
- Projector-style halogen reflector lights with static cornering lights
- Studio grey front grille
- Electrically-operated/heated door mirrors
- Full wheel covers (with single rear wheels)
- Front and rear parking sensors
- Heated windscreen
- Automatic headlights
- Autowipers

## Interior features

- Ford SYNC radio/CD with AUX, Bluetooth®, USB/iPod® connectivity and remote controls
- Leather-trimmed 4-spoke steering wheel
- Leather-trimmed gearshift knob
- Cruise control with Adjustable Speed Limiter
- Dual passenger's seat with lift-up seat stowage and fold-out table
- Map reading courtesy lights
- Passenger side load door footwell illumination
- Complete load compartment half-height trim board

## Option Packs

- Visibility Pack 3: Lane-Keeping Alert (including Auto High Beam and Driver Alert), rear-view camera, Quickclear Heated windscreen, washer fluid sensor, high series instrument cluster, electrically-operated and heated, power-foldable door mirrors, auto headlights, autowipers, front fog lights, variable cluster dimming (only with SYNC)
- Lane Keeping Alert Pack (contents include Ford SYNC radio/CD, high series instrument cluster, cruise control and leather-trimmed steering wheel) (standard on Bus models, option on Van NI)

For further option availability, please refer to the specification section.

## Engines

- 2.0 Ford EcoBlue 105 PS (Stage VI)
- 2.0 Ford EcoBlue 130 PS (Stage VI)
- 2.0 Ford EcoBlue 170 PS (Stage VI)

**Note** The Bluetooth® word mark and logos are owned by the Bluetooth SIG, Inc. and any use of such marks by Ford Motor Company Limited and its associated companies is under licence. Other trademarks and trade names are those of their respective owners.

Image right Ford Transit Van Trend with Lane and Max in Charcoal Black interior.



# Options and accessories

Storage solutions, extra protection and greater versatility are all available for Ford Transit.

## Engine undershield

Tough corrosion-resistant metal undershield protects engine from accidental stone and kerb damage. Easily removed for oil changes and routine servicing. (Option and accessory)

## All-weather floor mats

Equipped with the Transit nameplate. All-weather floor mats are tailor-made to fit your Ford perfectly and protect against dirt and damp. Securely fixed directly onto the vehicle's floor, the driver's mat cannot slip and interfere with the pedals. (Accessory)

## Q-Top® (Q-Tech) roof gallery

Lightweight aluminium construction allows additional load\*. Ideal for transportation of large, long or bulky items and gives you more flexibility in your daily business. Also available with a ladder roller at the rear end for easier loading. (Accessory)

\*Please refer to vehicle weight and load specification.

## Rear ladder

For easy access to the roof. (Option and accessory)

## Rear window protection grille

Grille fixes to inside of rear windows for enhanced security without obscuring rearward vision. (Option and accessory)

## Roof base carrier, lockable

Roof carrier holds up to 150 kg (depending on vehicle specifications) and is the base for various roof transportation attachments. (Accessory)



## Interior roof rack

Two black steel racks hold a maximum of 50 kg and can be fixed in different locations on the inside roof rails in line with the flex floor. (Option and accessory)



## Loadspace divider

Black metal mesh bulkhead can be fitted in various positions to the floor rails of the flex floor to extend the versatility of your loadspace and form a secure load box. (Option and accessory)

## ClimAir® wind deflectors

Reduce wind turbulence and noise, allowing you a more enjoyable drive with the front windows down, even during light rain. (Accessory)

## 16" alloy wheels

16" alloy 5x2-spoke alloy wheels in Sparkle Silver. (Option and accessory)

## Locking wheel nuts

Set of four locking wheel nuts to help protect wheels against theft. (Accessory)

## Brink® tow bar

For extra transport capability, the fixed tow bar can tow up to 3,500 kg, depending on engine. (Accessory) (Commercial users may need a digital tachograph. A fitting kit is available from your Ford Dealer)

For more accessories for your Ford Transit visit [www.ford-accessories.ie](http://www.ford-accessories.ie)

For a range of Ford branded items – from clothing to lifestyle products and model cars – visit [www.fordlifestylecollection.com](http://www.fordlifestylecollection.com)

+ Item covered by third party supplier's warranty, please see back cover for details.

	Availability	Part Number (FINIS)
Base roof carrier L2	○ A	1816678
Base roof carrier L3	○ A	1816680
Rear window protection grille	○ / ○ A	1838135
Thule®+ tow bar, fixed	○ A	1855715
Thule®+ electrical kit for tow bar 13-pin connector, LHD	○ A	1855712
Thule®+ electrical kit for tow bar 13-pin connector, RHD	○ A	1855713
ClimAir®+ wind deflectors, front, light grey	○ A	1856560
ClimAir®+ wind deflectors, front, dark grey	○ A	1856561
Bosch® reverse warning device	○ A	1713304
Xvision+ Parking Distance Sensor(s), front	○ A	1855856
Xvision+ Parking Distance Sensor(s), rear	○ A	1855854
16" 5x2-spoke alloy wheel	○ / ○ A	1842987
Locking wheel nuts, set of 4	○ / ○ A	1763879
Premium safety pack	○ A	1781293

○ = Optional, at extra cost, ○ A = Optional accessory, at extra cost, +Please see back cover for warranty information.

## Bosch® reverse warning device

Linked to reverse gear. Provides an audible warning when the vehicle is reversing. (Accessory)



## allsafe JUNGFALK® load retention pack and Delignit® load floor kit

Load retention pack comprising half-height and full-height side rails with fixing kit, including fittings, hooks and lashing straps. Load floor kit includes hardwood floor with anti-slip coating and integrated airline rails (500 daN/ISO compliant). (Option and accessory)

## allsafe JUNGFALK® TransSAFE® load restraint systems

Secure complex loads safely and easily with lightweight cargo net systems, ideal for courier and parcel delivery services. Choice of manually-operated TransSAFE® System Net Plus (option and accessory) or electrically-operated TransSAFE® go (option) that automatically secures your load at the push of a button.



# Electronic Stability Control

New Ford Transit is fitted with Electronic Stability Control (ESC)<sup>(1)</sup> as standard. The advanced system constantly monitors the path the vehicle is following and compares it to the driver's intended course. If ESC senses a significant difference, it automatically reduces engine torque and applies brakes to individual wheels to help stabilise the vehicle and keep it safely on track.

## Curve Control<sup>(2)</sup>

Senses when a driver takes a curve too quickly, and can rapidly reduce engine torque – and apply brakes to individual wheels – to help keep the vehicle safely under control. (Standard)

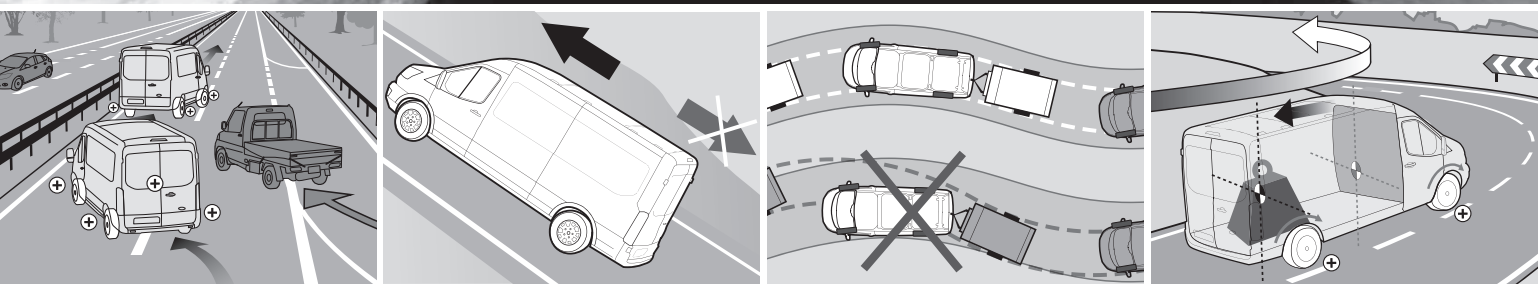

### Roll Stability Control<sup>(1)</sup>

Ford's unique roll-rate sensor helps the Roll Stability Control system to keep the tyres grounded under conditions of high centre of gravity and when driving through off-camber turns. (Standard)

### Hill Start Assist<sup>(2)</sup>

Designed to temporarily prevent you from rolling down a slope when you move your foot from the brake pedal to the accelerator pedal. It works in forward and reverse gears, so is ideal for towing and pulling heavy loads. (Standard)

### Trailer Sway Control<sup>(2)</sup>

When it detects trailer sway, the system is designed to reduce engine torque and apply the brakes to the appropriate wheel(s) to help maintain control – standard with all Ford tow bars. (Option and accessory)

### Load Adaptive Control<sup>(2)</sup>

Designed to adjust the responses of the ESC<sup>(1)</sup> system to compensate when the vehicle is unladen, partially- or fully-laden. (Standard)

# Get the most from your new Ford

We want to help you get the most from your new Ford. And to do that, you need to know how much it is designed to safely carry, both in terms of payload and load volume.

Your Ford Commercial Vehicle Dealer can provide professional advice on important specification aspects, and help to find the right van for your budget and business needs.

## The Ford Transit is designed to carry cargo – and lots of it.

Choosing a new van is an important decision with lots of factors to be considered. While some aspects, like selecting the most appropriate derivative, identifying the intended primary use and determining load box size are relatively simple, others, such as calculating payload are more complex.

### Payload capacity

To calculate payload, you need to know two things: the vehicle's gross vehicle mass (GVM) and its kerb mass.

GVM is the maximum permissible weight of the vehicle when loaded and ready to go – that includes the weight of the vehicle itself, ancillaries, driver and crew (assuming the industry standard weight of 75 kg/person), fluids, fuel tank 90% full (1 litre of diesel = approximately 0.85 kg), optional and aftermarket equipment, and cargo.

For simplicity, Ford Transit models are designated according to their GVM. For example, a 330 has a GVM of c. 3,300 kg; and a 350 has a GVM of c. 3,500 kg.

Kerb mass is the weight of a standard-specification Ambiente series vehicle, including fluids and fuel tank 90% full, but without the driver, crew or cargo.

**Payload** is the difference between the two.

### Gross vehicle mass minus kerb mass = payload

So to help you choose the right vehicle for your needs, here are some more detailed explanations about the factors that can influence a vehicle's payload. These include, but are not limited to:

### Driver and crew

We calculate the weight of the driver and crew based on the industry-standard weight of 75 kg/person. Remember that the driver and crew are not included in the kerb mass figure, so when a driver or crew boards the vehicle, its payload will be reduced accordingly.

## Factory-fitted options

Most factory-fitted options will affect a vehicle's payload. For example, air conditioning can add approximately 18 kg to a vehicle's weight, and therefore reduce its payload accordingly.

However, specifying a single front passenger seat in lieu of the standard dual seat will reduce the vehicle's weight by approximately 12 kg, and increase its payload by the same amount. Your Ford Commercial Vehicle Dealer will be able to tell you what features can add or reduce your vehicle's kerb mass and by how much.

## Series

All kerb masses quoted in this brochure are for standard-specification Ambiente series models. Trend series models will generally weigh more than Ambiente series due to the increased level of features and equipment.

## Manufacturing tolerances

Variations in manufacturing and production processes mean that no two vehicles are likely to weigh exactly the same.

## Accessories and aftermarket conversions

It is important to think carefully about what to do with your vehicle after you take delivery. Any accessories fitted or aftermarket conversions to the vehicle may adversely affect its payload. Please speak to your Ford Commercial Vehicle Dealer for more information and advice.

If payload is critical to your business, or if you plan to carry cargo at, or close to, the vehicle's maximum capacity, your Ford Commercial Vehicle Dealer can help.

Using their specialist expertise and knowledge, they can advise you on the exact specification of vehicle required to meet your individual business needs.

## Configure your van to suit your job

Ford Commercial Vehicles are available with a wide range of standard and optional features. Your Ford Commercial Vehicle Dealer can help you ensure that you specify the right vehicle features for your specific business needs, including technical items to aid aftermarket fitment of specialist equipment or conversion.

<sup>(1)</sup>Uses sensors.

<sup>(2)</sup>Safety feature.

<sup>(3)</sup>Driver assistance feature.

## Weights, loads and performance

	Max. gross payload (excluding driver) (kg)	Net payload (kg)	Gross vehicle mass (kg)	Min. kerb mass (excluding driver) (kg)	Mass in running order (kg)	Front axle plated mass (kg)	Rear axle plated mass (kg)	Max. trailer mass (kg) (a)	
								Braked	Unbraked
<b>Van</b>									
<b>FWD</b>									
290 L2 H2/H3	914-872	839-797	2940	2026-2068	2101-2143	1625	1575	2800	750
310 L2 H2/H3	1114-1072	1039-997	3140	2026-2068	2101-2143	1650	1725	2800	750
310 L3 H2/H3	1034-989	959-914	3140	2006-2051	2181-2226	1750	1725	2750	750
330 L2 H2/H3	1311-1269	1236-1194	3365	2054-2096	2129-2171	1750	2050	2800	750
330 L3 H2/H3	1231-1186	1156-1111	3365	2134-2179	2209-2254	1750	2050	2800	750
350 L2 H2/H3	1446-1404	1371-1329	3500	2054-2096	2129-2171	1750	2150	2800	750
350 L3 H2/H3	1366-1321	1291-1246	3500	2134-2179	2209-2254	1750	2250	2800	750
<b>RWD</b>									
350 L2 H2/H3	1319-1277	1244-1202	3500	2181-2223	2256-2298	1750/1850	2150	2800	750
350 L3 H2/H3	1256-1211	1181-1136	3500	2244-2289	2319-2364	1750/1850	2250	2800	750
350 L4 H3	959**-1111*	894**-1036*	3500	2389*-2531**	2464*-2606**	1750*/1850**	2250*/2450**	2800	750
350 L4 H3 HD	969	894	3500	2531	2606	1850	2450	2800-3500	750
470 L4 H3	2169	2094	4700	2531	2606	1850	3300	2300-3500	750
<b>AWD</b>									
350 L2 H2/H3	1216-1174	1141-1099	3500	2284-2326	2359-2401	1850	2150	2800	750
350 L3 H2/H3	1153-1108	1078-1033	3500	2347-2392	2422-2467	1850	2250	2800	750
350 L4 H3	1008	933	3500	2492	2567	1850	2250	2800	750
<b>Double Cab-in-Van</b>									
<b>FWD</b>									
350 L2 H2/H3	1289-1247	1214-1172	3500	2211-2253	2286-2328	1750	2150	2800	750
350 L3 H2/H3	1205-1160	1130-1085	3500	2295-2340	2370-2415	1750	2250	2800	750
<b>RWD</b>									
350 L2 H2/H3	1162-1120	1087-1045	3500	2338-2380	2413-2455	1750/1850	2150	2800	750
350 L3 H2/H3	1105-1060	1030-985	3500	2395-2380	2470-2515	1750/1850	2250	2800	750
350 L4 H3	947	872	3500	2553	2628	1750/1850	2250	2800	750
<b>AWD</b>									
350 L2 H2/H3	1059-1017	984-942	3500	2441-2483	2516-2558	1850	2150	2800	750
350 L3 H2/H3	992-947	917-872	3500	2508-2553	2583-2628	1850	2250	2800	750
350 L4 H3	844	769	3500	2656	2731	1850	2250	2600	750

**FWD** = Front-wheel drive, **RWD** = Rear-wheel drive, **AWD** = All-wheel drive, **L2** = Medium wheelbase, **L3** = Long wheelbase, **L4** = Extra long wheelbase, **H2** = Medium Roof, **H3** = High Roof. Figures apply to Medium Roof vehicles unless otherwise stated. For High Roof option vehicles, kerb mass is increased and payload reduced. Kerb mass is affected by many factors such as body styles, engines and options. It is the weight of a standard-specification base series vehicle (other series will have different kerb masses), including fluids and fuel tank 90% full, but without the driver (75kg), crew or cargo. Payload is the difference between gross vehicle mass and kerb mass. (a) Max. braked trailer mass is dependent on chosen engine power and dependent on the additional options/equipment selected. Consult your Ford Commercial Vehicle Dealer for more information. \*SRW, \*\*DRW.

## Tested to extremes

From frost-covered prototypes started up in -40°C at 4,500-metre altitudes, to sun-baked vehicles towing fully-laden trailers up long inclines in 50°C heat, new Transit has been pushed to extremes.



## Max GTM

Van/Double Cab-in-Van	Axle ratio <sup>a</sup>	GVM					
		290	310	330	350	430	470
<b>FWD</b>							
2.0 TDCi (105 PS (77 kW))	3.94/4.19	● / ○	4400/4940	4400/4940	-	-	-
2.0 TDCi (105 PS (77 kW))	4.71	●	-	-	5100	5100	-
2.0 TDCi (130 PS (96 kW))	3.94/4.19	● / ○	4840/4940	4840/4940	-	-	-
2.0 TDCi (130 PS (96 kW))	4.43/4.71	● / ○	-	-	5050/5500	5050/5500	-
2.0 TDCi (170 PS (125 kW))	4.19	●	5140	5140	-	-	-
2.0 TDCi (170 PS (125 kW))	4.71	●	-	-	5500	5500	-
<b>RWD</b>							
2.0 TDCi (105 PS (77 kW))	3.31/3.73	● / ○	-	-	-	5500	-
2.0 TDCi (130 PS (96 kW))	3.15/3.55	● / ○	-	-	-	5500/6000*	-
2.0 TDCi (130 PS (96 kW))	4.10	●	-	-	-	-	6000*
2.0 TDCi (170 PS (125 kW))	3.15/3.55	● / ○	-	-	-	5500/6300*	-
2.0 TDCi (170 PS (125 kW))	4.10	●	-	-	-	-	7000*
<b>AWD</b>							
2.0 TDCi (130 PS (96 kW))/(170 PS (125 kW))	4.10	●	-	-	-	6000	-

● = Standard, ○ = Option, at extra cost. **Note:** All engines are Stage VI unless stated and include coated Diesel Particulate Filter (cDPF). <sup>a</sup>The illustrated axle ratio shown is the one available dependent upon model, GVM payload and engine combination. \*GTM is limited to 5500 kg if fitted with rear air conditioning. Consult your Dealer for more information.

## Fuel Economy and Emissions

Van/Double Cab-in-Van	Axle ratio <sup>a</sup>	CO <sub>2</sub> emissions (g/km) <sup>80</sup>	Fuel consumption in L/100 km <sup>80</sup>			Fuel consumption in mpg <sup>80</sup>		
			Urban	Extra Urban	Combined	Urban	Extra Urban	Combined
<b>FWD</b>								
2.0 TDCi (105 PS (77 kW))/(130 PS (96 kW))	3.94/4.19	174-177	7.0	6.4-6.6	6.7	40.4	44.1-42.8	42.2
2.0 TDCi (105 PS (77 kW))/(130 PS (96 kW))/(170 PS (125 kW))	4.71	179-184	7.6-7.7	6.6-6.9	6.9-7.1	37.2-36.7	42.8-40.9	40.9-39.8
2.0 TDCi (130 PS (96 kW))	4.43	176-181	7.1-7.3	6.6-6.8	6.8-7.0	39.8-38.7	42.8-41.5	41.5-40.4
2.0 TDCi (170 PS (125 kW))	4.19	178-181	7.2-7.3	6.6-6.7	6.9-7.0	39.2-38.7	42.8-42.2	40.9-40.4
<b>RWD</b>								
2.0 TDCi (105 PS (77 kW))	3.31	189-191	8.3	6.8-6.9	7.3-7.4	34.0	41.5-40.9	38.7-38.2
2.0 TDCi (105 PS (77 kW))	3.73	200-202	8.7-8.8	6.9-7.1	7.5-7.7	32.5-32.1	40.9-39.8	37.7-36.7
2.0 TDCi (130 PS (96 kW))/(170 PS (125 kW))	3.15	185-187	8.0	6.6-6.7	7.1-7.2	35.3	42.8-42.2	39.8-39.2
2.0 TDCi (130 PS (96 kW))/(170 PS (125 kW))	3.55	196-198	8.6	6.9-7.0	7.6	32.8	40.9-40.4	37.2
2.0 TDCi (130 PS (96 kW))/(170 PS (125 kW))	4.10	210	9.1	7.4	8.1	31.0	38.2	34.9
<b>AWD</b>								
2.0 TDCi (130 PS (96 kW)) / (170 PS (125 kW))	4.10	224-226	10.0-10.2	7.7-7.8	8.6-8.7	28-27.7	36.7-36.2	32.8-32.5

**Note:** All Stage 6 LDTIII and Stage VI HDT include Diesel Particulate Filter (cDPF) and values are shown with Auto-Start-Stop where possible. Auto-Start-Stop system reduces CO<sub>2</sub> emissions and fuel consumption by 6 g/km and between 0.2 and 0.4 L/100km. <sup>a</sup>The illustrated axle ratio shown is the one available dependent upon model, GVM payload and engine/transmission combination. <sup>80</sup>The declared fuel consumptions and CO<sub>2</sub> emissions for Stage VI HDT engines are measured according to the technical requirements and specifications of the European Directive 80/1268/EEC and ECE R101.01. The declared fuel consumption and CO<sub>2</sub> emissions for Stage 6 LDTIII engines are measured according to the technical requirements and specifications of European Regulation (EC) 715/2007 and latest amendment. Fuel consumption and CO<sub>2</sub> emissions are specified for a vehicle variant and not for a single car. The applied standard test procedure enables a comparison between different vehicle types and different manufacturers and assumes a driver (75kg), 90% of fuel and AdBlue® plus 25kg. In addition, the specification and options selected may have an effect i.e. on vehicle weight and therefore on the emissions and fuel economy of the vehicle and also may influence the figures that appear in the individual vehicle documentation. This information is not part of any product offer made. Real world fuel consumption can vary as the fuel efficiency of a vehicle is influenced by (individual) vehicle configurations, driving behaviour, use of technical equipment such as air conditioning well as other non-technical factors. Consult your Dealer for more information.

## The drive for cleaner air

### Driving with AdBlue®

To operate correctly, the AdBlue® tank of your Ford Transit Euro6 diesel engine must be filled with AdBlue® fluid. System warnings illuminate when the fluid level becomes too low. For more information, please discuss with your Ford Dealer.

### Ford Easy-Fuel capless refuelling system

A unique safeguard ensures nobody can accidentally fill up with the wrong fuel. Plus no dirty fuel caps to touch. (Standard. Available as an option for capped systems)



## Van and Double Cab-in-Van dimensions

	L2 H2 Van		L2 H3 Van		L3 H2 Van		L3 H3 Van		L4 H3 Van
	FWD	RWD/AWD	FWD	RWD/AWD	FWD	RWD/AWD	FWD	RWD/AWD	RWD/AWD
<b>A</b> Overall length	5531	5531	5531	5531	5981	5981	5981	5981	6704
<b>B</b> Overall width with mirrors	2474	2474	2474	2474	2474	2474	2474	2474	2474
Overall width with folded back mirrors	2112	2112	2112	2112	2112	2112	2112	2112	2112
Overall width without mirrors (SRW)	2059	2059	2059	2059	2059	2059	2059	2059	2059
Overall width without mirrors (DRW)	-	-	-	-	-	-	-	-	2126
<b>C</b> Overall height*	2426-2490	2450-2542	2665-2781	2665-2781	2431-2541	2462-2543	2670-2780	2701-2782	2687-2790
<b>D</b> Wheelbase	3300	3300	3300	3300	3750	3750	3750	3750	3750
<b>E</b> Front of vehicle to front wheel centre	1023	1023	1023	1023	1023	1023	1023	1023	1023
<b>F</b> Rear of vehicle to rear wheel centre	1208	1208	1208	1208	1208	1208	1208	1208	1931
<b>G</b> Side door entry width	1300	1300	1300	1300	1300	1300	1300	1300	1300
<b>H</b> Side load door entry height	1700	1600	1700	1600	1700	1600	1700	1600	1600
<b>I</b> Rear door/tailgate entry width	1565	1565	1565	1565	1565	1565	1565	1565	1565
<b>J</b> Rear door/tailgate entry height	1748	1648	1987	1887	1748	1648	1987	1887	1887
<b>K</b> Maximum loadspace length (at floor with bulkhead)	3044	3044	3044	3044	3494	3494	3494	3494	4217
<b>L</b> Maximum loadspace width	1784	1784	1784	1784	1784	1784	1784	1784	1784
<b>M</b> Loadspace between wheel arches (SRW)	1392	1392	1392	1392	1392	1392	1392	1392	1392
Loadspace between wheel arches (DRW)	-	-	-	-	-	-	-	-	1154
<b>N</b> Load floor to roof	1886	1786	2125	2025	1886	1786	2125	2025	2025
<b>O</b> Loading height*	496-614	620-713	496-614	620-713	501-613	632-715	501-613	632-715	617-722
<b>P</b> Maximum load volume (with bulkhead) (cu.m)	10.0	9.5	11.2	10.7	11.5	11.0	13.0	12.4	15.1
Loadspace (with bulkhead) (VDA) (cu.m)	9.3	8.8	10.3	9.9	10.8	10.2	12.0	11.5	14.1
<b>Double Cab-in-Van unique measurements</b>									
<b>G</b> Side door entry width	1200	1200	1200	1200	1200	1200	1200	1200	1200
<b>P</b> Maximum load volume (with bulkhead) (cu.m)	6.1	5.7	6.7	6.4	7.6	7.2	8.4	8.0	10.6
Loadspace (with bulkhead) (VDA) (cu.m)	5.5	5.3	6.0	5.7	7.0	6.6	7.6	7.3	9.8
<b>Q</b> Maximum Loadspace Length	2038	2038	2038	2038	2488	2486	2488	2488	3211
<b>R</b> Useable load length at 1.2m height	1777	1777	1777	1777	2227	2227	2227	2227	2950
<b>Turning circle (m)</b>									
Kerb to kerb	11.9	11.9	11.9	11.9	13.3	13.3	13.3	13.3	13.3

**L2** = Medium wheelbase, **L3** = Long wheelbase, **L4** = Long wheelbase extended length, **H2** = Medium Roof, **H3** = High Roof, **FWD** = Front wheel drive, **RWD** = Rear wheel drive, **AWD** = All-Wheel Drive, **SRW** = Single rear wheels, **DRW** = Dual rear wheels. All dimensions (shown in mm) are subject to manufacturing tolerances and refer to minimum specification models and do not include additional equipment. \*Height dimensions show the range from minimum to maximum of a fully laden, lowest payload vehicle to unladen highest payload vehicle. These illustrations are for guidance only. **VDA method** This is the method used by the Verband der Automobilindustrie (VDA) in Germany. A VDA figure is determined by filling the loadspace with 'litre' blocks, each measuring 200x100x50 mm. The blocks are then counted, and the numerical result is converted into cubic metres.

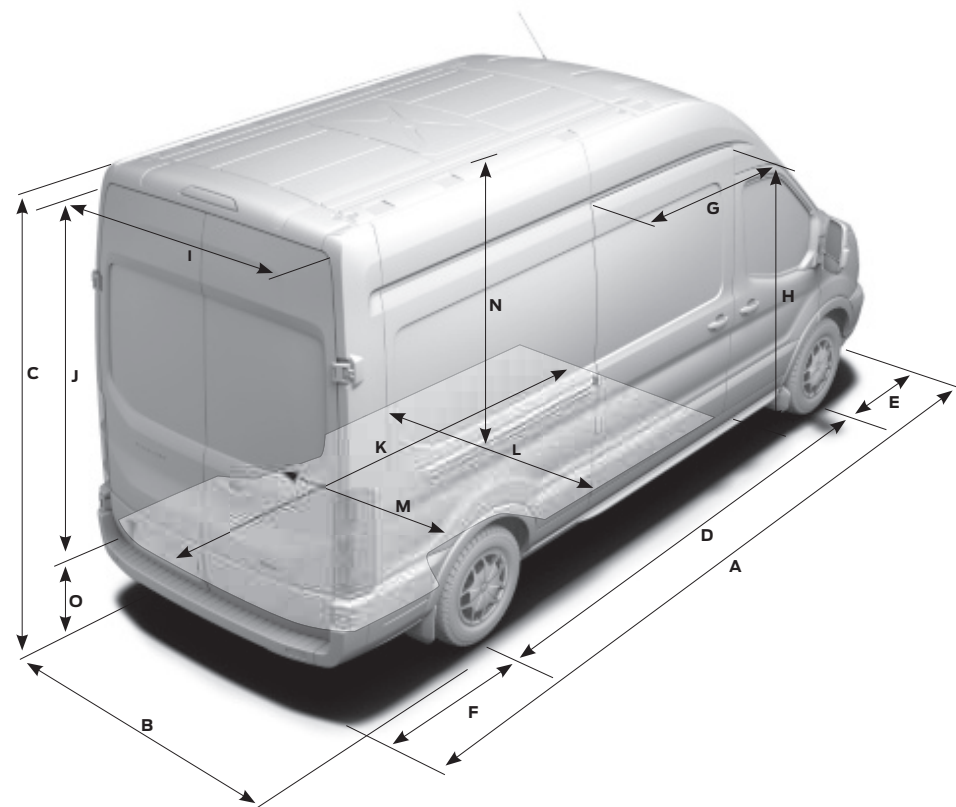







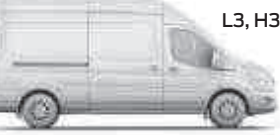

## Model availability

	290 L2 H2	290 L2 H3	310 L2 H2	310 L2 H3	310 L3 H2	310 L3 H3	330 L2 H2	330 L2 H3	330 L3 H2	330 L3 H3	350 L2 H2	350 L2 H3	350 L3 H2	350 L3 H3	350 L4 H3	350 HD L4 H3	430 L4 H3	470 L4 H3
<b>Van</b>																		
<b>FWD</b>																		
2.0 TDCi (105 PS (77 kW))	●	●	●	●	●	●	●	●	●	●	●	●	●	●	-	-	-	-
2.0 TDCi (130 PS (96 kW))	●	●	●	●	●	●	●	●	●	●	●	●	●	●	-	-	-	-
2.0 TDCi (130 PS (96 kW)) 6-speed automatic*	-	-	●	●	-	-	●	●	●	●	●	●	●	●	-	-	-	-
2.0 TDCi (170 PS (125 kW))	●**	●**	●	●	●	●	●	●	●	●	●	●	●	●	-	-	-	-
2.0 TDCi (170 PS (125 kW)) 6-speed automatic*	-	-	●**	●**	-	-	●**	●**	●**	●**	●	●	●	●	-	-	-	-
<b>RWD</b>																		
2.0 TDCi (105 PS (77 kW))	-	-	-	-	-	-	-	-	-	-	●	●	●	●	●	-	-	-
2.0 TDCi (130 PS (96 kW))	-	-	-	-	-	-	-	-	-	-	●	●	●	●	●	-	-	●
2.0 TDCi (170 PS (125 kW))	-	-	-	-	-	-	-	-	-	-	●	●	●	●	●	-	-	●
<b>AWD</b>																		
2.0 TDCi (130 PS (96 kW))	-	-	-	-	-	-	-	-	-	-	●	●	●	●	●	-	-	-
2.0 TDCi (170 PS (125 kW))	-	-	-	-	-	-	-	-	-	-	●	●	●	●	●	-	-	-
<b>Double Cab-in-Van</b>																		
<b>FWD</b>																		
2.0 TDCi (105 PS (77 kW))	-	-	-	-	-	-	-	-	-	-	●	●	●	●	-	-	-	-
2.0 TDCi (130 PS (96 kW))	-	-	-	-	-	-	-	-	-	-	●	●	●	●	-	-	-	-
2.0 TDCi (130 PS (96 kW)) 6-speed automatic*	-	-	-	-	-	-	-	-	-	-	●	●	●	●	-	-	-	-
2.0 TDCi (170 PS (125 kW))	-	-	-	-	-	-	-	-	-	-	●	●	●	●	-	-	-	-
2.0 TDCi (170 PS (125 kW)) 6-speed automatic*	-	-	-	-	-	-	-	-	-	-	●	●	●	●	-	-	-	-
<b>RWD</b>																		
2.0 TDCi (105 PS (77 kW))	-	-	-	-	-	-	-	-	-	-	●	●	●	●	●	-	-	-
2.0 TDCi (130 PS (96 kW))	-	-	-	-	-	-	-	-	-	-	●	●	●	●	●	-	-	-
2.0 TDCi (170 PS (125 kW))	-	-	-	-	-	-	-	-	-	-	●	●	●	●	●	-	-	-
<b>AWD</b>																		
2.0 TDCi (130 PS (96 kW))	-	-	-	-	-	-	-	-	-	-	●	●	●	●	●	-	-	-
2.0 TDCi (170 PS (125 kW))	-	-	-	-	-	-	-	-	-	-	●	●	●	●	●	-	-	-

● = Available, - = Not available. **L2** = Medium wheelbase, **L3** = Long wheelbase, **L4** = Long wheelbase extended length, **H2** = Medium Roof, **H3** = High Roof, **FWD** = Front-wheel drive, **RWD** = Rear-wheel drive, **AWD** = All-wheel drive. All engines are Stage VI with 6-speed manual transmission unless stated. \*Available from 2017.25MY production (Q4 2016). \*\*Trend only.

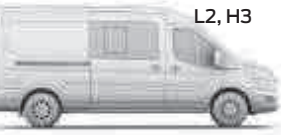
### Van

		
10.0*/9.3** cu.m (FWD), 9.5*/8.3** (RWD/AWD)	11.5*/10.8** cu.m (FWD), 11.0*/10.2** (RWD/AWD)	
		
11.2*/10.3** cu.m (FWD), 10.7*/9.9** (RWD/AWD)	13.0*/12.0** cu.m (FWD), 12.4*/11.5** (RWD/AWD)	15.1*/14.1** cu.m
<b>Double Cab-in-Van</b>		
		
6.1*/5.5** cu.m (FWD), 5.7*/5.3** (RWD/AWD)	7.6*/7.0** cu.m (FWD), 7.2*/6.6** (RWD/AWD)	
		
6.7*/6.0** cu.m (FWD), 6.4*/5.7** (RWD/AWD)	8.4*/7.6** cu.m (FWD), 8.0*/7.3** (RWD/AWD)	10.6*/9.8** cu.m

\*Maximum load volume (with bulkhead), \*\*Loadspace (with bulkhead) (VDA).

## Exterior features

	Base	Trend
<b>Design features</b>		
Body – H2 (Medium Roof; not available on L4)	●	●
Body – H3 (High Roof; standard on L4)	○/●	○/●
Door mirrors – Blind spot eliminator and integrated side indicator	●	●
Door mirrors – Manual adjust	●	–
Door mirrors – Electrically-operated and heated	○	–
Door mirrors – Power-foldable, electrically-operated and heated	○	●
Bodyside mouldings – Wide, self colour	●	●
Front bumper – Partial body colour	●	●
Rear bumper – Self colour with integrated step	●	●
Door handles – Self colour	●	●
Cargo door handle – Self colour	●	●
Front grille – Sterling Grey	●	–
Front grille – Studio grey	–	●
Rear privacy glass (Standard on DCIV Trend, optional on Van)	○	○/●
Mudflaps – Front	○	○
Mudflaps – Rear	●	●
Tinted glass – Complete (optional on DCIV Trend)	●	●
Tow bar with Trailer Sway Control and 13-pin electrics (tachograph may be required) (not available on Double Cab-in-Van AWB 310 and 350 models)	○	○
Paint – Metallic	○	○
<b>Wheels</b>		
Steel – 15"x6½" (Fitted with 215/65 R15 BSW tyres; standard on 290 and 310 series only)	●	●
Steel – 16"x6½" (Fitted with 215/65 R16C tyres; 350 series: 235/65 R16 BSW tyres; 430/470 series: 235/65 R16C 121/119 BSW tyres) and with automatic transmission	●	●
Steel – 16"x6", dual rear wheels, hub caps on front wheels (Fitted with 195/75 R16C BSW tyres; standard only on 430 and 470 series, and optional only on 350 L4 RWD series. Not available on AWD)	○	○
Alloy – 16"x6½", 5 spoke (Fitted with 215/65 R16C BSW tyres; 290 and 310 series: 215/65 R16C BSW tyres; 330, 350 and 370 series: 235/65 R16C BSW 115/113 BSW tyres; 410 series: 235/65 R16C 121/119 BSW tyres; includes locking wheel nuts)	–	○
Wheel covers – Half caps	●	–
Wheel covers – Full	–	●
Spare – Full-size steel with tool kit (standard with DRW on 350HD, 430 & 470 models)	○/●	○/●
Tyre inflator kit (not available with DRW on 350HD, 430 & 470 models)	●/–	●/–
<b>Convenience features</b>		
Headlights – Projector-style halogen reflector lights with chrome background and static cornering lights	–	●
Headlights – Daytime running lights	●	●
Headlights – Automatic on/off	□	□
Headlights – Courtesy delay, 30 seconds duration	●	●
Fog lights – Front	○	●
Doors – Driver's side load (sliding) door (not available on Double Cab-in-Van AWB AWD 350 models)	○	○
Doors – Passenger's side load (sliding) door	●	●
Doors – Passenger's side load (sliding) door and power step (not available on FWD and AWD)	○	○
Doors – Unglazed rear doors, hinged for 180° opening, positive stop at 90° (standard on L2 and L3, not available on L4)	●/–	●/–
Doors – Unglazed rear doors, hinged for widest opening, with magnetic door retainers (not available on L2, optional on L3 and standard on L4)	–/○/●	–/○/●



### Parking distance sensors, front and rear<sup>2)</sup>

An audible warning helps you judge the distance between your vehicle and obstacles at the front and rear, for easier parking and manoeuvring. (Standard on Trend, option and accessory on Base)

<sup>1)</sup>Uses sensors.  
<sup>2)</sup>Driver assistance feature.

## Exterior features

	Base	Trend
Rear window – Fixed	○	○
Doors – Glazed and heated	○	○
Roof marker lights (DRW Van models only)	●	●
Side marker lights (L4 models only)	●	●
Side windows – Second row, fixed (optional on Ambiente only on Double Cab-in-Van)	○	○
Side windows, Van – Second row, passenger's side, fixed	○	○
Side windows, Double Cab-in-Van, – Second row, sliding	●	●
Side windows, Double Cab-in-Van – Second row, fixed	○	–
Wipers – Front, variable/intermittent with electric wash	●	●
Wipers – Front, automatic with rain sensor (includes automatic headlights)	□	□
Wipers – Rear with auto reverse wipe and electric wash (only available with glazed rear doors) (standard on DCIV Trend)	○	○
Parking distance sensors – Front and rear (only available with front fog lights)	○	●
Rear window ladder (only available with 180° hinged rear doors) (not available with L4 models)	○	○
<b>Option packs</b>		
Visibility Pack 1 – Quickclear heated windscreen, washer fluid sensor, and electrically-operated and heated door mirrors	○	–
Visibility Pack 2 – Quickclear heated windscreen, washer fluid sensor, electrically-operated and heated, power-foldable door mirrors, automatic headlights, autowipers, front fog lights, and variable cluster dimming	○	●
Visibility Pack 3 – Lane-Keeping Alert (including Auto High Beam and Driver Alert), rear-view camera, Quickclear heated windscreen, washer fluid sensor, high series instrument cluster, electrically-operated and heated, power-foldable door mirrors, automatic headlights, autowipers, front fog lights, variable cluster dimming, rear (only available with SYNC)	–	○

● = Standard, ○ = Option, at extra cost, □ = Part of an option pack, at extra cost., L2 = MWB, L3 = LWB, L4 = ELWB.  
\*The wheel you choose will be fitted with the tyre size noted, but no choice of tyre brand is available.

## Interior features

	Base	Trend
<b>Design features</b>		
Floor covering – Cab, easy-clean rubber (only in Van)	●	●
Floor covering – Full length, easy-clean rubber (Double Cab-in-Van only)	●	●
Headlining – Cab, moulded (only in Van)	●	●
Headlining – Extended, moulded (standard on Double Cab-in-Van only)	●	●
Steering wheel – 4-spoke, polyurethane	●	–
Steering wheel – 4-spoke, leather-trimmed (Standard on N2 variants as part of Lane Keeping Alert)	□	●
Gearshift knob – Leather-trimmed	–	●
<b>Interior lighting</b>		
Courtesy lights – Header-mounted, front with theatre dimming	●	–
Courtesy lights – Header-mounted, front map lights	–	●
Courtesy lights – Rear seat, with theatre dimming (Double Cab-in-Van)	●	●
Courtesy lights – Footwell illumination (side load door only)	–	●
Loadspace compartment lights	●	●
Loadspace compartment lights – LED	○	○
Interior lighting/battery saver – 30 minutes	●	●

● = Standard, ○ = Option, at extra cost, □ = Part of an option pack, at extra cost.

# Engineered for maximum traction

### Braking system and all-wheel drive

Whatever the working environment, Transit makes driver and passenger protection its top priority. Standard safety features include ABS with Emergency Brake Assist (EBA) to help reduce emergency stopping distances. Larger brake pads and discs last longer and are more resistant to brake fade, while wear sensors indicate when pads are due for replacement. For more challenging conditions, Transit is available with all-wheel drive (AWD)\*. This latest system automatically directs more drive to the front axle for optimum traction, and can also operate pre-emptively to avoid wheel slip by monitoring the driver's actions.



\*All-wheel drive is available on Van 350 L2/L3; Double Cab-in-Van 350 L2/L3; Kombi M1 350 L2/L3/L4; and Kombi N1 350 L2/L3.

## Interior features

	Base	Trend
<b>Audio and communication systems</b>		
Delete audio system	○	-
Audio – Pre-equipment pack, Option on Van and Double Cab-in-Van	○	-
My Connection Radio, Bluetooth® with USB/iPod® connectivity port and iPod® functionality, remote audio controls, four front speakers (two woofers and two tweeters) (ICE Pack 2)	●	-
Radio/CD, SYNC (includes Emergency Assistance*) with Bluetooth®, Voice Control System, AppLink®, audible text messaging and privacy mode, 4" TFT display, extended integrated control panel, USB connectivity port with iPod® functionality remote audio controls, four front speakers (two woofers and two tweeters) (ICE Pack 8)	○	●
Radio/CD with DAB, SYNC (includes Emergency Assistance*) with Bluetooth®, Voice Control System, AppLink®, audible text messaging and privacy mode, 4" TFT display, extended integrated control panel, USB connectivity port with iPod® functionality, remote audio controls, four front speakers (two woofers and two tweeters) (ICE Pack 9)	○	○
Radio/SD-navigation system with DAB, SYNC 2 with 6" TFT Touchscreen display (includes Emergency Assistance*) with Bluetooth® Voice Control System and audible text messaging Privacy Mode, USB connectivity port with iPod® functionality, remote audio controls, four front speakers (two woofers and two tweeters) (ICE Pack 14)	○	○
<b>Instruments and controls</b>		
Trip computer (distance to empty, instant and average fuel consumption, average speed, outside temperature)	●	●
Water in fuel filter with sensor	●	●
Battery – Cold start (-20°C)	●	●
Battery – Twin Improved Flooded IF, Cold start -29°C (75Ah, 700CCA; Standard with Start-Stop) (standard on RWD and AWD, optional on FWD)	○	○
Alternator – Standard duty (165 Amp)	●	●
Alternator – Extra heavy duty (240 Amp)	○	○
Auxiliary Connection Point – 1 X 12V, 60A connection located under driver seat pedestal	●	●
Auxiliary Connection Point – 3 X 12V, 60A connections located under driver seat pedestal	□	□
Tachograph – Digital, electronic, 24-hour (not available on FWD derivatives when specified with automatic transmission)	○	○
Shift Indicator light	●	●
<b>Seats</b>		
Driver's seat – 8-way (fore/aft; recline; height; and tilt) with armrest	●	-
Driver's seat – 10-way heated (fore/aft; recline; height; tilt; and lumbar) with armrest	○	●
Driver's seat – 10-way power adjustable heated (fore/aft; recline; height; tilt; and lumbar) with armrest	-	○
Front passenger's seat – Single, 8-way (fore/aft; height; tilt; and recline)	○	○
Front passenger's seat – Single, 8-way heated (fore/aft; height; tilt; and recline)	○	○
Front passenger's seat – Dual, fixed back with split lift-up seat cushion for stowage	●	-
Front passenger's seat – Dual, heated, fixed back with split lift-up seat cushion for stowage	○	○
Front passenger's seat – Dual, fixed back with split lift-up seat cushion for stowage, fold out table	●	●
Front passenger's seat – Dual, heated, fixed back with split lift-up seat cushion for stowage, fold out table	○	○
Rear seats, Double Cab-in-Van – Second row; removable triple wide seats (includes moulded bulkhead with window behind 2nd row seats)	●	●
Rear seats, Double Cab-in-Van – Second row; removable quad seats with underseat storage (L3 350 variant only)	○	○

● = Standard, ○ = Option, at extra cost, □ = Part of an option pack, at extra cost,

\* Ford Emergency Assistance is an innovative SYNC feature that uses a paired and connected Bluetooth® mobile phone to help vehicle occupants initiate a direct call to the local Communications Centre, following a vehicle crash event involving an airbag deployment or fuel pump shut off. The feature operates in more than 40 European countries and regions. Note: The Bluetooth® word mark and logos are owned by the Bluetooth SIG, Inc. and any use of such marks by Ford Motor Company is under licence. Other trademarks and trade names are those of their respective owners.

### Rear-view camera

Select reverse gear and the image from the rear-view camera is displayed automatically in the rear-view mirror or satellite navigation screen. Marker lines overlaid on the camera image indicate where the vehicle is heading. (Option)



### Bluetooth® Audio Streaming

Stream your music collection from your compatible MP3 player or mobile phone to the vehicle's audio system.



### Navigation

3D map stored on SD card shows points of interest on a 5" colour screen. Also includes traffic announcements. (Option).

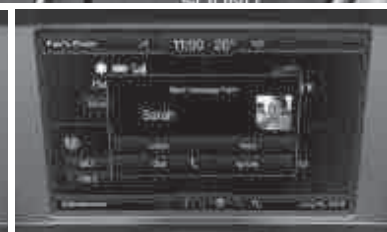

### Complete connectivity

Ford SYNC with AppLink\* lets you operate most popular MP3 players, Bluetooth®-enabled phones, USB drives and even control the apps on your smartphone with remarkably simple voice commands. Plus, the Emergency Assistance\* feature is designed to assist occupants to place an emergency call in the event of an accident in over 30 European countries. (Option)



### Emergency Assistance\*

Innovative SYNC feature that uses a Bluetooth®-paired and connected mobile phone to help vehicle occupants initiate a direct call to the local Communications Centre (in more than 40 European countries and regions), following a vehicle crash event involving an airbag deployment or fuel pump shut off. (Option, part of Ford SYNC)

### Audible SMS

Have your incoming text messages read to you from your connected phone, including commonly-used abbreviations and emoticons, and you can even respond with a choice of 15 preset text messages. Compatible mobile phone required.



\*Compatible and connected mobile phone required. You can browse a list of AppLink-compatible apps from your regional Ford website, or via the **App Catalog** available in iOS and Android stores. SYNC AppLink and Emergency Assistance are not supported by all European languages.

**Note** The Bluetooth® word mark and logos are owned by the Bluetooth SIG, Inc. and any use of such marks by Ford Motor Company Limited and its associated companies is under licence. Other trademarks and trade names are those of their respective owners.



## Interior features

	Base	Trend
<b>Comfort and convenience</b>		
Air conditioning – Front, including filter-air pollen purifier	○	○
Rear air conditioning (includes front manual A/C, 230V 3 pin power point and HD Alternator) RWD/AWD Van only, cool air only	○	○
Heater – Recirculation	●	●
Heater – Positive Thermal Co-efficient (PTC) (Standard only for GB on DCiV and Van)	●	●
Assist handle – Located on B-pillar	●	●
Bottle holder – Twin, 2-litre bottle capacity, fascia-mounted	●	●
Glovebox – With lid and A4 file storage capability	●	-
Glovebox – Lockable, with lid and A4 file storage capability	-	●
Power point socket – 2 x 12 V (located on instrument panel and in stowage bin)	●	●
Power point – 230 V (150 W) power converter	○	○
Power point socket – 12 V (located in rear)	○	○
Smokers' Pack – Cigar lighter and ash cups	○	○
Storage – Front door map pockets	●	●
Storage – Driver's side, storage compartment on fascia top with lift up lid	●	●
Storage – Underseat stowage compartment (under dual passenger seat)	●	●
Storage – Overhead stowage shelf (only on Van)	●	●
Windows – Electrically-operated front with one-touch on driver's side	●	●
Rear-view camera (including Trailer Hitch Assist and front and rear parking sensors) (image in 4" TFT display or 6" TFT Touchscreen display (standalone option or part of pack))	○/□	○/□
<b>Load compartment</b>		
Bulkhead – Delete (Vans only)	○	-
Bulkhead – Full width metal, unglazed (not Double Cab-in-Van)	●	●
Bulkhead – Full width metal with window (not Double Cab-in-Van) (requires glazed rear doors)	○	○
Bulkhead – Moulded with window (standard on Double Cab-in-Van)	●	●
Complete rear trim full-height board (only in Van)	○	○
Complete rear sidewall trim half-height board with wheelarch covers (standard on all DCiV)	○/●	●
Waist height cargo area trim boards (standard on Double Cab-in-Van)	○	●
Shoulder height cargo area trim boards	○	○
Easy Clean Load Floor (not Double Cab-in-Van)	○	●
Load area protection kit – Complete rear trim full-height board, Easy To Clean Load Floor and load compartment tie-down loops (not available with rear compartment heater) (not Double Cab-in-Van)	○	○
Load compartment – DIN 75410 compliant tie-down loops, minimum of 8 (L2 Double Cab-in-Van = 6)	●	●
Load retention pack (Van only)	○	○
Loadspace divider (only available with flex floor) (Van only)	○	○
Cargo Management System 1 (Van only)	○	○
Cargo Management System 2 (Van only)	○	○
Interior roof rack (Van only with unglazed rear doors)	○	○
Racking – Interior (Van only)	○	○
Rear window protection grille	○	○

● = Standard, ○ = Option, at extra cost, □ = Part of an option pack, at extra cost,



## A place for everything

Transit's driver-focused cab combines modern good looks with smart stowage solutions. With plenty of space for bottles, phones and papers, it will help make your workday easier and more efficient.

### Electrically-operated driver's seat

A 10-way electrically-adjustable heated driver's seat with lumbar support is an ideal choice for vehicles with multiple drivers. (Option on Trend)

### Adjustable driver's seat and steering wheel

An adjustable driver's seat with armrest and a steering wheel that adjusts to suit your height and arm length mean you can find your ideal driving position with ease. (Standard)



### Steering wheel-mounted controls

Allows you to operate the audio system and trip computer without taking your hands off the wheel. (Standard with Ford audio systems)



### Quickclear heated windscreen

Clears ice or demists the windscreen quickly, even on frosty mornings. Supplied with heated washer jets for year-round comfort and visibility. (Option)

### Lidded storage compartment with power point and USB port

Cleverly concealed storage compartment, located above the instrument cluster, features a 12-volt power supply and USB port. (Standard with Ford audio systems)



## Safety and security features

	Base	Trend
<b>Safety and driver assistance</b>		
Anti-lock braking system (ABS) with electronic brake-force distribution (EBD) <sup>1)</sup>	●	●
Electronic Stability Control (ESC) <sup>1)</sup>	●	●
Electronic Dynamic Cornering Control <sup>1)</sup>	●	●
Curve Control <sup>1)</sup>	●	●
Hill Start Assist (HSA) <sup>2)</sup>	●	●
Load Adaptive Control (LAC) <sup>3)</sup>	●	●
Emergency Brake Assist (EBA) <sup>3)</sup>	●	●
Emergency Brake Warning <sup>2)</sup>	●	●
Roll Stability Control (RSC) <sup>1)</sup>	●	●
Trailer Sway Control (TSC) <sup>1)</sup> (activated with Ford trailer tow attachments)	○	○
Airbag – Driver's <sup>1)</sup>	●	●
Airbag – Front passenger's* <sup>1)</sup> (includes passenger's airbag deactivation switch)	○	○
Airbag – Front side and curtain airbags <sup>1)</sup>	○	○
Lane-Keeping Alert <sup>2)</sup> (includes Driver Alert <sup>2)</sup> and Auto High Beam <sup>1)</sup> , high series instrument cluster, cruise control, leather-trimmed steering wheel, heated windscreen and SYNC audio system)	○	○/□
Cruise control (including leather-trimmed steering wheel and Adjustable Speed Limiter)	○	●
Adaptive Cruise Control (includes Pre-Collision Assist, Forward Alert and Traffic Sign Recognition) <sup>2)</sup> (Stage VI engine only when specified with Lane-Keeping System)	–	□
Seat belts – 3-point diagonal inertia reel (all seats) <sup>1)</sup>	●	●
Tyre Pressure Monitoring System (TPMS) <sup>1)</sup> (not available with dual rear wheels)	○	○
<b>Security</b>		
Alarm – Perimeter	○	○
Alarm – Thatcham Category 1 (not Double Cab-in-Van) – Cab interior sensing, inclination sensor and trailer coupling, when fitted (includes remote locking with 2 key fobs) (only available with full metal bulkhead and unglazed rear doors)	○	○
Alarm – Thatcham Category 1 (Van) – Cab interior sensing, inclination sensor and trailer coupling, when fitted (includes remote locking with 2 key fobs) (only available with full metal glazed bulkhead and unglazed rear doors)	○	○
Alarm – Thatcham Category 1 (Double Cab-in-Van) – Cab interior sensing, inclination sensor and trailer coupling, when fitted (includes remote locking with 2 key fobs) (only available with glazed moulded bulkhead and unglazed rear doors)	○	○
Doors – Unglazed rear (Van and Double Cab-in-Van only) (Standard on MWB & LWB)	●	●
Immobiliser – Safeguard Passive Anti-Theft System (PATS) (Insurance-approved Category 2 Immobiliser)	●	●
Locks – Power central locking	○	–
Locks – Power door deadlocks, shielded with strengthened mountings	●	●
Locks – Remote control central locking with one key fob	●	–
Locks – Remote control central locking with two key fobs	○	●
Locks – Manual fleet key (Not available on DCiV Trend)	○	○/–
Locks – Configurable unlocking – (Van) 2-stage unlocking*	●	●
Locks – Configurable unlocking – 2-stage unlocking* (only for DCiV)	●	●
Locks – Configurable unlocking – independent driver's door unlocking*	○	–
Locks – Configurable unlocking – courier unlocking with auto slam lock, zonal opposite door relocking and 3 second auto relocking* (Van only)	○	–
Locks – Auto relocking, doors relock after 45 seconds if no door is opened	●	●
Locks – Audio mis-lock feedback, audible signal if a door is ajar when locking activated	●	●
Locks – Auto locking on drive-away, doors automatically lock at 5 mph (not Double Cab-in-Van)	●	●
Two-stage unlicking with slam locking	○	–
Locks – Key-operated bonnet release	●	●
Vehicle Identification Number – Visible	●	●

● = Standard, ○ = Option, at extra cost.

<sup>1)</sup>Safety feature, <sup>2)</sup>Driver assistance feature, □ = Part of an option pack, at extra cost \*For details of the configurations available please consult your Ford Transit Centre. Please note: Configurable locking must be defined at the time of order, it cannot be ordered as a Dealer-fitted option or accessory.

**\*Note: A rear-facing child seat should never be placed in the front passenger seat when the Ford vehicle is equipped with an operational front passenger's airbag.**



### Configurable unlocking

Transit's new locking system is more secure than ever. That's because you can open one individual door without automatically unlocking the others. The other doors stay securely locked until you activate a switch on the driver's door. (Option on Base)

## Mechanical features

	Base	Trend
<b>Engine technology</b>		
Auto-Start-Stop system (not available with AWD)	○	○
Ford Eco Mode driver information system	●	●
Acceleration control	○	○
Coated diesel particulate filter (cDPF)	●	●
<b>Brakes</b>		
Dual-circuit, with self-adjusting servo-assistance and ABS. Front and rear discs	●	●
<b>Fuel tank</b>		
Standard – 80 litres	●	●
Long-range – 100 litres (not available with HDT6 engines and on FWD) (only available on Van)	○	○
Ford Easy-Fuel capless refuelling system with misfuel inhibit	●	●
Urea aftertreatment system – 21 litre (standard with Stage VI, not available on other engines)	●	●
<b>Steering</b>		
Power-assisted steering (PAS)	●	●
Steering column – Rake- and reach-adjustable	●	●
<b>Suspension</b>		
Front, independent MacPherson struts, variable rate coil springs, stabiliser bar gas-pressurised shock absorbers and rear leaf springs	●	●
<b>Engine governors</b>		
Speed Limiter – 155 km/h (97 mph)	●	●
Speed Limiter – 90 km/h (56 mph) (legal requirement on vehicles over 3.5 GVM) (standard on 430 & 470GVM models)	○/●	○/●
Speed Limiter – 100 km/h (62 mph)	○	○
Speed Limiter – 110 km/h (70 mph) (N/A on DCiV)	○	○
Speed Limiter – 120 km/h (75 mph) (Double Cab-in-Van only)	○	○
Speed Limiter – 130 km/h (80 mph)	○	○
Standard Duty Battery	●	●
Heavy Duty Battery (standard on N2)	□	□
Extra Heavy Duty Battery (available from 31.10.2016)	○	○

● = Standard, ○ = Option, at extra cost.

## SVO

	SVO Code	Base/Trend
<b>Body</b>		
Omit passenger seat (Van only; no pedestal) (not available on DCiV or HD Puma Stage VI engines)	A304	○
<b>Electrical</b>		
Engine RPM speed control, 1300-3000 rpm	A003	○
2 High performance deep-cycle AGM batteries (2 x 95 Ah capacity, 850 CCA batteries under driver's seat)	A738	○
Auxiliary fuse panel	A526	○
Beacon Preparation Pack – Switch and front and rear wiring (includes auxiliary fuse panel A526) (cannot be ordered with rear air conditioning)	A606	○
Utility Vehicle Switch Pack (Provides three switches for beacon and two power outputs; includes auxiliary fuse panel (A526) and Beacon Preparation Pack A606) (cannot be ordered with rear air conditioning)	A607	○
High Specification Interface Connector (Provides a range of hardwired signals and power; includes auxiliary fuse panel A526. Cannot be ordered with Utility Vehicle Switch Pack A607)	A608	○
Trailer tow electrics (connector and wiring) without the tow bar	A055	○
The Ford Programmable Battery Guard – Patented 10-mode programmable battery guard system capable of protecting Ford and 3rd party battery	A540	○
Converter – High Power Supply System – Meets heavy power-take-off requirements by equipping vehicles with two high performance deep cycle AGM Batteries (2 x 95 Ah), 240A alternator, Engine RPM speed control and the Ford Programmable Battery Guard (from December 2016)	A550	○
<b>Other</b>		
Service Line – Provides anti-skid ply floor, side lining, storage cabinets, lockable shelves, and pull-out vice and venting (only available in Central region) (not available to order with the RPO Easy To Clean Load Floor, load area protection kit or dual sliding side load doors) (Van L2 only)	A6	○
<b>Paint</b>		
Special paint, 140 solid colours available, consult your Ford Transit Centre for details*	Various	○

○ = Option, at extra cost.

\*SVO paint suffix must be entered at time of ordering. SVO paint pulls self-colour (black) bumpers, bodyside mouldings, mirror housings and door handles.

### Underseat stowage compartment

The front dual passenger seat cushions flip up to reveal a hidden compartment large enough to hold a toolbox. (Standard) The centre seat also incorporates a fold-down table, large enough to hold an A4 clipboard, tablet or a laptop computer. (Standard)



## Making life easy

Our range of finance, insurance, service and assistance options is designed with just one thing in mind – making life easy for you.

### Ford Credit

Your local Ford Specialist Dealer can offer advice on the various ways of financing your purchase. They can help you complete an application and get a decision, usually within one hour. Alternatively, our Ford Credit sales desk is always happy to help on ph: 1890 812 333.

**Business Hire Purchase** is a straightforward way to finance your business vehicle. Funding your vehicles by a separate line of credit leaves working capital free to be used in the business.

**Contract Hire** is the flexible way to finance, and the ideal plan if you are looking to regularly renew your vehicle. It includes an arrangement at the outset whereby, the vehicle is returned to the supplying Ford Dealer on completion of the term.

**Ford Insure** You can contact our call centre on 1850 449 444. Call centre opening times are: Monday – Friday: 9am to 8pm (excluding Bank Holidays). Why not try us out?

### Services

We understand that a Dealer network committed to meeting the needs of commercial vehicle customers is just as important to your business success as having a great commercial vehicle. Our Ford Dealers provide a range of additional services tailored to your needs, making it their business to keep your business going.

To find the location of your nearest Ford Dealer, visit [www.ford.ie](http://www.ford.ie)

**Ford Protect** Every new Ford Vehicle is protected by a 2-years/unlimited kilometres bumper-to-bumper warranty. Upgrades are also available, giving you the option of worry free motoring for up to 4 years\* (commercial vehicle) and 5 years\* (passenger car).

**Ford Perforation Warranty** Every new Ford commercial vehicle is covered by the Ford Perforation Warranty from the date of first registration\* for 12 years.

**Ford Assistance** All new Ford light Commercial Vehicles are supplied with 1 years' Ford Roadside Assistance cover, which can be extended for free upon having your vehicle serviced at your Ford Dealership\*.

**Ford Accident Repair Centres** Because no one knows Ford like we do, Ford Repair Centres are the perfect choice for repairing your Ford.

### Contacts

**Ford OneCall**, we are just one call away for any queries in relation to your Ford: **1800 77 11 99**.

\* Subject to terms and conditions.

## Colour and trim

Choose the body colour that you think best reflects your business brand.

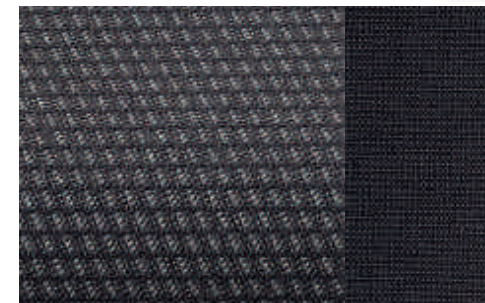

Base

Traxon seat insert in Charcoal Black  
Max seat bolsters in Charcoal Black



Base

Artec Vinyl seat insert in Pewter<sup>†</sup>  
Prima Vinyl seat bolsters in Pewter<sup>†</sup>



Trend

Lane seat insert in Charcoal Black  
Max seat bolsters in Charcoal Black

## Allergy-friendly interior

The new Transit interior uses materials that minimise the risk of an allergic reaction. Models fitted with air conditioning also have a high-performance pollen filter to prevent dust and pollen entering the passenger compartment.



**Frozen White**  
Solid body colour



**Race Red**  
Solid body colour



**Blazer Blue**  
Solid body colour



**Tectonic Silver**  
Metallic body colour\*



**Stratosphere**  
Metallic body colour\*



**Deep Impact Blue**  
Metallic body colour\*



**Magnetic**  
Metallic body colour\*



**Moondust Silver**  
Metallic body colour\*



**Lunar Sky**  
Metallic body colour\*



**Shadow Black**  
Mica body colour\*

**Special Vehicle Options (SVO)**

While the Ford Commercial Vehicle range already offers an extensive choice of off-the-shelf features and options, the Special Vehicle Options (SVO) programme goes a step further. Practical options range from heavy-duty batteries to a choice of over 100 colours to match your company's livery.

For more information, please speak to your local Ford Transit Specialist Dealer.

\*Metallic body colours are options at extra cost.  
The Ford Transit is covered by the Ford Corrosion Protection Warranty for 12 years from the date of first registration. Subject to terms and conditions.  
**Note** The vehicle images used are to illustrate body colours only and may not reflect current specification. Colours and trims reproduced within this brochure may vary from the actual colours, due to the limitations of the printing processes used.

# 12-year perforation warranty

The new Transit owes its durable exterior to a thorough multi-stage painting process. From the wax-injected steel body sections to the hard-wearing top coat, new materials and application processes ensure it will retain its good looks for many years to come.

Zinc coating      Phosphate coat      Electrocoat      Top coat      Clearcoat





MY 2016.75 IRL en

**Illustrations, descriptions and specifications.** This catalogue was correct at the time of going to print. However, Ford policy is one of continuous product development. The right is reserved to change specifications, colours and prices of the models and items illustrated and described in this publication at any time. For the latest details always consult your Ford Dealer. **Optional equipment.** Throughout this publication, wherever a feature is described as being an 'Option' or 'Option Fitment/Pack' etc, you should assume that it will be at extra cost to the base vehicle, unless specifically stated to the contrary. All models and colour combinations are subject to availability. **Note.** Some images portrayed are of a pre-production model and/or are computer generated, therefore, the design/features on the final version of the vehicle may differ in various respects. In addition, some of the features shown on the vehicles may be optional. **Note.** This brochure contains both original Ford accessories as well as a range of products from our suppliers. **+**The identified accessories are carefully selected third party supplier branded accessories which do not come with a Ford warranty but are instead covered by the third party supplier's own warranty, the details of which can be obtained from your Ford Dealer. **Note.** The Bluetooth® word mark and logos are owned by the Bluetooth SIG, Inc. and any use of such marks by Ford Motor Company is under licence. The iPod word mark and logos are the property of Apple Inc. Other trademarks and trade names are those of their respective owners. **Note.** Some driver assistance features and safety features described in this brochure are designed to function using sensors, whose performance may be affected under certain weather or environmental conditions.



Published by Henry Ford & Son Limited,  
Elm Court, Boreenmanna Road, Ireland.  
BJN 204570. FoE I57E.  
PN 677508/1016/7m/IRL en  
May 2016.  
© Ford Motor Company Limited.

[www.ford.ie](http://www.ford.ie)