

CHEVS OF THE 40'S

World's most complete supplier of 1937-54 Chevrolet car & truck parts

2021 EDITION TRUCK CATALOG

Order:

1-800-999-CHEV (2438)

1-360-816-0211

Fax: 1-800-888-CHEV (2438)

\$4.50



1-800-999-CHEV(2438)

Shop online: www.chevsofthe40s.com

Core charge information

All core charges are refundable when we receive your rebuildable unit in exchange. Please remove all external parts and brackets. Core returns must be same as purchased unit.

Part number information

Group and part numbers are original GM when applicable so you may refer to Chev parts book for questions.

Exceptions

Suffix "A"—part not originally available by itself.

Suffix "B"—not originally available as an assembly. Other suffixes, not originally available by itself or is a modified part.

If you have an addition or correction for this catalog, please give us a call. We want to provide the best possible service for you!

*CHEMICALS

Chemicals are shipped domestic ground only (lower 48 states only.) No international shipping.

Illustration Index

Air Conditioning & Heating	35T
Axle—Front & Rear	200T
Brake Parts	180T
Bumper	230T
Camshaft	20T
Chassis	pg. 6
Clutch, Drive Shaft and Rear End	140T
Complete Bed	pg. 7
Complete Truck Bed Order Form	490T
Crankshaft	20T
Custom Wheels	220T
Dash Knobs	340T
Door Assembly	380T
Door Panels	330T
Driving, Fog and Spot Lights	85T
Electrical System	pg. 5
Engine Assembly	20T
Engine ID Chart	20T
Engine Kits	20T
Exhaust System	130T
Exterior	pg. 6
Front & Rear Suspension Kits	205T
Gauges—Classic Instruments	350T
Glass	pg. 5
Headlamp	85T
Heating & Air Conditioning	35T
Horn Contact Parts	190T
IFS/IRS Suspension Kits	205T
Interior Kits	330T
Interior	pg. 4
Knobs	340T
Paint Combination Chart	pg. 11
Rubber	pg. 5
Series ID Table	pp. 8–10
Sheet Metal	pg. 7
Starter/Generator & Related	40T
Steering Gear	190T
Suspension (aftermarket)	205T
Suspension (stock)	200T
Taillamp	85T
Transmissions	150T
Truck Body Parts (Sheet Metal)	295T
Window Channel	450T
Windshield Wipers	370T
Wiring Harness	60T

Number ID, Production Numbers, Paint & Trim Charts (Sect. 5T, 8T)

Art, Collectibles, Tools, Auto Care, Truck Covers (Sect. 10T, 12T, 15T)

Engine (Sect. 20T, 22T, 24T, 26T)

Cooling, Heating (Sect. 30T, 35T)

Engine Electrical: Starters, Alternators, Distributors, Ignition (Sect. 40T, 45T, 50T, 55T)

Electrical, Horn (Sect. 60T)

Lighting: Turn Signals, Headlights, Tail Lights (Sect. 80T, 85T, 90T, 100T, 110T)

Fuel & Exhaust (Sect. 120T, 130T)

Clutch, Transmission, Driveline, Drive Shaft, Rear Axle, Rear End (Sect. 140T, 150T, 160T, 170T)

Brakes, Steering (Sect. 180T, 190T)

Suspension, Wheels, Hubcaps, Bearings (Sect. 200T, 205T, 210T, 220T)

Bumpers, Grilles, Hoods (Sect. 230T, 240T, 250T)

Fenders, Running Boards, Step Plates (Sect. 270T, 290T)

Body: Sheet Metal, Cab, Cab Mounting (Sect. 295T, 300T)

Firewall, Floorboard, Interior (Sect. 310T, 320T, 330T)

Dash, Mirrors, Radio, Wipers (Sect. 340T, 345T, 350T, 360T, 370T)

Doors (Sect. 380T, 390T, 400T)

Windows: Glass and Rubber (Sect. 420T, 430T, 440T, 450T, 460T, 480T)

Complete Beds & Parts (Sect. 490T)

Manuals, Tags, Decals, Photos (Sect. 520T, 530T, 550T, 560T)

Parts Index

To our Valued Customers:

For over 4 decades we have been providing the best in restoration parts for 1937–54 Chevrolet Cars & Trucks. We continue to expand our inventory of hard-to-find restoration parts while improving our selection of Street Rod Parts. We strive to provide the best in service, quality and variety of parts needed for your vehicle—from a complete restoration to a full-blown street machine. We have an easy to use Illustrated Index in the front of our catalog to make finding parts easy along with an alphabetical Parts Index in the back.

Street Rod parts are found in our STREET ROD HEADQUARTERS catalog and online at www.STREETRODHQ.com.

Thanks for your business!

*Ron Wade
CEO/Owner*

HOW TO ORDER

ONLINE: Order anytime by accessing our online catalog from our website, www.chevsofthe40s.com. Credit card information is secure and we don't sell our customer database to anyone.

Call toll-free: 1-800-999-CHEV (2438)

Our sales reps are available to assist you:

- via the phone: 6 a.m. – 5 p.m. Pacific Time, Mon. – Fri.
- in the showroom: 8 a.m. – 5 p.m., Mon. – Fri.
- via our lovable voice mail for after-hour and weekend calls.

Existing customers—Simply provide your name and customer number off your catalog label, vehicle year, series and body style, credit card number (if appropriate), part numbers with descriptions and quantities.

New customers—Please provide all of the above information as well as your phone number (in case we have a question about the order) and a complete address including zip code.

Stuff our attorneys want us to say: Chev's of the 40's will not be responsible for any expenses incurred for installation, modification, fitting or shop repairs of parts. The items sold in this catalog are without warranties of any kind. Items and prices in this catalog are subject to change without notice. Information in this catalog may contain typographical errors or inaccuracies. We reserve the right to correct errors or omissions.

HOW TO PAY

Use **Check by Phone** to achieve prompt shipping (10 days faster than mailing a check.) And because it helps reduce our costs, our reward to you is a 4% discount on parts when you place your first electronic-check order by phone. Try it—it's convenient and secure.

Checks by mail are welcome; however the accounting department may hold your order on uncertified funds. At company discretion, a mailed-in check may be converted to an electronic check.

Checks and money orders need to be in U.S. funds.

Returned checks will be charged an NSF fee.

Credit Cards—Visa, MasterCard and Discover are welcome! Ship-to address must match your credit card billing address.

HOW WE SHIP

How We Ship: We ship via UPS and USPS Flate Rate Priority Mail (size and weight permitting). For international orders we use UPS Expedited or USPS Priority Mail. Please talk to our sales staff for a shipping quote.

When purchasing oversized parts, some can be shipped via UPS and others need to be sent via truck freight, so please call for rates.

If paying by check, please call for shipping rates and order total.

Shipping Time on ground deliveries takes 2 to 14 days depending on your location. For faster service options, when placing an order, please ask your sales person for an express delivery quote.

Most orders ship the same day!

Sales Tax: Due to the Wayfair decision, we must now charge sales tax to all applicable states. Tax is calculated on the order total (including shipping). Tax rates vary according to your region.

HOW PROBLEMS ARE HANDLED

Damage Claims: If a package appears to be damaged upon delivery, open the package with the delivery driver and have them note any damages. Then call Chev's of the 40s immediately to notify us of any problems/damages. Do not ship to Chev's of the 40s; we will let you know what to do next.

Shortages: All orders are scanned with a bar code reader before shipping. If, in the unlikely event a shipment error occurs, call us immediately.

Back Orders: Our computerized inventory system allows us to maintain tight control on our stocking levels. However, we do not have control over our suppliers. Back orders are not charged until they ship. Shipment occurs immediately when we receive the part.

RETURNS/EXCHANGES

Made-to-order items, such as glass, are non-returnable. All other parts (excluding Odds & Ends) may be returned within 30 days. Damaged or altered parts cannot be returned. CODs will not be accepted. Returns subject to a 25% restocking fee.

1. Have your invoice ready.
2. Call 1-800-999-CHEV (2438).
3. Obtain return authorization number.
4. Write the number on the outside of the package and on a copy of the invoice.
5. Include invoice copy in package.

Remember: Shipping can take up to 14 days, so allow 3–4 weeks on returns. Warranty applies only to purchase price of item or replacement of part.

Unfortunately credit card companies no longer credit your credit cards for returns after 90 days. Therefore, we will issue in-store credits or a refund check.

Note: Product pricing and availability subject to change.

PHOTOS

Email us high-resolution photos of your restored and street rod Chevys! We love to see them and might even put them in one of our catalogs or advertisements!



You can now have your car or truck on the cover of your catalog!

It's easy!! Simply visit www.chevsofthe40s.com and click the link for "get your own vehicle on your own cover." After you upload a photo, the next time we print catalogs, your catalog will feature your car or truck framed on the cover!



SRHQ STREET ROD HEADQUARTERS

800-952-1752
www.streetrodhq.com

Need the latest and greatest parts for your street rod? Ask for our latest Street Rod Headquarters parts catalog. Call us at 800-952-1752 or visit us on the web at www.streetrodhq.com.

CHEVS OF THE 40'S
World's most complete supplier of 1937-54 Chevrolet car & truck parts
CAR CATALOG

Order:
1-800-999-CHEV (2438)
1-360-816-0211
Fax: 1-800-888-CHEV (2438)
\$4.50

1-800-999-CHEV(2438)
Shop online: www.chevsofthe40s.com

Call for your copy of our newest Car Catalog!

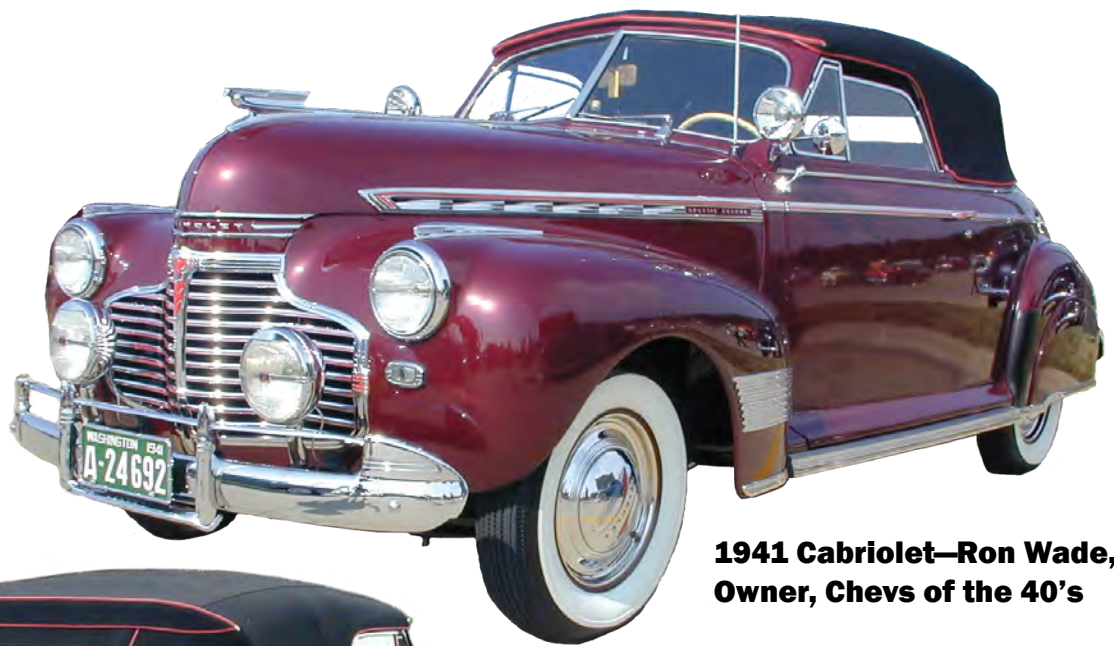

1941 Cabriolet—Ron Wade, Owner, Chevs of the 40's



Ron Wade's National Vintage Chevrolet Club of America's Best of Show 1941 Cabriolet has over 50 accessories:

Air filter-oil bath, antenna-reel, armrest-center, back-up light, beauty rings, clock-electric, compass, cowl vent knob-ivory, crank support-front bumper, crank-hand, defroster, driving lights, emergency brake whistle, exhaust tip-sharks tail, fender skirts, flashlight, fold-down rear guard, foot scraper, gas cap-GM locking, GM caroma, grill-winter guard, grill guard-bumper, heater-super deluxe, hood ornament-flying lady, horn-town & country, initial holder, license frames, mirror-day/night, mirror-lighted vanity, mirror-right, oil filter, passing lights, radiator screen-outside, radiator-overflow tank, radio-AM and 4-band short wave, radio-pocket portable, rear axle 3.70, rear fender guards, spare tire inflator, spotlight-left and right, steering wheel-spinner, thermometer, tire pump, tires-whitewall, tool kit, turn signals, umbrella-silk, valve cover breather, visor-clip-on, washboards-front fender, wheel disks, and windshield washers.



“After looking for over 40 years and talking to hundreds of people, nobody had ever seen the license plate reflectors. I was as excited as a little kid when I found them at the 2014 Hershey Swap Meet.”—Ron Wade

Picture Table of Contents — Interior

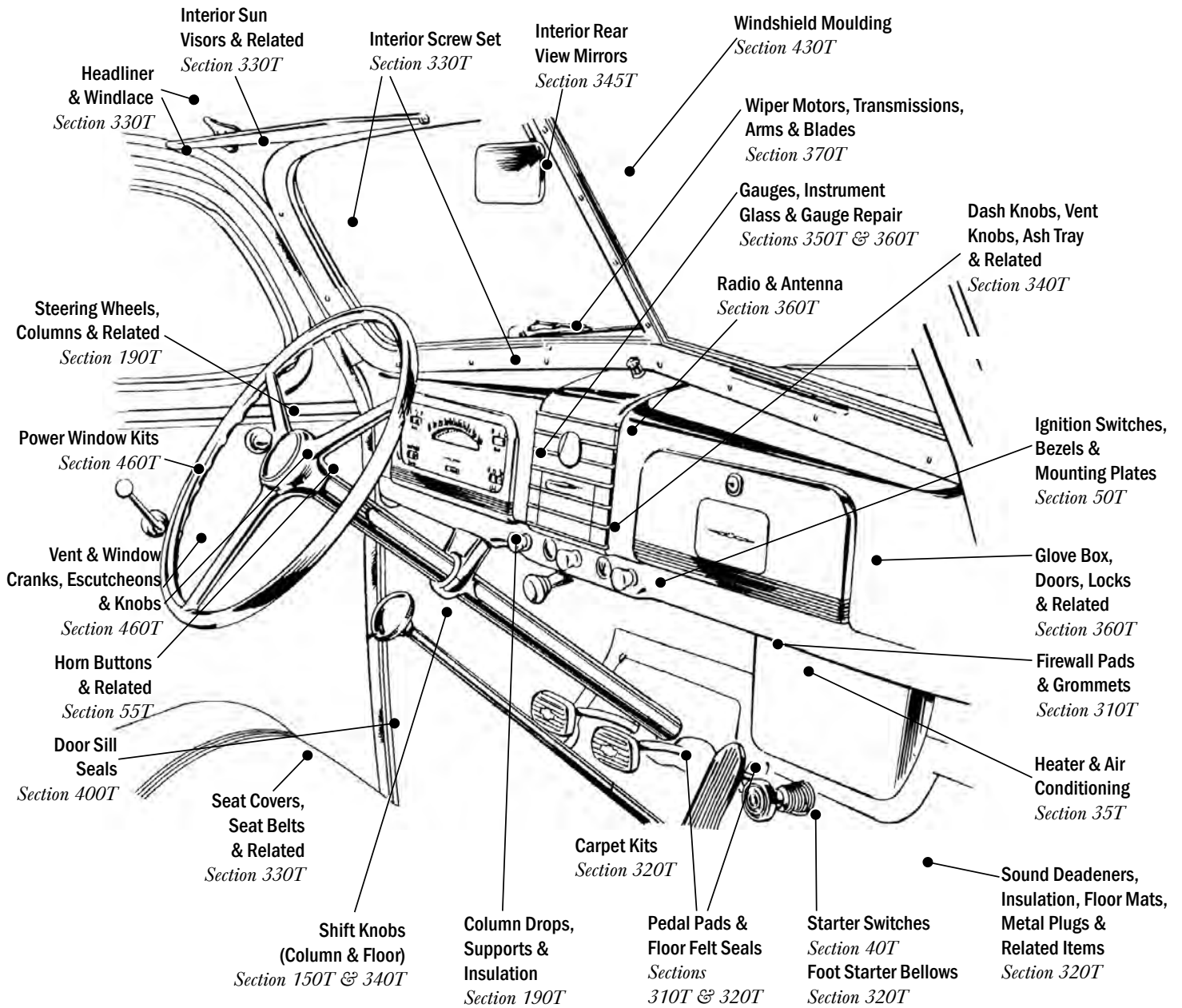

Returns require a return authorization number—Please call first. • Note: Product pricing and availability subject to change.

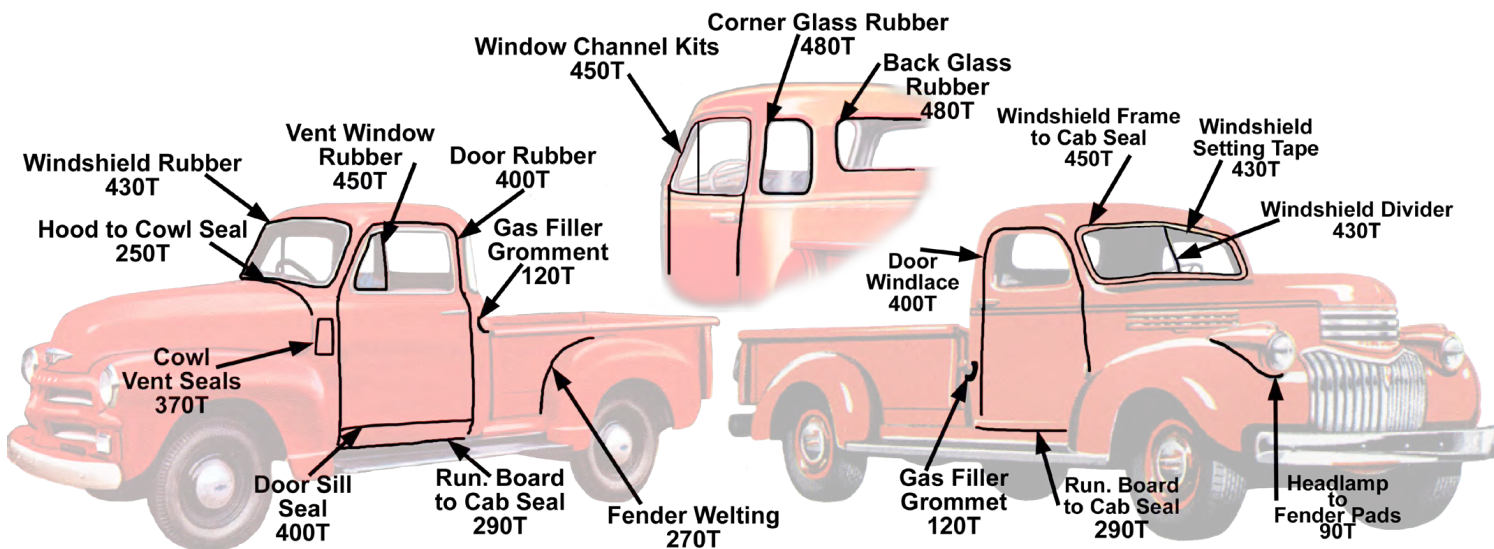
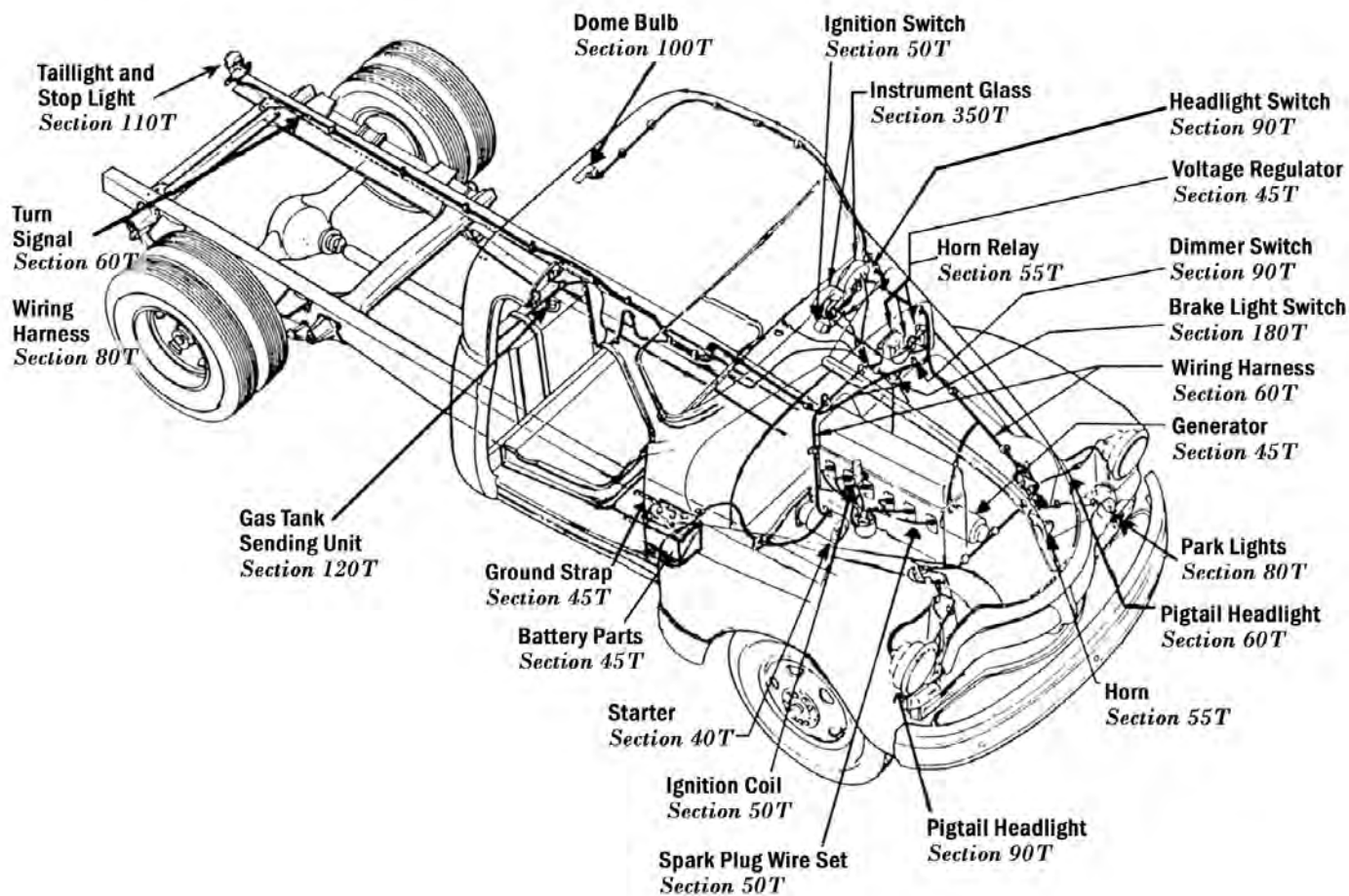

NOTE: Any chemicals will be shipped domestic ground only (Lower 48 states only). No international shipping.

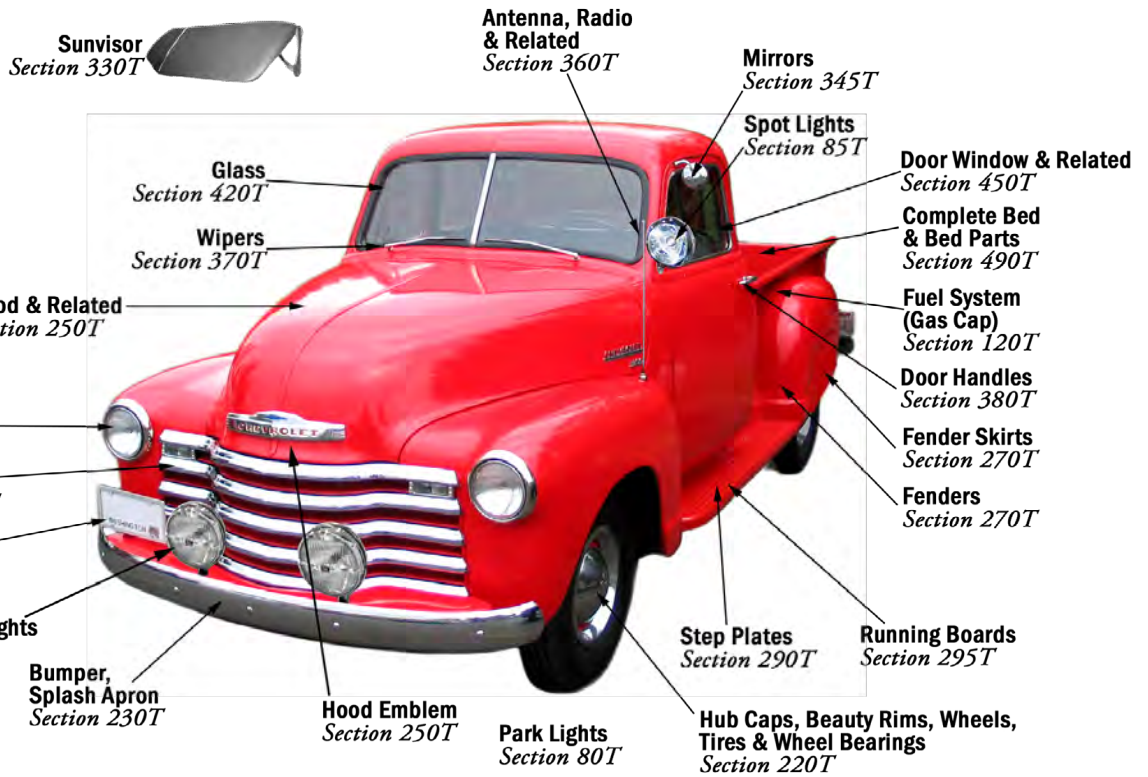
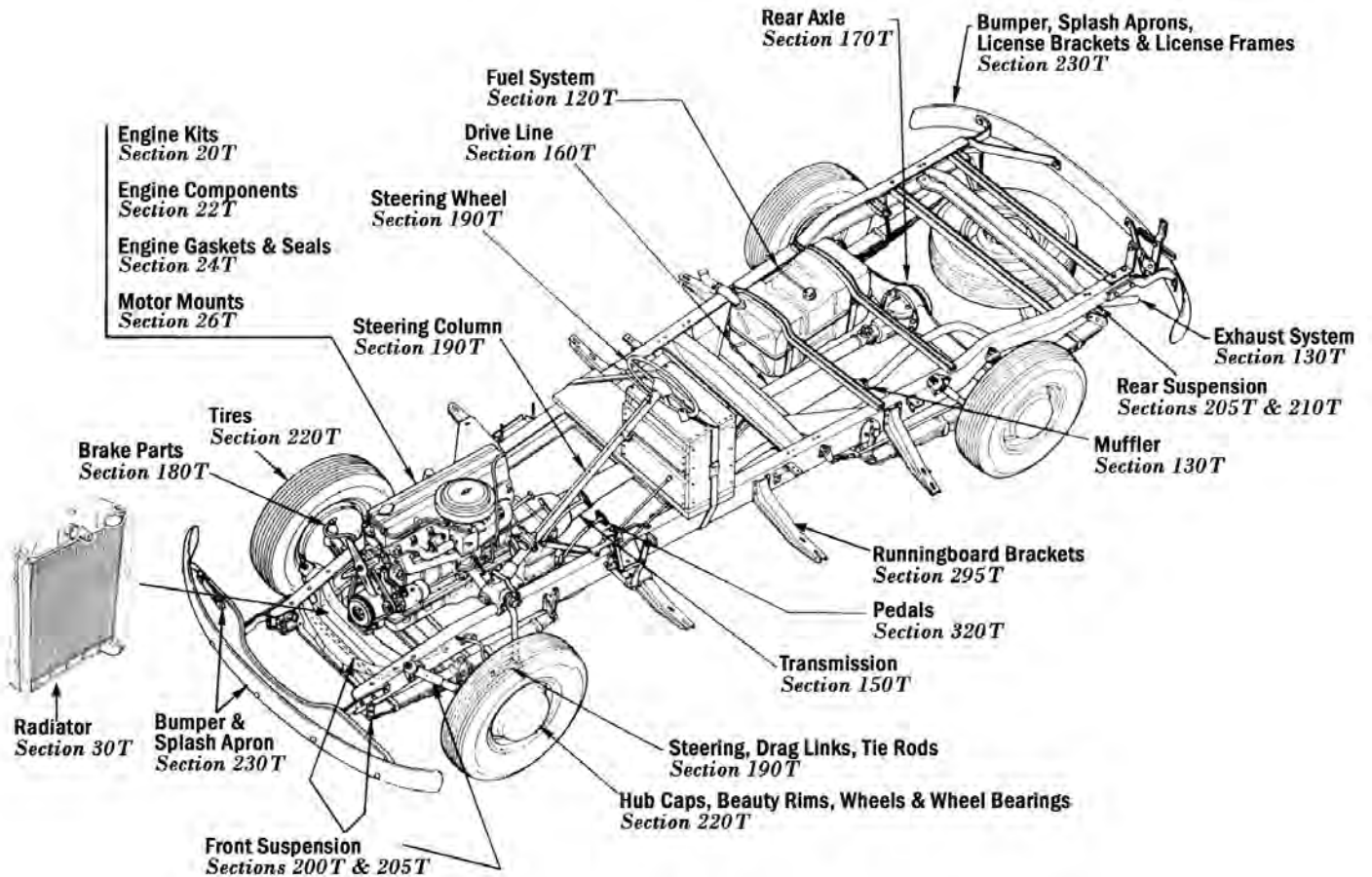

Returns require a return authorization number—Please call first. • Note: Product pricing and availability subject to change.



Truck Sheet Metal
All sheet metal can be found in Section 295T.

Truck Bed Parts
All Truck Bed Parts can be found in Section 490T.

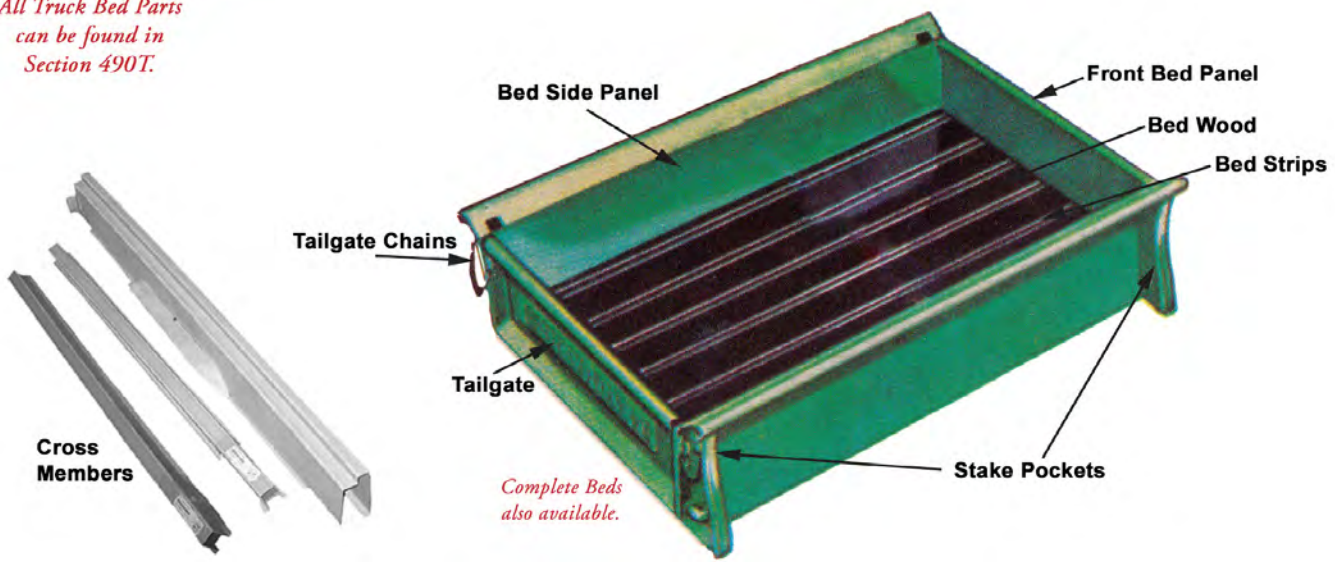

NOTE: Any chemicals will be shipped domestic ground only (Lower 48 states only). No international shipping.

Section 5T: Series Identification Table

Series	Wheelbase	Type of Vehicle	Series	Wheelbase	Type of Vehicle
1937			1939, continued		
GA	112-1/4	Passenger (Master De Luxe) with Knee Action (Enclosed Type)	VB	133	Utility—1-1/2 Ton Truck, Dual Wheels
GB	112-1/4	Passenger and Sedan Delivery (Master)	VC	158-1/2	Utility—1-1/2 Ton Truck, Single Wheels
GC	112	Commercial—1/2 Ton Truck	VD	158-1/2	Utility—1-1/2 Ton Truck, Dual Wheels
GD	122-1/4	Commercial—3/4 Ton Truck, 11 in. Brakes	VE	107-5/8	Utility—Cab Over Engine, Single Wheels
GE	122-1/4	Commercial—1 Ton Truck	VF	107-5/8	Utility—Cab Over Engine, Dual Wheels
SA	131-1/2	Utility—1-1/2 Ton Truck, Single Wheels	VG	131-1/8	Utility—Cab Over Engine, Single Wheels
SB	131-1/2	Utility—1-1/2 Ton Truck, Dual Wheels	VH	131-1/8	Utility—Cab Over Engine, Dual Wheels
SC	157	Utility—1-1/2 Ton Truck, Single Wheels	VM	156-5/8	Utility—Cab Over Engine, Single Wheels
SD	157	Utility—1-1/2 Ton Truck, Dual Wheels	VN	156-5/8	Utility—Cab Over Engine, Dual Wheels
1938			1940		
HA	112-1/4	Passenger (Master De Luxe) with Knee Action (Enclosed Type)	KA	113	Passenger (Special De Luxe) with Knee Action (Open Spring Type)
HB	112-1/4	Passenger and Sedan Delivery (Master)	KH	113	Passenger (Master De Luxe) with Knee Action (Open Spring Type)
HC	112	Commercial—1/2 Ton Truck	KB	113	Passenger and Sedan Delivery (Master “85”), Conventional Front Axle
HD	112-1/4	Commercial—3/4 Ton Truck, 11 in. Brakes	KC	113-1/2	Commercial—1/2 Ton Truck
HE	112-1/4	Commercial—1 Ton Truck, 14 in. Brakes	KD	123-3/4	Commercial—3/4 Ton Truck, 11 in. Brakes
TA	131-1/2	Utility—1-1/2 Ton Truck, Single Wheels	KE	123-3/4	Commercial—3/4 Ton Truck, 14 in. Brakes, Heavy Duty
TB	131-1/2	Utility—1-1/2 Ton Truck, Dual Wheels	KF	133	Commercial—1 Ton Truck
TC	157	Utility—1-1/2 Ton Truck, Single Wheels	WA	133	Utility—1-1/2 Ton Truck, Single or Dual Wheels
TD	157	Utility—1-1/2 Ton Truck, Dual Wheels	WB	158-1/2	Utility—1-1/2 Ton Truck, Single or Dual Wheels
1939			WV	193-5/8	Utility—School Bus Chassis, Dual Wheels
JA	112-1/4	Passenger (Master De Luxe) with Knee Action (Open Spring Type)	WD	107-5/8	Utility—Cab Over Engine
JB	112-1/4	Passenger and Sedan Delivery (Master “85”)	WE	131-1/8	Utility—Cab Over Engine
JC	113-1/2	Commercial—1/2 Ton Truck	WF	156-5/8	Utility—Cab Over Engine
JD	123-3/4	Commercial—3/4 Ton Truck, 11 in. Brakes	1941		
JE	123-3/4	Commercial—1 Ton Truck, 14 in. Brakes (Heavy Duty)	AH	116	Passenger (Special De Luxe) with Knee Action (Open Spring Type)
VA	133	Utility—1-1/2 Ton Truck, Single Wheels	AG	116	Passenger and Sedan Delivery (Master De Luxe) with Knee Action (Open Spring Type)

Returns require a return authorization number—Please call first. • Note: Product pricing and availability subject to change.

Series	Wheelbase	Type of Vehicle
1941, continued		
AK	115	Commercial—1/2 Ton Truck
AL	125-1/4	Commercial—3/4 Ton Truck, 11 in. Brakes
AM	125-1/4	Commercial—3/4 Ton Truck, 14 in. Brakes, Heavy Duty
AN	134-1/2	Commercial—1 Ton Truck
YR	134-1/2	Utility—1-1/2 Ton Truck, Single or Dual Wheels
YS	160	Utility—1-1/2 Ton Truck, Single or Dual Wheels
YT	195	Utility—School Bus Chassis, Dual Wheels
YU	109	Utility—Cab Over Engine
YV	132-1/2	Utility—Cab Over Engine
YW	158	Utility—Cab Over Engine

1942		
BH	116	Passenger (Special De Luxe)
BG	116	Passenger and Sedan Delivery (Master De Luxe)
BK	115	Commercial—1/2 Ton Truck
BL	125-1/4	Commercial—3/4 Ton Truck, 11 in. Brakes
BM	125-1/4	Commercial—3/4 Ton Truck, 14 in. Brakes
BN	134-1/2	Commercial—1 Ton Truck
MR	134-1/2	Utility—1-1/2 Ton Truck, Single or Dual Wheels
MS	160	Utility—1-1/2 Ton Truck, Single or Dual Wheels
MY	160	Utility—School Bus Chassis, Dual Wheels
MT	195	Utility—School Bus Chassis, Dual Wheels
MU	109	Utility—Cab Over Engine
MV	132-1/2	Utility—Cab Over Engine
MW	158	Utility—Cab Over Engine

First Design	Second Design	Wheelbase	Type of Vehicle
1946			
		DK	116 Passenger (Fleetmaster and Fleetline)
		DJ	116 Passenger (Stylemaster)
	DP	CK	115 Commercial—1/2 Ton Truck
	DR		125-1/4 Commercial—3/4 Ton Truck
	DS		134-1/2 Commercial—1 Ton Truck

First Design	Second Design	Wheelbase	Type of Vehicle
1946, continued			
OR	PJ	134-1/2	Utility—1-1/2 Ton Truck
OS	PK	160	Utility—1-1/2 Ton Truck
OW	PL	160	Utility—School Bus Chassis
OY		195	Utility—School Bus Chassis
OE	PV	134-1/2	Utility—2 Ton Truck
OF	PW	160	Utility—2 Ton Truck
OG	PX	195	Utility—School Bus Chassis
OH	PP	109	Utility—2 Ton Truck, Cab Over Engine
OI	PR	132-1/2	Utility—2 Ton Truck, Cab Over Engine
OJ	PS	158	Utility—2 Ton Truck, Cab Over Engine

Series	Wheelbase	Type of Vehicle
1947		
EK	116	Passenger (Fleetmaster and Fleetline)
EJ	116	Passenger (Stylemaster)
EP	116	Commercial Type of Vehicles
ER	125-1/4	Commercial—3/4 Ton Truck
ES	137	Commercial—1 Ton Truck
QJ	137	Utility—1-1/2 Ton Truck
QK	161	Utility—1-1/2 Ton Truck
QL	161	Utility—School Bus Chassis
QV	137	Utility—2 Ton Truck
QW	161	Utility—2 Ton Truck
QX	199	Utility—School Bus Chassis
QP	110	Utility—2 Ton Truck, Cab Over Engine
QR	134	Utility—2 Ton Truck, Cab Over Engine
QS	158	Utility—2 Ton Truck, Cab Over Engine

1948		
FK	116	Passenger (Fleetmaster and Fleetline)
FJ	116	Passenger (Stylemaster)
FP	116	commercial—1/2 Ton Truck
FR	125-1/4	Commercial—1/2 Ton Truck
FT	125-1/4	Commercial—3/4 Ton Truck (Dubl-Duti), Forward Control Delivery Chassis
FS	137	Commercial—1 Ton Truck
FU	137	Commercial—1 Ton Truck (Dubl-Duti), Forward Control Delivery Chassis
RJ	137	Utility-1-Utility—1-1/2 Ton Truck
RK	161	Utility-1-Utility—1-1/2 Ton Truck

NOTE: Any chemicals will be shipped domestic ground only (Lower 48 states only). No international shipping.

Section 5T: Series Identification Table

Series	Wheelbase	Type of Vehicle	Series	Wheelbase	Type of Vehicle
1948, continued			1950, continued		
RL	161	Utility—School Bus Chassis	TK	4400 161	Utility—1-1/2 Ton Truck
RV	137	Utility—2 Ton Truck	TLT	4500 161	Utility—School Bus Chassis
RW	161	Utility—2 Ton Truck	VS	6100 137	Utility—2 Ton Truck
RX	199	Utility—School Bus Chassis	TW	6400 161	Utility—2 Ton Truck
RP	110	Utility—2 Ton Truck, Cab Over Engine	TY	6500 179	Utility—2 Ton Truck
RR	134	Utility—2 Ton Truck, Cab Over Engine	TX	6700 199	Utility—School Bus Chassis
RS	158	Utility—2 Ton Truck, Cab Over Engine	TP	5100 110	Utility—2 Ton Truck, Cab Over Engine
1949			TR	5400 134	Utility—2 Ton Truck, Cab Over Engine
GK	2100 115	Passenger (Deluxe), Styleline and Fleetline	TS	5700 158	Utility—2 Ton Truck, Cab Over Engine
GJ	1500 115	Passenger (Special), Styleline and Fleetline	1951		
GP	3100 116	Commercial—1/2 Ton Truck	JK	2100 115	Passenger (Deluxe), Styleline and Fleetline
GR	3600 125-1/4	Commercial—3/4 Ton Truck	JJ	1500 115	Passenger (Special), Styleline and Fleetline
GT	3700 125-1/4	Commercial—3/4 Ton Truck (Dubl-Duti), Forward Control Delivery Chassis	JP	3100 116	Commercial—1/2 Ton Truck
GS	3800 137	Commercial—1 Ton Truck	JR	3600 125-1/4	Commercial—3/4 Ton Truck
GU	3900 137	Commercial—1 Ton Truck (Dubl-Duti), Forward Control Delivery Chassis	JT	3700 125-1/4	Commercial—3/4 Ton Truck (Dubl-Duti), Forward Control Delivery Chassis
SJ	4100 137	Utility—1-1/2 Ton Truck	JS	3800 137	Commercial—1 Ton Truck
SK	4400 161	Utility—1-1/2 Ton Truck	JUS	3900 137	Commercial—1 Ton Truck (Dubl-Duti), Forward Control Delivery Chassis
SL	4500 161	Utility—School Bus Chassis	UJ	4100 137	Utility—1-1/2 Ton Truck
VS	6100 137	Utility—2 Ton Truck	UK	4400 161	Utility—1-1/2 Ton Truck
SW	6400 161	Utility—2 Ton Truck	UL	4500 161	Utility—School Bus Chassis
SX	6700 199	Utility—School Bus Chassis	UV	6100 137	Utility—2 Ton Truck
SP	5100 110	Utility—2 Ton Truck, Cab Over Engine	UW	6400 161	Utility—2 Ton Truck
SR	5400 134	Utility—2 Ton Truck, Cab Over Engine	UY	6500 179	Utility—2 Ton Truck
SS	5700 158	Utility—2 Ton Truck, Cab Over Engine	UX	6700 199	Utility—School Bus Chassis
1950			UP	5100 110	Utility—2 Ton Truck, Cab Over Engine
HK	2100 115	Passenger (Deluxe), Styleline and Fleetline	UR	5400 134	Utility—2 Ton Truck, Cab Over Engine
HJ	1500 115	Passenger (Special), Styleline and Fleetline	US	5700 158	Utility—2 Ton Truck, Cab Over Engine
HP	3100 116	Commercial—1/2 Ton Truck	1952		
HR	3600 125-1/4	Commercial—3/4 Ton Truck	KK	2100 115	Passenger (Deluxe), Styleline and Fleetline
HT	3700 125-1/4	Commercial—3/4 Ton Truck (Dubl-Duti), Forward Control Delivery Chassis	KJ	1500 115	Passenger (Special), Styleline and Fleetline
HS	3800 137	Commercial—1 Ton Truck	KP	3100 116	Commercial—1/2 Ton Truck
HU	3900 137	Commercial—1 Ton Truck (Dubl-Duti), Forward Control Delivery Chassis	KR	3600 125-1/4	Commercial—3/4 Ton Truck
TJ	4100 137	Utility—1-1/2 Ton Truck	KT	3700 125-1/4	Commercial—3/4 Ton Truck (Dubl-Duti), Forward Control Delivery Chassis
			KS	3800 137	Commercial—1 Ton Truck

Returns require a return authorization number—Please call first. • Note: Product pricing and availability subject to change.

Series	Wheelbase	Type of Vehicle	Series	Wheelbase	Type of Vehicle
1952, continued			1953-54		
KI	3900 137	Commercial—1 Ton Truck (Dubl-Duti), Forward Control Delivery Chassis	A	1500 115	Passenger (One Fifty), excluding 1508
VJ	4100 137	Utility—1-1/2 Ton Truck	B	2100 115	Passenger (Two Ten)
VK	4400 161	Utility—1-1/2 Ton Truck	C	2400 115	Passenger (Bel Air)
VL	4500 161	Utility—1-1/2 Ton, School Bus Chassis	D	1508 115	Sedan Delivery
VV	6100 137	Utility—2 Ton Truck	H	3100 116	Commercial—3/4 Ton Truck
VW	6400 161	Utility—2 Ton Truck	J	3600 124-1/4	Commercial—3/4 Ton Truck (Dubl-Duti), Forward Control Delivery Chassis
VY	6500 179	Utility—2 Ton Truck	K	3700 124-1/4	Commercial—3/4 Ton Truck (Dubl-Duti), Forward Control Delivery Chassis
VX	6700 199	Utility—2 Ton Truck, School Bus Chassis	L	3800 137	Commercial—1 Ton Truck
VZ	6800 212	Utility—2 Ton Truck, School Bus Chassis	M	3900 137	Commercial—1 Ton Truck (Dubl-Duti), Forward Control Delivery Chassis
VP	5100 110	Utility—2 Ton Truck, Cab Over Engine	N	4100 137	Utility—1-1/2 Ton Truck
VR	5400 134	Utility—2 Ton Truck, Cab Over Engine	P	4400 161	Utility—1-1/2 Ton Truck
VS	5700 158	Utility—2 Ton Truck, Cab Over Engine	R	4500 161	Utility—School Bus Chassis
			S	5100 110	Utility—2 Ton Truck, Cab Over Engine
			T	5400 134	Utility—2 Ton Truck, Cab Over Engine
			U	5700 158	Utility—2 Ton Truck, Cab Over Engine
			V	6100 137	Utility—2 Ton Truck
			W	6400 161	Utility—2 Ton Truck
			X	6500 179	Utility—2 Ton Truck
			Y	6700 199	Utility—School Bus Chassis
			Z	6800 212	Utility—School Bus Chassis

COMMERCIAL
BODY PARTS SECTION
 GROUPS 16.000 - 17.721
 Six Cylinder Models — 1929-1950

KEY TO SYMBOLS

The usage of parts listed in this section is designated either by job numbers, chassis symbols, or model abbreviations shown below:

CAB BODIES (including Cab Over Engine) C CAB
 CAB OVER ENGINE COE
 OPEN CAB Open Cab
 SINGLE UNIT BODIES (Panels, Canopy Express, Suburban Carryall, Etc.) SGL UNIT
 SUBURBAN CARRYALL BODY SUB
 SUBURBAN CARRYALL BODY (with End Gate) Sub w/End Gate
 SUBURBAN CARRYALL BODY (with Panel Doors) Sub. w/Doors
 DOUBLE UNIT BODIES (With Cab and Separate Body) DBL. UNIT
 PLAIN CHASSIS LESS WINDSHIELD FTC or FLAT FACE COWL
 ALL ABOVE MODELS. ALL

See Commercial Body Model Identification Sheet on Next Page for Job Numbers and Chassis Symbols. Suburban Carryall Body Parts for the years 1939-50 are now being listed in the "Master Parts Catalog" along with comparable parts. Body parts which are common to Suburban Carryall, Panels and Canopy Express, may be found listed as Single Unit or under Corresponding Commercial Body Types.

NOTE: Any chemicals will be shipped domestic ground only (Lower 48 states only). No international shipping.

Section 5T: Series Identification Table



1937 was the first year Chevrolet began to offer 3/4- and one-ton trucks as standard models. Chevrolet also introduced the 216 engines and increased the number of

main bearings to four. With the gas tank under the passenger seat, the seat had to be removed to fill the tank. The half-ton bed length increased from 72 to 77 inches. Other Chevrolet truck changes that year included the truck headlights attached to the radiator shell sides and the treads on the running boards ran the length of the board.



The **1938** Chevrolet truck model was much like the 1937 model. The gas tank filler changed to be extended through the cab wall from its location under the seat,

and a heavier bumper with a painted streak was added. The pickup used the flat-head six-cylinder engine borrowed from Pontiac. This was the last year Chevrolet used the generator cutout.



The **1939** and 1940 Chevrolet trucks had a restyled and re-engineered cab and front sheet metal. The new models were the best-looking trucks in

Chevrolet's truck division's history. The Chevy cab was designed for driver comfort and convenience. In 1939, Chevrolet launched its first cab-over-engine truck. This was also the first year Chevrolet used script lettering on the tailgate, and the last year for oval taillights.



Chevrolet continued the new design into the **1940** model year. One of the more obvious differences from the 1939 models was the uppermost

grille bar with the large Chevrolet name written in red script letters. Minor changes in the cab included the instrument panel, curved with a rectangular gauge cluster design from the passenger cars. Chevrolet also introduced the rectangular taillight and the truck bed was three inches wider.



The **1941** Chevrolet truck's front end was all new. The larger, more impressive truck had an increased wheelbase and more power. Chevy discontinued the stamped name in the tailgate that year. The longer wheelbase gave the cab area additional legroom and the seat back was reclined to a more comfortable angle. The headlight assemblies were secured to the fenders.



The **1942**, Chevrolet trucks were essentially unchanged from 1941. The government halted all automobile production in early 1942 because of World War II.

Chevrolet resumed production of civilian trucks for general sales in August, 1945. The government allowed Chevrolet to build civilian heavy-duty chassis cabs for qualified essential users in 1944 and 1945, and the half-ton 115-inch wheelbase pickup in 1945 for qualified essential civilian users.



In **1946**, Chevrolet brought a full line of light, medium, and heavy-duty trucks to the market. All the trucks that year came complete with chrome trim. The Coupe pickup was the only prewar model that didn't return. The light-duty engine was the same as the prewar engine. Only minor changes were made to the Chevy models in 1946.



1947 saw major overhauls. The Advanced Design trucks entered production with a multitude of model changes. The new Chevys had a larger cab, more comfortable seats, and better driving vision. The gas tank was moved to under the truck bed that year. The three-inch wider bed had nine planks versus the seven from the year before. The Chevrolet name was stamped into the tailgate. The larger windshield and bigger side and rear window glass and optional rear-quarter windows greatly improved safety and driver vision.



Chevrolet only made minor changes to the models in **1948**. The transmission gear shift lever was moved to the steering column from the floor, while the parking brake was changed from a floor-mounted lever to a foot-actuated pedal.



Only minor changes were made in **1949**. The gas tank was moved into the cab behind the seat back. The Chevy hood emblem became chrome-plated steel. This was the last year Chevrolet used the lever-action shocks.



In **1950**, the 216.5 cubic-inch six-cylinder engine was tweaked to put out more horsepower. The new modern tubular shocks were introduced. The Chevrolet hood side emblems display their name plus 3100 for a 1/2-ton, 3600 on a 3/4-ton, and 3800 on a 1-ton.



In **1951**, the left-side cowl vent was eliminated and replaced with the door vent windows. The seat adjustment with the metal cable was changed to a rod under the cushion which was run through a rubber grommet and secured to the seat riser frame. In mid-year 1951, the Chevy truck bed changed from nine boards to eight. The maximum speedometer speed was 80 mph.



Push-button door handles were introduced in the **1952** model year. The Chevrolet hubcaps changed from being chrome-plated to gray painted steel with black block letters, though the stamping and shape remained the same as prior years. Some say a very few deluxe 1/2-ton pickups still carried the chrome hubcap. The truck speedometer showed a maximum speed of 90 mph.



In **1953** the Chevrolet truck hood emblem was stainless steel. This was the first year Chevy offered the optional left side mount spare tire on the pickups. This was also the last year for wood blocks under the truck bed.



In **1954** Chevrolet introduced the one-piece windshield, an all-new grille, new parking lights, a new steering wheel, and a redesigned dashboard, the new high-pressure 235 cubic-inch insert-bearing engine on the pickups, and the 261 cubic-inch six-cylinder on large trucks. The Chevy hubcaps had the same shape as before; however, they had only the bowtie emblem. The redesigned bed changed to increase the bed depth with all new bed sides. The optional rear bumper was dropped in the center to make room for a new license plate location.

Section 8T: Paint Combination Chart

Body		Moulding	Stripe		
1937-39					
242	Swifts Commercial Red	225	—	Argent Silver	2894202
243	Export Blue	314	—	Argent Silver	2894202
244	Brewster Green Med.	267	—	Gigolo Green	2899862
1940-46					
242	Swifts Commercial Red	Black Duco	2072122	Argent Silver	2894202
269	Boatswain Blue	Argent Silver	2894202	Totem Scarlet	28950165
257	Apple green	Cream Medium	2896596	Emerald Green	2893133
312	Amour Yellow	Omaha Orange	2896276	Moulding Black	2072122
234	Cream Medium	Export Blue	2897128	Argent Silver	2894202
314	Export Blue	Argent Silver	2894202	Totem Scarlet	28950165
262	Omaha Orange	Chess Blue	28950666	White Striping	289008
313	Aluminum (Silver)	Totem Scarlet	28950165	Moulding Black	2072122
Most Common Colors					
	Brewster Green	1940 uses Cream Medium		1940 uses Emerald Green	
	Black	Kildaire Green	28950701	Emerald Green	2893133
		Emerald Green	2893133	Cream Medium	2896596
		1940 uses Omaha Orange		1940 uses Chess Blue	
264	White	Kildaire Green	28950701	White Striping	289008
301	Hollywood Tan (Oakland Plant)	Moulding Black	2072122	White Striping	289008
	Bordeaux Maroon (Terrytown and Baltimore Plants)	Moulding Black	2072122	Gold Bronze Powder	
Upper Body	Lower Body	Moulding	Stripe		
1941-46 Suburban					
Airdale Brown	Circassion Brown	Kildaire Green	28950701	White Striping	289008
Body	Moulding	Stripe			
1947-49					
Fathom Green	—	—			
1947-53					
Windsor Blue	—	—			
Cape Maroon	—	—			
Swift Red (Commercial Red)	—	—			
Armour Yellow	—	—			
Sun Beige	—	—			
Forester Green	—	—			
Seacrest Green	—	—			
1947-55					
Omaha Orange (GMC)	—	Jet Black			
Cream Medium	—	Jet Black			
Mariner Blue	—	Cream Medium			
White	—	Juniper Green			
1948-49					
Channel Green	—	—			
1951-55					
Yukon Yellow	—	Jet Black			
Burgundy Maroon	—	Gold Bronze			
Copper Tone	—	Shell White			
Ocean Green	—	Jet Black			
Autumn Brown	—	Shell White			
Transport Blue	—	Cream Medium			
Juniper Green	—	Cream Medium			

Returns require a return authorization number—Please call first. • Note: Product pricing and availability subject to change.

**SECTION 010T
RESTORATION PARTS**

Gift Certificates

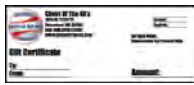

GIFTCERT0025 **ALL**
\$25 Gift Certificate -0
Certificate -0

..... **\$25.00 EA** ⚠

GIFTCERT0050 **ALL**

\$50 Gift Certificate -0
..... **\$50.00 EA** ⚠

GIFTCERT0075 **ALL**

\$75 Gift Certificate -0
..... **\$75.00 EA** ⚠

GIFTCERT0100 **ALL**

\$100 Gift Certificate -0
..... **\$100.00 EA** ⚠

GIFTCERT0150 **ALL**

\$150 Gift Certificate -0
..... **\$150.00 EA** ⚠

GIFTCERT0200 **ALL**

\$200 Gift Certificate -0
..... **\$200.00 EA** ⚠

GIFTCERT0500 **ALL**

\$500 Gift Certificate -0
..... **\$500.00 EA** ⚠

GIFTCERT1000 **ALL**

\$1000 Gift Certificate -0
..... **\$1,000.00 EA** ⚠

GIFTCERT5000 **ALL**

\$5000 Gift Certificate -0
..... **\$5,000.00 EA** ⚠

Fender/Trunk Script Emblems



R6272 **ALL**

"Supercharged" Emblem -0.15
..... **\$11.00 EA** ⚠



R6273 **ALL**

"Streetrod" Emblem -0.15
..... **\$9.95 EA** ⚠



R6274 **ALL**

"Hotrod" Emblem -0.2
..... **\$9.95 EA** ⚠

Fender/Trunk Script Emblems, cont.



R6276 **ALL**

"Blown" Emblem -0.15
..... **\$9.95 EA** ⚠



R6277 **ALL**

"Cruisin" Emblem -0.2
..... **\$9.95 EA** ⚠

R6278 **ALL**

"Turbocharged" Emblem -0.15
..... **\$9.95 EA** ⚠

Vehicle Accessories



10887 **ALL**

Chrome bullet wing nut license fastener.
Set of 4 -0.15
..... **\$5.00 SET** ⚠



8BALL70204 **ALL**

Fuzzy 8 Ball Black -0.15
..... **\$6.95 EA** ⚠

985094 **ALL**

Glass jewel reflector.
Specify Red, Green,
Blue, Amber, Burnt

Orange, Purple, Clear, Light Blue, Yellow,
Rainbow. (2 pcs). 9.777 -0.2
..... **starting at \$20.00 PR** ⚠



BIS77002 **ALL**

Bowtie hitch cover. -0.15
..... **\$32.00 EA** ⚠

Vehicle Accessories, cont.



DICE **ALL**

Classic Fuzzy Dice, Chose Black, Blue or
Red -0.15
..... **\$5.00 PR** ⚠



DLK70023 **ALL**

8 Ball Door Lock Knob -0.15
..... **\$7.00 PR** ⚠



DLK70044 **ALL**

Chrome Metal Tube Door Lock Knob -0.2
..... **\$7.00 PR** ⚠



DLK70095 **ALL**

Iron Cross Door Lock Knob -0.2
..... **\$8.95 PR** ⚠



FELIX **ALL**

Universal Felix the
cat license plate
ornament. -0.15
..... **\$20.00 EA** ⚠



FLAG01 **ALL**

License Plate Frame
Accessory, U.S.A.
Flag -0.4
..... **\$1.95 EA** ⚠

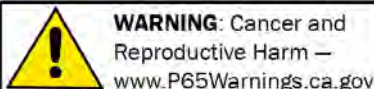

WARNING: Cancer and
Reproductive Harm —
www.P65Warnings.ca.gov

Chemicals shipped domestic ground only (Lower 48 states only). No international shipping.

Phone: (360) 816-0211 • (800) 999-CHEV (2438) • www.chevsofthe40s.com

Vehicle Accessories, cont.



FLAG02ALL
Flag Holder - 5
Post -0.15
..... **\$10.00 EA** ⚠



FLAG03ALL
Flag Holder-Chrome
3 Post -0
..... **CALL** ⚠



LF70045ALL
8 Ball License Plate Fastener -0.2
..... **\$5.95 PR** ⚠



LF70065ALL
Lion Head License Plate Fastener -0.2
..... **\$6.95 PR** ⚠



LF70070ALL
Chrome Dice License Plate Fastener -0.2
..... **\$5.95 PR** ⚠



LF70071ALL
Chrome Bullet License Plate Fastener -0.2
..... **\$7.95 PR** ⚠

Vehicle Accessories, cont.



LF70072ALL
Dice License Plate Fastener Green With
White Dots -0.15
..... **\$4.95 PR** ⚠



LF70073ALL
Dice License Plate Fastener Purple With
White Dots -0.15
..... **\$4.95 PR** ⚠



LF70074ALL
Large 8 Ball License Plate Fastener -0.15
..... **\$6.95 PR** ⚠



LF70096ALL
Iron Cross License Plate Fastener -0.15
..... **\$5.95 PR** ⚠



LF70315ALL
Chrome Skull License Plate Fastener -0.15
..... **\$4.00 PR** ⚠

Vehicle Accessories, cont.



VC69978ALL
Chrome Large 8 Ball Valve Cap -0.2
..... **\$9.95 SET** ⚠



VC69981ALL
Chrome Dice Valve Caps -0
..... **CALL** ⚠



VC70004ALL
Skull Valve Caps -0.15
..... **\$6.95 SET** ⚠



VC70005ALL
Dice Valve Caps-Red With White Dots -0.15
..... **\$4.00 SET** ⚠



VC70006ALL
Dice Valve Caps-White With Black
Dots -0.15
..... **\$4.00 SET** ⚠



VC70007ALL
Dice Valve Caps-Black With White
Dots -0.15
..... **\$4.00 SET** ⚠

Vehicle Accessories, cont.



VC70008ALL
Dice Valve Caps- Blue With White
Dots -0.15 **\$4.00 SET** ⚠



VC70022ALL
8 Ball Valve Caps -0.15 **\$4.00 SET** ⚠



VC70038ALL
Chrome Spike Valve Caps -0.15
\$7.95 SET ⚠



VC70054ALL
Dice Valve Caps- Purple With White Dots -0
..... **CALL** ⚠



VINTAGE01ALL
Registration holder
for your column w/
springs. 5-1/4" X
3-1/4" -0.15 **\$11.95 EA** ⚠

Vehicle Accessories, cont.



VINTAGE02ALL
Registration holder w/ clamps for your Sun
Visor. Reproduction protector for your
registration card. 5-1/4" x 3-3/8" -0.15
..... **\$11.95 EA** ⚠



WASITFDALL
Bluetooth speaker
fuzzy dice. Easy
setup with built in
microphone & stereo
speakers makes
hands free calling
safe & easy.
Works with your

smart phone for calling, music, navigation
& more.

Rechargeable long play battery. USB
charging cord included. Great in the shop
or at cruise nights too. -0.15
..... **\$109.00 EA** ⚠

Dog Collar/ Leash



BDDOGCCSALL
Dog collar black with "Chevy" bowtie logo
buckle and "Chevy" bowtie logo repeated
around the collar for small size dog -0
CALL ⚠



BDDOGLCALL
Dog leash with "Chevy" bowtie logo
repeated on a 4 foot by 1" strap -0
EA ⚠

Belt



BDSBBCALL
Belt black with "Chevy" bowtie logo buckle.
Made from black seat belt strap material.
47" long 1.5 wide. -0 **CALL** ⚠

Hoodies



HOODIE-CH1ALL
Large or XL cotton
hoodies with Chevs
chest logo. Choose
Black, Grey, Navy or
Red. 0.000 -0.15
..... **\$24.50 EA** ⚠

HOODIE-CH2ALL
XXL (Black, Navy or Grey) or XXXL (Black
or Navy). Single Chevs logo on left chest.
0.000 -0
..... **\$24.50 EA** ⚠

T-Shirts



SHIRT01ALL
Chevs Logo T-Shirt.
Available in Red,
White, Blue or Black.

S,M,L,XL,XXL,XXXL -0.15
..... **\$15.00 EA** ⚠



SHIRT03ALL
'41 Cabriolet
Art. Available in
Black or Red.

S,M,L,XL,XXL,XXXL -0.15
..... **\$15.00 EA** ⚠

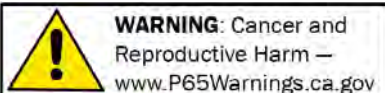

WARNING: Cancer and
Reproductive Harm —
www.P65Warnings.ca.gov

Chemicals shipped domestic ground only (Lower 48 states only). No international shipping.

Phone: (360) 816-0211 • (800) 999-CHEV (2438) • www.chevsofthe40s.com

T-Shirts, cont.



SHIRT04ALL
 '41 Cabriolet "Bustin Through". Available in Black or Blue.

S,M,L,XL,XXL,XXXL -0.15

\$15.00 EA ⚠



SHIRT07ALL
 47-53 Truck "Bustin Through". Available in black or blue,

S,M,L,XL,XXL,XXXL -0.15

\$15.00 EA ⚠



SHIRT08ALL
 T-Shirt "52 Bustin' Through". Available in black or blue,

S,M,L,XL,XXL,XXXL -0.15

\$15.00 EA ⚠



SHIRT09ALL
 T-Shirt "39 Bustin' Through". Available in black or blue,

S,M,L,XL,XXL,XXXL -0.15

\$15.00 EA ⚠



SHIRT10ALL
 T-Shirt "37 Bustin' Through". Available in black or blue,

S,M,L,XL,XXL,XXXL -0.15

\$15.00 EA ⚠

T-Shirts, cont.



SHIRT11ALL
 T-Shirt "40 Bustin' Through". Available in black or red,

S,M,L,XL,XXL,XXXL -0.15

\$15.00 EA ⚠



SHIRT13ALL
 Street Rod Headquarters basic Available in black ,

S,M,L,XL,XXL,XXXL -0

\$15.00 EA ⚠

Hats



HAT-CHEVS1B.ALL
 Black preformed ball cap with Chevs embroidered logo and red, white & blue detailing on brim. One size fits all with velcro closure. -0.15

\$14.00 EA ⚠

HAT-CHEVS1NALL
 Navy preformed ball cap with Chevs embroidered logo and red, white & blue detailing on brim. One size fits all with velcro closure. -0.15

\$14.00 EA ⚠



HAT-CHEVS2ALL
 Beanie/ Stocking cap 8". Navy with Chevs embroidered logo. One size fits all. -0.15

\$14.00 EA ⚠



HAT-CHEVS3ALL
 Beanie/ Stocking cap 12". Navy with Chevs embroidered logo. One size fits all. -0.15

\$14.00 EA ⚠



HAT-CHEVS4ALL
 Beanie/ Stocking cap 12". Black with Chevs embroidered logo. One size fits all. -0.15

\$14.00 EA ⚠

Hats, cont.



HAT-CHEVS5ALL
 Beanie/ Stocking cap 8". Black with Chevs embroidered logo. One size fits all. -0.15

\$14.00 EA ⚠

Model 1:6 Scale Chevy Small Block



MODEL12SRALL
 Produced by Liberty Classic. Cool scaled rendition of a tried-and-true classic (limited quantity). 0.000 -0.15

\$36.50 EA ⚠

Vintage Chevrolet Cooler



BLACKCOOLERALL
 Black beverage cooler. 16-1/2" x 7-1/2" x 9-3/8" internal dimensions. 0.000 -0

\$79.00 EA ⚠



BLUECOOLERALL
 Blue beverage cooler. 16-1/2" x 7-1/2" x 9-3/8" internal dimensions. 0.000 -0

\$79.00 EA ⚠



REDCOOLERALL
 Red beverage cooler. 16-1/2" x 7-1/2" x 9-3/8" internal dimensions. 0.000 -0

\$79.00 EA ⚠



Neon Marquee Sign 10 Foot Length



NEON120COALL
10 Feet Long! "Chevrolet Corvette Garage"
in Red, Black & Yellow. -0.15
\$5,000.00 EA ⚠️



NEON120UCALL
10 Feet Long! OK Used Cars in Red &
Yellow. -0.15 **\$5,000.00 EA** ⚠️

Neon Marquee Sign & Clock 72" Length



NEON72GO-REDALL
6' long x 26" tall. -0.15 **\$1,550.00 EA**
⚠️



NEON72SS-BWALL
6' long x 26" tall. -0.15 **\$1,550.00 EA**
⚠️



NEON72SV-BLKALL
6' long x 26" tall. -0.15 **\$1,550.00 EA**
⚠️



NEON72SV-YELALL
6' long x 26" tall. -0.15 **\$1,550.00 EA**
⚠️

Neon Marquee Sign & Clock 72" Length, cont.



NEON72UC-YELALL
6' long x 26" tall. -0.15 **\$1,550.00 EA**
⚠️

Neon Marquee Sign 48" Length



NEON48G-BLKALL
"ROUTE 66 GARAGE", 48" long x 24" tall,
8" deep. -0.15 **\$750.00 EA** ⚠️



NEON48G-GRNALL
"LAST CHANCE GARAGE", 48" long x 24"
tall, 8" deep. -0.15 **\$750.00 EA** ⚠️



NEON48G-YELALL
"CHEVROLET PARTS GARAGE", 48" long x
24" tall, 8" deep. -0.15 **\$750.00 EA**
⚠️



NEON48GL-REDALL
"TEXACO HIGH OCTANE GASOLINE", 48"
long x 24" tall, 8" deep. -0.15
\$750.00 EA ⚠️

Neon Marquee Sign 48" Length, cont.



NEON48S-BLKALL
"PHILLIPS 66 SERVICE", 48" long x 24"
tall, 8" deep. -0.15 ... **\$750.00 EA** ⚠️



NEON48S-GRNALL
"LAST CHANCE GARAGE SERVICE", 48"
long x 24" tall, 8" deep. -0.15
\$750.00 EA ⚠️



NEON48S-YELALL
"CHEVROLET SERVICE", 48" long x 24"
tall, 8" deep. -0.15 ... **\$750.00 EA** ⚠️



NEON48UC-YELALL
"OK USED CARS", 48" long x 24" tall, 8"
deep. -0.15 **\$750.00 EA** ⚠️

Neon Marquee Sign 34" Length



NEON34GS-BLKALL
"PHILLIPS 66 GAS", 34" long x 24" tall, 8"
deep. -0.15 **\$700.00 EA** ⚠️

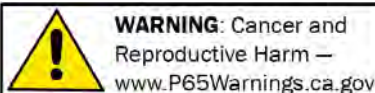

WARNING: Cancer and
Reproductive Harm —
www.P65Warnings.ca.gov

Chemicals shipped domestic ground only (Lower 48 states only). No international shipping.

Phone: (360) 816-0211 • (800) 999-CHEV (2438) • www.chevsofthe40s.com

Neon Marquee Sign 34" Length, cont.



NEON34GS-RED.....ALL
 "Mobilgas GAS", 34" long x 24" tall, 8" deep. -0.15 **\$700.00 EA** ⚠️



NEON34GST-RED.....ALL
 "TEXACO GAS", 34" long x 24" tall, 8" deep. -0.15 **\$700.00 EA** ⚠️



NEON34PG-BLK.....ALL
 "POLLY GAS", 34" long x 24" tall, 8" deep. -0.15 **\$700.00 EA** ⚠️

Wall Clocks

Neon to light up your garage, den, workshop or anywhere you can find a place for these large clocks.



CLOCK01GMMPALL
 Antique Sinclair Green Neon -0.15 **\$159.00 EA** ⚠️



CLOCK01RMMPALL
 Antique Sinclair Red Neon -0.15 **\$159.00 EA** ⚠️

Wall Clocks, cont.



CLOCK02MMP .ALL
 Chevy Garage Blue Neon -0.15 **\$159.00 EA** ⚠️



CLOCK03MMP .ALL
 Ford Motor Co Blue Neon -0.15 **\$159.00 EA** ⚠️



CLOCK04MMP .ALL
 Gear Head Blue Neon -0.15 **\$159.00 EA** ⚠️



CLOCK05MMP .ALL
 Genuine Chevy Parts Blue Neon -0.15 **\$159.25 EA** ⚠️



CLOCK06MMP .ALL
 GMC Truck White Neon -0.15 **\$159.00 EA** ⚠️



CLOCK07MMP .ALL
 GULF Blue Neon -0.15 **\$159.00 EA** ⚠️



CLOCK08BMMPALL
 Mobile Gas Blue Neon -0.15 **\$159.00 EA** ⚠️

Wall Clocks, cont.



CLOCK08RMMPALL
 Mobile Gas Red Neon -0.15 **\$159.00 EA** ⚠️



CLOCK09MMP .ALL
 Moon Eyes Yellow Neon -0.15 **\$159.25 EA** ⚠️



CLOCK10MMP .ALL
 Penzoil Red Neon -0.15 **\$159.00 EA** ⚠️



CLOCK11MMP .ALL
 Road Runner Orange Neon -0.15 **\$159.00 EA** ⚠️



CLOCK12MMP .ALL
 Corvette Garage Red Neon -0.15 **\$159.00 EA** ⚠️



CLOCK13MMP .ALL
 Genuine Ford Parts Blue Neon -0.15 **\$159.00 EA** ⚠️



CLOCK14MMP .ALL
 Poly Gas Green Neon -0.15 **\$159.00 EA** ⚠️

Returns require a return authorization number—call first. • Product pricing & availability subject to change.

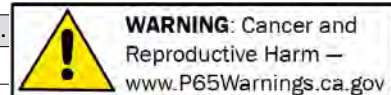

Wall Clocks, cont.



CLOCK15MMP .ALL
Pontiac Service Red
Neon -0.15
..... **\$159.00 EA** ⚠



CLOCK16MMP .ALL
Sunoco Gas Yellow
Neon -0.15
..... **\$159.00 EA** ⚠



CLOCK17MMP .ALL
76 Gas Blue
Neon -0.15
..... **\$159.00 EA** ⚠



CLOCK18MMP .ALL
Olds Rocket Red
Neon -0.15
..... **\$159.00 EA** ⚠



CLOCK19MMP .ALL
Rat Fink Green
Neon -0.15
..... **\$159.00 EA** ⚠



CLOCK20MMP .ALL
HURST Red
Neon -0.15
..... **\$159.00 EA** ⚠



CLOCK21MMP .ALL
Super Chevy Service
Yellow Neon -0.15
..... **\$159.00 EA** ⚠

Wall Clocks, cont.



CLOCK22MMP .ALL
Gilmore Gas red
Neon -0.15
..... **\$159.00 EA** ⚠



CLOCK23BMMPALL
OK Used Cars Blue
Neon -0.15
..... **\$159.00 EA** ⚠



CLOCK23RMMPALL
OK Used Cars Red
Neon -0.15
..... **\$159.00 EA** ⚠

Wall Sign



CHEVYGARALL
Polished stainless steel, laser cut "Chevy Garage" wall sign. 32" x 13" tall. Great for any garage, office or game room. -0.15
\$60.00 EA ⚠

Stools



STOOLB1ALL
Buick Service.
0.000-0.15
..... **\$105.00 EA** ⚠



STOOLB2ALL
Chevy Bowtie.
0.000-0.15
..... **\$105.00 EA** ⚠

Stools, cont.



STOOLB3ALL
Belair w/ backrest.
0.000-0.15
..... **\$150.00 EA** ⚠



STOOLG1ALL
GMC Trucks.
0.000-0.15
..... **\$105.00 EA** ⚠



STOOLO1ALL
Oldsmobile Service.
0.000-0.15
..... **\$105.00 EA** ⚠



STOOLPALL
Chevrolet Parts.
Yellow, red and blue swivel seat.
0.000-0.15
..... **\$105.00 EA** ⚠



STOOLP1ALL
Pontiac Service.
0.000-0.15
..... **\$105.00 EA** ⚠



STOOLPBALL
Chevrolet Parts.
Yellow, red and blue swivel with backrest.
0.000-0.15
..... **\$150.00 EA** ⚠



STOOLSALL
Chevrolet Service stool. Blue and white swivel seat.
0.000-0.15
..... **\$100.00 EA** ⚠

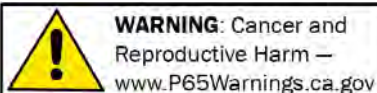

Chemicals shipped domestic ground only (Lower 48 states only). No international shipping.

Phone: (360) 816-0211 • (800) 999-CHEV (2438) • www.chevsofthe40s.com

Stools, cont.



STOOLSBALL

Chevrolet Service. Blue and white swivel seat with backrest. 0.000 -0.15

..... **\$150.00 EA** ⚠️

Car Wash & Cleaners



ADPD001ALL

“Car Shampoo” Adam’s soap, specially formulated Car Wash Soap is pH-balanced

and won’t strip the protective coating off your finish. This soap suds like crazy and is biodegradable. New formula can be used in a foam gun or foam cannon. 16 oz. bottle. 8.800 -0.15

..... **\$11.00 EA** ⚠️



ADPD011ALL

“CARPET & UPHOLSTERY CLEANER”, Adam’s Non-toxic, non-allergenic

cleaner. Contains no soap and will not create suds. 8.800 -0.15

..... **\$13.00 EA** ⚠️



ADPD012ALL

“GLASS CLEANER”, Adam’s Glass Cleaner out performs the competition and you will

love it. 16oz. spray bottle. 8.800 -0.15

..... **\$15.25 EA** ⚠️



ADPD014ALL

“UNDERCARRIAGE SPRAY” Adam’s All Purpose Cleaner. Don’t let ugly, soiled wheel

wells ruin your beautiful detail job! Spray Adams All Purpose Cleaner in your fender wells and give them a good scrubbing with a fender brush. Let the cleaner dwell while you clean the tire and wheel, then give everything a thorough rinsing. After washing, allow to air dry, blow dry or towel dry then spray a light coating of Invisible Undercarriage Spray to all areas of the fender well, then work the product in with an old towel. When you’re finished, your black fender well liners will have a perfect satin black finish. Works great for engine bays too!! 16oz. spray bottle. 8.800 -0.15

..... **\$14.00 EA** ⚠️

Car Wash & Cleaners, cont.



ADPD015ALL

“ALL-PURPOSE CLEANER”, Adam’s heavy duty w/ lemon scent. Tough on dirt but

easy on your car. Cleans wheels, tires, engines, and more. Safely cleans your foam buffing & polishing pads. 16oz. Spray bottle. 8.800 -0.15

..... **\$11.75 EA** ⚠️



ADPDWC16.....ALL

“DEEP WHEEL CLEANER” the ultimate way to remove stubborn brake dust and metallic

contamination from your wheels. Adam’s 36oz. spray. 8.800 -0.15

..... **\$19.25 EA** ⚠️



ADPDWC1GALALL

“DEEP WHEEL CLEANER” the ultimate way to remove stubborn brake dust and metallic

contamination from your wheels. Adam’s 1 Gallon 8.800 -0.15

..... **\$70.00 EA** ⚠️



ADPG001ALL

“CAR Shampoo” Adam’s soap, specially formulated Car Wash Soap is pH-balanced

and won’t strip the protective coating off your finish. This soap suds like crazy and is biodegradable. New formula can be used in a foam gun or foam cannon. 1 gallon. 8.800 -0.15

..... **\$46.75 EA** ⚠️



ADPK002ALL

“ESSENTIALS KIT”. Adam’s Packaged in a clear, 4-1/4 gallon detail bucket with a spin-off, sealable lid which doubles as a stool for detailing. This Kit Includes: Signature high-suds -P-H-neutral car wash soap, Clay bar, Detail spray, V.R.T., Revive Polish, Scratch & swirl remover, Butter wax, 2- Microfiber towels, Applicator pads, Detail sponges & 1 -Plush wash pad. Save money with this kit over buying individual items, While supplies last. 8.800 -0.15

..... **\$199.75 SET** ⚠️

Car Wash & Cleaners, cont.



ADPTID16ALL

“TOTAL INTERIOR DETAILER SPRAY” is your one step solution for a clean, dressed,

and factory looking interior. Adam’s 16 oz. bottle. 8.800 -0.15

..... **\$14.00 EA** ⚠️



ADPTID1GAL.....ALL

“TOTAL INTERIOR DETAILER” is your one step solution for a clean, dressed, and

factory looking interior. Adam’s 1 Gallon. 8.800 -0.15

..... **\$46.75 EA** ⚠️

Paint Sealant Kit



ADPD001PSALL

A blend of specially engineered acrylic polymers and bonding agents make Adam’s

Liquid Paint Sealant an ultra durable surface coating for your car’s finish. The heat and detergent resistant formula bonds with your paint’s surface to form a barrier of lasting protection against the elements as well as producing a bright, reflective shine that’s ideal for your daily driver, show car, or weekend toy. Kit includes a microfiber polishing towel and two microfiber sponge applicator pads. -.15

..... **\$45.00 EA** ⚠️

Wax & Polish



ADPAPW69ALL

“AMERICANA PREMIUM CARNAUBA CAR WAX” Adam’s 6.9 oz tub with applicator pad. 8.800 -.15

..... **\$70.09 EA** ⚠️



ADPD004ALL

“REVIVE HAND POLISH”, removes moderate oxidation, swirl marks, and fading, Adam’s 16

ounces. 8.800 -0.15

..... **\$21.50 EA** ⚠️



Wax & Polish, cont.



ADPD005ALL
 "SWIRL & HAZE
 REMOVER", Adam's
 16 oz. Not a rubbing
 compound and less

abrasive than toothpaste. Gently removes
 scratches from clearcoats and painted
 surfaces. For use by hand or machine. For
 best results, combine with Revive Polish.

8.800 -0.15
 **\$26.00 EA** ⚠️



ADPD006ALL
 "BUTTER WAX",
 Adam's 16 oz. bottle.
 Contains special blend
 of polymers, resins

and natural Carnauba without cleaners
 or abrasives and will not stain plastic or
 rubber. Use Clay Bar and Revive Polish on
 imperfect finishes before applying Butter
 Wax. 12-oz bottle covers many vehicles.

8.800 -0.15
 **\$23.50 EA** ⚠️



ADPD007ALL
 "BRILLIANT GLAZE",
 Adam's 16 oz. bottle.
 Add depth and clarity
 to chrome, glass and

paintwork. Extreme ease of use with ultra-
 high gloss results. Not for use on oxidized
 finishes. 8.800 -0.15

..... **\$29.25 EA** ⚠️



ADPD017ALL
 "FINE MACHINE
 POLISH", Adam's 16
 oz. Polish your car's
 clearcoat to a jewel-like

finish. Designed for application by dual-
 action car polishers. After just one or
 two uses, your clearcoat will have perfect
 clarity so you can enjoy all of the rich
 color below. Use it several times a year to
 maintain perfect gloss, without thinning
 your clearcoat.

To protect your finely polished finish,
 follow up with Machine Super Wax or
 Buttery Wax. Both products will add
 additional gloss, depth and rich color.

8.800 -0.15
 **\$25.00 EA** ⚠️



ADPD018ALL
 "MACHINE SUPER
 SEALANT", Protect your
 paint for months in just
 a matter of minutes.

Easy application and built to last through
 the toughest elements.. 16oz. 8.800 -0.15

..... **\$26.75 EA** ⚠️

Metal Polish



ADPD009ALL
 "METAL POLISH #1"
 Adam's Works on
 stainless, brass, billet,
 chrome, and nickel (for

use on non-clear coated parts). 8.800 -0.15
 **\$23.50 EA** ⚠️



ADPD010ALL
 "METAL POLISH #2",
 Adam's contains no
 abrasives. Highest gloss
 metal polish on the

market w/ effortless application. Keep a
 mirror-like finish on brass, stainless, billet,
 nickel, and chrome. 8.800 -0.15

..... **\$43.00 EA** ⚠️

Dressing & Conditioners



ADPD002LR37-64
 Pumpkin spice scented
 "DETAIL SPRAY",
 Adam's 16 oz. bottle.
 We use this spray

and it works! A waterless car wash, clay
 bar lubricant or to enhance the depth
 and clarity of paint, chrome, plastic,
 aluminum, and glass. Removes dirt,
 smudges and grime, leaving surfaces
 with a smooth, ultra-high gloss finish. Use
 in the sun or shade, and in hot or cool
 temperatures. 8.800 -0.15

..... **\$13.00 EA** ⚠️



ADPD02037-64
 "H2O Guard & Gloss"
 Adam's 16oz spray
 bottle. Delivers
 lasting protection and

unmatched gloss in a unique water-
 activated formula that's fast and easy to
 apply. The patented blend of acrylic resins
 and water activated nano-polymers leaves
 your paint slick and protected. The optical
 grade resins and detergent resistant
 polymers provide months of protection for
 any exterior surface including paint, trim,
 and glass. -0.15

..... **\$17.00 EA** ⚠️

Dressing & Conditioners, cont.



ADPD002ALL
 "DETAIL SPRAY",
 Adam's 16 oz. bottle.
 We use this spray and
 it works! A waterless

car wash, clay bar lubricant or to enhance
 the depth and clarity of paint, chrome,
 plastic, aluminum, and glass. Removes
 dirt, smudges and grime, leaving surfaces
 with a smooth, ultra-high gloss finish. Use
 in the sun or shade, and in hot or cool
 temperatures. 8.800 -0.15

..... **\$15.25 EA** ⚠️



ADPD003ALL
 "V.R.T." RUBBER
 DRESSING, Adam's 12
 oz. bottle. Enhance &
 protect plastic, rubber,

tires, moldings, dashboards and door
 panels. Applies easily with a sponge
 without a greasy film. Adds U.V. protection
 to keep vehicle interiors and exteriors
 looking and feeling like new. 8.800 -0.15

..... **\$23.50 EA** ⚠️



ADPD008ALL
 "LEATHER
 CONDITIONER", Adam's
 Nourish and conditions
 leather upholstery with

this thick, non-greasy cream. Contains
 U.V. blocking agents and will never dry
 your leather. 16 oz. bottle. 8.800 -0.15

..... **\$29.25 EA** ⚠️



ADPD013ALL
 "IN & OUT SPRAY",
 Adam's restores badly
 faded plastic, rubber,
 flat painted surfaces

and AC vents to their original luster and
 shine. 8.800 -0.15

..... **\$16.00 EA** ⚠️



ADPD016ALL
 "TIRE SHINE" Adam's
 Tire Shine gives you a
 Lustrous deep and Long
 lasting Shine or the Wet

look. 8.800 -0.15

..... **\$17.50 EA** ⚠️

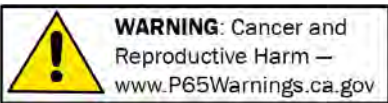

Chemicals shipped domestic ground only (Lower 48 states only). No international shipping.

Phone: (360) 816-0211 • (800) 999-CHEV (2438) • www.chevsofthe40s.com

Dressing & Conditioners, cont.



ADPG002ALL
 "DETAIL SPRAY", Adam's 1 gallon refill. We use this spray and it works! A waterless

car wash, clay bar lubricant or to enhance the depth and clarity of paint, chrome, plastic, aluminum, and glass. Removes dirt, smudges and grime, leaving surfaces with a smooth, ultra-high gloss finish. Use in the sun or shade, and in hot or cool temperatures. 8.800 -0.15

..... **\$44.75 EA** ⚠️



ADPG003ALL
 "V.R.T." RUBBER DRESSING, Adam's 1 gallon refill. Enhance & protect plastic, rubber,

tires, moldings, dashboards and door panels. Applies easily with a sponge without a greasy film. Adds U.V. protection to keep vehicle interiors and exteriors looking and feeling like new. 8.800 -0.15

..... **\$96.25 EA** ⚠️

303 Aerospace Protectant

Keeps UV-sensitive materials "like new" year after year. Gives 100% prevention of UV caused slow-fade with regular use. No other protectant beautifies as intensely, protects as powerfully or lasts as long.



030340ALL
 Used on Rubber, Vinyl, Gelcoat fiberglass, plastics, acrylics, polycarbonates, carbon-fiber resin composites & finished leather.

8.800 -0.15

..... **\$16.00 EA** ⚠️



030370.....ALL
 "303" Aerospace Protectant, "SPF 40" for your auto, 1 gallon refill. 8.800 -0.15

..... **\$73.00 EA** ⚠️

Clay Bar



ADPA001.....ALL
 "CLAY BAR", Adam's removes surface contamination without skid or swirl marks. The large 4-oz bar is suitable for 8-10 vehicles. 8.800 -0.15

..... **\$12.25 EA** ⚠️

Wash Pad



ADPP010ALL
 Adam's 10" Car Wash Pad.

Made of plush synthetic wool to ensure you are washing without introducing new swirls or scratches! -0.15

\$10.00 EA ⚠️

Detail Sponge & Applicators



ADPA003ALL
 Large washable sponge applies a thin, even coat of Adam's Vinyl, Rubber, & Tire (V.R.T.)

without the mess. 4 sponges. 8.800 -0.15

..... **\$11.00 SET** ⚠️



ADPBRSWAB15.....ALL
 "Interior Detailing Swabs", Adam's 15 Pack 8.800 -0.15

..... **\$12.75 SET** ⚠️

ADPBRSWAB6.....ALL
 "Interior Detailing Swabs", Adam's 6 Pack 8.800 -0.15

..... **\$5.75 SET** ⚠️



ADPM001ALL
 Large washable sponge. Adam's 8.800 -0.15

..... **\$11.50 SET** ⚠️



ADPTSPONGE . . .ALL
 Large washable detail sponge. Adam's 8.800 -0.15

..... **\$7.49 SET** ⚠️

Towels

ADPM0010.....37-64
 Adam's microfiber glass cleaning towel. Pairs perfectly with Adam's glass cleaner to leave a streak free surface. (2 Pack) -0.15

..... **\$10.75 EA** ⚠️



ADPM002ALL
 Adams Microfiber Polishing Towel is the softest, safest and most effective polishing

towel on the market. Measuring 16" x 24", the thick yellow towel is ideal for removing polish and Detail Spray. We use two polishing towels for a standard detail. 8.800 -0.15

..... **\$11.75 EA** ⚠️



ADPM008ALL
 Ultra-soft waffle starfiber jumbo microfiber drying towel. 25" x 36". Adam's

8.800 -0.15

..... **\$26.25 EA** ⚠️

Water Blade



ALLWB1ALL
 Dry your car in 1/3 the time! The super soft medical grade silicone blade will never scratch your paint. The original California Water Blade. -0.15

\$12.00 EA ⚠️

Polishing Ball



POWERBALL . . .ALL
 Mother's "PowerBall" Use with your favorite polishing compound/ liquid

on a drill/ screw gun to revitalize metal, plastic and more. 6" dia. 8.800 -0.15

..... **\$32.75 EA** ⚠️



POWERBALLM .ALL
 Mothers "PowerBall Mini" detail polishing ball with 10" extension for hard to reach areas. 3-1/4" dia. 8.800 -0.15

..... **\$26.25 EA** ⚠️



Tire Care

SECTION 010T RESTORATION PARTS

Tire Care

91800.....ALL
Wide White has been developed specifically to aid in restoring and beautifying wide whitewall tires. This cleaner is safe to use on white rubber and is made from environmentally friendly ingredients. Restore your sidewalls to snowy white luster. -0 ... **\$11.00 EA** ⚠



WHITEWIPE.....ALL
Bleach free white wall tire wipes. 7" x 9" wipe. 35 per container. -0 **CALL** ⚠

Duster



DUSTER.....ALL
California cotton duster w/ plastic handle. 8.800 -0.15 **\$15.95 EA** ⚠



DUSTERW.....ALL
California cotton duster w/ wood handle. 8.800 -0.15 **\$21.75 EA** ⚠

Truck Cover

Recommended for inside use only.



306800A.....ALL
Polycotton, 1/2T short bed. 16.550 -0.15 **\$265.00 EA** ⚠

306800T.....ALL
Polycotton, long bed. 16.550 -0.15 **\$280.00 EA** ⚠



306803F.....ALL
Flannel, 1/2T short bed. 16.550 -0.15 .. **\$306.00 EA** ⚠

Truck Cover, cont.

306804F.....ALL
Flannel, long bed. 16.550 -0.15 **\$310.00 EA** ⚠

Truck Cover Accessories



306800B.....ALL
Storage bag. 16.550 -0.15 **\$15.00 EA** ⚠



306800L.....ALL
Lock set. 16.550 -0.15 **\$15.00 EA** ⚠

Plastic Block

Scaled engine. Plastic block w/ steel inserts allow you to bolt on actual parts such as valve covers, exhaust headers, front engine pieces, intake and more. Great for engine/ chassis setup, garage display, education, coffee table, etc. Add harmonic balancer to aid in checking front component clearances.



PAP-2020.....ALL
Chevy SB, long block w/heads. 0.000 -0.15 **\$524.00 EA** ⚠



PAP-2021.....ALL
Chevy SB, short block. 0.000 -0.15 **\$524.00 EA** ⚠



PAP-2041.....ALL
Harmonic balancer for Chevy SB. Mount crank pulley for front end clearance. 0.000 -0.15 **\$56.00 EA** ⚠

Plastic Block, cont.

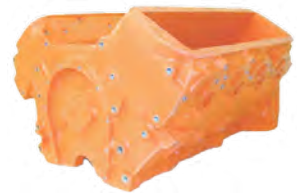

PAP-2120.....ALL
Chevy BB, long block w/heads. 0.000 -0.15 **\$616.00 EA** ⚠



PAP-2121.....ALL
Chevy BB, short block. 0.000 -0.15 **\$431.00 EA** ⚠



PAP-2125.....ALL
Harmonic balancer for Chevy BB. Mount crank pulley for front end clearance. 0.000 -0.15 **\$56.00 EA** ⚠

Auto Accessory

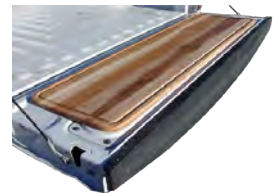

BWTGFPS.....ALL
Tailgate butcher block, 54" X 27" X 1". -0 **\$299.00 EA** ⚠



WARNING: Cancer and Reproductive Harm — www.P65Warnings.ca.gov

Chemicals shipped domestic ground only (Lower 48 states only). No international shipping.

Phone: (360) 816-0211 • (800) 999-CHEV (2438) • www.chevsofthe40s.com

**SECTION 012T
STREET ROD PARTS**

Battery Jump Starter



GB40.....ALL
Compact, yet powerful 1,000 Amp lithium-ion jump starter that delivers 7,000 Joules of starting power. Its patented safety technology features spark-proof technology and reverse polarity protection making it safe for anyone to use. Designed for use with gas engines up to 6 liters and diesel engines up to 3 liters and doubles as a portable power source for recharging smartphones, tablets and more. -0.15
..... **\$128.00 EA** ⚠



GB70.....ALL
The GB70 is a portable lithium-ion battery jump starter pack that delivers 2,000-amps (15,700 J3S) for jump starting a dead battery in seconds. It features a patented safety technology that provides spark-proof connections and reverse polarity protection making safe and easy for anyone to use. It's a powerful battery booster that doubles as a portable power source for recharging USB devices, like a smartphone, tablet and more, or powering 12-volt devices, like a tire inflator, power inverter and much more. And designed for a car, boat, RV, truck and more with gas engines up to 8 liters, and diesel engines up to 6 liters. -0.15
... **\$258.00 EA** ⚠

Genius Battery Chargers



G1100.....ALL
1.1 Amp UltraSafe Smart Battery Charger

Charge fully drained lead-acid and lithium-ion batteries up to 40 amp-hour with zero overcharge - Stay safely connected 24/7.
Ultimate performance and versatility. Charge 6-volt and 12-volt batteries, recover damaged batteries, suitable for micro-hybrid start-stop vehicles and works with CANBUS electrical systems.
Ultra-compact, portable, energy-efficient design that's impact, UV and water-resistant (IP65).
Actively monitors battery for safe and efficient charging. Includes spark-proof technology and reverse polarity protection.
Advanced diagnostics automatically tests and detects a bad, damaged, or shorted battery. -0.15

.. **\$50.00 EA** ⚠



G3500.....ALL
3.5 Amp UltraSafe Smart Battery Charger

Charge fully drained lead-acid and lithium-ion batteries up to 120 amp-hour with zero overcharge - Stay safely connected 24/7.
Ultimate performance and versatility. Charge 6-volt and 12-volt batteries, recover damaged batteries, suitable for micro-hybrid start-stop vehicles and works with CANBUS electrical systems.
Ultra-compact, portable, energy-efficient design that's impact, UV and water-resistant (IP65).
Actively monitors battery for safe and efficient charging. Includes spark-proof technology and reverse polarity protection.
Advanced diagnostics automatically tests and detects a bad, damaged, or shorted battery. -0.15

.. **\$72.00 EA** ⚠

Battery Minder Plus Battery Charger

Features:
Safely charges-maintains-conditions all size/type/brands of starter, deep cycle, maintenance-type, maintenance-free, sealed, gelled, agm or dry-type batteries.
Charges and maintains from 1 to 4 batteries (6 volt) at a time.
Automatically removes (dissolves) harmful sulphation using safe, u.s. patented electronic pulse technology.
Guaranteed to never overcharge any battery, regardless of how long connected.
No need to add water to maintenance-type batteries during long, non-use storage. isolation transformer and smart chip technology ensure safe, long-term performance.
Splash-proof construction.
Allows battery to be stored safely at -0f to +120f.
Unit comes complete with quick connect/disconnect battery clips and a ring terminal assembly (with easily replaceable fuse) for permanent connection.



BM06V.....ALL
6 Volt Charger.
2.332 -0.15
..... **\$60.00 EA** ⚠

Oil Pad

OILPAD..... ALL
Absorbs oil, water, etc. Holds approx 1 gallon (3 ft x 3 ft). 8.821 -0.15
..... **\$16.50 EA** ⚠



OILPAD1.....ALL
Absorbs oil, water, etc. Holds over 1 gallon. (3 ft x 5 ft). 8.821 -0.15
..... **\$22.49 EA** ⚠

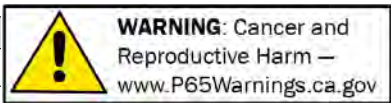

Gas Tank Restoration Kit



PORTANKALL
 Portank, Restore your tanks. Cleaner, metal prep, sealer (Slosh) and instructions. 3.001 -0.15 . . **\$89.00 KIT**

Gas Tank Cleaner

Works fast & makes petroleum-based cleaners nearly obsolete. Can be diluted with water up to 10 times its volume while remaining potent. Removes grease, oil, mildew, algae, musty odors, soap films & wax. Use it to clean canvas, vinyl, nylon, holding tanks, grease traps, auto parts and more.



PORCLEAN.ALL
 1 quart. MARINE-CLEAN cleans and degreases in one application without leaving residues, noxious fumes or flammable solvents. It makes petroleum-

based cleaners almost obsolete because it can be diluted with water up to 3, 4, 5 and even 10 times its volume while remaining more potent than other cleaners. 3.001 -0.15

\$13.25 EA ⚠

Metal Prep

Provides adhesion for POR-15 paint (Sect. 15) on aluminum and shiny polished metal surfaces. Etches metal and leaves a zinc phosphate coating. Non-caustic, non-corrosive, non-toxic & non-flammable.



PORMETALALL
 Etches Metal and Leaves a Zinc Phosphate Coating. Provides the best adhesion for POR-15 on any metal surface. Water based,

OSHA approved biodegradable solution. 3.001 -0.15

\$16.99 QT ⚠

Fuel Stabilizer

Keep fuel fresh. Removes water, cleans carburetors & fuel injectors. Protects engine from gum, varnish, rust, and corrosion. Eliminates need to drain fuel before storage. Special dispenser bottles measure exactly without waste. Contains NO alcohol.



111801ALL
 STA-BIL stabilizer. 8 oz bottle treats 20 gallons, for one year. 3.001 -0 **\$8.25 EA** ⚠



111801BALL
 STA-BIL fuel stabilizer. 32 oz bottle treats 80 gallons, for one year. 3.001 -0.15

\$21.00 EA ⚠

Rust Remover



1001PLALL
 Rust Remover. Works great, is biodegradable and non-caustic. Our shop loves this product. Great for cleaning inside gas tanks. Sold as a concentrate that

makes 3 gallons. 8.800 -0.15

\$30.00 EA ⚠

Rust Preventer



RPM8ALL
 This is liquid Rust Preventative Magic in an 8 ounce tub. The new wax-like product is easy to apply and will protect bare metal from rusting. It will not reverse rust or remove it, so you will need to sandblast or glass bead any rusty parts clean first. -0.15

\$35.09 EA ⚠

Brake Cleaner



6129423ALL
 Superior cleaner. Many uses (spray can). APPLICATIONS: ABS, disc, drum, brake cylinders, brake drums, brake linings, brake shoes, calipers, clutch discs, disc brake

pads, discs. Safe for use on all brake systems including: Springs & Wedge brakes.

4.683 -0.2

\$4.00 EA ⚠

Brake Fluid



5450285BALL
 Master "Fade Free" DOT 4 (12 oz). 4.683 -0.15

\$7.00 EA ⚠



603486BALL
 Mac's, DOT 5, silicone. Less corrosion. 12 ounce bottle. 4.683 -0.15

\$10.25 EA ⚠

Adhesives & Sealers



01608ALL
 3M plastic & emblem adhesive (5 oz. tube).

8.800 -0.15

\$10.00 EA ⚠



1015BPALL
 Gasket sealer, high temp silicone. Black (3.35 oz tube). 8.800 -0.15

\$9.75 EA ⚠

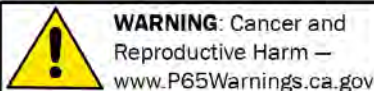

Chemicals shipped domestic ground only (Lower 48 states only). No international shipping.

Phone: (360) 816-0211 • (800) 999-CHEV (2438) • www.chevsofthe40s.com

Section 012T: Tools, Adhesives, Brake Fluid, Gas Tank Prep & Sealer, Carburetor & Brake Cleaners and Polishers

Adhesives & Sealers, cont.



306105ALL
Super Glue Gel.
Bonds to ABS,
Ceramic, cork,G10
Epoxy Glass, Leather
and paper. Splice
window gaskets &
sponge weather strip
& more. 8.800 -0.15

..... **\$3.25 EA** ⚠



306106ALL
LOCTITE Super Glue,
Ultra Gel Control.
Bonds to Metal,
Rubber, Ceramics,
Wood, Leather,
Paper & Plastics.
Rubber to metal &
rubber to rubber
bonding. Splice

window gaskets & sponge weather strip &
more. 8.800 -0.15

..... **\$6.50 EA** ⚠



511113ALL
Quality Spray
adhesive for bowdrill
cloth. Best product
available for all
interior trim. (14 oz.
spray can). 8.800 -0.2

..... **\$21.69 EA** ⚠



511114.ALL
3M, Black weatherstrip cement, 5-oz tube.
Superior product!. 8.800 -0.2

\$20.00 EA ⚠



986199AALL
3M Contact
cement for rubber
to metal. Bonds
instantly. Industrial
quality for gravel
guards, running
board rubber, etc.
8.800 -0.15

..... **\$63.25 QT** ⚠

GL14.ALL
Windshield sealer. Seals leaks in new &
old installation. Will not dry out rubber.
Remains pliable. 8.991 -0.15

..... **\$7.25 EA** ⚠

Adhesive Remover



3M8987ALL
Specially blended
solvent for removal of
light paint overspray,
adhesive residue, wax,
grease, tree sap, dirt, road tar, oil and
bugs in aerosol form. -0.15

..... **\$19.75 EA** ⚠

Safety Wire Pliers



R809.ALL
Safety Wire Pliers - 9". -0.15 . **\$33.50 EA**
⚠

Gas Tank Sealer



3657942CALL
Gas tank sealer slosh,
seals gas tank. Alcohol
and Ethanol proof.
Not for use with (MEK)
Methyl Ethyl Ketone. 3.001 -0.15

..... **\$32.25 QT** ⚠

SECTION 012T RESTORATION PARTS

Tools



4088134A.ALL
Installs door handle
ferrules. Return tool
in same condition
as sent for a \$20
refund. Does not
fit with 4125630
10.537 -0.15

..... **\$46.00 EA** ⚠

Lubricator & Bolt Loosener



PBLASTER.ALL
Powerful rust
inhibitor, bolt
loosener/
penetrant. -0.15

... **\$12.25 EA** ⚠

Clutch Head Socket Set



CHSS-4ALL
4 pc. 3/8 Drive 8.821 -0.15
..... **\$19.75 SET** ⚠

Clutch Head Driver W/ Bits



DRIVER.ALL
Magnetic clutch head driver, Chev's
imprint. w/ 5 bits (1/8 in., 5/32 in., 3/16
in., 1/4 in., 5/16 in.) 8.821 -0 . **\$22.25 SET**
⚠

Clutch Head Bits

3685592.ALL
Clutch head bit 5/32 in.
(1/4 in. drive) 8.821 -0.4
..... **\$5.00 EA** ⚠

3685593.ALL
Clutch head bit 1/4
(1/4 in. drive) 8.821 -0.4
..... **\$4.75 EA** ⚠

3685594.ALL
Clutch head bit 3/16 in.
(1/4 in. drive) 8.821 -0.3
..... **\$2.75 EA** ⚠

3685595.ALL
Clutch head bit 5/16 in.
(1/4 in. drive) 8.821 -0.2
..... **\$8.50 EA** ⚠

3685598.ALL
Clutch head bit 1/8 in.
(1/4 in. drive) 8.821 -0.15
..... **\$2.50 EA** ⚠

Clutch Bit Holder

3685596.ALL
Clutch bit holder for
your 1/4 in. drive
ratchet. Holds clutch
head bits. 8.821 -0.2

..... **\$7.00 EA** ⚠

Tool Bag



986362.....ALL
 Tool bag. Superb reproduction w/ pictures of tools which may be found at swap meets. 13-5/8" x 6". 8.821 -0.15
\$22.00 EA ⚠

Engine, Drivetrain Tools



3835222637-53
 Tool used to align oil dipper troughs in pan (\$375 refundable deposit upon return of tool) 1.427 -0.15 .. starting at **\$450.00 Rent**
 ⚠



595005A37-54
 Drive shaft bushing puller to rent (return in original condition for \$20.00 refund). 5.451 -0.15 **\$75.00 EA** ⚠



838956AALL
 Tool to align clutch disc. 0.866 -0.3
\$6.75 EA ⚠

Body Tools



3847415T.....42-54
 Inserts back glass rubber lock strip. 16.469 -0.2 **\$55.00 EA** ⚠



010351.....ALL
 Removes mouldings (Amazing!) 8.821 -0.15
\$18.50 EA ⚠

Body Tools, cont.



01832.....ALL
 To install windshield & back window rubber (exc 41-48 w/ mouldings) 8.821 -0.15
\$17.00 EA ⚠



WELDCLAMPALL
 Clamps two pieces of metal together for welding. -0.15 **\$23.50 SET** ⚠

Interior Tools



4173376A49-65
 Sets vent window pivot pin. 10.669 -0.15
\$5.00 EA ⚠

Stainless Steel Tubing



SSTUBING.....ALL
 304 seamless tubing in 1/2", 5/8" & 3/4" O.D. Can be cut to length. Total lengths up to 20 ft sticks (oversize shipping on long lengths). -0 starting at **\$10.00 FT** ⚠

Battery Terminal Cleaner



10653CLNR ... ALL
 For Top Post Batteries. -0.15
\$9.25 EA ⚠

Carburetor Cleaner



6505259.....ALL
 Gumout, 16 oz spray can. Cleans carburetors, linkage, choke valves and unpainted metal parts. 3.725 -0.15
\$5.25 EA ⚠

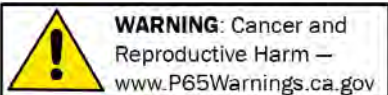

**SECTION 015T
STREET ROD PARTS**

POR-15 Rust Preventative Paint



POR-15QT.....ALL
1 quart. POR-15 Rust-preventative coating applied directly over rusted or seasoned metal surfaces. Dries as rock hard, nonporous finish that won't chip, crack or peel. Prevents rust from reoccurring. Choose Black, Semi-Gloss Black, Grey, Silver or Clear. 8.800-0.15 **\$48.50 QT** ⚠

Sound Deadener-Thermal Protection



8.800-0.15

DEADENERALL
Engineered for the interior & exterior side of body panels. 200% decrease in noise & vibration. Bonds to metal, fiberglass & wood. Covers 30 sq. ft.

\$85.00 GALLON ⚠



SPRAYGUN.....ALL
Spray gun. Siphon-feed spray gun for DEADENER.

8.800-0.15

\$89.25 EA ⚠



VB-1SPROALL
For exterior automotive panels such as inside fender wells, wheel arches and underside of the floor pan. Converts structural resonance and vibration into

low level heat through friction. It remains soft which allows it to absorb the impact of road debris. (NOTE: Only apply to exterior surfaces due to prolonged outgassing). 18 oz. aerosol can. Covers 4 sq. ft. 8.800-0.15

\$14.50 EA ⚠

Zero Rust Paint



511112C.....ALL
Satin black w/ rust inhibitors. Use on core supports, inner fender panels, etc. (12 oz. spray). Match to GM satin black. 8.800-0.15

\$20.50 EA ⚠

POR-15 Rust Paint Solvent



POR-15QTSLV . .ALL
Thinner. Use for easy cleanup or thinning of POR-15 paint.

8.800-0.15

\$15.75 QT ⚠

VHT Hi-Temp Engine Enamel



986959B.....ALL
VHT Hi-Temp Gloss Black Engine enamel (11 oz. spray can). 8.800-0.15

\$10.75 EA ⚠



986959FB.....ALL
VHT Hi-Temp Flat Black Engine enamel (11 oz. spray can). 8.800-0.15

\$9.00 EA ⚠



986959O.....ALL
VHT Hi-Temp Chevy Orange enamel (12 oz. spray can). 8.800-0.15

\$12.00 EA ⚠



986959R.....ALL
VHT Hi-Temp Universal Red Engine enamel (11 oz. spray can). 8.800-0.15

\$14.00 EA ⚠

VHT Hi-Temp Engine Enamel, cont.



986959SB....ALL
VHT Hi-Temp Chevy GM Satin Black Engine enamel (11 oz. spray can). 8.800-0.15

\$12.00 EA ⚠



986959UA....ALL
VHT Hi-Temp Universal Aluminum Engine enamel (11 oz. spray can). 8.800-0.15

\$10.49 EA ⚠

Exhaust Paint

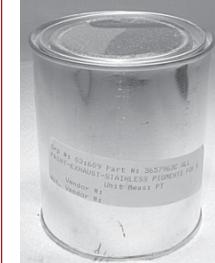

3657963C....ALL
Exhaust paint stainless steel pigments. For exhaust manifolds & pipes. Gives a soft grey, metallic finish. Pint 3.609-0

CALL ⚠



3657963E....ALL
Exhaust paint clear, high temp (1200 degree) for exhaust etc, 11 oz spray can. 3.609-0.15

\$15.00 EA ⚠



3657963FA....ALL
Exhaust paint very high temp, flat aluminum for manifolds & pipes. 11 oz spray can. 3.609-0.15

\$15.00 EA ⚠

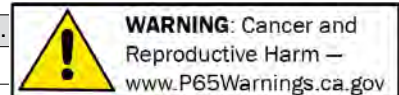

Cast Blast Paint



3657963DALL
Cast blast paint high temp 1200 degree. Grey, fresh cast look for exhaust manifolds, etc. Rust preventative, 11 oz spray can. 3.609 -0.15

..... **\$12.50 EA** ⚠



3657963FALL
Grey cast color paint, For non high heat applications. Gives fresh cast look. Rust preventative, 11 oz spray can. 3.609 -0.15

..... **\$6.75 EA** ⚠

Inner Fender Panel Paint



511112DALL
Flat black spray paint for use on core supports and inner fender panels. 8.800 -0.15

..... **\$11.00 EA** ⚠

SECTION 015T RESTORATION PARTS

Clear Coat Paint



10200ZALL
Gloss Clear Coat For Bare Metal Surfaces. Great for use on polished metal to keep the shine. 8.800 -0.15

..... **\$17.25 EA** ⚠

Engine Paint



986959A29-52
Engine Grey. Reduce using Xylene (max of 15%). 8.800 -0.15

..... **\$40.00 QT** ⚠

Engine Paint, cont.



986959S29-52
Chevy Engine Grey hi-temp (16 oz. spray can). Color has been tested and is correct. 8.800 -0.15

..... **\$25.25 EA** ⚠



986970G37-46
Engine (olive) GMC 8.800 -0.15

..... **\$56.75 QT** ⚠



986970M47-59
Engine (red orange) GMC 8.800 -0.15

..... **\$63.75 QT** ⚠



986970A53-62
Engine Blue 8.800 -0.15

..... **\$56.75 QT** ⚠



986970S53-62
Chevy Engine Blue (12-3/4 oz. spray can). 8.800 -0.15

..... **\$25.00 EA** ⚠

Carburetor Paint



12910ALL
Carburetor renew, bronze (5 oz. spray can) 8.800 -0

..... **\$19.00 EA** ⚠

Carburetor Paint, cont.



12911ALL
Carburetor renew, silver (5 oz. spray can) 8.800 -0.15

..... **\$21.25 EA** ⚠

Cab Interior Paint



604481P40-46
Beige hammertone-for cab interior (thin w/ enamel thinner) 16.080 -0

..... **CALL** ⚠



3693291P47-53
Semi flat brown, slight metallic for cab interior. Acrylic enamel (thin w/ enamel thinner). 16.080 -0

..... **CALL** ⚠



3700359P47-54
Pulsar grey, for cab interior, 47-54 Panel & Suburban 54 deluxe cab, interior enamel 16.080 -0.15

..... **\$57.50 QT** ⚠



985734S54
Pearl beige for interior of cab. 16.080 -0.15

..... **\$57.50 QT** ⚠

Battery Tray Paint



12998ALL
Battery tray Corrosion resistant, black (12 oz spray). 8.800 -0.15

..... **\$10.25 EA** ⚠



WARNING: Cancer and Reproductive Harm — www.P65Warnings.ca.gov

Chemicals shipped domestic ground only (Lower 48 states only). No international shipping.

Phone: (360) 816-0211 • (800) 999-CHEV (2438) • www.chevsofthe40s.com

Heater Paint



604481P 42-46
 Heater beige
 hammer-tone (thin
 w/ enamel thinner).
 16.080 -0
 **CALL** ⚠

Inner Fender Panel Paint



511112 ALL
 Zero Rust Inner
 fender panel satin
 black-also great
 for core supports.
 (quart) 8.800 -0.15
 **\$40.00 QT** ⚠

Hub Caps & Trim Paint



306505 ALL
 Black, for hub caps
 & trim (special
 lettering enamel)
 1/2 pint 8.800 -0.15
 **\$27.00 EA** ⚠



306553 ALL
 Blue, for hub caps &
 trim (special
 lettering enamel).
 1/2 pint. 8.800 -0.15
 **\$30.00 EA** ⚠



306567 ALL
 Red, for hub caps
 & trim (special
 lettering enamel)
 1/2 pint 8.800 -0.15
 **\$36.25 EA** ⚠



1937 1/2-ton — David Faller

 **WARNING:** Cancer and Reproductive Harm — www.P65Warnings.ca.gov

Engine Cylinder Head and Manifolds

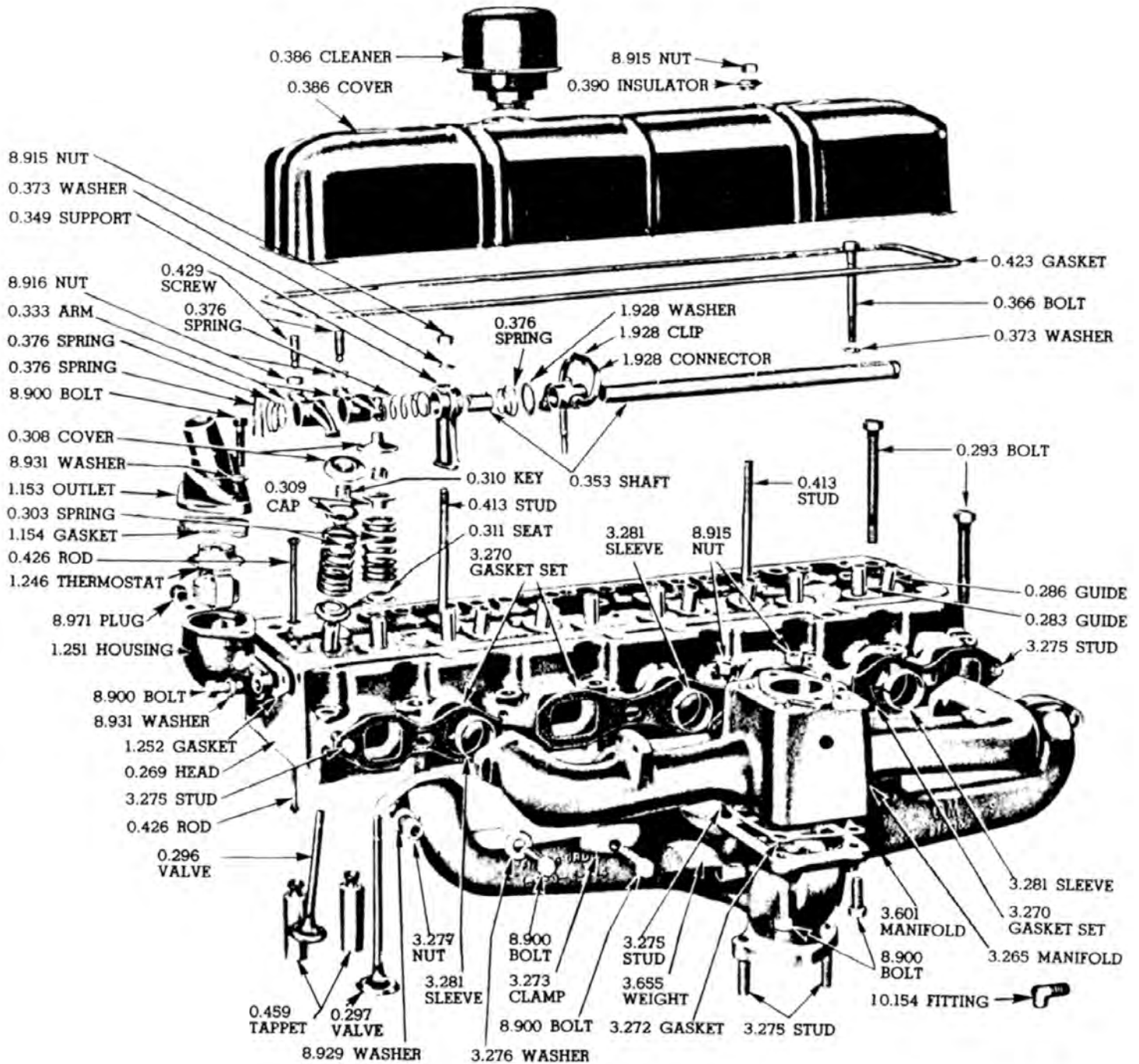

WARNING: Cancer and Reproductive Harm — www.P65Warnings.ca.gov

Chemicals shipped domestic ground only (Lower 48 states only). No international shipping.

Phone: (360) 816-0211 • (800) 999-CHEV (2438) • www.chevsofthe40s.com

Section 020T: Engine Kits

Engine ID Chart

Model Year	216 CU Inch Numbers	Block Numbers
1937	1 – 1187821	838101 838710
1938	1187822 – 1915446 B1 – B10502	838710
1939	1915447 – 2697267 B10503 – B105461	838941
1940	2697268 – 3665902 B105462 – B221935	839400
1941	AA 1001 – AA AC 1001 – AC 19549	1163720 839400
1942	2AA, 2AC, BA	839770
1946	DA	839770
1947	EA	839770
1948	FA	3835253
1949	GA	3835253
1950	AHCA, AHCM, BHCA, BHCM, HAA, HAM, HAC, HAP, HBA, HBM, HCA, HCM, HCD, HCQ	3835497
1951	AJCA, AJCM, BJCA, BJCM, JAA, JAM, JAC, JAP, JBA, JBM, JCA, JCM, JCD, JCQ	3835497
1952	AKCA, AKCM, BKCA, CKCM, KAA, KAM, KAC, KAP, KBA, KBM, KCA, KCM, KCD, KCQ	3835849
1953	ALCC, ALCP, BLCC, BLCP, LAG, LAT, LAJ, LAV, LBA, LAM, LCA, LCM, LCC, LCP, LCD, LCH, LCU	3835849

Model Year	235 CU Inch Prefixes	Block Numbers
1941	AG, AL	3660439
1942	BG, BL	839751
1946	BG, BL—1st design	839751
1946	DDA, DDM, DEA, DEM—2nd design	839751
1947	EDA, EDM, EEA, EEM	3835335
1948	FDA, FDM, FEA, FEM	3835309
1949	GDA, GDM, GEA, GEM	3835309
1950	HDA, HDM, HEA, HEM	3692703
1951	JDA, JDM, JEA, JEM	3692703
1952	KDA, KDM, KEA, KEM	3835692

Model Year	235 CU Inch Prefixes	Block Numbers
1953	LDA, LDM, LEA, LEM, LAA	3701946 3701483
1954	T54 or F54 followed by: L, LA, M, MA, MB, N, P, Q, R, S, T, TA, U, UA, UB, X, XZ, XB, Y, YE, YG, Z, ZC, ZE, ZH	3701481
1954	Except 53 ST	3701481
1954	First series	3733949
1955	Through 4/1/56	3836233

Model Year	261 CU Inch Engine Block	Block Numbers
1954–55	First series	3702436 3703414
1956	All	3836340
1957	All	3836340
1955–57	All	3836340
1958	All	3836340
1959	All	3759365
1960–62	All	3769923

Note: The 235 cu. in. engine can be distinguished from the 216 engine by the engine serial number prefix as follows:

1941	AG or AL
1942	BG or BL
1946	BG or BL (First Design)
1946	DDA, DDM, DEA, or DEM (Second Design)
1947	EDA, EDM, EEA, or EEM
1948	FDA, FDM, FEA, or FEM
1949	GDA, GDM, GEA, or GEM
1950	HDA, HDM, HEA, or HEM
1951	JDA, JDM, JEA, or JEM
1952	KDA, KDM, KEA, or KEM
1953	LDA, LDM, LEA, or LEM



WARNING: Cancer and Reproductive Harm – www.P65Warnings.ca.gov

Chemicals shipped domestic ground only (Lower 48 states only). No international shipping.

Phone: (360) 816-0211 • (800) 999-CHEV (2438) • www.chevsofthe40s.com

**SECTION 020T
RESTORATION PARTS**

Oversize shipping charges apply. Please call for rate.

Engine Kit

When ordering: SPECIFY exact year and size of engine (216ci, 235ci or 261ci), HYDRAULIC or solid lifters, standard or exact oversize of rod, main bearings, pistons and rings. Also SPECIFY stick shift or powerglide.

Call for availability of pistons & bearings before boring block or having crank turned.

MEK1 Engine Kit

MEK1 contains all parts necessary to overhaul a complete short block assembly. Including: Rods machined for insert bearings, rod bearings, main bearings, pistons with pins, piston rings, new camshaft, lifters, cam bearings, timing gears, full gasket set, soft plugs, plastigauge, oil pump, bolt boots & block sealant lube (1937-39 includes pushrods). *Assembly lube no longer included.

- MEK139** **.37-39**
216. Includes pushrods, does not include oil pump 0.001 -0.15
..... **\$1,600.00 KIT** ⚠
- MEK140** **40**
216 0.001 -0.15
..... **\$1,845.00 KIT** ⚠
- MEK147** **.41-47**
216 0.001 -0.15
..... **\$1,845.00 KIT** ⚠
- MEK153** **.48-53**
216 0.001 -0.15
..... **\$1,475.00 KIT** ⚠
- MEK162** **.53-62**
235. Except 53 stick 0.001 -0.15
..... **\$1,300.00 KIT** ⚠

EK Engine Kit

EK contents are same as MEK1 except w/ out pistons/rings & converted rods.

- EK39** **.37-39**
Includes pushrods 0.001 -0.15
..... **\$750.00 KIT** ⚠
- EK47** **.40-47**
This is an engine kit. (EK)

The kit contains:
Rod bearings (specify size)
Cam bearings
camshaft
Lifters
Timing gears
Full gasket set
Soft plug set
Plastigauge (used to measure bearing tolerances)
Bolt boots (go on rod bolts to protect crank)

- 0.001 -0.15
..... **\$825.00 KIT** ⚠
- EK53** **.48-53**
Except 53 Powerglide 0.001 -0.15
..... **\$895.00 KIT** ⚠
- EK62** **.53-62**
Except 53 stick 0.001 -0.15
..... **\$675.00 KIT** ⚠
- EK58** **.54-58**
For solid lifter 261ci 0.001 -0.15
..... **\$715.00 KIT** ⚠

RRK Re-Ring Kit

RRK contains: Rod bearings, piston rings, full gasket set, plastigauge, assembly lube & bolt boots.

- RRK39** **.37-39**
This is an piston re-ring kit (RRK) that includes:
Full gasket set
Rod bearings (choose size, std. to .060)
Piston rings (choose size)
Bolt boots for rod installation (protect crank)
Plastigauge (for measuring bearing tolerances)
Assembly Lube 0.001 -0.2
..... **\$625.00 KIT** ⚠
- RRK53** **.40-53**
Except 53 Powerglide 0.001 -0.4
..... **\$625.00 KIT** ⚠
- RRK62** **.53-62**
Except 53 stick 0.001 -0.3
..... **\$625.00 KIT** ⚠

RRK3 (Re-Ring Kit w/ Main Bearings)

RRK3 contents are same as RRK except main bearings are included.

- RRK339** **.37-39**
This is an RRK3 piston re-ring kit that includes:

Full gasket set
Rod bearings (choose size)
Main bearings (choose size)
Piston rings (choose size)
Bolt boots for rod installation (protect crank)
Plastigauge (for measuring bearing tolerances)
Assembly Lube
0.001 -0.4

- **\$625.00 KIT** ⚠
- RRK347** **.40-47**
This is an RRK3 piston re-ring kit that includes:

Full gasket set
Rod bearings (choose size)
Main bearings (choose size)
Piston rings (choose size)
Bolt boots for rod installation (protect crank)
Plastigauge (for measuring bearing tolerances)
Assembly Lube
0.001 -0.4

- **\$625.00 KIT** ⚠
- RRK353** **.48-53**
Except 53 Powerglide 0.001 -0.4
..... **\$625.00 KIT** ⚠
- RRK362** **.53-62**
Except 53 stick 0.001 -0.4
..... **\$625.00 KIT** ⚠

CLK (Cam & Lifter Kit)

CLK contains: Reground camshaft, lifters & timing cover gasket set.

- CLK39** **.37-39**
Solid lifter w/ pushrods 0.001 -0.15
..... **\$283.75 KIT** ⚠
- CLK53** **.40-53**
Solid lifter exc 53 Powerglide 0.001 -0.15
..... **\$315.00 KIT** ⚠
- CLK62** **.53-62**
Hydraulic lifter exc 53 stick 0.001 -0.15
..... **\$360.00 KIT** ⚠
- CLK58** **.54-58**
Solid lifter. 0.001 -0.15
..... **\$300.00 KIT** ⚠



Section 020T: Engine Kits

CLK3 (Cam, Lifter Kit & Timing Gears)

CLK3 contents are the same as CLK except timing gears are included.

CLK339 **37-39**
Solid lifter w/ pushrods 0.001 -0.15
..... **\$425.00 KIT** ⚠

CLK353 **40-53**
Solid lifter exc 53 Powerglide 0.001 -0.15
..... **\$450.00 KIT** ⚠

CLK362 **53-62**
Hydraulic lifter exc 53 stick 0.001 -0.15
..... **\$350.00 KIT** ⚠

CLK358 **54-58**
Solid lifter. 0.001 -0.15
..... **\$375.00 KIT** ⚠

PRK (Piston & Ring Kit)

PRK contains: Pistons with pins and piston rings.

PRK40 **37-40**
Domed piston 0.001 -0.15
..... **\$341.00 KIT** ⚠

PRK53 **41-53**
216ci 0.001 -0.15
..... **\$312.00 KIT** ⚠

PRK62 **41-62**
235ci (exc 53 Powerglide) 0.001 -0.15
..... **\$288.00 KIT** ⚠

PRK61 **54-62**
261ci 0.001 -0
..... **\$353.00 KIT** ⚠

SECTION 022T RESTORATION PARTS

Note: Pilot bearing bushing see Section 140T.

Note: Engine electrical see Section 40T, 45T & 50T.

Note: Fuel pump & carburetor see Section 120T.

Note: Pilot bearing bushing see Section 140T.

Valve & Rocker Cover Set



3836614S **50-62**
235ci chromed side cover & valve cover w/ breather cap and gaskets. Excellent finish. 0.386 -0 **\$116.00 SET** ⚠

Valve Cover



3686784C **37-53**
Chrome 1937-53 Chevy 216 6-cyl Valve Cover - Un baffled. -0.15 . **\$46.75 EA** ⚠

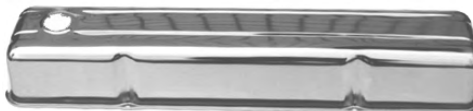

R9107 **50-62**
Chrome 1950-62 Chevy 235 6-cyl Valve Cover - Un baffled. -0.15 . **\$52.75 EA** ⚠

Finned Valve Cover



3686784F **37-62**
Finned aluminum valve cover for 216 & 235. -0 **\$279.75 EA** ⚠

Finned Valve Cover, cont.



3686784FP **37-62**
Finned polished aluminum valve cover for 216 & 235. -0 **\$389.00 EA** ⚠

Offenhauser Valve Cover



36867840 **37-53**
Offenhauser Ribbed for 216ci. Polished aluminum valve cover. 0.386 -0.15 **CALL** ⚠



38366140 **37-62**
Offenhauser Ribbed for 235ci. Polished aluminum valve cover. 0.386 -0.15 **\$299.00 EA** ⚠

Wayne Valve Cover



3686784W **37-62**
"Wayne" Finned aluminum cover. Superb reproduction w/ breather cap and stud kit. 0.386 -0 **CALL** ⚠

Side Covers Chevy Six Cylinder



3701541F **50-62**
Finned plain aluminum side cover. Fits 235ci-261ci. 0.439 -0 .. **\$219.50 EA** ⚠



WARNING: Cancer and Reproductive Harm —
www.P65Warnings.ca.gov

Chemicals shipped domestic ground only (Lower 48 states only). No international shipping.

Phone: (360) 816-0211 • (800) 999-CHEV (2438) • www.chevsofthe40s.com

Side Covers Chevy Six Cylinder, cont.



3701541FP **50-62**
Finned polished aluminum side cover. Fits 235ci-261ci. 0.439-0 .. **\$299.00 EA** ⚠

37015410F **50-62**
Offenhauser Finned polished aluminum side cover. Fits 235ci-261ci. -0 **\$299.00 EA** ⚠

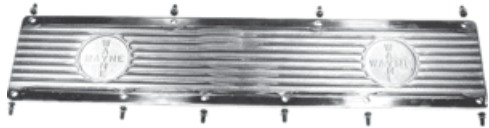

3701541W **50-62**
"Wayne" Finned aluminum side cover. Superb reproduction, fits 235ci-261ci. 0.439-0 **CALL** ⚠



R9108 **ALL**
Chrome 1950-62 Chevy 235 6-cyl Side Plate. -0.15 **\$33.75 EA** ⚠

Valve Cover Grommets



838083 **34-53**
2 pcs 0.413 -0.15 **\$4.75 PR** ⚠

Valve Cover Acorn Nut



131502 **29-53**
Stainless 8.915 -0.3 **\$6.50 PR** ⚠



131502C **29-53**
Chrome 8.915 -0.15 **\$4.00 PR** ⚠



131502P **29-53**
Polished stainless 8.915 -0.15 **\$13.00 PR** ⚠

Valve Cover Hardware Aftermarket



838083B **37-62**
Studs, washers & nuts for Wayne or Offy valve cover 0.413 -0.15 **\$20.75 SET** ⚠

8380830TB **37-62**
Studs, washers & acorn nuts for OTB valve cover 0.413 -0 **\$39.25 SET** ⚠

Valve Cover Breather



OTB-6810FP **37-62**
Finned Polished Aluminum 90 Degree Mount -0 **\$95.00 EA** ⚠



OTB-6811F **37-62**
Finned Aluminum 90 Degree Mount -0 **\$79.00 EA** ⚠



OTB-6801 **ALL**
Finned polished aluminum. 1" dia. neck for 1-1/4" hole using a rubber grommet. -0.15 **\$55.00 EA** ⚠



OTB-6805 **ALL**
Finned polished aluminum. For use with Offenhauser or Wayne valve covers -0.15 **\$52.25 EA** ⚠

Oil Fill Cap



OTB-6152FP **37-62**
Finned Polished Aluminum Oil Cap 2-5/8" Dia 1" Tall -0 **\$38.00 EA** ⚠



OTB-6153F **37-62**
Finned Aluminum Oil Cap 2-5/8" Dia 1" Tall -0 **\$30.00 EA** ⚠



3835665 **46-57**
Breather on rocker cover, replacement. 0.386 -0.3 **\$8.50 EA** ⚠



6150SP **ALL**
Valve cover Sprocket Polished Oil Cap Polished Diameter - 3". Height - 1-1/8". -0 **\$47.00 EA** ⚠



6151S **ALL**
Valve cover Sprocket Unpolished Oil Cap Polished Diameter - 3". Height - 1-1/8". -0 **\$35.00 EA** ⚠

Gasket Oil Fill Cap



836446 **31-48**
Oil Fill Cap Gasket. Exc 48 3/4T & larger 1.517 -0.2 **\$2.25 EA** ⚠

Cylinder Head Bolts



3837543 **34-62**
Long - Used 0.293 -0.15 **\$4.00 EA** ⚠

3837544 **37-62**
Short 0.293 -0.4 **\$4.75 EA** ⚠

Rocker Assembly

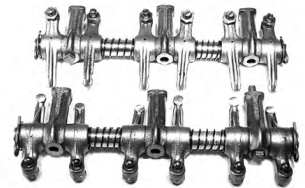

838244B **37-39**
Fits 216ci (\$100 core) 0.352 -0.15 **\$340.00 PR** ⚠

609925 **40**
Fits 216ci (\$100 core) 0.352 -0.15 **\$295.50 PR** ⚠

609924 **41-53**
Fits 216ci (\$50 core) 0.352 -0.15 **\$335.00 PR** ⚠

3729191 **50-58**
235ci (\$100 core) 0.352 -0.15 **\$365.00 PR** ⚠

Rocker Arm Shaft



839592 **40-58**
Requires 2 0.353 -0 **\$50.25 EA** ⚠

Rocker Arm



837385B **34-54**
Adjusting screw & nut. 0.429 -0.15 **\$15.00 EA** ⚠

Valve

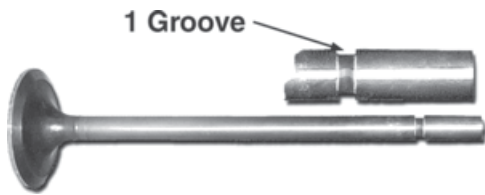

- 838437** **35-40**
Intake 0.296 -0.15 **\$15.50 EA** ⚠
- 838717** **35-40**
Exhaust (1 groove) 0.297 -0.4 **\$15.50 EA** ⚠
- 3835318** **41-49**
Exhaust (2 groove)
Note: replaces 839412 single groove. Must use 3835392 cap and 3835333 seal. 0.297 -0.15 **\$33.75 EA** ⚠
- 839504** **41-49**
Intake (1 groove) 0.296 -0.4 **\$15.50 EA** ⚠

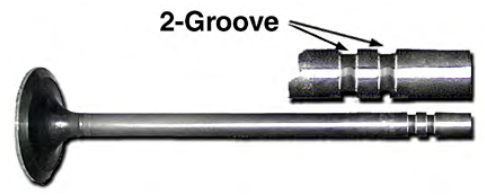

- 3688065** **41-53**
Intake (2 groove) exc 50 & later 235ci. 0.296 -0.2 **\$20.00 EA** ⚠
- 3835608** **41-53**
Exhaust exc 50 & later 235ci (2 groove) 0.297 -0.15 **\$15.49 EA** ⚠
- 3835519** **50-52**
Intake, 235ci only (1 groove). 0.296 -0.3 **\$15.50 EA** ⚠
- 3683569** **50-62**
Exhaust, 216 1950-1953, 235 1950-1962 (2 grooves). 0.297 -0.4 **\$16.25 EA** ⚠
- 3835910** **53-62**
Intake, 235ci only (2 grooves). 0.296 -0.15 **\$17.00 EA** ⚠

Valve Springs



- 3835626** **28-52**
216ci engines 0.303 -0.15 **\$4.75 EA** ⚠
- 3704142** **53-58**
235ci & 261ci engines 0.303 -0.2 **\$6.50 EA** ⚠

Valve Spring Cap



- 837264N** **35-42**
Valve spring cap (NOS) 0.309 -0.15 **\$2.00 EA** ⚠
- 837624** **35-47**
Inlet (set of 6) 0.309 -0 **CALL** ⚠
- 3835392N** **47-48**
Valve Spring Cap (NORS) 0.309 -0.2 **\$2.50 EA** ⚠

Valve Stem Locks



- 838029** **34-57**
Key (12 pcs) 0.310 -0.2 **\$5.75 SET** ⚠

Valve Seats



- 3688065A** **38-52**
Intake exc 50-52 235ci 0.296 -0.3 **\$9.00 EA** ⚠
- 3835318A** **38-52**
Exhaust exc 50-52 235ci 0.297 -0.3 **\$6.25 EA** ⚠
- 3683569A** **50-52**
Exhaust 235ci 0.297 -0.15 **\$10.00 EA** ⚠
- 3835519A** **50-62**
Intake 235ci 0.296 -0.3 **\$6.75 EA** ⚠
- 3683569B** **53-62**
Exhaust 235ci 0.297 -0.15 **\$5.00 EA** ⚠

Valve Guide



- 3688758** **38-40**
Intake 0.283 -0.15 **\$6.39 EA** ⚠
- 3688759** **38-40**
Exhaust 0.283 -0.15 **\$7.50 EA** ⚠
- 3688761** **41-62**
Exhaust 0.283 -0.4 **\$6.25 EA** ⚠

Valve Guide, cont.

- 3708168** **41-62**
Intake 0.283 -0.3 **\$6.75 EA** ⚠

Valve Seals



- 3835333** **38-57**
12 pcs 0.308 -0.3 **\$6.00 SET** ⚠

Lifters



- 838774** **29-39**
Solid 0.459 -0.15 **\$12.25 EA** ⚠
- 839263A** **37-55**
Solid, NOS original 40-55 (37-39 must be used w/ pushrods #3835776) 0.459 -0.15 **\$17.50 EA** ⚠



- 5230850** **50-58**
Hydraulic, w/ Powerglide 0.459 -0.15 **\$16.25 EA** ⚠

Pushrods



- 3835776** **37-53**
10-1/4". Fits 216ci, 37-39, use w/ lifter #839263 0.426 -0.2 **\$9.00 EA** ⚠
- 3836261** **41-55**
10-5/8". All 235ci exc Powerglide 0.426 -0.4 **\$15.50 EA** ⚠
- 3835777** **50-62**
11-1/4". All 235ci w/ Powerglide 0.426 -0.3 **\$13.50 EA** ⚠

Camshaft



- 3836491** **37-53**
For solid lifters, new 0.519 -0.15 **\$154.25 EA** ⚠
- 3836485** **50-53**
For hydraulic lifters, new 0.519 -0.15 **\$188.00 EA** ⚠
- 3836485R** **50-53**
For hydraulic lifters, reground (\$100 core) 0.519 -0.2 **\$125.00 EA** ⚠

WARNING: Cancer and Reproductive Harm — www.P65Warnings.ca.gov

Camshaft, cont.

3713919 **54-55**
For solid lifters, new, exc Powerglide & 261ci (for 261ci use part #3836484) 0.519 -0.15

..... **\$134.25 EA** ⚠

3713919R **54-55**
For solid lifters reground (\$40 core) exc Powerglide & 261ci (for 261ci use part # 383684R) 0.519 -0.3

..... **\$71.50 EA** ⚠

3836484 **54-58**
For solid lifters, new, 235ci, 261ci 0.519 -0.15

..... **\$135.00 EA** ⚠

3836483 **54-62**
For hydraulic lifters, new 0.519 -0.15

..... **\$143.50 EA** ⚠

3836483R **54-62**
For hydraulic lifters, reground (\$40 core) 0.519 -0.15

..... **\$71.50 EA** ⚠

3836484R **54-62**
For solid lifters, reground, 235ci, 261ci (\$40 core) 0.519 -0.15

..... **\$71.50 EA** ⚠

Camshaft Bearings



838846B **37-53**
Camshaft bearings. 0.539 -0.15

..... **\$59.00 SET** ⚠

3836191 **54-58**
Camshaft bearings 0.539 -0.15

..... **\$37.50 SET** ⚠

Camshaft Thrust Plate & Spacer



3702305 **37-57**
Thrust plate & spacer 0.533 -0.15

..... **\$16.25 SET** ⚠

Camshaft Thrust Plate Screws



3702305A **37-57**
Thrust plate screws 0.533 -0.3

..... **\$1.50 SET** ⚠

Timing Gear Cover



838869C **37-62**

Timing gear cover chrome. Fits cars and trucks 1937-62 216ci, 235ci, 261ci also

fits GMC 1939-1959 trucks with 228ci, 248ci, 270ci and 302ci engines -0

..... **\$54.25 EA** ⚠

Timing Gear



3835371B **37-62**

Aluminum crank & camshaft gear.

Matched set 0.728 -0.15 ... **\$85.25 SET**

⚠

Woodruff Keys



106751 **ALL**

For harmonic balancer, crank and cam gears (3

pcs) 8.960 -0.4

..... **\$2.00 SET** ⚠

Pistons



602806 **37-40**

Fits 216 Specify oversize (6 pcs) 0.629 -0.15

..... **starting at \$296.00 SET** ⚠

605260 **41-53**

Fits 216 Specify oversize (6 pcs)

0.629 -0.15

..... **starting at \$267.00 SET** ⚠

369398 **41-62**

Fits 235 Specify oversize (6 pcs)

0.629 -0.15

..... **starting at \$228.00 SET** ⚠

3707460 **54-62**

Fits 261 Specify oversize (6 pcs)

0.629 -0.15

..... **starting at \$288.00 SET** ⚠

Rings



608021 **37-53**

Fit 216ci (specify oversize) 0.643 -0.15

..... **starting at \$45.00 SET** ⚠

370405 **41-53**

235ci exc 53 Powerglide (specify oversize) 0.643 -0.15

..... **starting at \$60.00 SET** ⚠

370527 **53-54**

235ci exc 53 stick (specify oversize) 0.643 -0.2

..... **starting at \$60.00 SET** ⚠

3720210 **54-62**

261ci (specify oversize) 0.643 -0.15

..... **starting at \$65.00 SET** ⚠

Wrist Pins



838570 **37-62**

Standard 0.636 -0.15

..... **\$4.75 EA** ⚠

Rod Service

Note: Price subject to bearing availability. Before grinding crank shaft, please contact us to be sure undersize bearings needed are available.



602235A **37-53**

Send in your rods and we will machine them for insert bearings. 0.603 -0

..... **\$58.00 EA** ⚠

Rod

Note: SPECIFY exact model engine with rod casting number when possible. \$35 core charge refundable on rebuildable rod.

602235M **37-47**

Machined for insert bearing (NOS) 0.603 -0

..... **\$125.00 EA** ⚠

602235N **37-47**

Babbitt rods. Standard size only (NOS).

0.603 -0.4

..... **\$54.00 EA** ⚠

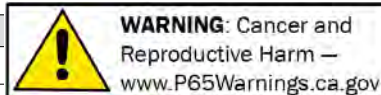

Rod Bolt & Nut



3835449.....33-53
Except 53 Powerglide
0.623 -0.15

\$5.50 EA ⚠



107823.....ALL
Pal lock nuts for rod
bolts 0.626 -0.4

\$11.00 SET ⚠

Rod Bolt Boots



986047B.....ALL
Protects crankshaft
during assembly

8.800 -0.15

\$3.00 PR ⚠



986047BB.....ALL
Protects crankshaft
during assembly

8.800 -0.15

\$5.00 SET ⚠

Alignment Tool



38352226.....37-53

Tool used to align oil dipper troughs in pan
(\$375 refundable deposit upon return of
tool) 1.427 -0.15

starting at **\$450.00 Rent** ⚠

Rod Dipper



3834884.....33-53

Used. For connecting rod. 0.604 -0.15

\$4.99 EA ⚠

Rod Bearing Shims



3692517.....29-53
.009 thick shims for rod
bearings, 12 per set.

0.619 -0.15

\$46.50 SET ⚠

Rod Bearings



370485.....37-53

Standard size to .060. (exc '53
Powerglide). 0.616 -0.15

starting at **\$200.00 SET** ⚠

370486.....53-62

Except 53 stick 0.616 -0.15

starting at **\$154.00 SET** ⚠

Main Bearings Shims



609118B.....40-53

Shims for main bearings. 0.143 -0.15

\$54.00 SET ⚠

Main Bearings



384706.....37-39

Standard to .075 under. 0.099 -0.15

starting at **\$250.00 SET** ⚠

384206.....40-47

Standard size to .075 under. 0.099 -0.15

starting at **\$251.00 SET** ⚠

368847.....48-53

Standard, .002, .010, .020, .030 exc 53
Powerglide. 0.099 -0.15

starting at **\$200.00 SET** ⚠

368855.....48-53

.040, .050, .060 (exc 53 Powerglide).

0.099 -0.15

starting at **\$130.00 SET** ⚠

370394.....53-62

Standard to .040 exc 53 stick. 0.099 -0.15

starting at **\$106.00 SET** ⚠

Plastigauge



609118P.....ALL

To check bearing clearance. 0.143 -0.15

\$6.00 EA ⚠

Dampener Balancer



605203.....37-54

Sleeve, repair seal
surface on crank
dampner 0.659 -0.2

\$8.00 EA ⚠

605635.....ALL

Recondition yours. 216ci, 235ci engines.

0.659 -0.15

\$199.50 EA ⚠

Stove Bolt



839301.....40-60

W/ lock washer correct
for timing cover,
pushrod cover & oil pan
(8 pcs) 1.428 -0

\$6.00 SET ⚠

Timing Hole Plug



836802A.....ALL

Rubber (rare) 0.714 -0.15

\$7.75 EA ⚠

Engine Bolt Kit Stainless Steel



368253A.....37-53

Hex head Chevy 216ci (exc 53 powerglide)
includes bolts for distributor, side cover,
valve cover, timing cover, thermostat, oil
pan, intake & exhaust, fuel pump & water
pump, also includes lube. 0.386 -0.15

\$68.50 SET ⚠

3836614A.....53-54

Hex head for a Chevy
235ci engine. Includes
bolts for distributor,
side cover, valve cover,
timing cover, thermostat, oil pan, intake
& exhaust, fuel pump & water pump and
lube. 0.386 -0.15

\$74.00 SET ⚠

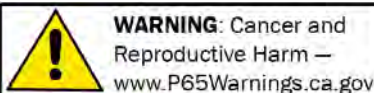

Chemicals shipped domestic ground only (Lower 48 states only). No international shipping.

Phone: (360) 816-0211 • (800) 999-CHEV (2438) • www.chevsofthe40s.com

Engine Bolt Kit Stainless Steel, cont.



3836614B55-62
Hex head for a Chevy 235/ 261ci engine. Includes bolts for distributor, side cover, valve cover, timing cover, thermostat, oil pan, intake & exhaust, fuel pump & water pump and lube. 0.386 -0.15
..... **\$74.00 SET** ⚠

Manifold Clamps & Bolts



838546B37-57
Intake - Exhaust manifold clamps (spreaders). Cast reproduction. 3.273 -0
..... **CALL** ⚠



838546BK37-57
Intake - Exhaust manifold bolt kit 3.273 -0



838546U37-57
Intake - Exhaust manifold clamps (spreaders). used 3.273 -0

..... **\$35.00 SET** ⚠

Manifold Sleeves (Metal)



83727334-53
Intake to head 216ci. Exc 50-53 235ci (3 piece set) 3.281 -0.15 ... **\$8.50 SET** ⚠

3835506 50-62
Intake to head 235ci, 261ci (3 piece set) 3.281 -0.15

..... **\$7.50 SET** ⚠

Engine Assembly Lube

Synthetic oils enable Royal Purple to make superior lubricants, but it is Royal Purple's advanced Synside additive technology that gives Royal Purple's EP lubricants their amazing performance. Engine Performance magazine raves about this product.



986047 ALL
Clevite Bearing Guard, 8 oz bottle. 8.800 -0.15
..... **\$10.00 EA** ⚠



986047D ALL
Royal Purple. Synthetic, 8 oz bottle. 8.800 -0.15

..... **\$21.50 EA** ⚠

Soft Plug Set



383512137-54
For complete plug kit you'll also need expansion plug #838127 0.034 -0.2

..... **\$7.75 SET** ⚠

Expansion Plug



83812738-54
Block, rear of camshaft 1-31/32in. 0.553 -0.15

..... **\$2.00 EA** ⚠



83812838-54
Block, rear of camshaft 1-5/8in. 0.553 -0.4

..... **\$9.25 EA** ⚠

Oil Pan Plug



34469028-57
W/ washer, 1/2 in., standard size 1.456 -0.4
..... **\$3.19 EA** ⚠

Oil Pan Plug, cont.

344690B 28-57
W/ washer, 1/2 in., single oversize 1.456 -0.2

..... **\$3.75 EA** ⚠

344690C 28-57
W/ washer, 1/2 in., double oversize 1.456 -0.15

..... **\$2.75 EA** ⚠

344690D 28-57
W/ washer, 1/2 in., triple oversize 1.456 -0.15

..... **\$2.50 EA** ⚠

Oil Dip Stick Tube



368570247-57
Cut to length 8-7/64in. 1.516 -0
..... **CALL** ⚠

Oil Pressure Line



60991236-53
Rocker arm, exc Powerglide w/ 235ci 1.519 -0.15
..... **CALL** ⚠



1399637B37-54
Engine to oil gauge. 1.519 -0.3

..... **\$26.00 EA** ⚠



217276A50-55
NOS rocker arm oiler kit 1.519 -0.15

..... **\$15.00 EA** ⚠

Oil Distributor Valve



83917340-53
Oil Distributor Valve Gasket 1.790 -0.3
..... **\$2.25 EA** ⚠

Oil Pickup Grommet



370156353-54
Grommet, oil pickup tube to screen assembly 1.664 -0
..... **\$1.75 EA** ⚠



Oil Pump



838440 **37-39**
For 216ci engine 1.652 -0.15 **CALL** ⚠



839157 **40-53**
Fits 216 & 235ci (exc 53 Powerglide).
1.652 -0.15 **\$195.25 EA** ⚠



3702363 **53-54**
Fits 235ci, exc 53 stick 1.652 -0.15
\$195.00 EA ⚠

Oil Pump Rebuild Kit



839157A **40-53**
Rebuild kit, exc Powerglide 1.652 -0
CALL ⚠



3702363A **53-54**
Rebuild kit, exc 53 stick 1.652 -0.15
\$62.00 EA ⚠

Oil Pump Drive Gear



839164 **40-53**
Drive gear. Exc 53
Powerglide (NOS)
1.659 -0.4
..... **\$5.00 EA** ⚠

Bee Hive Oil Filter



5573017A **ALL**
Super reproduction, painted. Hard to find
item 1.836 -0.15 **\$222.00 EA** ⚠



5573017C **ALL**
Mount bracket for Bee Hive Oil Filter,
painted 1.836 -0.15 **\$26.25 EA** ⚠



5573017FILT **ALL**
Filter Element for Beehive, 5" x 4"
1.836 -0.15 **\$16.00 EA** ⚠



5573017GASK **ALL**
Gasket For Beehive Filter 1.836 -0.15
\$2.75 EA ⚠

Oil Filter Element



5572288A **ALL**
3-1/2 in. o.d. x
4-1/16 in. high,
#P203. 1-1/8 in. I.D.
1.836 -0.15
..... **\$16.00 EA** ⚠



5572288B **ALL**
4-1/16 in. o.d. x
4-11/16 in. high.
1.836 -0.15
..... **\$18.50 EA** ⚠

Oil Filter Element, cont.



5572288C **ALL**
4-1/4 in. o.d. x 5
in. high, #P115 I.D.
9/16 in. 1.836 -0.15

..... **\$24.75 EA** ⚠



5572288D **ALL**
4-1/16 in. o.d.
x 7-3/4 in. high,
#P117. Inside hole
9/16 in. i.d. 1.836 -0.3

..... **\$22.00 EA** ⚠

Oil Filter Hose



3654629 **29-54**
19 in. 3.163 -0.15 **\$33.50 EA** ⚠

3702341 **37-54**
13 in. 3.163 -0.15
..... **\$33.50 EA** ⚠

Odds & Ends

Please call for availability on all Odds & Ends parts; once part is sold, it may no longer be in stock.

605487N **29-32**
Connecting rod bolts NOS 0.623 -0
..... **\$23.00 EA** ⚠

362477 **29-36**
Wrist Pins, .003 O.S. (NOS) 1.000 -0.4
..... **\$6.00 SET** ⚠

838774N **29-39**
Lifters (Solid) (NOS) 0.459 -0.2
..... **\$22.00 EA** ⚠

609533N **33-36**
Timing Gear Cover (NOS) 0.206 -0.4
..... **\$65.00 EA** ⚠

836867 **33-36**
Rocker Arm Shaft Oil Connector (NOS)
1.928 -0.4
..... **\$12.00 EA** ⚠

837365 **34-37**
Valve Spring All exc dc 0.303 -0.3
..... **\$3.75 EA** ⚠

838999 **34-40**
Rocker Arm- Exhaust 0.333 -0.4
..... **\$7.00 EA** ⚠

837385U **34-54**
Rocker arm & nut used 0.429 -0.4
..... **\$5.00 EA** ⚠

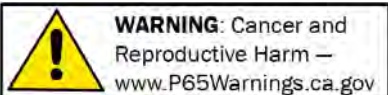

Chemicals shipped domestic ground only (Lower 48 states only). No international shipping.

Phone: (360) 816-0211 • (800) 999-CHEV (2438) • www.chevsofthe40s.com

Section 022T: Engine Components, Valve Covers, Rods, Bearings, Oil Pumps & Related

Odds & Ends, cont.

837656.....**35-36**
Oil pan seal at front crankcase. NOS-shelf worn. 0.213 -0.2

\$3.00 EA ⚠



837264N.....**35-42**
Valve spring cap (NOS)
0.309 -0.15

\$2.00 EA ⚠

00195.....**37-39**
Small spring around pushrod, inside -0.3

\$4.00 EA ⚠

838220.....**37-39**
Rocker Shaft Sleeve 1/8in. Id On One End, 1/2in. Id On Other End 1.928 -0.15

\$2.00 EA ⚠

838963N.....**37-39**
Body oil distributor valve (NOS) 1.785 -0.4

\$20.00 EA ⚠

6028060N.....**37-40**
Pistons. Fits 216ci standard bore (NOS).
0.629 -0.4

\$41.75 EA ⚠

60280660A.....**37-40**
Piston .060in. 0.629 -0.4

\$45.00 EA ⚠

60280680A.....**37-40**
Pistons .080in. (NOS) 0.629 -0.4

\$35.00 EA ⚠

60280680N.....**37-40**
Pistons. 216ci Engine .080 over (NOS)
0.629 -0.4

\$200.00 SET ⚠

838993.....**37-40**
Rocker Arm- Left Intake 0.333 -0.4

\$7.00 EA ⚠

838994.....**37-40**
Rocker Arm- Right Intake 0.333 -0.4

\$7.00 EA ⚠

3847065N.....**37-47**
Main bearing-front intermediate 0.099 -0.4

\$10.00 EA ⚠

00205.....**37-53**
Cambearings .030 (NOS) 0.539 -0.4

\$15.50 SET ⚠

3835246.....**37-53**
Pushrod cover seal. Cork. Fits all 216ci
0.454 -0.4

\$1.00 EA ⚠

3835344.....**37-53**
Push rod cover. Fits 216ci (Used) 1.000 -0.4

\$25.00 EA ⚠



608202.....**37-53**
Rings for 216ci .020 (NOS) 0.643 -0.4

\$60.00 SET ⚠

Odds & Ends, cont.

838246.....**37-53**
Rocker shaft support with 216 0.349 -0.4

\$40.00 EA ⚠

838483.....**37-53**
Flywheel Shield Extensions. 0.679 -0.4

\$15.00 EA ⚠

355936.....**37-54**
Valve rocker shaft retainer hair pin
0.376 -0.4

\$5.00 EA ⚠

3835508.....**37-54**
Rocker arm shaft spring (2-5/16" length)
0.376 -0.4

\$8.00 EA ⚠

602325.....**37-57**
Shims for crankshaft front bearing
0.146 -0.4

\$5.00 SET ⚠

839304.....**38-50**
Spring Valve All Exc PG (NOS) 0.603 -0.2

\$3.00 EA ⚠

609121.....**40-50**
Shims for crankshaft rear bearing
0.153 -0.4

\$5.00 EA ⚠

3712747.....**40-52**
Pipe & Cover Oil Pump (NOS) 1.664 -0.4

\$20.00 EA ⚠

839897.....**41-48**
Valve Spring Cap-Exhaust 0.309 -0.15

\$2.00 EA ⚠

3695373.....**41-55**
Exhaust Valve Rotor Assembly 0.309 -0.2

\$3.00 EA ⚠

3835392N.....**47-48**
Valve Spring Cap (NORS) 0.309 -0.2



\$2.50 EA ⚠

3701556.....**47-49**
Oil Dipstick NOS (Comm & Utility).
1000.000 -0.4

\$15.00 EA ⚠

3835548.....**50**
Rocker Arm. Exhaust, 235ci Engine
0.333 -0.4

\$16.00 EA ⚠

3701490.....**53-61**
Connecting Rod (fits 53 Pg & All 54-61)
0.603 -0.4

\$75.00 EA ⚠

3836090.....**54-56**
Rotator-Exhaust Valve, 1.5 Ton 0.309 -0.2

\$3.00 EA ⚠

3731676.....**54-60**
Piston ring set. NOS, fits 261ci engine,
standard bore. 0.643 -0.4

\$60.00 SET ⚠

Odds & Ends, cont.

3836026.....**55**
Exhaust Valves (Pass Exc P/g) (NOS)
0.297 -0.4

\$10.00 EA ⚠

3728993N.....**55-57**
Rear main bearings (NOS) 0.960 -0.4

\$15.00 PR ⚠

3836755.....**57**
Valve spring cap cover V-8 0.308 -0.4

\$10.00 SET ⚠

3730859.....**57-58**
Exhaust Valve, All exc Powerglide 1.000 -0.3

\$4.00 EA ⚠

38355144.....**ALL**
Push rod cover used 235ci (10 bolt holes
5-21/32 x 27) 0.439 -0

\$25.00 EA ⚠

955-INEX.....**ALL**
Oil Regulator Valve Silencing Cap 0.303 -0.4

\$20.00 SET ⚠

Returns require a return authorization number—call first. • Product pricing & availability subject to change.

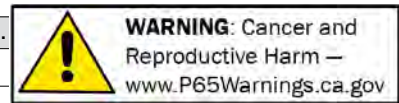

**SECTION 024T
RESTORATION PARTS**

Overhaul Gasket

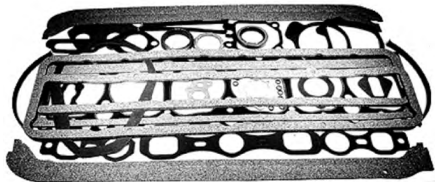

3702872 **37-53**
Overhaul complete set. All 216ci (exc 53
P.G.) 0.010 -0.15 **\$115.00 SET** ⚠

3702872A **50-52**
Overhaul complete set. Fits 235ci. 0.010 -0
..... **\$199.00 SET** ⚠



3719628 **53-62**
Overhaul complete set. Fits 235ci
0.010 -0.15 **\$111.25 SET** ⚠



3836107B **54-62**
Overhaul complete set. Fits 261ci
0.010 -0.15 **\$108.25 SET** ⚠

Valve Grind Gasket

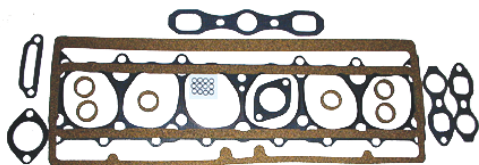

3691929 **37-53**
Valve Grind Exc 50-53 235ci. 0.289 -0.15
..... **\$74.00 SET** ⚠



3707038 **50-53**
Valve Grind Fits 235ci, exc 53 Powerglide.
0.289 -0.15 **\$65.00 SET** ⚠

Valve Grind Gasket, cont.



3709428 **53-62**
Valve Grind Fits 235ci, exc 53 manual
trans 0.289 -0.15 **\$80.00 SET** ⚠



3709429 **54-57**
Valve Grind Fits 261ci 0.289 -0.15
\$59.00 SET ⚠

Valve Cover Gasket



3694248 **37-53**
Valve cover 1/4in. thick 0.423 -0.15
\$13.00 EA ⚠



3696781 **54-62**
Valve cover cork. 0.423 -0.15 **\$13.25 EA**
⚠

Push Rod Cover Gasket



602336 **37-53**
Push rod Cover Gasket w/ plug seals. Exc
50-53 235ci 0.443 -0.15 **\$22.75 SET**
⚠



3835515 **50-62**
Push rod Cover Paper. Fits 235ci & 261ci
0.443 -0.15 **\$11.50 SET** ⚠

Head Gasket



839541 **37-53**
Head 216ci motor. 0.289 -0.15
\$51.50 EA ⚠



3835562 **50-52**
Head 235ci motor 0.289 -0.15
\$84.00 EA ⚠



3701296 **53-62**
Head 235ci motor 0.289 -0.15
\$50.75 EA ⚠



3836107 **54-62**
Head 261ci 0.289 -0.15 .. **\$65.00 EA** ⚠

Intake & Exhaust Manifold Gasket



602483A **37-53**
Intake & exhaust
manifold. Fits 216ci
(3pcs) 3.270 -0.15
..... **\$17.50 SET** ⚠



3707045 **50-62**
Intake & exhaust
manifold. Fits 235ci &
261ci (3pcs) 3.270 -0.15
..... **\$16.00 SET** ⚠

Manifold Gasket



838290 **37-53**
Rectangle between
manifolds. Fits 216ci
3.272 -0.15
..... **\$6.00 EA** ⚠



3835572 **50-62**
Rectangle between
manifolds. Fits 235ci &
261ci 3.272 -0.15
..... **\$6.00 EA** ⚠



WARNING: Cancer and
Reproductive Harm —
www.P65Warnings.ca.gov

Chemicals shipped domestic ground only (Lower 48 states only). No international shipping.

Phone: (360) 816-0211 • (800) 999-CHEV (2438) • www.chevsofthe40s.com

Section 024T: Engine Gaskets & Seals

Timing Cover Gasket



839048B**37-62**
Timing Cover Complete set w/ seal
0.005 -0.15 **\$21.50 SET** ⚠

Front Timing Cover Seal



3835946**37-58**
This is a seal for the front timing cover. made in the USA. 0.209 -0.3
..... **\$11.25 EA** ⚠



3835946N**37-58**
Timing cover seal NOS
0.209 -0.3
..... **\$8.00 EA** ⚠

Woodruff Keys



106751**ALL**
For harmonic balancer, crank and cam gears (3
pcs) 8.960 -0.4

..... **\$2.00 SET** ⚠

Rear Main Seal



3835774G**40-58**
As original rope. Replaces original asbestos type. Graphite (2 pcs). 0.137 -0.15
..... **\$27.00 EA** ⚠

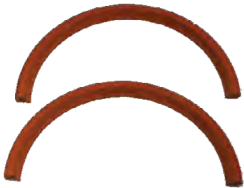

3835774R**56-62**
Rubber (2 pcs) 235-261 0.137 -0.15
\$46.00 SET ⚠

Oil Fill Cap Gasket



836446**31-48**
Oil Fill Cap Gasket. Exc 48 3/4T & larger
1.517 -0.2 **\$2.25 EA** ⚠

Oil Pan Gasket



602373**37-39**
Oil pan 1.429 -0.15 **\$16.00 SET** ⚠



604338**40-55**
Oil pan 1.429 -0.15 **\$15.50 SET** ⚠

Oil Distributor Valve Gasket



839173**40-53**
Oil Distributor Valve Gasket 1.790 -0.3
..... **\$2.25 EA** ⚠

Gasket Sealer

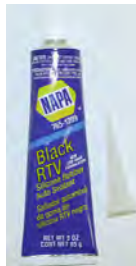

1015BP**ALL**
Gasket sealer, high temp silicone. Black (3.35 oz tube).
8.800 -0.15
..... **\$9.75 EA** ⚠

Engine Assembly Lube



986047**ALL**
Clevite Bearing Guard, 8 oz bottle.
8.800 -0.15
..... **\$10.00 EA** ⚠



986047D**ALL**
Royal Purple. Synthetic, 8 oz bottle. 8.800 -0.15
..... **\$21.50 EA** ⚠



**SECTION 026T
STREET ROD PARTS**

Crossmember V8 Conversion



3716772.....47-54
Motor mount crossmember will work for
40-46 truck if cut 1" from each end.
0.029-0.15 **\$68.00 EA** ⚠

**SECTION 026T
RESTORATION PARTS**

Metal Cover



3656502.....37-54
Front motor mount 0.029-0.15
\$12.00 EA ⚠

Motor Mount Front



3739939.....33-59
Also fits 39-54 GMC. 0.027-0.15
\$12.50 EA ⚠

Motor Mount Rear



3702198.....37-53
Chevy & 39-53 GMC (Exc 48-53 Chevy
1/2T & 47 2nd design). 0.027-0.2
\$18.25 EA ⚠



756700.....47-53
1/2T (47-2nd design). 0.027-0.2
\$15.00 EA ⚠



3705444.....54
Upper 0.027-0.3 **\$17.00 EA** ⚠



3789949.....54
Lower 0.027-0.4 **\$10.00 EA** ⚠

Odds & Ends

Please call for availability on all Odds & Ends parts; once part is sold, it may no longer be in stock.

602790.....37-46
Cushion-motor Mount Bracket Assy (Accy)
Heater 0.027-0.4

..... **\$45.00 PR** ⚠
602787.....37-50
Rear bracket for cushioned motor mount
0.027-0.4

..... **\$15.00 EA** ⚠

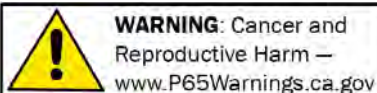

**SECTION 030T
STREET ROD PARTS**

Radiator V8 (Copper-Brass)

Oversize shipping charges apply on radiators. Please call for rate.



3118968A47-54
Chevy Truck W/ V8 small block, 4 core w/ trans cooler. 1.219-0.15 **\$398.75 EA** ⚠

Radiator V8 (Aluminum) W/ Stamped Tanks



3116352A41-46
100% TIG welded. All Aluminum.(2) 1.25" Tubes. Polished tanks.16 fins per inch. Corrugated fins that give more surface area and more thermal transfer. Pressure tested. For manual trans.

Direct fitment for 41-46 Chevy Truck. Upper Hose 1.50". Lower Hose 1.75" 1.219-0 **\$399.00 EA** ⚠



3118968AL47-54
V8 Chevy Trucks 1.219-0.15 **\$278.00 EA** ⚠



3118968AG48-54
100% TIG welded. All Aluminum.(2) 1.25" Tubes. Polished tanks.16 fins per inch. Corrugated fins that give more surface area and more thermal transfer. Pressure tested. For

manual trans. Direct fitment for 48-54 GMC Truck. Upper Hose 1.50". Lower Hose 1.75" 1.219-0 **\$398.00 EA** ⚠

Radiator V8 (Aluminum) Chevy ALUMRAD

ALUMRAD37-53
Chevy Type 1 size: 18"W x 27"H. 1.219-0.15 **\$494.50 EA** ⚠

ALUMRADT37-53
Chevy Type 1 - 18"Wx27"H W/ internal transmission cooler. 1.219-0.15 **\$566.50 EA** ⚠

ALUMRAD46-54
Chevy Type 2 size: 20-1/4"W x 24-1/2"H. 1.219-0.15 **\$494.39 EA** ⚠

ALUMRADT46-54
Chevy Type 2. 20-1/4"W x 24-1/2"H W/ internal transmission cooler. 1.219-0.15 **\$566.50 EA** ⚠

Radiator (Aluminum) GMC ALUMRAD

ALUMRADG37-54
GMC Rear mount. Size: 18"W x 27"H. 1.219-0.15 **\$557.00 EA** ⚠

ALUMRADGT37-54
GMC Rear mount. Size: 18"W x 27"H. w/ internal trans cooler. 1.219-0.15 **\$566.50 EA** ⚠

Radiator (Aluminum) ALUMRAD Upgrades

ALUMRADACCON ALL
Add an AC Condenser 1.219-0.15 **\$99.75 EA** ⚠

ALUMRADACMOUNT ALL
Mount AC condenser to radiator 1.219-0.15 **\$40.00 EA** ⚠

ALUMRADBUNG ALL
Extra bung welded in radiator. 1.219-0.15 **\$15.00 EA** ⚠

ALUMRADFAN ALL
Electric fan for aluminum radiators. 16", 2360CFM. Straight fan blades. 1.219-0.15 **\$150.25 EA** ⚠

ALUMRADFANCOVER ALL
Polished aluminum fan cover for electric fan. 1.219-0.15 **\$60.25 EA** ⚠

ALUMRADFANMOUNT ALL
Mount Fan to radiator 1.219-0.15 **\$40.00 EA** ⚠

ALUMRADFANWIRE ALL
Single Fan Wiring Harness 1.219-0 **\$56.00 EA** ⚠

ALUMRADSHROUD ALL
Aluminum fan shroud for radiators listed above. 1.219-0.15 **\$99.75 EA** ⚠

POLISHRAD ALL
Upgrade your radiator to a fully polished. 1.219-0 **\$125.00 EA** ⚠

POLISHSHROUD ALL
Upgrade fan shroud to polished 1.219-0.15 **\$40.00 EA** ⚠

Radiator Cap (Aluminum)



ALUMCAP16PRC . ALL
Billet aluminum radiator cap. 16lb. Smooth finish. 0.000-0.15 **\$19.99 EA** ⚠

**SECTION 030T
RESTORATION PARTS**

Radiator Core Support



370701147-55
For center fill radiator. 1.270-0.15 **\$344.50 EA** ⚠

Core Support Pads & Shims



36731439-46
Radiator core support mount. 4-1/4" x 1-1/2" (2-1/2" between bolt holes). 1.270-0.3 **\$10.50 SET** ⚠



3684763A47-49
Radiator core support mount. 2-1/4" x 1-1/4" x 1/4" thick. 1.270-0.15 **\$6.00 SET** ⚠



368476350-54
Radiator core support mount. 1.270-0.15 **\$5.00 PR** ⚠

Core Support Bolt Kit



367648041-54
Radiator core support to frame. 1.270-0.4 **\$4.00 SET** ⚠

Brace (V-Rod) Street Rod

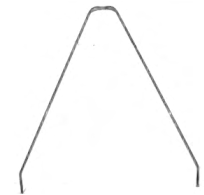

59477337-38
For 37-38 Chevy Trucks. Stainless Steel. 1.309-0 **\$180.00 EA** ⚠

Radiator (Copper-Brass)

Oversize shipping charges apply. Please call for rate.



310942338-40
6 cylinder, 3 core 1.219-0 **CALL** ⚠

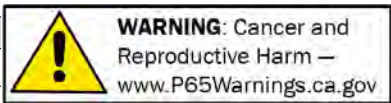

Radiator (Copper-Brass), cont.

3116352**41-46**
6 cylinder, 3 core. 1.219 -0
..... **CALL** ⚠



3118968**47-54**
6 cylinder, 3 core. 1.219 -0.15
.....
\$368.50 EA ⚠

Radiator (Aluminum)



3116352A**41-46**
100% TIG welded
All Aluminum
(2) 1.25" Tubes
Polished tanks

16 fins per inch
Corrugated fins that give more surface area and more thermal transfer
Pressure tested
For manual trans
Direct fitment for 41-46 Chevy Truck
Upper Hose 1.50"
Lower Hose 1.75" 1.219 -0
..... **\$399.00 EA** ⚠



3118968AG**48-54**
100% TIG welded
All Aluminum
(2) 1.25" Tubes
Polished tanks

16 fins per inch
Corrugated fins that give more surface area and more thermal transfer
Pressure tested
For manual trans
Direct fitment for 48-54 GMC truck
Upper Hose 1.50"
Lower Hose 1.75" 1.219 -0
..... **\$398.00 EA** ⚠

Radiator Cap



370683**34-36**
Seahorse (accessory). 1.203 -0
..... **CALL**
⚠

Radiator Cap, cont.



594498**37-52**
No pressure. 1.203 -0.2 **\$9.25 EA** ⚠



594498AC**37-52**
AC Delco RC-10. No pressure. 1.203 -0
\$33.50 EA ⚠



850501**53-54**
4 lb genuine AC. 1.203 -0.15 **\$15.50 EA**
⚠



850795R**53-57**
7 lbs. 1.203 -0 **\$7.50 EA** ⚠



850795**55-57**
7 lb genuine AC. 1.203 -0.15 **\$16.00 EA**
⚠

Radiator Petcock



134519**37-39**
Not as original.
1.229 -0.15
..... **\$4.00 EA** ⚠



3113456**40-47**
1/4" NPT 1.229 -0.15
..... **\$20.00 EA** ⚠

Radiator Petcock, cont.



3719518**48-57**
1/4" NPT 1.229 -0.4
..... **\$6.00 EA** ⚠

Overflow Tank



985528**37-54**
Original GM
accessory with
hose, mounting
bracket and screws
1.290 -0.15
..... **\$119.25 EA** ⚠

Overflow Tank Decal



DEC03**39-48**
Gold with red wings. 19.200 -0.4
.....
\$5.00 EA ⚠



DEC28**49-54**
Clear with orange lettering. 19.200 -0.15
..... **\$9.00 EA** ⚠

Overflow Tank Hose Set



601607B**37-48**
For accessory overflow tank w/ original
GM instruction sheet 1.240 -0.4
.....
\$14.50 SET ⚠

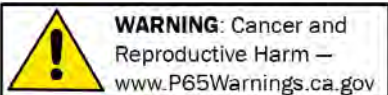

Chemicals shipped domestic ground only (Lower 48 states only). No international shipping.

Phone: (360) 816-0211 • (800) 999-CHEV (2438) • www.chevsofthe40s.com

Overflow Tank Hose Set, cont.



601607C **49-54**
 For accessory overflow tank w/ original
 GM instruction sheet 1.240-0.4
\$14.50 SET ⚠

Radiator Hose Set

2782488 **37-40**
 W/ metal elbow. 1.159-0
 **CALL** ⚠

2782488A **41-46**
 W/ metal elbow. 1.159-0
 **CALL** ⚠

3694277B **47-54**
 Molded hose with clamps. 1.173-0
 **CALL** ⚠

Upper Hose

364382P **37-46**
 6-3/4 in. 1.130-0.25
 **\$6.50 EA** ⚠

3702348 **47-54**
 Molded hose 1.159-0.2
 **\$8.00 EA** ⚠

Metal Elbow



378248 **35-40**
 In lower hose. 1.173-0.15 **\$17.50 EA** ⚠



3656796 **41-46**
 In lower hose. 1.173-0.15
 **\$19.00 EA** ⚠

Lower Hoses

3701363A **37-40**
 (2 pcs) (hoses are trim-to-fit). 1.159-0.2
 **\$12.00 SET** ⚠

3701363B **41-46**
 (2 pcs). 1.159-0.2
 **\$12.00 SET** ⚠

Moulded Lower Hose

3692230 **41-46**
 Replaces metal elbow & 2 hoses.
 1.173-0.2
 **\$15.75 EA** ⚠

Moulded Lower Hose, cont.

3694277 **47-54**
 Repro. 1.173-0
 **\$13.49 EA** ⚠

Radiator Hose Clamps



111616 **ALL**
 Upper hose (original) (2 pcs). 1.166-0.2
\$4.50 SET ⚠



111619 **ALL**
 Lower hose (original) (2 pcs). 1-7/8"
 hoses. 5/8" band. 1.166-0.2 **\$4.50 SET**
 ⚠

Water Pump

Note: 1937-38 & 1939-40 cores are becoming difficult to find. You may be required to send in your core for a rebuild.



3741033 **29-54**
 W/ short shaft (narrow) 3/8" pulley (not polished). For use on 55 & later 235ci & 261ci engines (\$100 core). 1.069-0
CALL ⚠



3741033LP **29-54**
 For doing a 235ci conversion in earlier chevys. Includes gasket for '55 & later 235ci & 261ci 6-cylinders. 1.069-0.2
\$140.00 EA ⚠

Water Pump, cont.

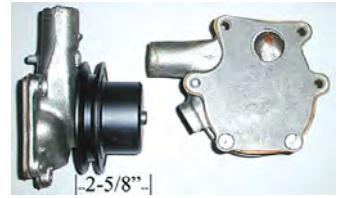

598308 **37-38**
 W/ gasket (\$150 core). 1.069-0.2
\$225.00 EA ⚠

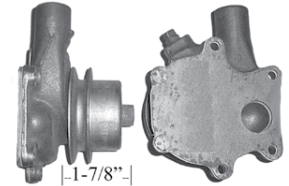

838903 **39-40**
 W/ gasket (\$150 core). 1.069-0.2
\$225.50 EA ⚠



939467 **41-52**
 W/ gasket (\$75 core). 1.069-0.15
\$185.00 EA ⚠

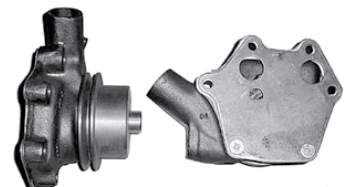

3836804 **53-54**
 W/ gasket (narrow pulley). \$75.00 core charge. 1.069-0.15 **\$148.00 EA** ⚠

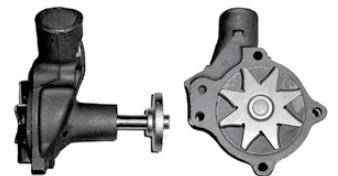

3774212 **54-55**
 Fits 261ci. W/ Gasket 1.069-0.15
\$78.00 EA ⚠

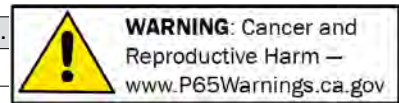

Water Pump, cont.



WPADAPT.....ALL
Water Pump Adapter Plate For 55 & Up
235, 261 Engines To Use Earlier 41-54
Water Pumps 1.069 -0.2 **\$44.00 EA** ⚠

Water Pump Rebuild Service

REBUILDWP.....ALL
Rebuild service for your water pump. -0.15
..... starting at **\$179.00 EA** ⚠

Water Pump Backing Plate



838151.....37-40
This is the metal backing plate behind the
water pump. It's very common for these to
rust through especially on cars that have
set for many years. 1.113 -0.15
\$24.00 EA ⚠

Backing Plate Gasket (Water Pump)



383150.....37-40
Backing plate gasket
1.114 -0.15 **\$3.75 EA** ⚠



839469.....41-54
Backing plate gasket
1.114 -0.3 **\$5.50 EA** ⚠

Water Pump to Block Gasket



838137.....37-40
Water pump to block
1.079 -0.2 **\$4.50 EA** ⚠



3836048.....41-54
Water pump to block
1.079 -0.15 **\$3.75 EA** ⚠



3836162.....55-61
Water pump to block.
For water pump w/
short pulley & shaft
(part # 3741033 55 &
later 235ci & 261ci engines) 1.069 -0.15
..... **\$3.25 EA** ⚠

Pulley Water Pump



598310.....37-38
Aluminum (brushed
finish). 1.069 -0
..... **CALL** ⚠



3836804A.....53-54
Cast Iron 1.069 -0.2 **\$37.50 EA** ⚠

Fan



838277.....37-54
Black finish fan blade. Fits 37-40 GA, HA,
KH & 41-54 Passenger. 1.064 -0.15
\$32.25 EA ⚠

Belts



3680776.....37-52
For fan & generator
1.066 -0.15 **\$18.50 EA** ⚠



2190650.....39-53
For fan & generator. Fits
GMC. 8.033 -0.2 **\$7.00 EA** ⚠



3713313.....53-54
For fan & generator
1.066 -0.15 **\$7.00 EA** ⚠



2304817.....54
For fan & generator. Fits
GMC. 1.066 -0.2 **\$9.00 EA** ⚠

Thermostat Housing



839232B.....40-57
Lower thermostat
housing / water neck,
all 6 cyl. 1.251 -0.15
..... **CALL** ⚠



839232T.....40-57
Upper thermostat
housing / water neck,
all 6 cyl. 1.251 -0.15
..... **\$45.00 EA** ⚠



OTB-6413.....ALL
1/2" aluminum
thermostat housing
spacer. Used to space
thermostat housing

away from aftermarket valve covers.
Includes mounting hardware. Fits 216ci,
235ci, 261ci -0

..... **\$39.25 EA** ⚠

Thermostat



3123995.....29-54
180 degree. 1.246 -0.15
..... **\$6.25 EA** ⚠



3133598.....29-54
160 degree. 1.246 -0.2
..... **\$7.50 EA** ⚠

Thermostat Housing Gasket



838341.....37-57
Thermostat housing
gasket. Fits gooseneck.
1.154 -0.2 **\$1.75 EA** ⚠

Head To Water Outlet Gasket



3838297.....37-62
Head to water outlet
1.252 -0.15 **\$1.75 EA** ⚠

Bushing



3837160.....38-62
For temp gauge. 3/8"
I.D. 1/2" NPT O.D.
1.150 -0.15 **\$9.75 EA** ⚠

Petcock In Engine Block



120842.....ALL
1/8" NPT Fits Engine
Block 8.951 -0
..... **\$4.99 EA** ⚠

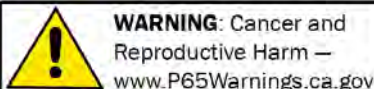

Chemicals shipped domestic ground only (Lower 48 states only). No international shipping.

Phone: (360) 816-0211 • (800) 999-CHEV (2438) • www.chevsofthe40s.com

OLD AIR — Air Conditioning & Heating System — GREAT FOR 6-CYLINDER APPLICATIONS!

Complete Universal systems with everything you need to install Heat & Air Conditioning in your vehicle (minus refrigerant). These Hurricane units are designed for efficiency and minimal use of space to allow for stereos, glove boxes, wiper motors, etc. Choose Hurricane unit with Upper, Lower or Side exit fittings (see dimensions below). System includes Sanden 508 Compressor (or equivalent), mounting brackets, Condenser (you'll need to measure your radiator), Receiver/ Drier, Binary Pressure Safety Switch, A/C & Heater Hose, Wire Harness, Clamps, 4 inch Vent Hose Kit, Control Panel w/ Knobs and more. Pick 4 vents to best suit your dash (some double vents count as 2). Optional items include Electronic Slide Controls (Vertical or Horizontal) in black or aluminum finish, Chrome Drier or Polished Compressor.

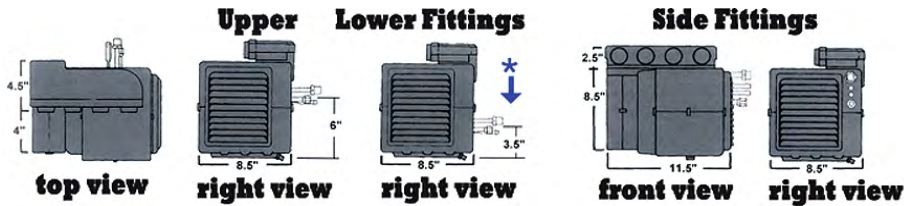

Condensers use flat tubes not round creating greater frontal area which equates to improved cooling.

The Heat & Defrost units for these systems mounts directly to your firewall. A/C & Heater lines pass through a custom rubber grommet that fits into the factory blower motor hole (shown below). Take a look at our In-Dash Vent and Switch kit below. These systems are designed for easy installation with custom condenser mounting, aluminum lines and step-by-step instructions. Retains cowl vent and majority of glove box. Has floor Heat and De-Humidified Defrost.



UNIVERSAL FOR MOST APPLICATIONS

A little tight on defroster space for your HVAC unit? Just let your sales rep know that you want the 90 degree defroster outlet option. And hey, we won't even charge you for it.



90° Defrost Option
Requires only 1-7/8" space above for duct hose routing, includes "Y" adapter.



Standard Defrost Outlets
Allow 2-1/2" to 3" above for duct hose routing



**SECTION 035T
RESTORATION PARTS**

Air Conditioning & Heating System



AC4000DC **47-54**
Cable operated controls. 9.779 -0.15
\$1,355.00 SET ⚠



AC4100DC **47-54**
Complete system. Mounts under dash.
Electronic Controls. 9.779 -0.15
\$1,450.50 SET ⚠



AC1000C **ALL**
Complete System with
Upper HVAC fittings
and Cable Controls.
9.779 -0.15
\$1,125.00 SET ⚠

AC1100C **ALL**
Complete System with Upper HVAC fittings
and Electronic Controls. 9.779 -0.15
\$1,225.00 SET ⚠

AC2000C **ALL**
Complete System with 90-degree HVAC
fittings and Cable Controls. 9.779 -0.15
\$1,125.00 SET ⚠

AC2100C **ALL**
Complete System with right side HVAC
fittings and Electronic Controls. 9.779 -0.15
\$1,225.00 SET ⚠

AC3000C **ALL**
Complete System with Lower HVAC fittings
and Cable Controls. 9.779 -0.15
\$1,125.00 SET ⚠

AC3100C **ALL**
Complete System with Lower HVAC fittings
and Electronic Controls. 9.779 -0.15
\$1,220.00 SET ⚠

**Air Conditioning & Heating System
-Radio Speaker Grille**



AC4000GC **47-53**
Complete system. Cable operated controls.
Choose 2 additional vents. 9.779 -0.15
\$1,355.25 SET ⚠

AC4000GI **47-53**
Interior only system. Cable operated
controls. Choose 2 additional vents (no
A/C items forward of firewall: compressor,
dryer, etc). 9.779 -0.15
\$720.00 SET ⚠

**Air Conditioning System Vents
Double Units**

VENT-20 **ALL**
HVAC vents under dash,
rectangular double vent
(2" x 10"), Counts as 2. 9.779 -0.15
\$26.00 EA ⚠

VENT-3 **ALL**
HVAC vents under dash,
rectangular double vent (2" x 11-1/2").
Counts as 2. 9.779 -0.15
\$26.25 EA ⚠

**Air Conditioning System Vents
Single Units**

VENT-1 **ALL**
HVAC vent under dash,
rectangular (2" x 6-1/4")
. 9.779 -0.15
\$14.50 EA ⚠

VENT-10 **ALL**
HVAC vents under dash,
round corner. 9.779 -0.15
\$34.50 PR ⚠

VENT-14 **ALL**
HVAC vents kick panel
louvers (pair). 9.779 -0.15
\$34.50 EA ⚠

VENT-2 **ALL**
HVAC vents under dash,
round (3" x 4-1/2").
9.779 -0.15
\$14.50 EA ⚠

VENT-21 **ALL**
HVAC vents in dash,
rectangular (3-1/2" x
3-1/2"). 9.779 -0.15
\$17.50 EA ⚠

**Air Conditioning System Vents
Single Units, cont.**

VENT-5 **ALL**
HVAC vents in dash,
rectangular (1-3/8" x
4-3/4"). 9.779 -0.15
\$14.00 EA ⚠

VENT-6 **ALL**
HVAC vents in dash,
rectangular (1-3/8" x
3-3/4"). 9.779 -0.15
\$14.00 EA ⚠

VENT-7 **ALL**
HVAC vents in dash,
rectangular (2-3/4" x
2-1/2"). 9.779 -0.15
\$14.00 EA ⚠

VENT-8 **ALL**
HVAC vents in dash,
rectangular (2" x 5-1/4")
. 9.779 -0.15
\$14.00 EA ⚠

**Air Conditioning & Heating System
Upgrade**

Options: We offer Horizontal or Vertical
Electronic Slide Controls. Your choice of
Brushed Aluminum or Black finish. You can
also shine up your engine bay with a Polished
Compressor and Chrome Drier (with polished
clamp) or add a Trinary pressure switch. All for
a very reasonable cost.



ACDRIERUP **ALL**
Chrome drier for air
conditioning. With
polished mounting
bracket. 8" L x 2-1/2"
dia. With sight glass. 9.779 -0.15
\$78.00 EA ⚠



ACDVENT **ALL**
Defroster vent.
Replaces missing or
worn vents. Plastic.
9.779 -0.15
\$18.50 EA ⚠



ACPNL-E **ALL**
Electronic controls. Smooth servo action.
Available in Horizontal or Vertical cover
plate and Brushed Aluminum or Black
finish. 9.779 -0 . starting at **\$85.00 EA** ⚠

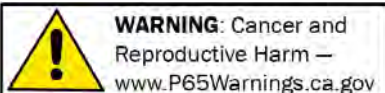

Chemicals shipped domestic ground only (Lower 48 states only). No international shipping.

Phone: (360) 816-0211 • (800) 999-CHEV (2438) • www.chevsofthe40s.com

Air Conditioning & Heating System Upgrade, cont.



ACTRINARY.....ALL
In-line Trinary Pressure Switch. 9.779 -.15
..... **\$19.99 EA** ⚠

Universal Heater / Defroster



506101.....ALL
GEN II COMPAC heater / defroster with electronic servo controls & 3 speed fan. 9.779 -0.15
..... **\$260.25 KIT** ⚠

Universal Heater



50515-VUH.....ALL
GEN II COMPAC heater only with electronic servo controls & 3 speed fan. 9.779 -0.15
..... **\$195.00 EA** ⚠

Fan



40848.....ALL
12 volt 6" steel blade heady duty fan. -0.15
..... **\$35.25 EA** ⚠

Heater Paint



604481P....42-46
Heater beige hammertone (thin w/ enamel thinner). 16.080 -0
..... **CALL** ⚠

Heater Decal



DEC07.....47-52
Chevrolet round emblem. 19.200 -0.15
\$9.75 EA ⚠



DEC08.....47-52
GMC round emblem. 19.200 -0.15
\$9.00 EA ⚠



DEC29.....49-51
Decal-Harrison 19.200 -0.15
\$9.00 EA ⚠



DEC09.....53
Fresh air round decal. 19.200 -0.15
\$6.00 EA ⚠



DEC17.....53
Recirculating round decal. 19.200 -0.15
..... **\$3.75 EA** ⚠



DEC10.....53-54
GMC round decal. 19.200 -0.15
\$4.75 EA ⚠

Heater Decal, cont.



DEC16.....54-55
Fresh air round decal. 19.200 -0.15
\$6.00 EA ⚠



DEC18.....54-55
Recirculating round decal. 19.200 -0.15
..... **\$5.25 EA** ⚠

Defroster Decal



DEC06.....47-55
On/off defroster decal. 19.200 -0.15
\$3.00 EA ⚠

Heater Box



986248.....47-54
Heater Box Deluxe 8.854 -0.15
\$153.00 EA ⚠

Heater Gasket

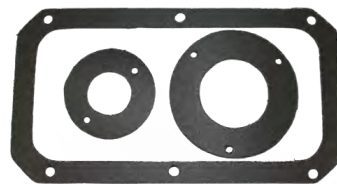

986248A.....47-54
Gasket, deluxe heater set. 8.845 -0.15
\$13.25 EA ⚠

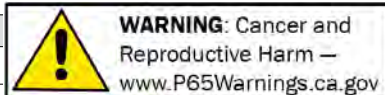

Heater Core



3115847 **41-46**
 Harrison Deluxe Heater Core New
 8.854 -0.15 **\$299.25 EA** ⚠️



3119687 **47-52**
 Fresh air heater core, Airflow heater only
 8.854 -0.15 **\$190.00 EA** ⚠️



3119687A **47-52**
 Fresh air heater core, Airflow heater only.
 Superior made in USA. 8.854 -0.15
\$330.00 EA ⚠️



986104 **47-54**
 Replacement for Harrison round heater
 core. 8.854 -0.15 **\$299.25 EA** ⚠️

Heater Core Rebuild

3115605R **37-54**
 Rebuild your heater core 8.854 -0.15
 **CALL** ⚠️

Heater Control Brackets



3119687B **47-55**
 For Fresh Air
 Heater -0.15
 **\$21.50 EA** ⚠️

Heater Control Valve



3128267D **47-55**
 Heater control valve
 rebuild service using
 your core. 8.861 -0.15
 **\$110.00 EA** ⚠️

Heater Control Valve Rebuild Kit



3128267C **47-54**
 Heater control
 valve rebuild kit, w/
 instructions. 8.861 -0.15
 **\$17.75 EA** ⚠️

Heater & Defroster Shutoff Valve



985533 **35-54**
 Heater shutoff valve replacement, screws
 into water pump. For 5/8" hose. 8.870 -0.15
 **\$45.00 EA** ⚠️

Heater & Defroster Nipple



3106066 **29-54**
 Heater/Defroster Nipple
 connects heater hose to
 engine. 8.866 -0.2
 **\$15.50 EA** ⚠️

Heater Motor

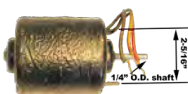

5047730 **47-54**
 Heater Motor. 6v exc
 airflow (5-1/2 in. x
 2-7/8 in. diameter),
 NOS. 8.855 -0
 **CALL** ⚠️

Heater & Defroster Motor



5047531 **37-54**
 Heater/Defroster motor 6v replacement (5
 in. x 2-3/4 in. diameter) 1-3/8 in. shaft,
 reversible. 8.855 -0.15 .. **\$55.50 EA** ⚠️



5047849 **37-54**
 Heater/Defroster motor 12v replacement,
 (5 in. x 2-7/8 in. diameter) 1-1/2 in. shaft,
 reversible. 8.855 -0.15 .. **\$57.25 EA** ⚠️

Heater Wiring Harness



3106048B... **37-49**
 Heater & defroster
 wiring harness
 8.853 -0.15
 **\$66.00 EA** ⚠️

Resistor

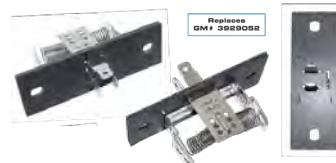

3829052 **38-72**
 Heater blower motor (w/o A/C).
 Note: Replaces GM #3929052
 Replaces AC Delco #15-80836 8.855 -0.15
 **\$19.25 EA** ⚠️

Heater Switch



3112682B... **ALL**
 Heater switch 6v,
 rotary rheostat,
 clamps to dash
 bottom.
 Variable speed.
 8.852 -0.15
 **\$19.50 EA** ⚠️



3112682C... **ALL**
 Heater switch 12v,
 rotary rheostat,
 clamps to dash
 bottom.
 3 speed. 8.852 -0.2
 **\$22.50 EA** ⚠️

Heater & Defroster Knob



3129274C... **47-53**
 Heater/Defroster
 knob warmer, maroon.
 Original color and
 quality. 8.861 -0.4
 **CALL** ⚠️



3129274D... **54**
 Heater/Defroster knob
 warmer, black. Original
 color and quality.
 8.861 -0.4
 **\$14.00 EA** ⚠️

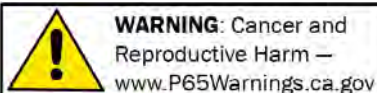

Cowl Vent Knob



3656663A40-46
As original, brown.
16.130 -0.15

..... **\$8.75 EA** ⚠



98560340-46
Ivory accessory 9.691 -0

..... **\$15.00 EA** ⚠



3682916A47-53
Side or top vent,
maroon. 16.130 -0.15

..... **\$7.00 EA** ⚠



3131111 54
Black. Original color
and quality. 16.130 -0.4

..... **\$14.00 EA** ⚠

Defroster Duct Hose



3119156RALL
Defroster duct hose 1-1/2 in. i.d. 36 in.
length. Plastic replacement (original was
cloth covered, wound wire) 9.779 -0

..... **\$21.00 EA** ⚠

3119719 ALL
Defroster duct hose 1-3/4 in. i.d. 36 in.
length. Cloth covered. 9.779 -0.15

..... **\$22.25 EA** ⚠

3125764 ALL
Defroster duct hose 2 in. i.d. 36 in.
length. Cloth covered. 9.779 -0.15

..... **\$24.00 EA** ⚠

Heater & Defroster Hose



3691292ALL
Heater Hose Black, 5/8" I.D., 7/8" O.D.
hose 8.846 -0.2

..... **\$2.00 FT** ⚠

Heater & Defroster Hose Clamps



432645ALL
Heater Hose Clamps
Fits 5/8" I.D. hose.
Original (4 pcs)

1.166 -0.2
..... **\$5.00 SET** ⚠

Aluminum Bundle Straps



13196ALL
.25" W X 4.05" L

Used to bundle wires or hoses. -0.2
\$4.00 EA ⚠



13197ALL
.25" W X 7.15" L

Used to bundle wires or hoses -0.2
\$5.00 EA ⚠

Heater Grommet



3691292A47-54
Grommet for 5/8 in.
heater hose (thru
firewall). 8.846 -0

..... **\$6.25 PR** ⚠



1947 1/2-ton — Steve Paul

**SECTION 040T
RESTORATION PARTS**

Engine Crank



3661378 **37-53**
Manual start, hardened steel. Repro.
0.239 -0.15 **\$68.50 EA** ⚠



3681380 **47-53**
Starting crank support
bracket 7.025 -0.15
..... **\$22.00 EA** ⚠

Starter



1107108 **38-54**
Foot operated (\$50 core) 2.041 -0
..... **\$175.00 EA** ⚠

1107108C **38-54**
12 volt foot operated (\$50 core) 2.041 -0
..... **\$250.00 EA** ⚠



1913369 **49-54**
Uses solenoid (\$100 core). Fits Passenger
& DUBL-DUTI Trucks. 2.041 -0.15
..... **\$185.00 EA** ⚠

1913369C **49-54**
12 volt. Uses solenoid (\$100 core). Fits
Passenger & DUBL-DUTI Trucks. 2.041 -0
..... **\$250.00 EA** ⚠



1913369GR **ALL**
High torque gear
reduction starter. Built
in solenoid 12v, fits 139
tooth Flywheel. Has

multiple mounting positions. -0.15
..... **\$329.00 EA** ⚠

Starter Rebuild Service

1864489 **37-54**
Rebuild yours 2.041 -0.15
..... **\$185.00 EA** ⚠

Starter Rebuild Kit



1900558 **37-54**
W/ brushes, springs, bushing (29 pcs).
2.053 -0.1 **\$53.50 KIT** ⚠

Starter Drive



1859020 **34-37**
This is the starter drive for 1934-37.
2.086 -0.15 **\$89.99 EA** ⚠



2873789 **38-54**
This is the starter drive
for 1938-54. 2.086 -0.15
..... **\$24.50 EA** ⚠

Starter Brush Set



811553 **25-54**
This is a starter brush
set for 1925-54.
2.051 -0.3
..... **\$5.00 SET** ⚠

Starter Bushing



810620 **29-37**
Drive end 2.083 -0.4
..... **\$4.00 EA** ⚠



1839345 **38-54**
Drive end 2.083 -0.4
..... **\$3.00 EA** ⚠



810620A **38-54**
Non-drive end 2.083 -0
..... **\$4.25 EA** ⚠

Starter Band



817114 **29-54**
Covers openings on starter. 2.070 -0.4
..... **\$9.50 EA** ⚠

Starter Oil Cover



114998 **29-54**
Hinged lid. 5/16 in.
o.d. insert. 2.305 -0.15
..... **\$12.75 EA** ⚠

Starter Switch



WKS1 **37-54**
Electric switch kit when
switching from foot
operated starter (part #
1913369GR) -0.15
..... **\$45.00 EA** ⚠



820052A **38-54**
Foot starter. No side
terminal. 2.100 -0.2
..... **\$13.50 EA** ⚠

Starter Solenoid



1118135 **54**
Double Duty & 54-55
Hydromatic (solenoid
only) 2.100 -0
..... **\$80.00 EA** ⚠

Starter Solenoid Repair Kit



1118135A **54-55**
Double Duty & 54-55
Hydromatic 2.100 -0.15
..... **\$25.00 EA** ⚠

Starter Solenoid Boot



1912448 **49-59**
Double duty model and
hydramatic 2.113 -0
..... **\$7.50 EA** ⚠

Insulator



1118135C **49-64**
Molded, keeps solenoid
cool. 2.100 -0.15
..... **\$16.75 EA** ⚠

Polarity Reverse Switch



1889827 **41-42**
On starter, w/ 1 in. x
1-1/2 in. base (NOS)
2.117 -0.4
..... **\$55.00 EA** ⚠



Polarity Reverse Switch, cont.



190712246-48
 On starter (NOS)
 2.117 -0.4
 **\$44.00 EA** ⚠

Polarity Reverse Switch Wiring Harness



188192941-48
 Wiring harness for
 reverse polarity
 switch. 2.122 -0.15
 **\$35.00 EA** ⚠

Starter Pedal Return Spring



365415237-54
 Return spring. 2.029 -0

. **\$3.99 EA** ⚠

Delco Remy Metal Tag



PLATE0737
 Generator, starter & distributor 19.400 -0.15
 **\$7.00 EA** ⚠



PLATE0538-54
 Generator, Starter or Distributor. Includes
 rivets. 19.400 -0.15 **\$7.00 EA** ⚠

Odds & Ends

Please call for availability on all Odds & Ends parts; once part is sold, it may no longer be in stock.

81355025-37
 Commutator end frame 25-37 Chevy. 26-29, 33-34 Pontiac 2.067 -0.4
 **\$15.00 EA** ⚠

184853234-37
 Spring Starter Motor 3.000 -0.4
 **\$10.00 EA** ⚠



1951 1/2-ton – Philippe Legrand



1954 & 2004 1/2-tons – Justin Wilder

040T



WARNING: Cancer and Reproductive Harm – www.P65Warnings.ca.gov

Chemicals shipped domestic ground only (Lower 48 states only). No international shipping.

Phone: (360) 816-0211 • (800) 999-CHEV (2438) • www.chevsofthe40s.com

**SECTION 045T
STREET ROD PARTS**

12 Volt Conversion Kits



12VKIT0137-54
Includes 63 amp alternator with 5/8" pulley, bracket & hardware, 10 AWG charge wire, coil, horn relay, headlight relay, fuel gauge voltage reducer, instructions. -0.15 **\$375.75 EA** ⚠



12VKIT0237-54
Includes 63 amp alternator with 3/8" pulley, bracket & hardware, 10 AWG charge wire, coil, horn relay, headlight relay, fuel gauge voltage reducer, instructions. -0.15 **\$375.75 EA** ⚠



12VKIT0337-54
Includes 100 amp alternator with 5/8" pulley, bracket & hardware, 10 AWG charge wire, coil, horn relay, headlight relay, fuel gauge voltage reducer, instructions. -0.15 **\$400.25 EA** ⚠



12VKIT0437-54
Includes 100 amp alternator with 3/8" pulley, bracket & hardware, 10 AWG charge wire, coil, horn relay, headlight relay, fuel gauge voltage reducer, instructions. -0.15 **\$400.25 EA** ⚠

12 Volt Conversion Kits, cont.

12VKIT0537-54
Includes 63 amp alternator with 5/8" pulley, bracket & hardware, 10 AWG charge wire, coil, starter solenoid, horn relay, headlight relay, fuel gauge voltage reducer, instructions. -0.15 **\$451.00 EA** ⚠

12VKIT0637-54
Includes 63 amp alternator with 3/8" pulley, bracket & hardware, 10 AWG charge wire, coil, starter solenoid, horn relay, headlight relay, fuel gauge voltage reducer, instructions. -0.15 **\$451.00 EA** ⚠

12VKIT0737-54
Includes 100 amp alternator with 5/8" pulley, bracket & hardware, 10 AWG charge wire, coil, starter solenoid, horn relay, headlight relay, fuel gauge voltage reducer, instructions. -0.15 **\$475.00 EA** ⚠

12VKIT0837-54
Includes 100 amp alternator with 3/8" pulley, bracket & hardware, 10 AWG charge wire, coil, starter solenoid, horn relay, headlight relay, fuel gauge voltage reducer, instructions. -0.15 **\$451.00 EA** ⚠

Alternator



89502CALL
6v-60 amp, 7.5v show chrome housing, 3/8" 2 groove pulley, internally regulated, comes w/ D.A. plug, uses original wiring,

new. 2.275-0

..... **\$296.50 EA** ⚠



89502SALL
6v-60 amp, 7.5v internally regulated, single groove 3/8" pulley.†(Rebuilt)
2.275-0

..... **\$255.00 EA** ⚠



905021ALL
10SI 12v, 63 Amp Internally Regulated With 3/8 "Pulley -0.15 **\$180.25 EA** ⚠

Alternator, cont.



905022ALL
CS130 12v, 100 Amp Internally Regulated With 3/8 "Pulley -0.15 **\$195.50 EA** ⚠



905023ALL
10SI 12v,Chrome Internally Regulated 1-Wire With 3/8 "Pulley -0.15 **\$170.25 EA** ⚠



905024ALL
10SI 12v,Chrome Internally Regulated 1-Wire With 5/8 "Pulley -0.15 **\$194.50 EA** ⚠



90502SALL
12v-60 amp, 14v internally regulated, simple two wire hookup, replace any 12v generator, comes with D.A. plug, new.
2.275-0.15 **\$245.00 EA** ⚠

PowerGen



82051ALL
Powermaster-PowerGen GM Long (90A,12V) Black -0.15 **\$425.00 EA** ⚠



82057ALL
Powermaster-PowerGen GM Long (60A,6V Neg Ground) Black -0.15 **\$435.00 EA** ⚠

PowerGen, cont.



82111ALL
Powermaster-PowerGen
GM Short (90A,12v)
Black 2.275 -0.15
..... **\$425.00 EA** ⚠



82117ALL
Powermaster-PowerGen
GM Short (60A,6V Neg
Ground) Black -0.15
..... **\$435.00 EA** ⚠

D.A. Plug



89502ALL
Connects 6v or 12v alternator to original
wiring. 2.275 -0.15 **\$19.75 EA** ⚠

Alternator Pulley



90502WP37-52
Fits 5/8 in. belt. 2.274 -0.15 **\$32.00 EA** ⚠



89502PALL
3/8" 2 groove.
2.274 -0.15
..... **\$37.50 EA** ⚠

Mount Bracket



839446B37-55
Universal alternator bracket. 2.277 -0.15
..... **\$90.00 EA** ⚠

839446D37-55
Alternator bracket. Mounting hardware
included. 2.277 -0.2 **\$76.00 KIT** ⚠

Mount Bracket, cont.



3714376B55-62
Alternator bracket (12v or 6v alt. 55-62
requires narrow pulley pump & 53-up
crank pulley). Mounting hardware
included. 2.277 -0.2 **\$73.75 EA** ⚠

3714376B55-62
Alternator bracket (12v or 6v alt. 55-62
requires narrow pulley pump & 53-up
crank pulley). Mounting hardware
included. 2.277 -0.2 **\$76.00 EA** ⚠

**Battery Minder Plus Battery
Charger**

Features:

Safely charges-maintains-conditions all
size/type/brands of starter, deep cycle,
maintenance-type, maintenance-free, sealed,
gelled, agm or dry-type batteries.
Charges and maintains from 1 to 4 batteries
(6 volt) at a time.
Automatically removes (dissolves) harmful
sulphation using safe, u.s. patented electronic
pulse technology.
Guaranteed to never overcharge any battery,
regardless of how long connected.
No need to add water to maintenance-type
batteries during long, non-use storage.
isolation transformer and smart chip
technology ensure safe, long-term
performance.
Splash-proof construction.
Allows battery to be stored safely at -0f to
+120f.
Unit comes complete with quick connect/
disconnect battery clips and a ring terminal
assembly (with easily replaceable fuse) for
permanent connection.



BM06VALL
6 Volt Charger. 2.332 -0.15
\$60.00 EA ⚠

Battery Jump Starter



GB40ALL
Compact, yet powerful 1,000 Amp lithium-
ion jump starter that delivers 7,000 Joules
of starting power. Its patented safety
technology features spark-proof
technology and reverse polarity protection
making it safe for anyone to use. Designed
for use with gas engines up to 6 liters and
diesel engines up to 3 liters and doubles
as a portable power source for recharging
smartphones, tablets and more. -0.15
..... **\$128.00 EA** ⚠



GB70ALL
The GB70 is a portable lithium-ion battery
jump starter pack that delivers 2,000-
amps (15,700 J3S) for jump starting a
dead battery in seconds. It features a
patented safety technology that provides
spark-proof connections and reverse
polarity protection making safe and easy
for anyone to use. It's a powerful battery
booster that doubles as a portable power
source for recharging USB devices, like a
smartphone, tablet and more, or powering
12-volt devices, like a tire inflator, power
inverter and much more. And designed for
a car, boat, RV, truck and more with gas
engines up to 8 liters, and diesel engines
up to 6 liters. -0.15 ... **\$258.00 EA** ⚠

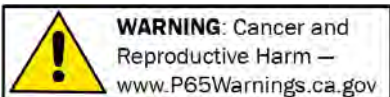

Chemicals shipped domestic ground only (Lower 48 states only). No international shipping.

Phone: (360) 816-0211 • (800) 999-CHEV (2438) • www.chevsofthe40s.com

Genius Battery Chargers



G1100.....ALL
1.1 Amp UltraSafe Smart Battery Charger

Charge fully drained lead-acid and lithium-ion batteries up to 40 amp-hour with zero overcharge - Stay safely connected 24/7.

Ultimate performance and versatility. Charge 6-volt and 12-volt batteries, recover damaged batteries, suitable for micro-hybrid start-stop vehicles and works with CANBUS electrical systems.

Ultra-compact, portable, energy-efficient design that's impact, UV and water-resistant (IP65).

Actively monitors battery for safe and efficient charging. Includes spark-proof technology and reverse polarity protection.

Advanced diagnostics automatically tests and detects a bad, damaged, or shorted battery. -0.15 .. **\$50.00 EA** ⚠



G3500.....ALL
3.5 Amp UltraSafe Smart Battery Charger

Charge fully drained lead-acid and lithium-ion batteries up to 120 amp-hour with zero overcharge - Stay safely connected 24/7.

Ultimate performance and versatility. Charge 6-volt and 12-volt batteries, recover damaged batteries, suitable for micro-hybrid start-stop vehicles and works with CANBUS electrical systems.

Ultra-compact, portable, energy-efficient design that's impact, UV and water-resistant (IP65).

Actively monitors battery for safe and efficient charging. Includes spark-proof technology and reverse polarity protection.

Advanced diagnostics automatically tests and detects a bad, damaged, or shorted battery. -0.15 .. **\$72.00 EA** ⚠

SECTION 045T RESTORATION PARTS

Generator



1102744.....40-52
10-1/2 in. long, 6v (\$75 core) - 5/8 in. belt pulley. To determine your generator size measure all the way to end of pulley. 2.275 -0.15 **\$194.75 EA** ⚠



1100024.....52-54
9-1/2 in. long, 6v (\$75 core). Narrow belt pulley. To determine your generator size measure all the way to the end of pulley. 2.275 -0.15 **\$195.00 EA** ⚠

Generator Rebuild Service

1100502.....29-54
Rebuild service for your generator 2.275 -0.15 **\$195.00 EA** ⚠

Generator Rebuild Kit



597667.....35-52
Pulley 2.274 -0.2 **\$39.50 EA** ⚠



1901243.....40-54
W/ brushes, gaskets, etc. (41 pcs). Pulley end bearing #954378 not included. 2.286 -0 **CALL** ⚠

Generator Brush Set



1857963.....37-39
3 pieces 2.285 -0.2 **\$9.75 SET** ⚠



1878209.....40-54
2 pieces 2.285 -0.3 **\$6.99 SET** ⚠

Generator Bearing



954378.....29-57
Pulley end 2.306 -0.2 **\$7.50 EA** ⚠



954685.....53-57
Commutator end 2.298 -0.15 **\$12.00 EA** ⚠

Generator Bushing



812823.....29-48
Commutator end 2.298 -0.4 **\$4.00 EA** ⚠



812824.....49-52
Commutator end 2.298 -0.4 **\$3.29 EA** ⚠

Generator Oil Cover



816341.....29-54
Metal, as original. 3/16 in. o.d. insert 2.305 -0.15 **\$4.00 EA** ⚠

Generator Band



816340.....29-52
Covers opening in generator. 2.299 -0.3 **\$8.50 EA** ⚠

Section 045T: Alternators, Generators, Voltage Regulators, Batteries, Battery Trays & Battery Cables

Generator Bolt & Nut



3682642B**37-54**
Set (generator to motor)
2.277 -0.15
..... **\$5.25 SET** ⚠

Delco Remy Metal Tag



PLATE07 **37**
Generator, starter & distributor 19.400 -0.15
..... **\$7.00 EA** ⚠



PLATE05 **38-54**
Generator, Starter or Distributor. Includes rivets. 19.400 -0.15
..... **\$7.00 EA** ⚠

Belt



3680776 **37-52**
For fan & generator
1.066 -0.15
..... **\$18.50 EA** ⚠

2190650 **39-53**
For fan & generator. Fits GMC. 8.033 -0.2
..... **\$7.00 EA** ⚠

3713313 **53-54**
For fan & generator 1.066 -0.15
..... **\$7.00 EA** ⚠

2304817 **54**
For fan & generator. Fits GMC. 1.066 -0.2
..... **\$9.00 EA** ⚠

Voltage Cut Out



1867781 **29-39**
Car and truck except COE 2.319 -0.3
..... **\$78.75 EA** ⚠

Voltage Regulator



1118301A **40-52**
35 Amp 6 Volt 2.500 -0.15
..... **\$125.00 EA** ⚠



1118331 **53-54**
45 Amp 6 Volt 2.500 -0.15
..... **\$69.75 EA** ⚠

Battery Tray



594062 **37-46**
Metal tray only. 2.333 -0.2
..... **\$45.00 EA** ⚠



594062A **37-46**
Metal tray w/ attaching brackets.
2.333 -0.15
..... **\$69.50 EA** ⚠



3683563 **47-54**
Base only. 2.333 -0.15
..... **\$16.00 EA** ⚠

Battery Tray, cont.



3683559 **47-55**
Complete with sides and studs. 2.333 -0.15
..... **\$57.00 EA** ⚠

Battery Hold Down



3653224 **47-54**
This is a battery hold down. 2.335 -0.15
..... **\$17.25 EA** ⚠



3653224A **ALL**
Adjustable for 9-3/16" X 7-3/16", 10-3/4" X 7-3/16" batteries -0.3
..... **\$16.25 EA** ⚠

Battery Cover



354120 **29-38**
Inspection cover in floor. 4-1/2" x 8"
16.547 -0.15
..... **\$19.75 EA** ⚠

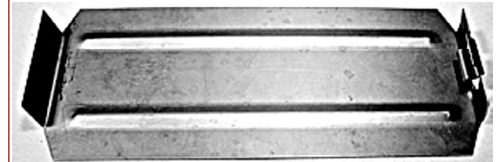

3652966 **39-46**
Inspection cover in floor. 4-1/2" x 10".
16.547 -0.15
..... **\$25.00 EA** ⚠



WARNING: Cancer and Reproductive Harm —
www.P65Warnings.ca.gov

Chemicals shipped domestic ground only (Lower 48 states only). No international shipping.

Phone: (360) 816-0211 • (800) 999-CHEV (2438) • www.chevsofthe40s.com

045T

Battery Mat



3686708BALL
Anti-corrosion pad to protect your battery tray. 7 3/4" X 12" x 1/8" thick. 2.333 -0.3 **\$15.25 EA** ⚠

Battery Cover Gasket

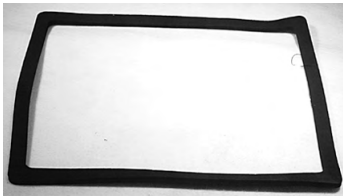

3683383A47-54
Battery inspection cover. 16.547 -0.15 **\$6.00 EA** ⚠

Battery Tray Paint



12998ALL
Battery tray Corrosion resistant, black (12 oz spray). 8.800 -0.15 **\$10.25 EA** ⚠

Ground Strap



529404A29-54
13in. 2.341 -0.15 **\$17.00 EA** ⚠



529404N29-54
13in. 2.341 -0 **\$25.00 EA** ⚠



60238747-54
Engine to frame. 9.650 -0.15 **\$12.00 EA** ⚠

Positive Cable



185407329-46
Fabric covered 25-1/4 in. 2.342 -0.15 **\$52.50 EA** ⚠



528894647-54
Fabric covered 39-1/2 in. 1/0 Wire. 1947-54 and 1955 1st Series Trucks. 2.342 -0.15 **\$57.00 EA** ⚠

Battery Terminal Cleaner



10653CLNR ...ALL
For Top Post Batteries. -0.15 **\$9.25 EA** ⚠

Odds & Ends

0094052-54
Battery Filler Cap Accessory. Save A Battery 2.332 -0.4 **\$35.00 SET** ⚠

0099157
Generator 12 volt rebuilt 3.000 -0.3 **\$200.00 EA** ⚠

SECTION 050T STREET ROD PARTS

Ignition Coil Pertronix 6 Volt



PER40001ALL
6 Volt Chrome. 1.5 Ohm primary resistance. 2.384 -0.15 **\$55.00 EA** ⚠



PER40011ALL
6 Volt Black. 1.5 Ohm primary resistance. 2.384 -0.15 **\$58.00 EA** ⚠

Ignition Coil Pertronix 12 Volt



PER40501ALL
12 Volt Chrome. 3.0 Ohm primary resistance. 2.384 -0.15 **\$56.25 EA** ⚠



PER40511ALL
12 Volt Black. 3.0 Ohm primary resistance. 2.384 -0.15 **\$48.00 EA** ⚠

Ballast Resistor



1931614ALL
For 12v (coil). 2.173 -0.2 **\$13.50 EA** ⚠

HEI Distributor & Wires



PED62720ALL
Chevy 6cyl 1949-62 216,235,261ci. DUI electronic Distributor 50,000 volt coil & Dyna-Module allows wider plug gaps & instant throttle response. Add a set of

Livewires to go with your electronic distributor. 0.000 -0.15 **\$394.00 EA** ⚠

HEI Distributor & Wires, cont.



PEDC9066-EALL
Chevy in-line 6 cyl., Black 0.000 -0.15 ..
\$94.75 SET ⚠

Wire Looms



5298107LALL
Chrome. Fits 216ci, 235ci. 0.000 -0.15 ..
\$29.00 SET ⚠

Pertronix Electronic Ignition System



1112362E1240-53
Chevy 6cyl. 12v. 2.384 -0.15 ..
\$148.75 SET ⚠



1112362E640-53
Chevy 6cyl. 6v. 2.384 -0 .. **\$123.00 SET**
⚠



1112388E1254-62
Chevy 6cyl. 12v. 2.384 -0.15 ..
\$160.25 EA ⚠

Pertronix Electronic Ignition System, cont.



1112388E654-62
Chevy 6cyl. 6v. 2.384 -0.15 ..
\$153.75 EA ⚠

SECTION 050T RESTORATION PARTS

Ignition Coil

111538047-54
6v, Delco (NOS) 2.170 -0 .. **CALL** ⚠



1115380A47-54
6v, replacement 2.170 -0.15 ..
\$49.00 EA ⚠



111509147-59
12v 2.170 -0.15 .. **\$23.25 EA** ⚠

Distributor



111236240-53
Exc 53 powerglide (\$40 core) 2.361 -0.2 ..
\$100.00 EA ⚠

111235853-57
Exc 53 stick shift (\$35 core) 2.361 -0.2 ..
\$100.00 EA ⚠

Points



185572033-40
2-1/8 in. overall length
2.384 -0.15 ..
\$12.25 SET ⚠

Points, cont.



188239141-48
With polarity reversing
switch (1-3/4 in. overall
length) 2.384 -0.15



..... **\$15.50 SET** ⚠
185572048-53
All (exc 48 w/ polarity
reversing switch & 53
235ci) 2-1/8 in. overall
length. 2.384 -0.15



..... **\$12.25 SET** ⚠
192457153-57
All (exc 216ci)
2-3/16 in. overall
length. 2.384 -0.15
..... **\$16.50 SET** ⚠

Condenser



192811137-54
Ignition 2.393 -0.15
..... **\$8.00 EA** ⚠

Hold Down Screw



816784ALL
Condenser & points
2.387 -0.4
..... **\$1.50 EA** ⚠

Rotor



82044533-52
All exc CC, DC & 53
235ci 2.382 -0.15
..... **\$10.00 EA** ⚠



192424553-57
All, exc 53 216ci
2.382 -0.15
..... **\$9.00 EA** ⚠

Distributor Cap



82473533-53
Except 53 235ci 2.364 -0.15 ..
\$15.25 EA ⚠



WARNING: Cancer and Reproductive Harm —
www.P65Warnings.ca.gov

Chemicals shipped domestic ground only (Lower 48 states only). No international shipping.

Phone: (360) 816-0211 • (800) 999-CHEV (2438) • www.chevsofthe40s.com

Distributor Cap, cont.



1924248**53-54**
With 235ci, 261ci 2.364 -0.15
\$26.50 EA ⚠

Delco Remy Metal Tag



PLATE07**37**
Generator, starter & distributor 19.400 -0.15
..... **\$7.00 EA** ⚠



PLATE05**38-54**
Generator, Starter or Distributor. Includes
rivets. 19.400 -0.15 **\$7.00 EA** ⚠

Vacuum Advance

\$10 shipping & handling fee for rebuild
service.



1116076R**37-54**
Rebuild service (we rebuild your core)
2.410 -0.15 **\$86.50 EA** ⚠



1909343A**39-55**
W/ bracket & timing
mark 90 degrees to
vacuum chamber. exc
261 2.410 -0.15
..... **\$38.50 EA** ⚠

Spark Plug Wire Set



5298107**34-54**
Superb reproduction w/ GM stamped on
metal ends. Copper core. 2.239 -0.15
..... **\$39.75 SET** ⚠

O-Rings



3652191**29-59**
Rubber, holds plug
wires. 1-5/16 in. o.d.,
3/4 in. i.d. 2.251 -0.4
..... **\$2.50 SET** ⚠

Spark Plugs



1559494**33-54**
Genuine AC 14 mm
plug (exc 41-48) (6 pcs)
2.270 -0.15
..... **\$23.25 SET** ⚠



1559459**41-48**
Genuine AC 10 mm plug
(6 pcs) 2.270 -0.15
..... **\$22.75 SET** ⚠

Polarity Reverse Switch



1889827 ... **41-42**
On starter, w/ 1 in. x
1-1/2 in. base (NOS)
2.117 -0.4
..... **\$55.00 EA** ⚠



1907122 ... **46-48**
On starter (NOS)
2.117 -0.4
..... **\$44.00 EA** ⚠

**Polarity Reverse Switch Wiring
Harness**



1881929 ... **41-48**
Wiring harness for
reverse polarity
switch. 2.122 -0.15
..... **\$35.00 EA** ⚠

Timing Hole Plug



836802A**ALL**
Rubber (rare) 0.714 -0.15
..... **\$7.75 EA** ⚠

Ignition Switch



1116452**40-54**
Bolt-in replacement, w/ "Start" &
"Accessory" positions - keeps original
appearance (6v or 12v) Needs original
& lock cylinder '35-'57 trucks (#1458180)
or '47-'48 trucks (#3716725) -not
included. 2.188 -0.15 **\$44.00 EA** ⚠



1116452T**47-53**
Reproduction. Bolts in like original. Screw
terminal. Foot starter & push button only.
2.188 -0.15 **\$37.50 EA** ⚠



1116469D**51-52**
As original for 1951-52 car (no accessory
position). Fits 1954-55 (1st Series) Chevy
truck also. 2.188 -0.15 **\$45.00 EA** ⚠



1116452A**ALL**
Using a fork lift ignition switch? Use our
flush mount switch w/ mounting bracket.
Keep original appearance use lock
cylinder #1458180 or #3716725
(including keys). 2.188 -0.15
..... **\$45.00 SET** ⚠

Ignition Switch Mounting Bracket



Faces rear of truck

3684097**47-53**
 Mounting bracket (behind dash). Chevy & GMC 2.192-0.15 **\$23.50 EA** ⚠

Ignition Switch Mounting Plate



3688155**ALL**
 Universal mounting plate conforms to your dash to mount your switch (cylinder not included). 2.192-0.3 **\$9.50 EA** ⚠

Ignition Lock



1458180**35-57**
 Cylinder & non-GM keys (Exc. 1947-48). 2.188-0.15 **\$14.00 EA** ⚠



3716725**47-48**
 Cylinder & keys (non GM). 2.188-0.15 **\$17.75 EA** ⚠

Key Blank



601272**35-54**
 Original GM round head. Fits trunk, glove box & locking gas cap

2.187-0.2 **\$4.00 EA** ⚠



3694624**35-57**
 Original GM octagon head. Fits ignition, door & spare tire locks.

2.187-0.15 **\$2.50 EA** ⚠

Odds & Ends

Please call for availability on all Odds & Ends parts; once part is sold, it may no longer be in stock.

1853749U**33-34**
 Electric lock cable (no key cylinder) 2.188-0.4 **\$50.00 EA** ⚠

1847432**34-37**
 Armature (Starter) All exc Dc 2.279-0.4 **\$42.00 EA** ⚠

00875**38-51**
 Ignition Coil NOS GMC w/ Fins 2.170-0.4 **\$50.00 EA** ⚠

1855520**39-48**
 Points 6.168-0.4 **\$15.00 EA** ⚠

1112362U**40-53**
 Distributor with points and cond (Used). 2.361-0.4 **\$75.00 EA** ⚠

1112363**51-52**
 Distributor, w/o contact plate (NOS) 2.361-0.4 **\$75.00 EA** ⚠

1869573 **57**
 Bracket, Holds Condensor 8cyl Use w/ # 1112330 (NOS) 2.393-0.15 **\$2.00 EA** ⚠

SECTION 055T STREET ROD PARTS

Horns



HORN3**ALL**
 Oogah horn. Heavy duty 12 volt motor. Easy installation. Limited lifetime warranty. 2.810-0.2



46128**ALL**
 Wolf Whistle. Designed as Original. Works Reliably. Die Cast Metal with all Metal Hardware.

Classic Wolf Sound. Has Strong Vacuum Hose and Instructions. -0.15 **\$59.00 EA** ⚠

SECTION 055T RESTORATION PARTS

Steering Wheels



755896**41-46**
 Black. Original in 41-45. Fits 36 spline 3/4" shaft. 6.513-0.15 **CALL** ⚠



755896BR**41-46**
 Brown. Original for 1946. 6.513-0.15 **\$196.75 EA** ⚠



756084A**47-53**
 Black. Superior quality. Shaft size: 11/16", 36 splines. Chevy & GMC 6.513-0.15 **CALL** ⚠



WARNING: Cancer and Reproductive Harm – www.P65Warnings.ca.gov

Chemicals shipped domestic ground only (Lower 48 states only). No international shipping.

Phone: (360) 816-0211 • (800) 999-CHEV (2438) • www.chevsofthe40s.com

050T

Steering Wheels, cont.



758625A **54**
 Black. Superior quality, beautiful finish.
 Chevy & GMC 6.513-0.15 **\$234.50 EA** ⚠

Horns



9000518 **40-54**
 W/ relay, 12v (pair). 2.810-0.15
\$69.00 SET ⚠

Horn Contact



265316 **41-46**
 W/ spring. Fits COE
 only. 2.819-0
 **CALL** ⚠

Horn Button Contact



270751 **47-53**
 Horn Button Brush With
 Spring 2.819-0.15
 **\$10.00 EA** ⚠



759037 **47-57**
 Contact w/ spring. Fits
 49-57 cars (& Corvette),
 37-57 Comm & Util. 2.819-0.15
 **\$6.50 EA** ⚠

Horn Contact Plate



758239 **47-53**
 Horn button snaps over
 this plate. 2-5/8" O.D.,
 9/16" I.D 2.819-0.15
 **\$20.00 EA** ⚠



758566 **54-59**
 Horn button snaps over.
 2-1/2" O.D., 9/16" I.D.
 2.819-0
 **\$24.50 EA** ⚠

Cup W/ Chrome Rim



473258 **29-40**
 For horn button.
 2.819-0.15
 **CALL** ⚠

Horn Button Assembly



753838 **29-40**
 S-wire, rubber button & metal cap.
 2.817-0.15 **\$62.00 SET** ⚠

Horn Button S-wire



753838B **29-40**
 This is a S-wire that
 locates in the horn
 button 2.817-0.15
 **\$8.75 EA** ⚠

Horn Button



753838C **29-40**
 Metal cap on rubber
 horn button. 2.817-0.15
 **\$10.00 EA** ⚠



124934 **34-46**
 Steering Wheel
 Retaining Nut 6.515-0.15
 **\$1.00 EA** ⚠

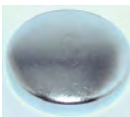

609620 **41-46**
 Horn Button 41-46
 Chevrolet and GMC
 trucks. 2.817-0.15
 **\$36.00 EA** ⚠



755850 **47-53**
 Chrome & painted.
 2.820-0.15
 **\$49.50 EA** ⚠



3720100 **54**
 Chrome & painted.
 2.820-0.15
 **\$55.00 EA** ⚠

Horn Button Spring



755284 **41-46**
 This is a horn button
 spring. 2.816-0.2
 **\$8.00 EA** ⚠

Horn Relay



1116775A **34-54**
 6v, replacement.
 2.815-0.2
 **\$15.00 EA** ⚠



1116775B **ALL**
 12v 2.815-0.15
 **\$15.50 EA** ⚠

Wire Pigtails



1860035B **53-54**
 On horn, cloth covered.
 2.814-0.15
 **\$12.00 EA** ⚠

Bushing w/ Horn Wire



1854761 **31-40**
 Bushing under steering
 wheel w/ horn wire.
 Also fits 36-40 GMC
 6.521-0
 **\$62.25 EA** ⚠

Bearing w/ Horn Wire



264887 **41-46**
 Bearing under steering
 wheel, w/ horn wire.
 6.521-0.15
 **\$23.00 EA** ⚠



270255 **47-54**
 Bearing under steering
 wheel, w/ horn wire.
 Chevy & GMC 6.521-0.15
 **\$48.00 EA** ⚠

Horn Wire Grommet



9000516 **40-54**
 Horn wire thru horn
 cover (2 pcs). 2.810-0.3
 **\$5.00 SET** ⚠



3711896 **41-46**
 Horn wire thru steering
 column. 9.775-0
 **\$4.49 EA** ⚠

Horn Button Retainer



754102 **41-46**
 Horn button retainer
 Chevrolet and GMC
 2.820-0.15
 **\$33.50 EA** ⚠

**SECTION 060T
STREET ROD PARTS**

**Main Wire Harness Street Rod
Route 9**



510625.....ALL
Route 9 Universal
Wiring System from
American Autowire. We
often receive requests

for a basic, or smaller sized, complete
wiring system, and this kit is designed
just for that market. -0.15

..... **\$289.00 EA** ⚠

**Main Wire Harness Street Rod (Hwy
15)**

HIGHWAY 15 "STREET ROD" WIRING KIT.
This is a complete fuse panel and full wiring
kit.

- Developed to handle the most demanding
power requirements and accessories.
- Longer coils of wire so you can place the fuse
box where YOU want it.



13237.....ALL
American Autowire Highway 15-Street Rod
Wire Harness 8.055 -0.15 **\$439.00 KIT**
⚠

**Main Wire Harness Street Rod (Hwy
15-Nostalgia)**



500944.....ALL
American Autowire Highway 15-Nostalgia
(Braided & Lacquered Wiring Kit) -0.15
..... **\$1,399.00 KIT** ⚠

**Main Wire Harness Street Rod (Hwy
22)**

The Highway 22 Panel packs all of the punch
of a high-powered OEM system into a smaller,
easy-to-install and extremely compact front
loading package. The components used in
this panel far exceed the power handling
capabilities of any other manufacturer's
system. Easy clamp-style system makes
adding and removing wires easy! No Terminals!
No Crimping! No Screws! Each Highway
Series wiring kit comes with complete, easy to
understand instructions to guide you through
every step.



500695.....ALL
Includes modern fuse box, instruction
sheet, dash harness, instrument cluster
kit, parking lamp kit, rear body kit, power
plus front lighting kit, engine & starter kit,
courtesy light connection kit, fuse relay
flasher kit, ignition switch, headlight
switch, dimmer switch and wire ties.
2.555 -0.15 **\$519.00 KIT** ⚠

**Main Wire Harness Street Rod
Truck**

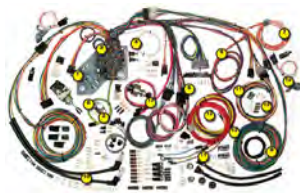

2960053SR47-55
For 1947-55 Chevy Trucks. Built on the
new 18 fuse, 21 circuit fuse box system,
kit comes completely ready to install under
the dash. Includes modern fuse box,
instruction sheet, dash harness,
instrument cluster kit, parking lamp kit,
rear body kit, power plus front lighting kit,
engine & starter kit, courtesy light
connection kit, fuse relay flasher kit,
ignition switch, headlight switch, dimmer
switch and wire ties. 2.555 -0.15
\$619.00 SET ⚠

Custom Wiring Harness



CK-540.....ALL
Converts your stock 6 volt engine to 12
volt or upgrade your existing 12 volt. -0.15
..... **\$421.00 SET** ⚠

Basic Auto Electricity Book

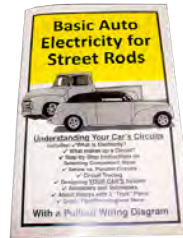

WASBAEB.....ALL
Contains sections
on: What is
Electricity? Covers
the battery,
alternator, voltage
regulator, grounding
and fuses, designing
a simple circuit &
more including.

Circuit Diagram, Ammeter and Volt Meter
usage. A full 48 pages plus Fold out
Circuit Diagram and 8-1/2" x 14" Pullout
Wiring Diagram to remove and customize
to match your own car's circuits.
0.000 -0.15
..... **\$11.00 EA** ⚠

Clamp



120521A.....ALL
5/16 in, insulated
bolt-on strap. For wire
or tube (4 pcs).

8.950 -0.4 **\$3.29 SET** ⚠

**SECTION 060T
RESTORATION PARTS**

Main Wire Harness Chevrolet

Note: Our cloth-covered wiring harnesses
below are superb reproductions with braided
harness cover and numbered ends for easy
installation.

Note: Turn signals are located in Section 80T.

Some 1953 & all 1954 trucks used plastic
wiring harnesses.



186531537-38
Original cloth 2.555 -0 **\$537.00 EA** ⚠

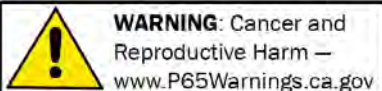

Chemicals shipped domestic ground only (Lower 48 states only). No international shipping.

Phone: (360) 816-0211 • (800) 999-CHEV (2438) • www.chevsofthe40s.com

Section 060T: Wiring Harness, Wiring Clips, Terminal Boards

Main Wire Harness Chevrolet, cont.

1872970	39
Original cloth 2.555 -0	
.....	\$523.00 EA ⚠
1872970A	39
Original cloth (fits fire truck, commercial, etc.) 2.555 -0.15	
.....	\$523.00 EA ⚠
1879561	40
Original cloth 2.555 -0.15	
.....	\$725.00 EA ⚠
4284502	41-46
Original cloth 2.550 -0.15	
.....	\$762.75 EA ⚠
4188864	47-49
Original cloth 2.555 -0	
.....	\$815.00 EA ⚠
5299874	50-53
Original cloth 2.555 -0.15	
.....	\$815.00 EA ⚠

Main Wire Harness GMC

Some 1953 & all 1954 trucks used plastic wiring harnesses.

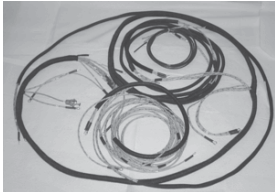

1865315G	37
GMC, original cloth, special order 2.555 -0.15	
.....	\$765.00 EA ⚠
1879561G	40
GMC, original cloth, special order 2.555 -0.15	
.....	\$872.00 EA ⚠
4284502G	41
GMC, original cloth, special order 2.555 -0.15	
.....	\$872.00 EA ⚠
5284496G	46
GMC, original cloth, special order 2.555 -0.15	
.....	\$667.00 EA ⚠
4188864G	47-49
GMC, original cloth, special order 2.555 -0.15	
.....	\$872.00 EA ⚠
5299874G	50-52
GMC, original cloth, special order 2.555 -0.15	
.....	\$817.00 EA ⚠
5299874A	53
GMC, original cloth, special order 2.555 -0.15	
.....	\$944.19 EA ⚠

Main Wire Harness Replacement Chevrolet

Note: Plastic wiring harnesses include turn signal harness.



1865315P	37-39
Plastic, generator. W/ voltage contact. 2.555 -0	
.....	\$235.00 EA ⚠
1865315PV	37-39
Plastic, alternator 2.555 -0	
.....	\$243.25 EA ⚠
4284502P	40-46
Plastic, generator 2.555 -0.15	
.....	\$298.00 EA ⚠
4284502PV	40-46
Plastic, alternator 2.555 -0	
.....	\$235.00 EA ⚠
4188864P	47-49
Plastic, generator 2.555 -0.15	
.....	\$179.50 EA ⚠
4188864PV	47-49
Plastic, alternator 2.555 -0.15	
.....	\$179.50 EA ⚠
5299874P	50-52
Plastic, generator 2.555 -0.15	
.....	\$179.50 EA ⚠
5299874PV	50-52
Plastic, alternator 2.555 -0.15	
.....	\$179.50 EA ⚠
2960053P	53-54
Plastic, generator 2.555 -0.15	
.....	\$179.50 EA ⚠
2960053PV	53-54
Plastic, alternator 2.555 -0.15	
.....	\$179.50 EA ⚠

Main Wire Harness Replacement GMC

Note: Order GMC wire harnesses when you want to add electric temperature and oil pressure gauges to your Chevrolet truck.

1865315T	37-39
Plastic, GMC, generator 2.555 -0	
.....	\$235.00 EA ⚠
1865315TV	37-39
Plastic, GMC, alternator 2.555 -0	
.....	\$243.25 EA ⚠
4284502T	40-46
Plastic, GMC, generator 2.555 -0.15	
.....	\$298.00 EA ⚠

Main Wire Harness Replacement GMC, cont.

4284502TV	40-46
Plastic, GMC, alternator 2.555 -0	
.....	\$235.00 EA ⚠
4188864T	47-49
Plastic, GMC, generator 2.555 -0.15	
.....	\$210.00 EA ⚠
4188864TV	47-49
Plastic, GMC, alternator 2.555 -0.15	
.....	\$215.00 EA ⚠
5299874T	50-52
Plastic, GMC, generator 2.555 -0.15	
.....	\$210.00 EA ⚠
5299874TV	50-52
Plastic, GMC, alternator 2.555 -0.15	
.....	\$215.00 EA ⚠
2960053T	53-54
GMC, plastic, w/ generator 2.555 -0.15	
.....	\$212.59 EA ⚠
2960053TV	53-54
GMC, plastic, w/ alternator 2.555 -0.15	
.....	\$215.00 EA ⚠

Headlight Pigtails

Note: Turn signals are located in Section 80T.



918977	37-39
Exc COE 2.750 -0.15	
.....	\$66.00 PR ⚠
5931796	41-46
And park light 2.750 -0.15	
.....	\$76.75 SET ⚠



5942312	47-55
W/ grommets 2.750 -0.15	
.....	\$83.00 PR ⚠

Returns require a return authorization number—call first. • Product pricing & availability subject to change.



WARNING: Cancer and Reproductive Harm —
www.P65Warnings.ca.gov

Terminal Boards



2-3/8" center to center

1865535 **40-53**
 (3 terminal) main wiring to headlight & park light pigtails w/ rivets. Mounting holes: 2-3/8" center-to-center. 2.560 -0.15
 **\$22.00 PR** ⚠



3" center to center

1998756 **40-54**
 (4 terminal) main wiring to headlight & park light pigtails w/ rivets. Mounting holes: 3" center-to-center. 2.560 -0.15
\$28.00 PR ⚠

Heater Harness



3106048B... **37-49**
 Heater & defroster wiring harness
 8.853 -0.15
 **\$66.00 EA** ⚠

Horn Harness



1997713A... **37-42**
 Town & Country horn
 2.832 -0.15
 **\$96.25 EA** ⚠



1860035B **53-54**
 On horn, cloth covered.
 2.814 -0.15
 **\$12.00 EA** ⚠

Polarity Reverse Switch Wiring Harness



1881929... **41-48**
 Wiring harness for reverse polarity switch. 2.122 -0.15
 **\$35.00 EA** ⚠

Transmission Wire Harness GMC



5299874B..... **53**
 GMC, for hydramatic original cloth, special order 2.555 -0.15
 **\$197.00 EA** ⚠

Wire Loom



1846572 **ALL**
 Black, original hard cover to protect wiring, 1/4 in. i.d. 2.530 -0.2 **\$2.00 FT** ⚠

1846573 **ALL**
 Black, original hard cover to protect wiring, 3/8 in. i.d. 2.530 -0.15
 **\$1.50 FT** ⚠

1846574 **ALL**
 Black, original hard cover to protect wiring, 5/16 in. i.d. 2.530 -0.15
 **\$1.50 FT** ⚠

1846575 **ALL**
 Black, original hard cover to protect wiring, 7/16 in. i.d. 2.530 -0.15
 **\$2.00 FT** ⚠

1846576 **ALL**
 Black, original hard cover to protect wiring, 1/2 in. i.d. 2.530 -0.15
 **\$2.00 FT** ⚠

Wire



985776A..... **ALL**
 Armored steel covered. 9.773 -0.3 **\$0.75 IN** ⚠

985777W..... **ALL**
 Lacquer coated braided, white. 9.773 -0.2
 **\$0.25 IN** ⚠

Clip



148129..... **ALL**
 (1/2 in. Slot) wiring or tubing (4 Pcs) 8.950 -0.15

..... **\$9.50 SET** ⚠



3735074A..... **ALL**
 1/8 in. slot, wiring or tubing (4 pcs) 8.950 -0

..... **CALL** ⚠



3735074C..... **ALL**
 3/8 in. slot, gas, brake line, wire harness (4 pcs). 8.950 -0.15

..... **\$6.50 SET** ⚠

Aluminum Bundle Straps



13196..... **ALL**
 .25" W X 4.05" L
 Used to bundle wires or hoses. -0.2
\$4.00 EA ⚠



13197..... **ALL**
 .25" W X 7.15 L"
 Used to bundle wires or hoses -0.2
\$5.00 EA ⚠

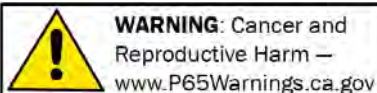

WARNING: Cancer and Reproductive Harm —
www.P65Warnings.ca.gov

Chemicals shipped domestic ground only (Lower 48 states only). No international shipping.

Phone: (360) 816-0211 • (800) 999-CHEV (2438) • www.chevsofthe40s.com

**SECTION 080T
STREET ROD PARTS**

Turn Signal Flasher LED



3713382L.....ALL
12V. For use w/ LED lights (3 prong). Low load . 2.892 -0.15
..... **\$13.75 EA** ⚠



3713382L2.....ALL
12v. For use w/ LED lights (2 prong). Low load. 2.892 -0.15
..... **\$17.75 EA** ⚠



FF552NL.....ALL
12v. For use w/ LED lights (2 prong). Adjustable blinker speed. 2.892 -0.15
..... **\$40.00 EA** ⚠



FF552NLF.....ALL
12v. For use w/ LED (2 prong). Fixed blinker speed. 2.892 -0.15
..... **\$10.25 EA** ⚠



FF552NLP.....ALL
12v. For use w/ LED (2 prong). Fully adjustable PULSING blinker speed control. 2.892 -0.15
..... **\$51.25 EA** ⚠

LED Bulbs

Note: LEDs are very directional and need to be angled correctly to be bright. Minimal current draw.



145416ALED6A...ALL
6V Amber, offset pins. Replaces bulb #1154. 8.991 -0.2
..... **\$10.00 EA** ⚠



145416J.....ALL
12V Amber, offset pins. Replaces bulb #1157. Use LED flasher #3713382L. 8.991 -0
..... **CALL** ⚠



145416K.....ALL
12v Amber, straight pins. Replaces bulb #1156. Use LED flasher #3713382L. 8.991 -0.15
..... **\$12.25 EA** ⚠



145416LED6A...ALL
6V Amber, straight pins. single contact Replaces bulb #1156. 8.991 -0.15
..... **\$14.00 EA** ⚠

**SECTION 080T
RESTORATION PARTS**

Park Light Assembly



595825.....37-39
Retainer plate & wire guide for park light 2.585 -0.15
..... **\$21.00 L&R** ⚠



916957.....37-39
Accessory. Complete assembly, 12v 2.585 -0.15
..... **\$90.00 EA** ⚠



916957T.....37-39
Accessory. Complete with turn signal. 12v 2.585 -0.15
..... **\$102.25 EA** ⚠



928664.....47-53
Amber, 12v, double element bulb for turn signals. 2.585 -0.15
..... **\$38.00 EA** ⚠

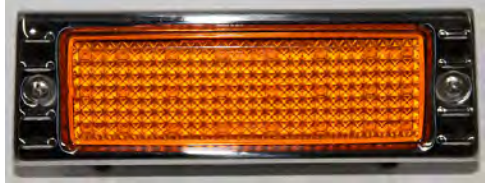

928664L.....47-53
LED Amber, 12v, dual function for park and turn signals. 2.585 -0.15
..... **\$60.00 EA** ⚠



928665.....47-53
Clear, 6v. 2.585 -0.15
..... **\$35.00 EA** ⚠

Park Light Assembly, cont.

928665B.....47-53
Clear, 12v, double element bulb for turn signals. 2.585 -0.15
..... **\$35.00 EA** ⚠



897429.....54-55
55 1st series. 2.585 -0.15
..... **\$39.50 EA** ⚠

Park Light Mounting Pads



603313.....37-39
Park light to fender (2 pcs) 2.599 -0.15
..... **\$21.00 PR** ⚠



3650817.....40
Park light to fender 2.599 -0.15
..... **\$6.00 PR** ⚠



917012.....41-42
Park light w/ die cast base. 2.599 -0.15
..... **\$10.50 PR** ⚠



5932996A.....42-46
Park light w/ 1 pc tin cover (2 pcs). 2.599 -0.15
..... **\$10.50 PR** ⚠



5936003G.....47-50
GMC park light (2 pcs). 2.599 -0.2
..... **\$5.25 PR** ⚠



5936003F.....52-53
GMC park light (2 pcs). 2.599 -0.15
..... **\$12.50 PR** ⚠

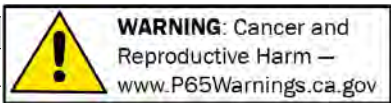

Park Light Mounting Pads

897429A..... 54
Park light to fender.
2.599 -0.15
..... **\$10.50 PR** ⚠

Park Light Rim

5930230..... 40
Stainless 2.593 -0.15
..... **\$29.75 EA** ⚠

5936795..... 47-53
Chrome. 2.593 -0.15
..... **\$10.00 EA** ⚠

Park Light Rim Screws

923315..... 40
Stainless steel (2 pcs)
2.688 -0.4
..... **\$0.75 SET** ⚠

5942152..... 47-53
4 pcs. 2.594 -0.4
..... **\$1.49 SET** ⚠

Park Light Lens

920249..... 37-39
Accessory Glass
2.589 -0.15
..... **\$18.00 EA** ⚠

924854..... 40
Glass 2.589 -0.3
..... **\$24.00 EA** ⚠

5930136P 41-42
Plastic, 4in. long for die
cast housing. 2.589 -0.15
..... **\$19.00 EA** ⚠

5932977..... 42-46
2in. long for tin cover
housing. 2.589 -0.15
..... **\$13.25 EA** ⚠

5936802G 47-50
GMC 2.589 -0.15
..... **\$17.00 EA** ⚠

5936801..... 47-53
Amber, glass. 2.589 -0.15
..... **\$10.00 EA** ⚠

5936801L..... 47-53
LED Amber lens, plastic.
12 Volt 2.589 -0.15
..... **\$29.75 EA** ⚠

5936802..... 47-53
Clear, glass lens.
2.589 -0.2
..... **\$9.00 EA** ⚠

Park Light Lens, cont.

5935955..... 51-53
GMC (glass). 2.589 -0.15
..... **\$12.00 EA** ⚠

5942151..... 54
Clear 2.589 -0.15
..... **\$6.25 EA** ⚠

5942151A 54
Amber 2.589 -0.15
..... **\$8.00 EA** ⚠

Park Light Lens Gasket

922758..... 40
This is the parking light
lens gasket. It will keep
moisture and dirt out
and will help prevent rattles. Sold as a
pair. 2.590 -0.15
..... **\$3.25 PR** ⚠

5930153..... 41-42
4 in. Long. 2.590 -0.2
..... **\$4.75 PR** ⚠

5932999..... 42-46
2-3/16 in. long (2 pcs).
2.590 -0.3
..... **\$5.00 PR** ⚠

5936804G 47-50
GMC (2 pcs). 2.590 -0.15
..... **\$3.25 PR** ⚠

5936804..... 47-53
2 pcs. 2.590 -0.15
..... **\$3.75 SET** ⚠

5936805G 51-53
GMC (2 pcs). 2.590 -0.15
..... **\$3.00 PR** ⚠

5942513..... 54
This is a park light
lens gasket 2 pieces.
2.590 -0.15
..... **\$2.50 PR** ⚠

Turn Signal Kit Self Canceling

- * Operates on all cars - 6 or 12 volts, Positive or Negative Ground.
- * Self Cancel feature uses time and lack of brake signal to know when to cancel.
- * Time-out user adjustable for 15, 30, 45 or 60 seconds. Factory set for 15 seconds. Turn signal will not time out with the brakes applied.
- * Audible beep on turn - user selectable for On/Off.
- * Easy installation with included instructions, wiring diagrams and terminal labels on control.
- * Fail safes with brake and park lights still functional even with blown turn signal control fuse or no power to the control box.
- * Can operate with combined brake and turn lights or separate brake and turn lamps in rear of car.
- * Can share front Park or Fog lights for front turn signals.
- * Flash rate independent of lamp load. Will flash LED lamps or incandescent lamps at the same rate.
- * 4-way Hazard function.
- * Controller can use any style momentary switch(es) to access all control functions.
- * 10 pin European style screw terminal connector prewired for power, ground and signal switch plug.
- * Internal 15 amp turn function fuse and separate Park and Brake circuit 10 amp fuses.
- * Quick disconnect of control box for easy service. Simply unplug the 10 pin connector.



9857209B **ALL**
Black column switch. 6 or 12 volt, positive or negative ground. Self canceling. -0.15
..... **\$250.00 EA** ⚠



9857209P **ALL**
Plain column switch. 6 or 12 volt, positive or negative ground. Self canceling. -0.15
..... **\$250.00 EA** ⚠

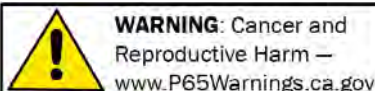

Chemicals shipped domestic ground only (Lower 48 states only). No international shipping.

Phone: (360) 816-0211 • (800) 999-CHEV (2438) • www.chevsofthe40s.com

Turn Signal Kit Self Canceling, cont.



9857209T.....ALL
Toggle switch. 6 or 12 volt, positive or negative ground. Self canceling. -0.15
\$140.00 EA ⚠️

Halogen Turn Signal Kit w/ Harness



9857206TK.....37-53
W/ (2) 6v halogen bulbs, wire harness, flasher sockets & switch (specify year when ordering). 2.761 -0starting at **\$240.00 SET** ⚠️

9857212TK.....37-53
W/ (2) 12v halogen bulbs, wire harness, flasher sockets & switch (specify year when ordering). 2.761 -0starting at **\$240.00 SET** ⚠️

Halogen Turn Signal Kit No Harness



9857207TK.....37-53
Comes With (2) 6v halogen bulbs, flasher sockets & switch, w/out wire harness (specify year when ordering). 2.761 -0starting at **\$110.00 SET** ⚠️

9857208TK.....37-53
Comes With (2) 12v halogen bulbs, flasher sockets & switch, w/out wire harness (specify year when ordering). 2.761 -0starting at **\$120.00 SET** ⚠️

Turn Signal Harness



985720A39.....37-39
Cloth, w/ flasher socket, extra pigtail for park lights and instructions 2.761 -0.15
\$226.75 EA ⚠️

985720A40.....40
Cloth, w/ flasher socket, extra pigtail for park lights and instructions 2.761 -0.15
\$226.75 EA ⚠️

985720D42.....41-42
Wire harness, plastic, w/ flasher socket, extra pigtail for park lights and instructions. 2.761 -0
\$186.00 EA ⚠️

985720D46.....42-46
Wire harness, plastic, w/ flasher socket, extra pigtail for park lights and instructions. 2.761 -0
\$186.00 EA ⚠️

985720D53.....47-53
Wire harness, plastic, w/ flasher socket, extra pigtail for park lights and instructions. 2.761 -0
\$186.00 EA ⚠️

Turn Signal Switch



5944127.....54-62
Original w/ pigtail 2.895 -0
\$25.00 EA ⚠️



985720.....ALL
Superior, with four way flasher 2.895 -0.15
\$27.00 EA ⚠️



985720E.....ALL
Economy 2.895 -0.15
\$24.25 EA ⚠️

Turn Signal Knob



5939511A.....54-59
Black, original color and quality. 2.906 -0.4
\$14.00 EA ⚠️

Flasher Socket



5297633.....ALL
W/ mounting bracket, three prong. 2.892 -0.15
\$14.25 EA ⚠️

Turn Signal Flasher



1335230.....ALL
6v 3 prong 2.892 -0.4
\$8.00 EA ⚠️



3713382.....ALL
12v 3 prong 2.892 -0.2
\$10.25 EA ⚠️

Turn Signal Flasher Audible



1335230TA.....ALL
Audible flasher. 6v, 3 prong. 2.892 -0.15
\$36.25 EA ⚠️

3713382TA.....ALL
Audible flasher. 12v, 3 prong. 2.892 -0.15
\$32.50 EA ⚠️



FF552TA.....ALL
Audible flasher. 12v, 2 prong. -0.15
\$29.25 EA ⚠️

Sockets & Bulbs For Park Lights w/ Turn Signals

Halogen Bulbs can be added to following kits for an additional \$20.

Park light socket and bulb kits also available with halogen or LED bulbs.



1873702S.....37-39
6v 2.750 -0.15
\$12.00 SET ⚠️

1873702U.....37-39
12v 2.750 -0
\$11.50 SET ⚠️

5930046S.....40
6v 2.750 -0.15
CALL ⚠️

5930046U.....40
12v -0.15
CALL ⚠️



Sockets & Bulbs For Park Lights w/ Turn Signals, cont.

- 5930153S** **41-42**
6V 2.750 -0.3
..... **\$17.50 SET** ⚠
- 5930153U** **41-42**
12V 2.750 -0.3
..... **\$17.00 SET** ⚠
- 5032299S** **42-46**
6V 2.750 -0.3
..... **\$17.50 SET** ⚠
- 5032299U** **42-46**
12V 2.750 -0.3
..... **\$17.00 SET** ⚠
- 5936804S** **47-53**
6V 2.750 -0.3
..... **\$17.50 SET** ⚠
- 5936804U** **47-53**
12V 2.750 -0.3
..... **\$17.00 SET** ⚠
- 5942094S** **54**
6V 2.596 -0.3
..... **\$17.50 SET** ⚠
- 5942094U** **54**
12V 2.750 -0.3
..... **\$17.00 SET** ⚠

LED Bulbs

- 145416N** **ALL**
12v Amber, straight pins. Replaces bulb #1156. Use LED flasher #3713382L. 8.991 -0.15
..... **\$14.99 EA** ⚠

Park Light Grommet



- 928665A** **47-54**
Park light wire-thru housing. 2.596 -0.15
..... **\$3.50 PR** ⚠

SECTION 085T RESTORATION PARTS

Note: Fog and driving lights are GM script w/ brackets, switch & wiring. Fog lights are amber, driving lights are clear.

Note: Headlight and spotlight bulbs see Section 100T.

Driving Lights

- 409185** **ALL**
Clear, 6v, 5 in. (specify year when ordering). 9.774 -0
..... **starting at \$244.00 PR** ⚠



- 409185A** **ALL**
Clear, 12v, 5 in. (specify year when ordering). 9.774 -0.4
..... **starting at \$241.00 PR** ⚠

- 409186** **ALL**
Clear, 6v, 6 in. (specify year when ordering). 9.774 -0
..... **starting at \$244.00 PR** ⚠

- 409186A** **ALL**
Clear 12v, 6 in. (specify year when ordering). 9.774 -0
..... **starting at \$244.00 PR** ⚠

Fog Light



- 985174** **37-38**
Amber nice repro w/ brackets. 9.774 -0.15
..... **\$285.75 PR** ⚠



- 985444** **39**
Amber nice repro w/ brackets. 9.774 -0.15
..... **\$296.00 PR** ⚠

Fog Light, cont.



- 409182** **ALL**
Amber with GM script. 6v, 5 in. dia. (specify year when ordering). 9.774 -0
..... **starting at \$244.00 PR** ⚠

- 409182A** **ALL**
Amber with GM script. 12v, 5 in. dia. (specify year when ordering). 9.774 -0
..... **starting at \$244.00 PR** ⚠

- 409183** **ALL**
Amber with GM script. 6v, 6in. dia. (specify year when ordering). 9.774 -0
..... **starting at \$244.00 PR** ⚠

- 409183A** **ALL**
Amber with GM script. 12v, 6in. dia. (specify year when ordering). 9.774 -0
..... **starting at \$244.00 PR** ⚠

Fog Light Lens



- 921415** **37-38**
Amber. 6-5/16" o.d. 9.774 -0.15
..... **\$21.50 EA** ⚠



- 923706** **39**
Amber (original repro). 6-3/4" dia. 9.774 -0
..... **CALL** ⚠



- 923706R** **39**
Amber. Fits reproduction fog lights. 6-1/4" o.d. 9.774 -0.15
..... **\$27.25 EA** ⚠



WARNING: Cancer and Reproductive Harm — www.P65Warnings.ca.gov

Chemicals shipped domestic ground only (Lower 48 states only). No international shipping.

Phone: (360) 816-0211 • (800) 999-CHEV (2438) • www.chevsofthe40s.com

Section 085T: Driving Lights, Fog Lights & Spot Lights

Fog Light Rim



5930366 **40**
 Chrome (NOS). 7" o.d. 9.774 -0 **CALL**
 ⚠️

Fog Light Emblem



984716E **41**
 This is the small emblem that is on a factory fog light.
 9.774 -0
 **CALL** ⚠️

GM Script Tag



985993M ... **37-54**
 Top of driving lights, fog lights and spotlight. 9.773 -0.2
 **\$9.59 EA** ⚠️

Fog Light Bracket



5933244 **ALL**
 W/ apron on bumper brackets. 9.774 -0.15
 **\$40.00 SET** ⚠️

Switch



924160 **ALL**
 Fog light, backup light, etc, rotary. Clamps to dash bottom. 9.774 -0.2
 **\$23.00 EA** ⚠️

Spotlights

Note: Spotlights have GM script and include right or left bracket and template.



985993A **37-54**
 6v, 6 in., (specify year & left or right when ordering). 9.773 -0 **starting at \$326.00 EA**
 ⚠️

985993F **37-54**
 12v, 6 in., (specify year & left or right when ordering). 9.773 -0
 **starting at \$326.00 EA** ⚠️

985993G **37-54**
 12v, 5 in. (specify year & left or right when ordering). 9.773 -0
 **starting at \$326.00 EA** ⚠️

985993H **37-54**
 6v, 5 in. (specify year & left or right when ordering). 9.773 -0
 **starting at \$326.00 EA** ⚠️

Spotlight Brackets



985993TL **37-54**
 Left (specify year when ordering). 9.773 -0
 **starting at \$54.00 EA** ⚠️

985993TR **37-54**
 Right (specify year when ordering). 9.773 -0
 **starting at \$54.00 EA** ⚠️

Spotlight Handle



985998B **ALL**
 Ivory w/ chrome housing & switch for spotlight. 9.773 -0.15 **\$60.00 EA** ⚠️

Wire Assembly



9.773 -0.2

985774A **ALL**
 W/ armored steel covered, cloth wire & metal fuse holder for spotlight, as original.

..... **\$31.00 SET** ⚠️

Fuse Holder



985775A **ALL**
 Metal fuse holder.
 9.773 -0.15

..... **\$12.00 EA** ⚠️

Wire



985776A **ALL**
 Armored steel covered. 9.773 -0.3
\$0.75 IN ⚠️

985777W **ALL**
 Lacquer coated braided, white. 9.773 -0.2
 **\$0.25 IN** ⚠️

Section 090T: Headlight Components, Frenched Kits, Halogen Conversions, Rims, Seals & Switches

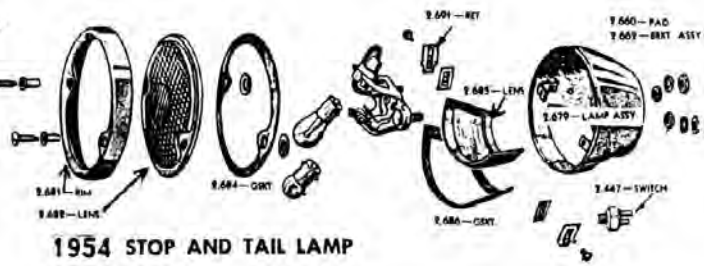
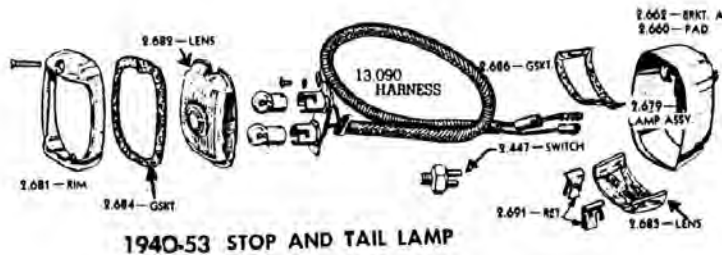
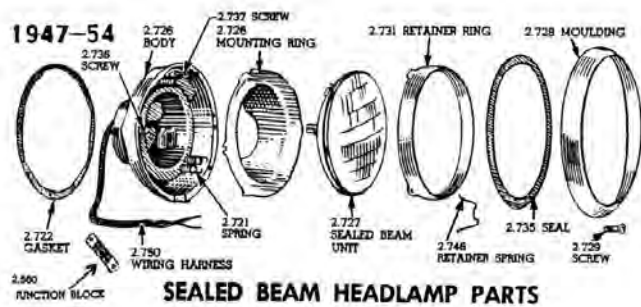
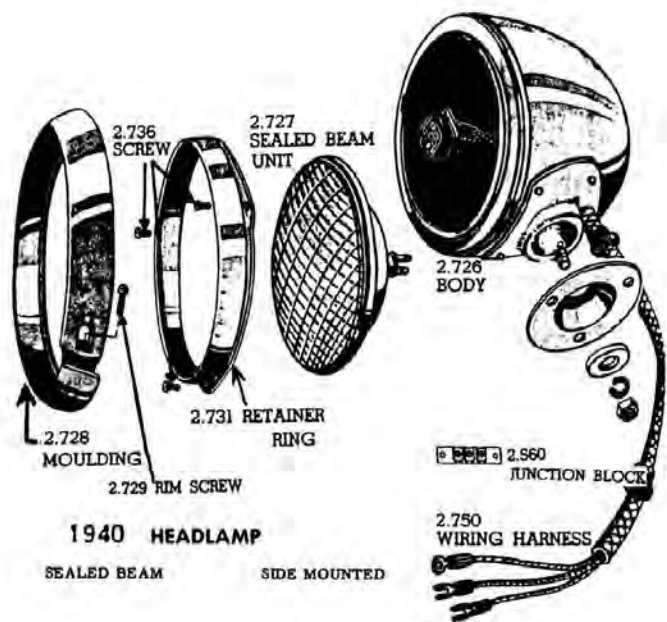
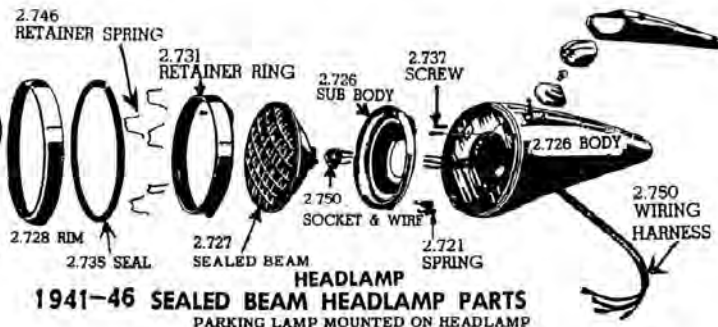
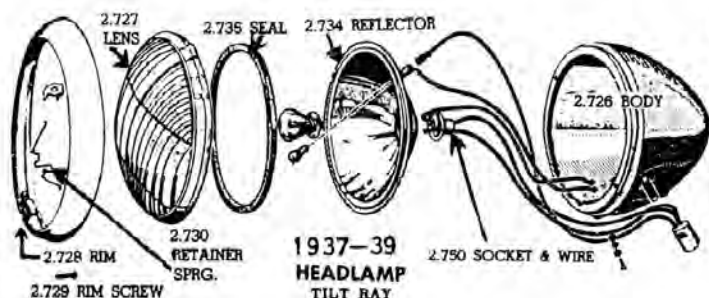

1060

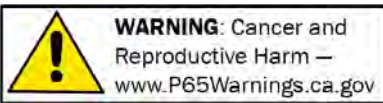

**SECTION 090T
STREET ROD PARTS**

Halogen Headlight with LED Turn Signal



31378.....ALL
7 inch, 12 Volt H-4 Halogens with AMBER LED turn signal or marker lights One row of LED lights on each side. Glass lens.
NOTE: Will not work on 37-38 Sealed Beam Conversion Kit (#920544S)
2.726 -0.15 **\$62.25 EA** ⚠

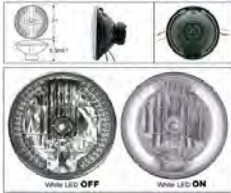

31379.....ALL
7 inch, 12 Volt H-4 Halogens with WHITE LED turn signal or marker lights. One row of LED lights on each side. Glass lens.
NOTE: Will not work on 37-38 Sealed Beam Conversion Kit (#920544S)
2.726 -0.15 **\$64.00 EA** ⚠



S2010LED.....ALL
7 inch, 12 Volt H-4 Halogens with amber LED turn signal-marker lights. One row of LEDs at the bottom of light. Glass lens.
NOTE: Will not work on 37-38 Sealed Beam Conversion Kit (#920544S) -0.15
..... **\$44.00 EA** ⚠

Halogen Headlight with LED Halo



31380HALO.....ALL
7 Inch, 12 Volt Headlight H-4 Halogens With Multi Color LED Halo, Includes Remote (No Turn Signal).
NOTE: Will not work on 37-38 Sealed Beam Conversion Kit (#920544S) -0.15
..... **\$270.00 PR** ⚠



31381HALO.....ALL
7 Inch, 12 Volt Headlight H-4 Halogens With White LED Halo (No Turn Signal)
NOTE: Will not work on 37-38 Sealed Beam Conversion Kit (#920544S) -0.15
..... **\$195.25 PR** ⚠

31382HALO.....ALL
7 Inch, 12 Volt Headlight H-4 Halogens With Multi-Color LED Halo, includes remote. Black Illusion (No Turn Signal)
NOTE: Will not work on 37-38 Sealed Beam Conversion Kit (#920544S) -0.15
..... **\$299.99 PR** ⚠



31383HALO.....ALL
7 Inch, 12 Volt Headlight H-4 Halogens With Multi Color LED Halo and Amber Turn signals, Includes Remote.
NOTE: Will not work on 37-38 Sealed Beam Conversion Kit (#920544S) -0.15
..... **\$320.25 PR** ⚠

Halogen Headlight with LED Halo, cont.



31384HALO.....ALL
7 Inch, 12 Volt Headlight H-4 Halogens With White LED Halo and Amber Turn Signals.
NOTE: Will not work on 37-38 Sealed Beam Conversion Kit (#920544S) -0.15
..... **\$245.25 PR** ⚠

LED Headlight Kit



5947212L.....ALL
Includes 2 - 7 inch headlights and LED bulbs. -0 **\$150.00 SET** ⚠

Halogen Headlights



110185H.....ALL
7 inch 6V. Flat lens & replaceable halogen bulb. 2.727 -0 **\$41.50 EA** ⚠



5947212H.....ALL
12V. Flat glass lens & replaceable bulb. 2.727 -0 **\$19.50 EA** ⚠



T70100A.....ALL
7 inch Clear glass w/ diamond cut reflector. Comes w/ H4 55/60 watt xenon filled bulb. 2.727 -0.15 **\$70.09 EA** ⚠

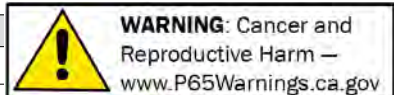

Section 090T: Headlight Components, Frenched Kits, Halogen Conversions, Rims, Seals & Switches

Halogen Headlights, cont.



T70300A.....ALL
7 inch Clear glass w/ diamond cut reflector & Tri-Bar w/ blue-dot. Comes w/ H4 55/60 watt xenon filled bulb. 2.727 -0.15
..... **\$100.09 EA** ⚠

LED Headlight Conversion

The Features Of LED Conversion Kit

1. Brightness reaches 8000 Lumens, in comparison a standard 55w H4 halogen bulb is about 1000 lumens.
2. Anti-glare design, better light pattern output
3. Life span over 30,000 hours
4. Excellent heat dissipation
5. Easy for installation (Plug-in Play)
6. Waterproof and dustproof. IP65



MAI005.....ALL
Single beam LED headlight conversion kit. Replaces 9006 Bulbs

Input voltage:DC 10V-32V. -0.2

..... **\$125.89 PR** ⚠



MAI011.....ALL
Hi/Low beam LED headlight conversion kit. Replaces H4 bulbs.

Voltage: DC 10V-32V. -0.15

..... **\$65.00 PR** ⚠

HID Headlight Conversion

The Features Of HID Conversion

Brighter/whiter illumination
HID lighting provides a crystal white beam of light that increases night time visibility by 3 times.

Quick snap water proof connectors, 35% less power consumption's that a standard halogen. Over 2000 hours of HID bulb life.

HID (High Intensity Discharge) Headlight Conversion. H4 6000K.

Convert your current halogens to Xenon HID.

Plug and play installation including instructions and ballast mounting hardware.

35 watts will draw less 3 amps.
3600 Lumens, in comparison a standard 55w H4 halogen bulb is about 1000 lumens.

*Race use only.



HIDCONV01.....ALL
Low beam Xenon HID w/ H4 Halogen high beam. 6000K.(off-road use only). 2.727 -0.15
..... **\$100.00 PR** ⚠

HIDCONV02.....ALL
Low & High beam Xenon. Converts halogens. H4 6000K. (off-road use only). 2.727 -0.15
..... **\$88.75 PR** ⚠

Halogen Headlight Conversion



110185A.....31-39
Halogen bulb. 12V headlight conversion. Double the light of sealed beam, retains original appearance. Uses original lens & reflector. Clear. Some trimming/modifications may be necessary. 8.991 -0.15
..... **CALL** ⚠

Halogen Headlight Conversion, cont.

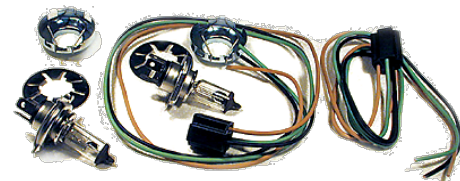

110185D.....31-39
Halogen bulb. 6V headlight conversion. Double the light of sealed beam, retains original appearance. Uses original lens & reflector. Clear. Some trimming/modifications may be necessary. 8.991 -0.15
..... **\$45.00 PR** ⚠

Tri-Bar Headlight Cover Blue Dot



193142TB.....ALL
Blue Dot. Fits 7 inch headlights. 2.731 -0.15
..... **\$10.00 EA** ⚠

Tri-Bar Headlight Cover Chrome Bullet



193142TC.....ALL
Chrome Bullet. Fits 7 inch headlights. 2.731 -0.15
..... **\$9.75 EA** ⚠

Headlight Visors



193142A.....ALL
Chrome half moon. Fits 7 inch round headlights. 2.731 -0.2
..... **\$9.00 PR** ⚠



193142AM.....ALL
Amber acrylic with chrome trim plate. Fits 7 inch round headlights. 2.731 -0.15
..... **\$13.25 PR** ⚠



193142B.....ALL
Chrome plated w/ blue dot jewel. Fits 7 inch round headlights. 2.731 -0.15
..... **\$22.00 PR** ⚠

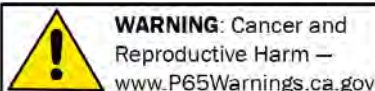

Chemicals shipped domestic ground only (Lower 48 states only). No international shipping.

Phone: (360) 816-0211 • (800) 999-CHEV (2438) • www.chevsofthe40s.com

Section 090T: Headlight Components, Frenched Kits, Halogen Conversions, Rims, Seals & Switches

Headlight Visors, cont.



193142BL.....ALL
Blue acrylic with chrome trim plate. Fits 7" round. 2.731-0.15
..... **\$13.25 PR** ⚠



193142D.....ALL
Chrome plated. Fits 7 inch round headlights. 2.731-0.15
..... **\$15.00 PR** ⚠



193142GR.....ALL
Green acrylic with chrome trim plate. Fits 7" round. 2.731-0.15
..... **\$13.25 PR** ⚠



193142RE.....ALL
Red acrylic with chrome trim plate. Fits 7" round. 2.731-0.15
..... **\$13.25 PR** ⚠

SECTION 090T RESTORATION PARTS

Note: Headlight Knobs see Sections 340T.

Note: Headlight bulbs see Section 100T.

Headlight Bulbs Sealed Beam



193142.....40-54
Sealed beam 6v. 2.727-0 **CALL** ⚠



193142H.....40-54
Halogen Sealed beam 6v. 2.727-0.2
\$37.25 EA ⚠



5947212.....ALL
Sealed beam 12v. 2.727-0.15
\$13.75 EA ⚠

Headlight Bucket Assembly



5932796C.....47-54
Complete w/ pigtail, retainer & 12v bulb, no rim. 2.726-0 **\$65.00 EA** ⚠



5932796D.....47-54
Complete w/ original style pigtail (plastic wires in cloth loom), retainer & 12v bulb (no rim). 2.726-0 **\$95.00 EA** ⚠

Headlight Lens



919787.....37-39
Glass replacement lens (exc COE) 2.727-0 **\$40.00 EA** ⚠

Headlight Bucket Housing



919475FR.....37-40
Fiberglass Right side. Commercial Only. 2.726-0 **CALL** ⚠

Headlight Bucket Stand



350777F.....37-40
Fiberglass, left. 2.544-0 **CALL** ⚠



350778F.....37-40
Fiberglass, right. 2.544-0 **CALL** ⚠

Headlight Bucket



924535.....41-54
Inner bucket only. Steel (also 55 6volt). 2.726-0 **\$36.00 EA** ⚠

Headlight Wire Grommet



5931584.....47-54
Bucket for pigtail (2 pcs). 9.775-0.15 **\$4.00 PR** ⚠

Headlight Grommet



3673139.....47-53
Fender inner panel. 9.775-0.4 **\$3.50 SET** ⚠

Headlight Bucket Pad



5933134.....41-46
Headlight bucket to fender. 2.544-0.15 **\$16.00 PR** ⚠

Headlight Bucket Gasket



3722121.....47-54
Headlight bucket to fender. 8-1/2 in. x 1/8 in. thick. 2.722-0.15 **\$7.00 PR** ⚠

Headlight Stand Mounting Pad



476489.....37
Left and right. 2.544-0.15 **\$4.00 L&R** ⚠



597992.....38
Left and right. 2.544-0.15 **\$4.00 L&R** ⚠



350910.....39-40
Left and right. 2.544-0.15 **\$5.00 L&R** ⚠

Clutch Head Screws



5932796A.....47-54
With tin u-nuts, attach headlight bucket to fender (32 pcs). 2.726-0 **\$10.50 SET** ⚠



Section 090T: Headlight Components, Frenched Kits, Halogen Conversions, Rims, Seals & Switches

Clutch Head Driver



DRIVERALL
Magnetic clutch head driver, Chevs imprint. w/ 5 bits (1/8 in., 5/32 in., 3/16 in., 1/4 in., 5/16 in.) 8.821-0
\$22.25 SET ⚠

Headlight Bucket Spring



92455141-46
Tension adjusting. 2.721-0.15

..... **\$5.50 EA** ⚠



593745247-54
Tension adjusting. 2.721-0.15

..... **\$3.50 EA** ⚠

Headlight Rim



92151436-39
Chrome (36 car, 37-39 trucks exc COE). Does not come with tab or screw 2.728-0

..... **CALL** ⚠



593041640
Chrome reproduction. 2.728-0.15

..... **\$45.00 EA** ⚠



92472241-46
Chrome 2.728-0.15

..... **\$27.50 EA** ⚠



594128547-54
Stainless Steel w/ clips. 2.728-0.15

..... **\$18.75 EA** ⚠

Headlight Lens Seal



60591832-39
2 pieces. 2.735-0.3

..... **\$11.25 PR** ⚠



5930594A40-54
Headlight rim to sealed beam retainer 2.735-0.3

..... **\$13.50 SET** ⚠



5930594C40-54
W/ wire insert headlight rim to retainer 2.735-0

..... **\$16.00 PR** ⚠

Headlight Rim Seal Clip



593479137-39
Does 2. 2.746-0.2

..... **\$8.00 SET** ⚠

593479140-54
Does 2. 2.746-0.2

..... **\$8.00 SET** ⚠

Sealed Beam Retainer Ring



593043340
Stainless repro. 2.731-0.15

..... **\$20.75 EA** ⚠



92453441-54
Stainless steel 2.731-0

..... **\$9.50 EA** ⚠



924534S41-54
Stainless steel 2.731-0

..... **\$10.00 EA** ⚠

Sealed Beam Retainer Ring Screws



92462240-54
Retainer screws (3 pcs) 2.729-0.4

..... **\$3.00 SET** ⚠

Terminal Boards



2-3/8" center to center

186553540-53
(3 terminal) main wiring to headlight & park light pigtailed w/ rivets. Mounting holes: 2-3/8" center-to-center. 2.560-0.15

..... **\$22.00 PR** ⚠



3" center to center

199875640-54
(4 terminal) main wiring to headlight & park light pigtailed w/ rivets. Mounting holes: 3" center-to-center. 2.560-0.15

..... **\$28.00 PR** ⚠

Headlight Switch



199504030-46
Replacement 2.485-0 ... **\$25.00 EA** ⚠



1995040A30-46
Delco original replacement, w/ removable shaft. Black knob, white "LIGHTS" text. 2.485-0

..... **CALL** ⚠



199400739
Genuine Delco, NOS. 2.485-0.15

..... **\$145.00 EA** ⚠



1995041A47-54
Replacement, nonremovable shaft. 12volt. 2.485-0.15

..... **\$19.75 EA** ⚠



1995041R47-54
For use w/ original nut, knob & removable shaft (locking groove on end only). Includes spade terminals. 12v 2.485-0

..... **\$45.75 EA** ⚠

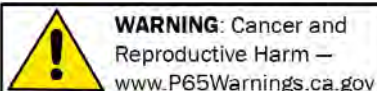

WARNING: Cancer and Reproductive Harm — www.P65Warnings.ca.gov

Chemicals shipped domestic ground only (Lower 48 states only). No international shipping.

Phone: (360) 816-0211 • (800) 999-CHEV (2438) • www.chevsofthe40s.com

Headlight Switch, cont.



1995041S47-54
6 Volt. Uses original nut, knob & removable shaft. Includes spade terminals (for units w/ locking groove at end of shaft). Chevy & GMC 2.485 -0.15
\$50.50 EA ⚠



1995041T47-54
12 Volt. Uses original nut, knob & removable shaft. Includes spade terminals (for units w/ locking groove at end of shaft). Chevy & GMC 2.485 -0.15
\$50.50 EA ⚠

Headlight Switch Shaft



199066147-53
With shaft 2.486 -0.15
\$8.00 EA ⚠



3653818S47-54
Removable type. 2.485 -0
\$5.00 EA ⚠

Headlight Switch Retaining Nut



1995041C47-54
Stainless 2.485 -0
\$12.50 EA ⚠

Dimmer Switch



199700829-54
Dimmer Switch. Includes fasteners. 2.459 -0.2
\$22.00 EA ⚠

Headlight Relay



1116789A37-54
6v replacement style. 2.485 -0.15
\$34.00 EA ⚠



1116789BALL
12v 2.485 -0.3
\$59.00 EA ⚠

Odds & Ends

Please call for availability on all Odds & Ends parts; once part is sold, it may no longer be in stock.

0387037-46
Headlight Switch, 37-38 Pass & 40-46 Truck 9.000 -0.4
\$55.00 EA ⚠

350966U39-40
Headlight stand, right side (Used) 2.546 -0.4
\$60.00 EA ⚠

0379047-53
Headlight knob w/ shaft, good used 2.485 -0.4
\$8.00 EA ⚠

1995041U47-54
Headlight Switch 2.487 -0.4
\$95.00 EA ⚠

SECTION 100T STREET ROD PARTS

Halogen Headlight Conversion Bulb



110185BALL
Headlight bulb. Clear 6v, H4 replacement. 8.991 -0.15
\$18.50 EA ⚠



110185CALL
Headlight bulb. Clear 12v, H4 replacement. 8.991 -0.15
\$15.00 EA ⚠

Halogen Bulbs



145416B37-54
Halogen tail light & park light w/ turn signal, 12v, dual filament, 30/10 watt, offset pin, replacement for #1157. 8.991 -0.15
\$6.00 EA ⚠



145416C37-54
Halogen tail light & park light, 6v 50 watt, single filament, straight pin. 8.991 -0.15
\$14.00 EA ⚠



145416D37-54
Halogen tail light & park light, 6v 20 watt, single filament, straight pin. 8.991 -0.15
\$17.00 EA ⚠



145416F37-54
Halogen tail light & park light w/ turn signal, 6v, dual filament, straight pin, replacement for #1158. 8.991 -0.15
\$27.25 EA ⚠



145416EALL
Halogen tail light & park light w/ turn signal, 6v, dual filament, offset pin, replacement for #1154. 8.991 -0.15
\$17.00 EA ⚠



145416GALL
Halogen tail light & park light w/ turn signal, 12v, dual filament, 55/5 watt, straight pins, replacement for #1156. 8.991 -0.15
\$20.00 EA ⚠



145416HALL
Halogen tail light & park light, 12v 20 watt, single filament, straight pin. 8.991 -0.3
\$12.00 EA ⚠

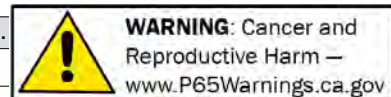

Section 100T: Light Bulbs (Incandescent & LED) and Sealed Beams

Halogen Bulbs, cont.



145416IALL
Halogen tail light & park light, 12v 20 watt, single filament, straight

pin. 8.991 -0.15

..... **\$12.25 EA** ⚠

LED Bulbs

Note: LEDs are very directional and need to be angled correctly to be bright. Minimal current draw.



145416ALED6RALL
6 Volt Red, offset pin. Replaces bulb #1154. 8.991 -0.2

..... **\$8.50 EA** ⚠



145416ALED6WALL
6 Volt White, offset pin. Replaces bulb #1154. 8.991 -0.2

..... **\$7.75 EA** ⚠



145416JALL
12V Amber, offset pins. Replaces bulb #1157. Use LED flasher #3713382L. 8.991 -0

..... **CALL** ⚠



145416KALL
12v Amber, straight pins. Replaces bulb #1156. Use LED flasher #3713382L. 8.991 -0.15

..... **\$12.25 EA** ⚠



145416LALL
12 Volt Red, offset pin. Replaces bulb #1157. Use LED flasher #3713382L. 8.991 -0.15

..... **\$13.00 EA** ⚠



145416LED6A ...ALL
6V Amber, straight pins. single contact Replaces bulb #1156. 8.991 -0.15

..... **\$14.00 EA** ⚠

LED Bulbs, cont.



145416LED6RALL
6 Volt Red, straight pin. Replaces bulb #1156. 8.991 -0.15

..... **\$9.75 EA** ⚠



145416LED6WALL
6 Volt White, straight pin. Replaces bulb #1156. 8.991 -0.3

..... **\$15.00 EA** ⚠

145416LWALL
12 Volt Red, offset pin. Replaces bulb #1157. Use LED flasher #3713382L. 8.991 -0

..... **CALL** ⚠



145416MALL
12 Volt Red, straight pin (single contact). Replaces bulb #1156. Use LED flasher #3713382L. 8.991 -0.3

..... **\$23.25 EA** ⚠

145416NALL
12v Amber, straight pins. Replaces bulb #1156. Use LED flasher #3713382L. 8.991 -0.15

..... **\$14.99 EA** ⚠

SECTION 100T RESTORATION PARTS

Headlight Bulbs



11018531-39
Headlight bulb. 6 volt. 8.991 -0.4

..... **\$12.25 EA** ⚠

Bulbs



115273ALL
High beam indicator & ignition lock lamp #51-6v. 8.991 -0.4

..... **\$2.25 EA** ⚠

Bulbs, cont.



115273AALL
High beam indicator & ignition lock lamp #53-12v. 8.991 -0.15

..... **\$0.50 EA** ⚠



119294ALL
Dome & stop lamp #87-6v (1 contact) w/ straight pins. 8.991 -0.3

..... **\$1.50 EA** ⚠



119294AALL
Dome & stop lamp #93-12v (1 contact) w/ straight pins. 8.991 -0.3

..... **\$3.00 EA** ⚠



119434ALL
Dome lamp #82-6v (2 contacts). 8.991 -0.4

..... **\$1.75 EA** ⚠



119434AALL
Dome lamp #90-12v (2 contacts). 8.991 -0.3

..... **\$1.75 EA** ⚠



120406ALL
Dome lamp #88-6v (2 contacts). 8.991 -0.2

..... **\$1.25 EA** ⚠



120406AALL
Dome lamp #94-12v (2 contacts). 8.991 -0.15

..... **\$1.00 EA** ⚠



125588ALL
Parking (in head lamp) instrument panel, clock, glove box, dome light, Cabriolet tail light indicator #55-6v. 8.991 -0.3

..... **\$1.00 EA** ⚠



125588AALL
Parking (in head lamp) instrument panel, clock, glove box, dome light, Cabriolet tail light indicator #57-12v. 8.991 -0.3

..... **\$0.75 EA** ⚠

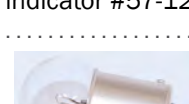

142303ALL
Tail light or license light. Fits some Sedan Delivery tail lights. #63-6v. 8.991 -0.2

..... **\$1.00 EA** ⚠

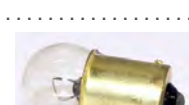

142303AALL
Tail light or license light. Fits some Sedan Delivery tail lights. #98-12v. 8.991 -0.15

..... **\$0.50 EA** ⚠

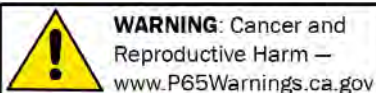

Chemicals shipped domestic ground only (Lower 48 states only). No international shipping.

Phone: (360) 816-0211 • (800) 999-CHEV (2438) • www.chevsofthe40s.com

100T

Section 100T: Light Bulbs (Incandescent & LED) and Sealed Beams

Bulbs, cont.



142306.....ALL
Dome lamp (panel)
#81-6v (1 contact).
8.991-0.2
..... **\$1.00 EA** ⚠



142306A.....ALL
Dome lamp (panel)
#89-12v (1 contact).
8.991-0.2
..... **\$1.00 EA** ⚠



142309.....ALL
Fog, back up & safety
light #1133-6v.
8.991-0.15
..... **\$1.50 EA** ⚠



145416.....ALL
Tail light & stop light
#1154-6v. 8.991-0.15
..... **\$1.50 EA** ⚠



145416A.....ALL
Tail light & stop light
(bright) #1157-12v w/
offset pins. 8.991-0.4
..... **\$1.50 EA** ⚠



145417.....ALL
Brake and turn signal.
Dual element 6v w/
equal height retaining
pins. #1158. 8.991-0.3
..... **\$2.25 EA** ⚠



145419.....ALL
Brake and turn signal.
Dual element 12v w/
equal height retaining
pins. #1176. 8.991-0.3
..... **\$3.50 EA** ⚠



145431.....ALL
Safety light-spotlight
#1323-6v. 8.991-0.15
..... **\$12.00 EA** ⚠



453138.....ALL
Dome lamp #210-6v (2
contacts). 8.991-0.15
..... **\$2.50 EA** ⚠



453138A.....ALL
Dome lamp #1004-12v
(2 contacts). 8.991-0.15
..... **\$1.25 EA** ⚠

Spotlight



444279.....ALL
6 in. sealed beam, 6v,
#4535. For Unity spot
lights. 9.773-0.15
..... **\$34.00 EA** ⚠



451927.....ALL
5 in. sealed beam,
12v, #4405 (fits unity
spotlight only). For Unity
spot lights. 9.773-0.2
..... **\$24.00 EA** ⚠



456720.....ALL
6 in. sealed beam, 12v,
#4435. For Unity spot
lights. 9.773-0.15
..... **\$24.00 EA** ⚠



987264.....ALL
5 in. sealed beam, 6v,
#4515. For Unity spot
lights. 9.773-0.3
..... **\$34.00 EA** ⚠

Driving Lights



3936674.....ALL
5 in. sealed beam.
Clear, 6v, #4015. For
Unity driving lights.
9.774-0.2
..... **\$39.00 EA** ⚠



593837.....ALL
5 in. sealed beam.
Clear, 12v, #4415. For
Unity driving lights.
9.774-0.3
..... **\$28.39 EA** ⚠



986942.....ALL
6 in. sealed beam.
Clear, 6v, #4012. For
Unity driving lights.
9.774-0.2
..... **\$38.59 EA** ⚠



987263.....ALL
6 in. sealed beam.
Clear, 12v, #4412. For
Unity driving lights.
9.774-0.15
..... **\$24.00 EA** ⚠

Fog Lights



3936674A.....ALL
5 in. sealed beam,
amber, 6v, #4015A.
For Unity fog lights.
9.774-0.15
..... **\$34.00 EA** ⚠



593837A.....ALL
5 in. sealed beam,
amber, 12v, #4415A.
For Unity fog lights.
9.774-0.2
..... **\$25.00 EA** ⚠



986942A.....ALL
6 in. sealed beam,
amber, 6v, #4012A.
For Unity fog lights.
9.774-0.15
..... **\$34.25 EA** ⚠



987263A.....ALL
6 in. sealed beam,
amber, 12v, #4412A.
For Unity fog lights.
9.774-0.2
..... **\$34.00 EA** ⚠

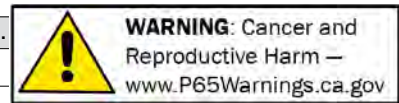

**SECTION 110T
STREET ROD PARTS**

Bed Roll Light



MAK102853**41-66**
Chevy - Red. Incandescent bulb (amber also available). 0.000-0 . **\$86.00 PR** ⚠



LEDBEDLITE**ALL**
LED tail light w/ Aluminum housing in 15/16" (red only), 1-1/8", 1-1/4" or 1-5/8" diameters. Choose Amber or Red. 12V 0.000-0 .. starting at **\$110.00 PR** ⚠



MAK102864**ALL**
Red LEDs. Billet aluminum w/ polished bezel. Dual intensity for tail light and brake/ turn signal. Includes 10" pigtail. Fits 40-66 Chevy, 40-87 GMC. 12V. 1-19/32 hole. 0.000-0 . **\$148.00 PR** ⚠



MAK102865**ALL**
19 Amber LEDs. 12V. 1-19/32 hole. 0.000-0 **\$148.00 PR** ⚠

Bed Roll Reflector



MAK102850 . . . **41-66**
red insert reflector.
0.000-0.15
..... **\$60.00 PR** ⚠

LED Bed Roll Light -Reverse Light



MAK102866**ALL**
19 White LEDs for back up lights. 12V. 1-19/32 hole. 0.000-0 **\$160.00 PR** ⚠

Blue Dots



920626A**ALL**
Glass w/ chrome ring (you install). 2.682-0.15 **\$7.25 PR** ⚠



920627A.....**ALL**
Chrome with amber Bowtie cut out. 2.682-0.15
..... **\$22.19 PR** ⚠



920627B.....**ALL**
Chrome with blue Bowtie cut out. 2.682-0.15
..... **\$22.25 PR** ⚠

**SECTION 110T
RESTORATION PARTS**

1934-39 Tail Light



363149.....**31-39**
Includes license light. 2.679-0.15 **\$111.00 EA** ⚠



913823.....**34-39**
Lens 2.682-0
..... **\$11.50 EA** ⚠



913823B.....**34-39**
Glass w/ Bowtie 2.682-0
..... **\$18.50 EA** ⚠



913824.....**34-39**
Gasket, lens. 2.684-0.2
..... **\$5.00 EA** ⚠

1934-39 Tail Light, cont.



913825**34-39**
Rim. Chrome With Bowtie center. 2.681-0.15
..... **\$48.00 EA** ⚠

1940-53 Tail Light Assembly Black Housing



927074GL.....**40-53**
Glass script lens, Black housing & chrome rim. Left side. 2.679-0.15 . **\$27.75 EA** ⚠



985608GR**40-53**
Glass script lens, Black housing & chrome rim. Right side. 2.679-0 .. **\$27.75 EA** ⚠

1940-53 Tail Light Assembly Chrome Housing



927074CL.....**40-53**
Chrome w/ script glass lens. Left side. 2.679-0 **\$37.50 EA** ⚠



985608CR**40-53**
Chrome w/ script glass lens. Right side. 2.679-0 **\$34.00 EA** ⚠

1940-53 Tail Light Assembly Blue Dot Black Housing



927074BL40-53
W/ glass lens, blue dot, & license light.
Left side. 2.679-0.15 **\$29.00 EA** ⚠



985608BR40-53
W/ glass lens & blue dot. Right side.
2.679-0 **\$39.00 EA** ⚠

1940-53 Tail Light Assembly Blue Dot Chrome Housing



927074DL40-53
Glass lens w/ blue dot and chrome housing. Left side. 2.679-0.15 **\$29.75 EA** ⚠



985608DR40-53
Chrome, glass w/ blue dot. Right side.
2.679-0 **\$36.00 EA** ⚠

1940-53 Tail Light Assembly Black Housing Plastic Lens



927074L40-53
W/ plastic lens. Left side. 2.679-0 **\$27.00 EA** ⚠

1940-53 Tail Light Assembly Black Housing Plastic Lens, cont.



985608R40-53
W/ plastic lens, right. 2.679-0 **\$27.75 EA** ⚠

1940-53 Tail Light Assembly LED Black Housing



927074EL40-53
Red LED tail light with black housing. White LED license light on bottom of housing. Left side. 12V 2.679-0 **\$49.00 EA** ⚠



985608ER40-53
Red LED tail light with black housing. Right hand side. 12V 2.679-0 .. **\$39.00 EA** ⚠

1940-53 Tail Light Assembly LED Stainless



927074FL40-53
Red LED tail/ brake light with Stainless steel housing. Left side w/ white LED license light. 12V 2.679-0.15 **\$59.75 EA** ⚠

1940-53 Tail Light Assembly LED Stainless



985608FR40-53
Red LED tail light with stainless steel housing. Right hand side. 12V 2.679-0.15 **\$52.00 EA** ⚠

1940-53 Tail Light Assembly LED Chrome Housing



927074HL40-53
Red LED tail light with chrome housing. White LED license light on bottom of housing. Left side. 12V 2.679-0 **\$54.00 EA** ⚠



985608HR40-53
Red LED tail light with chrome housing. Right hand side. 12V 2.679-0.15 **\$47.00 EA** ⚠

1940-53 Tail Light Lens Plastic



593716240-53
Tail light lens. Plastic, 4in. x 2-3/4in. 2.682-0.15 **\$5.00 EA** ⚠

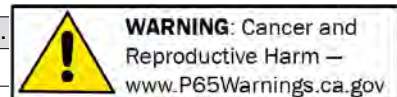

1940-53 Tail Light Lens Glass



920626 **40-53**
Tail light lens. Original script, glass, 4in. x 2-3/4in. 2.682-0 **\$5.50 EA** ⚠

1940-53 Tail Light Lens Blue Dot



920626B **40-53**
Tail light lens. Glass w/ blue dot, 4in. x 2-3/4in. 2.682-0 **\$10.50 EA** ⚠

1940-53 Tail Light Lens LED



920626LL **40-53**
LED conversion. Tail light & license lens w/ integrated LED. LEFT. 12V (must splice wires) 2.682-0.15 **\$39.00 EA** ⚠



920626LR **40-53**
LED conversion. Tail light w/ integrated LED. RIGHT. 12V (must splice wires) 2.682-0 **\$29.00 EA** ⚠



920626LS **40-53**
LED conversion. Tail light & license lens w/ integrated LED and sequential turn signals. LEFT. 12V (must splice wires) 2.682-0 **\$47.00 EA** ⚠

1940-53 Tail Light Lens LED, cont.



920626RS **40-53**
LED conversion. Tail light w/ integrated LED with sequential turn signals. RIGHT. 12V (must splice wires) 2.682-0 **\$35.00 EA** ⚠

1940-53 Tail Light Lens Blue Dot LED



920626LLB **40-53**
LED conversion. Tail light & license lens w/ integrated LED W/ Blue Dot. LEFT. 12V (must splice wires) 2.682-0.15 **\$47.75 EA** ⚠



920626LRB **40-53**
LED conversion. Blue Dot tail light w/ integrated LED. RIGHT. 12V (must splice wires) 2.682-0.15 **\$39.75 EA** ⚠

1940-53 Tail Light Components

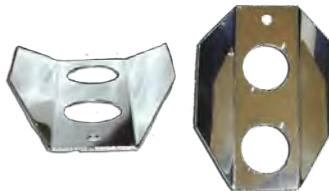

920626R **37-53**
Reflector. Brighten up tail light for improved safety. 2.682-0 **CALL** ⚠



5933830 **40-53**
Tail light rim, 4in. x 2-3/4in. 2.681-0.15 **\$7.00 EA** ⚠

1940-53 Tail Light Components, cont.



920625 **40-53**
Gasket, tail light lens, 4in. x 2-3/4in. 2.684-0.2 **\$1.25 EA** ⚠



923315 **40-53**
Screws for tail light rim. Stainless steel (2 pcs). 2.688-0.4 **\$0.75 SET** ⚠



142303 **ALL**
Tail light or license light. Fits some Sedan Delivery tail lights. #63-6v. 8.991-0.2 **\$1.00 EA** ⚠



142303A **ALL**
Tail light or license light. Fits some Sedan Delivery tail lights. #98-12v. 8.991-0.15 **\$0.50 EA** ⚠

1947-53 Tail Light Assembly - Panel & Suburban (optional)

Note: Tail light parts below fit Panels & Suburbans w/ 3in. O.D. round, bullet-shaped dual tail lights.



916877 **47-53**
Primed housing, red lens. 2.679-0.15 **\$42.00 EA** ⚠

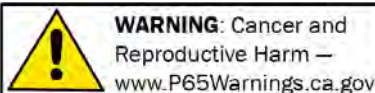

Chemicals shipped domestic ground only (Lower 48 states only). No international shipping.

Phone: (360) 816-0211 • (800) 999-CHEV (2438) • www.chevsofthe40s.com

110T

1947-53 Tail Light Assembly -Panel & Suburban (optional), cont.



916877C47-53
 Chrome housing, red lens. 2.679-0
\$50.00 EA ⚠



916877CLA47-53
 LED. Chrome housing w/ Amber lens. 12V 2.679-0
\$80.00 EA ⚠

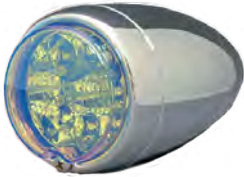

916877CLAC47-53
 LED. Chrome housing w/ Amber LED & clear lens. 12V 2.679-0 ..
\$80.00 EA ⚠



916877CLR47-53
 LED. Chrome Left housing w/ Red lens. 12V 2.679-0
\$75.00 EA ⚠

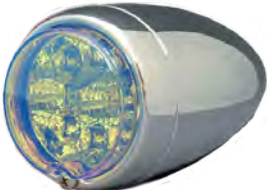

916877CLRC47-53
 LED. Chrome housing w/ Clear lens & Red LED. 12V 2.679-0
\$80.00 EA ⚠

1947-53 Tail Light Assembly -Panel & Suburban (optional), cont.



916877CRR47-53
 LED. Chrome right housing w/ Red lens. 12V 2.679-0
\$75.00 EA ⚠



916877LA47-53
 LED. Primered housing, amber lens. 12V 2.679-0
\$80.00 EA ⚠



916877LAC47-53
 LED. Primered housing w/ Amber LED & CLEAR lens. 12V 2.679-0
\$80.00 EA ⚠



916877LR47-53
 LED. Primered housing w/ Red lens left. 12V 2.679-0
\$80.00 EA ⚠



916877LRC47-53
 LED. Primered housing w/ Red LED & clear lens. 12V 2.679-0 ..
\$80.00 EA ⚠



916878LR47-53
 LED. Primered housing w/ Red lens right side. 12V 2.679-0
\$80.00 EA ⚠

1947-53 Tail Light Components Panel & Suburban (optional), cont.



920696LLR39-53
 RED lens for 3" LED tail light. Fits 39-52 car or 47-53 trucks (fits LED units above only). 2.682-0.15
\$2.00 EA ⚠



91687947-53
 Pad-for 3in. round tail lights (2 pcs) 2.660-0
\$18.00 PR ⚠



92069647-53
 Lens, glass (Fits 3 in. housing). 2.682-0
\$8.50 EA ⚠



920696B47-53
 Lens, glass (Fits 3 in. housing) w/ blue dot. 2.682-0
\$15.50 EA ⚠



92187247-53
 Gasket, lens (3in. o.d., round) (2 pcs). 2.684-0.2
\$3.50 PR ⚠



92332247-53
 Rim (3in. round). 2.681-0
\$7.00 EA ⚠

1954 Tail Light Assembly



897711 54
 Assembly. Black w/ boot & pigtail. Chevy & GMC 2.679-0.15
\$37.00 EA ⚠



897711C 54
 Assembly. Stainless w/ boot & pigtail. Chevy & GMC 2.679-0.15
\$52.75 EA ⚠

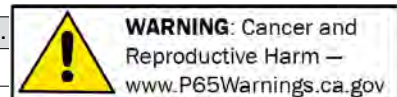

1954 Tail Light



5938745..... 54
Lens, plastic w/ guide
script. Chevy & GMC
2.682 -0.2

..... **\$7.00 EA** ⚠



914301..... 54
Gasket, lens. 2.684 -0.15

..... **\$6.50 EA** ⚠



918355..... 54
Rim stainless steel.
Chevy & GMC 2.681 -0.15

..... **\$6.50 EA** ⚠

Rubber Boot



5933167C 54-57
For tail light pigtail.
2.596 -0.15

..... **\$18.75 EA** ⚠

Tail Light Pigtails



5291632..... 54-57
With bulb contacts.
2.694 -0.15

..... **\$7.00 EA** ⚠

Tail Light Panel & Suburban



3676259..... 47-56
Pad (Panel, Suburban
w/ doors). 2.660 -0.15

..... **\$52.25 EA** ⚠



5936905..... 47-56
Gasket, license lens
(Panel, Suburban w/
doors). 2.686 -0.15

..... **\$1.75 EA** ⚠



5936906B 47-56
Glass lens w/ blue dot
(Panel, Suburban w/
doors). 2.682 -0.15

..... **\$27.00 EA** ⚠



5936906BP 47-56
Plastic lens w/ blue dot
(Panel, Suburban w/
doors). 2.682 -0.15

..... **\$22.00 EA** ⚠



5936907..... 47-56
Gasket, lens (Panel,
Suburban w/ doors).
2.684 -0.2

..... **\$2.50 EA** ⚠



3686479..... 47-57
Pad, 4-1/2 in. round,
(Panel, Suburban w/
tailgate). 2.660 -0.15

..... **\$32.00 EA** ⚠

Brake Light Contact



594904B..... 37-51
Rear door taillight
contacts Panel and
Suburban 2.447 -0.15

..... **\$69.75 EA** ⚠

Tail Light Brackets



602534..... 34-39
Painted Left. Tail light & license plate.
2.662 -0.15

..... **\$39.75 EA** ⚠



602535..... 34-39
Painted Right 2.662 -0.15

..... **\$37.75 EA** ⚠



604235..... 40-46
Painted Right 2.662 -0.15

..... **\$28.50 EA** ⚠



604293..... 40-46
Painted Left. Tail light & license plate.
2.662 -0.15

..... **\$34.25 EA** ⚠



3696238D 47-53
Right, chrome. 2.662 -0.15

..... **\$17.25 EA** ⚠



3696238E 47-53
Painted Right 2.662 -0.15

..... **\$10.25 EA** ⚠

Tail Light Brackets, cont.



3696238S 47-53
Right side. Stainless steel. 2.662 -0.15

..... **\$25.00 EA** ⚠



3847441D 47-53
Left, tail light & license plate. Chrome.
2.662 -0.15

..... **\$13.00 EA** ⚠



3847441E..... 47-53
Painted Left. Tail light & license plate.
2.662 -0.2

..... **\$14.00 EA** ⚠



3847441S 47-53
Left side, tail light & license plate.
Stainless steel. 2.662 -0.15

..... **\$25.00 EA** ⚠



2304056 54
Right, unpainted. Chevy & GMC 2.662 -0.15

..... **\$7.25 EA** ⚠



2304056C 54
Right, chrome. Chevy & GMC 2.662 -0.15

..... **\$9.50 EA** ⚠

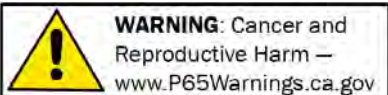

Chemicals shipped domestic ground only (Lower 48 states only). No international shipping.

Phone: (360) 816-0211 • (800) 999-CHEV (2438) • www.chevsofthe40s.com

110T

Tail Light Brackets, cont.



2304056S **54**
Right side. Stainless steel. Chevy & GMC
2.662 -0.15 **\$13.00 EA** ⚠



2309105 **54**
Left, unpainted. Chevy & GMC 2.662 -0.15
..... **\$7.25 EA** ⚠



2309105C **54**
Left, chrome. Chevy & GMC 2.662 -0.15
\$10.25 EA ⚠



2309105S **54**
Left side. Stainless steel. Chevy & GMC
2.662 -0.15 **\$13.00 EA** ⚠

1940-53 License Light Lens

827925 **40-53**
Retainer clips & screws,
license light lens.
2.691 -0.15
..... **\$16.50 SET** ⚠



920634 **40-53**
License light lens (glass). 2.685 -0.15
\$42.00 EA ⚠



920634P **40-53**
License light lens (plastic). 2.685 -0.2
\$5.00 EA ⚠

1940-53 License Light Lens, cont.



920808 **40-53**
Gasket for license light
lens 2.686 -0.2
..... **\$2.50 EA** ⚠

License Light Pad



3688071 **54**
Pickup w/ rear bumper.
2.702 -0
..... **\$14.50 PR** ⚠

Fog Light, Backup Light Switch



924160 **ALL**
Fog light, backup light, etc, rotary. Clamps
to dash bottom. 9.774 -0.2
..... **\$23.00 EA** ⚠

License Plate Bracket



3707021 **54-59**
Pickup (w/ rear bumper) exc Suburban &
Panel. Includes license light rear.
2.705 -0.15 **\$32.00 EA** ⚠

Wire Conduit



1842812A **31-39**
Retainer for galvanized
conduit. 2.646 -0.15
..... **\$17.25 EA** ⚠



985608SCL **40-72**
19in. length, Stainless Steel line.
2.679 -0.15 **\$10.75 PR** ⚠



985608SCS **47-54**
12in. length, Stainless
Steel line. 2.679 -0.2
..... **\$12.50 PR** ⚠

Odds & Ends

Please call for availability on all Odds & Ends parts; once part is sold, it may no longer be in stock.



913823BD **31-35**
Taillight Lens (glass) W/bowtie 2.682 -0
\$33.00 EA ⚠



919044 **47-57**
Lens (Panel/ Suburban
w/ tailgate) 4-3/16in.
O.D., round. (shelf worn)
2.682 -0
..... **\$100.00 EA** ⚠



Section 120T: Fuel System, Gas Tanks, Gas Tank Sending Units, Fuel Pumps, Carburetors, Air Cleaners & Intake Manifolds

SECTION 120T STREET ROD PARTS

Air Cleaner



OTB-4750.....ALL
Finned Unpolished Fits 2-1/4" Rochester, Carter, Zenith Carbs -0
..... **\$148.75 EA** ⚠



OTB-4750PALL
Finned Polished Fits 2-1/4" Rochester, Carter, Zenith Carbs -0
..... **\$169.50 EA** ⚠



OTB-4760.....ALL
Mini Mohawk Unpolished Fits 2-1/4" Rochester, Carter, Zenith Carbs -0
..... **\$149.00 EA** ⚠

OTB-4760P.....ALL
Ribbed Edge Polished Fits 2-1/4" Rochester, Carter, Zenith Carbs -0
..... **\$169.00 EA** ⚠



OTB-4770.....ALL
Mini Mohawk Unpolished Fits 2-1/4" Rochester, Carter, Zenith Carbs -0
..... **\$149.00 EA** ⚠



OTB-4770PALL
Mini Mohawk Polished Fits 2-1/4" Rochester, Carter, Zenith Carbs -0
..... **\$169.50 EA** ⚠

Fuel Fill Bowl Grommet



605238C.....ALL
Grommet for flush bed mounted fuel fill bowl.
3.001-0.15
..... **\$7.00 EA** ⚠

Fuel Fill Bowl



605238A.....ALL
Flush bed mount, stainless fuel fill bowl for under bed gas tank.
3.001-0.15
..... **\$33.00 EA** ⚠

Gas Cap



GAS-CAP-STNLS.....ALL
Stainless steel, flush cap with retaining chain & key. 3.028-0.15
..... **\$37.00 EA** ⚠

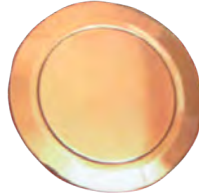

KUSC-312521.....ALL
Polished Billet Aluminum. 2-1/2" dia. Twist to pop open. -0.15
..... **\$131.00 EA** ⚠

Fenton Intake 2 Carb



838574B.....37-53
Heat kit. Split headers to intake. 216ci only.
3.640-0
..... **\$44.25 EA** ⚠



3687540B.....50-62
Install kit for Fenton intake manifold. Includes bellcrank, throttle rod & spring.
3.579-0.15
..... **\$40.09 EA** ⚠



3836071E.....50-62
2 carb intake kit. Includes linkage and fuel kit to install from existing fuel line. For 235ci & 261ci (261ci uses 235ci carbs, w/ 2-15/16" bolt spacing). No grinding required to fit headers. 3.265-0.15
..... **\$255.75 EA** ⚠



838573B.....50-62
Heat kit. Split headers to intake. 235ci only.
3.640-0
..... **\$44.25 EA** ⚠

Offenhauser Intake 2 Carb



3836071B.....37-53
Dual carb. Fits 216ci. Uses 216ci carbs with 2-5/8in. bolt spacing. Linkage included (carb only!). 3.265-0.15
..... **\$325.00 SET** ⚠

3836071A.....50-62
Dual carb. Fits 235ci. 261ci uses 235ci carbs with 2-15/16in. bolt spacing. Linkage included (carb only!). 3.265-0.15
..... **\$428.00 SET** ⚠

Offenhauser Intake 3 Carb



3836071D.....37-53
Triple carb. Fits 216ci. Uses 216ci carbs with 2-5/8in. bolt spacing. Linkage included (carb only). 3.265-0.15
..... **\$325.00 SET** ⚠

3836071C.....50-62
Triple carb. Fits 235ci. 261ci uses 235ci carbs with 2-15/16in. bolt spacing. Linkage included (carb-only). 3.265-0.15
..... **\$330.00 SET** ⚠

Air Cleaner Assembly



1528725L.....ALL
Louvered. Complete w/ 4in. filter and base clamp. 3.410-0
..... **\$12.75 EA** ⚠



1528725ML.....ALL
Complete with 4in. filter, chrome louvered housing, base clamp & 3 prong spinner. Smooth housing. 2-5/8in. neck. 3.410-0.15
..... **\$22.00 EA** ⚠



1528725MS.....ALL
Complete with 4in. filter, base clamp & 3 prong spinner. Smooth housing. 2-5/8in. neck. 3.410-0.15
..... **\$18.50 EA** ⚠

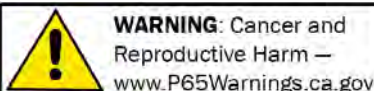

Chemicals shipped domestic ground only (Lower 48 states only). No international shipping.

Phone: (360) 816-0211 • (800) 999-CHEV (2438) • www.chevsofthe40s.com

Section 120T: Fuel System, Gas Tanks, Gas Tank Sending Units, Fuel Pumps, Carburetors, Air Cleaners & Intake Manifolds

Air Cleaner Assembly, cont.



1528725S.....ALL
Smooth. Complete w/
4in. filter and base
clamp. 3.410-0
..... **\$12.75 EA** ⚠



AIR95.....ALL
Stellings & Hellings
9-1/2" dia. Stainless
steel. Complete
w/ filter and base
clamp. Fits carbs
with 2-1/4" top.
3.410-0
..... **CALL** ⚠

Air Cleaner Adapter



1528725A.....ALL
2-5/8in. to 2-5/16in to
fit air cleaners. 3.410-0.2
..... **\$1.50 EA** ⚠

Air Filter Element



1528725E.....ALL
4 in. replacement for air cleaner
assemblies (#1528725S, 1528725L,
1528725ML and 1528725MS). 3.410-0.2
..... **\$8.75 EA** ⚠



AIR95F.....ALL
Replacement Air Filter
For AIR95 3.410-0.15
..... **\$16.75 EA** ⚠

Air Cleaner Clamp



1528725C.....ALL
Replacement for base
of 4in. air cleaner
(#1528725S &
#1528725L). 3.410-0.15
..... **\$2.75 EA** ⚠

Line Clamp Stainless

Lokar Line Clamps are stainless steel
and come with machine and sheetmetal
screws. For securing electric, brake, fuel or
transmission lines.



13274.....ALL
3/16" single (12 clamps). 8.950-0.15
..... **\$18.00 SET** ⚠

13275.....ALL
3/16" x 3/8" double combination (6
clamps). 8.950-0.15
..... **\$18.00 SET** ⚠

13276.....ALL
3/16" x 3/16" double (6 clamps).
8.950-0.15
..... **\$18.00 SET** ⚠

13277.....ALL
1/4" single (12 clamps). 8.950-0.15
..... **\$18.00 SET** ⚠

13278.....ALL
5/16" single (12 clamps). 8.950-0.15
..... **\$18.00 SET** ⚠

13279.....ALL
3/8" single (12 clamps). 8.950-0.15
..... **\$18.00 SET** ⚠

13280.....ALL
1/2" single (12 clamps). 8.950-0.15
..... **\$18.00 SET** ⚠

13281.....ALL
5/8" single (8 clamps). 8.950-0.15
..... **\$18.00 SET** ⚠

13282.....ALL
3/4" single (8 clamps). 8.950-0.15
..... **\$18.00 SET** ⚠

13283.....ALL
7/8" single (8 clamps). 8.950-0.15
..... **\$18.00 SET** ⚠

13284.....ALL
5/16" x 3/8" double combination (6
clamps). 8.950-0.15
..... **\$18.00 SET** ⚠



13285.....ALL
1/4" x 1/4" double (6 clamps). 8.950-0.15
..... **\$18.00 SET** ⚠

Line Clamp Stainless, cont.

13286.....ALL
5/16" x 5/16" double (6 clamps).
8.950-0.15
..... **\$18.00 SET** ⚠

13287.....ALL
3/8" x 3/8" double (6 clamps). 8.950-0.15
..... **\$18.00 SET** ⚠

13288.....ALL
1/2" x 1/2" double (6 clamps). 8.950-0.15
..... **\$18.00 SET** ⚠

13289.....ALL
5/8" x 5/8" double (4 clamps). 8.950-0.15
..... **\$18.00 SET** ⚠

13290.....ALL
3/4" x 3/4" double (4 clamps). 8.950-0.15
..... **\$18.00 SET** ⚠

13291.....ALL
7/8" x 7/8" double (4 clamps). 8.950-0.15
..... **\$18.00 SET** ⚠

Clamp



120521.....ALL
1/4 in. bolt-on strap.
For wire or tube (4 pcs).
8.950-0.4
..... **\$2.59 SET** ⚠



120521A.....ALL
5/16 in, insulated bolt-
on strap. For wire or
tube (4 pcs). 8.950-0.4
..... **\$3.29 SET** ⚠



120521B.....ALL
3/8 in. bolt-on strap.
For wire or tube (4 pcs).
8.950-0.4
..... **\$2.79 SET** ⚠

Voltage Reducer



1119004.....ALL
Reducer 12v to 6v. Best
for fuel gauge. Hi-Tech
w/ constant volts.
2.500-0.15
..... **\$19.00 EA** ⚠



Section 120T: Fuel System, Gas Tanks, Gas Tank Sending Units, Fuel Pumps, Carburetors, Air Cleaners & Intake Manifolds

Fuel Stabilizer

Keep fuel fresh. Removes water, cleans carburetors & fuel injectors. Protects engine from gum, varnish, rust, and corrosion. Eliminates need to drain fuel before storage. Special dispenser bottles measure exactly without waste. Contains NO alcohol.



111801.....ALL
STA-BIL stabilizer. 8 oz bottle treats 20 gallons, for one year. 3.001-0
..... **\$8.25 EA** ⚠



111801B.....ALL
STA-BIL fuel stabilizer. 32 oz bottle treats 80 gallons, for one year. 3.001-0.15
..... **\$21.00 EA** ⚠

Gas Tank Restoration Kit



PORTANK.....ALL
Portank, Restore your tanks. Cleaner, metal prep, sealer (Slosh) and instructions. 3.001-0.15
..... **\$89.00 KIT** ⚠

Metal Prep



PORMETAL.....ALL
Etches Metal and Leaves a Zinc Phosphate Coating. Provides the best adhesion for POR-15 on any metal surface. Water based,

Water based, OSHA approved biodegradable solution. 3.001-0.15

..... **\$16.99 QT** ⚠

Gas Tank Cleaner



PORCLEAN.....ALL
1 quart. MARINE-CLEAN cleans and degreases in one application without leaving residues, noxious fumes or flammable solvents. It makes petroleum-

based cleaners almost obsolete because it can be diluted with water up to 3, 4, 5 and even 10 times its volume while remaining more potent than other cleaners. 3.001-0.15

..... **\$13.25 EA** ⚠

Gas Tank Sealer



3657942C.....ALL
Gas tank sealer slosh, seals gas tank. Alcohol and Ethanol proof. Not for use with (MEK)

Methyl Ethyl Ketone. 3.001-0.15

..... **\$32.25 QT** ⚠

Gas Tank Straps



3658213A.....ALL
Universal, no hardware included. 42" L x 1-3/8" W. 3.022-0.15

..... **\$17.50 PR** ⚠

SECTION 120T RESTORATION PARTS

Main Fuel Line

Oversize shipping charges apply. Please call for rate.



348753.....37-54
Steel (specify year when ordering). Pre-bent. 8.964-0

..... **\$60.00 SET** ⚠



348753S.....37-54
Stainless (specify year when ordering). Pre-bent. 8.964-0.4

..... **\$55.00 SET** ⚠

Fuel Pump to Carb Fuel Line

Oversize shipping charges apply. Please call for rate.



348754.....ALL
Pre bent - Steel (specify year when ordering). 8.964-0.15

..... **\$20.00 SET** ⚠

Fuel Pump to Carb Fuel Line, cont.



348754S.....ALL
Pre bent Stainless (specify year when ordering). 8.964-0.15
..... **\$25.00 SET** ⚠

Electric Fuel Pump



5592627E.....ALL
Fuel will flow through pump when turned off so pump can be used just to prime or full time. Inline, 6 volt. (30 GPH, 4-6 PSI). 3.900-0.15

..... **\$223.25 EA** ⚠



5593256E.....ALL
Fuel will flow through pump when turned off so pump can be used just to prime or full time. Inline, 12 volt. (30 GPH, 4-6 PSI). 3.900-0.15

..... **\$50.00 EA** ⚠



5593256F.....ALL
Intank 12v electric fuel pump rated at 15 GPH and max 3 PSI. 3.900-0.15

..... **\$68.00 EA** ⚠



5593256G.....ALL
This is an Intank 12v electric fuel pump rated at 20-35 GPH and 4-6 PSI. 3.900-0.15

..... **\$73.00 EA** ⚠



5593256H.....ALL
Intank 12v electric fuel pump rated at 20-35 GPH and 3-5 PSI. 3.900-0.15

..... **\$71.00 EA** ⚠

Air Filter Element

Note: Air Filter Decals see Section 550T.



1529264.....37-54
Complete. 6" OD. 4.5" ID. 1.375 Tall 3.410-0.15
..... **\$30.00 EA** ⚠

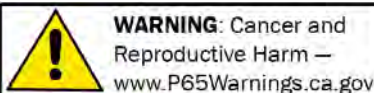

Chemicals shipped domestic ground only (Lower 48 states only). No international shipping.

Phone: (360) 816-0211 • (800) 999-CHEV (2438) • www.chevsofthe40s.com

120T

Section 120T: Fuel System, Gas Tanks, Gas Tank Sending Units, Fuel Pumps, Carburetors, Air Cleaners & Intake Manifolds

Air Filter Element, cont.



1529264A **.37-54**
Copper mesh only. 3.410 -0.15
\$15.25 EA ⚠

Wing Nut



120240 **.37-54**
Air filter wing nut
8.920 -0.4
..... **\$1.50 EA** ⚠

Gas Tank Die Stamped

Oversize shipping charges apply to all Gas Tanks. Please call for rate.



3657515 **.39-46**
Steel, as original. Under seat mount. 18 gallons (3 larger than original). For commercial only. 3.001 -0.15
\$395.00 EA ⚠



3708924 **.47-55**
Steel, as original. Fits 47-48 1/2Ton, 49-55 Panel, Suburban & Canopy Express. 13" wide x 24" long (plus 5/8" flange) x 13-1/2" tall. 3.001 -0 **\$330.00 EA** ⚠



3708971 **.49-54**
Behind seat, galvanized (as original). 17 gallons. 3.001 -0.15 **\$187.00 EA** ⚠

Gas Tank - Under Bed

Oversize shipping charges apply to all Gas Tanks. Please call for rate.

3692400 **.47-53**
Stainless steel w/ anti slosh baffle. Fits 47-48 1/2Ton truck & 47-54 1/2Ton Panel. Holds 13.5 gallons. 23-3/4" L x 12-1/2" W x 13" H. 3.001 -0
\$895.00 EA ⚠



3847690 **.47-53**
Under bed, frame rail mount. Bed fill tank with baffles. 19 gallons. 3.001 -0.15
\$374.00 EA ⚠



3708964 **.54-55**
Under bed, frame rail mount. Bed fill tank with baffles. 19 gallons. -0.15
\$374.00 EA ⚠



605238 **.ALL**
Polyethylene w/ straps. Fits under bed. Universal mount with 3in. neck. 22in. x 17in. x 9.5in. Holds 14 gallons. 3.001 -0.15
\$255.00 EA ⚠



605239 **.ALL**
Fits under bed. Universal mount. 27.75in. x 17.75in. x 8.5in. Holds 16 gallons (strap included). -0.15 **\$225.00 EA** ⚠

Gas Tank Straps



476972 **.37-46**
Tank straps. 3.001 -0.15 .. **\$67.75 PR** ⚠



3693463B **.47-55**
Tanks straps. Fits 47-48 1/2 ton, 49-54 Panel, Suburban & Canopy Express. 3.022 -0.15 **\$40.00 PR** ⚠



3690133B **.49-55**
With straps. For tanks behind the seat. 3.022 -0.15 **\$81.00 PR** ⚠

Gas Tank Mounting Pad



3690131 **.39-46**
4 pieces. 3.015 -0.15 **\$12.00 SET** ⚠



3690131B **.47-54**
Gas tank bumper & grommet kit (8 pcs). 3.015 -0.15 **\$13.50 SET** ⚠

Gas Tank Sending Unit

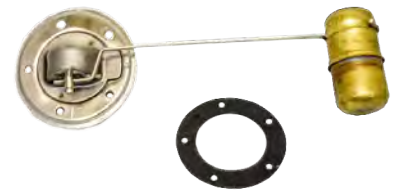

1516287 **.34-46**
0-30 ohms for Chevy gauges (6v or 12v). 3.107 -0.15 **\$45.00 EA** ⚠



Section 120T: Fuel System, Gas Tanks, Gas Tank Sending Units, Fuel Pumps, Carburetors, Air Cleaners & Intake Manifolds

Gas Tank Sending Unit, cont.



151546647-53
0-30 ohms for Chevy gauges (6v or 12v).
Brass float. Fits tanks behind the seat
3.107 -0.15 **\$35.00 EA** ⚠



1517952.....54-55
0-30 ohms for Chevy gauges (6v or 12v).
Brass float. 3.107 -0.15
\$40.00 EA ⚠

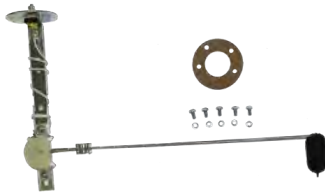

1516250ALL
W/ screws, gasket & instructions, correct
ohms (0-30) for early GM gauges, up to
1964 (6v or 12v). Adjustable float (plastic)
height. 3.107 -0 **\$25.00 EA** ⚠

Float



3708954.....47-59
Brass, for gas tank
sending unit. 3.107 -0.15

..... **\$7.00 EA** ⚠



1516250AALL
Cork. For gas tank
sending unit (2 floats).
3.107 -0.15

..... **\$7.50 SET** ⚠

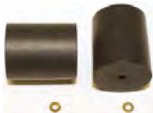

1516250RALL
Plastic. For gas tank
sending unit (2 floats).
3.107 -0.15

..... **\$9.75 PR** ⚠

Terminal Boot



1516252.....ALL
Sending unit wire boot.
3.107 -0.15

..... **\$24.00 EA** ⚠

Gas Gauge Wire Grommet



365374251-54
Gas gauge wire,
1/8in. I.D. X 1in. O.D.
9.775 -0.15

..... **\$5.75 EA** ⚠

Gas Tank Sending Unit Gasket



151606131-54
Gasket, gas tank
sending unit 3.112 -0.3

..... **\$2.00 EA** ⚠



1516061R31-54
Rubber gasket, gas tank
sending unit 3.112 -0.15

..... **\$2.00 EA** ⚠

Screws



1516061AALL
Screws for sending unit
(zinc). 3.112 -0.4

..... **\$5.50 SET** ⚠

Intermediate Fuel Line

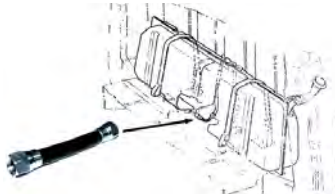

371116049-54
Intermediate line between main line and
sending unit at tank. 7" length. 3.107 -0.15

..... **\$18.00 EA** ⚠

Gas Shut Off Valve



368121549-54
Gas tank shut off valve - connects tank to
intermediate fuel line 3.107 -0.15

..... **\$45.25 EA** ⚠

Gas Filler Neck Delete



4754GD.....47-54
Metal filler panel to
patch the hole from
the filler neck if you
have relocated your gas

tank. -0
..... **\$15.00 EA** ⚠

Gas Tank Fill Hose Kit



368441049-57
Kit comes complete with hoses, clamps,
neck, cap & grommet. 3.003 -0.15
.....
\$59.25 SET ⚠



3684410C49-57
CHROME. Kit comes complete with hoses,
clamps, neck, cap & grommet. 3.003 -0.15
.....
\$84.75 SET ⚠

Fuel Filler Neck



3684410F47-48
47-48 1/2Ton. 3.003 -0 **CALL** ⚠

Gas Tank Filler Hose



365457037-48
GM script with clamps exc COE. 3.003 -0.2
.....
\$11.25 SET ⚠

365457049-57
GM script with clamps (panel, suburban &
school bus chassis). 3.003 -0.2
.....
\$12.25 SET ⚠

369253149-57
Filler & vent hose GM script w/ clamps
(conventional cab). 3.003 -0
.....
\$11.50 SET ⚠

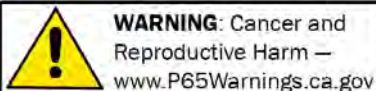

Chemicals shipped domestic ground only (Lower 48 states only). No international shipping.

Phone: (360) 816-0211 • (800) 999-CHEV (2438) • www.chevsofthe40s.com

120T

Section 120T: Fuel System, Gas Tanks, Gas Tank Sending Units, Fuel Pumps, Carburetors, Air Cleaners & Intake Manifolds

Gas Filler Hose Clamp



3834073B **37-57**
For 2-1/4 in. I.D. gas filler hose, original. Fits Panel, Suburban, Bus & 37-46 exc COE (2 pcs). 3.003-0 **\$4.00 SET** ⚠



111619 **49-57**
For 1-7/8 in. I.D. gas filler hose. Original, conventional cab (2 pcs). 1.166-0 **\$4.50 SET** ⚠

Fuel Line Hose



609742 **ALL**
1/2" I.D. Sold by the inch 3.003-0.4 **\$0.25 IN** ⚠

Gas Filler Grommet



598847 **38-46**
Rubber. 42-46 also use pad #3674211 (below). Except suburban 3.008-0.15 **\$15.00 EA** ⚠



3800461 **39-46**
Panel & Suburban. 3.008-0.15 **\$15.00 EA** ⚠



3674211 **42-46**
Flange, held by 4 screws & metal retainer. Use with grommet #598847 (above). 3.008-0.15 **\$12.00 EA** ⚠



3606433 **47-48**
Fits in right bedside. 3.008-0.15 **\$9.50 EA** ⚠

Gas Filler Grommet, cont.



3807278 **47-54**
Panel & Suburban. 3.008-0.2 **\$11.25 EA** ⚠



3807281 **49-54**
Exc. Panel & Suburban 3.008-0.2 **\$10.00 EA** ⚠

Gas Caps



595857 **28-57**
Non-locking, polished stainless steel (as original), w/ inside flange. (28-52 Car 28-57 Truck) 3.028-0.15 **\$7.75 EA** ⚠

595857C **28-57**
Non-locking, Show Quality Chrome (as original), w/ inside flange. (28-52 Car 28-57 Truck) 3.028-0 **\$12.00 EA** ⚠



595857L **28-57**
Locking, chrome w/ inside flange. Not original item. (28-52 Cars, 28-57 Trucks) 3.028-0.15 **\$12.75 EA** ⚠



985076 **38-57**
Original "GM" locking gas cap. With GM logo. (28-52 Car 28-57 Truck) 3.028-0.15 **\$48.00 EA** ⚠



985076A **38-57**
Locking with Bowtie. Inside flange. (28-52 Car 28-57 Truck) 3.028-0.15 **\$39.75 EA** ⚠

Fuel Filter



5451937 **33-56**
Replacement element (not for fuel pump filter). 3.890-0.15 **\$6.00 EA** ⚠



986640 **33-56**
Complete assembly w/ glass bowl and filter. 3.890-0 **\$27.00 EA** ⚠



986640LAC **33-56**
Genuine AC. Complete assembly w/ glass bowl & filter. 3.890-0.15 **\$37.25 EA** ⚠

In Line Filter Bowl Gasket



5452822 **37-57**
Gasket, inline filter bowl. 2-7/64" 3.890-0.2 **\$2.00 EA** ⚠

Fuel Pump Gasket



5590039 **37-56**
Fuel pump filter bowl gasket, 2-1/4in. o.d. 3.904-0.2 **\$2.50 EA** ⚠

Fuel Pump Mounting Gasket



838263 **37-57**
Fuel pump mounting gasket 3.932-0.15 **\$1.50 EA** ⚠

Glass Bowl



1523094 **37-55**
Fuel pump (1-15/16". I.D., 2-1/4" O.D.) w/ gasket 3.903-0.15 **\$18.50 SET** ⚠



Section 120T: Fuel System, Gas Tanks, Gas Tank Sending Units, Fuel Pumps, Carburetors, Air Cleaners & Intake Manifolds

Fuel Pump



1523429 **37-51**
W/ glass bowl, includes gasket. 3.900-0
..... **CALL** ⚠



5591457 **37-51**
W/ vacuum pump (glass bowl) stops slow wipers, original accessory. Also fits GMC, includes gasket. 3.900-0.15
..... **CALL** ⚠



5591457M .. **37-51**
W/ vacuum pump (metal bowl) includes gasket. 3.900-0.15
..... **\$118.00 EA** ⚠



5592627 **37-51**
W/ metal bowl, includes gasket. 3.900-0.15
..... **\$60.00 EA** ⚠



5592627G ... **52-57**
W/ glass bowl, includes gasket. 3.900-0
..... **CALL** ⚠



5592627M **52-57**
W/ metal bowl, includes gasket. 3.900-0.15
..... **\$75.00 EA** ⚠

Fuel Pump, cont.



5592675 **52-57**
W/ vacuum pump (glass bowl) stops slow wipers, original accessory. 3.900-0.15
..... **\$145.50 EA** ⚠



5592675M .. **52-57**
W/ vacuum pump (metal bowl) stops slow wipers, original accessory. 3.900-0.15
..... **\$134.00 EA** ⚠

Fuel Pump Rebuild Kit



5591844 **37-51**
W/ vacuum pump 3.901-0.15
..... **\$89.00 EA** ⚠



5592945 **37-51**
Without vacuum pump 3.901-0.15
..... **\$64.75 EA** ⚠



5591825 **52-57**
W/ vacuum pump 3.900-0
..... **\$77.00 EA** ⚠



5592988 **52-57**
Without vacuum pump 3.901-0.15
..... **\$64.75 EA** ⚠

Carburetor

All carburetors are rebuilt units. Base gaskets are included.
Core returns must be same style as purchased unit.



838938 **37-40**
Carter W-1 (\$150 core) 3.725-0.15
..... **\$190.50 EA** ⚠



839987 **41-48**
Carter W-1 (\$150 core) 3.725-0.15
..... **\$190.50 EA** ⚠



3692429C **49**
Carter W-1 (\$150 core). 3.725-0.15
..... **\$190.50 EA** ⚠



7004600 **49-53**
Rochester. Fits 216ci (\$150 core) 3.725-0.15
..... **\$190.50 EA** ⚠



7004468 **50-59**
Rochester. Fits 235ci (\$150 core). 3.725-0.15
..... **\$190.00 EA** ⚠

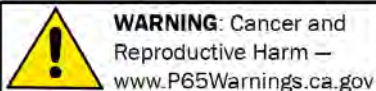

Chemicals shipped domestic ground only (Lower 48 states only). No international shipping.

Phone: (360) 816-0211 • (800) 999-CHEV (2438) • www.chevsofthe40s.com

Section 120T: Fuel System, Gas Tanks, Gas Tank Sending Units, Fuel Pumps, Carburetors, Air Cleaners & Intake Manifolds

Carburetor, cont.



838939.....**ALL**
New universal carb. Fits 216,235,261ci engines. -0.15 **\$360.00 EA** ⚠

Carburetor Rebuild Service

CARBREBUILD.....**ALL**
Send in your carburetor to have rebuilt. Carter W-1, YF and Rochester model B single barrels. 3.725 -0.15
..... **\$190.50 EA** ⚠

Matched Rebuilt Carbs

MATCHEDCARBS.....**ALL**
Matched rebuilt carburetors for when ordering for a multi carb setup (\$150 core per carb) 3.725 -0.15
..... **\$190.50 EA** ⚠

Carburetor Cleaner



6505259.....**ALL**
Gumout, 16 oz spray can. Cleans carburetors, linkage, choke valves and unpainted metal parts. 3.725 -0.15
..... **\$5.25 EA** ⚠

Carburetor Rebuild Kit



7004363.....**32-62**
Rochester, fits 1 barrel models B, BC, BV 3.725 -0.15 **\$40.50 EA** ⚠

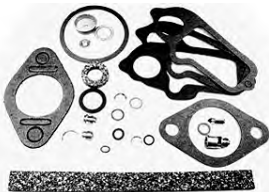

603978.....**36-40**
Fits Carter W-1, 216ci engine 3.725 -0.15
..... **\$52.25 EA** ⚠

Carburetor Rebuild Kit, cont.



3902169C.....**37-56**
Fits Carter Y-F, 216ci 3.725 -0.15 **\$34.75 EA** ⚠



609993.....**41-48**
Carter W-1 (216ci) 3.725 -0.15 **\$48.75 EA** ⚠



3692429.....**49**
Carter W-1 3.725 -0.15 **\$48.75 EA** ⚠

Carburetor Parts



839509A.....**33-49**
Oversized throttle shaft for W-1 carburetor only 3.752 -0.15 **\$39.75 EA** ⚠



836636.....**37-49**
Carburetor float Carter W-1 3.725 -0.15
\$49.25 EA ⚠



7002672.....**37-57**
Carburetor float Rochester 3.745 -0.15
..... **\$21.50 EA** ⚠



7002082A.....**49-60**
Oversized throttle shaft for Rochester carburetor only 3.752 -0.15 .. **\$39.75 EA** ⚠

Carburetor Insulator



3692797.....**34-53**
Bakelite exc 50-53 235ci. 2-11/16". 3.726 -0
..... **\$9.99 EA** ⚠



3692797.....**39-55**
Bakelite insulator (GMC). 3.726 -0
..... **\$9.99 EA** ⚠



3692799.....**50-59**
Bakelite (235ci). 2-15/16". 3.726 -0.2
..... **\$11.75 EA** ⚠

Carburetor Base Gasket



601348.....**34-49**
Carter W-1 base gasket 2-11/16 inch bolt centers. 3.726 -0.2
..... **\$2.75 EA** ⚠



839632.....**50-53**
216ci engine. 2-3/4 inch bolt centers. 3.726 -0.15
..... **\$3.75 EA** ⚠



3712549.....**50-62**
Carburetor base (235ci, 261ci engine). 3inch bolt centers. 3.726 -0.15
..... **\$3.75 EA** ⚠

Throttle Return Spring



838420.....**37-47**
Throttle lever stud mounted to left side of engine block 3.582 -0.15 **\$25.50 EA** ⚠



3659431.....**41-49**
Throttle return spring 3.459 -0.15 **\$9.25 EA** ⚠



3695705.....**50-59**
All 6 cylinder. 3.459 -0 **\$4.00 EA** ⚠

Section 120T: Fuel System, Gas Tanks, Gas Tank Sending Units, Fuel Pumps, Carburetors, Air Cleaners & Intake Manifolds

Throttle Lever Stud



3650230**37-40**

Throttle return spring 3.459 -0.15

\$5.00 EA ⚠

Vacuum Advance Line

Oversize shipping charges apply. Please call for rate.



217278**ALL**

Pre bent. Carb to distributor. Steel (specify year when ordering). 8.964 -0.15

..... starting at **\$20.00 SET** ⚠



217278S**ALL**

Pre bent. Carb to distributor. Stainless (specify year when ordering). 8.964 -0.15

..... starting at **\$25.00 SET** ⚠

Gas & Fuel Line Clip



148129A**ALL**

Double ended, holds 1/4in. brake & 5/16 in. gas line to frame (snaps into hole). 8.950 -0.4

\$5.00 EA ⚠



3735074C**ALL**

3/8 in. slot, gas, brake line, wire harness (4 pcs). 8.950 -0.15

\$6.50 SET ⚠



599119**ALL**

Holds gas & vacuum lines together, fuel pump to carburetor

(uses 4) 8.950 -0.4

\$6.00 PR ⚠

Manifold Gasket



(3pcs) 3.270 -0.15

602483A**37-53**

Intake & exhaust manifold. Fits 216ci

\$17.50 SET ⚠



838290**37-53**

Rectangle between manifolds. Fits 216ci 3.272 -0.15

\$6.00 EA ⚠

Manifold Gasket, cont.



3707045**50-62**

Intake & exhaust manifold. Fits 235ci & 261ci (3pcs) 3.270 -0.15

\$16.00 SET ⚠



3835572**50-62**

Rectangle between manifolds. Fits 235ci & 261ci 3.272 -0.15

\$6.00 EA ⚠

Manifold Clamps & Bolts



838546B**37-57**

Intake - Exhaust manifold clamps (spreaders). Cast reproduction. 3.273 -0

CALL ⚠



838546BK**37-57**

Intake - Exhaust manifold bolt kit 3.273 -0

\$5.00 SET ⚠



838546U**37-57**

Intake - Exhaust manifold clamps (spreaders). used 3.273 -0

\$35.00 SET ⚠

Manifold Sleeves-(Metal)



837273**34-53**

Intake to head 216ci. Exc 50-53 235ci (3 piece set) 3.281 -0.15

\$8.50 SET ⚠

3835506**50-62**

Intake to head 235ci, 261ci (3 piece set) 3.281 -0.15

\$7.50 SET ⚠

Odds & Ends

Please call for availability on all Odds & Ends parts; once part is sold, it may no longer be in stock.

593306**34-58**

Gas Lines NORS 7in. long 8.964 -0.4

\$15.00 EA ⚠

1573094U**37-55**

Fuel pump glass bowl used 3.903 -0

\$10.00 EA ⚠

05160**49**

Carburetor, Carter We w/ Auto Choke 3.724 -0.4

\$300.00 EA ⚠

7002890**50-51**

Carb Float Bowl, 235ci Rochester (NOS) 3.724 -0.4

\$25.00 EA ⚠

05280**50-53**

Carburetor, Carter Y-F. For 216ci engine 3.725 -0.4

\$300.00 EA ⚠

5592876**52**

Diaphragm rebuild kit (NORS). Use w/ part #559226 11.000 -0.4

\$15.00 EA ⚠

5592877**52-55**

Diaphragm rebuild kit (NORS). Use w/ part #5592627 11.000 -0.4

\$15.00 EA ⚠

5592922**52-55**

Diaphragm rebuild kit (NORS). Use w/ part #5592765 3.725 -0.4

\$15.00 EA ⚠

700408S**54-57**

Carburetor Kit - 6 Cyl w/ H.T. 3.724 -0.4

\$15.00 EA ⚠

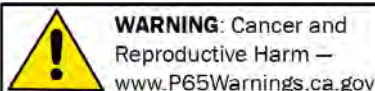

WARNING: Cancer and Reproductive Harm -

www.P65Warnings.ca.gov

Chemicals shipped domestic ground only (Lower 48 states only). No international shipping.

Phone: (360) 816-0211 • (800) 999-CHEV (2438) • www.chevsofthe40s.com

120T

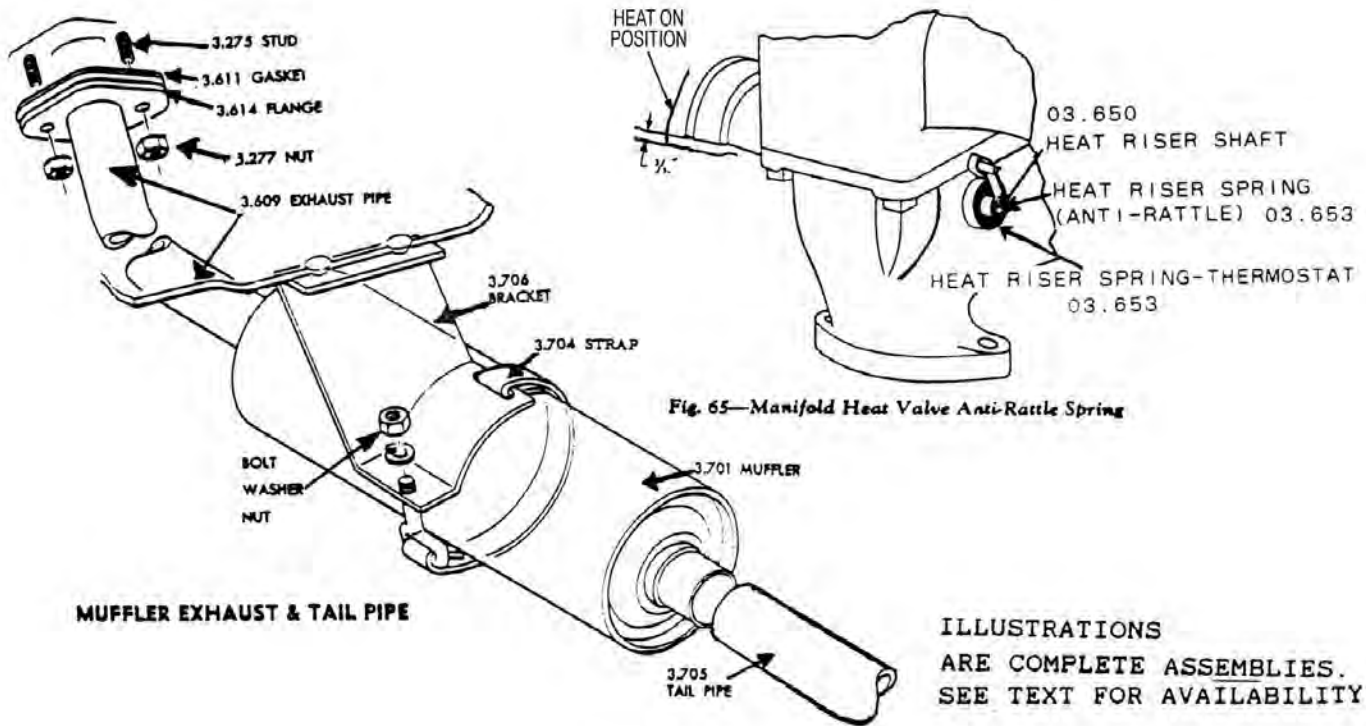

ILLUSTRATIONS ARE COMPLETE ASSEMBLIES

SEE TEXT FOR AVAILABILITY

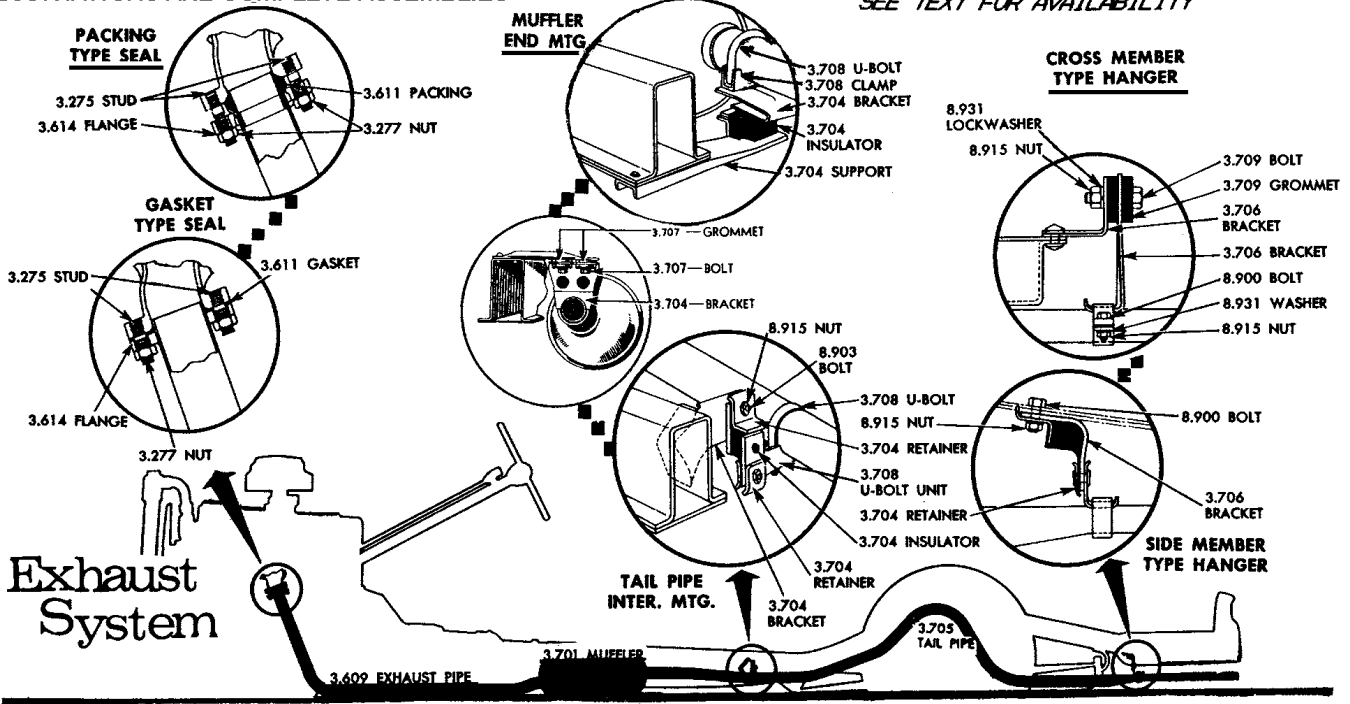

Illustrations are for example and reference only. They do not indicate that we have all the parts shown.

WARNING: Cancer and Reproductive Harm —
www.P65Warnings.ca.gov

**SECTION 130T
STREET ROD PARTS**

Dual Exhaust System



2031DUAL47-53
Standard Transmission,
1/2 Ton -0.15
..... **\$695.00 EA** ⚠

2032DUAL54-55
First Series (Standard Transmission) 1/2
Ton -0.15
..... **\$693.50 EA** ⚠

Fenton Headers



3657963A37-62
Fenton headers. Cast iron, for all 1937-62
216ci, 235ci & 261ci engines. Comes with
header flange and gaskets.
3.609-0 **\$199.00 PR** ⚠

3657963G37-62
Fenton headers. Cast iron, for all GMC
228ci, 248ci, 270ci & 302ci engines.
Comes with header flange and gaskets.
3.609-0 **\$199.95 PR** ⚠

Fenton Header Parts



838574B37-53
Heat kit. Split headers
to intake. 216ci only.
3.640-0
..... **\$44.25 EA** ⚠



3657963S37-62
Bolt set for Fenton
headers. 3.609-0
..... **\$5.50 SET** ⚠



838573B50-62
Heat kit. Split headers
to intake. 235ci only.
3.640-0
..... **\$44.25 EA** ⚠



3692831ALL
Header pipe to Fenton
or tube headers
(requires 2). 3.611-0.15
..... **\$3.25 EA** ⚠

Tube Headers

Tube Headers
Tubing is mandrel bent to provide the highest
flow possible, and fixture welded to ensure
precise fit. Mounting flanges are O-ringed to
reduce leakage.



3657963SS37-62
Polished stainless finish. Includes weld-on
header pipe flanges. Fits 216ci or 235ci.
3.609-0.2 **\$175.00 SET** ⚠



3657963T37-62
Black painted finish. Includes weld-on
header pipe flanges. Fits 1937-62 216ci,
235ci & 261ci. 3.609-0.2 **\$125.00 PR**
⚠

**SECTION 130T
RESTORATION PARTS**

Exhaust System

Note: Complete system includes header pipe
gasket, studs and nuts, header pipe spring
(1938-42), header pipe, muffler, muffler
clamps, muffler hanger, tailpipe and tailpipe
hanger as needed. Will not fit GMC. All pipes
are aluminized.

Oversize shipping charges apply to all Exhaust
Systems. Please call for rate.

599397B37-40
3/4Ton 3.705-0.15
..... **\$300.00 EA** ⚠

599415B37-40
1/2Ton 3.705-0.15
..... **\$300.00 EA** ⚠

3656764B41-46
1/2Ton 3.705-0.15 **\$300.00 EA** ⚠

3656962B41-48
1-1/2 Ton w/ 134-1/2 in. wheelbase.
3.705-0.15
..... **\$300.00 EA** ⚠

3657135B41-48
3/4Ton 3.705-0.15
..... **\$300.00 EA** ⚠

Exhaust System, cont.

3683656B47-48
1/2Ton 3.705-0.15
..... **\$300.00 EA** ⚠

3656962C49
1-1/2Ton w/ 134-1/2 in. wheelbase.
3.705-0.15
..... **\$300.00 EA** ⚠

3657135C49
3/4Ton 3.705-0.15
..... **\$300.00 EA** ⚠

3683656C49
1/2Ton 3.705-0.15
..... **\$300.00 EA** ⚠

3692828A50-53
1-1/2Ton & 2Ton 216ci. 3.705-0.15
..... **\$300.00 EA** ⚠

3696161A50-53
3/4Ton exc. double duty. 3.705-0.15
..... **\$300.00 EA** ⚠

3696161C50-53
3/4Ton exc. double duty. 3.705-0
..... **\$300.00 EA** ⚠

3696806A50-53
1/2Ton 3.705-0.15 **\$300.00 EA** ⚠

3696806C50-53
1/2Ton w/ 235ci. 3.705-0
..... **\$300.00 EA** ⚠

3715243A50-53
1Ton 3.705-0.15
..... **\$300.00 EA** ⚠

3692828B50-54
1-1/2Ton & 2Ton 235ci. 3.705-0
..... **\$275.00 EA** ⚠

3696161B54
3/4Ton exc. double duty. 3.705-0
..... **\$300.00 EA** ⚠

3696806B54
1/2Ton 3.705-0 **\$300.00 EA** ⚠

3715243B54
1Ton 3.705-0
..... **\$300.00 EA** ⚠

Exhaust Manifold



369197149-53
Exhaust Manifold Fits 49 All (exc D-D,
COE), 50-53 All 216ci 3.601-0.15
..... **\$200.50 EA** ⚠

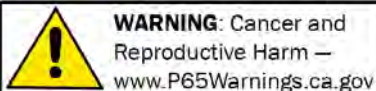

Chemicals shipped domestic ground only (Lower 48 states only). No international shipping.

Phone: (360) 816-0211 • (800) 999-CHEV (2438) • www.chevsofthe40s.com

Manifold Clamps



838546B37-57

Intake - Exhaust manifold clamps (spreaders). Cast reproduction. 3.273-0
..... **CALL** ⚠



838546U37-57

Intake - Exhaust manifold clamps (spreaders). used 3.273-0
..... **\$35.00 SET** ⚠

Manifold Gasket



602483A37-53

Intake & exhaust manifold. Fits 216ci
(3pcs) 3.270-0.15
..... **\$17.50 SET** ⚠



83829037-53

Rectangle between manifolds. Fits 216ci 3.272-0.15
..... **\$6.00 EA** ⚠



370704550-62

Intake & exhaust manifold. Fits 235ci & 261ci (3pcs) 3.270-0.15
..... **\$16.00 SET** ⚠



383557250-62

Rectangle between manifolds. Fits 235ci & 261ci 3.272-0.15
..... **\$6.00 EA** ⚠

Heat Riser Spring



60279937-54

Anti-rattle 3.653-0.4
..... **\$7.00 EA** ⚠



83857337-54

Thermostatic spring. Allows flap to open and close with temperature. 3.653-0.2
..... **\$16.95 EA** ⚠

Heat Riser Shaft



596264A37-54

Oversize requires reaming worn manifold holes 3.650-0.15
..... **CALL** ⚠

Flange Plate



59360737-53

Holds header pipe to manifold, 216ci 3.610-0.15
..... **\$9.50 EA** ⚠

3696988F37-62

For Fenton Headers 3.610-0.15
..... **\$5.00 EA** ⚠



369698851-57

235ci 3.610-0.15
..... **\$15.00 EA** ⚠

Gasket



59360637-49

Header pipe to manifold. 3.611-0
..... **\$4.00 EA** ⚠



369283150-54

Header pipe to manifold. 3.611-0
..... **\$3.50 EA** ⚠

Studs In Manifold



837552B29-54

For header pipe, 3/8 in. x 2 in. w/ brass hex nuts 3.275-0
..... **\$3.25 SET** ⚠

Spring



36824432-48

Supports rear of header pipe (exc 40-46 1T & 39-46 utility), overall Length 3-1/4". 4.827-0
..... **\$6.50 EA** ⚠

Header Pipe

Oversize shipping charges apply to all Header Pipes. Please call for rate.

365272537-40

All 3.609-0.15
..... **\$90.00 EA** ⚠

368410841-48

All 3.609-0.15
..... **\$90.25 EA** ⚠

369127749

All 3.609-0.15
..... **\$90.00 EA** ⚠

369371250-53

All with 216ci motor. 3.609-0.15
..... **\$90.25 EA** ⚠

369371550-54

All with 235ci motor. 3.609-0.15
..... **\$90.00 EA** ⚠

Muffler



Muffler style & sizes vary

60374635-40

This is a muffler for 1935-1940. The muffler size and variety may differ from the picture shown. 3.701-0.15
..... **\$90.25 EA** ⚠

365659841-49

This is a muffler for 1941-1949. The muffler size and variety may differ from the picture shown. 3.701-0.15
..... **\$90.25 EA** ⚠

369371050-54

This is a muffler for 1950-1954. The muffler size and variety may differ from the picture shown.

Muffler is 5" dia and 21" long excluding pipes. 3.701-0.15
..... **\$103.25 EA** ⚠

Muffler Clamp

369381137-49

Front, 1-7/8in. 3.708-0
..... **\$2.75 EA** ⚠



369381237-49

Rear, 1-5/8 in. 3.708-0
..... **\$2.50 EA** ⚠

369381150-54

Rear, 1-7/8in. 3.708-0.3
..... **\$4.25 EA** ⚠

369483750-54

Front, 2 in. 3.708-0.15
..... **\$2.25 EA** ⚠

Muffler Hanger



367625737-55

This is a muffler hanger for 1937-55. 3.704-0.15
..... **\$12.25 EA** ⚠

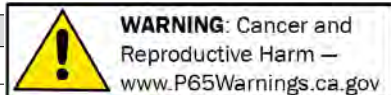

Section 130T: Exhaust Systems, Headers, Extensions

Muffler Hanger, cont.



3676257A47-54
Muffler Hanger bracket - Mounts to frame and attaches to muffler with strap
3.704 -0.15 **\$17.25 EA** ⚠

Tailpipe

Oversize shipping charges apply on all tailpipes. Please call for rates.

59939737-40
3/4Ton 3.705 -0.15
..... **\$90.00 EA** ⚠



59941537-40
1/2Ton 3.705 -0.15 **\$90.00 EA** ⚠



365676441-46
1/2Ton 3.705 -0.15 **\$90.00 EA** ⚠



365696241-49
1-1/2Ton w/ 134-1/2in. wheelbase & 1Ton. 3.705 -0.15 **\$90.00 EA** ⚠



365713541-49
3/4Ton 3.705 -0.15 **\$90.00 EA** ⚠

368365647-49
1/2Ton 3.705 -0.15
..... **\$90.00 EA** ⚠

368957450-54
Panel, Suburban, Canopy Express.
3.705 -0.15
..... **\$89.99 EA** ⚠

..... **\$89.99 EA** ⚠

Tailpipe, cont.



369282850-54
1-1/2Ton & 2Ton, 8-3/8 in. long. 3.705 -0.2
..... **\$22.25 EA** ⚠



369616150-54
3/4Ton exc Double
Duty. 3.705 -0.15
..... **\$90.00 EA** ⚠



369680650-54
1/2Ton 3.705 -0.15 **\$90.00 EA** ⚠

371524350-59
1Ton 3.705 -0.15
..... **\$89.99 EA** ⚠

..... **\$89.99 EA** ⚠

Tailpipe Hanger

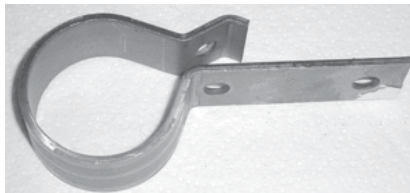

365679137-54
Correct reproduction. 3.706 -0.2
..... **\$13.99 EA** ⚠



3656791A37-54
Replacement. 3.706 -0.15 .. **\$6.00 EA**
⚠

Tailpipe Clamp



594135ALL
Clamp, original for
tailpipe extension w/
nut & bolt. 3.708 -0.15
..... **\$5.25 EA** ⚠

..... **\$5.25 EA** ⚠

Tailpipe Heat Shield

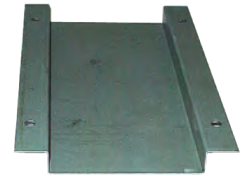

3689481R37-46
Under bed. 3.706 -0.15 .. **\$9.75 EA** ⚠

3689481S47-54
Under bed. 3.706 -0.15
..... **\$8.50 EA** ⚠

3689481SS47-54
Stainless steel. Under bed. 3.706 -0.15
..... **\$16.00 EA** ⚠

Exhaust Extension



985707 41
Exhaust Extension
Whale Tail shaped. Left
side. Superb stainless
reproduction of original
accessory. 3.705 -0.15
..... **\$346.50 EA** ⚠



985808 41
Exhaust Extension Right
Side Whale Tail shaped,
with clamp. Superb
chrome reproduction of
original accessory. 3.705 -0.15
..... **\$347.00 EA** ⚠



98584842-48
Bearclaw shape.
Superb chrome
reproduction of
original. 3.705 -0
..... **\$124.50 EA** ⚠



51A18529PALL
Plain, Polished
Stainless. -0.15
..... **\$15.00 EA** ⚠



985992AALL
Era accessory
stainless steel w/
stamped bowtie.
3.705 -0.15
..... **\$18.50 EA** ⚠

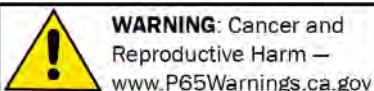

Chemicals shipped domestic ground only (Lower 48 states only). No international shipping.

Phone: (360) 816-0211 • (800) 999-CHEV (2438) • www.chevsofthe40s.com

Exhaust Extension, cont.



985992CALL
 CHROME Bowtie shaped outlet.
 2-1/4" I.D. (not pre-drilled). 3.705 -0.15

. **\$32.50 EA** ⚠



986885SALL
 STAINLESS STEEL Bowtie shape.
 2-1/4" I.D. (not pre-drilled). 3.705 -0.15

. **\$32.50 EA** ⚠

Exhaust Paint



3657963CALL
 Exhaust paint stainless steel pigments. For exhaust manifolds & pipes. Gives a soft grey, metallic finish. Pint 3.609 -0

. **CALL** ⚠



3657963DALL
 Cast blast paint high temp 1200 degree. Grey, fresh cast look for exhaust manifolds, etc. Rust preventative, 11 oz spray can. 3.609 -0.15

. **\$12.50 EA** ⚠



3657963EALL
 Exhaust paint clear, high temp (1200 degree) for exhaust etc, 11 oz spray can. 3.609 -0.15

. **\$15.00 EA** ⚠



3657963FAALL
 Exhaust paint very high temp, flat aluminum for manifolds & pipes. 11 oz spray can. 3.609 -0.15

. **\$15.00 EA** ⚠

Odds & Ends

Please call for availability on all Odds & Ends parts; once part is sold, it may no longer be in stock.

369416350-57
 Intake manifold. Fits all exc 216ci & DD (Used) 3.609 -0.4

. **\$65.00 EA** ⚠



1946 1/2-ton — Roger Mann

**SECTION 140T
RESTORATION PARTS**

Flywheel Ring Gear



838177.....37-54
139 teeth (exc
powerglide). 0.667 -0.2
..... **\$65.00 EA** ⚠

Complete Clutch Kit



838956B.....38-53
Replacement 9in. clutch and pressure
plate kit. Includes pilot bushing, throwout
bearing, alignment tool and lube.
0.863 -0.15 **\$235.75 EA** ⚠

Pressure Plate



838646.....38-53
Clutch Pressure Plate
Spring 0.863 -0.2
..... **\$5.75 EA** ⚠



838949.....38-53
Rebuilt Heavy duty,
10-3/4in. (\$150 core).
0.863 -0.15
..... **\$179.00 EA** ⚠



838956.....38-53
Rebuilt 9in. (\$50 core).
0.863 -0.15
..... **\$127.00 EA** ⚠



8386715.....54-57
Rebuilt Use w/ 9in. &
10in. disc (\$50 core).
0.863 -0.15
..... **\$133.25 EA** ⚠

Clutch Disc, cont.



8385483.....38-53
Rebuilt 10-3/4in. o.d.
(\$100 core). 0.886 -0.15
..... **\$141.00 EA** ⚠



8385483N.....38-53
New 10-1/2" No Core
0.886 -0
..... **\$159.75 EA** ⚠



83847450.....38-54
Rebuilt 9in. o.d. (\$40
core). 0.886 -0.15
..... **\$98.00 EA** ⚠

Clutch Disc, cont.



8386119.....54-57
Rebuilt 10in. (\$40
core). 0.886 -0.15
..... **\$107.75 EA** ⚠

8386119N.....54-57
10in. (\$40 core). 0.886 -0
..... **\$115.00 EA** ⚠

Tool



838956A.....ALL
Tool to align clutch disc.
0.866 -0.3
..... **\$6.75 EA** ⚠

Pressure Plate Bolts



838653.....38-57
Pressure plate bolts.
Shouldered 3/8-16,
1" length, grade 8.
Includes lock washers.

Set of 6. Restoration only for Chevy I-6cyl.
0.863 -0.15
..... **\$19.75 SET** ⚠



839756.....38-57
Mounts flywheel to
crank. 7/16-20,
31/32", grade 8.
Includes lock washers.

Set of 6. Restoration only for Chevy I-6cyl.
0.669 -0.15 **\$18.75 SET** ⚠

Throwout Bearing



909422.....38-54
This is the throw out
bearing that resides
in the bellhousing
for engaging or
disengaging the clutch. 0.799 -0.2
..... **\$32.50 EA** ⚠

Pilot Bearing



907109.....31-39
This roller style
pilot bearing fits
into the end of the
engine crankshaft
and supports the input shaft of the
transmission. 0.649 -0.15
..... **\$18.50 EA** ⚠

Pilot Bushing



412562.....39-66
This bushing style pilot
bearing fits into the end
of the engine
crankshaft and
supports the input shaft of the
transmission. 0.649 -0.2
..... **\$4.50 EA** ⚠

Throwout Arm Ball



2054961C.....32-37
2 pieces w/o clips or
lockwasher. 0.796 -0

..... **CALL** ⚠



2054961.....38-54
Stud, 1-1/2in. long.
0.796 -0.4
..... **\$6.00 EA** ⚠

Clip



838987.....31-54
Throwout arm to ball
stud. 0.823 -0.15
..... **\$6.00 EA** ⚠

Throwout Arm Spring



3664881.....41-46
7-5/16in. 0.844 -0.15

..... **\$10.50 EA** ⚠



3653114.....47-54
17.5" 0.844 -0.15
..... **\$10.00 EA** ⚠

Clutch Pedal Return Spring



368244.....32-46
Clutch Pedal Return
Spring. Overall Length

3-1/4". 4.827 -0.3
..... **\$6.50 EA** ⚠



3698665.....47-57
Overall length 5-3/4in.

4.827 -0.3
..... **\$10.00 EA** ⚠

Clutch Linkage Rod



3676398.....47-59
Offset rod (L shape)
2-1/4in. 0.787 -0.15
..... **\$19.50 EA** ⚠



3676454.....47-59
Rod 7-1/16in. (1 hook
& 1 eye). 0.787 -0.15
..... **\$10.50 EA** ⚠

Odds & Ends

Please call for availability on all Odds & Ends
parts; once part is sold, it may no longer be in
stock.

473503.....33-36
2nd & 3rd spd clutch-commercial
4.380 -0.4 **\$35.00 EA** ⚠

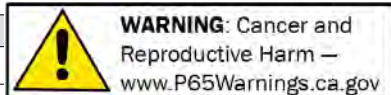

**SECTION 150T
STREET ROD PARTS**

Line Clamp Stainless

13275..... **ALL**
3/16" x 3/8" double combination (6
clamps). 8.950 -0.15
..... **\$18.00 SET** ⚠

13276..... **ALL**
3/16" x 3/16" double (6 clamps).
8.950 -0.15
..... **\$18.00 SET** ⚠

13284..... **ALL**
5/16" x 3/8" double combination (6
clamps). 8.950 -0.15
..... **\$18.00 SET** ⚠

Crossmember



3711049.....**42-57**
Truck Universal transmission mounting
bracket for engine swap. 4.081 -0.15
..... **\$62.75 EA** ⚠

Transmission Mount

3711049B**42-57**
Rubber, for turbo 350,
2-hole mount only.
4.081 -0.15
..... **\$11.00 EA** ⚠

3711049C**42-57**
Rubber, for turbo 350,
turbo 400, & 400R,
1-hole mount. 4.081 -0.2
..... **\$25.00 EA** ⚠

**SECTION 150T
RESTORATION PARTS**

Note: Die cut pad & gaskets for floor insert
over transmission see Section 320T.

Synchro Ring



605020A**40-54**
Press in, brass 4.380 -0.15 .. **\$25.00 EA** ⚠

Speedometer Cable



1567793**37-57**
W/ original housing assembly exc 1939-
54. 4.342 -0 **\$56.00 EA** ⚠

1588291A**37-57**
Cable without housing. 85" length (0.130
dia.). 4.342 -0.4
..... **\$48.00 EA** ⚠

158829 **39-54**
W/ original metal housing assembly. 70"
length. 4.342 -0
..... **\$18.00 EA** ⚠



158829P**39-54**
W/ plastic housing assembly. 4.342 -0
\$20.50 EA ⚠

Tip



1565706.....**37-57**
Tip, steel (speedometer
end of, speedo cable).
4.342 -0.3
..... **\$4.75 EA** ⚠

Shift Knob



374993**29-47**
3-speed floor shift push-
on. Black. 4.009 -0.15
..... **\$8.50 EA** ⚠



374993B.....**29-54**
4-speed screw-on.
Black. Chevy & GMC
4.009 -0.15
..... **\$9.50 EA** ⚠



985099..... **37**
Brown, accessory.
4.009 -0.15
..... **\$35.00 EA** ⚠



3686898.....**47-53**
Maroon. Chevy & GMC
4.009 -0.15
..... **\$13.00 EA** ⚠



3698233.....**54-59**
Black Chevy & GMC
4.009 -0.15
..... **\$8.00 EA** ⚠

Floorshift Seal



3653420.....**37-47**
Floor to transmission
3-speed.
Top: 2-3/4 in. O.D.
Bottom: 2 in. O.D.
Inside Diameter: 1-1/4 in. 4.015 -0.15
..... **\$40.25 EA** ⚠

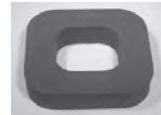

3687200.....**37-54**
Floor to transmission
4-speed. 4.015 -0.15
..... **\$5.50 EA** ⚠

Floor Shift Boot



3651348A**ALL**
Replacement-3 speed
(uses #3654365T trim
ring). 4.015 -0.3
..... **\$9.75 EA** ⚠

Trim Ring



3654365T.....**ALL**
Stainless retains boot
#3651348A. 4.044 -0.15
..... **\$14.00 EA** ⚠

Bushing



3710401.....**39-57**
Grommet with metal
lining. Shift arm to
steering column.
4.040 -0.15
..... **\$4.50 EA** ⚠

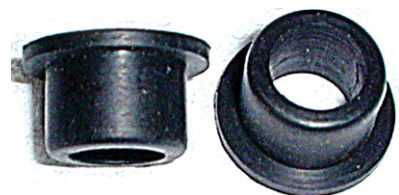

365244.....**48-53**
Rubber bushing shift rod ends (4 pcs).
4.016 -0.15 **\$7.50 SET** ⚠

365244..... **54**
Rubber bushing shift rod ends (6 pcs).
4.016 -0.15
..... **\$11.00 SET** ⚠

Shift Tube Support Bracket



3698234.....**48-54**
Supports top of shift
tube under steering
wheel. 4.018 -0.15
..... **\$19.75 EA** ⚠

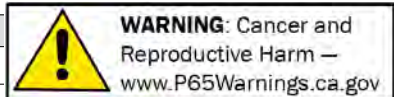

Spring & Pivot Pins



3654731.....40-57
Column shift handle
(fits 40-54 car & 48-57
truck). 4.025 -0.15
..... **\$21.75 SET** ⚠

Pivot Pins



3653719.....40-57
Column shift handle (2 pcs). 4.025 -0.15
..... **\$2.00 PR** ⚠

Metal Plug



142024.....48-54
In shift box (also 49-54 car). 9.008 -0.3
\$1.00 EA ⚠

Rubber Bellows



3686796.....48-59
On shift box, base
of steering column.
4.015 -0.15
..... **\$3.50 EA** ⚠

Cluster Gear Bushing



591210.....37-53
Fits bushing-styled
cluster (2 pcs). 4.422 -0.2
..... **\$12.00 SET** ⚠

Bearing Transmission



954168.....37-54
Rear of trans case
(tail shaft). Fits 3spd
4.408 -0.2
..... **\$42.50 EA** ⚠



435844.....37-57
Front bearing on main
drive gear. (3spd)
4.355 -0.2
..... **\$42.50 EA** ⚠

Tailshaft Bushing



3717682.....48-54
Rear of tailshaft, 1/2T,
4-speed. 4.445 -0
..... **CALL** ⚠

Shift Fork



4.107 -0.15

591660.....48-55
Seal for inside cover,
3-speed (2 pcs).

..... **\$13.75 SET** ⚠



3845048.....49-55
2nd & 3rd gear (\$20
core). 4.303 -0
..... **CALL** ⚠

Transmission Gasket Set



606664.....31-47
4-speed. 4.005 -0.15
\$25.25 SET ⚠



3764394.....37-54
Transmission gasket set 3-speed (Except
Powerglide). Includes torque tube ball seal
kit 37234890 4.005 -0.15
..... **\$20.25 SET** ⚠

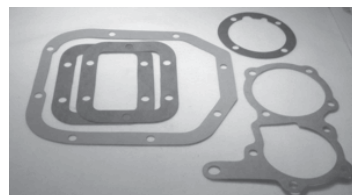

3689458.....48-63
Muncie 4-speed. 4.005 -0.15
..... **\$13.75 SET** ⚠

Reverse Idler Gear



591264.....41-47
4 speed. 4.430 -0
..... **\$30.00 EA** ⚠

Cluster Shaft



591213.....40-57
3 speed roller bearing type. Fits bushing
w/ modifications. 4.428 -0
CALL ⚠

Soft Plug



103892.....39-48
End of cluster shaft
& reverse idler shaft.
8.970 -0.4
..... **\$1.50 EA** ⚠

Small Parts Kit



609926.....37-54
Thrust washers, needle bearings
(3-speed). 4.004 -0.15
..... **\$45.00 KIT** ⚠

Transmission Mount



594117.....37-39
Transmission Mount.
4.081 -0
..... **CALL** ⚠



3652730A.....37-54
Rebuild kit: Pad & bolts. 4.081 -0.15
\$10.00 SET ⚠



3688234.....48-53
Steel 4.081 -0.15
..... **\$64.75 EA** ⚠

Odds & Ends

Please call for availability on all Odds & Ends
parts; once part is sold, it may no longer be in
stock.

590481.....31-37
Front Main Bearing Retainer 12.000 -0.4
..... **\$25.00 EA** ⚠

609951.....34-37
Fork Unit Clutch Release COMM & Utility
12000.000 -0.4 **\$20.00 EA** ⚠

590853.....37-39
Shift Yoke Shaft 1st & Reverse All 3
speed 12000.000 -0.4 **\$35.00 EA** ⚠



WARNING: Cancer and
Reproductive Harm —
www.P65Warnings.ca.gov

Chemicals shipped domestic ground only (Lower 48 states only). No international shipping.

Phone: (360) 816-0211 • (800) 999-CHEV (2438) • www.chevsofthe40s.com

Section 150T: Transmissions, Shifters, Transmission Mounts, Knobs, Shift Boots & Cables
Section 150T: Transmissions, Shifters, Transmission Mounts, Knobs, Shift Boots & Cables

Odds & Ends, cont.

- 590925**.....**37-39**
Reverse idler gear for 3 Speed (NOS)
12.000 -0.4 **\$30.00 EA** ⚠
- 954451**.....**37-39**
Bearing diff. side 37-39 all util. 5.536 -0.4
..... **\$40.00 EA** ⚠
- 591119**.....**40**
Retainer trans rear bearing (All 4 speed)
4.317 -0.4 **\$45.00 EA** ⚠
- 905207**.....**41-47**
Bearing Propeller Shaft 5.436 -0.4
..... **\$30.00 EA** ⚠
- 3682372**.....**46-47**
Propeller shaft bearing retainer (NOS)
5.439 -0.4 **\$20.00 EA** ⚠
- 954394**.....**46-50**
Front pinion bearing. All 1/2T (NOS)
4.355 -0.4 **\$50.00 EA** ⚠
- 591667**.....**48-50**
Counter Gear, 1st Speed all w/ 4 speed
12000.000 -0.4 **\$75.00 EA** ⚠
- 3686836**.....**48-54**
Gearshift Operating Lever & Clamp
12.000 -0.4 **\$12.00 EA** ⚠
- 3687429**.....**48-54**
Clamp, Gearshift Selector housing
12000.000 -0.4 **\$10.00 EA** ⚠
- 591501**.....**48-54**
Input shaft COMM & Utility w/ 4 speed
4351.000 -0.4 **\$25.00 EA** ⚠
- 3686812**.....**48-55**
Lever, Gearshift Selector, 2nd & 3rd
(4-1/4in) fits 48-52 COMM, 53-55 COMM
1st series exc DD, 55 COMM 3sp 6 cyl
2nd series 4.016 -0.4 **\$15.00 EA** ⚠
- 3692608**.....**48-57**
Trans Main Shaft 4 speed (All)
12000.000 -0.4 **\$65.00 EA** ⚠
- 591603**.....**48-57**
Clutch Gear Synchronizing Cone 4 Speed
4.384 -0.4 **\$35.00 EA** ⚠
- 591906**.....**48-57**
Yoke, 1st & 2nd Speed All (4sp)
12000.000 -0.4 **\$30.00 EA** ⚠
- 954358**.....**48-57**
Bearing Front On Main Drive Gear
4.355 -0.4 **\$24.75 EA** ⚠
- 954864**.....**48-57**
Bearing Main Shaft Rear (4 speed)
4.408 -0.4 **\$30.00 EA** ⚠
- 954869**.....**48-57**
Main shaft gear 4.112 -0.4 .. **\$40.00 EA** ⚠
- 591780**.....**49-54**
2 & 3rd Shifter Shaft W Plate 12.000 -0.4
..... **\$12.00 EA** ⚠

Odds & Ends, cont.

- 3688159**.....**49-55**
Lever, Gearshift Selector, 2nd & 3rd (5-
1/4in overall length), fits 49-54 pass 3sp,
53-55 DD 3sp 1st series, 4.016 -0.4
..... **\$15.00 EA** ⚠
- 3691568N**.....**50-52**
Ring-washer torque conv retain NOS
13000.000 -0.4 **\$6.00 PR** ⚠
- 3692835**.....**50-54**
Collar, U-joint Ball 50-54 Pass Powerglide
13.000 -0.4 **\$25.00 EA** ⚠
- 3694491**.....**51-54**
Reverse Band Brake Strut, P/g (NOS)
12.000 -0.4 **\$70.00 EA** ⚠
- 904913**.....**54-55**
Bearing 3 Speed, rear trans (COMM)
4.405 -0.4 **\$30.00 EA** ⚠
- 1307238**.....**54-61**
Transmission Oil Plug w/ Seal (NOS)
12.000 -0.4 **\$6.00 EA** ⚠
- 5668232**.....**55-56**
Mast jacket bearing assembly, fits
COMM & Utility 6.521 -0.4 .. **\$40.00 EA** ⚠

**SECTION 160T
RESTORATION PARTS**

U-Joint Rebuild Kit

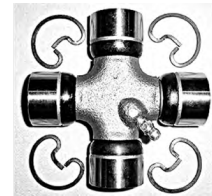

- 609948**.....**33-53**
33-39 4 speed front, rear exc VE, VF; 40
front exc KC, WD; 41-53 front 3/4 exc
Double-Duty. 5.548 -0.15 .. **\$35.50 EA** ⚠



- 609944**.....**40-54**
Fits car & 1/2T.
Includes lock plates and
Bolts 5.548 -0.15
..... **\$54.50 EA** ⚠

U-Joint Lock Plates



- 3723489**.....**40-54**
2 plates & 4 bolts 5.586 -0.4 .. **\$9.50 SET**
⚠

U-Joint Assembly

- 602795**.....**37-39**
W/ yokes, 3/4T, 3-speed. 5.548 -0.15
..... **\$178.50 EA** ⚠
- 3653380**.....**40**
W/ yokes 1-1/2T (exc WD). 5.548 -0
..... **\$153.00 EA** ⚠
- 604373**.....**40-47**
W/ yokes 3/4 & 40 1t 3-speed front.
5.548 -0.2
..... **\$99.00 EA** ⚠
- 591642**.....**48-54**
W/ yokes 1/2T 3-speed. 5.548 -0
..... **CALL** ⚠

Torque Tube



- 3723490**.....**29-54**
Ball seal kit, for drive shaft 29-40 & 41-54
cars, 1/2T& 3/4T truck w/ manual trans.
5.572 -0.15 **\$11.00 EA** ⚠

Returns require a return authorization number—call first. • Product pricing & availability subject to change.

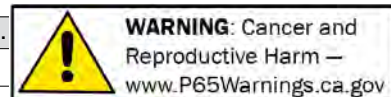

Torque Tube, cont.



3723490P.....50-54
Ball seal kit, for drive shaft. Fits 50-54 cars w/ Powerglide.
5.572 -0.15

\$19.25 EA ⚠

Dowel Pin



347813.....29-50
5/16 in. , retains drive shaft bushing.
5.450 -0.3

\$7.00 EA ⚠

Coupling Pin



3657332.....40-54
Drive shaft to pinion. 5.457 -0.2

\$9.25 EA ⚠

Drive Shaft Bushing



3694733.....51-54
Rear, Car & 1/2T Truck. 5.451 -0

CALL

Drive Shaft Seal



595010.....37-39
1/2, 3/4 & 1T. 5.469 -0.3

\$14.00 EA ⚠

3691457.....40-50
40 all & 41-50 1/2T. 1" i.d. 5.469 -0.15

\$14.50 EA ⚠

Oakie Bushing & Seal

Replaces front & rear drive shaft bushing & seal without disassembling rear end and driveline.



595005B.....37-39
Car, 1/2T, 3/4T & 1T 5.451 -0.15

\$82.79 EA ⚠



3652328B.....40-50
Car and 1/2 ton truck. 5.451 -0.15

\$85.00 EA ⚠



609930A.....40-50
Oakie bushing seal
5.451 -0.15

\$9.00 EA ⚠



3694733B.....51-54
Car, 1/2T 5.451 -0.15

\$83.00 EA ⚠

Tool Oakie Bushing Puller



595005A.....37-54
Drive shaft bushing puller to rent (return in original condition for \$20.00 refund).
5.451 -0.15

\$75.00 EA ⚠

Odds & Ends

Please call for availability on all Odds & Ends parts; once part is sold, it may no longer be in stock.

901105.....33-35
Pinion shaft bearing. Rear exc CC
13.000 -0.4

\$25.00 EA ⚠

370416.....33-39
Prop Shaft Bushing, Front (Utility)
13000.000 -0.4

\$20.00 EA ⚠

3653931.....40
Propeller shaft housing bushing front
13000.000 -0.4

\$25.00 EA ⚠



WARNING: Cancer and Reproductive Harm – www.P65Warnings.ca.gov

Chemicals shipped domestic ground only (Lower 48 states only). No international shipping.

Phone: (360) 816-0211 • (800) 999-CHEV (2438) • www.chevsofthe40s.com

**SECTION 170T
RESTORATION PARTS**

Rear Axle Cover



475308.....37-62
Chrome with chrome filler plug. Chevy 1/2Ton & 1937-42 3/4 and 1Ton trucks. Does not include gasket, use 370245 37-59. 5.398-0 **\$60.00 EA** ⚠

Ring & Pinion Conversion Kit



3705439A.....40-54
3.55:1 Chevy trucks 1/2 ton only! Bolt in for 1940-53 (1937-39 requires drive line modifications). 1954 1/2 Ton truck needs the correct carrier to install this conversion (spool casting #3652336-40-43, 1/2 Ton trucks). Will not fit Canadian spec trucks. 5.529-0.15 **\$370.00 SET** ⚠

Ring & Pinion Installation Kit



3705430KT.....40-50
Chevy truck gaskets, seals, bearings. 5.529-0 **\$499.00 SET** ⚠

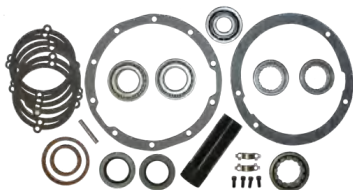

3705439KT.....51-54
Chevy. Gaskets, Seals, Bearings. 5.529-0 **\$499.00 EA** ⚠

Ring & Pinion Shim Set



SHIMSET01.....37-54
Ring & Pinion Shim Set -0.2 **\$20.00 EA** ⚠

Rear Axle Seal



592441.....33-54
1/2T & 37-42 3/4 & 1T. 5.822-0.4 **\$32.19 EA** ⚠

3663166.....41-42
Except 1/2T. 5.469-0.3 **\$17.00 EA** ⚠



3686563.....46-57
3/4 & 1T. 5.822-0.15 **\$20.25 EA** ⚠

Rear Axle Bearing & Seal



111121B.....37-54
This is a rear axle bearing and seal for 1937-1954 1/2 ton pickup and 1937-1942 3/4 ton and 1 ton truck. It does 1 side. 5.855-0.4 **\$99.38 SET** ⚠

188930B.....46-57
3/4 & 1T. 5.855-0 **\$81.25 SET** ⚠

Rear Axle Bearing



111121.....37-54
1/2T & 37-42 3/4 & 1T. 5.855-0.4 **\$74.75 EA** ⚠



188930.....46-57
3/4 & 1T. 5.855-0.15 **\$63.00 EA** ⚠

Axle Gasket



370245.....37-59
Center cover on rear axle, rear gasket, 1/2T & 37-42 3/4 & 1T. 5.399-0.15 **\$6.00 EA** ⚠

Axle Gasket, cont.



370246.....37-59
Differential to axle housing, front gasket, 1/2T & 37-42 3/4 & 1T. 5.508-0.3 **\$7.75 EA** ⚠

Differential Fill



344829.....29-54
Plug w/ gasket. 5.400-0 **CALL** ⚠

Carrier Bearing

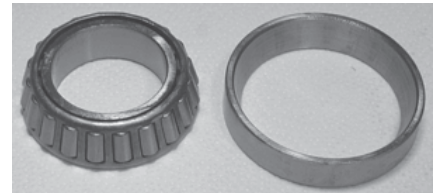

7450385.....46-56
1/2T & 40-42 3/4T & 1T (uses 2). 5.536-0.15 **\$75.75 EA** ⚠

Pinion Seal



3653618.....40-57
40 COE, 41-42 1-1/2T & larger (exc 1/2T & 40-55 2-speed). 5.469-0.4 **\$24.00 EA** ⚠

Pinion Bearing



125630.....35-54
Rear. Cars; 35-54 pass & 53-55 Corvette. Trucks; 35-42 COMM, 46-54 1/2Ton 5.484-0.3 **\$64.50 EA** ⚠



954780.....35-54
Front, Passenger & 1/2T. 5.447-0.15 **\$53.00 EA** ⚠

Spring Pivot Seals



597267.....38-54
Rear end to spring pivot bolt (4 ea). 5.404-0.3 **\$15.75 SET** ⚠

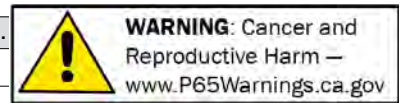

Bushing Rear Spring Pivot



3652182A **48-54**
 Bolt w/ nut, rear end to spring pivot,
 1/2Ton. 5.403 -0.15 **\$33.00 PR** ⚠

Odds & Ends

Please call for availability on all Odds & Ends parts; once part is sold, it may no longer be in stock.

901305 **33-39**
 Bearing Pinions Shaft NOS Rear Utility
 13000.000 -0.4
 **\$25.00 EA** ⚠

473636 **36-57**
 Nut-Rear Wheel Bearing (36-53 Utility)
 13000.000 -0.4
 **\$10.00 EA** ⚠

473636N **36-57**
 Nut-Rear Wheel Bearing NOS (36-53
 Utility) 13000.000 -0.4
 **\$15.00 EA** ⚠

595647 **37-39**
 Shaft Bolt Lock Axle 3-1/8 I.D.
 13000.000 -0.4
 **\$15.00 EA** ⚠

3651377 **39-41**
 Stud, shaft to hub cap 2 spd axle 1.5 ton
 13000.000 -0.4
 **\$6.00 SET** ⚠

3653928 **40-47**
 Spacer gasket, metal rear wheel hub w/
 1/2in. axle bolt holes fits utility 5.811 -0.4
 **\$10.00 EA** ⚠

7450385N **46-56**
 Carrier Bearing- 1/2in. (NOS) w/ race.
 5.536 -0.4
 **\$60.00 SET** ⚠

901604 **48-50**
 Bearing counter shaft rear (4-speed)
 4.408 -0.4
 **\$30.00 EA** ⚠



1941 Suburban — Antonio Ramos

170T

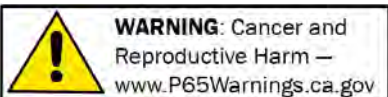

Chemicals shipped domestic ground only (Lower 48 states only). No international shipping.

Phone: (360) 816-0211 • (800) 999-CHEV (2438) • www.chevsofthe40s.com

**SECTION 180T
STREET ROD PARTS**

Master Cylinder & Brake Booster Assy



EC-50547-54
New 7" booster & master cylinder assembly. Mounts in stock location using original brake pedal. Auto Trans only. 1/2 Ton only. -0.15 **\$425.00 KIT** ⚠

Master Cylinder Dual Reservoir For Disc Brakes

For drum/drum use 10lb valve in front line.
For disc/drum use 2lb valve in front line.
Large reservoir for front, small reservoir rear.



EC-445ALL
67-72 Mustang w/ 1" bore. disc/drum applications -0.15 **\$75.00 KIT** ⚠

Master Cylinder Adapter Kit



EC-42047-54
Adapts either EC-445 or EC-446 master cylinder to the stock brake pedal in the stock master

cylinder location on 47-54 Chevy 1/2 ton trucks. Supplied with pushrod, rod end & hardware. -0

..... **\$89.75 KIT** ⚠

Disc Brake Conversion Kit

EC-6711SCK28-40

Car & 1/2 ton truck. Complete kit for straight axles. Including rotors, calipers, pads, brackets & fasteners (brake hoses sold separately). 6x5.5" lug. Does not include bearings or seals. Uses original bearings and seals for 29-40. Inner Bearing 909002 26-40, Outer Bearing 909001 29-57, Seal 352488 29-40. -0

..... **\$475.00 KIT** ⚠

Disc Brake Conversion Kit, cont.



EC-711S28-40
Car & 1/2 ton truck. Bracket kit only (no rotors, calipers, pads, etc). (exc. 33-36 standard cars and trucks w/ light duty spindle). -0.15 **\$200.00 KIT** ⚠



EC-711SCK28-40
Car & 1/2 ton truck. Complete kit for straight axles. Including rotors, calipers, pads, brackets & fasteners (brake hoses sold separately). 5x4-3/4" lug. (exc. 33-36 standard cars and trucks w/ light duty spindle). -0 **\$475.00 KIT** ⚠

EC-6711CK41-54
1/2 ton truck. Complete kit for straight axles. Including rotors, calipers, pads, brackets & fasteners (brake hoses sold separately). 6x5.5" lug NO HUB, NO SEALS, NO BEARINGS -0

..... **\$476.25 KIT** ⚠



EC-71141-54
1/2 ton truck, Bracket kit only (no rotors, calipers, pads, etc). 1/2 ton only. -0.15 **\$205.00 KIT** ⚠



EC-711CK41-54
For 1/2 Ton Truck. Complete kit including rotors, calipers, pads, brackets & fasteners (brake hoses sold separately). 5 lug standard. -0 **\$475.00 KIT** ⚠

Disc Brake Conversion Kit, cont.



EC-751ALL
Rubber brake hose kit for ECI conversion kits. Front only. 10mm for '78-81 GM Calipers. -0.15 **\$60.00 PR** ⚠

Line Clamp Stainless



13274ALL
3/16" single (12 clamps). 8.950 -0.15 **\$18.00 SET** ⚠

13275ALL
3/16" x 3/8" double combination (6 clamps). 8.950 -0.15

..... **\$18.00 SET** ⚠

13276ALL
3/16" x 3/16" double (6 clamps). 8.950 -0.15

..... **\$18.00 SET** ⚠

13277ALL
1/4" single (12 clamps). 8.950 -0.15

..... **\$18.00 SET** ⚠

13278ALL
5/16" single (12 clamps). 8.950 -0.15

..... **\$18.00 SET** ⚠

13279ALL
3/8" single (12 clamps). 8.950 -0.15

..... **\$18.00 SET** ⚠

13280ALL
1/2" single (12 clamps). 8.950 -0.15

..... **\$18.00 SET** ⚠

13281ALL
5/8" single (8 clamps). 8.950 -0.15

..... **\$18.00 SET** ⚠

13282ALL
3/4" single (8 clamps). 8.950 -0.15

..... **\$18.00 SET** ⚠

13283ALL
7/8" single (8 clamps). 8.950 -0.15

..... **\$18.00 SET** ⚠

13284ALL
5/16" x 3/8" double combination (6 clamps). 8.950 -0.15

..... **\$18.00 SET** ⚠

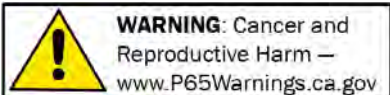

Chemicals shipped domestic ground only (Lower 48 states only). No international shipping.

Phone: (360) 816-0211 • (800) 999-CHEV (2438) • www.chevsofthe40s.com

Line Clamp Stainless, cont.



- 13285.....ALL**
1/4" x 1/4" double (6 clamps). 8.950 -0.15
..... **\$18.00 SET** ⚠
- 13286..... ALL**
5/16" x 5/16" double (6 clamps).
8.950 -0.15 **\$18.00 SET** ⚠
- 13287..... ALL**
3/8" x 3/8" double (6 clamps). 8.950 -0.15
..... **\$18.00 SET** ⚠
- 13288..... ALL**
1/2" x 1/2" double (6 clamps). 8.950 -0.15
..... **\$18.00 SET** ⚠
- 13289..... ALL**
5/8" x 5/8" double (4 clamps). 8.950 -0.15
..... **\$18.00 SET** ⚠
- 13290..... ALL**
3/4" x 3/4" double (4 clamps). 8.950 -0.15
..... **\$18.00 SET** ⚠
- 13291..... ALL**
7/8" x 7/8" double (4 clamps). 8.950 -0.15
..... **\$18.00 SET** ⚠

Clamp



120521.....ALL
1/4 in. bolt-on strap.
For wire or tube (4 pcs).
8.950 -0.4

..... **\$2.59 SET** ⚠



120521A.....ALL
5/16 in, insulated
bolt-on strap. For wire
or tube (4 pcs).
8.950 -0.4

..... **\$3.29 SET** ⚠



120521B.....ALL
3/8 in. bolt-on strap.
For wire or tube (4 pcs).
8.950 -0.4

..... **\$2.79 SET** ⚠

Brake Cleaner



6129423ALL
Superior cleaner. Many uses
(spray can). APPLICATIONS:
ABS, disc, drum, brake
cylinders, brake drums, brake
linings, brake shoes, calipers,
clutch discs, disc brake pads,
discs. Safe for use on all brake
systems including: Springs &
Wedge brakes.

4.683 -0.2 **\$4.00 EA** ⚠

**SECTION 180T
RESTORATION PARTS**

Brake Overhaul Kit



BRKHAUL.....36-50

Brake Overhaul Kit.
Kit includes:
Shoes & Linings for 4 wheels
4 Wheel Cylinder Kits (rubber cups only)
1 Master Cylinder Kit
4 Wheel Hold Down Kits
3 Brake Hoses
Brake Return Springs
4 Adjusting Hole Covers
Fits cars and 1/2 ton trucks. 5.017 -0.15
..... **\$199.00 KIT** ⚠

BRKHAUL..... 51-52

Brake Overhaul Kit.
Kit includes:
Shoes & Linings for 4 wheels
4 Wheel Cylinder Kit (rubber cups only)
1 Master Cylinder Kit
4 Wheel Hold Down Kits
3 Brake Hoses
Brake Return Springs
4 Adjusting Hole Covers
Fits cars and 1/2 ton trucks. 5.017 -0.15
..... **\$165.00 KIT** ⚠

BRKHAUL..... 53-54

Brake Overhaul Kit.
Kit includes:
Shoes & Linings for 4 wheels
4 Wheel Cylinder Kit (rubber cups only)
1 Master Cylinder Kit
4 Wheel Hold Down Kits
3 Brake Hoses
Brake Return Springs
4 Adjusting Hole Covers
Fits cars and 1/2 ton trucks. 5.017 -0.15
..... **\$250.00 KIT** ⚠

Emergency Brake Release



369040448-51

Handle (chrome). 4.592 -0.15
..... **\$10.00 EA** ⚠

Emergency Brake Release, cont.



3687252.....48-55
U-bolt for foot brake
release lock guide.
4.603 -0.15
..... **\$22.75 EA** ⚠



1990717.....52-53
Knob chrome w/
maroon center. Original
color and quality.
4.600 -0

..... **CALL** ⚠



1990717A..... 54
Knob (black). , original
color and quality.
4.600 -0.15
..... **\$10.00 EA** ⚠

Emergency Brake Bracket



3687303 ...48-55
For foot operated
pedal. 4.648 -0.15
..... **\$49.50 EA** ⚠

Emergency Brake Cable



597327.....37-46
1/2 ton (takes 2). Does not include clevis.
55" length. 4.826 -0.15 **\$55.25 EA** ⚠
3694170.....47-54
1/2 ton (takes 2) (1947-50 use your end).
4.826 -0.15
..... **\$39.00 EA** ⚠

Gasket Emergency Cable



476136.....36-54
Emergency cable to backing plate.
4.834 -0.2 **\$4.00 PR** ⚠



Boot



3691420**37-54**
Emergency cable to cable housing.
4.834 -0.15 **\$5.00 SET** ⚠

Clevis End Pin



3682642**37-53**
Emergency brake.
4.833 -0.3 **\$6.00 PR** ⚠



3687752**47-54**
Emergency brake cable
4.826 -0.15 **\$8.00 EA** ⚠

Control Rod Assembly



3689297**48-54**
Emergency brake (goes back to cables).
Fits 1/2T. 4.826 -0.15 .. **\$89.00 SET** ⚠

Grommet



3696521**51-54**
Emergency brake
release 9.775 -0.15
..... **\$4.25 EA** ⚠

Anti Rattle Rubber Spacer



369387**37-54**
Hand brake handle
release rod. 4.605 -0.4
..... **\$7.00 EA** ⚠

Spring



373980**32-57**
Emergency hand brake
release lever. 4.597 -0.15
..... **\$7.50 EA** ⚠



3695565**48-55**
Parking brake release
spring 4.597 -0.15
..... **\$6.00 EA** ⚠

Brake Pedal Return Spring



368244**36-46**
Brake Pedal Return Spring. Overall Length
3-1/4". 4.827 -0 **\$6.50 EA** ⚠



3698665**47-57**
Overall length 5-3/4in. 4.827 -0.3
\$10.00 EA ⚠

Bushings



3682074**37-46**
Clutch & brake pedal
shaft (13/16 in. O.D. x
3/4 in. I.D. x 1-25/64
in. long) 4.626 -0.15
..... **\$27.00 PR** ⚠



3683016**47-54**
Clutch & Brake Pedal
Shaft (1-1/16 in. O.D.
X 1 in. I.D. X 1-1/4 in.
Long) 0.831 -0.15
..... **\$18.00 PR** ⚠

Tinnerman Nuts



365897**ALL**
Retains rear brake
drum (6 pcs). 5.810 -0.2
..... **\$7.50 SET** ⚠

Brake Drum Gasket



365673**29-57**
Brake drum (6 lug) front or rear. 5.819 -0.15
..... **\$3.75 PR** ⚠

Brake Drum



601985**36-50**
Rear 1/2Ton & 37-42 3/4Ton (6 lug). 6 on
5-1/2 in. bolt pattern. 5.809 -0.15
\$89.50 EA ⚠

Brake Drum, cont.



602432A**36-50**
Front, straight axle. 1/2Ton & commercial
(6 lug). 6 on 5-1/2 in. bolt pattern. 5.809 -0
..... **\$125.00 EA** ⚠

3696266**51-56**
Front or rear 1/2Ton. 5.809 -0.15
..... **\$59.00 EA** ⚠

Brake Shoes



3681129**36-52**
36-50 1/2Ton front & rear, 37-42 3/4Ton
rear w/ 11 in. brakes, 37-52 3/4Ton front,
37-42 1Ton front (does 2 wheels) 5.017 -0.2
..... **\$40.00 SET** ⚠

3695709**51-56**
Rear 2 wheels (\$15 core) w55b.
5.017 -0.15
..... **\$40.00 SET** ⚠

3696177**51-56**
Front 2 wheels (\$15 core). 5.017 -0.15
..... **\$35.00 SET** ⚠

3703512**53-59**
3/4Ton & 1Ton front, 3/4Ton rear (exc.
14 in. brakes, duals & 7.50 in. x 17 in.
tire). 5.017 -0.2
..... **\$85.00 PR** ⚠

Brake Shoe Hold Down Kit



3696704**51-57**
2 wheels (8 pcs). 5.043 -0 **\$8.00 SET**
⚠

Brake Shoe Hold Down



475506**36-50**
J-hook (2 pcs). 1 set
does 1 wheel 5.102 -0.3
..... **\$3.00 SET** ⚠

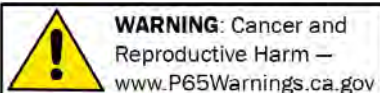

WARNING: Cancer and Reproductive Harm —
www.P65Warnings.ca.gov

Chemicals shipped domestic ground only (Lower 48 states only). No international shipping.

Phone: (360) 816-0211 • (800) 999-CHEV (2438) • www.chevsofthe40s.com

Brake Shoe Hold Down, cont.



475509 **36-50**
Spring (2 pcs). 1 set
does 1 wheel 5.046 -0.3

..... **\$5.99 SET** ⚠

Brake Shoe Return Springs



475511 **37-50**
For 2 wheels (2 pcs) 36-42 all, 46-50
1/2Ton, 3/4Ton front only. 5.026 -0

\$7.00 SET ⚠



3680890 **46-52**
3/4Ton rear and 1Ton front. 5.026 -0.15

..... **\$14.00 EA** ⚠

Brake Shoe Springs



3694822 **51-54**
Return & adjusting, Passenger & 1/2Ton
(does 2 wheels) (6 pcs). 5.026 -0.15

\$9.00 SET ⚠

Pin Lock



358829 **30-52**
Shoe anchor 29/32in.
o.d. (1/2T& most 3/4T)
(3 Pieces - 1 Set Per
Wheel) 5.057 -0

..... **\$6.00 SET** ⚠



358829E **30-52**
Replacement (e-clip)
brake shoe, 29/32in.
o.d. (2 pcs). 5.057 -0

..... **\$1.75 SET** ⚠



359380 **30-57**
Shoe anchor 1-3/16 in.
O.D. some 3/4Ton &
most 1Ton (2 pcs). 5.057 -0.3

..... **\$8.75 PR** ⚠



359380E **30-57**
E-clip for brake shoe,
1-3/16 in. O.D. some
3/4Ton & most 1Ton (2

pcs). 5.057 -0.4

..... **\$2.00 SET** ⚠

Pin Lock, cont.



475508 **36-52**
Brake shoe 9/16
in. O.D. (exc. 51-52
1/2Ton) (2 pcs) 1 set
does 1 wheel 5.030 -0.25

..... **\$3.00 SET** ⚠



475508E **36-52**
E-clip. Replaces original
on brake shoe. 9/16 in.
O.D. (exc 51-52 1/2Ton)
(2 pcs). 1 set does 1

wheel 5.030 -0

..... **\$1.75 SET** ⚠

Adjuster Assembly



496351B **51-57**
Brake shoe w/ star wheel, fits Passenger
& 1/2T. 5.110 -0.15

..... **\$11.50 EA** ⚠

Brake Adjust Hole Plugs



475516 **36-54**
Plugs (original metal) (8
pcs). 5.188 -0.3

..... **\$8.50 SET** ⚠



475516B **36-54**
Plugs (rubber) (8 pcs).
5.188 -0.4

..... **\$6.75 SET** ⚠

Brake Hose



476719 **36-54**
36-50 all, 51-54 3/4Ton only, takes 3.
4.680 -0.2

..... **\$17.99 EA** ⚠

3696551 **51-57**
Takes 3. (Except 3/4 ton) 4.680 -0.15

U-clip



334961 **36-57**
For brake hose to frame
(uses 3) (3 piece set).
4.681 -0.4

..... **\$3.50 SET** ⚠

Copper Washer



231343 **36-57**
For brake hose (3 pcs).
4.671 -0.3

..... **\$3.00 SET** ⚠

Brake Line Sets

Oversize shipping charges apply to all Brake
Line Sets. Please call for rate.



Brake lines shown may vary from your specific model

3696844 **37-52**
Pre bent Steel 3/4Ton (specify year when
ordering). 4.865 -0

..... **starting at \$145.00 SET** ⚠

369684S **37-52**
Pre bent Stainless 3/4Ton (specify year
when ordering). 4.865 -0

..... **starting at \$155.00 SET** ⚠

3696833 **37-54**
Steel 1/2Ton (specify year when
ordering). 4.865 -0

..... **starting at \$145.00 SET** ⚠

369683S **37-54**
Stainless 1/2Ton (specify year when
ordering). 4.865 -0

..... **starting at \$170.00 SET** ⚠

Gasket Master Cylinder Cap



080445 **37-57**
Master cylinder cap.
4.651 -0.2

..... **\$1.25 EA** ⚠

Master Cylinder



5450257 **36-37**
1/2Ton (\$100 core). 4.650 -0.15

..... **\$175.00 EA** ⚠



5454381 **38-46**
Except 1/2Ton 4.650 -0.15

..... **\$125.00 EA** ⚠

Returns require a return authorization number—call first. • Product pricing & availability subject to change.



Master Cylinder, cont.



5454576 **38-46**
 Rebuilt 1/2Ton (\$125 core). 4.650-0.15
 **\$175.00 EA** ⚠



5454576E **38-46**
 New for 1/2Ton. Includes push rod.
 4.650-0.15 **\$156.00 EA** ⚠



5454575 **47-50**
 1/2Ton (\$35 core). Chevy & GMC
 4.650-0.15 **\$94.00 EA** ⚠



5454382 **47-51**
 Except 1/2Ton . Chevy & GMC 4.650-0.15
 **\$119.00 EA** ⚠



5454384 **51**
 1/2Ton (\$35 core). Chevy & GMC 4.650-0
 **\$125.00 EA** ⚠

Master Cylinder, cont.



5454382 **52-54**
 1-1/2Ton, 2Ton & 52 Double Duty.
 4.650-0.15 **\$107.50 EA** ⚠



5454459 **52-54**
 1/2Ton & 53-54 3/4Ton & 1Ton (exc.
 Hydramatic & Double Duty) Chevy & GMC
 4.650-0.15 **\$98.00 EA** ⚠

5454459R **52-54**
 1/2Ton & 53-54 3/4Ton & 1Ton (exc.
 Hydramatic & Double Duty) (\$35 core).
 Chevy & GMC 4.650-0.15
 **\$130.00 EA** ⚠



5454384 **53-54**
 Double Duty & Hydramatic (\$35 core).
 4.659-0.15 **\$125.00 EA** ⚠

Master Cylinder Rebuild Kit



5453950 **36-50**
 1/2Ton (1 in. bore). 4.650-0.15
\$20.00 EA ⚠



5454428 **36-59**
 1937-1952 3/4-ton, 1938-1952 1-ton,
 1936-1959 1 1/2-ton, and 1947-1959
 2-ton trucks. (1 1/4-inch bore) (1-1/4 in.
 bore). 4.649-0.15 **\$29.00 EA** ⚠

Master Cylinder Rebuild Kit, cont.



5450962 **51-54**
 1/2Ton & 53-54 3/4Ton, 1Ton (1-1/8 in.
 bore). 4.649-0.15 **\$32.75 EA** ⚠

Floor Plug Master Cylinder



592865 **36-54**
 Master cylinder inspection (in floor). 3-3/8
 in. diameter for 3 in. hole. 12.541-0.15
 **\$7.50 EA** ⚠

Rubber Boot Master Cylinder



5450551 **36-57**
 On master cylinder. 4.659-0.3
\$11.25 EA ⚠

Front Wheel Cylinder



5300869 **36-52**
 36-50 1/2Ton, 3/4Ton, 1Ton, 1-1/2Ton,
 2Ton & 51-52 3/4Ton (exc. 50 Double
 Duty). 4.665-0 **\$39.50 EA** ⚠

5453780 **51-52**
 1-1/2Ton & 2Ton. 1-3/8" bore 4.665-0.15
 **\$117.50 EA** ⚠

5455478R **51-59**
 Right 1/2Ton. 4.665-0.15
\$28.00 EA ⚠

5455479L **51-59**
 Left 1/2Ton. 4.665-0.15
\$28.00 EA ⚠

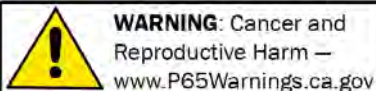

Chemicals shipped domestic ground only (Lower 48 states only). No international shipping.

Phone: (360) 816-0211 • (800) 999-CHEV (2438) • www.chevsofthe40s.com

Front Wheel Cylinder, cont.

5453819 **53-54**
 1-1/2Ton & 2Ton (1 in. piston). 4.665 -0
 **\$45.00 EA** ⚠

Rear Wheel Cylinder



5300866 **36-50**
 1/2Ton, 37-42 3/4Ton w/ 11 in. drum.
 4.665 -0.2 **\$40.00 EA** ⚠

5300885 **36-50**
 1-1/2Ton. 4.665 -0.15 **\$69.75 EA** ⚠

5450071 **37-52**
 1Ton & 3/4Ton w/ 14 in. drum. 4.665 -0.15
 **\$62.50 EA** ⚠

5453865 **51-53**
 Rear on rear axle (1-1/2Ton, 2Ton).
 4.665 -0.15 **\$124.00 EA** ⚠

5453866 **51-53**
 Front on rear axle (1-1/2Ton, 2Ton).
 4.665 -0.15 **\$124.00 EA** ⚠

5453819 **51-54**
 Rear. Also fits 53-55 Corvette. 4.665 -0.15
 **\$28.00 EA** ⚠

5455480L **53-57**
 Left, 1Ton. 4.665 -0.15 **\$22.00 EA** ⚠

5455480R **53-57**
 Right, 1Ton. 4.665 -0.2 **\$22.00 EA** ⚠

5454313 **53-59**
 Front on rear axle (1-1/2Ton, 2Ton).
 4.665 -0.15 **\$75.59 EA** ⚠

5454314 **53-59**
 Rear on rear axle (1-1/2Ton, 2Ton).
 4.665 -0.15 **\$73.25 EA** ⚠

Front Wheel Cylinder Rebuild Kit



5450431 **36-52**
 36-50 1/2Ton, 3/4Ton, 1Ton, 1-1/2Ton,
 2Ton & 51-52 3/4Ton (exc 50 Double
 Duty) (1-1/4 in. bore). 4.665 -0
 **\$18.50 EA** ⚠

Front Wheel Cylinder Rebuild Kit, cont.



5455661 **51-59**
 1/2Ton & 53-57 3/4Ton & 1Ton. 4.665 -0.15
 **\$7.00 EA** ⚠



5455660 **53**
 1-1/2Ton & 2Ton. 4.665 -0.3
 **\$11.50 EA** ⚠



5454399 **54-59**
 1-1/2T & 2T. 4.665 -0.2 .. **\$9.00 EA** ⚠

Rear Wheel Cylinder Rebuild Kit



5450429 **36-50**
 1/2Ton & 37-42 3/4Ton with 11 in. drum
 (1-3/16 in. bore). 4.665 -0.15
 **\$23.50 EA** ⚠

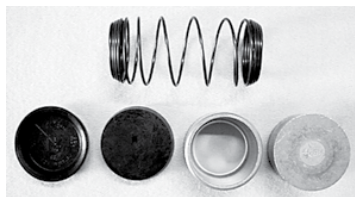

5450435 **36-50**
 W/ pistons 1-1/2Ton & 2Ton (1-1/2 in.
 bore). 4.665 -0.2 **\$45.00 EA** ⚠

Rear Wheel Cylinder Rebuild Kit, cont.



5450434 **36-52**
 W/ pistons 3/4Ton with 14 in. drum 40-52
 1Ton (exc. Double Duty) (1-3/8 in. bore).
 4.665 -0.15 **\$29.00 EA** ⚠



5454488 **51-57**
 1-1/2Ton & 2Ton. 4.665 -0.15
 **\$24.50 EA** ⚠



5455661 **51-57**
 3/4Ton (exc 56 Double Duty). 4.665 -0
 **\$7.00 EA** ⚠



5455660 **51-59**
 1/2Ton 4.665 -0.3 **\$11.50 EA** ⚠



5454252 **53-59**
 1Ton 4.665 -0.15 **\$10.50 EA** ⚠

Wheel Cylinder Rod



509233 **51-57**
 Rod connecting wheel cylinder to brake
 shoes 4.675 -0.3 **\$4.00 EA** ⚠

Bleeder Valve



5300926.....36-57
Wheel cylinder. 4.666 -0.2
..... **\$1.50 EA** ⚠

Brake Line Junction Bolt



476099.....36-50
Brake line junction
block bolt. Fits 36-50 all
(inc. GMC) 4.686 -0.15
..... **\$6.00 EA** ⚠

Brake Line Junction Block



476100.....36-50
Block for rear line to
wheel cylinder. Fits
1936-50 ALL, 51-57
3/4Ton, 1Ton & Utility.

4.686 -0.15

..... **\$19.50 EA** ⚠



497756.....36-57
Block for rear brake
hose at rear axle
housing. Fits 1936-50
All, 1951-57 3/4Ton,

1Ton & Utility. 4.686 -0.15

..... **\$21.50 EA** ⚠



3692044.....47-57
Block. Front brake line
at master cylinder. Fits
49-54 Convertible &
47-53 Chevy trucks.

Includes nut. 4.686 -0.15

..... **\$28.00 EA** ⚠



3696540.....51-54
Block, left front brake
line at master cylinder.
Fits 1951-54 PASS
(EXC. CONV) & 52-54

1/2Ton. 4.686 -0

..... **CALL** ⚠



3696553.....51-55
Block for rear line to
wheel cylinder. Fits
51-54 Pass, 51-55
1st Ser 1/2ton, 53-55

Corvette -0

..... **\$19.00 EA** ⚠



3696552.....51-57
Block for rear brake
hose at rear axle
housing. Fits 1951-
57 Pass. & 1/2Ton.

4.686 -0.15

..... **\$23.00 EA** ⚠

Clip



148129A.....ALL
Double ended, holds
1/4in. brake & 5/16 in.
gas line to frame (snaps
into hole). 8.950 -0.4

..... **\$5.00 EA** ⚠



3735074C.....ALL
3/8 in. slot, gas, brake
line, wire harness (4
pcs). 8.950 -0.15

..... **\$6.50 SET** ⚠

Brake Light Switch



1997725.....36-42
Hydraulic (41-42 COE
only). Screw on terminal
2.447 -0.15

..... **\$13.50 EA** ⚠



403936.....41
Hydraulic. Exc. COE.
Press on terminal
2.447 -0.2

..... **\$10.75 EA** ⚠

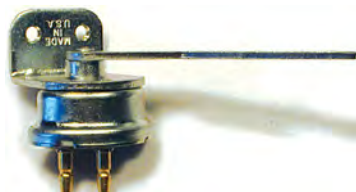

1997901.....42-54
Mechanical (exc 42 COE). 2.447 -0
..... **\$13.50 EA** ⚠

Brake Light Switch T Fitting



652B.....ALL
Add a hydraulic brake
light switch to your
3/16" brake line. -0.4

..... **\$9.75 EA** ⚠

652C.....ALL
Add a hydraulic brake light switch to your
1/4" brake line. -0

..... **CALL** ⚠

Brake Fluid



5450285B.....ALL
Master "Fade Free"
DOT 4 (12 oz).
4.683 -0.15

..... **\$7.00 EA** ⚠

Brake Fluid, cont.



603486B.....ALL
Mac's, DOT 5,
silicone. Less
corrosion. 12 ounce
bottle. 4.683 -0.15

..... **\$10.25 EA** ⚠

Odds & Ends

Please call for availability on all Odds & Ends parts; once part is sold, it may no longer be in stock.

1409123.....36
Wheel brake cylinder cup rear 1-1/16in.
4.665 -0.15

..... **\$2.00 EA** ⚠

144526.....36-40
Inner Race & Roller outer axle bearing
13000.000 -0.4

..... **\$25.00 EA** ⚠

5450431N.....36-48
Wheel brake cylinder spring & cups. Front
for 1-1/4 in. bore, Delco NOS. 4.665 -0.4

..... **\$15.00 SET** ⚠

5300890.....36-50
Wheel brake cylinder cup 1-1/2in. rear
4.665 -0.15

..... **\$2.00 EA** ⚠

592420U.....36-50
Pin for brake link used 5.036 -0

..... **\$15.00 EA** ⚠

596565.....37-50
Bolt, flange plate spacer fits 1937-52
Utility Exc COE, HD or 1946-50 1-1/2T
except school bus chassis 5.002 -0.4

..... **\$15.00 PR** ⚠

597235.....39
Front anchor plate & links. 5.075 -0.4

..... **\$40.00 EA** ⚠

3650735.....39-48
Seal - wheel bearing front fits 39 COE,
40-48 2 Ton & 46-48 school bus chassis
6.326 -0.4

..... **\$10.00 EA** ⚠

5451615-1.....46-48
Wheel brake cylinder rear 4.665 -0.4

..... **\$19.00 EA** ⚠

5450073.....46-50
Wheel brake cylinder cups front 1-3/8in.
4.665 -0.15

..... **\$2.00 EA** ⚠

7450131.....49-53
Front inner bearing, 49-50 2 ton
13000.000 -0.3

..... **\$45.00 EA** ⚠



WARNING: Cancer and
Reproductive Harm —
www.P65Warnings.ca.gov

Chemicals shipped domestic ground only (Lower 48 states only). No international shipping.

Phone: (360) 816-0211 • (800) 999-CHEV (2438) • www.chevsofthe40s.com

Odds & Ends, cont.

- 3693451****51-55**
Backing Plate, Rear Left fits 51-54
Passenger, 53-55 Corvette, 51-55 1/2Ton
(1st series) 5.001 -0.4
..... **\$35.00 EA** ⚠
- 3693452****51-55**
Brake backing plate right side 5.001 -0.4
..... **\$34.00 EA** ⚠
- 3695834****51-57**
Propeller shaft dual shoe brake link outer
connecting angle on one end fits 51-55 1
ton utility first series except COE, 55-57
2nd series all 5.610 -0.4
..... **\$15.00 EA** ⚠
- 5450031****51-59**
Wheel brake cylinder cups. Fits 51-52
and 53-59 CBL 4.665 -0.15
..... **\$2.00 EA** ⚠
- 3687294****52-55**
Foot brake pedal latch bar, COMM NOS
14000.000 -0.4
..... **\$17.50 EA** ⚠
- 5455484N****53-57**
Wheel cylinder rear 1 ton DD
14000.000 -0.4
..... **\$55.00 EA** ⚠
- 5300866U****54-60**
Wheel cylinder NOS shelf worn 4.665 -0.4
..... **\$50.00 EA** ⚠
- 5300800****ALL**
Wheel cylinder cup 1-3/16 in 4.667 -0.15
..... **\$2.00 EA** ⚠



1954 GMC — Kevin Staal

 **WARNING:** Cancer and Reproductive Harm — www.P65Warnings.ca.gov

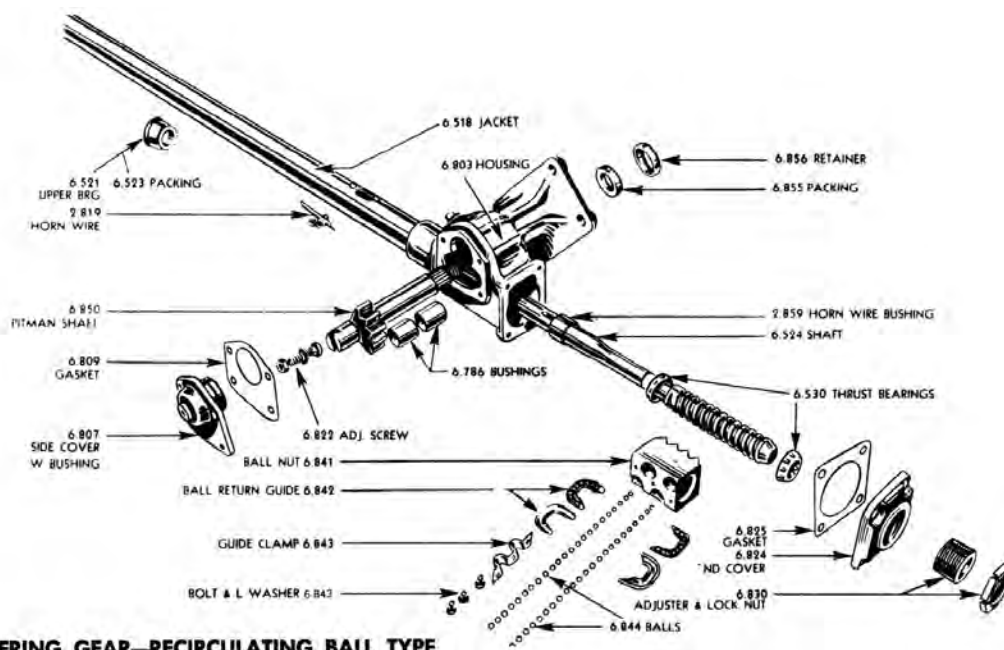

1941-46 STEERING GEAR—RECIRCULATING BALL TYPE

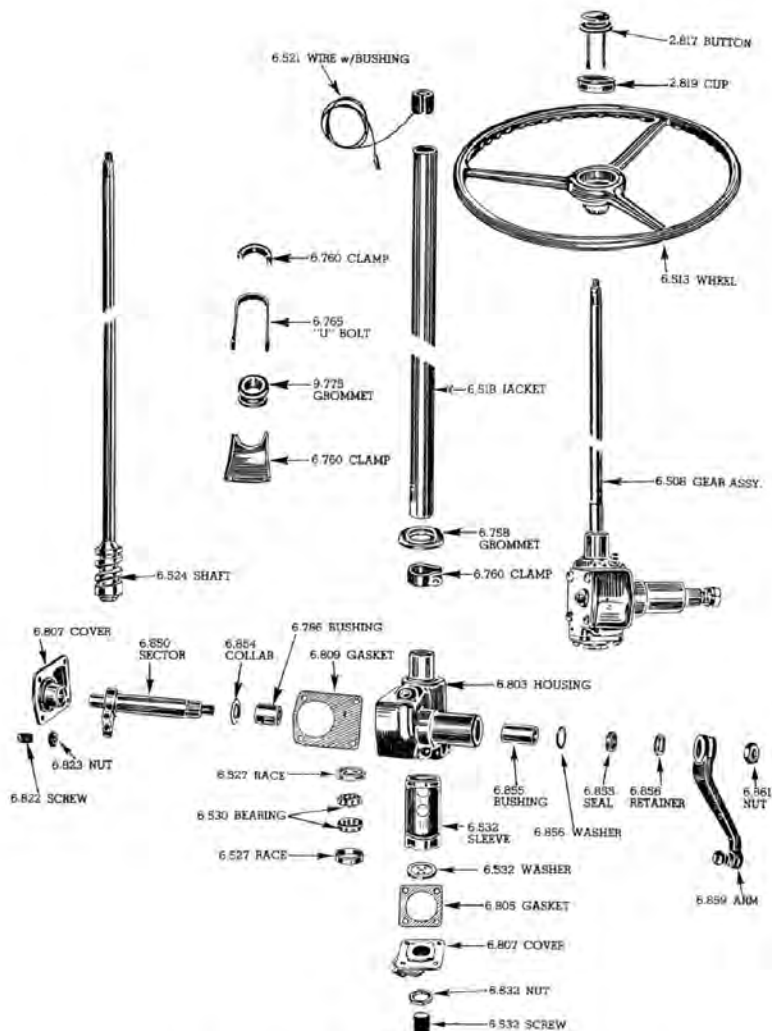

1937-40 TRUCK AND 1937 GB SERIES PASSENGER CAR



WARNING: Cancer and Reproductive Harm — www.P65Warnings.ca.gov

Chemicals shipped domestic ground only (Lower 48 states only). No international shipping.

Phone: (360) 816-0211 • (800) 999-CHEV (2438) • www.chevsofthe40s.com

HORN CONTACT PARTS

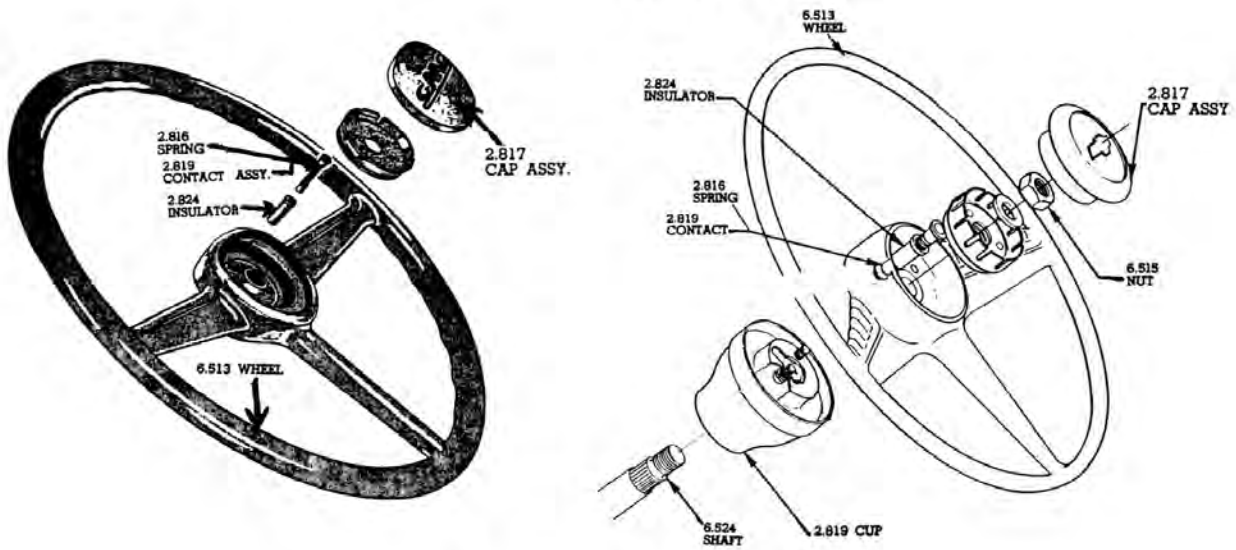

*ILLUSTRATIONS ARE COMPLETE ASSEMBLIES
SEE TEXT FOR AVAILABILITY*

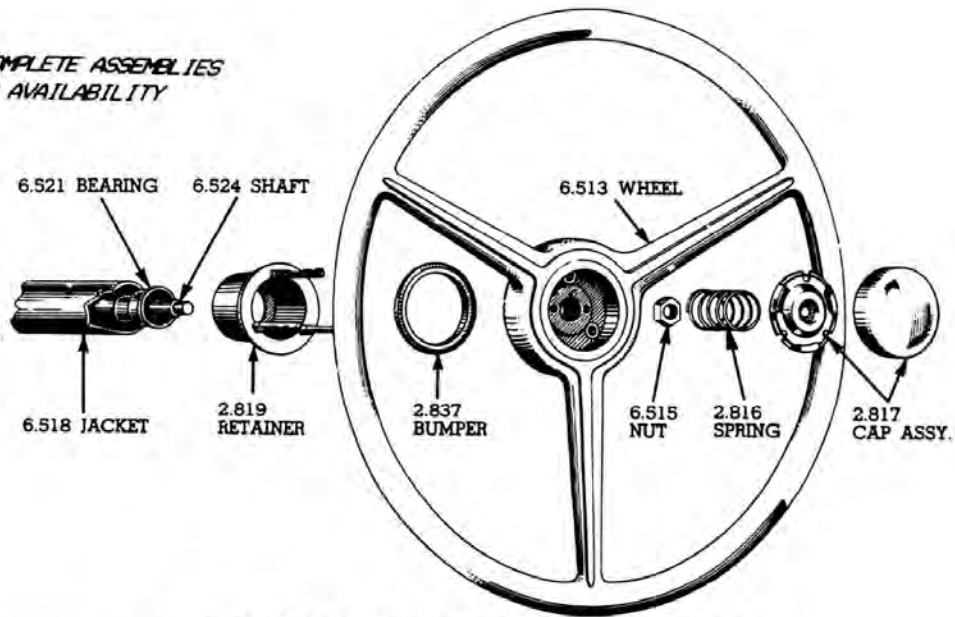

HORN CONTACT PARTS—CONVENTIONAL TRUCK

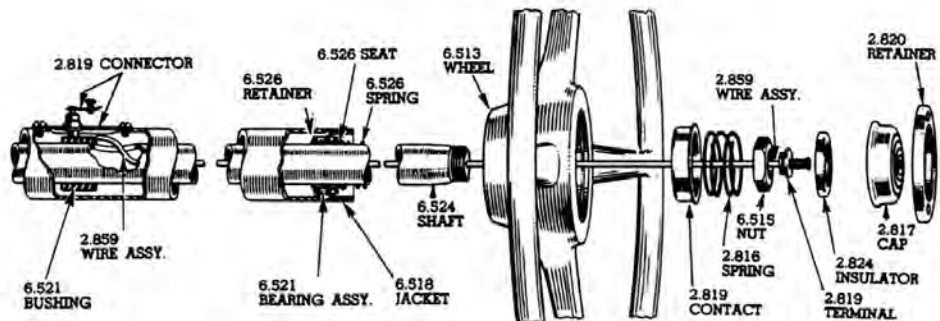

HORN CONTACT PARTS—CAB-OVER-ENGINE

Returns require a return authorization number—call first. • Product pricing & availability subject to change.

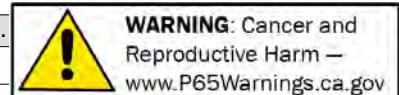

**SECTION 190T
STREET ROD PARTS**

Power Steering Conversion Kit



588072347-59
Chevy truck. For use with late model 1969-87 Chevy 2WD Saginaw steering box with 13/16" 36 spline input shaft.

Note: if you have a steering box with 3/4" 30 spline, use our u-joint part number FR1733DD. 6.859 -0 **\$298.00 SET** ⚠

Pitman Arm



5880723S47-54
Power steering conversion kit, for stock suspension. Fits 1969-87 Chevy 2WD truck power steering box with a 13/16"-36 spline input shaft. 6.859 -0.15 **\$91.00 EA** ⚠

**SECTION 190T
RESTORATION PARTS**

Steering Wheel



75589641-46
Black. Original in 41-45. Fits 36 spline 3/4" shaft. 6.513 -0.15 **CALL** ⚠



755896BR41-46
Brown. Original for 1946. 6.513 -0.15 **\$196.75 EA** ⚠

Steering Wheel, cont.



756084A47-53
Black. Superior quality. Shaft size: 11/16", 36 splines. Chevy & GMC 6.513 -0.15 **CALL** ⚠



758625A 54
Black. Superior quality, beautiful finish. Chevy & GMC 6.513 -0.15 **\$234.50 EA** ⚠

Steering Column Clamp



59467034-40
U-bolt with fasteners. 6.765 -0.15 **\$25.00 EA** ⚠



365703141-46
U-bolt with fasteners. 6.765 -0.15 **\$24.50 EA** ⚠

Steering Column Insulator



3681057A34-46
Steering column to dash, brown exc COE. 6.758 -0 **\$13.50 EA** ⚠



59814534-46
Steering column to dash, black exc COE. 6.758 **\$2.00 EA** ⚠



368552447-53
Steering column to dash, black exc COE. 6.758 -0 **\$3.00 EA** ⚠

Steering Column Insulator, cont.



3700190 54
Steering column to dash. 6.758 -0.15 **\$3.00 EA** ⚠

Grommet



35750729-46
Steering column at floor (exc COE). 6.758 -0.15



..... **\$10.50 EA** ⚠
368287147-54
Steering column at firewall (floor shift). 6.758 -0.2



..... **\$4.00 EA** ⚠
368592847-54
Steering column with metal core & sponge seal #3682871 at firewall (floor shift).

Chevy & GMC 6.758 -0.15 **\$13.00 EA** ⚠



3685928A47-54
Steering column without metal core at firewall (floor shift). Chevy & GMC 6.758 -0.15

..... **\$45.00 EA** ⚠



368720447-54
Sponge seal. Steering column at firewall (column shift). 6.758 -0.3

..... **\$5.75 EA** ⚠



368720548-54
Steering column grommet with metal core & sponge seal #3687204 at firewall (column shift). 6.758 -0.15 **\$13.50 EA** ⚠

Rubber Ring



75589941-46
Anti-rattle under steering wheel. 2.819 -0.3

..... **\$4.00 EA** ⚠



Chemicals shipped domestic ground only (Lower 48 states only). No international shipping.

Phone: (360) 816-0211 • (800) 999-CHEV (2438) • www.chevsofthe40s.com

Section 190T: Steering Columns, Steering Wheels, Shafts, Rebuild Kits, Steering Components & Related

Bushing w/ Horn Wire



1854761.....31-40
Bushing under steering wheel w/ horn wire. Also fits 36-40 GMC 6.521 -0

\$62.25 EA ⚠️

Bearing w/ Horn Wire



264887.....41-46
Bearing under steering wheel, w/ horn wire. 6.521 -0.15

\$23.00 EA ⚠️



270255.....47-54
Bearing under steering wheel, w/ horn wire. Chevy & GMC 6.521 -0.15

\$48.00 EA ⚠️

Steering Gear Shaft w/ Worm

264279.....38-40
Worm Gear & Shaft (All Utility exc. COE) 6.524 -0.4

\$250.00 EA ⚠️



267793A.....41-46
Steering box worm gear assembly w/ shaft 6.508 -0.15

\$235.25 EA ⚠️

267888.....41-46
Worm Gear & Shaft Utility exc COE 15000.000 -0

\$250.00 EA ⚠️

267879.....42-46
Wormgear & shaft. Fits 1/2T and 3/4T, BK, BL, BM, CK, DP, DR. 6.524 -0

\$250.00 EA ⚠️

270260.....47-53
Worm Gear & Shaft 2T & School Bus Chassis (exc. COE) 15000.000 -0

\$250.00 EA ⚠️

Steering Gear Shaft w/ Worm, cont.



270927A.....47-53
Steering box worm gear assembly w/ shaft 6.508 -0.15

\$111.00 EA ⚠️

Steering Gear Overhaul Kit

Note: Steering gear overhaul kits do not include worm gear, pitman shaft or sector shaft. Those items sold separately.



264277A.....38-40
Includes roller bearings. 6.524 -0.4

\$250.00 KIT ⚠️



267880A.....41
This is a steering gearbox overhaul kit that includes gaskets, seals, bushings, worm gear balls, races and bearings. 6.524 -0

\$150.00 KIT ⚠️



267880B.....42-46
Exc. 1Ton & larger COE. 6.524 -0

\$150.00 KIT ⚠️



5060231A.....47-54
This is a steering gearbox overhaul kit that includes bushings, worm gear balls, races and bearings. 6.524 -0

\$150.00 SET ⚠️

Bearings & Balls For Steering Worm Gear



261866B.....37-40
Thrust bearing (2) & race (2). 6.530 -0.15

\$44.00 SET ⚠️



266741.....41
Balls in ball nut steering worm gear (30 piece). 0.0025 dia. 6.844 -0.4

\$13.75 SET ⚠️



179291B.....41-54
Thrust bearing (2) & race (2). 6.530 -0

\$126.50 SET ⚠️



267689.....41-59
Worm gear adjuster nut for lowering bearing 6.830 -0.15

\$99.75 EA ⚠️



206800.....42-57
Balls in ball nut steering worm gear (30 piece). 6.844 -0

\$8.25 SET ⚠️

Gasket



269298.....41-46
Steering gear side cover. 6.809 -0.3

\$3.50 EA ⚠️

Pitman Shaft



609936.....38-40
Steering gear. 6.850 -0.4

\$153.50 EA ⚠️

609937.....41-46
Pitman Shaft (Steering Gear) 6.850 -0

CALL ⚠️

Returns require a return authorization number—call first. • Product pricing & availability subject to change.



WARNING: Cancer and Reproductive Harm — www.P65Warnings.ca.gov

Section 190T: Steering Columns, Steering Wheels, Shafts, Rebuild Kits, Steering Components & Related

Pitman Shaft Screw



266678.....41-57
Adjuster for pitman shaft. 6.822-0
..... **CALL** ⚠

Pitman Shaft Bushing



266316.....34-54
Pitman shaft.
Length=1.350",
I.D.=1.130",
O.D.=1.250". 6.786-0.3

..... **\$25.25 EA** ⚠

Pitman Shaft Seal



262155.....37-57
This is a pitman shaft seal for the steering box. 6.855-0.1
..... **\$10.00 EA** ⚠

Drag Link Rebuild Kit



608840.....32-59
Tie rod end rebuild kit, plugs, springs, seats, exc. 53-59 drag link. 6.874-0
..... **\$30.00 PR** ⚠

Drag Link



609749.....37-46
Includes part #608840 (Tie rod end rebuild kit). Fits 37-46 1/2Ton, 3/4Ton, 1Ton and 1-1/2Ton vehicles. 6.870-0.15
..... **\$118.75 EA** ⚠



3699489.....47-52
Includes Drag Link Kit #608840.
6.870-0.15
..... **\$107.75 EA** ⚠

Drag Link, cont.



3696469.....53-54
With tie rod ends. 6.870-0.15
..... **\$111.75 EA** ⚠

Drag Link Seals



3705009.....32-52
2-1/4 in. long, rubber replacement.
6.886-0.15
..... **\$20.25 SET** ⚠



3705009A.....32-52
2-7/8 in. long, metal as original. 6.886-0
..... **\$22.00 SET** ⚠

Long Tie Rod



367528.....32-54
Rod only (40-54 1/2T& 3/4T). 43-1/4" long. 6.230-0
..... **\$40.00 EA** ⚠

Tie Rod End



374226R.....34-54
1/2T& 3/4T (replacement type, non-tapered. Complete w/ ball) right. 6.233-0.15
..... **\$45.00 EA** ⚠

374227L.....34-54
1/2T& 3/4T (replacement type, non-tapered. Complete w/ ball), left. 6.233-0.15

..... **\$45.00 EA** ⚠

Odds & Ends

Please call for availability on all Odds & Ends parts; once part is sold, it may no longer be in stock.

374226N.....32-56
Tie rod end left (4-59/64 in) (25/36-16 right hand thread) Stamped R. Fits 32-34 all exc CC & DC, 35-38 Pass, COMM exc EC, FC, GB & HB, 39-42 COMM, 46-56 1/2T & 3/4T exc DD. 6.233-0.4

..... **\$35.00 EA** ⚠

374227N.....32-56
Tie rod end. Left side. (4-59/64in.) (25/36-16 left hand thread) Stamped L. Fits 32-34 all exc CC & DC, 35-38 Pass, COMM exc EC, FC, GB & HB, 39-42 COMM, 46-56 1/2T & 3/4T exc DD. 6.233-0.4

..... **\$35.00 EA** ⚠

373781.....34-36
Steering connecting rod (drag link)
6.870-0.4

..... **\$75.00 EA** ⚠

3667227.....37-50
Steering arm fits 1-1/2 ton left or right
6.103-0

..... **\$25.00 EA** ⚠

753325.....38-40
Steering wheel fits all except JA, KA, KB, KH & COE (Used) 6.513-0

..... **\$100.00 EA** ⚠

266667.....41
Ball nut for steering gear, fits all commercial & utility exc COE 15000.000-0.4

..... **\$45.00 EA** ⚠

3678194.....46-50
Steering knuckle stop NOS (fits 46 PP, PR, PS; 47-50 DD, SBC & 2T) use with 3681101 forged I-beam 6.009-0

..... **\$15.00 EA** ⚠

756084U.....47-53
Steering Wheel Used 4000.000-0.4

..... **\$70.00 EA** ⚠

3703563.....53-57
Steering knuckle (spindle) fits 3/4T & 1T 15000.000-0.4

..... **\$65.00 EA** ⚠

3701357U.....54-57
Steering wheel hub without single level hole used 6.512-0

..... **\$20.00 EA** ⚠



WARNING: Cancer and Reproductive Harm —
www.P65Warnings.ca.gov

Chemicals shipped domestic ground only (Lower 48 states only). No international shipping.

Phone: (360) 816-0211 • (800) 999-CHEV (2438) • www.chevsofthe40s.com

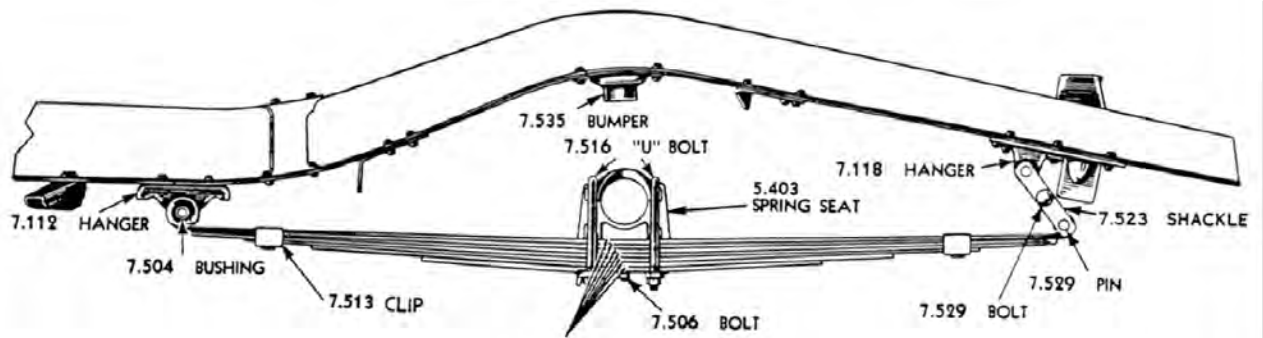

REAR SPRING AND PARTS

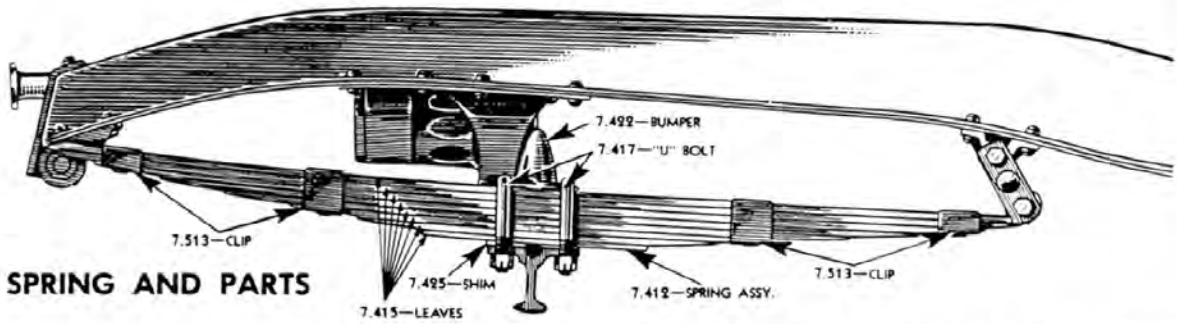

FRONT SPRING AND PARTS

ILLUSTRATIONS ARE COMPLETE ASSEMBLIES.
SEE TEXT FOR AVAILABILITY.

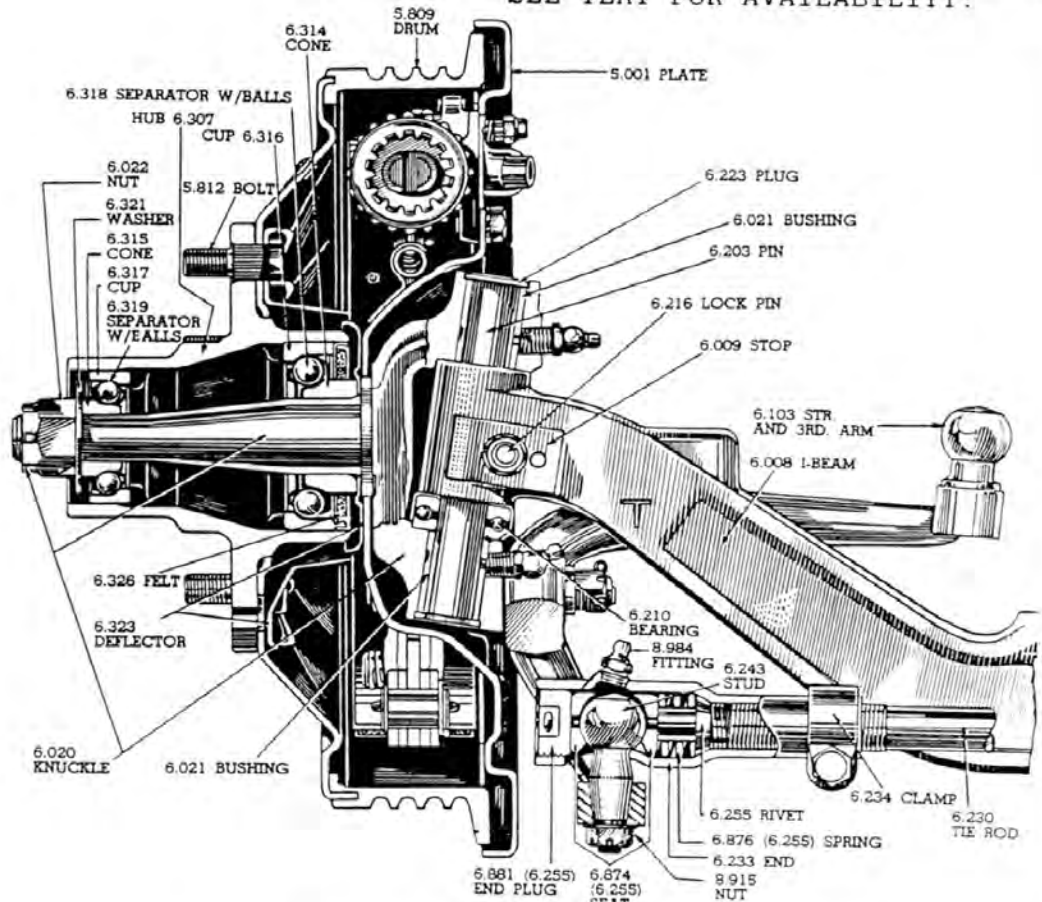

FRONT AXLE—CONVENTIONAL TRUCK (EXC. H.VY. DUTY)

**SECTION 200T
STREET ROD PARTS**

IFS Mustang II Kit Weld In

Mustang II Suspension kits come complete with crossmember, paintable tubular upper and lower full A-frame style control arms, 11" five lug rotors, bearings and seals, springs, shocks, stock spindles, GM calipers with brackets and pads, manual rack and pinion with tie rod ends and bushings, rubber spring cushions, spindle nuts w/washers, and all mounting hardware.

 **HEIDTSIFS0137-54**
Independent Front Suspension Kit.
Heidt's weld in. Tubular A-arms with crossmember. 6.008-0

\$2,090.75 KIT ⚠️

HEIDTSIFS0237-54
Independent front suspension kit
Heidt's weld in. Tubular A-arms, without crossmember. 6.008-0.15

\$2,106.00 KIT ⚠️

Shock Conversion Kit



3700440B37-49
This conversion kit includes 4 gas shocks, upper and lower steel shock mounts, and hardware for front and rear shocks. This was designed for 1947-1949 1/2 ton trucks, you can use this on 1937-1946 1/2 ton trucks as well. You will need to drill holes in your frame rail for the upper shock mounts. There is no template to drill the frame available. 7.395-0

\$375.00 SET ⚠️

Sway Bar



368302847-54
Sway bar, front, complete, 1-1/8in. diameter w/ links and bushings 7.241-0.15

\$180.25 SET ⚠️

**SECTION 200T
RESTORATION PARTS**

IFS Mustang II Crossmember Weld In



CX305E37-39
Heidt's Mustang II weld in crossmember. 6.008-0

\$535.00 EA ⚠️



CX306E40-46
Heidt's Mustang II weld in crossmember. 6.008-0

\$535.00 EA ⚠️



CX307E47-54
Heidt's Mustang II weld in crossmember. For single lower pivot.

6.008-0

\$535.00 EA ⚠️

Shocks



105414434-46
Left front, single action (#1430CA) \$100 core 7.345-0

\$244.00 EA ⚠️



105414634-46
Right front, single action (#1430DA) \$100 core 7.345-0

\$244.00 EA ⚠️



107270734-50
Right front, dual action (#1730-A) \$75 core.(exc COE) 7.345-0.15

\$249.75 EA ⚠️

107270834-50
Left front, dual action (#1730B) \$75 core 7.345-0.15

\$249.75 EA ⚠️

Shocks, cont.



105414447-50
Right front, single action (exc HP, HR, HS) (#1430CA) \$100 core 7.345-0

\$244.00 EA ⚠️



105414647-50
Left front, single action (exc HP, HR, HS) (#1430DA) \$100 core 7.345-0

\$244.00 EA ⚠️



5516237G50-54
Front, 1/2Ton & 3/4Ton 7.345-0.15

\$64.00 PR ⚠️

Shock Absorber Fluid



603489SALL
Shock Absorber Fluid. 6.386-0.15

\$12.00 QT ⚠️

Tube Shock Mounts



365532847-54
Lower rear, left or right, 1/2Ton (replacement for 50-54). 7.395-0.15

\$20.25 EA ⚠️



369368747-54
Lower front, left 7.395-0.15

\$16.00 EA ⚠️



369368847-54
Lower front, right 7.395-0.15

\$41.75 EA ⚠️



370044047-54
Upper front or rear. Fits 1/2Ton (replacement for 50-54). 7.395-0.15

\$32.00 EA ⚠️

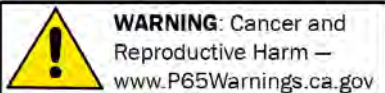

Chemicals shipped domestic ground only (Lower 48 states only). No international shipping.

Phone: (360) 816-0211 • (800) 999-CHEV (2438) • www.chevsofthe40s.com

Shock Link



043032A**30-49**
9-5/16 in. overall 7.355 -0 **CALL** ⚠

Bushings Shock



041133**30-49**
Shock link. 1/2Ton & 3/4Ton. 7.388 -0.15
..... **\$13.00 PR** ⚠



041133B**30-49**
Shock link single action w/ brass bushings, pins & cotter keys for beam axle. Superior. 7.388 -0
..... **\$16.00 PR** ⚠



043816**33-53**
Shock link double action shock 33-46 all, 47-49 1/2Ton, 3/4Ton, 1Ton & 50-55 Double Duty. 7.388 -0
..... **\$9.50 SET** ⚠



041153**33-54**
In Shock Arm (rubber)-double Action 7.377 -0
..... **\$9.50 EA** ⚠



3708378**50-57**
Shock, rubber, w/ washers & nuts. 7.388 -0
..... **\$17.25 SET** ⚠

Bushing Sway Bar



350146**39-46**
Sway bar shaft (steel bushed rubber) use with #3501467
7.240 -0.15
..... **\$60.00 PR** ⚠



3501467**39-46**
Sway bar (rubber) use with #350146 (2 piece)
7.240 -0.15
..... **\$19.75 SET** ⚠

Bushing Sway Bar, cont.



3708378**50-54**
Sway bar rubber links w/ washers & nuts
7.388 -0 **\$17.25 SET** ⚠

King Pins



602691**29-39**
1/2Ton, 34-39 3/4Ton & 1Ton 6.203 -0.15
..... **\$55.00 PR** ⚠

602690**40**
1/2Ton, 3/4Ton & 1Ton 6.203 -0.15
..... **\$80.00 PR** ⚠

605121**41-54**
1/2Ton 6.203 -0.15
..... **\$55.25 PR** ⚠

601019**46-52**
46-52 3/4Ton, 1Ton 6.203 -0.15
..... **\$101.25 PR** ⚠

3691111**46-57**
Double Duty, 2Ton, 46-47 1-1/2Ton, 48-57 1-1/2Ton heavy duty 6.203 -0
..... **CALL** ⚠

3704112**53-54**
3/4Ton, 1Ton, 1-1/2Ton (exc Double Duty, School Bus chassis, Heavy Duty)
6.203 -0.15
..... **\$69.99 PR** ⚠

Shackles



604478**34-46**
Front 34-36 all, 37-40 (exc COE) 41-46
1/2Ton & 3/4Ton 7.523 -0
..... **\$139.50 SET** ⚠

609071**39-54**
Front COE & 41-46 1Ton, 1-1/2Ton, 2Ton
7.436 -0
..... **\$151.69 SET** ⚠

3847459**47-54**
Front (1/2Ton & 3/4Ton) 7.436 -0.15
..... **\$75.00 SET** ⚠

Shackles, cont.



3847460**47-56**
Front 1Ton & larger exc. Double Duty & COE 7.436 -0.15
..... **\$105.00 L&R** ⚠

Shackle Rebuild Kit



373199**30-54**
Does 2. Pins, bushings & seals, 1/2Ton & 3/4Ton (16 pcs). 7.427 -0.15
..... **\$80.00 SET** ⚠

3653273**39-54**
Does 2, pins, bushings, seals, 39-40 COE, 41-54 1Ton, 1-1/2Ton, 2Ton, Double Duty (16 piece) 7.427 -0.15
..... **\$103.00 SET** ⚠

Seals Shock



593705**34-54**
Rubber for steel bushed shackles (8 pcs).
7.443 -0.3
..... **\$14.75 SET** ⚠

Spring Bolt & Bushing



593990B**37-54**
Fixed end front springs, 1/2Ton & 3/4Ton (2 piece) 7.428 -0.15
..... **\$69.00 SET** ⚠



3657393**39-54**
Fixed end front spring, 41-54 1Ton, 1-1/2Ton & 2Ton (39-40 COE)
7.428 -0.15
..... **\$56.75 PR** ⚠

Grease Fitting



110347**ALL**
1/4 in. x 28 taper thread, 90 degree.
8.984 -0.2
..... **\$0.99 EA** ⚠



191758**ALL**
1/8 in. national pipe, straight. 8.984 -0.4
..... **\$1.69 EA** ⚠

Axle Bumper



3653084.....40-54
 Axle (exc Double Duty
 & 53-54 3/4Ton, 1Ton,
 1-1/2Ton & 2Ton)
 7.422 -0.15

\$20.00 SET ⚠

U-Bolt



601231.....34-54
 W/ nuts, front axle to
 spring, 34-49 1/2Ton,
 3/4Ton, 1Ton & 50-54
 1/2Ton 7.417 -0.15

\$16.00 EA ⚠

Bolt



1288224ALL
 Leaf spring center (exc utility vehicle) (2
 pcs). 7.506 -0.2

\$9.75 SET ⚠

Front Leaf Spring

Note: Spring Order requires purchase of fixed
 end pins & bushings (pressed in free).

Oversize shipping charges apply to all Front
 Leaf Springs. Please call for rate.

599316.....39-46

1/2Ton (7 leaves) 7.412 -0.15

\$608.00 PR ⚠

365661041-46

3/4Ton (8 leaves) 7.412 -0.15

\$608.00 PR ⚠

3702793.....47-54

1/2Ton & 3/4Ton, exc Double Duty (8
 leaves) 7.412 -0.15

\$449.75 PR ⚠

Liner



3699910T.....37-54

For leaf springs. 1-3/4" wide x 20 feet
 long. 7.495 -0.15

\$59.00 SET ⚠

Odds & Ends

Please call for availability on all Odds & Ends
 parts; once part is sold, it may no longer be in
 stock.

1054146U 50

Shock front left used fits Double Duty
 7.345 -0.4

\$75.00 EA ⚠



1946 Chevrolet Fire Truck — Nicholas & Audrey Stanislawek

200T



WARNING: Cancer and
 Reproductive Harm —
www.P65Warnings.ca.gov

Chemicals shipped domestic ground only (Lower 48 states only). No international shipping.

Phone: (360) 816-0211 • (800) 999-CHEV (2438) • www.chevsofthe40s.com

Corvette C4-IFS & IRS Installation Kits for 47-53 Chevy Trucks

Now you can have the ride, superior handling, cornering and braking provided only by the advanced technology built into the Corvette suspension.



We offer quality kits to adapt the late model ('84-'87 and '88-'95) Corvette front and rear independent suspensions to your '47-'55 Chevy truck. (Suspension not included.)



These kits are designed to fit your frame. All brackets are laser cut from cold rolled steel and heli-arc welded for strength and unsurpassed good looks.

These kits utilize Corvette C-4 front and rear suspension components mounted to your frame using the stock Corvette geometry. The real bonus is this system uses the stock Corvette Power Rack and Pinion Steering Unit as designed by

Gm, eliminating and “bump steer” problems inherent with units from vehicles designed in the '70s with light weight vehicles and economy in mind. You can GM sports car handling on your GM manufactured truck. All the corvette suspension components are manufactured from forged aluminum which allows you to decrease vehicle weight while also maintaining strength and a solid suspension.



Not only will you be amazed at how well your truck rides but how fun it will be drive with a Corvette front and rear suspension installed. And let's not forget 4-wheel disc brakes designed to mount to your suspension.

Available **Aldan Eagle coilover shocks** for front or rear allow you to adjust the ride to your liking with 6-position adjustable compression damping and spring rate adjustment also. Rugged construction and combination of oil and gas charging incorporated in each shock are only part of the reason we recommend them with our IFS and IRS kits. Kits complete with instructions and all hardware.



You'll enjoy the handling and new life brought to your truck with these very affordable suspension kits for years to come.

FRONT CROSSMEMBER ⚠

SUSCORF1	84-87 C-4 IFS-front without coilover shocks (see below)	\$895.00
SUSCORF2	88-96 C-4 IFS-front without coilover shocks (see below)	\$945.00

REAR CROSSMEMBER ⚠

SUSCORR1	84-87 C-4 IRS-rear without coilover shocks (see below)	\$750.00
SUSCORR2	88-96 C-4 IRS-rear without coilover shocks (see below)	\$765.00

ALDAN COILOVER SHOCKS ⚠

SHOCKF1	Front shock	\$555.00 pr
SHOCKF2	Front shock w/ chrome springs	\$567.00 pr
SHOCKF3	Front shock w/ polished housing	\$650.00 pr
SHOCKF4	Front shock w/ chrome sprints & polished housing	\$689.00 pr
SHOCKR1	Rear shock	\$527.00 pr
SHOCKR2	Rear shock w/ chrome springs	\$565.00 pr
SHOCKR3	Rear shock w/ polished housing	\$650.00 pr
SHOCKR4	Rear shock w/ chrome sprints & polished housing	\$689.00 pr



Returns require a return authorization number—call first. • Product pricing & availability subject to change.

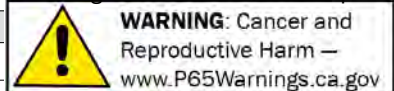

**SECTION 210T
STREET ROD PARTS**

Lowering Blocks

Lowering blocks are available with square or round u-bolts. Please specify when ordering.



- 373201A** **37-54**
1", w/ u-bolts. 7.427 -0.2
..... **\$85.00 SET** ⚠
- 373201B** **37-54**
2", w/ u-bolts. 7.427 -0.15
..... **\$85.00 SET** ⚠
- 373201C** **37-54**
3", w/ u-bolts. 7.427 -0
..... **\$90.00 SET** ⚠

Shock Conversion Kit



- 3700440B** **37-49**
This conversion kit includes 4 gas shocks, upper and lower steel shock mounts, and hardware for front and rear shocks. This was designed for 1947-1949 1/2 ton trucks, you can use this on 1937-1946 1/2 ton trucks as well. You will need to drill holes in your frame rail for the upper shock mounts. There is no template to drill the frame available. 7.395 -0
..... **\$375.00 SET** ⚠

**SECTION 210T
RESTORATION PARTS**

Shock Link



- 043031A** **30-39**
8in. overall, exc CC. 7.355 -0.4
..... **\$20.00 EA** ⚠

Single Action Shock



- 1054421** **34-49**
Left rear, 1/2Ton, #1430MA (\$50 core).
7.345 -0.15 **\$335.00 EA** ⚠
- 535256** **34-49**
Right rear, 1/2Ton, #1430LP (core \$50).
7.345 -0.15 **\$335.00 EA** ⚠

Dual Action Shock

- 1054424** **34-47**
1/2 Ton right rear, #1731-T (\$100 core).
7.345 -0.15 **\$200.00 EA** ⚠



- 1054425** **34-47**
1/2 Ton left rear, #1731-U (\$100 core).
7.345 -0.15 **\$200.00 EA** ⚠
- 1054424** **48-49**
Left rear, #1731-T (\$100 core). 7.345 -0.15
..... **\$220.00 EA** ⚠

- 1054425** **48-49**
1/2 Ton Right rear, #1731-U (\$100 core).
7.345 -0.15 **\$220.00 EA** ⚠

Gas Shocks



- 5394579G** **47-54**
Rear, 3/4Ton (original 50-54 will fit 47-49 w/ conversion). 7.345 -0.15
..... **\$61.25 SET** ⚠
- 5516239G** **47-54**
Rear, 1/2Ton (original 50-54 will fit 47-49 w/ conversion). 7.345 -0
..... **\$69.00 PR** ⚠

Tube Shock Mounts



- 3655328** **47-54**
Lower rear, left or right, 1/2Ton
(replacement for 50-54). 7.395 -0.15
..... **\$20.25 EA** ⚠



- 3700440** **47-54**
Upper front or rear. Fits
1/2Ton (replacement
for 50-54). 7.395 -0.15
..... **\$32.00 EA** ⚠

Bushing Shock Link



- 041133** **30-49**
Shock link. 1/2Ton &
3/4Ton. 7.388 -0.15
..... **\$13.00 PR** ⚠



- 041133B** **30-49**
Shock link single action
w/ brass bushings, pins
& cotter keys for beam
axle. Superior. 7.388 -0
..... **\$16.00 PR** ⚠



- 043816** **33-53**
Shock link double action shock 33-46 all,
47-49 1/2Ton, 3/4Ton, 1Ton & 50-55
Double Duty. 7.388 -0
..... **\$9.50 SET** ⚠

Bushing Shock



- 041153** **33-53**
In shock arm, rubber,
double action. 7.377 -0
..... **\$9.50 EA** ⚠



- 3708378** **50-57**
Shock, rubber, w/ washers & nuts. 7.388 -0
..... **\$17.25 SET** ⚠

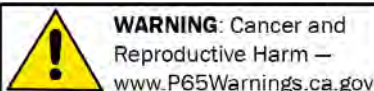

WARNING: Cancer and Reproductive Harm –
www.P65Warnings.ca.gov

Chemicals shipped domestic ground only (Lower 48 states only). No international shipping.

Phone: (360) 816-0211 • (800) 999-CHEV (2438) • www.chevsofthe40s.com

Section 210T: Rear Suspension, Leaf Springs, Rebuild Kits, Shocks & Hardware

Bushing Rear Spring Pivot



3652182A**48-54**
Bolt w/ nut, rear end to spring pivot,
1/2Ton. 5.403-0.15 **\$33.00 PR** ⚠

Spring Pivot Bolt & Bushing



593990B**34-54**
Front of rear spring, 1/2Ton. 7.428-0
..... **\$69.00 PR** ⚠

Seals Rear End To Spring Pivot



597267**38-54**
Rear end to spring pivot
bolt (4 ea). 5.404-0.3
..... **\$15.75 SET** ⚠

Rear Shackles



350441**34-54**
1/2Ton & 3/4Ton (2 pcs). 7.523-0
..... **\$105.00 SET** ⚠

Shackle Rebuild Kit



373199**30-54**
Does 2. Pins, bushings & seals, 1/2Ton &
3/4Ton (16 pcs). 7.427-0.15 **\$80.00 SET**
⚠



3725531B**33-55**
3/4Ton, 1Ton & Utility (exc Panel). 7.573-0
..... **\$143.00 SET** ⚠

Grease Fitting



110347**ALL**
1/4 in. x 28 taper
thread, 90 degree.
8.984-0.2

..... **\$0.99 EA** ⚠



191758**ALL**
1/8 in. national pipe,
straight. 8.984-0.4
..... **\$1.69 EA** ⚠

Shackle Seals



593705**34-54**
Rubber for steel bushed
shackles (8 pcs).
7.443-0.3

..... **\$14.75 SET** ⚠

Rear Axle Bumper



365627**34-46**
1/2Ton 7.535-0.15

..... **\$32.25 PR** ⚠

U-Bolt



602509**31-46**
Rear axle to spring, 1/2Ton. 7.417-0.15

..... **\$16.00 EA** ⚠



602509R**37-46**
Round U-Bolt W/ nuts,
spring to axle, fits 37-46
truck with rear original
cast iron bracket
7.516-0.15

..... **\$16.00 EA** ⚠



601231**47-54**
W/ nuts, rear axle to spring pivot, 1/2Ton.
7.417-0.15 **\$16.00 EA** ⚠

Bolt



1288224**ALL**
Leaf spring center (exc utility vehicle) (2
pcs). 7.506-0.2 **\$9.75 SET** ⚠

Teflon Liner



3699910T**37-54**
For leaf springs. 1-3/4" wide x 20 feet
long. 7.495-0.15 **\$59.00 SET** ⚠

Rear Leaf Spring

Oversize shipping charges apply to all Rear
Leaf Springs. Please call for rate.

3659368 **36-46**
1/2Ton (8 leaves). 7.503-0.15

..... **\$635.00 PR** ⚠

SPECIFY65T**37-54**

Original springs will allow severe axle wrap
w/ the torque tube removed and these are
needed for an open drive shaft. Also helps
to center axle in wheel wells.

Can be made with arch to lower vehicle.
7.503-0.15 **\$589.00 PR** ⚠

3656559 **41-54**
3/4Ton (7 leaves). 7.503-0.15

..... **\$780.00 PR** ⚠

3683317**47-54**
1/2Ton (8 leaves). 7.503-0.15

..... **\$650.00 PR** ⚠

Odds & Ends

Please call for availability on all Odds & Ends
parts; once part is sold, it may no longer be in
stock.

3656558**46-47**
U-bolt fits 1-1/2Ton, School bus chassis &
panel 7.516-0.4

..... **\$20.00 EA** ⚠



**SECTION 220T
STREET ROD PARTS**

Custom Wheel Artillery (Bare)



AB**ALL**
Bare Steel Artillery Rim. 15" Only. Specify width and backspace. Available in 5,6,7,8,10,12,14 inch widths. 5x4-3/4", 6x5-1/2" Chevy or 5x4-1/2" Ford lug patterns. -0starting at **\$157.00 EA** ⚠️

Custom Wheel Artillery (Chrome)



AC**ALL**
All Chrome Artillery Rim. 15" Only. Specify size, width and backspace. Available in 5,6,7,8,10,12,14 inch widths. 5x4-3/4", 6x5-1/2" Chevy or 5x4-1/2" Ford lug patterns. -0starting at **\$239.00 EA** ⚠️

Custom Wheel Nostalgia (Bare)



NB**ALL**
Bare Steel Rim: 14, 15 or 16" Rims Specify size, width and backspace. Available in 5,6,7,8,10,12,14 inch widths. 5x4-3/4", 6x5-1/2" Chevy or 5x4-1/2" Ford lug patterns. -0starting at **\$77.00 EA** ⚠️

Custom Wheel Nostalgia (Chrome)



NC**ALL**
All Chrome Rim. 14, 15 or 16" Rims Specify size, width and backspace. Available in 5,6,7,8,10,12,14 inch widths. 5x4-3/4", 6x5-1/2" Chevy or 5x4-1/2" Ford lug patterns. -0starting at **\$105.00 EA** ⚠️

Custom Wheel Nostalgia (Chrome Rim)



NCC**ALL**
Chrome rim, bare steel center. 14, 15 or 16" Rims Specify size, width and backspace. Available in 5,6,7,8,10,12,14 inch widths. 5x4-3/4", 6x5-1/2" Chevy or 5x4-1/2" Ford lug patterns. -0starting at **\$100.00 EA** ⚠️

Custom Wheel Rally (Bare)



RB**ALL**
Rallye Bare Steel. 14, 15 or 16" Rims Specify size, width and backspace. Available in 5,6,7,8,10,12,14 inch widths. 5x4-3/4", 6x5-1/2" Chevy or 5x4-1/2" Ford lug patterns. -0starting at **\$88.00 EA** ⚠️

Custom Wheel Rally (Chrome)



RC**ALL**
All Chrome Rim: 14, 15 or 16" Rims Specify size, width and backspace. Available in 5,6,7,8,10,12,14 inch widths. 5x4-3/4", 6x5-1/2" Chevy or 5x4-1/2" Ford lug patterns. -0starting at **\$116.00 EA** ⚠️

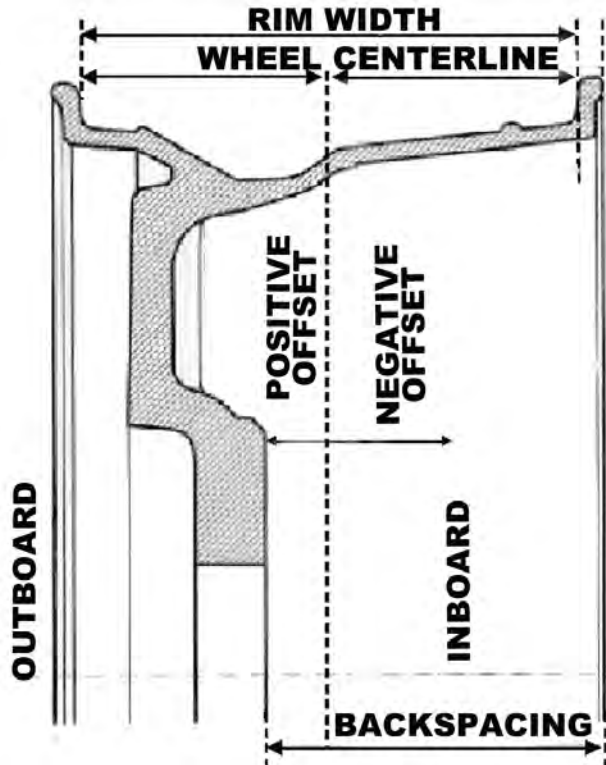

WARNING: Cancer and Reproductive Harm – www.P65Warnings.ca.gov

Chemicals shipped domestic ground only (Lower 48 states only). No international shipping.

Phone: (360) 816-0211 • (800) 999-CHEV (2438) • www.chevsofthe40s.com

Custom Wheel Rally (Chrome Rim)



RCC.....ALL
 Chrome rim with bare steel center. 14, 15 or 16" Rims Specify size, width and backspace. Available in 5,6,7,8,10,12,14 inch widths. 5x4-3/4", 6x5-1/2" Chevy or 5x4-1/2" Ford lug patterns. -0 ... **CALL** ⚠

Hub Caps Modified For Artillery / Nostalgia



594453M.....37-38
 Modified for artillery / nostalgia wheel
 5.858 -0.15 **\$120.00 EA** ⚠
594453MS.....37-38
 Stainless. Modified for artillery / nostalgia wheel. 5.858 -0.15
 **\$85.00 EA** ⚠



599748MS.....39
 Stainless. Modified to fit artillery / nostalgia wheel. 5.858 -0.2 **\$82.00 EA** ⚠



654307M.....40
 Chrome. Modified to fit artillery / nostalgia wheel. 5.858 -0 **\$85.00 EA** ⚠

Hub Caps Modified For Artillery / Nostalgia, cont.



3658374M.....41-48
 1941-48 Passenger (41-46 Commercial exc 46 1Ton). Modified to fit artillery / nostalgia wheel. 5.858 -.15 **\$65.00 EA** ⚠



3658374MS.....41-48
 Stainless 1941-48 Passenger (41-46 Commercial exc. 46 1Ton) For artillery / nostalgia wheels 5.858 -0.15 **\$65.00 EA** ⚠



3705092A.....47-53
 1/2Ton, modified to fit nostalgia wheel. Chrome 5.858 -0.15 **\$84.75 EA** ⚠



3908671.....ALL
 Police, plain. Fits artillery / nostalgia wheel. 5.858 -0.3 **\$22.00 EA** ⚠
MODIFY.....ALL
 Modify your hub cap to fit custom artillery / nostalgia or rally wheel 5.858 -0.15
 **\$60.00 EA** ⚠

Hub Caps Modified For Rallye



594453MRS.....37-38
 Stainless. Modified for rallye wheel. 5.858 -0.15 **\$92.00 EA** ⚠

Hub Caps Modified For Rallye, cont.



599748MR.....39
 Chrome. Modified to fit rallye wheel. 5.858 -0 **CALL** ⚠



599748MRS.....39
 Stainless. Modified to fit rallye wheel. 5.858 -0.15 **\$85.00 EA** ⚠

654307MR.....40
 Chrome. Modified to fit rallye wheel. 5.858 -0.15
 **CALL** ⚠



3658374MR.....41-48
 1941-48 Passenger (41-46 Commercial exc 46 1Ton) Modified to fit rallye wheel. 5.858 -0.2 **\$75.75 EA** ⚠



3705092AR.....47-53
 1/2Ton, modified to fit rallye wheel. 5.858 -0.15 **\$85.00 EA** ⚠



3908672.....ALL
 Police, plain. Fits rallye wheel. 5.858 -0.15
 **\$50.00 EA** ⚠

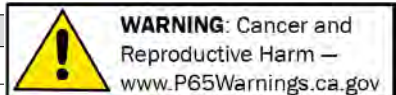

Section 220T: Wheels, Hub Caps, Beauty Rims, Tires & Wheel Bearings

Hub Caps Modified For Rallye, cont.



3908673ALL
Police w/ bowtie. Fits rallye wheel 5.858 -0.2
..... **\$50.00 EA** ⚠

MODIFY.....ALL
Modify your hub cap to fit custom artillery
/ nostalgia or rally wheel 5.858 -0.15
..... **\$60.00 EA** ⚠

Wheel Cover



HCAPCADDY16ALL
16" Cadillac Sombrero -0.15
\$222.75 SET ⚠



HCAPSBURST14ALL
14 inch Starburst Style 5.858 -0.15
\$105.25 SET ⚠



HCAPSBURST15ALL
15 inch Starburst Style 5.858 -0.15
\$79.75 SET ⚠



HCAPSOMBRERO16ALL
Wheel Covers Bullet Sombrero Style
16"- Set of 4 -0.15 **\$215.00 SET** ⚠

Custom Hub Caps



3705092NALL
14 in. Nude Figure. Chrome. 5.858 -0.15
..... **\$323.25 SET** ⚠



3705092ZALL
15 in. nomad style. chrome -0
\$105.00 EA ⚠

HCAPCROSS14 ALL
14 inch Crossbar style. 5.858 -0.15
..... **\$250.00 SET** ⚠



HCAPCROSS15ALL
15 inch Crossbar style. 5.858 -0.15
\$245.00 SET ⚠



HCAPLANCER.....ALL
15 inch 59 Lancer style. 5.858 -0.15
\$299.00 SET ⚠



HCAPLANCERB14ALL
14 inch 57 Lancer style. 5.858 -0.15
\$249.00 SET ⚠

HCAPLANCERB15..... ALL
15 inch 57 Lancer style. 5.858 -0.15
..... **\$225.00 SET** ⚠

Custom Hub Caps, cont.



HCAPPOLARA15ALL
15" Polara Style custom hub caps(set of
4) 5.858 -0.15 **\$265.00 SET** ⚠

Nude Lady



3705092HALL
3 dimensional nude
figure handle or hubcap
ornament. Chrome,
12-1/4 in. length.

5.858 -0.15

..... **\$43.25 EA** ⚠

SECTION 220T RESTORATION PARTS

Stock Hub Caps



594453S37-38
Stainless 5.858 -0.15 **\$46.25 EA** ⚠



3705092M.....37-48
Baby moon, 37-48 Cars. 37-46 1/2Ton &
37-41 3/4Ton. 5.858 -0.15 **\$178.25 SET**
⚠



599748S..... 39
Stainless 5.858 -0.15 **\$60.25 EA** ⚠



654307..... 40
Chrome 5.858 -0 **CALL** ⚠



WARNING: Cancer and
Reproductive Harm —
www.P65Warnings.ca.gov

Chemicals shipped domestic ground only (Lower 48 states only). No international shipping.

Phone: (360) 816-0211 • (800) 999-CHEV (2438) • www.chevofthe40s.com

220T

Section 220T: Wheels, Hub Caps, Beauty Rims, Tires & Wheel Bearings

Stock Hub Caps, cont.

654307S **40**
Stainless 5.858 -0.15
..... **\$39.50 EA** ⚠



3658374S **41-48**
Stainless 1941-48 Passenger (41-46
Commercial exc. 46 1Ton) 5.858 -0.15
..... **\$55.25 EA** ⚠



3680919 **47-53**
Chrome with red (3/4Ton, 1Ton) 5.858 -0.15
..... **\$56.00 EA** ⚠

3705092 **47-53**
1/2Ton. Chrome w/ red letters. 5.858 -0
..... **\$40.00 EA** ⚠



3705092G **47-53**
GMC chrome with red lettering. 1/2Ton
only 5.858 -0.15 **\$32.50 EA** ⚠

3705092S **47-53**
1/2Ton. Stainless steel. 5.858 -0.15
..... **\$66.00 EA** ⚠



3708057 **54**
1/2 Ton 5.858 -0.15 **\$56.25 EA** ⚠

3708057C **54**
1/2 Ton Stainless 5.858 -0.15
..... **\$39.75 EA** ⚠

Stock GMC Hub Caps



2019471 **37-46**
GMC 1/2Ton & 37-41 GMC 3/4Ton.
5.858 -0.15 **\$42.75 EA** ⚠



3705092P **47-53**
GMC chrome with white lettering. 1/2Ton
only 5.858 -0.15 **\$35.00 EA** ⚠



2312395 **47-55**
These hub caps are for 1946-53 3/4 ton
and 1 Ton GMC Will Work on 1954-1955.
Polished Stainless With Red Lettering 11"
Dia -0 **\$59.50 EA** ⚠



3708058 **55-59**
GMC 1/2Ton (superior) 5.858 -0
..... **CALL**

Hub Cap Retaining Clip

3704844 **39-53**
Retaining clip. Fits
39-53 Pass (w/ 15in
wheels) & 39-58 1/2T
truck (w/ 16in wheels). 5.864 -0.15
..... **\$2.50 EA** ⚠



Decal Hub Cap



3705092K **47-53**
Black (set of 4) 5.858 -0.15 **\$14.50 SET**
⚠

Decal Hub Cap, cont.



3705092R **47-53**
Red (set of 4) 5.858 -0 **\$23.75 SET** ⚠

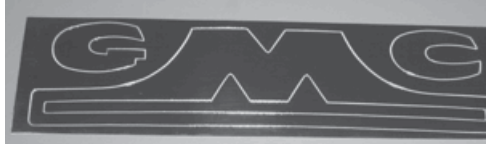

3705092GK **47-55**
GMC decal. Black (set of 4) 5.858 -0.15
..... **\$14.50 SET** ⚠

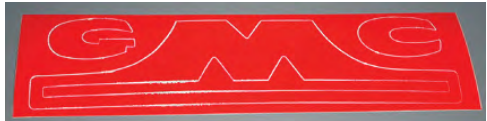

3705092GR **47-55**
GMC decal. Red (set of 4) 5.858 -0.15
..... **\$15.50 EA** ⚠



3705092GW **47-55**
GMC decal. White (set of 4) 5.858 -0.15
..... **\$14.50 SET** ⚠

Beauty Rings



1279680 **ALL**
Ribbed 16 in. (outer wheel). 5.858 -0.15
..... **\$33.50 EA** ⚠

1279680S **ALL**
Smooth 16 in. (outer wheel). 5.858 -0.15
..... **\$26.75 EA** ⚠

986259 **ALL**
Ribbed 15 in. (outer wheel). 5.858 -0.15
..... **\$29.75 EA** ⚠

986259S **ALL**
Smooth 15 in. (outer wheel). 5.858 -0.15
..... **\$25.00 EA** ⚠



Tires

Oversize shipping charges apply. Please call for rate.

Tire With White Wall, Radial

Note: All tires must be inflated to manufacturers recommended PSI.



368981RALL
(670x15) Coker classic. 2-3/8 in. white wall 5.804 -0 **\$242.50 EA** ⚠

3693215R ALL
(650x16) Diamond Back Classics 3-1/2 in. white wall. Tubeless. 5.804 -0 **\$289.75 EA** ⚠



3693215RC ...ALL
(650x16) Coker Classic 3-1/4 in. white wall. 5.804 -0 **\$340.00 EA** ⚠

Tire With Black Wall, Radial



599887RALL
(600x16) Coker, BF Goodrich. Made from original molds. 5.804 -0.15 .. **\$330.00 EA** ⚠

Tire With White Wall, Bias Ply

368981 ALL
(670x15) Coker, BF Goodrich 3-5/8 in. white wall tubeless 5.804 -0 **\$231.75 EA** ⚠

3693215 ALL
(650x16) Coker, BF Goodrich 3-3/4 in. white wall 5.804 -0 **\$245.75 EA** ⚠

3693215F ALL
(650x16) Coker, Firestone 3-1/4 in. white wall. 5.804 -0 **\$245.00 EA** ⚠

Tire With White Wall, Bias Ply, cont.



599886ALL
(600x16) BF Goodrich 3-1/2 in. white wall. Made from original molds. 5.804 -0 **\$236.00 EA** ⚠

Tire With Black Wall, Bias Ply

368981B ALL
(670x15) Coker, BF Goodrich. Tubeless. 5.804 -0 **\$202.00 EA** ⚠

3693215B ALL
(650x16) Coker, BF Goodrich. 5.804 -0 **\$211.50 EA** ⚠



599887ALL
(600x16) BF Goodrich. 4 ply. Made from original moulds. 5.804 -0 **\$197.75 EA** ⚠

Tire Care

91800 ALL
Wide White has been developed specifically to aid in restoring and beautifying wide whitewall tires. This cleaner is safe to use on white rubber and is made from environmentally friendly ingredients. Restore your sidewalls to snowy white luster. -0 ... **\$11.00 EA** ⚠



WHITEWIPEALL
Bleach free white wall tire wipes. 7" x 9" wipe. 35 per container. -0 **CALL** ⚠

Tube



599885ALL
600-650 x 16 5.804 -0 **\$25.00 EA** ⚠

Valve Stem Cap

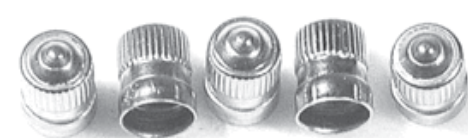

599884ALL
Original metal style (5 pcs) 5.804 -0.4 ... **\$5.00 SET** ⚠

Valve Stem Cap, cont.



CROWNCAPGDALL
Crown cap. Gold plastic (5 pcs). 5.804 -0 **\$9.50 SET** ⚠



CROWNCAPRALL
Crown cap. Red plastic (5 pcs). 5.804 -0.15 **\$6.25 SET** ⚠



VC69978ALL
Chrome Large 8 Ball Valve Cap -0.2 **\$9.95 SET** ⚠



VC69981ALL
Chrome Dice Valve Caps -0 **CALL** ⚠



VC70004ALL
Skull Valve Caps -0.15 **\$6.95 SET** ⚠



VC70005ALL
Dice Valve Caps-Red With White Dots -0.15 **\$4.00 SET** ⚠



VC70006ALL
Dice Valve Caps-White With Black Dots -0.15 **\$4.00 SET** ⚠



VC70007ALL
Dice Valve Caps-Black With White Dots -0.15 **\$4.00 SET** ⚠



VC70008ALL
Dice Valve Caps- Blue With White Dots -0.15 **\$4.00 SET** ⚠



VC70022ALL
8 Ball Valve Caps -0.15 **\$4.00 SET** ⚠



VC70038ALL
Chrome Spike Valve Caps -0.15 **\$7.95 SET** ⚠



VC70054ALL
Dice Valve Caps- Purple With White Dots -0 **CALL** ⚠

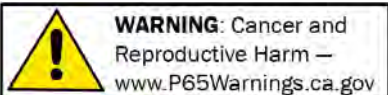

Chemicals shipped domestic ground only (Lower 48 states only). No international shipping.

Phone: (360) 816-0211 • (800) 999-CHEV (2438) • www.chevsofthe40s.com

Section 220T: Wheels, Hub Caps, Beauty Rims, Tires & Wheel Bearings

Tinnerman Nuts



365897 **ALL**
Retains rear brake drum (6 pcs). 5.810 -0.2

..... **\$7.50 SET** ⚠

Lug Nut



358501 **29-57**
Pass Car, 1/2Ton & 29-42 3/4Ton & 1Ton 5.813 -0.3

..... **\$0.99 EA** ⚠

Stud For Lug Nut



370465 **36-50**
Front 1/2Ton & 36-42 3/4Ton, 1Ton 5.812 -0.2

..... **\$3.75 EA** ⚠



375696 **36-57**
Rear 1/2Ton & 36-42 3/4Ton, 1Ton 5.812 -0.2

..... **\$3.75 EA** ⚠



476515 **51-57**
Front 1/2Ton 5.812 -0.4

..... **\$2.25 EA** ⚠

Spindle Nut & Washer



379656 **35-57**
1-1/2Ton & 2Ton, 46-57 3/4Ton 6.022 -0

..... **CALL** ⚠



378137 **40-54**
1/2Ton & 40-42 3/4Ton, 1Ton 6.022 -0.15

..... **\$4.00 SET** ⚠

Dust Cover



370262 **36-54**
Front wheel bearing dust cover. Fits 1/2Ton & 36-42 3/4Ton & 1Ton 5.858 -0.2

..... **\$13.00 PR** ⚠

Front Wheel Bearing Seal



352488 **29-40**
Cars & 1/2Ton trucks. 6.326 -0.3

..... **\$24.00 EA** ⚠



379654 **35-57**
1-1/2Ton, 46-57 3/4Ton & 1Ton exc. 42 Bus, 51-52 1-1/2Ton & Heavy Duty 6.326 -0.15

..... **\$24.75 EA** ⚠

Front Wheel Bearing Seal, cont.



3656536 **41-57**
1/2Ton, 41-42 3/4Ton & 1Ton 6.326 -0.2

..... **\$14.00 EA** ⚠

Front Inner Wheel Bearing



909002 **29-40**

Inner. Front wheel. Fits Pass, 1/2Ton & 3/4Ton 6.311 -0.2

..... **\$105.00 EA** ⚠

909026 **35-52**

35-42 utility, 46-50 3/4Ton, 1Ton, 1-1/2Ton; 51-52 3/4Ton & 1Ton 6.311 -0.15

..... **CALL** ⚠

909052 **41-57**

Inner. Fits 41-42, 1/2Ton, 3/4Ton, 1Ton 6.311 -0.2

..... **\$85.00 EA** ⚠

173241 **46-49**

Utility, 2T, school bus chassis 6.317 -0.15

..... **\$136.00 EA** ⚠

909046 **53-57**

3/4Ton, 1Ton, 1-1/2Ton 6.311 -0.15

..... **\$150.00 EA** ⚠

Front Inner Wheel Bearing, Roller



909002R **29-40**

ROLLER replacement. Inner, front. PASS & 1/2Ton & 3/4Ton. 6.311 -0

..... **CALL** ⚠

909026R **35-52**

Roller replacement 35-42 utility, 46-50 3/4Ton, 1Ton, 1-1/2Ton; 51-52 3/4Ton & 1Ton 6.311 -0.15

..... **\$167.50 EA** ⚠

909052R **41-57**

Inner. Roller replacement. Fits 1/2Ton, 41-42 3/4Ton, 1Ton 6.311 -0

..... **\$72.75 EA** ⚠

909046R **53-57**

Roller for 3/4Ton, 1Ton & 1-1/2Ton (not original). 6.311 -0

..... **\$99.00 EA** ⚠

Front Outer Wheel Bearing



909001 **29-57**

Outer. Fits Pass and 1/2Ton & 29-42 3/4Ton (Exc. 33-36 Standard CC-DC-EC-FC) 6.313 -0.3

..... **\$50.00 EA** ⚠

909025 **35-52**

35-42 1-1/2Ton, 2Ton; 46-50 3/4Ton, 1Ton, 1-1/2Ton; 51-52 3/4Ton & 1Ton 6.313 -0.2

..... **\$38.00 EA** ⚠

173238 **46-49**

2Ton & Bus with 15/16 in. diameter hole (49 early) 6.313 -0.15

..... **\$125.25 EA** ⚠

188932 **46-57**

3/4Ton, 1Ton rear 5.855 -0.15

..... **\$70.00 EA** ⚠

909045 **53-57**

3/4Ton, 1Ton, 1-1/2Ton 6.313 -0.15

..... **\$129.75 EA** ⚠

Front Outer Wheel Bearing, Roller



909001R **29-57**

ROLLER replacement. Outer. Fits Pass & 1/2Ton & 29-42 3/4Ton 6.313 -0.15

..... **\$29.25 EA** ⚠

909025R **35-52**

Roller replacement. Outer. (35-42 1-1/2Ton, 2Ton; 46-50 3/4Ton, 1Ton, 1-1/2Ton; 51-52 3/4Ton & 1Ton)

6.313 -0.15

..... **\$71.75 EA** ⚠

909045R **53-57**

Roller replacement. Outer. For 3/4Ton, 1Ton & 1-1/2Ton (not original). 6.313 -0.15

..... **\$125.00 EA** ⚠

Returns require a return authorization number—call first. • Product pricing & availability subject to change.

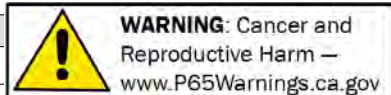

Front Wheel Bearing Roller Conversion



BEARINGKIT.....41-57
 Convert your ball bearings to roller. For both sides of front end. 1/2 ton only.
 6.311 -0 **\$268.00 SET** ⚠

Odds & Ends

Please call for availability on all Odds & Ends parts; once part is sold, it may no longer be in stock.

370957.....29-38
 Oil Deflector, Front Hub, Straight
 14.000 -0.4

..... **\$6.00 EA** ⚠

3689081N.....40-47
 Rear Wheel Hub Conversion Kit (Utility)
 13000.000 -0.4

..... **\$25.00 EA** ⚠

985705.....41-42
 Wheel discs w/o ribs. Needs rechromed
 16.000 -0.4

..... **\$150.00 EA** ⚠

909602U.....46-57
 Inner bearing cup, NOS fits 1/2Ton
 6.316 -0.4

..... **\$30.00 EA** ⚠

986108N.....47-48
 Accy. Tire Tracks to get out of snow and sand. -0.4

..... **\$100.00 SET** ⚠

12380.....48
 Accy. Wheel Covers, 16in. (Used)
 16.000 -0.4

..... **\$65.00 EA** ⚠

986358U.....49-50
 Accy. Wheel Cover (Used) 16.000 -0.4

..... **\$65.00 EA** ⚠

909066.....60-61
 Front wheel bearing-inner, fits 1/2Ton
 6.311 -0.4

..... **\$25.00 EA** ⚠



Linda Mannon

220T

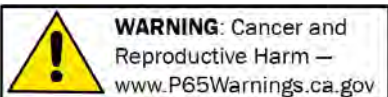

Chemicals shipped domestic ground only (Lower 48 states only). No international shipping.

Phone: (360) 816-0211 • (800) 999-CHEV (2438) • www.chevsofthe40s.com

Section 230T: Bumpers, Bumper Brackets, Splash Aprons, License Brackets, & License Frames

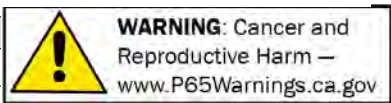
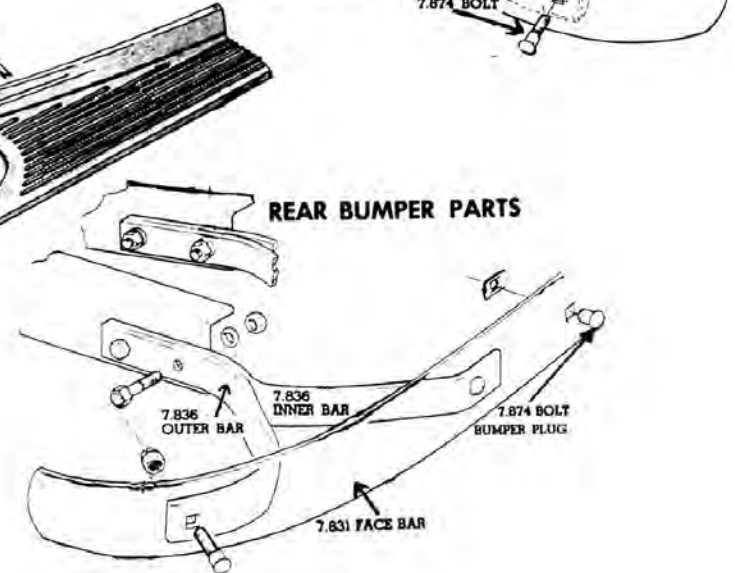
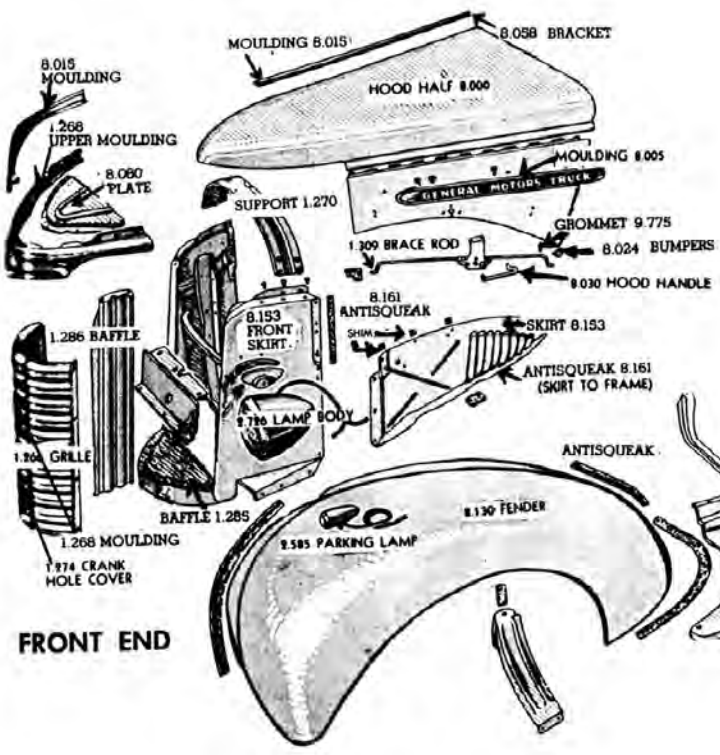
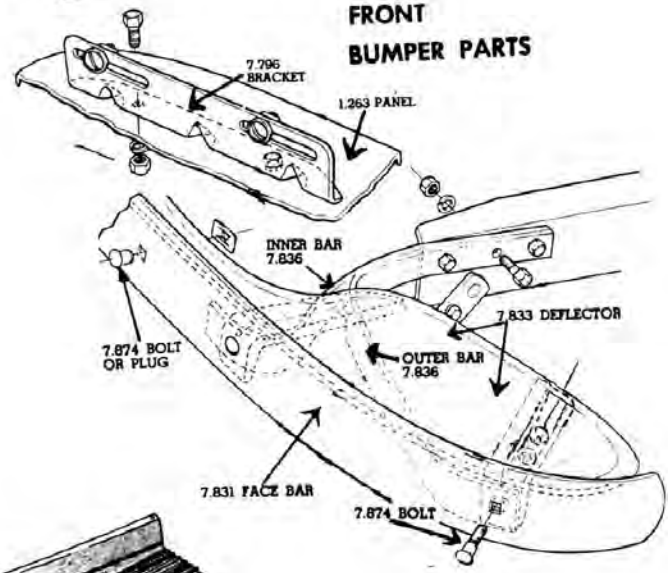
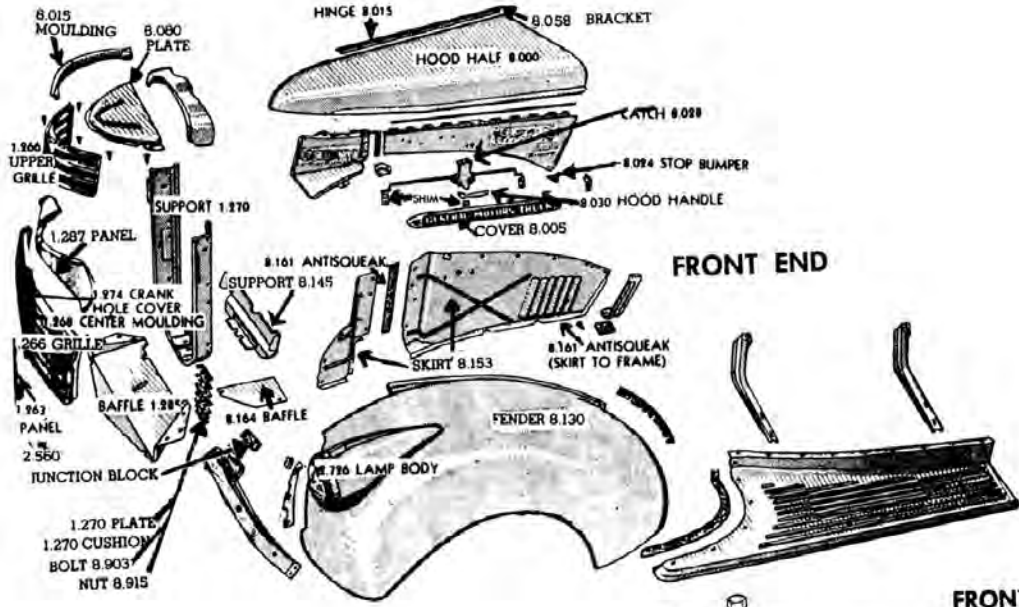

**SECTION 230T
STREET ROD PARTS**

Briz Bumpers



BRIZ5RIB35-54

Original 5 rib, fully polished (front and rear) alloy bumper. Fits 35-48 Chevy cars, 37+54 Chevy trucks. 4-1/2 in. face. Mount Front or Rear. 7.831 -0.15

\$300.00 EA ⚠️



BRIZ5RIB-C47-54

5 rib polished alloy contoured bumper. Contoured to match the front of your truck. Fits 47-54 Chevy trucks. 4-1/2 in. face (does not include brackets or bolts). -0.15

\$450.00 EA ⚠️



BRIZ5RIB-SHALL

Original 5 rib polished alloy bumper. Fits 49-53 Chevy cars, 41-54 Chevy trucks. 4-1/2 in. face. 7.831 -0.15

\$320.00 EA ⚠️



BRIZBOLTALL

Polished, Stainless bumper bolt. Radiused head to fit over ribs. -0.15

\$11.50 EA ⚠️

Bumper Brackets, Alloy



BRACKETYF-C47-54

UN-Polished, "Y" style for 5 rib contoured front bumper, 47-54 Chevy Trucks. -0.15

\$198.75 L&R ⚠️



BRACKETYFP-C47-54

Polished, "Y" style for 5 rib contoured front bumper, 47-54 Chevy Trucks. -0.15

\$275.75 L&R ⚠️



BRACKETJFPALL

Polished, "J" style front. Call for your specific application. Fits BRIZ & other bumpers for most 37-54 Chevy trucks, 28-32 (some 33-36 & 46-57) Ford cars & most 28-56 Ford trucks. -0.15

\$214.09 L&R ⚠️



BRACKETYFPALL

Polished, "Y" style front. Call for your specific application. Fits BRIZ & other bumpers for 37-48 (some 35-36) Chevy cars, some 37-54 Chevy trucks, 37-41 (some 33-36) Ford cars & some 33-41 Ford trucks. -0.15

\$275.75 L&R ⚠️

Bumper Brackets, Alloy, cont.



BRACKETYRPALL

Polished, "Y" style rear. Call for your specific application. Fits BRIZ & other bumpers for 37-48 Chevy cars, some 37-54 Chevy trucks, 37-41 Ford cars & some 33-41 Ford trucks. -0.15

\$275.75 L&R ⚠️



BRIZBRKTALL

License plate mounting bracket for BRIZ license guard. -0.15

\$29.50 EA ⚠️

Briz Bumper License Guard/Bracket



BRIZBGUARDALL

Polished. '49 Chevy style. -0.15

\$194.25 EA ⚠️

Rear Roll Pans

Oversized shipping charges apply. Please call for rate.



3658265P41-46

Steel pan. Rear with license plate recess. Replaces back bumper for smooth look.

7.831 -0.15 **\$167.00 EA** ⚠️



3683305P47-53

Steel pan. Rear with license plate recess. Replaces back bumper for smooth look.

7.831 -0.15 **\$167.00 EA** ⚠️



WARNING: Cancer and Reproductive Harm — www.P65Warnings.ca.gov

Chemicals shipped domestic ground only (Lower 48 states only). No international shipping.

Phone: (360) 816-0211 • (800) 999-CHEV (2438) • www.chevsofthe40s.com

Rear Roll Pans, cont.



3683305PS47-53
Steel pan. Replaces back bumper for smooth look. 7.831-0.15 **\$115.00 EA** ⚠



3705437P54-87
Steel pan. Rear with license plate recess. Replaces back bumper for smooth look. Fits stepside only 7.831-0.15
\$167.00 EA ⚠

**SECTION 230T
RESTORATION PARTS**

Bumpers

Oversized shipping charges apply. Please call for rate.

Oversized shipping charges apply to. Please call for rate.



594648 37
Copper-Nickel-Chrome. Fits on Master front & Front or Rear on trucks. 7.831-0
\$430.50 EA ⚠



594648S 37
Polished Stainless. Fits on Master front & Front or Rear on trucks. 7.831-0.15
\$499.00 EA ⚠



384730538-39
Copper-Nickel-Chrome. Front or Rear. 7.831-0
\$430.00 EA ⚠

Bumpers, cont.



3847305S38-39
Polished Stainless. Front or Rear. No holes. Studs for brackets welded to back. 7.831-0.15
\$499.00 EA ⚠



3653339 40
Copper-Nickel-Chrome. Fits front or rear (exc. rear of Wagon & Sedan Delivery). 7.831-0
\$430.50 EA ⚠



3653339S 40
Polished Stainless. No holes. Studs for brackets welded to back. Fits front or rear (exc. rear of Wagon & Sedan Delivery). 16.400-0.15
\$499.00 EA ⚠



365826541-46
Nickel-Chrome. Front. Exc 41-42 COE & 46 1-1/2T w/ 160in. wheelbase. 7.831-0
\$325.00 EA ⚠



3658265A41-46
Nickel-Chrome. Rear. 1/2Ton & 3/4Ton (original panels & Suburbans w/ doors had 1-1/2 in. less arc). 7.831-0
\$325.00 EA ⚠



3658265S41-46
Polished stainless. Front with bolt holes (exc 41-42 COE & 46 1-1/2Ton w/ 160 in. wheelbase). 7.831-0.15
\$499.00 EA ⚠

Bumpers, cont.



3658265SA41-46
Polished stainless. Rear with bolt holes. Fits 1/2Ton & 3/4Ton Truck (panels & Suburbans w/ doors had 1-1/2 in. less arc). 7.831-0.15
\$499.00 EA ⚠



368335047-53
Nickel-Chrome. Rear. Exc panel & Suburban. 7.831-0.15 ..
\$169.00 EA ⚠



3683350S47-53
Polished stainless. Rear, exc. Panel & Suburban. Nice!. Chevy & GMC 7.831-0.15
CALL ⚠



370043847-54
Nickel-Chrome. Front. Also fits rear of panel and Suburban. 7.831-0.15
\$177.75 EA ⚠



3700438P47-54
PAINTED. Front. Also rear of panel and Suburban. 7.831-0.15
\$109.25 EA ⚠



3700438S47-54
Polished stainless Front, also fits rear of Panel & Suburban. Chevy & GMC 7.831-0.15
\$499.00 EA ⚠

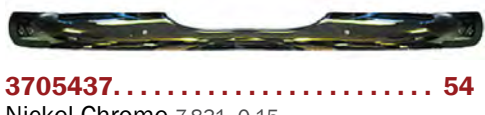

3705437 54
Nickel-Chrome 7.831-0.15
\$179.00 EA ⚠

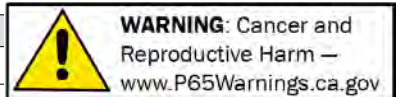

Bumper Guard



597827 **38-39**
 Front or rear bumper. Fits left or right.
 7.828 -0.15 **\$159.25 EA** ⚠️



986113 **47-54**
 Front or rear (accessory). 7.828 -0.15 ..
\$89.75 L&R ⚠️



986113R **47-54**
 Front or rear (accessory). Rubber face.
 Includes mounting hardware. 7.828 -0.15
 **\$25.00 EA** ⚠️

Bumper Bolt



594206 **37-46**
 With oval head bolt,
 nut & lock washers, as
 original. 7.874 -0
 **\$8.00 EA** ⚠️



3695906 **47-54**
 With standard bolt,
 marsden nut , flat
 & lock washers, as
 original. 7.874 -0
 **CALL** ⚠️



3695907 **47-54**
 Stainless w/ standard
 bolt, nut , flat & lock
 washers, as original.
 7.874 -0
 **CALL** ⚠️



3695907C **47-54**
 Chrome w/ standard
 nut & washers.
 7.874 -0.15
 **\$2.75 EA** ⚠️

Bumper Guard Bolt



597825A **37**
 1-1/8in. x 2-1/2in. With
 nut and lock washer
 7.829 -0.15
 **\$35.00 EA** ⚠️



597825 **38-39**
 1-3/8in. x 2-1/2in.
 7.829 -0.15
 **\$12.50 EA** ⚠️

Bumper Bracket

Note: Bumper brackets are supplied in raw steel. Preparation will be required before paint.



594154 **37**
 Rear 7.836 -0.15 **\$169.00 L&R** ⚠️



594711 **37**
 Front 7.836 -0.2 **\$160.00 L&R** ⚠️



350590 **38-39**
 Front 7.836 -0.2 **\$155.25 L&R** ⚠️



597872 **38-39**
 Rear 7.836 -0.15 **\$170.25 L&R** ⚠️



3653681 **40**
 Front 7.836 -0.15 **\$150.00 L&R** ⚠️

Bumper Bracket, cont.



3653862 **40**
 1/2 Ton Rear 7.836 -0.15 **\$169.00 L&R**
 ⚠️



3658053 **41-46**
 Front, 1/2 & 3/4 Ton 7.836 -0
\$118.75 L&R ⚠️



599382B **41-46**
 Rear. 6 piece set. Fits 1/2 ton & 3/4 ton.
 7.836 -0.1 **\$119.50 L&R** ⚠️



3684827B **47-54**
 Rear (1/2T). Chevy & GMC 7.836 -0.15
\$75.00 L&R ⚠️



3684833 **47-54**
 Rear (3/4 & 1T). 7.836 -0.15
\$129.00 L&R ⚠️



3701949 **47-54**
 Front (1/2T& 3/4T). Chevy & GMC
 7.836 -0.15 **\$106.50 L&R** ⚠️

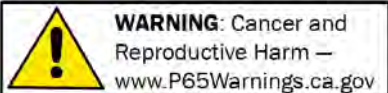

Chemicals shipped domestic ground only (Lower 48 states only). No international shipping.

Phone: (360) 816-0211 • (800) 999-CHEV (2438) • www.chevsofthe40s.com

Bumper Grommets



59974339-46
Rear bumper panel,
Suburban (2 pcs).
7.792 -0.15
..... **\$33.00 PR** ⚠



365800341-46
Front bumper. 7.792 -0.15
..... **\$18.25 PR** ⚠

Front Splash Apron

Oversized shipping charges apply. Please call for rate.



368414547-53
Bumper to grille. Steel (does not fit GMC)
superior quality. 1.287 -0.15 **\$89.00 EA** ⚠



3684145C47-53
Bumper to grille. Chrome (does not fit
GMC). 1.287 -0.15 **\$159.00 EA** ⚠



3684145G49-53
Bumper to grille. Steel, GMC. 1.287 -0.15
..... **\$110.25 EA** ⚠

3701226 54
Bumper to grille. Steel (does not fit GMC).
1.287 -0.15 **\$89.00 EA** ⚠

3701226C 54
Bumper to grille. Chrome (does not fit
GMC). 1.287 -0.15 **\$159.00 EA** ⚠

Rear Splash Apron



3690258A47-53
Fits over bumper brackets. (Exc. Panel &
Suburban) Original for 1/2 ton.
Modification needed for 3/4 ton due to
different bumper brackets. 7.833 -0.15
..... **\$150.00 EA** ⚠

Bumper Seal



369025747-54
Body to rear bumper panel or Suburban.
7.833 -0.15 **\$21.00 EA** ⚠

License Accessories



98509637-64
Chrome Diamond, choose diamond color:
clear, amber, red, green, blue, purple.
9.777 -0.15 **\$14.00 EA** ⚠



10887ALL
Chrome bullet wing nut license fastener.
Set of 4 -0.15 **\$5.00 SET** ⚠



985094ALL
Glass jewel reflector. Specify Red, Green,
Blue, Amber, Burnt Orange, Purple, Clear,
Light Blue, Yellow, Rainbow. (2 pcs).
9.777 -0.2starting at **\$20.00 PR** ⚠



985094PALL
Plastic jewel reflector. Red (2 pcs).
9.777 -0.15 **\$3.00 PR** ⚠



FLAG01ALL
License Plate Frame
Accessory, U.S.A.
Flag -0.4
..... **\$1.95 EA** ⚠

License Accessories, cont.



FLAG02ALL
Flag Holder - 5
Post -0.15
..... **\$10.00 EA** ⚠



FLAG03ALL
Flag Holder-Chrome
3 Post -0
..... **CALL** ⚠

License Plate Toppers



FELIXALL
Universal Felix the
cat license frame
ornament. -0.15
..... **\$20.00 EA** ⚠



PLATETOP48ALL
48 Star Flag -0
..... **\$16.99 EA** ⚠



PLATETOPCATALL
Cat with moving eyes
and tongue. -0
..... **\$16.99 EA** ⚠



VPALPT007ABALL
Chrome Safety Star
With Amber Led
Illumination -0.15
..... **\$44.00 EA** ⚠



VPALPT007GNALL
Chrome Safety Star
With Green Led
Illumination -0
..... **CALL** ⚠



VPALPT007RDALL
Chrome Safety
Star With Red Led
Illumination -0.15
..... **\$44.00 EA** ⚠



VPALPT008ALL
Pegasus (Drive
Safety) -0.15
..... **\$17.00 EA** ⚠



VPALPT017ALL
H-Bomb Plate
Topper -0.15
..... **\$35.00 EA** ⚠

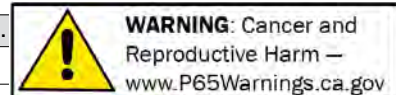

Section 230T: Bumpers, Bumper Brackets, Splash Aprons, License Brackets, & License Frames

License Plate Frame



986710.....37-54
 Year on top and "Chevrolet" on bottom of frame. Choose 1937-1954 (Exc 43-45). Specify year when ordering. (2 pcs).
 - Made For Modern Plates 9.777 -0 starting at **\$18.50 SET** ⚠️



986708.....ALL
 Telescoping (8 pcs), 2 ribs on end of each piece. Polished stainless. Original accessory 48-55. 9.777 -0.15
\$50.75 EA ⚠️

License Plate Bracket

Note: Rear License Plate Bracket see Tail Light Bracket Section 110T.



595805.....37-40
 Front 7.796 -0.15 **\$37.50 EA** ⚠️



605358.....41-46
 Front 7.796 -0.15 **\$30.75 EA** ⚠️



3847439.....47-53
 Front 7.796 -0.15 **\$10.00 EA** ⚠️



3847439C.....47-53
 Front (chrome). 7.796 -0.2 **\$23.00 EA** ⚠️

License Plate Bracket, cont.



3847440A.....54
 Front 7.796 -0.15 **\$12.50 EA** ⚠️



3707021.....54-59
 Pickup (w/ rear bumper) exc Suburban & Panel. Includes license light rear. 2.705 -0.15 **\$32.00 EA** ⚠️

Odds & Ends

Please call for availability on all Odds & Ends parts; once part is sold, it may no longer be in stock.

3656466.....41-46
 Bumper Bracket Front Outer NOS

17000.000 -0.4 **\$20.00 EA** ⚠️

3683665.....47-55
 Bumper Bracket Front & Rear Outer Left

17000.000 -0.4 **\$20.00 EA** ⚠️

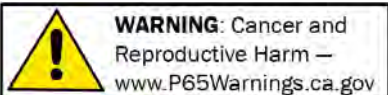

Chemicals shipped domestic ground only (Lower 48 states only). No international shipping.

Phone: (360) 816-0211 • (800) 999-CHEV (2438) • www.chevsofthe40s.com

**SECTION 240T
RESTORATION PARTS**

Grilles

Note: Oversize shipping charges apply on all grilles. Please call for rates.

1937 Grille With Billet Aluminum Bars



595112BNC ... 37
Chromed bars. Narrow spacing (1/4in. space). 1.266 -0
... **\$1,826.00 EA** ⚠

595112BNF 37
Polished (front bars only). Narrow bar spacing (1/4in. space). 1.266 -0
..... **\$1,075.00 EA** ⚠

595112BNP 37
Fully polished. Narrow bar spacing (1/4in. space). 1.266 -0
..... **\$1,295.00 EA** ⚠

595112BWC 37
Chromed. Standard bar spacing (3/8in. space). 1.266 -0
..... **\$1,520.00 EA** ⚠

595112BWF 37
Polished (front of bars only). Standard bar spacing (3/8in. space). 1.266 -0
..... **\$850.00 EA** ⚠



595112BWP ... 37
Fully polished. Standard bar spacing (3/8in. space). 1.266 -0
... **\$1,025.00 EA** ⚠

1937 "Gangster Grille"



595112LP 37
Laser cut. Bare steel for street rod. 1.266 -0.15
..... **\$445.00 EA** ⚠

1937 "Gangster Grille", cont.



595112LS 37
Laser cut. Polished stainless for street rod. 1.266 -0.15
..... **\$675.00 EA** ⚠

1937 Grille



595112 37
Bare steel as original. 1.266 -0.15
..... **CALL** ⚠



595112S 37
Stainless, like original. 1.266 -0
..... **\$904.00 EA** ⚠

1937 Grille Moulding



594721 37
Side moulding. Cut to length. 1.268 -0
\$180.00 L&R ⚠



595311 37
Upper moulding. Polished stainless. 1.268 -0.15
..... **\$250.25 EA** ⚠



595539 37
Clips 4 piece set. (2 sets required) 1.269 -0.15
..... **\$14.00 SET** ⚠

1937 Grille Center Strip

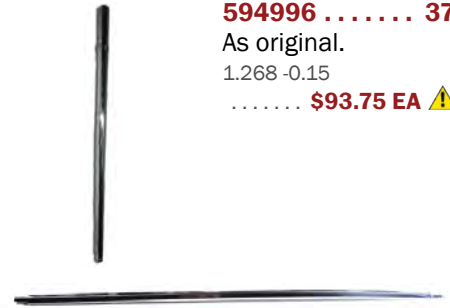

594996 37
As original. 1.268 -0.15
..... **\$93.75 EA** ⚠

594996S 37
Street rod (no holes for emblem or crank). 1.268 -0.15
..... **\$143.00 EA** ⚠

1937 Crank Hole Cover



595039 37
This is a crank hole cover. 1.274 -0
..... **\$48.50 EA** ⚠

1937 Grille Emblem



595376 37
Chrome. 1.303 -0
..... **\$90.00 EA** ⚠



595376P 37
Chrome with painted details. 1.303 -0
CALL ⚠

1937 Grille Shell



602395 37
Fiberglass. 1.263 -0
..... **CALL** ⚠

1938 "Gangster Grille"



597829LP 38
Laser cut. Bare steel for street rod.
1.266 -0.15
..... **\$415.00 EA** ⚠



597829LS 38
Laser cut. Polished stainless for street rod.
1.266 -0.15
..... **\$675.00 EA** ⚠

1938 Grille Center Strip



597988 38
This is a center strip for the grille.
1.268 -0.15
..... **\$88.75 EA** ⚠

1938 Grille Center Strip Clip



597463 38
Clips for center strip.
Uses 2. 1.269 -0.15
..... **\$12.50 PR** ⚠

1938 Crank Hole Cover



597719 38
2 pieces 1.274 -0.15
..... **\$59.25 SET** ⚠

1939 Grille



350422 39
W/ center strip-chrome (not for show) 1.266 -0
..... **CALL** ⚠

1939 Grille, cont.



350422NC 39
W/ center strip (bare steel). 17 bars.
1.266 -0
..... **CALL** ⚠

1939 Grille Center Strip



580814 39
21-3/4in. 1.268 -0
..... **CALL** ⚠

1939 Grille Lettering



350422L 39
Top grille bar-vinyl. 1.266 -0.15
..... **\$23.50 EA** ⚠

1940 Grille



3653523 40
W/ center strip-chrome (not for show) 1.266 -0
..... **CALL** ⚠

1940 Grille Center Strip



3653529 40
20-1/4in. 1.268 -0
..... **CALL** ⚠

1940 Grille Lettering



3653523A 40
This is a vinyl "Chevrolet" grille script.
1.266 -0.15 **\$16.75 EA** ⚠

1941-46 Grille

3657169NC 41-46
Upper half only - bare steel. 1.266 -0.15
..... **\$185.00 EA** ⚠

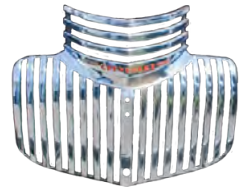

3657185 41-46
Upper & lower, chrome (not for show). (exc COE) 1.266 -0
..... **CALL** ⚠



3657185NC 41-46
Upper & lower. Bare steel (exc COE).
1.266 -0.15 **\$898.75 EA** ⚠

3657185NCNL 41-46
Upper & Lower. Bare steel without logo.
1.266 -0
..... **CALL** ⚠

1941-46 Crank Hole Cover



3658076 41-46
Crank Hole Cover- Polished Stainless
- For original grills only
1.274 -0.15
..... **\$83.75 EA** ⚠



3658076R 41-46
Crank Hole Cover- Polished Stainless - For reproduction grills only
1.274 -0.15
..... **\$83.25 EA** ⚠

1941-46 Grille Screw Set



3651169 41-46
Upper grille to fender.
1.269 -0.15
..... **\$8.25 SET** ⚠

3657169A 41-46
Upper grille to lower grille. 1.266 -0.15
..... **\$7.25 SET** ⚠

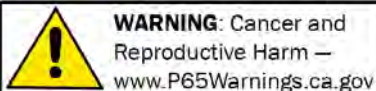

Chemicals shipped domestic ground only (Lower 48 states only). No international shipping.

Phone: (360) 816-0211 • (800) 999-CHEV (2438) • www.chevsofthe40s.com

1941-46 Grille Emblem



365726941-46
Lower. 1.303 -0.15
..... **\$39.25 EA** ⚠

1941-46 Grille Lettering



3657186.41-46
Red vinyl. 1.266 -0.15 **\$21.00 SET** ⚠

1941-46 Grille Filler Panel



3664734.41-46
Upper grille baffle. Fits between upper grille & radiator. Fiberglass. 1/2Ton & 3/4Ton. 1.286 -0.15 **\$99.00 EA** ⚠



606785FP41-46
Lower grille filler panel, fiberglass. Fits all exc. COE 1.286 -0.15 **\$169.25 EA** ⚠

1941-46 Grille Moulding Clips



597522A.41-46
For moulding above lower grille (8 pcs).

8.005 -0.4
..... **\$6.50 SET** ⚠

1941-46 Panel Below Grille



368081041-46
Fiberglass. 1.266 -0.15 **\$90.00 EA** ⚠

1941-46 Panel Below Grille, cont.



3680810G41-46
GMC fiberglass. 1.266 -0.15 **\$95.25 EA** ⚠



3680810GS41-46
GMC fiberglass w/out bumper cutouts street rod application. 1.266 -0.15 **\$139.00 EA** ⚠



3680810S41-46
Fiberglass w/out bumper cutouts street rod application. 1.266 -0.15 **\$139.00 EA** ⚠



3680810SC41-46
Steel with bumper cutouts 1.266 -0 **\$172.00 EA** ⚠



3680810SM.41-46
Steel w/out bumper cutouts street rod application. 1.266 -0 **CALL** ⚠

1947-53 Grille Bolt Kit



3650205B.47-53
Grille 1.269 -0.3
..... **\$16.75 SET** ⚠

1947-53 Grille



3847340.47-53
Chrome and painted, pre-assembled very nice. 1.266 -0 **\$372.00 EA** ⚠



3847340B47-53
Billet aluminum for Chevy Trucks. 1.266 -0 **\$1,499.50 EA** ⚠



3847340BA47-53
Billet aluminum for Chevy Trucks with movable "CHEVROLET" lettering. 1.266 -0 **\$1,600.00 EA** ⚠



3847340BAP47-53
Billet aluminum for Chevy Trucks with movable "CHEVROLET" lettering and polished face. 1.266 -0 **\$1,850.00 EA** ⚠



3847340BP47-53
Billet aluminum for Chevy Trucks with polished face 1.266 -0 **\$1,700.00 EA** ⚠

1947-53 Grille, cont.



3847340C **47-53**

All chrome, front and rear.
Pre-assembled very nice. 1.266-0.15 ...
\$499.50 EA ⚠️

3847340I **47-53**

Chrome and painted cream,
pre-assembled very nice. 1.266-0
..... **\$399.00 EA** ⚠️

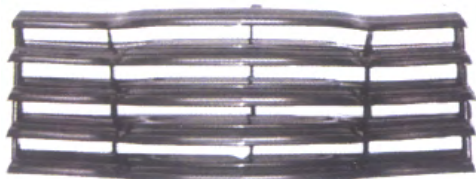

3847340P **47-53**

Painted. Nice detail. Preassembled.
1.266-0.15 **\$340.00 EA** ⚠️



2250239 **49-54**

Chrome-detailed, preassembled very nice.
GMC (exc COE). 6.076-0.15 .. **\$585.00 EA**
⚠️

Grille Guard



986153A **47-53**

Front Grille Guard Accessory 17000.000-0.15
..... **\$67.75 SET** ⚠️

Grille Filler Panel



3683583 **47-53**

Lower grille, EDP coated steel. 1.286-0.15
..... **\$149.50 EA** ⚠️

1954 Grille



3700339B **54**

Chrome plated. Comes assembled. 1.268-0
..... **\$875.00 EA** ⚠️

1954 Grille Vertical Bar



3701112 **54**

Vertical center grille bar. Chrome.
1.268-0.15
..... **\$158.00 EA** ⚠️



3701112A **54**

Unplated Center Grille Bar. 1.268-0.15
..... **\$64.25 EA** ⚠️

1954 Grille Bolt Kit



3701113A **54**

Grille (84 pieces). 1.269-0.15 **\$24.00 EA**
⚠️

1954 Grille Decals



3710929C **54**

For chrome grille & hood emblem.
8.055-0.15 **\$12.00 SET** ⚠️

1954 Grille Decals, cont.



3710929P **54**

For painted grille & hood emblem.
8.055-0.15 **\$12.00 SET** ⚠️

1955 (1st Series) Grille Decals



3701185C **55**

(1st series) for chrome grille & hood emblem. 8.055-0 **\$13.25 SET** ⚠️



3701185P **55**

(1st series) for painted grille & hood emblem. 8.055-0 **\$14.50 SET** ⚠️

Core Support Pads & Shims



367314 **39-46**

Radiator core support mount. 4-1/4" x 1-1/2" (2-1/2" between bolt holes).
1.270-0.3 **\$10.50 SET** ⚠️



3684763A **47-49**

Radiator core support mount. 2-1/4" x 1-1/4" x 1/4" thick. 1.270-0.15
..... **\$6.00 SET** ⚠️



3684763 **50-54**

Radiator core support mount. 1.270-0.15
..... **\$5.00 PR** ⚠️

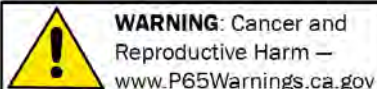

Chemicals shipped domestic ground only (Lower 48 states only). No international shipping.

Phone: (360) 816-0211 • (800) 999-CHEV (2438) • www.chevsofthe40s.com

Core Support Bolt Kit



3676480 **.41-54**
Radiator core support to frame. 1.270 -0.4
..... **\$4.00 SET** ⚠

Brace (V-Rod)



594773 **.37-38**
For 37-38 Chevy Trucks. Stainless Steel.
1.309 -0 **\$180.00 EA** ⚠

Odds & Ends

Please call for availability on all Odds & Ends parts; once part is sold, it may no longer be in stock.

5936674 **.46-48**
Rim (trim ring) for spotlight (NOS)
7.000 -0.4
..... **\$15.00 EA** ⚠

 **WARNING:** Cancer and Reproductive Harm — www.P65Warnings.ca.gov

**SECTION 250T
STREET ROD PARTS**

Fiberglass Hood

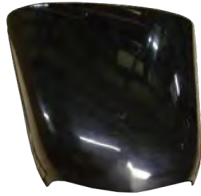

602345F **37**
1-piece top section. 8.001 -0 **CALL** ⚠



602985F **38**
1-piece top section. 8.001 -0 **CALL** ⚠



3701466F **47-55**
1-piece top section. 8.000 -0 **CALL** ⚠

Fiberglass Hood Sides

602346F **37**
Hood sides, smooth 8.001 -0 **CALL** ⚠

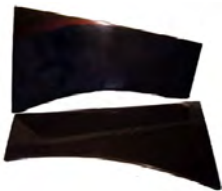

602346FS **37**
Hood sides, original style. 8.001 -0 **CALL** ⚠

Bullnose



3701990B **47-53**
Truck, replaces center strip & hood ornament. 57 in. length x 1/2" wide, polished aluminum, w/ clips. 8.015 -0 **CALL** ⚠

Hood Hinge Kits



602564 **34-46**
Front Tilting, for use with Chevy fiberglass hood. 1934-1940 Cars & 1934-1946 Trucks 8.000 -15 **\$429.00 SET** ⚠

**SECTION 250T
RESTORATION PARTS**

Hood Deflector

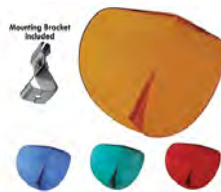

C5018 **ALL**
Classic "Bi-Flector" accessory attaches to hood center strip. Choose Amber, Blue, Clear, Green or Red. -0 starting at **\$13.00 EA** ⚠

Hood Hinge Kits



TILTHD **ALL**
Kit makes it easy to reverse the tilt on your hood! Not only does it give you a custom look, it also allows for easy access and maximum visibility! Easy installation, universal application. High Strength Black Finish. Adjustable kit ships with detailed instructions. -0.15 **\$250.00 KIT** ⚠

Hood Latch Lower Assembly



3682709C **47-53**
Hood latch assembly fits above grille. Chrome. Includes latch. Chevrolet Only, will not fit GMC. 8.080 -0.15 **\$255.00 EA** ⚠

Hood Latch Lower Assembly, cont.



3682709P **47-53**
Hood latch assembly fits above grille, black. Includes latch. Chevrolet Only, will not fit GMC. 8.080 -0.15 **\$150.00 EA** ⚠

Hood Latch Plate



2228975 **47-53**
Hood latch assembly fits above Grille. Includes latch. Fits GMC. 6.079 -0.15 **\$179.50 EA** ⚠

Hood Latch Assembly



3682707A **47-53**
Mechanism only. 8.080 -0.15 **\$62.50 EA** ⚠



3684297A **47-55**
Upper hood latch handle return spring with clevis and cotter pin 8.083 -0.15 **\$13.00 SET** ⚠

Hood Center Strip



3681480 **47-55**
For hood bullnose-steel w/ clips will not fit GMC. 55-1/4" length, tip-to-tip. 8.015 -0 **\$75.00 EA** ⚠

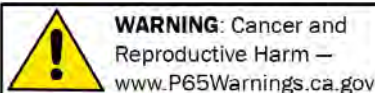

WARNING: Cancer and Reproductive Harm — www.P65Warnings.ca.gov

Chemicals shipped domestic ground only (Lower 48 states only). No international shipping.

Phone: (360) 816-0211 • (800) 999-CHEV (2438) • www.chevsofthe40s.com

Hood Center Strip, cont.



- 3681480S** **47-55**
Truck, stainless steel w/ clips. Will not fit GMC. 8.015 -0.15 **\$88.00 EA** ⚠️
- 3681480SG** **47-55**
Truck, stainless steel w/ clips. GMC. 8.015 -0.15 **\$83.25 EA** ⚠️

Hood Ornament



- 595591** **37**
This is a beautiful chrome hood ornament for '37. 1.265 -0 **\$294.00 EA** ⚠️



- 598015** **38**
This is a beautiful chrome hood ornament for 1938 Chevrolet truck. 1.265 -0 **\$294.00 EA** ⚠️



- 350805** **39-40**
This is a beautiful chrome hood ornament. 1.265 -0 **CALL** ⚠️



- 986162** **47-53**
Accessory (original 47-52). 1.265 -0.15 **\$109.75 EA** ⚠️

Hood Ornament, cont.

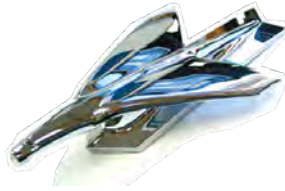

- 986982** **53**
Accessory 1.265 -0 **CALL** ⚠️

Hood Emblem



- 3684340** **47-53**
Front of Hood - Stainless. Commercial exc D-D 8.055 -0.15 **\$75.25 EA** ⚠️



- 3699021A** **47-53**
Hood emblem set-script. Red "Chevrolet" & stripes, blue "Bowtie". 8.055 -0.15 **\$10.00 EA** ⚠️



- 3701185** **54-55**
Front of Hood - Stainless. 8.055 -0.15 **\$209.75 EA** ⚠️

Hood Emblem Gasket



- 3699021B** **47-53**
Hood emblem. 8.055 -0.15 **\$5.00 EA** ⚠️



- 3710929A** **54**
Hood emblem. 8.055 -0.15 **\$5.00 EA** ⚠️

Grille Decals



- 3710929C** **54**
For chrome grille & hood emblem. 8.055 -0.15 **\$12.00 SET** ⚠️



- 3710929P** **54**
For painted grille & hood emblem. 8.055 -0.15 **\$12.00 SET** ⚠️



- 3701185C** **55**
(1st series) for chrome grille & hood emblem. 8.055 -0 **\$13.25 SET** ⚠️



- 3701185P** **55**
(1st series) for painted grille & hood emblem. 8.055 -0 **\$14.50 SET** ⚠️

Hood Side Emblem



- 474797** **36-38**
Bowtie all chrome. 8.039 -0.15 **\$60.00 EA** ⚠️



- 474797A** **36-38**
Bowtie painted-superior quality. 8.039 -0 **\$39.00 EA** ⚠️

Hood Side Emblem



3683134 **47-48**
Chevrolet Thriftmaster. 8.039 -0.15
\$21.50 EA ⚠



2313213 **47-54**
GMC, painted white w/ red. 10.096 -0.15
\$85.00 PR ⚠



3692106 **49-51**
3100 8.039 -0.15 **\$15.00 EA** ⚠



3699024 **49-52**
Chevrolet. 8.039 -0.15 .. **\$45.00 PR** ⚠



3700202 **53-54**
3100 8.039 -0.15 **\$37.50 PR** ⚠

Hood Side Moulding



350631B **39-40**
Excellent reproduction with painted details. 8.005 -0.15 **\$75.00 PR** ⚠



3657265 **41-46**
Left 8.005 -0.15 **\$19.00 EA** ⚠



3657266 **41-46**
Right 8.005 -0.15 **\$19.00 EA** ⚠

Hood Side Clips & Bolts



350507 **39-40**
Side moulding clip. Sold as each. 8.005 -0.15 **\$3.25 EA** ⚠



350651 **39-40**
Side moulding. 1 side requires 1 stud 8.005 -0.15 **\$3.50 EA** ⚠



59752346 **41-46**
Does 1 moulding. Drilling new holes is required 8.005 -0 **\$7.75 SET** ⚠

Hood Handle



597521A **36-46**
Stainless 37-39 Cars 36-46 Trucks. 8.030 -0.15 **\$50.25 EA** ⚠



597521P **36-46**
Plain steel, primed. Paintable, as original. Chrome 37-39 Cars 36-46 Trucks. 8.030 -0 **CALL** ⚠

Adhesives & Sealers



01608 **ALL**
3M plastic & emblem adhesive (5 oz. tube). 8.800 -0.15 **\$10.00 EA** ⚠

Underhood Light



986250 **47-48**
Super reproduction. 8.890 -0 **CALL** ⚠

Hood Corners



3678834 **37-38**
Rubber front. 8.024 -0.2 **\$12.00 PR** ⚠

3678834 **39-46**
Rubber rear. 8.024 -0.2 **\$12.00 PR** ⚠

Bumpers (Rubber)



595304 **37**
Hood to grille shell (6 pcs). 8.024 -0 **\$6.00 SET** ⚠



3681093B **38-46**
Hood to grille shell (6 pcs). 8.024 -0.3 **\$6.00 SET** ⚠



3676360B **47-54**
Hood set (10 pcs). 8.024 -0.3 **\$10.00 SET** ⚠

Retainers w/ Screws



3654168B **29-54**
For hood to cowl seal (Set of 8). 9.127 -0.4 .. starting at **\$8.00 SET** ⚠

Hood To Cowl Seal



374969 **29-46**
Webbing with wire insert. 9.127 -0.15 **\$26.00 PR** ⚠



374969A **29-46**
Webbing-also radiator shell to hood (9 ft). 9.127 -0.2 **\$12.00 EA** ⚠



3658468A **41-46**
2 44 in. rubber strips. 9.127 -0.15 **\$18.00 PR** ⚠



3688792 **47-55**
2 32-1/2 in. rubber strips. 9.127 -0.15 **\$16.25 PR** ⚠

3664008BULK **ALL**
Rubber sold by the inch 9.127 -0 **\$0.50 IN** ⚠

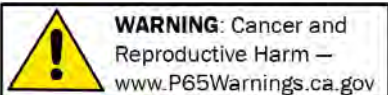

WARNING: Cancer and Reproductive Harm — www.P65Warnings.ca.gov

Chemicals shipped domestic ground only (Lower 48 states only). No international shipping.

Phone: (360) 816-0211 • (800) 999-CHEV (2438) • www.chevsofthe40s.com

Section 250T: Hoods, Hinges, Springs, Rubber, Emblems & Ornaments

Hood To Grille Seal



374969C **31-40**
Webbing with wire
insert. 9.127 -0.15
..... **\$21.99 EA** ⚠



3660532 **37-46**
Webbing with wire
insert. 9.127 -0.15
..... **\$17.00 PR** ⚠

Hood Hinge Bracket



473987 **34-46**
Bracket for hood hinge
hold down (rear).
8.058 -0.15
..... **\$14.25 EA** ⚠

473987S **34-46**
Stainless. Rear hood hinge hold
down. -0.15
..... **\$20.00 EA** ⚠

Hood Hinge



372828 **34-40**
Chrome with fasteners (exc COE). 8.015 -0
..... **\$99.00 SET** ⚠

372828P **34-40**
Painted with fasteners (exc COE).
8.015 -0.15
..... **\$67.00 SET** ⚠



3657264 **41-46**
Chrome with fasteners (exc COE). 8.015 -0
..... **\$99.00 SET** ⚠

3657264P **41-46**
Painted with fasteners (exc COE).
8.015 -0.15
..... **\$67.00 SET** ⚠



3686039 **47-54**
Upper & lower (left). 8.015 -0.15
..... **\$45.00 SET** ⚠

3686040 **47-54**
Upper & lower (right). 8.015 -0.15
..... **\$45.00 SET** ⚠

Hood Hinge Bolt



3688414 **47-54**
1/2 in. hex head, 3/8
in" shoulder
commercial utility (exc
COE) (uses 2). 8.016 -0
..... **\$5.50 PR** ⚠



3688414S **47-54**
Stainless steel.
Shouldered-1/2 in. hex
head, 3/8 in. shoulder
commercial utility (exc
COE) (uses 2). 8.016 -0
..... **\$15.00 PR** ⚠



3689234 **47-54**
5/8 in. hex head, 7/16
in. shoulder, shoulder
commercial utility (exc
COE) (uses 4). 8.016 -0
..... **\$6.00 PR** ⚠



3689234S **47-54**
Stainless steel 5/8
in. hex head, 7/16 in.
shoulder. Fits Comm &
Utility (exc COE) (uses
4). 8.016 -0
..... **\$15.00 PR** ⚠

Odds & Ends

Please call for availability on all Odds & Ends parts; once part is sold, it may no longer be in stock.

3657264U **41-46**
Hood hinge (Used). 8.015 -0.4
..... **\$60.00 EA** ⚠



Section 270T: Fenders, Fender Skirts, Fender Welting, Fender Gaskets, Mud Flaps, Hardware & Mouldings

SECTION 270T STREET ROD PARTS

Fender Front (Fiberglass)



- 594955L**.....37-38
Left. 8.130 -0.15 **\$500.00 EA** ⚠
- 594956R**.....37-38
Right. 8.130 -0.15
..... **\$500.00 EA** ⚠
- 599991L**..... 39-40
Left. 8.130 -0.15
..... **\$500.00 EA** ⚠
- 599992R**..... 39-40
Right. 8.130 -0.15
..... **\$500.00 EA** ⚠
- 3664961L**..... 41-46
Left. 8.130 -0.15
..... **\$500.00 EA** ⚠
- 3664962R**..... 41-46
Right. 8.130 -0.15
..... **\$500.00 EA** ⚠
- 3682657L**.....47-53
Left. 8.130 -0.15
..... **\$500.00 EA** ⚠
- 3682658R**.....47-53
Right. 8.130 -0.15
..... **\$500.00 EA** ⚠

Fender Rear (Fiberglass)



- 594181L**.....37-38
Left. 8.203 -0.15 **\$400.00 EA** ⚠
- 594181W**.....37-38
Left 2" Wider. 8.203 -0.15
..... **\$415.00 EA** ⚠
- 594182R**.....37-38
Right. 8.203 -0.15
..... **\$400.00 EA** ⚠
- 594182W**.....37-38
Right 2" Wider. 8.203 -0.15
..... **\$415.00 EA** ⚠
- 599295L**..... 39
Left (1/2, 3/4 & 1T). 8.203 -0.15
..... **\$415.00 EA** ⚠

Fender Rear (Fiberglass), cont.

- 599296R** 39
Right (1/2, 3/4 & 1T). 8.203 -0.15
..... **\$415.00 EA** ⚠
- 599121L**..... 39-46
Left (Panel, Suburban). 8.164 -0
..... **CALL** ⚠
- 599122F** 39-46
Right (Panel, Suburban). 8.164 -0
..... **CALL** ⚠
- 3681977L** 40-46
Left 8.203 -0.15
..... **\$415.00 EA** ⚠
- 3681977W**..... 40-46
Left, 2" wider, exc 1T. 8.203 -0
..... **CALL** ⚠
- 3681978R** 40-46
Right 8.203 -0.15
..... **\$415.00 EA** ⚠
- 3681978W**..... 40-46
Right, 2" wider, exc 1T. 8.203 -0
..... **CALL** ⚠
- 3682835L**47-54
Left (all pickups). 8.203 -0.15
..... **\$415.00 EA** ⚠
- 3682835W**.....47-54
Left, 2-1/2" wider, all pickups. 8.203 -0.15
..... **\$435.00 EA** ⚠
- 3682836R**47-54
Right (all pickups). 8.203 -0.15
..... **\$415.00 EA** ⚠
- 3682836W**.....47-54
Right, 2-1/2" wider, all pickups. 8.203 -0.15
..... **\$435.00 EA** ⚠
- 3684691L**47-54
Left (Panel, Suburban). 8.203 -0.15
..... **\$435.00 EA** ⚠
- 3684692R**47-54
Right (Panel, Suburban). 8.203 -0.15
..... **\$435.00 EA** ⚠

Inner Fender Apron Kit Street Rod Style

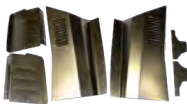

- 3686239**.....47-54
Inner fender Apron
Kit. Cleans look of
engine bay. Bolt-in.
Stock or Smooth firewalls/ core supports.
Chevrolet Only 16.545 -0.15
..... **\$415.00 SET** ⚠

Inner Fender Panel (Fiberglass) Front

- 595889F**37-38
Left. 8.164 -0
..... **CALL** ⚠
- 595890F**37-38
Right. 8.164 -0
..... **CALL** ⚠



- 3664975F**41-46
Left. 8.164 -0 **CALL** ⚠

Headlight Bucket Stand



- 350777F**.....37-40
Fiberglass, left. 2.544 -0
..... **CALL** ⚠



- 350778F**.....37-40
Fiberglass, right. 2.544 -0
..... **CALL** ⚠

Clutch Head Driver



- DRIVER**ALL
Magnetic clutch head driver, Chev's
imprint. w/ 5 bits (1/8 in., 5/32 in., 3/16
in., 1/4 in., 5/16 in.) 8.821 -0
..... **\$22.25 SET** ⚠

Clutch Head Socket Set



- CHSS-4**ALL
4 pc. 3/8 Drive 8.821 -0.15
..... **\$19.75 SET** ⚠



WARNING: Cancer and
Reproductive Harm —
www.P65Warnings.ca.gov

Chemicals shipped domestic ground only (Lower 48 states only). No international shipping.

Phone: (360) 816-0211 • (800) 999-CHEV (2438) • www.chevsofthe40s.com

Section 270T: Fenders, Fender Skirts, Fender Welting, Fender Gaskets, Mud Flaps, Hardware & Mouldings

SECTION 270T RESTORATION PARTS

Fender Front (Steel)

Note: Steel fenders ship EDP coated to protect from rust. Oversize shipping charges apply. Please call for rates.



368248147-53
Left side. Metal. Exc COE. 8.130 -0.15
\$399.00 EA ⚠

368248247-53
Right side. Metal. Exc COE. 8.130 -0.15
\$419.00 EA ⚠



3682481A47-55
Left side repair, back of front fender.
8.130 -0.15 **\$114.50 EA** ⚠

3682482A47-55
Right side repair, back of front fender.
8.130 -0.15 **\$114.50 EA** ⚠



370018154-55
Left side. Metal. Fits 1st Series, Exc COE.
8.130 -0.15 **\$399.00 EA** ⚠

370018254-55
Right side. Metal. Fits 1st Series, Exc
COE. 8.130 -0.15 **\$419.00 EA** ⚠

Fender Rear (Steel)

368197740-46
Left, all commercial cabs (exc. KF, AN, BN,
DS) 8.203 -0 **\$995.00 EA** ⚠

368197840-46
Right, all commercial cabs (exc. KF, AN,
BN, DS) 8.203 -0 **\$995.00 EA** ⚠



3682835S47-54
Left 8.203 -0.15 **\$368.50 EA** ⚠

3682836S47-54
Right 8.203 -0.15 **\$368.50 EA** ⚠

Inner Fender Panel (Steel) Front



368307647-53
Right. 8.153 -0.15 **\$135.00 EA** ⚠



368738147-53
Left. 8.153 -0.15 **\$135.00 EA** ⚠

Bolt & Washer Set

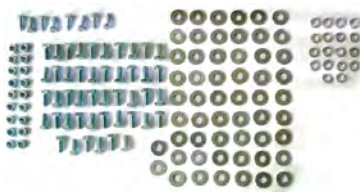

3682481BZ47-55
Front fender. Zinc plated. 8.130 -0
\$12.00 SET ⚠

Gasket Set



3701900A41-46
Inner panel w/ lower rear mount pads.
8.154 -0.2 **\$38.00 SET** ⚠



3701900C47-54
Inner panel & front fender (8 pcs).
8.154 -0.15 **\$19.00 SET** ⚠

Fender Gaskets



60972547-54
Fender to cowl (die cut). 8.205 -0.15
\$23.00 SET ⚠

Fender Welting

601726A27-46
Set (4 fenders). 8.205 -0.2
\$22.00 SET ⚠

601726E37-54
Rear fenders (optional 47-54). 8.205 -0.2
\$20.00 PR ⚠

601726F37-54
Chrome mylar rear (optional 47-54).
8.205 -0 **\$35.00 PR** ⚠

609275B47-54
Set (4 fenders) (optional). 8.205 -0.15
\$20.50 SET ⚠

601726 ALL
Black 1/4in. x 1-3/16in. 37-48 rear
fenders use approx 15 ft. 8.205 -0
\$0.99 FT ⚠



Section 270T: Fenders, Fender Skirts, Fender Welting, Fender Gaskets, Mud Flaps, Hardware & Mouldings

Fender Welting Chrome Mylar



601726CALL
 Chrome mylar (1-1/4" x 3/16"). 8.205 -0
 **\$1.99 FT** ⚠

Deluxe Fender Mouldings



367620347-55
 Left and right upper fender moulding
 8.132 -0.15 **\$232.00 L&R** ⚠
367620447-55
 12 piece set with mounting hardware. For
 lower rear of fenders. 8.132 -0.15
 **\$1,741.00 SET** ⚠

Fender Marker (Guide)



98513437-54
 Illuminated. Clamps
 to front fender,
 chrome plated. Milky
 colored top w/ clear
 lens & stainless fin.
 15.5" tall -0.15
 **\$65.25 PR** ⚠



985134BULBALL
 Replacement bulb. 3
 watt, 12 volt threaded
 base -0.15
 **\$1.00 EA** ⚠



985135ALL
 lighted Fender Guide,
 Chrome With Green,
 Red, Blue Or Amber

Inserts -0.15
 **\$65.00 PR** ⚠

Curb Feelers



985289AALL
 Chrome flex wire, clamp on vintage
 accessory helps prevent wheel & fender
 damage by creating a noticeable scraping
 sound when vehicle is too close to the
 curb.
 8.214 -0.15 **\$12.00 PR** ⚠



985289BALL
 Chrome plated, vintage clamp on
 accessory helps prevent wheel & fender
 damage by creating a noticeable scraping
 sound when vehicle is too close to the
 curb. 8.214 -0.15 **\$12.75 PR** ⚠

Headlight Grommet



367313947-53
 Fender inner panel.
 9.775 -0.4
 **\$3.50 SET** ⚠

Fender Clutch Head Bolt



3681977B39-46
 5/16in., nut, washer
 rear fender (3 pcs).
 8.206 -0.15

367647847-54
 5/16in., nut, washer rear fender (10 per
 fender) (3 piece set). 8.206 -0.4
 **\$2.50 SET** ⚠



368197747-54
 5/16in., nut, washer
 fender brace (3 pcs).
 8.206 -0.4
 **\$2.50 SET** ⚠

Fender Braces



365430040-46
 These are correct for 1942-1946 but
 works well on 1940-1941. Fits under the
 top crown of the fender. 8.212 -0.15
 **\$32.75 EA** ⚠

368394747-54
 Rear - 1/2 Ton 8.212 -0.15
 **\$12.00 EA** ⚠

3683947A47-54
 Truck rear, for 2" widened fenders.
 8.212 -0.4
 **\$15.50 EA** ⚠



3683947S47-54
 Stainless, Front & rear (4 piece set). 1/2
 Ton 8.203 -0.2 **\$94.00 SET** ⚠



3683947SF47-54
 Stainless, Front. 1/2 Ton 8.203 -0.15
 **\$47.00 SET** ⚠



3683947SR47-54
 Stainless, Rear. 1/2 Ton 8.203 -0.15
 **\$47.00 SET** ⚠

368398347-54
 Rear. 3/4 Ton 8.212 -0
 **\$30.00 PR** ⚠



3683983S47-54
 Polished Stainless. Rear, 3/4 Ton. 8.212 -0
 **\$50.00 PR** ⚠

368484147-54
 Front fender braces 8.144 -0.15
 **\$22.50 L&R** ⚠



WARNING: Cancer and
 Reproductive Harm —
www.P65Warnings.ca.gov

Chemicals shipped domestic ground only (Lower 48 states only). No international shipping.

Phone: (360) 816-0211 • (800) 999-CHEV (2438) • www.chevsofthe40s.com

Section 270T: Fenders, Fender Skirts, Fender Welting, Fender Gaskets, Mud Flaps, Hardware & Mouldings

Fender Braces, cont.



3685644B**47-54**
 Fender to Firewall 8.155 -0.15
\$45.00 PR ⚠

Fender Skirts



604503P**36-46**
 Fabricated 8.175 -0.15 **\$327.00 L&R** ⚠



985641**36-46**
 Superb die-stamped production of 1940's original steel tear drop skirts. Includes rubber seals. 8.175 -0 **\$521.25 L&R** ⚠

Odds & Ends

Please call for availability on all Odds & Ends parts; once part is sold, it may no longer be in stock.

3664975U**41-46**
 Skirt extension bracket spacer left hand used 8.153 -0

..... **\$25.00 EA** ⚠

3694962U**47-53**
 Right front fender (Used) 8.130 -0.4

..... **\$200.00 EA** ⚠



COE — Sergio Orrantia

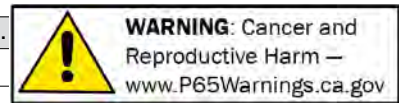

Section 290T: Sill Plates, Running Board Gaskets, Step Plates, Rocker Panel Mouldings & Fasteners

SECTION 290T RESTORATION PARTS

Note: Running Boards and Rocker Panels can be found in Section 295C.

Running Board Step Plate



350274B47-54
(super repro) very rare genuine chevrolet accessory 8.316 -0.15 . **\$75.00 L&R** ⚠



350274A.....ALL
Chrome rim w/ rubber insert (7-5/8 in. x 10-11/16 in.) 8.316 -0 **CALL** ⚠



350274C.....ALL
Die cast with bowtie (5-5/16 in. x 10-7/8 in.) Does not include any hardware. 8.316 -0.15 **\$55.25 L&R** ⚠

Running Board Bolt Kit



3687271B37-54
This is a running board bolt kit. 8.299 -0.4 **\$12.50 SET** ⚠

Running Board To Fender Gaskets



365670339-40
Running board to fenders (4) 8.299 -0.15 **\$15.00 SET** ⚠

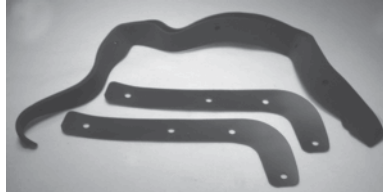

3656703A41-46
Running board to fenders (4) 8.299 -0.15 **\$15.00 SET** ⚠

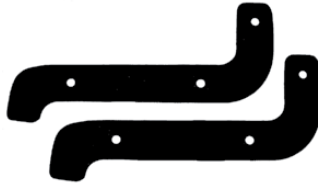

3687271A47-54
Running board to rear fender 8.299 -0.15 **\$7.00 PR** ⚠

Running Board To Cab Seal

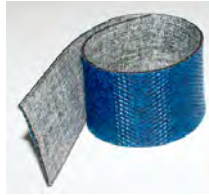

6039554033-40
(anti-squeak) to body (120 in.) 8.237 -0 **\$13.00 SET** ⚠

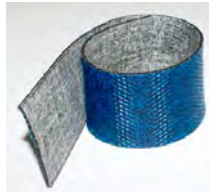

6039554641-46
Running board to body (Panel & Suburban) (120 in.) 8.237 -0.15 ... **\$11.50 SET** ⚠

Running Board To Cab Seal, cont.



368543347-54
Running board to cab (exc Panel & Suburban). 8.205 -0.15 .. **\$20.75 PR** ⚠



3685433A47-54
Running board to body (Panel & Suburban). 8.205 -0.15 . **\$29.99 PR** ⚠

Metal Retainer



3685433B47-55
Running board to cab seal 8.205 -0.15 **\$10.00 EA** ⚠

Screws

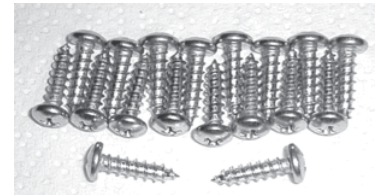

3685433C47-54
For running board to cab seal retainer (18 piece) 8.205 -0.4 **\$3.50 SET** ⚠



WARNING: Cancer and Reproductive Harm — www.P65Warnings.ca.gov

Chemicals shipped domestic ground only (Lower 48 states only). No international shipping.

Phone: (360) 816-0211 • (800) 999-CHEV (2438) • www.chevsofthe40s.com

1937-40 PARTS

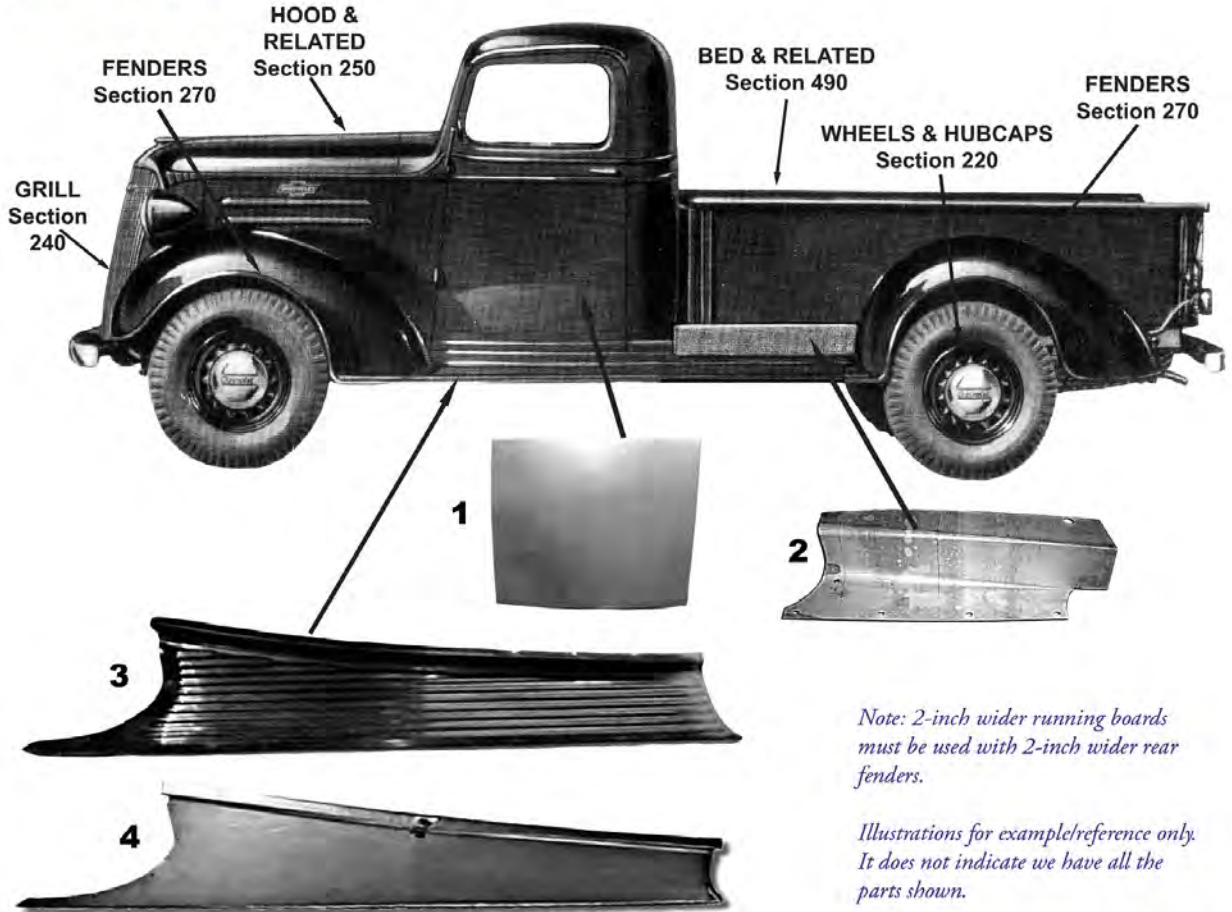

Note: 2-inch wider running boards must be used with 2-inch wider rear fenders.

Illustrations for example/reference only. It does not indicate we have all the parts shown.

SECTION 295T RESTORATION PARTS

1. Door Patch Panel 1936-40	
602455.....	36-38
Fabricated. Outer left. 16.150 -0.15	
.....	\$110.00 EA ⚠
602455A.....	36-38
Fabricated. Pickup Lower Door Skin, LH -0.15	
.....	\$45.00 ⚠
602456.....	36-38
Fabricated. Outer right. 16.150 -0.15	
.....	\$110.00 EA ⚠
602456A.....	36-38
Fabricated. Pickup Lower Door Skin, RH -0.15	
.....	\$45.00 ⚠
3666518.....	39-46
Fabricated. Outer right. 16.150 -0.15	
.....	\$110.25 EA ⚠
3666518A.....	39-46
Fabricated. Pickup Lower Door Skin, RH -0.15	
.....	\$52.50 ⚠
603339.....	39-46
Fabricated. Outer left. 16.150 -0.15	
.....	\$110.25 EA ⚠

1. Door Patch Panel 1936-40, cont.	
603339A.....	39-46
Fabricated. Pickup Lower Door Skin, LH -0.15	
.....	\$52.50 ⚠
2. Side Splash Apron 1937-39	
599731L.....	37-39
Fabricated Left-1/2Ton. 8.228 -0.15	
.....	\$39.00 EA ⚠
599732R.....	37-39
Fabricated. Right-1/2Ton. 8.228 -0.15	
.....	\$39.00 EA ⚠
3. Running Boards w/ Built-in Mounting Points (Fiberglass) 1937-1940	
594265S.....	37-38
Fiberglass-stock 1/2Ton. 8.299 -0.15	
.....	\$572.00 PR ⚠
594265W.....	37-38
Fiberglass-smooth 1/2Ton (2 in. wider). 8.299 -0.15	
.....	\$545.00 PR ⚠
594266F.....	37-38
Fiberglass-smooth 1/2Ton. 8.299 -0.15	
.....	\$558.00 PR ⚠
599578FS.....	39-40
Fiberglass-smooth 1/2Ton. 8.299 -0	
.....	CALL ⚠

3. Running Boards w/ Built-in Mounting Points (Fiberglass) 1937-1940, cont.	
599578FW.....	39-40
Fiberglass-smooth 1/2Ton (2 in. wider). 8.299 -0	
.....	CALL ⚠
4. Running Boards w/ Built-in Mounting Points (Steel) 1937-1940	
594266S.....	37-38
Fabricated. Smooth 16ga.cold rolled steel. 1/2Ton. 8.299 -0.15	
.....	\$600.50 PR ⚠
594266SW.....	37-38
Fabricated. Smooth 16ga.cold rolled steel. 1/2Ton (2 in. wider). 8.299 -0.15	
.....	\$619.00 PR ⚠
599578S.....	39-40
Fabricated. Smooth 16ga.cold rolled steel. 1/2Ton. 8.299 -0.15	
.....	\$599.50 PR ⚠
599578SW.....	39-40
Fabricated. Smooth 16ga.cold rolled steel. 1/2Ton (2 in. wider). 8.299 -0.15	
.....	\$619.00 PR ⚠

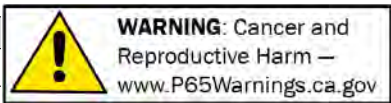

1937-40 FABRICATED PARTS

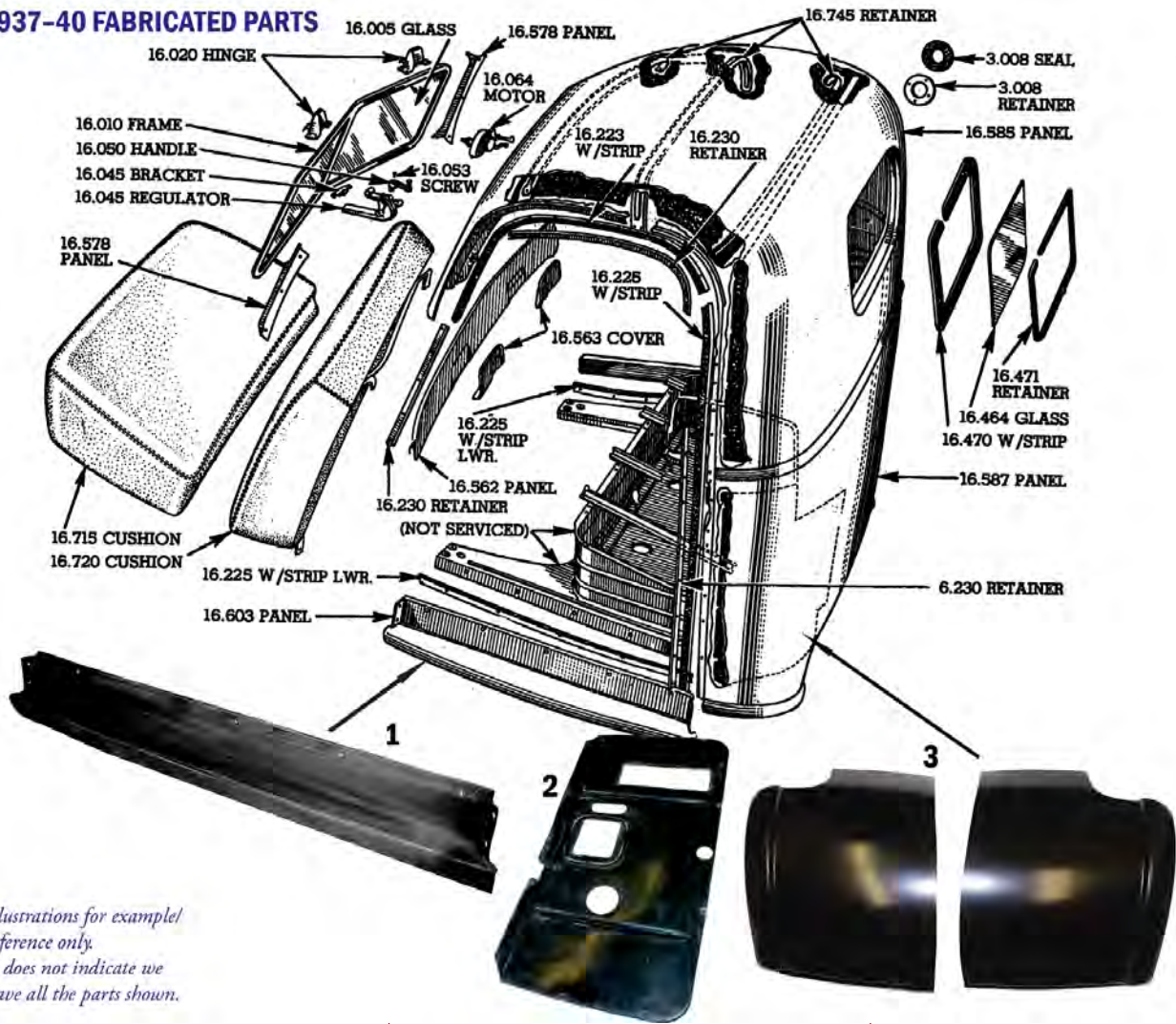

*Illustrations for example/
reference only.
It does not indicate we
have all the parts shown.*

1. Rocker Panel 1936-1940

477143	36-38
Left-fiberglass. 16.603 -0	
.....	\$70.00 EA ⚠
477144	36-38
Right-fiberglass. 16.603 -0	
.....	\$70.00 EA ⚠
598655	39-46
Stamped. Left-steel (as original)	
16.603 -0.25	
.....	\$125.00 EA ⚠
598655F	39-46
Left-fiberglass. 16.603 -0	
.....	\$70.00 EA ⚠
598656	39-46
Stamped. Right-steel (as original)	
16.603 -0.3	
.....	\$125.00 EA ⚠
598656F	39-46
Right-fiberglass. 16.603 -0	
.....	\$70.00 EA ⚠

2. Floorboard 1937-40

594987	36-38
Fabricated. Pickup Front Floor Pan	
3Spd -0.15	
.....	\$124.25 ⚠
594987SR	36-38
Fabricated. Pickup Front Floor Pan Rat	
Rod -0.15	
.....	\$124.25 ⚠
594993	36-38
Fabricated. Pickup Front Floor Pan	
4Spd -0.15	
.....	\$124.25 ⚠
594993	37-38
Door to door (fiberglass) 4-speed.	
16.545 -0.15	
.....	\$108.50 EA ⚠
3653207	39-40
Fabricated. Pickup Front Floor Pan 3Spd	
1/2 Ton -0.15	
.....	\$124.25 ⚠

2. Floorboard 1937-40, cont.

3653211S	39-40
Fabricated. Pickup Front Floor Pan 4Spd	
1/2 Ton -0.15	
.....	\$124.25 ⚠
3. Cab Corner Patch Panel Outer 1936-40	
598671B	36-46
Stamped. Outer right and left, rear.	
16.587 -0.15	
.....	\$69.50 L&R ⚠



WARNING: Cancer and Reproductive Harm — www.P65Warnings.ca.gov

Chemicals shipped domestic ground only (Lower 48 states only). No international shipping.

Phone: (360) 816-0211 • (800) 999-CHEV (2438) • www.chevsofthe40s.com

1941-46 PARTS

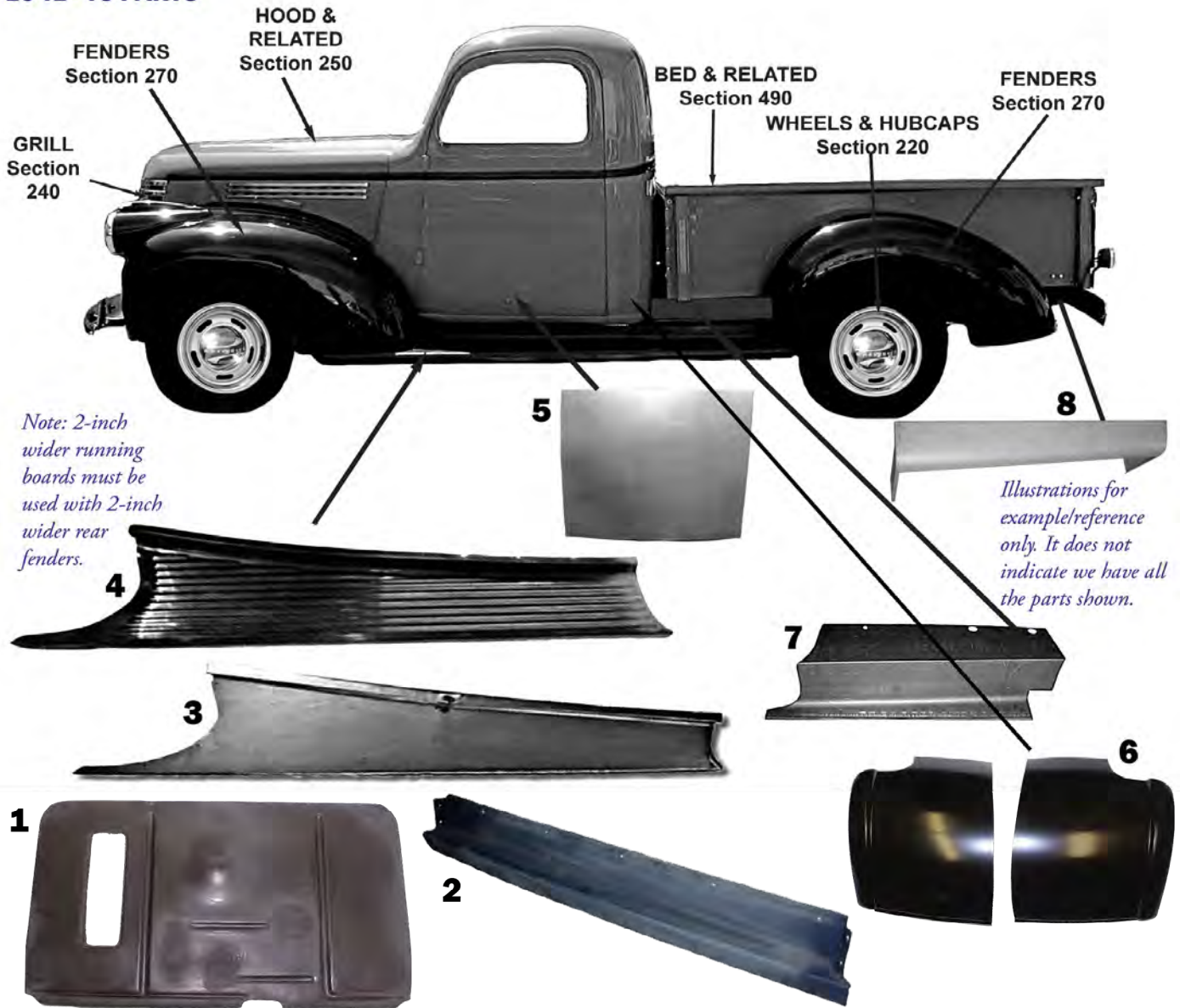

Toe Board 1941-46

3693869 **.41-46**
 Fabricated. Pickup Front Toe Board -0.15
 **\$91.25** ⚠

1. Floorboard 1941-46

187694B **.41-46**
 Bolt set for floor board (21 pcs).
 16.542 -0.15
 **\$8.75 SET** ⚠
3681279 **.41-46**
 Door to door (fiberglass), 3-speed.
 16.545 -0
 **CALL** ⚠
3681279S **.41-46**
 Fabricated. Pickup Front Floor Pan 3Spd
 1/2 Ton -0.15
 **\$119.75** ⚠

1. Floorboard 1941-46, cont.

3681279SR **.41-46**
 Fabricated. Pickup Front Floor Pan Rat
 Rod -0.15
 **\$120.00** ⚠
3681281 **.41-46**
 Fabricated. Pickup Front Floor Pan 4Spd
 3/4 Ton, 1 Ton, 1 1/2 Ton -0.15
 **\$119.75** ⚠
3681395 **.41-46**
 Fabricated. Pickup Front Floor Pan 4Spd
 1/2 Ton -0.15
 **\$119.75** ⚠

2. Rocker Panel 1941-46

598655 **39-46**
 Stamped. Left-steel (as original)
 16.603 -0.25
 **\$125.00 EA** ⚠
598655F **39-46**
 Left-fiberglass. 16.603 -0
 **\$70.00 EA** ⚠
598656 **39-46**
 Stamped. Right-steel (as original)
 16.603 -0.3
 **\$125.00 EA** ⚠
598656F **39-46**
 Right-fiberglass. 16.603 -0
 **\$70.00 EA** ⚠

Returns require a return authorization number—call first. • Product pricing & availability subject to change.

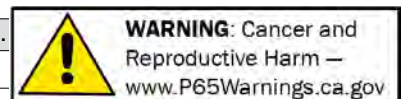

3. Running Boards w/ Built-in Mounting Pointes (Steel) 1941-46

3656702S **41-46**
 Fabricated. Smooth 16ga.cold rolled steel. 1/2Ton. 8.299 -0.15

..... **\$600.50 PR** ⚠

3656702SW **41-46**

Fabricated. Smooth 16ga.cold rolled steel. 1/2Ton (2 in. wider). 8.299 -0.15

..... **\$619.00 PR** ⚠

4. Running Boards w/ Built-in Mounting Points (Fiberglass) 1941-46

3656702F **41-46**
 Fiberglass-smooth 1/2Ton. 8.299 -0

..... **CALL** ⚠

3656915FS **41-46**

Fiberglass-smooth 3/4Ton long bed. 8.299 -0

..... **CALL** ⚠

3656915FW **41-46**

Fiberglass -2" wider-smooth 3/4Ton long bed. 8.299 -.15

..... **\$560.00 PR** ⚠

5. Door Patch Panel 1941-46

3666518 **39-46**
 Fabricated. Outer right. 16.150 -0.15

..... **\$110.25 EA** ⚠

3666518A **39-46**

Fabricated. Pickup Lower Door Skin, RH -0.15

..... **\$52.50** ⚠

603339 **39-46**

Fabricated. Outer left. 16.150 -0.15

..... **\$110.25 EA** ⚠

603339A **39-46**

Fabricated. Pickup Lower Door Skin, LH -0.15

..... **\$52.50** ⚠

6. Outer Cab Corner Patch Panel 1941-46

598671B **36-46**
 Stamped. Outer right and left, rear. 16.587 -0.15

..... **\$69.50 L&R** ⚠

7. Side Splash Aprons 1940-46

3654023L **40-46**

Fabricated. Left-1/2T. 8.228 -0.15

..... **\$35.00 EA** ⚠

3654024R **40-46**

Fabricated. Right-1/2T. 8.228 -0.15

..... **\$35.00 EA** ⚠

3654025L **40-46**

Fabricated. Left-3/4T. 8.228 -0.15

..... **\$55.00 EA** ⚠

3654026R **40-46**

Fabricated. Right-3/4T. 8.228 -0.15

..... **\$55.00 EA** ⚠

8. Rear Pan 1941-46

3658265P **41-46**

Steel pan. Rear with license plate recess. Replaces back bumper for smooth look. 7.831 -0.15

..... **\$167.00 EA** ⚠

3658265PS **41-46**

Steel roll pan. Rear without license plate recess. Replaces back bumper for smooth look. 7.831 -0.15

..... **\$128.25 EA** ⚠

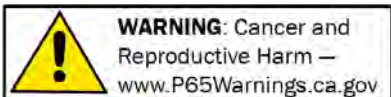

Chemicals shipped domestic ground only (Lower 48 states only). No international shipping.

Phone: (360) 816-0211 • (800) 999-CHEV (2438) • www.chevsofthe40s.com

1947-55 PARTS

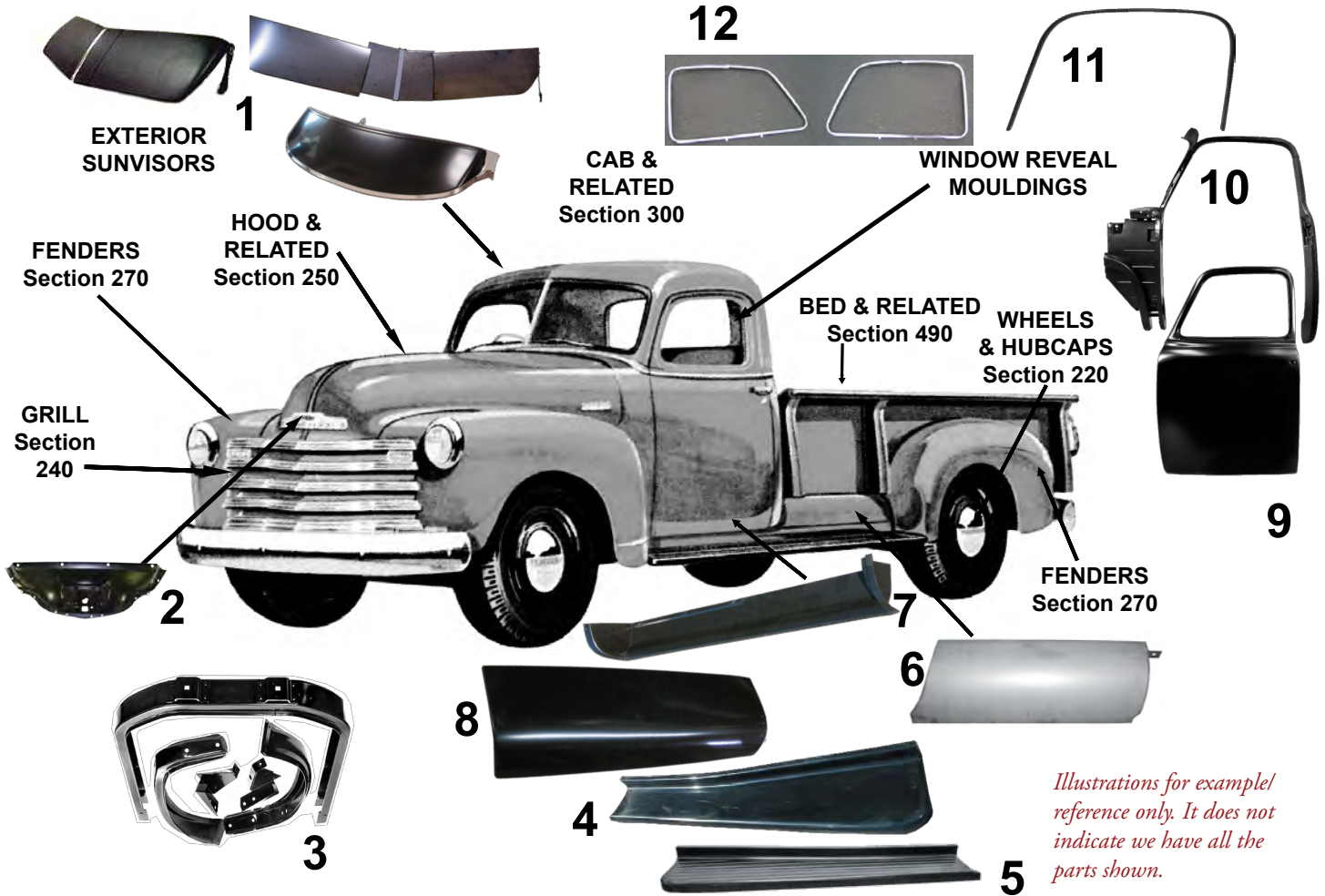

Illustrations for example/ reference only. It does not indicate we have all the parts shown.

1. Exterior Sunvisor

986877 **47-53**
Truck. Accessory. Exterior Sunvisor.
10.201-0.15

..... **\$325.00 EA** ⚠

986878S **54-55**
Steel reproduction with mounting hardware & instructions. Fits Chevy & GMC trucks. 10.201-0.15

..... **\$459.00 EA** ⚠

2. Hood Latch Lower Assembly

3682709C **47-53**
Hood latch assembly fits above grille. Chrome. Includes latch. Chevrolet Only, will not fit GMC. 8.080-0.15

..... **\$255.00 EA** ⚠

3682709P **47-53**
Hood latch assembly fits above grille, black. Includes latch. Chevrolet Only, will not fit GMC. 8.080-0.15

..... **\$150.00 EA** ⚠

2. Hood Latch Lower Assembly GMC

2228975 **47-53**
Hood latch assembly fits above Grille. Includes latch. Fits GMC. 6.079-0.15

..... **\$179.50 EA** ⚠

3. Radiator Core Support

3707011 **47-55**
For center fill radiator. 1.270-0.15

..... **\$344.50 EA** ⚠

4. Running Boards w/ Built-in Mounting Points (Fiberglass)

3682721S **47-54**
Fiberglass-smooth 1/2T. 8.299-0.15

..... **\$545.00 PR** ⚠

3682721W **47-54**
Fiberglass-smooth 1/2T (2in. wider). 8.299-0.15

..... **\$545.00 PR** ⚠

5. Running Boards w/ Built-in Mounting Points (Steel)

3687271 **47-54**
Steel (super repro) 1/2Ton. Ribbed. 8.299-0.15

..... **\$525.50 PR** ⚠

3687271S **47-54**
Fabricated. Smooth 16ga.cold rolled steel. 1/2Ton. 8.299-0.15

..... **\$600.50 PR** ⚠

3687271SC **47-54**
Chrome, ribbed steel. 1/2Ton. 8.299-0.15

..... **\$600.50 PR** ⚠

3687271SW **47-54**
Fabricated. Smooth 16ga.cold rolled steel. 1/2Ton (2 in. wider). 8.299-0.15

..... **\$619.00 PR** ⚠

6. Side Splash Apron

3676427L **47-53**
Stamped. Left-1/2Ton. 8.228-0.15

..... **\$32.00 EA** ⚠

3676428R **47-53**
Stamped. Right-1/2Ton. 8.228-0.15

..... **\$32.00 EA** ⚠

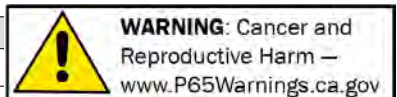

6. Side Splash Apron, cont.

- 3676429L**47-53
Stamped. Left -3/4Ton. 8.228 -0.15
..... **\$38.25 EA** ⚠
- 3676430R**47-53
Stamped. Right -3/4Ton. 8.228 -0.15
..... **\$38.25 EA** ⚠
- 3700361L** 54
Stamped. Left-1/2Ton. 8.228 -0.15
..... **\$38.00 EA** ⚠
- 3700362R** 54
Stamped. Right -1/2Ton. 8.228 -0.15
..... **\$38.00 EA** ⚠
- 3700365L** 54
Stamped. Left -3/4Ton. 8.228 -0.15
..... **\$42.00 EA** ⚠
- 3700366R** 54
Stamped. Right -3/4Ton. 8.228 -0.15
..... **\$42.00 EA** ⚠

7. Door Patch Panel (Inner)

- 3684147DL**47-54
Stamped. Inner bottom, left (superior).
16.150 -0.15
..... **\$44.75 EA** ⚠
- 3684147DR**47-54
Stamped. Inner bottom, right (superior).
16.150 -0.15
..... **\$44.75 EA** ⚠

8. Door Patch Panel (Outer)

- 3684147BL**47-54
Stamped. Outer bottom left (superior).
16.150 -0.15
..... **\$46.25 EA** ⚠
- 3684147BR**47-54
Stamped. Outer bottom right (superior).
16.150 -0.15
..... **\$46.25 EA** ⚠

9. Metal Door

- 3684147**47-50
Steel door. Left side minus trim &
hardware. EDP black finish. Exc COE.
16.150 -0.15
..... **\$499.00 EA** ⚠
- 3684148**47-50
Steel door. Right side minus trim &
hardware. EDP black finish. Exc COE.
16.150 -0.15
..... **\$499.00 EA** ⚠
- 3810915** 52-55
Steel door. Left side minus trim &
hardware. EDP black finish. Exc COE.
16.150 -0.15
..... **\$498.50 EA** ⚠
- 3810916** 52-55
Steel. Right side minus trim & hardware.
EDP black finish. Exc COE. 16.150 -0.15
..... **\$499.25 EA** ⚠

10. Door Pillar

- 3807227B**47-53
Outer, left side w/ side cowl panel &
windshield frame. 16.578 -0.15
..... **\$400.00 EA** ⚠
- 3807228B**47-53
Outer, right side w/ side cowl panel &
windshield frame. 16.578 -0.15
..... **\$400.00 EA** ⚠

11. Window Drip Rail

- 3684289**47-54
Left door. Window drip rail. 16.642 -0.15
..... **\$45.00 EA** ⚠
- 3684290**47-54
Right door. Window drip rail. 16.642 -0.15
..... **\$45.00 EA** ⚠

12. Window Reveal Mouldings

- 3684847**47-54
Left door, primered. 16.185 -0.15
..... **\$55.25 EA** ⚠
- 3684847B**47-54
Exterior chrome plated Stainless.
16.185 -0.15
..... **\$189.00 L&R** ⚠
- 3684848**47-54
Right door, primered. 16.185 -0.15
..... **\$55.25 EA** ⚠



WARNING: Cancer and
Reproductive Harm –
www.P65Warnings.ca.gov

Chemicals shipped domestic ground only (Lower 48 states only). No international shipping.

Phone: (360) 816-0211 • (800) 999-CHEV (2438) • www.chevsofthe40s.com

1947-54 PARTS

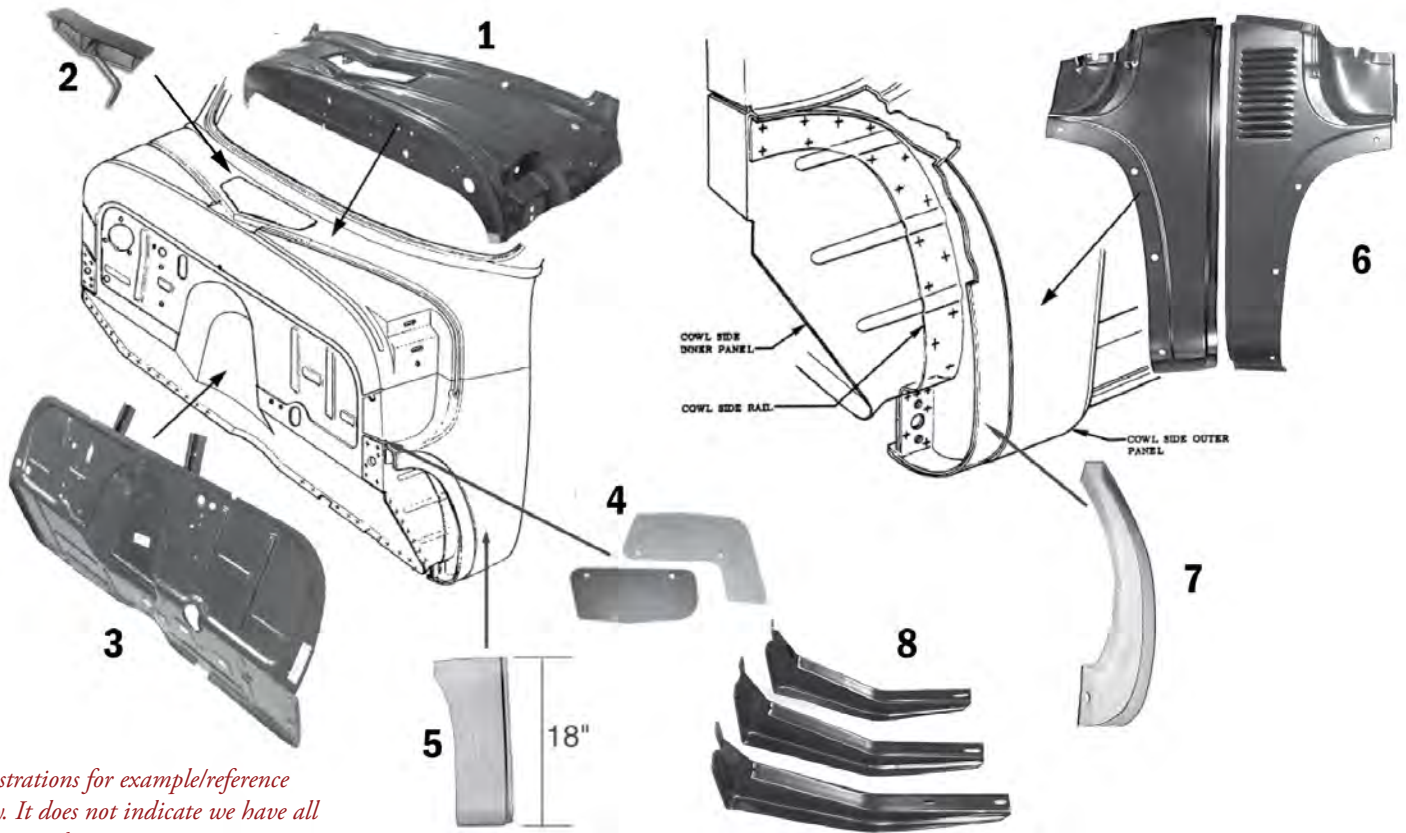

Illustrations for example/reference only. It does not indicate we have all the parts shown.

1. Upper Cowl Panel

3696433A47-53
Stamped. Nice quality panel. Full top of cowl. 16.551-0.15

..... **\$278.00 EA** ⚠

2. Cowl Vent

368291947-53
Assembly with handle. 16.125-0.15

..... **\$138.75 EA** ⚠

3. Firewall (Steel)

3696815A47-54
Complete repro steel firewall. Excellent quality. EDP coated. Without heater holes. 16.551-0.15

..... **\$285.50 EA** ⚠

4. Metal Filler Panel

368564247-54
Firewall to inner panel. 8.155-0.15

..... **\$12.50 PR** ⚠

5. Outer Cowl Patch Panel Fabricated

3683002B47-54
Fabricated. Lower-right. 16.551-0.15

..... **\$54.00 EA** ⚠

3683003B47-54
Fabricated. Lower-left. 16.551-0.15

..... **\$54.00 EA** ⚠

6. Outer Cowl Patch Panel Stamped

3683002SR47-54
Stamped. Right-superior (w/ louvers). 31" height. 16.551-0.15

..... **\$61.25 EA** ⚠

3683003SL47-54
Stamped. Left-superior (no louvers). 31" height. 16.551-0.15

..... **\$61.25 EA** ⚠

7. Cab Front Lower Corner

368403247-54
Fabricated. Arc-shaped firewall corners (behind tires) right. 16.551-0.15

..... **\$59.00 EA** ⚠

368729147-54
Fabricated. Arc-shaped firewall corners (behind tires) left. 16.551-0.15

..... **\$59.00 EA** ⚠

8. Running Board Brackets

3683573B47-55
Stamped. Left side. 7.016-0.15

..... **\$149.50 SET** ⚠

3683574B47-55
Stamped. Right side. 7.016-0.15

..... **\$149.50 SET** ⚠

1947-54 PARTS

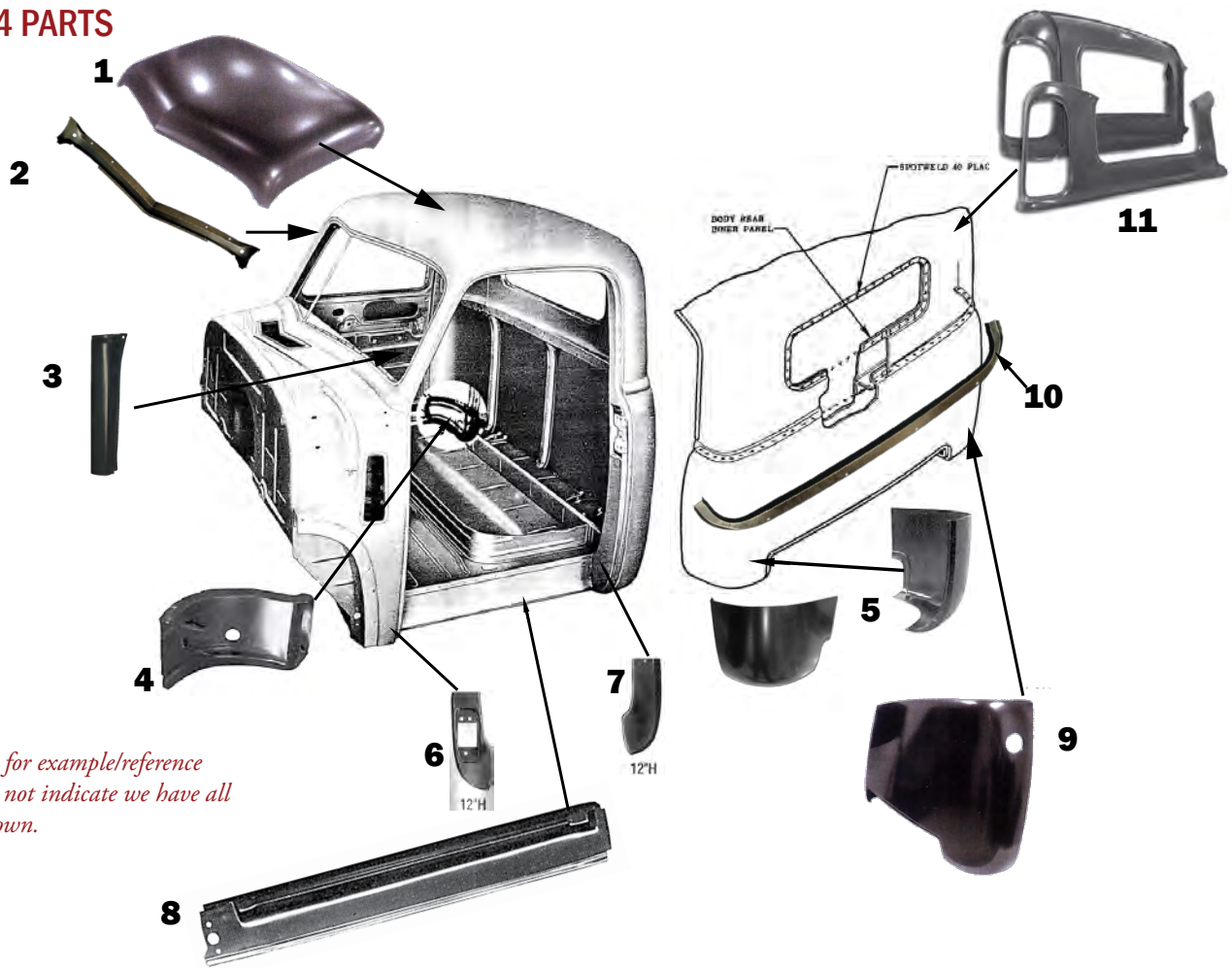

Illustrations for example/reference only. It does not indicate we have all the parts shown.

1. Cab Roof

3693099A47-53
Stamped metal replacement panel.
16.585 -0.15

\$335.00 EA ⚠

2. Windshield Upper Roof Panel Brace

380923147-53
Die stamped, Coated with weld-thru primer. 16.553 -0.15

\$65.00 EA ⚠

3. Windshield Pillar Panel

3807227L47-53
Stamped. Left side. 16.578 -0.15

\$29.75 EA ⚠

3807227R47-53
Stamped. Right side. 16.578 -0.15

\$29.75 EA ⚠

4. Inner Cab Corner Patch Panel

3693002B47-54
Stamped. Inner right. 16.587 -0.15

\$45.00 EA ⚠

3693003B47-54
Stamped. Inner left. 16.587 -0.15

\$45.00 EA ⚠

5. Outer Cab Corner Patch Panel

3693002A47-54
Stamped. Outer right. 16.587 -0.15

\$58.25 EA ⚠

3693003A47-54
Stamped. Outer left, rear. 16.587 -0.15

\$58.25 EA ⚠

6. Lower Door Hinge Post

370048147-54
Stamped. Left. 16.603 -0.15

\$49.25 EA ⚠

370048247-54
Stamped. Right. 16.603 -0.15

\$49.25 EA ⚠

7. Lower Door Latch Post

370355147-54
Stamped. Left. 16.163 -0.15

\$44.75 EA ⚠

370355247-54
Stamped. Right. 16.603 -0.15

\$44.75 EA ⚠

8. Outer Rocker Panel

3692809S47-54
Stamped. Left (superior). 16.603 -0.15

\$60.25 EA ⚠

8. Outer Rocker Panel, cont.

3692810S47-54
Stamped. Right (superior). 16.603 -0.15

\$60.25 EA ⚠

9. Lower Cab Back Panel

369300047-54
Stamped. Exterior panel below back window. 16.587 -0.15

\$399.00 EA ⚠

10. Lower Rear Cab Back Panel Crossmember

3693000R47-54
Stamped. Cab Lower Rear Back Panel Crossmember. Mounts at beltline. 16.587 -0.15

\$55.75 EA ⚠

11. Upper Cab Back Panel

369309947-54
Stamped. Upper exterior panel for 5 window cabs. 16.585 -0.15

\$356.25 EA ⚠

3809365B47-54
Stamped. Upper interior panel for 5 window cabs. 16.585 -0.15

\$338.00 EA ⚠



WARNING: Cancer and Reproductive Harm — www.P65Warnings.ca.gov

Chemicals shipped domestic ground only (Lower 48 states only). No international shipping.

Phone: (360) 816-0211 • (800) 999-CHEV (2438) • www.chevsofthe40s.com

1947-54 PARTS

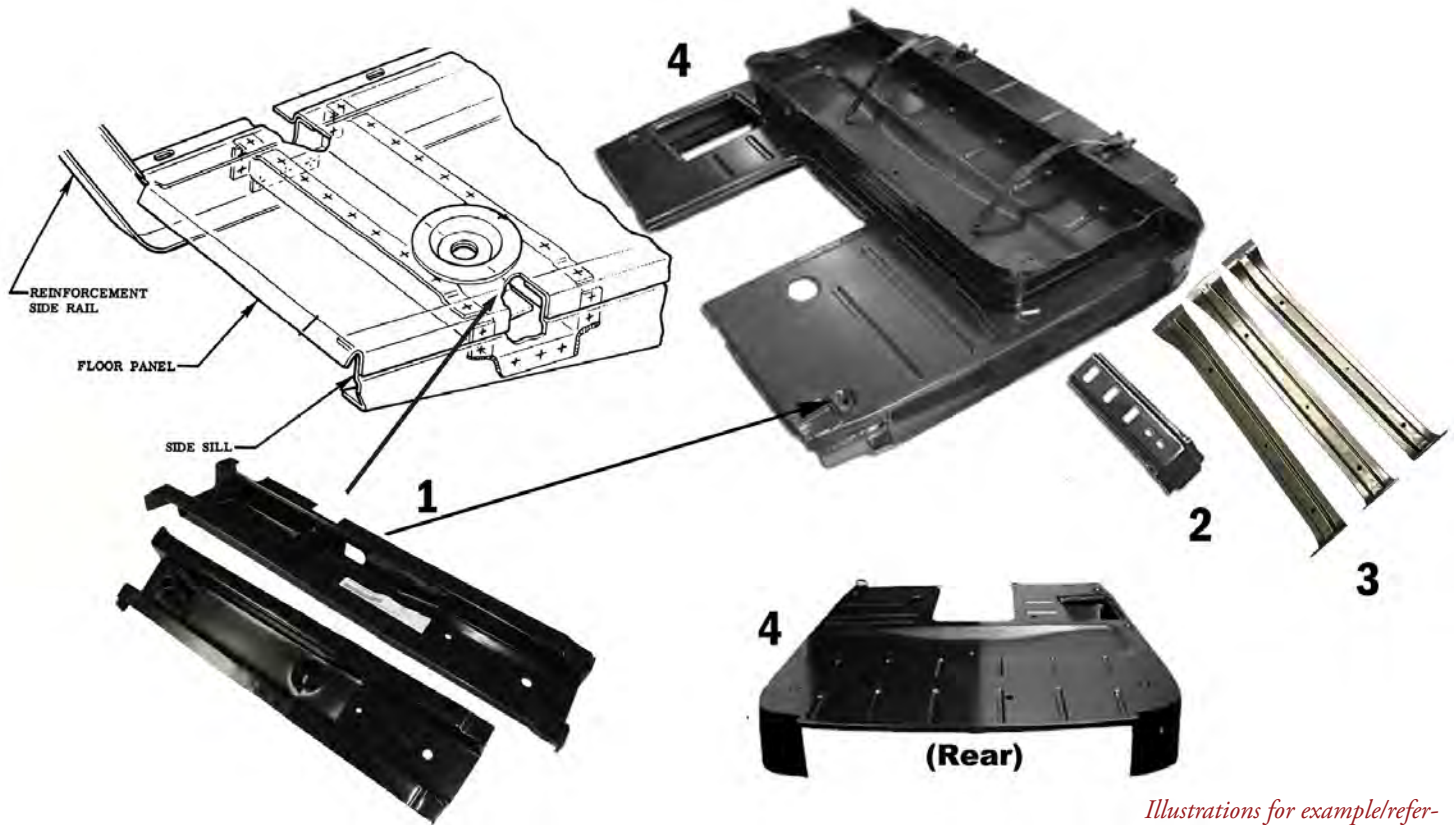

Illustrations for example/reference only. It does not indicate we have all the parts shown.

1. Front Cab Mount brace

3809493S47-54
Front left-die stamped (superior).
16.545 -0.15

..... **\$33.00 EA** ⚠

3809494S47-54
Front right-die stamped (superior).
16.545 -0.15

..... **\$33.00 EA** ⚠

2. Rear Cab Mount Brace

380949547-54
Stamped. Connects cross brace.
16.545 -0.15

..... **\$36.75 EA** ⚠

380949647-54
Stamped. Connects cross brace
16.545 -0.15

..... **\$36.75 EA** ⚠

3. Cab Back Panel Supports

3693000S47-54
Stamped. 3 pieces. 16.587 -0.15

..... **\$60.25 SET** ⚠

4. Floor Pan

3713907A47-54
Stamped. with braces. 16.000 -0.15

..... **\$550.75 EA** ⚠

3713907AC47-54
Complete Metal Floor Pan w/ tank straps,
seat riser and floor braces. Excellent
quality. 16.000 -0.15

..... **\$625.00 EA** ⚠

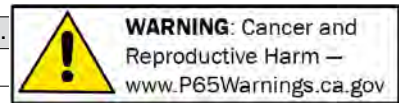

1947-54 PARTS

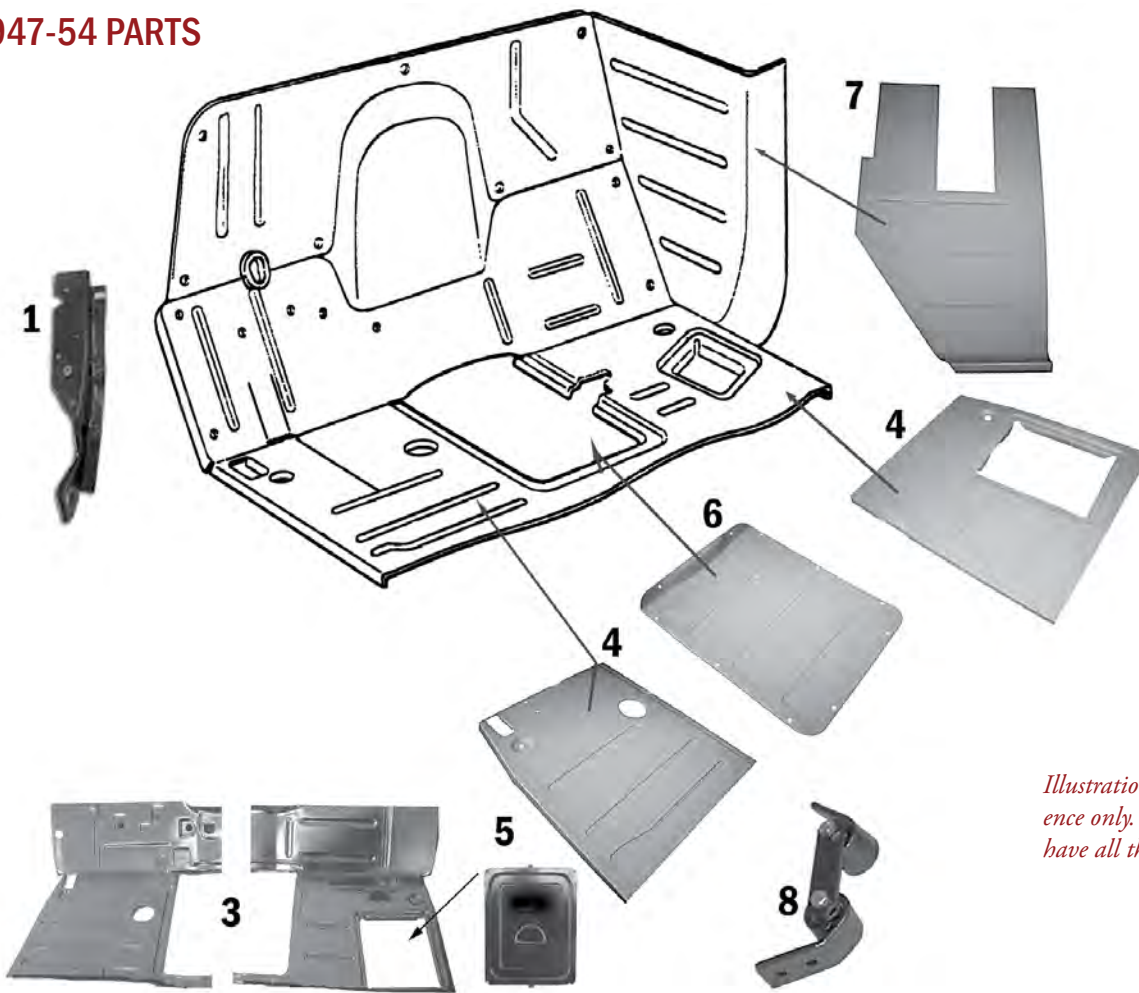

Illustrations for example/reference only. It does not indicate we have all the parts shown.

1. Emergency Brake Bracket

3687303 **48-55**
 For foot operated pedal. 4.648 -0.15
 **\$49.50 EA** ⚠

3. Floor Panel (From Seat Forward) W/ Toe Board

3701601LC **47-54**
 Stamped. Complete with toe board left.
 16.545 -0.2

..... **\$116.75 EA** ⚠

3701601RC **47-54**
 Stamped. Complete with toe board right.
 16.545 -0.2

..... **\$116.75 EA** ⚠

5. Battery Cover

3683383 **47-54**
 Mounts in floor. 16.547 -0.15

..... **\$64.00 EA** ⚠

6. Floor Insert Over Transmission

3682939 **47-55**
 Stamped. Metal 3 speed. 16.547 -0

..... **\$49.50 EA** ⚠

3697607 **47-55**
 4 speed. 16.547 -0.15

..... **\$75.00 EA** ⚠

3697607F **47-55**
 Stamped. Fiberglass 4 speed. 16.547 -0.15

..... **\$55.00 EA** ⚠

7. Kick Panel (Metal Repair Panel)

3693495 **47-50**
 Stamped. Inner left. 16.551 -0.15

..... **\$44.00 EA** ⚠

3809358 **47-54**
 Stamped. Kick Panel-Metal Repair Panel.
 Inner right. 16.551 -0.15

..... **\$35.50 EA** ⚠

3684403 **47-55**
 Heater delete cowl plate 16.551 -0.15

..... **\$20.25 EA** ⚠

3696023 **51-54**
 Stamped. Inner left. 16.551 -0.15

..... **\$39.00 EA** ⚠

8. Cab Mount Shackles & Brackets

53CABFRNTL **47-54**
 Cab mounting bracket, front left 7.330 -0.15

..... **\$60.75 EA** ⚠

53CABFRNTR **47-54**
 Cab mounting bracket, front right

7.330 -0.15

..... **\$60.75 EA** ⚠

53CABREAR **47-54**
 Shackle assembly, cab mount 9.009 -0.15

..... **\$245.00 L&R** ⚠



WARNING: Cancer and Reproductive Harm — www.P65Warnings.ca.gov

Chemicals shipped domestic ground only (Lower 48 states only). No international shipping.

Phone: (360) 816-0211 • (800) 999-CHEV (2438) • www.chevsofthe40s.com

FABRICATED SHEET METAL PARTS



Illustrations for example/reference only. It does not indicate we have all the parts shown.

1. Recessed Firewall (Steel)

3693009S54 **47-54**
Kit w/ set back. Smooth for V8. Use with front floor kit #3686335b54 or stock floor. 16.545 -0.15

..... **\$433.25 EA** ⚠

3693009SC **47-54**

Kit w/ set back. Smooth curved for V8. 16.545 -0.15

..... **\$450.50 EA** ⚠

Smooth Firewall Bead Rolled

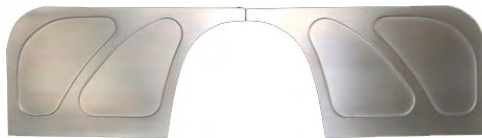

4754KA **47-54**

2 panels. Firewall Filler Panels are designed to be easily installed by the DIY or a professional. The Firewall Panels are laser cut from 18 gauge steel 1.000 -0

\$140.00 EA ⚠

Smooth Firewall Bead Rolled, cont.



4754TR **47-54**

2 panels. Firewall Filler Panels are designed to be easily installed by the DIY or a professional. The Firewall Panels are laser cut from 18 gauge steel 1.000 -0

\$140.00 EA ⚠

2. Radiator Core Support

3684764 **47-53**

For Chevy Trucks. Allows you to adjust your radiator up and down, side to side to get the fit you want. The radiator can be mounted up to 2-1/4" lower than stock which will allow the use of an engine mounted fan. 16.545 -0.15

..... **\$419.00 KIT** ⚠

3684764B **54-55**

For Chevy Trucks. Allows you to adjust your radiator up and down, side to side to get the fit you want. The radiator can be mounted up to 2-1/4" lower than stock which will allow the use of an engine mounted fan. 16.545 -0.15

..... **\$360.00 EA** ⚠

3. Cowl Vent Filler Panel

3683004A53 **47-53**

Weld in panel to delete vent. 16.545 -0.15

..... **\$24.00 EA** ⚠



4754CF **47-54**

Upper Cowl Filler finishes off your clean firewall look when paired with our Firewall Filler Panels. The piece is laser cut from 18 gauge steel and easily installed in the original recess. 1.000 -0

... **\$40.00 EA** ⚠

3683004B54 **54**

Weld in panel to delete vent. 16.545 -0.3

..... **\$18.00 EA** ⚠

4. Drivers Side Vent Filler Panel

3683001 **47-54**

Weld in panel to delete vent. 16.545 -0.15

..... **\$24.00 EA** ⚠

5. Inner Fender Apron Kit

3686239 **47-54**

Inner fender Apron Kit. Cleans look of engine bay. Bolt-in. Stock or Smooth firewalls/ core supports. Chevrolet Only 16.545 -0.15

..... **\$415.00 SET** ⚠

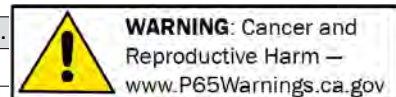

6. Floor Kit

3686335B54.....47-54

Front floor panels with toe board. For use with direct sheetmetal firewall

#3693009S54. 0.000 -0.15

\$314.75 SET ⚠

Toe Board Bead Rolled



4754TB.....47-54

These Toe Boards give the ultimate custom and clean look to finish off the engine bay. The Toe Boards are laser cut from 18 gauge steel and are to be used as a replacement part for the original toe boards. All holes for pedals, wiring etc. will need to be cut by the installer. -0

\$200.00 SET ⚠



1951 Panel – Pierre Moberg

295T

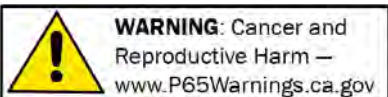

Chemicals shipped domestic ground only (Lower 48 states only). No international shipping.

Phone: (360) 816-0211 • (800) 999-CHEV (2438) • www.chevsofthe40s.com

**SECTION 300T
RESTORATION PARTS**

Cab Mount



3654239K39-46
Includes pads, blocks, springs & hardware.
9.015 -0.15 **\$79.75 SET** ⚠

Cab Mount Body To Frame



3701322B47-54
Pads & bolts. 9.015 -0.15 **\$32.00 SET**
⚠

Cab Mount Pads

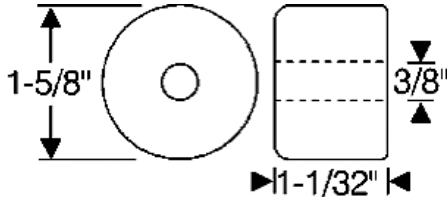

3654239B37-46
At #4 bolt. 9.015 -0.15 **\$49.50 PR** ⚠



365423939-46
w/ blocks & #4 bolt
pads (1-7/8" dia. x
1-5/8" thickness x 1/2"
bolt hole). 9.015 -0.15
..... **\$35.75 SET** ⚠



370132247-54
Front 9.023 -0.2
..... **\$4.99 SET** ⚠

Cab Mount Wood Blocks



476534B39-40
These are wood blocks cab mount.
9.015 -0.15 **\$8.00 PR** ⚠

Body Mount Pads

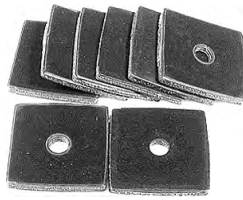

3685018A47-54
Panel or Suburban. 9.009 -0.15
\$15.00 SET ⚠

Cab Mount Rear



366054047-54
Rubber bushings (8 pcs). 7.524 -0.3
\$18.75 SET ⚠

Cab Mount Bolt Set

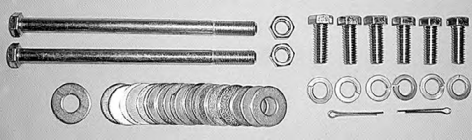

3654239A37-40
This is a set of cab mount bolts. 9.015 -0.3
..... **\$14.00 SET** ⚠

3654239A41-46
This is a set of cab mount bolts. 9.015 -0
..... **\$27.00 SET** ⚠



3701322C47-54
Front 9.008 -0.3
..... **\$4.50 SET** ⚠



3701322S47-54
Complete cab mount bolt kit. 9.008 -0.15
..... **\$48.50 SET** ⚠

Cab Mount Shims



366982ALL
1/16in. shims (1-3/4in. x 1-1/8in. with
1/2in. slot) (6 pcs). 9.023 -0.4
\$3.59 SET ⚠

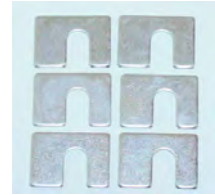

366983ALL
1/8in. shims (1-3/4in. x 1-1/8in. with
1/2in. slot) (6 pcs). 9.023 -0.3
\$3.49 SET ⚠



366984ALL
1/16in. shims (1-1/4in.
x 1-1/8in. with 3/8in.
slot) (6 pcs). 9.023 -0.4
..... **\$4.00 SET** ⚠



366985ALL
1/8in. shims (1-1/4in. x
1-1/8in. with 3/8in.
slot) (6 pcs). 9.023 -0.4
..... **\$4.00 SET** ⚠

Cab & Bed Bolt Kits

BODYBOLT B41-46
Cab & Short Bed. Indented Hex Head
Stainless Steel hardware kit. Complete
headlight to taillight (Exc. cab and bed
mount bolts.) 9.008 -0.15
..... **\$355.00 SET** ⚠



BODYBOLT B47-51
Cab & Short Bed. Indented Hex Head
Stainless Steel hardware kit. 9.008 -0.15
..... **\$438.00 SET** ⚠

BODYBOLT B52-53
Cab & Short Bed. Indented Hex Head
Stainless Steel hardware kit. 9.008 -0.15
..... **\$430.00 SET** ⚠

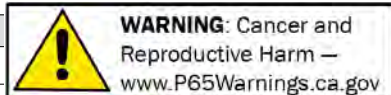

Cab & Bed Bolt Kits, cont.

BODYBOLTB **54-55**
 Cab & Short Bed. Indented Hex Head
 Stainless Steel hardware kit. 54-55 (1st
 Series). 9.008 -0.15
 **\$472.75 SET** ⚠

Cab Bolt Kits

BODYBOLT **41-46**
 Cab only. Indented Hex Head Stainless
 Steel hardware kit. 9.008 -0.15
 **\$234.25 SET** ⚠

BODYBOLT **47-51**
 Cab only. Indented Hex Head Stainless
 Steel hardware kit. 9.008 -0.15
 **\$250.00 SET** ⚠

BODYBOLTP **47-51**
 Panel. Indented Hex Head Stainless Steel
 hardware kit. 9.008 -0.15
 **\$424.75 SET** ⚠

BODYBOLT **52-53**
 Cab only. Indented Hex Head Stainless
 Steel hardware kit. 9.008 -0.15
 **\$214.00 SET** ⚠

BODYBOLTP **52-53**
 Panel. Indented Hex Head Stainless Steel
 hardware kit. 9.008 -0.15
 **\$426.00 SET** ⚠

BODYBOLT **54-55**
 Cab only. Indented Hex Head Stainless
 Steel hardware kit. 54-55 (1st Series).
 9.008 -0.15
 **\$215.00 SET** ⚠

BODYBOLTP **54-55**
 Panel. Indented Hex Head Stainless
 Steel hardware kit. 54-55 (1st Series).
 9.008 -0.15
 **\$423.00 SET** ⚠



COE — Rick Michael

300T

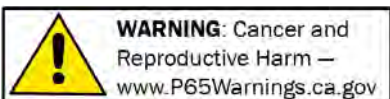

WARNING: Cancer and
 Reproductive Harm —
www.P65Warnings.ca.gov

Chemicals shipped domestic ground only (Lower 48 states only). No international shipping.

Phone: (360) 816-0211 • (800) 999-CHEV (2438) • www.chevsofthe40s.com

**SECTION 310T
STREET ROD PARTS**

**Polyurethane Firewall Pad w/
Insulation**



3693007**37-46**
Truck 16.802-0.15 **\$227.00 EA** ⚠



3693009**47-54**
Truck 16.802-0.15 **\$212.50 EA** ⚠

3702869**47-54**
Truck, No holes. 16.802-0.15
..... **\$205.50 EA** ⚠



3693009B**47-54**
Truck, fits Street Rod-style firewall
#3693009S54. 16.802-0.15
\$229.00 EA ⚠

Insulation



3693008A**ALL**
Jute w/ foil on 1 side (4
ft wide). 16.802-0.15
..... **\$9.49 FT** ⚠

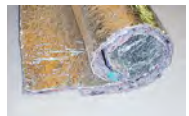

3693008B**ALL**
Jute w/ foil on 2 sides
(4 ft wide). 16.802-0.15
..... **\$12.69 FT** ⚠

**SECTION 310T
RESTORATION PARTS**

**Fiber Board Firewall Pad w/
Insulation**

Oversize shipping charges apply. Please call
for rates.



3687451.....**47-50**
Firewall Pad with insulation and fiber
board cover.
This item is oversized, extra shipping
charges will apply. 16.802-0 **CALL** ⚠

Metal Clips



3692752.....**47-54**
Firewall pad 1-5/16 in.
long (3 pcs). 15.282-0.15
..... **\$11.00 SET** ⚠



3692753.....**47-54**
Firewall pad 1-1/2 in.
long (3 pcs). 15.282-0
..... **\$10.50 SET** ⚠

Firewall Grommets



357507**29-46**
Steering column at floor
(exc COE). 6.758-0.15
..... **\$10.50 EA** ⚠



3681071.....**32-46**
Throttle, choke, oil,
temperature 3-7/8 in.
long, 4 holes. 9.775-0.15
..... **\$10.00 EA** ⚠



3681096.....**33-46**
Ignition armored coil
cable. 9.775-0
..... **\$8.00 EA** ⚠



3673139.....**36-54**
Vacuum hose. 9.775-0
..... **\$1.75 EA** ⚠



3653762A.....**39-53**
Main wiring harness.
9.775-0
..... **\$4.00 EA** ⚠

Firewall Grommets, cont.



874420A.....**39-53**
Speedometer cable
with 3 holes- use with
windshield washer.
9.775-0.15
..... **\$6.39 EA** ⚠



875520.....**39-53**
Speedometer cable.
9.775-0.4
..... **\$2.75 EA** ⚠



3684771.....**47-49**
4 holes. 9.775-0.3
..... **\$5.00 EA** ⚠



3685928.....**47-54**
Steering column with
metal core & sponge
seal #3682871 at
firewall (floor shift).
Chevy & GMC 6.758-0.15
..... **\$13.00 EA** ⚠



3685928A.....**47-54**
Steering column without
metal core at firewall
(floor shift). Chevy &
GMC 6.758-0.15
..... **\$45.00 EA** ⚠



3691292A.....**47-54**
Grommet for 5/8 in.
heater hose (thru
firewall). 8.846-0
..... **\$6.25 PR** ⚠



3687205.....**48-54**
Steering column
grommet with metal
core & sponge seal
#3687204 at firewall
(column shift). 6.758-0.15
..... **\$13.50 EA** ⚠



4805844.....**49-52**
Rubber plug for 3/4 in.
holes. 9.775-0
..... **\$2.25 EA** ⚠



3689044.....**50-52**
4 holes. 9.775-0.15
..... **\$17.50 EA** ⚠



3711896.....**51-53**
Wiring harness
11/16in. diameter.
9.775-0
..... **\$4.49 EA** ⚠

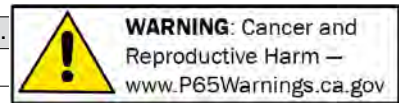

Firewall Grommets, cont.



3695170.....53-59
4 holes. 9.775 -0.15
..... **\$3.00 EA** ⚠



3653762B54-59
Main wiring harness.
9.775 -0.15
..... **\$5.00 EA** ⚠

Sponge Seal



3682871.....47-54
Steering column at
firewall (floor shift).
6.758 -0.2
..... **\$4.00 EA** ⚠



3687204.....47-54
Sponge seal. Steering
column at firewall
(column shift). 6.758 -0.3
..... **\$5.75 EA** ⚠

Screws



3687205A.....47-54
Stainless steel for
steering column
grommet. 6.758 -0.2
..... **\$1.99 EA** ⚠

Felt Floor Seal



3657153.....41-46
Floor seal, floor felt for
steering column, brake
& clutch. 0.829 -0.15
..... **\$7.75 EA** ⚠



WARNING: Cancer and
Reproductive Harm –
www.P65Warnings.ca.gov

Chemicals shipped domestic ground only (Lower 48 states only). No international shipping.

Phone: (360) 816-0211 • (800) 999-CHEV (2438) • www.chevsofthe40s.com

**SECTION 320T
STREET ROD PARTS**

Sound Deadener/ Insulation Kit

ACOUSTI-SHIELD KIT INCLUDES: FULLY ILLUSTRATED INSTRUCTIONS FOR A PAINLESS, TWO-HOUR INSTALLATION. STAGE 1: PRE-SIZED SOUND DAMPER PADS. The first stage consists of pre-trimmed, self adhesive, Sound Damper Pads. Bonded to strategically located trouble spots on the floor pan and roof of the vehicle to control body panel vibration and noise. These spots are mapped and labeled in detailed instructions which are included in the kit. STAGE 2: PRE-TRIMMED HEAT ABSORBER/BARRIER PANELS, SPRAY ADHESIVES AND SEALING TAPE. The second stage uses a high-tech absorbing, barrier material bonded to the body panels. Will deaden sound and insulate the vehicle from radiant heat penetration. Each absorber panel is cut to the correct shape and contour and is mapped and labeled in the detailed instructions.



- 12927** **37-46**
Fits 1937-46 Truck. 15.492 -0.15
\$511.00 KIT ⚠
- 12928** **47-53**
Fits 1947-53 Truck. 15.492 -0.15
\$565.00 KIT ⚠
- 15894** **47-53**
Fits 1947-54 SUBURBAN. 15.492 -0.15
\$907.00 KIT ⚠
- 15893** **47-54**
Fits 1947-54 Panel Truck. 15.492 -0.15
\$1,045.00 KIT ⚠
- 15889** **54-55**
Fits 1954-55 (1st Series) trucks.
15.492 -0.15
\$564.00 KIT ⚠

Body Deadener



121126C **ALL**
Hi-tech, 1/2 pound per square foot (3/16 in. x 3 ft x 8 ft). 15.492 -0.15
\$37.75 EA ⚠

Insulation



3693008C **ALL**
Foil tape for jute insulation (30 foot x 2 in. roll). 16.802 -0.15
\$12.00 EA ⚠

Jute Insulation Pad



3693008 **ALL**
Floor mat (3 ft x 6 ft). 16.802 -0.15
\$29.75 EA ⚠

Web Adhesive Spray



SB-WEBAD **ALL**
12 oz. can. Ideal for acoustic panel installation. An aggressive aerosol adhesive designed to be used with all lightweight cotton, fiberglass and Poly Acoustic absorption

panels. Unlike other types of aerosol adhesive, SB-WEBAD does not atomize as it is applied. This means more material ends up on the surface to be treated and none left floating in the air. -0.15
\$19.00 EA ⚠

Carpet With Pad

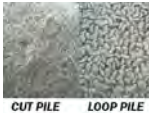

3716701C **37-46**
Covers firewall to seat riser and side of seat riser. Specify Loop or Cut pile, Color and year of vehicle when ordering. 16.800 -0.15
\$342.75 EA ⚠

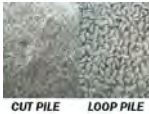

3698177C **47-53**
Covers firewall to seat riser and side of seat riser. Specify Loop or Cut pile and Color when ordering. 16.800 -0.15
\$326.00 EA ⚠



3716701C **54-55**
Covers firewall to back of cab. Specify Loop or Cut pile and color when ordering. 16.800 -0.15
\$326.00 EA ⚠

**SECTION 320T
RESTORATION PARTS**

Felt Body Deadener



121126A **ALL**
Original waffle pattern, used on door skins, roofs, etc (3/32in. x 3 ft x 8 ft). 15.492 -0
\$109.75 EA ⚠



121126B **ALL**
Original waffle pattern, used on door skins, roofs, etc (1/8in. x 3 ft x 8 ft). 15.492 -0
CALL ⚠

Jute Insulation Pad



3698181 **47-54**
Floor mat (die cut). 16.800 -0.15
\$27.00 EA ⚠

Floor (Front) Mat



3716701 **37-46**
Fits 37-40 w/ modification 16.800 -0.15
\$120.00 EA ⚠



3698177A **47-54**
Reproduction 16.800 -0.15 .. **\$100.00 EA** ⚠

Metal Plug



594289B **ALL**
Fits 1-1/2in. hole in floor over body mount bolts (2 pcs) 9.008 -0.3 ... **\$7.89 PR** ⚠
594289C **ALL**
Fits 3/4in. holes in floor (2 pcs) 9.008 -0.2
\$1.50 SET ⚠

Metal Plug, cont.

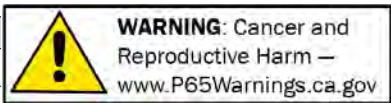

Section 320T: Floorboard Parts, Seals, Sound Deadeners, Mats & Pedals

594289D **ALL**
Fits 1/2in. holes in floor (2 pcs) 9.008-0.3

..... **\$1.69 PR** ⚠



594289E **ALL**
Fits 1-1/4in. hole (2 pcs) 9.008-0.3

..... **\$7.29 PR** ⚠



594289F **ALL**
Fits 1" hole (2 pcs) 9.008-0.4

..... **\$7.25 PR** ⚠

Battery Cover



354120 **29-38**
Inspection cover in floor. 4-1/2" x 8"
16.547-0.15

..... **\$19.75 EA** ⚠

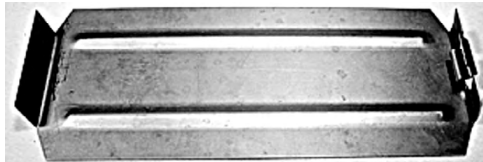

3652966 **39-46**
Inspection cover in floor. 4-1/2" x 10".
16.547-0.15

..... **\$25.00 EA** ⚠

Floor Gasket

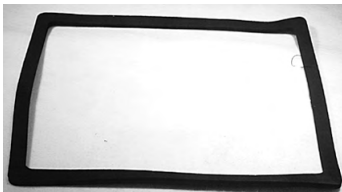

3683383A **47-54**
Battery inspection cover. 16.547-0.15

..... **\$6.00 EA** ⚠



3697605 **47-54**
For transmission cover in floorboard.
16.547-0.15

..... **\$5.00 SET** ⚠

Screw, Bolts For Floorboard



3693869B **39-46**
Floor and Toeboard. 21 pieces. 16.544-0.15

..... **\$9.75 SET** ⚠



187694B **41-46**
Bolt set for floor board (21 pcs). 16.542-0.15

..... **\$8.75 SET** ⚠

Screws



3652879 **47-54**
For transmission cover in floorboard.
12.559-0.15

..... **\$4.00 SET** ⚠

Bushing



378431 **37**
Gas pedal rod (in floor).
7/16 in. I.D. hole for rod.
2 in. O.D. mounting

pad. 3.469-0.15

..... **\$25.00 EA** ⚠

Gas Pedal



3653533 **37-40**
2-1/4 in. x 7-3/4 in.
3.451-0.15

..... **\$33.50 EA** ⚠



3681341A **42-46**
2-5/8 in. x 7-3/4 in. w/
pad. 3.451-0.15

..... **\$29.75 EA** ⚠



3682873 **46-52**
2-7/8 in. x 8-1/16 in.
3.451-0.15

..... **\$14.00 EA** ⚠



3701621 **53-57**
2-7/8 in. x 8-1/16 in.
3.451-0.15

..... **\$16.00 EA** ⚠

Floorshift Seal



3653420 **37-47**
Floor to transmission 3-speed.
Top: 2-3/4 in. O.D.
Bottom: 2 in. O.D.

Inside Diameter: 1-1/4 in. 4.015-0.15

..... **\$40.25 EA** ⚠



3687200 **37-54**
Floor to transmission 4-speed. 4.015-0.15

..... **\$5.50 EA** ⚠

Floor Shift Boot



3651348A **ALL**
Replacement-3 speed (uses #3654365T trim ring). 4.015-0.3

..... **\$9.75 EA** ⚠

Trim Ring



3654365T **ALL**
Stainless retains boot #3651348A. 4.044-0.15

..... **\$14.00 EA** ⚠

Hand Brake Seal

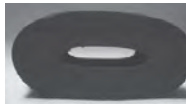

3653418 **40-54**
Sponge (under floor).
4.612-0.2

..... **\$6.00 EA** ⚠

Seal & Bumper



3694124A **48-54**
Emergency pedal brake shaft. 4.612-0.2

..... **\$5.00 SET** ⚠

Emergency Pedal Boot



3694124 **48-54**
Under floor. 4.612-0.15

..... **\$8.50 EA** ⚠



3694125 **48-54**
Metal retainer. 4.615-0.15

..... **\$7.00 EA** ⚠



594988A **ALL**
Floor hand brake (not original) uses trim plate #595026 4.612-0.3

..... **\$8.50 EA** ⚠

Trim Plate



595026 **ALL**
Stainless-retains boot #594988A 4.613-0.15

..... **\$10.25 EA** ⚠

Floor Plug Master Cylinder



592865 **36-54**
Master cylinder inspection (in floor).
3-3/8 in. diameter for 3 in. hole. 12.541-0.15

..... **\$7.50 EA** ⚠



WARNING: Cancer and Reproductive Harm —
www.P65Warnings.ca.gov

Chemicals shipped domestic ground only (Lower 48 states only). No international shipping.

Phone: (360) 816-0211 • (800) 999-CHEV (2438) • www.chevsofthe40s.com

Starter Pedal



39757729-54
Foot starter rubber cap/
button (black). 1/2"
height, 2-1/16" dia.
2.004 -0.15

\$16.00 EA ⚠



365415237-54
Return spring. 2.029 -0

\$3.99 EA ⚠



365413438-54
Foot starter rubber
button. 2" dia., 1-1/4"
total height. 2.004 -0.3

\$9.50 EA ⚠



371671138-54
Rubber bellows.
2.014 -0.15

\$6.25 EA ⚠

Pedal Pad



36402229-46
Brake & clutch with
bowtie. 4.630 -0

\$40.00 PR ⚠



368349047-59
Brake, clutch &
emergency. 4.630 -0.3

\$8.00 EA ⚠

Bumper



368106537-46
Clutch pedal (under
floor). 9.108 -0.15

\$20.00 EA ⚠



365338847-54
Brake & clutch arms to
floor (2 pcs). 9.108 -0.4

\$8.75 SET ⚠

Brake Pedal Return Spring



36824432-46
Clutch Pedal Return
Spring. Overall Length

3-1/4". 4.827 -0.3

\$6.50 EA ⚠



369866547-57
Overall length 5-3/4in.

4.827 -0.3

\$10.00 EA ⚠

Bushings



368207437-46
Clutch & brake pedal
shaft (13/16 in. O.D. x
3/4 in. I.D. x 1-25/64

in. long) 4.626 -0.15

\$27.00 PR ⚠



368301647-54
Clutch & Brake Pedal
Shaft (1-1/16 in. O.D.
X 1 in. I.D. X 1-1/4 in.
Long) 0.831 -0.15

\$18.00 PR ⚠

Seal



365715341-46
Floor seal, floor felt for
steering column, brake
& clutch. 0.829 -0.15

\$7.75 EA ⚠



59433747-51
Floor felt brake & clutch
pedal (2 pcs). 0.829 -0.15

\$6.00 SET ⚠



3658395B47-54
(felt) gas pedal rod in
floor. 3.469 -0.15

\$4.75 SET ⚠



594337A52-54
Floor felt brake & clutch
pedal (2 pcs). 0.829 -0.15

\$5.00 SET ⚠

Odds & Ends

Please call for availability on all Odds & Ends parts; once part is sold, it may no longer be in stock.

3672713U42
Gas pedal. Fits all COMM & UTIL. 2-5/8in.
X7-7/8in. (Used) 3.451 -0.4

\$20.00 EA ⚠

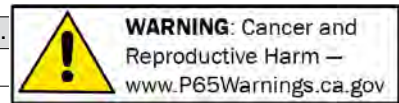

Section 330T: Interior, Sunvisors, Dome Lights, Headliners, Interior Screws, Door Panels, Kick Panels, Seats, Seat Covers & Belts

SECTION 330T STREET ROD PARTS

Seat Belts

 **1001**ALL
Lap belts available in black, burgundy, Grey or tan (specify color when ordering). Comes with standard pushbutton release. 52" 14.875 -0.15

..... **\$21.00 EA** ⚠

 **2002**ALL
2-point retractable lap only belts available in black, burgundy, Grey or tan (specify color when ordering). Comes with standard pushbutton release. 14.875 -0.15

..... **\$60.00 EA** ⚠



SBELTAALL
Aircraft style, chrome buckle lap belt. Choose color: Black, Dark Blue, Brown, Grey, Maroon, Red Wine, Red or Tan (hardware kit sold separately). 74" 14.875 -0

..... **\$22.00 EA** ⚠

Seat Belts, cont.



SBELTGMALL
GM push button, chrome/silver buckle lap belt. Choose color: Black, Blue, Grey, or Red (hardware kit sold separately). 74" 14.875 -0

..... starting at **\$29.00 EA** ⚠

Seat Belt Anchor Kit



13245ALL
Hardware anchor kit for one complete seat belt. Includes 2 of each: bolts, washers, lock washers and nuts. 14.875 -0.2

..... **\$4.00 SET** ⚠



SBHPALL
Deluxe reinforcing anchor plates. Reduces chance of floor damage on high belt loads. Kit for 1 belt. 14.875 -0.15

..... **\$20.00 SET** ⚠

Seat Belt Anchor Kit



SBHPAALL
Angled anchor mounts for flat floor applications. Use with part #SBHP to complete your seat belt installation. Kit for 1 belt. 14.875 -0.15

..... **\$15.50 SET** ⚠

Headliner Conversion

3808406C**37-54**
Napped Cotton Headliner conversion kit for Panel trucks and Suburbans. Any remnants of original headliner must be discarded. Conversion headliner is bow suspended much like vintage passenger cars. Hardware is included with kit. Bows are fitted to roof by installer (drilling over doors is required). Professional Installation is recommended. Specify color: taupe, dark taupe, maroon, beige, grey, ivory, light green, dark green, aqua, red, medium blue or black. 16.742 -0

..... starting at **\$299.00 EA** ⚠

1947-'55 Pretrimmed Panels

The panels and pieces below are model specific, designed for your truck. Finish them off by covering them with stretchable tweed, vinyl, ultraleather, ultrasuede or leather available from RodDoors. Find more details on materials on the following pages. ⚠

The Eureka



Design: Ron Mangus
Door Panels with built-in armrest \$259 pr
RD-3080
Kickpanels \$109 pr
RD-3083
Headliners \$249 ea
RD-3085 47-48 split window
RD-3086 49-53 split window (smooth)
RD-3087 54-55 round window (smooth)
Rear Cab Covers
RD-3090 47-48 no tank \$275 ea
RD-3091 49-55 no tank, Quinn design .. \$275 ea

The Quinn

Design: Rich Santana



Door Panels with optional arm rest
RD-3242 w/o armrest \$249 pr
RD-3241 w/ armrest \$275 pr
Door Panels with optional deco shape
RD-3240 with armrest \$299 pr
Headliners \$299 ea
RD-3088/RD-3089 47-48, 49-53
Gas Tank Cover \$275 ea
RD-3092 Fits over stock gas tank. Built-in package tray and room to mount speakers.



WARNING: Cancer and Reproductive Harm — www.P65Warnings.ca.gov

Chemicals shipped domestic ground only (Lower 48 states only). No international shipping.

Phone: (360) 816-0211 • (800) 999-CHEV (2438) • www.chevsofthe40s.com

Section 330T: Interior, Sunvisors, Dome Lights, Headliners, Interior Screws, Door Panels, Kick Panels, Seats, Seat Covers & Belts

Headliner Molded ABS Plastic

These are ABS Plastic with a medium embossed leather grain texture. This material is easily formed with heat and duplicates the original look and texture exactly. ABS plastic is very tough, yet flexible, and does not show scratches or scuffs. It can be easily dyed with a flat vinyl plastic spray paint. All of our patterns are based on out-of-vehicle originals. With few exceptions, truck headliners were black or brown when they came from the factory during the early years. ABS plastic can be easily dyed with a flat, vinyl plastic spray paint. The panels also can be covered with cloth or acoustic material.



593125P37-38
Fits Chevy trucks (exc. Suburban).
16.742 -0.15 **\$246.50 EA** ⚠



3654634P39-46
Fits Chevy trucks (exc. Panel & Suburban).
16.742 -0.15

..... **\$246.50 EA** ⚠

3676356P47-53
Fits Chevy trucks (exc. Suburban).
16.742 -0.15

..... **\$246.00 EA** ⚠

3676357P47-53
Fits Chevy trucks (exc. Suburban).
16.742 -0.15

..... **\$189.00 EA** ⚠



3700527P 54
Fits Chevy trucks (exc. Suburban). 16.742 -0.15

..... **\$189.00 EA** ⚠

Sound & Vibration Damping

Note: Oversize shipping charges apply. Please call for rates.



V-MAXAPPALL
Application tool. Great tool to use when installing or forming damping material.

8.800 -0.15

..... **\$7.50 EA** ⚠

Sound & Vibration Damping, cont.



VB-2ALL
Individual sheet.
Thickness= .042".
8.800 -0.15

..... **\$61.00 EA** ⚠



VB-2HDALL
HEAVY DUTY individual sheets. Thickness= .075" 8.800 -0.15

..... **\$95.25 EA** ⚠

Header Panel



59336936-38
Mounts above windshield (fiberglass).
16.562 -0.15 **\$149.00 EA** ⚠



59877239-46
Mounts above windshield (fiberglass).
16.563 -0.15 **\$149.00 EA** ⚠

SECTION 330T RESTORATION PARTS

Exterior Sunvisor



98687747-53
Truck. Accessory. Exterior Sunvisor.
10.201 -0.15 **\$325.00 EA** ⚠



986877FS47-53
Truck exterior visor. Metal, Fulton reproduction with mounting hardware & instructions. Adjustable. 10.201 -0 **\$495.00 EA** ⚠

Exterior Sunvisor, cont.



986878S54-55
Steel reproduction with mounting hardware & instructions. Fits Chevy & GMC trucks. 10.201 -0.15 **\$459.00 EA** ⚠

Sunvisor



368563747-53
Left side interior visor with bracket, screws & template.

Choose color: Black, Brown or Grey.
16.070 -0 starting at **\$45.00 EA** ⚠

98615547-53
Right side interior visor with bracket, screws & template.

Choose color: Black, Brown or Grey.
16.070 -0 starting at **\$45.00 EA** ⚠



3685637B47-59
Interior visor. Brown. 16.070 -0.15 **\$31.00 EA** ⚠

3685637C47-59
Interior visor. Black. 16.070 -0.15 **\$31.00 EA** ⚠

3685637D47-59
Interior visor. Grey. 16.070 -0.15 **\$31.00 EA** ⚠



3703645 54
Interior visor with bracket, screws & template. Left side, black, brown & Grey (specify color). 16.070 -0 starting at **\$45.00 EA** ⚠

Returns require a return authorization number—call first. • Product pricing & availability subject to change.

182 Phone: (360) 816-0211 • (800) 999-CHEV (2438) • www.chevsofthe40s.com

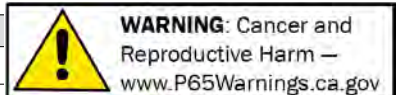

Section 330T: Interior, Sunvisors, Dome Lights, Headliners, Interior Screws, Door Panels, Kick Panels, Seats, Seat Covers & Belts

Sunvisor, cont.

986773 **54**
Interior visor with bracket, screws & template. Right side, black, brown & Grey (specify color). 16.070-0
..... starting at **\$45.00 EA** ⚠

Sunvisor Components



985628A **39-46**
Interior visor Support (Right or Left Side)
16.070-0.15 **\$29.75 EA** ⚠



3685637L **47-53**
Interior visor support bracket. Left side with screws & template. 16.070-0.15
..... **\$25.75 EA** ⚠

986155R **47-53**
Interior visor support bracket. Right side with screws & template. 16.070-0.15
..... **\$25.75 EA** ⚠

3685637EB **47-59**
Board only for interior visor. Fits Chevy & GMC. Fits left or right. 16.070-0.15
..... **\$18.00 EA** ⚠

3703645L **54**
Interior visor support. Left side with screws & template. 16.070-0.15
..... **\$24.75 EA** ⚠

986773R **54**
Interior visor support. Right with screws & template. 16.070-0.15
..... **\$24.75 EA** ⚠

Rear Sun Shade



985715T **47-54**
Rear window sun shade blinds. 11.204-0.15
..... **\$119.25 SET** ⚠

Headliner Die Cut Cardboard



593125 **37-38**
1-piece. Choose Black, Brown or Grey.
16.742-0.15 starting at **\$45.00 EA** ⚠



3801123 **39-41**
1-piece. Choose Black, Brown or Grey.
16.742-0.4 starting at **\$44.00 EA** ⚠



3654634 **42-46**
2-piece. Choose Black, Brown or Grey.
16.742-0.15 starting at **\$35.00 SET** ⚠

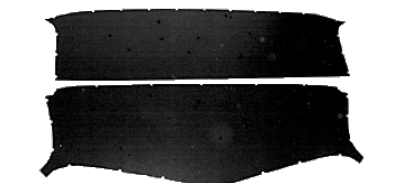

3694283 **47-49**
Black, Brown or Grey (specify color when ordering). 16.742-0.15
..... starting at **\$35.00 SET** ⚠



3676357 **50-53**
2-piece. Choose Black, Brown or Grey.
16.742-0 **\$35.00 SET** ⚠

3700527 **54**
2-piece. Choose Black, Brown or Grey.
16.742-0.3 **\$45.00 SET** ⚠

Headliner Bow



3807558 **50-54**
Center (52in. long). Paintable bare steel.
16.745-0.15 **\$37.75 EA** ⚠

Headliner Washers



3654636 **34-41**
Rubber. Perfect repro.
16.747-0.15

..... **\$5.50 SET** ⚠

J-Nut Retainer



0184001 **37-46**
Front of headliner (5 pcs). 16.742-0.4

..... **\$3.75 SET** ⚠

Screw Set



477366 **41-46**
Headliner 8 x 32 x 1/2in. clutch head (22 pcs). 16.742-0.3

..... **\$11.25 SET** ⚠



3684161A **47-53**
Door panel, cardboard, does both doors (12 pcs). 16.290-0.4

..... **\$3.00 SET** ⚠



3654597B **47-54**
Headliner. 16.290-0.4

..... **\$5.00 SET** ⚠



3684481A **47-54**
Windshield garnish moulding (14 pcs). 16.290-0.4

..... **\$3.50 SET** ⚠



3684481B **47-54**
Window garnish mouldings, 2 doors.

16.290-0.3

..... **\$6.00 SET** ⚠



3694284B **47-54**
Headliner, door panel, window & windshield garnish mouldings.

16.290-0.4

..... **\$17.50 KIT** ⚠

Interior Screws



3654597A **37-50**
8 x 32 x 1/2in. clutch head (100 pcs). 16.170-0.15

..... **\$30.00 SET** ⚠



WARNING: Cancer and Reproductive Harm — www.P65Warnings.ca.gov

Chemicals shipped domestic ground only (Lower 48 states only). No international shipping.

Phone: (360) 816-0211 • (800) 999-CHEV (2438) • www.chevsofthe40s.com

Section 330T: Interior, Sunvisors, Dome Lights, Headliners, Interior Screws, Door Panels, Kick Panels, Seats, Seat Covers & Belts

Interior Screws, cont.



3654597C37-50
8 x 32 x 1/2in. clutch
head (10 pcs). 16.170 -0

..... **\$3.00 SET** ⚠

Clutch Head Driver



DRIVER**ALL**
Magnetic clutch head driver, Chevs
imprint. w/ 5 bits (1/8 in., 5/32 in., 3/16
in., 1/4 in., 5/16 in.) 8.821 -0
.....
\$22.25 SET ⚠

Clutch Head Socket Set



CHSS-4**ALL**
4 pc. 3/8 Drive 8.821 -0.15
.....
\$19.75 SET ⚠

Windshield Divider Moulding



3684697B**47-53**
Painted with upper & lower caps &
fasteners. 16.018 -0.15
..... **\$22.00 SET**
⚠



3684697S**47-53**
Interior. Stainless windshield division trim.
16.018 -0.15
..... **\$39.75 EA** ⚠

Kick Panels



474791**36-38**
Inner. Choose Black,
Brown or Grey. Specify
color when ordering.
16.700 -0.15
.....
starting at **\$15.00 L&R** ⚠

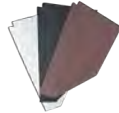

609526**39-46**
Inner. Choose Black,
Brown or Grey. Specify
color when ordering.
16.700 -0.15
.....
starting at **\$15.00 L&R** ⚠



609527**47-54**
Inner. Choose Black,
Brown or Grey (not
original). Specify
color when ordering.
16.700 -0.15
.....
\$12.00 L&R ⚠

Kick Panels Bead Rolled Steel



4754KP**47-54**
Kick Panels are made to install as a cover
or can be used as a replacement part. The
kick panels are laser cut from 18 gauge
steel and can be fastened with screws,
Velcro, welding or however the installer
sees fit. -0
..... **\$140.00 L&R** ⚠

Door Panel Metal Frames

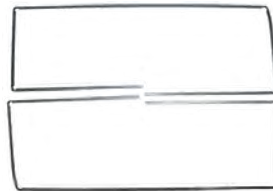

3686120**47-54**
Less clips. 16.166 -0.15
..... **\$25.00 PR** ⚠

3686120S**47-54**
Polished stainless steel
with clips. 16.166 -0.15
.....
\$42.00 PR ⚠

Metal Frame Joint Clips



3697673**47-54**
Zinc 16.166 -0.2
.....
\$2.50 PR ⚠

Metal Frame Joint Clips, cont.



3697673S**47-54**
Polished Stainless
16.166 -0.15
.....
\$2.00 PR ⚠

Door Panel Fasteners



WF18**ALL**
This is a nail on panel
repair clip for the
interior door panel.
10.000 -0.3
.....
\$2.00 PR ⚠

Door Panels Cardboard

3700543**47-54**
Choose Black, Brown or Grey. Specify
color when ordering. 16.165 -0
.....
starting at **\$25.75 L&R** ⚠

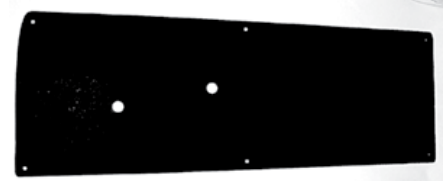

3700543A**47-54**
Original leather grain Black or Maroon.
Specify color when ordering. 16.165 -0.4
.....
starting at **\$18.00 L&R** ⚠

Door Panels Bead Rolled Aluminum

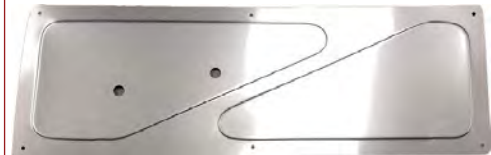

4754DP**47-54**
Aluminum Door Panels are a replacement
part for the original cardboard door
panels. Made from 20 gauge aluminum
these door panels mount with screws in
the factory location. -0
\$140.00 L&R ⚠

Rear Cab Panel

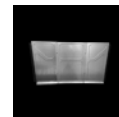

4754BSP**47-54**
Behind seat panel. 18G
raw steel, 3 pieces,
bead rolled.
-0
..... **\$350.00 EA** ⚠

Rear Cab Corners



4754SB1**47-54**
Smooth with 6.5"
speaker holes -0
.....
\$480.00 EA ⚠

Returns require a return authorization number—call first. • Product pricing & availability subject to change.



WARNING: Cancer and
Reproductive Harm —
www.P65Warnings.ca.gov

Section 330T: Interior, Sunvisors, Dome Lights, Headliners, Interior Screws, Door Panels, Kick Panels, Seats, Seat Covers & Belts

Rear Cab Corners, cont.



4754SB2.....47-54
Smooth with 6"x9"
speaker holes -0
..... **\$85.25 EA** ⚠



4754SB3.....47-54
Bead rolled with 6.5"
speaker holes -0
..... **\$106.50 SET** ⚠



4754SB4.....47-54
Bead rolled with 6"x9"
speaker holes -0
..... **\$106.50 EA** ⚠

Retainer Button



3707152.....53-55
Door panel cardboard,
use 12. 16.165 -0.3
..... **\$1.00 EA** ⚠

Seat Cover



593345..... 37
W/ split seat bottom
(brown). 16.715 -0.15
..... **\$175.00 EA** ⚠



593345A..... 37
W/ split seat bottom
(black). 16.715 -0.15
..... **\$175.00 EA** ⚠

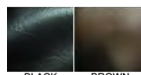

3808199.....37-46
Black 16.715 -0.4
.starting at **\$135.00 EA** ⚠



3808200.....47-49
Matches repro door
panels-black or
brown(specify color
when ordering). 16.715 -0
.....starting at **\$150.00 EA** ⚠



3808201.....47-49
Original-maroon (specify
year when ordering).
16.715 -0.15
.starting at **\$175.00 EA** ⚠



3808205.....50-54
Original-black, brown or
tan (specify color when
ordering). 16.715 -0.4
.starting at **\$175.00 EA** ⚠



3808204..... 54
Original (spanish grain
brown). 16.715 -0.15
..... **\$179.00 EA** ⚠

Upholstery Batting



4092635B37-54
Cotton material placed
in between upholstery
and burlap. 24in. wide.
15.500 -0.15

..... **\$2.50 FT** ⚠

Hog Rings



HOGRING.....ALL
Upholstery hog rings,
set of 100 pieces. -0.4

..... **\$7.50 SET** ⚠



HOGTOOLALL
Hog ring upholstery
pliers to install seat
upholstery. 14.880 -0.15

..... **\$14.00 EA** ⚠

Seat Bumpers



16.772 -0.15

3681216.....36-46
These are the little
rubber bumpers for
between the top and
bottom seat halves.

..... **\$3.75 PR** ⚠

Seat Frame



367314B.....47-54
Rear bumper &
screw set (4 pieces).
16.682 -0.15

..... **\$7.50 PR** ⚠

Grommet



3695783.....51-54
(anti-rattle) seat adjust
rod. 16.682 -0.15

..... **\$5.00 EA** ⚠

Vintage Style Flashlight



ACCFLASHALL
Chrome flashlight has an all-metal casing,
glass lens, hanging loop, adjustable beam,
incandescent bulb, & Morse code button.,
Uses 2 D cell batteries (not included) -0.15
..... **\$8.75 EA** ⚠



ACCFLASHBKT.....ALL
Mount for ACCFLASH w/ zinc plated
finish -0.15
..... **\$8.50 EA** ⚠



ACCFLASHBKT2...ALL
Mount for ACCFLASH w/
hammertone finish -0.15
..... **\$10.00 EA** ⚠

Dome Light Lens



4073975.....37-46
With round stainless
rim. Fits panel &
Suburban. 16.494 -0
..... **\$35.00 EA** ⚠

Dome Light Assembly



5937080.....47-54
Original finish with lens,
bulb & fasteners (6 or
12 volt). 16.494 -0.15
..... **\$45.00 EA** ⚠



5937080C47-54
Chrome with lens, bulb
& fasteners (6 or 12
volt). 16.494 -0.15
..... **\$50.00 EA** ⚠

Dome Light Lens Gasket



5937080A.....47-54
Gasket for dome light
lens. 16.494 -0.15
..... **\$2.00 EA** ⚠

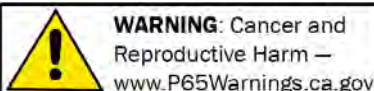

Chemicals shipped domestic ground only (Lower 48 states only). No international shipping.

Phone: (360) 816-0211 • (800) 999-CHEV (2438) • www.chevsofthe40s.com

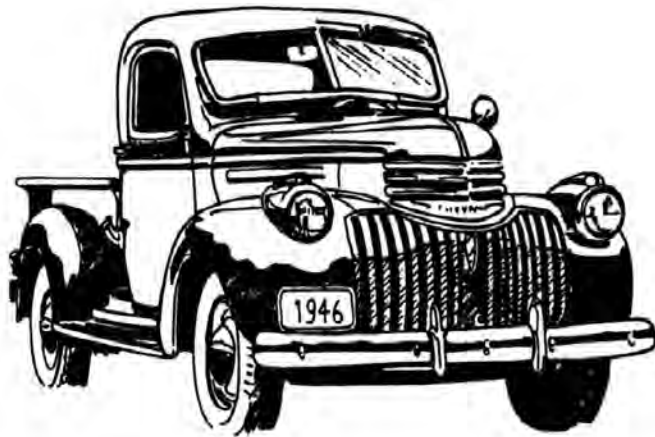

1936-9 Trk Choke, Throttle, Lights Black



3.521 3.481 2.486
1940-46 Trk Choke, Throttle, Lights Rose Tan

WINDOW RISER KNOBS

1939 Trk Window Knob Black

1940-46 Trk Window Rose Tan



16.270

1940-46 Trk Ash Tray Rose Tan



16.120



16.183

1947-53 Trk Vent Knob Maroon 1954 Trk Black



9.650

1954 Trk Windshield Wiper Black GMC Grey



2.906

1954-9 P.U. Turnsignal Knob Black



9.650

1954 Trk Radio Black GMC Grey

Radio Knobs—See Section 360T

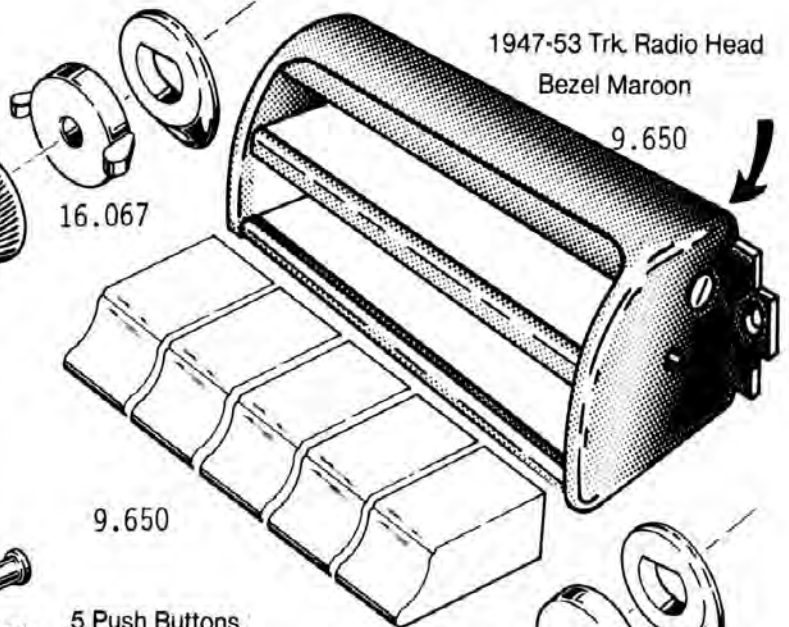

1947-53 Trk Radio Head Bezel Maroon

9.650

16.067

9.650

5 Push Buttons

1947-53 Trk 4 Piece Set

9.650

1947-53 Trk Radio Escutcheon Maroon



**SECTION 340T
RESTORATION PARTS**

Fan



40848.....ALL
12 volt 6" steel blade heady duty fan. -0.15
..... **\$35.25 EA** ⚠️

Traffic Light Viewer



986550.....50-56
Superb reproduction. 10.201 -0.15
\$45.25 EA ⚠️



986550G.....50-56
"GUIDE". 10.201 -0.15
..... **\$23.50 EA** ⚠️



986550MB.....ALL
"GUIDE" magnetic base mount. 10.201 -0.15
..... **CALL** ⚠️

Steering Column Insulator



594670.....34-40
U-bolt with fasteners.
6.765 -0.15
..... **\$25.00 EA** ⚠️



3681057A.....34-46
Steering column to dash, brown exc COE.
6.758 -0
..... **\$13.50 EA** ⚠️

Steering Column Insulator, cont.



598145.....34-46
Steering column to dash, black exc COE.
6.758
..... **\$2.00 EA** ⚠️



3657031.....41-46
U-bolt with fasteners.
6.765 -0.15
..... **\$24.50 EA** ⚠️



3685524.....47-53
Steering column to dash, black exc COE.
6.758 -0
..... **\$3.00 EA** ⚠️



3700190.....54
Steering column to dash. 6.758 -0.15
..... **\$3.00 EA** ⚠️

Cowl Vent Knob



3656663A.....40-46
As original, brown.
16.130 -0.15
..... **\$8.75 EA** ⚠️



985603.....40-46
Ivory accessory 9.691 -0
..... **\$15.00 EA** ⚠️



3682916A.....47-53
Side or top vent,
maroon. 16.130 -0.15
..... **\$7.00 EA** ⚠️



3131111.....54
Black. Original color
and quality. 16.130 -0.4
..... **\$14.00 EA** ⚠️

Wiper Knob



3685141.....47-49
Chrome Chevy & GMC 16.067 -0.4
..... **\$6.00 EA** ⚠️

Wiper Knob, cont.



3699117.....50-53
Maroon Chevy & GMC, original color and
quality. 16.067 -0.4
..... **\$6.00 EA** ⚠️



3703853.....54
Black 16.067 -0.15
..... **\$8.00 EA** ⚠️

Emergency Brake Release



3690404.....48-51
Handle (chrome).
4.592 -0.15
..... **\$10.00 EA** ⚠️



1990717.....52-53
Knob chrome w/
maroon center. Original
color and quality.
4.600 -0
..... **CALL** ⚠️



1990717A.....54
Knob (black). , original
color and quality.
4.600 -0.15
..... **\$10.00 EA** ⚠️

Emergency Brake Release Grommet



3696521.....51-54
Emergency brake
release 9.775 -0.15
..... **\$4.25 EA** ⚠️

Windshield Crank Grommet



598986.....37-38
Grommet, windshield
crank to dash.
16.053 -0.15
..... **\$1.75 EA** ⚠️

Window or Windshield Knob



598910A.....39
Window or windshield
crank. Black. 16.270 -0.15
..... **\$14.75 EA** ⚠️



3654632B.....40-46
Window or windshield
crank. Rose tan.
16.270 -0.15
..... **\$14.00 EA** ⚠️

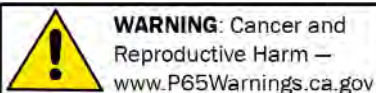

Chemicals shipped domestic ground only (Lower 48 states only). No international shipping.

Phone: (360) 816-0211 • (800) 999-CHEV (2438) • www.chevsofthe40s.com

Windshield Crank



598909 **39**
W/ black knob 16.050 -0.15 **\$29.75 EA** ⚠



3654631A **40-46**
W/ brown knob 16.050 -0.15 **\$29.75 EA** ⚠

Turn Signal Knob



5939511A **54-59**
Black, original color and quality. 2.906 -0.4 **\$14.00 EA** ⚠

Headlight Knob



1861895 **36-39**
Black 2.486 -0.15 **\$14.00 EA** ⚠



599352 **40-46**
Rose tan 2.486 -0.15 **CALL** ⚠



1990661 **47-53**
With shaft 2.486 -0.15 **\$8.00 EA** ⚠



1990661A **47-53**
Chrome with maroon center. Original color and quality. 2.486 -0.4 **\$6.00 EA** ⚠



1990734 **54**
Exc forward control. Black. 2.486 -0.2 **\$9.00 EA** ⚠



3653818K **54**
With shaft. Black. 2.485 -0.15 **\$10.00 EA** ⚠

Choke Knob



476495A **36-39**
Black, original color and quality. 3.521 -0.4 **\$14.00 EA** ⚠



3657151A **40-46**
Rose tan, original color and quality. 3.521 -0.15 **\$9.75 EA** ⚠



1992564A **47-53**
Chrome over maroon., original color and quality. 3.521 -0.2 **\$9.75 EA** ⚠



199637A **54**
Exc Double Duty, COE, FFC. Black., original color and quality. 3.521 -0.4 **\$9.75 EA** ⚠

Choke Cable Assembly



476495 **36-39**
W/ knob 3.521 -0.4 **\$35.00 EA** ⚠



3657151 **40-46**
W/ knob, original color and quality. 3.521 -0.4 **\$30.00 EA** ⚠



1992564 **47-53**
W/ knob 3.521 -0.15 **\$18.00 EA** ⚠



199637 **54**
W/ knob-exc Double Duty, COE, FFC. 3.521 -0.15 **\$16.00 EA** ⚠

Throttle Knob



476751A **36-39**
Black 3.481 -0.15 **\$14.00 EA** ⚠



3654274A **40-46**
Rose tan, original color and quality. 3.481 -0.4 **\$14.00 EA** ⚠



1991581A **47-53**
Chrome over maroon., original color and quality. 3.481 -0.4 **\$14.00 EA** ⚠



1992599A **54**
Black exc Double Duty, COE, FFC., original color and quality. 3.481 -0.15 **\$14.00 EA** ⚠

Throttle Cable Assembly



476751 **36-39**
W/ knob 3.481 -0.4 **\$30.00 EA** ⚠



3654274 **40-46**
W/ knob, original color and quality. 3.481 -0.4 **\$30.00 EA** ⚠



1991581 **47-53**
W/ knob 3.481 -0.15 **\$18.00 EA** ⚠

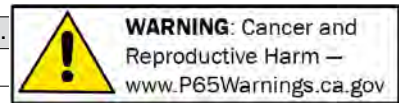

Throttle Cable Assembly, cont.



1992599 **54**
 W/ knob exc Double Duty, COE, FFC.
 3.481 -0.15 **\$16.00 EA** ⚠

Shift Knob



374993 **29-47**
 3-speed floor shift push-on. Black. 4.009 -0.15
 **\$8.50 EA** ⚠



374993B **29-54**
 4-speed screw-on. Black. Chevy & GMC
 4.009 -0.15 **\$9.50 EA** ⚠

Column Shift Knob



3686898 **47-53**
 Maroon. Chevy & GMC
 4.009 -0.15 **\$13.00 EA** ⚠



3698233 **54-59**
 Black Chevy & GMC
 4.009 -0.15 **\$8.00 EA** ⚠

Wire Stop



3655561 **ALL**
 Adjustable end for hood, choke, throttle cables, etc. 8.077 -0.4
 **\$1.25 EA** ⚠

Ash Tray Knob



3658055 **40-46**
 Rose tan, original color and quality. 16.120 -0.4
 **\$14.00 EA** ⚠



3685694 **47-53**
 Chrome 16.122 -0.15
 **\$10.75 EA** ⚠

Cigarette Lighter



986050K **47-53**
 12v w/ socket & knob maroon w/ chrome ring (original 51-53). 9.709 -0
\$23.50 EA ⚠



986050L **47-53**
 6v w/ socket & knob maroon w/ chrome ring (original 51-53). 9.709 -0.15
\$23.50 EA ⚠



3707720A **54**
 6v w/ socket & knob. 9.709 -0
\$21.75 EA ⚠



3707720B **54**
 12v w/ socket & knob. 9.709 -0
\$21.75 EA ⚠



986050J **ALL**
 6V w/ socket & element, no knob.
 9.709 -0.15 **\$22.50 EA** ⚠

Lighter Element



986050A **42-53**
 6v, fits original Casco (NOS). 9.709 -0.4
 **\$20.00 EA** ⚠

Odds & Ends

Please call for availability on all Odds & Ends parts. Once part is sold, it may no longer be in stock.

3847003U **41-46**
 Firewall grommet bracket (Used) 3.000 -0.4
 **\$10.00 EA** ⚠

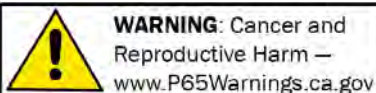

WARNING: Cancer and Reproductive Harm — www.P65Warnings.ca.gov

Chemicals shipped domestic ground only (Lower 48 states only). No international shipping.

Phone: (360) 816-0211 • (800) 999-CHEV (2438) • www.chevsofthe40s.com

**SECTION 345T
RESTORATION PARTS**

Vanity Mirror



987919.....47-72
Vanity mirror with
comb holder and clear
comb. -0.15
..... **\$125.25 EA** ⚠

Tissue Dispenser



986672.....53-55
Superb repro, w/ bowtie. 8.891 -0.15
\$70.00 EA ⚠



TISSUE.....ALL
Box of tissue for tissue dispenser. 100
sheets. -0.3 **\$5.25 EA** ⚠

Interior Mirror Bracket



986875A.....47-53
Stainless 16.069 -0.15
..... **\$7.00 EA** ⚠



986898.....54
This mirror bracket is
for interior use on your
'54. 16.069 -0.15
..... **\$20.00 EA** ⚠



986898A.....54
Chrome 16.069 -0.15
..... **\$20.00 EA** ⚠

Rear View Mirror



516506.....41-52
Chrome (exc. CBL,
CVT, HTP & SDL).
Dims: 6-3/4" x 2-1/2".
10.185 -0.15
..... **\$29.75 EA** ⚠

Rear View Mirror, cont.



4584708.....53-59
Stainless 10.185 -0.15 **\$25.50 EA** ⚠

Rear View Mirror (Day/ Night)



985994.....41-50
Original 42-50 accessory. 10.185 -0
CALL ⚠



986632.....51-52
Original accessory. 10.185 -0.15
\$45.25 EA ⚠



986948.....53-59
Original accessory. 10.185 -0.15
\$36.00 EA ⚠

Peep Mirror



985235A.....37-54
Original 40-50, less GM script, left.
10.185 -0 **\$19.50 EA** ⚠

Peep Mirror, cont.



985231A.....ALL
Original era. 3in. round. Fits left or right.
10.185 -0.15 **\$15.00 EA** ⚠



985231B.....ALL
Original era. 4in. round. Fits left or right.
10.185 -0.15 **\$15.00 EA** ⚠



985231BL.....ALL
Original era. 4in. round. Now with built in
LED arrow for signal. Fits left or right.
10.185 -0.15 **\$25.00 EA** ⚠



985231E.....ALL
Extension for peep, moves mirror head out
1-1/2" to increase visibility and safety
10.185 -0.15 **\$11.50 EA** ⚠



Visor Only.
Pictured With Mirror
For Reference.

985231SS.....ALL
Stainless visor for 4" Peep mirrors.
10.185 -0.15 **\$9.50 EA** ⚠

Mirror Head



3696632 **31-54**
 Exterior. 5" (as original). Fits left or right side. 16.068 -0.15 **\$9.25 EA** ⚠



3696632B **31-54**
 Exterior. 5" (chrome). Fits Left or Right. 16.068 -0.15 **\$11.75 EA** ⚠



3696632R **47-72**
 Exterior, rectangular (stainless). Fits left or right side. 16.068 -0.15 **\$16.50 EA** ⚠



3696632RB **47-72**
 Exterior, rectangular (black). Fits Left or Right. 16.068 -0.15 **\$14.00 EA** ⚠

Exterior Mirror Arm



592145 **36-38**
 Left 16.069 -0.15 **\$31.75 EA** ⚠



592146 **36-38**
 Right 16.069 -0.15 **\$31.75 EA** ⚠



599013L **39-46**
 Left 16.069 -0.15 **\$31.75 EA** ⚠



599014R **39-46**
 Right 16.069 -0.15 **\$31.75 EA** ⚠

Exterior Mirror Arm, cont.



3684883 **47-50**
 Left, unfinished cast 16.068 -0.15 **\$18.00 EA** ⚠



3695368 **47-54**
 Right 16.068 -0.15 **\$20.50 EA** ⚠



3695368C **47-54**
 Right, chrome 16.068 -0.15 ... **\$25.75 EA** ⚠



3696059 **47-54**
 Left, original 51-54. Black 16.068 -0.15 **\$19.00 EA** ⚠



3696059C **47-54**
 Left, chrome, original 51-54. 16.068 -0.15 **\$25.75 EA** ⚠

Mirror Arm Screws



604714A **47-54**
 Mirror arm, outside, stainless steel (2 pcs). 16.069 -0.15 **\$2.00 SET** ⚠

Mirror Arm Gasket



597606 **47-54**
 Mirror arm to cowl, outside. 16.069 -0.15 **\$1.75 EA** ⚠

Mirror Arm Pad



597606A **47-54**
 Mirror arm (rubber w/ beaded edge). 16.069 -0.3 **\$2.50 EA** ⚠

Odds & Ends

Please call for availability on all Odds & Ends parts. Once part is sold, it may no longer be in stock.

3696059U **47-54**
 Exterior mirror arm. Left, original for 51-54. Need screw & gasket (Used). 16.068 -0.4 **\$15.00 EA** ⚠

516505U **ALL**
 Rear view mirror. Painted back (Used). 10.185 -0.4 **\$40.00 EA** ⚠

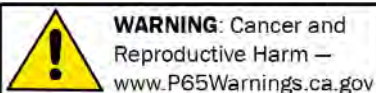

Chemicals shipped domestic ground only (Lower 48 states only). No international shipping.

Phone: (360) 816-0211 • (800) 999-CHEV (2438) • www.chevsofthe40s.com

Section 350T: Gauges, Dash Panels, Instrument Glass, Dash Parts, Glove Boxes & Voltage Reducers

SECTION 350T RESTORATION PARTS

Dash Paint see Section 15T.

Dash Panel



ALUMDASH.....37
Billet aluminum polished for five gauges. Fits most gauges. Specify when ordering.. Gauges not included. 10.230 -0.15
\$134.99 EA ⚠️



ALUMDASH.....40-46
Billet aluminum polished for five gauges. Fits most gauges. Specify when ordering.. Gauges not included. 10.230 -0.15
\$137.50 EA ⚠️



ALUMDASHQ.....40-46
Billet aluminum polished for two 3-3/8in gauges. Fits most gauges. Specify when ordering.. Gauges not included. 10.230 -0.15
\$137.50 EA ⚠️



ALUMDASHT.....40-46
Billet aluminum polished for 3 gauges. Fits most gauges. Specify when ordering.. Gauges not included. 10.230 -0.15
\$137.50 EA ⚠️

Dash Panel, cont.



3847353A.....47-53
Complete metal replacement. Superior!. 16.550 -0.15
\$349.00 EA ⚠️



ALUMDASH5.....47-53
Billet aluminum polished for two 5in gauges. Fits most gauges. Specify when ordering.. Gauges not included. 10.230 -0.15
\$102.00 EA ⚠️

ALUMDASH5.....54
Billet aluminum polished for two 5in gauges. Fits most gauges. Specify when ordering.. Gauges not included. 10.230 -0.15
\$118.00 EA ⚠️

Voltage Reducer

1119004.....ALL
Reducer 12v to 6v. Best for fuel gauge. Hi-Tech w/ constant volts. 2.500 -0.15
\$19.00 EA ⚠️

1119004A.....ALL
12v conversion. 1 per gauge Hi-Tech w/ voltage not constant. 2.500 -0.15
\$4.50 EA ⚠️

1119004B.....ALL
Single 12v input, dual 6v outputs. 2.500 -0.15
\$38.50 EA ⚠️

1119005.....ALL
12v to 6v voltage reducer to operate heater, radio & gauges. Hi-tech, delivers constant volts. Superior quality. 2.500 -0.15
\$93.25 EA ⚠️

1119005C.....ALL
12v to 6v voltage reducer to operate heater. 2.500 -0.15
\$19.75 EA ⚠️

Voltage Reducer, cont.



1506373A.....ALL
12v to 6v. Up to 4 amp draw affects voltage. 2.500 -0.4
\$8.50 EA ⚠️

Voltage Booster



1119007.....ALL
6v to 12v high current booster (3.7-5.0 amps) great for: radar detectors, CB radios, mobile phones, modern stereo radios w/ CD & tape and alarm systems (control only). 2.500 -0.15
\$97.00 EA ⚠️

Gauge Repair

\$10 shipping & handling fee for electrical gauge repair. Parts needed for repair will be in addition to servicing.

1565912R.....ALL
Speedometer gauge repair service. Parts extra 9.743 -0.15
\$190.00 EA ⚠️

Gauge Cluster

858983R6.....36-39
Rebuilt fits 6 cylinder (\$150 core). 9.748 -0.15
\$544.00 EA ⚠️



1564308R6.....40-46
Rebuilt fits 6 cylinder. 0-30psi oil pressure (\$150 core). 9.748 -0.15
\$520.00 EA ⚠️



1564309R6.....40-46
Rebuilt fits 6 cylinder. 0-60psi oil pressure (\$150 core). 9.748 -0.15
\$520.00 EA ⚠️

1500924R6.....47-54
Rebuilt fits 6 cylinder (\$150 core). 9.748 -0.15
\$425.00 EA ⚠️

Returns require a return authorization number—call first. • Product pricing & availability subject to change.



WARNING: Cancer and Reproductive Harm — www.P65Warnings.ca.gov

Section 350T: Gauges, Dash Panels, Instrument Glass, Dash Parts, Glove Boxes & Voltage Reducers

Gauge Cluster (V8)

- 858983R8** **36-39**
Rebuilt fits V8 (\$150 core). 9.748 -0.15
..... **\$600.00 EA** ⚠
- 1564308R8** **40-46**
Rebuilt fits V8 (\$150 core). 9.748 -0.15
..... **\$518.75 EA** ⚠
- 1500924R8** **47-54**
Rebuilt fits V8 (\$150 core). 9.748 -0.15
..... **\$507.00 EA** ⚠

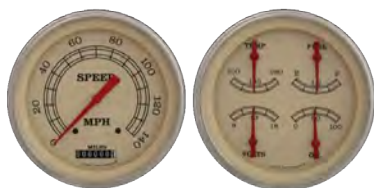

DirectFit RestoMod Gauges

-  **CT47CW62** **47-53**
1947-53 GM Pick-Up Package Classic White Series 4
5/8" Speedtachular (Speedometer/Tachometer Combination) & Quad (Fuel 240-33 OHM) with Stainless Low Step Bezel Flat Glass Lens. The package includes model specific rings, mounting hardware, and all sending units. -0.15
..... **\$875.25 EA** ⚠



- CT47VT52** **47-53**
1947-53 GM Pick-Up Package Vintage Series 4 5/8" Speedometer & Quad (Fuel 240-33 OHM) with Stainless Low Step Bezel Flat Glass Lens. The package includes model specific rings, mounting hardware, and all sending units. -0.15
..... **\$659.00 EA** ⚠

Speedometer Hand

-  **1567794** **47-50**
Super quality (also 52-53 GMC). 9.748 -0.15
..... **\$7.75 EA** ⚠
-  **1567795** **51-53**
Super! 9.748 -0
..... **CALL** ⚠
-  **1567795A** **51-53**
Needle only 9.748 -0
..... **\$7.50 EA** ⚠

Speedometer Cable



- 1567793** **37-57**
W/ original housing assembly exc 1939-54. 4.342 -0
..... **\$56.00 EA** ⚠
- 1588291A** **37-57**
Cable without housing. 85" length (0.130 dia.). 4.342 -0.4
..... **\$48.00 EA** ⚠
- 158829** **39-54**
W/ original metal housing assembly. 70" length. 4.342 -0
..... **\$18.00 EA** ⚠

Bushing In Cylinder Head



- 3837160** **38-62**
For temp gauge. 3/8" I.D. 1/2" NPT O.D.
1.150 -0.15
..... **\$9.75 EA** ⚠

Oil Pressure Line



- 1399637B** **37-54**
Engine to oil gauge.
1.519 -0.3
..... **\$26.00 EA** ⚠

Instrument Glass



- 1564308G** **40-46**
With original markings (GMC). 9.748 -0.15
..... **\$17.00 EA** ⚠
- 1565308** **40-46**
With original markings (Fits 1940 Car, and 1940-46 Truck) 9.748 -0.15
..... **\$19.75 EA** ⚠

Instrument Glass, cont.



- 1565308A** **40-46**
V8 markings w/ temp to 220 degrees & oil pressure at 60 psi (Fits 1940 Car, and 1940-46 Truck). 9.748 -0.15
..... **\$20.50 EA** ⚠

Decal Instrument Set



- 858983** **36-39**
Instrument set w/ speed & odometer (black center). 9.748 -0.15
..... **\$15.00 EA** ⚠

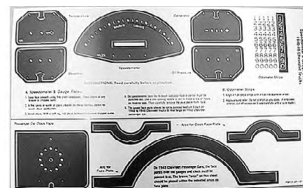

- 1564308B** **40-46**
Instrument cluster w/ speed & odometer. 9.748 -0
..... **\$13.00 EA** ⚠



- 1564308H** **40-46**
Instrument cluster w/ speed & odometer (GMC). 9.748 -0.15
..... **\$12.75 EA** ⚠



- 1500924B** **47-50**
Instrument set w/ speed & odometer. 9.748 -0.15
..... **\$17.00 SET** ⚠

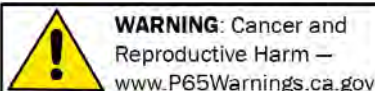

WARNING: Cancer and Reproductive Harm — www.P65Warnings.ca.gov

Chemicals shipped domestic ground only (Lower 48 states only). No international shipping.

Phone: (360) 816-0211 • (800) 999-CHEV (2438) • www.chevsofthe40s.com

Section 350T: Gauges, Dash Panels, Instrument Glass, Dash Parts, Glove Boxes & Voltage Reducers

Decal Instrument Set, cont.



1500924G47-53
Instrument set w/ speedo & odometer
(GMC). 9.746 -0.15 .. **\$12.25 SET** ⚠



1500924C51-53
Instrument set w/ speedo & odometer.
9.748 -0.15 **\$17.00 SET** ⚠



1582460C 54
Instrument set w/ speedo & odometer.
9.748 -0.15 **\$12.25 EA** ⚠



1582460G54-59
Instrument set w/ speedo & odometer
(GMC). 9.748 -0.15 **\$25.00 EA** ⚠

Gauge Cluster Bezel



156547240-46
Chrome (Chev & GMC). 9.746 -0.15
\$46.00 EA ⚠



158152647-53
W/ speedo (Chev & GMC), chrome.
9.746 -0.15
..... **\$14.50 EA** ⚠

Gauge Cluster Bezel, cont.



158265954-55
Chrome. 9.746 -0.15

..... **\$22.00 EA** ⚠



1582659S54-55
Stainless. 9.746 -0.15

..... **\$24.00 EA** ⚠

Instrument Gasket



156530940-46
Instrument glass to housing (Chev & GMC). 9.749 -0
..... **\$5.75 EA** ⚠



150092547-53
Speedometer Chev
gauge glass to
bezel(Chev & GMC).
9.749 -0.3
..... **\$3.50 PR** ⚠

Billet Glove Box Door & Speaker Grille



4753BD47-53
Billet aluminum speaker grille and glove
box door. Pieces are CNC milled from
6061 aluminum and come with a
machined finish. Speaker Grille Cover has
the ash tray deleted. All required mounting
hardware included. Custom Engraving
Available! -0 **\$600.00 SET** ⚠

Dash Moulding Speaker Grille



3654082B40-46
Mouldings - On dash below instruments &
glove box - with attaching clips 16.081 -0
..... **\$55.00 SET** ⚠



365455040-46
For moulding across
dash (10 pcs). 12.118 -0
..... **\$6.25 SET** ⚠

Dash Moulding Speaker Grille, cont.



368403347-53
Dash moulding assembly speaker grille w/
script & ashtray assembly (painted). Upper
and lower mouldings are stainless and
ashtray knob is chrome. 16.083 -0.15
..... **\$109.50 EA** ⚠



3684033G47-53
Dash moulding assembly speaker grille w/
script & ashtray assembly, GMC (painted).
Upper and lower mouldings are stainless
and ashtray knob is chrome. 16.083 -0.15
..... **\$109.50 EA** ⚠

Glove Box Door



598857 39
Hinge assembly
10.262 -0.15
..... **\$44.50 EA** ⚠



3693927B47-53
Hinges 16.115 -0.15
..... **\$38.00 L&R** ⚠



369875147-53
Stainless with painted details. (Driver
quality) 16.110 -0.15 **\$99.50 EA** ⚠



3698751S47-53
Stainless unpainted. (Driver quality)
16.110 -0.15 **\$99.50 EA** ⚠



3701367B54-55
54-55 1st series Billet Glove Box Door
Machine Finish 16.110 -0 **\$350.00 EA** ⚠

Returns require a return authorization number—call first. • Product pricing & availability subject to change.



WARNING: Cancer and
Reproductive Harm —
www.P65Warnings.ca.gov

Section 350T: Gauges, Dash Panels, Instrument Glass, Dash Parts, Glove Boxes & Voltage Reducers

Glove Box Door, cont.

3701367BP **54-55**
54-55 1st Series Billet Glove Box Door
Polished Finish 16.110 -0
..... **\$399.00 EA** ⚠

Decal Radio Grille



306543 **47-53**
Chevrolet radio grille. Black lettering.
18.550 -0.15 **\$3.50 EA** ⚠

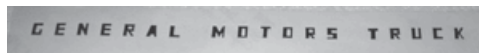

306543G **47-53**
GMC radio grille. 18.550 -0 **\$6.00 EA** ⚠

Glove Box



473524 **36-38**
W/ clips 16.100 -0.15 **\$14.50 EA** ⚠



473524C **36-38**
Cloth lined W/ clips 16.100 -0.15
\$27.00 EA ⚠

598886 **39**
W/ clips 16.100 -0.15
..... **\$12.50 EA** ⚠

598886C **39**
Cloth lined W/ clips 16.100 -0.15
..... **\$27.00 EA** ⚠

3654001 **40-46**
W/ clips 16.100 -0.15
..... **\$12.50 EA** ⚠

3654001C **40-46**
Cloth lined W/ clips 16.100 -0.15
..... **\$27.00 EA** ⚠

3676451 **47-49**
Without clips. 16.100 -0.15
..... **\$12.50 EA** ⚠

367645AIR **47-49**
Trucks with A/C, moulded from ABS
16.100 -0
..... **\$116.00 EA** ⚠

Glove Box, cont.

3704220 **50-53**
W/ clips 16.100 -0.15
..... **\$12.50 EA** ⚠

3701366 **54**
W/ clips 16.100 -0.15
..... **\$12.50 EA** ⚠

3701366G **54**
W/ clips (GMC). 16.100 -0.15
..... **\$12.50 EA** ⚠

Screw Set



431616 **ALL**
To install glove box
10.261 -0.4
..... **\$1.79 SET** ⚠

Rubber Bumpers



4072911B **37-39**
Glove box door
(rectangle). 11.139 -0.4
..... **\$0.75 SET** ⚠



3765243 **40-54**
Glove box door (round).
10.263 -0.4
..... **\$1.75 PR** ⚠

Glove Box Light



985772 **37-54**
w/ bulb. 12V. 10.275 -0.2
..... **\$25.00 EA** ⚠

Striker



3701376 **54-59**
Glove box latch.
16.110 -0.2
..... **\$8.75 EA** ⚠

Gasket



4099314C **40-53**
Glove box lock to door.
16.110 -0.2
..... **\$0.75 EA** ⚠



4566764A **54**
Glove box lock to door.
16.110 -0.2
..... **\$2.25 EA** ⚠

Glove Box Lock



4099314 **40-53**
Assembly with
key. Chevy & GMC
16.110 -0.15
..... **\$30.00 EA** ⚠



4099314B **40-53**
Retainer for glove
box lock assembly.
16.110 -0.2
..... **\$7.50 EA** ⚠

Glove Box Lock, cont.



4566764B **54**
Assembly with case
& key. Chevy & GMC
10.266 -0.2
..... **\$30.75 EA** ⚠

Glove Box Lock Retainer



4099314A **40-54**
Repair Kit (hook & pin).
16.110 -0.15
..... **\$4.00 KIT** ⚠



4599106 **54-59**
Retainer for glove box
lock assembly. Chevy &
GMC 10.267 -0
..... **\$3.75 EA** ⚠

Key Blank



601272 **35-54**
Original GM round
head. Fits trunk, glove
box & locking gas cap
2.187 -0.2
..... **\$4.00 EA** ⚠



3694624 **35-57**
Original GM octagon
head. Fits ignition,
door & spare tire locks.
2.187 -0.15
..... **\$2.50 EA** ⚠

Odds & Ends

Please call for availability on all Odds & Ends parts. Once part is sold, it may no longer be in stock.

1506092 **40-42**
Shelf worn 1.803 -0.4

..... **\$45.00 EA** ⚠

1500558 **40-46**
Ammeter. Fits 40 Pass & 41-46 Truck
(NOS). 2.055 -0.15

..... **\$60.00 EA** ⚠

1506373 **40-46**
Oil Gauge- 40 Pass, 41-46 Truck (NOS)
28.000 -0

..... **\$50.00 EA** ⚠

1565473 **40-46**
Retainer - instrument face 9.747 -0.4

..... **\$15.00 EA** ⚠

1506379 **41-46**
Oil Pressure Gauge GMC 0-80 PSI NOS
28000.000 -0.4

..... **\$65.00 EA** ⚠

1507088N **47-48**
Oil Pressure Gauge Red Needle (NOS)
28000.000 -0.4

..... **\$50.00 EA** ⚠

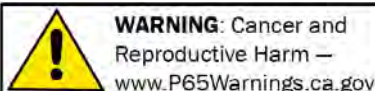

Chemicals shipped domestic ground only (Lower 48 states only). No international shipping.

Phone: (360) 816-0211 • (800) 999-CHEV (2438) • www.chevsofthe40s.com

Odds & Ends

- 1500924****47-53**
Instrument glass, used 9.748 -0.4
..... **\$15.00 EA** ⚠
- 1511960****47-53**
Temp gauge GMC GMC-0.4
..... **\$100.00 EA** ⚠
- 1511960U****47-53**
Temp gauge GMC. Needs new needle
(Used) GMC-0.4
..... **\$60.00 EA** ⚠
- 1516973G****47-53**
Cluster gear bezel fits GMC has yellow
face 9.748 -0
..... **\$15.00 EA** ⚠
- 1501198N****49-53**
Ammeter. Fits comm & utility 54-55 FFC
(NOS) 28000.000 -0
..... **\$50.00 EA** ⚠
- 1507401**.....**49-53**
Oil gauge white needle (COMM, Utility)
28000.000 -0.4
..... **\$50.00 EA** ⚠
- 1501471**..... **54**
Ammeter NOS 28000.000 -0.4
..... **\$37.50 EA** ⚠
- 1508246****55-57**
Oil Pressure Gauge 1.803 -0.4
..... **\$50.00 EA** ⚠

**SECTION 360T
STREET ROD PARTS**

Power Antenna



- 984995P****ALL**
Fully automatic. Fits on top of cowl or
fender. 9.645 -0.15 **\$75.00 EA** ⚠

1947-53 New Radio

Small size, big features! Original looking unit with current day audio technology. Fits stock dash radio opening without modifications. Shallow 3-1/4 inch case depth allows room for dash components such as electric wipers, air conditioning, etc. 4 x 45 watts RMS output, allows up to 180 watts of audio power. Original style AM dial scale in foreground with FM dial scale in background. Analog controls look and feel like the original radio. All audio controls are easily accessible: Volume, bass, treble, balance, fader and tuner from original looking controls. CD or XM (satellite) inputs included. LED dial lights which never need replacing. Digitally tuned AM/FM/Stereo front end provides stable, high quality reception with 10 station presets (5 AM, 5 FM). 40 year memory retention (presets, etc) with power disconnected. Inputs for CD. Maximum power = 180 watts RMS (45 watts x 4 speakers). Dimensions: 9in. W x 3.25in. H x 4.6in. D. 1/2" dia. shafts on controls for mounting (same size and thread as original shafts). Made in the USA. 1 year guarantee.



- 986444R****47-53**
Radio without speaker 9.650 -0.15
\$631.00 EA ⚠

1947-53 New Radio, cont.



- 986444RG****47-53**
GMC without speakers 9.650 -0.15
\$632.50 EA ⚠



- 986444S****47-53**
Radio with speakers. Pair of 4in x 6in
mounted to new radio. 9.650 -0.15
\$748.00 SET ⚠

1954-55 (1st Series) New Radio

First time a NEW radio has been available for this truck in 50 years! Offers the same features as the 47-53 unit plus: Chrome plated die cast nose piece looks original. Includes primed dash bezel exactly like the original (must be painted to match) and correct knobs. Optional Dash Speaker (shown) provides two 4"x6" 3-way speakers that fit in original 6"x 9" opening.



- 986771CG** **54**
GMC without speakers 9.650 -0.15
\$577.50 EA ⚠



- 986771R****54-55**
Radio with out speakers 9.650 -0.15
\$577.50 EA ⚠

1954-55 (1st Series) New Radio, cont.



986771S **54-55**
Radio with speakers. Pair of 4in x 6in mounted to new radio (not sold separately). 9.650 -0.15 **\$693.00 SET** ⚠

SECTION 360T RESTORATION PARTS

Note: Radio & Heater Paint see Section 15T.

Voltage Booster -Radio



1119007 **ALL**
6v to 12v high current booster (3.7-5.0 amps) great for: radar detectors, CB radios,

mobile phones, modern stereo radios w/ CD & tape and alarm systems (control only). 2.500 -0.15

..... **\$97.00 EA** ⚠

Antenna

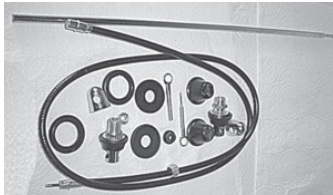

985531 **39-46**
W/ original side mount posts. Superior! 9.645 -0 **CALL** ⚠



986069 **47-54**
W/ template. Superb Reproduction. 9.645 -0.15 **\$120.00 EA** ⚠



984995R **ALL**
Cowl Top or fender top replacement. Adjustable base (swivels). 9.645 -0.2 **\$22.25 EA** ⚠

Antenna, cont.

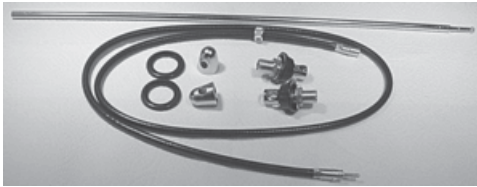

985996R **ALL**
2 post side cowl mount. 9.645 -0.15 **\$33.00 EA** ⚠

Antenna Eye Bolt



603797 **39-46**

Antenna upper eye bolt for base takes 2 (1941

uses 1). 9.644 -0.2 **\$21.25 EA** ⚠

Antenna Base



603795 **39-46**

Bakelite post base. 39-40 takes 2, 41 takes 1. 9.644 -0.3

..... **\$24.25 EA** ⚠

Antenna Base & Nut



986069A **47-54**

Base & nut. Fits Bakelite. 9.645 -0.15

..... **\$19.75 SET** ⚠

Antenna Pad



605184 **39-46**

Rubber pad for bakelite post (original antenna). 9.645 -0

..... **\$9.25 PR** ⚠



986069C **47-54**

Rubber pad for antenna base. 9.645 -0.15

..... **\$4.50 EA** ⚠

1937 Radio

985252A **37**
Tube set, 6-tube single unit radio #985252. 9.650 -0 **\$89.00 SET** ⚠

1938 Radio



7232768 **38**

Radio knob, ivory. Original color and quality. 9.650 -0.4

..... **\$14.00 EA** ⚠

1939 Radio



7232626 **37-39**

Radio dial lens, 2in. diameter. 9.650 -0.2

..... **\$35.50 EA** ⚠

1939 Radio, cont.

985286A **38-39**

Tube set, 6-tube single unit radio #985286. 9.650 -0

..... **\$108.00 SET** ⚠



7236509 **39**

Radio knob, rose tan. Original color and quality. 9.650 -0

..... **CALL** ⚠

1940 Radio



7239043 **40**

Radio knob, ivory. Original color and quality. 9.650 -0

..... **CALL** ⚠

985538A **40**

Tube set, 5-tube single unit radio #985538. 9.650 -0

..... **\$102.00 SET** ⚠

1941 Radio

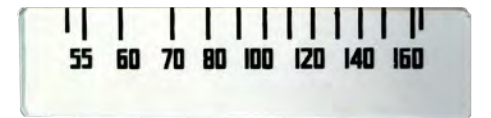

1213876 **40-41**

Radio dial lens, 3-5/8in. x 7/8in., glass. 9.650 -0.15

..... **\$23.50 EA** ⚠



7238833 **40-41**

Radio dial lens, 3-1/2in. x 1-1/4in., plastic. 9.650 -0

..... **CALL** ⚠

985651A **40-41**

Tube set, 5-tube plug in portable radio #985651. 9.650 -0

..... **\$45.00 SET** ⚠

985651A **40-41**

Tube set, 5-tube plug in portable radio #985651. 9.650 -0

..... **\$45.00 SET** ⚠



604369 **41**

Radio knob, chrome with swirl center. 9.650 -0.4

..... **\$14.00 EA** ⚠

985696A **41**

Tube set, 5-tube single unit radio #985696. 9.650 -0.15

..... **\$134.00 SET** ⚠

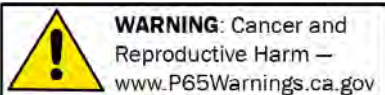

WARNING: Cancer and Reproductive Harm — www.P65Warnings.ca.gov

Chemicals shipped domestic ground only (Lower 48 states only). No international shipping.

Phone: (360) 816-0211 • (800) 999-CHEV (2438) • www.chevsofthe40s.com

1942-1946 Radio



7242249.....42-46
Radio knob, ivory w/
copper swirl center.
9.650 -0
..... **CALL** ⚠

985792A 42-46
Tube set, 5-tube single unit radio
#985792. 9.650 -0
..... **\$111.00 SET** ⚠

1947-1953 Radio



725690247-50
Radio dial lens, molded plastic. 9.650 -0
..... **CALL** ⚠

986067A47-50
Tube set, 6-tube single unit radio
#986067. 9.650 -0.15
..... **\$146.00 SET** ⚠



368403347-53
Dash moulding assembly speaker grille w/
script & ashtray assembly (painted). Upper
and lower mouldings are stainless and
ashtray knob is chrome. 16.083 -0.15 ...
\$109.50 EA ⚠



3684033G47-53
Dash moulding assembly speaker grille w/
script & ashtray assembly, GMC (painted).
Upper and lower mouldings are stainless
and ashtray knob is chrome. 16.083 -0.15
..... **\$109.50 EA** ⚠

1947-1953 Radio, cont.



4753BD47-53
Billet aluminum speaker grille and glove
box door. Pieces are CNC milled from
6061 aluminum and come with a
machined finish. Speaker Grille Cover has
the ash tray deleted. All required mounting
hardware included. Custom Engraving
Available! -0 **\$600.00 SET** ⚠



986264.....47-53
Radio knob, tan. 9.650 -0
..... **\$14.00 EA** ⚠

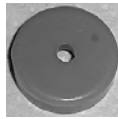

986264A.....47-53
Disk dummy (knob)
behind front radio knob.
9.650 -0
..... **\$14.00 EA** ⚠



986264B.....47-53
Disk w/ lever (knob)
behind front radio knob.
9.650 -0
..... **\$14.00 EA** ⚠



986444547-53
Rubber seal, radio speaker to dash.
9.650 -0.15 **\$14.50 EA** ⚠



9864445S47-53
Sponge seal, radio speaker to dash.
9.650 -0.15 **\$12.00 EA** ⚠

986444A47-53
Radio bezel gasket (2 pcs). 9.650 -0.15
..... **\$3.50 PR** ⚠



986444C.....47-53
Radio bezel, teardrop
behind knobs Original
color and quality.
9.650 -0.15
..... **\$14.00 EA** ⚠

1947-1953 Radio, cont.



986444D47-53
Pushbuttons (5 pcs). 9.650 -0.15
\$15.50 SET ⚠



986444E.....47-53
Spacers, front of radio
to dash. Upper (2 pcs).
9.650 -0
..... **CALL** ⚠



986444EF.....47-53
Spacers, front of radio
to dash. Upper and
Lower (4pcs). 9.650 -0
..... **\$14.00 SET** ⚠



986694D47-53
Radio face housing, maroon. 9.650 -0.4
\$20.00 EA ⚠

986443A 51-53
Tube set, 6-tube single unit radio
#986443. 9.650 -0.15
..... **\$146.00 SET** ⚠

1954 Radio



986668B 54
Radio dial lens, GMC. 9.650 -0.15
\$18.50 EA ⚠

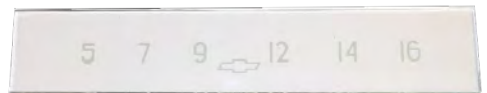

986669B 54
Radio dial lens. 9.650 -0.15 .. **\$25.00 EA**
⚠



986694..... 54
Disk w/ lever (knob),
black, behind radio
knob. Original color and
quality. 9.650 -0.15
..... **\$14.00 EA** ⚠



1954 Radio, cont.



986694C 54
Radio face housing (rough casting)
9.650 -0.15 **\$29.00 EA** ⚠



986694E..... 54
Radio knob, black (outer). Original color and quality. 9.650 -0.15 **\$14.00 EA** ⚠



986694H..... 54
Disk dummy (knob) black behind radio knob. Original color and quality. 9.650 -0.15 **\$14.00 EA** ⚠



986694J 54
Radio knob, GMC. Grey (outer). Original color and quality. 9.650 -0.15 **\$14.00 EA** ⚠



986694K..... 54
Disk dummy (knob), grey, GMC, behind radio knob. Original color and quality. 9.650 -0.15 **\$14.00 EA** ⚠



986694L..... 54
Disk w/ lever (knob) grey, GMC, behind radio knob. Original color and quality. 9.650 -0.15 **\$14.00 EA** ⚠

986770A 54
Tube set, 6-tube single unit radio #986770. 9.650 -0 **\$126.00 SET** ⚠



986770C..... 54
Radio speaker cover, cardboard. 9.650 -0.15 **\$10.00 EA** ⚠



986771BKT54-55
1st Series radio mounting bracket
9.650 -0.15 **\$50.00 EA** ⚠

Radio Tubes



121192437-54
OZ-4. Solid state (\$15 core-exchange).
9.650 -0.4 **\$50.00 EA** ⚠

Vibrator



7239124E37-38
6v w/ negative grounds. Solid state, no more radio hum (if original vibrator doesn't hum, it's time to replace it). 9.650 -0.15 **\$45.00 EA** ⚠



723912439-54
6v w/ negative grounds. Solid state, no more radio hum (if original vibrator doesn't hum, it's time to replace it). 9.650 -0.15 **\$45.00 EA** ⚠



7239124RALL
12v w/ negative grounds. Solid state, no more radio hum (if original vibrator doesn't hum, it's time to replace it). 9.650 -0.15 **\$56.50 EA** ⚠

Thin Hex Nut



120369.....ALL
For 3/8in. Shaft-radio
(2 Pc Set) 9.650 -0.4 **\$3.00 SET** ⚠



604275.....ALL
For 1/2in. Shaft-radio
(2 Pc Set) 9.650 -0.4 **\$6.25 SET** ⚠

Odds & Ends

Please call for availability on all Odds & Ends parts; once part is sold, it may no longer be in stock.

7239124U39-54
Vibrator - 6 volt used. 1.664 -0.4 **\$20.00 EA** ⚠
605300N42-48
Knob. Radio (small ivory w/ swirl)
9.650 -0.4 **\$15.00 EA** ⚠

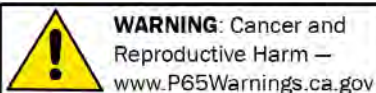

WARNING: Cancer and Reproductive Harm — www.P65Warnings.ca.gov

Chemicals shipped domestic ground only (Lower 48 states only). No international shipping.

Phone: (360) 816-0211 • (800) 999-CHEV (2438) • www.chevsofthe40s.com

**SECTION 370T
STREET ROD PARTS**

Header Panel



593369.....36-38
Mounts above windshield (fiberglass).
16.562 -0.15 **\$149.00 EA** ⚠️
598772.....39-46
Mounts above windshield (fiberglass).
16.563 -0.15
..... **\$149.00 EA** ⚠️

Wiper Motor Access Hole Cover



593351L.....36-38
Left (fiberglass). 16.563 -0.15
\$28.00 EA ⚠️



593352R.....36-38
Right (fiberglass). 16.563 -0.15
\$28.00 EA ⚠️

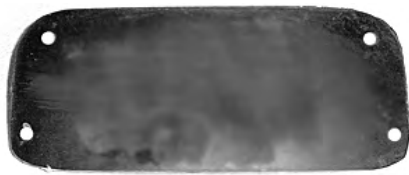

593353.....36-38
Blank cover for the right side wiper access
hole made of fiberglass. 16.563 -0.15
..... **\$22.00 EA** ⚠️



598811L.....39-46
Left (fiberglass). 16.563 -0.15
\$23.50 EA ⚠️

**Wiper Motor Access Hole Cover,
cont.**



598813R.....39-46
Right (fiberglass). 16.563 -0
\$25.00 EA ⚠️

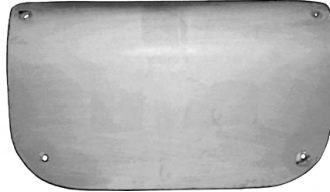

598814.....39-46
Blank (fiberglass). 16.563 -0
\$18.50 EA ⚠️

Wiper Cap



BIS248810.....-54
Billet Bullet cap
replaces wiper arm
on shaft. 11/16"
or smaller shaft.
10.159 -0.15
..... **\$29.75 PR** ⚠️



BIS248815.....-54
Billet Bullet cap
replaces wiper arm
on shaft. 11/16"
or smaller shaft.
10.159 -0.15
..... **\$29.75 PR** ⚠️



4601065.....ALL
Wiper chrome cap
replaces wiper arm
on shaft. 9/16" ID
10.159 -0.15
..... **\$18.00 PR** ⚠️



4601065C.....ALL
Wiper chrome cap
replaces wiper arm
on shaft. Bullet cover.
9/16" ID 10.159 -0.15
..... **\$17.50 PR** ⚠️

Wiper Motor w/ Linkage Kit

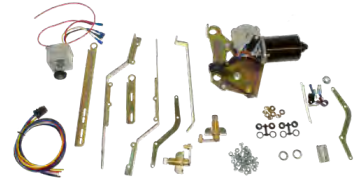

4089935D.....47-53
Chevy truck W/ linkage-12v, 2-speed w/
delay & park (replaces old cable & spool
system). 10.150 -0.15 **\$525.50 EA** ⚠️

4089935S.....47-53
Chevy truck W/ linkage-12v, 2-speed w/
park (replaces old cable & spool system).
10.150 -0.15
..... **\$470.00 EA** ⚠️

Wiper Motor Electric Kit



598989G.....37-46
Chevy truck 12v, w/
arm & blade easy
installation. 16.064 -0.15
..... **\$197.75 EA** ⚠️



598989H.....37-46
Chevy truck 6v, w/ arm & blade easy
installation. 16.064 -0.15 .. **\$200.50 EA**
⚠️

Electric Wiper Motor



4089935M.....47-53
Chevy truck 2 speed & self park (6v).
16.064 -0.15 **\$198.75 EA** ⚠️



4089935N.....47-53
Chevy truck 2 speed &
self park (12v), also fits
GMC. 16.064 -0.15
..... **\$240.00 EA** ⚠️



3710004M.....54
Chevy truck 2 speed &
self park (6v). Comes
w/ original style knob.
16.064 -0.15
..... **\$199.00 EA** ⚠️



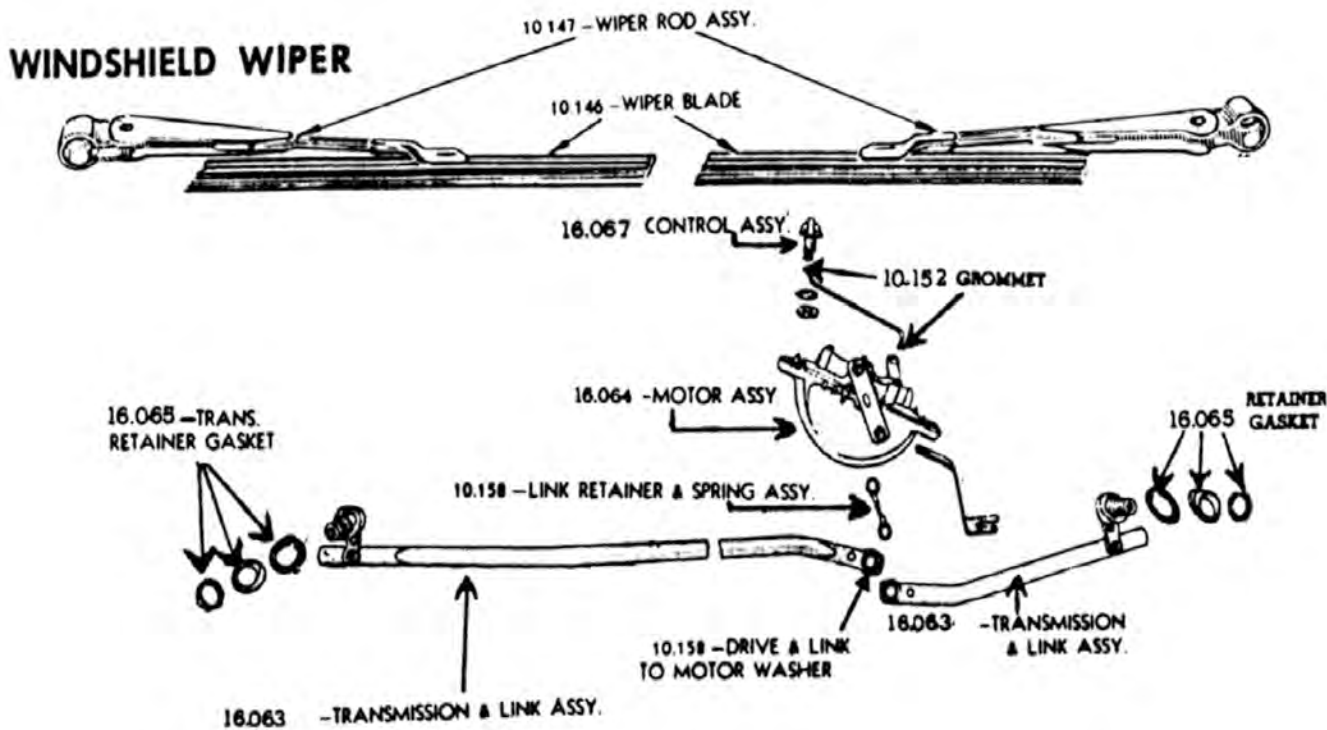

Electric Wiper Motor, cont.



3710004N 54
Chevy truck 2 speed & self park (12v), also fits GMC. 16.064 -0.15
..... **\$240.00 EA** ⚠



598989E.....ALL
Universal. 6v. 3 3/16" Length x 1/4" Diameter. 16.064 -0.15
..... **\$67.00 EA** ⚠

Electric Wiper Conversion Kit

Clean Wipe System. Replaces factory wiper system. Comes with 12 volt, two-speed electric motor, complete with bracketing, linkage arms, wiper transmissions, wiper arms & blades, wiring and switch. Designed to fit in stock location above the windshield. For wiper delay add part #4073750D

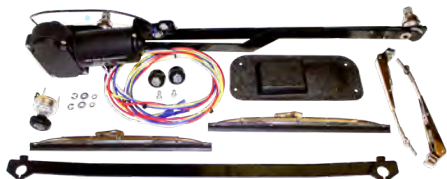

594640KD37-38
Chevy Truck Deluxe Clean Wipe System 12v. Stainless wiper arms & blades. 16.064 -0 **\$420.00 KIT** ⚠

Electric Wiper Conversion Kit, cont.

598989KD 39-46
Chevy Truck Deluxe Clean Wipe System 12v. Stainless wiper arms & blades. 16.064 -0
..... **\$420.00 KIT** ⚠

Intermittent Delay Switch



4073750DALL
For electric wiper motors. 10.150 -0
..... **\$95.00 EA** ⚠

Hose



609742ALL
1/2" I.D. Sold by the inch 3.003 -0.4
..... **\$0.25 IN** ⚠

Wiper Blade



561094S55-59
12in. 10.146 -0.15 **\$19.00 EA** ⚠

Wiper Blade, cont.



NE13006ALL
6" stainless wiper blade for use with 3683910A adjustable wiper arm. 10.146 -0.15 **\$17.50 EA** ⚠



NE13008ALL
8" stainless wiper blade for use with 3683910A adjustable wiper arm. 10.146 -0.15 **\$20.00 EA** ⚠



NE13010ALL
10" stainless wiper blade for use with 3683910A adjustable wiper arm. 10.146 -0.3 **\$16.25 EA** ⚠



WARNING: Cancer and Reproductive Harm — www.P65Warnings.ca.gov

Chemicals shipped domestic ground only (Lower 48 states only). No international shipping.

Phone: (360) 816-0211 • (800) 999-CHEV (2438) • www.chevsofthe40s.com

Section 370T: Cowl Vents, Wiper Motors, Wiper Arms, Knobs & Windshield Washers

Wiper Blade, cont.



NE13012ALL
12" stainless wiper blade for use with 3683910A adjustable wiper arm.
10.146-0.3 **\$16.25 EA** ⚠

Wiper Arm



3683910AALL
Chrome. Adjustable length and wiper angle, 6-11". Fits wiper transmissions with a 9/16" spline shaft. Use with blades NE13... 10.146-0 **CALL** ⚠



3683910SAALL
Stainless. Adjustable length and wiper angle. 6-11" Use with blades NE130... 10.146-0.15 **\$22.50 EA** ⚠

Wiper Arm & Blade



603047R31-38
7in. stainless arm w/ 8-1/4in. blade (2 pcs). 10.146-0 **\$51.00 EA** ⚠

SECTION 370T RESTORATION PARTS

Fuel Pump

Tired of your wipers stopping when you get on the accelerator? Replace your fuel pump with one that also has a vacuum pump for consistent wiper movement.



559145737-51
W/ vacuum pump (glass bowl) stops slow wipers, original accessory. Also fits GMC, includes gasket. 3.900-0.15 **CALL** ⚠

Fuel Pump, cont.



5591457M ..37-51
W/ vacuum pump (metal bowl) includes gasket. 3.900-0.15 **\$118.00 EA** ⚠



559267552-57
W/ vacuum pump (glass bowl) stops slow wipers, original accessory. 3.900-0.15 **\$145.50 EA** ⚠



5592675M ..52-57
W/ vacuum pump (metal bowl) stops slow wipers, original accessory. 3.900-0.15 **\$134.00 EA** ⚠

Fuel Pump Rebuild Kit



559184437-51
W/ vacuum pump 3.901-0.15 **\$89.00 EA** ⚠



559182552-57
W/ vacuum pump 3.900-0 **\$77.00 EA** ⚠

Cowl Vent Knob



3656663A40-46
As original, brown. 16.130-0.15 **\$8.75 EA** ⚠



98560340-46
Ivory accessory 9.691-0 **\$15.00 EA** ⚠

Cowl Vent Knob, cont.



3682916A47-53
Side or top vent, maroon. 16.130-0.15 **\$7.00 EA** ⚠



3131111 54
Black. Original color and quality. 16.130-0.4 **\$14.00 EA** ⚠

Cowl Vent Seal



37339834-38
Non-absorbing, molded. 16.140-0.15 **\$31.25 EA** ⚠



368106739-46
Non-absorbing, molded. 16.140-0.15 **\$26.00 EA** ⚠

3681067A 39-46
Sponge 16.140-0.15 **\$7.00 EA** ⚠



368438947-50
Side vent, non-absorb molded. 16.140-0.3 **\$12.00 EA** ⚠

3684389A47-50
Side vent, sponge. 16.140-0.2 **\$6.25 EA** ⚠



368285647-53
Non-absorb molded. 16.140-0.15 **\$7.50 EA** ⚠

3682856A47-53
Sponge 16.140-0.15 **\$6.00 EA** ⚠

Section 370T: Cowl Vents, Wiper Motors, Wiper Arms, Knobs & Windshield Washers

Cowl Vent Seal, cont.

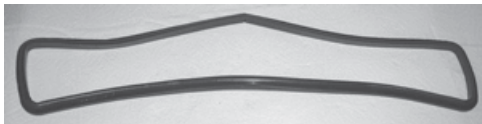

- 3703560** **54**
Non-absorb molded. 16.140 -0.15
\$6.00 EA ⚠
- 3703560A** **54**
Sponge 16.140 -0.15
\$9.19 EA ⚠

Hose

- 4027764** **39-46**
Cowl vent drain.
16.127 -0.4
\$2.00 EA ⚠
- 3683657** **47-54**
Cowl vent drain.
16.127 -0.2
\$7.50 EA ⚠

Bolt

- 4023060** **39-46**
Cowl vent hinge
(shouldered bolt).
16.135 -0.15
\$19.75 PR ⚠

Wiper Knob

- 3685141** **47-49**
Chrome Chevy & GMC
16.067 -0.4
\$6.00 EA ⚠
- 3699117** **50-53**
Maroon Chevy & GMC,
original color and
quality. 16.067 -0.4
\$6.00 EA ⚠
- 3703853** **54**
Black 16.067 -0.15
\$8.00 EA ⚠

Vacuum Hose

- 601607** **ALL**
Wiper motor to engine,
1/4 in. I.D. 10.155 -0.3
\$1.25 FT ⚠

Wiper Control Link

- 3699117A** **47-53**
Rod 16.067 -0.15
\$3.75 EA ⚠

Wiper Control Link Grommet

- 4093397** **47-53**
Wiper control link
16.065 -0.15
\$1.75 PR ⚠

Windshield Washer Hose

- 604041B** **37-50**
9 ft. w/ original GM instruction sheet &
firewall grommet. 8.962 -0.4
\$30.75 KIT ⚠

Windshield Washer Nozzles

- 604354** **40-50**
Chrome w/ mounting
bracket. 8.798 -0
CALL ⚠

Hose Connector 3-way

- 3682929** **ALL**
Y wiper & washer,
7/32in. 16.066 -0.2
\$0.50 EA ⚠

Pivot Rubber Bushings

- 3746483** **47-53**
For wiper motor
10.158 -0.3
\$1.50 PR ⚠

Wiper Motor Pivot Linkage Retainer

- 4065091** **47-53**
For wiper motor, Length 2-3/16".
10.158 -0.15
\$2.50 EA ⚠
- 4570135** **54-57**
For wiper motor retainer, 2-3/4" length.
10.158 -0
\$5.00 EA ⚠

Vacuum Operated Wiper Motor

\$15 shipping & handling for rebuild service.



- TRICO ONLY** **SPECIFY ALL** **ALL**
Rebuild yours (please
send motor only-do not
send any other parts)
10.150 -0.15
\$176.00 EA ⚠

Wiper Blade

- 985459** **29-46**
8-1/2in. 10.146 -0
\$5.00 EA ⚠
- 985982** **39-46**
9in. 10.146 -0.2
\$5.00 EA ⚠
- 3683905** **47-53**
10in. 10.146 -0.3
\$7.75 EA ⚠



- 3683905S** **54-55**
10in. Stainless Steel. 10.146 -0.15
\$12.00 EA ⚠

Wiper Arm

- 603047** **31-38**
7in. stainless arm 10.147 -0.15
\$19.50 EA ⚠
- 598991** **39-46**
This is a windshield wiper arm is made of
stainless steel. 10.147 -0.3
\$23.75 EA ⚠
- 3697280** **47-53**
Left 10.147 -0.2
\$20.00 EA ⚠
- 3697282** **47-53**
Right 10.147 -0.2
\$20.00 EA ⚠

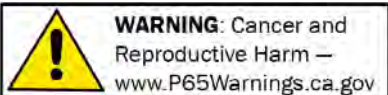

WARNING: Cancer and Reproductive Harm —
www.P65Warnings.ca.gov

Chemicals shipped domestic ground only (Lower 48 states only). No international shipping.

Phone: (360) 816-0211 • (800) 999-CHEV (2438) • www.chevsofthe40s.com

370T

Section 370T: Cowl Vents, Wiper Motors, Wiper Arms, Knobs & Windshield Washers

Wiper Arm, cont.



3722488 **54-59**
Right 10.147 -0 **\$13.00 EA** ⚠



3730483 **54-59**
Left 10.147 -0 **\$13.00 EA** ⚠

Wiper Transmission & Link Assembly



3683915B **47-53**
Like original. 16.063 -0.15
\$127.00 L&R ⚠



3703856B **54-55**
54-55 (1st Series). 16.063 -0.15
\$127.00 L&R ⚠

Gasket



593383 **36-38**
Wiper motor bezel to cab 16.065 -0.3
..... **\$1.75 EA** ⚠



598993 **39-46**
Wiper motor bezel to cab 16.065 -0.2
..... **\$1.25 EA** ⚠



3685793A **47-53**
Wiper transmission 16.065 -0.15
..... **\$1.75 PR** ⚠



3703860A **54**
Wiper transmission 16.065 -0.3
..... **\$5.25 PR** ⚠

Chrome Bezel



593384 **36-38**
Wiper transmission 16.065 -0.15
..... **\$26.75 EA** ⚠



598994 **39-46**
Wiper transmission 16.065 -0
..... **CALL** ⚠



3683911 **47-53**
Wiper transmission 16.065 -0.15
..... **\$14.00 PR** ⚠



3703859 **54**
Wiper Transmission 16.065 -0.15
..... **\$12.25 SET** ⚠

Nuts



3683913 **47-59**
Retains chrome wiper bezel to cowl 16.065 -0.15
..... **\$5.00 PR** ⚠

Odds & Ends

Please call for availability on all Odds & Ends parts; once part is sold, it may no longer be in stock.

3683915U **47-53**
Wiper trans link left hand (Used) 16.063 -0
..... **\$10.00 EA** ⚠

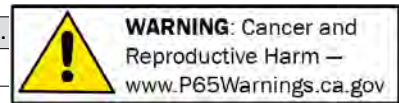

ILLUSTRATIONS ARE COMPLETE ASSEMBLIES.
SEE TEXT FOR AVAILABILITY.

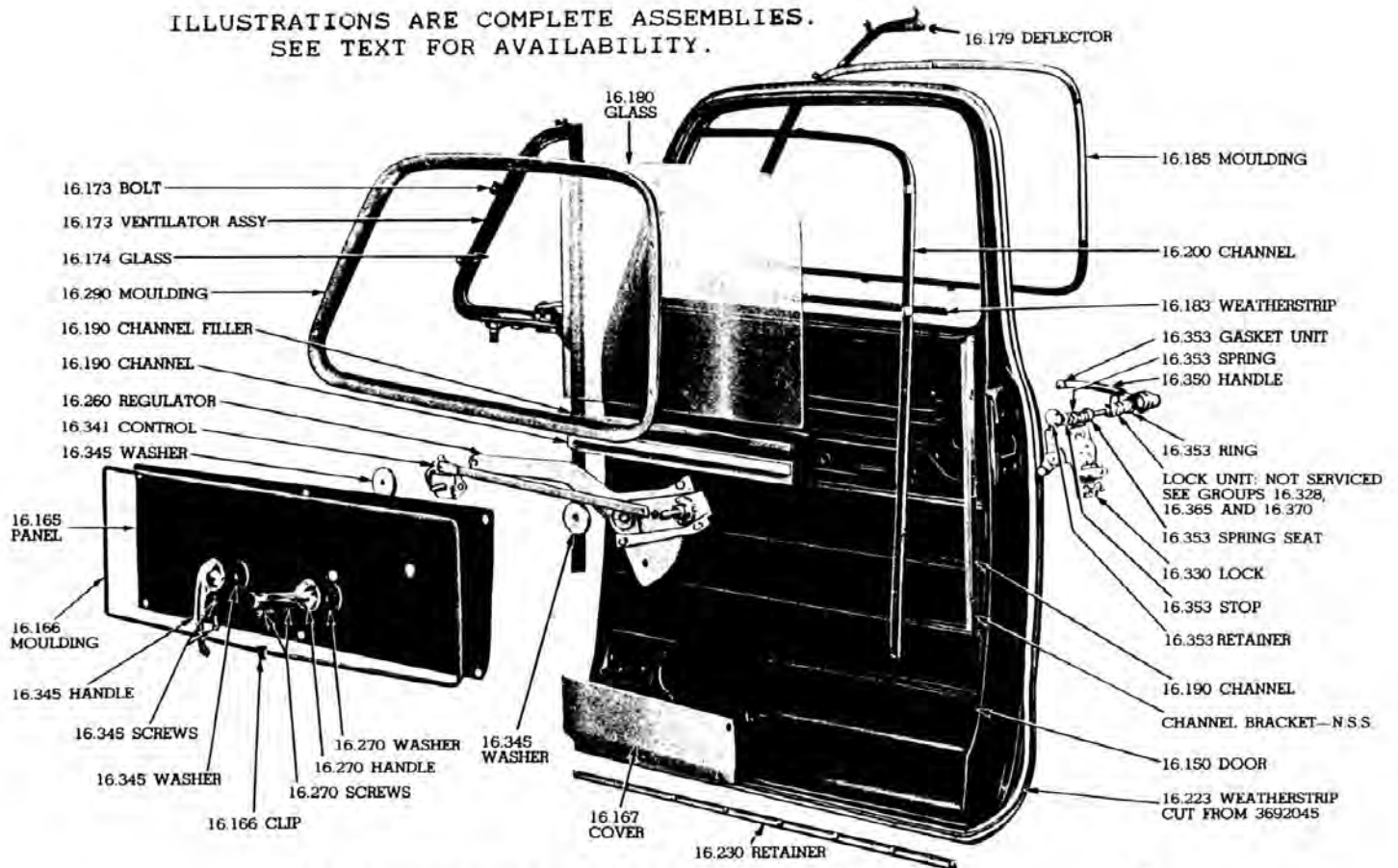

1951-53 CONVENTIONAL CAB DOOR ASSEMBLY

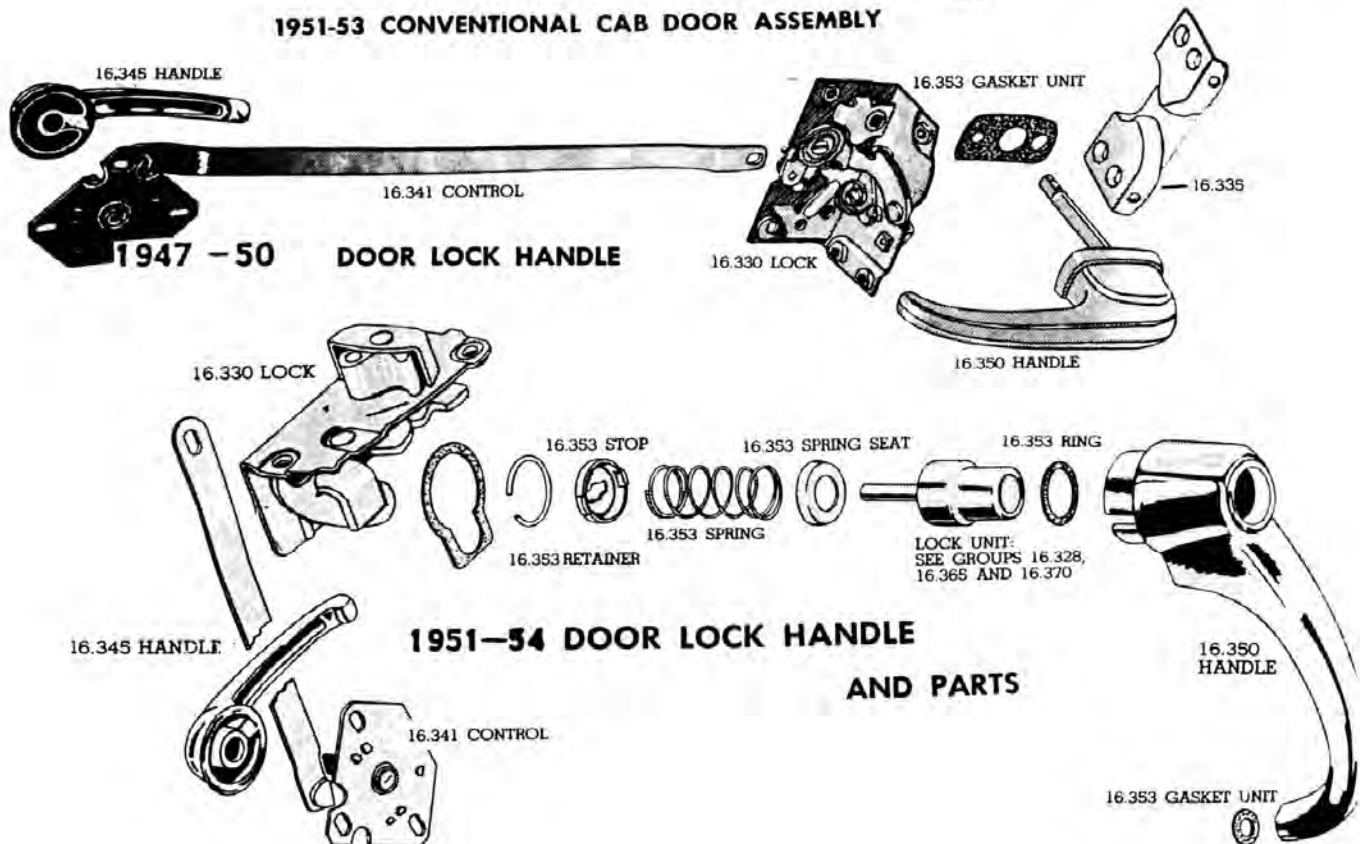

1947 - 50 DOOR LOCK HANDLE

1951-54 DOOR LOCK HANDLE AND PARTS



WARNING: Cancer and Reproductive Harm — www.P65Warnings.ca.gov

Chemicals shipped domestic ground only (Lower 48 states only). No international shipping.

Phone: (360) 816-0211 • (800) 999-CHEV (2438) • www.chevsofthe40s.com

**SECTION 380
STREET ROD PARTS**

Clutch Head Driver

For individual clutch head bits, see Section 15T.



DRIVER.....ALL
Magnetic clutch head driver, Chevs imprint. w/ 5 bits (1/8 in., 5/32 in., 3/16 in., 1/4 in., 5/16 in.) 8.821-0
\$22.25 SET ⚠

Clutch Head Socket Set



CHSS-4.....ALL
4 pc. 3/8 Drive 8.821-0.15
\$19.75 SET ⚠

**SECTION 380
RESTORATION PARTS**

Note: Window Cranks see Section 460T.

Door Pulls



DLK70023.....ALL
8 Ball Door Lock Knob -0.15
\$7.00 PR ⚠



DLK70044.....ALL
Chrome Metal Tube Door Lock Knob -0.2
\$7.00 PR ⚠



DLK70095.....ALL
Iron Cross Door Lock Knob -0.2
\$8.95 PR ⚠

Door Handle Exterior



474991.....34-38
Non-locking. LH 16.360-0.15
\$60.00 EA ⚠



3654589.....39-46
Non-locking. Chrome finish. 16.360-0.15
\$39.50 EA ⚠



3654589NC.....39-46
Non-locking. Paintable finish 16.360-0.15
\$38.00 EA ⚠



3686255.....47-51
Left & right 16.360-0.15
\$65.25 PR ⚠



5254BDH.....52-54
GM / Chevy Billet Door Handles -0
\$350.00 L&R ⚠



3698881.....52-59
Non-locking pushbutton (left side) & right side w/o pushbutton (install yours or use our pt #3700318). 16.350-0.15
\$69.00 PR ⚠

Pushbutton



3700318.....52-59
For right side door handle w/ lock cylinder & 2 keys. 16.365-0.15 ..
\$40.00 EA ⚠

Door Handle Exterior Return Spring



3683067A.....39-46
Left 16.330-0.15
\$6.50 EA ⚠



3683068.....39-46
Right 16.330-0.15
\$6.50 EA ⚠



3684168.....47-51
Exterior 16.330-0.15
\$6.00 EA ⚠

Door Handle Exterior Guard



3698881C.....52-59
Chrome 16.350-0.15
\$22.50 PR ⚠

Door Handle Exterior Gasket



603954A.....47-51
Door handle & lock (exterior). 16.353-0.15
\$4.00 SET ⚠



3700098.....52-59
Door handle (exterior). 16.353-0.15
\$2.00 SET ⚠

Section 380T: Door Handles, Armrests, Door Latches & Strikers

Screw Set



3694071.....47-50
Attaches upper and lower door and frame glass.
16.190 -0.15

..... **\$5.00 SET** ⚠



4147641A.....47-51
Door handle bezel (exterior) (4 pcs).
16.270 -0.15

..... **\$3.75 SET** ⚠



3684161A.....47-53
Door panel, cardboard, does both doors (12 pcs). 16.290 -0.4

..... **\$3.00 SET** ⚠



3684481B.....47-54
Window garnish mouldings, 2 doors.
16.290 -0.3

..... **\$6.00 SET** ⚠



3694284B.....47-54
Headliner, door panel, window & windshield garnish mouldings. 16.290 -0.4

..... **\$17.50 KIT** ⚠

Door Lock



3684820.....47-53
W/ 2 keys, exterior 47-51 right door, also Panel & Suburban.
Will fit late 1942-46 by shortening the shaft and flattening one corner. 16.328 -0

..... **\$55.00 EA** ⚠

Retainer



3676359.....47-51
For door lock cylinder. 16.328 -0.15

..... **\$7.50 EA** ⚠

Door Lock Gasket



1393155A.....42-46
Key (exterior).
16.328 -0.15

..... **\$1.50 EA** ⚠

Key Blank



601272.....35-54
Original GM round head. Fits trunk, glove box & locking gas cap.
2.187 -0.2

..... **\$4.00 EA** ⚠



3694624.....35-57
Original GM octagon head. Fits ignition, door & spare tire locks.
2.187 -0.15

..... **\$2.50 EA** ⚠

Door Lock Knob

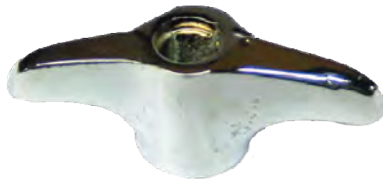

3654592.....34-40
Small Chrome T-handle. 3/16" square hole. 16.392 -0.15

..... **\$13.75 EA** ⚠



3658537.....41-46
Small chrome t-handle. 1/4" square hole. 16.390 -0.15

..... **\$13.00 EA** ⚠

Door Latch Striker

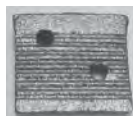

598777A.....39-46
Replacement.
16.335 -0.15

..... **\$24.00 EA** ⚠

Door Latch Striker, cont.



3684235B.....47-51
This is a door latch striker. 16.335 -0.15

..... **\$21.25 PR** ⚠



3753185B.....52-59
These are a pair of door latch strikers. 16.335 -0.15

..... **\$25.25 PR** ⚠

Door Dovetail Plate



474884.....37-46
Dovetail Wedge plate welds onto door
16.420 -0.15

..... **\$17.50 EA** ⚠

Door Dovetail Rubber Bumper



3681079.....37-46
2 rubber bumpers w/ metal caps. 2 pairs required per truck. 16.400 -0.15

..... **\$29.75 PR** ⚠

Door Latch Assembly



3684166.....47-51
Right 16.335 -0.15

..... **\$47.25 EA** ⚠

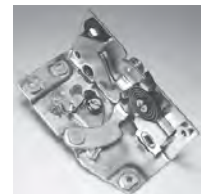

3684167.....47-51
Left 16.335 -0.15

..... **\$47.25 EA** ⚠

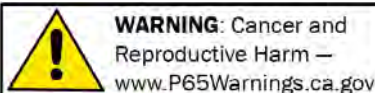

Chemicals shipped domestic ground only (Lower 48 states only). No international shipping.

Phone: (360) 816-0211 • (800) 999-CHEV (2438) • www.chevsofthe40s.com

Door Latch Assembly, cont.



TRQ-AEL0747-51
Altman easy latch set for Chevy trucks. Replace factory door latch assemblies with modern style latching mechanisms. 16.335 -0.15 **\$350.00 SET** ⚠



369881352-54
Left 16.335 -0.15 **\$54.25 EA** ⚠



369881452-54
Right 16.335 -0.15 **\$56.50 EA** ⚠



TRQ-AEL0852-54
Altman Easy Latch set. Replace factory door latch assemblies, with modern style latching mechanisms. 16.335 -0.15 **\$350.00 SET** ⚠

Latch Repair



3684167R47-63
Repair spring 16.335 -0.15 **\$5.00 EA** ⚠

Clutch Head Screw Set



3707583A47-51
Latch assembly to door (does both doors). 16.270 -0 **\$10.00 SET** ⚠



370758352-54
Latch assembly to door (does both doors). 16.270 -0.15 **\$6.25 SET** ⚠

Clutch Head Screw Set, cont.



4147641C52-54
Door latch striker (does both doors) (8 pcs). Uses 3/16" bit. 16.270 -0.3 **\$6.25 EA** ⚠

Ferrule



400374829-38
Chrome, w/ grommet, door handle. 10.537 -0 **\$7.50 EA** ⚠

408205639-46
Chrome, w/ grommet, door handle. 10.537 -0.4 **\$15.25 EA** ⚠

Rubber Grommet



4125630A39-46
Door handle ferrule. 10.537 -0 **\$7.00 EA** ⚠

Ferrule Tool



4088134AALL
Installs door handle ferrules. Return tool in same condition as sent for a \$20 refund. Does not fit with 4125630 10.537 -0.15 **\$46.00 EA** ⚠

Door Handle Interior



373434B34-38
Chrome. 16.345 -0.15 **\$36.50 EA** ⚠



365459339-46
Unplated, military army green color (NOS). 16.345 -0.15 **\$25.00 EA** ⚠



3654593C39-46
Chrome interior door handle. 16.345 -0.15 **\$33.00 EA** ⚠

Door Handle Interior, cont.



384887347-66
This is a chrome interior door handle. 16.345 -0.2 **\$13.00 EA** ⚠

Door Handle Interior Gasket



3686114B47-54
Interior door & window handles with door panel spacers (12pcs). 16.345 -0.15 **\$8.00 SET** ⚠

Screws



365459536-46
Window crank and interior door handle retaining screw 16.270 -0.15 **\$4.75 EA** ⚠



368325847-53
Retains original GM interior handles. 16.270 -0.4 **\$5.00 PR** ⚠

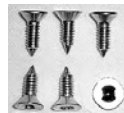

4147641B47-54
Clutch head, attaches the interior door handle remote to the door (6 pcs). 16.341 -0.15 **\$6.25 SET** ⚠

Return Spring



3661465B39-46
Both handles 16.342 -0.15 **\$13.25 PR** ⚠



369887947-54
Fits remote for interior handle. 16.342 -0.15 **\$9.50 EA** ⚠

Remote w/ Linkage

598912 **39-46**
 Metal link fits inside door, connects latch to inside handle. Fits left or right. Also fits GMC -0
 **\$12.00 EA** ⚠



3698877 **47-55**
 Left side for inside handle (original 52-55). 16.341 -0.15 **\$20.50 EA** ⚠

3698878 **47-55**
 Right side for inside handle (original 52-55). 16.341 -0.15 **\$20.50 EA** ⚠

Door Arm Rests



986154 **47-54**
 Brown (super!) 16.155 -0.15 **\$37.50 EA** ⚠

986154D **47-54**
 Black (super!) 16.155 -0.15 **\$37.50 EA** ⚠

986154M **47-54**
 Maroon. As original, Superb! 6" mounting holes (center-to-center). 16.155 -0.15 **\$51.25 EA** ⚠

Arm Rest Rubber Pad



3684360 **47-54**
 This is a arm rest rubber pad. 16.155 -0.15 **\$24.75 EA** ⚠

Arm Rest Bracket



3684383 **47-54**
 Black, plastic. 16.155 -0.15 **\$30.75 EA** ⚠

3684384 **47-54**
 Brown 16.155 -0.15 **\$28.25 EA** ⚠

Metal Trim Plate

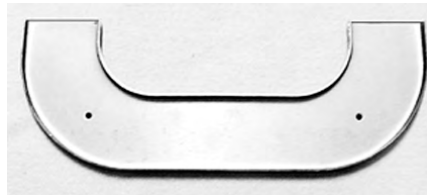

3684383A **47-54**
 For arm rest. 16.155 -0.15 **\$14.00 EA** ⚠

Odds & Ends

Please call for availability on all Odds & Ends parts; once part is sold, it may no longer be in stock.

598907 **39-46**
 Door Lock Remote 16.341 -0.4 **\$35.00 EA** ⚠

3684166U **47-51**
 Door latch assembly, used fits right hand 16.335 -0.4 **\$30.00 EA** ⚠

3848873U **47-66**
 Door handle (Used) 16.345 -0 **\$15.00 EA** ⚠

3695977 **51-54**
 Interior window moulding stainless steel (left) used in good condition 16.290 -0.4 **\$45.00 EA** ⚠

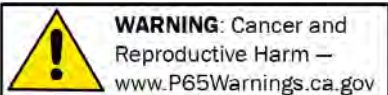

**SECTION 390T
RESTORATION PARTS**

Door Hinges



600211A37-38
Upper or lower. Fits left or right. Attaches to the cab post. 16.320 -0.15 **\$33.25 EA** ⚠



60334439-46
Lower w/ attaching bolts and pins. Fits left or right. 16.320 -0.15 **\$45.75 EA** ⚠



60334539-46
Upper w/ attaching bolts and pins. Fits left or right. 16.320 -0.15 **\$45.00 EA** ⚠



3847527B47-55
Left, upper & lower hinges (47-53 & 54-55 1st Series). Exc. COE 16.320 -0.15 **\$155.00 SET** ⚠



3847528B47-55
Right, upper & lower hinges (47-53 & 54-55 1st Series). Exc. COE 16.320 -0.15 **\$155.00 SET** ⚠

Door Hinge Bolt



3847527A47-55
Includes star lock washer. 6 per hinge needed. -0.4 **\$1.00 EA** ⚠

Hinge Seal



380777747-55
Back door, Panel & Suburban (4 pcs). 16.325 -0.15 **\$34.50 SET** ⚠

Hinge Pin



59865329-46
This is a door hinge pin made out of steel it that's 2-5/8 inch long. 16.323 -0.2 **\$2.00 EA** ⚠



598653A29-46
For Accessory Mirror. 16.323 -0.2 **\$6.50 EA** ⚠



598653S29-46
Stainless steel. 16.323 -0.15 **\$3.00 EA** ⚠



4023559B39-54
Pin w/ bushings. Fits back door on Suburban & Panel (3 pcs). 10.466 -0 **CALL** ⚠



384768547-54
1/8in. Oversize. 16.323 -0.3 **\$2.75 EA** ⚠

Door Strap Check Bracket



59640939-46
Replaces original which is normally rusted & broken. 16.440 -0.15 **\$19.75 EA** ⚠

Door Check Link Assembly



368174739-46
W/ rubber, pin & spring. 16.430 -0.15 **CALL** ⚠

Door Check Link Springs



369044747-54
These are door check link springs for the upper hinge. 16.323 -0.15 **\$7.25 PR** ⚠

Check Link Bumper

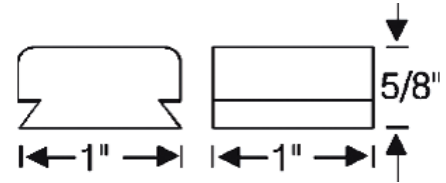

371131247-59
Back door (Panel & Suburban) 16.430 -0.15 **\$33.50 PR** ⚠

Odds & Ends

Please call for availability on all Odds & Ends parts; once part is sold, it may no longer be in stock.

3688764U47-55
Hinge. Door, right upper (Used) exc COE. 16.320 -0.4 **\$40.00 EA** ⚠

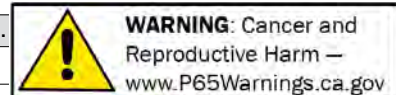

**SECTION 400T
RESTORATION PARTS**

Door Windlace



- 3847443** **36-49**
Black rubber 16.225 -0.2 **\$60.00 PR** ⚠
- 3681081G** **37-40**
Grey vinyl covered 16.225 -0 **CALL** ⚠
- 3681081K** **37-40**
Black vinyl covered 16.225 -0.15
..... **\$45.75 PR** ⚠
- 3681081N** **37-40**
Brown vinyl covered 16.225 -0.15
..... **\$45.75 PR** ⚠



- 3653999** **41-46**
Brown vinyl covered. 120" per side.
16.225 -0.15 **\$43.75 PR** ⚠
- 3681082** **41-46**
Black vinyl covered. 120" per side.
16.225 -0.15
..... **\$46.25 PR** ⚠
- 3681082G** **41-46**
Grey vinyl covered. 120" per side.
16.225 -0
..... **CALL** ⚠
- 3692458** **50-54**
Grey tan rubber 16.225 -0.15
..... **\$39.50 PR** ⚠



- 3692458A** **50-54**
Black rubber 16.225 -0.3 **\$83.50 PR** ⚠

Windlace Retainer



- 599595** **36-46**
On hinge post between dash and floor. Left and Right. Also fits GMC
16.230 -0
..... **\$19.75 PR** ⚠



- 3685651B** **50-55**
Left side, door. 3 pcs. 16.230 -0.15 **\$81.00 EA** ⚠



- 3685652B** **50-55**
Right side, door. 3 pcs. 16.230 -0.15 **\$81.00 EA** ⚠

Door Sill Seal



- 3681212** **37-46**
Attaches to cab, black (6 foot length)
16.225 -0.15 **\$24.75 EA** ⚠



- 3676019** **47-49**
Attaches to cab, black
16.225 -0.15
..... **\$12.00 SET** ⚠



- 3700547** **50-54**
Attaches to cab, grey/
brown 16.225 -0.15
..... **\$18.00 PR** ⚠



- 3700548** **50-54**
Attaches to cab (black)
16.225 -0.15
..... **\$10.25 PR** ⚠



- 3700548B** **50-55**
Attaches to cab, dark
blue, original, 54-55
Deluxe cab 16.225 -0.15
..... **\$21.50 PR** ⚠



- 3700548G** **50-55**
Attaches to cab, dark
green, original 54-55
Deluxe cab 16.225 -0.15
..... **\$21.50 PR** ⚠

Door Sill Seal Retainer



- 3683660** **47-49**
Steel (door sill seal) on cab. 16.230 -0.15
..... **\$15.00 EA** ⚠



- 3683660S** **47-49**
Stainless (door sill seal) on cab.
16.230 -0.15 **\$33.75 EA** ⚠



- 3683660BA** **47-53**
Polished billet aluminum door sill seal, on
cab (33-1/4"). 16.230 -0.15 **\$92.50 PR** ⚠



- 3693500** **50-54**
Steel (door sill seal) on cab. 33-5/8" long.
16.230 -0.15 **\$20.00 PR** ⚠



- 3693500S** **50-54**
Stainless (door sill seal) on cab. 33-5/8"
long. 16.230 -0.2 **\$64.25 SET** ⚠

Screws



- 3654597** **47-49**
Door sill metal retainer
(16 piece) 16.231 -0.4
..... **\$4.75 SET** ⚠



- 3654598** **50-54**
Door sill metal retainer
(8 pieces) 16.231 -0.4
..... **\$2.50 SET** ⚠

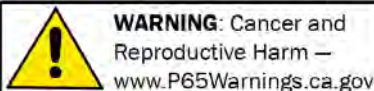

Chemicals shipped domestic ground only (Lower 48 states only). No international shipping.

Phone: (360) 816-0211 • (800) 999-CHEV (2438) • www.chevsofthe40s.com

Section 400T: Door Bumpers, Windlace & Weatherstrip

Door Weatherstrip



3700548A**37-54**
Original 47-54, does 2 doors 16.225 -0.15
..... **\$35.00 PR** ⚠



4143075A**39-46**
Panel. For both rear doors 10.694 -0
CALL ⚠



3700548A**47-54**
Panel & Suburban, does rear 2 doors
16.225 -0.15 **\$34.50 PR** ⚠

Metal Retainer



3691189**47-54**
Weatherstrip on door bottom (original
50-59) 16.230 -0.15 **\$18.00 SET** ⚠



3691189S**47-54**
Weatherstrip on door bottom (original
50-59) stainless steel with dull finish
16.230 -0.15 **\$28.00 PR** ⚠

Weatherstrip Clips



4076045**41-54**
Retains back door weatherstrip. Fits Panel
& Suburban (5 pcs) 10.695 -0
\$3.25 SET ⚠

Adhesives & Sealers



511114**ALL**
3M, Black weatherstrip cement, 5-oz tube.
Superior product!. 8.800 -0.2
\$20.00 EA ⚠

Door Bumper



3681070**30-46**
Door hinge post, 1in. x 1/4in. thick, held
by screw (2 pcs). 16.400 -0.15
\$9.00 SET ⚠



3681078**36-46**
Door jamb, rear. 5/8in. x 7/8in. x
1-7/16in. (41-46 uses 4). 16.400 -0.4
\$5.00 EA ⚠



3684752B**47-54**
Door jamb, rear (4 pcs). 3/4" dia
16.400 -0.3 **\$4.00 SET** ⚠

Dovetail Bumper



3807343**47-55**
Bumper, left, back door. Panel, Suburban
(use with old casings). 16.405 -0.15
\$17.25 EA ⚠

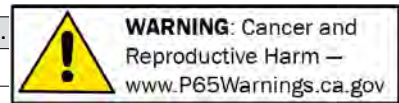

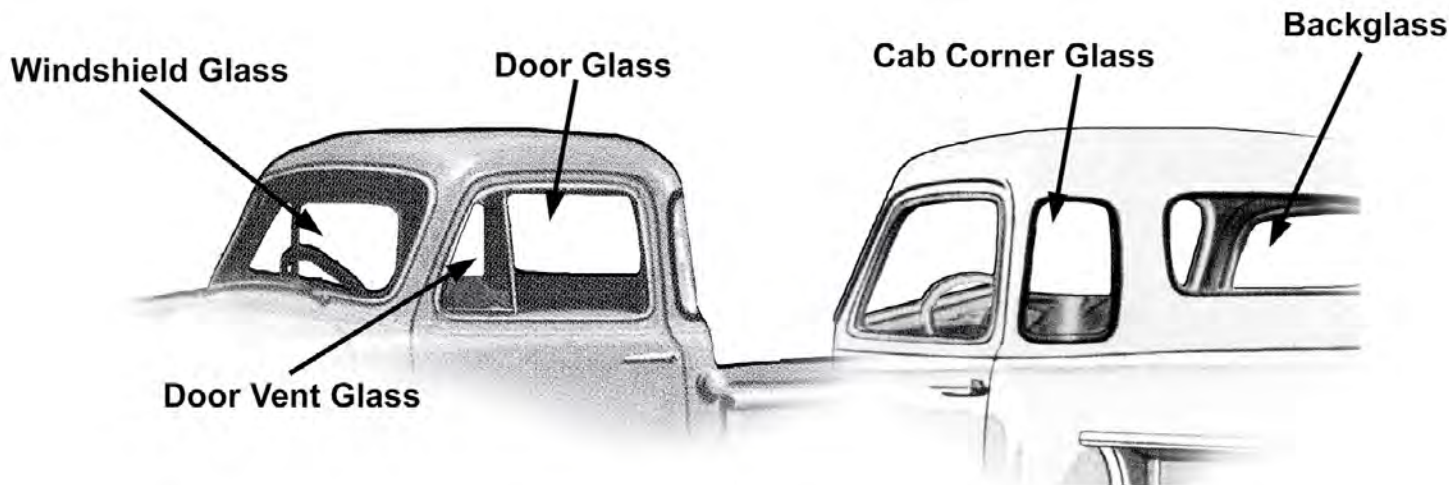

**SECTION 420T
STREET ROD PARTS**

One Piece V-Bent Windshield Glass

Give your truck that clean, customized look with a one piece windshield. No more messy silicone sealing the center seam found on V-Butt windshields. All V-Bent windshields come with rubber seal.



- 1021V** **39-46**
Clear. 16.005 -0.15 ... **\$399.00 EA** ⚠
- 1021VCS** **39-46**
Clear w/ shaded top. 16.005 -0.15
..... **\$440.00 EA** ⚠
- 1021VT** **39-46**
Tinted Green. 16.005 -0.15
..... **\$420.00 EA** ⚠
- 1021VTS** **39-46**
Tinted w/ shaded top. 16.005 -0.15
..... **\$440.00 EA** ⚠
- 4235V** **47-53**
Clear. 10.027 -0.15
..... **\$480.00 EA** ⚠
- 4235VCS** **47-53**
Clear w/ shaded top. 10.027 -0.15
..... **\$449.99 EA** ⚠
- 4235VG** **47-53**
Tinted grey. 10.027 -0.15
..... **\$540.00 EA** ⚠
- 4235VGS** **47-53**
Tinted grey w/ shaded top. 10.027 -0.15
..... **\$560.00 EA** ⚠

One Piece V-Bent Windshield Glass

- 4235VT** **47-53**
Tinted green 10.027 -0.15
..... **\$430.00 EA** ⚠
- 4235VTS** **47-53**
Tinted green w/ shaded top. 10.027 -0.15
..... **\$460.00 EA** ⚠

Back Glass & Frame

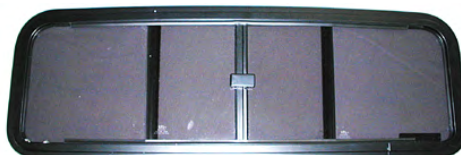

- 3704319C** **47-54**
Slider, with snap closer. Smoke tinted glass. Black frame. 16.464 -0.15
..... **\$169.25 EA** ⚠

**SECTION 420T
RESTORATION PARTS**

Windshield Glass

Note: Oversize shipping charges apply on all windshields. Please call for rate.

Note: Windshield glass dark tint unavailable. All glass is custom made. \$7 packaging fee.

- 985** **37-38**
Clear 16.005 -0.15
..... **\$100.00 EA** ⚠
- 985G** **37-38**
Tinted Grey 16.005 -0.15
..... **\$118.00 EA** ⚠
- 985GS** **37-38**
Tinted Grey with a shaded top 16.005 -0.15
..... **\$132.00 EA** ⚠

Windshield Glass, cont.

- 985S** **37-38**
Tinted Green w/ shaded top. 16.005 -0.15
..... **\$110.00 EA** ⚠
- 985T** **37-38**
Tinted Green 16.005 -0.15
..... **\$100.00 EA** ⚠
- 1021** **39-46**
Clear. Sold per side. 16.005 -0.15
..... **\$64.00 EA** ⚠
- 1021G** **39-46**
Tinted grey. Sold per side. 16.005 -0.15
..... **\$72.00 EA** ⚠
- 1021GS** **39-46**
Tinted grey with shaded top. Sold per side. 10.027 -0.15
..... **\$80.00 EA** ⚠
- 1021S** **39-46**
Tinted Green with shaded top. Sold per side. 10.027 -0.15
..... **\$72.00 EA** ⚠
- 1021T** **39-46**
Tinted Green. Sold per side. 16.005 -0.15
..... **\$64.00 EA** ⚠
- 4235G** **47-53**
Tinted Grey . Sold per side. 16.005 -0.15
..... **\$72.00 EA** ⚠
- 4235GS** **47-53**
Tinted Grey with shaded top. Sold per side. 16.005 -0.15
..... **\$180.00 PR** ⚠
- 4235S** **47-53**
Clear. Sold per side. 16.005 -0.15
..... **\$64.00 EA** ⚠
- 4235SGG** **47-53**
Tinted Grey. Sold per side. 16.005 -0
..... **\$80.00 EA** ⚠

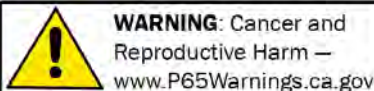

Chemicals shipped domestic ground only (Lower 48 states only). No international shipping.

Phone: (360) 816-0211 • (800) 999-CHEV (2438) • www.chevsofthe40s.com

Section 420T: Glass







Windshield Glass, cont.

4235SS	47-53
Tinted Green with shaded top. Sold per side. 16.005 -0.15	
.....	\$72.00 EA ⚠
4235ST	47-53
Tinted Green. Sold per side. 16.005 -0.15	
.....	\$64.00 EA ⚠
DW362	54
Curved Clear. 1-piece windshield. 16.005 -0.15	
.....	\$247.25 EA ⚠
DW362GS	54
Tinted Grey with shaded top. 1-piece windshield. 16.005 -0.15	
.....	\$291.50 EA ⚠
DW362S	54
Tinted Green with shaded top. 1-piece windshield. 16.005 -0.15	
.....	\$221.25 EA ⚠

Door Glass

3907	37-38
Clear 16.180 -0.15	
.....	\$48.00 EA ⚠
3907D	37-38
Tinted Grey -0.15	
.....	\$52.00 EA ⚠
3907T	37-38
Tinted Green -0.15	
.....	\$48.00 EA ⚠
4074	39-40
Clear 16.180 -0.15	
.....	\$58.00 EA ⚠
4074D	39-40
Tinted Grey -0.15	
.....	\$62.00 EA ⚠
4074T	39-40
Tinted Green -0.15	
.....	\$58.00 EA ⚠
4084S	41-46
Clear 16.180 -0.15	
.....	\$54.00 EA ⚠
4084SD	41-46
Tinted Grey -0.15	
.....	\$58.00 EA ⚠
4084ST	41-46
Tinted Green -0.15	
.....	\$54.00 EA ⚠
4236S	47-50
Clear 16.180 -0.15	
.....	\$60.00 EA ⚠
4236SD	47-50
Tinted Grey -0.15	
.....	\$64.00 EA ⚠

Door Glass, cont.

	4236SLSB	47-50
Clear left side, w/ black frame. 16.180 -0.15		
.....	\$147.00 EA ⚠	
	4236SLSC	47-50
Clear left side, w/ chrome frame. 16.180 -0.15		
.....	\$165.00 EA ⚠	
	4236SRSB	47-50
Clear right side, w/ chrome frame. 16.180 -0.15		
.....	\$147.00 EA ⚠	
	4236SRSC	47-50
Clear right side, w/ chrome frame. 16.180 -0.15		
.....	\$165.00 EA ⚠	
4236ST	47-50	
Tinted Green -0.15		
.....	\$60.00 EA ⚠	
4377S	51-54	
Clear 16.180 -0.15		
.....	\$44.00 EA ⚠	
4377SD	51-54	
Tinted Grey -0.15		
.....	\$50.00 EA ⚠	
	4377SLS	51-54
Clear left side w/ setting channel. 16.180 -0.15		
.....	\$99.00 EA ⚠	
	4377SRS	51-54
Clear right side w/ setting channel. 16.180 -0.15		
.....	\$99.00 EA ⚠	
4377ST	51-54	
Tinted Green 16.180 -0.15		
.....	\$44.00 EA ⚠	

Door Vent Glass

2907S	51-54
Clear. 16.174 -0.15	
.....	\$30.00 EA ⚠
2907SD	51-54
Tinted Grey -0.15	
.....	\$34.00 EA ⚠
2907ST	51-54
Tinted Green. -0.15	
.....	\$30.00 EA ⚠

Back Glass

2690	37-38
Clear 16.174 -0.15	
.....	\$32.00 EA ⚠
2690D	37-38
Tinted Grey -0.15	
.....	\$36.00 EA ⚠
2690T	37-38
Tinted Green -0.15	
.....	\$32.00 EA ⚠
2839	39-42
Clear for cab w/ die cast frame 16.174 -0.15	
.....	\$38.00 EA ⚠
2839D	39-42
Tinted Grey for Cab W/ Die Cast Frame. -0.15	
.....	\$42.00 EA ⚠
2839T	39-42
Tinted Green for Cab W/ Die Cast Frame. -0.15	
.....	\$38.00 EA ⚠
2651S	42-46
Clear 16.174 -0.15	
.....	\$38.00 EA ⚠
2651SD	42-46
Tinted Grey -0.15	
.....	\$42.00 EA ⚠
2651ST	42-46
Tinted Green -0.15	
.....	\$38.00 EA ⚠
2720S	47-54
Clear. 16.174 -0.15	
.....	\$54.00 EA ⚠
2720SD	47-54
Tinted Grey 16.174 -0.15	
.....	\$58.00 EA ⚠
2720ST	47-54
Tinted Green. 16.174 -0.15	
.....	\$54.00 EA ⚠

Rear Corner Cab Glass (Laminated)

BB57C	47-54
Clear, laminated (will not fit COE) 16.174 -0.15	
.....	\$180.00 PR ⚠
BB57G	47-54
Tinted grey, laminated (will not fit COE) 16.174 -0.15	
.....	\$192.00 PR ⚠
BB57T	47-54
Tint green, laminated (will not fit COE) 16.174 -0.15	
.....	\$180.00 PR ⚠

Returns require a return authorization number—call first. • Product pricing & availability subject to change.

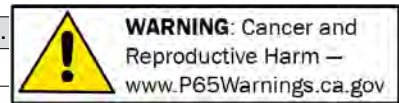

Section 420T: Glass

Suburban/ Panel Back Glass

2689 37-38 Clear 16.174 -0.15 \$44.39 EA ⚠
2689D 37-38 Grey -0.15 \$57.25 EA ⚠
2689T 37-38 Green Tint -0.15 \$45.75 EA ⚠
2838 39-46 Clear 16.174 -0.15 \$15.00 EA ⚠
2838D 39-46 Tinted Grey -0.15 \$34.00 EA ⚠
2838T 39-46 Tinted Green -0.15 \$30.00 EA ⚠
BB59C 47-54 Chevy/GMC, Suburban end lift gate, tempered, Clear -0.15 . \$484.09 EA ⚠
BB59G 47-54 Chevy/GMC, Suburban end lift gate, tempered. Tinted Grey -0.15 \$511.00 EA ⚠
BB59T 47-54 Chevy/GMC, Suburban end lift gate, tempered. Tinted Green -0.15 \$490.25 EA ⚠
DB60 47-54 Panel & Suburban. Clear, left (curved). 16.174 -0.15 \$110.00 EA ⚠
DB60G 47-54 Panel & Suburban. Tint Grey, left (curved) 16.174 -0 \$130.00 EA ⚠
DB60T 47-54 Panel & Suburban. Tint Green, left (curved) 16.174 -0.15 \$110.00 EA ⚠
DB61 47-54 Panel & Suburban Clear Right (Curved) 16.174 -0.15 \$110.00 EA ⚠
DB61G 47-54 Panel & Suburban Tint Grey Right (Curved) 16.174 -0 \$130.00 EA ⚠
DB61T 47-54 Panel & Suburban Tint Green Right (Curved) 16.174 -0.15 \$110.00 EA ⚠

Suburban Front Side Glass

2719S 47-52 Clear 17.136 -0.15 \$58.00 EA ⚠
2719SD 47-52 Tinted Grey -0.15 \$62.00 EA ⚠
2719ST 47-52 Tinted Green -0.15 \$58.00 EA ⚠
3007SD 52-54 Tinted Grey -0.15 \$72.25 EA ⚠
3007S 53-54 Clear 17.136 -0.15 \$69.75 EA ⚠
3007ST 53-54 Tinted Green -0.15 \$58.00 EA ⚠

Suburban Rear Side Glass

4237S 47-52 Clear 17.136 -0.15 \$70.89 EA ⚠
4237SD 47-52 Tinted Grey -0.15 \$93.25 EA ⚠
4237ST 47-52 Tinted Green -0.15 \$74.50 EA ⚠
4467S 53-54 Clear 17.136 -0.15 \$88.75 EA ⚠
4467SD 53-54 Tinted Grey -0.15 \$93.25 EA ⚠
4467ST 53-54 Tinted Green -0.15 \$74.50 EA ⚠

Suburban Qtr Front Glass

4075 39-46 Clear 17.136 -0.15 \$76.00 EA ⚠
4075D 39-46 Tinted Grey -0.15 \$80.00 EA ⚠
4075T 39-46 Tinted Green -0.15 \$76.00 EA ⚠
2721S 47-52 Clear 17.136 -0.15 \$69.75 EA ⚠
2721SD 47-52 Tinted Grey -0.15 \$72.25 EA ⚠



Suburban Qtr Front Glass, cont.

2721ST 47-52 Tinted Green -0.15 \$58.00 EA ⚠
3008S 53-54 Clear 17.136 -0.15 \$69.75 EA ⚠
3008SD 53-54 Tinted Grey -0.15 \$72.25 EA ⚠
3008ST 53-54 Tinted Green -0.15 \$58.00 EA ⚠

Suburban Qtr Rear Glass

4076 39-46 Clear 17.136 -0.15 \$80.00 EA ⚠
4076D 39-46 Tinted Grey -0.15 \$84.00 EA ⚠
4076T 39-46 Tinted Green -0.15 \$80.00 EA ⚠
4238S 47-52 Clear 17.136 -0.15 \$75.09 EA ⚠
4238SD 47-52 Tinted Grey -0.15 \$98.39 EA ⚠
4238ST 47-52 Tinted Green -0.15 \$79.25 EA ⚠
4466S 53-54 Clear 17.136 -0.15 \$94.00 EA ⚠
4466SD 53-54 Tinted Grey -0.15 \$98.50 EA ⚠
4466ST 53-54 Tinted Green -0.15 \$79.25 EA ⚠

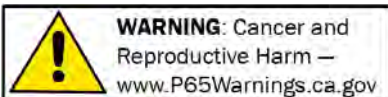

Chemicals shipped domestic ground only (Lower 48 states only). No international shipping.

Phone: (360) 816-0211 • (800) 999-CHEV (2438) • www.chevsofthe40s.com

**SECTION 430T
RESTORATION PARTS**

Windshield Regulator Rebuild



3654088**36-46**
Rebuild service, casting & metal tape must be good, exchange. 16.045 -0.15
..... **\$299.00 EA** ⚠

Windshield Regulator



475838B.....**36-38**
CB-238 New Casting
Handcrafted In The
USA -0
..... **\$425.00 EA** ⚠

475838R**36-38**
Rebuilt #CB-238 (\$150 core charge)
16.045 -0.15
..... **CALL** ⚠



598876R **39**
Rebuilt #CB-291 (\$100 core charge)
16.045 -0.15 **\$249.00 EA** ⚠

3654088B**40-46**
CB-301 New Casting Handcrafted In The
USA -0
..... **\$425.00 EA** ⚠



3654088R**40-46**
Rebuilt #CB-301 (\$150 core charge)
16.045 -0.15 **\$325.00 EA** ⚠

Strap Bracket



475838A**36-38**
Windshield crank-out. 16.045 -0.3
..... **\$16.00 EA** ⚠

Strap Bracket, cont.



3653708**39-46**
Windshield crank-out, black stamped
steel. 16.045 -0.15 **\$19.75 EA** ⚠

Windshield Crank



476536**36-38**
With chrome knob
16.050 -0.15
..... **\$39.75 EA** ⚠



598909..... **39**
W/ black knob 16.050 -0.15
..... **\$29.75 EA** ⚠



3654631A **40-46**
W/ brown knob 16.050 -0.15
..... **\$29.75 EA** ⚠

Grommet



598986.....**37-38**
Grommet, windshield
crank to dash.
16.053 -0.15
..... **\$1.75 EA** ⚠

Knob



598910A..... **39**
Window or windshield
crank. Black. 16.270 -0.15
..... **\$14.75 EA** ⚠



3654632B**40-46**
Window or windshield
crank. Rose tan.
16.270 -0.15
..... **\$14.00 EA** ⚠

Windshield Rubber Bumper



3681093**37-46**
Windshield Rubber Bumper 16.058 -0
..... **\$9.25 PR** ⚠

Windshield Divider



3651622**39-46**
Rubber retainer
w/ threaded steel
core, no moulding.
16.017 -0.15
..... **\$85.75 SET** ⚠

598972D**39-46**
Windshield interior center divider -0.15
..... **\$25.00 EA** ⚠

Windshield Frame



602132..... **36**
Steel, low roof cab, special order (Super!)
16.010 -0.15 **\$419.00 EA** ⚠



602132C **36**
Chrome, low roof cab, (Super!) 16.010 -0.15
..... **\$845.00 EA** ⚠



602498B**37-38**
Steel (Super!) 16.010 -0.15
..... **\$489.00 EA** ⚠

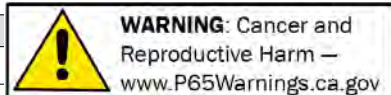

Section 430T: Windshield Rubber, Windshield Frames, Windshield Cranks & Related

Windshield Frame, cont.



602498C **37-38**
 Chrome (Super!) 16.010 -0.15
\$875.00 EA ⚠



598972 **39-46**
 Steel (Super!) 16.010 -0.15
\$480.00 EA ⚠

598972C **39-46**
 Chrome (Super!) 16.010 -0.15
\$998.00 EA ⚠

Trim Clip



602498A **37-38**
 Windshield frame.
 16.010 -0.15
\$24.75 PR ⚠

Windshield Frame Connecting Inserts



602132A **36-38**
 W/ stainless steel screws.
 Holds frame halves together.
 16.025 -0.2
\$73.50 SET ⚠



592329 **39-46**
 W/ stainless steel screws.
 Holds frame halves together.
 16.025 -0.15
\$29.00 SET ⚠

Windshield Moulding



3676579 **39-46**
 Exterior. Center aluminum w/ 2 pc rubber
 set. 16.017 -0.15 **\$94.50 SET** ⚠

Windshield Moulding, cont.



3684697B **47-53**
 Painted with upper & lower caps &
 fasteners. 16.018 -0.15 **\$22.00 SET**
 ⚠



3684697S **47-53**
 Interior. Stainless windshield division trim.
 16.018 -0.15 **\$39.75 EA** ⚠



3684807 **47-53**
 Complete set of exterior mouldings.
 Stainless Steel. 16.041 -0.15
\$80.00 SET ⚠



3684809 **47-53**
 Exterior. Stainless windshield division trim.
 16.017 -0.15 **\$43.75 EA** ⚠

Windshield Frame Seal



3681322B **36-38**
 36 low roof cab,
 vulcanized. 16.042 -0.15
\$43.75 EA ⚠



3681322 **39-46**
 Vulcanized. 16.042 -0.15
\$43.75 EA ⚠

Windshield Rubber

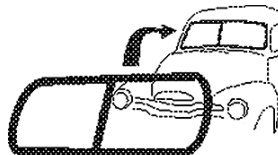

3684695 **47-53**
 For mouldings. 16.040 -0.3
\$92.00 EA ⚠



3684802 **47-53**
 Without mouldings (no
 holes in center of
 rubber). 16.040 -0.15
\$40.25 EA ⚠

Windshield Rubber, cont.

3684802A **47-53**
 W/out mouldings. 1 piece for V-Bent,
 V-Butt. 16.040 -0.15
\$101.25 EA ⚠



3703533 **54**
 W/out mouldings.
 16.040 -0.15
\$37.00 EA ⚠



3703534 **54**
 For mouldings.
 16.040 -0.15
\$37.50 EA ⚠

Setting Tape



603954B **29-46**
 Windshield glass (120 in. length). 10.696 -0
 **\$25.75 SET** ⚠

603954BULK^ **ALL**
 1/32 in. thick, sold by the inch 10.696 -0

..... **\$0.25 IN** ⚠



603955BULK^ **ALL**
 Setting tape 1/16 in.
 thick sold by the inch
 10.696 -0

..... **\$0.25 IN** ⚠

Screw Set



3684481A **47-54**
 Windshield garnish moulding (14 pcs).
 16.290 -0.4 **\$3.50 SET** ⚠

Odds & Ends

Please call for availability on all Odds & Ends
 parts; once part is sold, it may no longer be in
 stock.

3684809U **47-53**
 Moulding outer windshield w/
 reinforcement 16.017 -0.4

..... **\$50.00 EA** ⚠

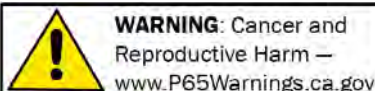

WARNING: Cancer and
 Reproductive Harm —
www.P65Warnings.ca.gov

Chemicals shipped domestic ground only (Lower 48 states only). No international shipping.

Phone: (360) 816-0211 • (800) 999-CHEV (2438) • www.chevsofthe40s.com

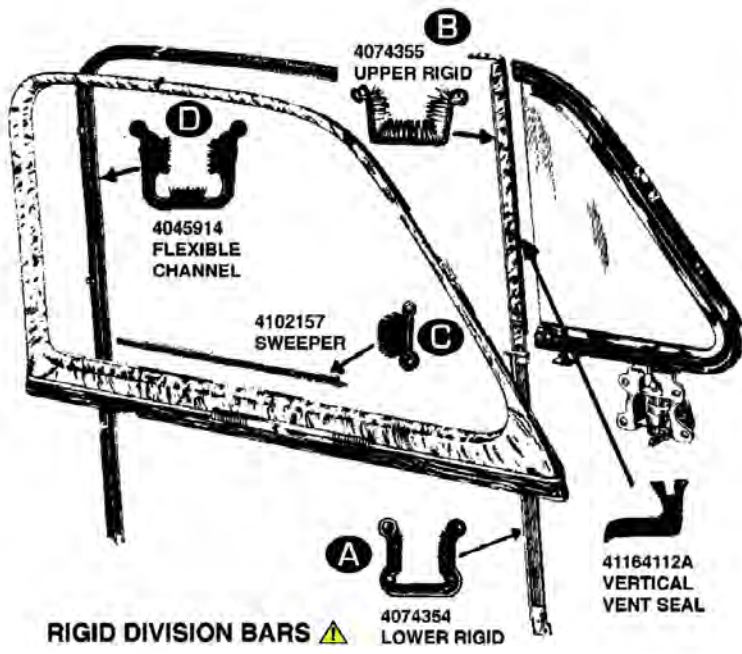

RIGID DIVISION BARS ⚠️

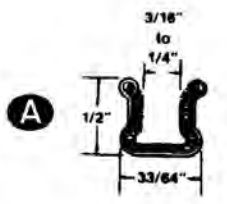

'40-60 GM RIGID RUN CHANNEL SIDE WINDOW, LOWER
4074354-36" PC. \$12.75 EA

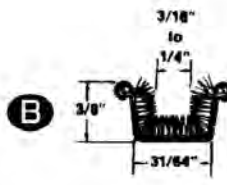

'33-60 GM CARS RIGID DIVISION BAR WITH STAINLESS STEEL BEAD
4074355-36" PC. \$12.75 EA
ACTUAL SIZE



FLEXIBLE SWEEPER
G.M.C. TRUCKS '46-'49
LATE 50's GM CARS
STAINLESS STEEL BEAD
3684760 \$0.50 per inch



FLEXIBLE SWEEPER
'33-'60 CHEV
INNER & OUTER
BELT-LINE, ALSO
SLIDING QTR. WINDOWS.
EASILY FORMED FOR
QTR. WIND.
STAINLESS STEEL BEAD
4102157 \$0.25 per inch



FOR RELINING PERMANENT GUIDE BARS ON A FEW CONVERTIBLES. BLACK MOHAIR LINING MATERIAL WITH RUBBERIZED BACKING TO BE CEMENTED IN PLACE.

CC 22 (1 5/8" WIDE) \$7.25 FT.

For all Nomads & Wagons

'46-'56 GLASS SETTING SEAL USED ON TL GATE ONLY.
01C201PL \$3.50 FT.



LOWER SIDE WINDOW CARRIER GLASS SETTING WITH WEATHER LIP FOR 5/8 CHANNEL DEPTH.
'30-'40 CHEV.
'46-'56 STATION WAGON
01A201PL \$4.75 FT.

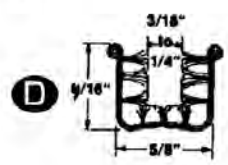

FLEXIBLE GLASS CHANNEL, MOHAIR LINED, CLOTH COVERED, STAINLESS STEEL BEADS. FITS '33-'60 GM SIDE WINDOWS.
4045914-108" PC. \$36.00 EA

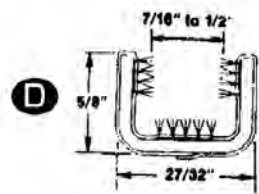

FLEXIBLE GLASS CHANNEL, MOHAIR LINING. '50-'83 CHEV & GMC TRUCKS '41-'64 GM CARS. FOR WINDOWS WITH METAL FRAMES ONLY.
4075477-96" PC. \$34.25 EA
4075477-72" PC. \$26.00 EA

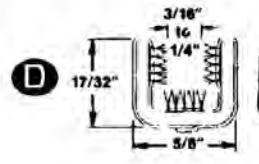

FLEXIBLE, UNBEADED PILE LINED. FITS '33-'62 CHEV & GMC PICKUPS & PANELS WITHOUT FRAMED SIDE GLASS.
598746-96" PC. \$29.00 EA



2127 Parkerized

Door window reveal moulding fastener, corner: Chevrolet '41-'48 Special Deluxe Oldsmobile '41-'48, Model 60 Pontiac '41-'48, Models 25 and 27 \$3.00 EA

TO BE SLIPPED ON DOOR PANEL FASTENER STRIP FOR REPAIRS TO REPLACE BROKEN NAILS IN PANEL EDGING.



7/16" NAIL (.460)
ALL GENERAL MOTORS
WF18 \$2.00 (2 pcs)
"NAIL ON" DOOR PANEL REPAIR CLIPS

**SECTION 440T
RESTORATION PARTS**

Vent Window Assembly



3699713B51-54
Left side assembly with glass and chrome post.
16.173 -0.15
..... **\$299.00 EA** ⚠



3699713BP51-54
Left side assembly with glass and painted post. 16.173 -0.15
..... **\$279.00 EA** ⚠



3699714B51-54
Right side assembly with glass and chrome post. 16.173 -0.15
..... **\$300.00 EA** ⚠



3699714BP. .51-54
Right side assembly with glass and painted post
16.173 -0.15
..... **\$279.00 EA** ⚠



369565551-55
Left side outer assembly. Black frame (no glass).
Note: Does not come with vertical vent seals.

16.173 -0.15
..... **\$148.00 EA** ⚠

3695656 51-55
Right side outer assembly. Black frame (no glass).
Note: Does not come with vertical vent seals. 16.173 -0.15
..... **\$148.00 EA** ⚠

Vent Window Handle



3695416R51-54
Right. 16.176 -0.15
..... **\$15.50 EA** ⚠



3695417L.51-54
Left. 16.176 -0.15
..... **\$15.50 EA** ⚠

Vent Window Rubber



369602751-54
Original C shape w/
upper pivot pins,
verticals w/ metal
backs. 16.175 -0.15

..... **\$49.25 PR** ⚠



3696027A51-54
Vertical vent window rubber seal 16.175 -0
..... **\$49.00 PR** ⚠

Pivot Pin



417337651-65
Vent window. Upper
10.669 -0.4
..... **\$2.50 PR** ⚠

Tool



4173376A49-65
Sets vent window pivot pin. 10.669 -0.15
..... **\$5.00 EA** ⚠



WARNING: Cancer and Reproductive Harm —
www.P65Warnings.ca.gov

Chemicals shipped domestic ground only (Lower 48 states only). No international shipping.

Phone: (360) 816-0211 • (800) 999-CHEV (2438) • www.chevsofthe40s.com

**SECTION 450T
RESTORATION PARTS**

Window Reveal Mouldings

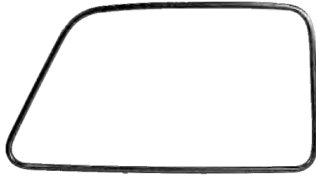

368484747-54
Left door, primered. 16.185-0.15
\$55.25 EA ⚠



3684847B47-54
Exterior chrome plated Stainless.
16.185-0.15 **\$189.00 L&R** ⚠

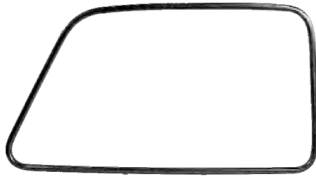

368484847-54
Right door, primered. 16.185-0.15
\$55.25 EA ⚠

Garnish Moulding



368448147-50
Interior left side. Primered. 16.290-0.15
\$85.00 EA ⚠

368448247-50
Interior right side. Primered. 16.290-0.15
\$85.00 EA ⚠

Window Shades



987203A51-54
Accessory. Stainless steel mounts over
door glass. 9.694-0.15 **\$38.50 PR** ⚠

Glass Channel Kit

Window Channel Kits: These are super complete and include sweepers, rigid channel, flexible channel, stops, screws, clips & rubber bumpers as needed. Complete for 2 doors.

Note: Window Channel Kits are oversized. Special shipping rates apply, please call for rate.

598746B37-46
Glass channel kit includes flexible cloth covered channel, inner and outer rubber window wiper, window stop bumpers, clips and screws to install. 16.200-0.15
\$91.00 KIT ⚠

368443447-50
Glass Channel Kit. 16.200-0.15
\$130.00 KIT ⚠

3699865B51-54
For original doors with vent windows. 16.200-0.15
\$110.00 KIT ⚠

3699865C51-54
For doors that have been modified with removed vent windows. 16.200-0.15
\$135.00 KIT ⚠

Quarter Channel Kit Suburban

4070069C47-54
Fits Suburban. Complete for two windows. W/ quarter window rubber (#4070069). 17.136-0
\$110.00 SET ⚠

Lower Glass Sash Channel

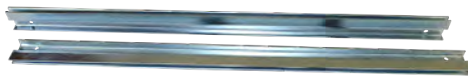

59869036-40
Lower door glass setting channel as original 16.190-0.2 **\$72.75 L&R** ⚠



365749141-46
Lower door glass setting channel as original 16.190-0.2 **\$79.75 L&R** ⚠



3684169B47-50
Lower door glass setting channel as original. Doesn't include track for window regulator. 16.190-0.15 **\$72.39 L&R** ⚠

Lower Glass Sash Channel, cont.



369555151-55
51-55 (1st Series) 16.190-0.15
\$46.00 EA ⚠

Regulator Upper Guide



409997447-50
Cam Track 16.261-0.2 **\$35.00 EA** ⚠

Setting Tape Door Glass



6039544037-40
Setting tape for 2 doors (120 in. length). 10.696-0
\$16.25 SET ⚠

6039545041-50
Setting tape for 2 doors (168 in. length). 10.696-0.15
\$16.50 SET ⚠

6039545451-54
Setting tape for 2 doors (90 in. length). 10.696-0.15
\$10.75 SET ⚠

603954BULK^ALL
1/32 in. thick, sold by the inch 10.696-0
\$0.25 IN ⚠



603955BULK^ALL
Setting tape 1/16 in. thick sold by the inch 10.696-0
\$0.25 IN ⚠

Window Wiper



384705136-46
Inner & outer rubber included in channel kit (4 piece) 16.183-0.15
\$17.25 SET ⚠



384760847-50
Outer (rubber included in channel kit). 16.183-0.15
\$33.50 PR ⚠



3847608A51-54
Outer (rubber included in channel kit). 16.183-0.15
\$8.00 SET ⚠



Channel (Guide)



3809865B47-50
W/ brackets, lower rear door glass.
16.190 -0 **CALL** ⚠



3721781A51-54
W/ brackets, lower rear door glass.
16.190 -0.15 **\$38.00 PR** ⚠

Lower Glass Run Post



368536947-50
Left side W/ brackets, lower front door
glass. 16.190 -0.15 **\$40.00 KIT** ⚠

368537047-50
W/ brackets, right lower front door glass.
16.190 -0.2 **\$40.00 KIT** ⚠



3685369M47-54
W/ brackets, lower front door glass. For
vent window removal. 16.190 -0.2
\$40.00 KIT ⚠

3685370M47-54
W/ brackets, lower front door glass. For
vent window removal. 16.190 -0.2
\$40.00 KIT ⚠

Window Stop Bumper



368107236-46
Window Stop Bumper.
16.245 -0.3 **\$2.29 PR** ⚠

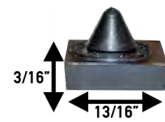

413105247-54
Window Stop Bumper
10.716 -0.15 **\$4.00 PR** ⚠

Screws & Sleeve Nuts



369407147-50
Attaches upper and
lower door frame glass.
16.190 -0.15 **\$5.00 SET** ⚠

Adhesives & Sealers



306105ALL
Super Glue Gel.
Bonds to ABS,
Ceramic, cork,G10
Epoxy Glass, Leather
and paper. Splice
window gaskets &
sponge weather strip
& more. 8.800 -0.15

..... **\$3.25 EA** ⚠



306106ALL
LOCTITE Super Glue,
Ultra Gel Control.
Bonds to Metal,
Rubber, Ceramics,
Wood, Leather,
Paper & Plastics.
Rubber to metal &
rubber to rubber
bonding. Splice

window gaskets & sponge weather strip &
more. 8.800 -0.15

..... **\$6.50 EA** ⚠



511114ALL
3M, Black weatherstrip cement, 5-oz tube.
Superior product!. 8.800 -0.2
\$20.00 EA ⚠

Adhesives & Sealers, cont.



986199AALL
3M Contact
cement for rubber
to metal. Bonds
instantly. Industrial
quality for gravel
guards, running
board rubber, etc.
8.800 -0.15
..... **\$63.25 QT** ⚠



GL14ALL
Windshield sealer.
Seals leaks in new &
old installation. Will
not dry out rubber.
Remains pliable.
8.991 -0.15
..... **\$7.25 EA** ⚠

Odds & Ends

Please call for availability on all Odds & Ends
parts; once part is sold, it may no longer be in
stock.

368484747-53
Reveal door mouldings, left (Used)
16.181 -0.4

..... **\$75.00 EA** ⚠

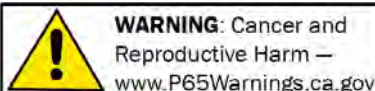

WARNING: Cancer and
Reproductive Harm —
www.P65Warnings.ca.gov

Chemicals shipped domestic ground only (Lower 48 states only). No international shipping.

Phone: (360) 816-0211 • (800) 999-CHEV (2438) • www.chevsofthe40s.com

**SECTION 460T
STREET ROD PARTS**

Window Crank Switch

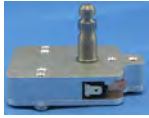

NU-CRANKS12 ALL
Use your original crank handles as your switches. GM 1949 & earlier, small round

spline. Pair. -0.15

\$240.00 PR ⚠

NU-CRANKS13 ALL
Use your original crank handles as your switches. GM 1950 & later, large round spline, long shaft. Pair. -0.15

\$240.00 PR ⚠

NU-CRANKS14 ALL
Use your original crank handles as your switches. GM 1950 & later. Large round spline, short shaft. Pair. -0.15

\$240.00 PR ⚠

NU-CRANKSU ALL
Use your original crank handles as your switches. Upgrade to power window kit only -0.15

\$180.00 PR ⚠

Power Window Conversion Gear Driven Bolt In

These kits directly bolt into original mounting holes. 1018 cold rolled steel, brass oilite thrust bearings, Delco OEM Motors and gear teeth cryogenically treated for long life. Includes Delco OEM Chrome or Illuminated switches and conduit for wiring. Comes with a lifetime warranty.



3684175 36-46
1936-46 Chevy truck. Complete kit with chrome or black switches. 16.180 -0

\$524.00 PR ⚠

3684176 47-50
1947-50 Chevy truck. Complete kit with chrome or black switches. Fits Suburban & COE also 16.180 -0

\$474.00 PR ⚠

3684177 51-54
1951-54 Chevy Truck, Panel Truck, Suburban and COE. Complete kit with chrome or black switches. 16.180 -0

\$474.00 PR ⚠

Power Window Conversion Gear Driven Bolt In, cont.

36841771 51-54
1951-54 Chevy truck. Complete kit with chrome or black switches. Includes kit for vent window removal conversion. 16.180 -0

\$579.00 PR ⚠

Power Window Conversion Cable Driven

These kits come complete with two cable drive regulators. Uses heavy duty OEM style motors (switches & harness sold separately)



3684164 51-54
Trucks WITH vent window. Bolt in. Does NOT include switches or wiring harness (sold separately). 16.180 -0.15

\$418.00 PR ⚠

**SECTION 460T
RESTORATION PARTS**

Window Regulator



594279A 36-46
Repair kit. Left or right side. Includes rivets & spring inside cup. 16.260 -0.15

CALL ⚠



594279AS 36-46
Spring -Window Regulator Clutch 16.260 -0

\$3.25 EA ⚠



594279GA 36-46
Window Regulator Large Metal Gear 38 Teeth 16.260 -0.15

\$22.00 EA ⚠



3676433 47-50
Complete with arms. Left. 16.260 -0.15

\$59.50 EA ⚠

Window Regulator, cont.



3676433A 47-50
Repair kit. Left or right side. Includes rivets & spring inside cup. -0.15

\$29.75 KIT ⚠



3676434 47-50
Complete with arms. Right. 16.260 -0.15

\$59.50 EA ⚠



3695521A 47-54
Spring. 16.260 -0.15

\$4.75 EA ⚠



3695521 51-54
Complete with arms. Left. 16.260 -0.15

\$59.50 EA ⚠

3695522 51-54
Complete with arms. Right. 16.260 -0.15

\$59.50 EA ⚠

Knob



598910A 39
Window or windshield crank. Black. 16.270 -0.15

\$14.75 EA ⚠



3654632B 40-46
Window or windshield crank. Rose tan. 16.270 -0.15

\$14.00 EA ⚠



3683723A 47-50
Window crank, chrome. Original color and quality. 16.270 -0

CALL ⚠



3702164A 54-57
Window crank, black. 16.270 -0.4

\$15.00 EA ⚠

Section 460T: Window Crank, Window Regulator & Power Window Kits

Window Crank



4200151**29-38**
 With chrome knob 16.270 -0.15
\$42.50 EA ⚠



3654595**36-46**
 Window crank and interior door handle
 retaining screw 16.270 -0.15 **\$4.75 EA**
 ⚠



598910 **39**
 With black knob. 16.270 -0.15
\$34.75 EA ⚠



3654632A**40-46**
 With rose tan knob. 16.270 -0.15
\$39.75 EA ⚠



3683723**47-50**
 W/ chrome knob for you to install. 16.270 -0
 **CALL** ⚠

Window Crank, cont.



3702164B**47-60**
 W/ replacement black knob. 16.270 -0.15
 **\$13.75 EA** ⚠



3702164**54-57**
 W/ black knob. 16.270 -0.2 **\$16.50 EA**
 ⚠

Odds & Ends

Please call for availability on all Odds & Ends parts; once part is sold, it may no longer be in stock.

3654632U**39-46**
 Window crank w/ ivory knob (Used)
 16.270 -0.4
 **\$15.00 EA** ⚠
3702164BU**47-60**
 Window crank (Used) 16.200 -0
 **\$6.00 EA** ⚠

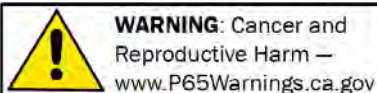

Chemicals shipped domestic ground only (Lower 48 states only). No international shipping.

Phone: (360) 816-0211 • (800) 999-CHEV (2438) • www.chevsofthe40s.com

**SECTION 480T
STREET ROD PARTS**

Back Glass & Frame

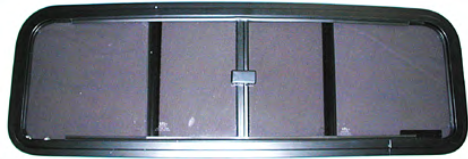

3704319C47-54
Slider, with snap closer. Smoke tinted glass. Black frame. 16.464 -0.15
\$169.25 EA ⚠

**SECTION 480T
RESTORATION PARTS**

Back Glass Rubber

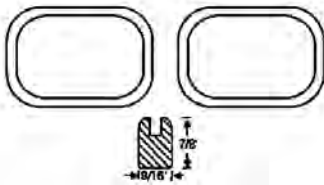

46353534-38
Panel & Suburban, vulcanized 16.470 -0.15
\$110.25 PR ⚠

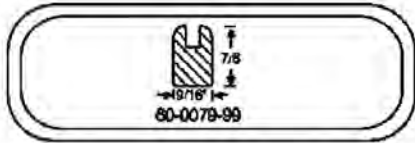

384742136-38
Low roof cab, vulcanized 16.470 -0.15
\$109.75 EA ⚠

59970136-42
For die cast frame 16.470 -0.15
\$30.75 EA ⚠



384742039-42
Vulcanized, for die cast frame 16.470 -0.15
\$109.75 EA ⚠

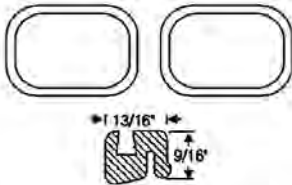

380625239-46
Panel & Suburban, vulcanized 16.470 -0.15
\$118.25 PR ⚠

Back Glass Rubber, cont.

384741842-46
W/ chrome lock strip 16.470 -0.2
\$18.00 SET ⚠

384741942-46
With lock strip 16.470 -0.2
\$18.00 SET ⚠

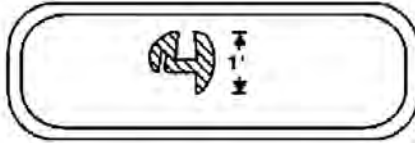

380791747-54
Panel & Suburban w/ end gate, vulcanized 16.470 -0.15
\$104.50 EA ⚠

384741647-54
W/ chrome lock strip 16.470 -0.15
\$18.00 SET ⚠

384741747-54
W/ lock strip 16.470 -0.15
\$18.00 SET ⚠

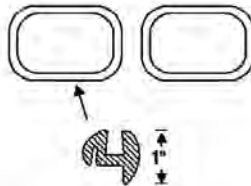

380753547-57
Panel & Suburban w/ doors, vulcanized 16.470 -0.15
\$112.50 PR ⚠

3807535A47-57
Panel & Suburban w/ doors. 16.470 -0.15
\$34.25 PR ⚠

Screw Set

3667020B37-41
Back glass frame (clutch head). 16.475 -0.15
\$6.75 SET ⚠

Rear Corner Glass Rubber



384741447-54
W/ chrome lock strip 16.470 -0.15
\$18.00 PR ⚠

Rear Corner Glass Rubber, cont.



384741547-54
W/ lock strip 16.470 -0.15
\$18.00 PR ⚠

Chrome Lock Strip

3847415A42-54
Back glass (8 ft) 16.469 -0.15
\$6.00 EA ⚠

3847415B47-54
Corner glass (8ft) 16.469 -0.15
\$6.00 PR ⚠

Rectangular Retaining Rubber



407006947-54
For quarter window, Suburban (does two windows) 17.136 -0.15
\$52.00 PR ⚠

Black Lock Strip Bulk

01B7951ASALL
For Back Glass Rubber. Fits rear and quarter glass. Sold by the foot. 16.469 -0.4
\$1.50 FT ⚠

Chrome Lock Strip Bulk

01B7951ACALL
For rear and quarter glass. Sold by the foot. 16.469 -0.3
\$1.50 FT ⚠

Tool



3847415T42-54
Inserts back glass rubber lock strip. 16.469 -0.2
\$55.00 EA ⚠

ADD COLOR AND STYLE TO YOUR TRUCK BED WITH EXOTIC AND DOMESTIC BED WOODS!!

Kiln-dried and stabilized. Properly milled, sanded and ready to finish.

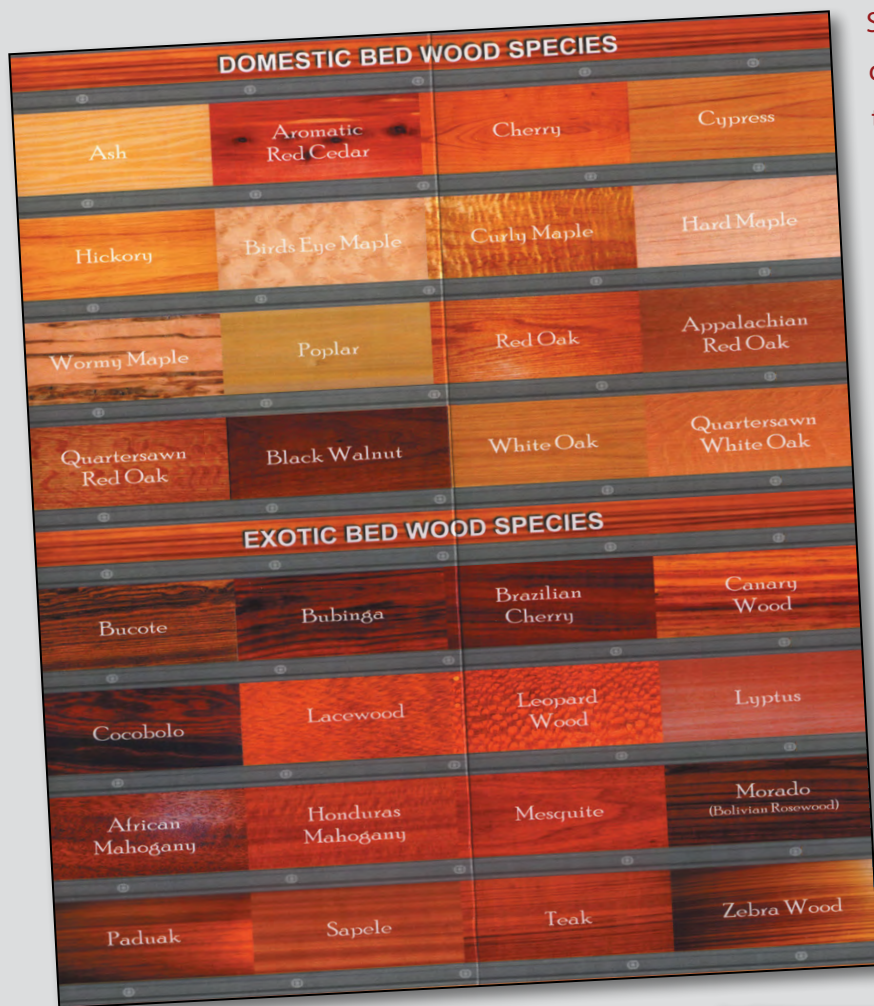

Sets are **milled to order** using only kiln dried "better than cabinet grade" lumber to assure you receive only the **highest quality product**. All pieces are 3/4" thick, grooved and trimmed to length. **Sanded** using a multi-step process providing a uniform and **extremely smooth surface**, read to finish right out of the box. (Does not come stained or with final finish.) Boards individually numbered for ease of installation and chosen and matched based on color, character and grain. **Grooves available** to fit both OEM and Custom-style bed strips at **no extra charge**. Professional packaging to minimize potential damage during shipping. **Custom width and lengths** are available to meet your specific requirements. **Many other types of woods available**. Call for pricing.

part #	Short Beds		
BWP101	1937-39	6 boards	75-7/8"
BWP102	1940-45	6 boards	76-7/8"
BWP103	1946	7 boards	76-7/8"
BWP104	1947-51	9 boards	76-7/8"
BWP105	1951-54	8 boards	77-1/8"
Long Beds			
BWP109	1937-45	6 boards	85-7/8"
BWP111	1946	7 boards	85-7/8"
BWP112	1947-51	9 boards	85-13/16"
BWP113	1951-53	8 boards	85-13/16"
BWP114	1954	8 boards	89"
1 Ton			
BWP118	1947-51	8 boards	107"
BWP119	1952-54	8 boards	107"

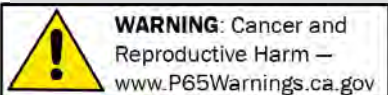

WARNING: Cancer and Reproductive Harm – www.P65Warnings.ca.gov

Chemicals shipped domestic ground only (Lower 48 states only). No international shipping.

Phone: (360) 816-0211 • (800) 999-CHEV (2438) • www.chevsofthe40s.com

**SECTION 490T
STREET ROD PARTS**

Bed Lids

Standard Features and Benefits

- Resin filled composite honeycomb give a durable, long lasting construction.
- Built in stainless steel cross bar hinge is laminated into the truck lid giving our hinge system strength and durability.
- 2 double stage locking system for extra security.
- Dual heavy duty gas struts are mounted to assist in opening & closing the lid.
- Double weather seal helps protect cargo from the elements.
- Neoprene inside trim seal helps protect bed rail from excessive wear and tear.
- Nylon pull strap to assist in closing.
- Their classic lids are made out of composite fiberglass to last the test of time just like your classic truck.
- Reduces wind drag and saves fuel.
- Easy to install or remove.
- Proven, tight fit.
- Black, white or primered finish.
- *OPTION: Under the lid charcoal carpeting tops the interior of our Traditional Lids giving it a plush look and feel.



BEDLID-TPC47-53
Primered finish. With carpet under lid.
17.499 -0.15 **\$2,150.00 EA** ⚠

Bed Lids, cont.



BEDLID-BPC 54
Primered finish. With carpet under lid.
17.499 -0.15 **\$1,450.00 EA** ⚠



BEDLID-TP 54
Primered finish. 17.499 -0.15
\$1,300.00 EA ⚠

Pros Pick Custom Bed Chevy

FABRICATED FROM 16 GAUGE, SATIN COATED STEEL (SIMILAR TO GALVANIZED)

- Plug welded construction (no unsightly spot welds).
- Epoxy primed so you can block sand and paint.
- Includes 2 sides, closed stake pockets, front panel and all cross members.
- *TAILGATE, BED STRIPS AND WOOD NOT INCLUDED.



*'54-'55 (1st Series) Chevy Truck shown

2523010030-36
Standard bed size and height. 20.000 -0.15
..... **\$1,575.00 SET** ⚠

2523710037-39
Standard bed size and height. 20.000 -0.15
..... **\$1,575.00 SET** ⚠

25240100 40-46
Standard bed size and height. 20.000 -0.15
..... **\$1,576.75 EA** ⚠

2524710047-53
Standard bed size and height. 20.000 -0.15
..... **\$1,575.00 EA** ⚠

25247T10047-53
3 inch taller height than standard.
20.000 -0.15
..... **\$1,720.00 EA** ⚠

Pros Pick Custom Bed Chevy, cont.

25254100 54-55
Standard bed size and height. Fits 1st Series. 20.000 -0.15
..... **\$1,720.00 SET** ⚠

Custom Tailgate

Stock tailgates have exposed hinges that leak rusty water, chains that damage expensive paint and unsightly, poorly designed latches. These custom tailgates are manufactured from 16 gauge, satin coated steel. Hidden hinges concealed into the rear cross member. Hidden latch assemblies actuated by 2 small knobs on the inside of the tailgate. Nylon latch bolts and stainless steel strikers assure smooth, quiet and rust free operation. Mounts to Pro's Pick Custom Beds as well as Stock Beds to add a clean custom look to your original bed.



TAILGATEPRO46-87
Smooth, clean finish. Add-on option to complete Pros' Pick bed (also sold separately). Smooth, clean finish. -0.15
..... **\$851.00 EA** ⚠



TAILGATEPROW46-87
Smooth, clean finish. Fits pro's pick and other stock beds. -0.15 .. **\$1,015.75 EA** ⚠

Power Tailgate



POWERGATEALL
Electric power unit operates your tailgate either thru your remote or switch (included). 17.615 -0.15 . **\$500.00 KIT** ⚠



Pros Pick Custom Roll Pan Chevy



01101500TL...47-53
LED Tail Light for pro's pick roll pan. Upgrade only. . 12V -0.15

..... **\$359.00 PR** ⚠️



23247100.....47-53
Bolt-on, smooth. 1-piece, 12ga. steel. Recess for license plate. Use with Pro's

Pick tailgate only (order 4-piece roll pan for stock tailgates). -0.15

..... **\$450.00 EA** ⚠️

Steel Corrugated Bed Floor

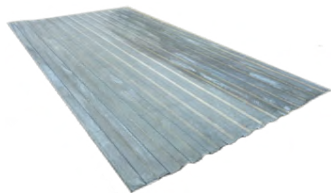

3847403S.....ALL
Do you use your truck for work and don't want to ruin a nice wood floor? This steel corrugated bed floor was designed for you. 80" long for short stepside beds. -0

\$750.00 EA ⚠️

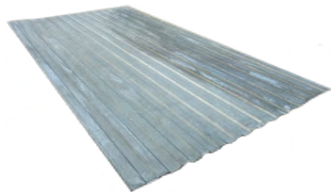

3847404S.....ALL
Do you use your truck for work and don't want to ruin a nice wood floor? This steel corrugated bed floor was designed for you. 96" long for long stepside beds. -0

\$950.00 EA ⚠️

Fuel Filler Concealment Kit

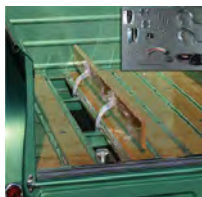

LHRSCK.....ALL
Hide your fill neck in the bed. Motor lifts a bed wood panel for easy access. All stainless & aluminum hardware, hinges, motor & switch included. 17.438 -0

\$748.00 SET ⚠️

Tailgate Hidden Latch

Stock tailgates are beautiful, they hold the classic look that is near and dear to all enthusiasts. They also carry those tailgate chains that ruin our \$10,000 paint jobs. When Pros Pick designed this kit they felt the criteria had to be:
-Anyone could handle the installation.
-The tailgate had to slam shut.
-No rattles allowed as you drive down the road.
-None of the materials used could ever rust.
-It had to have check straps that could not damage the paint.
-You could install it on a painted bed without damaging the paint job.
-It had to look cool, yet be compatible with the vintage look of the truck.
-A touch of the release buttons on each side allow the gate to open.



26300016.....ALL
Latch kit with 16 inch straps. -0.15
..... **\$185.25 SET** ⚠️

26300021.....ALL
Latch kit with 21 inch straps. -0.15
..... **\$185.25 SET** ⚠️

Tailgate Link Assembly



MAK102835.....41-53
Remove tailgate chains (modification to bed sides required). Includes instructions. 1941-53 -0.15
..... **\$84.25 PR** ⚠️

MAK102835S.....41-53
Remove tailgate chains (modification to bed sides required). Includes instructions. Polished Stainless. 1941-53 -0.15
..... **\$160.25 PR** ⚠️

Tailgate Link Assembly, cont.



MAK102834.....54-87
Remove tailgate chains (modification to bed sides required). Includes instructions. 1954-87 Stepside only. -0.15
..... **\$84.25 PR** ⚠️

MAK102834S.....54-87
Remove tailgate chains (modification to bed sides required). Includes instructions. Polished Stainless. 1954-87 Stepside only. -0.15
..... **\$160.25 PR** ⚠️

LED Bed Roll Light



LEDBEDLITE.....ALL
LED tail light w/ Aluminum housing in 15/16" (red only), 1-1/8", 1-1/4" or 1-5/8" diameters. Choose Amber or Red. 12V 0.000 -0 .. starting at **\$110.00 PR** ⚠️



MAK102864.....ALL
Red LEDs. Billet aluminum w/ polished bezel. Dual intensity for tail light and brake/ turn signal. Includes 10" pigtail. Fits 40-66 Chevy, 40-87 GMC. 12V. 1-19/32 hole. 0.000 -0
..... **\$148.00 PR** ⚠️



MAK102865.....ALL
19 Amber LEDs. 12V. 1-19/32 hole. 0.000 -0
..... **\$148.00 PR** ⚠️



WARNING: Cancer and Reproductive Harm — www.P65Warnings.ca.gov

Chemicals shipped domestic ground only (Lower 48 states only). No international shipping.

Phone: (360) 816-0211 • (800) 999-CHEV (2438) • www.chevsofthe40s.com

LED Bed Roll Light, cont.



MAK102866 **ALL**
19 White LEDs for back up lights. 12V.
1-19/32 hole. 0.000 -0 **\$160.00 PR** ⚠

Truck Bed Tail Light



MAK102853 **41-66**
Chevy - Red. Incandescent bulb (amber
also available). 0.000 -0 **\$86.00 PR** ⚠

Bed Roll Reflector



MAK102850 . . . **41-66**
red insert reflector.
0.000 -0.15
..... **\$60.00 PR** ⚠

Billet Caps



466423B **37-39**
1-1/4in. polished
aluminum w/ bowtie,
covers hole in bed roll
17.505 -0
..... **\$56.00 PR** ⚠



3806518B **41-55**
1-19/32in. polished
aluminum w/ bowtie,
covers hole in bed roll
17.505 -0
..... **\$56.00 PR** ⚠



3806518C **41-55**
1-19/32 in. brushed
aluminum, covers hole
in bed roll. 17.505 -0
..... **\$43.00 PR** ⚠

Gas Cap



GAS-CAP-STNLS **ALL**
Stainless steel, flush cap with retaining
chain & key. 3.028 -0.15 **\$37.00 EA** ⚠

Gas Cap, cont.



KUSC-312521 **ALL**
Polished Billet Aluminum. 2-1/2" dia. Twist
to pop open. -0.15 **\$131.00 EA** ⚠

SECTION 490T RESTORATION PARTS

Bed Metal Kit

The metal parts in this kit are manufactured of 16 or 14 gage steel, according to the original parts. Parts are ready to primer and bolt together. The kit includes hardware to bolt these parts together and bolt holes are provided. The kit also comes with instructions for bed assembly and bed wood installation. This kit does not include the wood bed floor parts, which may be ordered separately or as a wood bed kit.

- Kit includes the following:
- Rear Cross Sill Hardware - Zinc Plated Steel
 - Front Bed Panels - Original
 - Tailgates
 - Tailgate Chains - Zinc-Plated Steel - Import
 - Tailgate Chain Covers - Black
 - Tailgate Hinges - Steel
 - Rear Cross Sills - Original
 - Cross Sills - Front
 - Bed Sides - Driver Side Original
 - Bed Sides - Passenger Side Original
 - Cross Sills - Second cross sill from the front bed panel.
 - Bed Mounting Blocks and Pads - Blocks and Pads

Note: Midway through the 51 model year, GM changed the number of bed strips from eight (8) to seven (7) strips. This change affects the bed wood, cross sills, rear cross sill and bolt kit. If you are ordering for a 51 GM pickup, please be sure to select 47-51 for trucks with eight (8) bed strips or 51-53 for trucks with seven (7) bed strips so your cross sills and rear sill will be correct.
34-38 and 41-46 Chevy kits include smooth tailgate. 39-40 and 47-53 Chevy kits include "CHEVROLET" script tailgate. 47-53 GMC kits include "GMC" script tailgate.

Bed Metal Kit, cont.

3690612 **37-54**
Short bed 1/2 Chevy and GMC -0
..... *starting at* **\$1,316.99 EA** ⚠

3690613 **41-53**
Long Bed, 3/4 ton Chevy, 1/2 ton GMC,
3/4 ton GMC -0
..... *starting at* **\$1,884.75 EA** ⚠

Bed Wood Kit

3690615 **37-53**
Long bed, pine wood with steel strips -0
..... *starting at* **\$421.99 EA** ⚠

3690617 **37-53**
Long bed, oak wood with polished
stainless strips. -0
..... *starting at* **\$670.99 EA** ⚠

3690619 **37-53**
Long bed, oak wood with polished
stainless strips and hidden fasteners -0
..... *starting at* **\$786.99 EA** ⚠

3690614 **37-54**
Short bed, pine wood with steel strips -0
..... *starting at* **\$396.99 EA** ⚠

3690616 **37-54**
Short bed, oak wood with polished
stainless strips. -0
..... *starting at* **\$610.99 EA** ⚠

3690618 **37-54**
Short bed, oak wood with polished
stainless strips and hidden fasteners -0
..... *starting at* **\$715.99 EA** ⚠

Front Bed Panel

Note: Oversize shipping charges apply on all Front Bed Panels. Please call for rates.



463673 **34-39**
W/out hardware, 34-39 Chevy & 34-38
GMC 20.455 -0.15 **\$135.25 EA** ⚠

3800261T45 **40-45**
W/ hardware, 48-1/2 in. wide (for 5 bed
strips). 1/2Ton. 20.455 -0.15
..... **\$135.25 EA** ⚠

3800261T46 **46**
W/ hardware, 48-1/2 in. wide (for 6 bed
strips). 1/2Ton. 20.455 -0.15
..... **\$135.25 EA** ⚠

3810042T50 **47-50**
W/ hardware (1Ton) length 50 in.
20.455 -0.15
..... **\$297.00 EA** ⚠

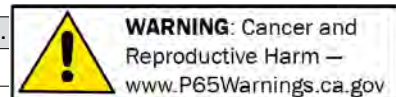

Section 490T: Complete Bed & Bed Parts

Front Bed Panel, cont.

3810042 **47-53**
W/ hardware, 50 in. wide (1/2Ton & 3/4Ton) 20.455 -0.15
..... **\$135.25 EA** ⚠

3810042T53 **51-53**
W/ hardware (1Ton) length 50 in. 20.455 -0.15
..... **\$297.00 EA** ⚠

3810404 **54-59**
No hardware length 49-3/4 in. 20.455 -0.15
..... **\$135.25 EA** ⚠

Bed Side Panel

Note: Bed Side Panels are sent Freight Collect. \$75 Crate charge per pair. (Specify with or without stake pockets holes.)

46642338 **37-38**
1/2Ton w/ stake pocket & bed corner strip, left side. 20.455 -0
..... **\$393.50 EA** ⚠

46642438 **37-38**
1/2Ton w/ stake pocket & bed corner strip, right side. 20.455 -0
..... **\$393.50 EA** ⚠

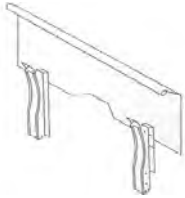

46642339 **39**
1/2Ton w/ stake pocket & bed corner strip, left side. 78-3/8 in. length. 20.455 -0.15
..... **\$487.00 EA** ⚠

46642439 **39**
1/2Ton w/ stake pocket & bed corner strip, right side. 78-3/8 in. length. 20.455 -0.15
..... **\$487.00 EA** ⚠

46642340 **40**
1/2Ton w/ stake pocket & bed corner strip, left side. 20.455 -0.15
..... **\$487.50 EA** ⚠

46642440 **40**
1/2Ton w/ stake pocket & bed corner strip, right 20.455 -0.15
..... **\$487.50 EA** ⚠

46642540 **40**
3/4Ton w/ stake pocket & bed corner strip, left 20.455 -0
..... **\$522.00 EA** ⚠

46642640 **40**
3/4Ton w/ stake pocket & bed corner strip, right 20.455 -0
..... **\$522.00 EA** ⚠

Bed Side Panel, cont.

380685746 **41-46**
1/2Ton w/ stake pocket & bed corner strip, left side. 20.455 -0.15
..... **\$393.50 EA** ⚠

380685846 **41-46**
1/2Ton w/ stake pocket & bed corner strip, right side. 17.505 -0.15
..... **\$393.50 EA** ⚠

380651753 **41-53**
3/4Ton w/ stake pocket & bed corner strips, left side. 20.455 -0.15
..... **\$565.00 EA** ⚠

380651853 **41-53**
3/4Ton w/ stake pocket & bed corner strips, right side. 20.455 -0.15
..... **\$565.00 EA** ⚠

380685753 **47-53**
1/2Ton w/ stake pocket & bed corner strip, left side. 79-3/4 in. length. 17.505 -0.15
..... **\$393.50 EA** ⚠

380685853 **47-53**
1/2Ton w/ stake pocket & bed corner strip, right side. 79-3/4 in. length. 17.505 -0.15
..... **\$393.50 EA** ⚠

381042954 **54**
1/2Ton w/ stake pocket & bed corner strips, left side. 20.455 -0.15
..... **\$467.50 EA** ⚠

381043054 **54**
1/2Ton w/ stake pocket & bed corner strips, right side. 17.615 -0.15
..... **\$467.50 EA** ⚠

381251354 **54**
3/4Ton w/ stake pocket & bed corner strips, left side. 17.505 -0.15
..... **\$645.00 EA** ⚠

381251454 **54**
3/4Ton w/ stake pocket & bed corner strips, right side. 17.505 -0.15
..... **\$645.00 EA** ⚠

Stake Pocket Hole Covers



MAK2001190 **ALL**
Paintable steel top, stainless base (2 pairs needed per bed). -0.15
..... **\$32.00 PR** ⚠

Stake Pockets



466423F **34-39**
Front 17.462 -0.15
..... **\$56.25 EA** ⚠

466423L **34-39**
Left rear 17.462 -0.15
..... **\$89.25 EA** ⚠

466424R **34-39**
Right rear 17.462 -0.15
..... **\$89.25 EA** ⚠

3806857F **39-53**
Front (specify left or right) 17.462 -0.15
..... **\$56.25 EA** ⚠

466424L **40**
Left rear 17.462 -0
..... **\$112.25 EA** ⚠

466424R **40**
Right rear 17.462 -0
..... **\$112.25 EA** ⚠

3806857L **41-46**
Left rear 17.462 -0.15
..... **\$69.25 EA** ⚠

3806858R **41-46**
Right rear 17.462 -0.15
..... **\$69.25 EA** ⚠

3806859L **47-53**
Left rear 17.462 -0
..... **\$69.25 EA** ⚠

3806860R **47-53**
Right rear 17.462 -0
..... **\$69.25 EA** ⚠

3810428FL **54-59**
Front Left 17.462 -0.15
..... **\$74.00 EA** ⚠

3810428FR **54-59**
Front Right 17.462 -0.15
..... **\$74.00 EA** ⚠

3810429L **54-59**
Left rear 17.462 -0.15
..... **\$81.00 EA** ⚠

3810430R **54-59**
Right rear 17.462 -0.15
..... **\$81.00 EA** ⚠



WARNING: Cancer and Reproductive Harm — www.P65Warnings.ca.gov

Chemicals shipped domestic ground only (Lower 48 states only). No international shipping.

Phone: (360) 816-0211 • (800) 999-CHEV (2438) • www.chevsofthe40s.com

Section 490T: Complete Bed & Bed Parts

Bed Strips

Note: Bed Strips over 96 inches are available. Special order, call for price.

Note: Oversize shipping charges apply on Bed Strips. Call for rates. Bed Strips over 96 inches are sent freight collect.

384734BS**37-59**
Strips, aluminum with hidden fasteners, 3/4Ton. 17.438 -0
..... starting at **\$245.00 SET** ⚠

384734S**37-59**
ALUMINUM strips with hidden fasteners, 1/2Ton. 17.438 -0
..... starting at **\$175.00 SET** ⚠

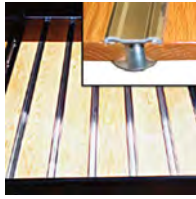

3847634A**37-59**
Short (74 in.-78 in.) aluminum w/ hidden fasteners included (anodized bolt heads hide below strip. Strip end has a blunt finish). Specify year when ordering. For 1/2Ton trucks. 17.438 -0
..... starting at **\$30.00 EA** ⚠

3847634P**37-59**
Short (74 in.-78 in.) w/ pre-punched square holes. steel, 1/2Ton, specify year when ordering. 20.438 -0.2
..... starting at **\$9.00 EA** ⚠

3847634X**37-59**
Short (74 in.-78 in.) w/ pre-punched square holes. stainless steel, 1/2Ton, specify year when ordering. 17.438 -0
..... starting at **\$14.00 EA** ⚠

3847634Y**37-59**
Short (74 in.-78 in.) w/ pre-punched square holes. polished stainless, 1/2Ton, specify year when ordering. 17.438 -0
..... starting at **\$20.00 EA** ⚠

3847635A**37-59**
Long (79 in.-96 in.), aluminum, w/ hidden fastener bolts for hidden fastening included, specify year when ordering. For 3/4Ton trucks. 17.438 -0
..... starting at **\$35.00 EA** ⚠

3847635P**37-59**
Long (79 in.-96 in.), w/ pre-punched square holes. steel, specify year when ordering. 17.438 -0.15
..... starting at **\$10.00 EA** ⚠

Bed Strips, cont.

3847635X**37-59**
Long (79 in.-96 in.), w/ pre-punched square holes. stainless, specify year when ordering. 17.438 -0
..... starting at **\$16.50 EA** ⚠

3847635Y**37-59**
Long (79 in.-96 in.), w/ pre-punched square holes. polished stainless, specify year when ordering. 17.438 -0
..... starting at **\$24.50 EA** ⚠

3847634 **ALL**
Short (77-1/8 in.), steel, 1/2Ton, no holes. 17.438 -0.15
..... **\$11.50 EA** ⚠

3847634S **ALL**
Short (78 in.), stainless, 1/2Ton, no holes. 17.438 -0.15
..... **\$17.00 EA** ⚠

3847634SP **ALL**
Short (78 in.), polished stainless, 1/2Ton, no holes. 17.438 -0.15
..... **\$23.50 EA** ⚠

3847635 **ALL**
Long (96 in.), steel, no holes. 17.438 -0.15
..... **\$12.50 EA** ⚠

3847635S **ALL**
Long (79 in.), stainless, no holes. 17.438 -0.15
..... **\$17.00 EA** ⚠

3847635SP **ALL**
Long (79 in.-96 in.), polished stainless, no holes. 17.438 -0.15
..... **\$27.00 EA** ⚠

Corner Strips

Note: Corner Strips over 96 inches are available. Special order, call for price.

Note: Oversize shipping charges apply on Corner Strips. Call for rates. Corner Strips over 96 inches are sent freight collect.

3810803P**37-59**
Short bed (74 in.-78 in.) w/ pre-punched square holes. steel, 1/2Ton, specify year when ordering. 17.438 -0.4
..... starting at **\$30.00 PR** ⚠

3810803X**37-59**
Short bed (74 in.-78 in.) w/ pre-punched square holes. stainless, 1/2Ton, specify year when ordering. 17.438 -0.15
..... starting at **\$50.00 PR** ⚠

3810803Y**37-59**
Short bed (74 in.-78 in.), w/ pre-punched square holes. polished stainless, 1/2Ton, specify year when ordering. 17.438 -0.4
..... starting at **\$60.00 PR** ⚠

Corner Strips, cont.

3810804P**37-59**
Long bed (74 in.-78 in.) w/ pre-punched square holes. steel, specify year when ordering. 17.438 -0.4
..... starting at **\$36.00 PR** ⚠

3810804X**37-59**
Long bed (79 in.-96 in.) w/ pre-punched square holes. stainless, specify year when ordering. 17.438 -0.3
..... starting at **\$56.00 PR** ⚠

3847636Y**37-59**
Long bed (79 in.-96 in.) w/ pre-punched square holes. polished stainless, specify year when ordering. 17.438 -0.4
..... starting at **\$74.00 PR** ⚠

3810803S **ALL**
Short bed (77-1/8 in.). Stainless, 1/2Ton, no holes. 17.438 -0.15
..... **\$25.00 EA** ⚠

3810803SP **ALL**
Short bed (77-1/8 in.). Polished stainless, 1/2Ton, no holes. 17.438 -0
..... **\$31.50 EA** ⚠

3847637SP **ALL**
Long bed (96 in.), polished stainless steel, no holes. 17.438 -0.15
..... **\$34.50 EA** ⚠

Bed Wood

Note: Oversize shipping charges apply on all Bed Wood. Call for rates.

38474030**37-59**
OAK. Sized & grooved, 1/2Ton. NO HOLES (specify year when ordering). 20.438 -0
..... starting at **\$275.00 SET** ⚠

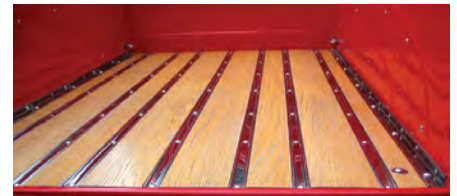

3847403P**37-59**
PINE. Sized & grooved, 1/2Ton. NO HOLES (specify year when ordering). 17.438 -0.15
..... starting at **\$280.00 SET** ⚠

38474040**37-59**
OAK. Sized & grooved, 3/4Ton. NO HOLES (specify year when ordering). 17.438 -0
..... starting at **\$285.00 SET** ⚠

3847404P**37-59**
PINE. Sized & grooved, 3/4Ton. NO HOLES. (specify year when ordering). 17.438 -0.15
..... starting at **\$297.00 SET** ⚠



Section 490T: Complete Bed & Bed Parts

Bed Wood, cont.

38474030H40-59
OAK. Sized & grooved, 1/2Ton. With mounting holes (specify year when ordering). 17.438 -0
.....starting at **\$365.00 SET** ⚠

3847403PH 40-59
PINE. Sized & grooved, 1/2Ton. WITH MOUNTING HOLES (specify year when ordering). 17.438 -0
.....starting at **\$310.00 SET** ⚠

38474040H40-59
OAK. Sized & grooved, 3/4Ton. WITH MOUNTING HOLES (specify year when ordering). 17.438 -0
.....starting at **\$380.00 SET** ⚠

3847404PH 40-59
PINE. Sized & grooved, 3/4Ton. WITH MOUNTING HOLES (specify year when ordering). 17.438 -0
.....starting at **\$327.00 SET** ⚠

Bed Wood GMC

3847405037-39
OAK. Sized & grooved, GMC long bed. NO HOLES (specify year when ordering). 17.438 -0
.....starting at **\$370.00 SET** ⚠

3847405P37-39
PINE. Sized & grooved, GMC long bed. NO HOLES (specify year when ordering). 17.438 -0
.....starting at **\$297.00 SET** ⚠

38474050H37-55
OAK. Sized & grooved, GMC long bed. WITH MOUNTING HOLES (specify year when ordering). 17.438 -0
.....starting at **\$400.00 SET** ⚠

3847405PH37-55
PINE. Sized & grooved, GMC long bed. WITH MOUNTING HOLES (specify year when ordering). 17.438 -0
.....starting at **\$327.00 SET** ⚠

Bed Wood Washer



458394WALL
Offset square hole, 1/2T (6 piece) 17.447 -0.15 **\$11.29 SET** ⚠

458394WS ALL
Offset square hole, stainless steel, 1/2T (6 piece) 17.447 -0.15
..... **\$18.00 SET** ⚠

Bed Wood Washer, cont.

458395W ALL
Offset square hole, 3/4T (8 piece) 17.447 -0.15
..... **\$15.00 SET** ⚠

458395WS ALL
Offset square hole, stainless steel, 3/4T (8 piece) 17.447 -0
..... **\$23.75 SET** ⚠

Bed Wood & Bed Mount Bolts

45839337-59
3/4T & long bed, zinc-plated, specify year when ordering. 17.447 -0.4
.....starting at **\$40.00 SET** ⚠

458393S37-59
3/4T & long bed, stainless steel, specify year when ordering. 17.447 -0.4starting at **\$82.00 SET** ⚠

458393Z37-59
3/4T & long bed, polished, specify year when ordering. 17.447 -0.4
.....starting at **\$100.00 SET** ⚠

45839437-59
1/2T, zinc-plated, specify year when ordering. 17.447 -0.4
.....starting at **\$33.75 SET** ⚠

458394S37-59
Stainless steel, 1/2T. Specify year when ordering. 17.447 -0
.....starting at **\$72.00 SET** ⚠

458394Z37-59
1/2T, polished 17.447 -0
.....starting at **\$92.00 SET** ⚠

Bed Mounting Blocks

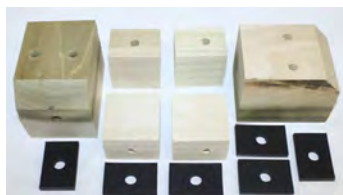

458394G36-46
& pads, cypress, 1/2T 17.447 -0.15 **\$23.00 SET** ⚠



458394J37-46
& pads, cypress, 3/4T 17.447 -0.15 **\$29.75 SET** ⚠

Bed Mounting Blocks, cont.



458394D47-53
& pads, cypress, 1/2T 17.447 -0.15 **\$15.00 SET** ⚠

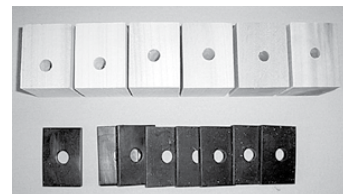

458394E47-53
& pads, cypress, 3/4T 17.447 -0.15 **\$22.50 SET** ⚠

Bed Mounting Rubber Pads



458394F54-59
1/2T 17.447 -0.15 **\$7.00 SET** ⚠

458394H 54-59
Long bed & 3/4T 17.447 -0.15
..... **\$12.00 SET** ⚠

Small Crossmember



386056637-57
Front or center comes with flange brackets (specify year when ordering). 17.405 -0
starting at **\$20.00 EA** ⚠

Rear Crossmember

380657847-51
3/4T, no holes, use only on 8 strip 9 board beds only 17.405 -0.15
..... **\$168.00 EA** ⚠

380658147-53
1T, no holes 17.405 -0.15
..... **\$168.00 EA** ⚠

3806578 51-53
3/4T, no holes, use only on 7 strip 8 board beds only 17.405 -0.15
..... **\$168.25 EA** ⚠



WARNING: Cancer and Reproductive Harm — www.P65Warnings.ca.gov

Chemicals shipped domestic ground only (Lower 48 states only). No international shipping.

Phone: (360) 816-0211 • (800) 999-CHEV (2438) • www.chevsofthe40s.com

Section 490T: Complete Bed & Bed Parts

Rear Crossmember, cont.



3713954 **.54-55**
3/4T, no holes (55 1st series) 17.405 -0.15
..... **\$168.25 EA** ⚠



3810032 **ALL**
1/2T (specify year when ordering)
17.405 -0.4 starting at **\$95.00 EA** ⚠

Flange Bracket

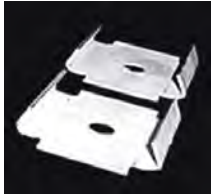

3860566A **.37-53**
Flange Bracket. Crossmember. Sold as a
pair. 20.405 -0.3 **\$14.50 PR** ⚠

Tailpipe Heat Shield

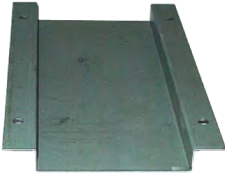

3689481R **.37-46**
Under bed. 3.706 -0.15 **\$9.75 EA** ⚠
3689481S **.47-54**
Under bed. 3.706 -0.15
..... **\$8.50 EA** ⚠
3689481SS **.47-54**
Stainless steel. Under bed. 3.706 -0.15
..... **\$16.00 EA** ⚠

Tailgate

Note: Oversize shipping charges apply. Please call for rates.



471196 **.34-39**
Complete w/out script, also GMC, original
1934-38. 46-1/2" wide. 17.615 -0.15 ...
\$270.25 EA ⚠

Tailgate, cont.



471196A **.34-39**
Chevrolet script, complete, original 1939.
46-1/2" wide. 17.615 -0.15 .. **\$319.50 EA**
⚠

3800262 **40**
Complete w/out script, also GMC. 49-1/2"
wide. 17.615 -0.15 **\$270.25 EA** ⚠



3800262D **40**
Chevrolet script, complete. 49-1/2" wide.
17.615 -0.15 **\$319.50 EA** ⚠



3801850 **.41-46**
Complete. Chevy/ GMC. 48-1/4" wide. No
Script. 17.615 -0.15 **\$209.25 EA** ⚠



3801850A **.41-46**
Skin no script. Fits GMC also. 49-1/4"
wide. 17.615 -0.15 **\$81.25 EA** ⚠



3801850L **.41-46**
Complete w/ louvers (7 rows w/ 6 louvers
each row) (also GMC). 17.615 -0.15
\$313.00 EA ⚠

Tailgate, cont.



3806856 **.47-53**
Chevrolet script, complete. 17.615 -0.15
\$270.25 EA ⚠

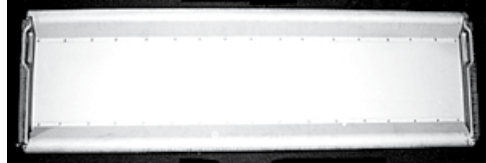

3806856B **.47-53**
Complete w/out script, also GMC.
17.615 -0.15 **\$209.25 EA** ⚠



380685H **.47-53**
GMC script, complete 17.615 -0.15
\$270.25 EA ⚠

3810424G **.54-57**
GMC script, complete 17.615 -0.15
\$281.75 EA ⚠



3810424 **.54-87**
Chevrolet script, complete. Fits Stepside.
17.615 -0.15 **\$319.50 EA** ⚠

3810424A **.54-87**
Complete w/out script, also GMC. Stepside
only. 17.615 -0.15 **\$209.00 EA** ⚠



3810424B **.54-87**
49 louvers. Complete (also fits GMC).
Stepside only. 17.615 -0.15 .. **\$313.00 EA**
⚠

Returns require a return authorization number—call first. • Product pricing & availability subject to change.



WARNING: Cancer and
Reproductive Harm —
www.P65Warnings.ca.gov

Tailgate, cont.

3810424S **54-87**
Bowtie, complete, flush fit (double wall)
Stepside, no latch 17.615 -0.15
\$289.00 EA ⚠

Tailgate Cover



3806856HS **47-53**
Skin. No script. Also fits GMC. 17.615 -0.15
.....
\$81.25 EA ⚠



3806856J **47-53**
Cover, hides the dents. 4 rows of louvers
(also fits GMC). 17.615 -0.15
\$157.00 EA ⚠



3806856M **54-87**
Cover 50-7/8" X 19-1/4" With Embossed
Bowtie 31-1/2" X 10" 17.615 -0.15
\$123.00 EA ⚠



810424C **54-87**
Cover, hides the dents. 7 rows of louvers.
Stepside only 17.615 -0.15 .. **\$123.00 EA**
⚠

Tailgate Butcher Block

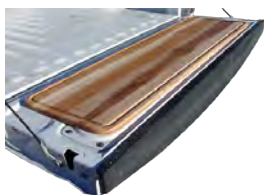

BWTGFPS **ALL**
Tailgate butcher block, 54" X 27" X 1". -0
.....
\$299.00 EA ⚠

Tailgate Decal

3800262A **39-40**
Chevrolet script, white 17.615 -0
.....
\$11.75 EA ⚠



3800262B **39-40**
Chevrolet script, chrome 17.615 -0.15
.....
\$16.25 EA ⚠

3800262C **39-40**
Chevrolet script, black 17.615 -0.15
.....
\$13.25 EA ⚠

3806856D **47-53**
Chevrolet script, white. 17.615 -0.15
.....
\$12.50 EA ⚠



3806856E **47-53**
Chevrolet script, chrome. 17.615 -0.15
.....
\$14.00 EA ⚠

3806856F **47-53**
Chevrolet script, black. 17.615 -0.15
.....
\$12.50 EA ⚠

3806856G **47-53**
GMC script, white. 17.615 -0
.....
\$9.25 EA ⚠

3806856H **47-53**
GMC script, black. 17.615 -0
.....
\$9.25 EA ⚠



3806856I **47-53**
GMC script, chrome. 17.615 -0.15
.....
\$15.00 EA ⚠



3810424D **54-57**
Chevrolet script, white 17.615 -0.15
.....
\$27.00 EA ⚠

3810424E **54-57**
Chevrolet script, black 17.615 -0.15
.....
\$13.25 EA ⚠

3810424F **54-57**
Chevrolet script, chrome 17.615 -0.15
.....
\$14.39 EA ⚠

Tailgate Hinges



463671 **34-39**
primered 17.625 -0.15 **\$24.00 EA** ⚠

3806884A **40**
With bushing 17.625 -0.15
.....
\$28.00 EA ⚠

3806884 **41-53**
This is a tailgate hinge 17.625 -0.2
.....
\$20.00 EA ⚠



3806884S **41-53**
Chrome. 17.625 -0.15 **\$55.75 PR** ⚠

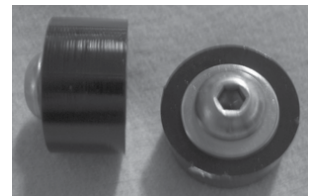

3810706 **54-87**
Trunnion & bolt. stepside only 17.625 -0.15
.....
\$37.00 PR ⚠

Tailgate Hinge Adapter



SLEEVEN **40**
Nylon adapter for
use on 41-53 tailgate
hinges to mount 1940
tailgate (1940 larger

than 41-53 hinges). 17.625 -0.15
.....
\$42.00 PR ⚠

Tailgate Chain Bracket



3801845B **34-40**
Right 17.635 -0.15
.....
\$14.00 EA ⚠



3801845C **34-40**
Left 17.635 -0.15
.....
\$14.00 EA ⚠

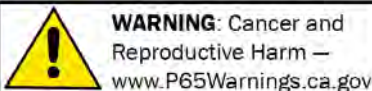

WARNING: Cancer and
Reproductive Harm —
www.P65Warnings.ca.gov

Chemicals shipped domestic ground only (Lower 48 states only). No international shipping.

Phone: (360) 816-0211 • (800) 999-CHEV (2438) • www.chevsofthe40s.com

Eye Bolt



3801845D**34-53**
Tailgate chain 17.635 -0.15 . **\$9.75 EA** ⚠

Tailgate Chains



3801845J**32-53**
Assembly, zinc plated 17.635 -0.15
\$25.00 PR ⚠

3801845S **32-53**
Assembly, stainless 17.635 -0.15
..... **\$50.25 PR** ⚠

3810823 **54-60**
Assembly, zinc plated 17.635 -0.15
..... **\$26.75 PR** ⚠

3810823S **54-60**
Assembly, stainless 17.635 -0.15
..... **\$45.00 PR** ⚠

Tailgate Chain Covers



3810750**32-60**
Black rubber 17.635 -0.15 ... **\$10.00 SET**
⚠

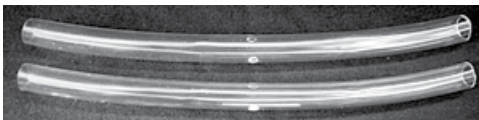

3810750C**32-60**
Clear rubber 17.635 -0.15 .. **\$8.00 PR** ⚠

Spare Tire Carrier

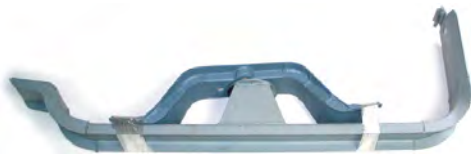

358451**41-50**
Assembly under bed 7.608 -0 ... **CALL**
⚠



WARNING: Cancer and Reproductive Harm —
www.P65Warnings.ca.gov

**SECTION 520T
RESTORATION PARTS**

Engineering Feature Manual



ENG37M 37
Engineering Feature Manual, Car & Truck
18.300-0.15
..... **\$24.00 EA** ⚠



ENG39M 39
Engineering Feature Manual, Car & Truck
18.300-0.15
..... **\$24.00 EA** ⚠



ENG47M 47
Engineering feature manual, Car & Truck
18.300-0.15
..... **\$24.00 EA** ⚠



ENG48M 48
Engineering Feature Manual, Car & Truck
18.300-0.15
..... **CALL** ⚠



ENG49T 49
Engineering Features Trucks Only Manual. 18.300-0.15
..... **\$23.99 EA** ⚠

Engineering Feature Manual



ENG50T 50
Engineering Features Trucks Only Manual. 18.300-0.15
..... **\$23.99 EA** ⚠



ENG52M 52
Car & Truck
18.300-0.15
..... **\$24.00 EA** ⚠



ENG53T 53
Engineering features manual, Truck Only
18.300-0.15
..... **\$24.00 EA** ⚠



ENG54T 54
Truck Only 18.300-0.2
..... **\$15.00 EA** ⚠

Sales Brochure



SALET 37-55
Super color reproduction of original brochure (specify year when ordering)
18.000-0 **starting at \$10.00 EA** ⚠

Shop Manual on CD



SHOP37CD .. 37-38
Car & truck on CD
18.300-0.15
..... **\$30.75 EA** ⚠

Shop Manual on CD



SHOP39CD .. 39-40
Car & truck manuals on CD. 18.300-0.15
..... **\$30.75 EA** ⚠



SHOP41CD .. 41-48
41-48 Car & 41-46 Truck on CD.
18.300-0.15
..... **\$30.75 EA** ⚠



SHOP47CD .. 47-53
48-52 trucks.
18.300-0.15
..... **\$30.75 EA** ⚠



SHOP49CD .. 49-54
49-54 Cars.
18.300-0.15
..... **\$30.75 EA** ⚠



SHOP54CD 54
54-55 (1st Series) Trucks on CD.
18.300-0.15
..... **\$30.75 EA** ⚠

Owners Manual



OWNT 37-55
Specify year when ordering 18.000-0.4

..... **starting at \$12.00 EA** ⚠



OWNTG 41-55
GMC, specify year when ordering (exc 37-40 & 47-48).
18.000-0.4
..... **\$12.00 EA** ⚠

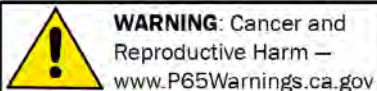

Chemicals shipped domestic ground only (Lower 48 states only). No international shipping.

Phone: (360) 816-0211 • (800) 999-CHEV (2438) • www.chevsofthe40s.com

Folder



OWNFDALL
For owners' manual & papers, Chevrolet Motor Division, original type

18.000 -0.15

..... **\$6.00 EA** ⚠

Assembly Manual

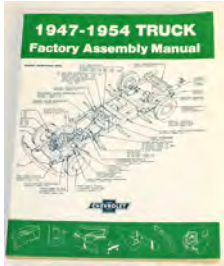

ASS4747-54
This truck manual has 550 pages of Incredible detail! A must have (original 54). 18.100 -0.15

..... **\$36.00 EA** ⚠

Bed Assembly



BED00ALL
& restoration manual. 18.000 -0.15

..... **\$4.75 EA** ⚠

AC Parts Catalog



PARTAC41 . . .29-41
Oil, fuel & air filters, speedometer cables 18.200 -0.4

..... **\$4.00 EA** ⚠

Parts Book



PART3929-42
For 42 & Earlier 18.200 -0.15

..... **\$50.00 EA** ⚠



PART5029-50
For 50 & Earlier 18.200 -0.15

..... **\$57.25 EA** ⚠

Parts Book



PART5429-54
Chevrolet Master Parts and Accessories catalog, reprint. 18.200 -0.15

..... **\$75.25 EA** ⚠



PART5729-57
Chevrolet Body Parts and Accessories Catalog 18.200 -0.15

..... **\$75.25 SET** ⚠



PART42W . . .35-41
Woody wagon & Suburban 18.200 -0.3

..... **\$10.00 EA** ⚠



PART48W . . .42-48
Suburban 18.200 -0.15

..... **\$27.50 EA** ⚠

Parts Interchange



PART51N29-52
Chev, Pontiac, Oldsmobile 18.200 -0.15

..... **\$24.00 EA** ⚠

Books



BOOK12VALL
6v to 12v conversion 19.500 -0.15

..... **\$12.00 EA** ⚠

Books



GASBOOK01 . . .ALL
Title of this book "The Official Guide to Modern Gasoline & Oil for Antique Vehicles" says it all. 19.500 -0.15

..... **\$15.00 EA** ⚠



HOTSTARTBOOKALL
Each of us has owned, or knows of someone who has owned an antique vehicle, muscle car, or hot rod that refuses to start when the engine is warm. To make

this more aggravating, the vehicle seems to start fine when the engine is cold. In this book Randy will help you to identify and fix your hot start problem once and for all. 68 pages with color illustrations throughout. -0.15

..... **\$17.25 EA** ⚠

Shop Manuals on CD

All CDs contain the factory service or shop manual and any applicable supplement. The factory manual is essential. It includes coverage on all mechanical and electrical systems. This is where you find specifications, wiring diagrams, diagnostic procedures, troubleshooting, installation and removal, and covers all systems.

CDs contain the body service manual as well. In some cases, the body information is included in the service manual.

Parts books are included on most CDs; check content information for specifics.

Shop & Service Manuals on CD



DCDGM-51 37
Includes 1937 shop manual, 29-48 parts book for 1937 cars & trucks. 18.300 -0.3

..... **\$35.00 EA** ⚠

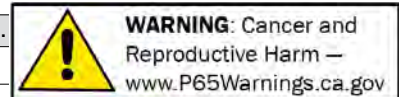

Shop Manuals on CD

DCDGM-52..... 38-38
Includes 1938 shop manual, 29-48 parts book & 38-68 parts book for 1938 cars & trucks. 18.300 -0.3

..... **\$35.00 EA** ⚠

DCDGM-53..... 39
Includes 1939 shop manual, 39-40 Fisher body manual, 29-48 parts book & 38-68 parts book for 1939 cars & trucks. 18.300 -0.3

..... **\$35.00 EA** ⚠

DCDGM-55..... 41
Includes 1941 shop manual, 29-48 parts book & 38-68 parts book for 1941 cars & trucks. 18.300 -0.3

..... **\$35.00 EA** ⚠

DCDGM-56..... 42-48
Includes 1942-48 shop manual, 29-48 parts book & 38-68 parts book for 1942-48 cars & 42-48 trucks. 18.300 -0.2

..... **\$54.99 EA** ⚠

DCDGM-74..... 47
Includes 1947 shop manual, 29-48 parts book, 38-68 parts book & 47-55 assembly manual for 1947 trucks. 18.300 -0.4

..... **\$55.00 EA** ⚠

DCDGM-75..... 48-53
Includes 1948-53 shop manual, 29-48 parts book, 38-68 parts book & 47-55 assembly manual for 1948-53 trucks. 18.300 -0.3

..... **\$35.00 EA** ⚠

DCDGM-76..... 54
Includes 1954 shop manual, 49-58 parts book & 54-65 parts book for 1954 trucks. 18.300 -0.3

..... **\$35.00 EA** ⚠

Parts Book on CD

PART61CD29-61
29-61 Cars, Trucks & 53-61 Corvette. 18.200 -0.15

..... **\$30.75 EA** ⚠

DCDGM-145.....29-72
29-72 parts book. 18.300 -0.3

..... **\$35.00 EA** ⚠

PART72CD...38-72
38-64 Cars, 38-72 Trucks & 53-64 Corvette. 18.200 -0.15

..... **\$30.75 EA** ⚠



Shop Manual

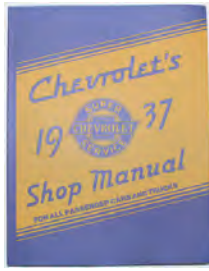

SHOP37..... 37
Car & truck, full size. Superb! 18.300 -0.15
..... **\$24.00 EA** ⚠

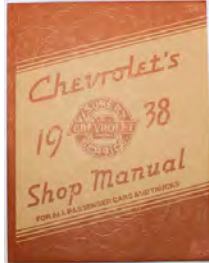

SHOP38..... 38
W/ car & truck, full size. Superb! 18.300 -0.15
..... **\$24.00 EA** ⚠

SHOP38P..... 38
W/ car & truck, 3/4 size photocopy 18.300 -0 **CALL** ⚠



SHOP39..... 39
W/ car & truck, full size. Superb! 18.300 -0.15
..... **\$24.00 EA** ⚠

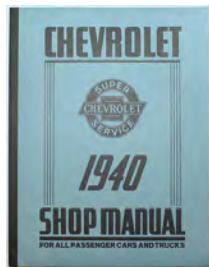

SHOP40..... 40
W/ car & truck, full size. Superb! 18.300 -0.15
..... **\$24.00 EA** ⚠



SHOP41..... 41
W/ car & truck, full size. Superb! 18.300 -0.15
..... **\$24.00 EA** ⚠

Shop Manual

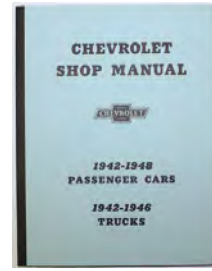

SHOP42..... 42-48
Car & 42-46 truck, full size. Superb! 18.300 -0.15
..... **\$24.00 EA** ⚠

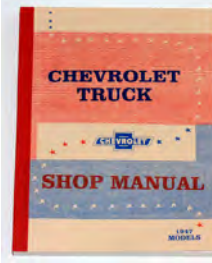

SHOP47T..... 47
Original Shop Manual 1947 Only 18.300 -0.15
..... **\$39.00 EA** ⚠

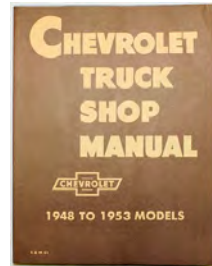

SHOP47..... 47-53
Original 48-52, full size. Superb! 18.300 -0.15
..... **\$24.75 EA** ⚠



SHOP47G... 47-54
GMC, full size. Superb! 18.300 -0.15
..... **\$30.00 EA** ⚠



SHOP54..... 54
Full size. Superb! 18.300 -0.15
..... **\$24.75 EA** ⚠

Shop Supplement



SHOP55..... 55
1st series, full size 18.300 -0.15
..... **\$10.75 EA** ⚠

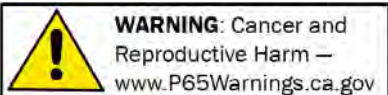

WARNING: Cancer and Reproductive Harm —
www.P65Warnings.ca.gov

Chemicals shipped domestic ground only (Lower 48 states only). No international shipping.

Phone: (360) 816-0211 • (800) 999-CHEV (2438) • www.chevsofthe40s.com

Good Housekeeping



HOUS1 ALL
 In your car by GM, Fisher body, removing 17 upholstery stains, 29 pages 18.230 -0.3
 **\$6.25 EA** ⚠

Service Bulletins

Note: 1 service bulletin was issued every month (except during WWII) to Chevrolet dealers on fixing new car problems. Introduction issue is previous year so we recommend three years for complete coverage of your vehicle. Invaluable.



SERV 37-54
 12 month, specify year when ordering 18.500 -0.15
 ..starting at **\$20.00 EA** ⚠

Glove Box Accessory Book



ACC37B 37
 Color repro of original w/ pictures of all those rare accessories. 18.600 -0.15
 **\$14.00 EA** ⚠



ACC38B 38
 Repro of original w/ pictures of all those rare accessories. Sepia, 9in. x 11in. 18.600 -0.15
 **\$14.00 EA** ⚠



ACC39B 39
 Color repro of original w/ pictures of all those rare accessories. 18.600 -0.15
 **\$14.00 EA** ⚠

Glove Box Accessory Book



ACC40B 40
 Color repro of original w/ pictures of all those rare accessories. 18.600 -0.15
 **\$14.00 EA** ⚠



ACC41B 41
 Color repro of original w/ pictures of all those rare accessories. 18.600 -0.15
 **\$14.00 EA** ⚠



ACC48B 46-48
 Color repro of original w/ pictures of all those rare accessories. Original 48. 18.600 -0.15
 **\$14.00 EA** ⚠

Accessory Identifying Book



ACC01B 46-78
 All accessories 1946-78 in numerical order, superb for identifying. 18.600 -0.15
 **\$25.00 EA** ⚠

Accessory List



ACC_L 37-54
 With part numbers & prices (great for swap meets) (specify year after "ACC"). 18.700 -0.4
 starting at **\$5.00 EA** ⚠

Data Book

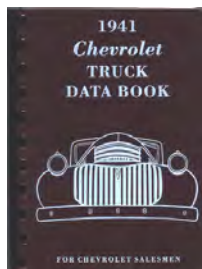

DATA41 41-46
 Salesman, all the specs, original 1941 18.800 -0.15
 **\$36.75 EA** ⚠

Data Book

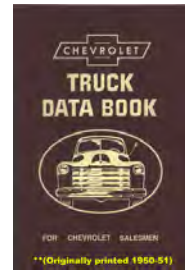

DATA51 47-53
 Salesman, all the specs, original 1950 18.800 -0.15
 **\$39.50 EA** ⚠

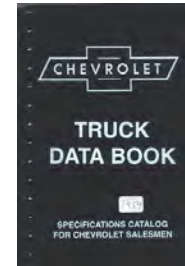

DATA54 54
 Salesman, all the specs 1954 18.800 -0.15
 **\$34.50 EA** ⚠

RPO Booklet

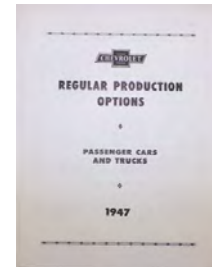

RP047 47
 W/ regular production options 18.800 -0.15
 **\$5.00 EA** ⚠

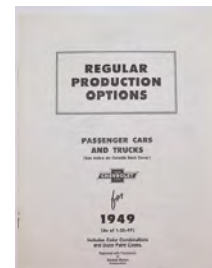

RP049 49
 W/ regular production options 18.800 -0.15
 **\$5.00 EA** ⚠



RP053 53
 W/ regular production options 18.800 -0.15
 **\$5.00 EA** ⚠



RP054 54
 W/ regular production options 18.800 -0.2
 **\$6.50 EA** ⚠

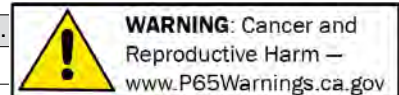

Price Guide



PRICE37 37
 Advertised delivered prices of vehicles & accessories
 18.700 -0.15
 **\$3.25 EA** ⚠



PRICE38 38
 Advertised delivered prices of vehicles & accessories
 18.700 -0.15
 **\$5.50 EA** ⚠



PRICE39 39
 Advertised delivered prices of vehicles & accessories
 18.700 -0.15
 **\$3.25 EA** ⚠

Casting Numbers



CAST42 29-42
 Identification book
 18.600 -0.15
 **\$10.00 EA** ⚠

SECTION 530T RESTORATION PARTS

Accessory Installation Manual

Copies of originals wanted: Original accessory instruction sheets 1937-54 or sharp copies.



ACC49M 49
 Superb 18.900 -0.15
 **\$14.00 EA** ⚠

ACC49E 49-54
 Per accessory 18.900 -0
 **CALL** ⚠



ACC50M 50
 Superb 18.900 -0.15
 **\$12.00 EA** ⚠



ACC51M 51
 Superb 18.900 -0.15
 **\$12.00 EA** ⚠



ACC52M 52
 Superb 18.900 -0.15
 **\$14.50 EA** ⚠



ACC53M 53
 Superb 18.900 -0.15
 **\$12.00 EA** ⚠

Accessory Installation Manual

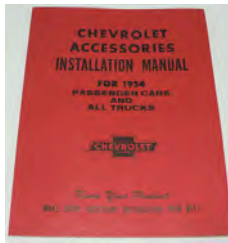

ACC54M 54
 Superb 18.900 -0.15
 **\$14.00 EA** ⚠

Antenna Installation Sheets



ACC65I 37-40
 Under running board (original 40)
 18.900 -0.15
 **\$2.00 EA** ⚠



985531I 39-46
 Install instructions
 18.900 -0.4
 **\$2.00 EA** ⚠

ACC76I 47-54
 Includes template 18.900 -0.15
 **\$2.00 EA** ⚠

Cigarette Lighter Installation Sheet

ACC45I 42-53
 This is a nice reproduction of the original cigar / cigarette lighter installation sheet.
 18.900 -0.15
 **\$2.00 EA** ⚠

Compass Installation Sheets



ACC25I 37-42
 For glove box
 18.900 -0.3
 **\$2.00 EA** ⚠

ACC26I 46-48
 For glove box 18.900 -0.3
 **\$2.00 EA** ⚠

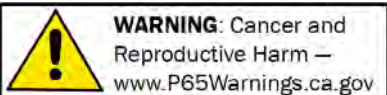

Chemicals shipped domestic ground only (Lower 48 states only). No international shipping.

Phone: (360) 816-0211 • (800) 999-CHEV (2438) • www.chevsofthe40s.com

Fog Light Installation Sheets

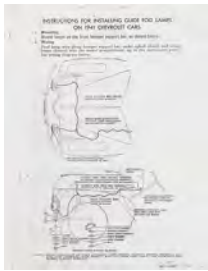

ACC181..... 41
 This is a nice reproduction of the original fog light installation sheets. 18.900 -0.3
 **\$2.00 EA** ⚠

ACC401..... 42-48
 This is a nice reproduction of the original fog light installation sheets. 18.900 -0.15
 **\$2.00 EA** ⚠

Gas Filter Installation Sheet

ACC561..... 33-56
 Genuine AC 18.900 -0.15
 **\$2.00 EA** ⚠

Glove Compartment Lamp Installation Sheet

ACC021..... 41-54
 This is a nice reproduction of the original glove compartment lamp/light installation sheet. 18.900 -0.15
 **\$1.00 EA** ⚠

Heater & Defroster Installation Sheet

ACC241..... 37-46
 (deluxe) Original 42-46 18.900 -0.15
 **\$1.00 EA** ⚠
ACC231..... 47-48
 Non-fresh air, also COE 18.900 -0.3
 **\$2.00 EA** ⚠

Heater Installation Sheet

ACC471..... 47-53
 Recirculating, 3000-4000-6000 series 18.900 -0.15
 **\$2.00 EA** ⚠
ACC611..... 47-53
 Recirculating 18.900 -0.4
 **\$2.00 EA** ⚠

Horn Installation Sheet



ACC621..... 37-38
 (Matched) with City & Country switch, original 37 19.900 -0.4
 **\$2.50 EA** ⚠

ACC091..... 37-39
 (Matched) with City & Country switch, original 39 18.900 -0.4
 **\$2.50 EA** ⚠

Town & Country Horn Installation Sheet

ACC101..... 40-42
 This is a nice reproduction of the original Town and Country horn installation sheet. 18.900 -0.4
 **\$3.00 EA** ⚠

Lock & Key Service Manual

ACC891..... ALL
 9 pages 18.900 -0.4
 **\$5.00 EA** ⚠

Vanity Mirror Installation Sheet

ACC631..... 37-41
 With vertical lights 18.900 -0.15
 **\$2.00 EA** ⚠

Peep Mirror Installation Sheet

ACC531..... 37-50
 This is a nice reproduction of the original 'peep' mirror installation sheet. 18.900 -0.4
 **\$1.00 EA** ⚠

Oil Filter Installation Sheet

ACC881..... 37-41
 Original AC 18.900 -0.4
 **\$3.00 EA** ⚠



ACC661..... 42-47
 Original AC 18.900 -0.3
 **\$4.00 EA** ⚠

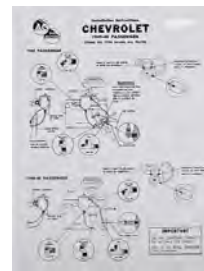

ACC871..... 48-49
 Original AC 18.900 -0.2
 **\$3.00 EA** ⚠



ACC671..... 50-52
 Original AC 18.900 -0.15
 **\$2.00 EA** ⚠



ACC681..... 53-55
 Original AC 18.900 -0.15
 **\$2.00 EA** ⚠

Overflow Tank Installation Sheet

ACC071..... 37-48
 Install instructions 18.900 -0.3
 **\$2.00 EA** ⚠

ACC081..... 49-54
 This is a nice reproduction of the original overflow tank (radiator) installation sheet. 18.900 -0.3
 **\$2.00 EA** ⚠

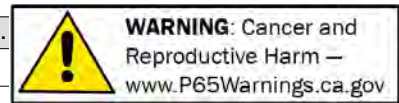

Park Light Installation Sheet



ACC60I.....37-39
 Fender lamps
 18.900 -0.15
 **\$2.00 EA** ⚠

Passing Lamp Installation Sheet

ACC19I..... 41
 This is a nice reproduction of the original passing lamp / light installation sheet.
 18.900 -0.3
 **\$2.00 EA** ⚠

Radiator Insect Screen Installation Sheet

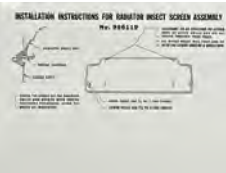

ACC71I.....47-53
 This is a nice reproduction of the original radiator insect screen installation sheet.
 18.900 -0.15
 **\$2.00 EA** ⚠

Radio Manual

ACC43I.....36-47
 18.900 -0
 **CALL** ⚠
985538M..... 40
 5 tube, 4 button (original 40). 18.900 -0.4
 **\$3.00 EA** ⚠



986067M ...47-50
 Original 47
 18.900 -0.4
 **\$6.00 EA** ⚠
986771M..... 54
 This is a nice reproduction of the original radio manual. 18.900 -0.4
 **\$6.00 EA** ⚠

Radio Shop & Service Manual

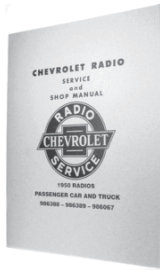

ACC44I.....47-53
 Original 50
 18.900 -0.15
 **\$9.75 EA** ⚠

Sunvisor

ACC57I.....ALL
 Application chart for Fulton exterior visor.
 18.900 -0.15
 **\$2.00 EA** ⚠

Spotlight Template



ACC39I.....37-54
 W/ instruction
 18.900 -0.15
 **\$2.00 EA** ⚠

AST.....39-46
 W/ Instruction 0.000 -0.2
 *starting at* **\$2.50 EA** ⚠

Umbrella Holder Installation Sheet

ACC11I.....ALL
 This is a nice reproduction of the original umbrella holder installation sheet.
 18.900 -0.3
 **\$2.00 EA** ⚠

Underhood Lamp Installation Sheet

ACC82I.....49-54
 This is a nice reproduction of the original under hood lamp installation sheet.
 18.900 -0
 **\$1.00 EA** ⚠

Utility Pocket Unit Installation Sheet

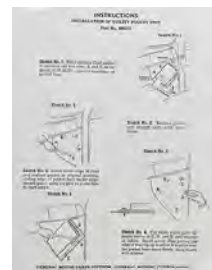

ACC70I.....48-50
 This is a nice reproduction of the original utility pocket unit installation sheet. 18.900 -0.15
 **\$2.00 EA** ⚠

Windshield Washer Installation Sheet

ACC59I.....38-39
 This is a nice reproduction of the original windshield washer installation sheet.
 18.900 -0.15
 **\$2.00 EA** ⚠

ACC12I.....40-42
 This is a nice reproduction of the original windshield washer installation sheet.
 18.900 -0.3
 **\$2.00 EA** ⚠

Windshield Wiper Installation Sheet



ACC72I.....39-46
 Right 18.900 -0.15
 **\$2.00 EA** ⚠

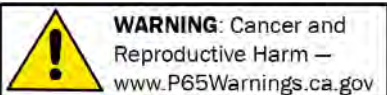

WARNING: Cancer and Reproductive Harm —
www.P65Warnings.ca.gov

Chemicals shipped domestic ground only (Lower 48 states only). No international shipping.

Phone: (360) 816-0211 • (800) 999-CHEV (2438) • www.chevsofthe40s.com

**SECTION 550T
RESTORATION PARTS**

Signs



SIGN03**ALL**
Chevrolet decal (as on metal sign).
19.450 -0.15 **\$15.75 EA** ⚠️

Air Cleaner

AIR350**34-39**
Oil bath decal
19.300 -0.15 **\$3.50 EA** ⚠️

AIR37 **37**
Dry decal 19.300 -0 **\$5.50 EA** ⚠️

AIR38T**38-46**
Dry decal 19.300 -0.2 **\$12.75 EA** ⚠️

AIR400T **40-54**
Oil bath decal
19.300 -0.15 **\$10.00 EA** ⚠️

AIR47T**47-54**
Dry decal 19.300 -0.15 **\$3.00 EA** ⚠️

AIR470T**47-59**
Oil bath decal, heavy
duty 19.300 -0 **\$4.75 EA** ⚠️

Antifreeze

TAG10**ALL**
GM tag 19.100 -0.2 **\$8.25 EA** ⚠️

Battery

TAG03**ALL**
Guarantee card
19.100 -0.15 **\$4.75 EA** ⚠️

Break-in Instructions

TAG01**39-47**
Card 19.100 -0.15 **\$4.00 EA** ⚠️

Break-in Instructions



TAG11**48-56**
Card 19.100 -0.15 **\$4.50 EA** ⚠️

Cigar Lighter



TAG02**39-50**
Card-Casco 19.100 -0.15 **\$4.00 EA** ⚠️

Compass



TAG23**37-42**
Tag (cut in outline of
compass) 19.100 -0.2 **\$2.50 EA** ⚠️

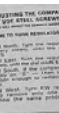

DEC12**37-59**
Instruction decal
19.200 -0.15 **\$3.00 EA** ⚠️

Data Plate (Metal)



PLATE39T**39-41**
Right side cowl 1/2T
19.400 -0.15 **\$21.00 EA** ⚠️



PLATE42T **42-46**
Right side cowl 1/2T
19.400 -0.15 **\$23.75 EA** ⚠️



PLATE47T**47-49**
Door post 1/2T
19.400 -0.15 **\$22.25 EA** ⚠️



PLATE50G **50**
Door post 1/2T, GMC
19.400 -0.15 **\$18.00 EA** ⚠️



PLATE50T **50**
Door post 1/2T
19.400 -0.15 **\$15.99 EA** ⚠️



PLATE51T**51-52**
Door post 1/2T
19.400 -0.15 **\$17.00 EA** ⚠️

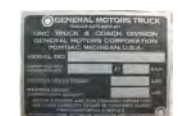

PLATE53G **53**
Door post 1/2T, GMC
19.400 -0.15 **\$22.25 EA** ⚠️



PLATE53T **53**
Door post 1/2T
19.400 -0.15 **\$22.25 EA** ⚠️

Data Plate (Metal)



PLATE54G **54**
Door post 1/2T, GMC
19.400 -0.15 **\$18.00 EA** ⚠️



PLATE54T **54**
Door post 1/2T
19.400 -0.15 **\$17.00 EA** ⚠️

Delco Remy Metal Tag



PLATE07 **37**
Generator, starter & distributor
19.400 -0.15 **\$7.00 EA** ⚠️

Delco Remy Tag



PLATE05**38-54**
Generator, Starter or Distributor. Includes
rivets. 19.400 -0.15 **\$7.00 EA** ⚠️

Generator Warning Tag



TAG04**ALL**
This is a nice
reproduction of the
warning tag that was
originally installed on
the generator. 19.100 -0.3 **\$3.00 EA** ⚠️

Heater



DEC07**47-52**
Chevrolet round
emblem. 19.200 -0.15 **\$9.75 EA** ⚠️



DEC08**47-52**
GMC round emblem.
19.200 -0.15 **\$9.00 EA** ⚠️



DEC06**47-55**
On/off defroster decal.
19.200 -0.15 **\$3.00 EA** ⚠️



DEC29**49-51**
Decal-Harrison
19.200 -0.15 **\$9.00 EA** ⚠️

Returns require a return authorization number—call first. • Product pricing & availability subject to change.

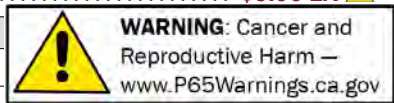

Heater



DEC09 **53**
 Fresh air round decal.
 19.200 -0.15
 **\$6.00 EA** ⚠



DEC17 **53**
 Recirculating round
 decal. 19.200 -0.15
 **\$3.75 EA** ⚠



DEC10 **53-54**
 GMC round decal.
 19.200 -0.15
 **\$4.75 EA** ⚠



DEC16 **54-55**
 Fresh air round decal.
 19.200 -0.15
 **\$6.00 EA** ⚠



DEC18 **54-55**
 Recirculating round
 decal. 19.200 -0.15
 **\$5.25 EA** ⚠

Key Decal



DEC11 **36-54**
 Glove box 19.200 -0.2
 **\$4.50 EA** ⚠

Lubrication Sticker



DEC05 **ALL**
 Chevrolet script
 (blue, yellow & white)
 19.200 -0.15
 **\$3.00 SET** ⚠

Mirror Glare Proof

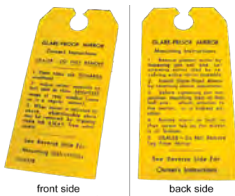

front side back side

TAG09 **ALL**
 Day-night card hangs on mirror arm (nice!)
 19.100 -0.2 **\$2.50 EA** ⚠

Oil Filter



DEC30 **37-41**
 Decal. Original, AC Kleer Kleen 19.200 -0.15
 **\$9.75 EA** ⚠



DEC19 **40-49**
 Decal set (1940's) Fram 3-piece
 19.200 -0.15 **\$8.00 EA** ⚠



DEC04 **42-54**
 Decals-set of 2, original AC 19.200 -0
 **\$5.25 EA** ⚠



DEC20 **50-59**
 Decal set (1950's) Fram 4-piece
 19.200 -0.15 **\$9.50 EA** ⚠

Overflow Tank Decal



DEC03 **39-48**
 Gold with red wings. 19.200 -0.4
 **\$5.00 EA** ⚠



DEC28 **49-54**
 Clear with orange lettering. 19.200 -0.15
 **\$9.00 EA** ⚠

Paint Lacquer

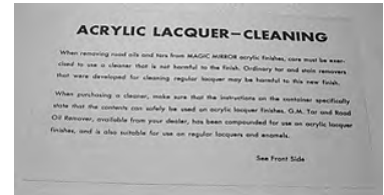

TAG16 **53-58**
 Instruction card 19.100 -0.2
 **\$6.00 EA** ⚠

Quality Control Card



TAG15 **49-54**
 This is a reproduction of the 1949-54 quality control card.
 19.100 -0.2
 **\$12.00 EA** ⚠

Service Policy



TAG25 **37-51**
 This is a reproduction of the 1937-51 service policy card.
 19.100 -0.2
 **\$5.99 EA** ⚠



TAG13 **51-59**
 This is a reproduction of the 1951-59 service policy card.
 19.100 -0.15
 **\$4.00 EA** ⚠

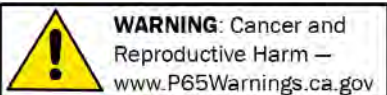

Chemicals shipped domestic ground only (Lower 48 states only). No international shipping.

Phone: (360) 816-0211 • (800) 999-CHEV (2438) • www.chevofthe40s.com

Spotlight Card



TAG0837-54
Original S3-S4 hung
on light 19.100-0.4

..... **\$3.00 EA** ⚠

Tire Pump Decal



DEC34.....ALL

For hard to find genuine Chevrolet
accessory. By Monroe -0.2 **\$5.00 EA** ⚠

Valve Cover Decal



DEC15.....47-53

Thriftmaster for 216ci 19.200-0.15
\$6.00 EA ⚠



DEC25..... 54

Thriftmaster 235ci 19.200-0.15
\$6.00 EA ⚠

Warranty Card



TAG1454-60

Here's a
reproduction of
an impossible to
find warranty card.
19.100-0.15

..... **\$4.00 EA** ⚠

Windshield Washer



DEC0239-50

Decal on metal
basket 19.200-0.15

..... **\$4.00 EA** ⚠



DEC13.....51-54

Lid decal 19.200-0.15 **\$9.00 EA** ⚠



DEC1451-54

Basket decal
19.200-0.15

..... **\$9.00 EA** ⚠

**SECTION 560T
RESTORATION PARTS**

**Hemmings Collector Car
Encyclopedia**

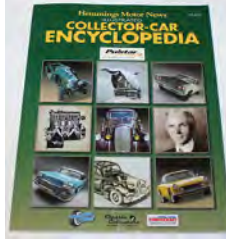

**HEMMINGPEDIA...
ALL**

Hemmings
Collector Car
Encyclopedia -0.15

..... **\$14.00 EA** ⚠



Curing Slow Starting Problems On 1936-1953 6 Volt Vehicles

(Cadillacs Used In This Example)

BY JAY FRIEDMAN AND ART GARDNER

We love six-volt Cadillacs and encourage folks to keep 'em six-volt! Unfortunately, slow or hard starting sometimes causes owners to consider converting the car to 12 volts, which usually is unnecessary and sometimes regretted afterwards.

On six-volt cars, the margin for error is much smaller than on 12-volt cars. On a 12-volt car, if the grounds are iffy, it'll probably still crank. If the 12-volt cables are skinnier than specified, it'll probably still start. If the 12-volt starter is tired or the engine is hot, it'll probably still turn over fine. But, on a six-volt car, maybe not.

Starting from only a nominal six volts (or, more technically, 7.2 volts), if the system experiences much of a voltage drop, there just isn't enough voltage potential to make things work well. So, you need a quality six-volt battery, a good charging system, an ignition system that is in tune, and, most of all, you need **proper cables and good grounds**. If you have paid attention to each of these details and still find the starter motor turning the engine slowly, here is one more trick: add a heavy ground strap directly to the starter's commutator endplate. This article explains how to do that.

Most 1936-'48 Cadillacs' battery ground straps extend from the battery to a bolt on the car's frame. Beginning in 1949, the battery's ground strap extends from this grounding point on the frame to one of the bolts holding the starter to the engine. If you read the CLC online Discussion Forum from time to time, you may have come across a series of postings some months ago that discussed an improvement, which consists

of grounding the battery directly to the "commutator endplate" of the starter.

The first time either of the authors saw one of those postings on the Forum, we were quite skeptical about whether this would really help. However, after additional reading, we not only found out all about endplates, but learned how to go about installing a new grounding bolt on a 1949's starter endplate and hooking up a ground strap to it. We did it on two cars, and, as a result, both now start perfectly.

Look at the back of your car's starter; that is, the end that does **not** go in the motor. This back end is the "commutator endplate," or, as it is called in some Cadillac literature, the "end frame." They are the same on all 1936-'52 Cadillac starters. [See photo below.]

▼ **THE ARROW** points to the commutator endplate of this starter.



Inside the starter, the endplate supports the starter's commutator and its brushes. Using a ruler or even a string, roughly determine the approximate distance from the endplate to the nearest point of your car's battery ground strap. As mentioned in a previous paragraph, on a '36-'48 car, this is probably a point on the frame, while on a '49-'52 car, it is one of the starter mounting bolts. File this distance away for the moment.

Remove the starter from the car and put it on a bench. You'll see that there are two bolts that hold the endplate to the rest of the starter. Remove these very long bolts that go right through the starter, pry open the endplate with a thin screwdriver or scraper and pull it off. (In doing so, you may hear a loud snap as the brush springs are released.) Don't let the rest of the starter components come apart, as the two long bolts hold the whole starter together. You'll see four brush assemblies on the inside of the

endplate. The brushes are the parts on the assembly with a screw through them. They fit over the commutator, which is the copper-colored round part that you can see in the main starter housing.

Hold the endplate up to the starter housing in the position it would be if it were still mounted on the starter. You'll see there is a small hole in the starter housing, into which goes a small pin on the inner perimeter of the endplate that positions the endplate on the starter. In this way, you may get a more precise idea as to the place on the outside of the endplate that is closest to the point on the frame or starter to which your current ground strap is bolted.

On a drill press, or, if you don't have one, using a hand drill, from the inside of the endplate, drill a $\frac{1}{8}$ -inch hole in the endplate about $\frac{3}{4}$ inch in from its outer perimeter, as near as possible to the place on the endplate you noted in the previous paragraph. Make sure the hole doesn't interfere with a brush assembly. Put a rag or piece of rolled-up paper in the hole in the center of the inside of the endplate that contains the bushing to

prevent any drill chips from going in the hole. Using a file or a "deburring" tool, clean off any burrs caused by the drilling on the perimeter of the drilled hole.

Buy a stainless steel $\frac{1}{8}$ -inch coarse-threaded ($\frac{1}{8} \times 16$) bolt $1\frac{1}{4}$ or $1\frac{1}{2}$ inches long, along with two stainless steel $\frac{1}{8}$ -inch nuts and two $\frac{1}{8}$ -inch lock washers. Using one of the nuts and one lock washer, install the bolt on the endplate with the bolt head inside the endplate and the threaded part of the bolt on the outside of the endplate.

Reinstall the endplate on the starter. Holding it at a 45-degree angle against the starter, push one, or, if you can, two of the brush assemblies over the commutator, while at the same time, you bend out the remaining brush assembly springs with a screwdriver so they go over the commutator. This is a bit tricky, so be patient. Make sure the small pin on the inner perimeter of the endplate that positions the endplate on the starter goes into the small hole in the starter housing. Reinstall and tighten the two long bolts. [See photo at right.]

Clean any paint off the other end of the starter where it mates to the motor as well as the adjacent surfaces of the motor. Reinstall the starter back on the motor.

Using the distance you estimated earlier, or, better yet, after measuring it again with the new bolt installed, obtain a ground strap of that length similar to the one in the photo below. It must be long enough to reach from the bolt that holds your battery ground

strap to the car's frame ('36-'48) or the starter ('49-'52) to the new bolt on the endplate. Ground straps like this can be found on eBay, on Amazon or at a local auto parts store. If the holes in the new ground strap are less than $\frac{1}{8}$ inch in diameter, drill them out to $\frac{1}{8}$ inch.

Unbolt the current ground strap from the frame or starter bolt, but not from the battery. Clean any paint or dirt off the place on the frame or starter and its bolt that the ground strap touches. Together with the original ground strap, bolt one end of your new ground strap to the same bolt on the frame or starter to which the original current ground strap is bolted. (You now have two ground straps bolted to the same place on the frame or starter.) Put the other end of the new ground strap over the new bolt on the starter endplate and fasten it with the second lock washer and the second nut.

You are now finished. [See photo, next page.] Your engine will turn over



► **COMMUTATOR ENDPLATE** with new grounding bolt installed.

▼ **TYPE OF** second ground strap needed, length to be determined.



MATERIALS NEEDED

- One 3/8-inch stainless steel coarse-threaded bolt 1/4 or 1/2 inches long;
- Two 3/8-inch coarse threaded nuts;
- Two 3/8-inch lock washers; and
- One ground strap as per the photo, length to be determined.

TOOLS NEEDED OTHER THAN ORDINARY HAND TOOLS

- Drill press or handheld drill; and
- Curved "starter" wrenches for the bolts holding the starter to the motor. [On most cars, the starter wrenches must be 5/8 inch.]

a lot faster and start more easily. By providing a more direct grounding of the starter commutator endplate, more of the battery's electrical potential (voltage) is applied to the starter's brushes, maximizing the effectiveness of the starter. You'll be surprised at how much of a difference this can make—we certainly were! ■

Jay Friedman, winner of the 2010 THE SELF-STARTER Author of the Year award, lives in Decatur, Ga. Art Gardner lives in Marietta, Ga.



NEW SECOND GROUND STRAP on a 1949-'52 starter. (A shorter second strap could have been used.) Arrow points to new grounding bolt. On a 1949-'52 motor, the battery ground strap will be attached to the same bolt at the left as the new second ground strap. On 1936-'48 cars, the second ground strap will be bolted to the grounding bolt on the frame.

Reprinted With Permission From, "The Self-Starters"

Fifty Reasons We Love This '41



Text By Dan Burrill

**Photos By Dan Burrill
&
Jeff Stites**

Today cars come with many standard features that were rare options 60-years ago. This perfectly restored 1941 Chevrolet Cabriolet, owned by Ron Wade is a classic example. In fact this car is so unusual and so well done that it won the Prestigious National Vintage Chevrolet Club of America's Best of Show. But the really unusual things about this car are the 50 factory offered options or accessories that are on the car.

This is partly due to the fact that Ron Wade is a visionary when it comes to rare and collectable cars. In the early 1970's he put together a list of the 25 most desirable cars that he would like to own, cars that were low production, typically Hi-Performance, convertibles or luxury cars.

Now keep in mind that at that time he didn't own any of these cars and in some cases it would be years before he actually found the cars and started restoring them. However, he knew what he wanted, and he started buying NOS parts and accessories for these cars, while the parts were still available at swap meets and from dealers. So years later, when he actually started restoring these low production collector cars, he already had a stockpile of parts.

One of those cars high up on the wish list was this 1941 Chevrolet Cabriolet. He bought the first '41 in about 1984 and before he got started on it, some folks came

by with a better car that they were going to ship to Australia. But when they discovered the cost to ship a car that far, they opted to trade the car to Ron for a crate of original vintage Chevrolet parts and they shipped that instead, and Ron received a nicer car for his restoration project.

Although Ron had many of the required optional accessories, there were many more that were (are) so rare that it took him years to acquire them and several of the optional accessories are on this car may very well be the only ones in existence.

When talking about this car, the word, "rare," comes up about 100 times in the conversation. In fact, it took Ron years just to find the books, brochures, and parts catalogs that showed pictures of some of the original accessories and then the search was on for the actual items.



Needless to say, this is a frame off restoration that took years to complete. The car was in average condition for a '41, so once the car was completely dismantled everything needed to be cleaned, fixed, repaired, re-welded, reinforced or replaced.

Like all restored vehicles the work is tremendous and very time consuming, not to mention the financial aspect. The Restoration was done by Bill Baker; Paint and body by Keith Grendahl at New Start Autobody; Upholstery by the late Ken Jones; and a great deal of credit goes to Master Technician Ray Holland for his help in finishing the project.

After years of collecting parts, Ron's passion finally developed into a business and for the last 34-years his company, Chev's of the 40's, (Vancouver, WA), has been providing the best in restoration parts for 1937-54 Chevrolet Cars and Trucks. And, of course, the "Fabulous '41," has become the Flagship car for the company.

Here are the 50 original accessories that make this a very rare car:

Under The Hood

- Air Filter: The oil bath air filter.
- Valve Cover & Breather: The April 1941 Service Bulletin showed an optional valve cover and breather cap. After some searching, the item was found on a military vehicle in a wrecking yard. Ron speculates these may have been for the military as we were gearing up for WWII.
- The ground strap going from the firewall to the back of the head was only used on cars with 5-band radios.
- The external oil filter was not a standard item and was difficult to find. It was 15-years before Ron could even find what it looked like.
- The windshield washer reservoir bottle with pump on the firewall.
- Radiator overflow return tank.

Exterior

- Antenna – Reel: Took 20-years of aggressive looking to locate one that could be restored.
- The hand crank and the crank support – front bumper. "These are the only ones we have ever seen."
- Driving Lights.
- The sharks tail exhaust tip is extremely rare.
- Fender skirts: These were very hard to find and even in their "found" condition, they were expensive. The fender skirt moldings are almost impossible to find today.
- Fold down rear guard: The rear guard had to fold down for the spare tire to be removed.
- Foot Scraper: This was the first year that Chevrolets didn't have running boards, and GM was concerned that the farmers wouldn't buy the cars because they didn't have anyplace to wipe their feet (before getting into the car). So the designers at GM made "foot scrapers," an option that received mixed reviews.



Exterior-Continued

- Gas cap – GM locking.
- Grille guard bumper and Grille winter guard.
- The Initial holder over the rear license plate frame is a great personal touch. Is this the only one in existence? Ron has never heard of another one.
- Passenger side outside mirror.
- Spare tire inflator.
- Back up light.
- Wing tips, bumper.
- License plate frames are adjustable and the '41s are unusual because the outside corners are reversed in that they go over the top of the straight pieces instead of going under.
- Rear axle ratio 3.70:1
- Washboard, front fender.
- Whitewall tires, wheel disks, and beauty rings.



- Windshield washers.
- The Flying Lady Hood Ornament adds a lot of class, and breaks up the wide expanse of the hood and front fenders.



- Outside Thermometer is mounted on the driver's side door so it can be seen from inside the car without rolling down the window. This was a hard item to find and it took a few years for Ron to finally locate this one.

Interior

- Armrest – center. This center armrest was an unusual item that adds a nice touch to the burgundy front seat.
- Electric clock -An interesting side note; The gold in the electric clock is a different color than the gold in the speedometer even though they were from the same year.
- The Compass is a nice touch and fits well on the center of the windshield.
- Cowl vent knob – ivory.
- Emergency brake whistle.
- Flashlight: this was another hard-to-find item.
- Super Deluxe Heater and Defroster. These are two items that we think of as being part of any modern car, but the defroster and the Super Deluxe Heater were options in 1941. The optional under seat heater couldn't be used with the Cabriolet because there was an X-member added to the frame for additional support.
- Horn, Town and Country.
- Mirror, day/night. This style mirror was only used one year, which made the search just that much more difficult.
- Mirror, lighted vanity for the ladies. The lighted vanity mirror was also a practical item because there are places to write the mileage for the next oil change, check battery, record next lube job, spark plugs, and tune motor.
- Radio – AM and 4 short wave bands. It's been said that at night you could pick up Europe.
- The left and right spot lights with the ivory ball on the handle were only offered for the first half of the model year.

- Radio, pocket portable has become a very expensive item and very hard to find a good one. This also was a 20-year search.
- This Silk Umbrella may very well be the only one that survived. The silk was oiled and over the years the silk is stuck or glued together, so the umbrella is never opened. Still in the NOS box.
- Steering wheel spinner was a neat touch and a handy item to have in the 1940's. Because they cracked easily there are very few around and they require total restoration.
- Tire pump has been restored and the new labels are available. It took years to find out what the original tire pump even looked like. Ron finally found it in a 1937 Chevy parts book.



- This NOS Tool kit is all original and the box has been faithfully reproduced.



- This all purpose combination tool was another rare item.



- Turn signals were another item that took 20-years to find.
- The clip on visor was great for reducing glare.
- Air freshener on visor.



A

AC53
 AC VENTS53
 ADHESIVES & SEALERS..... 27-28, 155
 AIR CLEANERS 91-92, 242
 AIR CONDITIONING..... 53-54
 AIR FILTERS 92-94
 ALTERNATORS..... 59-60
 ALUMINUM BUNDLE STRAP 56, 71
 ANTENNAS196-197
 ARM RESTS.....209
 ASH TRAYS189
 AUTO LITERATURE69, 236-239, 244

B

BACK GLASS..... 213-215, 224
 BACKUP LIGHTS..... 76, 90
 BALLAST RESISTOR64
 BATTERY CHARGERS 26, 60
 BATTERY & RELATED 26, 29, 61-63, 179, 242
 BEAUTY RINGS138
 BED..... 85, 227-228
 BED ROLL LIGHTS85
 BILLET.....194
 BODY BOLT KITS.....175
 BODY MOUNTING COMPONENTS174
 BOLT LOOSENER28
 BRAKE CLEANER27
 BRAKE FLUID 27, 121
 BRAKE HOSE118
 BRAKE LIGHTS 89, 121
 BRAKE LINES 118, 121
 BRAKE OVERHAUL KITS.....116
 BRAKE PEDALS..... 117, 180
 BRAKES & RELATED..... 116-118, 121
 BULBS..... 72, 75, 82-84
 BULK TUBING29
 BULLNOSE153
 BUMPER BOLTS145
 BUMPER BRACKETS 143, 145
 BUMPER GUARDS145

C

CAB MOUNT 174-175
 CAM & LIFTER KITS 36-37
 CAMSHAFTS 39-40
 CARBURETOR CLEANER29
 CARBURETORS..... 97-98
 CAR CARE22-25
 CARPET & RELATED178
 CAR WASH,WAX,CLEANERS.....24
 CHOKE CABLES188
 CHOKE KNOBS.....188
 CIGARETTE LIGHTERS 189, 242
 CIGAR LIGHTERS242
 CLAMP-WIRE.....69
 CLIPS-LINE121
 CLIPS-WIRE.....71
 CLOTHING 17-18
 CLUTCH HEAD DRIVER..... 81, 157, 184, 206
 CLUTCH HEAD SCREWS..... 80, 208
 CLUTCH HEAD SOCKET SET..... 28, 157, 184, 206
 CLUTCH PEDALS.....180
 CLUTCH & RELATED106
 COLLECTIBLES15, 18-22
 CONDENSERS65
 CORE SUPPORTS151-152
 COWL VENTS56, 187, 202-203
 CRANK HOLE COVER148-149
 CROSSMEMBER.....47
 CURB FEELERS.....159

D

DASH & RELATED..... 192, 194
 DECALS.....242-244
 DEFROSTER 54, 56
 DIMMER SWITCH82
 DISC BRAKES115
 DISTRIBUTORS 64-65
 DOME LIGHTS.....185
 DOOR 184, 206-212, 214, 220-221
 DOOR BUMPERS212
 DOOR CHECK LINKS210
 DOOR GLASS & RELATED214
 DOOR HANDLES..... 206, 208-209

DOOR HINGES210
 DOOR LATCHES 207-208, 212
 DOOR LOCKS207
 DOOR PANELS 184, 207
 DOOR PULLS.....206
 DOOR PUSHBUTTONS206
 DOOR SILLS211
 DOOR WEATHERSTRIP.....212
 DOOR WINDOW COMPONENTS.....220-221
 DRAG LINKS127
 DRIVE SHAFTS111
 DRIVING LIGHTS.....75-76, 84

E

EMERGENCY BRAKES 116-117, 187
 ENGINE ASSEMBLY LUBE 42, 46
 ENGINE BOLT KITS..... 41-42
 ENGINE COMPONENTS 37-42
 ENGINE GASKETS & SEALS..... 45-46
 ENGINE HAND CRANK58
 ENGINE KITS.....36
 EXHAUST..... 42, 99, 101-104, 182, 200
 EXHAUST MANIFOLDS 42, 99, 102
 EXHAUST & RELATED101-104, 182, 200

F

FAN 54, 187
 FANS51
 FENDER MOULDINGS159
 FENDERS 15, 157-160
 FIREWALL & RELATED176-177
 FLASHLIGHT185
 FLOORBOARDS..... 108, 178-179
 FLOOR MAT.....178
 FLYWHEEL RING GEAR.....106
 FOG LIGHTS75-76, 84
 FOG LIGHT SWITCH90
 FRONT BUMPERS..... 143-144, 146
 FRONT SUSPENSION129-131
 FUEL LINES..... 93, 95-96, 99
 FUEL PUMPS..... 93, 96-97, 202
 FUEL SENDING UNITS 94-95
 FUEL STABILIZERS 27, 93

FUEL SYSTEM91, 95-96
 FUSE HOLDER 76

G

GARNISH MOULDINGS.....220
 GAS 27-28, 91, 93-96, 179
 GAS CAPS 91, 96
 GAS FILLER..... 91, 96
 GASKET SEALER.....46
 GAS PEDALS179
 GAS SHUT OFF VALVE.....95
 GAS TANK PREP & SEALER93
 GAS TANK RESTORATION KIT27
 GAS TANKS27, 93-95
 GAS TANK SEALER SLOSH.....28
 GAS TANK SENDING UNITS 94-95
 GENERATORS 51, 61-62, 242
 GIFTS.....15, 18-22
 GLASS 213-215, 224
 GLOVE BOX194-195
 GREASE FITTINGS 130, 134
 GRILLES 148-151, 154
 GROUND STRAPS.....63

H

HEAD GASKET45
 HEADLIGHTS..... 78-83, 157, 188
 HEADLINERS.....181-183
 HEATER & RELATED 54-56
 HOG RINGS.....185
 HOOD & RELATED 153-156, 166
 HORNS & RELATED 67-68, 71, 126
 HOSE-BULK..... 201, 203
 HOSE CONNECTOR.....203
 HUB136-138
 HUB CAPS.....137-138

I

IFS.....129
 IGNITION & RELATED 64, 66
 INSTALLATION MANUALS.....239-241
 INSTRUMENT GAUGES & RELATED..... 95, 192-194
 INSULATION 30, 176, 178

NOTE: Any chemicals will be shipped domestic ground only (Lower 48 states only). No international shipping.

INTAKE MANIFOLDS 42, 91, 99, 102

K

KEY BLANKS 66, 207
 KICK 184
 KICK PANELS 184
 KING PINS 130

L

LEAF SPRINGS 131
 LED 78
 LICENSE 90, 143, 146-147
 LICENSE LIGHTS 90
 LICENSE PLATES & RELATED 90, 143, 146-147
 LIFTERS 39
 LINE CLAMPS 92, 108, 115-116
 LOWERING BLOCKS 133
 LUBRICATOR 28
 LUG NUTS 140

M

MAIN BEARINGS 41
 MANUALS 235-237, 239-241
 MASTER 115, 118-119, 179
 MASTER CYLINDERS 115, 118-119, 179
 METAL PREP 27, 93
 MIRRORS 190-191
 MOTOR MOUNTS 47
 MUFFLERS 102-103

N

NOVELTIES 17

O

OAKIE BUSHINGS 111
 OILING COMPONENTS 26, 38, 42-43, 46, 193
 OIL TROUGH ALIGNMENT TOOL 41
 ORIGINAL CARDS 242-244
 OVERFLOW TANKS 49-50

P

PAINTS 22, 30-32, 54, 104
 PARK LIGHTS 72-75

PETCOCK 51
 PILOT BEARINGS 106
 PILOT BUSHINGS 106
 PISTONS & RELATED 37, 40
 PITMAN ARM 125
 PITMAN SHAFT 126-127
 PLASTIC BLOCK 25
 PLASTIGAUGE 41
 POINTS 64-65
 POWER STEERING 125
 POWER WINDOWS 222
 PRESSURE PLATES 106
 PUSHRODS 39

R

RADIATORS 48-51, 152
 RADIOS 195-199
 REAR AXLE 112-113
 REAR BUMPERS 143-144, 146
 REAR CORNER CAB GLASS 214
 REAR SPLASH APRON 146
 REAR SUSPENSION 133-134
 REGULATOR 220
 RESISTORS 55
 REVERSE POLARITY SWITCH 58-59, 65, 71
 RING & PINION 112
 ROCKER ARMS 38
 ROD BEARINGS 41
 ROD DIPPER 41
 ROD SERVICE 40
 ROLLER BEARING CONVERSION 141
 ROLL PANS 143-144
 ROTORS 65
 RUNNING BOARDS 161
 RUST TREATMENT 27

S

SALES BROCHURES 235, 239
 SCREWS-INTERIOR 183-184
 SEATS 17, 181, 185
 SERVICE BULLETINS 238
 SETTING TAPE 217
 SHACKLES 130, 134

SHEET METAL164
 SHIFTERS108-109
 SHIFT KNOBS108, 189
 SHOCK LINKS130, 133
 SHOCKS-FRONT129, 134
 SHOCKS-REAR133-134
 SMOOTH172
 SOUND DEADENING178
 SOUND-VIBRATION DAMPING182
 SPARE TIRE CARRIER234
 SPARK PLUGS65
 SPARK PLUG WIRES65
 SPEEDOMETERS108, 193
 SPINDLE NUT140
 SPLASH APRONS146
 SPOTLIGHTS76
 STARTERS & RELATED58-59, 180
 STEEL BED FLOOR227
 STEERING COLUMNS & RELATED125-126, 187
 STEERING WHEELS67-68, 125-126
 STOVE BOLTS41
 SUN SHADE183
 SUNVISORS182-183
 SWAY BAR BUSHING130
 SWAY BAR-FRONT129

T

TAGS-ANTIFREEZE242
 TAGS-CIGAR242
 TAGS-DATA242
 TAGS-DELCO REMY62, 65, 242
 TAGS-HEATER242-243
 TAGS-OIL FILTER243
 TAILGATES226-227, 232-234
 TAIL LIGHTS85, 87-90
 TEMPERATURE GAUGE51, 193
 TEMPLATES239-241
 TERMINAL BOARDS71, 81
 THERMOSTATS51
 THROTTLE CABLES & RELATED98-99, 188-189
 THROWOUT ARM & BEARING106
 TIE RODS127
 TIMING CHAINS46

TIMING COVER40, 46
 TIMING COVER GASKETS46
 TIMING GEARS40
 TIMING HOLE PLUG41, 66
 TINNERMAN NUTS140
 TIRES25, 139
 TISSUE DISPENSERS190
 TOE173
 TOOLS28-29
 TORQUE TUBES110-111
 TRAFFIC LIGHT VIEWERS187
 TRANSMISSIONS & COMPONENTS108-109, 204
 TRUCK BEDS226-232
 TRUCK COVERS25
 TUBE SHOCK MOUNTS129
 TURN SIGNALS72-74, 188

U

U-BOLT131
 U-JOINTS110

V

VACUUM ADVANCE LINES99
 VACUUM ADVANCES65
 VACUUM HOSE203
 VALVE COVERS37-38, 45
 VALVE GRIND GASKETS45
 VANITY190
 VEHICLE ACCESSORIES15-17
 VENT GLASS214
 VENT WINDOW & RELATED219
 VOLTAGE BOOSTERS192, 197
 VOLTAGE CUT OUTS62
 VOLTAGE REDUCERS92, 192
 VOLTAGE REGULATORS62

W

WALL CLOCKS20-21
 WALL SIGNS21, 242
 WATER24, 50-51
 WATER PUMPS50-51
 WHEEL BEARING DUST COVER140
 WHEEL BEARINGS140

NOTE: Any chemicals will be shipped domestic ground only (Lower 48 states only). No international shipping.

WHEEL CYLINDERS	119-121
WHEELS	67-68, 125-126, 135-137
WINDLACE	211
WINDOW CHANNELS	220
WINDOW COMPONENTS	220-221
WINDOW CRANKS	222-223
WINDOW KNOBS	187
WINDOW REGULATORS	222
WINDSHIELD COMPONENTS	216-217
WINDSHIELD CRANKS	187-188
WINDSHIELD GLASS	213-214
WINDSHIELD KNOBS	187
WINDSHIELD MOULDINGS	184
WINDSHIELD WASHERS	203
WINDSHIELD WIPERS	187, 200-204, 220
WIRE-BULK	71, 76
WIRE CONDUIT	90
WIRE HARNESES	69-71, 74
WIRE LOOMS	64, 71
WOODRUFF KEYS	40, 46

A Short History of Chevs of the 40's



We're not your average parts house! We didn't buy a building, slap a name on it and say, "We're Chevs of the 40's." Neither were we a planned business venture. When President Ron Wade began restoring his 1941 Chevrolet Special Deluxe Cabriolet, he found himself running in circles searching for the correct restoration parts. If he couldn't find it, he had it made. Many of the parts had to be ordered in such a large volume that he began placing classified ads selling these parts that nobody else offered.



So, where did he store all of these parts and pieces? Under the bed, on the fridge, in the rafters over the garage; virtually any place there was an empty hole in the house. That was over three decades ago. Now Chevs has over 25,000 square feet of shelf space, 20 full-time employees who run the day-to-day operation and the latest in computer technology. We constantly research the much-needed, hard-to-find parts that everyone is looking for and if there's a demand, we consider having them made. What was a rather limited supply of parts three decades ago has turned into well over 800,000 parts in stock from which you can choose.



A lot was learned restoring Ron's Cabriolet. Countless hours have dedicated to having the correct parts made as well as improving the products we sell today. Ron's Cabriolet has over 50 (yes 50) factory accessories that have been collected and restored over the last three decades. The accessories are worth more than the car itself!

The 1941 Cabriolet took home "Best of Class" and "Best of Show" in the VCCA National Convention, held in Springfield, Illinois. It also received "Best of Class" at the Forest Grove Concourse D'Elegance, and was one of three cars on the podium for "Best of Show." (The Best of Show award went to a rare 1931 V16 Cadillac.)

1939 = 17 bars; 1940 = 16 bars

He didn't do it all himself-he had help! The restoration was performed by Bill Baker; the arrow-straight body and paint is courtesy of Keith Grendahl; Ken Jones stitched up the leather upholstery; and master technician Ray Holland provided all of the nitty-gritty details that make this car factory-correct. (And, of course, the able assistance of the Chevs staff.)





CHEVS OF THE 40'S
1605 NE 112th St.
Vancouver, WA 98686
800-999-2438

PRSRT STD
US POSTAGE
PAID
CHEVS OF 40'S

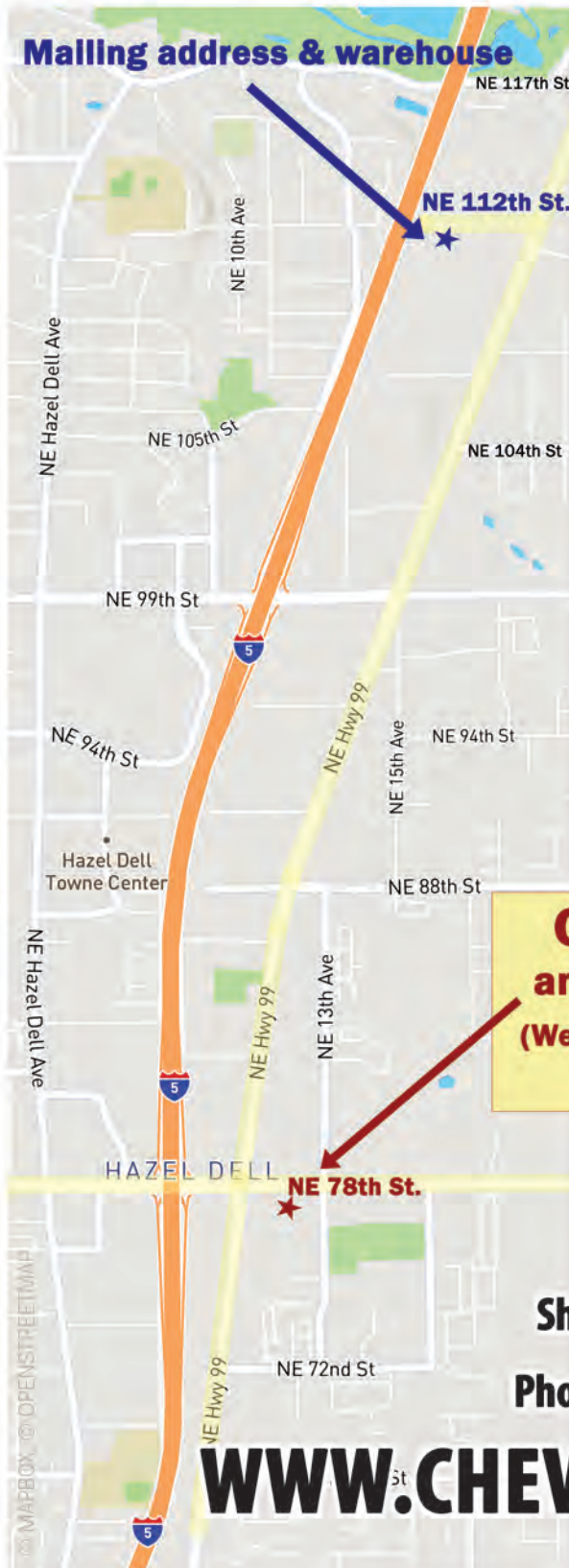

**Chevs of the 40's Showroom
and Cars by Ron Wade at WAAAM West
(Western Aeroplane and Antique Automobile Museum)
1015 NE 78th St. • Vancouver, WA 98665**

West Coast Hours

Showroom: M-F 8 a.m. – 5 p.m.

Phone Orders: M-F 6 a.m. – 5 p.m.

WWW.CHEVSOFTHE40S.COM



Visit us
online!