

Unical®

ELLPREX.

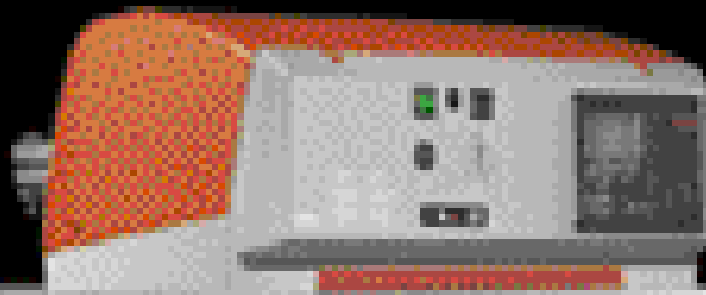

Unical

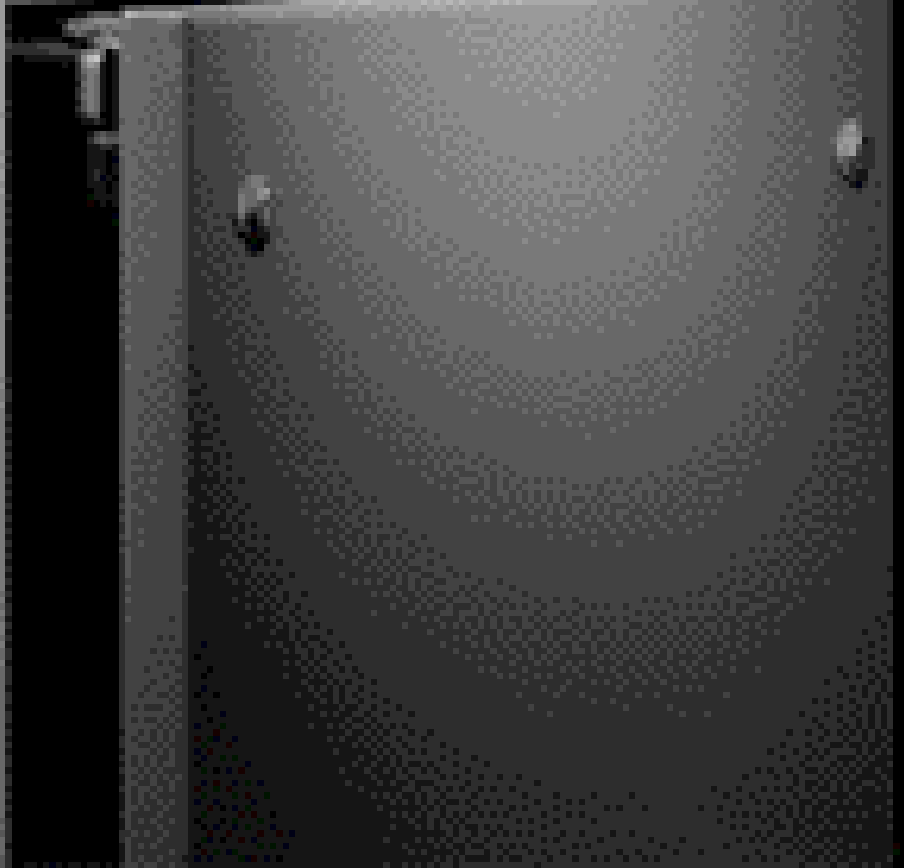

ELLPREX: *tradition and innovation*

Steel pressurised boilers ELLPREX cover a large power range which satisfies any system's need. In this boilers series the technicians will find:

- Large power extension:
18 models from 170 to 3500 KW.
- Flexibility in use thanks to the power range approval.
- Easy installation thanks to the compact dimensions.
- Maximum working pressure of 6 bar.

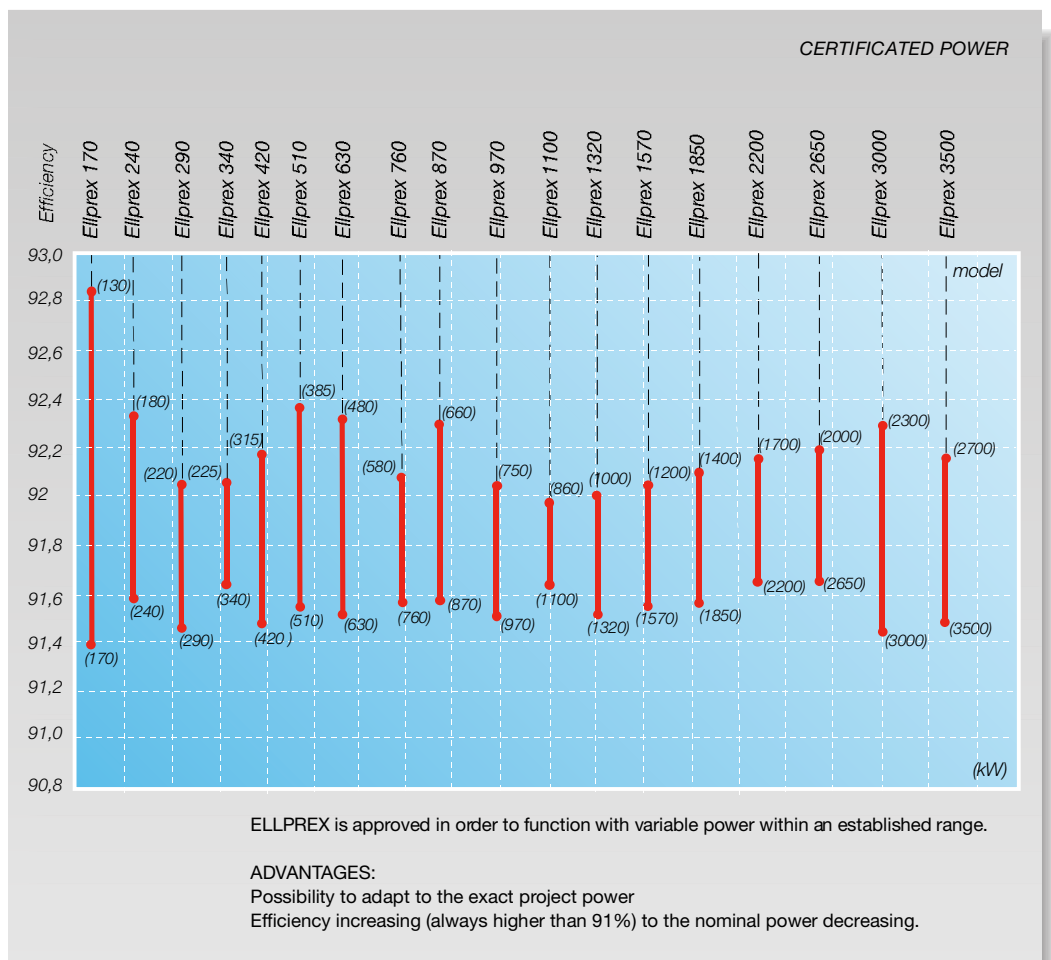

The elliptic shape great advantages

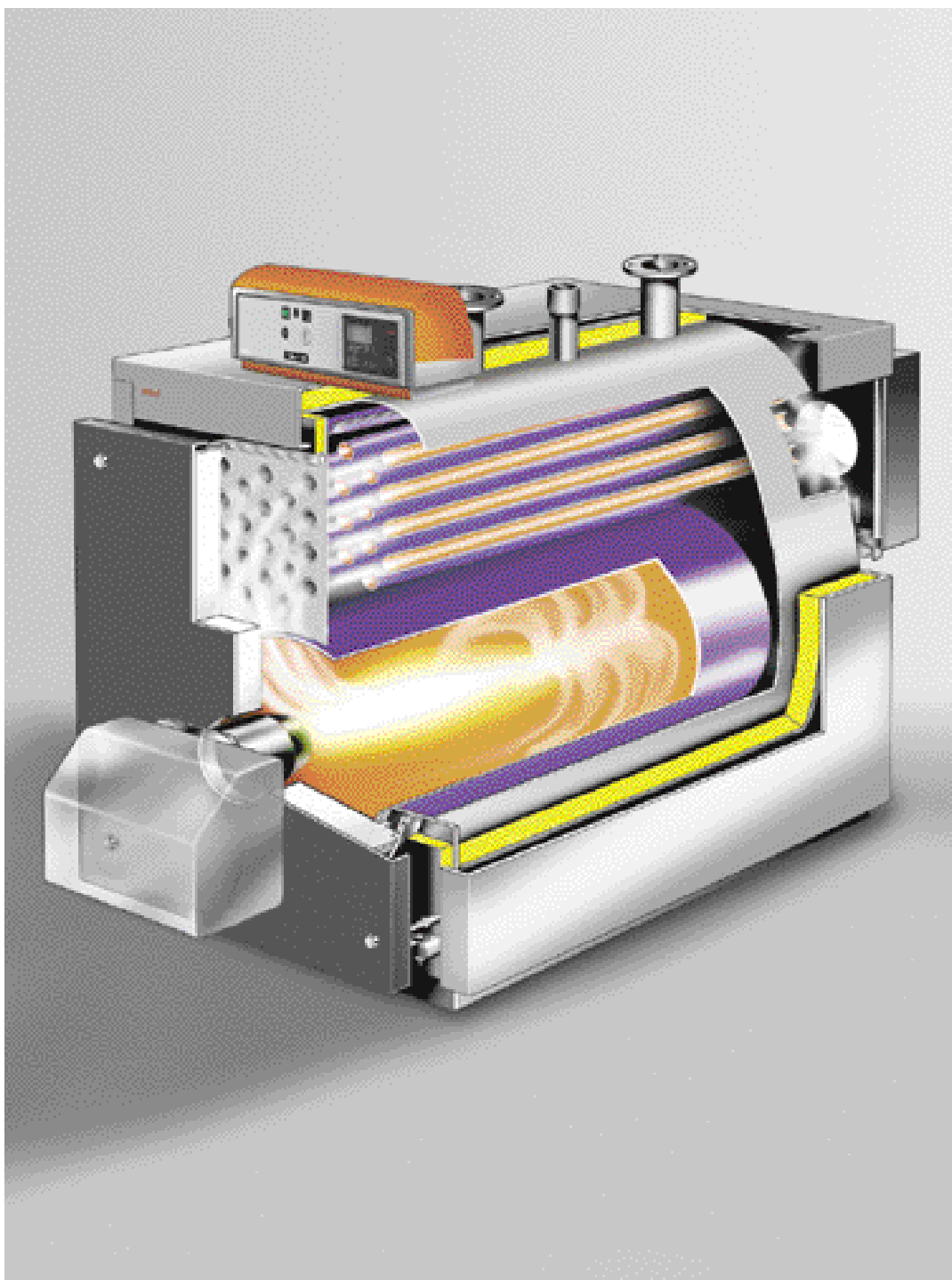

THE ELLIPTIC SHELL SHAPE (UP TO 970 KW) HAS INTERESTING ADVANTAGES:

- smaller dimensions (for easier transport and positioning).

- pipes positioning above the furnace with drastic reduction of the possible condensation.

THERMAL EXCHANGE OPTIMISATION BY DRIVEN WATER PASSAGE INTO THE BOILER.

SMOKE PIPES AT HIGH THICKNESS WITH ANTI-CONDENSING EFFECT.

BOTTOM OF THE FURNACE WITH DISSIPATION PLATES FOR GREATER PERFORMANCE AND GREATER MECHANICAL RESISTANCE.

CYLINDRICAL FLOATING FURNACE ANTI THERMO-MECHANIC STRESS FROM 970 KW.

INTERNAL DOOR INSULATION IN CERAMIC FIBRE.

EXTERNAL PROTECTION WITH ISOLATING CASING.

FRONT DOOR WITH AUTO CENTRAL LOCKING.

EXTERNAL CASING INCLUSIVE OF 80 MM ROCK WOOL INSULATION.

THERMOSTATIC AND ELECTRONIC CONTROL PANELS.

POSSIBLE INSTALLATION WITH MONO / BI / THREE STAGE AND MODULATING BURNERS.

FACILITATED TRANSPORT THANKS TO THE UPPER HOOKS AND STRONG BASE PLATES.

AVAILABLE IN NOT ASSEMBLED VERSION FOR ASSEMBLING INTO THE BOILER HOUSE, FROM 170 TO 970 KW.

TURBOLATORS FOR THE THERMAL EXCHANGE OPTIMISATION INTO THE SMOKE PIPE.

The technique...

The door

The experience of Unical technicians in the development of this boilers range has greatly improved the characteristics of front door insulation, responsible for 30% of the boilers heat losses for irradiation. Up to the capacity of 970 KW a ceramic fibre with high insulation is used, lighter and 50% more resistant compared to traditional materials. Over 970 KW, instead, a special double refractory cement is used.

The perfect gas soundness, not only important for heat losses, but also for the door life is guaranteed by the auto central and reversible closing (right or left) with fine registration:

- *vertical*, via the insertion of spacers (up to Ellprex 630) or acting on regulating nuts (from 760 onwards)
- *transversal*; slackening and moving the hinges
- *axial*: screwing more or less the locking nuts

Thermal balancing

Great thermal stability thanks to homogenous temperature distribution on the shell: the internal hydraulic circuit of ELLPREX has been studied to take full advantage of thermal exchange and at the same time cool off the more stressed parts thus reducing the calcium deposits formation. As shown in the previous page figure, the return of cold water is driven to a specific eave in order to cover the more thermally stressed parts (front plate, front part of smoke pipes and furnace). This system causes the structure cooling down and the calcifying phenomena reduction.

The boiler body oval shape preserves the boiler "vital parts" from the accumulation of possible mud present into the system guaranteeing a high distance between the furnace and the shell itself.

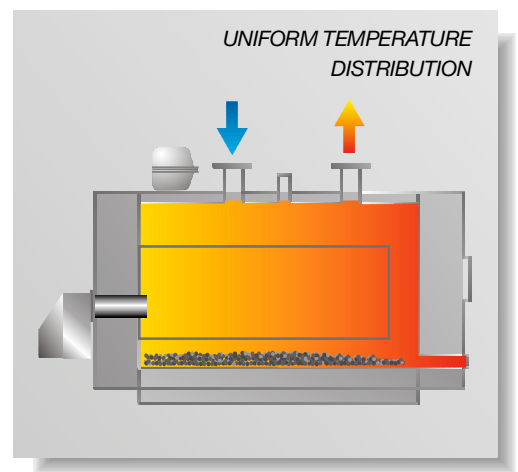
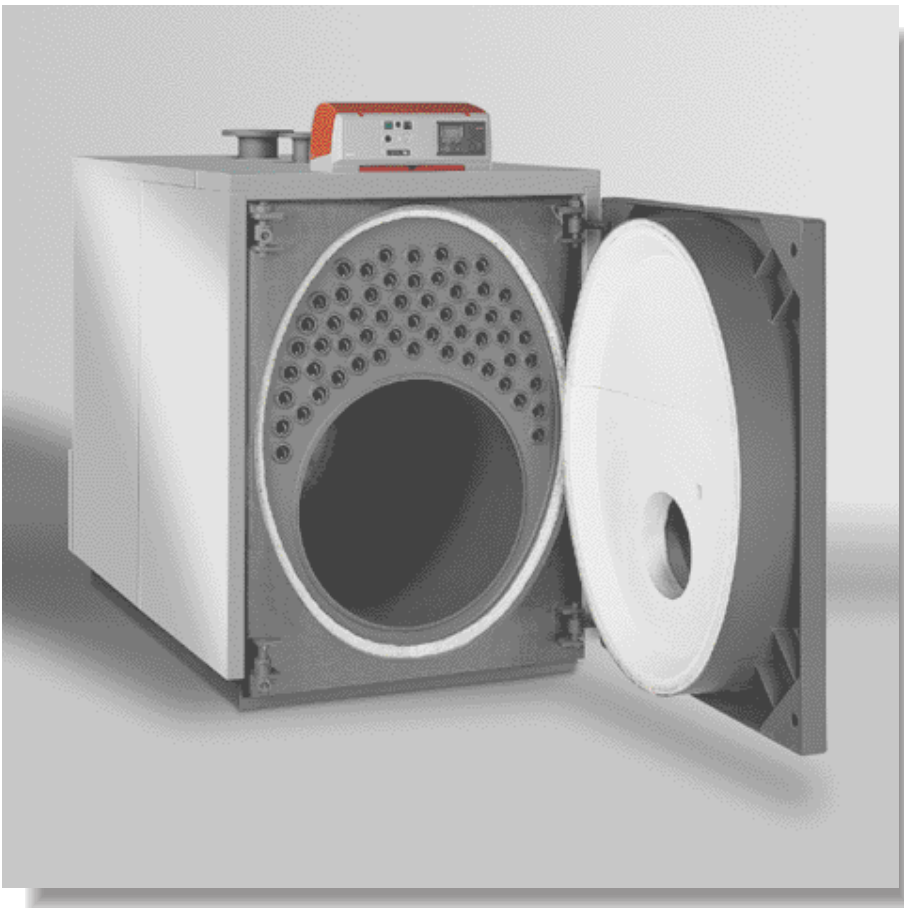

...and the boiler art

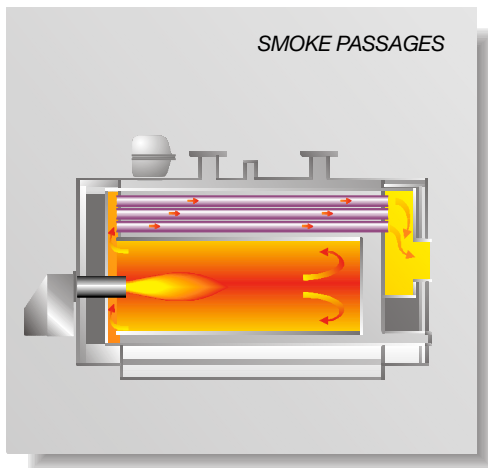

Tab effect

A further system for acid condensation reduction and therefore prolong the boiler life, in particular into the smoke pipes and in their welding to the rear plate, is to raise the pipe length over the plate itself. This system causes a tab effect which directs the accumulated heat towards the welding line drying the condensation around it and avoiding its formation.

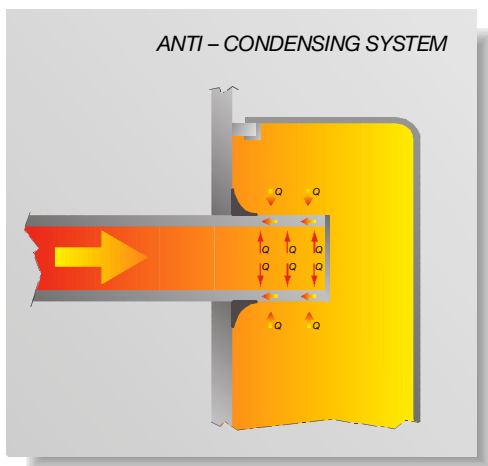

Floating Cylindrical Furnace

On particularly big boilers the longitudinal expansion of the furnace become consistent. It is for this reason that, from ELLPREX 1100 onwards, with an extremely fine technology, already experimented for long times, Unical welds the furnace only on the front plate. It remains free to dilate guaranteeing a long duration and operation elasticity.

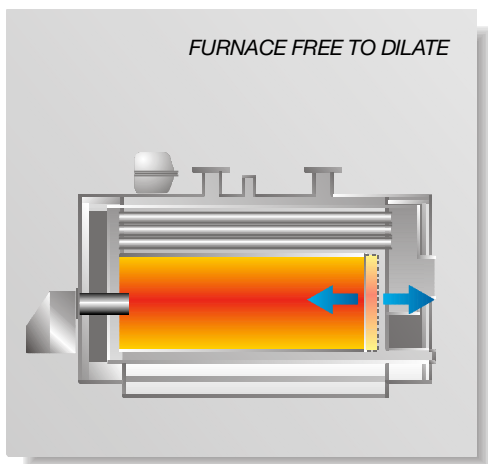

The control panel

The ELLPREX range is supplied with a control panel type 21057 in accordance with the regulations in force, that allows the thermostatic regulation of the burner, pump and water temperature. It is supplied with:

- General switch
- System pump switch
- Burner switch
- Thermometer
- Working thermostat with two stages
- Safety thermostat
- Minimum thermostat.

For more complex and refined systems, electronic panels are available with a mounted and wired thermoregulation (type 21109) in order to control:

- a system with a direct zone without mixing valve, or
- a system with a direct zone with a motorized mixing valve, or

- a system with two zones: one direct and one with mixed valves (boiler, DHW tanks, flow and outdoor sensors included).

On request, the management of two boilers in cascade is allowed.

Among the thermoregulation features we remind:

Autoadapting: this function that is obtained only if the room thermostat is installed allows, by an elaboration of the data taken on by the thermoregulation itself, to adapt the boiler operation according to the building features. This function is a guarantee of a constant monitoring of the room temperature to the outdoor temperature variation, taking into consideration the thermal inertia of the building and the “free” heat contribution (solar irradiation, internal heat fonts, etc.)

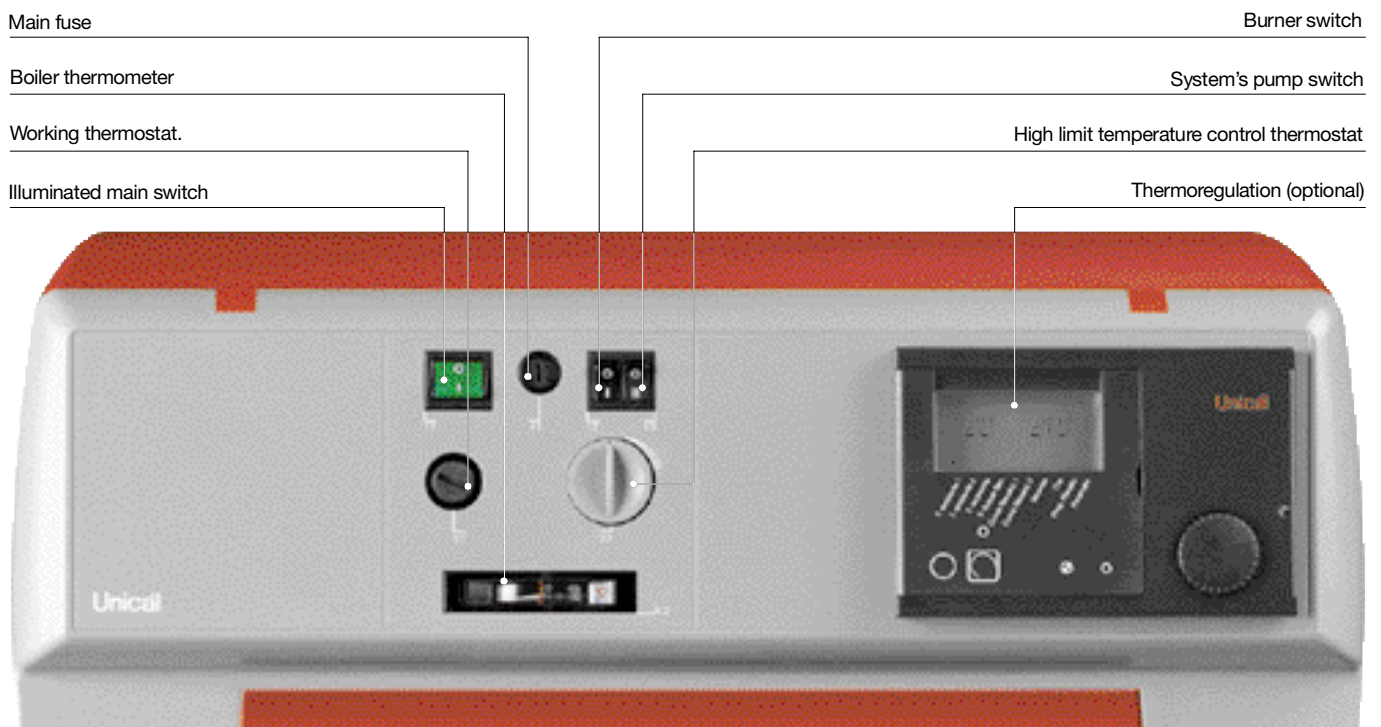

For a simple and economical heat management

Optimization:

the thermoregulation, on the basis of the timing set by the user, and valued the system characteristics, will proceed with greater or minor anticipation at the flame ignition or modification, in order to assure a comfortable temperature at the time set by the user.

Anti superheating:

the control of the safety heating is assured by the pump post circulation, so as to dissipate possible thermal inertia accumulated, before the stop, into the furnace and smoke pipes.

Control of more zones:

with the same thermoregulation it is possible to control 2 independent circuits with different characteristics, having assured all the described functions.

Production of sanitary water:

there are various programs that manage the sanitary water production. It's possible to choose from the maximum comfort to the maximum economy. For a rapid boiler heating, the thermoregulation provides to take the boiler temperature to the maximum set up value.

Anti-pathogenic bacteria:

this function is obtained by increasing the DHW tank temperature to 60°C every 20 heating cycles or at least once a week, on Saturday, at 1.00 am. With this procedure it is possible to eliminate possible pathogenic elements that may have been present in the sanitary water.

Programs set-up:

the timings can be set daily or weekly, with more switching on and off or temperature reductions during the day.

ELECTRIC AND HYDRAULIC HEATING SYSTEM AND HOT WATER PRODUCTION CONNECTIONS

Key:

P1 - Direct System Pump

P2 - Mixed System Pump

Pb.- Dhw Tank Pump

Vm2 - Mixing Valve

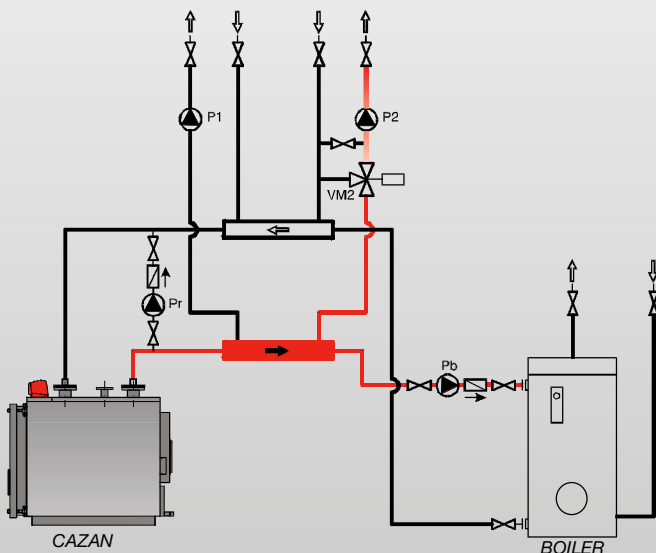

fig. 1

Here represented is a typical installation diagram for DHW production storage tank; the circuit is composed by two zones: one of these is controlled by a motorized mixing valve.

Both zones are managed by thermoregulation.

Quick and easy installation

ELLPREX is studied in order to be quickly installed in new systems and in their substitutions:

narrow and compact, with a maximum width of 780 mm (up to the 630 kW model), can be introduced through limited width doors and it can easily be placed in the boiler room.

When the difficulties are irresolvable, it is also available in ELLPREX S version, to be assembled and welded directly in the boiler room, maintaining all the peculiar characteristics of the ELLPREX boilers range.

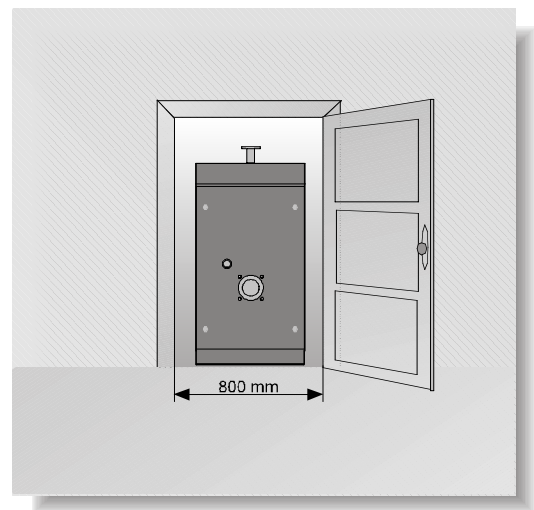

MODELS WITH NARROW SECTION

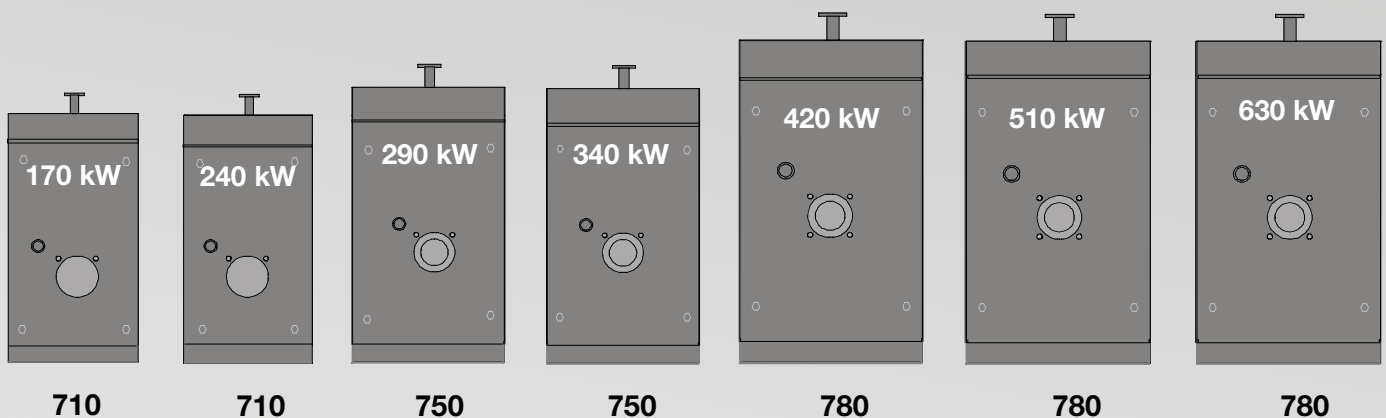

DIMENSIONS IN WIDTH OF THE BOILER BODY WITHOUT THERMAL INSULATION (measured in mm)

ELLPREX S: The solution for all the problems

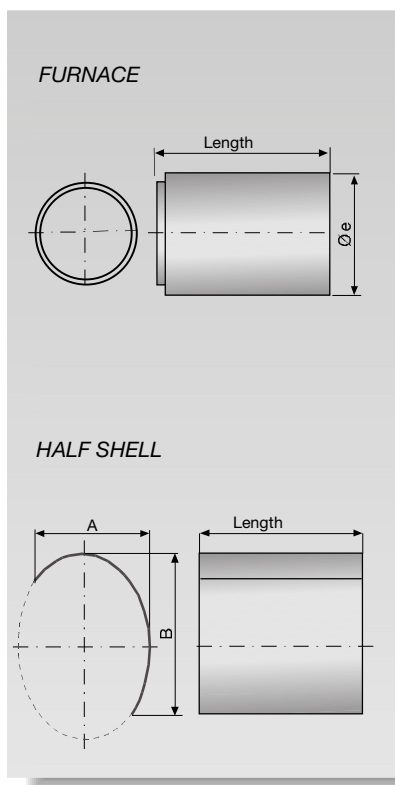

Often the need to substitute the old boiler obsolete with new mono-block devices, causes the impossibility to introduce the new boiler into the boiler house, without having to knock down parts of the existing building structure. The solution to such a problem is found in the ELLPREX S boilers, to be assembled in the boiler house, which furthermore maintains all the peculiar characteristics of the mono-block ELLPREX boiler series (performance, flexibility in functioning etc.). Our qualified or authorised by us staff will directly assemble the boiler into the boiler house and will complete the work with the final hydraulic test.

Local Predisposition

For the welding operations it's necessary to have at disposition an electric energy of minimum 6 kW. The installer will also remove the old boiler and introduce the constituting parts of the new ELLPREX S. The space in the boiler room must be such to allow free boiler parts movement

during the welding operation. In doubt it is advisable to have a preliminary inspection to verify the existence of such conditions.

The main components

ELLPREX S includes the following components properly positioned on a supporting structure for transport and movement:

- front plate
- rear plate
- shell (in two pieces)
- furnace
- insulation
- smoke pipes
- turbolators
- connections, tile distributors, lifting hooks, inspection door,
- front door
- smoke chamber
- control panel box
- casing and insulation box(es)

MAIN COMPONENTS DIMENSIONS AND WEIGHTS

Model	FURNACE			HALF SHELL		DOOR		SMOKE CHAMBER	
	ø ext. (mm)	length (mm)	weight (kg)	A x B x length (mm)	weight (kg)	width x height x depth (mm)	weight (kg)	width x height x depth (mm)	weight (kg)
ELLPREX S 170	480	790	64	558 x 788 x 775	30	710 x 905 x 170	60	610 x 440 x 170	18
ELLPREX S 240	480	1050	82	558 x 788 x 1035	40	710 x 905 x 170	60	610 x 440 x 170	18
ELLPREX S 290	530	986	88	590 x 879 x 970	51	750 x 1005 x 170	70	660 x 510 x 170	21
ELLPREX S 340	530	1116	98	590 x 879 x 1100	58	750 x 1005 x 170	70	660 x 510 x 170	21
ELLPREX S 420	580	1181	114	617 x 1047 x 1165	84	780 x 1165 x 170	82	690 x 660 x 170	27
ELLPREX S 510	580	1376	131	617 x 1047 x 1360	98	780 x 1165 x 170	82	690 x 660 x 170	27
ELLPREX S 630	580	1686	157	617 x 1047 x 1670	120	780 x 1165 x 170	82	690 x 660 x 170	27
ELLPREX S 760	700	1462	224	802 x 1082 x 1490	121	1024 x 1280 x 216	225	900 x 790 x 170	47
ELLPREX S 870	700	1657	251	802 x 1082 x 1685	137	1024 x 1280 x 216	225	900 x 790 x 170	47
ELLPREX S 970	700	1852	277	802 x 1082 x 1880	153	1024 x 1280 x 216	225	900 x 790 x 170	47

Dimensions and technical data

ELLPREX 170 - 630

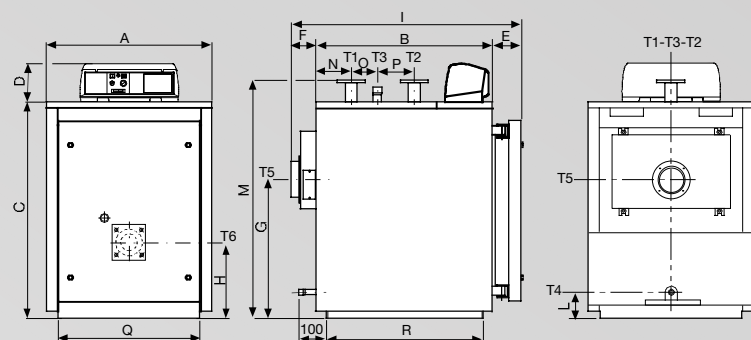

Key:

- T1 - Central Heating flow
- T2 - Central Heating return
- T3 - Expansion vessel connection
- T4 - Boiler drain
- T5 - Flue socket
- T6 - Burner connection

ELLPREX 760 - 970

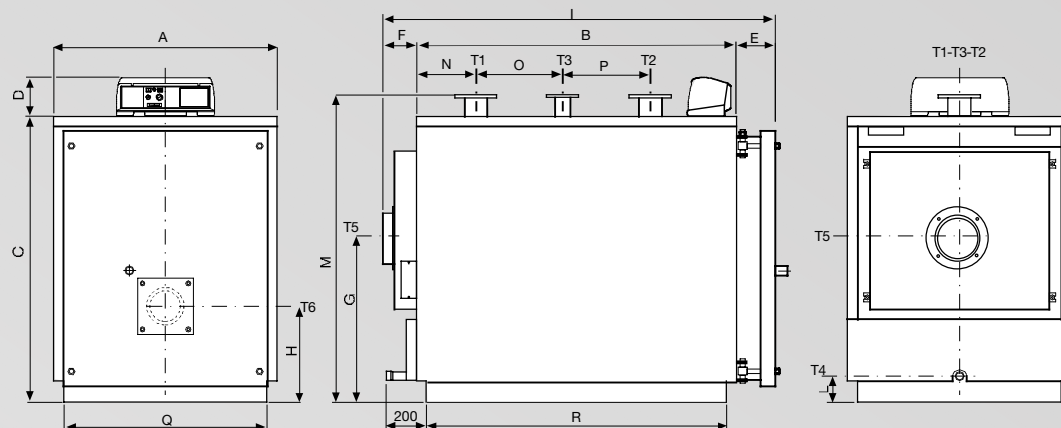

ELLPREX 1100 - 3500

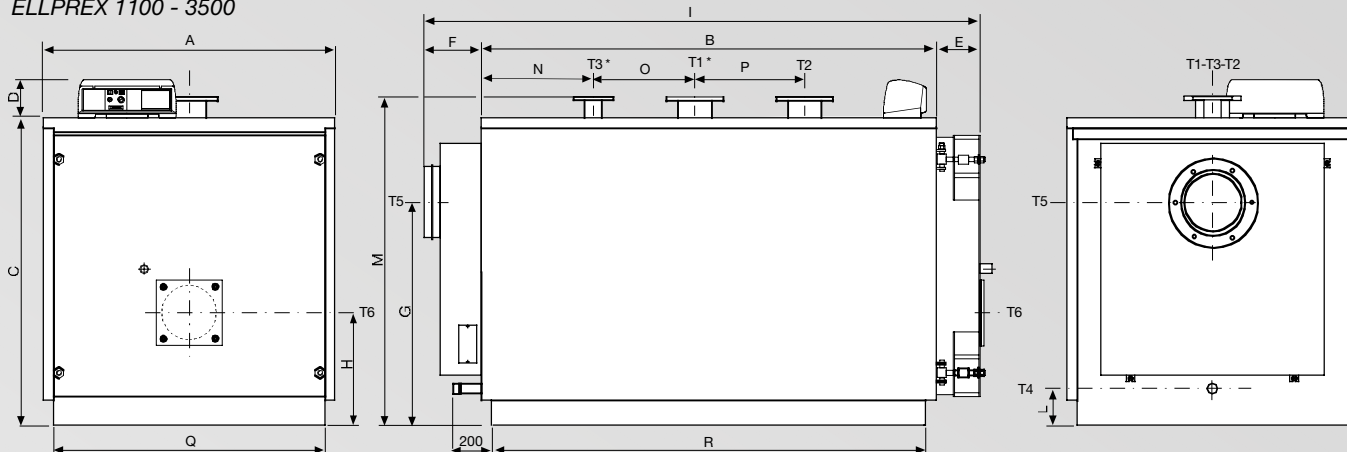

*For models ELL 3000 and ELL 3500 T1 and T3 are reversed and T4 is on the front plate instead of the rear one.

Model	Output min / max	Input min / max	Water content	Water side pressure loss*	Smoke side pressure loss	Maximum working pressure	Combustion chamber volume	Weight
	kW	kW	l	w.c. m	w.c. mm	bar	m ³	kg
ELLPREX 170	130÷170	140÷186	190	0,09÷0,15	9÷15	6	0,128	435
ELLPREX 240	180÷240	195÷262	251	0,19÷0,33	15÷28	6	0,173	510
ELLPREX 290	220÷290	239÷317	264	0,12÷0,21	13÷25	6	0,198	588
ELLPREX 340	255÷340	277÷371	298	0,16÷0,28	17÷34	6	0,226	629
ELLPREX 420	315÷420	342÷459	398	0,09÷0,17	16÷29	6	0,288	796
ELLPREX 510	385÷510	418÷557	462	0,14÷0,25	24÷43	6	0,337	919
ELLPREX 630	480÷630	520÷688	565	0,21÷0,38	27÷55	6	0,416	1049
ELLPREX 760	580÷760	630÷830	671	0,15÷0,26	18÷30	6	0,513	1341
ELLPREX 870	660÷870	715÷950	753	0,19÷0,33	20÷35	6	0,584	1447
ELLPREX 970	750÷970	815÷1060	836	0,24÷0,41	26÷43	6	0,656	1553
ELLPREX 1100	860÷1100	935÷1200	1040	0,18÷0,30	32÷58	6	0,748	1821
ELLPREX 1320	1000÷1320	1087÷1442	1242	0,20÷0,35	43÷75	6	0,869	2030
ELLPREX 1570	1200÷1570	1304÷1715	1418	0,19÷0,33	31÷53	6	1,087	2780
ELLPREX 1850	1400÷1850	1520÷2020	1617	0,26÷0,45	42÷73	6	1,303	3280
ELLPREX 2200	1700÷2200	1845÷2400	2086	0,21÷0,34	39÷65	6	1,650	4145
ELLPREX 2650	2000÷2650	2170÷2890	2324	0,28÷0,48	51÷90	6	1,866	4465
ELLPREX 3000	2300÷3000	2492÷3280	2667	0,36÷0,62	50÷85	6	2,313	5110
ELLPREX 3500	2700÷3500	2930÷3825	4142	0,54÷0,84	47÷78	6	2,601	6700

Model																	CONNECTIONS				
	A	B	C	D	E	F	G	H	I	L	M	N	O	P	Q	R	T1	T3	T4	T5	T6
	mm	mm	mm	mm	mm	mm	mm	mm	mm	mm	mm	mm	mm	mm	mm	mm	PN 16	ISO 7/1	Ø	Ø	Ø
ELLPREX 170	820	885	1082	190	139	145	648	380	1169	130	1210	175	130	185	710	785	DN65	Rp1½	Rp¾	200	180
ELLPREX 240	820	1145	1082	190	139	145	648	380	1429	130	1210	175	390	185	710	1045	DN65	Rp1½	Rp¾	200	180
ELLPREX 290	860	1080	1182	190	139	145	708	400	1366	130	1310	215	210	250	750	982	DN80	Rp2	Rp¾	250	210
ELLPREX 340	860	1210	1182	190	139	145	708	400	1496	130	1310	215	340	250	750	1112	DN80	Rp2	Rp¾	250	210
ELLPREX 420	890	1275	1352	190	139	145	748	440	1561	125	1485	255	285	315	780	1177	DN100	Rp2	Rp¾	250	210
ELLPREX 510	890	1470	1352	190	139	145	748	440	1756	125	1485	255	480	315	780	1372	DN100	Rp2	Rp¾	250	210
ELLPREX 630	890	1780	1352	190	139	145	748	440	2066	125	1485	255	790	315	780	1682	DN100	Rp2	Rp¾	300	210
ELLPREX 760	1122	1605	1432	190	195	145	765	480	1944	125	1540	298	435	440	1020	1504	DN125	DN 65	Rp1¼	350	270
ELLPREX 870	1122	1800	1432	190	195	145	765	480	2139	125	1540	298	630	440	1020	1699	DN125	DN 65	Rp1¼	350	270
ELLPREX 970	1122	1995	1432	190	195	145	765	480	2334	125	1540	298	825	440	1020	1894	DN125	DN 65	Rp1¼	350	270
ELLPREX 1100	1352	1952	1432	190	207	287	810	595	2446	75	1540	461	330	500	1250	1846	DN150	DN 80	Rp1½	400	320
ELLPREX 1320	1352	2292	1432	190	207	287	810	595	2786	75	1540	461	670	500	1250	2186	DN150	DN 80	Rp1½	400	320
ELLPREX 1570	1462	2282	1542	190	227	287	880	640	2796	75	1650	561	510	550	1360	2176	DN175	DN100	Rp1½	450	320
ELLPREX 1850	1462	2652	1542	190	227	287	880	640	3166	75	1650	561	880	550	1360	2546	DN175	DN100	Rp1½	450	320
ELLPREX 2200	1622	2692	1702	190	259	289	950	690	3240	75	1810	661	670	700	1520	2590	DN200	DN125	Rp1½	520	380
ELLPREX 2650	1622	3014	1702	190	258	288	950	690	3560	75	1810	662	990	700	1520	2910	DN200	DN125	Rp1½	520	380
ELLPREX 3000	1670	3246	1890	190	247	317	1315	772	3810	206	1990	333	1100	1180	1600	3200	DN200	DN125	Rp1½	570	380
ELLPREX 3500	1920	3216	2150	190	300	358	1535	915	3874	135	2270	390	1060	1130	1850	3164	DN200	DN125	Rp1½	620	380

* Hydraulic resistance for Δt of 15°C

