

1962 CORVAIR LINE

BODY STYLE	SERIES - MODELS			
	500	700	900 MONZA	GREEN-BRIER
2-Door Coupe 5-Passenger	527	727		
2-Door Coupe 4-Passenger			927	
4-Door Sedan 6-Passenger		769	969	
4-Door Station Wagon, 2-Seat		735	935	
6-Door Station Wagon, 2-Seat				R1206
6-Door Deluxe Sta. Wgn., 2-Seat				R1206 Deluxe

CORVAIR 700

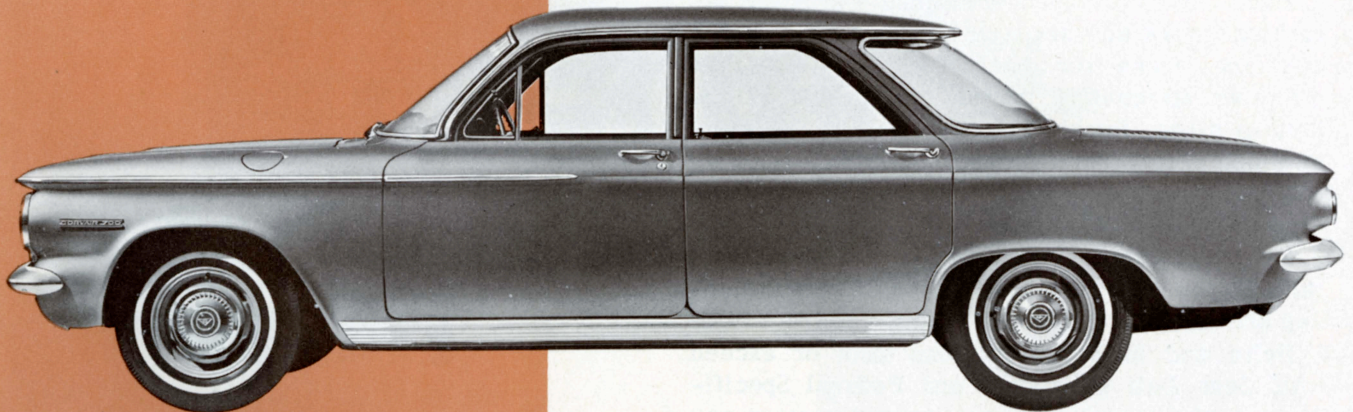
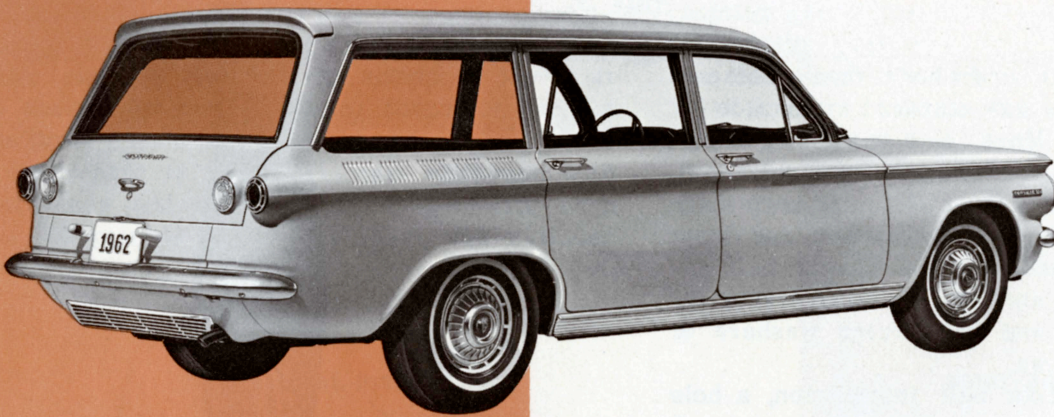

CORVAIR 500

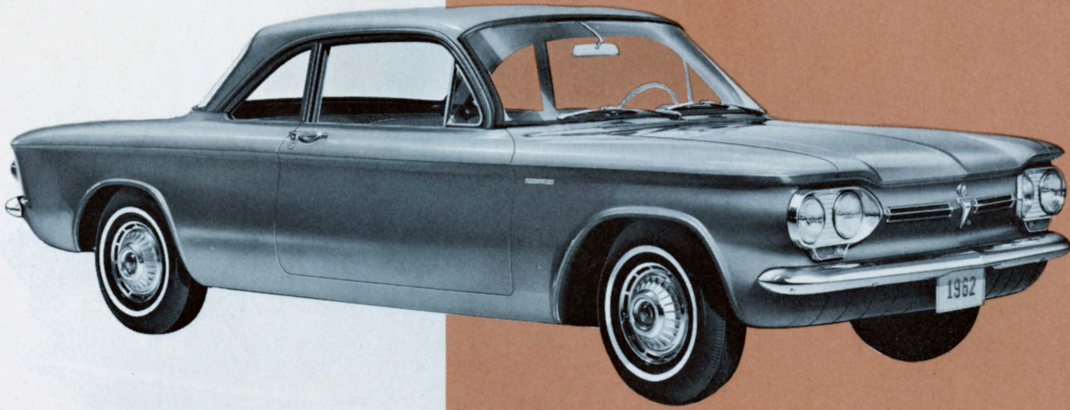

CORVAIR MONZA

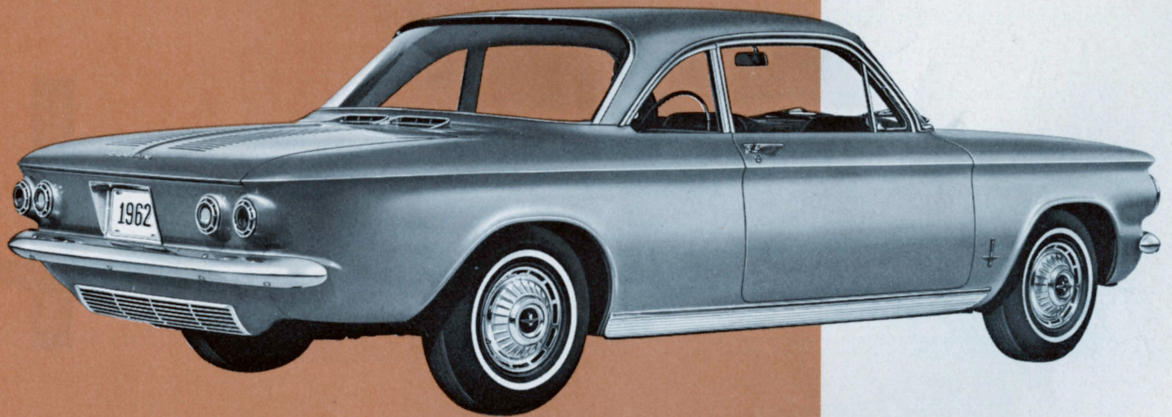

GREENBRIER

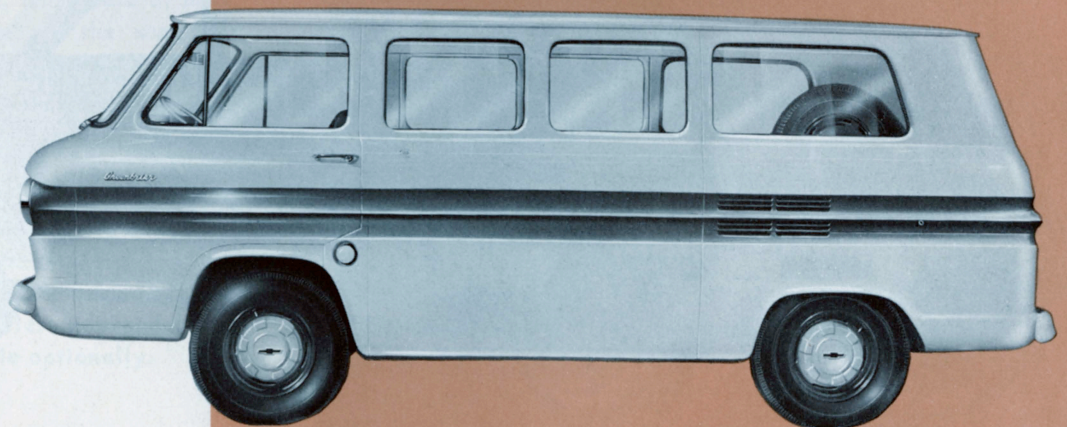

CORVAIR STYLING

Although basic styling of all Corvair models is unchanged, new appointments contribute to the 1962 appearance.

Twin front ornamental grilles and center emblem identify all regular Corvairs with distinctive new series nameplates and body sill moldings for the 700 Series and Monza models. The body molding on the 700 Series models and Monza Station Wagon is confined to the forward portion of the vehicle.

Fourteen exterior colors are available for all regular Corvair models with ten two-tone combinations offered for the 500 and 700 Series. Fifteen exterior colors and fifteen two-tone combinations are available for the Greenbrier Sports Wagons.

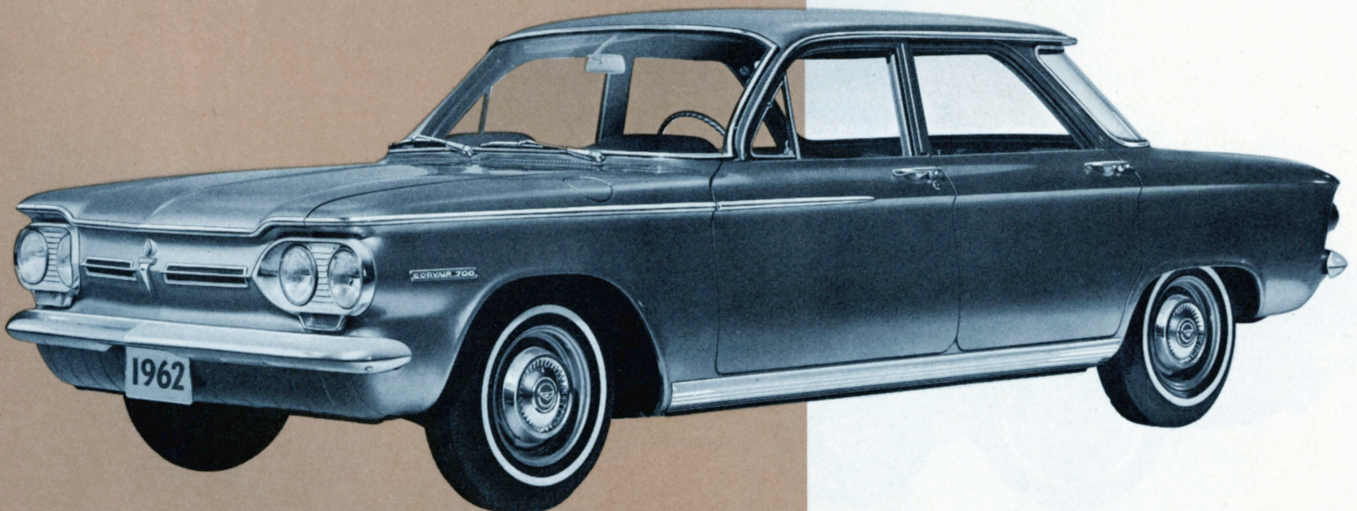
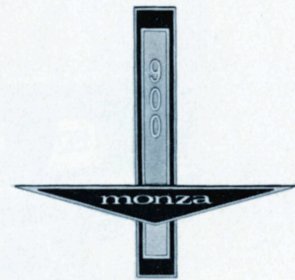
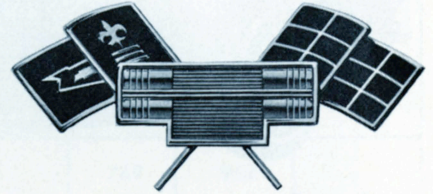

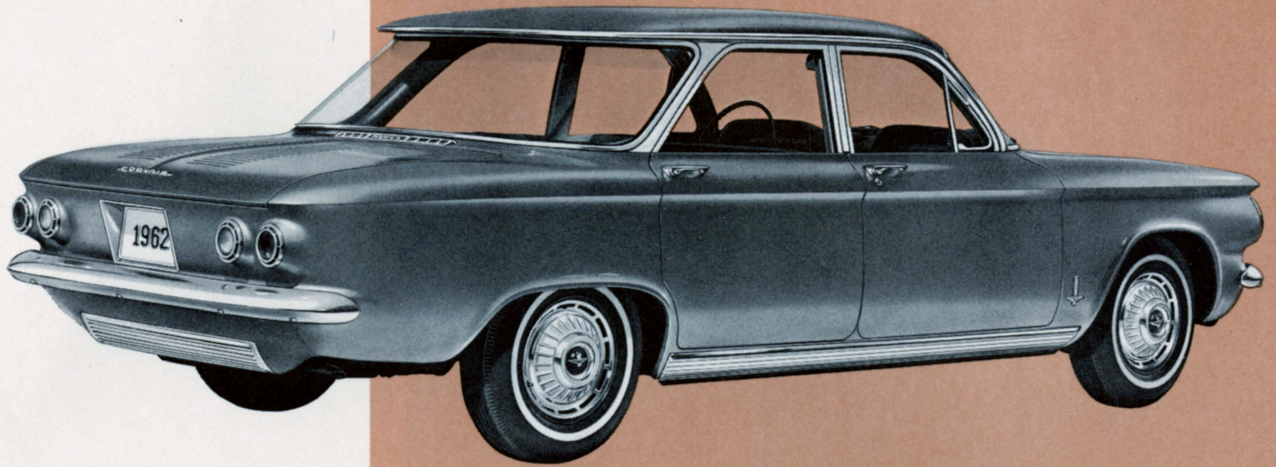

Restyled tail lamps, nameplate and engine air exhaust grille enhance the rear view of all 1962 regular Corvair models. A special emblem with crossed flags, located below the nameplate, identifies models equipped with the optional Turbo-Air 145 engine.

A bright metal Chevrolet nameplate, low on the right rear cargo door, complements the functional styling of the Greenbrier Sports Wagons.

A Chevrolet emblem, on a field of blue, decorates the center of the stainless steel hub caps for 500 and 700 models. Wheel disks for Monza models feature an attractive center insert, displaying the series emblem. With the substitution of a center insert containing the Chevrolet emblem, these same disks are available as accessories for 500 and 700 models. Greenbrier hub caps are unchanged, with regular passenger car wheel disks available optionally.

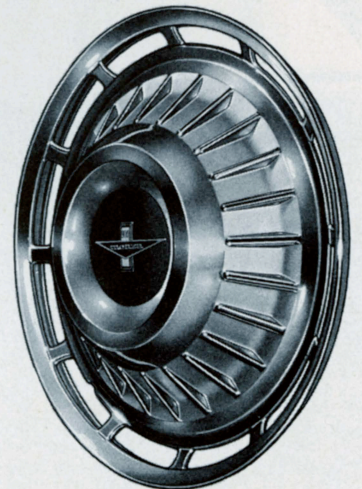
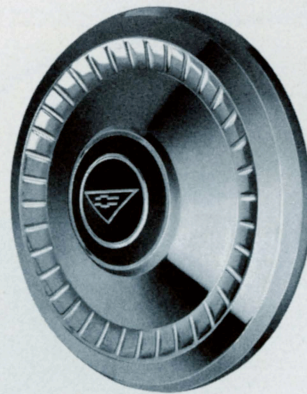

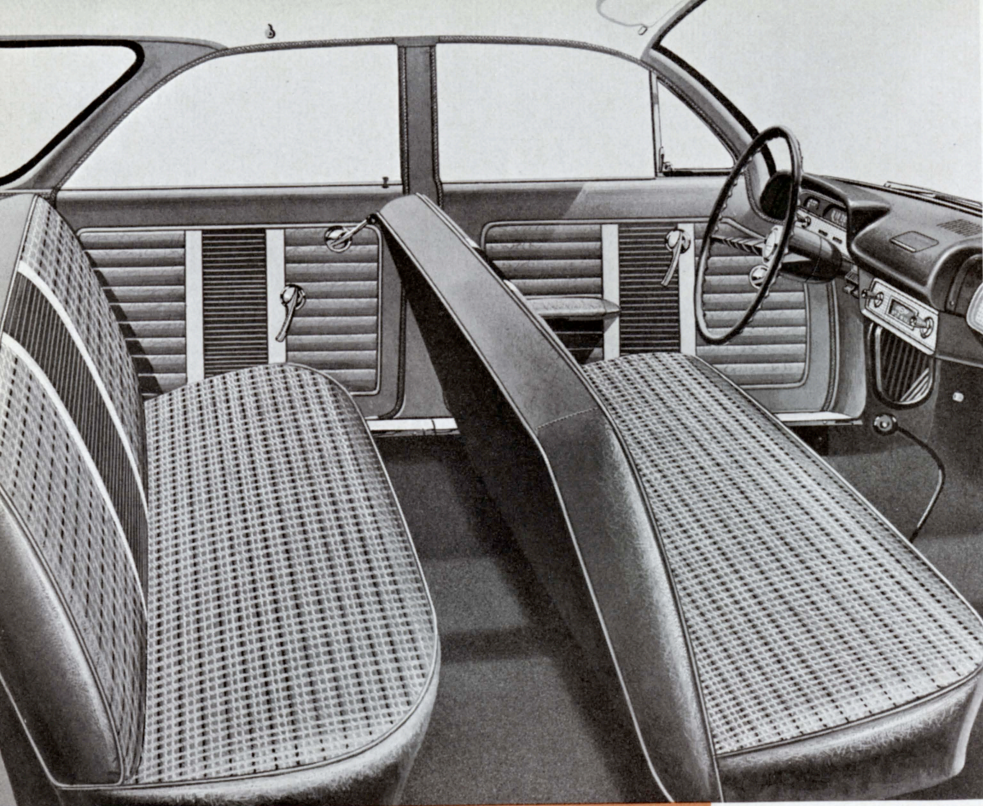

CORVAIR 700

Four interior colors – fawn, aqua, red and blue are offered for the 700 Series. Seats are trimmed in colorful pattern cloth, with accent panels and facing of leather grain vinyl. Headlining is cloth for the coupe and sedan and vinyl for the station wagon. Spatter design rubber floor mats are used throughout the 700 Series. As in all 1962 regular Corvairs, interior paint is color-keyed to interior trim.

CORVAIR 500

Available in fawn, aqua or red, Corvair 500 interiors feature seat trim of attractive pattern cloth with side facings and side wall inserts of leather grain vinyl. Headlining is cloth, and floor mats are black rubber. Front door armrests, cigarette lighter and dual sunshades are standard equipment.



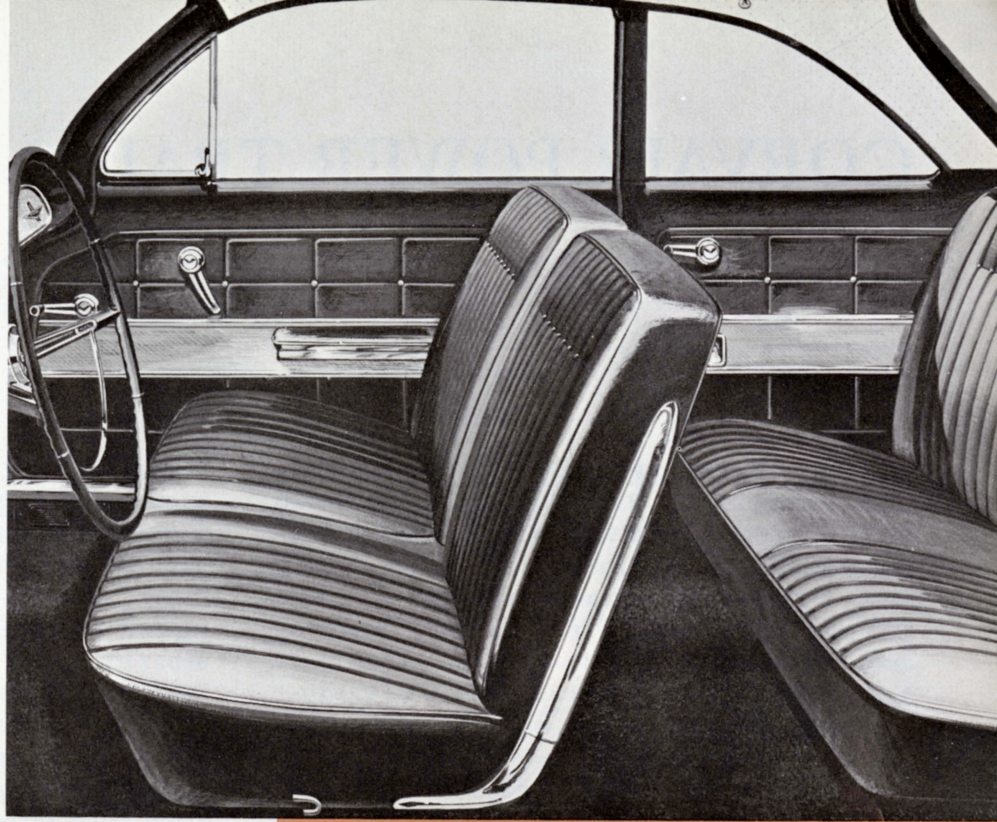

Bucket-type front seats and all-vinyl interiors are continued as standard equipment in the Monza Coupe and optional for the Sedan and new Station Wagon. A full width bench-type front seat and combination cloth and vinyl interiors are standard in the latter models. All-vinyl interiors are available in a choice of six colors; combination cloth and vinyl interiors are offered in five colors. Bright metal front seat end panels, dual arm door hardware and deep-twist floor carpets are among the features of all Monza models.

CORVAIR 900

GREENBRIER

The standard interior, as shown, features colorful new multi-stripe seat fabric faced with fawn leather grain vinyl. Interior paint, also fawn, complements the new trim, with white applied to the steering wheel and instrument panel face for accent. The deluxe interior features distinctive fawn or aqua seat fabrics with bolsters and facings of fawn, red, aqua or green leather grain vinyl. Side walls again include matching vinyl trim panels, and ash trays are now provided for rear seat passengers.



CORVAIR POWER TRAINS

ENGINE. The 145 cubic inch displacement aluminum engine for the 1962 Corvair is again rated at 80 horsepower for all models, except Monza-Powerglide combinations. For Monza models with Powerglide, engines were equipped with 9.0-to-1 compression ratio cylinder heads in mid-season 1961, and in 1962 are rated at 84 horsepower. Also equipped with the 9.0-to-1 compression ratio heads in mid-season 1961, the high performance engine (Regular Production Option 649) is rated at 102 horsepower.

The convenience of a new automatic choke is incorporated into each Corvair carburetor assuring quick, easy starts. A lag-free control arrangement quickly opens chokes when the engine is sufficiently warmed up, and prevents choke return until it is needed. Air intake ducts and cleaner elements remain unchanged for 1962.

The carburetor float bowl cover now includes a vacuum operated diaphragm, mechanically linked to the choke pivot shaft. Mechanical linkage connects choke valves to bimetallic coil thermostats, located directly below corresponding cylinder heads. Fuel air mixture, then, is regulated according to need determined by both the inlet manifold pressure and engine operating temperature.

The remote thermostat location precludes the need for transporting hot air to choke locations, which in turn eliminates extra piping required to provide manifold vacuum to move the hot air from engine to carburetor choke. With the sensing units placed nearer to the source of combustion heat, choke response is quicker and more accurate, and the simplified heat supply arrangement enhances choke operational reliability. Linkage between throttle lever and choke valve includes a five step fast idle cam, so that engine idle speed regulation is related to the degree of choke application.

Exhaust system arrangement and outlet sizes remain the same as used previously for both regular production and high performance engines. However, improved corrosion prevention is provided by the use of aluminum coatings in place of zinc on the sheet metal outer cover, which protects the asbestos wrap enclosing the muffler shell.

Designed to provide quieter operation, a new engine cooling blower was incorporated into all Corvair engines in late mid-season 1961. The new design involves revised impeller vanes of fewer number. Previously, 24 short vanes were welded between the circular blower base and separate upper rim, leaving the center area open around the hub. Sixteen new vanes extend in to the hub and upward in the impeller central area. The increased blade length provides longer confined flow passages, which prevent air recirculating through the blades to eliminate roar or blower boom.

Blower efficiency is improved by the axial inlet, which better positions impeller blades to pick up undisrupted air, and maintains control for smooth air movement. Blower operational improvement ranges from approximately 22 percent with cooling exhaust gates two-thirds open to 5 percent when wide open.

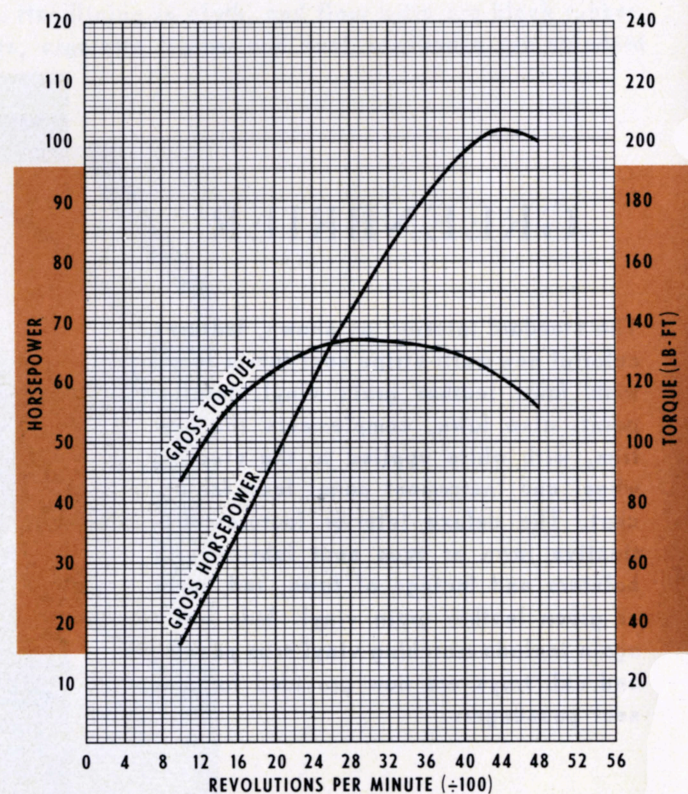

ENGINE	COMPRESSION RATIO	TRANSMISSION	APPLICATION	AXLE RATIO
Turbo-Air 145 80 Horsepower 145 Cubic Inch	8.0-to-1	3-Speed	Sedans and Coupes	3.27
			Station Wagon	3.55
			Greenbrier	3.89
		4-Speed	Sedans and Coupes	3.27
			Station Wagon	3.55
			Greenbrier	3.89
		Powerglide	Sedans and Coupes	3.27
			Station Wagon	3.55
			Greenbrier	3.89
Turbo-Air 145 84 Horsepower 145 Cubic Inch	9.0-to-1	Monza Models with Powerglide	Sedans and Coupes	3.27
			Station Wagon	3.55
Turbo-Air 145 102 Horsepower 145 Cubic Inch	9.0-to-1	3-Speed	Sedans and Coupes	3.27
			Station Wagon	3.55
		4-Speed	Sedans and Coupes	3.27
			Station Wagon	3.55
		Powerglide		

102 HP TURBO-AIR 145

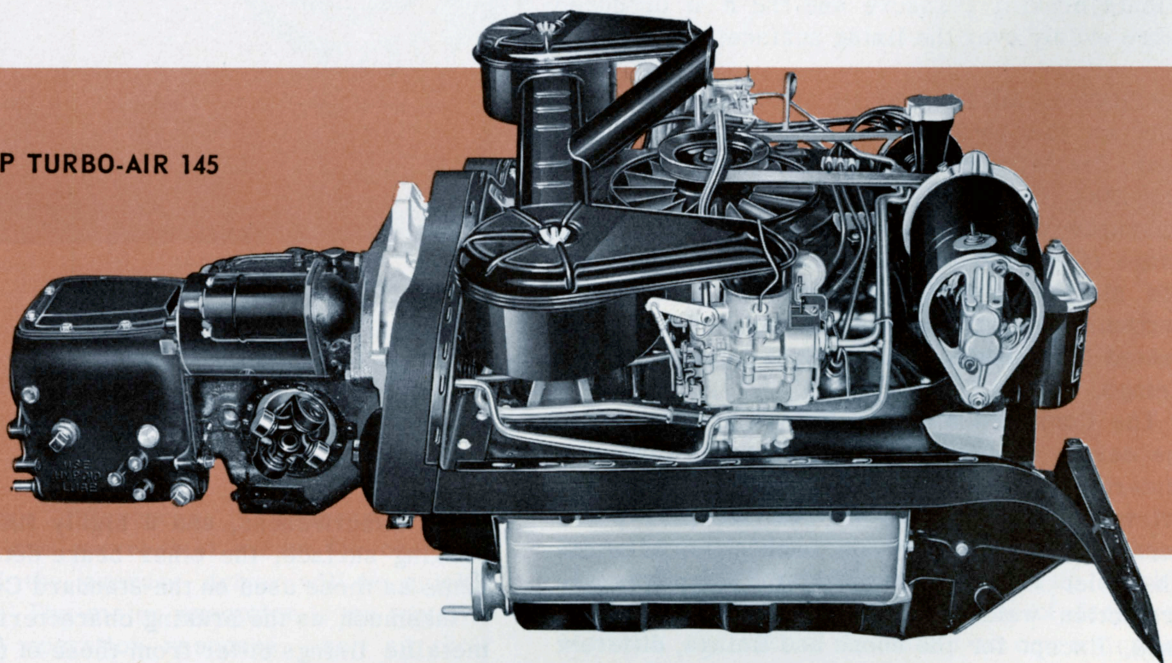

CORVAIR CHASSIS

The 1962 Corvair chassis program consists of refinements and modifications to the previous model for product improvement. In addition, the Corvair's versatility is extended by the introduction of new optional equipment.

BRAKES. The Corvair service brake system has been improved and simplified through the use of a new master cylinder, revisions to the wheel assemblies, and increased lining area.

The new master cylinder is basically the same two bolt unit used on the Chevy II and Chevrolet. Relocated from under the instrument panel in the passenger compartment to a depression formed in the dash wall inside the front luggage compartment, the unit, its operation, and actuating linkage is more direct and greatly simplified.

While unchanged in composition, width, and thickness, primary linings are 10 percent longer than the previous units, increasing the total effective area. In addition, the primary linings are repositioned on the shoe for maximum effectiveness.

Modifications to all shoe assemblies increase the unit's flexibility without sacrifice in strength. This has been accomplished by elimination of the plates at the anchor end of the web and revision of the web contour. The more flexible shoe conforms better to slight drum deflection during severe braking. This action helps distribute braking pressure and the heat produced more evenly over the lining surface.

OPTIONAL METALLIC BRAKES will be available on the 1962 Corvair early in the model year. Stable, virtually non-fading, and not water sensitive, the metallic linings give braking performance under arduous conditions beyond the range of normal driving. In addition, long brake life makes the option a worthwhile investment, particularly for the vehicle subjected to repeated hard usage, which might damage organic linings.

The Corvair's metallic linings are similar to the design used on the Chevrolet and Corvette. Sintered iron segments, a total of 6 on the primary shoe and 10 on the secondary, are arranged in two rows on each shoe. Like the Chevrolet and the Corvette, the segments are projection welded to the shoes. No rivets are used. Except for the shoes and linings, different hold down and return springs to provide maxi-

mum effectiveness, and a highly finished drum braking surface, the other brake details are the same as those used on the standard Corvair.

Inasmuch as the braking characteristics of the metallic linings differ from those of the organic, the uninitiated driver should be cautioned to

expect some differences in response. These variations are not radical except for one condition, and the average driver will be quickly acclimated. The major exception is the metallic unit's cold operation response, such as their first use in the morning after setting overnight.

When cold, the metallic linings require somewhat more pedal pressure than do organic facings. However, the optional units warm up quickly when used, and the full benefits of fade resistance and virtual immunity to contamination from water and oil are realized.

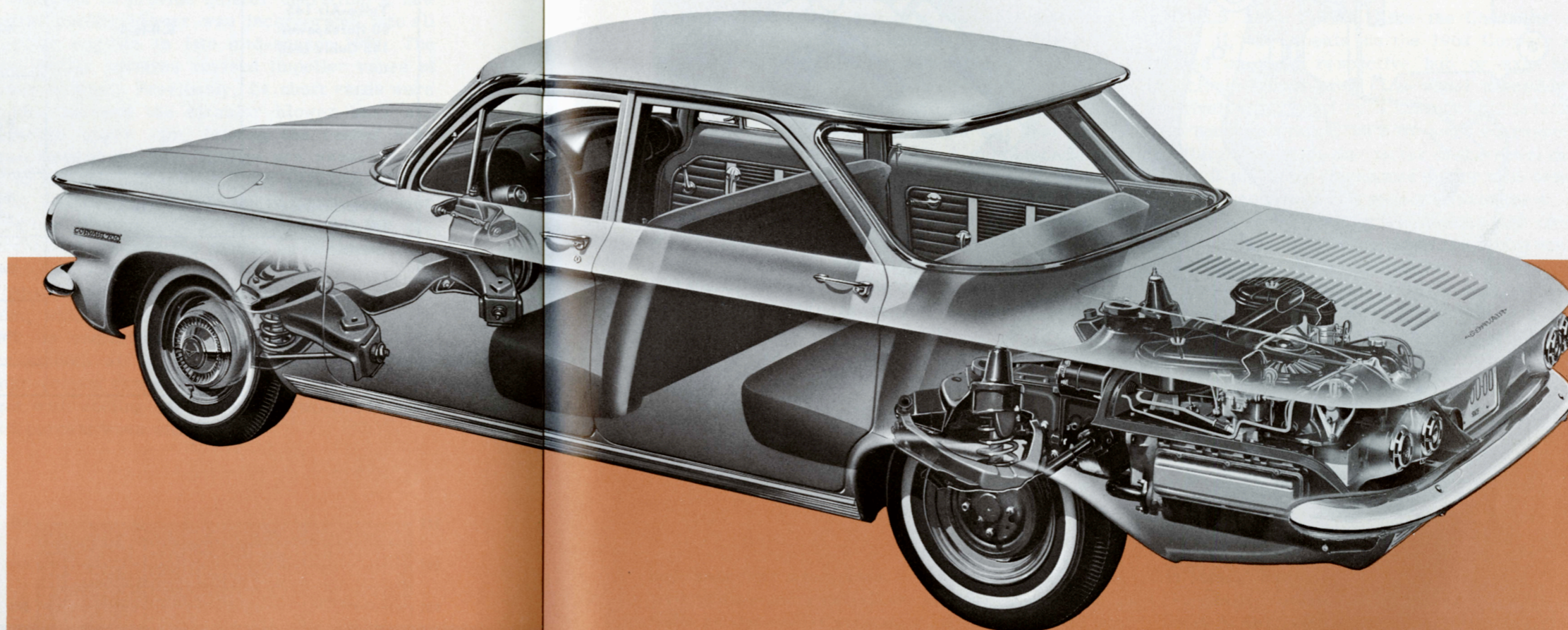

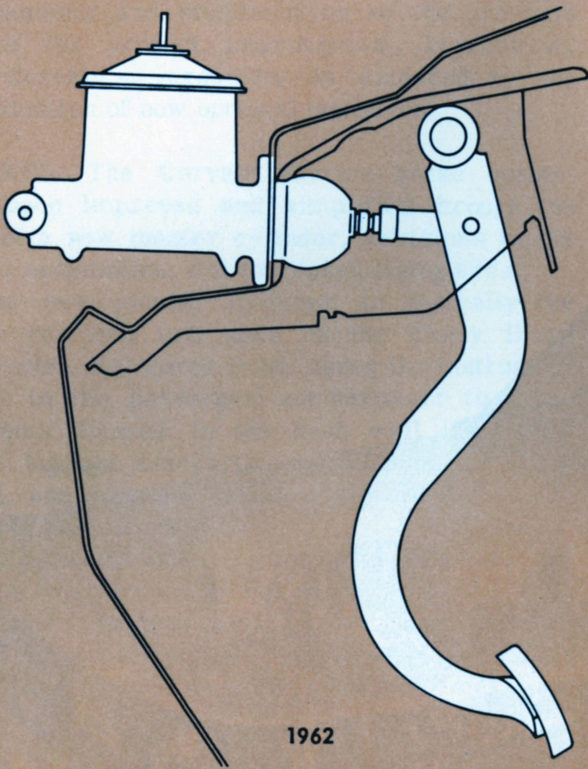

1962

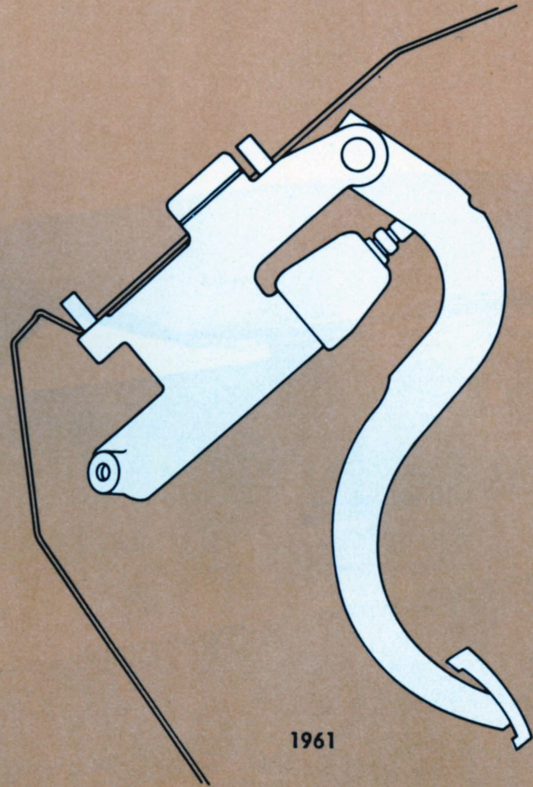

1961

BRAKES

Larger relocated primary linings, redesigned brake shoes, and a new, simplified master cylinder and pedal arrangement improves the Corvair's braking effectiveness. The 10 percent larger primary linings produces more self-energizing effect thus reducing the amount of effort required by the driver. More flexible than the previous design, the new brake shoes conform more closely to drum surfaces reducing the possibility of "hot spotting" during severe braking. With the master cylinder now located in the front luggage compartment, operation of the unit, its connecting linkage, and suspension of the brake pedal is more direct and greatly simplified.

HEAVY DUTY SUSPENSION OPTION. The already broad versatility of the Corvair is extended still further by the introduction of a heavy duty suspension option, to be available on all coupe and sedan models early in the model year.

Designed to accommodate the demands of severe vehicle operation, the package consists of heavier, higher rate front and rear springs, newly calibrated front and rear shock absorbers tailored to spring requirements, a new link-type front stabilizer bar, and new rear axle rebound straps. Other chassis components are revised or relocated to receive the new units.

Normal vehicle heights are reduced slightly less than 1.0 inch at curb weight and approximately 0.375 at design load. A corresponding reduction in the height of the center of gravity is gained.

With the lower vehicle trim, front and rear wheel geometry changes, requiring a set of specifications peculiar to this option in most instances. Most noticeable change is the negative rear camber at curb weight, rather than the

familiar standard vehicle positive camber.

While the ride by boulevard standards is, of necessity, compromised to some extent by use of the new units, handling and stability, particularly in cornering, is considerably enhanced. This option, especially when combined with the new Corvair Positraction and metallic brakes, provides a vehicle of extremely broad capability to meet the demands of severe service customers and driving enthusiasts alike.

WHEELS AND TIRES. Like the Chevrolet and Chevy II, the wheels on the 1962 Corvair are located on their respective hub or axle by a full circle center-pilot. The wheel assembly is positively positioned by a closely held relationship between a machined boss and a corresponding flanged hole in the center of the wheel disk.

The 2-ply tires introduced during mid-season 1961 are continued. Of recent development, the new tires are more flexible, lighter, and cooler operating than 4-ply units, while remaining equally as strong. Customer benefits are softer ride and contributions to improved traction and lower fuel consumption without sacrifice in durability.

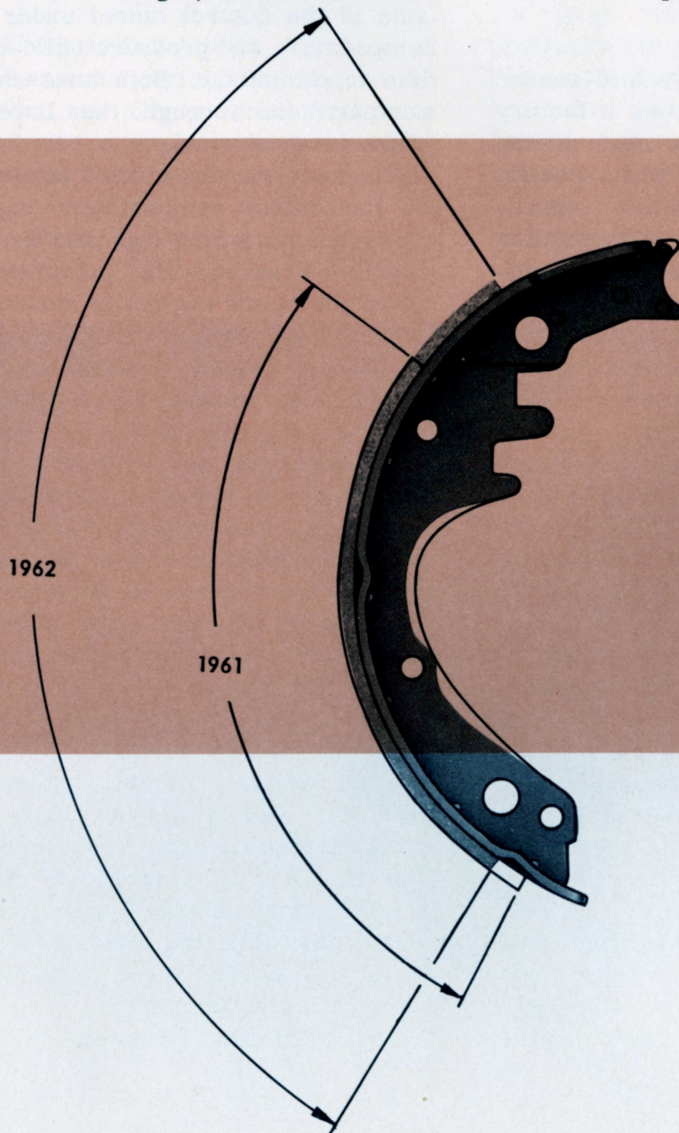

OTHER CORVAIR OPTIONAL EQUIPMENT

Corvair optional equipment is comparable with that of previous models. With the perimeter heater now standard equipment, only the gasoline heater is available as a dealer accessory. The air conditioning unit introduced during mid-season 1961 is again available with a new quieter six cylinder axial compressor. Wheel trim disks, simulating wire wheels in appearance, are an extra-cost item. The 2-speed windshield wiper and washer unit has a new more efficient wiper motor and fluid container. A new Positraction rear axle provides even greater traction for rear wheels under extremely adverse road conditions. New front seat belts are offered as a factory and dealer installed accessory for use with the production attaching provisions in the underbody.

AIR CONDITIONING, introduced in mid-season of the previous year, is available as a factory or dealer installed accessory for sedans and coupes. The unit, designed for the specific requirements of the Corvair, operates on recirculating air, and is independent of the heating system. Pivoting ball-type nozzles and a centrally located barrel outlet provide excellent distribution of cool air throughout the car interior.

Styled to conform to the underside of the radio cover, the face of the distribution duct contains the cool air outlets and unit controls. Centrally located below the radio, a rotating louvered barrel outlet is adjustable in a vertical plane. Swiveling in sockets, the ball nozzles effectively permit circular cool air patterns with the centers aimed at passenger and driver.

Two control knobs, within easy reach of front seat occupants, are located at each end of the barrel outlet. The COOL-PULL knob regulates temperature with a push-pull action, by changing the thermostatic switch contact point setting. The switch, sensing air temperature at the outlet side of the evaporator, governs amount of cooling. The left knob when rotated selects LO, MED, and HI blower speeds from the OFF position.

The centrifugal blower, with outlet connected to the distributor duct, forms a right angle connection with the evaporator case which extends to the right in the forward area under the

glove compartment. Openings in the case top permit entry of recirculating air to be cooled. Two one-inch channels, bolted to the lower instrument panel flange, support the evaporator case containing core and expansion valve. Valve inlet and core outlet connections are on the left side of case adjacent to the upper portion of the toe pan. Tubes from the case to the underbody exterior drain the evaporator condensate.

Refrigerant hoses from valve and core are routed to the engine compartment where connections are made to the receiver and compressor. The high pressure liquid line follows an exterior routing while the low pressure or suction line is routed through the passenger compartment. By following a path on the right side of the control tunnel under the floor mats, temperature and pressure build-up in the suction line is minimized. Both hoses enter the engine compartment through the lower right corner of the forward panel.

The receiver-dehydrator is vertically mounted on the engine compartment right side rail in the space formerly occupied by the spare wheel carrier bracket. The compressor, located to the right of the engine, is mounted on adjustable brackets and is belt driven by the extra sheaved crankshaft pulley. A magnetic clutch regulated by cooling demand actuates the compressor. Location of components in the engine compartment requires the stowage of the spare wheel in the front luggage compartment.

The compressor is the new quieter six cylinder axial type similar to that used on the Chevrolet except for reversed shaft rotation required by compressor position in the engine compartment. Smaller in silhouette than the former five cylinder model, the new compressor occupies less space. The rear head, now removable, contributes to complete field serviceability.

The new compressor has three double-acting pistons driven by a swash plate. Front and rear cylinder blocks each have three piston bores. The double pistons are cast of aluminum with a connecting "bridge" making each set an integral part. For the Corvair application, piston faces are counterbored to reduce the effective cubic inch displacement.

The condenser, mounted above the engine

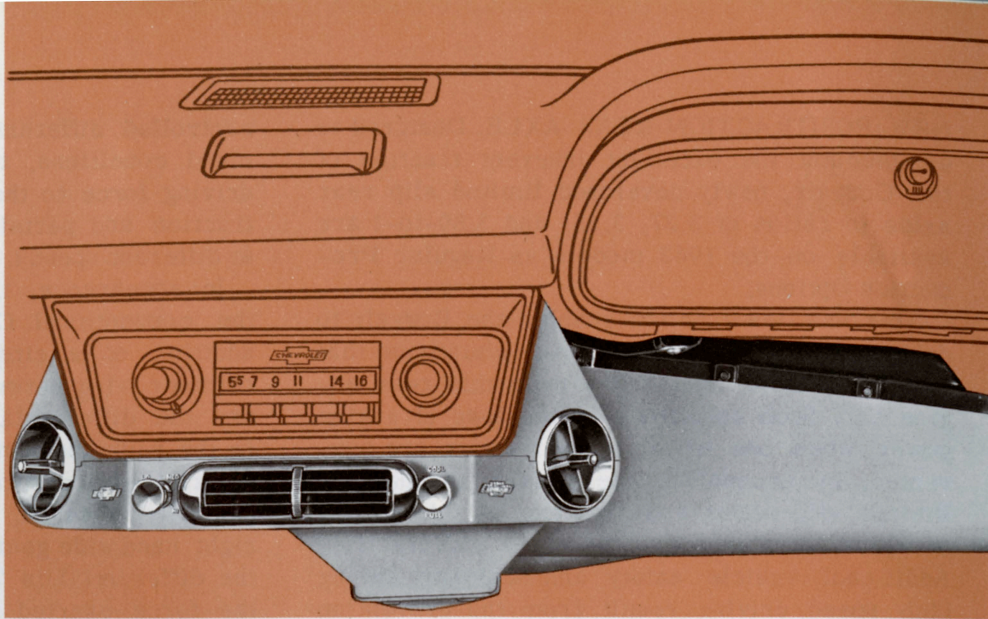

blower eye, is supported by a rectangular shroud fitted to the blower inlet. All engine air passes through the condenser and cools the refrigerant. Space exists between the condenser and deck lid underside to equalize distribution of engine cooling air through the condenser.

TWO-SPEED WIPER AND WASHER. The 2-speed wiper and washer combination, included in the FOA 120 Comfort and Convenience Group, is completely new with a more dependable wiper motor, an improved fluid container, and a different pump.

Basically the same as the new single speed

wiper motor, the 2-speed motor case is slightly longer but much smaller than the unit it replaces. Improved insulation permits the elimination of the overheat circuit breaker and results in improved reliability.

The new washer fluid jar with rounded corners of large radii is made from higher density polyethylene plastic to withstand higher temperatures. A larger filler neck and improved cap permits faster refills and tighter sealing. A small hole remains in the cap to aid fluid discharge. Raised markers in 0.5 pint graduations, with 1, 2, and 3 pint levels lettered, aid in mixing washer fluids.

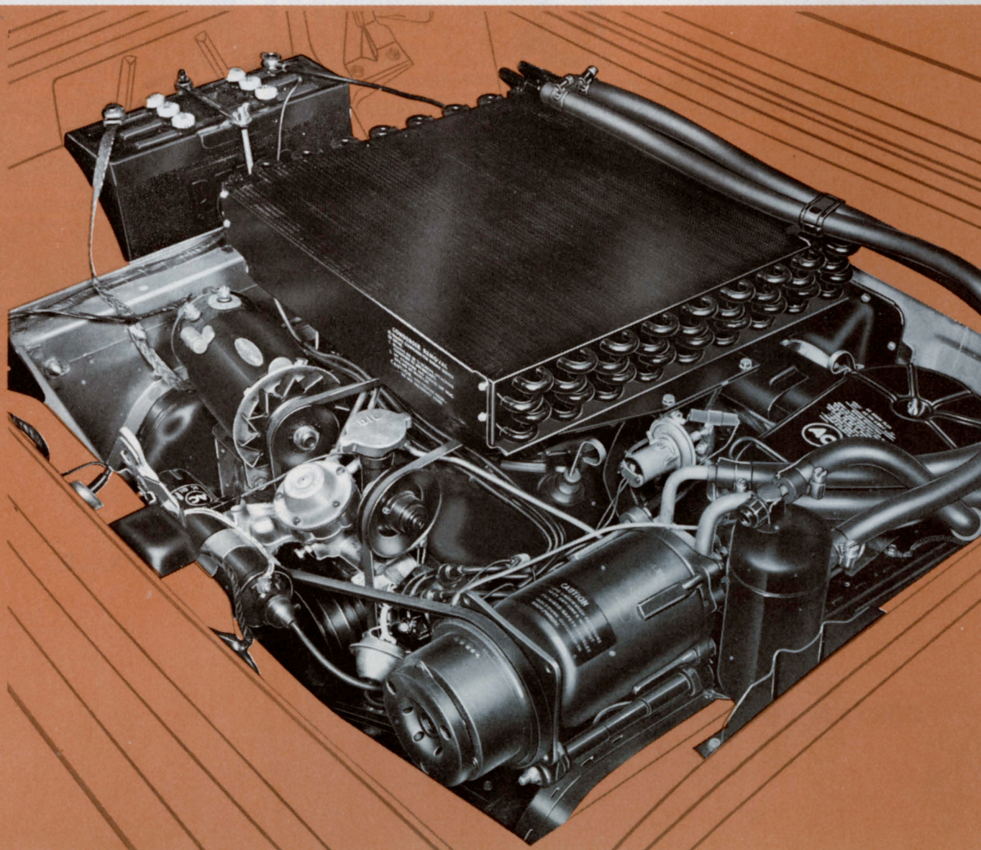

NEW POSITRACTION REAR AXLE. Designed to complement the excellent inherent traction of the Corvair, newly developed limited slip rear axles in ratios of 3.27, 3.55, and 3.89-to-1 are available on the 1962 models as Regular Production Options.

This new Positraction enables the Corvair to drive out of extreme adverse situations that would otherwise immobilize even this rear engine car. Such conditions as the loss of engine power when one wheel loses traction are prevented, by unequal torque division through the limited slip action and direction of this torque to where it is useful -- the wheel with traction. Additional vehicle safety and stability during high speed driving result from the prevention of "run-away" wheel spinning and sudden shock loads due to wheel bounce or non-uniform surface conditions. The often quickly encountered situations such as ice and snow spots, wet and dry pavements, sand and gravel, and one wheel getting off the pavement are more safely traversed.

The new Corvair Positraction is a friction

controlled differential which, according to demand conditions, transmits the major vehicle driving force to the rear wheel with the better traction and permits the rear wheels to travel at different speeds.

In appearance, the new unit looks much like the conventional Corvair differential with the addition of a single friction clutch pack and retainer ring between the right hand side gear and the differential case. A Belleville spring in the pack loads the clutch disks with carefully determined pressure, so that the clutch is always partially engaged. Relative movement of the right hand side gear is restricted, and, in effect, the differential is "locked-up" to the extent of the force exerted by the friction clutch. Additional clutch engagement results from the slight lateral movement of the right hand side gear, created by forces in the meshing action with the pinion gears. This action further restricts differential movement within the unit, directing engine power to the driving wheel with traction.

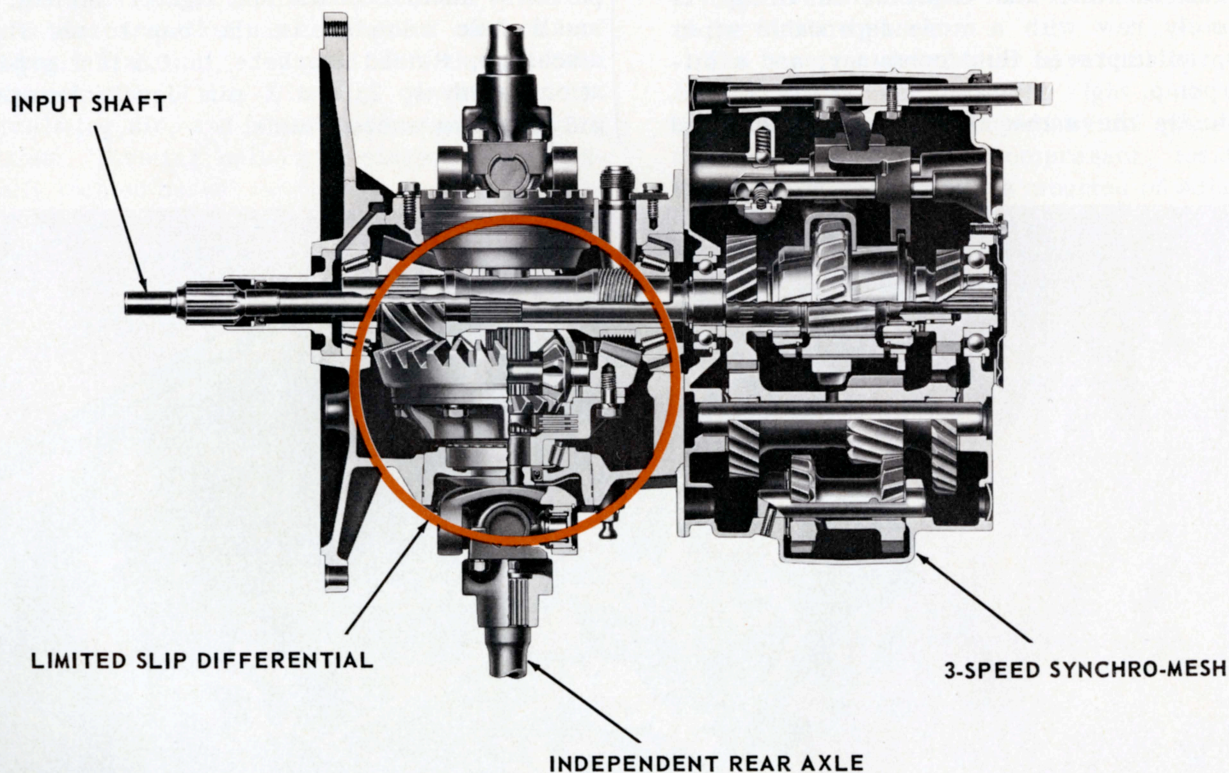

CORVAIR POSITRACTION

REGULAR PRODUCTION EQUIPMENT - EXTERIOR

CORVAIR EXCEPT GREENBRIER

		ITEM	MODELS	
Bright metal trim	Anodized aluminum	Dual headlight, parking, and turn signal light bezels	All	
		Dual stop, tail, and directional signal light bezels		
		Dual back-up light location cover plates	500-700	
		Back-up light bezels	900	
		Exhaust grille panel		
	Chrome plated metal	Front emblem	All	
		Body front simulated grille		
		Front fender nameplate		
		Deck lid or liftgate nameplate		
		Ventipane frame		
	Stainless steel	Luggage compartment lock	All	
		Hub caps	500-700	
		Wheel disks	900	
		Moldings	Windshield reveal	700-900
			Drip gutter cap	
			Rear window (liftgate reveal on 735,935)	
			Center pillar	969
			Front fender side	700, 935
			Front compartment lid	
			Rear body lock pillar upper	969
			Rear quarter window upper frame	927
			Door upper frame	900 (Exc 935)
Rocker panel			700-900	
Simulated air scoop			900 (Exc 935)	
Front door side			700, 935	
Key locks on front doors				
Dual single-speed electric wipers		All		
Cowl air inlet				
Gasoline filler door (left front fender)				
Rear license lamp (dual on 735-935)				
Deck lid air intake louvers		All (Exc 535-735-935)		
Rear quarter air intake louvers		735-935		
Single horn		500		
Dual horns		700-900		
Back-up lamps		900		

REGULAR PRODUCTION EQUIPMENT - INTERIOR

CORVAIR EXCEPT GREENBRIER

		ITEM	MODELS	
Instrument Panel	Cluster Area	Dual directional signal indicators	All	
		Fuel indicator		
		Speedometer		
		High beam indicator		
		Bright Control Knobs		Light
				Windshield wiper
				Cigarette lighter
				Ignition switch (4-positions)
		Oil and generator warning lights	All	
		Anodized aluminum trim plate	900	
		Bright trim plate molding		
		Ash tray	All	
		Radio speaker grille		
		Dual vent control knobs (black plastic)		
		Glove Box	Painted door	500
			Anodized aluminum trim plate	700-900
			Nameplate (Corvair 700 or Monza)	
	Bright trim plate molding		900	
	Glove box lamp			
	Dual spoke steering wheel (2-tone on 900)		All	
	Horn button, chrome		500-700	
	Half circle horn ring		900	
	Inside rear view mirror (painted 500-700; bright 900)		All	
	Friction type front ventipanes			
	Door locking buttons, rear (except 527-727-927)			
	Door locking control handles, front			
	Painted interior trim moldings			
	Dome lamp (chrome bezel on 900)			
	Dome lamp switch, in main light switch			
	Front door jamb switch, dome lamp			700-900
	Folding rear seat		735, 900	
	Door and window control handles - dual arm type		900	
	Door and window control handles - conventional type		500-700	
	Front bucket seats		927	
	Front door armrests (bright base on 900)		All	
	Rear door armrest with ashtray (bright base)		969, 935	
	Rear quarter ash tray		927	
	Anodized aluminum seat end panels		900	
	Coat hooks		All	
	Dual sunshades			
	Perimeter heater			

REGULAR PRODUCTION EQUIPMENT - EXTERIOR

CORVAIR GREENBRIER

ITEM		MODEL
Bright metal trims	Anodized aluminum	Dual headlamp frames
		Dual parking and directional signal light frames
		Front air inlet grille
		Front air inlet grille ornament
	Chrome plated	Door handles
		Front door nameplates (Greenbrier)
		Right rear door nameplate (Chevrolet)
	Stainless steel	Windshield wiper arms
		Key locks
	Rubber windshield and rear door reveal moldings	
Dual single-speed electric windshield wipers		
Front, double right hand side, and double rear doors		
Air intake louvers in rear outer side panels		
Gasoline Filler door (rear of left front fender wheel opening)		
Single tail, stop, and directional signal lights		
Dual headlamps		
Parking and directional signal lights		
Dual rear license lamps		
Double right hand side and double rear door rubber stops		
Single horn		
Painted areas	Front and rear bumpers	
	Hub caps	
	Ventipane frames	

REGULAR PRODUCTION EQUIPMENT - INTERIOR

CORVAIR GREENBRIER

ITEM		MODEL	
Instrument Panel	Cluster Area	Dual Directional Signal Indicators	
		Fuel Gauge	
		Speedometer	
		High Beam Indicator	
		Bright Control Knobs	Light
			Windshield Wiper
		Cigarette Lighter Cover Plate	
		Ignition Switch (4-positions)	
		Engine Warning Lights	
	Anodized Aluminum Trim Plate		
	Odometer		
	Ash Tray		
	Dual Vent Control Knobs		
	Powerglide Selector Cover Plate		
	Radio Speaker Grille		
Dispatch Box Painted Door with Key Lock			
Front and Rear Full Width Seats	R1206		
Dual Spoke Steering Wheel			
Brushed Aluminum Horn Button			
Inside Rear View Mirror			
Friction Type Front Ventipanes			
Front Door Locking Control Handles			
Double Right Hand Side Door Locking Control Handles and Push Button Lock			
Window Regulator Handles			
Dome Lamp (Operated by Main Switch)			
Painted Interior Body Panels			
Breathable Fabric Cloth Seat Covering with Vinyl Facings			
Vinyl Coated Roof Panel Inserts			
Left Hand Sunshade			
Black Embossed Rubber Floor Mat			
Spare Wheel and Tire			
Jack			
Combination Jack Handle and Wheel Wrench			

EXTERIOR-INTERIOR COLOR COMBINATIONS

CORVAIR MONZA SERIES

EXTERIOR	INTERIOR		
Solid Colors and Wheels*	Trim and Paint		
All Models	Coupe	Sedan **	Sta. Wgn.
Tuxedo Black	Fawn	Fawn	Fawn
	Aqua	Aqua	Aqua
	Red	Red	Red
	Blue	Blue	Blue
	Gold	Gold	--
	Black	--	--
Ermine White	Fawn	Fawn	Fawn
	Aqua	Aqua	Aqua
	Red	Red	Red
	Blue	Blue	Blue
	Gold	Gold	--
	Black	--	--
Roman Red	Fawn	Fawn	Fawn
	Red	Red	Red
	Black	--	--
Satin Silver	Red	Red	Red
	Blue	Blue	Blue
	Black	--	--
Silver Blue	Blue	Blue	Blue
Nassau Blue			
Twilight Turquoise	Aqua	Aqua	Aqua
	Black	--	--
Twilight Blue	Aqua	Aqua	Aqua
	Black	--	--
Surf Green	Fawn	Fawn	Fawn
Laurel Green			
Autumn Gold			
Adobe Beige	Red	Red	Red
	Fawn	Fawn	Fawn
Coronna Cream	Red	Red	Red
	Fawn	Fawn	Fawn
	Gold	Gold	--
Honduras Maroon	Black	--	--
	Fawn	Fawn	Fawn
	Black	--	--

* - Wheels are black when optional white sidewall tires are factory-installed.
 ** - Black interior also available when optional bucket-type front seats with all vinyl trim are specified.

EXTERIOR-INTERIOR COLOR COMBINATIONS

CORVAIR 700 SERIES

EXTERIOR		INTERIOR	
Solid Colors Wheels*, and Lower Body Color of Two-Tone Models	Roof of Two-Tone Models	Trim and Paint	
Tuxedo Black	Ermine White	Fawn	
		Aqua	
		Red	
		Blue	
Ermine White	---	Fawn	
		Aqua	
		Red	
		Blue	
Roman Red	Ermine White	Fawn	
Satin Silver		Red	
Silver Blue		Blue	
Nassau Blue			
Twilight Turquoise	Silver Blue	Aqua	
Twilight Blue	---		
	Ermine White		
Twilight Turquoise	Twilight Turquoise		
Surf Green	Ermine White	Fawn	
Laurel Green	Surf Green		
Autumn Gold	Adobe Beige		Red
			Fawn
Adobe Beige	---	Fawn	
Coronna Cream		Red	
		Honduras Maroon	Fawn

* - Wheels are black when optional wheel disks and white sidewall tires are factory-installed.

EXTERIOR-INTERIOR COLOR COMBINATIONS

CORVAIR 500 SERIES

EXTERIOR		INTERIOR
Solid Colors Wheels *and Lower Body Color of Two-Tone Models	Roof of Two-Tone Models	Trim and Paint
Tuxedo Black	Ermine White	Fawn
		Aqua
		Red
Ermine White	-----	Fawn
		Aqua
		Red
Roman Red	Ermine White	Fawn
Satin Silver		Red
Silver Blue		Fawn
Nassau Blue	Silver Blue	Fawn
Twilight Turquoise	-----	Aqua
Twilight Blue	Ermine White	
	Twilight Turquoise	
Surf Green	Ermine White	Fawn
Laurel Green	Surf Green	
Autumn Gold	Adobe Beige	Red
Adobe Beige	-----	Fawn
		Red
		Fawn
Coronna Cream		
Honduras Maroon		

* - Wheels are black when optional wheel disks and white sidewall tires are factory-installed.

EXTERIOR-INTERIOR COLOR COMBINATIONS

CORVAIR GREENBRIER

EXTERIOR		INTERIOR	
Solid Colors, Wheels and Main Body Color of Two-Tone Models	Cove of Two-Tone Models	Trim and Paint	
All Models		Standard	Deluxe
Jet Black	Cameo White	Fawn	Aqua
Cameo White	Cardinal Red		Red
Pure White			
Cardinal Red	Cameo White		Fawn
Georgian Gray			Aqua
Brigade Blue			Fawn
Balboa Blue			Green
Crystal Turquoise			Fawn
Seamist Jade			
Glenwood Green			
Woodland Green			
Tangier Gold			
Desert Beige			Fawn
Yuma Yellow			
Omaha Orange			

REGULAR PRODUCTION OPTIONS AND FACTORY OPTIONAL ACCESSORIES

CORVAIR

500, 700, AND 900 SERIES

GROUP	ITEM		OPTION NUMBER	MODELS	
Engine	Crankcase ventilation		242	All	
	Generator, 35 amp		650	All	
	High performance engine		649	All	
Transmission	Automatic transmission		360	All	
	Four speed transmission		651	All	
Chassis	Heavy duty front and rear suspension		696	All except wagons	
	Limited slip axle (3.27, 3.55, 3.89:1)		480	All	
	Metallic brakes		686	All	
	Rear axle, 3.89:1		662	All	
	Rear axle, 3.55:1		693	All except wagons	
	Tires	6.50 x 13-4 pr w/w rayon		661	All except wagons
		7.00 x 13-4 pr w/w rayon		449	735, 935
		6.50 x 13-4 pr b/w rayon		491	All except wagons
		7.00 x 13-4 pr b/w		492	735, 935
	Wire wheel cover, simulated		133	All	
Wheel trim cover		117	500-700		
Body	Air conditioning		114	All except wagons	
	Arm rest		248	769, 735	
	Comfort and Convenience	Back up lamp		120	500-700
		Glove box lamp			500-700
		Outside rear view mirror			All
		2-speed w/s wiper and washer			All
		Inside non-glare mirror			All
	Folding rear seat		664	All except wagons & 900	
	Instrument panel pad		427	All	
	Radio, manual		103	All	
	Radio, push button		104	All	
	Seat belts		148	All	
	Spare wheel lock		384	All except wagons	
Tinted body glass		398	All		

REGULAR PRODUCTION OPTIONS AND FACTORY OPTIONAL ACCESSORIES

CORVAIR GREENBRIER

GROUP	ITEM	OPTION NUMBER	MODELS	
Engine	Generator, 35 amp L. C. I.	650	R1206	
	Ventilation, crankcase	243		
Transmission	Four speed	652		
	Powerglide	667		
Chassis	Axle, limited slip (3.89:1)	481		
	Spring, heavy duty front	255		
	Tires	7.00 x 14-4 pr blackwall rayon		648
		7.00 x 14-4 pr whitewall rayon		647
7.00 x 14-6 pr whitewall rayon		674		
Body	Belt, seat unit	148		
	Bumper, chrome - front and rear	393		
	Cover, wheel trim	132		
	Custom Equipment	Anodized aluminum dispatch box trim plate		431
		Chrome plated front and rear bumpers		
		Chrome plated hub caps		
		Chrome cigar lighter		
		Front and rear dome lamp		
		Rear door red cove inserts, chrome bezels		
		Right hand sunshade		
		Stainless steel windshield reveal moldings		
		Spare tire cover, vinyl		
		Special roof panel paint treatment		
		LH and RH driver and rear passenger arm rest (Rear armrest used with RPO 269)		
		LH and RH rear compartment ash tray		
		Two-tone steering wheel		
		Vinyl and nylon faced cloth seats (foam)		
	Vinyl coated rubber floor covering			
	Vinyl trim pads (doors and sidewalls)			
	Four interior colors keyed to exterior color			
	Door, body side, LH	645		
	Glass, laminated	370		
	Heater, gasoline	128		
	Heater, direct air	138		
	Mirror, rear view	210		
	Radio, manual	123		
	Seat, supplementary	269		
Wiper and washer, 2-speed	355			
Taxi cab equipment	420			

DEALER-INSTALLED ACCESSORIES

CORV AIR

500, 700, AND 900 SERIES

Item	Models
Alarm - Parking brake	All
Antenna - Radio	All
Belt - Seat	All
Bezel - License plate rear	All except wagons
Cap - Gas tank filler locking	All
Carrier - Roof luggage	All 4-Door models
Clock - Instrument panel	All
Conditioning - Air	All
Cover - Front seat cushion	All
Cover - Roof luggage carrier	All 4-Door models
Cover - Wheel trim	500-700
Deflector - Rain	All
Extension - Coat hook	All
Guard - Front and rear bumper	All
Guard - Body front panel	All
Guard - Door edge	All
Guard - Gas tank filler door	All
Heater - Gasoline	All
Lamp - Back up	500-700
Lamp - Courtesy	All
Lamp - Luggage compartment	All
Lamp - Portable spot	All
Lamp - Underhood	All
Lamp - Glove compartment	500-700
Lock - Rear door safety	All 4-Door models
Lock - Spare wheel	All except wagons
Mat - Floor mat	All
Mirror - Outside rear view	All
Mirror - Rear view prismatic	All
Mirror - Visor vanity	All
Radio - Manual	All
Radio - Push button	All
Rest - Rear door arm	All 4-Door models
Tool Kit	All
Washer - Windshield	All
Unit - Tissue dispenser	All
Unit - Litter container	All
Unit - Tissue dispenser and litter container	All

DEALER INSTALLED ACCESSORIES

CORVAIR GREENBRIER

Item	Models	
Belt - Seat	R1206	
Cap - Gas tank filler locking		
Carrier - Roof luggage		
Clock - Instrument panel		
Container - Litter		
Cover - Roof luggage carrier		
Cover - Wheel trim		
Deflector - Rain		
Dispenser - Tissue		
Dispenser - Tissue and litter container		
Guard - Bumper (chrome or painted)		
Heater - Direct air		
Heater - Gasoline		
Lamp - Courtesy		
Lamp - Dome		
Lamp - Portable spot		
Lamp - Spot inside operated		
Lamp - Traffic hazard flasher		
Lighter - Cigarette		
Mirror - Outside rear view		
Mirror - Rear view prismatic		
Radio - Manual		
Rest - Door arm		
Sporting Equipment		Breezeway
		Campster
		Car camper child bed
		Cargo netting
		Drawer
		Sleeper
		Table
		Tent
Window screen		
Sunshade - R. H.		
Tool Kit		
Windshield washer		